

A FILM PROJECTION INSTALLATION WITH WATER-COOLED MERCURY LAMPS

778.553 : 621.317.31

The water-cooled mercury lamp is a light source of great intensity, and is therefore suitable for the projection of films. Compared with the carbon arc the mercury lamp has the advantage of smaller dimensions and of much less heat development. Moreover it is free of certain disadvantages connected with the use of the carbon arc, such as the change of position and size of the crater, and the sputtering of small particles. The employment of the water-cooled mercury lamp has made it possible to construct a very compact apparatus for the reproduction of films. The apparatus is described in this article. Special attention is paid to the factors which are important in the construction of an illumination objective for water-cooled mercury lamps.

Introduction

The high intensity of illumination of the film which is necessary for cinema projection requires a very intense light source. It was therefore to be expected that the light source would be used for this purpose which had the greatest brightness known, namely the carbon arc. This light source, however, has various technical objections. The crater changes in shape and size, and, moreover, tiny particles are thrown out of the arc, which soon cause a decrease in the reflecting power of the condensing mirror.

These objections have led to the attempt to replace the arc lamp by an electric filament lamp. With the increasing size of the cinema theatres it was, however, found impossible to satisfy the also increasing demands of the public as to brightness of the picture. The following calculations may serve to define the requirements made of a light source for film projection.

In *fig. 1* the ordinary arrangement for film projection is given. *O* is the area of the source of light with the brightness *B*. By means of this light source and a condenser, for which a mirror is often used, the film window *G* with the area *g* is uniformly illuminated. We assume that the condenser has such a large aperture that the objective is completely filled by the beam which passes through every point of the surface of the film. The maximum angle of radiation *w* is therefore determined by the aperture of the objective.

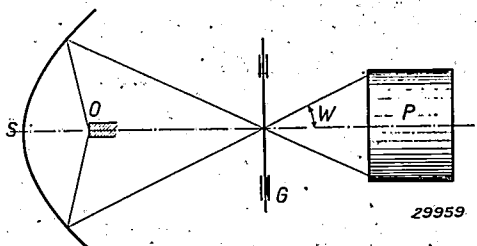

Fig. 1. Ordinary arrangement for film projection. *O* light source, *S* reflector, *G* film window, *L* projection lens.

According to a well-known theorem of geometrical optics, in an ideal optical system, without absorption or scattering, the brightness of every cross section of the beam, observed in the direction of the path of the rays, is the same as that of the source of light. By applying this theorem to the surface *g* in *fig. 1* we find for the light flux Φ , through the projection lens *P*:

$$\Phi = K g B \pi \sin^2 w, \quad (1)$$

where $K < 1$ and is a factor which accounts for the losses by absorption and reflection.

The surface *g* of the film window is fixed, it measures $1.57 \times 2.02 \text{ cm} = 3.17 \text{ sq. cm}$. The maximum angle of radiation is determined, as mentioned above, by the relative aperture¹⁾ of the projection objective. For an objective with the relative aperture 1 : 2, $w = 14^\circ$; $\sin^2 w = 0.0585$. The efficiency factor *K*, roughly estimated, is $\frac{1}{2}$, and becomes $\frac{1}{4}$ due to the cutting off of light by the rotating sector.

When these values are substituted we obtain:

$$\Phi = \frac{1}{4} \cdot 3.17 \cdot \pi \cdot 0.0585 \cdot B \doteq 0.146 B \quad (2)$$

The greatest brightness which can be obtained with a filament lamp for projection is about 4000 c.p./sq.cm; with this one should therefore be able to obtain a light flux of 580 lm of the screen, according to equation (2).

Actually this value is reduced by aberration defects of the condenser, which must have a very great relative aperture, by the action of shadows from the fixtures in the path of the rays, by scattering of the light at boundary surfaces, etc., so that in practice the light flux is not much more than about 400 lm.

In the case of transportable installations and

¹⁾ The relative aperture indicates the ratio of the effective diameter (diaphragm opening) to the focal length of the lens.

small cinemas, where the area of the screen is only a few square metres, this light flux is sufficient; in large cinemas, on the other hand, the required light flux may be five to ten times the above value. If a screen surface of 30 sq.m. is taken and an intensity of illumination of 100 lx, the required light flux is 3 000 lm.

It is therefore understandable that a light source has been sought with a greater surface brightness than a filament lamp and easier to operate than the usual carbon arc.

Such a light source was discovered several years ago in the water-cooled mercury lamp, which easily matches the carbon arc and even the so-called "high-intensity" arc in brightness. This light source has none of the above-mentioned disadvantages and has moreover the advantage of developing much less heat than the carbon arc.

Because of the necessity of water cooling, and because of the linear form of the light source, new problems were presented which made it necessary to consider anew the construction of the illumination objective. On the other hand the small dimensions of the mercury lamp and its slight heat development offered new possibilities for the construction of the whole projector. These considerations have led to the construction of an entirely new installation for film reproduction which makes full use of the advantages offered by the water-cooled mercury lamp.

The most important parts of this installation will be dealt with in the following.

The light source

The properties of discharges in mercury vapour at a high pressure have been dealt with repeatedly in this periodical²⁾. It has been found that the efficiency of this light source increases steadily with the energy supplied per unit of length of the column. For that reason the mercury discharge is economically very suitable as a light source of high intensity. To obtain such a source it is necessary to develop a large amount of light within a small space, and this is a way of promoting the efficiency.

A large supply of energy per unit of length of the column means a high value of the product of potential gradient (volt/cm) and current. Since too high a current is undesired (because of cathode losses) provision must be made for a high value of the potential gradient, and this is possible by keeping the diameter of the discharge tube small.

²⁾ Cf. also the article: Water-cooled Mercury Lamps, Philips techn. Rev. 2, 165, 1937.

On this principle, short, thin discharge tubes are obtained, which dissipate a large amount of energy. The increase of temperature and internal super-pressure are pushed as far as the tube can stand.

The mercury lamp for film projection dissipates an energy of 1000 W over a length of 12.5 mm between the electrodes. It has an internal diameter of 1.8 mm and an external diameter of 4 mm. The walls are of quartz and are cooled with water. Two tungsten wires led in through the ends of the tube serve as electrodes. In addition to a small amount of mercury the tube contains an inert gas filling of low pressure. This inert gas is necessary for ignition.

For use in film projection the tube must be fed with direct current. A transformer and a rectifier are used for this purpose. The most important data are given in the table below:

Table I
Data of the water-cooled mercury lamp

Length of the discharge	12.5 mm
Internal diameter	1.8 mm
External diameter	4 mm
Pressure of the mercury vapour	100 Atm.
Power { mercury lamp	1 000 W.
{ transformer + rectifier	500 W
Current	2 A
Working Voltage	500 V
Ignition voltage	800 V
Light flux	60 000 lm
Surface brightness in the axis of the discharge	57 000 c.p./sq.cm.
Efficiency	60 lm/W

The optical system

The existing systems for picture projection can be divided into two groups:

- a) the film projection system;
- b) the lantern slide system.

Both systems consist of a light source, a condenser which concentrates the light radiated on the diapositive, and a projection lens which gives the image of the illuminated diapositive on the screen. There are, however, fundamental differences between the two systems in dimensions and in arrangement of the parts.

The requirements made in the projection of films and of lantern slides are to a certain extent opposite to each other. With films one is concerned with very small surfaces and very high light intensities, and therefore with a very great heat development in the neighbourhood of film and light source. This makes it impossible to have the condenser and the other parts of the optical system too

small, or to place them too close to the light source. A scheme of construction is therefore chosen in which the lenses and mirrors have reasonably large dimensions and are reasonably far away from the light source, and the film window is placed at the point where the beam, emitted from the light source and concentrated by the condenser, has the smallest diameter. This is about the point where an image of the light source is formed by the condenser (see fig. 2a).

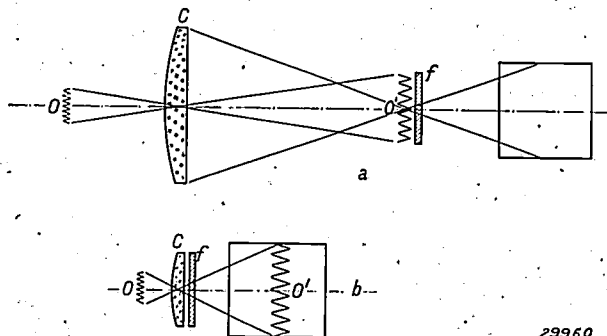

Fig. 2. Two systems of projection:

- The ordinary system for film projection. The film is situated about at the spot where the light source O is focussed by the condenser C .
- The usual system for the projection of lantern slides. The slide is directly behind the condenser. With the same size of diapositive the arrangement b permits a much more compact construction than the arrangement a .

In the projection of much larger lantern slides the required light flux can be attained with a much lower intensity of illumination of the slide, than is necessary in film projection. The heat development is not so great that minimum dimensions must be prescribed for the system, and in order to save space the condenser is made as small as possible. With respect to the position of the slide this means that the narrowest part of the beam is no longer chosen, but on the contrary, exactly the place where the beam has its greatest diameter, *i.e.* immediately behind the condenser (see fig. 2b).

A further very important advantage of this arrangement is, that it is much easier to obtain a uniform illumination of the object to be projected than with the arrangement for film projection. In the arrangement for film projection the light source is focussed on the film and the distribution of brightness over the film therefore more or less corresponds to the distribution of brightness over the surface of the light source. This latter must therefore be uniform over a sufficiently large part of its area having the shape of the film window. In the arrangement for the projection of lantern slides no such strict requirements are made as to size and distribution of brightness of the radiating surface.

Summarizing, we may say that the arrangement according to fig. 2a has the advantage of permitting a much greater heat development than that according to fig. 2b. On the other hand it has the disadvantage that very definite requirements are made as to form and brightness distribution of the light source.

If, instead of a filament lamp or an arc lamp, a mercury lamp is used, then because of the water-cooling the heat development is of no importance. The advantage of the arrangement of fig. 2a therefore loses its importance. The disadvantages of this arrangement now become very evident. Since the radiating column has a pronounced oblong shape (1 cm by 1 mm wide) it is difficult to focus it on the film window in such a way that the latter is uniformly illuminated.

The arrangement ordinarily used for lantern slides, that of fig. 2b, is therefore much more satisfactory for mercury lamps, and actually forms the basis of the construction of the new installation for film reproduction.

Fig. 3 gives a cross section and view from above of the optical system.

The mercury lamp 1 is in a metal boat which is shown separately in fig. 4. This boat is placed in a tube (see fig. 5) through which the cooling water flows. The boat is closed by a plane glass 2. In front of this is a planoconvex lens 3 which receives the light from the mercury lamp over an angle of divergence of about 90° .

This lens has a relatively small refraction because one surface is bounded by water instead of air. Therefore a second condenser lens (4) must be used. Between the two lenses (3 and 4) space is left for the rotating sector.

The light which the lamp emits in the backward direction is directed forward by a cylindrical mirror 5.

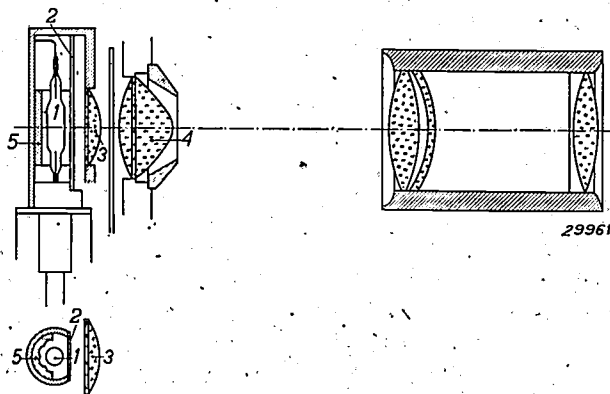

Fig. 3. Cross section of the optical system for the illumination of the film by means of a water-cooled mercury lamp. 1 mercury lamp, 2 glass plate, 3 and 4 lenses of the condenser, 5 rear mirror.

It is desirable to concentrate as much light as possible in the neighbourhood of the light source. A certain lateral deviation is, however, necessary because, due to the strong refraction of the quartz,

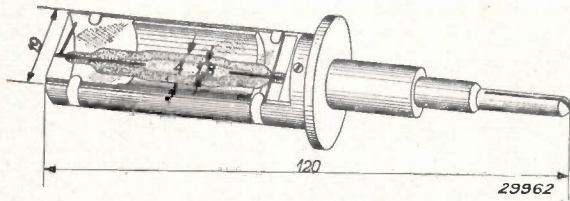

Fig. 4. The boat with the mercury lamp. The numbers give the chief dimensions in mm. The projecting pin on the right is one of the electrical connections, the other is formed by the container of the boat. The cooling-water flows in on the left and out through a hole in the rear wall. The boat is closed by a glass plate.

it is impossible to send light through the free space between the constricted discharge and the inner wall of the mercury tube.

The action of the rear mirror may be seen in fig. 6. If the path of the rays is examined in a transverse cross section, four images are seen to appear beside the discharge, which together form a lighted surface about 8 mm wide. In the longitudinal cross section there is no focussing, but this is unnecessary because, due to the oblong form of the source, the beams have a sufficiently great angle of divergence in the longitudinal cross section.

The direct and reflected light of the mercury lamp must now be used to illuminate the film uniformly. A gradual variation of brightness, namely a decay of brightness toward the edges of the film, is by itself not a great objection since the eye is also only slightly sensitive to differences in bright-

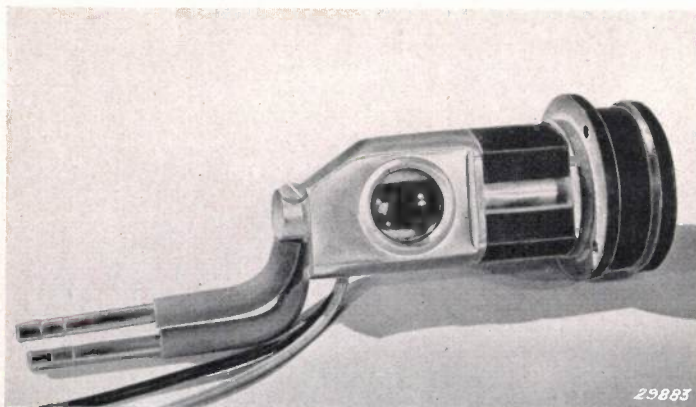

Fig. 5. The tube which contains the boat for the mercury lamp. The boat is slid in from the right and fixed in position with a hollow screw in such a way that the flange forms a watertight closing. Afterwards the large cover is set on the tube from the right. The electrical contact is first made through this cover between the positive terminal of the supply voltage and the pin of the boat. During assembly or demounting, therefore, the lamp can never be under tension.

ness. The eye is, however, very sensitive to small changes in the spectral composition of the light. Since the condenser is not completely achromatic, so that the light of the blue mercury line is distributed over the film in a somewhat different way from the green mercury line, very disturbing colour differences might occur if there were a slight irregularity in the illumination of the film.

When such differences in colour are observed, it has been found sufficient to place a frosted glass plate between the source and the condenser. The spreading of the light by this plate is only slight, because it is immersed in water, *i.e.* in a medium with practically the same index of refraction. Nevertheless this scattering is enough to make the illumination of the film absolutely uniform.

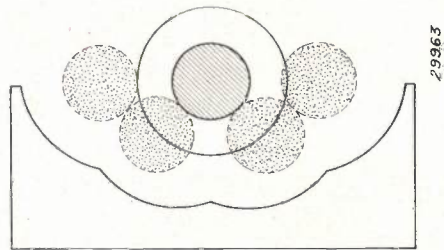

Fig. 6. The action of the rear mirror. In the transverse cross section of the light source four images of the radiating column appear beside the source, so that directly in front of the condenser a high concentration of light is attained.

Light production and colour

The light flux which is directed on the screen is practically the same as that of a carbon arc of 45 A, and, with the sector rotating and without film, it is about 2 500 lumens. The light is bluish-white in colour and resembles that of the so-called "high-intensity" arc.

The spectrum of the light of the mercury lamp is, as is well known, not continuous, but consists of a number of lines, chiefly a green one, a yellow one and several blue ones. However, thanks to the high pressure to which the mercury vapour is subjected, a continuous background³⁾ appears between the lines, so that with increasing loading of the mercury lamp the spectrum begins more and more to resemble that of an incandescent body.

The spectral composition is of particular importance when colour films are shown. In that case it is not enough to require

³⁾ In this connection see the articles: Comparison between discharge phenomena in sodium and mercury vapour lamps, Philips techn. Rev. 1, 2, 1936; The Mercury Vapour Lamp HP 300, Philips techn. Rev. 1, 129, 1936; Watercooled Mercury Lamps, Philips techn. Rev. 2, 165, 1937.

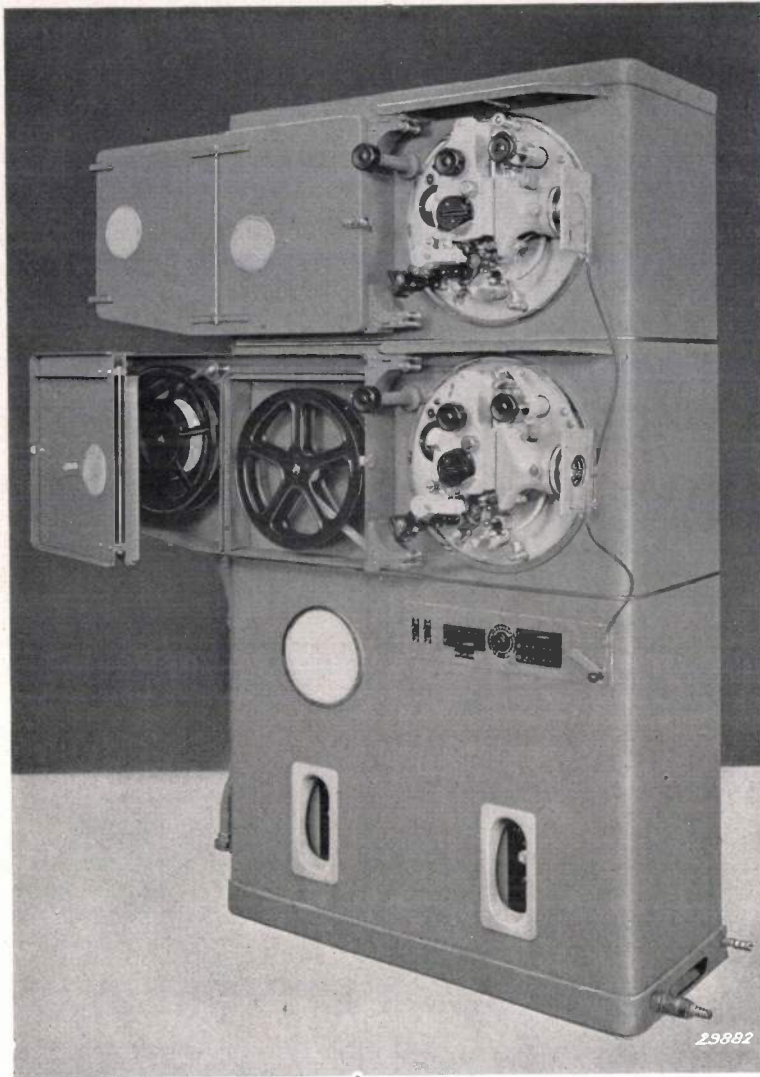

Fig. 7. The Philips double film reproduction installation FP2. It consists of two projectors one above the other. The lower cabinet contains the amplifiers, the supply apparatus and the cabin loud speaker. The two projectors are housed together with the necessary arrangements for sound scanning; behind each projector there are two film drums.

that the light source should be "white", but the additional requirement must be made that the light must have about the same relative distribution in the various wave length regions as daylight.

In table II the distribution is indicated of the light flux of the mercury lamp for cinema projection over different sections of the wave length scale, and compared with that of various other sources of white light. The choice of the sections is adapted to the properties of the eye⁴⁾ in a way which was discussed previously in this periodical.

It may be seen from the table that the radiation of the mercury lamp is quite similar to that of daylight in the middle sections (3 to 6). In the blue sections 1 and 2 the intensity is about twice as high. This excess of light can be absorbed by a yellow filter. The highest relative deviations appear, however, in the red sections 7 and 8 where the intensity of the mercury lamp is only $\frac{1}{3}$ of that of daylight.

The intensity of the red radiation can be increased by using red-transmitting sectors instead of opaque ones in the rotating sector disk. A further increase of the intensity in the red is possible by increasing the specific loading of the mercury lamp.

⁴⁾ See the articles: Colour Reproduction in the Use of Different Sources of "White" Light, Philips techn. Rev. 2, 1, 1937.

Table II

Relative light flux (% of the total light flux) which is radiated in different sections of the wave length scale.

Light source	Section (Å)	4 000 - 4 200	4 200 - 4 400	4 400 - 4 600	4 600 - 5 100	5 100 - 5 600	5 600 - 6 100	6 100 - 6 600	6 600 - 7 200
		(1)	(2)	(3)	(4)	(5)	(6)	(7)	(8)
Electric lamp		0.005	0.058	0.25	5.4	33.5	42.7	16.6	1.54
Carbon arc		0.013	0.116	0.43	7.4	37.3	40.0	13.6	1.13
Sunlight		0.016	0.175	0.64	9.2	39.3	38.2	11.6	0.91
Daylight		0.025	0.26	0.91	11.1	40.8	36.2	9.9	0.73
High intensity arc		0.050	0.27	0.97	10.2	43.7	33.2	10.6	0.94
High pressure mercury lamp for film projection		0.042	0.53	0.87	4.6	52.6	37.6	3.4	0.25
More highly loaded mercury lamp with red sector and yellow filter		0.03	0.4	0.9	4.4	50	37	6.8	0.5

Experiments have shown that upon application of these measures a satisfactory colour reproduction is possible. The last line in Table II gives the spectral distribution of a mercury lamp with increased load provided with a red rotating sector and a yellow filter.

The energy consumed by the mercury lamp (with rectifier) is 1.5 kW. In the case of a carbon arc of 45A the total consumption is about 3 kW so that a saving of 50 per cent is achieved. Because of this the heat development of the mercury lamp is much less, and moreover about 90 per cent of the heat radiation is removed by the cooling water.

Fig. 8. Rear view of the film reproduction installations (opened). In the middle of either cabinet is the motor for moving the film. To the left of the motor the projection arrangement may be seen mounted in a ring. Behind the motor are the two tubes which conduct the cooling water to the jacket of the mercury lamp. The screened cable may also be seen which connects the photocell for sound scanning to the photocell amplifier in the upper left-hand corner of each projection cabinet.

Fig. 9. The projection arrangement for lantern slides, mounted on the back of the upper projector cabinet. It consists of two light sources (mercury lamp, extreme right), each with its condenser and projection lens (to the left, movable along the bars). The two systems work alternately. Upon changing from one slide to another the beam of light of one system is gradually cut off by a lever switch (on the middle bar) with the help of a diaphragm set up behind each objective, while at the same time the beam of the other system is raised to full strength.

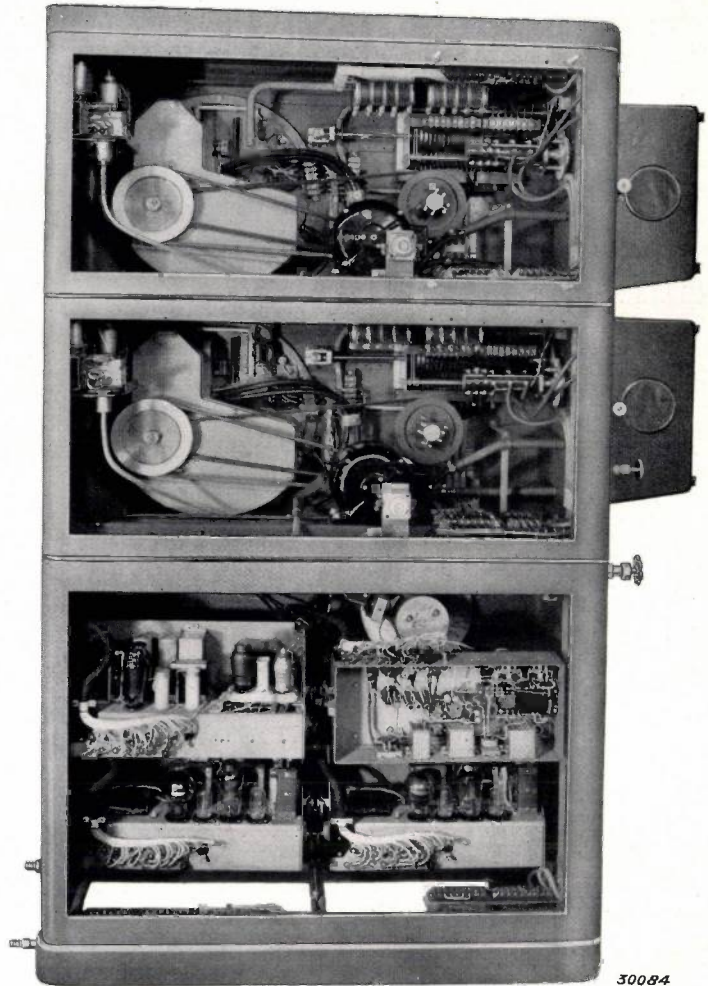

Fig. 8

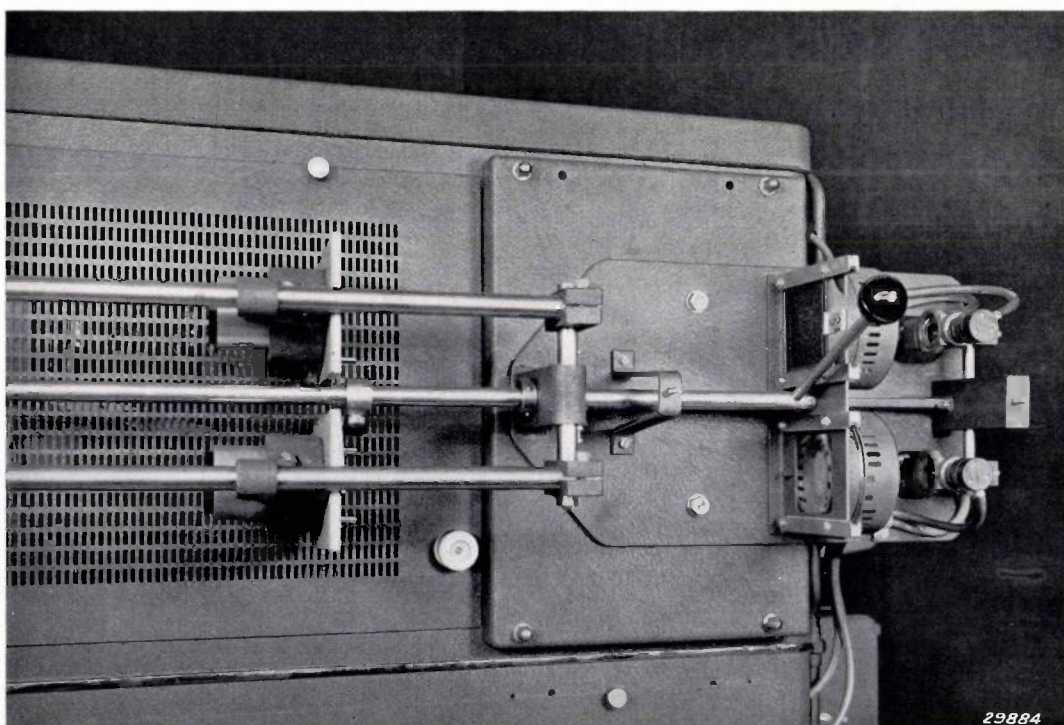

Fig. 9

The arrangement of the whole installation

Following the foregoing explanation of the optical system we shall consider the installation for film reproduction as a whole. *Fig. 7* is a photograph of the apparatus. The compact structure which was made possible by the very small dimensions of the light source is immediately striking.

The lamp forms as it were a unit with the film window. At the spot where the arc lamp ordinarily

In each of the projector cabinets there is the optical system with the necessary water-cooling, and further the scanning apparatus for the sound track with the first stage of the necessary amplification. In the cabinet also is the mechanical arrangement for moving the film across the optical system and the "sound head".

In the cabinet below are the amplifiers and the supply apparatus. *Fig. 8* is a photograph of the

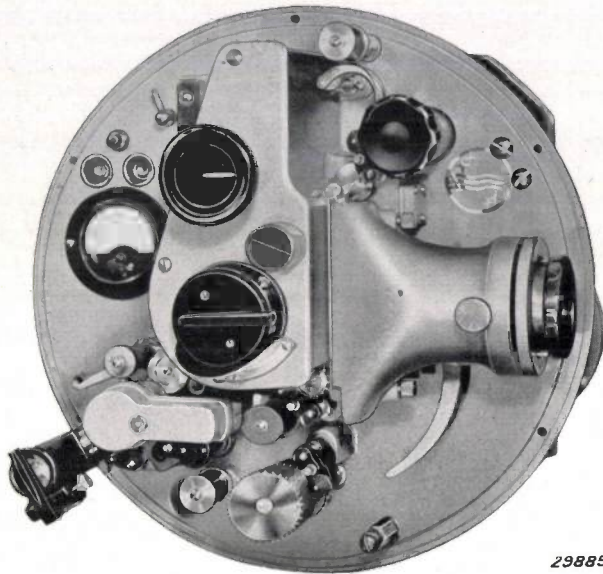

29885

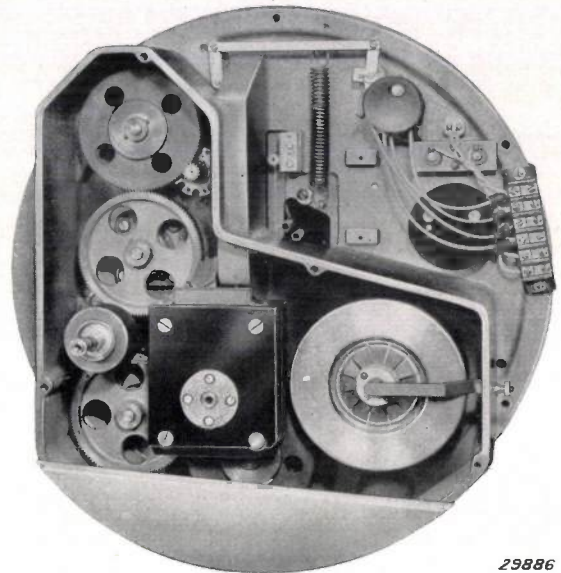

29886

Fig. 10. Front and rear side of the projector. The whole mechanism (mercury lamp and lenses) can be moved in a vertical direction by means of the knob with the white line. In this way the position of the film window can be so adjusted, that in the positions of rest of the rotating sector it corresponds exactly with the position of one film picture (framing). The knob in the middle of the figure is that of a revolving head which contains two mercury lamps. By giving this knob a half turn the lamps can be interchanged. At the same time the connections for electric current and cooling water are switched over to the lamp put into use. The knob in the upper left-hand corner serves to switch on the apparatus. The switching on takes place in four steps:

- 1) Switching on of motor and primary winding of transformer.

- 2) Motor brought up to normal number of revolutions.
- 3) Ignition of the lamp.
- 4) Current in lamp raised to normal working strength.

The lamp current can be read off from the ammeter. In the lower left-hand corner is the system for sound scanning. Below to the extreme left is the exciter lamp. Diagonally upward follow: a condenser, a slit, a reversed microscope lens which focusses a reduced image of the slit on the sound track, and a photocell contained in the grey box. In the photograph of the rear side may be seen the heavy fly-wheel which serves to keep the motion of the film through the sound-scanning apparatus absolutely uniform. To the left of the fly-wheel is the rotating sector inside the square container. The rotating sector turns in oil which is kept clean by means of magnetic filters. The magnetic filter has been described previously in this periodical (see Philips techn. Rev. 2, 297, 1937).

stands are the film drums. This arrangement has made it possible to mount one above the other the two projectors which are necessary in order to be able to change the reels of film without interrupting the performance. This means a great saving of space.

In order to align the projectors in the vertical plane they are mounted in a ring as may be seen in the photograph so that they can be turned about a horizontal axis. In the horizontal plane the projector cabinet which contains the ring can itself be turned a few degrees.

apparatus taken from the rear. The covers of the cabinets have been removed so that the interior may be seen.

On the cover of the upper projector cabinet the arrangement for projecting lantern slides is mounted (see *fig. 9*). Here also mercury lamps of the type described in this article are used. *Fig. 10* gives pictures of several details of the mechanism of the projector, which are described in more detail in the text under the figure.

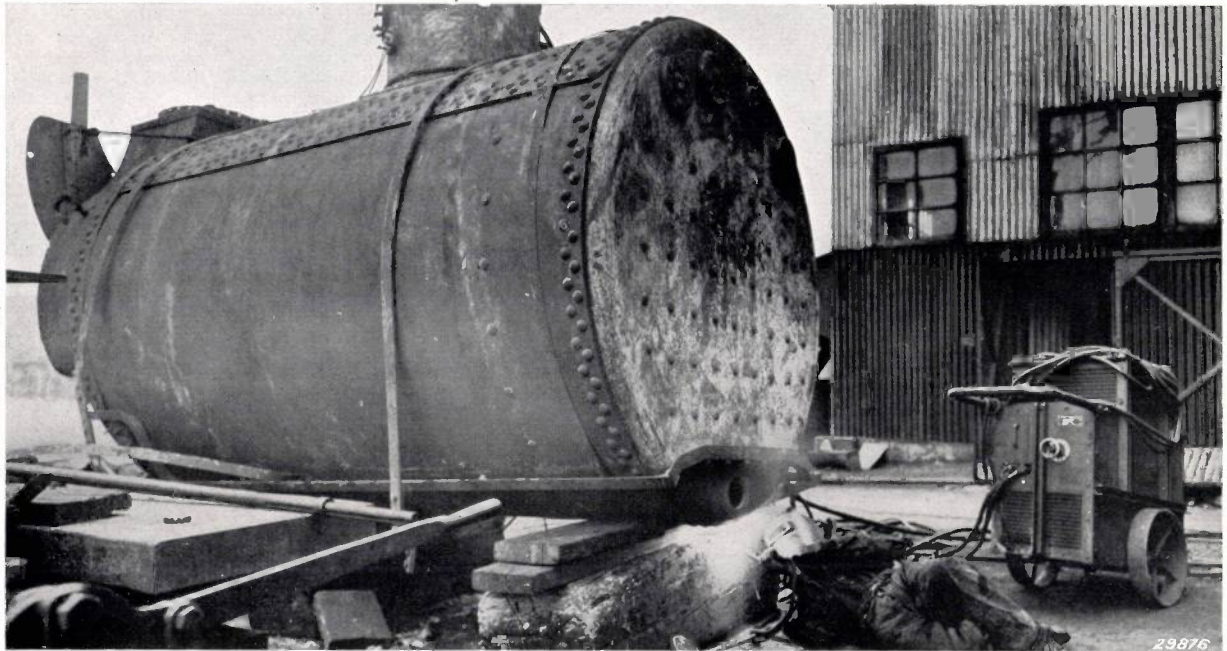

OVERHEAD WELDING

by J. SACK.

621.791.052

In this article a study is made of the forces acting during the transfer of weld metal from the welding rod to the piece of work in overhead welding. In this case the transfer of welding material is opposed by the weight of the drops, the kinetic pressure of the electrons in the arc and the electrodynamic forces on the charged drops due to the convergence of the current lines of force at the crater. On the other hand the transfer is promoted by capillary forces, electrodynamic forces due to the constriction of the liquid metal as the drops leave the rod and explosive forces. From an estimation of these forces it is clear that overhead welding is possible, as experience has in any case proved.

Introduction

In arc welding use is made of welding rods which are melted by the heat developed by an electric arc between welding rod and piece of work. Welding is usually done in such a position that the piece of work is below the welding rod, this is called horizontal welding. But it is sometimes necessary to carry out the welding operation from below, on the under side of the object to be welded. The operator must of course stand in such a position that he can easily see the arc and the pool (the area of molten metal on the article being welded). The work is then above his head, and the process is called overhead welding. Experience has shown that this work can easily be performed with suitable welding rods such as the type PH 50.

It is known that the metal is transferred from the welding rod to the weld in the form of larger or smaller drops¹⁾, which, in the case of overhead welding, means that the force of gravity is overcome. In overhead welding it is clear that there are other

forces besides that of gravity acting on the drops, and the question naturally arises as to the nature of these forces. The explanations which have been proposed are vague or inadequate. Only with the help of X-ray cinematography²⁾ have we been successful in obtaining a clear picture of what occurs in overhead welding.

A survey and an estimation of the intensity of the forces which act during the formation and transfer of a drop are given below. Some of these forces oppose the transfer of drops and will be called opposing forces. They must be overcome by the forces which we shall call the propelling forces.

Opposing forces

Force of gravity

The weight of the drops can be determined by moving the rod in such a way that the drops fall separately and can be weighed. For the sake of

¹⁾ J. Sack, Philips techn. Rev. 2, 129, 1937.

²⁾ J. Sack, Philips techn. Rev. 1, 26, 1936.

simplicity this is done in horizontal welding.

Separate drops are obtained by moving the welding rod sufficiently rapidly over the work (a flat plate for example)²⁾. If a welding rod with an iron core is used — and we shall deal only with that kind in this article — and a plate not of iron but of copper, the drops do not stick to the plate, but can be removed and weighed.

Fig. 1. shows graphically the result of this experiment. It may be seen from the graph that 2.3 g of the rod were melted into drops whose weight varied from 120 to 140 mg. As average weight is taken the weight determined by the abscissa of the densest part of the diagram, and in the case of fig. 1 this is:

$$\bar{G} = 148 \text{ mg}$$

In table I are given the average weights together with the average dimensions of drops obtained with welding rods of the types PH-50 and PH-48 having different core diameters d : Type PH-50, with an inorganic coating, gives a drop with an average diameter of $0.7 d$. This drop is considerably smaller than that of type PH-48 with a partially organic

coating, which gave an average diameter of drop of $0.9 d$. A difference in size of drop is manifested in a difference in welding properties, and the oper-

Table I

TYPE	d	J	\bar{G}	\bar{d}	\bar{d}/d	
	mm	amp	mg	mm		
PH 50	5	220	150	3,3	0,66	0,69
	5	190	190	3,6	0,72	
	3 1/4	116	50	2,3	0,71	
	3 1/4	116	40	2,15	0,66	
	2 1/2		22	1,75	0,70	
PH 48	4	111	196	3,6	0,90	0,89
	4	131	214	3,7	0,93	
	4	143	148	3,3	0,83	

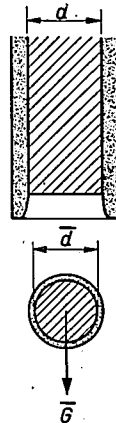

29874

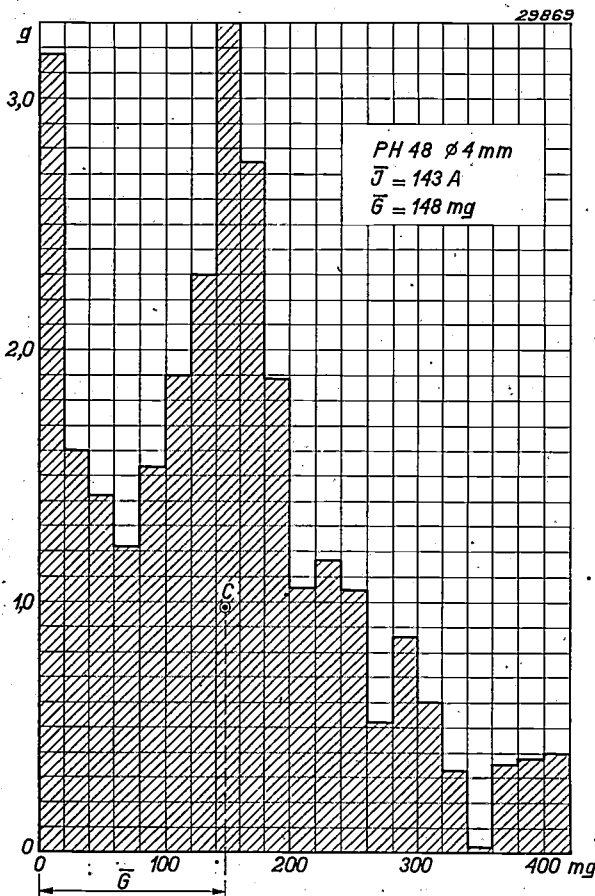

Fig. 1. Graph showing the size of the drops in welding. The ordinate shows how much material (in grams) was transferred in the form of drops of a weight given by the corresponding interval on the abscissa axis.

ator will immediately classify the welding rod PH-48 as a coarse-drop rod, and the rod PH-50 as a fine-drop or "spraying" rod. In overhead welding it is important to have the weight of the drop small; in this respect a rod of the type PH-50 is to be preferred.

Other opposing forces

In order to find out whether other forces besides that of gravity act on the drop, the action of gravity may be excluded by welding on a vertical plate with the rod held in a horizontal position. It is then observed that when the arc burns, and before any drops are transferred, there is a force acting which pushes the welding rod away from the plate and which is dependent upon the current strength.

The value of this force may vary somewhat for different types of welding rods, and it sometimes also depends upon the polarity. Under normal working conditions the force is about 1 g for welding rods of 4 mm and about 2 g for those of 6 mm, thus many times greater than the weight of the drop. The relation between this pressure force and the current may be represented approximately by the equation:

$$K = 0.05 I^2 \text{ (dyne)}$$

where I is the current in amperes³⁾.

The pressure force on the liquid drop of the welding rod forms a depression in the drop which is al-

³⁾ This formula is deduced from measurements by F. Nieburg, *Elektroschweißung* 9, 101, 127, 1938. Similar, somewhat less accurate, results were obtained previously by F. Creedy, R. O. Lerch, P. W. Seal, and G. P. Gordon, *A.I.E.E. Paper No. 32 - 41, Abstract Electr. Eng.* 51, 49, 1932. Both estimations referred only to the force of pressure several seconds or fractions of seconds after the ignition of the arc. The variations in the force during welding were not determined.

ways observed in X-ray cinematographic pictures (see for instance fig. 2c).

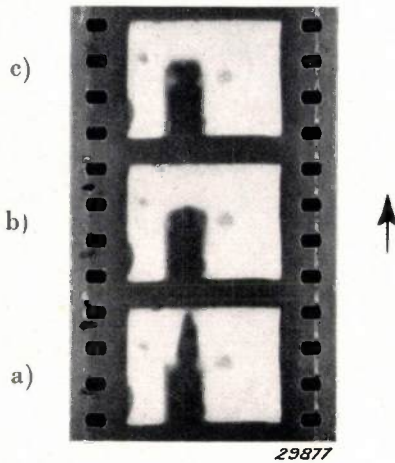

Fig. 2. X-ray cinematographic film (50 pictures per sec) of the drop in overhead welding. The stretchedout form of the drop in picture a and the depression on the top of the drop in c should be noticed especially.

The present state of knowledge about the welding arc is inadequate to give perfect insight into the causes of this opposing force. Physicists are most interested in what happens at the cathode of the discharge, and the pressure has been theoretically examined at the cathode⁴). From the calculation it is found that the repelling force may be mainly ascribed to the bombardment of the cathode by positive ions. If n is the number of ions (or electrons) per unit volume of the column of the arc, the pressure of the ions on the cathode is

$$p = nkT, \dots \dots \dots (1)$$

where T is the absolute temperature of the electrons and k is Boltzmann's constant.

In the welding arc the temperature of the electrons as well as that of the ions is about 6 000 °K, while the concentration of electrons may be estimated at $n = 2 \cdot 10^{16}$ electrons per cubic centimetre⁵). Using these values in equation (1) a pressure is obtained of $p = 17\,000$ dynes/sq.cm.

The size of the cathode spot on which the pressure

⁴) L. Tonks, Phys. Rev. 46, 278, 1934.

⁵) This estimation is based on the assumption that there exists an ionization equilibrium between the electrons and the iron vapour in the arc. The degree of ionization α of the iron can be calculated by means of Saha's formula which is as follows:

$$\lg \frac{\alpha^2 P}{1-\alpha^2} = -\frac{5000 V_i}{T} + 2.1 \lg T - 6.5.$$

P is here the pressure of the iron vapour, in our case 1 atmosphere. V_i is the ionization potential of the iron atoms and is equal to 7.8 volts. The degree of ionization α is small compared with unity. If the relation between the gas density and the temperature is taken into account, the

acts, follows from the current density at the cathode, which is about 7 000 A/sq.cm. With a current of 180 A the area of the cathode spot is $f = 180/7\,000 = 0.026$ sq.cm, and the force on the cathode thus becomes:

$$k = pf = 17\,000 \cdot 0.026 = 440 \text{ dynes} = 0.435 \text{ g},$$

while the observations under these circumstances give an average value more than twice as great.

Finally the electrodynamic forces must be taken into account, which are due to the action of the electro-magnetic field on the lines of force of the current. The electric current through a conductor may be considered to be flowing through tubes of current which attract each other since the direction of the current is the same in all the tubes.

If the top of a welding rod is examined in the initial state, i.e. before any drop has been formed (see fig. 3), it will be seen that the current lines



Fig. 3. Current lines of force at the top of the welding rod. The arrows indicate the direction of the electrodynamic forces. The convergence of the current lines gives rise to a resultant downward force.

converge at the crater. The electrodynamic forces, which are also represented in fig. 3, have a downward resultant due to the curve in the lines of force of the current. The value of the resultant force can be calculated (see p. 14) and we find:

$$k = \frac{I^2}{200} \ln \frac{O_2}{O_1} \text{ dyne}, \dots \dots \dots (2)$$

where O_1 is the area of the crater and O_2 the cross section area of the iron core of the welding rod, while I must be in amperes. For $I = 180$ A and a negative crater (0.026 sq.cm) one finds $k = 255$ dynes = 0.26 g.

If the crater is positive then its area is so large that one may hardly speak of a convergence of the lines of force. In this case therefore the electrodynamic force may be neglected.

following is found for the number of electrons per cc:

$$n = 4.3 \cdot 10^{18} \sqrt[4]{T} \cdot 10^{-\frac{2500}{T} V_i},$$

and for $T = 6\,000$ °K and $V_i = 7.8$ volts it follows that $n = 2 \cdot 10^{16}$.

Propelling forces

We noted above that the resultant opposing force at the beginning of drop formation is many times greater than the weight of the drops. The propelling forces must be able to overcome these forces, since otherwise the transfer of drops would be impossible in overhead welding.

The most important propelling forces are the surface tension, the electrodynamic and explosive forces.

Surface tension

Capillary force or surface tension already plays an important part during the formation of the drops. It is due to this force that the liquid metal remains on the top of the welding rod and does not run along the rod and drip off. Surface tension also keeps the molten metal in the inverted pool.

When the arc is kept short enough the drop on the welding rod can make contact with the pool, which can then absorb part of the drop of liquid metal. *Figs. 4a, b, c* and the X-ray photographs

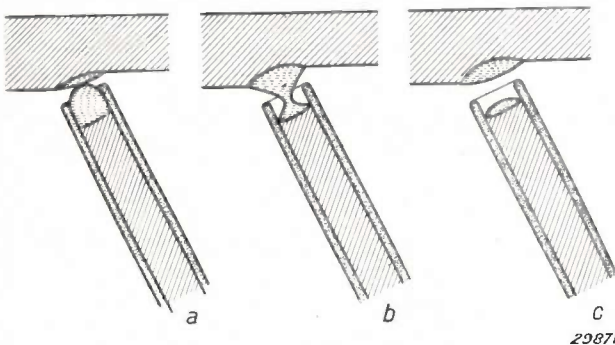

Fig. 4. Transfer of liquid material from the welding rod to the piece of work.

fig 5 show the three stages of this process:

- The molten metal of the piece of work makes contact with that on the welding rod.
- The drop of metal between the work and the welding rod becomes attenuated and finally splits into two parts.
- The division is complete; the pool has become larger, the drop smaller. Material has therefore been transferred *from* the welding *to* the piece of work. For this transfer of material the pool must not be too large at the beginning of the process. This requirement will not be fulfilled in overhead welding if the current is too high or the piece of work too hot. In the latter cases the liquid metal falls out of the pool and instead of welding, a hole is burned in the work.

The manner of material transfer just described is of particular importance when bare welding rods are used, since with bare rods it is impossible to

weld except with a short arc. With an arc which is too long the liquid metal simply drips from the welding rod.

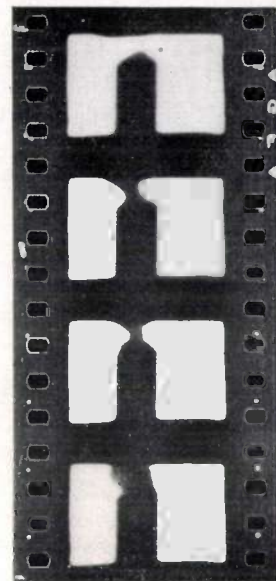

29878

Fig. 5. X-ray photograph of the transfer of material from a thinly coated welding rod to the piece of work in the manner indicated in *fig. 3*.

Electrodynamic forces

The arc is usually kept as short as possible in welding. In overhead welding with bare welding rods this is — as we have just seen — absolutely necessary. But with thickly coated welding rods it is also possible to work with a longer arc, and in this case the material transfer takes place in quite a different way as can be seen from the X-ray photographs (*fig. 6*). The molten metal on the top of the welding rod breaks away usually in the form of a spherical drop which is thrown upwards with a fairly great speed. If the distance from the welding rod to the work is too great the drop thus shot upward will not reach the piece of work, but will fall to the ground along a more or less parabolic path.

The drop formation of the molten metal of the welding rod may be explained as follows. As was represented in *fig. 3* the mutual attraction of the current lines of force causes radial forces in the rod. These forces are generally too small to cause a deformation of a solid conductor. They may, however, with a sufficiently high current, be great enough to cause changes of form in a fluid conductor. This was first noticed and investigated theoretically in connection with induction smelting furnaces⁶⁾ in which iron is heated and fused by induction in a horizontal ring-shaped gutter. The smelt forms

⁶⁾ E. F. Northrup, *Phys. Rev.* 24, 474, 1907.

a ring-shaped fluid conductor in which constrictions appear under certain circumstances. How will

graphic pictures: fig. 2a shows a stretched drop and fig. 8 a flattened one.

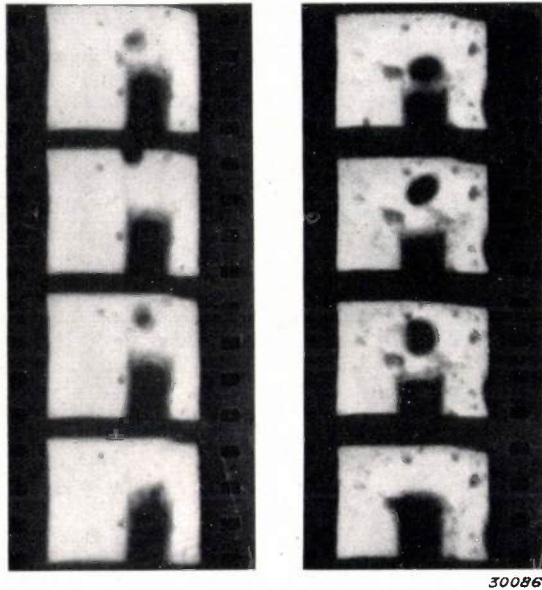

Fig. 6. X-ray photograph of the transfer of drops between welding rod and work. The arc is very long. In contrast to fig. 4 where the drops touch the piece of work and then let loose from the welding rod, the drops are in this case "shot away" from the welding rod.

this effect, which is called the pinch effect be manifested in the case of the drops from welding rods?

When there is a large enough quantity of liquid material on the top of the welding rod, a constriction will occur with coated welding rods as is shown in fig. 7a. The current lines of force no longer run parallel to the axis of the rod, and as a result the pressure force is given an axial component. When for some reason or other the drop is flattened (fig. 7b) or stretched (fig. 7c) the electrodynamic forces will reinforce the deformation, and very much deformed drops can occur in this way. Such drops can sometimes be observed in the cinemato-

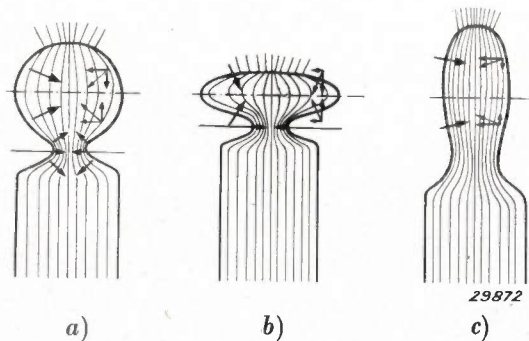

Fig. 7. Current lines in the welding rod and drop. The arrows indicate the direction of the electrodynamic forces. It may be seen that the forces have the tendency to constrict the neck of the drop and to tear it loose from the welding rod. From figs. b and c it may be seen that the forces act to make a flattened drop still flatter and a stretched drop still longer.

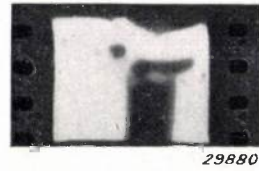

Fig. 8. A drop temporarily very much flattened by electrodynamic forces.

In general the constriction of the neck becomes steadily greater until the drop is quite free. The constriction is due partly to surface tension, but may be ascribed mainly to the above-discussed electrodynamic forces, as may be seen from fig. 7 where the liquid metal is shown to be torn apart at the place where the constriction occurs.

As the neck of the drop becomes smaller the upward component of the electrodynamic force becomes greater. Calculations, which will be given briefly below, show that the electrodynamic force on a piece of a conductor is always directed from the smaller to the larger cross section, and therefore in this case upwards, when the cross section of the neck is smaller than the area of the crater.

The area of a negative crater of an arc usually only amounts to several square millimetres, while the area of the positive crater is the same as that of the cross section of the drop. An upwardly directed electrodynamic force will therefore mainly occur when the welding rod is connected to the positive terminal. When the neck of the drop has been sufficiently constricted the force becomes greater than the force of gravity acting on the drop (and other opposing forces), with the result that the drop leaves the welding rod with some speed.

This is also shown in the film reproductions in fig. 6. In these cases the path of the drop could be followed in several pictures, and the initial velocity

Table II

$\phi = 4 \text{ mm} \quad J = 140 \text{ A}$

m	V_0	S	T
mg	cm/sec	$dyne \text{ sec}$	erg
72	32	2,3	37
62	16	1,0	8
157	17	2,7	23
		$\bar{S} = 2,0$	$\bar{T} = 23$

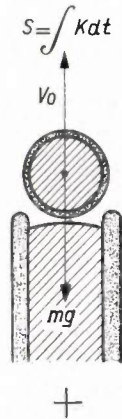

of the drop could be estimated from it. If one assumes that only the force of gravity acts on the free drop, the initial velocities given in table II are obtained from the sections of film which can be used for the determination. The drop is thus "shot" away with an average impulse of 2 dynes/sec, or an average kinetic energy of 23 ergs.

A theoretical estimation of the electrodynamic forces leads to the same order of magnitude. If one calculates for a solid of revolution as in fig. 9 the electrodynamic force which acts

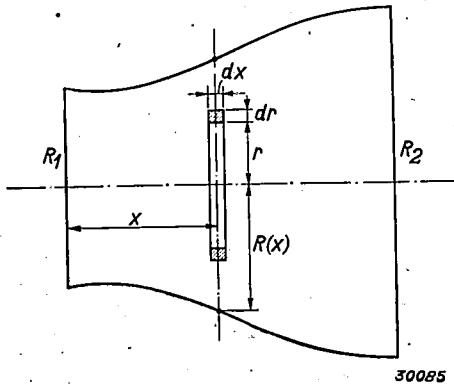

Fig. 9. Sketch for the purpose of calculating the electrodynamic forces acting on a piece of a solid of revolution.

on a ring-shaped element of volume (position x , radius r), a resultant force in the x direction is found of the magnitude:

$$dK_x = I^2 \cdot \frac{4 r^3}{100 R^5} \cdot \frac{dR}{dx} dx dr \text{ (dynes),}$$

in which R is the radius of the body at the point x and I is the current in amperes. This formula is valid under the assumption that R changes only slowly with x ⁷⁾.

The total force on the body is obtained by integrating the above expression with respect to r (from 0 to R) and to x (from x_1 to x_2). The following is the result:

$$K_x = \frac{I^2}{100} \ln \frac{R_2}{R_1} = \frac{I^2}{200} \ln \frac{O_2}{O_1}$$

It may be seen from this formula that the force depends upon the current and the cross sections at the beginning and of the piece of conductor considered, and that it is always directed from the smaller to the larger area.

If this result is applied to the molten drops, the area of the crater must be used for O_2 and the cross section of the neck for O_1 .

The force K_x becomes a propelling force the moment the cross section of the neck becomes smaller than the crater. Upon further constriction, at a certain radius R_1 of the neck, the upward electrodynamic force will be equal to the weight G of the drop. From that moment the drop will begin an upward movement, and as a consequence the constriction will be accelerated.

In order to calculate the total energy which is transferred to the drop we must know the length of the path over which the electrodynamic forces act until the drop is quite free.

⁷⁾ In this case it may be assumed that the axial component of the current density is equal at all points of a plane cross section perpendicular to the axis.

This path will be of about the same order as the radius R_1 of the neck. We shall make this supposition more definite by assuming that in the upward motion the radius of the neck decreases at the same rate as the drop moves upward. With this assumption we find for the total kinetic energy T which is given to the drop up to the moment when it is freed:

$$T = \frac{I^2}{100} \cdot R_1$$

Let us examine particularly the experiments whose results are given in table II for the case of a welding rod with a core diameter d of 4 mm, a drop of $0.7 d = 2.8$ mm diameter and a direct current of 140 A. The current density at the crater determines the area of the latter and at the same time also the magnitude of the upward electrodynamic force. If the current density is considered to be 7000 A/sq.cm for the cathode spot and 1400 A/sq.cm for the anode spot, one finds, according as the welding rod is positive or negative, values for R_1 of 0.09 and 0.05 cm respectively, and for T , 18 and 10 ergs respectively. Under the conditions of the observations of table 2, i.e. positive polarity, the energy of 18 ergs taken up by the drop is in good agreement with the observed average of 23 ergs.

Explosive forces

In the following attention will be concentrated on the phenomena occurring in the neck of the drop. Due to the electrodynamic forces the neck is continually narrowed, but since the electrical conductivity of liquid iron is much greater than that of the molten coating, the electric current will continue to flow chiefly through the ever narrowing neck. The heat developed by the electric current will increase the temperature of the neck until the boiling point of iron has been reached.

Since the whole process is completed in several tenths of a millisecond, as will appear from the discussion below, it is understandable that a merely slight delay in boiling can lead to a considerable exceeding of the boiling point, whereupon the neck passes into the vapour form explosively. A temporary over-pressure then occurs which can shoot the drop away with considerable speed, especially when the space between the drop and the rod is partly closed by molten flux so that the gases cannot immediately escape. This is always so in the case of coating welding rods. A similar phenomenon may occur due to the fact that the iron contains dissolved gases which are probably driven out of the iron before it reaches its normal boiling point. We may then expect that a bubble of gas will be formed inside the neck, a fact which has actually been observed several times by means of photographs (fig. 10).

The increase of temperature due to the electric current through the ever narrowing neck can easily be calculated if one assumes that heat dissipation does not occur; this will only be true in the case of a very narrow neck such as may occur imme-

diately before the explosion. The diameter of the neck can be estimated from observations of the variation of voltage by means of a cathode ray oscillograph. It will be seen that every transfer of a drop is accompanied by a voltage peak of about 20 volts on the average with a welding current of 140 A. The duration of this peak is of the order of $2 \cdot 10^{-4}$ sec.



29881

Fig. 10. Preparation for an explosion. A vapour or gas bubble is formed in the interior of the neck.

This voltage peak may be ascribed chiefly to the electrical resistance of the neck which can be calculated from it and is found to amount to 0.14 ohm. If the neck is considered to be a cylinder 1 mm in height (in agreement with the photographs) the

area of the cross section is found to be $3.6 \cdot 10^{-4}$ sq. cm.

The time which would be necessary to vaporize this neck completely would be $6 \cdot 10^{-4}$ sec at the given voltage and current. It is reasonable to assume that the actual lifetime is only a fraction of this time (in agreement with the observed value of $2 \cdot 10^{-4}$ sec), because during the vaporization the narrowing of the neck continues and, moreover, the speed of evaporation is thereby increased.

The fall in voltage in the neck during the transfer of the drop does not occur only in overhead welding but also in other positions. This voltage drop is in series with the arc voltage and may, if the available voltage is too low, lead to the extinction of the arc. In welding with a welding transformer it has been found that the phenomenon of extinction of the arc occurs at a no-load voltage of the machine which is too low, and that it occurs often the lower the no-load voltage. For this reason transformers which have too low a no-load voltage (less than 50 volts for example) cannot be considered suitable as welding transformers.

ILLUMINATION AND BLACK-OUTS

by P. J. BOUMA.

628.97 : 355.585

From a study of physiological data the brightnesses and intensities of illumination are deduced which under various circumstances are permissible in times of danger from air-raid. General principles are given for the illumination at such times. It is shown how the Philips "Protector" lamps provide a solution of the problem. In conclusion the influence of the colour of the light is briefly discussed.

The problem of planning a satisfactory outdoor illumination under normal conditions has already been discussed in this periodical from a number of different points of view. The problem takes on quite a different character when it is studied in connection with a possible danger of air-raids in time of war.

The primary requirement made of the illumination is that it must not enable the aviators to orient themselves or observe the position of cities, buildings, etc. There is then also the secondary requirement that on the ground there should be high enough visibility so that traffic is still possible, although with very much reduced speeds.

In the following the conditions will be studied on the basis of physiological optical data for satisfying the primary requirement of "non-visibility from the air", and the way in which these conditions can be realized in practice while retaining the best possible visibility on the ground.

Physiological optical basis

Accurate information about visibility of light

spots of different sizes and brightness under the conditions which hold for the observer in an aeroplane during an air-raid can only be obtained by experiments on a large scale made by aviators from the air. Even then it will still be very hard to imitate actual conditions accurately. The observer will in the tests usually fly over well-known country, the psychological factor is also quite different from that during an air-raid, etc. All such factors may exert an influence on the result which should not be underestimated.

Since we possess no reliable results of such practical observations, we shall try to obtain the necessary numerical data in quite a different way. We shall begin with the large amount of observational material which has been collected in numerous laboratories on the visibility of objects of different size and brightness. Practical experience has, however, shown that under laboratory conditions much lower threshold values are obtained than under practically occurring conditions. In order to solve this problem we shall make use of the

diately before the explosion. The diameter of the neck can be estimated from observations of the variation of voltage by means of a cathode ray oscillograph. It will be seen that every transfer of a drop is accompanied by a voltage peak of about 20 volts on the average with a welding current of 140 A. The duration of this peak is of the order of $2 \cdot 10^{-4}$ sec.



Fig. 10. Preparation for an explosion. A vapour or gas bubble is formed in the interior of the neck.

This voltage peak may be ascribed chiefly to the electrical resistance of the neck which can be calculated from it and is found to amount to 0.14 ohm. If the neck is considered to be a cylinder 1 mm in height (in agreement with the photographs) the

area of the cross section is found to be $3.6 \cdot 10^{-4}$ sq. cm.

The time which would be necessary to vaporize this neck completely would be $6 \cdot 10^{-4}$ sec at the given voltage and current. It is reasonable to assume that the actual lifetime is only a fraction of this time (in agreement with the observed value of $2 \cdot 10^{-4}$ sec), because during the vaporization the narrowing of the neck continues and, moreover, the speed of evaporation is thereby increased.

The fall in voltage in the neck during the transfer of the drop does not occur only in overhead welding but also in other positions. This voltage drop is in series with the arc voltage and may, if the available voltage is too low, lead to the extinction of the arc. In welding with a welding transformer it has been found that the phenomenon of extinction of the arc occurs at a no-load voltage of the machine which is too low, and that it occurs often the lower the no-load voltage. For this reason transformers which have too low a no-load voltage (less than 50 volts for example) cannot be considered suitable as welding transformers.

ILLUMINATION AND BLACK-OUTS

by P. J. BOUMA.

628.97 : 355.585

From a study of physiological data the brightnesses and intensities of illumination are deduced which under various circumstances are permissible in times of danger from air-raid. General principles are given for the illumination at such times. It is shown how the Philips "Protector" lamps provide a solution of the problem. In conclusion the influence of the colour of the light is briefly discussed.

The problem of planning a satisfactory outdoor illumination under normal conditions has already been discussed in this periodical from a number of different points of view. The problem takes on quite a different character when it is studied in connection with a possible danger of air-raids in time of war.

The primary requirement made of the illumination is that it must not enable the aviators to orient themselves or observe the position of cities, buildings, etc. There is then also the secondary requirement that on the ground there should be high enough visibility so that traffic is still possible, although with very much reduced speeds.

In the following the conditions will be studied on the basis of physiological optical data for satisfying the primary requirement of "non-visibility from the air", and the way in which these conditions can be realized in practice while retaining the best possible visibility on the ground.

Physiological optical basis

Accurate information about visibility of light

spots of different sizes and brightness under the conditions which hold for the observer in an aeroplane during an air-raid can only be obtained by experiments on a large scale made by aviators from the air. Even then it will still be very hard to imitate actual conditions accurately. The observer will in the tests usually fly over well-known country, the psychological factor is also quite different from that during an air-raid, etc. All such factors may exert an influence on the result which should not be underestimated.

Since we possess no reliable results of such practical observations, we shall try to obtain the necessary numerical data in quite a different way. We shall begin with the large amount of observational material which has been collected in numerous laboratories on the visibility of objects of different size and brightness. Practical experience has, however, shown that under laboratory conditions much lower threshold values are obtained than under practically occurring conditions. In order to solve this problem we shall make use of the

experience gained in navigation in the observation of light signals.

The most important laboratory data upon which we base our considerations will be found reproduced in *fig. 1*. In this figure the minimum intensity of

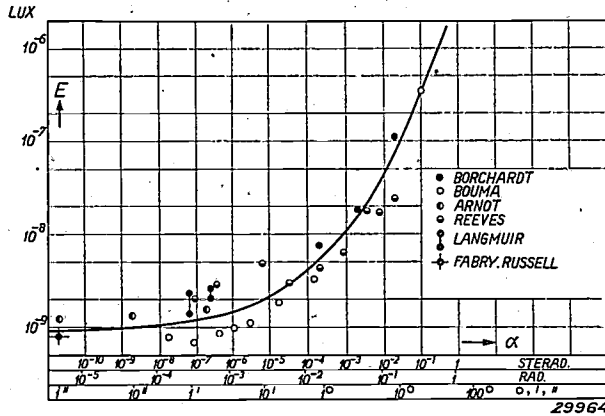

Fig. 1. Intensity of illumination E , which a circular object must give to the eye in order to be seen, as a function of the size of the object (expressed as angle or solid angle within which the object is seen).

illumination E , which a circular source of light must give to the eye in order to be observed is plotted as a function of the angle α within which the source of light is observed¹). This curve was composed from data of six different authors²); in spite of the very diverse sources (physical, technical, physiological and astronomic investigations) all the data showed reasonable agreement. It may be seen from *fig. 1* that with very small angles of vision (smaller than about 1 min) E is independent of α : for such small points of light it is not the brightness but only the total light intensity which is the important factor. With very large angles (above about 10 degrees) E is proportional to α^2 , *i.e.* to the apparent area; for such large light spots, the dimensions play no further part and it is the brightness alone which determines the visibility. For very small angles of vision the threshold is $E = 10^{-9}$ lux, for very large angles of vision $B = 3.4 \cdot 10^{-10}$ stilb.

In practice we are often concerned with the region which lies between these two extremes and where therefore both the brightness and the dimensions are important for visibility.

In practical navigation a threshold value of $E = 2 \cdot 10^{-7}$ lux is counted on for small angles

¹) α is given as an ordinary angle both in radians and in degrees, minutes and seconds.

²) Arndt, *Das Licht* 5, 220, 1935.
Borchardt, *Zs. für Sinnphys.* 48, 176, 1914.
Bouma, (unpublished).
Fabry, *Trans. Ill. Eng. Soc.* 20, 12, 1925.
Langmuir-Westendorp, *Physics* 1, 273, 1931.
Reeves, *Astrophys. J.* 47, 141, 1918.
Russell, *Astrophys. J.* 45, 60, 1917.

of vision, so that for the transition from laboratory experiment to practical observation a factor of 200 is added. This factor seems surprisingly large, but it becomes more comprehensible when we take the following factors into account.

- 1) In the laboratory experiment the eye of the observer was completely adapted to the dark, this was not so in the practical case. The great importance of this factor is shown by the fact that the light of the clear moonless sky raises the threshold value E by a factor of 10 (Russell).
- 2) In the laboratory experiment it is known where the light point is to be expected, this is not true in practice.
- 3) Light points which lie close to the threshold value are often observed for a moment and then lost from view again. For the practical case such an observation is inadequate.
- 4) In the laboratory there is an unlimited time for observation.
- 5) In the laboratory it is possible to concentrate all one's attention calmly on the visual observation.

The factor of 200 mentioned may not, however, be immediately applied to the problem of black-out, since we are in this case concerned with the requirement that the light shall be just not visible, whereas in navigation the requirement is that it shall just be visible. From numerous physiological observations it has been found that the difference in the threshold value may amount to a factor of $1\frac{1}{2}$ to 2 when these two different criteria are applied.

We shall, therefore, find the threshold values for the black-out problem fairly accurately if we multiply the values of E of *fig. 1* by a factor 100.

Maximum permissible brightnesses and intensities of illumination

For very large illuminated surfaces we find from the above a maximum permissible brightness of $3.4 \cdot 10^{-8}$ stilb. If we assume that the lighted road surface is diffusely reflecting with a reflection coefficient of 15 per cent (a value which often occurs with granite block pavement, the coefficients are still much lower for asphalt), this means a maximum permissible intensity of illumination of $7 \cdot 10^{-3}$ lux³). The average level of illumination of highways and streets may therefore not exceed this value. Since the above-mentioned factor of 100, while correct for small angles of vision, will be somewhat

³) It may be noted for the sake of comparison that on a clear moonless night the illumination intensity is about $0.2 \cdot 10^{-3}$ lux, and with a full moon about 0.2 lux.

too high for very large surfaces, care must be taken that the surfaces which can be illuminated to this level are not larger than absolutely necessary.

For light sources in the form of a point *E* is about 10^{-7} lux for the eye: a light intensity of $\frac{1}{10}$ of a candle may, under favourable weather conditions, be observed at a height of 1 kilometre. This shows that it is of primary importance that the light sources do not radiate any light at all in an upward direction.

In table I are given the data for several intermediate cases. For circular light spots of different diameters *d* (in metres) the maximum permissible intensity of illumination in lux is given which the spot may have and still not be observed from a height of 300, 1 000, 3 000 metres. 30 per cent is taken as the coefficient of reflection of objects, persons, etc. which are situated within the light spot.

Table I

Height \ <i>d</i>	0.1 m	1 m	10 m	100 m
300 m	14	0.26	0.013	0.0041
1000 m	135	1.9	0.051	0.0057
3000 m	1200	14	0.26	0.013

The table shows among other things that an intensity of illumination of 1 lux (about the lowest limit at which it is possible to read properly) is permissible with a height of the plane of 1 000 m when the light spot has a diameter of 1 m, but for much larger light spots it becomes absolutely inadmissible.

It may also be seen that for very large illuminated areas (100 metres) the visibility decreases only slowly with increasing height of the plane: from 300 to 3 000 metres the permissible intensity of illumination of the area increases only by a factor 3. Small light spots (1 metre) on the other hand disappear very quickly as the plane rises: from 300 to 3 000 metres height the permissible intensity of illumination increases by a factor 54.

It may further be seen from the table that a window of a well-lighted room (100 lux) which has an area of 0.8 sq.m must be provided with a curtain which allows not more than 2 per cent or $\frac{1}{4}$ per cent of the light to pass if it is to be made invisible at 1 000 metres and 300 metres distance respectively. It may be seen from these values that many curtains used in ordinary times are inadequate, even without considering the influence of slits and openings.

General guiding principles for "black-out illumination"

The most important requirements which must be

made of "black-out illumination" are the following:

- a) The general level of the outdoor illumination must be very low (about 0.007 lux).
- b) Even this low level may not be used over larger areas than necessary.
- c) The illumination must be very uniform; this being the only way to obtain a fairly effective lighting without exceeding the permissible level locally.
- d) The sources of light may not radiate any light at all in an upward direction; a few tenths of a candle may already be too much.
- e) Care must be taken that the source of light does not become visible from the air by reflection.
- f) It is desirable that the sources of light radiate a certain amount of light in a practically horizontal direction; in this way the light sources may help the road user by serving as beacons at greater distances. This radiation may not in any case, however, be too strong since the eye would very quickly be blinded at these low levels of brightness.
- g) We shall discuss the influence of the colour of the sources of light at the end of this article.

It has several times been proposed to satisfy requirement a) by lowering the voltage of the electric lamps from a central point. Apart from technical objections connected with this operation, the measure is in itself inadequate. In order to black-out a city satisfactorily in this way the level of illumination would have to be lowered by a factor of about 2 000 when the brightly lighted streets are taken into account; a decrease in voltage from 220 to about 35 volts would be necessary. With such a drastic lowering the visibility in most of the streets would become too poor because of the great lack of uniformity.

In addition there is the fact that at such low voltages the electric lamps would radiate very red light which is very undesirable (see below).

In order to satisfy all the requirements a) to f) it will be necessary to replace the sources of light by others which better answer the purpose.

This could be done by providing the existing light sources in wartime with special fittings, shields, etc. This system has, however, two objections:

- 1) It will be difficult to shield all the existing, often very divergent, types of light sources in the same satisfactory manner.
- 2) When the shield or fitting is damaged without the lamp being broken, the much too intense lamp may suddenly become visible.

The "Protector" lamp

These considerations have led to the development of a special lamp for black-out purposes, the so-called "Protector" lamp, which is manufactured in two different models.



Fig. 2. "Protector" lamp for outdoor illumination.

Fig. 2 is a picture of type I for outdoor illumination. It consists of a 25 watt⁴⁾ vacuum electric lamp with a specially shaped bulb, almost the entire surface of which has been sprayed with dull black paint. Only a narrow frosted ring has been left free. Since this ring radiates the light chiefly at relatively small angles to the horizon, the light distribution curve of fig. 3 is obtained. In the

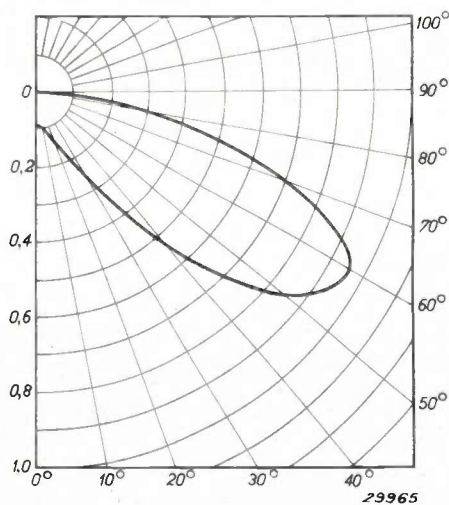

Fig. 3. Light distribution (candle power as a function of direction) of the "Protector" lamp for outdoor illumination.

vertical direction the radiation is at a minimum so that the appearance of a spot with too high a brightness directly under the lamp, as well as the danger of the strong reflection in almost vertical directions is avoided. The great increase of light intensity at larger angles contributes to a more uniform distribution of the light intensity. For angles

⁴⁾ For certain cases a still smaller wattage can be used.

smaller than 25° with the horizon the radiation decreases sharply, so that too great a glare is avoided. In the horizontal direction the lamp has a very small intensity (about 0.05 candle), above the horizontal plane no light is radiated. With this light distribution curve the greatest intensity of illumination on the road will occur at the point where the light source is observed at an angle of about 45° with the horizon. If the lamp is mounted at a height of 6 metres the maximum intensity is exactly 0.007 lux; at all other points the intensity is still lower.

If the lamp is mounted at a height of only 4 metres, then outside a circle with a radius of about 6 m from a point directly under the lamp the intensity of illumination will remain below 0.007 lux, while within the circle described an average intensity of about 0.012 lux will be obtained. It may be seen from table I that such a light spot also begins to be invisible from a height of 300 metres.



Fig. 4. "Protector" lamp for indoor lighting.

Fig. 4 gives a reproduction of the "Protector" lamp type II, intended for indoor illumination. In this case also the most important characteristic is that all light in an upward direction is rigorously avoided by shielding, so that even when the effect of the curtains is inadequate, direct light can never be observed by the aviators. This is accomplished by means of a bulb which is also black for the most part with the exception of a frosted window. In contrast to type I the light distribution curve of this type is at a maximum in the vertical direction and there is almost no radiation at angles smaller than 30° with the horizon (see fig. 5). In this way it is made possible to have sufficient intensity of illumination directly under the lamp to carry out certain kinds of work while the light spot is not made unnecessarily large and thereby easily visible.

It is by no means the intention to make the closing of curtains unnecessary by the use of these lamps. They are rather intended to make it possible

to attain a satisfactory black-out in spite of the often imperfect shielding by ordinary curtains.

As to the use of type I it must be noted that it is impossible at the moment when an air-raid is imminent to change the lamps quickly. The black-out lamps will have to be used during the whole period of possible danger. Over against the disadvantage of having to get along with the very imperfect illumination all that time, is the advantage that when danger actually threatens one is accustomed to this kind of illumination and no extra panic is caused by the sudden dimming of the lights.

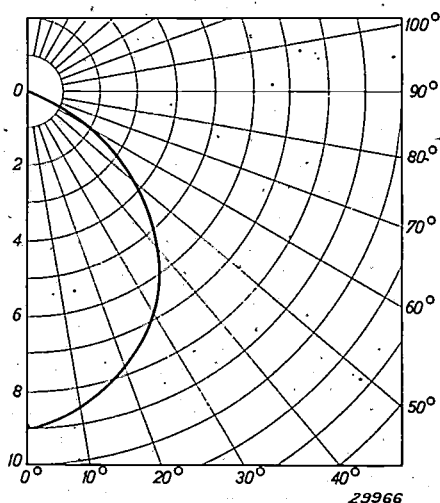

Fig. 5. Light distribution of the "Protector" lamp for indoor illumination.

For those cases where a still lower light intensity is desired, both types of "Protector" lamps can also be supplied with blue coloured ring or window.

It may in conclusion be remarked that the practical experience with "Protector" lamps gained during various black-out tests in the past year was found to be in good agreement with the considerations given here as to visibility.

The colour of the light

Opinions vary very much about the desirability of using coloured lights during air-raids. The use of blue light is very strongly recommended by many, others deny absolutely that blue light offers any advantage over white light. This difference of opinion is understandable when it is kept in mind that there has seldom been an opportunity to carry out a real test of the question, which test would have to consist in the comparison from an aeroplane of a blue and a "white" illumination which gave the same degree of visibility for road users. It has been ascertained that colouring the lamps blue was usually an improvement, but it has not

been possible to ascertain with certainty whether or not this improvement was due exclusively to the decrease in intensity.

The problem of the colour may be formulated most clearly in the following form: for what colour is the relation between the visibility for road users and from a plane most favourable? From this way of putting the question it may immediately be seen that many factors which determine vision under ordinary circumstances must be neglected here since they affect the visibility of the ground and from the air in the same way. We must therefore concentrate attention on the factors which are different from the point of view of visibility from an aeroplane from that of a road user. Among these factors the following are important:

- a) The aeroplane observer is at a greater distance, he sees all objects within a smaller angle of vision and therefore makes more use of the central portion of the eye and less of the peripheral parts, while the road user makes constant use of peripheral vision. Therefore colours for which peripheral vision is relatively sensitive (blue-green and blue) will probably offer certain advantages.
- b) The observer in an aeroplane must try to recognize certain light points out of a collection of very low intensities with here and there vague spots of somewhat greater intensity. This will be easiest when a colour is presented which deviates very much from the colour of starlight. Red or deep yellow coloured light will therefore certainly not be chosen; it may on the other hand offer some advantage to choose a somewhat bluer colour than that of electric light, without, however, using a saturated blue. It must also be noted that when the intensity of red light decreases, the light retains its striking colour until it is almost invisible, while the less saturated colours lying more toward the blue lose their striking colour gradually at lower intensities.

Summarizing we may say that deep red or yellow light sources must certainly not be used, while the use of a somewhat bluer source of light than the electric lamp may offer some advantages. The influence of such variations in colour is, however, infinitesimal compared to the influences discussed above of the intensity, good distribution of light and efficient shielding.

The above is a brief "theory of black-out illumination". It is to be hoped that this theory may never need to be put into practical use.

CARRIER-TELEPHONY ON LOADED CABLES

by F. DE FREMERY and G. J. LEVENBACH. 621.395.44: 621.315.054.3

For the application of carrier-telephony the cable used must have a sufficiently high cut-off frequency. This means that the loading may not be too heavy and therefore considerable attenuation must be accepted in some cases. For long distance connections the loading is, however, already limited by the permissible phase distortion and the transition time, so that the possibility is immediately offered of the introduction of one or more carrier-channels. With very light loading the decrease in attenuation with respect to the non-loaded cable is not very great; but in systems with few channels it is still of practical advantage. For systems with many channels loading offers no appreciable advantage. Finally points are discussed which arise in connection with different carrier-systems.

In order to make the most economical use of a telephone cable between two places far away from each other, so-called carrier-telephony is applied in many cases. This is based upon the following principle. The speech vibrations which must be transmitted for an intelligible telephone conversation occupy a frequency band from 300 to 2 700 c/s. In ordinary telephony, therefore, only these low-frequencies are transmitted. They may however also be used to modulate a carrier-wave which has a frequency of 6 000 c/s for instance. The oscillation obtained contains, in addition to the carrier-frequency, two side bands with frequencies from 5 700 to 3 300 c/s and from 6 300 to 8 700 c/s. Since for the transmission of speech one side band is sufficient, and since in addition the carrier wave itself can also be suppressed after the modulation, the speech has finally been transposed into a vibration with frequencies between 3 300 and 5 700 c/s. The speech thus transposed can be transmitted over the same pair of conductors as the ordinary speech vibrations. The same process can of course also be carried out with carrier waves of higher frequencies. These links running along the same circuit with different frequency bands are called "channels". According to the number of "channels" used at the same time, different systems of carrier-telephony result: in the 1+1 system for example, there is one carrier-wave channel in addition to the ordinary voice-frequency channel; in the 1+4 system, there are 4 carrier channels besides the voice-frequency channel; in the 12 channel system the voice-frequency channel is omitted and there are thus only 12 carrier channels. Systems have even been developed with several hundred channels, in which therefore several hundred conversations may take place at the same time over one circuit. In *table I* the frequency distribution of two common systems is given as an example.

Before the introduction of carrier-telephony an important device already existed for the economical

use of a telephone link: the application of loading-coils. It will appear from the following that the application of carrier-telephony and loading are mutually exclusive to a certain degree, so that a compromise must be made. In order to present clearly the different factors which here play a part, we shall first recall a few general facts about the propagation of electrical oscillations in a conductor¹⁾.

Table I

Frequency bands in two carrier-wave systems (frequencies in c/s). The 1 + 4 system is used in England.

	1+1 channel system	1+4 channel system
Voice-frequency channel	300 - 2 800	300 - 2 600
1st carrier-channel	3 200 - 5 700	3 400 - 5 700
2nd " "	—	6 600 - 8 900
3rd " "	—	9 900 - 12 200
4th " "	—	13 400 - 15 700

Propagation of oscillations in a cable

If a sinusoidal voltage with an angular frequency ω is applied to the end of a cable, it propagates itself along the cable in the form of a damped travelling wave. The amplitude of the voltage after a distance l is decreased by a factor e^{-al} . The damping a is given by

$$a = \sqrt{\frac{R\omega C}{2}} \sqrt{1 + \frac{\omega^2 L^2}{R^2}} - \frac{\omega L}{R} \quad (1)$$

R is here the resistance, C the capacity, L the self-induction per unit of length of the cable. It is assumed that the leakage of the cable is small compared to ωC and $(\omega C) \cdot (\omega L / R)$, which conditions

¹⁾ Cf. also W. Six, The use of loading coils in telephony Philips techn. Rev. 1, 353, 1936; J. L. Snoek, Magnetic cores for loading coils, Philips techn. Rev. 2, 77, 1937; W. Six and H. Mulders, The use of amplifiers (repeaters) in telephony, Philips techn. Rev. 2, 209, 1937.

are always satisfied by a good cable for the speech frequencies to be transmitted.

A composite oscillation, such as speech, when propagated along a cable, will be continually weakened and at the same time distorted, since according to (1) the damping depends upon the frequency. Due to various factors the distance bridged is limited, since the distortion may not exceed a certain limit if the speech is to be intelligible and the speech vibrations may only be weakened to such an extent that, at the end of the cable or, with longer links, at the next repeater station, they still emerge sufficiently above the ever present disturbances.

For an ordinary cable, in general, $R \gg \omega L$ so that α becomes simply

$$\alpha = \sqrt{\frac{R \omega C}{2}} \dots \dots \dots (2)$$

The attenuation can be reduced by making the resistance and the capacity smaller. The cable is therefore constructed so that its capacity is as small as possible. To reduce the resistance a large cross section of copper is necessary. A limit prescribed by economic considerations is soon reached.

There is however another possibility of decreasing the attenuation, namely by increasing the self-induction. Formula (1), for the case where $\omega L \gg R$, then becomes:

$$\alpha = \sqrt{\frac{R \omega C}{2}} \cdot \sqrt{\frac{R}{2 \omega L}} = \frac{R}{2} \sqrt{\frac{C}{L}} \dots (3)$$

The attenuation is here smaller by a factor $\sqrt{R/2\omega L}$ than in the case of formula (2) and it is also independent of the frequency, so that the speech is no longer subjected to linear distortion if we neglect the lowest frequencies at which the condition $\omega L \gg R$ may not be satisfied.

The practical method of increasing L in most cases is by loading: at regular distances self-induction coils are introduced into the circuit.

Since with increasing L the attenuation becomes steadily smaller, see equation (3), it seems advisable to apply heavy loading, i.e. to introduce large coils at short distances. Aside from the fact that here also economic considerations would set a limit, an objectionable influence is exerted by heavy loading in the transmission of higher frequencies. We shall deal with this influence in some detail.

Loading and cut-off frequency

From equation (3) we concluded that α becomes independent of the frequency when $\omega L \gg R$. This

is, however, only true when the self-induction L , like the resistance R and the capacity C , is distributed uniformly along the cable. For a loaded cable, where the self-induction is concentrated chiefly at definite points, (3) is valid only in a definite frequency range, namely, as long as the wave length is large with respect to the length of section s , i.e. the distance between two successive coils. Above this frequency range the attenuation α begins at a definite frequency, the cut-off frequency ω_0 , to increase sharply so that higher frequencies than this are practically not transmitted. The loaded cable thus behaves as a low-pass filter, and the cut-off frequency is given approximately by

$$\omega_0 = \frac{2}{\sqrt{L_s \cdot s C}} \dots \dots \dots (4)$$

where L_s is the self-induction per section (Cf. Philips techn. Rev. 2, 210, 1937 for this formula). Since the self-induction of the conductor is in general much smaller (0.6 mH/km) than that of the coils, L_s is approximately equal to the self-induction of the type of loading coil used. The larger L_s i.e. the heavier the loading, the lower the cut-off frequency becomes, and the narrower the frequency range in which formula (3) is valid. In fig. 1 the attenuation for various common types of loading is plotted as a function of the frequency.

It would of course also be possible to obtain a high cut-off frequency when large self-inductions L_s are used, by decreasing the length of the sections s , see equation (4). The attenuation is at the same

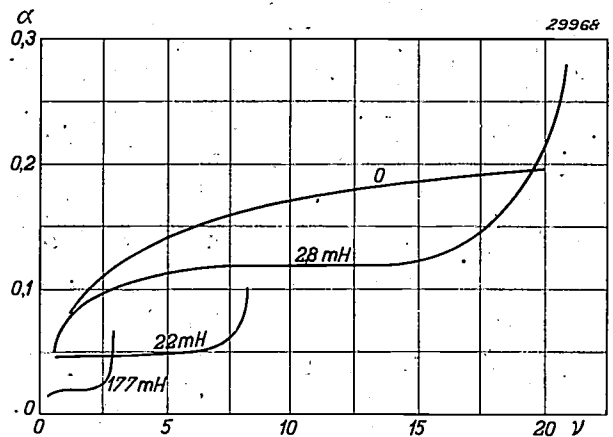

Fig. 1. Attenuation curves of a cable with different types of loading. The attenuation α in Nepers²⁾ is plotted against the frequency ν in kc/s. Curve 0 is for a non-loaded cable, while in the other three cases drawn loading is applied with coils of 2.8 mH, 22 mH and 177 mH respectively. The length of section is 1830 m, the core diameter 0.9 mm and the cable capacity is 0.0385 μ F/km.

²⁾ An attenuation of 1 N (Neper) means a decrease in voltage by a factor $1/e = 1/2.718$; a difference in level of 0.12 N thus corresponds to a voltage ratio $1/e^{0.12} = 0.89$.

time still more reduced, since the self-induction per unit length, $L = L_s/s$, is greater. If the latter is kept constant by decreasing L_s proportionally to s , then with constant attenuation an increase of the cut-off frequency is achieved (ω_0 then increases inversely proportional to s). This is obvious even without formulae, because proportional reduction of L_s and s means a more uniform distribution of the total self-induction of the cable, and therefore a better approximation of the limiting case of a homogeneous cable in which the "cut-off frequency" is infinite. This method cannot, however, generally be applied in practice since the shortening of the sections involves considerably more expense because, in addition to more coils, extra coil cases and man-holes are necessary. In most countries a section length of 1.83 km is used (in Germany 1.7 km), which length is assumed in the curves of fig. 1. It is immediately clear from fig. 1 that heavily loaded cables with coils of 177 mH cannot be considered for carrier-telephony. When there is only one carrier channel above the low-frequency channel (1+1 channel system) frequencies up to 5700 c/s must be transmitted. A sufficiently high cut-off frequency is necessary for this. A lighter loading is thus necessary, and this is even more the case for carrier-systems with a larger number of channels. With light loading, for instance with coils of 22 or 2.8 mH, however, as is shown by fig. 1, the attenuation in the flat part of the curve which can be used effectively is much greater than with heavy loading. This means that for a given distance a greater number of repeater stations or a larger copper diameter would be necessary. By the application of carrier-telephony the cable is used more efficiently, but at the same time the connection is more expensive (especially if we also consider the cost of the carrier-apparatus in the terminal stations), so that it is natural to ask whether there is any other advantage.

Transition time and phase distortion

In the case of links over long distances there is, however, another reason for changing over to light loading, namely distortion. The abovementioned linear distortion which occurs because the attenuation at the ends of the range transmitted is no longer independent of the frequency, can be corrected to some extent by balancing networks which together with the intermediate repeaters have a suitable characteristic. There are, however, other causes of distortion.

Oscillations with different frequencies are in

general propagated along the cable with different speeds. With long distances considerable differences in transition times can occur between the lowest and the highest frequencies of speech, which gives the latter an unpleasant character and finally makes it unintelligible. This is called phase distortion. For the difference in transition time Δt between two frequencies ω_1 and ω_2 which are not too close to the frequency ω_0 , the following formula is approximately valid:

$$\Delta t = \frac{l (\omega_1^2 - \omega_2^2)}{s \omega_0^3} \dots \dots \dots (5)$$

Formula (5) may be derived as follows. Every coil causes a certain rotation of phase φ_s of the voltage; the sections of cable between the coils also cause a phase rotation, which is however small, so that we may neglect its contribution. The equivalent circuit of one section of the cable is drawn in fig. 2, in which the ohmic resistance of the cable is neglected. The section is considered as a cell of a low-pass filter which is shut off from the cable at one side by the impedance $Z = \sqrt{L_s/C_s} \sqrt{1 - (\omega/\omega_0)^2}$ C_s is the capacity per section. For a voltage E_1 on the left hand terminals of the coil the impedance is

$$j\omega L_s + \frac{Z \cdot \frac{1}{j\omega C_s/2}}{Z + \frac{1}{j\omega C_s/2}}$$

for the voltage on the right-hand terminals the impedance is

$$\frac{Z \cdot \frac{1}{j\omega C_s/2}}{Z + \frac{1}{j\omega C_s/2}}$$

The ratio of the voltages becomes:

$$\frac{E_1}{E_2} = \frac{Z}{(1 + Zj\omega C_s/2) (j\omega L_s + \frac{Z}{1 + Zj\omega C_s/2})} = \frac{Z}{Z(1 - 2\omega^2/\omega_0^2) + j\omega L_s}$$

When worked out further this gives for the phase angle φ_s between E_1 and E_2 the relation

$$\sin \varphi_s = 2 \frac{\omega}{\omega_0} \sqrt{1 - \left(\frac{\omega}{\omega_0}\right)^2} \dots \dots \dots (6)$$

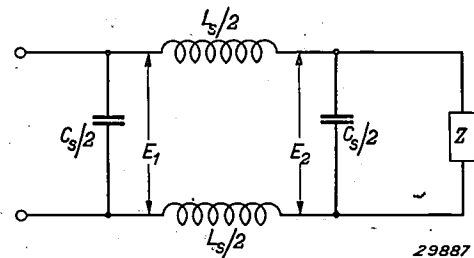

Fig. 2. Equivalent circuit for the loaded cable. A section length is considered as a cell of a low pass filter. C_s is the capacity of the cable per section, L_s is the self-induction concentrated in the loading coil, Z is the cable impedance. A phase rotation φ_s occurs between the voltages E_1 and E_2 .

A transition time for the wave of φ_s/ω corresponds to the phase rotation φ_s . For the distortion, however, it is not a question of the transition time of the waves, but of the "group transition time" of a finite wave train. The group transition time per section of the cable is

$$t_s = \frac{d\varphi_s}{d\omega}$$

With equation (6) one obtains

$$t_s = \frac{2}{\omega_0} \frac{1}{\sqrt{1 - \left(\frac{\omega}{\omega_0}\right)^2}}$$

and for the transition time over a length of cable l :

$$t = \frac{l}{s} \frac{2}{\omega_0} \frac{2}{\sqrt{1 - \left(\frac{\omega}{\omega_0}\right)^2}} \approx \frac{l}{s} \left(\frac{2}{\omega_0} + \frac{\omega^2}{\omega_0^3} \right) \quad (7)$$

For the difference in transition times between two frequencies equation (5) follows from the above.

On the basis of intelligibility tests the C.C.I.F. (Comité consultatif international des communications téléphoniques à grande distance) has prescribed that the "phase distortion" (the difference in group transition time) on international lines may not be more than 15 milliseconds when the frequencies 300 and 2400 c/s are taken for $\nu_1 = \omega_1 2\pi$ and $\nu_2 = \omega_2 2\pi$. For the maximum distance to be linked l_m in kilometres, when the cut-off frequency $\nu_0 = \omega_0 2\pi$ is calculated in kc/s the following value is found:

$$l_m = 30.4 \cdot \nu_0^3 \quad (8)$$

In table II the maximum distance calculated with this value is given for different types of loading, while equation (3) is represented graphically in fig. 3. While it is possible to raise the limit given by the differences in transition time by means of correcting networks, it nevertheless remains necessary to apply light loading for long distances. In loading with coils of 22 mH phase distortion is no longer felt, even at the greatest distances

Table II

Limitation of the distance bridged by phase distortion and transition time. Section length 1.83 km.

Loading with coil of (mH)	Cut-off frequency	l_m (km)	l'_m (km)
177	~ 2.85	700	2 500
22	~ 8.0	15 500	6 900
2.8	~ 21	> 100 000	17 000

³⁾ The precise specification states that the phase distortion may be 10 milliseconds for the frequencies 300 and 800 c/s and another 5 m sec for 800 cycles and the highest frequency used. For the latter a smaller value is taken here as actually applied, because, if equation (4) is also to be used for the 177 mH loading, the frequency must be sufficiently far below the cut-off frequency.

occurring. The higher cut-off frequency, which then automatically prevails, makes it possible to apply a 1+1 carrier-system. This is actually the way in which carrier-telephony developed: the great international lines were given a higher cut-off frequency, and this opened the way for the introduction of carrier-systems.

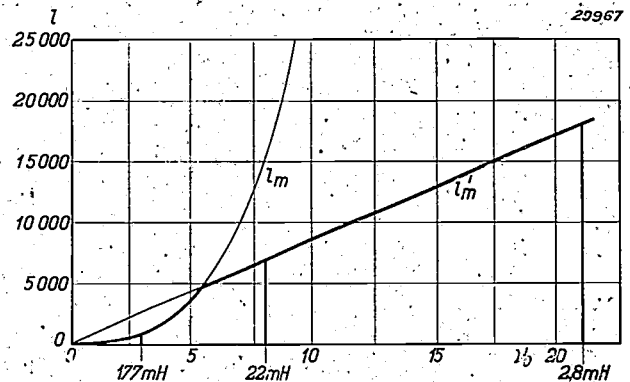

Fig. 3. Limitation of the distance to be bridged due to phase distortion and transition time. The maximum distance in km: $l_m = 30.4 \nu_0^3$ or $l'_m = 860 \cdot \nu_0$ is plotted as a function of the cut-off frequency ν_0 in kc/s. Below about 5 000 km the phase distortion, and above that distance the transition time is the dominating factor. The three cases of loading with coils 177 mH, 22 mH and 2.8 mH respectively are specially indicated.

With extremely long distances ($> 5 000$ km) there is an even stricter limitation of the permissible loading. The delay in arrival of the speech at the ear of the one spoken to, due to the finite speed of propagation of the speech frequencies along the cable, may lead to disturbances in the conversation even with transmission which is quite free of distortion. When the one speaking pauses, for instance, and his partner asks a question during the pause, the question only arrives after the first speaker has again begun to talk. It has been shown statistically that even with a transition time of 0.4 sec disturbances occur during the conversation in half of all the calls made. Therefore a time of 150 milliseconds has been fixed by the C.C.I.F. as a maximum permissible transition time t'_m for international communication. Here again it is not a question of phase distortion, but of group transition time. For loaded lines the following holds approximately for the transition time (see equation (7)):

$$t = \frac{l}{s} \cdot \frac{2}{\omega_0} \quad (9)$$

The distance which can be bridged when the maximum permissible transition time is taken into consideration is:

$$l_m = \frac{s}{2} t'_m \cdot \omega_0$$

With the above-mentioned value of t'_m and a cut-off frequency ν_0 in kc/s we obtain for l'_m in kilometres:

$$l'_m = 860 \cdot \nu_0 \dots \dots \dots (10)$$

This function is shown in fig. 3. The values of l'_m for several loadings are indicated in table II. It may be seen that with distances greater than 5 000 km loading which is not yet accompanied by inadmissible phase distortion already causes too long a transition time.

Furthermore it must also be taken into account that in case of insufficient matching or inaccurate tuning of the balancing network in the end stations⁴⁾ the speech frequencies may be reflected at the end of the cable, and then after a certain interval return to the speaker as an echo. With a given intensity this phenomenon is the more disturbing the longer the interval, and forms another restriction on the transition time⁵⁾, unless it is neutralized by means of so-called echo suppressors.

For these reasons the loading for linking the longest distances must be lighter than is prescribed by the phase distortion. In loading with 2.8 mH coils which are suitable for the purpose, the cut-off frequency is so high that 3 or 4 channels may be introduced above the low-frequency channel.

Influence of loading on the distance between repeaters

If we compare in fig. 1 the above-mentioned 2.8 mH loading with the heavy loading 177 mH coils, it is seen that the advantage to be derived from loading, namely decrease of the attenuation, has disappeared for the most part. The difference from the non-loaded cable does not appear very great, and it is natural to ask whether light loading for long distances really serves a useful purpose. Since a change to entirely non-loaded cables offers much more scope to carrier-telephony we shall give briefly the considerations which argue for the application of light loading.

The distance necessary between repeaters on a line depends upon the attenuation which may be permitted between two repeaters, and this latter in turn on the permissible transmitting and receiving level. The minimum receiving level required is determined by disturbances. A fundamental restriction is formed by the noise caused by the thermal motion of the electricity and the shot effect

in the amplifier valves. Of much greater importance, however, are the disturbances due to induction of external fields (near by high power lines, for instance) and to so-called cross-talk. The latter consists in the fact that the modulation of one conversation, whether or not intelligible as such, also becomes audible in other circuits or channels in the same cable.

Various causes of cross-talk may be pointed out:

- 1) the lack of linearity of the loading coils;
- 2) the mutual capacity between the different pairs of conductors;
- 3) the mutual induction effect.

It is clear that the non-linearity of loading coils leads not only to distortion of the speech, but in the case of carrier-telephony to cross-talk also between the different channels.

The harmonics of the speech frequencies occurring in the low-frequency channel fall in the carrier-channels, while the combination tones of different frequencies in one carrier-channel may appear as disturbances in the low-frequency channel. The disturbance increases when the amplitude of the speech currents on the loading coils in the line are increased. In order to keep this kind of cross-talk within permissible limits, therefore, the transmitting level must not be taken too high⁶⁾.

The mutual capacitive and inductive effects of the pairs of conductors is limited as much as possible by special construction of the cable.

There are two main types of construction. In the first type the quads consist of two twisted pairs of wires which are twisted together (D.M. cable), in the second type of four conductors which are twisted together in such a way that in a cross section the wires lie at the four points of a star (star cable). The mutual effects between two pairs and between the pairs and the phantom circuit (see below) are hereby very much decreased. In order also to limit the mutual influence between the quads, different degrees of twisting are chosen for the adjacent quads in one layer, and opposite directions of lay for successive layers in the cable.

In the case of four-wire lines the most important part of the remaining effect is the mutual effect of two pairs of opposite direction of transmission. This effect will be greater, the greater the difference of the speech levels of the two pairs in question. The maximum difference in level occurring is equal to the amplification applied in each repeater station; in the neighbourhood of a station the outgoing speech is amplified to the normal transmitting level, while the incoming speech has been subjected to attenuation by the length of cable through which

⁴⁾ See in this connection the article by Six and Mulders cited in footnote 1).

⁵⁾ The limits of the transition time set by the echo are given in the C.C.I. White Book, part I bis, page 148.

⁶⁾ We hope to return to these questions shortly in this periodical, and to discuss particularly measurements which have been carried out here with an artificial cable.

Table III
Attenuation and distance between repeaters in different cables for carrier telephony

Carrier-System	Type of Cable	Permissible amplification, in N	Non-loaded, 40 lbs cable		Loaded 40 lbs. cable			
			Attenuation per km at highest frequency in N	Possible distance between repeaters in km	Loading	Cut-off frequency in c/s	Attenuation per km at highest frequency in N	Possible distance between repeaters in km
1+1	One cable with separated quads	~4.5	0.09	50	H 22	8 000	0.026	170
1+4	One cable with separated quads	~4.0	0.11	36.5	H 2.8 B 4.6	21 000 23 500	0.065 0.045	60 90
1+4	two cables	~5.0	0.11	45.5	H 2.8	21 000	0.065	80

*) The letter H indicates that the section length $s = 1.83$ km, the letter B that $s = 0.915$ km.

it has passed. The permissible amplification is limited by this and by the other disturbances mentioned. The general disturbances by induction from the outside decrease sharply at high frequencies due to the increasing effectiveness of the screening by the cablesheath. In order to profit from this property which is very favourable for carrier-systems with many channels, every effort is made to decrease the cross-talk which increases at higher frequencies, by laying the cores of opposite directions of transmission in quite separate cables. But also in the case of one cable for both directions cross-talk, even at high frequencies, can be kept so low that a satisfactory amplification becomes possible. To do this the two branches of a four-wire circuit are not led to pairs of the same quad but to pairs which lie in different parts of the cable. The pairs which lie between then function as screening to some extent. Separate groups are thus formed for the two directions of transmission⁷⁾.

The maximum permissible amplification is given in table III for several cases. At the same time the table gives the attenuation per km of a non-loaded cable with 40 lbs conductors for the highest frequency to be used i.e. 5 700 c/s with the 1+1 system and 15 700 c/s with the 1+4 system of table I. From this follows the necessary distance between the repeaters which is given in the next column.

The normal distance between repeater stations for voice-frequency telephony is about 80 km with four-wire repeaters and 20 lbs conductors. It may be seen from the table that even with 40 lbs conductors the repeater stations of a non-loaded telephone line cannot be placed at this distance. Even with 55 lbs conductors which make the cable

quite expensive, this distance is not reached. If it is desired to use a normal distance between the repeaters of about 80 km — and this is desirable for economic and practical reasons — the attenuation of the cable must be reduced by suitable loading. The values for this are also given in table III. It may be seen that a distance between repeaters of 80 km is made possible by the loading. Only in the case of the 1+4 channel system in one cable the attenuation is still too high when the coils are placed at intervals of 1.83 km. In this case therefore heavier conductors would have to be used or a shorter section length, for instance 0.915 km.

Summarizing, we may say that loading with light coils such as those of 2.8 mH may be desirable and economical for long distances.

Different carrier-systems

While it has been found that for long distances only a light loading is desirable, and that with this loading carrier-telephony can be applied without making any sacrifices, the decision is not so simple for short distances. A comparison of several systems will show the truth of this statement. The cable loaded with 2.8 mH coils gives an attenuation of 0.12 N/km with 20 lbs conductors in the "flat" region (see fig. 1), that with 177 mH coils gives an attenuation of 0.02 N/km. This means that with the light loading in question the distance between the repeaters along the line would have to be six times as small, or the copper weight six times as great as with heavyloading.

However, what is lost, in a manner of speaking, in the height of the attenuation curve, is regained in the width of the flat region, by the possibility of more channels. With 2.8 mH loading, 1+4 channels can be used for every pair of quads. With every quad, however, there is an extra connection available, namely the phantom circuit where the two con-

7) If necessary, cross-talk can be further reduced by means of special compensating networks.

ductors of one direction of transmission are used together once more as a conductor, see *fig. 4*. Because the increasing cross-talk with higher frequencies between the phantom and the main

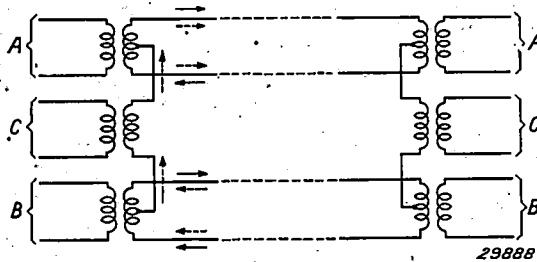

Fig. 4. One twin-core conductor provides three circuits: two main circuits *A* and *B* and the phantom circuit *C*.

circuit it is practically impossible to introduce more than one carrier-channel on these phantom circuits, so that only the 1+1 system can take advantage of this extra circuit. Two pairs may therefore provide three fourwire connections (two main circuits and one phantom circuit) with 177 mH coil loading⁸⁾; with 22 mH there can be six, since in each connection there can be one more carrier-channel, and with 2.8 mH there can be ten (by application of the 1+4 system in which the use of phantom circuits is no longer possible).

Over against this advantage of carrier-telephony is the necessity of more equipment in the terminal stations, which, especially in the case of short cables, may constitute an important part of the total expense. No general conclusion is possible which would point out a definite system as the most economical one, but for each case it is necessary to balance the different factors against each other. The decision will often be influenced by the presence of other lines on the traject in question and by the prospect of later expansion.

With multi channel carrier-systems still other

⁸⁾ The phantom circuit is of course again loaded, and in such a way that it is given the same attenuation as the main circuit. Since the ohmic resistance of the phantom circuit is about one half and the capacity less than twice the value in the main circuit, a smaller self-induction of the coils is sufficient, for instance 63 mH, with 177 mH in the main circuit. In this way one arrives at coils of 177/63 mH, and in the same way at 22/9 mH in the following case.

factors play a part. In England for example a 12 channel system is used for which frequencies up to about 60 kilocycles are necessary. The very high cut-off frequency required immediately excludes the above-mentioned normal loading, especially because with the ordinary section-length the necessary self-induction per section would already be smaller than the self-induction of the cable itself. Only with section-lengths reduced to $\frac{1}{3}$ or less, loading would provide any advantage in copper-weight or repeater-distance. It is, however, simpler in this case to use non-loaded cables. At the same time the latter have the advantage that when expansion of the number of calls becomes necessary, there is no sharp cut-off frequency which prevents increasing the number of channels.

Another example is the 9/17 channel system, developed by Philips. Frequencies up to 72 kilocycles are used. If 9 channels are included in this frequency range with a carrier-spacing of 8 kilocycles, the advantage is obtained that considerably simpler filters can be used for separating the channels. In the same frequency band, however, 17 channels can be included with carrier spacings of 4 kilocycles.

When non-loaded cables are used more care must be devoted to removing the linear distortion by means of balancing networks, as may be seen in *fig. 1*. At high frequencies the attenuation curve becomes flatter and flatter, which is understandable since at higher frequencies the condition $\omega L \gg R$ for formula (3) is automatically more and more satisfied. Balancing is therefore easier here. It is most difficult in the voice frequency region, especially in the case of long cables, because then an automatic compensation becomes necessary in the balancing networks for the dependence of the cable constants on the temperature. In this connection the omission of the frequency channel or its use only for short distances may mean a considerable simplification and saving. This is always done in multi channel carrier-systems and may even be considered in a system with only 4 carrier-channels.

⁹⁾ Although the resistance R also increases due to the skin effect, nevertheless $\omega L/R$ becomes steadily greater.

THE ROLE OF MERCURY LAMPS WITH FLUORESCENT BULBS IN PHOTOGRAPHY

by J. A. M. VAN LIEMPT.

621.327.3: 666.265 : 771.44

In a previous article¹⁾ we pointed out that ordinary mercury lamps, either high or super high pressure (HO or HP lamps) are unsuited for photographic purposes when a correct reproduction of colours is desired. The difficulty with these lamps is that they give too much blue and too little red radiation. This difficulty can be met, however, by providing the mercury lamp with a fluorescent bulb (HLP lamp), whereby the ultraviolet radiation of the discharge is transformed by means of a fluorescent substance on the inside of the bulb into visible radiation which consists in part of red radiation. The excess of blue and the lack of red of the ordinary HP lamp is hereby corrected. It may therefore also be expected that the photographic colour reproduction will be considerably better, especially when only panchromatic plates are used.

The tables below show the results of some measurements carried out with the Agfa colour chart with normal as well as special red-sensitive panchromatic material illuminated with the lamp HPL 300. For the sake of comparison we also give the colour reproduction with daylight, with light from the ordinary HP lamp and from the sodium lamp, and with sodium and mercury light combined in the correct proportion as previously discussed¹⁾.

From these results it may be seen that a very good colour reproduction may be obtained with HPL lamp and extra red-sensitive panchromatic material. This fact is also demonstrated in *fig. 1*.

A. Normal panchromatic material

Light source	Colour reproduction		
	red	yellow	blue
HP 300	50	70	160
Na light	120	120	40
Na + Hg light	90	90	90
HPL 300	70	70	100
Daylight	70	40	160

B. Special red-sensitive panchromatic material

Light source	Colour reproduction		
	red	yellow	blue
HP 300	50	70	160
Na light	120	110	40
Na + Hg light	90	90	90
HPL 300	90	90	90
Daylight	120	70	120

¹⁾ Philips techn. Rev. 2, 24, 1937.

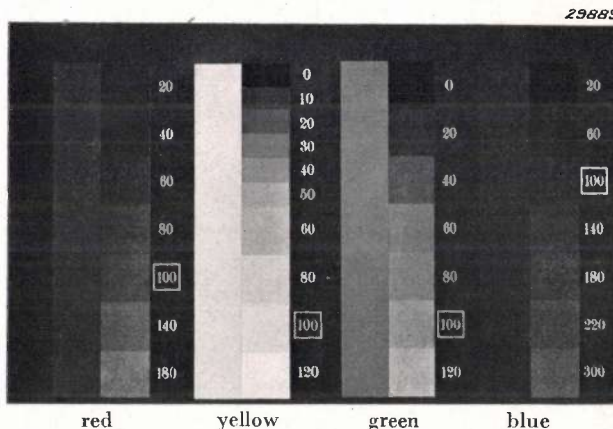

Fig. 1. Photograph of an Agfa colour chart on special red-sensitive panchromatic material, illumination by a mercury lamp provided with a fluorescent bulb.

The advantage of this lamp over the much used combination of mercury and sodium lies in the fact that only one lamp need be employed. However, one is confined to the use of a definite kind of plate, while with mercury-sodium light good results are obtained with ortho as well as panchromatic plates. It remains to be seen which light source is to be preferred; in any case, in view of the results given above, the new HPL lamp deserves the attention of every photographer.

ABSTRACTS OF RECENT SCIENTIFIC PUBLICATIONS OF THE N.V. PHILIPS' GLOEILAMPENFABRIEKEN

1330: J. Sack: Le transport du métal dans l'arc de soudure (Rev. univ. Mines 14, 439 - 443, June 1938).

In this lecture given at a congress in Liege (Febr. 1938), the way was discussed in which the transport of molten material from the welding rod takes place. For part of the material of this lecture we may refer to articles contributed by the author to this periodical (Philips techn. Rev. 1, 26, 1936, 2, 129, 1937), while the author intends to deal with the latest research on this subject in a coming article also in this periodical.

1331: J. Sack: Est-il logique de fixer une limite supérieure pour la résistance à la traction du métal d'apport dans les cahiers des charges (Rev. univ. Mines 14, 484 - 487, June 1938).

For the material of this lecture given at Liege (Febr. 1938) the reader is referred to: Philips techn. Rev. 3, 283, 1938.

1332: K. F. Niessen: Erdabsorption bei horizontalen Dipolantennen (Ann. Physik 32, 444 - 458, June 1938).

In the case of a horizontal infinitesimally small dipole aerial, above an earth considered flat, part of the energy emitted is absorbed by the earth. This part is calculated as a function of the height above the earth, the wave length, the dielectric constant of the earth and its conductivity.

The progress made with respect to earlier calculations on this problem consists in the fact that account may now also be taken of the finite conductivity of the earth's surface, while previously the earth had to be treated as a pure dielectric. The integrals which occur in the calculation can easily be worked out graphically for a definite kind of soil, wave length and height. The formulae obtained here are of importance in deciding whether a horizontal or a vertical aerial should be chosen with a given kind of soil and a given wave length for the sake of minimum absorption by the earth.

1333: J. H. de Boer: Atomic irregularities in simple compounds (Chem. Wbl. 35, 542 - 552, July 1938).

In this lecture, which was held in Amsterdam on April 21st 1938 to commemorate the 35th anniversary of the Netherlands Chemical Society, it was shown how our ideas on the subject of the transport of material and electricity through crystals of simple chemical compounds have developed in the last 35 years.

1334: F. M. Penning: The elementary processes taking place in the breakdown of gases between plane parallel plates (Ned. T. Natuurk. 5, 33-56, Mar. 1938).

In this article a survey is given of the phenomena which occur upon the setting in of an electrical discharge between large parallel plates. The manner in which the ionization coefficient depends upon the potential difference traversed per free path is dealt with. From this dependence an estimation is made for the case of oxygen of the number of negative ions formed by an electron per volt and per centimetre. The result obtained agrees satisfactorily with the results of direct measurements. For various gases and mixtures of gases it is possible to calculate what parts of the energy obtained by the electrons from the electric field are used for ionization, for excitation of electron levels or vibration levels, for elastic collisions and for the acceleration of electrons.

The different processes which produce new electrons are also discussed. For low values of the potential difference traversed per free path, it follows from the variation of the quotient of the number of ions freed by the cathode and the number of ionizations in the gas, that for air the positive ions probably pass over in larger groups (clusters), which are only able to free electrons to a smaller extent; for the rare gases the photoelectric effect becomes important in this region.

Several qualitative calculations are given on the question of whether the breakdown with long spark gaps and with overvoltage in air at 1 atmosphere must be ascribed to a collapse of the space charge or to thermal effects. Finally several remarks are made about the passage of sparks at very high and very low voltages.

Philips Technical Review

DEALING WITH TECHNICAL PROBLEMS
RELATING TO THE PRODUCTS, PROCESSES AND INVESTIGATIONS OF
N.V. PHILIPS' GLOEILAMPENFABRIEKEN

EDITED BY THE RESEARCH LABORATORY OF N.V. PHILIPS' GLOEILAMPENFABRIEKEN, EINDHOVEN, HOLLAND

LAMPS FOR LIGHTHOUSES

by TH. J. J. A. MANDERS and L. J. van der MOER.

621.326.7 : 627.92

The conditions are discussed which must be fulfilled by a source of light intended for use in a normal lighthouse optical system. Light distribution curves are given of several electric filament lamps developed especially for use in lighthouses. The effective luminous intensity and optical range are discussed which are attained in a lighthouse optical system with different kinds of filament lamps.

Introduction.

From the bonfires lighted on the shore to guide the navigator in the dark, a network of lighthouses has been developed through the years to serve as beacons in navigation. In the previous century these lighthouses were lighted with paraffin lamps and various kinds of incandescent gas burners, but in the last few decades there has been a gradual change over to electric filament lamps for this purpose. The construction of lighthouse lamps was continually improved, due to the technological advances made, until one of the most recent types contains a doubly spiralized filament for 4.2 kW.

In addition to the source of light, the optical system of the lighthouse is also important, that is the combination of lenses, prisms and, in some cases, mirrors which provide for the formation of a satisfactory beam. In this article we shall first discuss the optical system in order to show what conditions must be satisfied by the source of light when it is used in combination with the ordinary lighthouse optical systems.

Formation of the beams of light

There are two kinds of lighthouse lights, stationary and revolving. In the case of a stationary light the lighthouse sends out its light uniformly distributed in all directions in a horizontal plane, so that the whole horizon is always uniformly illuminated. If all lighthouses were provided with such a stationary light it would be difficult to distinguish one from the other. By having large lighthouses which send out only a few, slightly divergent beams, while the whole optical system revolves slowly, the observer at any point on the hori-

zon will observe flashes of light at regular intervals. Each light may be given an individual character by making the length of the successive intervals different for each lighthouse. Moreover because of the concentration of the light in a few narrow beams a much greater optical range of the light is obtained.

In order to form the beams, emitted by a lighthouse, use is made of lenses and prisms which are combined in a special way and make up the optical system of the lighthouse. For a stationary light an optical system is necessary which is rotationally

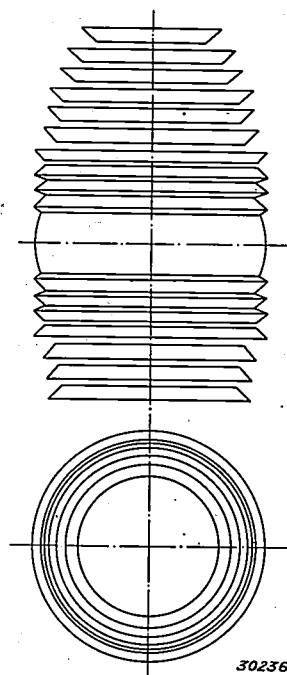

30236

Fig. 1. Barrel-shaped optical system for a stationary light.

symmetrical around a vertical axis (see the barrel-shaped system shown in *fig. 1*). The main cross section through this lens is shown in *fig. 2*. The cylindrical echelon lens (*MN*), of which

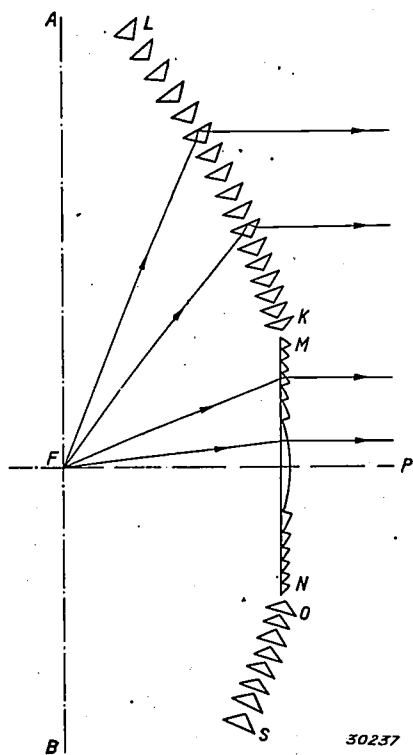

Fig. 2. Cross section of a lighthouse optical system. *F* is the focus, *MN* an echelon lens. *KL* and *OS* are prismatic rings. *AB* is the vertical through the focus.

the vertical line *AB* through the focus *F* is the axis of revolution, consists of a middle section with several ring-shaped sections of lens arranged in steps at the top and bottom; all the rays which pass through this lens from the focus are refracted in such a way that they leave the lens in a horizontal direction. The lens *MN* is flanked at the top (*KL*) and bottom (*OS*) by a number of prismatic rings with *AB* as axis, at the rear surface of which the rays of light are totally reflected, and which are arranged in such a way that the rays from *F* leave the optical system in a horizontal direction.

A revolving optical system consists of several panels each of which provides for the formation of one beam. Such an optical panel can be obtained by causing the cross section in *fig. 2* to rotate around *FP* as an axis. The panel shown in *fig. 3* is then obtained, and is composed of a Fresnel lens surrounded by a number of prismatic rings with *FP* as an axis. The different parts of this optical system are so arranged that all the rays from the focus leave the system parallel to the main axis. If a number of such panels are joined side by side with a common focus around the axis of rotation *AB*, the

light emitted by the source in all directions is used effectively to make up the beams of the lighthouse except for a very small part which is lost.

The beam of light formed by such an optical panel is composed of two different parts:

- 1) the part formed by the lens, and
- 2) the part contributed by the prismatic rings.

The form and position of the source of light affect these two components in quite different ways. If standing immediately in front of the panel one observes the source through a small hole in a screen, so that only a small portion of the surface of the lens contributes to the beam, the source of light may plainly be seen in an upright position through every element of surface of the Fresnel lens. The images which are seen through different surface elements of the lens differ only slightly.

If, however, a surface element of one of the prismatic rings is observed the image of the light source seen depends very much upon the position of the element of surface chosen. If only elements of surface in the neighbourhood of the horizontal bisector of the panel contribute to the formation of the beam the light source is seen upright, surface elements in the neighbourhood of the vertical bisector of the panel give an inverted image, while through surface elements at 45° to one of the former directions the light source is seen lying on one side or the other, thus turned through an angle of 90° .

Since the surface elements of the prismatic rings

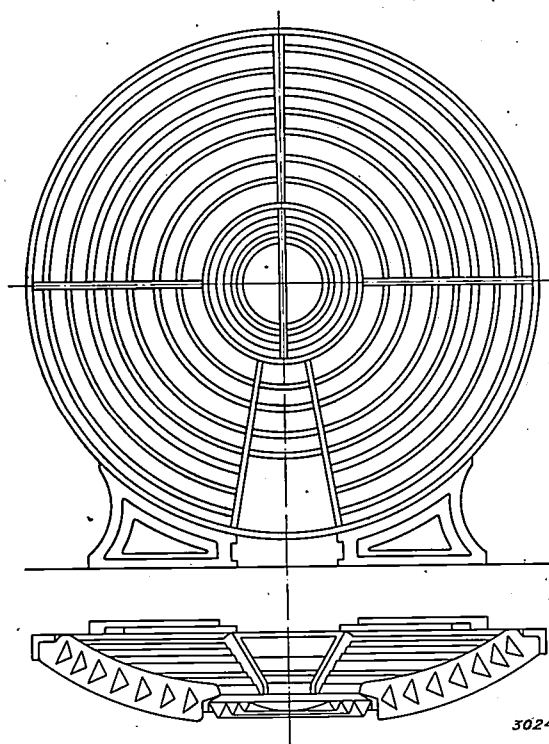

Fig. 3. An optical panel obtained by allowing the cross section in *fig. 2* to rotate around *FP* as axis.

lie so far outside the main axis, one looks through them at the light source in a direction which makes a fairly large angle with the main axis. A certain amount is also contributed to the total light beam given by the prismatic rings by very different projection figures of the source. Although the light source is not an uninterrupted surface of uniform brightness the light intensity of the total beam sent out by the optical system does not change very much over the core of a perpendicular cross section, since we are concerned with the sum of the contributions of all these different component beams.

In the case of lighthouse lights, a beam is considered homogeneous if the light intensity curve in a plane through the axis of the beam is a trapezium, so that the light intensity is constant throughout the core of the beam. It is customary to call the angle of divergence within which the light intensity does not vary, the spreading of the beam.

The beams of lighthouses should be as homogeneous as possible. The ideal would be to have a sphere of constant brightness as source, but with suitable forms of light source the above-described optical systems can give a fair approximation of a homogeneous beam of light. The spreading of a beam which is emitted from the whole panel is determined by the spreading of the outermost prismatic rings, and depends further upon the shape of the light source. In constructing a light source for a lighthouse therefore the requirements must be taken into account which will be made as to homogeneity and spreading of the beam.

Brightness of the source of light

If we assume that the light source is situated at the focus of a lens, or of a mirror in some cases, the light intensity of the beam emitted through this optical system is proportional not only to the solid angle of divergence of the system but also to the average brightness¹⁾ of the source of light. In order to increase the intensity of the beam, attempts have been made not only to increase the surface of the lens but also the brightness of the sources of light. Since the brightness of light sources has been so much increased in recent years, it has become possible to obtain satisfactory light from lighthouses without very large and therefore very expensive panels.

The brightness of the paraffin lamps with six wicks was only about 10 c.p./sq.cm, that of in-

candescent paraffin burners was already about 40 c.p./sq.cm.

In addition to these sources of light electric arcs are also used in lighthouses, but they have practical disadvantages in spite of the fact that they may attain very high brightnesses of up to 10^5 c.p./sq.cm in the case of the high-intensity arc. A very important objection to the use of electric arcs in lighthouse optical systems is the fact that the arc does not occupy a stationary position on the electrode, so that the centre of the light source is not always situated with sufficient accuracy at the focus of the optical system, with the result that the correct formation of the beams is very much disturbed. Now that electric filament lamps specially developed for lighthouses are available, which do not need constant supervision, it is naturally considered to be a great objection that electric arcs must be constantly supervised. In the lighthouse at Creach d'Ouessant on the west coast of Brittany, constructed by the firm of Barbier Benard and Turenne of Paris, and shown in *fig. 4* extremely intense arc lamps have never-

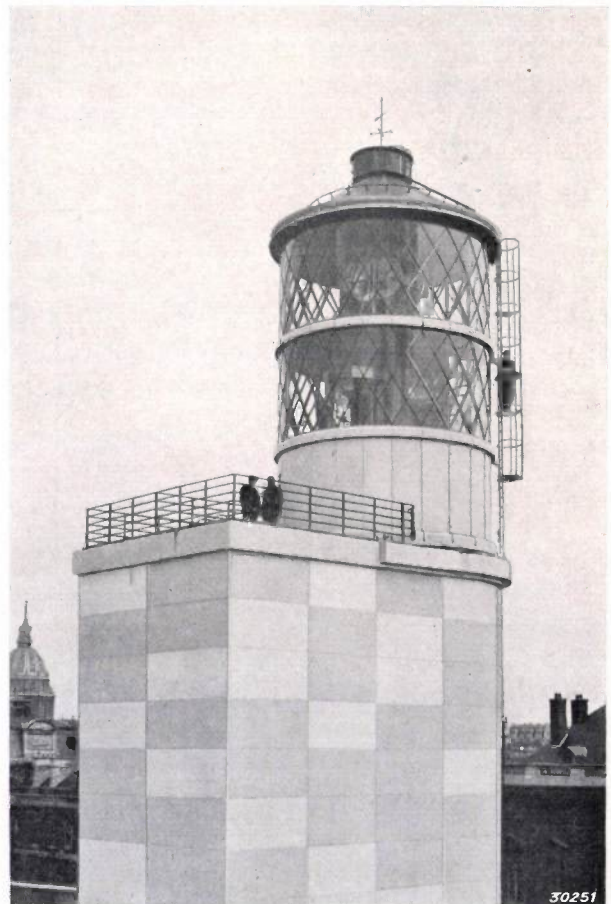

Fig. 4. The upper part of the lighthouse constructed by the firm of Barbier, Benard and Turenne of Paris at Creach d'Ouessant on the west coast of Brittany.

¹⁾ By average brightness is meant the light intensity of the light source measured in the direction of the axis of the beam, divided by the area of the cross section perpendicular to this direction.

theless been installed for very bad weather conditions. These lamps, however, are so very expensive in use that in more favourable weather they are replaced by considerably cheaper electric filament lamps for 110 volts, 3 000 W.

The water-cooled super high pressure mercury lamps have a high surface brightness (for instance $3 \cdot 10^4$ c.p./sq. cm) which approaches that of the high-intensity arc, without the disadvantage of mobility of the centre of the light source possessed by the crater of the electric arc. Nevertheless this water-cooled mercury lamp cannot immediately be installed in the existing lighthouse optical systems, because it is so slender and linear in form and must in addition burn in a horizontal position. It may perhaps be found possible to use the super high pressure mercury lamp as a light source in lighthouses by using several mercury lamps together or by combining several optical systems.

From its foundation in 1909 the Testing Station of the Netherlands Lighthouse Service has always tried to adapt new light sources with higher surface intensities for use in existing lighthouse optical systems²⁾. The incandescent paraffin burners were improved with this purpose in view, and attempts were also made to construct suitable light sources out of Nernst rods. After the appearance of the gas-filled electric lamp with a spiralized filament, these lamps were adapted for use in lighthouses, in collaboration with Philips. The problem was here to construct a filament system whose projections in different directions have as nearly as possible an equally large radiating surface which forms a well-connected whole, while the focus lies in the centre. This could for example be approximated by similar filaments mounted in three mutually perpendicular planes, but since this could not be carried out technically, the filaments were hung in only two vertical planes perpendicular to each other and the third horizontal plane was omitted.

A lamp with such a "cross-shaped" filament system was first constructed in 1918 for 108 volts, 20 A. Since at that time some difficulty was experienced with sagging of the filament, the filament system had to be made 2.5 times as wide as its height. With these first electric filament lamps for lighthouses an average brightness of 450 c.p./sq. cm was already obtained, which meant almost a tenfold improvement over the ordinary Pharoline incandescent lights of those days, which had a brightness of about 50 c.p./sq. cm. In the further

development of these lamps with cross-shaped filament system two standard types have been evolved, namely for 80 volts, 30 A, and for 80 volts, 50 A. Since these 4 kW lamps have proved their usefulness especially in the well-known Brandaris lighthouse at Westerschelling which is shown in *fig. 5*, they are often called Brandaris lamps.

When the difficulties connected with the sagging of the filaments had been overcome, cylindrical filament systems could be made for lighthouse lamps, whose projections in different directions more nearly approached the ideal of continuous incandescent surfaces of the same size and brightness. The surface brightness was further increased during the course of years by increasing the temperature of the filaments. Since in the course of years also a method of treating tungsten wires was learned by which better recrystallization is obtained, the most modern lighthouse lamps are now fitted with doubly spiralized filaments.

Filament systems

The filament systems now in use may be divided into three main classes (*fig. 6*) namely:

A Cone-shaped filament systems of singly spiralized wire, all parts of which are connected in series.

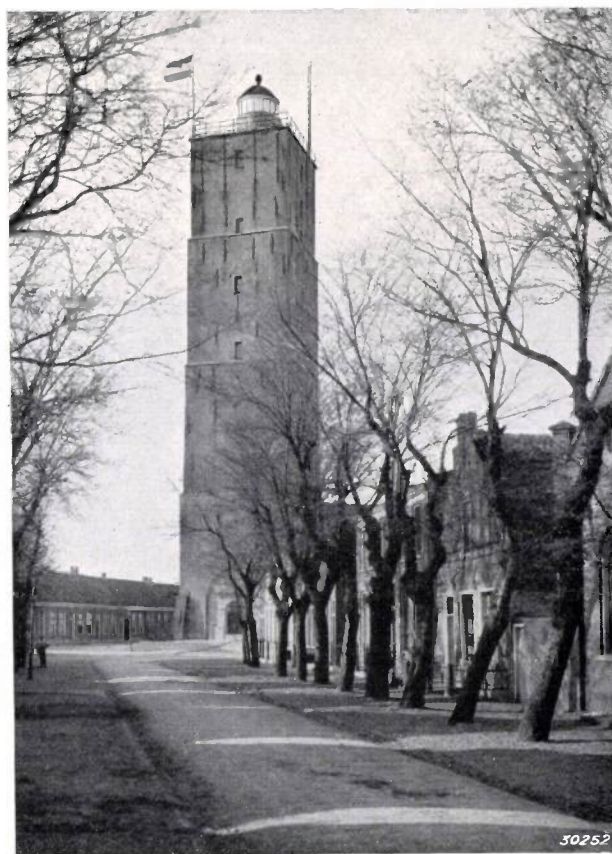

Fig. 5. The lighthouse Brandaris at Westerschelling.

²⁾ Cf. No. 1 of the literature.

B Cylindrical filament systems of singly spiralized wire which may consist of one (B1) or more (B2 and B3) circuits.

C Doubly spiralized filament systems.

In the following we shall deal with systems B and C. If the cylindrical filament system is divided into two equal current circuits (B2), these circuits may be connected in series as well as in parallel. A lamp for 100 volts, 60 A may therefore burn on 100 volts with 60 A as well as on 200 volts with 30 A. If the two parts are connected in parallel, then as a rule when one of them is defective the other continues to burn. Since it is important to keep points with a large potential difference as far away from each other as possible, the lamps are connected according to the scheme indicated in fig. 7. The opposite end-points M of the two windings are always connected to each other and led out together, while the other two end-points are connected separately to P and Q. A direct or alternating voltage of 200 volts is applied between

P and Q, so that M automatically reaches a potential which is half of that between the ends. A direct or alternating voltage of 100 volts is, however, applied between M and the points P and Q which

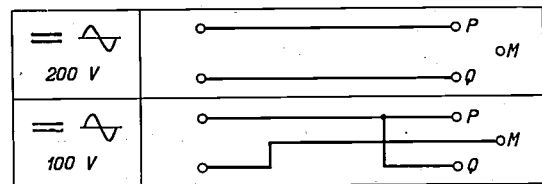
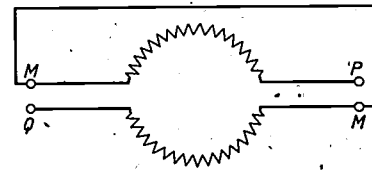

30239

Fig. 7. Circuit diagram for a lighthouse lamp consisting of two current circuits. The lamp can be connected to direct or alternating voltage of 200 or 100 volts.

are then connected to each other. Between two points of the filament lying close together there is therefore never a greater potential difference than 100 volts.

Especially for high power consumption it is very important to use a lighthouse lamp which exerts an equal load on the three phases of the ordinary three-phase mains. Therefore, for powers of 1 500, 3 000, 6 000 and 10 000 W, lamps have been developed with filament systems divided into three equal parts (fig. 6, B3). Such a lamp is shown in fig. 8. A similar lamp for 110 volts 3 kW is used in favourable weather in the lighthouse on the westcoast of Brittany shown in fig. 4. From the circuit diagram of fig. 9 it may be seen that these three-phase lamps can be connected to a direct and alternating voltage as well as to a star connection of 110 volts. For lighthouses which must often be supplied with current from a very distant source, these three-phase lamps also mean a saving in the cost of the supply lines since they are more evenly loaded than when a lamp with two current circuits is connected to a three-phase network.

Doubly spiralized filaments (fig. 6C) are now used in lighthouse lamps (fig. 10) for 70 volts, 60 A as well as for 60 volts, 50 A.

In fig. 11 the polar luminous intensity diagram is given for this lamp for 3 kW, while for comparison fig. 12 shows the same diagram for a lighthouse lamp with a cylindrical filament system for 60 volts, 50 A. It may be seen clearly from these figures that with the doubly spiralized filament, while higher intensities of light are obtained, the intensity is less

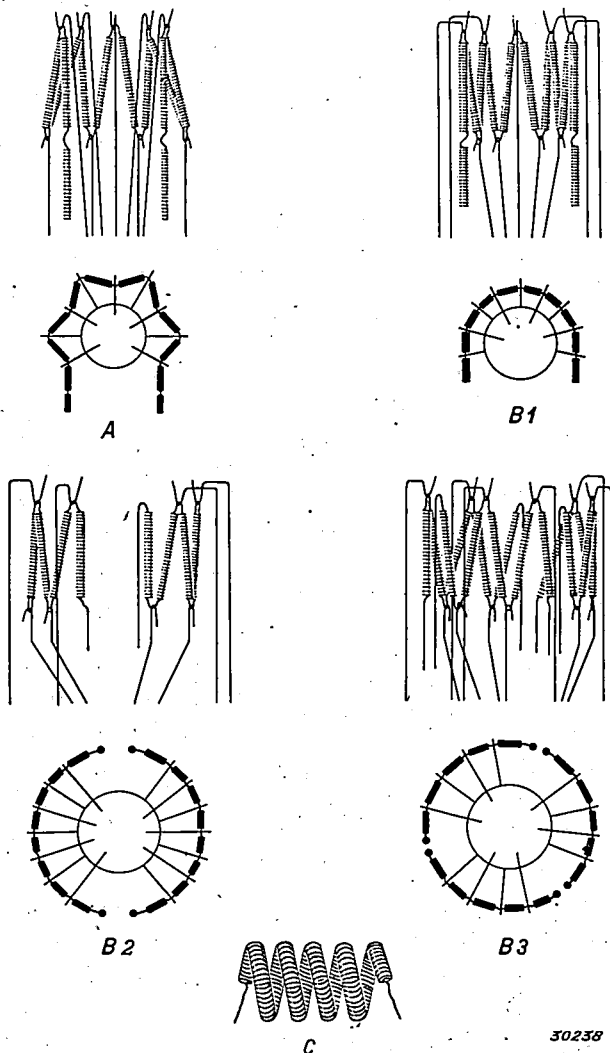

30238

Fig. 6. Filament systems. A conical, B cylindrical, consisting respectively of 1, 2 or 3 current circuits. C doubly spiralized.

evenly distributed over the whole circumference than in the case of the cylindrical system. Fig. 13 shows the doubly spiralized filament seen from different angles in the horizontal plane³⁾. With each photograph the angle of observation is given in degrees⁴⁾ (cf. fig. 11), the luminous intensity in candle power, the projected surface in square centimetres and the average brightness in c.p./sq. cm. Since experience has shown that better results are obtained in lighthouses with doubly spiralized filaments than with other lamps having the same or even somewhat greater power, we shall deal with this point in more detail in the following.

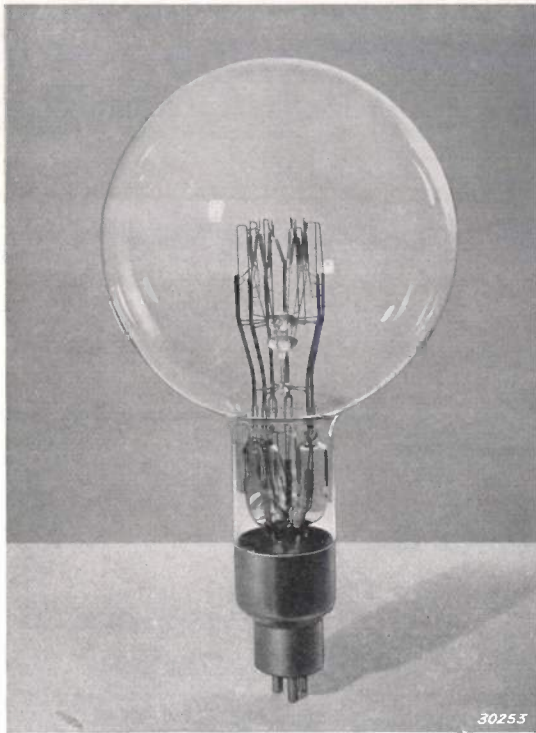

Fig. 8. Lighthouse lamp consisting of three current circuits in order to load the three-phase mains symmetrically.

Comparative measurements on lamps with different filament systems⁴⁾.

The Testing Station of the Netherlands Lighthouse Service has carried out measurements on five lamps with different filament systems, namely: 1 lamp with a cross-shaped filament system, 2 lamps with a cylindrical filament system and 2 lamps with doubly-spiralized filaments.

These lamps were placed one after another at the focus of an optical panel and the distribution of the light in the beam emitted was measured. The dimen-

³⁾ Cf. Nos. 4 and 5 of the literature.

⁴⁾ Although somewhat different values are valid for the lighthouse lamps now being manufactured, the original data are given here since they give a sufficiently correct impression.

sions and other data of these lamps are given in the following table together with the maximum, luminous intensities of the beams.

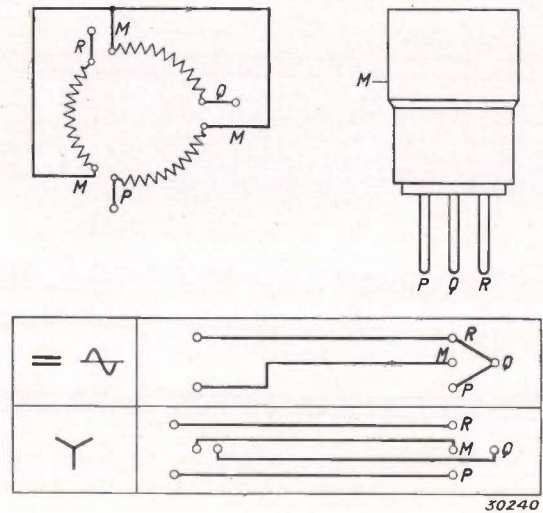

Fig. 9. Circuit diagram for a lighthouse lamp with three circuits which can be fed with direct or alternating voltage, but which is especially constructed to produce a symmetrical loading of three-phase mains in star connection.

Effective luminous intensity of a lighthouse

By the effective luminous intensity of a lighthouse with a rotating optical system, sometimes called the light value, is understood the intensity of a

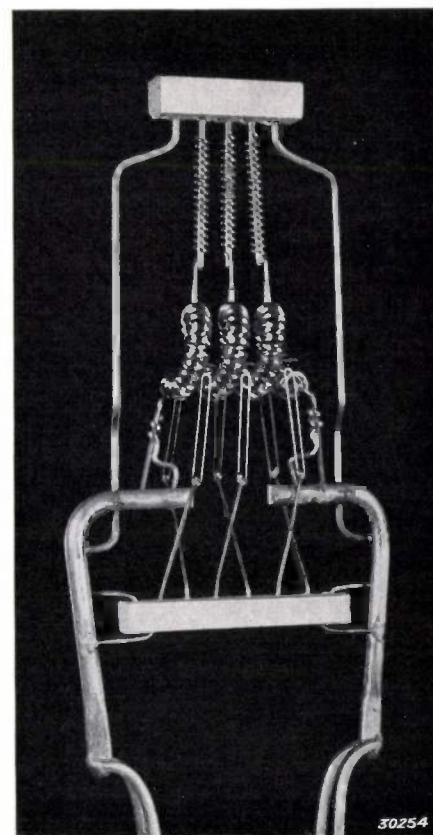

Fig. 10. Doubly-spiralized filament for a lighthouse lamp.

stationary light which can be observed from an equally great distance.

As is known, the light impression received from a source of light does not depend exclusively upon

of the order of magnitude of 0.1 sec. which must be determined experimentally.

Formula (1) only holds strictly at the limit of visibility, *i.e.* in the neighbourhood of the thresh-

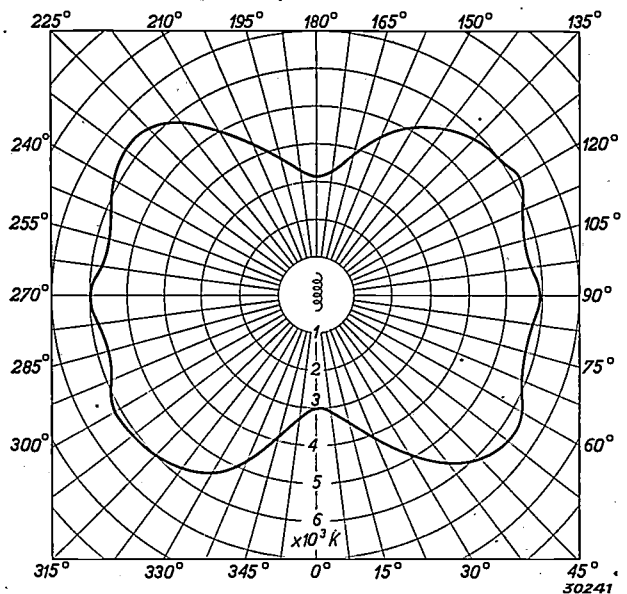

Fig. 11. Polar diagram of light intensity, measured in the horizontal plane, of a lighthouse lamp with a doubly spiralized filament for 60 volts, 50 A.

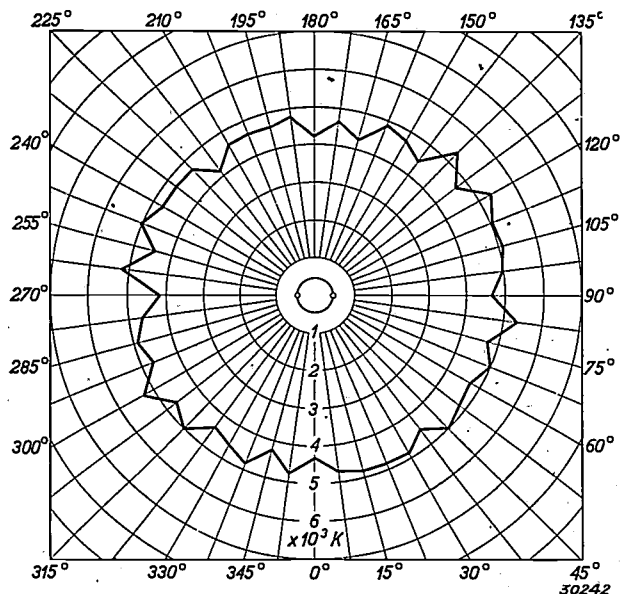

Fig. 12. Polar diagram of light intensity, measured in the horizontal plane, of a lighthouse lamp with a cylindrical filament system for 60 volts, 50 A.

the intensity of the light, but also upon the time during which the impression lasts. It used to be believed that a flash of light lasting 0.1 sec gave the same light impression as a fixed light of the same intensity, but it was found later that this is only true when the flashes of light last longer than 1 sec. Blondel⁵⁾ and Rey have shown that, for the case where the luminous intensity *I* is constant, as long as the light is present, the effective luminous intensity *I_e* can be determined by the formula

$$I_e = \frac{I t}{c + t} \dots \dots \dots (1)$$

where *t* is the duration of one flash and *c* is a constant

⁵⁾ Cf. No. 6 of the literature.

hold value of the light impression. As the threshold value of the intensity of illumination presented by a point source of light to the eye the value $2 \cdot 10^{-7}$ lux is internationally established; this is by no means an extreme value but a value which may confidently be used under the most unfavourable conditions in the dark. Under favourable conditions the actual threshold value may amount to only one-twentieth of this value!

It is not easy to determine accurately the value of the constant *c*. In practice, however, very usable results are obtained, when, for lighthouses with a trapezium-shaped light distribution, formula (1) is used with *c* = 0.15, and *t* is taken as the total duration of the flash and *I* the maximum luminous

Lamp No.	Filament system	Width	Height	Voltage	Power	Light	Brightness	Maximum candle power of beam
		mm	mm	volts	watts	lumens	c.p./sq.cm.	10 ⁶ c.p.
1	cross-shaped	28.0	28.0	80	3 892	67 300	865	2.3
2	cylindrical *)	23.4	23.0	110	3 770	69 000	1 280	2.46
3	cylindrical *)	22.5	24.0	60	2 961	49 800	920	1.56
4	doubly-spiralized	23.5	21.2	70	4 200	84 100	1 680	4
5	doubly-spiralized	19.5	17.2	60	2 907	59 900	1 720	3.5

*) Lighthouse lamps have since been constructed with cylindrical filament systems with a power of 4 and 3 kW respectively and a light flux of 78 000 and 54 000 lumens respectively, which have a brightness of 1400 and 1030 c.p./sq.cm, and which in use may be expected to give a somewhat higher intensity of the beam when used in the same optical system as the cylindrical filament systems mentioned in this table.

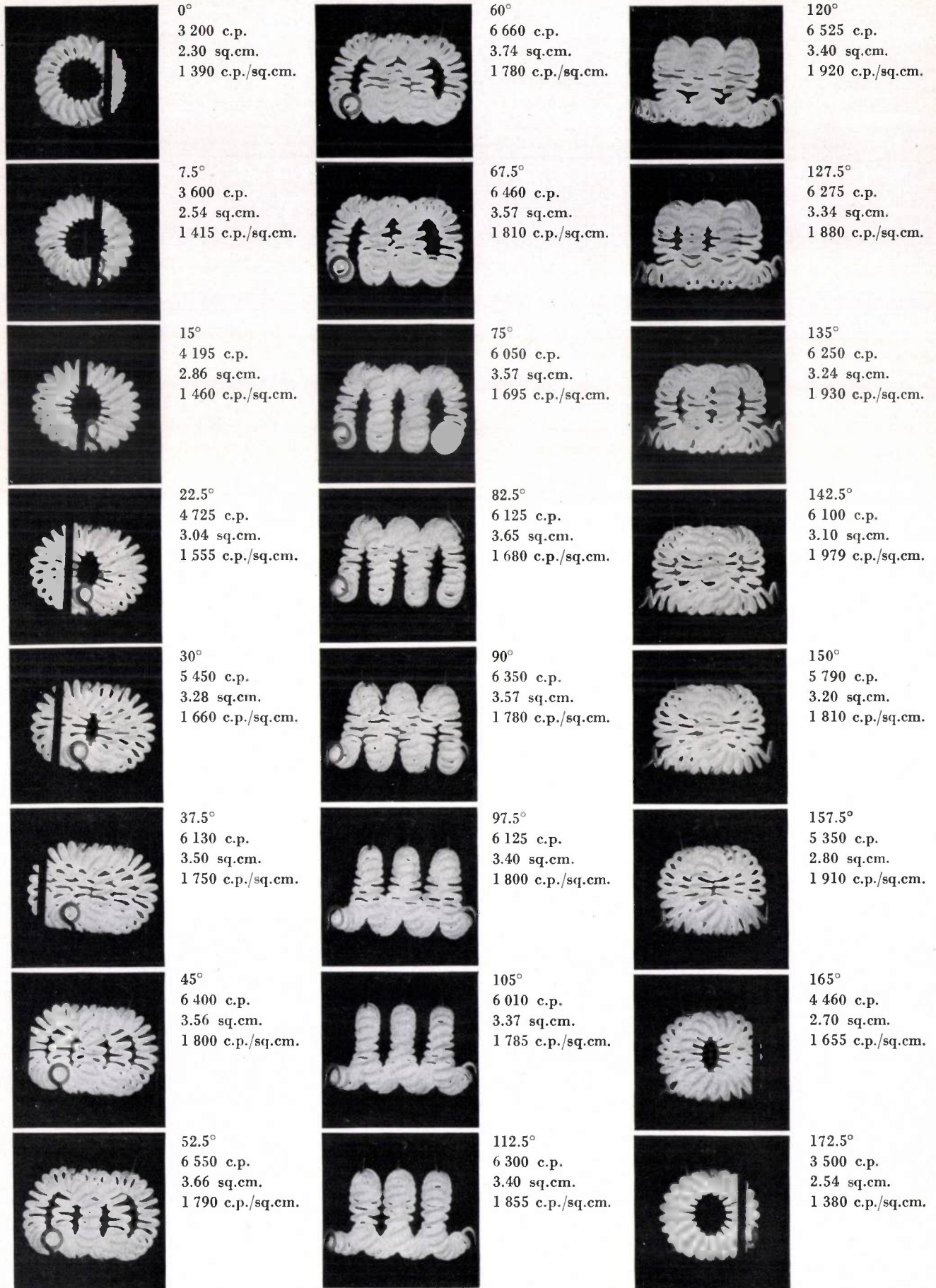

Fig. 13. Doubly spiralized filament seen from different angles in the horizontal plane (cf. fig. 11). With each picture the angle is indicated at which the picture is taken, the candle power, the projected surface in sq. cm and the average brightness in c.p./sq.cm.

intensity I_m which occurs at the core of the beam. Although the third International Lighthouse Conference in Berlin did not accept formula (1), it is nevertheless used on a large scale, since the results have been found reliable. We shall therefore continue to use formula (1) in this article.

If d represents the diameter of the incandescent body and f the focal length of the optical system, and therefore also the distance between source and optical panel, the small angle within which the optical panel transmits light is equal to d/f radians. If the whole optical system makes n revolutions per minute, the duration of a flash is given by:

$$t = \frac{d/f}{2 \pi n} 60 \text{ sec.} \dots \dots (2)$$

When a maximum light intensity I_m has been determined in the laboratory, then in normal use it must be taken into account that about 15 per cent of the intensity may be lost by blackening of the lamp and possible burning at too low a voltage, while about 10 per cent is absorbed by the framework of the lighthouse windows and 10 per cent more by all the glass. A total factor of 0.7 is calculated for this weakening⁶⁾. For the effective luminous intensity we therefore finally obtain the formula:

$$I_e = 0.7 \frac{t}{0.15 + t} I_m \dots \dots (3)$$

Since for this determination of the effective luminous intensity I_e use must be made of somewhat uncertain factors, a maximum luminous intensity, $0.7 \cdot I_m$, is given, taking into account the absorption, which maximum is however always much higher than I_e . For a constant effective luminous intensity $I_e = 1.5 \cdot 10^6$ c.p. it is shown in fig. 14 how the maximum intensity varies with the duration t of the flash⁷⁾, when c is taken equal to 0.15. For large values of t , $0.7 \cdot I_m$ is found to approach I_e as an asymptote. For durations of more than 1.4 sec the light intensity $0.7 \cdot I_m$ of a rotating light is found to be less than 10 per cent higher than its effective light intensity I_e .

The maximum light intensity of the beam is proportional to the brightness of the source, which can be represented by the quotient of the intensity i of the source and its projected surface S . This latter is proportional to the square of the diameter d of the source. Since the flash time t is proportional to this diameter, the effective intensity I_e is found

to be proportional to the product of i/d^2 times $d/c'+d$ so that I_e is proportional to

$$\frac{i}{d^2} \cdot \frac{d}{c' + d} = \frac{i}{d(c' + d)} \dots \dots (4)$$

It is therefore possible to increase the effective intensity of a lighthouse lamp with the same intensity of the source by making the filament system as concentrated as possible. If care is taken that $i/d(c' + d)$ remains constant, lighthouse lamps can be constructed which, in the same optical system, have the same effective intensity as higher powered lamps with a less concentrated filament system. On the basis of these considerations it could be expected that especially in lighthouse lamps the application of doubly spiralized filaments with their great brightness and small projection image would meet with much success.

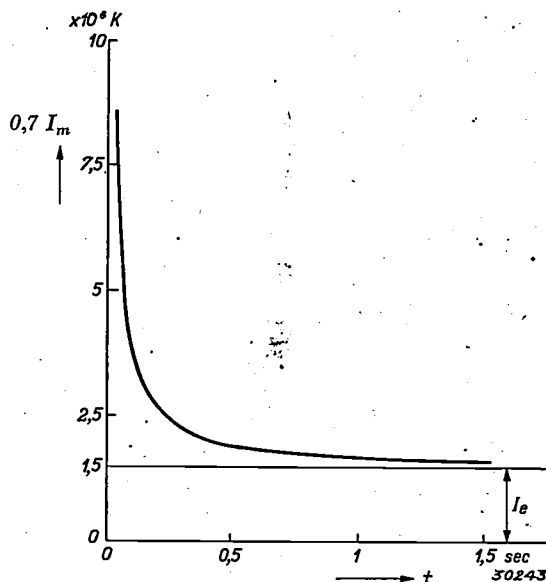

Fig. 14. The maximum light intensity $0.7 I_m$ in c.p. as a function of the duration of a flash t in sec, necessary to obtain an effective light intensity $I_e = 1.5 \cdot 10^6$. This relation is represented by formula (3).

Optical range of a lighthouse

For a navigator it is very important to know at what point a given lighthouse must come into his field of vision. This of course depends not only upon the effective light intensity I_e of the lighthouse, but also, among other factors, on the coefficient of transparency a of the air, i.e. the fraction of the light which is transmitted through unit distance⁸⁾ in air. If A represents the smallest intensity of illumination which the eye can just observe, and x the optical range in metres, i.e. the greatest

⁶⁾ Cf. No. 2 of the literature.
⁷⁾ Cf. No. 6 of the literature.

⁸⁾ As a matter of fact distances are expressed by sailors in miles (1855 m). For this rather theoretical considerations we prefer, however, to use the metre as the unit of length.

distance at which the light can just be observed with a given atmospheric condition, then, due to the spherical propagation of light, there is the following relation between these two quantities:

$$A = \frac{I_e a^x}{x^2} \dots \dots \dots (5)$$

Usable results are obtained with this formula if A is taken equal to $2 \cdot 10^{-7}$ lux; formerly the value 10^{-7} lux was used, and instead of the effective the maximum intensity was used, so that formula (5) appeared to be less useful than it actually is.

Visibility curves ⁹⁾.

Since 1907 observations have been made regularly in the Netherlands on the optical range of the different lighthouses in all kinds of weather conditions, so that much empirical data on this subject are available. In practice so-called visibility curves are often used, which may be derived in the following way from formula (5). The formula is written in the logarithmic form:

$$\lg \frac{A}{I_e} = \lg \frac{a^x}{x^2} = \lg \frac{1}{x^2} + x \lg a \dots \dots (6)$$

The following curve may easily be drawn:

$$y = \lg \frac{1}{x^2} = -2 \lg x, \dots \dots \dots (7)$$

as has been done in *fig. 15*. In addition the straight lines:

⁹⁾ Cf. Nr. 2 and 3 of the literature index.

$$y = (-\lg a) x + \lg \frac{A}{I_e} \dots \dots \dots (8)$$

have also been drawn, which cut the y-axis at points $y = -\lg I_e/A$ and have a slope whose tan-

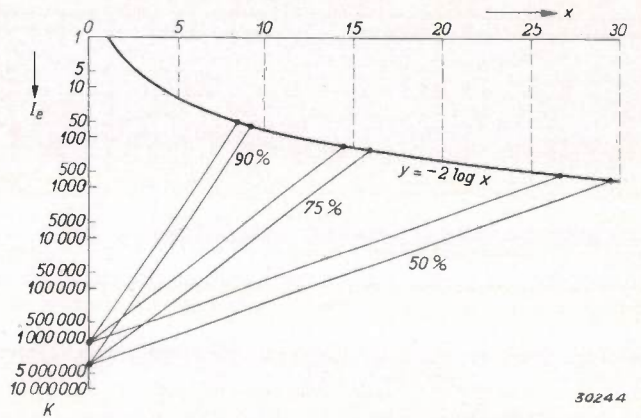

Fig. 15. The optical range x in nautical miles (1 nautical mile = 1855 m) is found as the point of intersection of the curve: $y = -2 \log x$ (formula (7)) with one of the straight lines (formula (8)) whose slope depends only on the transparency of the atmosphere. The intersection of these lines with the negative y-axis is determined by the effective light intensity I_e in candle powers plotted on a logarithmic scale along this axis.

gent is $-\lg a$, which thus depends upon the atmospheric condition. On the negative y-axis the effective light intensity I_e is plotted on a logarithmic scale, while the x-axis is marked off in a linear scale of nautical miles. The optical range of a given lighthouse under given atmospheric conditions is then given by the abscissa of the point of intersection of the curve of formula (7) with one of the straight lines of formula (8), whose intersection

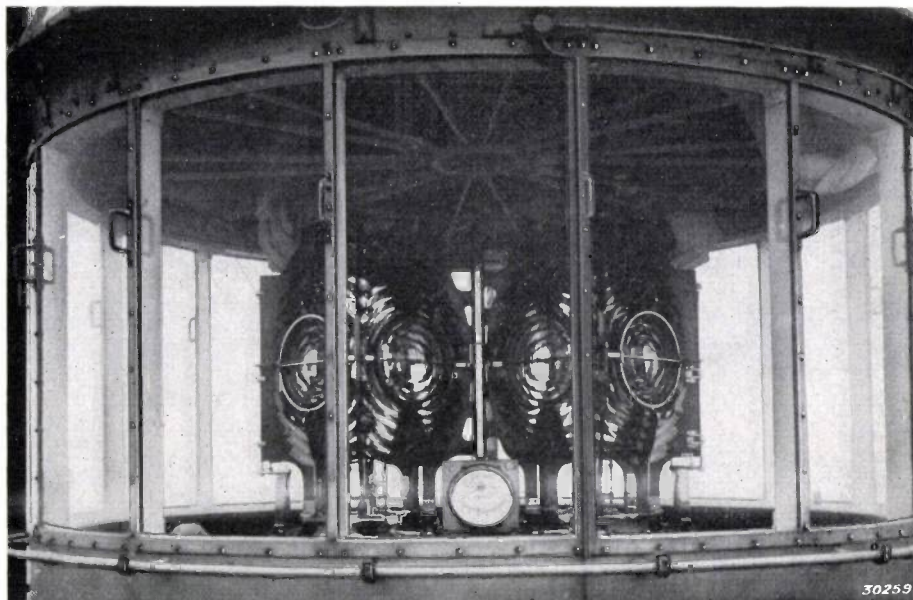

Fig. 16. The double optical system of the Brandaris, the ray diagram of which is drawn in *fig. 17*.

No.	Filament system	Prescribed power	Duration of flash	Maximum light intensity		Effective light intensity	Effective light intensity per optical system per 1 000 W
				per optical system	total		
				10 ⁶ c.p.	10 ⁶ c.p.		
1	cross-shaped	4 000	0.30	2.3	4.6	2.14	0.275
2	cylindrical	4 000	0.244	2.78	5.56	2.42	0.302
3	"	3 000	0.234	1.69	2.38	1.44	0.240
4	doubly-spiralized	4 200	0.25	4	8	3.5	0.418
5	"	3 000	0.206	3.5	7	2.84	0.49

In this table the light flux of the lamps with cylindrical filamentsystem has been taken 78 000 and 54 000 lumens (cf. Note on page 31).

with the vertical axis depends upon the effective light intensity of the lighthouse in question, while its slope is determined by the atmospheric condition. The straight lines of formula (8) are drawn in fig. 15 for two different lighthouse lamps (nos. 3 and 4 of the table on page 39), corresponding to three different coefficients of transparency of the atmosphere which are exceeded by the actual value of the transparency coefficient during 50, 75 and 90 per cent of the year.

Calculation of effective light intensity and optical range in a practical case

As a practical example we shall in conclusion calculate the effective light intensity and optical range which are obtained with several of the lamps discussed when they are placed in the optical system (fig. 16) of the Brandaris at Terschelling shown in fig. 5.

This optical system is a so-called double optical system. It was constructed when the Brandaris was equipped with arc light, and due to the small dimensions of the spot of light with a carbon arc a large enough panel could not be used, since the beams would have become so narrow that the flash time would have been too short. In order to obtain a sufficiently high luminous intensity two optical systems were set up side by side in a manner indicated clearly in fig. 17. Each of the two systems gives four beams in mutually perpendicular directions, which in pairs of two form the four beams of the lighthouse.

Each panel occupies an angle of 90° and has a focal length of 30 cm. We shall now calculate the effective luminous intensity of this double system when the different lamps are used which have already been indicated in the table on page 39. As example we take the doubly spiralized lamp for 70 volts, 60 A, No. 4 in the table. The width of the spiral is 2.35 cm so that with 3 revolutions per minute, according to formula (2), a flash will last

$$t = \frac{2.35/30}{2 \pi \cdot 3} \cdot 60 = 0.25 \text{ sec.}$$

According to the measurements of the Testing Station of the Netherlands Lighthouse Service the maximum light intensity for one optical system was: $I_m = 4 \times 10^6$ c.p., and for the total beam therefore: 8×10^6 c.p. According to formula (3) the effective light intensity then becomes

$$I_e = 0.7 \cdot \frac{0.25 \cdot 8 \cdot 10^6}{0.15 + 0.25} = 3.5 \cdot 10^6 \text{ c.p.}$$

If the same calculation is carried out for the other lamps in the table, the results given in the table below are obtained.

It may be seen from this table that the lighthouse lamp with a doubly-spiralized filament for 4 200 watts burns about 40 per cent more economically than the lamp with the cylindrical filament sys-

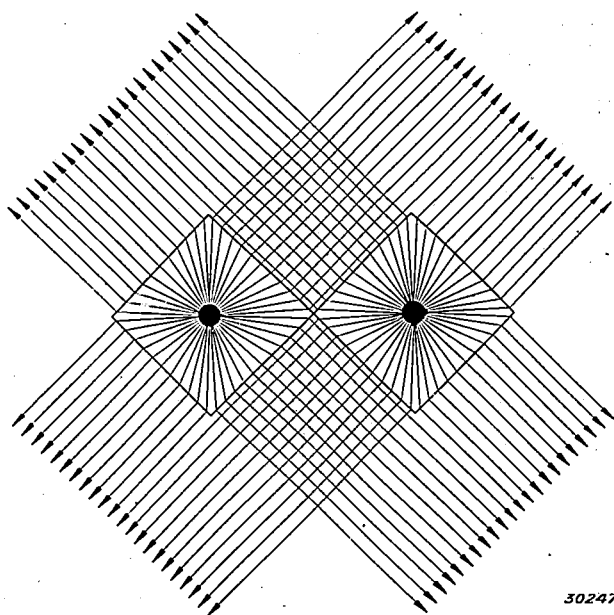

50247

Fig. 17. Diagram of the paths of the rays in a double optical system consisting of two light sources surrounded by four perpendicular panels.

tem for 4 000 watts, and about 50 per cent better than the lamp with the cross-shaped filament system for 4 000 watts. Furthermore the lamp with the doubly-spiralized filament for 3 000 watts is found to be 100 per cent more economical than the one with the cylindrical filament system.

In the following table the optical range in nautical miles is given of the various lamps for a visibility occurring during 50, 75 and 90 per cent of the year.

No.	Filament system	Power W	Optical range in nautical miles during:		
			50% of the year	75% of the year	90% of the year
3	cross-shaped	4 000	27.2	15.2	8.1
1	"	4 000	27.2	15.2	8.1
2	cylindrical	3 000	25.2	14.5	7.7
4	doubly-spiralized	4 200	29.5	16.2	8.5
5	"	3 000	28	15.8	8.3

LITERATURE

- 1) P. van Braam van Vloten: Onderzoekingen ter vaststelling van voor kustlichtoptieken geschikte modellen van elektrische met gas gevulde spiraaldraad gloeilampen: Ingenieur 36, 863, 1921.
- 2) P. van Braam van Vloten: La valeur lumineuse des feux à éclats comme base de calcul des portées lumineuses. 14e Congrès International de Navigation, Le Caire 1926.
- 3) P. van Braam van Vloten: De optische dracht van Kustlichten: Ingenieur 39, 67, 1924.
- 4) P. van Braam van Vloten: Incandescence électrique; d'une nouvelle forme de filament. 2me Conférence internationale de signalisation maritime, Paris 1933.
- 5) P. van Braam van Vloten: Introduction of new incandescent electric lamps in the Netherlands Lighthouse Service. Effective luminous intensities of the Revolving Flashing Lights. 3rd Intern. Lighthouse Conf. Berlin 1937.
- 6) André Blondel: Méthodes expérimentales pour la détermination de la portée des phares à éclats: Rev. gen. El. 33, 747, 788 and 811, 1933.
- 7) Georges Dupouy: Conditions spéciales d'emploi des lampes à incandescence électrique dans les phares. 3rd Intern. Lighthouse Conf. Berlin 1937.

**PICTURE TAKEN DURING THE ASSEMBLY OF A LARGE FILAMENT LAMP
FOR 110 V, 10 KW.**

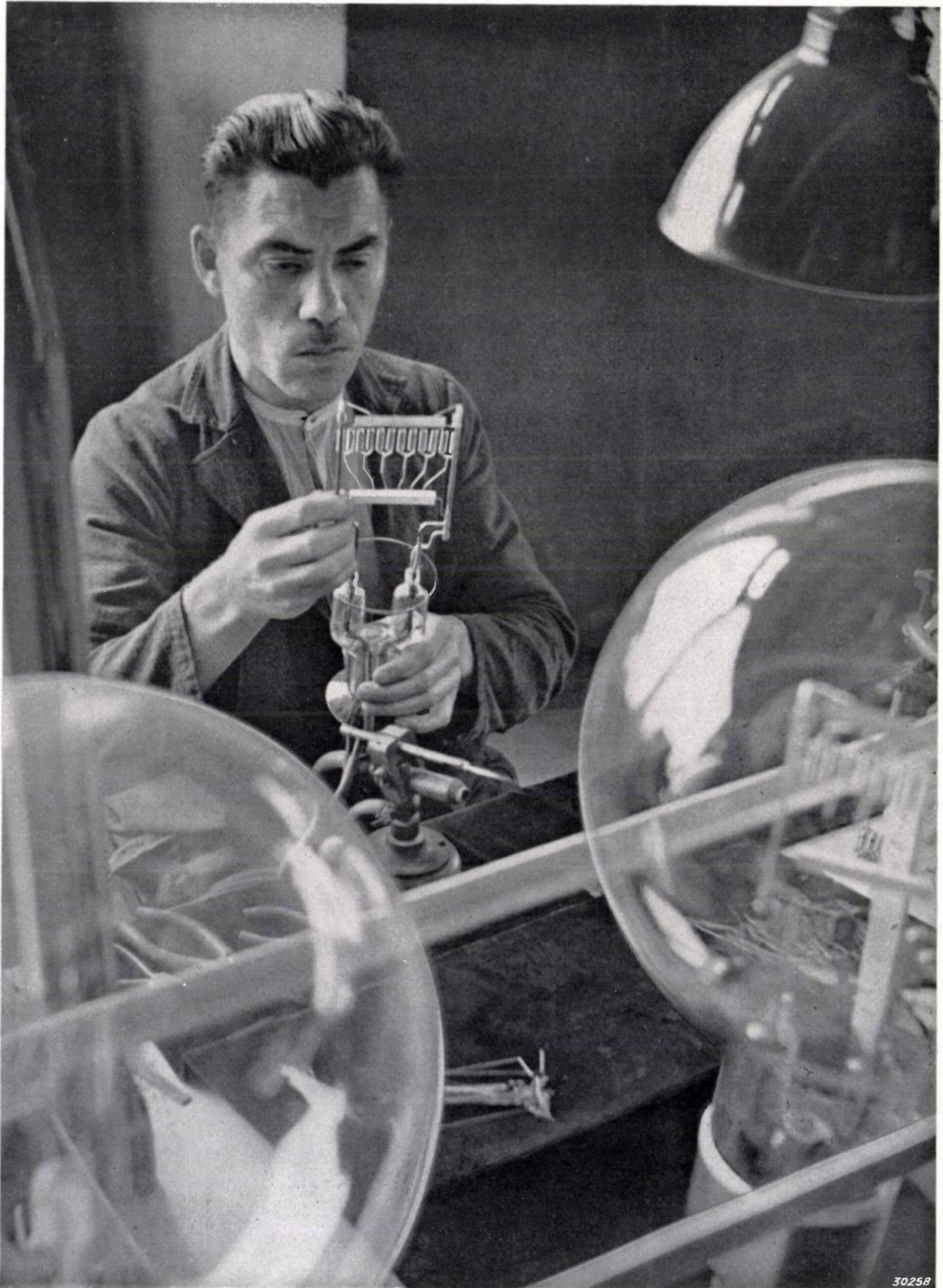

THE NIPKOW DISC

by H. RINIA and L. LEBLANS.

621.397.33

After an explanation of the way in which a Nipkow disc is designed for a certain method of scanning, a discussion is given of the technical details of the construction and mounting of the disc. The most difficult problem is that of making the holes, which must be only 27μ wide, and of locating them in the correct places. A very satisfactory solution of this problem has been found by making each hole on a separate plate and mounting the thus prepared plates (81 in this case) on the disc in such a way that the holes can be adjusted to the correct position after the disc is fastened in a dividing machine.

A television installation for broadcasting films has been described in two articles in this periodical^{1,2}). The most distinctive feature of this installation is the Nipkow disc for scanning the film. We shall here discuss the problems which arise during the construction of the disc and the way in which the difficulties were met.

The design of the disc

In the first place the size of the disc must be determined, (*i.e.* the diameter of the ring of holes), its speed of rotation, the number of holes necessary and their size. The values determined upon will depend upon the scanning system chosen in the way briefly described below.

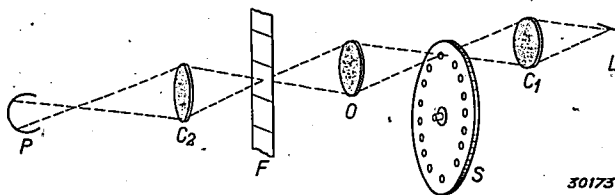

Fig. 1. Arrangement for film scanning with a Nipkow disc. L = linear light source (super high pressure mercury lamp); C_1 = condenser lens; S = Nipkow disc; O = lens which focusses the holes in the disc on the film F ; C_2 condenser lens; P = photocell (electron multiplier).

Fig. 1 is a diagram of the arrangement for scanning. The holes in the rotating disc S are focussed by the lens O on the film F with a certain enlargement which we shall call μ . Since the image of a hole must touch the film just as the image of the preceding hole leaves the film at the other side, the following condition holds for the distance s between the holes:

$$\mu s = b, \quad \dots \dots \dots (1)$$

where b is the width of the film picture. The length of path of the scanning spot which corresponds to the duration of the synchronization signal must be added to the width of the film. If the light spot must scan m lines per picture and N pictures per

second, then Nm holes must pass per second. The speed V_s of the disc at the position of the holes (*i.e.* approximately the peripheral velocity) must be:

$$V_s = Nm s = Nm b \frac{1}{\mu} \dots \dots \dots (2)$$

If a given enlargement μ is chosen the peripheral velocity of the disc is thereby determined. At the same time the diameter g of the holes is also determined since the image of the hole must have a diameter equal to the distance between the lines in scanning.³) On one film picture, height h , m lines are scanned, therefore

$$g = \frac{h}{m} \cdot \frac{1}{\mu} \dots \dots \dots (3)$$

What value should be chosen for the enlargement μ ? If μ is made very large, then according to equation (3) the holes must be very small. With h equal to 16 mm, $m = 405$ lines and an enlargement of $\mu = 4$, a hole diameter of $g \approx 0.01$ mm is arrived at. Such small holes are practically impossible to make because of the great accuracy required.

If on the other hand μ is small, then according to equation (2) the peripheral velocity of the disc must be very great. With a maximum width $b = 23$ mm of the film picture to be scanned, $m = 405$, $N = 25$ pictures per second, and an enlargement of $\mu = 0.5$, a peripheral velocity of $V_s \approx 400$ m/sec is obtained. This is almost the velocity of a projectile from a gun. The centrifugal forces become so great (with a disc diameter of 40 cm they are 80 000 times as great at the circumference as the force of gravity), that there is a chance of permanent deformation or even explosion of the disc.

In the choice of enlargement μ a compromise must therefore be found, such that on the one hand the speed of the disc is not too great, and on the

¹) H. Rinia and C. Dorsman, Philips techn. Rev. 2, 72, 1937.

²) H. Rinia, Philips techn. Rev. 3, 289, 1938.

³) Actually this condition only holds for square holes. For practical reasons, however, the holes are made circular. The actual diameter is then chosen somewhat larger than that here derived theoretically, so that the lines overlap somewhat.

other hand the holes are not too small. For the installation in the Philips laboratory μ was chosen equal to 1.7, so that $V_s \approx 140$ m/sec and $g \approx 0.025$ mm.

A similar value of μ is also reached in quite a different way by finding out how the light flux Φ on the scanning spot depends upon μ , and then making Φ as large as possible.

We consider the position and size (h/m) of the image of the hole constant and vary the enlargement μ by moving the lens O , i.e. by changing the distance q (see fig. 2). At the same

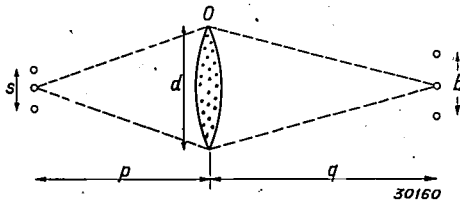

Fig. 2. The lens O , diameter d and focal length f , focusses the holes in the Nipkow disc on the film with an enlargement μ . With a width of film b and a distance between the holes s , $\mu s = b$. We assume that the enlargement μ is varied by changing the distance g between lens and film and then changing s and p correspondingly in each case.

time the position of the disc (distance p) and the size of the holes must be of course also be changed in order to satisfy the condition for obtaining a sharp image⁴⁾:

$$\frac{1}{f} = \frac{1}{p} + \frac{1}{q} \dots \dots \dots (4)$$

(f is the focal length of the lens O) and also to satisfy equation (3). The only change which is observable on the film as a result of this manipulation is a change in the solid angle φ of the beam thrown on the film by the lens O . The amount of light Φ is in this case proportional to the solid angle:

$$\Phi = \text{const.} \frac{\pi d^2}{4 q^2},$$

where d is the diameter of the lens. From (4) it follows that

$$q = f \left(1 + \frac{q}{p} \right),$$

and since q/p is equal to the enlargement $b/s = \mu$, we obtain

$$\Phi (\cdot) \left(\frac{df}{1 + \mu} \right)^2 \dots \dots \dots (5)$$

With a lens with a given relative aperture d/f , Φ is thus proportional to $(1 + \mu)^{-2}$. This function is drawn in fig. 3 with the reciprocal of the enlargement $1/\mu$ as abscissa. From equations (2) and (3) it may be seen that this curve also represents the dependence of the amount of light on the speed of the disc V_s or on the size g of the holes. With infinite enlargement ($p = f$, $V_s = 0$ and $g = 0$) Φ is equal to zero; when μ decreases, Φ at first increases with the square of $1/\mu$, thus proportional to V_s^2 . The increase of Φ then becomes slower, and at $\mu = 2$, Φ increases only proportional to $1/\mu$. (thus $(\cdot) V_s$). It is therefore of little additional advantage to choose μ much smaller than 2.⁵⁾

4) We naturally neglect spherical aberration in this case. Actually the lens must be specially corrected for every enlargement because of this factor.

5) In the article cited in footnote 1) a similar result is derived by means of a different hypothetical experiment, in which the lens O was replaced by a system of two lenses. There also it was found that the amount of light at first increases with the square of the speed of the disc, with $\mu = 1$, how-

Moreover the amount of light no longer forms a difficulty. Since the publication of the article quoted in the first footnote, where it was shown that when a super high pressure mercury lamp was used as a source of light (L in fig. 1) a more than adequate amount of light was available, the brightness of the super high pressure mercury lamp has been increased by a factor 3 (it is now about 90 000 c.p./sq.cm), so that from this point of view a larger value of μ (smaller V_s) could also be used if it were not that the holes would then have to be too small.

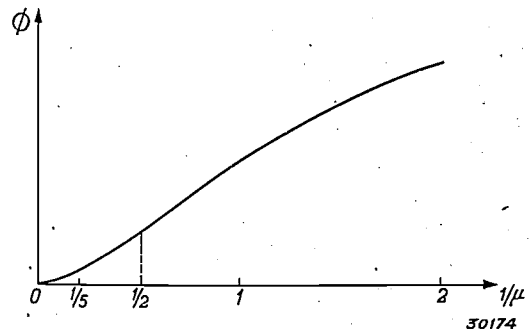

Fig. 3. Variation of the light flux Φ (in arbitrary units) on the scanning spot on the film, as a function of the reciprocal of the enlargement $1/\mu$ (the latter is proportional to the required peripheral speed of the disc, V_s , and the required size of the holes g).

When the enlargement μ and therefore also the diameter of the holes g and the speed of the disc V_s are determined, the radius r of the ring of holes must be chosen. It is best not to make r too large in order not to obtain too heavy a disc with correspondingly heavy driving motor and large bearings. On the other hand r may also not be too small, since in connection with the scanning it is necessary that the arc of a circle between two holes may be regarded as a straight line. With the radius $r = 17.5$ cm which we have chosen this latter condition is adequately fulfilled.

The necessary number G of holes in the disc and the required number of revolutions n per second now follow from the equations (see also equation (1)):

$$G \cdot s = 2 \pi r$$

and

$$2 \pi r \cdot n = V_s.$$

The results obtained are $G = 81$ and $n = 125$ revolutions per second⁶⁾.

Mounting of the disc

The required high speed of the disc makes it necessary that it be rotated in an atmosphere at

ever, a sharp limit appeared for the amount of light, while in the case here imagined a gradual slowing up of the increase occurred instead.

6) Because of the necessary synchronization, one is actually bound by the condition that the number of revolutions of the disc and of the film motor (50 r.p.s.) must have a simple relation, for example $n = 75$, $n = 100$, $n = 125$, $n = 150$, etc. One has therefore only to choose between a number of discrete values of r which are hereby determined.

reduced pressure. If it should rotate in air at atmospheric pressure, the overcoming of the friction of the air would require an amount of energy of $\frac{1}{2}$ to 1 kW. Moreover the great heat development might be dangerous for the disc, since it must rotate in a closed space in order that the holes may remain clean and for the sake of safety, and the heat is therefore not easily dissipated. At the pressure chosen of about 1 cm of mercury the heat of friction is less than 30 W. The pressure could not be made much lower than 1 cm since the disc is very strongly irradiated in the neighbourhood of the holes during use, and a certain layer of air is

into the evacuated space. The pressure of the atmosphere on the oil tends of course to press it into box *A*. The film of oil around the shaft in the first bearing is, however, so thin (about 2μ) that its resistance to flow is high enough to prevent any large quantity of lubricating oil being pressed into box *A*, in spite of the fact that very thin oil must be used because of the friction at the high speed of revolution (7 500 r.p.m.). It has been found in practice that less than 1 cc of oil per hour leaks into the vacuum. A ring around the shaft prevents this oil from reaching the Nipkow disc and causes it to flow off into a small reservoir.

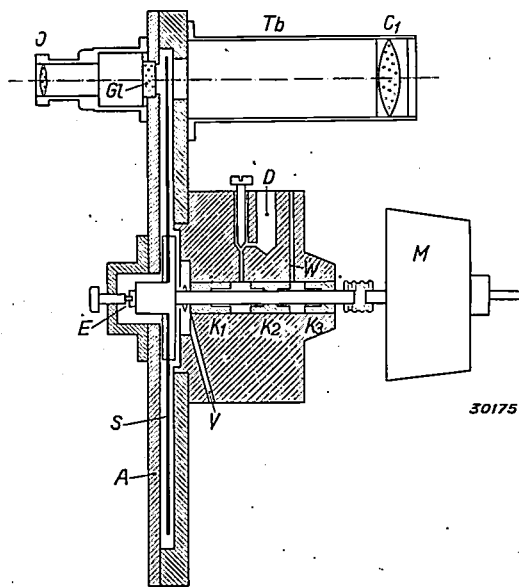
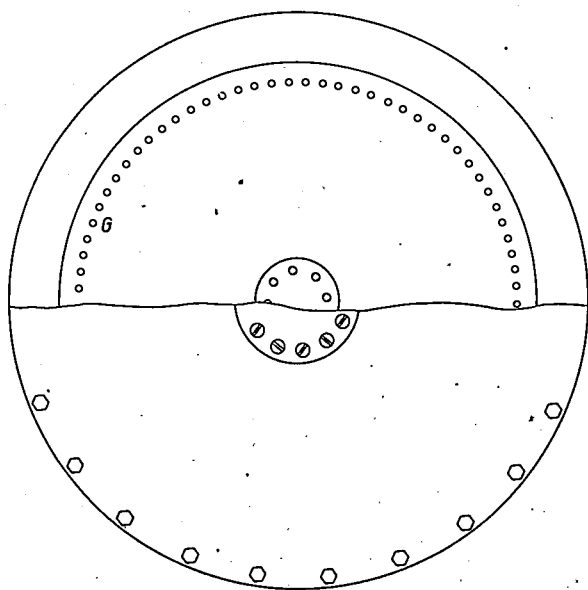

Fig. 4. Set-up of the Nipkow disc *S* in the evacuated iron box *A*. The shaft turns in three bearings K_1 , K_2 and K_3 . K_1 also serves as gas-tight seal. *D* = oil reservoir; *W* = outlet tube; *E* = pressure bearing (see fig. 5); *M* = motor; *O* = lens (a camera objective); *G1* = glass plate as vacuum seal. On the other side of the disc this glass plate, with its accompanying loss of light is avoided by fastening the condenser lens C_1 in the tube *Tb* to the box *A* by an air-tight joint; *G* = ring of holes.

necessary in order that the disc may give off the heat developed.

The disc *S* therefore rotates in an evacuated iron box *A*, see fig. 4. This box is quite heavily constructed so that in case the disc should break the pieces cannot escape.

Bearings

The axle of the disc turns in three bearings, K_1 , K_2 , K_3 which are lubricated with oil. They must also serve as gas-tight seals for the box *A*. The foremost bearing K_1 is therefore made to fit extremely accurately, which is also necessary for smooth running of the disc. Furthermore the space between the bearings is completely filled with oil which is supplied from the reservoir *D*. No air can therefore pass the bearings and penetrate

The middle bearing K_2 is introduced to keep the shaft turning true. The shaft is also made very thin because of friction. The hole *W* serves to allow the air to escape when the bearings are filled with oil, so that the space between the second and third bearings K_2 and K_3 is always filled with oil. The extremity of the shaft is connected with the driving motor by means of a flexible coupling made of tombac.

On the opposite side of the disc the shaft does not extend outside the box. Here it must experience a pressure opposite to the inward force of the unilateral air pressure. In order to avoid any possible difficulties of lubrication a ball bearing (*E*) is here used like that represented in fig. 5 twice its actual size. Because of the large centrifugal forces it was necessary to make this ball bearing as small as

possible. It consists of a ball race with three balls 1 mm in diameter against which the flat, ground surface of a hard steel pin presses. This pin is fastened to the end of the shaft. The balls roll on the flat ground surface of a half ball of a larger size which rests against a ring. This type of bearing ensures the smooth running of the disc, since the plane surface on which the balls roll can adjust itself automatically to all positions.

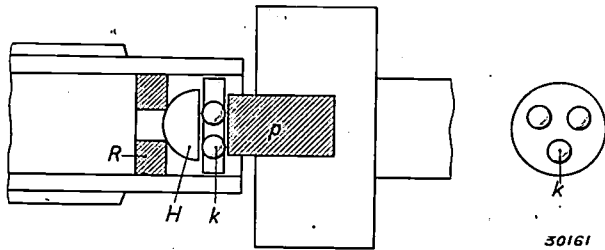

Fig. 5. Ball bearing (*E* in fig. 4), which holds back the shaft of the disc pressed inward by air pressure: Three balls *k* turn between the end surface of a pin *p* in the shaft and the plane ground side of a half ball *H* which rests against a ring *R*. This latter surface can adjust itself automatically in all positions. Because of the high centrifugal forces the ball bearing is made very small (here drawn about twice its actual size).

Material of the disc

Aluminium was chosen as material for the disc. This material has the advantage that the disc can be made absolutely flat and free of stress, simply by heating it between two iron discs. It is obvious that absolute freedom from stresses is an essential requirement. In order to obtain accurate scanning through the holes the distance of the holes from the centre must be accurate within 5 μ . Upon rotation of the disc a deformation takes place due to the stresses from centrifugal forces, in the sense that the holes are displaced away from the centre. This can easily be observed when the holes in the rotating disc are examined through a microscope. A thin line is seen which is displaced toward the circumference when the speed of rotation is increased. In order to satisfy the above-mentioned condition about the radial position of the holes, the displacement must be the same for all the holes, i.e. only symmetrical rotational deformations are permissible. Therefore there must be no (unevenly distributed) initial stresses in the disc which, when the centrifugal forces are added, might lead to a local stress exceeding of the limit of elasticity or even of the yield value.

Another advantage of aluminium is its good heat conductivity which prevents local overheating due to the irradiation. The strength of the material is also more than adequate to withstand the stresses due to the centrifugal forces. The greatest stresses

occurring in the disc, which can be determined directly by means of the above-mentioned experiment, are about 1 kg/sq.mm at the usual speed of rotation, while the permissible loading of aluminium amounts to 6 kg/sq.mm.

Making the holes

By far the most difficult problem in the construction of the Nipkow disc is the making of the 81 holes and locating them in the proper places. In addition to the above-mentioned requirement that the position of the holes may show deviations of not more than 5 μ in the radial direction, the distance between the holes must also be equally accurate. Furthermore it is very important that all the holes allow exactly the same amount of light to pass through in order to obtain a picture of uniform brightness. Therefore the diameter of the holes, which is chosen at 27 μ , must be accurate within 1 per cent. With greater deviations than this the eye already observes disturbing differences in brilliance of the different lines.

The most obvious method is that of punching the holes in thin foil. Such a hole is shown diagrammatically in fig. 6, and a number of light rays coming from different directions are also indicated. It may be seen that the effective aperture of the hole is smaller for the obliquely incident rays (*bb* and *cc*) than for the normal rays (*aa*). The difference in effective aperture due to the different angles of incidence depends upon the depth of the hole. This can, especially with a very divergent beam, lead to differences in the amount of light transmitted, since the depth of the holes may vary slightly due to burrs which occur in punching. The reduction of the effective aperture for oblique rays is indeed partially compensated for by the fact that some rays (*b'b'*, for instance) are reflected. Nevertheless

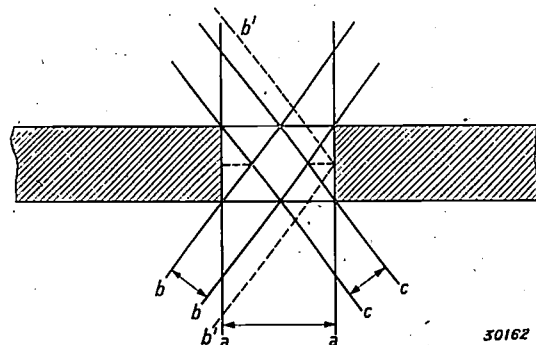

Fig. 6. Punched hole. For obliquely incident rays (*bb*, *cc*) the effective aperture is smaller than for beams normal to the surface (*aa*). The difference in amount of light transmitted caused by the differences in angle of incidence depends upon the depth of the hole. The reflection at the walls (*b'b'*) compensates this effect to some extent but is, however, dependent upon the condition of the wall.

this compensation is different for the different holes, since the reflective power of the walls of the holes may vary very much. It is therefore advisable to limit the whole effect to a minimum by making the hole as shallow as possible. A disc was first made by the authors on which the holes were punched in duraluminium of 5μ . Fair results were obtained with this disc but it was found difficult

steel plate *P* about 2 mm in diameter and 0.3 mm thick a conical depression was made with a sharp point (*fig. 7a*). The plate was hardened and then ground so that a hole occurred at the point of the cone. It was finally polished until the hole *G* had exactly the correct diameter of 27μ . This latter operation was checked indirectly by allowing light to fall on the plate and then by means of a

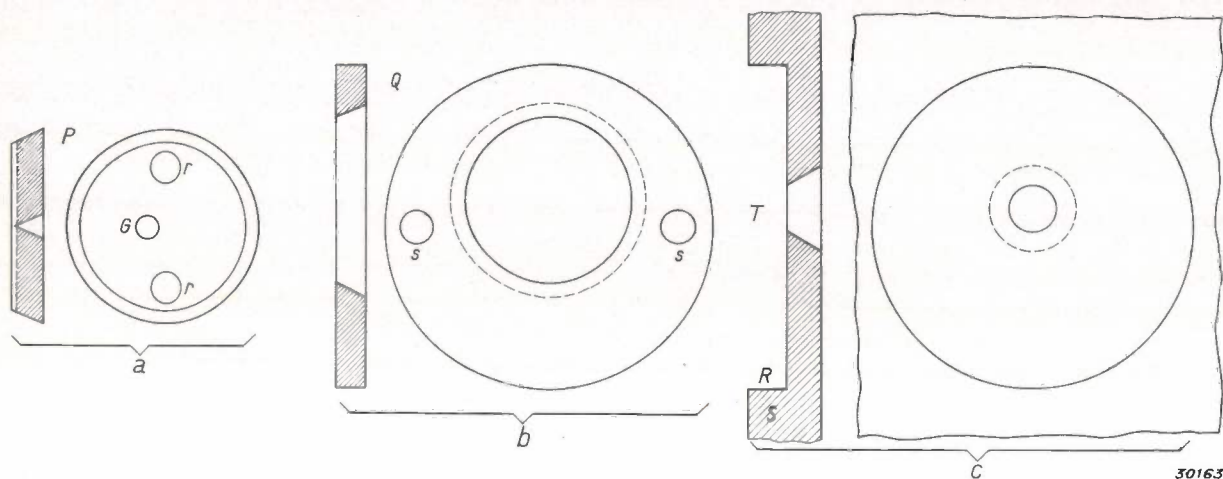

Fig. 7. Making and mounting the holes in the Nipkow disc.

- A conical depression is made in an unhardened steel plate *P*. After hardening the plate is ground so that a hole *G* is formed at the apex of the cone. This hole is given the required diameter by polishing.
- Duraluminium plate *Q* with a conical opening into which the conical outer surface of plate *P* fits.
- Piece of the Nipkow disc *S* with circular depression *R* cut out, into which plate *Q* exactly fits. Conical hole *T* bored at about the place where the hole *G* must be.

to rid the holes of dust or other contaminations, because the foil is weak and the capillary forces which hold a drop of liquid in the holes are very large.

For that reason we adopted the following method of construction. In a small unhardened circular

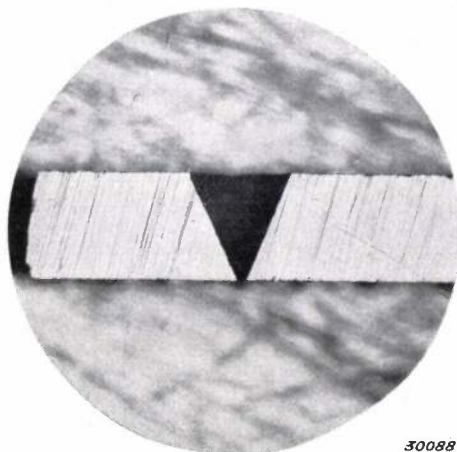

Fig. 8. Photomicrograph of the ground surface cut through a plate *P* (magnification 30 times). The sharp boundary of the hole *G* at the apex of the cone may be seen. The edge is actually still sharper than is shown here since it has been broken away slightly by the grinding of the cut surface.

photocell and amplifier measuring the amount of light passing through the hole. 81 holes were made in this way and were mounted on the disc in a manner which will be described later.

The edges of the holes obtained are sharp so that fuzziness is avoided. The photomicrograph *fig. 8* shows a cross section of a plate through the hole. The cut surface has been ground in order to show the sharp boundary of the hole at the point of the cone. The holes can now easily be cleaned since the plates are extraordinarily strong in contrast to the earlier used extremely delicate foil. A further important advantage of the method is that each hole can be replaced separately in case of defect or damage.

The correct placing of the holes

The method of mounting the holes at the correct places on the Nipkow disc is the following. The holes are not exactly at the centres of the plates *P* but slightly excentric, as may be seen clearly in *fig. 7a*. The steel plate *P* which has a conical outside surface is not fastened directly to the Nipkow disc but is placed in a conical cavity of a larger cir-

cular plate *Q* of duraluminium, in which it fits exactly but projects slightly. The cavity in *Q* is also excentric, see fig. 7*b*. Plate *Q* in turn fits exactly into a circular depression *R* which is cut out of the Nipkow disc at approximately the place where there must be a hole, fig. 7*c*. A conical hole *T* is here bored through the disc.

When plates *P* and *Q* are put together and placed in the depression *R*, the edge of the latter is forced slightly over the edge of plate *Q*, so that *Q* and at the same time *P* are held fixed. Both plates can now however still be turned by means of small keys which fit into the openings *rr* and *ss*. By means of the double excentric the hole *G* can be given any position within a certain ring-shaped area, and a correct placing of the holes is thus easily attained. This is more clearly illustrated in fig. 9 where only the lines joining the pivot points and the hole *G* on the plates *P* and *Q* are drawn. The hole *G* is fastened as it were to the free end of two hinged bars of lengths *a* and *b*. The ring-shaped surface which can be compassed is shaded. By placing the excentrics at such an angle that *b* and *a'* are perpendicular at the rough adjustment, the displacements caused by the turning of both of the excentrics are perpendicular to each other, which makes the correct placing very simple, especially if *a* is made equal to $b\sqrt{2}$, so that in the position drawn $b = a'$, and turning of the two excentrics through equal angles gives equal displacements. In practice *a* was chosen 0.35 mm and *b*, 0.25 mm; the distance of the holes from the axis of the disc can thus be varied by 0.6 mm. The permissible deviations during construction are therefore considerably greater than if the holes were made directly in the

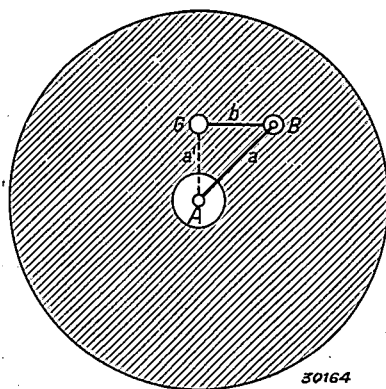

50164

Fig. 9. Diagram showing the principle of the method of correct placing of the holes. The hole *G* is excentric in the plate *P* (fig. 7*a*) and this plate in turn is excentric in plate *Q* (fig. 7*b*). Both plates can be turned. This is equivalent to fastening the hole *G* to the end of two hinged bars *a* and *b* with the pivotal points *A* and *B*. By a suitable position of the bars *G* can be placed at any point within the shaded ring.

disc. In fig. 10 the arrangement of the excentrics on the Nipkow disc is again shown in its entirety.

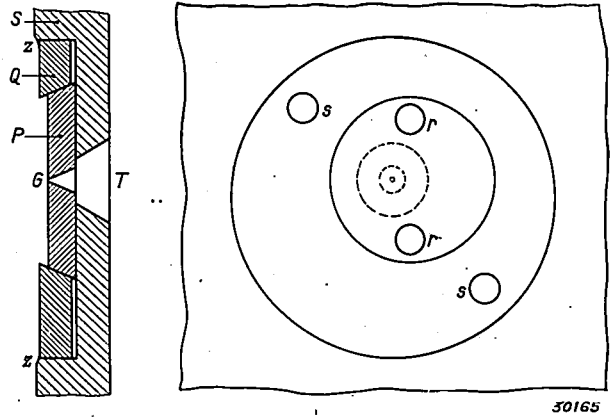

50165

Fig. 10. Arrangement of the two excentrics mounted on the disc. The edge *z* of the depression in *S* is forced slightly over *Q*, so that the whole is fixed except for a possible rotation of *P* and *Q* by means of small keys which fit in the holes *rr* and *ss* respectively.

After the holes *G* have been placed at approximately the correct positions, the precise adjustment takes place on a dividing machine. It was found necessary to maintain a constant temperature within 1° during this fairly lengthy operation, in order not to introduce errors due to the different degrees of expansion of the disc and the dividing machine. The accuracy thus attained in the position of the holes is considerably higher than the requirement, the deviations do not amount to more than 2 μ. When the disc is in use the temperature may be neglected since because of the rapid rotation, and even with the above-mentioned strong local heating, the temperature distribution exhibits a rotational symmetry.

After the correct placing of the holes the plates are fixed with a small amount of lacquer. This is necessary because of the strong centrifugal forces which occur during rotation. These forces do not indeed exert a couple on the plates in the first instance, but because of the lack of symmetry in the plates slight displacements might occur if vibrations should set in, and such displacements would destroy the work of placing the holes.

The high centrifugal forces also make it necessary that the disc be very carefully balanced. An unbalanced weight of 1 g at the circumference of the disc would experience a force of more than 10 kg when the disc is turning at its usual speed! Balancing is facilitated by the fact that the whole mass of the disc lies in the neighbourhood of one plane. No bending forces therefore are to be expected upon rotation, and the disc can be satisfactorily balanced statically.

TIME LAG PHENOMENA IN GAS-FILLED PHOTOELECTRIC CELLS

by A. A. KRUTHOF.

621.383.2.032.12

In many applications of photocells the ratio of noise to signal can be made smaller by amplifying the photocurrents already *in the cell*. This may be done by filling the cell with gas; the photoelectrons are then multiplied by the ionization of the gas. Due to the finite transit time of the ions formed, the cell shows a time lag which causes a sharp fall in the frequency characteristic of the cell at high frequencies. The time lag increases with the amplification factor. If this is smaller than 10, the time lag is insignificant up to frequencies of about 10 000 cycles/sec, so that gas-filled cells may be used for sound film. The theoretically derived frequency characteristics of the cells are confirmed in the main by measurements. An experimentally found extra time lag at lower frequencies (1 000–5 000 c/s) is explained as due to a contribution to the amplification by metastable atoms.

The direct transformation of light into electric current by means of photocells was soon put to many uses, for example for the measurement of quantities of light in the photometer, for the operation of light relays in signal lights and safety devices, etc. The photoelectrically sensitive material originally used was selenium. When, however, new applications of the photoelectric effect appeared, such as sound film and television, where rapidly changing quantities of light had to be transformed into electric voltage fluctuations, selenium was no longer found satisfactory. The photoelectric effect with this material is accompanied by a certain time lag. In the first mentioned applications (photometer, light relay) this factor was not important. If, however, a sinusoidally modulated light flux is allowed to fall on a selenium cell, then due to the inertia the fluctuations are smoothed out to some extent, so that the photocurrent obtained shows a smaller depth of modulation than the light flux. The decrease in the depth of modulation will be greater, the higher the frequency of the light modulation and the greater the inertia of the cell. In the case of the sound film frequencies up to about 10 000 cycles/sec, and in television even up to $3 \cdot 10^6$ cycles/sec must be reproduced, so that only those photocells can be used for this purpose which have a sufficiently small time lag.

In modern photocells the external photoelectric effect of alkali metal atoms adsorbed on an oxide layer¹⁾ is used: electrons are freed by the light which falls on this sensitive surface, the cathode, and are drawn toward the anode by means of an accelerating voltage. Such a photoelectric cathode in an evacuated bulb gives a transformation of light into electric current which is practically free from inertia.

The sensitivity of these modern photocells may

amount to $20 \mu\text{A}/\text{lm}$ for example in a practical case. The maximum intensity of illumination which the cathode can withstand in use without permanent injury is, however, relatively small, namely only some thousandths of a lumen per sq. cm. A cell of reasonable dimensions can therefore not be allowed to give a larger photocurrent than about $5 \mu\text{A}$ even when an unlimited amount of light is available. The photocurrent is usually a great deal smaller, because of the fact that the amount of light available in the apparatus is limited. It is clear that this photocurrent must first be amplified for practical applications²⁾.

Amplification of the photoelectric current

The diagram of a commonly-used connection of a photocell with an amplifier is given in fig. 1.

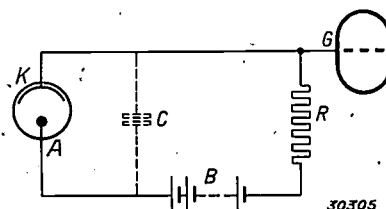

Fig. 1. Diagram of the connection of a photocell with an amplifier. K = photocathode, A = anode, B = source of accelerating voltage, R = coupling resistance, G = grid of the first amplifier valve, C = capacity of the cell and connections.

A background noise is present in the voltage obtained on the resistance R , which may be ascribed mainly to³⁾:

- a) The thermal motion of the electrons in resistance R ;

²⁾ H. Rinia and C. Dorsman, Television system with Nipkow disc, Philips techn. Rev. 2, 72, 1937; A. L. Timmer and A. H. van Assum, A surveyance system using infrared rays, Philips techn. Rev. 1, 306, 1936.
³⁾ M. Ziegler, The cause of noise in amplifiers, Philips techn. Rev. 2, 136, 1937; Noise in amplifiers contributed by the valves, Philips techn. Rev. 2, 329, 1937.

¹⁾ M. C. Teves, The photoelectric effect and its application in photoelectric cells, Philips techn. Rev. 2, 13, 1937.

b) The fact that the negative charge is emitted by the cathode *K* of the photocell, not in the form of a continuous current, but in the form of discrete amounts of charge, the electrons (shot effect).

The first effect mentioned causes a voltage fluctuation whose mean square is given for every frequency band of the width $\Delta\nu$ by the following:

$$\overline{V^2} = 4 k T R \Delta\nu; \dots \dots \dots (1)$$

k is the Boltzmann constant and *T* the absolute temperature. The shot effect causes a current fluctuation whose mean square, again considered for the band of width $\Delta\nu$, is proportional to the average photocurrent:

$$\overline{I^2} = F^2 \cdot 2 e \overline{I_f} \Delta\nu \dots \dots \dots (2)$$

In this expression *e* is the charge of the electron and F^2 the so-called noise factor ($F^2 < 1$) which expresses the fact that the shot effect is partially neutralized by the space charge. F^2 depends upon the anode voltage of the photocell. The square of the total noise voltage on the resistance *R* becomes

$$(4 k T R + F^2 \cdot 2 e \overline{I_f} R^2) \Delta\nu.$$

The square of the signal voltage on the resistance *R* is $I_w^2 R^2$, where the effective alternating photocurrent is given by

$$I_w^2 = (\overline{I_f} - \overline{I_f})^2.$$

For the ratio of the energies of noise and signal the following is obtained when the noise contributions of all the frequencies passed by the amplifier are added:

$$G \cdot \frac{4 k T R + F^2 \cdot 2 e \overline{I_f} R^2}{I_w^2 R^2} \dots \dots \dots (3)$$

where the proportionality factor *G* depends upon the frequency characteristic of the amplifier.

If the anode voltage V_a is chosen so that the photocurrent I_f reaches its saturation value — this is the most important practical case, — then F^2 becomes equal to 1. By filling in the numerical values for *e* and *k*, when *T* is set equal to 300 °K (i.e. room temperature), the following is obtained:

$$G \cdot \frac{0.052 + \overline{I_f} R}{I_w^2 R} \dots \dots \dots (4)$$

$\overline{I_f}$ and I_w are in amperes and *R* in ohms.

For good quality in reproduction it is important to make the ratio of noise to signal given by (4) as small as possible. This is accomplished in the first instance by choosing *R* large. A limit is, however, set to the size of *R* due to the capacity of the cell and the supply lines which are often screened. In fig. 1 this capacity is shown dotted. With too large a value of *R* the *RC* time of the circuit (i.e. the charging time of the “condenser” *C*) would become too great with the result that attenuation of the high frequencies would occur. Practically, the coupling resistance *R* must not exceed 100'000 ohms in the case of sound film and must be smaller than a few thousand ohms in the case of television²⁾.

The second term in the numerator of (4), usually has a value between 0.01 and 0.1 in the application for sound film. If the amplifier itself gives appreciable noise, this must be taken into account by increasing the resistance *R* in the first term of the numerator of (3) by the so-called noise resistance of the amplifier. The first term (thermal voltage fluctuations) in most cases makes a large contribution to the noise. In the case of television the first term is always much larger than the second.

In the case where fluctuations outside the cell (first term) dominate over those inside the cell (shot effect, second term) the ratio of noise to signal is improved by amplifying the photocurrent already in the cell. If in this way the photocell is made to give an anode current $I_a = N \cdot I_f$, then, although the noise from the shot effect increases approximately with the square of N^4 , the ratio (4) becomes smaller:

$$G \cdot \frac{0.052 + N^2 \overline{I_f} R}{N^2 I_w^2 R} = G \cdot \frac{0.052/N^2 + \overline{I_f} R}{I_w^2 R}.$$

If the first term of (4) is large compared with the second, (4) decreases inversely proportional to N^2 . Moreover there is the not unimportant advantage that for a given output voltage an *N* times smaller amplification following the cell is sufficient, so that it becomes easier to reduce the hum of the amplifier satisfactorily.

An amplification of the photoelectric current in the cell may be attained by causing a multiplication of the electrons on their way from cathode to anode. There are two possible methods of doing this:

⁴⁾ In formula (2) not only $\overline{I_f}$ but also the effective elementary charge *e* are multiplied by a factor *N*; in the practical realization of the multiplication of photoelectrons to be described later the factor *N* is determined only statistically, so that the increase of the shot effect is somewhat more rapid than with the square of *N*.

- 1) Multiplication by secondary emission. Specially constructed cells are necessary for this method. An "electron multiplier" which uses secondary emission has already been described in this periodical⁵⁾.
- 2) Multiplication by ionization of a gas. This method necessitates no change in the ordinary construction of vacuum cells, a small amount of gas only is added to the cell. In order to avoid chemical action of the gas on the photocathode, an inert gas, usually argon, is chosen for the filling.

Gas-filled photocells have the advantage that considerably higher currents are obtained without the cells becoming more complicated than the original vacuum cells. A disadvantage is, however, that gas-filled photocells, in contrast to vacuum cells, exhibit a certain time lag. We shall now examine the causes of this timelag and see to what degree it restricts the possibility of application of the gas-filled cells.

Mechanism of amplification by ionization

When the photoelectrons, which have been freed by the light incident on the cathode, have been sufficiently accelerated they will be able to ionize atoms of the gas upon collision. In order to do this the accelerating voltage must be higher than the ionization potential of the gas, which in the case of argon is 16 volts. The electrons newly formed by ionization form an amplification of the primary photocurrent.

How many ionizations does a photoelectron cause in the argon on its way to the anode? The number depends in the first place on the accelerating voltage V_a , and further on the configuration of the electrodes and on the density of the gas. The number of ionizations increases when V_a is increased: if V_a is more than twice the ionization potential, the electron which has used up its energy in one ionization process may again be accelerated and cause more ionizations. The electron set free in the first ionization is also accelerated and causes ionizations just as every electron freed by any further ionization; so that instead of one primary photoelectron a whole "avalanche of electrons" arrives at the anode. The greater V_a the more the avalanche can increase on its way. V_a is usually chosen equal to 100 volts.

The influence of the configuration on ionization is best studied in the simple case where two plane

parallel plates are set up in the gas (at a distance of 1 cm for instance.) The dependence of the number of electrons n of the avalanche on the density of the gas is represented in this case by the curve⁶⁾

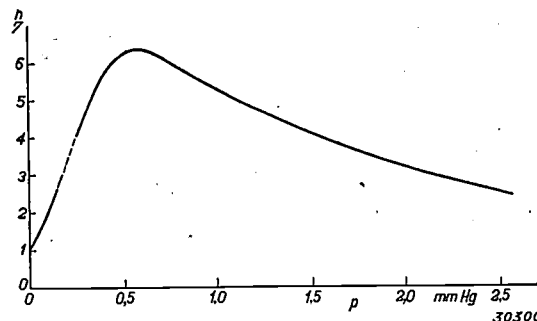

Fig. 2. Number of electrons n of the avalanche caused by one photoelectron between two plane parallel electrodes 1 cm apart in argon at the pressure p . The accelerating voltage was $V_a = 100$ volts.

of fig. 2. At very low gas pressure (low density) the ionization is small since the electrons meet few atoms along their path, and n therefore differs only little from unity. With increasing pressure p the number of ionizations increases, and it increases more rapidly than in proportion to p since the new electrons which are freed by the ionization in turn cause ionizations. If the pressure is continually increased the free path of the electrons between two collisions becomes shorter and shorter. The number of collisions in which the electron has not yet sufficient energy for the ionization of a gas atom increases sharply, and with it, the chance that the electrons give up their energy to the gas atoms in smaller amounts as energy of excitation. Since the energy of excitation is lost for ionization, the curve in fig. 2, after passing a maximum (at $p = 0.55$ mm Hg), begins to fall again.

In the practical construction of the photocells the cathode is usually part of a cylinder, while the anode consists of one or more metal wires or rods. If it is desired to calculate the number of ionizations for this configuration, it must be taken into account that the field strength between cathode and anode is not everywhere the same. Moreover in this case the total path of the electrons is longer on the average than the distance from cathode to anode. The electrons will pass by the anode several times before they are captured.

Until now we have only considered the newly formed electrons. The ions formed will also contrib-

⁵⁾ J. L. H. Jonker and M. C. Teves, Technical applications of secondary emission, Philips techn. Rev. 3, 133, 1938.

⁶⁾ The data for the left-hand side of the curve are given in: P. T. Smith, Phys. Rev. 36, 1293, 1930; those for the right-hand side in: A. A. Kruithof and F. M. Penning, Physica 3, 515, 1936. The two parts of the curve are joined by the dotted line.

ute something to the increase of the electron current, since they move toward the cathode and liberate electrons from it. Because of their greater mass, however, the ions have a much lower speed than the electrons, so that the electrons freed from the cathode by ions will follow the primary photoelectrons with a certain delay. The same process is repeated with these newly formed electrons and with the ions which they form in turn, so that a second, third, etc. group of electrons follow with ever increasing time lags. This phenomenon is the cause of the time lag in gas-filled photocells.

The total amplification

We shall first attempt to discover the degree of multiplication which is finally attained, i.e. the amount of charge which is obtained for one photoelectron. Every electron avalanche which occurs as the immediate result of the emission of one electron by the cathode into the gas contains n electrons. At the same time $n-1$ ions have been formed in the gas which move toward the cathode. The number of electrons liberated from the cathode per ion we shall call γ . The $n-1$ ions thus liberate $\gamma (n-1)$ electrons, which are again multiplied in the gas to $n \gamma (n-1)$. $\gamma (n-1)^2$ new ions are then formed which again free $\gamma^2 (n-1)^2$ electrons from the cathode, etc. The total number of electrons which per photoelectron flow through the cell is therefore

$$N = n + n(n-1)\gamma + n(n-1)^2\gamma^2 + \dots \quad (5)$$

N is called the amplification factor. The sum of the geometrical series (5) has a finite value, if the ratio $\gamma (n-1) < 1$. Then

$$N = \frac{n}{1 - \gamma (n-1)} \dots \quad (6)$$

If $\gamma (n-1) = 1$, N becomes infinite, breakdown occurs in the cell. This is the case practically when

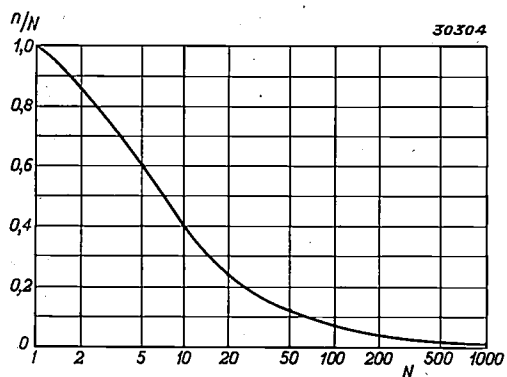

Fig. 3. The ratio n/N of the number of electrons per avalanche to the total amplification as a function of the total amplification N . It is assumed that on the average 0.2 electron ($\gamma = 0.2$) is freed per ion striking the cathode.

n is made too large by increasing the accelerating voltage. For a photocathode $\gamma = 1/3$ to $1/6$. Breakdown therefore occurs at $n = 4$ to 7 .

The part of the electron current which is formed without the agency of ions is n/N . This part shows practically no time lag with respect to the incident light. In fig. 3 n/N is plotted as a function of N according to equation (6) for the case where $\gamma = 0.2$.

Influence of the transit time of the ions

For the remaining part $(N-n)/N$ of the current we may assume an average length of time which, roughly estimated, will be several times greater than the time τ_i necessary for an ion to move from the place where it was formed in the gas to the cathode. The number of ion transit times before the current caused by one photoelectron has fallen to an insignificant fraction (1 per cent for instance) of its initial value is determined by the ratio $\gamma (n-1)$ of the series (5). At $N = 10$ and $\gamma = 0.2$ (see fig. 3) $\gamma (n-1)$ is equal to 0.6, therefore $[\gamma (n-1)]^{10} \approx 0.01$, i.e. after 10 ion transit times the current has practically disappeared. The transit time depends upon the anode voltage, gas pressure and the separation of the electrodes. For a definite case which we shall use later, it amounts to $3.5 \cdot 10^{-6}$ sec. The time lag of the cell in transforming light fluctuations into a fluctuating photocurrent will be appreciable, when the frequency ν of the oscillation to be reproduced becomes so high that a minimum of the photocurrent is affected by the preceding maximum, i.e. when

$$\frac{1}{2} \cdot \frac{1}{\nu} \approx 10 \cdot 3.5 \cdot 10^{-6},$$

$$\nu \approx 15\,000 \text{ c/s.}$$

With larger amplification factors N the time lag will become appreciable already at lower frequencies, since a larger value of $\gamma (n-1)$ corresponds to a larger value of N .

By means of a simplified representation we shall now calculate the frequency characteristic of the gas-filled photocell.

Calculation of the frequency characteristic of the gas-filled photocell

If we allow a light fluctuation with the angular frequency ω and a depth of modulation of 100 per cent to fall upon the photocathode the primary photoelectric current i varies according to the following relation:

$$i = i_0 (1 - \cos \omega t) \dots \quad (7)$$

The amplification N which the photocurrent undergoes in the gas can be divided into an inertia-free amplification N_1 by the electrons formed on the path to the anode (as we shall soon see, $N_1 < n$), and a delayed amplification N_2 caused by the ions, which is expressed in the second, third, etc. terms of series (5). Thus for every photoelectron a charge $N_1 e$ is transported without time lag, and in addition a delayed current flows which gradually dies out. It is obvious that the variation of this decaying current may be represented approximately by an exponentially decreasing function of the time:

$$A \varepsilon^{-qt} \dots \dots \dots (8)$$

where ε is the base of the natural logarithms and q must be chosen so that the decrease of (8) with time corresponds to the decrease of the terms of series (5), which succeed each other at intervals of the average ion transit time τ_i ; thus

$$\begin{aligned} \varepsilon^{-q\tau_i} &= \gamma (n-1), \\ q &= -\frac{\ln \gamma (n-1)}{\tau_i} \dots \dots \dots (9) \end{aligned}$$

The factor A in (8) follows from the condition that the integral of the delayed current from $t = 0$ to $t = \infty$ must be equal to the total charge $N_2 e$ transported with a certain time-lag, thus:

$$\int_0^\infty A \varepsilon^{-qt} dt = N_2 e,$$

from which it follows that

$$A = N_2 e q.$$

N_1 and N_2 are connected by the condition

$$N = N_1 + N_2 \dots \dots \dots (10)$$

The total current I which corresponds to the photocurrent (7) is, according to the above, built up of two parts: the inertia-free part

$$N_1 \cdot i_0 (1 - \cos \omega t)$$

and a part which is found by adding at every moment t the contributions (8) to the current caused during all the preceding time intervals t' , thus

$$\int_{-\infty}^t i_0 (1 - \cos \omega t') N_2 q \varepsilon^{-q(t-t')} dt'$$

The total current is

$$\begin{aligned} I &= N_1 i_0 (1 - \cos \omega t) + \\ &+ \int_{-\infty}^t i_0 (1 - \cos \omega t') N_2 q \varepsilon^{-q(t-t')} dt'. \end{aligned}$$

This gives

$$I = N i_0 [1 - \eta \cos (\omega t - \varphi)], \dots \dots (11)$$

with

$$\eta = \frac{1}{N} \sqrt{N_1^2 + \frac{N_2^2 + 2 N_1 N_2}{1 + \omega^2/q^2}} \dots (12)$$

The phase shift φ is of no further interest here ⁷⁾. It is, however, important that the alternating current (11) no longer has the depth of modulation of 100 per cent of the primary photocurrent, but only a depth of modulation η , which depends upon the frequency according to (12). From (12) it follows directly that the "efficiency" η of the amplification by ionization is equal to 1 when $\omega = 0$; when $\omega \rightarrow \infty$ it approaches N_1/N . Therefore the part of the amplification which is retained at very high frequencies is N_1/N . If η is plotted as a function of ω , the curve obtained gives the frequency characteristic of the photocell.

N_1 and N_2 must be known in order to calculate η . The inertia-free part, N_1 , of the total amplification is given in the first instance by the previously introduced quantity n , the size of the electron avalanche, the first term of the geometric series (5). Upon closer consideration, however, N_1 is found to be smaller than n . The number of electrons n can be divided into the primary electron and the electrons produced along its path: $n = 1 + (n-1)$. Only the first has its source on the cathode, the others, in each case together with an ion, are produced in the space between cathode and anode. In the movement of each of these electrons toward the anode only the induced charge ze of the electron on the cathode is transported through the external circuit of the cell. The factor z depends upon the point where the electron is produced. For the previously mentioned simple configurations of the electrodes z can easily be calculated. If it is known how the points of origin of the $n-1$ new electrons formed by a primary electron are distributed over the distance between the electrodes, the average value Z of the correction factor can be calculated. The $n-1$ electrons thus cause a non-lagging current $Z(n-1)e$, so that

$$N_1 = 1 + Z(n-1), \dots \dots (13)$$

where $Z < 1$, so that $N_1 < n$.

When all n electrons and all the corresponding ions have reached the anode and cathode respectively, the total charge ne has of course been transported by the current. The part $(1-Z)(n-1)e$, i.e. the induced charge of the ions on the anode, is,

⁷⁾ It would be of interest if the cell were to be used for television. Gas-filled cells are, however, as will be seen later, not suitable for this purpose.

however, transported during the movement of the ions, and must therefore be considered a part of the "delayed" amplification N_2 . By means of (13) N_2 follows from (10).

Under certain simplifying assumptions Z can be calculated, and for a cell with plane electrodes (at $V_a = 100$ volts) Z is found equal to about 0.4. With this value N_1 is calculated from n (or N). η can then be calculated, with N as a parameter. In fig. 4 η is drawn as a function of the frequency for two values of N .

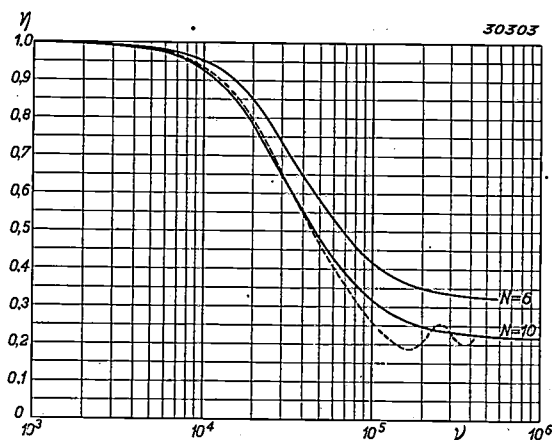

Fig. 4. Theoretically derived frequency characteristics of a gas-filled photocell. The cell is assumed to have plane electrodes with $\gamma = 0.2$. The efficiency η of the amplification is plotted as a function of the frequency ν (in cycles/sec) for two values of the amplification factor N : $N = 6$ and $N = 10$. The dotted curve is calculated according to the more rigorous theory of Ollendorff. For high frequencies the two curves approach the same limiting value: $N_1 = 2.16$ at $N = 10$.

Results and conclusions

The amplification N_1 which remains at very high frequencies (with $Z = 0.4$) is about 1.92 at $n = 3.3$, *i.e.*, in the case where $\gamma = 0.2$, about 32 per cent of the amplification N at low frequencies. At $n = 4$, *i.e.* $N = 10$, N_1 is about 2.2, or only 22 per cent of N .

The relative decrease in the amplification N_1 at high frequencies thus becomes more pronounced with increasing value of N . The absolute value of N_1 increases somewhat, but approaches a limit of a fundamental nature which can be derived directly from (13). We have seen that n cannot be larger than $1 + 1/\gamma$, since otherwise breakdown occurs in the gas. From this maximum value of n the limiting value of N_1 of $1 + 0.4/\gamma$ follows, *i.e.* 3 when $\gamma = 0.2$.

Due to this limitation of the amplification for high frequencies the advantage of gas-filled photocells over vacuum cells is only slight in the case of television, where frequencies of up to $3 \cdot 10^6$ cycles/sec must be transmitted.

In the region of audio frequencies, as with sound

film, the case is different. In this case satisfactory amplifications, for instance of $N = 10$, can be obtained. As to the shape of the characteristic at the highest frequencies to be reproduced, even a fairly great decrease could be compensated for by a suitable characteristic of the amplifier. In that case, however, the correction would only serve for a single definite curve, *i.e.* for one value of the amplification factor N . A variation of the anode voltage of the photocell would destroy the compensation. The cells and amplifiers could also no longer be freely interchanged. It is therefore desirable that the cell have a frequency characteristic such that no special adaptation of the amplifier to the photocell is necessary for obtaining a uniform reproduction of all audible frequencies. For this purpose the requirement must be made that the characteristic shall exhibit no larger variations than about 2 dB, which means that η may not decrease by more than about 25 per cent at the highest frequencies to be reproduced. It may be seen from fig. 4 that, at $N = 10$, the largest amplification factor ordinarily used, this condition is satisfied: at $\nu < 10,000$ cycles/sec the decrease in η is less than 7 per cent (about 0.6 decibel) which is quite imperceptible with sound film.

The different amplification factors N for which the curves in fig. 4 are drawn are obtained by giving suitable values to the gas pressure in the cell. η is determined by the gas pressure, among other factors (see fig. 2) and therefore also N (see equation (5)). It may be seen from fig. 2 that in general the same value of n may be obtained with two different gas pressures, lying to the right and left of the maximum. With increasing pressure, however, the ion transit time τ_i increases, and with it the time lag of the cell. In order to keep the time lag as small as possible, therefore, the smaller of the two gas pressures corresponding to the desired amplification is chosen.

Exact calculation of the frequency characteristic

For the configuration of electrodes assumed in fig. 4 an exact calculation of η has been given by Ollendorff⁸⁾. In this calculation the geometric series (5) is not replaced by an exponential function. The result is a complicated function of ν , which is shown in fig. 4 for $N = 10$ and $\gamma = 0.2$ as a dotted line. It is remarkable that the amplification as a function of the frequency exhibits maxima and minima. This phenomenon may be explained as follows. When the average transit time τ_i of the ions is about equal to an odd number of half oscillation times, the excess of ions formed by a maximum of the illumination arrives at the cathode just during one of the following minima of the illumination. This minimum is

⁸⁾ F. Ollendorff, Z. techn. Phys. 13, 606, 1932.

thus filled up somewhat by the electrons freed, which means a decrease in the depth of modulation. Exactly the opposite takes place when τ_i is about equal to a whole number of oscillation times: the ions formed at a light maximum give an extra amplification of one of the following maxima, and thus an increase in the depth of modulation. The theoretically expected maxima and minima in the η curve have actually been found in measurements carried out by Skellett⁹⁾ as a check on the calculations of Ollendorff. The maxima and minima were encountered at the calculated points.

The agreement between the curves according to the exact calculation and those according to our simplified calculation is good as long as $1/\nu$ is several times as large as τ_i . For shorter times the actual variation of the current transported by the ions evidently begins to exert its influence, so that the approximation by an exponential function is no longer adequate. For $\nu \rightarrow \infty$, however, the curve according to the simplified calculation approaches the same limiting value (see (13) as the curve according to Ollendorff.

Measurement of the time lag of photocells

In order to measure the efficiency factor η as a function of the frequency it is necessary to have a light source whose light flux can be modulated sinusoidally with variable frequency. The commonly used method of obtaining such a source by interrupting the light by openings of a suitable form in a rotating disc has the disadvantage that it is difficult to measure at high frequencies. In our measurements, therefore, the modulation of the light was obtained by means of a gas-discharge lamp with light inertia (glow lamp with concentrated discharge in order to obtain sufficiently high surface brightness). The current through the glow lamp was modulated by means of an audio-frequency generator. A disadvantage of this method is that the depth of modulation of the light always remains less than 100 per cent; it decreases especially at higher frequencies. In our case, however, this is no objection since the time lag of the photocell (with not too great intensities of illumination) is practically independent of the depth of modulation of the light. The alternating current component of the photocurrent given by the cell was amplified, and the amplified current was measured by means of a thermocouple and a galvanometer. For checking the amplified photocurrent a cathode ray oscillograph was used with which it was ascertained that the modulation was sinusoidal.

At each frequency the amplification obtained by ionization was determined by measuring the voltage on the resistance R (fig. 1) at an anode voltage $V_a = 100$ volts, and dividing this value by that found at an anode voltage $V_a = 15$ volts. In the latter case no ionization takes place, since V_a

is less than the ionization potential of argon¹⁰⁾, i.e. the amplification is unity. The efficiency factor $\eta(\nu)$ is then obtained by dividing the amplification found by that at very low frequencies (N).

Results of measurements

Measurements on cells of a type used with sound film gave the frequency characteristics reproduced in fig. 5, where η is plotted as a function of the frequency with the amplification factor N as parameter, for the values: $N = 2, 4, 6, 10$ and 15 .

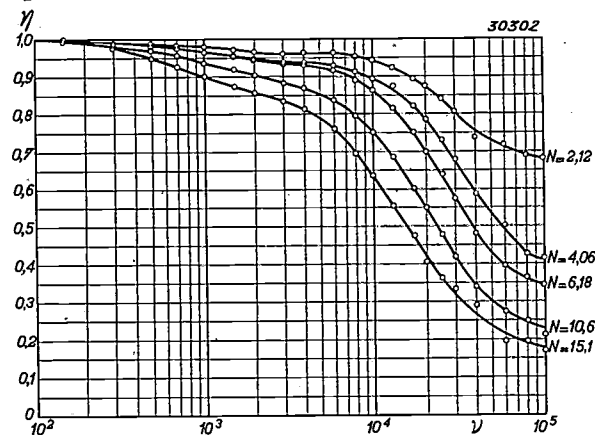

Fig. 5. Experimentally found frequency characteristics $\eta(\nu)$ of a photocell of a type used with sound film, for several values of the amplification factor N .

Although the ionization, which is the cause of the time lag illustrated in fig. 5, depends not only on the gas pressure p , but also on the anode voltage V_a , the variation of $\eta(\nu)$ is found to be independent of p and V_a within certain limits of these quantities, and to be already determined by the amplification factor N in which the influence of p and V_a is combined. For different cells (with the same configuration of the electrodes and the same gas) the same variation of $\eta(\nu)$ is therefore found when V_a is so adjusted with each cell that N has the same value¹¹⁾.

The shape of the curves in fig. 5 corresponds in the main with that of the curves derived theoretically for $N = 10$ and $N = 6$ in fig. 4. The conclusions already drawn from the theoretical curves about the utility of gas-filled cells for different frequencies are therefore confirmed in the main.

¹⁰⁾ In this method of calculation it is assumed that no other sources of inertia are present at the small value of V_a mentioned.

¹¹⁾ The ionization, and with it the time lag, depends further on the light flux on the cell. This influence on the efficiency curve can, however, also be almost entirely removed by reducing the anode voltage V_a so far that N takes on its original value when the light flux is increased. The increasing amplification with larger luminous flux involves a certain amount of non linear distortion. For cells, however, filled with a pure inert gas this distortion is so small, that it is insignificant for sound film purposes.

⁹⁾ A. M. Skellett, J. Appl. Phys. 9, 631, 1938.

More accurate comparison of theory and experiment

In order to test more accurately the theory developed-above the measured and the calculated frequency characteristics of a given cell are drawn in *fig. 6* for $N = 10$. The values of τ_i , γ and Z must

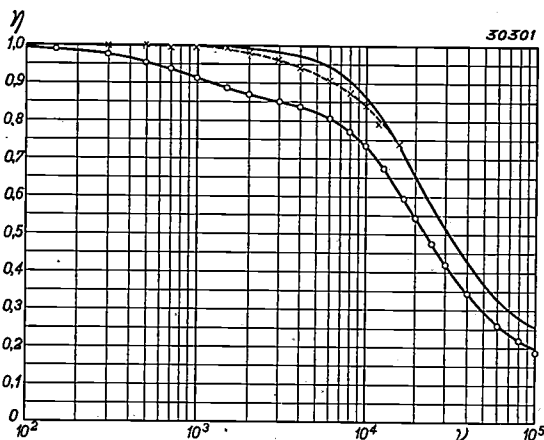

Fig. 6. Comparison of the calculated and measured frequency characteristic (measured points indicated by circles) of a cylindrical cell with rod-shaped anode; $N = 10$, $\gamma = 1/3$. The dotted curve (measured points crosses) is measured with a gas filling of neon plus 10% argon instead of with pure argon.

be known for the calculation. The cell filled with argon at a pressure of 0.07 mm Hg contained a cylindrical cathode 25 mm in diameter, along the axis of which a rod-shaped anode was placed. The average transit time of the ions can be calculated for this case; the value found is $\tau_i = 3.5 \times 10^{-6}$ sec (a value which we have already used above). The coefficient γ of the cathode in this cell was determined experimentally: $\gamma = 1/3$. The factor Z was calculated in the way described above, and at $V_a = 100$ volts it was 0.48.

If the two curves are compared it is seen that the large decrease in the efficiency occurs at the same frequency in both cases. From the measured curve,

however, it follows that the cell has an extra time lag for frequencies between 1000 and 5000 cycles/sec. This deviation cannot be explained by a mistake in the value of the constants used for the calculation; the more exact theory of Ollendorff is also unable to reproduce the measured curves. The explanation of the deviation may be found in the occurrence of excited atoms in a metastable state. These metastable atoms, like ions, can free electrons from the cathode, and thus make a contribution to the total amplification. Since, however, they are not charged, and only reach the cathode because of their irregular thermal motion, their transit time is many times longer than the ion transit time. The electrons liberated by metastable atoms will therefore be still much more delayed with respect to the primary photoelectrons than the electrons freed by the ions. This extra late group of electrons will therefore make itself felt already at lower frequencies as a time lag of the amplification. By taking the influence of the metastable atoms into account in the way discussed above in the simplified theory of the time lag, the theoretically calculated curve can be made to correspond entirely with the results found experimentally.

The explanation given is confirmed qualitatively by the following simple test. A cell is filled with neon plus 10 per cent of argon instead of with pure argon. The metastable neon atoms which are formed in this cell will for the most part have returned to the normal state by collisions with argon atoms before they can reach the cathode. It may therefore be expected that the extra time lag at lower frequencies will be considerably smaller in this case than in an ordinary cell filled with argon. The efficiency curve found with this cell actually more nearly resembles the theoretical curve than that of the ordinary cell as may be seen from *fig. 6*.

RECORDING THE CHARACTERISTICS OF TRANSMITTING VALVES

by T.J. DOUMA and P. ZIJLSTRA.

621.317.755:621.396.615.012

A record can be made of the relation between different voltages with a cathode ray tube by applying them to the horizontal and vertical deflection plates respectively. An arrangement is described in this article with which it is possible to record the anode or screen grid current of a transmitting valve as a function of the anode voltage. By this method a number of curves are obtained at one time for different grid voltages.

Introduction

An arrangement was recently discussed in this periodical for recording the characteristics of receiving valves by means of cathode ray tubes. To each set of deflection plates of the cathode ray tube a voltage is applied which is proportional to one of the two quantities whose relation is represented by the characteristic obtained. If, for example, it is desired to record the I_a-V_a characteris-

The advantage of recording characteristics with the oscillograph over the point-by-point measurement with dial instruments lies not only in the great speed, but chiefly in the fact that it is possible to reach parts of the characteristic where slow measurement would lead to overloading of the valve.

These parts of the characteristics may be of great practical importance. This is especially true in the case of valves with which the load in ordinary use is not much smaller than the maximum permissible load, which is often the case with transmitting valves for example. When a transmitting pentode is normally loaded, the maximum permissible continuous value of the grid currents and the anode current is far exceeded at the positive peaks of the oscillating control grid voltage. It is important to know the shape of the characteristic for this high control-grid voltage, in order for instance to be able to calculate the output power of a transmitting valve.

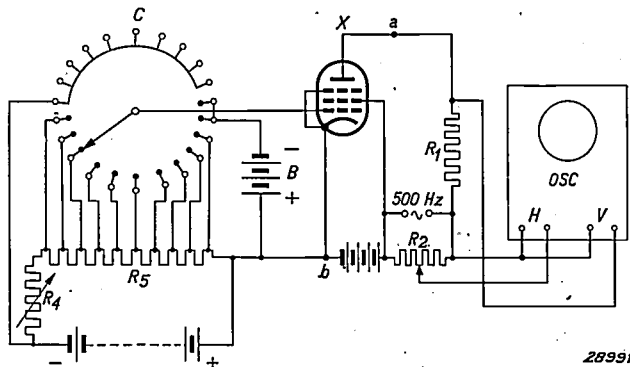

Fig. 1. Circuit for recording characteristics of receiving valves. The oscillogram represents the anode current of the valve X as a function of the anode voltage. By means of the rotating switch C a number of different control-grid voltages are applied during every revolution, so that a series of curves appears on the screen.

tic of a valve, the cathode ray is given a horizontal deflection proportional to the anode voltage V_a and a vertical deflection proportional to the anode current I_a . If the anode voltage is then allowed to oscillate with a sufficiently high frequency between zero and its maximum value, a line is observed on the fluorescent screen which has the form of the I_a-V_a curve.

Instead of a single characteristic, it is also possible to make a whole series of characteristics appear on the screen at the same time. In this way it is possible to show the relation between anode current and anode voltage with the control grid voltage as a parameter. To do this it is only necessary that the control grid voltage should take on a number of different values while the characteristic is being recorded.

The measurement of transmitting valve characteristics

Fig. 1 gives the principle of the previously described arrangement which was used for the recording of receiving valve characteristics. The anode of the valve to be examined is fed with a direct voltage and an alternating voltage of the same maximum value, so that the total voltage oscil-

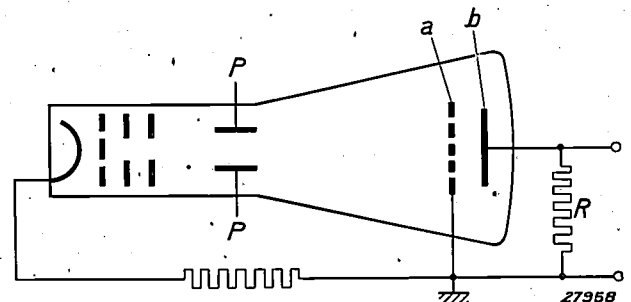

Fig. 2. Diagram of the circuit of the "impulse tube". The electron beam of a cathode ray tube is deflected proportionally to the voltage between the plates P. Whenever this variable voltage passes through certain values, the electron beam falls on a slit in the screen a and part of the electrons pass through to the screen b. A voltage impulse thus occurs on the resistance R.

¹⁾ Philips techn. Rev. 3, 347, 1938.

lates between zero and a maximum value. By means of a rotating commutator C a number of different control grid voltages are successively applied during each revolution, the horizontal deflection is obtained by means of a voltage which is taken from the potentiometer R_2 , and which is proportional to the momentary value of the voltage anode. The vertical deflection is determined by the fall in voltage

sparks occur at the interrupter contacts due to the grid current, so that the voltage cannot be switched off at the desired moments. In the second place the voltage at the interrupter contacts does not remain constant on the occurrence of grid current because the grid circuit has resistance.

It was particularly the second difficulty which led to a modification of the principle. Instead of

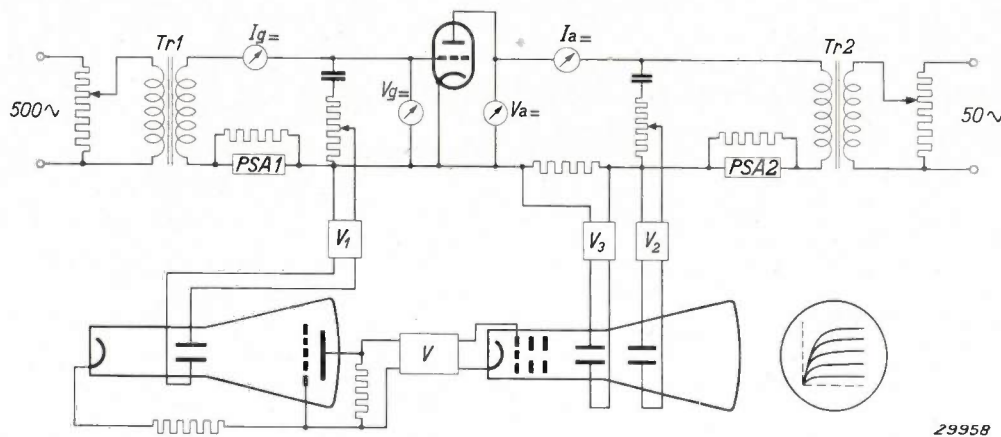

Fig. 3. Diagram of the circuit of the measuring arrangement. V_1 , V_2 , V_3 and V are amplifiers which supply the direct voltage.

at the measuring resistance R_1 , and is proportional to the anode current. On the screen of the tube there appears a series of $I_a \cdot V_a$ characteristics with V_g as a parameter.

This method is useful only when, as in the case given, curves are being recorded with negative control-grid voltages. When the value of the control-grid voltage is positive various difficulties are experienced with the commutator. In the first place

varying the grid voltage in steps, an ordinary practically sinusoidal alternating voltage is supplied to the grid. By means of an electronic switch, which will be described below, it was arranged so that the cathode ray tube only gives light when the grid voltage has just those values which have been chosen as parameters of the $I_a \cdot V_a$ characteristics. In order to carry this out, irrespective of the form of the grid alternating voltage, which may change in some cases due to the appearance of grid currents, a switch arrangement without inertia is required. This can be obtained with the help of a second cathode ray tube which will be called the impuletube²⁾.

Fig. 2 indicates the principle of the impulse tube. The tube contains a pair of deflection plates P , to which is applied a voltage proportional to the control-grid voltage of the tube being investigated. Instead of a screen the impulse tube has two parallel plates a and b , the first of which is provided with thirty narrow parallel slits at equal distances. When the cathode ray swings back and forth across plate a under the influence of an oscillating deflection voltage, a small current strikes the plate b every time the ray passes across a slit, and a voltage impulse on the resistance R results. After amplification this impulse with the correct sign is applied to the regulatory electrode of the cathode ray tube

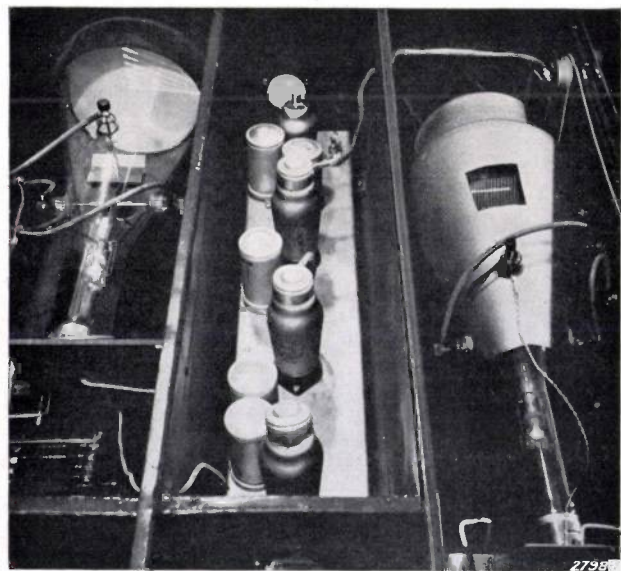

Fig. 4. Photograph of the measuring apparatus. On the left the characteristic tube, on the right the impuletube.

²⁾ This idea was proposed by K. Posthumus.

which records the characteristics, and which we shall call the "characteristic tube" to avoid misunderstanding. This regulatory electrode has a

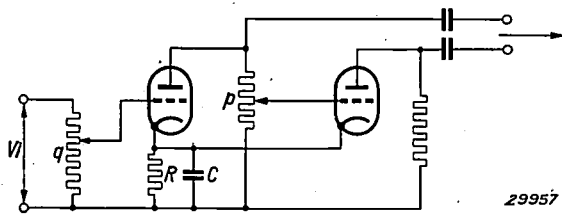

Fig. 5. Diagram of the circuit of the amplifiers V_1 , V_2 , V_3 . With a given input voltage, phase and amplitude of the output voltage may be regulated by means of the potentiometers p and q .

negative bias such that the signal current of the characteristic tube is usually completely suppressed, and only flows during the impulses.

the transformer $Tr 1$, while the anode of the valve is supplied through $Tr 2$ with an alternating voltage of 50 cycles/sec. Both voltages can be regulated and read. In addition the grid as well as the anode has a direct current which can also be regulated and read.

The grid direct voltage is best chosen strongly negative, so that current only flows during a small part of the period. This greatly reduces the average load³⁾. The amplitude of the grid alternating voltage must of course be chosen so great that the maximum grid voltage still has the desired value. The anode direct voltage, as mentioned before, is best adjusted at a value equal to the amplitude of the anode alternating voltage.

The measuring voltages taken off are fed to the amplifiers V_1 , V_2 and V_3 . V_1 receives the control-

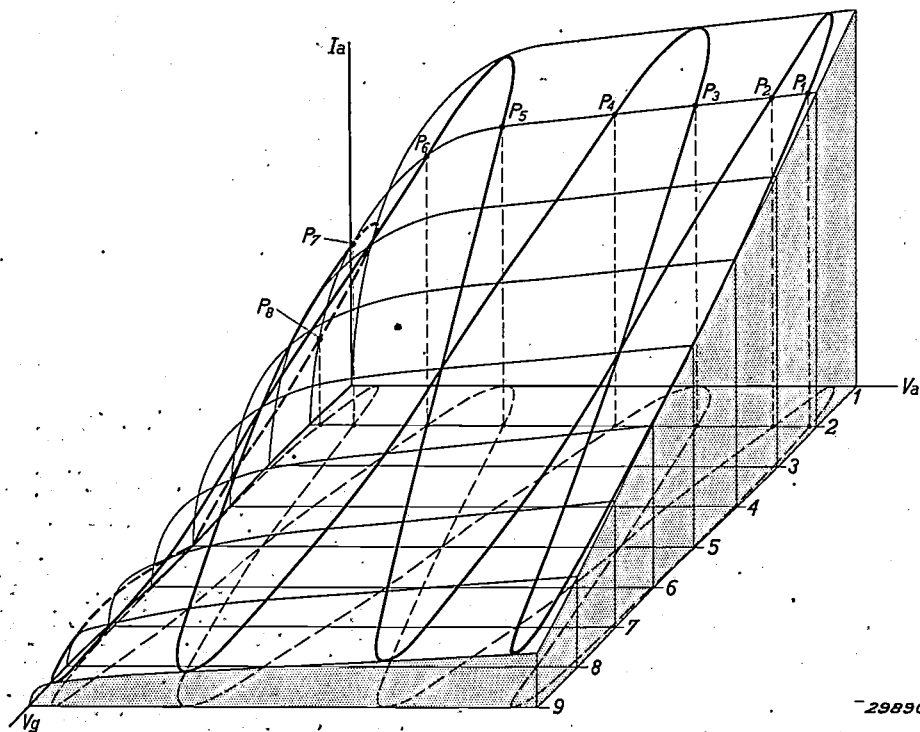

Fig. 6. Anode current I_a as a function of the anode voltage V_a and the control-grid voltage V_g . The electron beam in the impulse tube in the case shown passes nine slits at grid voltages indicated by 1-9. The relation between the grid voltage and the anode voltage during measurement is given by the dotted Lissajous figure in the V_a - V_g plane. The points $P_1 \dots P_9$ are given as examples of the points which appear on the screen of the characteristic tube due to the second slit of the impulse tube. These points are actually not stationary but run along one of the I_a - V_a curves. In the same way eight other I_a - V_a curves are drawn in this case.

Details of the circuit

After this description of the impulse tube we shall consider briefly the other components of the measuring arrangement. The diagram of the circuit of the measuring arrangement is reproduced in fig. 3, while fig. 4 is a photograph of it. An alternating voltage of 500 cycles/sec is supplied to the control grid of the valve to be investigated by

grid voltage, V_2 the anode voltage and V_3 the anode current. The amplified control-grid voltage is fed to the impulse tube and finally regulates the beam current of the characteristic tube. The anode voltage

³⁾ This adjustment of grid direct voltage and alternating voltage, the so-called class C amplification, is often applied in practice to transmitting valves. See in this connection the article on transmitting pentodes: Philips techn. Rev. 2, 257, 1937.

provides the horizontal deflection and the anode current the vertical deflection of the electron beam. In order to obtain a good picture of the characteristics it is necessary that the amplified voltages on the deflection plates and the regulatory electrode of the characteristic tube should be exactly in phase with the corresponding quantities on grid or anode of the transmitting valve. A certain difference of time between the voltage on the characteristic tube and the corresponding quantity on the transmitting tube is of course permissible if it is the same for all three quantities. The amplifiers are so changed that the phase relation of output voltage and input voltage can be regulated to a certain extent. In the ordinary adjustment output and input voltage are in phase. If, however, for instance due to coupling condensers, a phase shift occurs, it must be corrected by a slight change of adjustment.

The circuit diagram of the amplifiers is given in *fig. 5*. Part of the input voltage V_i is tapped off from the potentiometer q and is amplified in two stages of resistance amplification. Each of the two anodes is connected over a condenser with one of the deflection plates of the cathode ray tube.

As may be seen the sum of the two anode currents flows through the circuit formed by the resistance R and the condenser C . This causes a feedback. The feedback voltage will not be in phase with the input voltage because the RC circuit does not have a purely ohmic impedance. The result is that the output voltage is generally also out of phase with the input voltage. If, however, the anode alternating currents of the two amplifier valves have precisely opposite amplitudes, so that the sum of the anode currents is constant, the back coupling disappears and with it the phase difference between output voltage and input voltage. This latter is the normal adjustment.

As may be seen from the diagram the normal adjustment can be obtained by setting potentiometer p so that the amplitudes of the two anode currents become equal in size. Since the two amplifier valves work in opposite phases, the sum of the two anode currents then really does remain constant and the phase shift becomes zero. When, however, a slight phase shift occurs in the external circuits of the amplifier, it can be corrected by changing the potentiometer p .

How the installation works

The way in which the images are formed can be seen from *fig. 6*. In that figure of the curved surface $I_a = f(V_a, V_g)$ is drawn with the I_a-V_a

characteristics corresponding to nine aequidistant values of the grid voltage. Each of these voltages may be made to correspond to a slit in the plate of the impulse tube; when the electron beam passes one of these slits the grid voltage has a definite value and a point of the respective I_a-V_a characteristic is drawn, point P for example. On the screen of the characteristic tube appear the projections on the I_a-V_a plane of the nine characteristics drawn on the surface.

For the sake of clearness in *fig. 6* the frequency of the grid voltage is taken equal to four times that of the anode voltage (instead of ten times), and both are considered to be sinusoidal. It may be seen that the same points are traced over and over, so that a stationary picture of discrete points is obtained. In the V_a-V_g plane the same curve is traced over and over, namely a Lissajous figure for the frequency ratio 4 : 1.

The direct voltage for the anode, as already indicated, is chosen so that the total anode voltage varies between zero and twice the value of the direct voltage. It is hereby assumed that the anode current causes practically no voltage loss in the external circuit of the anode, a circumstance which is not always attainable in practice. If this is not the case the parts of the I_a-V_a characteristic corresponding to the highest positive grid anode voltages are of course not reached (see *fig. 7*).

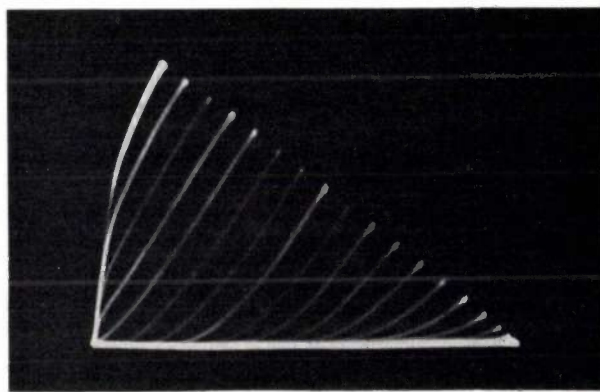

Fig. 7. I_a-V_a characteristics of the transmitter triode $7C^{03/3}$. Abscissa : 1 cm = 150 volts; ordinate: 1 cm = 30 mA. The anode current was limited by an external resistance. The uppermost curve is for $V_g = 40$ volts, in the succeeding curves the grid voltage is 10 volts lower in every case.

If the frequencies of the alternating voltages for grid and anode of the valve being investigated were 500 and 50 cycles/sec respectively, a stationary image, as is *fig. 6*, consisting of a number of points would appear. Actually the two voltages are taken from two independent sources which are practically never exactly synchronous. The result is that the points are not stationary but run along the char-

acteristic, so that the curves are drawn as continuous lines.

In order to obtain sufficiently sharp points on the characteristic tube, the width of the slits and the diameter of the electron beam must be carefully chosen in the construction of the impulse tube. If the width of slit or diameter of beam is too great, vertical lines instead of points appear in the characteristic tube, which decreases the precision. If they are both too small the impulses are too short, and the brightness of the image in the characteristic tube is too low.

Furthermore, in order to obtain sharp charac-

teristics it is necessary that the impulse amplifier also be able to amplify relatively high frequencies sufficiently, so that the correct form of the voltage peaks will be retained. If for example twenty slits have been passed over, and the frequency of the grid voltage is 500 cycles/sec, then, since each slit is passed over twice in every oscillation, there will be $500 \cdot 20 \cdot 2 = 20\,000$ impulses per sec. The duration of each voltage peak is thus in any case small compared with $1/20\,000$ sec, and the amplifier must be able to amplify high harmonics of 20 000 cycles/sec in order to transmit these voltage peaks undistorted.

ABSTRACTS OF RECENT SCIENTIFIC PUBLICATIONS OF THE N.V. PHILIPS GLOEILAMPENFABRIEKN

1335: F. M. Penning: The relation between the Paschen breakdown curve and the elementary processes (Ned. T. Natuurk. 5, 146-151, June 1938).

For several typical cases (air, Ne, Ne + 0.1% Ar) the relation is given between the breakdown potential between parallel plates and the elementary processes. From the manner in which the breakdown potential depends upon the potential difference traversed per free path, the relation is deduced between the breakdown potential and the product of gas density and breakdown distance (Paschen curve), which is a measure of the breakdown distance with unit density of gas. The shapes of these different kinds of curves are discussed.

1336: M. J. Druyvesteyn: Various kinds of breakdown in a gas. Ned. T. Natuurk. 5, 85-95, Apr. 1938).

The breakdown in a gas differs in many cases from the simple case of breakdown between two parallel plates. The breakdown potential and the characteristic of the corona discharge are explained qualitatively. The ignition of the positive column and of an arc with externally heated cathode are discussed.

1337: W. de Groot: Electrical breakdown in gases as a phenomenon of finite duration (Ned. T. Natuurk. 5, 152-167, June 1938).

The experiments of Strigel, Braunbek, Hertz and Schade on the temporal aspect of the breakdown in gases at different pressures are discussed. Especially attention is given to Schonland's physical explanation of lighting discharges, and the possibility is pointed out of generating artificial lighting.

1338: Balth. van der Pol and H. Bremmer: The propagation of radio waves over a finitely conducting spherical earth (Phil. Mag. 25, 817-834, Suppl. June 1938).

As a supplement to previous investigations (cf. 1264 and also 1318) the distribution of field strength is calculated for a transmitter which emits radio waves over a homogeneous spherical earth with an arbitrary electrical conductivity and dielectric constant. The transmitter and receiver are assumed to be on the surface of the earth. As far as is known to the authors the calculations give the most accurate results. Finally curves are given for the field strength as a function of the distance of propagation over the sea and over an average type of land.

acteristic, so that the curves are drawn as continuous lines.

In order to obtain sufficiently sharp points on the characteristic tube, the width of the slits and the diameter of the electron beam must be carefully chosen in the construction of the impulse tube. If the width of slit or diameter of beam is too great, vertical lines instead of points appear in the characteristic tube, which decreases the precision. If they are both too small the impulses are too short, and the brightness of the image in the characteristic tube is too low.

Furthermore, in order to obtain sharp charac-

teristics it is necessary that the impulse amplifier also be able to amplify relatively high frequencies sufficiently, so that the correct form of the voltage peaks will be retained. If for example twenty slits have been passed over, and the frequency of the grid voltage is 500 cycles/sec, then, since each slit is passed over twice in every oscillation, there will be $500 \cdot 20 \cdot 2 = 20\,000$ impulses per sec. The duration of each voltage peak is thus in any case small compared with $1/20\,000$ sec, and the amplifier must be able to amplify high harmonics of 20 000 cycles/sec in order to transmit these voltage peaks undistorted.

ABSTRACTS OF RECENT SCIENTIFIC PUBLICATIONS OF THE N.V. PHILIPS GLOEILAMPENFABRIEKN

1335: F. M. Penning: The relation between the Paschen breakdown curve and the elementary processes (Ned. T. Natuurk. 5, 146-151, June 1938).

For several typical cases (air, Ne, Ne + 0.1% Ar) the relation is given between the breakdown potential between parallel plates and the elementary processes. From the manner in which the breakdown potential depends upon the potential difference traversed per free path, the relation is deduced between the breakdown potential and the product of gas density and breakdown distance (Paschen curve), which is a measure of the breakdown distance with unit density of gas. The shapes of these different kinds of curves are discussed.

1336: M. J. Druyvesteyn: Various kinds of breakdown in a gas. Ned. T. Natuurk. 5, 85-95, Apr. 1938).

The breakdown in a gas differs in many cases from the simple case of breakdown between two parallel plates. The breakdown potential and the characteristic of the corona discharge are explained qualitatively. The ignition of the positive column and of an arc with externally heated cathode are discussed.

1337: W. de Groot: Electrical breakdown in gases as a phenomenon of finite duration (Ned. T. Natuurk. 5, 152-167, June 1938).

The experiments of Strigel, Braunbek, Hertz and Schade on the temporal aspect of the breakdown in gases at different pressures are discussed. Especially attention is given to Schonland's physical explanation of lighting discharges, and the possibility is pointed out of generating artificial lighting.

1338: Balth. van der Pol and H. Bremmer: The propagation of radio waves over a finitely conducting spherical earth (Phil. Mag. 25, 817-834, Suppl. June 1938).

As a supplement to previous investigations (cf. 1264 and also 1318) the distribution of field strength is calculated for a transmitter which emits radio waves over a homogeneous spherical earth with an arbitrary electrical conductivity and dielectric constant. The transmitter and receiver are assumed to be on the surface of the earth. As far as is known to the authors the calculations give the most accurate results. Finally curves are given for the field strength as a function of the distance of propagation over the sea and over an average type of land.

Philips Technical Review

DEALING WITH TECHNICAL PROBLEMS
RELATING TO THE PRODUCTS, PROCESSES AND INVESTIGATIONS OF
N.V. PHILIPS' GLOEILAMPENFABRIEKEN

EDITED BY THE RESEARCH LABORATORY OF N.V. PHILIPS' GLOEILAMPENFABRIEKEN, EINDHOVEN, HOLLAND

THE ILLUMINATION OF RAILWAY YARDS WITH SODIUM LAMPS

by H. ZIJL.

621.327.44 : 628.971.8

Sodium lamps are becoming more and more common for the illumination of railway yards. In addition to the well-known advantages of sodium light such as great contrast, high visibility and speed of observation, slightness of glare, the high efficiency of sodium lamps is also an important factor in the case of railway yards where very large areas must be lighted. In this article different systems of lighting railway yards are dealt with, and several points are indicated which are important in the designing and calculation of the illumination of a railway yard with sodium lamps.

Introduction

An efficient illumination is indispensable for smooth running and safety in shunting operations after dark. The illumination must reveal the shunt lines with the rolling stock on them, buffers, turntables and other items of the equipment of such a yard. It is of particular importance that the position of switches be clearly visible. Although the position of a switch may be deduced from the position of the operating mechanism, or may be indicated by means of a signal, the shunters prefer a direct observation of the position of the switch tongues. Possible doubt about this position will lead to delay and may lead to damage and accidents.

A railway yard has a large surface to be illuminated, and therefore economy prohibits a strong illumination. Moreover, the majority of the objects to be made visible, as well as the ground itself, are dark in colour and without striking colours. In such a difficult situation the emphasis must be laid upon making strong contrasts in brightness, and disturbing factors such as glare must be avoided as much as possible.

The strongest contrasts in brightness between the usually vertical objects and the horizontal ground occur when the light is incident either vertically or approximately horizontally. Two completely different systems of illumination have therefore been developed. This development had already taken place before sufficient theoretical knowledge had been obtained to serve as a guide. Experience had shown what was usable and what could not be considered suitable, which of course

does not mean that much of what was usable, and which therefore remained, is not capable of being improved upon.

At the present time gas-discharge lamps and especially sodium lamps are being used to an increasing degree for the illumination of railway yards. Because of this fact experiments have been carried out with this new light source, which is known to be easily capable of providing the required strong contrasts. Moreover, the high efficiency of the sodium lamp is a factor which may not be too lightly estimated, because of the large area to be lighted. In the following we shall discuss the ordinary systems for the illumination of railway yards and then investigate the advantages to be obtained by the use of gas-discharge lamps.

Two systems of illumination of railway yards

The first and oldest lighting system consists of a number of standards with lanterns distributed more or less uniformly over the yard. Initially these lanterns had no definite light distribution which made them particularly efficient for the purpose in view. They gave light, and that was, in those times, almost the only requirement made of illuminating engineering. Since an increase in intensity of the light sources used accompanied the development of the railway industry, measures had to be taken to decrease the disturbing glare. Diffusing bulbs were at first used to decrease the brightness of the source of light. This measure is, however, of only moderate help in dark surroundings, so that enam-

melled reflectors began to be more commonly used. These restricted the radiation to a cone with an apex angle of $2 \times 70^\circ$ to $2 \times 75^\circ$. By this restriction of the radiation not only was the glare reduced to a negligible quantity¹⁾, but in addition the intensity of illumination was about doubled in comparison with the older freely radiating fixtures which waste a large amount of light by radiation upward and to the sides.

The second system of lighting is also old, and it arose when electric filament lamps of high power became available. These lamps are mounted in mirror reflectors which give concentrated beams of great intensity. These searchlights are set up in batteries at some height, and the beams are directed on to the yard about in the main direction of the tracks (fig. 1).

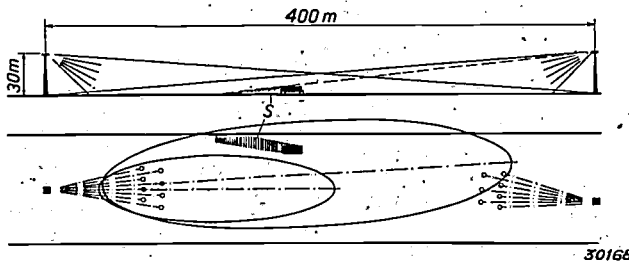

Fig. 1. Schematic illustration of illumination by means of search lights. Each part of the yard must be lighted from two sides, in order to prevent the formation of long shadows (S) as much as possible. Eight projectors are mounted on each standard. The small circles indicate the spots where the axes of the light beams touch the ground. The ellipses indicate the parts of the yard lighted by the beams of 30° for the two black circles. The beams do not have sharp boundaries and light also falls outside the ellipses.

Both systems have their advantages and disadvantages. For the first system a cable network is necessary, which covers the whole yard. The installation of this net is fairly expensive because of the many unavoidable crossings of the tracks. The second system has the advantage of a very simple supply network, since the current consumption is concentrated at only a few points. Over against this is the disadvantage that the high positions for mounting are usually absent and must be built in the form of standards 15 to 35 m in height.

From the point of view of light technology the use of scattered lanterns is in general to be preferred to the use of searchlights, as will be seen in the following discussion of the most important characteristics of the two systems.

Efficiency

The efficiency of a simple enamelled fixture is 55 to 65 per cent, i.e. 55 to 65 per cent of the light

flux is directed downward toward the ground. Some light is obviously lost because it falls outside the boundary of the yard, but this quantity is not large when the system is properly installed.

With a good mirror reflector the beam with an apex angle of $2 \times 15^\circ$ includes 30 per cent of the total light flux of the lamp, thus much less than with scattered lanterns. The stray light, which represents about 35 per cent of the light flux of the lamp, is practically lost (fig. 2).

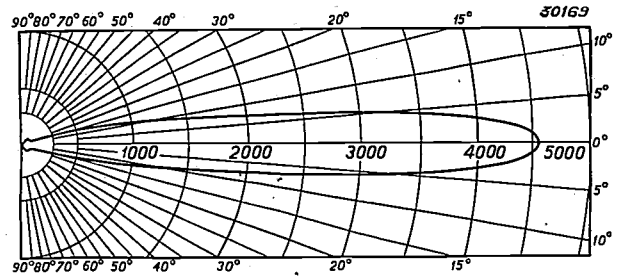

Fig. 2. Light distribution of the projector FLC 1.

Loss of light due to dirt and mist

In both systems dirt on the fixtures will cause a weakening of the illumination. In the case of the simple enamelled reflectors dirtiness results in a decrease of the reflective power, and the light distribution changes only slightly. With mirror reflectors there is not only absorption in the covering glass and a decrease in the reflective power of the mirror, but in addition a scattering of the beam. The influence of dirt is therefore larger than with scattered lanterns. The loss of light due to mist is also greater in the case of concentrated light beams than with the scattered arrangement, because the rays have to cover longer distances through the air.

Formation of contrast

In judging the contrast two things must be distinguished, the brightnesses of the rather diffusely reflecting surfaces of the carriages, the side surface of the rails and the ground, and the brightness of the smooth, specular running surfaces of the rails.

With the system with scattered lanterns the light falls mainly from above. In general therefore the vertical walls of the carriages will be less strongly lighted than the ground, in the same way the vertical surfaces of the rails will remain dark. The shadows will be short, and will therefore not only cause little trouble, but will also serve to bring out the line of the rails.

On the running surface of the rails a moderate reflection takes place at the point where the rails lie between the observer and a lantern. The tracks are

¹⁾ See the article: Technical considerations in the lighting of country roads, Philips techn. Rev. 2, 239, 1937.

therefore seen as bright bands against a dark background (see *fig. 3*). Since when a long shunting yard is seen in perspective the lanterns are seen scattered over the whole width, this reflection will occur throughout the whole yard except where the carriages intercept the light rays, *i.e.* in the shadows. The state of illumination has the same character as that in daylight as regards average brightnesses.

of incidence. The contrast obtained is thus confined to the surfaces which stand more or less perpendicular to the length of the yard.

Glare

In the case of illumination with search lights glare forms a serious obstacle. It is impossible to give the beams such a steep slope that no radiation strikes the eye within an angle of 15° with the direc-

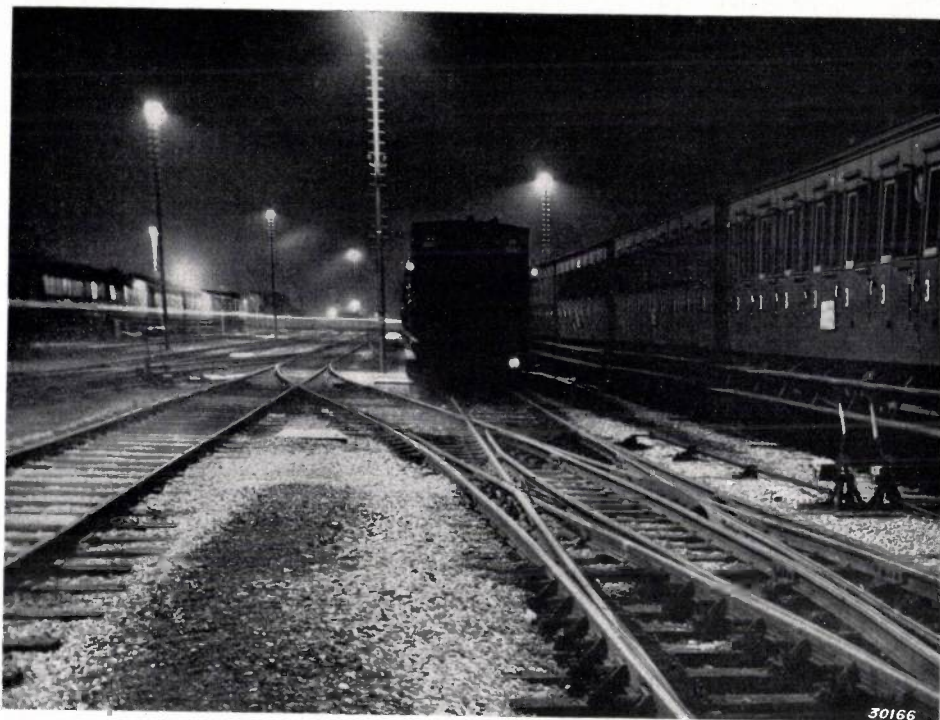

Fig. 3. The photograph shows how the bright running surface of the rails contrasts with the dark sides and the ground. The position of the switch tongues is clearly visible. The carriages are easily seen by the contrast in brightness with their surroundings. Within the short shadow of the carriage in the middle of the photograph the reflection of the rails disappears.

With illumination by means of concentrated beams the intensity of illumination on the sides of carriages toward the light source is stronger than the illumination on the ground. Since the chief directions of vision correspond approximately with the direction of the illuminating beams (because of the greater lengthwise dimension of the yard) the objects will appear bright against the dark background of sky and ground. If there are also beams which radiate in the opposite direction the reflection by the rails is very strong. This a favourable condition, but the long shadows are apt to spoil the efficiency.

Illumination of the side walls of the cars is impossible unless the batteries of lights are stationed along one side of the yard (see *fig. 4*). Even then it is impossible to obtain a strong illumination of the side walls because of the unfavourable direction

tion of vision. If this were done the sphere of action would be so reduced (see *fig. 4*) that the system would no longer meet the requirements. Moreover, the scattered light which is emitted outside the effective beam would also be able to cause glare. By locating the lights at one side the glare can be

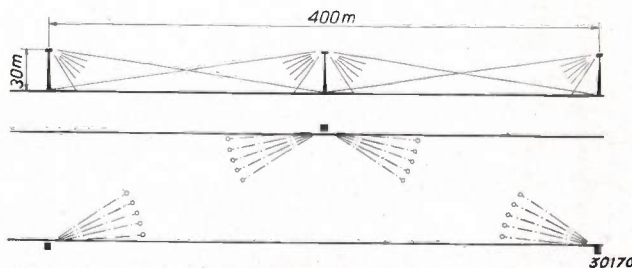

Fig. 4. In order to reduce the glare the beams may be directed obliquely to the general direction of observation and downward as much as possible. This, however, reduces the sphere of action of the batteries and makes a larger number of standards necessary.

reduced for the main direction of the yard. The objection to this is, however, that lights would have to be set up at more points, which would increase the cost of installation.

From the foregoing it may be seen that better results are in general to be expected from an illumination of railway yards with scattered lanterns, if well carried out, than from an illumination with searchlights. In order to understand how the use of searchlights was ever able to maintain itself, it must be kept in mind that this type of illumination originated at the time when illumination with scattered light sources also produced considerable glare because of the use of freely radiating lanterns.

Application of gas-discharge lamps in railway yards

If we now investigate whether certain gas-discharge lamps, especially sodium and mercury

electric light or mercury light of the same intensity³⁾.

- f) The disturbing effect experienced by looking directly into the light source (afterimages) or by the influence of reflection in puddles (direct and indirect simultaneous glare) is at a minimum with sodium light.

On the basis of these considerations various countries have begun to use "Philora" gas-discharge lamps for the illumination of railway yards. The sodium lamp is usually chosen because, as appears from the above, it satisfies the purpose better than the mercury lamp. Of the two systems of illumination described above only the first one may be considered because the sodium lamp is too large a source of light to be used in projectors.

At the beginning of 1934 the Netherlands Railways carried out an experiment in the railway yard

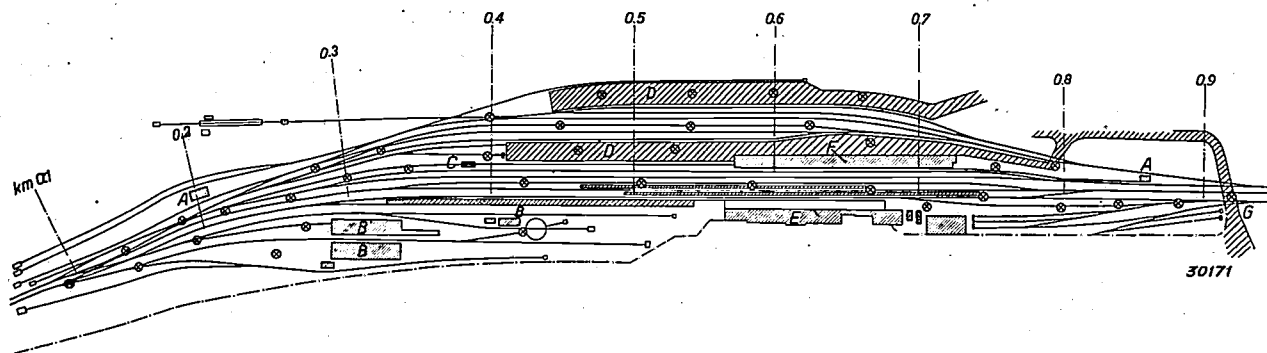

Fig. 5. Ground plan of the railway yard in Breda. A signal box, B work shops, C weighing cabin, D unloading yard, E station building, F goods shed, G level crossing.

vapour lamps, offer special advantages for the illumination of railway yards, the following factors must be considered:

- The gas-discharge lamp has a high efficiency, with which not only a saving of current, but also an increase of the level of illumination can be attained. Among the various gas-discharge lamps, the sodium lamp is more efficient than the mercury lamp.
- The incorrect colour reproduction by gas-discharge lamps is of little or no importance in shunting operations.
- With mercury lighting as well as with sodium lighting a high visibility is attained²⁾.
- The speed of observation is higher with sodium light than with ordinary electric light or mercury light²⁾.
- The contrast is considerably greater with sodium light of low intensity than with ordinary

at Amersfoort. This was followed by a permanent installation in the Born yards in South Limburg. The results were so good that new railway yards will always be provided with sodium illumination, and in older installations the electric filament lamps are being gradually replaced by sodium lamps (Philora SO 85 W).

The experience which has been obtained in practice⁴⁾ confirms the presence of the above-mentioned advantages of sodium light for lighting railway yards. Moreover, another advantage was found in the fact that considerable saving was achieved in the installation of the cable network as may be seen in the following paragraph.

Because of the small amount of power taken from the mains the voltage loss is relatively low. Moreover, the sodium lamp is less sensitive to changes in

²⁾ See P. J. Bouma: Visual acuity and speed of vision in road lighting, Philips techn. Rev. 1, 215, 1936.

³⁾ P. J. Bouma: Contrast with sodium light, mercury light and white light, De Ingenieur 49 A, 290, 1934. See also Philips techn. Rev. 1, 166, 1936.

⁴⁾ See in this connection G. J. de Vos van Nederveen Cappel, Sodium lighting on railway yards, Ingenieur 52 V, 41, 1937.

voltage than an electric filament lamp, *i.e.* the decrease of the light flux is very much less for a given fall in voltage. In addition the lamp transformers for "Philora" sodium lamps are provided with taps which make it possible to neutralize a certain voltage loss.

In the installation of new systems it is possible to use conductors with a smaller cross section if sodium lamps are used, and this means a not inconsiderable reduction of the capital invested.

Technical features of the illumination of railway yards with sodium lamps

The following must be kept in view in the installation of a sodium lamp system:

The intensity of illumination on the ground must be on the average not lower than 1 lux. If we take into account a decrease of the level of illumination by 50 per cent due to the lamps and reflectors becoming dirty, a decrease which must certainly be expected in a railway yard, then a new installation must be calculated on a basis of an average intensity of 2 lux.

If one counts on an efficiency of 60 per cent of the reflectors, and a loss of light which falls outside the yard of 20 per cent, then the light flux per square metre of the lamps to be installed is

$$f = \frac{2}{0.6 \times 0.8} = \text{about } 4 \text{ lumens.}$$

This means for sodium lamps with an efficiency of about 60 lm/W, a power of 0.07 watt per square metre of surface. According to this one may for example install one "Philora" sodium lamp SO 85 W

(light flux 6 500 lumens) per 1600 sq.m. of surface.

In practice account must be taken of the fact that certain parts of the grounds must be better lighted than the rest, for instance at the points

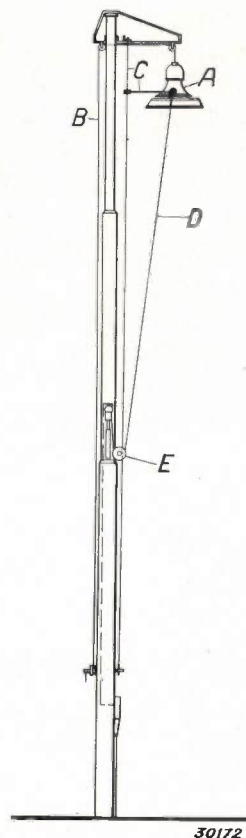

Fig. 6. Method of mounting the fixture for sodium illumination. The cast-iron cap A hangs by the steel wire B which can be run out. Two more steel wires C help to prevent swinging of the fixture in the wind. For the same reason the cast-iron cap is heavily constructed and also contains the leakage transformer of the sodium lamp. The flexible supply lines D are kept taut with the help of two rollers E.



Fig. 7. Railway yard, Dijkgracht, Amsterdam, lighted with 39 "Philora" sodium lamps SO 85 W. The height of the light points is 10.5 m.

where there are many switches, or where different parts of trains are customarily ranged alongside of each other. At such places it is usually necessary to place the lanterns closer together, not primarily to obtain a stronger illumination, but mainly to neutralize the shadows occurring in the compass of one lantern by the light of another lantern. Therefore the power installed will be increased at such a spot to 0.1 to 0.15 watt per sq.m.

On the ground plan of the railway yard in Breda (*fig. 5*) it may be seen that the ends of the yard, where relatively many switches are located, are more thickly occupied by lanterns than the middle section with straight continuous tracks.

The light distribution of the reflectors for sodium lamps is not symmetrical in all directions.

The maximum light intensities lie in the plane perpendicular to the axis of the lamp. The reflectors must therefore in general be mounted perpendicular to the length of the yard.

In a railway yard, as already suggested, the lanterns will quickly become dirty because of the large quantities of smoke and soot in the air. Regular cleaning is therefore essential. To facilitate this the fixtures are best mounted in such a way that they can easily be lowered. In *fig. 6* the method of hanging the lanterns used by the Netherlands Railways is shown, while in the text under the figure further particulars are given. Finally *fig. 7* is a photograph of a railway yard in Amsterdam which is lighted with sodium lamps in the fixtures shown in *fig. 6*.

A PHOTOMETER FOR THE INVESTIGATION OF THE COLOUR RENDERING REPRODUCTION OF VARIOUS LIGHT SOURCES

by P. M. VAN ALPHEN.

535.247.4 : 535.62 : 628.93

For the investigation of the colour reproduction obtained with different kinds of light a photometer has been developed in this laboratory with which it is possible to measure the light flux in definite wave-length regions of the spectrum. The photometer is described in this article. Special attention is paid to the circuit which is used for the measurement of very small photocurrents. Finally it is shown by means of several examples what type of investigations can be carried out with this instrument.

The colour reproduction of various sources of more or less white light has been repeatedly discussed in this periodical. It was always pointed out that it is impossible to conclude from the colour of the light radiated, how the colours of illuminated objects will be reproduced under the light in question. In order to judge this one must know how the intensity of the source of light varies as a function of the wavelength. A complete description of a light source therefore must include a curve or an elaborate table.

It is of course desirable to be able to characterize a light source by means of a smaller number of values, and it was actually found possible to divide the spectrum into eight different blocks in such a way, that the colour reproduction of a kind of light is sufficiently accurately characterized by the value of the light flux which is emitted in each of these eight blocks. This block method is often applied in this laboratory in the investigation of light sources and has often been mentioned in this periodical¹⁾.

The following will be a description of the photom-

eter which was designed especially for these measurements. Several examples will then be discussed which serve to give an impression of the usefulness of the instrument.

The choice of the blocks

The blocks must be chosen so small that the colour of commonly used pigments does not change significantly under the light when shifted within one block. In order to attain this requirement to the same degree for every colour it was found necessary to choose the intervals smaller in the blue than elsewhere. The following division proved satisfactory: 4 000—4 200—4 400—4 600—5 000—5 500—6 000—6 500—7 000 Å.

Later, in connection with the photometry of mercury light, a somewhat different division was

¹⁾ See for example the articles; P. J. Bouma, Colour reproduction in the use of different sources of "white light", *Philips techn. Rev.* 2, 1, 1937; W. Uytendhoeven and G. Zecher, Low-pressure mercury discharge within a luminescent tube, *Philips techn. Rev.* 3, 277, 1938; G. Heller, A film projection installation with water-cooled mercury lamps, *Philips techn. Rev.* 4, 2, 1939.

where there are many switches, or where different parts of trains are customarily ranged alongside of each other. At such places it is usually necessary to place the lanterns closer together, not primarily to obtain a stronger illumination, but mainly to neutralize the shadows occurring in the compass of one lantern by the light of another lantern. Therefore the power installed will be increased at such a spot to 0.1 to 0.15 watt per sq.m.

On the ground plan of the railway yard in Breda (*fig. 5*) it may be seen that the ends of the yard, where relatively many switches are located, are more thickly occupied by lanterns than the middle section with straight continuous tracks.

The light distribution of the reflectors for sodium lamps is not symmetrical in all directions.

The maximum light intensities lie in the plane perpendicular to the axis of the lamp. The reflectors must therefore in general be mounted perpendicular to the length of the yard.

In a railway yard, as already suggested, the lanterns will quickly become dirty because of the large quantities of smoke and soot in the air. Regular cleaning is therefore essential. To facilitate this the fixtures are best mounted in such a way that they can easily be lowered. In *fig. 6* the method of hanging the lanterns used by the Netherlands Railways is shown, while in the text under the figure further particulars are given. Finally *fig. 7* is a photograph of a railway yard in Amsterdam which is lighted with sodium lamps in the fixtures shown in *fig. 6*.

A PHOTOMETER FOR THE INVESTIGATION OF THE COLOUR RENDERING REPRODUCTION OF VARIOUS LIGHT SOURCES

by P. M. VAN ALPHEN.

535.247.4 : 535.62 : 628.93

For the investigation of the colour reproduction obtained with different kinds of light a photometer has been developed in this laboratory with which it is possible to measure the light flux in definite wave-length regions of the spectrum. The photometer is described in this article. Special attention is paid to the circuit which is used for the measurement of very small photocurrents. Finally it is shown by means of several examples what type of investigations can be carried out with this instrument.

The colour reproduction of various sources of more or less white light has been repeatedly discussed in this periodical. It was always pointed out that it is impossible to conclude from the colour of the light radiated, how the colours of illuminated objects will be reproduced under the light in question. In order to judge this one must know how the intensity of the source of light varies as a function of the wavelength. A complete description of a light source therefore must include a curve or an elaborate table.

It is of course desirable to be able to characterize a light source by means of a smaller number of values, and it was actually found possible to divide the spectrum into eight different blocks in such a way, that the colour reproduction of a kind of light is sufficiently accurately characterized by the value of the light flux which is emitted in each of these eight blocks. This block method is often applied in this laboratory in the investigation of light sources and has often been mentioned in this periodical¹⁾.

The following will be a description of the photom-

eter which was designed especially for these measurements. Several examples will then be discussed which serve to give an impression of the usefulness of the instrument.

The choice of the blocks

The blocks must be chosen so small that the colour of commonly used pigments does not change significantly under the light when shifted within one block. In order to attain this requirement to the same degree for every colour it was found necessary to choose the intervals smaller in the blue than elsewhere. The following division proved satisfactory: 4 000—4 200—4 400—4 600—5 000—5 500—6 000—6 500—7 000 Å.

Later, in connection with the photometry of mercury light, a somewhat different division was

¹⁾ See for example the articles; P. J. Bouma, Colour reproduction in the use of different sources of "white light", *Philips techn. Rev.* 2, 1, 1937; W. Uyterhoeven and G. Zecher, Low-pressure mercury discharge within a luminescent tube, *Philips techn. Rev.* 3, 277, 1938; G. Heller, A film projection installation with water-cooled mercury lamps, *Philips techn. Rev.* 4, 2, 1939.

adopted, namely: 4 000 - 4 200 - 4 400 - 4 600 - 5 100 - 5 600 - 6 100 - 6 600 - 7 200 Å.

In the first-mentioned division the green mercury line of 5 461 Å would have fallen practically on the boundary between two blocks, which is undesirable practically because a small error in the adjustment of the blocks would lead to the light flux of that line being divided between two blocks in quite different ways. As to the value of the blocks for colour impression, the new division is practically equivalent to the one first chosen.

The principle of the measuring process

The principle of the measuring process is illustrated in *fig. 1*. Light from the source being investigated falls on a slit *S* of a prism spectroscopie. By means of lens *L* and prism *P* a spectrum is thrown on the window *D*. In this window there is an opening which transmits only a certain part of the spectrum. The light flux transmitted is measured by means of the photocell *F*.

monochromator, by which the already small light flux is reduced even more. A description of the measuring arrangement will precede the estimation of the light flux.

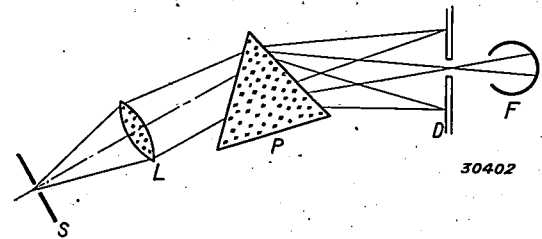

Fig. 1. Diagram of a spectrometer for the determination of the light flux in a certain section of the spectrum. A spectrum of the light which passes through the slit *S* is formed by means of the lens *L* and the prism *P* on the window *D*. This window has an opening which transmits only a certain part of the spectrum. The light flux transmitted is measured by means of the photocell *F*.

The measuring arrangement

Fig. 2 is a diagram of the complete measuring

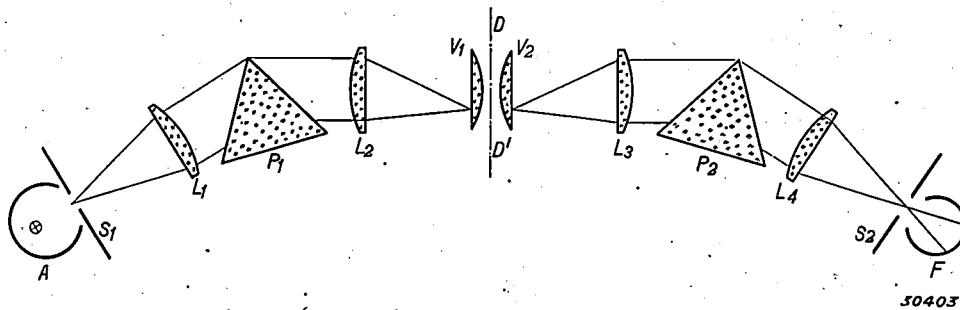

Fig. 2. Arrangement of a spectrometer on the same principle as in *fig. 1*. In order to avoid scattered light the set up of *fig. 1* is elaborated to a double monochromator. The light source is placed in an Ulbricht sphere *A*.

mitted is measured by means of a photocell *F*. The height of the opening in the window *D* has been made to correspond to the sensitivity of the eye for that wave length for every wave length of the spectrum, and in such a way that the photocurrent, which with a given intensity also depends upon the wave length, is a direct measure of the light flux which is emitted in the block of the spectrum under consideration. By using different screens with openings at different parts of the spectrum corresponding with the different blocks, the light flux can be measured in the eight blocks of the spectrum.

Although the principle is very simple, the technical execution presents difficulties which we shall here discuss briefly. The light flux available, as will be shown later, is extremely small, so that for accurate measurement it is necessary to exclude absolutely any influence from scattered light, especially from scattered light with undesired wave lengths. For this purpose it is desirable to use a double

arrangement. In an Ulbricht sphere *A*, 50 cm in diameter, the lamp to be tested is placed. The walls of the sphere illuminate the slit *S*₁ which is 0.3 mm wide. By means of the achromatic lenses *L*₁ and *L*₂ and the prism *P* a spectrum is formed on the plane *DD'*. In this plane there is a diaphragm which transmits a certain block of the spectrum. The function of this plane is to cut off scattered light. The plane *DD'* is situated between two lenses *V*₁ and *V*₂ which form an image of lens *L*₂ on lens *L*₃, so that every ray of light which leaves lens *L*₂ also passes through lens *L*₃.

The paths of the rays for all non-scattered rays on both sides of *DD'* are mirror images of each other. It follows from this that the rays of different wavelengths which pass through a slit in the screen *S*₁ are again focussed on a slit in the screen *S*₂ and finally reach the photocell *F*. If, however, due to reflection or scattering, light of a given wave length passes through the wrong block opening in *DD'* then this light is so refracted by prism *P*₂ that it

does not strike the slit and cannot therefore act on the photocell.

Because of the arrangement described the photocell receives light only from a certain block of the spectrum. We shall now discuss the photocurrents which may be expected as a result of this illumination.

The available light flux in a block

The total light flux which passes through the apparatus is the following:

$$\Phi = K \cdot \pi \cdot B \cdot O \cdot \sin^2 \frac{1}{2} \varphi \text{ lumen} \quad (1)$$

where φ is the angle of divergence of the monochromator, O the area of the first slit, B the brightness of the first slit, and K the loss factor.

The light strength of the spectrograph is determined by the relative aperture of the lens L_1 . In our case this is 1 : 3.5 (i.e. $\frac{1}{2} \varphi = 8^\circ$), which may be considered a high value. The image of the slit is focussed on the plane DD' in actual size, and a spectrum is formed in that plane whose total width is about 15 mm, so that each block is 1.5 to 2 mm long. If the wave length regions are to be fairly accurately defined, the width of the first slit must be sufficiently small compared with this 1.5 mm. The height of the slit is limited by the appearance of aberration for object points outside the axis. We chose a width of 0.3 mm and a height of 17 mm, so that the area O was equal to 0.051 sq.cm.

In order to be able to measure the light flux of small lamps with an Ulbricht sphere it is desirable to be able to work with a low brightness in the plane of the slit, for example $B = 0.1$ c.p./sq.cm.

The loss factor K is quite considerable because the light must pass through nine glass bodies (six lenses, two prisms, and the window DD' , since the diaphragm in this plane is deposited on glass photographically). The loss in the glass is caused chiefly by reflection. The average transmission of each glass body is about 90 per cent, so that the total transmission will be:

$$K = 0.9^9 = 40 \text{ per cent.}$$

For the light flux Φ according to equation (1) we find:

$$\Phi = 0.4 \pi \times 0.1 \times 0.051 \times \sin^2 8^\circ = 125 \times 10^{-4} \text{ lumen.}$$

Only a small part of this light flux is found in the blue block from 4 000 - 4 200 Å. In the case of sunlight this part is about 0.01 per cent; in the case of many sources of artificial light, which usually

contain less blue, the amount of blue radiation will be ten times as small.

If it is desired to measure this amount of blue radiation of 0.001 per cent with an accuracy of 5 per cent, it is necessary to be able to distinguish differences in light flux of 0.6×10^{-10} lumen. A vacuum photocell was chosen with potassium as the photo-sensitive material. These cells are very constant and have a sensitivity of 40 μ A/lumen in the light of an ordinary electric lamp. In the first blue block the sensitivity is about 100 times greater than this. When this cell is used and light differences of 10^{-10} lumen must be registered it must be possible to measure a current difference of about 10^{-13} A.

How such small photocurrents are measured

The very small photocurrent can easily be measured by changing the charge on a condenser by means of this current, and measuring the difference in voltage between the plates of the condenser electrostatically. This can for instance be done by means of a so-called electrometer triode, i.e. a triode whose control grid is very carefully insulated from the other electrodes.

In fig. 3 the circuit is given which was used for measuring the photocurrent. The photocurrent flows from the photocell F to the covering 1 of the condenser C . The grid of the electrometer triode T (type 4060) is connected to the same covering.

When the voltage of this grid changes, the anode current, which can be read off on the micro-ammeter B , also changes.

The other plate of the condenser is connected with a potentiometer. By moving the contact of the potentiometer toward the right the grid voltage of the triode, which is about 1 volt negative at the beginning of the measurement, can be made more negative. In this way, the increase of the grid

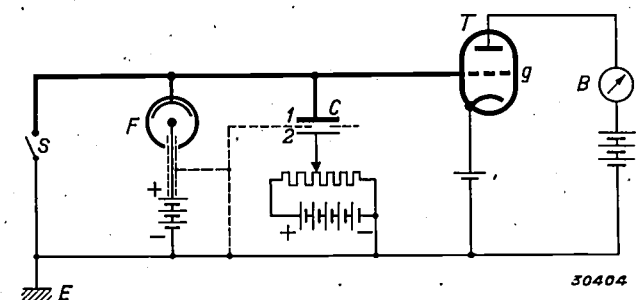

Fig. 3. Circuit for the measurement of the photocurrent. The photocurrent from the cell F changes the charge on the condenser C and consequently also the voltage on the grid g of the electrometer triode T . This voltage is kept constant while the photocurrent flows by moving the potentiometer so that the anode current (instrument B) remains constant. The time t in which the voltage on the potentiometer changes by a certain value V is a measure of the photocurrent i , since $i = CV/t$.

voltage which is due to the photocurrent can be continually compensated and the anode current remains constant.

The measurement is begun by opening the switch S . The grid thus has the potential of the earth terminal E at the beginning of the measurement, and is kept at this potential during the measurement by sliding the potentiometer contact. The time is measured in which the voltage on the potentiometer is changed by a certain value V . If C is the capacity of the condenser and t the time measured, the photocurrent is

$$i = C V/t.$$

If we choose the voltage to be compensated $V = 1$ volt, and if the capacity $C = 100 \mu\mu\text{F}$, then with a current of 10^{-12} A the charging time is 100 sec. Since this charging time is easily measured reproducibly with an accuracy of 1 sec, the accuracy of measurement is 10^{-14} A, which is quite sufficient. If the capacity C is made smaller the sensitivity becomes even greater. The limit is given by the irregularity of the ever present grid current and lies at about 10^{-17} A.

In order to attain this great accuracy various precautionary measures must be taken. In the first place the apparatus must be shielded from external disturbances by placing the whole thing in an earthed container. Care must also be taken that the voltage of the battery of the photocell remains quite constant, since variations in this voltage can act on the system *via* the capacity of the photocell. Finally care must be taken that no leakage currents are able to flow from the part of the circuit drawn with heavy lines.

One advantage of the arrangement is that this last requirement can be easily satisfied. The portion of the circuit which is sensitive to leakage currents remains at earth potential during the entire measurement so that leakage can be avoided by placing screening plates at dangerous points and connecting them with the earth terminal E . Moreover the air in the metal container in which the apparatus is situated is carefully dried with phosphorus pentoxide. Only three parts then require a very high insulation: the cathode of the photocell with respect to the anode, the plate of the condenser with respect to the other plate, and the grid of the electrometer triode with respect to the anode. In the photocell and the triode the insulating medium is a high vacuum; it was found desirable to place the condenser also in a vacuum in order to avoid leakage current due to the presence of ionized air between the plates when this was not done.

The calibration of the photometer

The apparatus was calibrated by placing a tungsten band lamp with known spectral distribution in front of the slit S_1 , and then moving a narrow slit slowly across the spectrum DD' . In this way the strength of the photocurrent was measured for every wave length. The curve resulting does not agree with the spectral distribution curve of the lamp because the sensitivity of the photocell varies in quite a different way with the wave length (it changes much more slowly with the wave length) from the sensitivity of the eye which we assume to be given by the international eye-sensitivity curve.

If we wish the photocurrent to be a direct measure of the light flux, the height of the opening in the screen DD' can be so chosen for every wave length that with equal intensity of radiation the photocurrent of the radiation transmitted is proportional for every wave length to the eye sensitivity for the wave length in question.

The proportionality factor need not be constant for the whole spectrum, but can be chosen separately for each of the eight blocks. This has the advantage that in the blue blocks, although the eye sensitivity is very low here, we nevertheless can obtain fairly large photocurrents in order to measure the small quantities of light in the blue with sufficient accuracy. In the calculation of the photocurrent this is taken into account by assuming that the sensitivity of the photocell in the blue block is 100 times as great as for ordinary electric light where the greater part of the light flux lies in blocks 5 and 6.

Making the blocks

The shape of the blocks which is determined by the above described calibration is shown in *fig. 4*. In the middle of the spectral region (blocks 5 and 6), where the sensitivity of the cell shows almost the same variation as the sensitivity of the eye, the height of the blocks is practically

30406

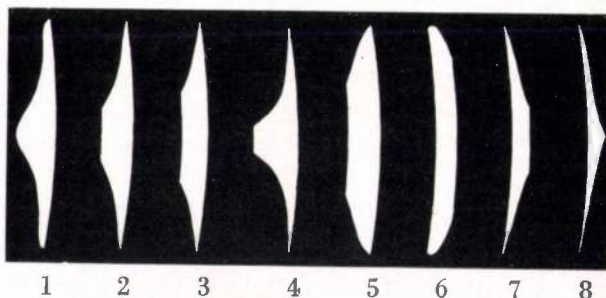

Fig. 4. Shape of the blocks which transmit the eight wave length divisions of the spectrum.

constant, but in the red and blue sections the top and bottom are cut away, because in these blocks the eye sensitivity decreases more strongly than the sensitivity of the cell with increasing or decreasing wave length. The wave length boundaries of the blocks are curved because the spectral lines are also curved in the spectrograph.

A tenfold enlarged drawing is made of the calculated shape of the blocks. This is photographed in a tenfold reduction on a plate and from the negative so obtained a positive copy is made on a second plate. In the choice of the kind of plate and the developer, fine grain and great hardness was sought. In this way the transparent region of the block was absolutely clear: no grains could be observed under the microscope. These prints were mounted in metal slides and are used immediately as diaphragms for the corresponding blocks.

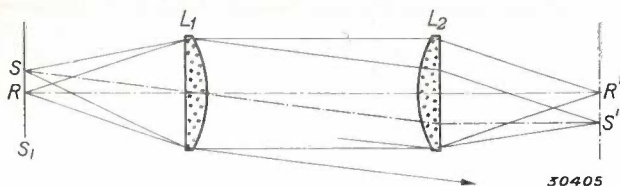

Fig. 5. Formation of the image of the first slit S_1 on the screen DD' (see fig. 2). The middle R of the slit is focussed on the screen with a greater intensity than the upper or lower end (S) because a vignette effect occurs in the focussing of the ends of the beam.

In order to be able to adjust the blocks accurately in relation to the spectrum, a small dot was made on each block at the point where, when correctly placed, a known spectral line should fall (a line of mercury or helium for example). The adjustment could now be checked by examining the block and the spectrum projected upon it with a magnifying glass. By means of a setting screw the block was given the correct position.

In calculating the shape of the blocks the following must be kept in mind. If it is necessary to reduce the light flux by a factor $\frac{1}{2}$ for a certain wave length, it is not enough to decrease the height of the slit by one half. Even though the illumination of the first slit is absolutely uniform over its entire height, this is not the case for the highest part of the spectrum. This is due to the vignette effect of the lenses L_1 and L_2 (see fig. 5). Since there is a prism between these lenses, the lenses are about 8 cm apart. The whole of the cone of light which passes from the middle R of the slit S_1 through lens L_1 also passes through L_2 , but the beam which passes through L_1 from the point near the end S is only partially incident on L_2 . The result is that the upper and lower edge of the spectrum

are more weakly illuminated than the middle. This variation in illumination is determined experimentally (see fig. 6) and taken into account in fixing the shape of the blocks.

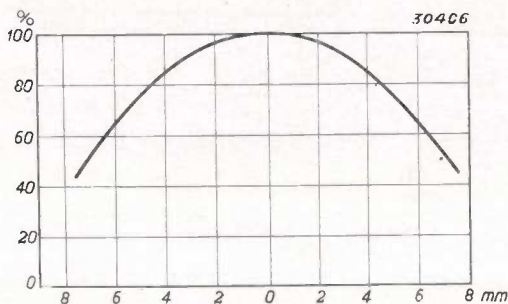

Fig. 6. Variation of the intensity as a function of the height of a spectral line when the first slit is uniformly illuminated.

Checking the photometer

It is possible to check the position of the blocks by examining the light leaving the last slit by means of a spectroscope. In fig. 7 the spectra are reproduced which were obtained by photographing the spectrum of the electric lamp in the eight blocks. The eight transmitting regions are seen to succeed each other continuously from 4 200 to 7 200 Å.

The results obtained with the photometer were checked by investigating three standardized light sources whose spectral distributions are known. These sources of light are obtained with an electric lamp of 2840° colour temperature with different liquid filters. Light sources are obtained in this way which correspond as to colour: *A* with an ordinary gas-filled tungsten filament lamp, *B* with sunlight (colour temperature 4 800°) and *C* with average daylight (colour temperature 6 500°).

The light flux of these sources was measured

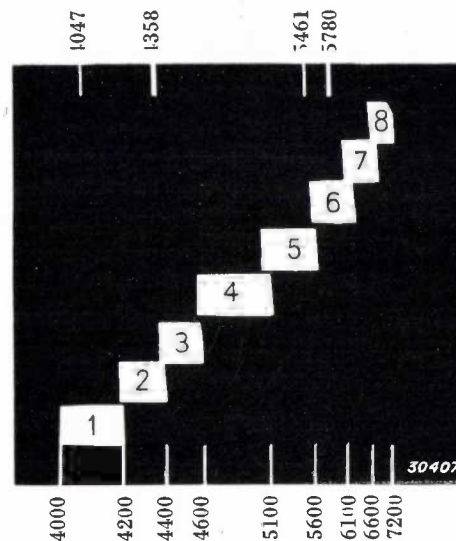

Fig. 7. Spectrum of the light which is transmitted through the eight blocks of the spectrometer.

Table I.

Relative light flux (% of the total light flux) radiated by different standard light sources in the different blocks of the spectrum.

Wave length limits of the blocks in Å	4000	4 200	4 400	4 600	5 100	5 630	6 100	6 600	7 200
Strong mercury lines in blocks	4047	4358			5461	5780			
Number of block	1	2	3	4	5	6	7	8	
Colour	violet	blue		blue/green	green	yellow/orange	red		
Standard A	calculated	0.005	0.06	0.25	5.4	33.5	42.7	16.6	1.54
	measured	0.006	0.06	0.25	5.1	34.3	42.8	16.1	1.42
Standard B	calculated	0.016	0.18	0.64	9.2	39.3	38.2	11.6	0.91
	measured	0.018	0.19	0.72	9.3	40.5	37.4	11.0	0.86
Standard C	calculated	0.025	0.26	0.91	11.1	40.8	36.2	9.9	0.73
	measured	0.029	0.29	1.04	11.4	42.1	35.4	9.2	0.70

in the eight blocks and also calculated from the known spectral distribution. The measured and calculated values are given in *table I*, and show satisfactory agreement.

Special care is necessary in the photometry of line spectra. If a line falls at a point in a block where the height of the transmitted part of the spectral line changes rapidly with the wave length, a slight inaccuracy in the position of the diaphragm may exert a great influence. Therefore the adaptation of the photometer to the international eye-sensitivity curve was specially checked for the spectral lines of most practical importance, namely those of the mercury lamp. This was possible by determining the spectral distribution of energy of a mercury lamp by means of a thermopile.

Several examples of applications

The most important application is for the estimation of the colour reproduction of sources of white light. We may refer the reader to the articles mentioned in the first footnote for this subject. In *table II* are given the results of measurements on several lamps and natural sources of light.

The first lines of the table show how electric light differs from sunlight by an excess of red and too little blue, and how this difference can be compensated to a large degree by the use of a suitable filter (sunlight lamp). From the other items it may be seen that the mercury lamp deviates very much from daylight by an excess of violet and a lack of red; this deviation is much greater with the low-pressure mercury tube than with the high-pressure mercury tube (HP 300). The last lines show how it is possible by the use of fluorescent substances

with a discharge in mercury vapour to obtain a source of light which, as to spectral composition, is intermediate between electric light and daylight.

A quite different type of application is the numerical determination of the tint of coloured objects under a given illumination. When a surface, whose reflective capacity as a function of the wave length is known, is irradiated with light of known spectral composition, the colour of the surface can be given by calculating the corresponding coordinates in the colour triangle. Another determination which is more obvious is obtained by calculating the dominating wave length and the saturation²⁾.

When the reflective capacity of the surface may be considered constant within a block, it is sufficient to indicate the reflection in the eight blocks instead of the whole spectral variation of the reflection. If in addition the light flux of the source in the eight blocks is known, an appreciable saving of work in measurement and calculation is obtained in this way.

As an example we give in *table III* the dominating wave length calculated in this way and the saturation for the colour of the human skin and for the colour of oak when illuminated with different sources of light. It may be seen that the skin, which has a yellowish colour in daylight (wave length 5 860 Å), does not change much under electric light (5 890 Å), but takes on a deeper colour. Under the mercury lamp the colour is a little saturated greenish-white. By the application

²⁾ For the calculation of colour coordinates, dominating wave length and saturation see: P. J. Bouma. Philips techn. Rev. 1, 283, 1936; 2, 39, 1937.

Tabel II.

Relative light flux radiated by different sources of light, natural and artificial in the different blocks of the spectrum.

Limits of blocks in Å	4 000	4 200	4 400	4 600	5 100	5 600	6 100	6 600	7 200
Number of block	1	2	3	4	5	6	7	8	
"Bi-Arlita" tungsten lamp	0.005	0.05	0.23	5.3	32.7	42.2	17.7	1.8	
Sunlight tungsten lamp	0.009	0.09	0.40	7.6	38.6	39.5	11.7	1.0	
Sunlight	0.016	0.18	0.64	9.2	39.2	38.2	11.6	0.9	
Average daylight	0.025	0.26	0.91	11.1	40.8	36.2	10.0	0.7	
HP 300 (mercury lamp)	0.017	0.83	0.09	0.92	51.5	45.8	0.7	0.06	
HPL 300 (with fluorescence)	0.007	0.23	0.15	1.57	46.4	47.3	4.1	0.29	
Low-pressure mercury tube	0.05	3.1	—	1.0	75.5	20.3	—	—	
Idem with fluorescence	0.003	0.27	0.03	1.0 ₁	33.7	48.7	15.8	0.58	
Idem different type	0.006	0.33	0.20	4.2	38.5	43.1	13.4	0.61	

Table III.

Colour of the skin and of oak when illuminated with different kinds of light.

Light source	Skin colour (palm of hand)		Oak (stained)	
	Wave length (Å)	Satura- tion (%)	Wave length (Å)	Satura- tion (%)
Electric lamp	5 890	70	5 870	72
Daylight	5 860	22	5 860	26
Mercury lamp with fluores- cence	5 710	70	5 710	70
Mercury lamp	5 500	24	5 500	20

of fluorescent bulbs the dominating wave length is shifted toward the red, and in addition the saturation increases from 24 to 72 per cent.

The colour of oak corresponds quite well with that of the human skin. This is also observed directly when both are so strongly illuminated that they have the same brightness.

It is clear that in this way the colour reproduction can be calculated with simultaneous illumination with different sources, thus with mixed light. This may be important in cases where the reproduction of a certain colour, for instance that of the human face or of furniture, is of special importance for the value of the illumination.

A MOTOR VAN FOR SOUND RECORDING BY THE PHILIPS-MILLER SYSTEM ¹⁾

681.84.081

A motor van is described which is equipped for sound recording by the Philips-Miller system previously described in this periodical ¹⁾. The advantages are discussed of this system over sound recording systems in use until now, in general, and particularly when the installation must be used when in motion.

Introduction

Not only for the sound recording of concerts, operas, plays and, in short, all program material which is not presented before the microphone in the studio of the broadcasting company, but also for commentaries a mobile installation for sound recording may prove useful, since it is not bound to a single spot during the recording. In constructing a motor van for this purpose in which the sound is

Equipment of the van

Fig. 1 is a general view of the van showing the striking glass turret on the body for the purpose of radio reportage. As may be seen from the plan sketched in *fig. 2*, behind the chauffeur's cabin *B* is the observer's cabin *R*, from which the eyewitness account is given, and next to it the mixing room *M* where the sound which is received from different microphones outside the van comes to-

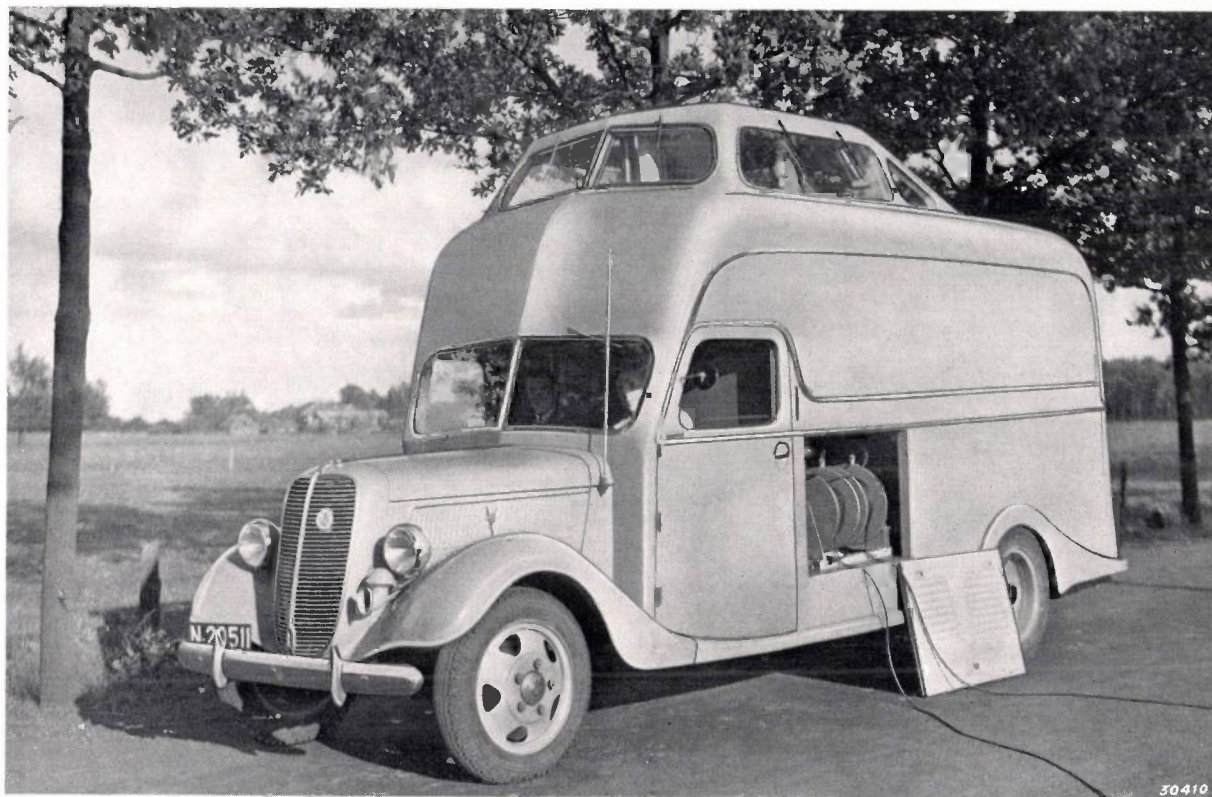

Fig. 1. Motor van for sound recording by the Philips Miller system.

recorded by the Philips-Miller system ¹⁾ we have attempted to construct an installation which is suitable not only for recording a concert program which makes the highest demands technically, but also for recording commentaries in such a way that they can be broadcast in the radio program at any desired moment with practically the original quality and without the use of telephone lines.

gether to be mixed in the desired way with the remarks of the observer. The rear end of the van is entirely taken up by the recording room *O*, in which the sound is recorded.

By constructing the observer's cabin and the mixing room on a somewhat higher level under the turret (*cf. fig. 1*), and furthermore by introducing a large window in the partition between these two cabins, the observer as well as the sound mixer are provided with as free a view as possible over the

¹⁾ Philips techn. Rev. 1, 102, 135, 211 and 231, 1936.

whole surroundings. The observer's cabin is reached through a sliding door in the rear wall of the chauffeur's cabin. The mixing room is, however, connected directly with the recording room in which

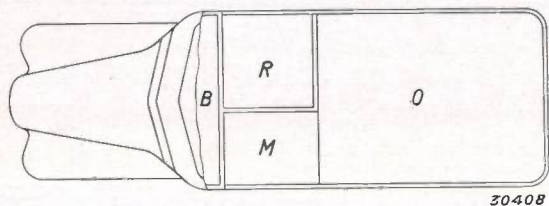

Fig. 2. Plan of the sound recording van. *B* chauffeur's cabin, *R* observer's cabin, *M* mixing room and *O* recording room.

the recording machines are housed with their amplifiers and other necessary apparatus. With this arrangement the sound mixer and the recording technicians are always in communication with each other, while the observer can always enter and leave his cabin without disturbing the technicians.

Because of the higher level of the observer's cabin and the mixing room there is space beneath them for the supply battery necessary when no connection can be made with the alternating current mains, as well as for the cables which make connection with the mains and those which are connected to the microphones set up outside the van. The battery stands in the middle of the space and is flanked on either side by cable drums. This space can be reached from the outside on both sides of the car by means of removable doors provided with ventilation grills. The battery can be reached through traps in the floor of the observer's cabin and the mixing room.

If the sound recording takes place in noisy surroundings or close to the source of sound, it is necessary to provide insulation against sound coming from the outside in order to make possible a good control of the recording. Similarly the sound from the control loud speaker situated in the recording room must be insulated from the outside. In the construction of the body the necessary sound insulation was obtained by covering the walls with two layers of celotex between which a layer of glass wool was introduced. This also improved the acoustics inside the van.

The van is built on a chassis with double rear wheels having a wheel base of 4 m and provided with an 85 h.p. engine. The greatest width is 2 m and the greatest height is 3.20 m from the ground. The total weight is 5 tons. Two steel beams which are part of the body were welded directly to the chassis. The whole installation was then fastened to these beams, and is in this way nowhere con-

nected with the wood of the body. This type of construction insures great stability of the whole installation.

The double doors in the rear end of the van give access to the recording room. These doors are purposely made narrow, each is only 50 cm wide, so that when open they do not extend outside the width of the van, and their swing is limited which makes for economy in parking space.

The turret is provided with double glass windows with panes of different thicknesses, so that they do not have the same resonance frequency and therefore ensure better sound insulation. In order to avoid undesired reflections in the glass the two panes of one window are not parallel. The panes are made of safety glass which may break but does not splinter.

There are no windows in the side walls of the body, in order not to arouse the curiosity of the public who might hinder the work of the technicians. Plenty of light is, however, obtained in the recording room through the glass turret which extends partly over the roof of the recording room, and also through the windows in the rear doors. In the observer's cabin and the recording room

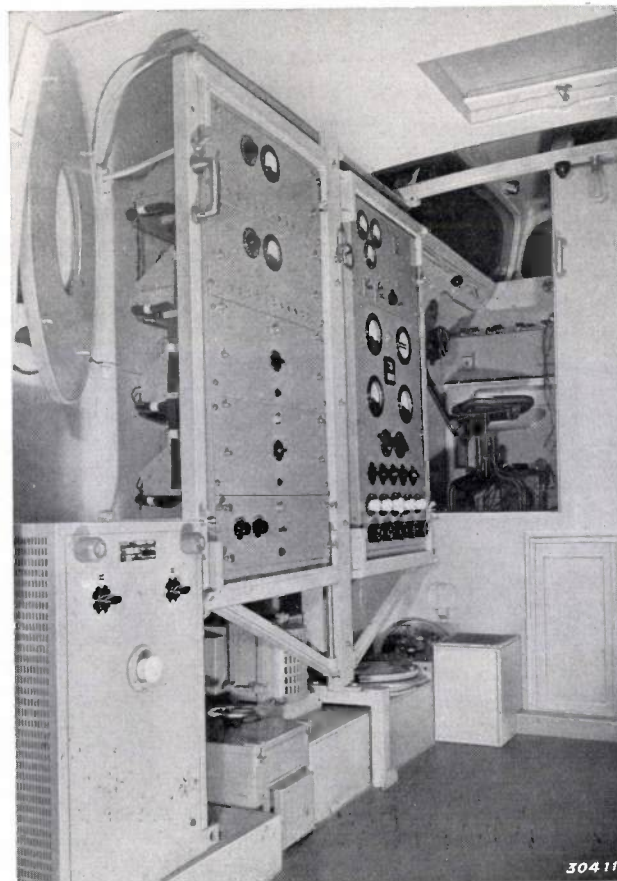

Fig. 3. View of the left side of the recording room showing the opening into the mixing room in the background.

shutters for ventilation have been let into the roof, which can also serve as emergency exits.

In *figs. 3 and 4* may be seen the left-hand and right-hand sides respectively of the recording room. In the background of *fig. 3* the communicating door between recording room and mixing cabin may clearly be seen, while at the upper right in *fig. 4* the recording machines are visible.

The recording machines

As has already been described in the series of articles in this periodical quoted above, the recording of sound by the Philips Miller system takes place in the following way. A wedge-shaped cutter driven in the rhythm of the sound pressure cuts out a track of varying width in the thin, non-transparent covering layer of a transparent recording film. The reproduction of the sound takes place in the same way as with sound film recorded by the optical method. This method therefore avoids the objections connected on the one hand with the mechanical reproduction of sound recorded on gramophone records, and on the other hand those connected with the optical recording on a sound film. The mechanical recording on

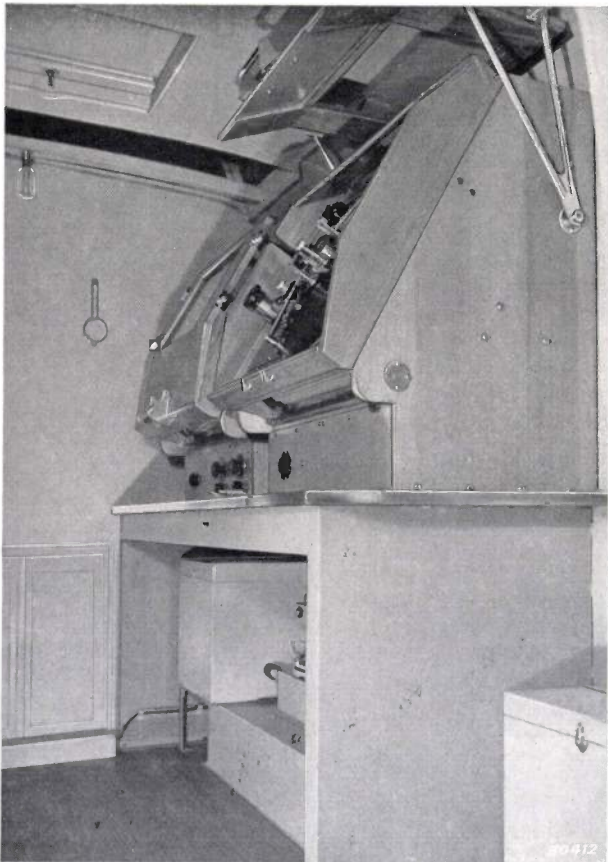

Fig. 4. View of the right side of the recording room showing the two recording machines.

“Philimil” film has the advantages over optical recording, that all operations can take place in daylight, and that the sound track is immediately ready for reproduction without first being developed, while in addition the recording of the high tones is not limited by the size of the photographic grain. As to sound reproduction, “Philimil” film has the advantage that the quality of the sound does not depreciate due to long storage of the film or repeated use, as is the case with gramophone records. Many good copies of “Philimil” film can therefore be made by recording the sound produced by playing it over, while in addition it is also possible, by joining several strips of sound film, to arrange different items one after the other as desired to make a united whole (sound editing).

Since the cutting tool which has been developed for recording by the Philip-Miller system is strongly built and can be combined with the rigid assembly plate of the recording machine to give a strong unit, it is possible to construct an apparatus which is insensitive to shocks, since shocks to the whole apparatus cause no motion of the cutter with respect to the sound track. While in the cutting of gramophone records, shocks do cause difficulties since the cutting pressure must be provided by gravity, the Philips-Miller system is particularly suitable for use in a car when sound must be recorded while riding over rough ground.

The two machines, which may be seen in *fig. 4* and one of which is shown in more detail in *fig. 5*, serve not only for recording, but also for reproduction of the sound. Tests have shown that when riding over a rough road, as well as with jolts due to persons stepping in or out or the slamming of doors, a track can be cut with a stationary cutter in this sound recording van which is in no way distinguishable from the track similarly cut when the car is not moving. While in the recording of gramophone records it is absolutely necessary that they lie perfectly horizontal, the Philips-Miller recording machines need not be level, so that slopes of the ground are quite without effect on the performance of this apparatus.

The recording machines are so constructed that it is possible to pass directly from the resting to the working state and *vice versa*. The motor of the machines works continuously, while the transport of the sound film is carried out by a friction gear. When the film is pressed by means of a rubber finger against its support, it can no longer be drawn along, but when the finger is released slightly the friction gear immediately carries it along. The same knob

which switches the film transport on and off also serves to start and stop the cutting action by bringing the cutter in contact with the band and removing it, so that as little time and material as possible is lost in beginning and ending the recording process.

A sound program can be completely put together in this van with the same rapidity as if a special editing table were available, since an electrically heated splicer is set up on one of the recording machines. This is an apparatus which by electrical heating melts the layer of glue on a plaster (fig. 6)

Mixing cabin

In the mixing cabin (fig. 7) is housed a mixing amplifier with which the microphone signals are mixed and their intensity regulated. For this purpose a normal line amplifier for radio broadcasting is used. This amplifier has four microphone input channels, two of which are provided with filters. In addition to the main control which determines the volume of the sound, the amplifier has a control with which it is possible to switch over at any moment from the microphone signal to that of the



Fig. 5. Detail of a recording machine.

together with the gelatine of the ends of two pieces of "Philimil" film laid end to end, in order to join them. The recording machines are closed by glass covers to keep them free of dust. This cover is opened in the case of one of the machines in fig. 4. To the left underneath may be seen a sound-insulated box in which is the suction arrangement for removing the shavings produced by the cutter.

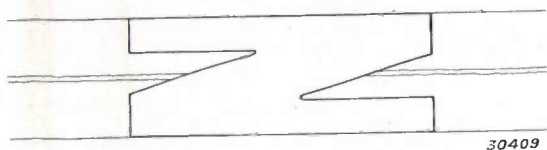

Fig. 6. The plaster with which two pieces of "Philimil" band laid end to end can be joined.

"Philimil" film to be reproduced. This is desirable when it is necessary to transmit, immediately after the recording has been completed, the sound recorded together with the commentary of the observer or announcer; with the help of one of the cables for microphone connections the connection with the telephone network is then made. The amplifier has two output terminals, one of which serves for connection to this transmitting cable, while the other supplies the recorder amplifiers. Such an independent supply prevents them from influencing each other. The end stage of the recorder amplifiers contains a recorder correction filter. For checking the depth of modulation the mixer amplifier is provided with a volume indicator.

This mixer amplifier is fed entirely with alter-

nating current. The supply apparatus is placed in the amplifier panel in the recording room (fig. 3 left-hand panel, bottom). It contains a small audio frequency generator for adjusting the modulation meter and testing the transmission line. The mixer amplifier and the supply apparatus are so constructed that they can be taken out of the van and set up in the theatre or concert hall in which recordings are to be made, and where it is also necessary to be able to see the stage or platform.

Observer's cabin

In the observer's cabin there is plenty of room for two persons so that eye-witnesses can compose the commentary together, and there is also opportunity for questions and answers. By the introduction of a wall covering of celotex, which in turn is partially covered with plates of veneer in order not to make the absorption of the high tones too great, an attempt has been made to adapt the acoustics of the cabin as well as possible to the greatest possible variety of high and low voices of very

different timbre. The quality of speech in this cabin is actually found not to be inferior to that in a good speaker's studio.

Amplifier and switch panels

The panel for the recorder amplifier may be seen in fig. 3 on the left and the switch panel on the right. The panels are mounted in a door frame so that they can be opened for inspection. This door frame is fastened directly to the chassis of the car, the panels, however, rest on a number of steel springs.

In the amplifier panel (left) are the two push-pull amplifiers for the sound recording, one above the other, each of which supplies one of the two cutting instruments. Underneath are the two separate supply apparatus, while the lowest compartment of the left-hand panel is occupied by the removable supply apparatus for the mixer amplifier.

The switch panel (right) is occupied by measuring instruments and switches for power supply from alternating current mains, to which the car can be connected by means of a supply cable. This right-hand panel contains a voltmeter, a frequency meter and an ampere-hour meter. There are furthermore a number of switches by which separate parts of the apparatus can be switched on. Underneath is a row of fuses and finally a row of plug connections by which various auxiliary instruments such as a soldering iron can be connected.

The loud speaker amplifier with its control switches and volume control is also mounted in the switch panel. It can be connected as desired to the signal of the mixing amplifier, or to either of the two reproducing machines, or to the output signals of the two recorder amplifiers. In case of an interruption it is therefore possible to localize the trouble immediately. The loudspeaker amplifier can in addition also be connected with the car receiving set when it is desired to record or broadcast sound in the recording van in collaboration with a broadcasting station.

If it is difficult to make connection with the alternating current mains, it is possible to supply the whole installation with the previously mentioned accumulator battery of 40 volts and 270 ampere-hours, with the introduction of a motor generator which gives an alternating voltage of 28 volts which is transformed to the ordinary mains voltage of 220 volts, with which the whole installation is fed. Measuring instruments are introduced to measure the voltage of this supply battery as well as the charging and discharging current.

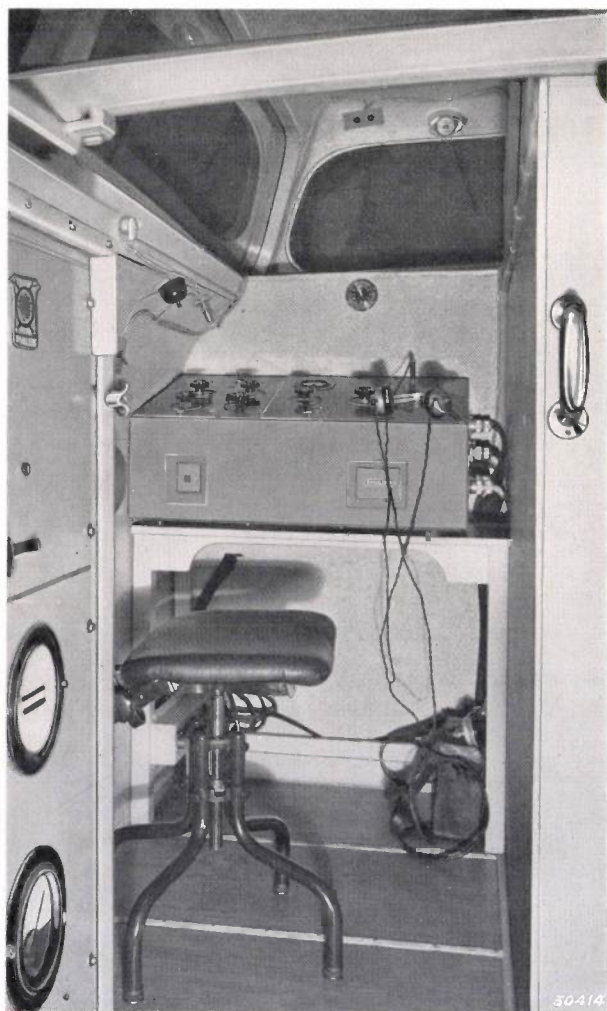

Fig. 7. View of the mixing room.

On the left in the foreground of fig. 3 the rectifier may be seen for charging the supply battery.

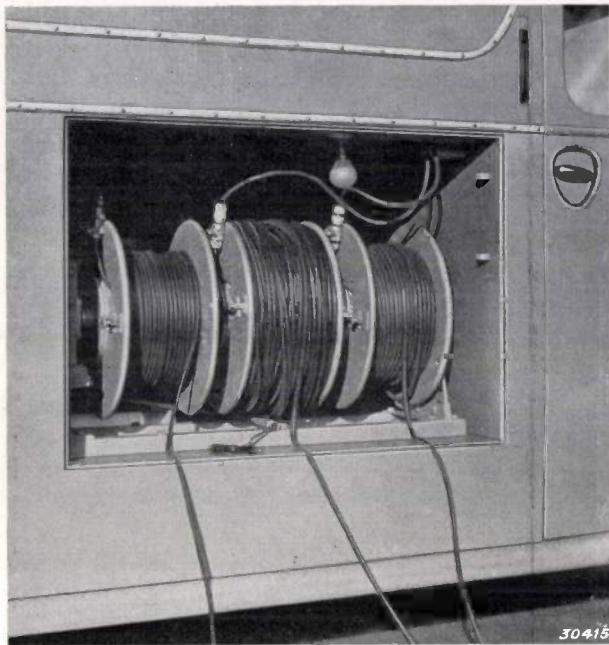

Fig. 8. The cable drums, on a common axle, are kept in the space under the observer's cabin and the mixing room.

When the battery is charged to the normal number of ampere hours the rectifier is automatically switched off. The counting mechanism of the ammeter, whose pointer indicates how many ampere-hours are still available, is so constructed, in order to ensure that oversaturation is always reached in charging the battery, that it indicates only $3/4$ of the number of ampere-hours in the battery during charging, while, it indicates the full number of ampere-hours used from the battery. The illumination of the car is connected directly to this supply battery.

The different cables for power supply and for the microphone connection are wound on cable drums which may be seen in *fig. 8*. These drums turn on a common axle which is driven by an electromotor *via* a worm gear. As may be seen in the photograph each of the cable drums has a catch by which it is fastened to the axle. 200 m of shielded cable can be stored on each drum, while there are five such drums in the van and the cables can be connected in series.

Compiled by M. J. C. VAN DER MEULEN.

NON-LINEAR DISTORTION IN LOADED CABLES

by G. J. LEVENBACH and H. VAN DE WEG. 621.396.813 : 621.315.054.3

In carrier telephony by the 1+1 system (also with more channels), just as in ordinary low-frequency telephony, coils with magnetic cores are used. The non-linear distortion which results may be more disturbing in carrier telephony in low-frequency telephony because of the intermodulation than of the distortion which occurs in a loaded cable in the case of a single frequency, different measurements of distortion are described, especially in the case of speech, which were carried out on an artificial cable.

In a previous article¹⁾ it was explained that for constructing a carrier telephone connection a cable is necessary with a sufficiently high cut-off frequency, which means that loading must be applied by means of coils with sufficiently small self-induction. In *table I* the cut-off frequency and the usual self-induction of the coils are given for three cases: ordinary low-frequency telephony, the 1+1-channel system in which one carrier channel is used above the low-frequency speech channel, and the 1+4-channel system in which, in addition to the low-frequency channel, there are 4 carrier channels.

Table I

Cut-off frequency and loading in different telephone systems
(section length between two coils = 1.83 km).

System	Cut-off frequency (kilo-cycles/sec.)	Self-induction of the coils (mH)
Low-frequency telephony	3	177
1+1 system	8	22
1+4 system	21	2.8

The small value of the self-induction for the last case given can easily be obtained with air-core coils. For the coils with high self-induction, however, which are used in low-frequency telephone cables, and also for the 22 mH coils of the 1+1 system, only coils with cores of magnetic material can be used. Air-core coils for this self-induction would (with the same value of ohmic resistance) have very large dimensions; this would cause serious difficulties in connection with the cable boxes, since the cables, especially in low-frequency telephony contain a fairly large number of cores on a trajectory. Moreover, the spreading of the lines of force is so great with air-core coils that cross-talk between different cores is not easily restricted.

The occurrence of a non-linear distortion in the coils is inherent in the use of cores with magnetic material, because of the non-linear relation be-

tween the magnetic induction and the field strength. In low-frequency telephony non-linear distortion in the coils plays no part, since it is much smaller than that which is caused by the microphones. Moreover the harmonics and combination tones occurring as results of the distortion are from the nature of the case not independent of the conversation taking place, and can therefore at the most distort the speech somewhat, but cannot exist as a separate interference. The situation is different in the case of the transmission of more than one frequency band *via* a single conductor, as for instance in the 1+1 system. Part of the distortion products of the coils here falls in the neighbouring frequency band, where it causes a non-intelligible noise which may have an adverse effect on the intelligibility of the conversation.

Therefore, since carrier telephony is more sensitive to non-linear distortion in the coils than low-frequency telephony, it was desirable to investigate in more detail the effect of this distortion. The 1+1-channel system was chosen for this purpose, since it is the simplest one. In the following, after a few theoretical considerations, we shall describe different measurements which were carried out on an artificial cable for this purpose.

Total distortion in a loaded cable

The distortion in a coil due to the non-linear relation between induction and field strength has already been dealt with in this periodical²⁾. We shall here recall the conclusions which are important for our purpose. If a current $I = I \cdot \cos \omega t$ is sent through a coil, the magnetic field strength is given by $H = H \cdot \cos \omega t$. The induction B is a non-linear function of H , so that harmonics of ω occur in B . With increasing H , B varies in a different way than with decreasing H , and due to the properties of symmetry of the hysteresis loop traced in a full period all the even harmonics in B fall away. Since the overtones decrease rapidly with increasing order, we need only concen-

¹⁾ F. de Fremery and G. J. Levenbach, Carrier telephony on loaded cables, Philips techn. Rev. 4, 20, 1939.

²⁾ J. W. L. Köhler, Non-linear distortion phenomena of magnetic origin, Philips techn. Rev. 2, 193, 1937.

trate on the lowest overtone present, *i.e.* the third harmonic. By means of Fourier analysis with the help of a simple analytic representation of the hysteresis loop which represents the actual case very well, the amplitude of the third harmonic in the induction can be calculated. By this calculation, the amplitude of the third harmonic of the EMF induced in the coil is found to be

$$E_3 = \frac{3}{5} R_h I_1, \dots \dots \dots (1)$$

where R_h is the so-called hysteresis-loss resistance. R_h is given by the formula

$$R_h = K \nu L^{3/2} I_1 \dots \dots \dots (2)$$

L is here the self-induction of the coil, ν the frequency and K a constant in which the properties of the material of the core of the coil are accounted for. The $3/2$ power of L occurs by the elimination of the number of windings n , because R_h is proportional to n^3 , and L to n^2 .

According to (1) and (2) E_3 is proportional to I_1^2 .

Passing on from a single coil to a loaded cable, every coil may be considered as a generator of third harmonics. Due to the damping of the oscillation in its propagation along the cable, however, the contributions of the successive coils to the distortion becomes smaller and smaller, not only absolutely but also relatively; E_3 decreases with the square of I_1 . How great will the resulting distortion be at the end of the cable?

Let the cable consist of $n-1$ sections without the so-called starting section, so that a coil occurs at the beginning and end. Totally, therefore, there are n coils. We imagine the cable to be cut through on both sides of the coil with the index letter p , where the current of the main frequency is $I_{1,p}$, and an EMF

$$E_{3,p} = F I_{1,p}^2 \dots \dots \dots (3)$$

to be introduced (F is a proportionality factor) The cable is shut off on both sides in such a way that no reflections occur and the coil is loaded on both sides with the impedance Z of the cable, see *fig. 1*. The current due to $E_{3,p}$ in this section becomes

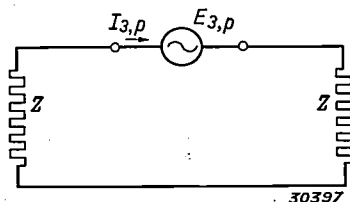

Fig. 1. Each coil (index letter p) gives an EMF, $E_{3,p}$, of the third harmonics. The coil is loaded with $2Z$ (Z is the impedance of the cable).

$$I_{3,p} = \frac{E_{3,p}}{2Z} = \frac{F I_{1,p}^2}{2Z}$$

If a is the damping per section of cable, and thus e^{-a} the relation of the current at the beginning and end of the section, then $E_{3,p}$ gives at the end of the cable the current contribution

$$I_{3,n} = I_{3,p} e^{-(n-p)a} \dots \dots \dots (4)$$

We shall assume that the frequencies of the main wave and of the third harmonics both still lie in the "flat" part of the frequency characteristic of the cable, so that both experience the same damping. Then the current from the main frequency at the end of the cable is

$$I_{1,n} = I_{1,p} e^{-(n-p)a} \dots \dots \dots (5)$$

We thus obtain

$$I_{3,n} = \frac{F}{2Z} I_{1,n}^2 e^{(n-p)a} \dots \dots \dots (6)$$

Adding all the current contributions due to the coils $p = 1$ to $p = n$ gives the total current of the third harmonic at the end of the cable:

$$\sum I_{3,n} = \frac{F}{2Z} I_{1,n}^2 \sum_{p=1}^n e^{(n-p)a}$$

On the right-hand side of this equation is a geometrical series with the ratio e_a , whose sum is given by the formula:

$$\sum_{p=1}^n e^{(n-p)a} = e^{(n-1)a} \frac{1 - e^{-na}}{1 - e^{-a}}$$

If the number of sections is so great that we may neglect e^{-na} , with respect to 1 and further if a is so small that $e^{-a} \approx 1-a$ (both conditions are well satisfied in practice) then

$$\sum I_{3,n} = \frac{F}{2Z} I_{1,n} \cdot \frac{I_{1,n} e^{(n-1)a}}{a} \dots \dots (7)$$

In this expression we substitute for $I_{1,n} e^{(n-1)a}$ the current $I_{1,1}$ at the beginning of the cable and further for $F \cdot I_{1,1}$, $3/5 R_{h1}$ (see equations (3) and (1)):

$$\sum I_{3,n} = \frac{3 R_{h1}}{10 a Z} I_{1,n} \dots \dots \dots (8)$$

The logarithm a_h of the relation between the absolute value of $I_{1,n}$ and $\sum I_{3,n}$ is called the distortion damping³⁾:

$$a_h = \ln \left| \frac{10 a Z}{3 R_{h1}} \right| \text{ nepers } \dots (9)$$

(In order to obtain a_h in decibels the value calculated must be multiplied by 8.69).

The quantity a_h indicates how large the amplitude of the main frequency is at the end of the

³⁾ W. Deutschmann, *El. Nachr. Techn.* 6, 80, 1929.

cable with respect to the harmonics; it thus provides a measure of the disturbing effect of the distortion by the coils.

The distortion damping

In the above derivation, in addition to the simplification that the same damping constant was used in (4) and (5), the fact is also neglected that the current contributions (6) to be added may have a phase shift ⁴⁾. Furthermore in (7) the cable is assumed to be very long. All these simplifications influence the result in the same direction: they make a_h smaller, *i.e.* the distortion greater. Therefore a practical case can never be worse than the result given by formula (9).

It may be seen from this formula that in the first place the distortion becomes less when the damping a is made greater, for instance by choosing a smaller core diameter. In practice this possibility will not generally be made use of, since the core diameter is already fixed by other considerations.

Furthermore a_h also becomes smaller with increasing R_{h1} . Since R_{h1} is proportional to $I_{1,1}$ (equation (2)), this means that, the distortion becomes worse with increasing transmission level at the beginning of the cable. This relation is represented graphically in *fig. 2*. The permissible distortion determines how high the transmission level may be raised. The relation drawn is however valid only for a definite value of the proportionality factor between R_h and I_1 , thus of the factor $K \nu L^{3/2}$ in equation (2). Since in practice it is only possible to influence the value of K , namely by the choice of a suitable core for the coils, the coil is characterized by giving the value of $R_h/L^{3/2}$ at a definite frequency ν and current I . It is customary to choose $\nu = 800$ cycles and $I_1/\sqrt{2} = 1$ mA (effective current): the value of $R_h/L^{3/2}$ thereby measured is called the hysteresis factor (q_2).

For a definite distortion, *i.e.* for a definite value of R_{h1} , the transmission level ($I_{1,1}$) can be chosen higher, the smaller the hysteresis factor. Since the transmission level helps to fix the necessary distance between repeaters ⁶⁾, it is important to keep the

hysteresis factor as low as possible. The C.C.I.F. (Comité consultatif international des communications téléphoniques à grande distance) prescribes that the hysteresis factor q_2 of coils for the 1+1 system may amount to 6 ohms/henry^{3/2} at the most, while coils for low-frequency telephony, where the distortion of the coils causes little difficulty, may have a q_2 equal to 12. If for the 1+3 or 1+4 system, where the distortion is even more disturbing than in the 1+1 system, it is also desired not to use air-core coils, but coils with magnetic cores, a value of q_2 less than 3.3 is required.

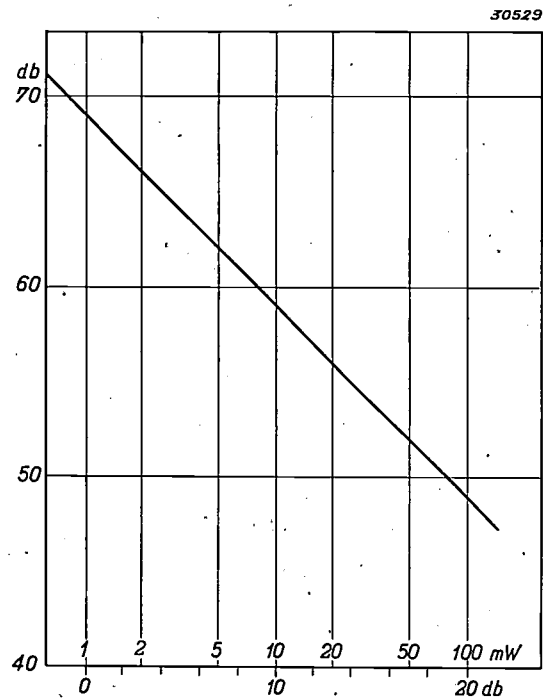

Fig. 2. Distortion damping a_h (in dB) as a function of the transmission level (in mW), according to formula (9) due to Deutschmann. $Z = 600$ ohms $a = 0,4$ dB.

Measurement of the distortion damping

In the calculation of the distortion given above a sinusoidal signal was assumed. The case where the signal contains two frequencies is in general impossible to calculate due to the fact that the hysteresis loop traced takes on a very complex shape. The case of speech is still less amenable to theoretical treatment. In order to find out to what degree the distortion of speech follows a course analogous with the simple case considered above, measurements were carried out on an artificial cable. This consisted of 20 sections which had the same resistance and capacity as a cable with a core diameter of 1.3 mm, and was loaded with coils of 22 mH. The low-frequency channel contained the frequencies from 300 to 2 700 c/s, the carrier-wave channel those from 3 300 to 5 700 c/s.

⁴⁾ More precisely stated: it is assumed that the waves of the third harmonic have the same transit line as the main wave. For this the shift in phase angle must be proportional to the frequency (see the article in footnote 1 on pages 24, formula (6) and following). This is approximately true for a not too great frequency range.
⁵⁾ The factors mentioned can also be taken into account in the calculation. In this way a more exact formula has been derived by K. E. Latimer, *Intermodulation in Loaded Cables*, *El. Comm.* 14, 275, 1935/36. Formula (9) is adequate for our purpose.
⁶⁾ See the article quoted in footnote 1 on pages 25 and 26.

Measuring arrangement

The measuring arrangement used is represented in *fig. 3*. At the input side of the artificial cable *K* the speech vibrations from the low-frequency channel were admitted. A low-pass filter *L* is therefore connected in series here, which cuts off frequencies above 2 700 cycles. The total voltage at the output side of the cable (main-frequencies and new frequencies originating in the cable) is, in position *I* of the switches, fed to a voltmeter *V* over a constant damping D_c of 40 dB and a variable attenuator D_v . In position *II* of the switches the current first flows through a bandfilter *B* which only passes the carrier-wave channel, *i.e.* the frequencies from 3 300 to 5 700 c/s originating in the cable. In both positions the variable attenuator is adjusted until the voltmeter gives the same deviation *A*. The difference between the two adjustments of the damping increased by the constant

is also necessary at the beginning of the cable: at the low-pass filter the higher frequencies formed in the cable would be reflected and this would render the result of the measurement incorrect. The low-pass filter now receives ten times the power which is applied to the cable. Care must therefore be taken that no harmonics can originate in the coils of the filter, which harmonics, due to the great difference in power, might be comparable with the overtones formed in the cable. Because of this possibility air-core coils are used in the filter. By measuring the distortion damping of the apparatus without cable, it was ascertained that the results of the measurement were not influenced by non-linear distortion in other elements.

Measurements

With the help of this arrangement various measurements were carried out, beginning with

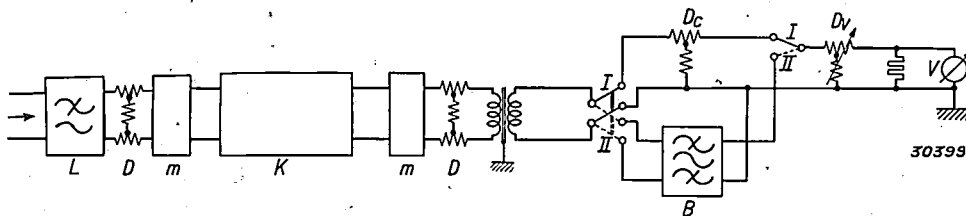

Fig. 3. Arrangement for measuring the distortion damping of a cable. *K* artificial cable of 20 sections; *m*, *m*-sections, *D* damping sections, *L* low-pass filter for 300 to 2 700 cycles, *B* band filter for 3 300 to 5 700 cycles, D_c constant damping of 40 dB, D_v variable attenuator, *V* voltmeter.

damping difference of 40 dB gives the required distortion damping a_h .

Special attention had to be paid here to the termination of the cable at both ends. In order to be able to terminate the cable with an ohmic resistance, a so-called *m*-section (*m*) is connected at the beginning and end of the cable. The terminating resistance can then be 600 Ohms, which was desired in connection with the measuring apparatus. If the band filter were now connected directly to the cable in position *II* of the switches, the main frequencies of 300 to 2 700 cycles would here undergo strong reflection, since the band filter has no real impedance of 600 ohms in this frequency region. The current distribution in the sections of the cable, and with it the contribution to distortion of the separate coils due to the dependence of R_h on the current, would be affected by the reflected waves. Therefore at the end of the cable another constant damping *D* of about 10 dB is added to the circuit; the reflected waves which return into the cable are attenuated by 20 dB and thus no longer have any appreciable effect. For similar reasons a damping of 10 dB

one frequency, namely 1 500 c/s. This lies just in the middle of the region of frequencies (1 000 to 2 000 c/s) whose third harmonic falls in the carrier-wave channel. The distortion damping was determined as a function of the power applied to the beginning of the cable. The results are represented in *fig. 4*. The continuous line *I* was measured, the broken line was calculated according to equation (9) for the same values of α , Z and q_2 . The measured distortion is smaller than the calculated, which was to be expected from the above explanation. The deviation here may be ascribed chiefly to the fact that the number of sections was too small compared with that of a real cable, namely not large enough for the simplification introduced into equation (7).

The measurement was repeated with another value of q_2 , *i.e.* with a set of loading coils with different cores. The continuous line *II* in *fig. 4* gives the result, q_2 had about the value 4 in the case of line *I*, in the case of line *II* it had about the value 18. According to equation (9) this relation must correspond to a difference of 13 dB in the distortion damping, while according to *fig. 4* a difference of

about 14 dB was measured. Considering the accuracy⁷⁾ which can be attained in the measurement of q_2 and the inevitable lack of uniformity in material properties the agreement is satisfactory.

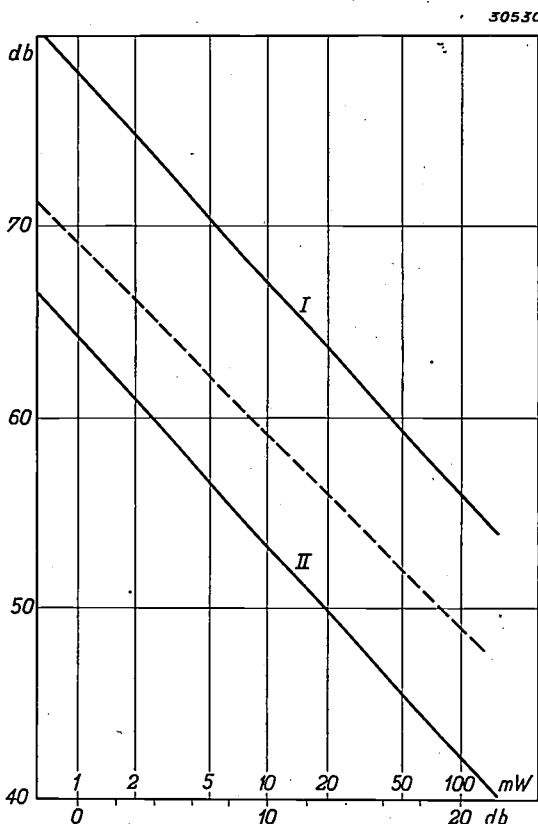

Fig. 4. Distortion damping a_h in the case of one frequency (1 500 cycles/sec) as a function of the transmission level. The continuous lines are measured, the broken line calculated by formula (9) for the same values of a , Z and q_2 as in line I. Lines I and II are recorded at different values of q_2 ; I, $q_2 = 4$; II $q_2 \approx 18$.

In distortion measurements on speech the greatest difficulty is the determination of the level of speech. The average power might be determined by means of a measuring instrument with very great inertia. This average value may be useful for judging the level of the speech of a given speaker, but it has however no direct significance for the distortion, since intermodulation, cross-talk between different channels, is due exactly to the peaks. By the C.C.I.F. the speech level is defined as follows. The voltmeter is calibrated with a voltage. The deflection which is exceeded once in three seconds during the measurement of the speech indicates the level of speech. The voltmeter used must have an integration time of 0.1 sec., i.e.

⁷⁾ The hysteresis factor q_2 is measured as the difference between the values of the coil resistance with two different currents. Since the hysteresis-loss resistance is very small compared with the total resistance a small error in absolute value in the measurement of the resistance gives quite a large relative error in the value of q_2 . In series measurements an accuracy of the order of 5% can be attained.

within this time it must indicate the final value accurately to 2 dB in the case of a constant voltage.

In order to obtain a reproducible transmission level speech was recorded on a gramophone record. During the recording a voltmeter with high inertia was placed next to the microphone, so that the speaker could check the volume of his voice and could keep it as nearly as possible constant (see above). When the record was reproduced the speech was fed to the artificial cable over an adjustable amplifier, so that the transmission level could be regulated at will.

In practice the determination of the transmission level is as follows. A sinusoidal voltage of known power, 1 mW for example, is fed to the cable with the switches in position I (see fig. 3). With the help of the variable attenuator the deflection of the voltmeter was adjusted at a value A , for which a damping of a_1 is necessary, for example. Then with a definite, temporarily unknown transmission level the speech is fed to the cable. The number of voltage peaks is now counted which extend beyond the deflection A . When the record is finished the counting is repeated several times, each time with a different value of the variable damping in the circuit. If the number of peaks per second is

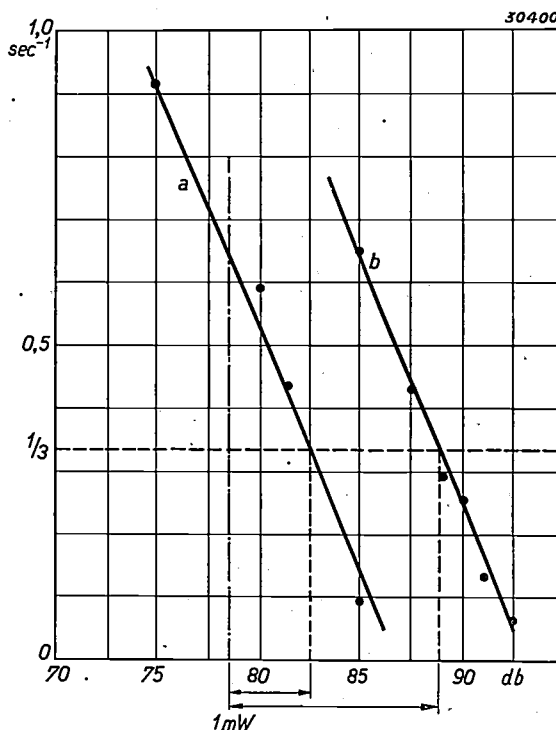

Fig. 5. Number of peaks per second during the reproduction of a record of speech, as a function of the damping in the circuit (Dv in fig. 3). The zero level indicated by a line thus — — — is that of a sinusoidal voltage of 1 mW. The level of speech is determined as the level which is exceeded once in 3 sec. For every transmission level of the speech a line is obtained like the one here drawn for two values of the transmission level. With line a it is found from the figure that the transmission level is 2.5 mW, with line b it is 11 mW.

plotted as a function of this damping, see *fig. 5*, this damping a_2 can be found by interpolation at which A is exceeded once in 3 seconds. The difference between a_2 and a_1 in dB indicates how many dB the transmission level of speech lies above 1 mW.

This process is repeated after the switches are put in position *II*. The level of the non-intelligible noise caused by the distortion products in the carrier-wave channels is thus measured. A damping a_{2v} is found at which the deflection A is exceeded once in 3 seconds and the difference between a_2 and a_{2v} gives the distortion damping a_h corresponding to the transmission level.

The measurement is thus quite elaborate: to obtain one measured point it is necessary according to the above to play over the record of the speech a fairly large number of times.

Fig. 6 shows the relation recorded in this way between distortion damping and transmission level for a given speech record. With a different speech record of the same speaker a line was found which deviated nowhere by more than $\frac{1}{2}$ dB from the one with the first record.

By means of the relation drawn it can now be determined how high the transmission level can be raised in practice without exceeding the permissible distortion. If, for example, a distortion damping of at least 65 dB, (C.C.I.F. Oslo 1938), is required, it follows from *fig. 6* that the transmission level may be 5 mW.

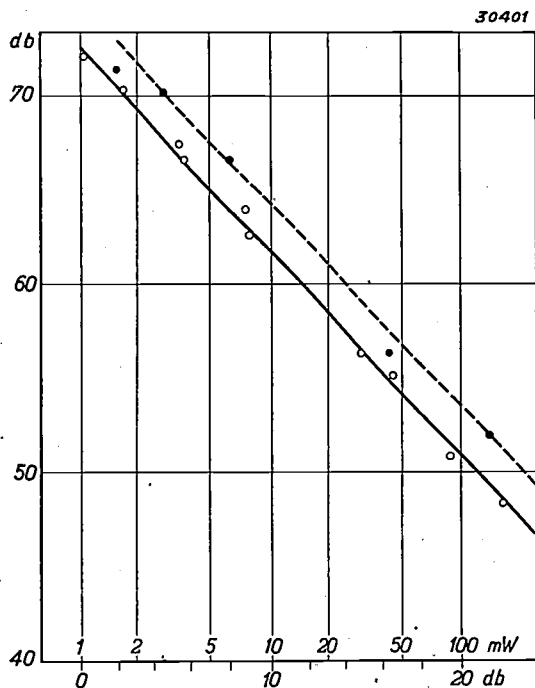

Fig. 6. Distortion damping measured for speech, as a function of the transmission level. Continuous line: speaker with a heavy voice, broken line: speaker with a lighter voice. By means of such a curve the transmission level is determined in connection with the permissible distortion damping.

The same measurements carried out with gramophone records of a speaker with a lighter voice gave the broken line in *fig. 6*. The distortion is smaller here than with the first speaker. This may be explained from the fact that in the case of the speaker with the lighter voice the peaks in the speech energy occur relatively more often at tones with frequencies above 2 000 cycles. These peaks contribute less to the distortion observed, since the third harmonics and different combination tones of these frequencies fall outside the carrier-wave channels.

The voltmeter with which the measurements are done integrates over the energy contribution of all frequencies. The measurements therefore do not give a direct measure of the physiological impression of the distortion; in practice all the frequencies will not contribute to the same degree to the disturbance, since the oscillations first undergo the influence of the frequency characteristics of the telephone and of the ear. This can be taken into account by taking for the measurement a so-called "psophometer", by which the influence of the telephone and the ear are imitated by a filter in series. We have not done so in order to make it easier to compare the measurements with the theory.

Finally it might still be asked whether, due to the insertion of the gramophone record in the natural course of events, too great a compression of the speech intensities does not occur which might invalidate the measurement of the distortion; it is just the peaks, which are most damped upon compression, which play the greatest part. The nature of speech can in this respect be characterized by the slope of the curves as given in *fig. 5*. Beginning with the level which lies just above the highest peaks in speech, and which is therefore never exceeded, it has been shown in measurements by Fletcher⁸⁾ that in normal speech the level lying 3 dB lower is exceeded once in $6\frac{1}{4}$ sec., and that lying 11 dB lower once in $1\frac{1}{4}$ sec. The slope determined by these measured points agrees very well with that of the measured lines in *fig. 5*. The character of speech, as far as causes of distortion are concerned, is therefore not falsified by the gramophone⁹⁾. The noise of the needle of the pick-up can have no unfavourable effect on the results of the measurement since it is almost completely removed by the low-pass filter at the beginning of the cable.

⁸⁾ H. Fletcher, *Bell Syst. Techn. J.* 10, 349, 1931.

⁹⁾ In practice it must be taken into account that a limitation of the amplitude always occurs at the beginning of the cable (by the so-called limiter), which limitation corresponds to a certain compression.

APPLICATION OF CATHODE RAY TUBES IN MASS PRODUCTION

by H. van SUCHTELEN.

621.317.755

Two examples are discussed of cases in which the cathode ray oscillograph makes it possible to adapt an otherwise rather complicated measurement to the tempo of mass production. The examples refer to the checking of the resonance curve of radio receiving sets and the detection of defects in the windings of motor or dynamo armatures.

There are various considerations which may make the use of a cathode ray oscillograph advisable. An obvious case is that of a measurement requiring an instrument with no inertia, as for example the recording of a dynamical characteristic referring to a periodic phenomenon. The oscillograph is also a welcome aid in increasing the speed of measurement when a static measurement would injure the object being measured, or when it is a question of carrying out check measurements in a rapid tempo. This latter use may be of special importance in mass production. We shall discuss here two examples in which the cathode ray oscillograph makes it possible to adapt an otherwise fairly complicated measurement to the tempo of mass production.

The measurement of resonance curves of radio receiving sets

The resonance curve of a receiving set gives the voltage on the detector as a function of the frequency difference between the tuning of the set and the frequency of a signal which is fed in on the aerial side with a constant amplitude. The curve is important, since it indicates decisively the selectivity of the receiver, and thus the degree to which an interfering transmitter with a frequency differing from the tuning frequency is suppressed. Moreover the difference in reproduction between the carrier wave and the side bands due to modulation may be read off from the curve. Although a sharp resonance curve ensures good selectivity, it nevertheless cuts out of the frequency spectrum received those side bands which correspond to the high frequencies in the modulation¹⁾. The compromise which may be made leads to a resonance curve which has been rather accurately determined. If it is not desired to keep to this compromise, there is also the possibility of adjusting the set so that the shape of the resonance curve can be changed at will. In such a case one speaks of sets with variable band-width.

From this it follows that the measurement of the resonance curve during manufacture of a set, or after repairs have been made on a set, is important. In order to make the rapid recording of this curve

possible a special apparatus has been developed by Philips, the frequency modulator GM 2881, which, in combination with a cathode ray oscillograph, permits immediate inspection of the whole resonance curve.

Principle of the measurement

It is obvious that in the first place a source of high-frequency voltage must be available which gives the same frequency as that to which the receiver being tested is tuned, but whose frequency in a region on either side of the tuning point can be varied. At each frequency the voltage on the detector of the receiving set is measured. A directly visible diagram results when this voltage is registered in a vertical direction on the screen of an oscillograph, and when at the same time care is taken that there is a horizontal deviation proportional to the variation in the frequency. In order to obtain a lasting image on the screen, this process must be repeated rapidly (50 times per second for instance). The frequency of the incoming signal thus "wobbles" back and forth about its mean value, and the frequency modulator which causes it to do so is called a "wobbulator" to use an Americanism.

In the apparatus here described the normal oscillograph GM 3152 or the smaller one GM 3153 were used. In these oscillographs a sawtooth auxiliary voltage is generated which provides the horizontal deflection of the light spot. In order to obtain a fixed relation between the horizontal deflection and the measuring frequency the sawtooth voltage must also control the frequency modulator. This can be realized with various circuits, one of which is shown diagrammatically in fig. 1.

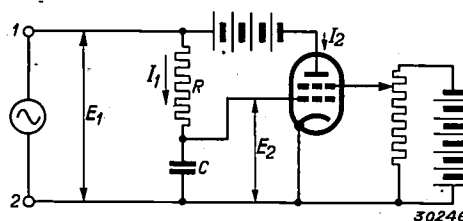

Fig. 1. The voltage E_1 causes a current through the valve $I_2 = E_1 \cdot S/j\omega CR$, so that the circuit is equivalent to a self-induction L having the value CR/S . By regulation of the slope of the valve S the value of this equivalent self-induction can be varied.

¹⁾ See also C. J. van Loon, Philips techn., Rev. 1, 264, 1936.

In this circuit if R is large enough compared with $1/\omega C$, an alternating voltage E_1 between the terminals 1 and 2 will cause a current I_1 to flow which is practically equal to E_1/R . This current causes a voltage on the condenser C ,

$$E_2 = I_1 \frac{1}{j\omega C} = \frac{E_1}{j\omega CR},$$

which is 90° in phase behind E_1 . The voltage E_2 acts on the control grid of a multiple-grid valve whose anode current I_2 therefore becomes

$$I_2 = S E_2 = E_1 \frac{S}{j\omega CR}.$$

S is here the slope of the valve.

If instead of the circuit drawn we had simply connected a self-induction L to terminals 1 and 2, the current in it would have become

$$I_2 = E_1 \frac{1}{j\omega L}.$$

The circuit is therefore equivalent to a self-induction of the value

$$L = \frac{CR}{S}.$$

This equivalent self-induction can be influenced by changing the slope of the valve, which can easily be done by varying the voltage on one of the other grids. In fig. 1 the voltage on the second grid is assumed to be adjustable.

The circuit of fig. 1 therefore finally gives an equivalent of a self-induction whose value can be varied by an applied control voltage. If such a circuit is now included as a part of the total self-induction in an oscillating circuit, the characteristic

frequency of this circuit is in turn influenced by the control voltage applied. If we use for this voltage the sawtooth voltage of the cathode ray oscillograph, we have in principle a solution of the problem.

A certain horizontal deflection of the light spot now corresponds to a certain variation ΔL in the total self-induction of the oscillating circuit with which the frequency to be supplied is tuned. For the characteristic frequency f of this circuit the following holds:

$$f = \frac{1}{2\pi\sqrt{LC}},$$

from which it follows that

$$\frac{\Delta f}{f} = -\frac{1}{2} \frac{\Delta L}{L}.$$

If it is now desired to record the resonance curve of the receiving set at different tuning points, it would seem reasonable to regulate the characteristic frequency f correspondingly, for instance by means of a rotating condenser. If this were done, however, the absolute frequency fluctuation on both sides of the tuning frequency for a given horizontal deflection of the light spot would become very different for different tunings, since, according to the above formula, the percentage frequency fluctuation $\Delta f/f$ remains constant. For example, in the recording of the resonance curve at 100 kilocycles and at 1000 kilocycles the width of the diagram obtained in kilocycles would be 10 times as small in the first case as in the second. This is undesirable. In practice it is desired always to command the same frequency range of for instance 50 kilocycles.

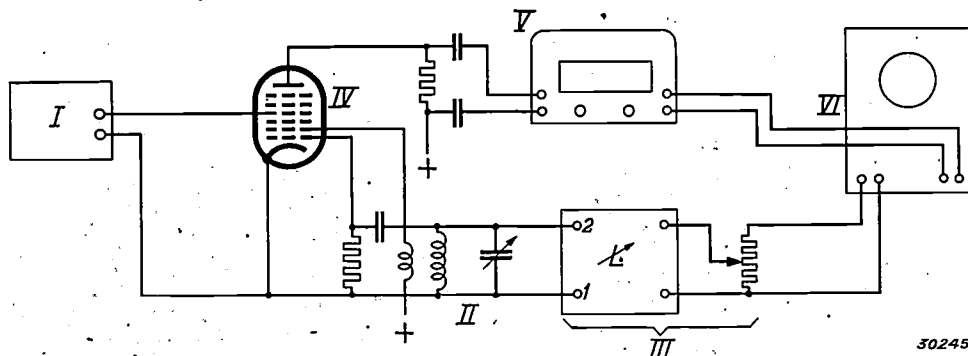

Fig. 2. Arrangement for recording resonance curves. The receiving set to be investigated, V , is tuned in for instance on 1 000 kilocycles. The signal generator I is then adjusted to a frequency of 5 000 kilocycles. The self-oscillating circuit II has a fixed output frequency of 4 000 kilocycles, so that in the frequency changer IV a frequency difference of 1 000 kilocycles occurs which is fed to the receiver. The frequency of circuit II is influenced by the equivalent self-induction III in parallel with it (circuit according to fig. 1), which is controlled by the sawtooth voltage from the cathode ray oscillograph VI . The frequency of II therefore "wobbles" 50 times per second, for instance, by an amount of 50 kilocycles about its fixed mean value of 4 000 kilocycles. The frequency of the signal fed to V therefore exhibits the same fluctuation, so that the oscillograph which measures the detector voltage of V gives a lasting picture of the whole resonance curve.

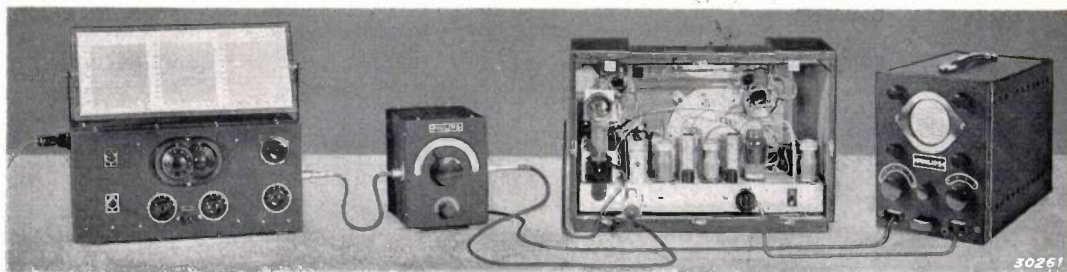

Fig. 3. Photograph of the arrangement according to fig. 2. The components *II*, *III* and *IV* there shown are combined into one apparatus, the frequency modulator GM 2881.

Therefore the frequency modulator is designed for a constant average frequency f , and the desired measuring frequency is obtained by adding another non-fluctuating frequency according to the well-known superheterodyne principle.

Measuring arrangement

On the basis of the above an arrangement is arrived at as shown in *fig. 2*. Let us assume that the receiver to be examined, *V*, is tuned at 1 000 kilocycles. A signal of this frequency is obtained by mixing in valve *IV* a signal of 5 000 kilocycles from a normal signal generator *I*. (GM 2880) and an oscillation of 4 000 kilocycles from the self-oscillating circuit *II*. In parallel with the latter is introduced a circuit similar to that in *fig. 1* (*III*), which is controlled by the sawtooth voltage from the oscillograph *VI*.

The equivalent self-induction of *III* is large with respect to that of circuit *II*; the connection in parallel therefore has relatively little influence on the circuit. Since, however, its original frequency is quite high (4 000 kilocycles), the fluctuations in kilocycles are still of the order of 50 kilocycles.

If it is desired to measure the resonance curve of the receiving set *V* at another tuning, the frequency of the oscillator *I* must be so changed that

it always lies 4 000 kilocycles above the tuning frequency of *V*.

When a suitable modulator valve is used in the circuit of *fig. 1* a practically linear relation between the frequency variation and the control voltage can be obtained within sufficiently wide limits. The diagram on the screen then has a linear frequency scale. In order to calibrate the size of this scale rapidly a simple device has been introduced into circuit *II*. This circuit is tuned by means of a variable condenser provided with a scale calibrated in kilocycles. In this way it is possible to alter by a known amount the original frequency of 4 000 kilocycles which corresponds to the original position of the light spot on the screen. By this means the image on the screen is displaced over a distance which corresponds to the number of kilocycles change in tuning. It is therefore only necessary to measure the displacement in order to determine the number of mm for 1 kilocycle.

The control voltage obtained from the oscillograph may first be reduced in *III*. Then with the same horizontal deflection a smaller variation of frequency is obtained, in other words, the frequency scale of the diagram is changed.

In the practical construction, components *II*, *III* and *IV* of *fig. 2* are combined in one apparatus,

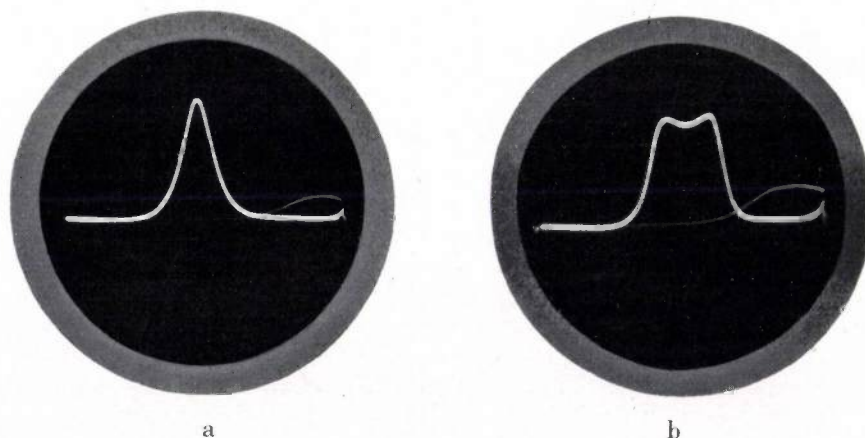

Fig. 4. Resonance curve of a receiving set with adjustable band width; a) adjustment on "narrow"; b) adjustment on "wide".

GM 2882. This may be seen in fig. 3 in the second place between the signal generator GM 2880 and the receiver to be tested. The small oscillograph GM 3153 is also included in the set-up.

Records of the voltage on the detector obtained with this apparatus are shown in figs. 4a and b. Both records were with a receiving set with adjustable band width. Fig. 4a gives the resonance curve at the "narrow" adjustment, fig. 4 b that at "wide" adjustment. In the last figure the typical "shoulders" may be seen which occur with so-called over-coupled band filters.

When the oscillograph GM 3152 is used, which can take care of very high frequencies, there is the possibility of tapping off the voltage of the receiving set even in front of the detector, which may sometimes be desirable. A linear diagram is then not formed, but a surface filled by the high-frequency oscillation, as in fig. 5. This last diagram was recorded on a receiving set with a rejector filter for the suppression of an interfering transmitter close to the tuning point of the set. It may be seen very clearly how the amplitude is suppressed for the frequency in question.

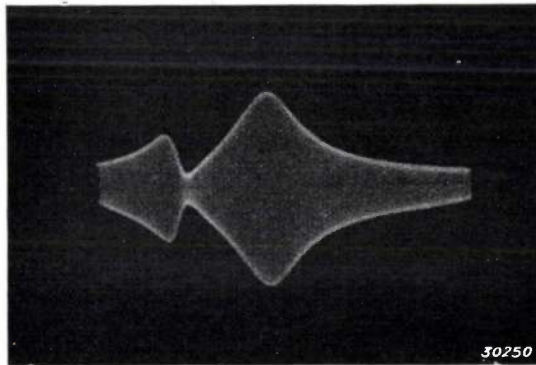

Fig. 5. Resonance curve of a receiving set with rejector filter in series for suppressing an interfering transmitter close to the tuning point. The voltage measured is here tapped off in front of the detector of the receiver, so that the surface of the diagram is filled by the high-frequency oscillation.

Measurement of resistance on motor or dynamo armatures

After a collector armature has been wound it must be tested to see whether any of the coils of which the winding consists has a short circuit or a break. Such defects may easily occur during the soldering of the ends of the coils to the lamina of the collector. In the case of small armatures, for example, 20 measurements of a resistance must be carried out in this testing. In mass production, as in the manufacture of vacuum cleaners, sewing machines, starter motors, etc. it is important to save time in the checking measurements. The fol-

lowing method has been worked out for this purpose.

When the resistance is measured by being read off a dial instrument, it is customary to place two contacts on the collector in such a way that the resistance is measured between two successive laminae. The collector is then turned slowly under the contacts so that the different coils are measured in turn. The tempo is determined by the time necessary for the meter to come to rest and be read.

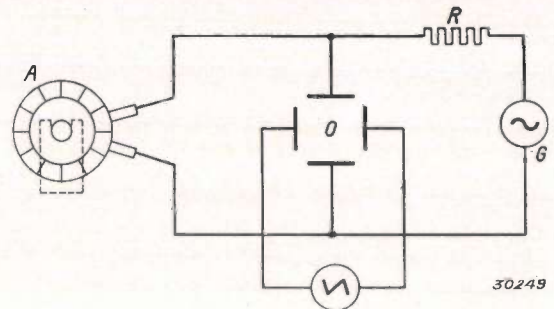

Fig. 6. Circuit for the testing of collector armatures. Two measuring contacts are placed on two adjacent laminae of the collector. The oscillograph *O* is connected between these contacts and in parallel with it over the resistance *R* the signal generator *G* (built into the Philips oscillograph GM 3153). The resistance *R* is about equal to the impedance of one coil of the armature winding. If the armature runs synchronously with the time base of the oscillograph, a stationary diagram is obtained which makes it possible to inspect the condition of the whole armature.

The cathode ray tube, which is a measuring instrument with no inertia, permits much more rapid measurement, and moreover it is possible to record a diagram of the resistance as a function of the point on the collector, and thus to see at a glance the condition of the whole armature.

This idea may be realized in a very simple way with the help of the Philips oscillograph GM 3151. For practical reasons the impedance is measured instead of the usually quite low resistance. For this purpose a small alternating voltage generator of 10 000 cycles is used and built into the oscillograph. This generator is connected over a resistance *R* to the measuring contacts which are placed on the collector, and which are in parallel with the oscillo-

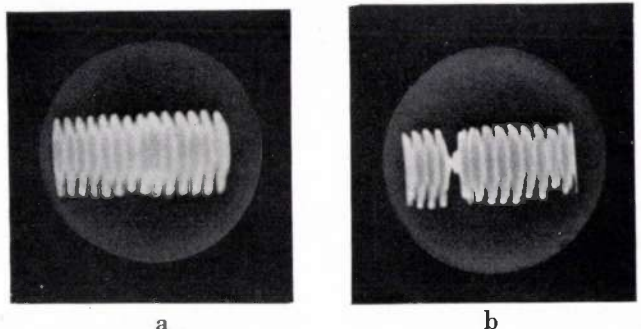

Fig. 7. Records of two motor car dynamos.
a) The armature is in order
b) The armature has a short circuit.

graph plates, see *fig. 6*. If R is about the order of magnitude of the impedance of one coil, then the voltage on the oscillograph becomes one half the generator voltage. If there is a break in a coil the voltage becomes equal to the generator voltage, with a short circuit it becomes zero. This rough indication of the impedance in the winding is sufficient for testing an armature.

For a rapid measurement the armature is placed in half bearings and driven by a friction disc. It is then also possible to provide for a linear time base on the screen of the oscillograph in the ordinary

way. If the sawtooth frequency is chosen equal to the number of revolutions of the armature, a given horizontal deflection corresponds to the passing of a given pair of laminae under the contacts.

In *figs. 7a* and *b* are two records made of motor car dynamos. The armature *a* was normal, *b* had a short circuit. A defect is detected in this way in the time which would otherwise be necessary for the measurement of one coil. It is of course possible to detect short circuits between the laminae and the mass of the armature in the same way.

ABSTRACTS OF RECENT SCIENTIFIC PUBLICATIONS OF THE N.V. PHILIPS' GLOEILAMPENFABRIEKEN

1339: J. L. Snoek: Time effects in magnetization (Physica 5, 663-688, Aug. 1938).

A theory is proposed for the mutual magnetic action of long duration and for the reversible decrease in permeability (disaccommodation). These two phenomena are considered to be caused by the elastic after-effect which occurs due to magnetostriction in the boundary surfaces of the Weiss regions.

This theory is found to be capable of explaining qualitatively all the phenomena observed up to the present. Moreover, the theoretical conclusion that the two phenomena can only occur simultaneously (although in different temperature ranges) is confirmed by investigations of the authors. If the elastic after-effect is described by a single extinction time, and if it is further assumed that the Weiss regions have mutually identical properties, it is possible to set up elementary formulae for the two effects in which the reciprocal value of the permeability plays an important part. The formula for the reversible decrease in permeability is then found to be in good agreement. In the formulae for the magnetic after-effect a longer extinction time is found to occur. The formulae, however, are not strictly valid since the parameters occurring in them take on different values in different Weiss regions. Nevertheless the after-effect theory agrees satisfactorily with experiment.

1340: M. J. O. Strutt and A. van der Ziel: On electronic space charge with homogeneous initial electron velocity between plane electrodes (Physica 5, 705-717, Aug. 1938).

In this discussion of the space charge phenomena between parallel electrodes due to electrons which all leave the cathode with the same speed, the electrons which return to the space between grid and anode because of the space charge are not neglected as soon as they have left the space. Part of these electrons return a second, third, etc. time to the space between the grid and anode, and therefore have a strong influence on the variation of voltage and current at that place. The possible forms of these curves are studied as fully as possible for a number of cases.

1341: K. F. Niessen: Ueber die Phase des Magnetfeldes (Physica 5, 769-774, Aug. 1938).

Because of the fact that several textbooks fail to carry out calculations consistently with the correct phase of the magnetic field, and fail to apply correctly the limiting conditions of Maxwell (for example in the case of receiving aeri-als), several fundamental calculations are discussed critically with this in mind.

1342: R. Vermeulen: Das Philips-Miller-System zur Tonaufzeichnung (Akust. Z. 3, 65-73, Mar. 1938).

A short survey is given in this article of the Philips-Miller system of sound recording, for which we may refer to a series of four articles in the first volume of this periodical (Philips techn. Rev. 1, 107, 135, 211 and 231, 1936).

1343: A. Bouwers: Generators for gamma rays and neutrons, and radiotherapeutic possibilities (Radiology 31, 89-93, July 1938).

graph plates, see *fig. 6*. If R is about the order of magnitude of the impedance of one coil, then the voltage on the oscillograph becomes one half the generator voltage. If there is a break in a coil the voltage becomes equal to the generator voltage, with a short circuit it becomes zero. This rough indication of the impedance in the winding is sufficient for testing an armature.

For a rapid measurement the armature is placed in half bearings and driven by a friction disc. It is then also possible to provide for a linear time base on the screen of the oscillograph in the ordinary

way. If the sawtooth frequency is chosen equal to the number of revolutions of the armature, a given horizontal deflection corresponds to the passing of a given pair of laminae under the contacts.

In *figs. 7a* and *b* are two records made of motor car dynamos. The armature *a* was normal, *b* had a short circuit. A defect is detected in this way in the time which would otherwise be necessary for the measurement of one coil. It is of course possible to detect short circuits between the laminae and the mass of the armature in the same way.

ABSTRACTS OF RECENT SCIENTIFIC PUBLICATIONS OF THE N.V. PHILIPS' GLOEILAMPENFABRIEKEN

1339: J. L. Snoek: Time effects in magnetization (Physica 5, 663-688, Aug. 1938).

A theory is proposed for the mutual magnetic action of long duration and for the reversible decrease in permeability (disaccommodation). These two phenomena are considered to be caused by the elastic after-effect which occurs due to magnetostriction in the boundary surfaces of the Weiss regions.

This theory is found to be capable of explaining qualitatively all the phenomena observed up to the present. Moreover, the theoretical conclusion that the two phenomena can only occur simultaneously (although in different temperature ranges) is confirmed by investigations of the authors. If the elastic after-effect is described by a single extinction time, and if it is further assumed that the Weiss regions have mutually identical properties, it is possible to set up elementary formulae for the two effects in which the reciprocal value of the permeability plays an important part. The formula for the reversible decrease in permeability is then found to be in good agreement. In the formulae for the magnetic after-effect a longer extinction time is found to occur. The formulae, however, are not strictly valid since the parameters occurring in them take on different values in different Weiss regions. Nevertheless the after-effect theory agrees satisfactorily with experiment.

1340: M. J. O. Strutt and A. van der Ziel: On electronic space charge with homogeneous initial electron velocity between plane electrodes (Physica 5, 705-717, Aug. 1938).

In this discussion of the space charge phenomena between parallel electrodes due to electrons which all leave the cathode with the same speed, the electrons which return to the space between grid and anode because of the space charge are not neglected as soon as they have left the space. Part of these electrons return a second, third, etc. time to the space between the grid and anode, and therefore have a strong influence on the variation of voltage and current at that place. The possible forms of these curves are studied as fully as possible for a number of cases.

1341: K. F. Niessen: Ueber die Phase des Magnetfeldes (Physica 5, 769-774, Aug. 1938).

Because of the fact that several textbooks fail to carry out calculations consistently with the correct phase of the magnetic field, and fail to apply correctly the limiting conditions of Maxwell (for example in the case of receiving aeri-als), several fundamental calculations are discussed critically with this in mind.

1342: R. Vermeulen: Das Philips-Miller-System zur Tonaufzeichnung (Akust. Z. 3, 65-73, Mar. 1938).

A short survey is given in this article of the Philips-Miller system of sound recording, for which we may refer to a series of four articles in the first volume of this periodical (Philips techn. Rev. 1, 107, 135, 211 and 231, 1936).

1343: A. Bouwers: Generators for gamma rays and neutrons, and radiotherapeutic possibilities (Radiology 31, 89-93, July 1938).

For part of the contents of this article we may refer to several articles which have appeared in this periodical (Philips techn. Rev. 2, 161, 1937 and 3, 331, 1938). In addition a description is given of an X-ray tube for 1 MV developed by the X-ray laboratory.

1344: J. A. M. van Liempt: Die Gasabgabe erhitzter Metalle in Vakuum (Rec. Trav. chim. Pays Bas 57, 871-882, Aug. 1938).

Simple formulae are derived for the way in which the percentage of gas given off by metal strips and wires upon being heated in a high vacuum depends upon the time and the temperature. These formulae are found to agree satisfactorily with experimental data.

1345: J. A. M. van Liempt: Notiz zur Selbstdiffusionswärme (Rec. Trav. chim. Pays Bas 57, 891-892, Aug. 1938).

The relation is indicated between a formula previously derived by the author (cf. 1037) for the heat of autodiffusion and a formula since found by Cichocki in quite a different way.

1346*: W. G. Burgers and J. J. A. Ploos van Amstel: Elektronenoptische Beobachtung von Umwandlungs- und Rekristallisationserscheinungen in Zirkon (Erg. techn. Röntgenk. 6, 165-176, 1938).

A survey is given in this article of phenomena of modification change and of recrystallisation observed electron optically with zirconium; (cf. 1303.)

1347: M. J. O. Strutt and A. van der Ziel: The causes for the increase of the admittances of modern high-frequency amplifier tubes on short waves (Proc. Inst. Rad. Eng. 24, 1011-1032, Aug. 1938).

In recent investigations of high-frequency pentodes the input and output losses and the reaction capacitance are found to increase considerably for short wave lengths (to 300 megacycles per sec.). This must not be ascribed chiefly to the transition times of the electrons, but to the influence of capacitances and inductances of the electrodes and of their connecting wires, both inside and outside the amplifier valves. For different high-frequency amplifiers a general theory is developed about the influence of these quantities on the valve admittances. On the basis of a series of measurements

*) An adequate number of reprints for the purpose of distribution is not available of those publications marked with an asterisk. Reprints of other publications may be obtained on application to the Natuurkundig Laboratorium, N.V. Philips' Gloeilampenfabrieken, Eindhoven (Holland), Kastanjelaan.

it is shown that one to two thirds of the input damping for short waves with modern European high-frequency valves must be ascribed to inductive effects, and not to the transition times of the electrons. From measurements of transition times it follows that the transition time between input grid and screen grid may not be neglected in comparison with that between cathode and input grid. The theoretical formulae for the inductive effects are well confirmed by measurements, those for transition time effects are, however, less well confirmed. The reasons for this are indicated. It follows from various measurements that for short waves the output admittance and the feed-back admittance must be entirely ascribed to inductive effects.

1348: J. H. de Boer: Energieaustausch an Grenzflächen (Z. Elektrochem. 44, 488-497, Aug. 1938).

In this article a summary is given of phenomena in which the exchange of energy at boundary surfaces plays a part. Among these phenomena are activated adsorption, lowering of the ionization energy for the adsorbed state, etc.

1349: E. H. Reerink and J. van Niekerk: Vitamin D Bestimmung (Z. Vitaminforsch. 7, 269-277, 1938).

After having explained that no colour reactions are known which are specific enough for the satisfactory determination of vitamin D content, these investigators describe their own method of calibrating preparations by means of biological tests with rats.

1350*: M. J. O. Strutt: Moderne Mehrgitter-Elektronenröhren. Zweiter Band: Elektrophysikalische Grundlagen (144 pages, Julius Springer, Berlin 1938).

In completion of part one of this book (1249), part two gives the derivation of the characteristics of electron tubes from the fundamental laws of electrodynamics. In addition the complex movements of the electrons in tubes with more than one grid are investigated on the basis of measurements and calculations. Measurements in the short-wave region are chiefly used for this purpose. Finally the heat problems are also dealt with which are important for tubes with more than one grid.

1351: E. H. Reerink: The determination of vitamin D. (Chem. Wbl. 35, 577-580, July 1938).

For the contents of this article see 1349.

1352: J. D. Fast: Ueber die Herstellung der reinen Metalle der Titangruppe durch thermische Zersetzung ihrer Jodide IV. Das Auftreten niedriger Zirkonjodide bei der Herstellung duktilen Zirkons (Z. anorg. allg. Chem. 239, 145-154, Sept. 1938).

Upon heating zirconium tetraiodide with an excess of zirconium lower zirconium iodides are formed. If the speed of formation of ductile zirconium is determined in the thermal decomposition of ZrI_4 on a wire heated to $1300^\circ C$ as a function of the temperature at which the reacting substances are maintained, it is found to increase rapidly up to $250^\circ C$. Above $300^\circ C$ the speed of formation decreases with increasing temperature as a result of the reaction of zirconium tetraiodide with an excess of the metal zirconium present in the reaction mixture. From other experiments it may be deduced that at $400^\circ C$ ZrI_4 forms ZrI_3 with zirconium, while at $560^\circ C$ ZrI_2 is formed. Furthermore above $310^\circ C$ there appears to be a reaction equilibrium between ZrI_3 , ZrI_2 and ZrI_4 , and above $430^\circ C$ between ZrI_2 , Zr and ZrI_4 . Due to the reaction of ZrI_4 with an excess of zirconium it is no longer possible to bring about the formation of ductile zirconium at an oven temperature of $250^\circ C$ or lower in a preparation tube which has previously been heated to $400^\circ C$ or higher.

1353: J. E. de Graaf and W. J. Oosterkamp: X-ray tube for crystal analysis and stress measurements (J. sci. Instrum, 15, 293-303, Sept. 1938).

This publication is very similar to an article contributed by the authors to this periodical (Philips techn. Rev. 3, 263, 1938). In addition, on the basis of calculations on the flow of heat in the anode of the X-ray tube, the relation between the specific focus loading and the thickness of the anode is derived for a linear and for a circular focus.

1354: J. F. Schouten: The rotating pendulum and the state of adaptation of the eye (Nature 142, 615, Oct. 1938).

By a method developed by the writer it is ascertained that the presence of a region causing glare in the field of vision of the eye causes an appreciable decrease in the sensitivity of the fovea within 0.1 sec. This cannot be ascribed to diffusion of photochemical substances or other purely physical or chemical phenomena, but is based upon the transference of this stimulation from the part of the retina concerned to the fovea by the nerves which cause a decrease in the sensitivity of the

latter. This supports Lythgoe's explanation of the effect observed by him with Pulfrich's pendulum.

1355: J. L. H. Jonker and A. J. W. M. van Overbeek: A new converter valve (Wirel. Eng. 15, 423-431, Aug. 1938). For the contents of this article the reader is referred to Philips techn. Rev. 3, 271, 1938.

1356: M. J. O. Strutt and A. van der Ziel: Einige dynamische Messungen der Elektronenbewegung in Mehrgitterröhren (El. Nachr. Techn. 15, 277-283, Sept. 1938).

Measurements were carried out of the input admittance between the cathode and the nearest grid, and of the complex slope from this grid to the anode. The influence is discussed which is exerted on the input admittance by the electrons which reverse their direction in front of a grid with a negative potential. The formulae derived are applied to the measurements of the input admittance, and conclusions are drawn about the movement of the electrons. Further, formulae are derived for the influence of the returning electrons on the size and phase angle of the slope. It is found finally that these formulae when applied to the measurements carried out, give good agreement with the conclusions drawn previously in this article about the movement of the electrons.

1357*): R. Houwink: Elastizität, Plastizität und Struktur der Materie; 367 pages, 1938 Steinkopf, Dresden und Leipzig).

This book is a considerably amplified edition in German of the English book (1219*)) by the same author.

1358: Balth. van der Pol: Beyond radio (Proc. World Rad. Conv., Sydney 1938).

Various subjects were dealt with in this lecture, which are more or less connected with research on the subject of radio, although they can by no means be considered to belong directly to this subject. The following subjects among others were discussed, diathermy with very high frequencies, accurate measurement of time intervals with the characteristic vibrations of a quartz crystal, relaxation oscillations (cf. for example Philips techn. Rev. 1, 39, 1936) and the propagation of waves along the surface of a sphere which is large with respect to the wave length (cf. 1264, 1318 and 1338) which can also be applied to the rainbow.

1359: J. E. de Graaf: Zur Densitometrie von Röntgenfilmen und ihrer Normung (Z. wiss. Photogr. 37, 147-159, Aug. 1938).

In order to understand the great differences obtained when the same strip of film is measured with two different density meters, the influence is studied of the angle at which the light falls in the film, of the scattering at the film and of the angle of divergence not only of the receiver but also of the incident beam. Conclusions are drawn for the construction of a density meter for X-ray films and for the visual observation of these films. For the determination of the quality of a film it is important that the optical constants of the density meter be adapted to the purpose for which the film is used.

1360: K. F. Niessen: Zur Entscheidung zwischen horizontalen oder vertikalen elektrischen Dipolen zwecks minimaler Erdabsorption bei gegebener Bodenart und Wellenlänge (Ann. Physik **33**, 404-418, Oct. 1938).

For the same electrical dipole which is situated at least two wave lengths above the earth's surface in horizontal or vertical position and which emits a certain quantity of energy per sec, it is investigated what part of this energy disappears into the earth as a function not only of the size but also of the angle of the index of refraction. For a definite kind of soil (with a degree of moisture of 24%) the part of the energy radiated which is taken up by the earth is indicated as a function of the wave length.

1361: G. C. E. Burger and B. van Dijk: Zur Bestimmung der kleinst wahrnehmbaren Objektgröße bei der Durchleuchtung (Fortschr. Röntgenstr. **58**, 382-385, Oct. 1938).

By means of plates of "Philite" in which different holes are bored and which are placed between the X-ray tube and the fluoreoscope screen, the smallest observable object size is ascertained with different currents at a maximum voltage on the tube of 54 kilovolts. Easily reproducible results are obtained by this method, and it has been used to find out to what extent the use of a fine grid diaphragm is to be recommended in X-ray fluoreoscope work. Although this diaphragm gives an improvement by diminishing the interference by scattered rays, this improvement is almost entirely compensated by the decrease in brightness. It is therefore of little use to employ a fine grid diaphragm in observing the lungs by means of the fluoreoscope.

1362: C. J. Dippel and J. H. de Boer: Der lamellare Bau von CaF_2 -Schichten und die

Cs- und J_2 -Adsorption (Rev. trav. chim. Pays Bas **57**, 1087-1096, Oct. 1938).

By comparative measurements of adsorption of iodine and caesium on sublimed CaF_2 layers it may be concluded that the sometimes great change in the apparent surface of the salt upon variation of the amount of CaF_2 sublimed and the speed of sublimation is not caused by variation in the thickness of the primary lamellae but by sintering. The average thickness of the lamellae is always about 6 or 7 molecules. However, the more of the salt sublimed and the more slowly it is done, the more these primary lamellae are cemented together by a kind of sintering. This makes part of the surface inaccessible for iodine molecules. Upon the adsorption of caesium, by which this sintering effect can be reversed, there are at the most three layers of atoms one above the other.

1363: M. J. Druyvesteyn: The abnormal cathode fall of the glow discharge. (Physica **5**, 875-881, Oct. 1938).

The theory of van Engel and Steenbeck, according to which the characteristic of the normal cathode fall is determined only by the normal cathode fall and the corresponding current density, does not agree with the observations carried out by the author on the rare gases helium, neon, argon, krypton and xenon. With a graphite cathode helium, with its greater cathode fall, exhibits a more rapid rise in the voltage of the cathode fall with increasing current density, while argon showed a slower rise than the theory demands. The possible causes are discussed.

In December 1938 appeared:

Philips Transmitting News **5**, No. 4.

Philips ultra shortwave beacon type B.R.A. 200/8.

Compiled by R. F. Volz and A. G. de Jager:

A nomogram for determination of the field-strength around a transmitter.

The wireless installation on board the twin-screw steamer "Nieuw Amsterdam".

J. P. Heyboer:

Difficulties encountered in measuring the high frequency output of aircooled transmitting valves at frequencies below 20 mc/s.

Philips Technical Review

DEALING WITH TECHNICAL PROBLEMS
RELATING TO THE PRODUCTS, PROCESSES AND INVESTIGATIONS OF
N.V. PHILIPS' GLOEILAMPENFABRIEKEN

EDITED BY THE RESEARCH LABORATORY OF N.V. PHILIPS' GLOEILAMPENFABRIEKEN, EINDHOVEN, HOLLAND

THE ILLUMINATION AND BEACONING OF AERODROMES

by G. L. van HEEL.

628.971.8 : 656.71

After a discussion of the visibility of different sources of coloured light and their use as beacons on aerodromes, the illumination of obstacles, of the boundaries of the aerodrome and of the landing area is dealt with. Finally the special precautions are discussed which should be taken in the case of landing in mist: approach lights, access lights and illuminated buttons in the landing area.

Introduction

Although the illumination of aerodromes is still at the beginning of its development, many problems which are connected with good beaconing and illumination of aerodromes can already be solved satisfactorily by the use of modern gas discharge lamps. Since, when different sources of coloured light are used for marking an aerodrome, the question arises as to the degree to which the colours used may be confused with each other or with other colours in clear weather as well as in more or less thick mist, we shall begin with a short discussion of the visibility of different sources of coloured light under different weather conditions, and the possibilities for their use arising therefrom. We shall then deal in turn with possibilities of satisfying the requirement that the pilot, in order to make a safe and smooth landing, must be able to orient himself as to the place, height and position of his machine. With good visibility it is desirable and possible to make the following features plainly visible to him:

- a) the shape and the boundaries of the part of the field suitable for landing (boundary lights);
- b) the obstacles in the immediate neighbourhood of the aerodrome (obstruction lights);
- c) the wind direction;
- d) the surface of the part of the field on which he must land, in order to be able to carry out the actual landing (illumination of the landing area).

We shall finally discuss the measures for landing with poor visibility.

Visibility and the use of sources of different coloured light

In choosing the different colours to be used in

the illumination of an aerodrome care must be taken to make it impossible to confuse the different colours, while they must also not appear too much changed in character in misty weather for the observer at some distance.

The colours proposed by the I.C.I. (International Commission on Illumination) in 1935 and later prescribed by the C.A.I. (Conférence Aéronautique Internationale) for aerodrome lighting are determined¹⁾ as follows in the colour triangle (*fig. 1*). For red a colour may be used out of an extended region lying along the spectral red with a dominant wave length of at least 6 100 Å, which corresponds to a limitation in height by the condition that $y \leq 0.35$. The width is restricted by the condition that $z \leq 0.002$, by which a saturation of at least 97 per cent is ensured. Neon light has the coordinates $y = 0.325$ and $z = 0.003$ in the colour triangle and thus satisfies the requirements for aeronautical red. As aeronautical yellow a broader rectangle in the colour triangle has been determined which is bounded by the following conditions: $z \leq 0.007$ and $0.402 \leq y \leq 0.46$, so that the wave length lies between 5 840 and 5 940 Å while the saturation is at least 97 per cent. Yellow sodium light has the coordinates $y = 0.428$ and $z = 0.007$ and therefore falls in the middle of this rectangle. For "aeronautical green" a large region is allowed in the right-hand upper corner of the colour triangle which is limited at the lower side by the lines:

$$z = 0.610 - 0.829 y$$

$$z = 1.170 - 2 y$$

$$0.24 z = 0.76 y - 0.173.$$

¹⁾ Cf.: Philips techn. Rev. 2, 39, 1937.

The experience which has been obtained since 1935 in the actual practice of aerodrome illumination with the colours thus determined, gives as yet no occasion for changing the colours. It is clear that the limits of these colours in the colour triangle are so far away from each other that sources of light emitting these three colours cannot be confused with each other in clear weather. It might, however, still be asked whether in the case of haze or thick mist and when observed from a greater distance the colour might not be so much changed that it

haze very well, with a thick mist there is no great difference between the penetrating power of lights of different colours. Sodium lamps, however, have an advantage in that case also over ordinary electric lamps, namely the high luminous intensity which is obtained already with small current consumption.

Especially for the lights to be used for marking the aerodrome and its surroundings colours should be used which are as striking as possible. In this respect red occupies the first place, so that it is obvious that this colour should always be used to indicate danger. In agreement with common practice point sources of red light are prescribed by the C.A.I. to indicate obstructions. By the prescription of the shape of the source the possibility of using linear sources of red light for the boundary lights of an aerodrome is left open, since this was already customary in Germany. For boundary lights yellow is now internationally prescribed, with the understanding that linear red lights and

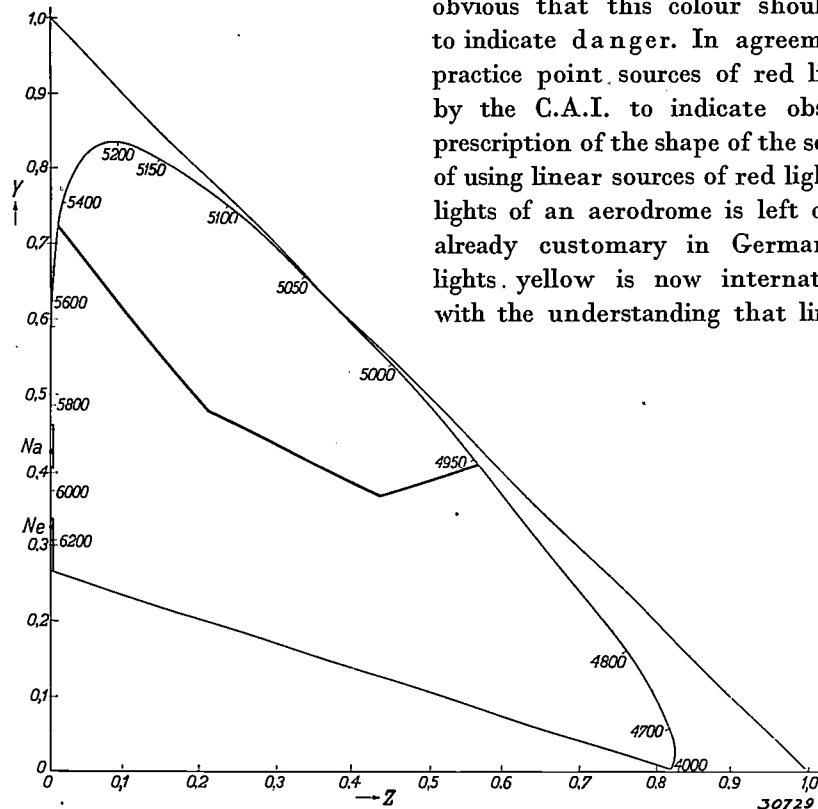

Fig. 1. Colour triangle according to the system recommended by the I.C.I. in 1931 (cf. Philips techn. Rev. 2, 45, 1937: fig. 4, in which y and z are indicated by t_2 and t_3 respectively). The spectral colours lie on the full line curve; their wave lengths are indicated. The regions sketched represent the colour regions prescribed for aeronautical lights for red, yellow and green. Ne and Na indicate respectively the colour point of red neon and yellow sodium light.

could be mistaken. The variation of colour in haze and mist can be caused by selective absorption, or because the intensity becomes so low that colourless vision with the rods of the eye (Purkinje effect) begins to play a part. In that case red remains the easiest colour to recognize, while blue and green quickly become indistinguishable. It is a great advantage of sodium lamps that they emit a practically monochromatic yellow light which retains its colour well even at low intensity while a change of colour due to selective absorption is impossible.

Although experience (in the illumination of roads) has shown that sodium light penetrates

under special circumstances white flicker lights may also be used. In agreement with the custom also prevailing in signal services green is recommended to indicate places where certain manoeuvres can be carried out safely. With this colour therefore may be indicated, for example, where it is best to approach the aerodrome.

Boundary lights

The main function of boundary lights consists in the fact that they must indicate the safe boundaries of the aerodrome to the pilot in an easily recognizable way. It is therefore essential that it be impossible ever to confuse the boundary lights

with other sources of light either on or near the aerodrome. It is best therefore not to use white boundary lights. For districts where electric current is not easily available, and where, therefore, use must be made of acetylene flickers for example, white boundary lights must obviously be used, although in this case precautions must be taken against glare.

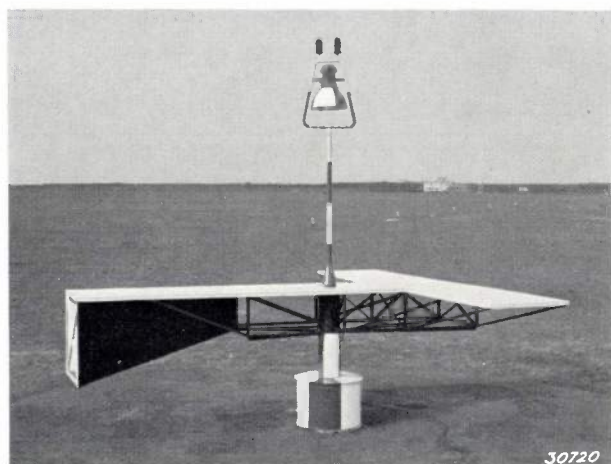

Fig. 2. Illuminated wind indicator.

The boundary lighting generally used in Germany with linear red neon lamps does not of course guarantee the impossibility of confusion with red point sources as obstruction lights in the case of heavy mist as absolutely as does yellow boundary lighting. If yellow boundary lights are to be installed, the use of simple sodium lamps, for instance "Philora" type SO 250, offers many advantages for this purpose over the use of sources of white light provided with a yellow filter. With equal current consumption 10 times as much light is obtained as with ordinary lights with a yellow filter, and as to colour one is not dependent upon the accuracy with which the filters are manufactured.

The colour of the monochromatic light of sodium lamps cannot change in misty weather due to selective absorption, as we have already seen. Moreover yellow sodium light has the advantage over white light that, due partly to the low brightness of the sources, it gives only little occasion for glare.

The boundary lights must if possible also serve as an aid in estimating the height of the machine and the dimensions of the field. In other words they must by perspective give the pilot an idea of his position above the field and also make it possible for him to see at a glance the size of the field by counting the lights. Therefore it has been prescribed internationally that the boundary lights

should be placed along the boundary of the aerodrome at equal distances of 100 m.

Obstruction lights

It is not difficult to provide that all obstructions around the landing area are indicated by point sources of red light, so that they are immediately recognized as obstructions by the pilot. The objects which must be considered as obstructions are determined by their height in relation to the shortest distance to the edge of the landing area. It is further to be recommended generally that buildings in the immediate neighbourhood of the aerodrome be made visible by a simple system of floodlighting. This gives the scene more depth and it makes it easier for the pilot to judge his height.

Indication of the direction of the wind

For making a landing under normal circumstances it is very important for the pilot to know the exact direction of the wind at the surface of the field. This direction is indicated by a T-shaped wind indicator, and it is therefore essential that this should be well lighted. In the simple construction shown in *fig. 2* the white upper surface of the T can be brightly lighted by means of a mercury lamp. Against the dark background the bright T gives a good contrast which is enhanced by the T-shaped shadow cast by the wind indicator on the ground (*fig. 3*).

Illumination of the landing area

The super high pressure mercury discharge has several properties which make it particularly

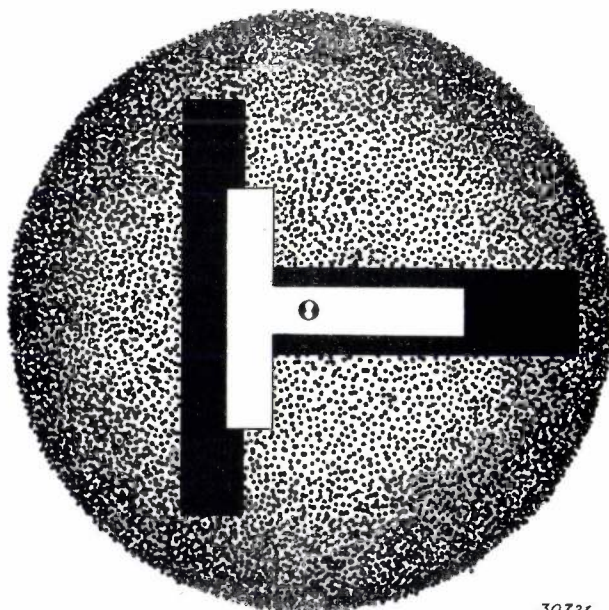

Fig. 3. The illuminated white upper surface of the T contrasts especially strongly with its own shadow.

suitable for use in floodlighting the landing area. In the first place the discharge column is long and slender so that such a lamp is very suitable for mounting along the focal line of a parabolic cylindrical reflector in order to obtain a fan-shaped beam which has wide horizontal and slight vertical spread. Furthermore these lamps have high brilliance and efficiency, while the spectral composition of the light which they emit is very favourable as we shall see later.

The landing area light constructed by Philips which is already installed on several Netherlands aerodromes consists of two mercury lamps of 1 000 W whose 25 cm discharge columns are mounted in two parabolic cylindrical mirrors one above the other. As may be seen from the horizontal light distribution curve (fig. 4) the horizontal spread of the beam is about 120° , so that a large area of the field is covered by such a landing area light. Because of the small diameter of the discharge it was possible to limit the vertical spread to a few degrees, as may clearly be seen in the vertical light distribution curves of fig. 5. The light flux is 40 000 lumens per mercury lamp, while the maximum brightness is 1 400 c.p./sq.cm. If the losses at the covering glass of the reflector are taken into account the maximum luminous intensity per mirror is 250 000 c.p. By adjusting the mirrors in the correct way it is therefore possible to obtain a total intensity of 500 000 c.p. as indicated in figs. 4 and 5.

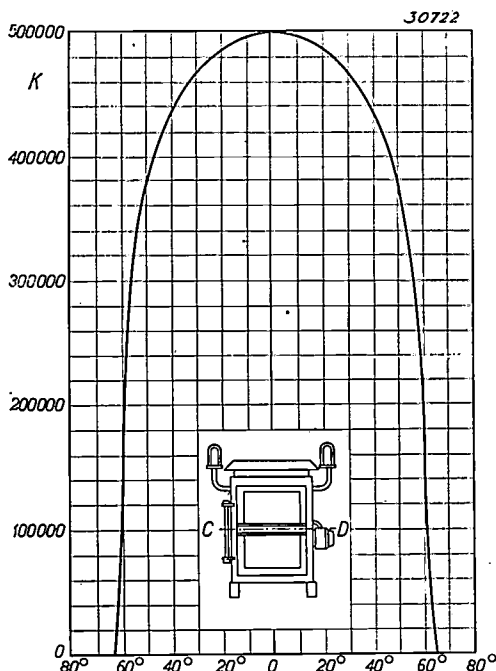

Fig. 4. Curve for horizontal light distribution (in candle power) of a landing area floodlight with about 120° horizontal spread of the beam.

Such a landing area light may be placed upon a simple steel construction at a height of a few metres at the edge of the aerodrome as shown

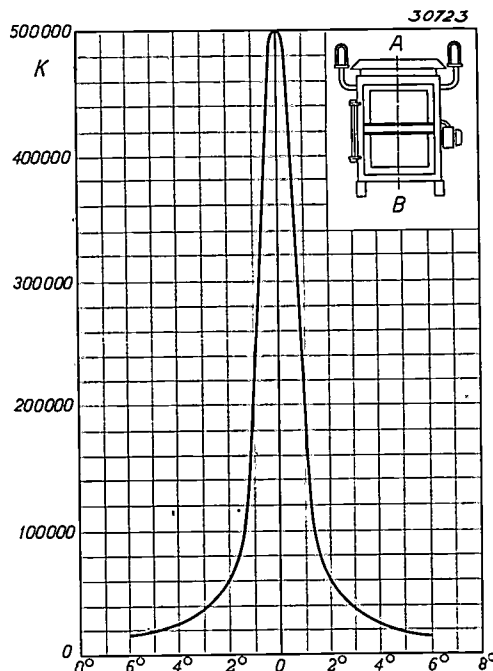

Fig. 5. Curve for vertical light distribution (in candle powers) of a landing area floodlight with only about 2° vertical spread of beam.

in fig. 6. When after landing the machine taxis across the field toward the station building or hangar, the pilot might be blinded by the oblique beam of the landing light, and it should then be extinguished. If these mercury lamps of 1 000 W are switched off and then immediately afterwards on again, it is several minutes before they have cooled off enough to re-ignite, and it then takes several minutes more before they have reached full intensity. It will be obvious that because of this, lamps of this type are particularly suitable for small aerodromes at which only a few airline machines land, and whose time of arrival is known precisely by means of the radio. Because of the much heavier traffic larger aerodromes usually require that the landing lights must be able to be switched on and off quickly. For this purpose it is possible to provide the landing lights with shutters which can be operated at some distance so that it becomes unnecessary to switch the lamps themselves on and off. It is then moreover possible, at the request of the pilot about to land, immediately to add to or subtract from the number of lights.

The result obtained with the landing lights is usually judged by measuring the intensity of illumination at different spots throughout the whole field on areas 10 cm above the ground perpendicular

to the incident rays. In *fig. 7* curves are drawn on the field connecting points with equal intensity of illumination under illumination by one mercury lamp of 1 000 W (iso-lux curves). From these curves it may be seen that with a landing light which contains two of these mercury lamps one does not obtain at least 2 lux over an area of 600 by 300 m, as is proposed in the international recom-

Tests have been made at the aerodrome Schiphol with three water-cooled super high pressure mercury lamps each having a power of 2 000 W (*fig. 8*). These lamps reach their full intensity immediately upon being switched on, so that in this case no measures need be taken for temporary covering of the landing lights. The discharge column is 5 cm long and is again placed along the focal line

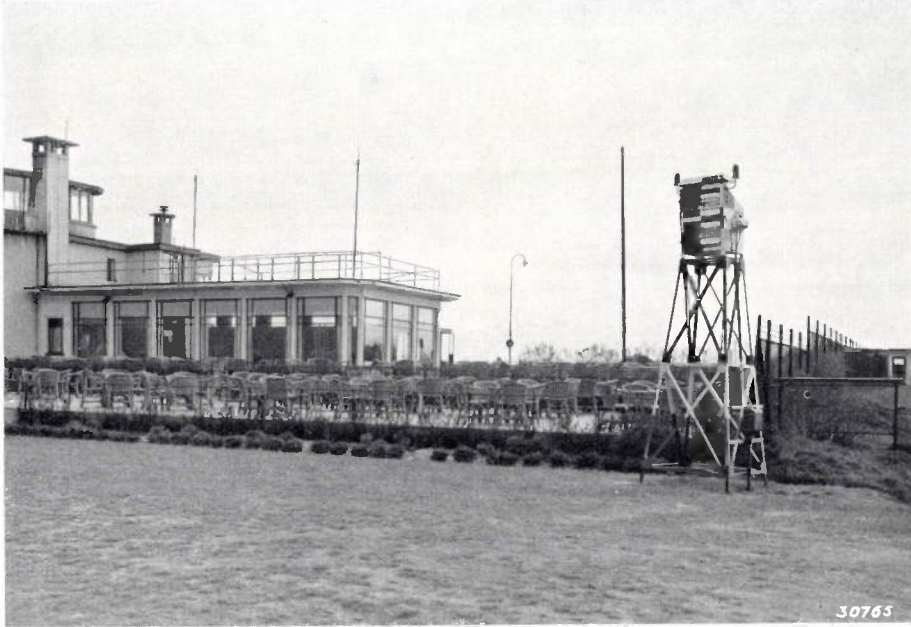

Fig. 6. Landing area floodlight mounted on a simple iron structure. The light consists of two super high pressure mercury lamps placed one above the other in parabolic cylindrical mirrors.

mendations. Nevertheless this landing light is found to be satisfactory in practice, which fact is due to the spectral composition of the mercury light. Mercury light is unusually suitable for the illumination of a green grass field! The light of the mercury lamps consists namely

- for 33% of the yellow line from 5 770 - 5 790 Å,
- for 53% of the green line at 5 460 Å,
- for 1% of the blue and violet lines at 4 358 Å and from 4 047 - 4 078 Å, and
- for 13% of the continuous background of the spectrum.

Because of its high content of green, mercury light is particularly suitable for illuminating a green field. As has already been discussed elsewhere in this periodical ²⁾ the sharpness of vision is also much greater for mercury light than for other technically used lights. It is therefore possible to observe the small irregularities of the field better with mercury light, so that during landing the height above the ground can be estimated with more confidence.

²⁾ Philips techn. Rev. 1, 215, 1936.

of a parabolic cylindrical mirror. The light flux per lamp is 120 000 lumens and the maximum brightness is 33 000 c.p./sq.cm, while the maximum luminous intensity is one million candle power per mirror. Since provision is made that the mirrors can be adjusted accurately, with these three lamps placed one above the other, a total light intensity of three million candle power can be attained. The horizontal spread is about 120° like that of the previously described 1 000 W mercury lamps, while the vertical spread is even less than is indicated in *fig. 5*.

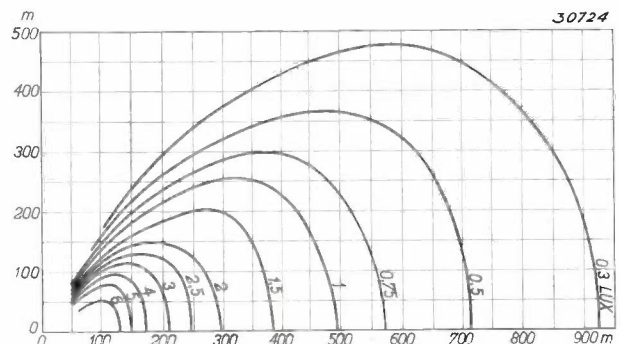

Fig. 7. Curves connecting points on the aerodrome which are equally strongly illuminated by one mercury lamp of 1 000 W.

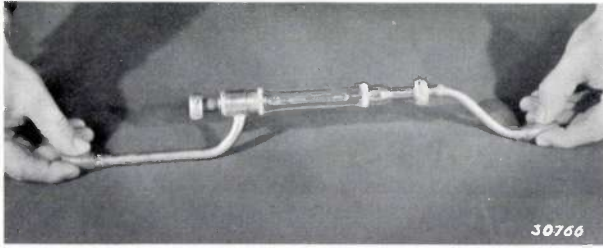

Fig. 8. Water-cooled super high pressure mercury lamp with a power of 2 kW, which gives a light flux of 120 000 lumens.

Landing with poor visibility

In several articles in this periodical the great significance of the ratio for course finding³⁾ and for landing⁴⁾ of aeroplanes under unfavourable conditions has been dealt with. Although the radio was initially a reinforcement of the light beacons, at present the illumination must rather be regarded as a supplement to the radio beacon for landing with poor visibility. Due to the development of radio beacons and direction finding stations it is at present quite possible to fly a desired course without seeing the ground. The requirements made of route lights could therefore be lowered. This is, however, not the case in landing on the radio beacon, where in addition to the radio beacon, in order to effect a good landing on the field, an efficient auxiliary illumination is certainly necessary. It is obvious that from economic considerations an attempt will be made to make this auxiliary illumination such that it makes landing in the mist possible in the daytime as well as at night.

As to the visibility of different sources of coloured light in the daytime in hazy or misty weather, L. Bloch⁵⁾ in collaboration with the German railways has carried out practical measurements. He characterizes the density of the haze by the "visibility" S , that is the distance at which during his tests flag poles and telephone poles (close at hand) and factory chimneys and church steeples (far away) could just be seen. Tests were made in mists with a "visibility" of from 200 to 1 400 m, in which the determinations of "visibility" were found to be accurate to about 50 m. Between the luminous intensity I in candle power, the "visibility" S in metres and the distance a in metres at which the differently coloured light sources were just visible, Bloch found the following experimental relation:

$$I = c \frac{a^4}{S^{4/3}} 10^{-4}, \dots \dots \dots (1)$$

³⁾ Philips techn. Rev. 2, 184, 1937.

⁴⁾ Philips techn. Rev. 2, 370, 1937.

⁵⁾ L. Bloch: Organ Fortschr. Eisenbahnw. 68, 99, 1931.

where the constant c depends upon the colour. For red light it is 540, while for white, yellow and green light it is 1 080. This means that a light of another colour must be twice as strong as a red light to be seen at the same distance through the same mist. Although it is easier to increase the light intensity of a white light source than that of a red one, it is nevertheless better not to seek the solution in that direction, since for night landings white light is too apt to cause glare. If it is desired to use the same auxiliary illumination for mist landings in the daytime and at night, red is the colour indicated. By giving the auxiliary light a suitable form care must be taken to avoid their confusion with the point obstruction lights and especially with red boundary lights if present. If yellow boundary lights are used, linear red lights may be used without danger for these auxiliary lights.

A strong approach light should be placed in the landing line given by the radio beacon at a distance of about 500 m in front of the boundary of the aerodrome. Tests are being carried out at the present time to find out whether it is desirable to bridge the distance from this light to the same type (placed at intervals of 100 m for example) or by a large number of weaker approach lights. At the point where the line of access marked in this way crosses the boundary of the field it is desirable to install special boundary lights, so-called access lights, which may not project higher above the ground than the boundary lights. The indication of the strip of ground on the field given by the radio beacon (landing area) can in misty weather only be by means of sunken illuminated buttons and not by the landing area floodlights since the latter would only succeed in illuminating the mist in a very disturbing manner.

When yellow boundary lights are used, red should be chosen for approach lights, as shown above, and neon lamps should be used. A low tension neon lamp of 475 W, 1 m long and with a diameter of 4 cm has been successfully used as approach light in a parabolic cylindrical mirror with an opening of 60 cm. The beam of light has a horizontal spread of about 120° and a vertical spread of about 10°. The maximum luminous intensity is 8 000 candle power. In misty weather in the daytime and with a "visibility" of 200 m this approach light is visible from a distance of 670 m according to formula (1). If two or three such neon lamps are placed side by side in the line given by the radio beacon at about 500 m in front of the boundary of the aerodrome, and if their maxi-

imum intensity makes a suitable angle with the horizon (15° for instance) the result is a satisfactory approach light.

For the lights to be installed at regular intervals between approach light and the boundary of the field, use could be made of high tension neon lamps, which are 2 m long and have a diameter of 1.4 cm. This lamp has an energy of 110 W, and when placed in a parabolic cylindrical mirror with an opening of 15 cm can produce a maximum luminous intensity of about 1 200 candle power. With a visibility of 200 m this light can be seen at a distance of 420 m according to formula (1).

Since in very bad weather it is impossible to make the whole aerodrome visible to the pilot either with the boundary lights or with the landing area floodlights, steps must be taken to accentuate clearly the landing area itself. As explained above this can be done with sunken light sources; if, however, lights were used for this purpose which were entirely flush with the ground, the beams of light would be emitted chiefly in a vertical direction, and the pilot would see only the light which was scattered in a horizontal direction by the mist. Since the machine flies very low over the ground before landing it is desirable to have the beams emitted from the illuminated buttons in directions which make an angle of 20° at the most with the horizon. Therefore these lights, which are installed at intervals of 25 m in two rows along the edges of the landing area, must project slightly above the ground. This, however, is found to offer no difficulties for machines which may ride over them.

In *fig. 9* such an illuminated button may be seen, (a) closed, and (b) open, which was designed for the "Philora" sodium lamp SO 400. This brings us automatically to the question of the colour which should be chosen for these sunken lights.

On the one hand many aeronautical authorities would like to see yellow sodium lights used for this purpose, since these can be observed under all circumstances. Although the danger of confusion with yellow boundary lights is in this case decreased by the shorter distance between these lights (25 m instead of 100 m) and also perhaps by the different character of their light distribution, such a confusion could be so dangerous that it must be made absolutely impossible in any case by choosing different colours for the boundary lights and the illuminated buttons. For example yellow might be chosen for the latter and red for the linear boundary lights, with special provision against

confusion of the latter with red approach lights when present.

On the other hand, however, it is proposed to meet this difficulty by making the illuminated buttons green along the first 300 m of the landing area, white in the middle, with precautions against glare, and red along the last 300 m. This would correspond to the older method of marking the landing area with storm lanterns where green indicates that at that point the landing manoeuvre may be safely begun, while red indicates that it is dangerous to be at that point without having completed the landing. If, however, in order to avoid glare a green-yellow-red system is used, the possibility would again arise that yellow boundary lights might be taken for illuminated buttons. This possibility may perhaps be avoided by extinguishing the boundary lights during a landing on the radio beacon since, as has already been seen, the boundary lights play a much less important part in a heavy mist.

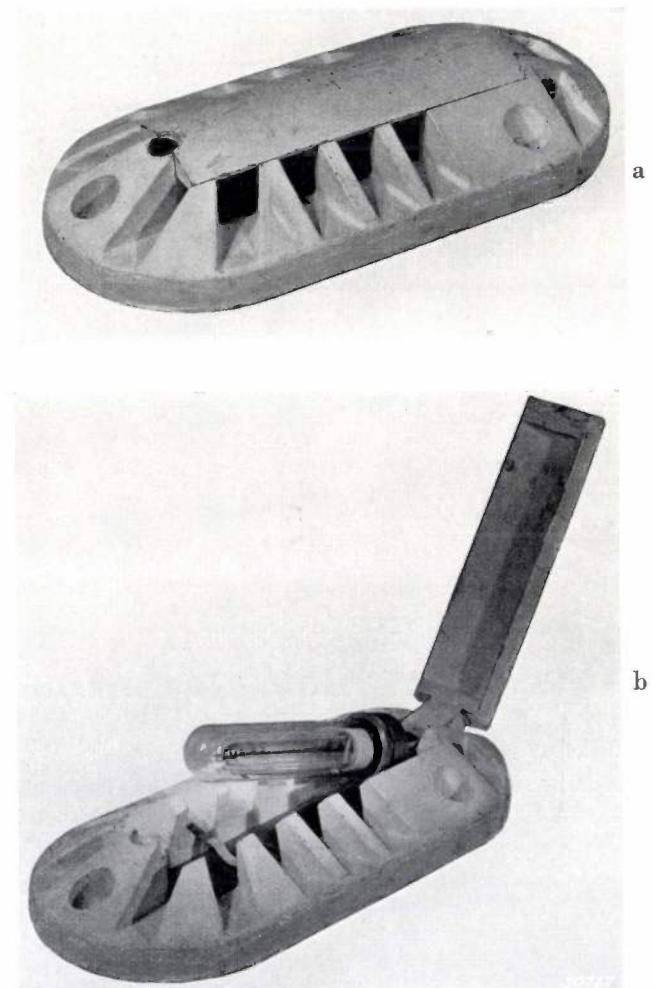

Fig. 9. Illuminated button closed (a) and open (b), in which a "Philora" sodium lamp, type SO 400, can be mounted.

BLOCKING LAYER RECTIFIERS

by W. CH. van GEEL.

621.314.63

Certain combinations of materials exhibit a resistance to the passage of current which is dependent on the direction of the current. This phenomenon is given practical application in the so-called blocking layer rectifiers. The action of the blocking layer rectifier is dealt with in this article. Two special kinds of blocking layer rectifiers are discussed in detail, namely the copper-cuprous oxide and selenium rectifiers.

Introduction

The increasing use of alternating current in electro-technology has increased the importance of the problem of converting alternating current into direct current. A choice may be made among various methods, depending upon the strength of the rectified current and the voltage to be rectified, and especially on the requirements made of the character of the rectification.

Rectifiers have been repeatedly discussed in this periodical¹⁾ which make use of discharge tubes, and particularly of high-vacuum tubes with hot cathodes or gas discharge tubes either with hot cathode or mercury cathode. In this article we shall discuss a quite different type of rectifier whose action is based on the phenomenon that with certain kinds of contacts, the resistance to current is many times greater in one direction than in the other.

The first rectifier of this type was discovered by Braun²⁾ in 1874 who observed that many crystals, and especially those of metallic sulphides, show a rectifying action when brought into contact with the end of a wire. The resistance to a current from the crystal to the wire can differ very much from the resistance in the reverse direction. Although this phenomenon depends very much upon the condition of the surface of the crystal and can never be reproduced exactly, rectifiers constructed on this principle have played a large part in the development of radio technology as crystal detectors.

Almost simultaneously with Braun's discovery a similar uni-directional resistance was found in the case of copper contacts when one of the copper surfaces had first been oxidized. This phenomenon was found at first to be even less reproducible than the rectifying action of crystals. It was only in 1920 that Grondahl discovered that technically usable rectifiers could be constructed on this principle, which are suitable even for high currents³⁾.

¹⁾ See for example Philips techn. Rev. 1, 6, 11, 65, 1936.

²⁾ F. Braun, Pogg. Ann. 153, 556, 1874, Ann. Phys. 1, 95, 1877.

³⁾ In this connection the reader is referred to the electrolytic rectifier which, as to function, shows some similarity with

Such rectifiers are now well known in various types and are called metal or blocking layer rectifiers.

Construction of the blocking layer rectifier

The common characteristic of all blocking layer rectifiers constructed until now is that they consist of two electrodes of different nature which are separated by an insulating layer (blocking layer). For the first electrode a metal is usually taken, often a so-called "rectifying metal", *i.e.* a metal on which a layer of oxide is automatically formed on exposure to the air or on which such a layer can easily be obtained. The oxide layer then serves as blocking layer. Such metals are aluminium, zirconium, titanium, tantalum, niobium. It is, however, by no means necessary that the insulating layer be obtained by chemical treatment of one of the electrodes. Any desired insulating substance can be used as material for the blocking layer, such as resin, sulphur, cellulose, paraffin, paper. The most suitable substances for the other electrode are poorly conducting metallic compounds, such as oxides, sulphides and iodides of metals (for instance copper sulphide, lead sulphide, molybdenum sulphide, cuprous oxide, manganese oxide, copper iodide, etc.). All these substances are semi-conductors.

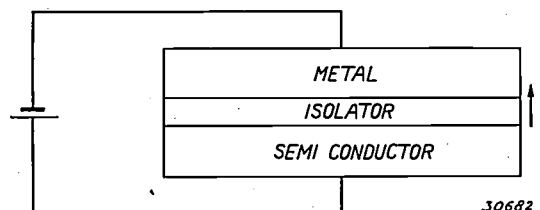

Fig. 1. Scheme for a blocking layer rectifier. The arrow indicates the current direction in which the resistance is generally lower.

Thus for the blocking layer rectifier we arrive at the scheme represented in *fig. 1*: metal - insulator - semi-conductor.

An example of a rectifier of this type is the se-

the blocking layer rectifier. The electrolytic rectifier was discussed previously in this periodical in an article on electrolytic condensers (Philips techn. Rev. 2, 65, 1937).

lenium rectifier manufactured by Philips. One electrode of this rectifier consists of selenium which is brought into a semi-conducting modification by a suitable heat treatment, whereby at the same time an insulating layer is formed on the surface. For the other electrode an alloy with a low melting point is chosen which can easily be deposited on the insulating layer without the selenium being melted.

Fig. 2a shows how the current of a selenium rectifier (diameter 45 mm) varies as a function of the voltage. The curve, shows that the resistance to currents in the positive direction (which corresponds to the passage of electrons from the metal to the semi-conductor) is on the average much smaller than that for currents in the negative direction.

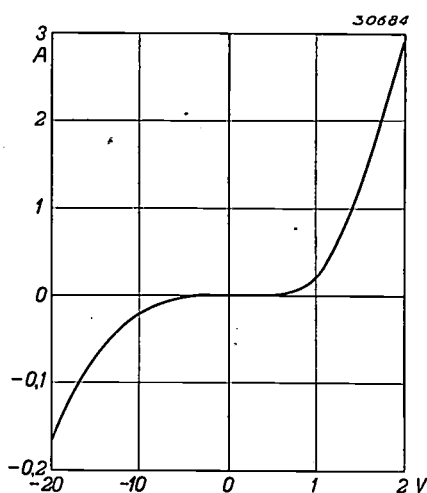

Fig. 2. Current-voltage characteristic of a selenium rectifier with a diameter of 45 mm. Please consider the entirely different scales for positive voltages and currents and for negative voltages and currents.

Explanation of the rectifying action

As stated above a blocking layer rectifier consists of two electrodes of different electrical nature which are separated by an insulating layer. This combination exhibits a uni-directional conductivity due to the fact that the electrons can pass over from the metal through the insulator to the semi-conductor, but apparently cannot pass, or only to a much smaller degree, in the opposite direction.

At first sight it seems surprising that this current transport is possible in the insulating material; the insulating power of such a material is based on the fact that the elementary particles of electricity are not mobile in this substance, or at least that they experience great difficulty in moving. With a sufficiently thin layer of an insulating substance this is, however, by no means true.

In order to understand this it must be pointed out that empty space is also an excellent insulator. Between two electrodes in a vacuum, for instance the cathode and anode of an X-ray tube, there must be a field strength of about 10^6 volts/cm before current begins to flow. It is clear that in this case the cause of the resistance cannot be sought in a hindrance of the motion of the charged particles in the space between the electrodes. As soon as charged particles have been successfully introduced into the space between the electrodes there is nothing to prevent these particles from passing from one electrode to the other. The hindrance to the flow of current is thus due only to the fact that energy is necessary to free charged particles from the cathode and bring them into the vacuum. According as the work necessary to do this, the so-called work function, is smaller, the current which flows through the vacuum will be larger.

When instead of empty space there is an insulator between the electrodes, there is no great fundamental difference. It is true that the work function will now depend upon the nature of the insulator, and will often be different from the work function for emission into empty space. The order of magnitude will, however, generally be the same, namely it will correspond to a voltage of a few volts, and this energy is, just as with a vacuum, much more important for the resistance to current than the opposition which the electrons experience in the insulating layer itself.

In order to understand the current-voltage characteristic of a blocking layer rectifier, we must therefore find out what processes affect the passage of electrons from a metal or from a semi-conductor into an insulator. To do this we shall in the following consider in some detail the significance of an insulator and a semi-conductor for the electrons.

The electrons in a metal

A metal like all materials consists of atoms. Each atom is composed of a positively charged nucleus and a number of negative electrons which exactly neutralize the charge of the nucleus so that the whole atom is uncharged.

For example, an atom of copper has 29 electrons, an atom of lead 82 electrons. Most of these electrons circle around the nucleus as planets around the sun; they cannot leave the nucleus and therefore do not contribute to conduction. A small portion of the electrons, usually only 1 or 2 per atom, are, however, not bound to definite orbits but can migrate throughout the whole metal, and the weakest

electric field will already cause them to move in the direction of the field strength.

These electrons are therefore as it were freely moving, with, however, the restriction that they cannot leave the metal. In order to draw an electron out of the metal a definite amount of energy, a certain energy of evaporation as it were, is necessary, which amounts to 2 to 5 electron volts depending on the kind of metal.

The electrons in an insulator

When a solid substance is not a metal, but a chemical compound there are usually no conduction electrons present in it. Due to the formation of the chemical compound new orbits are formed for the electrons, and with chemically equivalent amounts of the elements in the compound the number of orbits is equal to the number of electrons, so that all the electrons are bound. The material is then an insulator. When, however, the number of electrons is greater than the number of orbits, for instance because of the fact that electrons enter the insulator from the outside, these extra electrons are freely moving like the conduction electrons of a metal as explained above.

The electrons in a semi-conductor

When a chemical compound, the oxide of a metal for instance, is not composed of exactly chemically equivalent amounts of the elements but contains too little oxygen for example, not all the electrons are bound and a certain conductivity is retained. The same phenomenon can also occur when the compound contains certain impurities. The number of conduction electrons is, however, much smaller than in a metal (for instance 1/1000 of the number of atoms), and consequently the conductivity is also much smaller. Such substances are called semi-conductors, or, more accurately, "excess" semi-conductors, since the conductivity is caused by an excess of electrons.

If the composition deviates from chemical equivalence in the opposite direction, thus in our case if the oxide, instead of too little oxygen, contains too much oxygen, the number of orbits becomes greater than the number of electrons, so that all the electrons are bound and there are in addition a number of orbits in which no electrons move. There remain therefore a number of atoms which could bind another electron.

In this case also a certain conductivity appears. It is for instance possible for an atom which can bind another electron to receive this electron from

its right-hand neighbour. The latter can now receive an electron from its right-hand neighbour and so on, so that the spot where an electron is missing is steadily displaced toward the right. This has exactly the same effect as if a positive charge were moved to the right through the material, in other words, a current flows toward the right. This type of conduction might be called "deficiency" semi-conduction.

After this consideration of the mechanism of conduction in the three components of a blocking layer rectifier we are ready to examine how the conduction takes place in the whole combination.

The action of a blocking layer rectifier

As already stated the resistance of a blocking layer rectifier in the two directions is determined chiefly by the processes which take place in the transition of electrons from the metal or semi-conductor into the insulator.

Thermionic emission

It would seem most obvious to consider this transition as thermionic emission of electrons, *i.e.* as an evaporation of electrons from the emitting material. At a given temperature the electrons have a certain distribution of velocities. The average kinetic energy is much smaller than the work function, and only the speediest electrons can escape. The speed of evaporation is determined by the heat of evaporation which may have different values in the case of the metal and that of the semi-conductor. If it is assumed that the heat of evaporation for electrons (the work function) is smaller in the case of the metal than in that of the semi-conductor, the electrons would show a preference to flow in the direction from the metal to the semi-conductor, in agreement with the observed rectifying action.

Upon consideration of the current-voltage diagram of a blocking layer rectifier, however, it is found that thermionic emission is not capable of accounting for the entire phenomenon. If it were so then, at a given temperature, saturation of the current would occur with increasing voltage and this saturation would be determined by the emission of the electrodes. This phenomenon would have to be plainly noticeable at the voltages which are necessary to cause the rectifier to function. This is found, however, not to be the case: the current continues to increase with increasing voltage. It increases even in both directions more strongly than proportional to the voltage.

The manner in which the current varies with a

given voltage is also not easily explained by thermionic emission. With thermionic emission the current should depend strictly on the temperature and should practically disappear when the rectifier is sufficiently cooled. Actually this is not the case, the current in the direction of passage only decreases slightly with a constant voltage on the blocking layer upon strong cooling and it certainly never becomes zero ⁴⁾.

From these discrepancies it may be concluded that the emission of electrons is not caused exclusively by the temperature, but that electrons can be drawn out by the voltage applied independent of the thermal motion. This becomes more easily understandable when it is kept in mind that, thanks to the slight thickness of the blocking layer, very high field strengths occur at the surface of the cathode even at very low voltages.

If for example a blocking layer 10^{-5} cm thick is used, a field strength of 10^6 volts/cm is obtained with a voltage of 10 volts. Moreover there are practically always points on the surface of the electrodes, due to which concentrations of the field occur which can easily increase the field strength locally by a factor 10. Field strengths of the order of 10^7 volts/cm may therefore be expected in the blocking layer rectifier.

Cold emission

When fields of this order of magnitude are applied to electrodes situated in a vacuum it is observed that an electron current occurs which is much greater than the thermionic emission; this current is called "cold emission". Cold emission can be obtained for example by placing the end of a wire as cathode against a plane electrode. Due to the concentration of the field the necessary strong field is obtained at the end of the wire with relatively low voltages. The current density of cold emission may be very high (of the order of 1000 A/sq. cm), the emitting surface in these experiments is, however, only 10^{-7} to 10^{-8} sq.cm., so that the currents observed are nevertheless very small.

An explanation of cold emission was first made possible by applying the new points of view revealed by wave mechanics. We shall not enter into details on this subject, but shall only attempt to show by means of fig. 3 how the occurrence of this phenomenon can be deduced from the idea that a current of electrons behaves like a train of waves.

In fig. 3a the energy diagram is given of an electron which is moving in a conductor toward the surface of that conductor. At the surface the potential energy makes a jump which we have learned to know as the work function of the electron. Outside the surface the energy decreases again due to the electric field, and to the right of point Q it is lower than the energy of the electron which moves toward the surface from the inside.

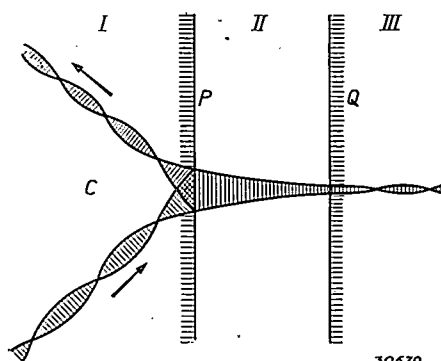
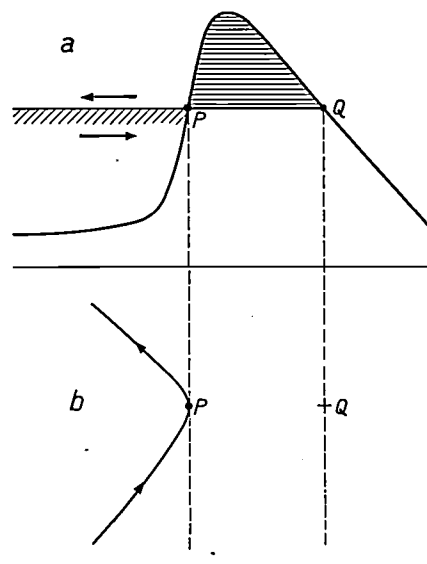

Fig. 3. Explanation of cold emission. a) Energy diagram for a particle which, coming from the interior, strikes the surface of a metal. At point P the potential energy (continuous line) is equal to the kinetic energy (broken line). The electron then comes to rest and reverses its direction. b) Path of the electron which strikes the surface. c) The reflection of an electron which "wishes" to leave the metal and is reflected, exhibits a certain analogy with a light wave which "wishes" to leave a glass body and is totally reflected. If the air gap II is narrow enough part of the light penetrates to the second glass body (III). In the same way an electron can pass the emission potential if the region between P and Q, in which the potential energy is greater than the total energy, is sufficiently narrow.

According to classical mechanics the electron should be reflected at the potential barrier. The path of the electron "seen from above" is represented in fig. 3b. The electron cannot move forward

⁴⁾ If the current is kept constant, the total voltage on the rectifier increases on cooling, since the resistance of the semi-conductor increases.

farther than line P , where the potential energy is equal to the total energy of the electron. The region between lines P and Q is inaccessible to the electron according to the law of the conservation of energy, and it is thus impossible for the electron to be emitted. The electron might exist in the region to the right of the line Q without violating the law of the conservation of energy, but it cannot reach this region without passing through the potential barrier.

When we describe the collision of the electron with the potential barrier in the terms of wave mechanics, the reflection of the electrons means that a total reflection of the waves of matter occurs.

The total reflection of a wave at the boundary between two media does not mean that no oscillation phenomenon at all occurs on the other side of the boundary. We shall demonstrate this by means of an optical analogy. If for example we have two glass blocks to the left of line P and to the right of line Q which are separated by an air gap (see fig. 3), then a light ray incident at a sufficiently large angle φ would be totally reflected at the surface P . In the air gap, however, there is still a certain electric field which decreases exponentially with increasing distance from the boundary P . This results in the fact that reflection is really only total with an infinitely thick air gap. When the thickness of the air gap is not many times greater than the wave length of the light, an appreciable portion of the radiation will be transferred to the second block.

If these considerations are applied to waves of matter which describe the movement of the electron, an explanation is obtained for the phenomenon of cold emission. The length of the waves of matter of the conduction electrons is of the order of 10^{-7} cm. If the thickness of the inaccessible zone is comparable with this wave length, and this is the case with a field strength of 10^6 to 10^7 volts/cm, the material waves will penetrate the potential barrier, which means that electrons are emitted.

When the theory of cold emission is worked out quantitatively, one finds for the current density as a function of the electrical field strength F a relation having the following form:

$$i = AF^2 e^{-B/F}, \dots \dots (1)$$

where B is proportional to the work function to the $3/2$ power.

The current in the direction of rectification can be approximately described by a formula of the form of equation (1) if it is assumed that the field

strength F is proportional to the voltage V on the rectifier. The relation between F and V is difficult to give precisely, because the thickness of the blocking layer is not usually everywhere the same, and moreover it is not known to what degree the field strength is raised by the presence of projecting points.

The higher resistance to current in the direction opposite to that of rectification must be explained by assuming that in this direction a much smaller cold emission occurs. It may then be expected that other manners of current passage, such as thermionic emission and electrolytic conduction of the blocking layer will play a relatively greater part. It is also found that in the direction opposite to that maximum flow equation (1) does not hold so well and that the shape of the $I-V$ curve found is strongly affected by the way in which the rectifier is constructed.

The fact that the cold emission of the metal plate is different from that of the semi-conducting plate may be due to various reasons:

In the first place the electrons in a semi-conductor, are much less mobile than in a metal. Consequently much fewer electrons will strike the surface per second, so that the number of electrons which leaves the surface per second will be much smaller with the semi-conductor than with the metal.

In the second place cold emission just as thermionic emission depends upon the work function, which may be different in the case of a semi-conductor and a metal.

In the third place, depending on the method of construction, it is possible that sharper points project from the surface of one electrode than from that of the other, so that at a given voltage stronger fields occur at the surface of one electrode than at the surface of the other.

The first effect results in the fact that electrons can pass more easily from the metal to the semi-conductor, while the second and third effects may favour one direction or the other according to the circumstances.

Each of the three effects may of itself be large enough to explain a rectifying action of the order of magnitude observed. It is possible that in technically important blocking layer rectifiers there is a collaboration of different phenomena which cannot be separated from each other experimentally.

The construction of blocking layer rectifiers

The first blocking layer rectifier which had practical significance also for higher currents consisted of a combination of copper and cuprous

oxide. To make a cuprous oxide rectifier, a plate of pure copper is heated in air to a temperature of about 1040 °C. The copper oxidizes in air and becomes covered with a layer of cuprous oxide, Cu_2O . This cuprous oxide by itself is not a semiconductor, but an insulator. By means of a suitable heat treatment the cuprous oxide can, however, be made to take up oxygen from the air and thus become semi-conducting.

From the method of preparation there is no evidence of the existence of a blocking layer between the copper and the cuprous oxide. The fact that such a blocking layer is present may be explained as follows. We saw above that pure cuprous oxide forms an insulator and only obtains its conductive properties by an excess of oxygen. At the boundary surface of the cuprous oxide and copper a certain diffusion of atoms takes place, so that the composition changes gradually from Cu_2O with excess oxygen to pure copper. In this case, however, there must be a certain layer present in which the cuprous oxide has exactly the stoichiometrical composition, and this layer forms the blocking layer. The cuprous oxide rectifier thus corresponds to the scheme metal-insulator-semiconductor.

As already mentioned a blocking layer rectifier has been developed by Philips in which selenium is employed as semi-conducting material.

Selenium is a substance which occurs in various modifications. When powdered selenium is fused, a glassy mass results which has a high specific resistance. When this mass is brought to a temperature between 100 and 220° C the selenium passes over into a grey crystalline modification which is more conducting, and which in thin layers is useful as semi-conducting electrode of a blocking layer rectifier. Selenium is always used in the form of a thin plate on a metal base plate because it is so brittle.

The molten selenium is deposited on the base plate and pressed to a thin layer. Then the above-mentioned heat treatment is applied and the grey modification is obtained. At the same time a blocking layer is formed on the free upper surface of the selenium (thus not between the selenium and the base).

After cooling a thin layer of metal is deposited on the blocking layer. An alloy of tin, cadmium and bismuth with a low melting point is used. This layer is connected to one supply wire by means

of a contact spring. The other contact is made on the base plate.

Properties of the selenium rectifier

The current-voltage characteristic of the Philips selenium rectifier has already been given in fig. 2. The current in the direction of rectification can be approximately represented for voltages below 1 volt by a formula of the following form:

$$i = AV^2 e^{-b/V},$$

where A and b are constants. At higher voltages there are deviations from this formula because the resistance of the selenium layer at higher current causes a voltage drop which may not be neglected.

In the direction of least flow of current the remarkable situation occurs that upon application of the voltage it takes some time before the current reaches its final value. This effect is already noticeable upon comparison of the current-voltage characteristics for direct voltage and for an alternating voltage of 50 c/s, especially when the rectifier has been working for some time.

The characteristics reproduced refer to room temperature. Upon increase of temperature the current in both directions increases. In the direction of rectification the increase of current per degree of temperature increase is about 1 per cent, in the other direction it is an average of 5 to 10 per cent.

The permissible current strength for continuous action through the blocking layer rectifier is 300 mA in the direction of rectification, which corresponds to about 0.9 volt; in the other direction about 20 volts are permissible. At too high a voltage on the blocking layer breakdown may occur. This usually results in the burning away of the projecting points which caused the breakdown. This has, however, no unfavourable effect on the action of the rectifier, since no permanent destruction (short circuit) of the blocking layer results. The cuprous oxide rectifier is much more sensitive to breakdown. In this case breakdown always leads to permanent short circuit.

In addition to breakdown, overheating may also occur upon overloading the rectifier, with the result that the metal electrode melts. In that case it may happen that the contact springs push through the blocking layer and cause permanent short circuit. In most cases, however, the selenium rectifier can withstand even this severe test.

A SIMPLE APPARATUS FOR SOUND RECORDING

by K. de BOER and A. Th. van URK.

681.84.081.3: 681.85

A simple instrument is described which makes it possible for the layman to make sound records of very satisfactory quality. The sound is recorded on discs which can be played on an ordinary gramophone. The choice of system and the construction of the recorder are discussed in detail. The recorder has a flat frequency characteristic between 60 and 4 500 cycles/sec and only requires a driving power of 0.6 W. Therefore no other amplifier is necessary for the microphone currents than the low-frequency part of a radio receiving set. This fact makes the instrument particularly suitable for use in music and elocution schools and in the teaching of languages. In conclusion particulars are given for the operation.

While the possibility of recording visual impressions by means of photography has found wide application in the hands of the layman, the possibility of recording acoustic impressions has found relatively little application outside sound film and gramophone studios. There are nevertheless many cases where it would be very useful to be able to record sound. Musicians and actors might in this way be enabled to criticize their own production without being compelled at the same time to concentrate upon the performance. The same is true in the case of speakers engaged in preparing a speech. It is a well known fact that while speaking one hears one's own voice quite differently from the way in which the audience hears it, due among other factors to the conduction of the sound through the bones of the ear. The pedagogical possibilities are very great for music and elocution schools. The teaching of languages may also profit very much from good records of speech, as is proved by the existence and results of teaching systems based solely on gramophone records.

At the same time sound records may also be of interest to the private person, for recording important telephone conversations, for correspondence by means of gramophone records or other similar purposes.

A recording apparatus which is to be suitable for the applications mentioned must be simple in operation, while at the same time the quality of reproduction must be satisfying. In the following we shall describe a simple instrument, which was developed in this laboratory and which makes it possible for non-technical persons to make sound records of very satisfactory quality, which can later be reproduced in the same way as ordinary gramophone records.

Choice of the recording system

All the mechanical systems of sound recording ¹⁾

have one common feature: a cutting tool moving in the rhythm of the sound vibrations cuts a sound track in a more or less soft material. This material may be deposited on a cylinder, as was the case with Edison's phonograph and as is still customary with dictaphones, or it may be on flat discs. The construction of the recording apparatus can of course only be suitable for one of these forms. The instrument was designed for recording on discs, since the intention was that one should be able to reproduce the recorded sound on an ordinary gramophone.

The sound track on the record can be modulated in two ways: the depth of the groove cut may vary in the rhythm of the sound vibrations (Edison recording), or the vibrations may be reproduced as the transverse wave-like form of the groove (Berliner recording). Edison recording has the advantage that the spirals of the groove may lie very close together, while with Berliner recording a space must be left between the spirals which is equal to twice the amplitude of the greatest deviation occurring. With Edison recording therefore it is possible to obtain a longer playing time of the record with the same diameter of the disc. Over against this are the disadvantages that the recording apparatus for this system is more difficult to construct and more easily leads to distortion. At the present time gramophone records are made almost exclusively by the Berliner system, and the pick-ups of ordinary gramophones are constructed for this system. The recording apparatus therefore has also been designed for "Berliner" recording.

There are moreover two alternative methods of recording, depending on whether the groove is to be cut from the centre toward the edge or from the edge toward the centre of the disc. The last-

¹⁾ We may here neglect the optical system of sound recording such as is used for sound film, since it is too elaborate and expensive for the purpose in view.

mentioned system is the customary one, so that the automatic stopping switch which most gramophones possess is always designed for this manner of recording. The system however has the disadvantage that care must be taken during the cutting process that the cutter does not touch the shaving previously cut out. The shaving, if it is not removed, lies on the disc in a circle which — probably due to shrinkage — has a diameter somewhat smaller than that of the groove cut. Contact between cutter and shaving might lead to damage to cutter or groove. When the groove is cut from the centre toward the edge, this difficulty cannot arise, but on the other hand in that case the automatic stopping switch can also not be used when the record is played. In order to leave it to the user to decide which factor is more important for him, greater ease in cutting or greater convenience in playing, our recorder has been so constructed that by interchanging a few parts it is possible to pass over from one method of cutting to the other.

Another disadvantage of cutting from the edge toward the centre is that the high tones are apt to suffer. Good reproduction of the high tones depends upon whether the point of the needle with which the record is played can easily follow the waves of the groove. To do this it is necessary that the radius of curvature of the waves shall be greater than the radius of the point of the needle. The point of the needle suffers considerable wearing down even after playing one record of hard material like the wax records now on the market. The point of a new needle has a diameter of about 50 μ , at the end of the record it has become blunter, however, and is for instance 100 μ thick. The radius of curvature of the waves of the groove is, at a definite recorded frequency, proportional to the distance from the centre of the disc, thus in the outermost grooves it is 2 to 3 times as great as in the inner grooves. It is therefore best from the point of view of reproduction to begin with the new, fine needle point where the radius of curvature of the groove is the smallest, namely at the inner grooves.

The sound recorder

The cutter is driven according to the electromagnetic method. Fig. 1 shows diagrammatically the construction of the sound recorder. The armature is situated in the field of the permanent magnet between two pole pieces, which are excited by the magnet *NZ*. The motion of the armature about the torsion axis *T* is caused by the alternating field which is excited by the alternating current flowing through the coil *Sp*. If the current (for instance that amplified in the low-frequency part of a radio set) from a microphone into which some one is speaking is sent through the coil, the armature oscillates in the rhythm of the sound to be recorded. The cutter is attached to the armature,

and upon oscillation of the armature it cuts an undulating groove in the record rotating beneath it.

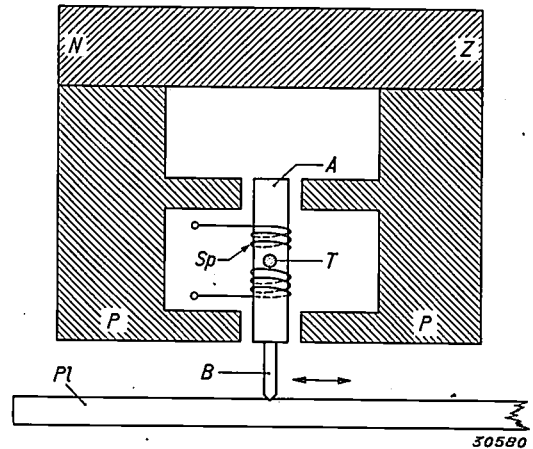

Fig. 1. Diagram of a sound recorder according to the electromagnetic principle. *NZ* magnet, *P* pole pieces, *A* armature, *Sp* coils through which flows the microphone current which varies in the rhythm of the sound vibrations. *B* cutter which cuts a transverse wavelike groove in the moving record *Pl* upon the oscillation of the armature.

We shall now calculate the amplitude taken on by the cutter during the oscillation of the armature. With a sinusoidal alternating field having the peak value ΔH a varying couple is experienced by the armature which has the peak value

$$K = \frac{1}{2\pi} H_0 \Delta H \cdot O \cdot r_a \dots (1)$$

where H_0 is the permanent field in the air gap, O the area of the surface of the pole pieces and r_a the length of the lever upon which the forces making up the couple act. Under the influence of this varying couple the armature oscillates, as long as the frequency ω of the alternating field is small with respect to the resonance frequency ω_0 , with an angular amplitude K/c , when c is the resistance to torsion of the clamping point at *T*. The amplitude a of the cutter which is fastened at a distance r_b from the turning point becomes

$$a = r_b \cdot K/c \dots (2)$$

The torsion resistance c may be expressed in the resonance frequency ω_0 of the oscillating system and the moments of inertia I_a and I_b of the armature and the cutter with the help of the relation:

$$\omega_0 = \sqrt{\frac{c}{I_a + I_b}} \dots (3)$$

For a we obtain the equation

$$a = k \frac{H_0 \Delta H}{\omega_0^2} \dots (4)$$

with the coefficient.

$$k = \frac{1}{2\pi} \cdot \frac{r_b \cdot O \cdot r_a}{I_a + I_b} \dots \dots \dots (5)$$

In practice it is important to make the sensitivity of the cutter high, *i.e.* to be able to obtain the desired deflection of the armature with as small an amount of electric energy as possible. In order to do this, in the first place the numerator of (4) must be large. The alternating field ΔH is proportional to the coil current; the proportionality factor depends upon the so-called alternating current permeability μ of the material in the whole magnetic circuit. The value of μ in the pole pieces, however, depends once more on the magnetic induction which (aside from leakage) is equal to the field H_0 in the air gap. For a certain value of H_0 the product $H_0 \Delta H$ reaches a maximum. H_0 is adjusted to this value by a suitable choice of the dimensions of the magnet.

Furthermore a large amplitude a could be obtained according to equation (4) by keeping the resonance frequency ω_0 low. In this case however there are other important considerations to which we shall return later.

Finally a may be enlarged by making the factor k in (4) large. According to equation (5) it is in the first place desirable that the moments of inertia I_a of the armature and I_b of the cutter be made as small as possible. The quantities of length which also occur in k are partly determined by structural considerations. For the case where $I_a \gg I_b$, however, another general conclusion may be drawn from equation (5). Since I_a has the dimensions of a density times a length to the fifth power, k has the dimensions of the reciprocal of a length times density. Therefore if in equation (4) both $H_0 \Delta H$ and ω_0 are considered constant, it is clear that a becomes greater when the cutter as a whole and in all its parts is reduced proportionally in size. A limit is set to this reduction by two conditions:

- 1) The armature must have certain minimum dimensions in order to have the power necessary to overcome the resistance of the gramophone record (Moreover it is not permissible to reduce the size of the cutter at will with the whole system, so that the condition that $I_a \ll I_b$ for the above consideration is no longer fulfilled).
- 2) The air gap must remain large with respect to the amplitude of the armature, since otherwise a non-linear distortion occurs in the recording. (The deflection of the armature is then no longer proportional to the coil current).

As to the first condition, the reduction in size of the whole recording apparatus could have been carried much further than was actually done in the construction. No advantage has been taken of this possible gain in sensitivity in order to continue to satisfy the second condition as well as possible. The sensitivity obtained is in any case quite sufficient for practical cases as we shall see in the following.

Comparison with the sound recorder of the Philips-Miller system

It is interesting to compare the sound recorder of the instrument with that of the Philips-Miller system²⁾. The latter system of sound recording on a special film has been developed to satisfy to the extremely high requirements of modern broadcasting. In addition to this it offers special advantages for sound film. With the Philips-Miller system the sound is recorded as a groove of varying width on a film. This groove is obtained by means of a wedged-shaped knife which is pressed by the oscillating armature more or less deeply into the moving film. While the two sound recorders show considerable similarity there is one essential difference: in the Philips-Miller system it is the armature itself which must provide the force to overcome the resistance of the material and prevent the cutter being pushed out of the material. It is the variation of this force which provides the modulation. With the described recorder on the other hand, where a groove of a constant depth and width is cut, the force which holds the cutter in the material is constant and can therefore be obtained by means of a weight attached to the cutter.

The required force of the armature in the recorder of the Philips-Miller system is thus many times greater than with the recording of discs. If it is tried to obtain the required sensitivity by reducing the size of the whole recorder the limit prescribed by the force attainable is much sooner reached with the Philips-Miller system than the limit prescribed by the requirement of linearity. With recording on gramophone discs, however, the situation is just the reverse and the limit in this case lies at much more reduced dimensions.

Construction of the Recorder

Fig. 2 is a photograph of two sound recorders. The left-hand one has been opened. To the left

²⁾ R. Vermeulen, The Philips-Miller system of sound recording, Philips techn. Rev. 1, 107, 1936; A. Th. van Urk, The sound recorder of the Philips-Miller system, Philips techn. Rev. 1, 135, 1936.

may be seen the magnet with the pole pieces. The armature is provided with a hole in which the cutter is set and fixed with a screw. The armature

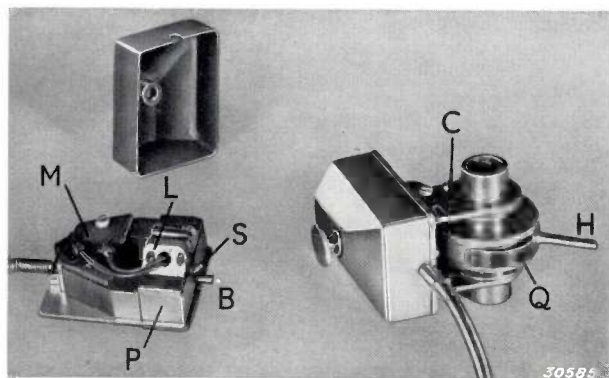

Fig. 2. Two examples of the sound recorder. The one on the left which is open shows the magnet *M*, the pole pieces *P* with the side blocks *L* between which the armature is clamped and the cutter *B* which is fastened into the armature with the screw *S*. The recorder on the right is mounted on the bridge *C* with which the displacement during the cutting is obtained.

is sketched in *fig. 3*. The armature proper is connected by two rods to the plates *K*, which are clamped between the side blocks *L* of the pole pieces, see *fig. 2* (the lower pair of side blocks is not visible there but may be seen in *fig. 5* on the extreme right). The front surfaces of the pole pieces with side blocks, as well as the armature block drawn in *fig. 3*, are ground plane. By laying copper plates of a definite thickness between the plates *K* and pole piece blocks *L* while the armature is being clamped in, an air gap is obtained with accurately defined dimensions.

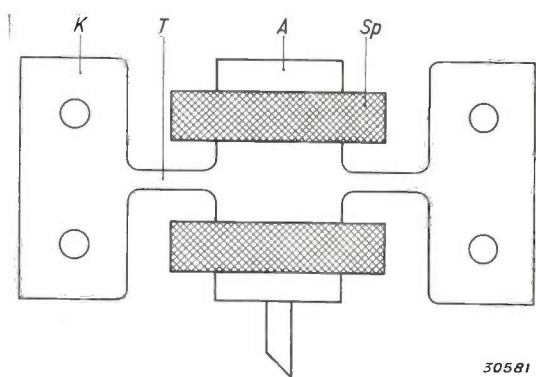

Fig. 3. Armature block of the sound recorder. The plates *K* which are clamped between the side blocks *L* (*figs. 2* and *5*) of the pole pieces bear the armature proper *A* by means of the rods *T* which serve as torsion axes. *Sp* coils.

Transport arrangement

The cutter is mounted on a bridge (*C* in *fig. 2*, on the right), which moves slowly over the disc during the cutting in such a way that the cutter follows a diameter of the disc. The whole arrangement is shown in *fig. 4*. Details of the transport

system are shown in *fig. 5*. After the disc to be cut has been laid on the turn-table, the flange *F* is set on the centre of the disc and fastened tight with a setting screw to the axle of the motor. A worm on the axle of the flange turns the screw shaft *W* via a pinion. The shaft *W* has a bearing outside the disc consisting of a bronze pin screwed into a support fastened to the base plate of the apparatus. The support is adjustable in height in order to be able to set the shaft exactly parallel to the disc to be cut.

When the cutting is completed, the bridge with the recorder must be brought back to the starting point of the groove. For this purpose the bridge is constructed as follows. On either side it has two bushings (best seen in *fig. 2*) which slide freely along the shaft. The recorder is fastened to the piece joining the two bushings. Between the two bushings is a half nut which is pressed by a spring (*Q* in *fig. 2*) into the screw of the shaft so that the recorder is carried along. By means of a small lever the nut can be lifted from the shaft so that the recorder can then be moved freely along the shaft.

The axle of the flange *F* must be exactly perpendicular to the disc, in order not to oscillate upon turning. The flange therefore does not rest directly on the disc to be cut, but has three points of contact with it which are fastened to the rear side of the flange. If the disc has a slight irregularity, which is often the case, then by turning the flange slightly it is always possible to find a position where the axle of the flange is accurately in a straight line with the axle of the motor.

A circle of small brushes is fastened to the flange which remove the shaving if it is guided toward them at the beginning of the cutting process. This precautionary measure, as explained above, is only necessary when the groove is cut from the edge toward the middle. In cutting from the middle toward the edge the shaving may be disregarded. If it is desired to use the latter method, only the screw shaft *W* and the nut in the bridge need be exchanged.

Driving power of the record

During the cutting process the cutter must overcome the resistance of the material of the disc, which exercises a retarding couple on the motor. The magnitude of this retardation depends upon the quantity of material which must be cut at each moment, and it is clear that this is greater the greater the deflections of the groove, *i.e.* the louder the passage to be recorded. It is essential that the varying couple should have no effect on



Fig. 4. The recorder in action. At the centre and outer edge of the record, shorter recordings have already been made. The shaving from the grooves just cut may be seen lying on the record in a circle slightly smaller than the groove (normally the shaving is removed by the brushes at the centre). On the left, the pick-up for reproduction. Right foreground the switch. Along the circumference of the turn-table may be seen the divisions which serve for checking the number of revolutions per minute. Under the turn-table the motor is suspended on springs.

the number of revolutions per minute of the motor, since otherwise the height of the tone of the sound to be reproduced rises and falls to the same degree (this is a well known and very disturbing effect especially in the case of piano music). The motor must therefore be sufficiently strong. If the turntable is given a large moment of inertia so that

it can act as fly-wheel and take up to some extent the variations of the retarding couple, a motor with a couple of 5 000 gem is sufficient.

In the reproduction of a record the forces acting are much smaller than in the cutting. In this case therefore a weak motor is sufficient and no fly-wheel is needed. Ordinary gramophone motors

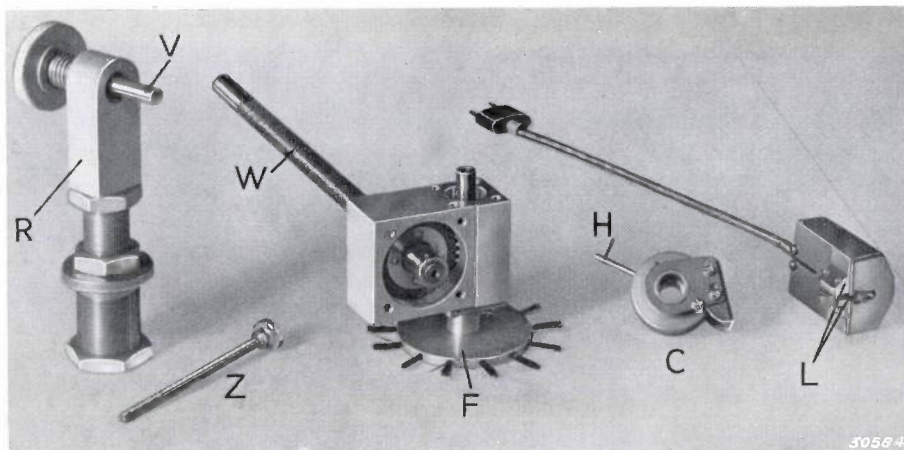

Fig. 5. Parts of the transport arrangement. *F* flange which is set on the record to be cut; *Z* setting screw; *W* screw shaft which via a worm and pinion (visible in the opened housing) is driven by the motor axle. *C* bridge which carries the recorder (extreme right) and which is transported by the screw shaft *W* by means of a half nut (visible through the hole). The nut is pressed by a spring (*Q* in fig. 2) into the screw of the shaft *W*, it can however be lifted by means of the lever *H* in order to be able to move the bridge freely along *W*. *V* the pin which is screwed into the support *R* and forms the outermost bearing of the shaft *W*.

only have a couple of about 800 g cm. This makes it absolutely impossible to cut satisfactory records by means of an ordinary gramophone.

An additional requirement is that the motor may not transfer any vibrations to the turn-table, since otherwise these vibrations would also be recorded on the record while the sound was being recorded. The motor axle is therefore coupled to the axle of the turn-table *via* an intermediate section of rubber. In order to prevent any vibrations from the motor from reaching the base plate of the apparatus and from there *via* the bearings reaching the turn-table, the motor is hung on the ground plate with rubber rings at points of contact. In order to be able to check the number of revolutions per minute of the motor the circumference

to the recorder for all frequencies. According to equation (4) the amplitude a is proportional to ΔH , and therefore also proportional to the coil current. The impedance of the armature coils is determined chiefly by their self-induction; the current, and therefore also a , is then proportional to $1/\omega$ at constant voltage.

Equation (4) only holds as long as the frequency ω lies far below the resonance frequency ω_0 . If the frequency is allowed to increase until it reaches the neighbourhood of ω_0 , the deflection increases sharply and resonance occurs. Care must therefore be taken that the resonance frequency of the armature is sufficiently high above the highest frequency of the sound vibrations to be reproduced. On the other hand, however, as we have

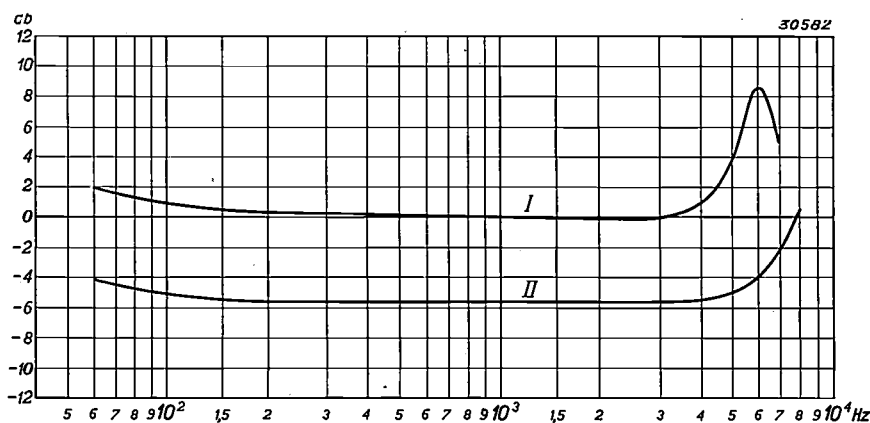

Fig. 6. Frequency characteristics, recorded during the cutting process. The velocity amplitude ω_a is plotted as a function of the frequency $\nu = \omega/2\pi$. Curve I is for the ordinary recorder, curve II for a special recorder with a lower sensitivity.

of the turn-table is marked off in certain divisions. If these are examined by the light of a source which is modulated with 100 c/s (an ordinary electric lamp burning on an alternating current main), then, due to the stroboscopic effect the turn-table appears to be stationary when the motor has the correct number of revolutions per minute (78 r.p.m.).

On the turn-table there is also a pick-up (fig. 4, left), so that the record can immediately be played.

Frequency characteristic of the sound recorder

For the cutting of gramophone records it is desirable that the velocity amplitude ωa of the armature should be independent of the frequency ω of the current through the armature coils³⁾. This is attained by supplying a constant voltage

seen, the resonance frequency must be low for the sake of sensitivity. (according to formula (4) the sensitivity is inversely proportional to ω_0^2). A compromise must therefore be found such that not only the sensitivity but also the shape of the characteristic satisfy reasonable requirements.

In the use by the layman, simplicity of operation is important. If it is assumed that as amplifier for the microphone currents to be supplied to the recorder a radio set will be used, then in connection with the available power, the resonance frequency of the armature may lie at about 6 000 c/s. The recording instrument has been constructed with this in view. In cutting into the record an extra resistance due to the resistance of the material of the record is added to that of the armature so that the resonance frequency in practice lies about 10 per cent higher. In order to make the frequency characteristic flat as long as possible, up to very close to the resonance frequency, copper cores

³⁾ This is because of considerations given in the article by Vermeulen, quoted in footnote 2, on p. 108.

have been introduced into the armature coils. The eddy current loss resistance hereby caused increases with ω^2 and begins to be appreciable just at those frequencies where the amplitude would begin to increase gradually due to resonance.

In this way a frequency characteristic is obtained which is flat in the region from 60 to 4 500 c/s. In *fig. 6* (curve I) the velocity amplitude ω_a at constant voltage obtained during cutting is given as a function of the frequency $\nu = \omega/2\pi$. As may be seen the deviations from the flat curve are smaller than 2 dB in the frequency region mentioned, and this deviation is still imperceptible for the ear.

If there is no objection to the use of an extra amplifier so that more power is available, the resonance frequency may be made higher. This is desirable for scientific investigation, for example, where very high requirements are made on the quality of reproduction. For this purpose a sound recorder is constructed with a resonance frequency of 8 500 c/s. Since according to equation (3) ω_0 increases with increasing stiffness c of the clamping point of the armature, the higher value of ω_0 is obtained simply by making the torsion rods T (*fig. 3*) somewhat higher. The frequency characteristic of this recorder is given in *fig. 6* as curve II; it is flat between 50 and 6 500 c/s. Since the deflection of the armature according to equation (4) is proportional to $1/\omega_0^2$, in this case twice as high a current through the armature coils is necessary for the same deflection as was the case with the first recorder described.

Fig. 7 gives the amplitude of the armature as a function of the current in the coils. The curve was recorded at 200 c/s, since in the region of low frequencies there is the greatest chance of non-linear distortion. The largest amplitudes occur in this region. It may be seen from the figure that the amplitude varies with the current according to a practically linear relation.

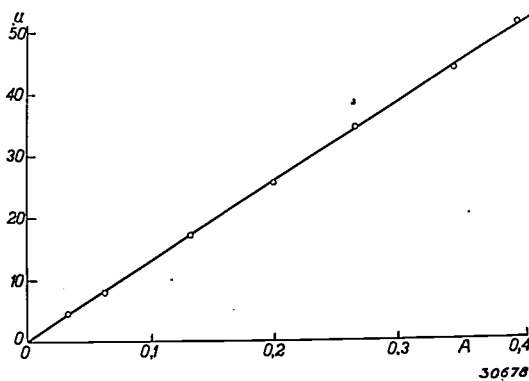

Fig. 7. Amplitude of the armature of the recorder as a function of the current in the armature coils, recorded at 200 c/s. The relation is fairly approximately linear.

The operation of the recorder

As already stated, it was assumed that a radio set would be used as amplifier. Receiving sets with

a triode or an inverse feed-back pentode as end valve (the Philips sets of recent years belong to this category) give an output voltage independent of the frequency such as is required for the instrument. The impedance of the recorder (5 ohms at 1000 c/s) is so chosen that it can be connected directly to the extra loudspeaker terminals of the Philips sets. The necessary energy is about 0.6 W, which can be supplied by a good set with less than 5 per cent distortion.

The microphone which picks up the sound to be recorded is connected to the terminals of the radio set intended for connection to a pick-up. *Fig. 8* shows the complete arrangement. The voltmeter, which may be seen next to the recorder, is connected in parallel and serves for controlling whether or not the permissible amplitude (about 50 μ) is exceeded. There is a mark on the scale indicating the greatest permissible deflection. The instrument reacts quickly enough to indicate the peaks in the sound which might just become dangerous.

Ordinary gramophone records are always recorded at low frequencies with constant amplitude (instead of an amplitude increasing with $1/\omega$) in order not to reach very great amplitudes, and thus make a large distance between the grooves necessary. Ordinary pick-ups are therefore adapted to this variation of the amplitude with the frequency, and in cutting records with our instrument this must be taken into account: if the cutting were carried out with constant velocity amplitude everywhere, then in the reproduction with ordinary pick-ups too many low tones would be obtained. With this in mind it is advisable to set the speech-music switch of the receiving set being used as amplifier in the "speech" position. The output voltage for the low frequencies below about 300 c/s is hereby decreased.

The ordinary kinds of cutters and blank records found on the market are suitable. With steel cutters two records can generally be made (thus both sides of one disc). Sapphire cutters are worn out only after 20 to 30 recordings⁴⁾. The records are usually made of glass on which a thin layer of wax or gelatine is deposited. The cutter is so designed that it can overcome the resistance of the softest material by its own weight. With harder materials it must be weighted by the addition of small weights.

The life of the finished records, like that of ordinary gramophone records, depends very much

⁴⁾ Diamond cutters are also used which last longer but are expensive and quite brittle.

upon how they are played. If a good electric pick-up is used which is light and in which the needle can be moved by very small forces, wax or gelatine can be played about 100 times. When a mechanical pick-up is used, such as that of a portable gramophone, the records wear out more

rapidly because of the required greater forces on the needle; the life of the record is then limited to being played about 30 times. Because of the greater forces necessary with the mechanical pick-up a stronger motor is also necessary for reasonably satisfactory reproduction.

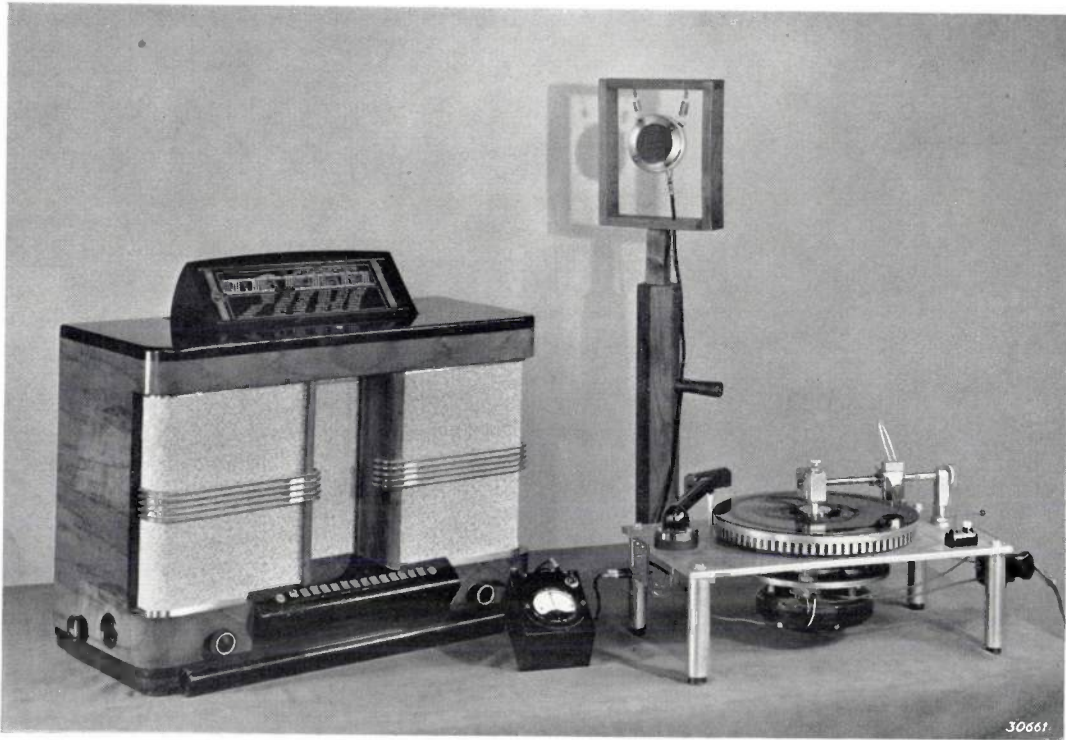

Fig. 8. Complete set-up for sound recording. From left to right: radio receiving set serving as amplifier, voltmeter for controlling the amplitude, recorder with turntable. The carbon microphone stands in the background.

SEVERAL PROBLEMS OF X-RAY FLUOROSCOPY

by B. van DIJK.

621.386.8

Several problems are dealt with in this article which are connected with the protection against X-rays and the visibility in the X-ray picture of certain abnormalities to be detected. Both problems were encountered in the examination by X-ray fluoroscopy of large numbers of persons as carried out regularly in the Philips concern for the detection of cases of tuberculosis, but they may also be important in other connections. Special attention is paid to the methods of investigation developed for estimating the security against the rays and the resolution of the fluoroimage, while in conclusion a number of results of the investigation are given.

When in 1932 a systematic X-ray examination of the personnel of the Philips factories was begun for the purpose of early detection of cases of tuberculosis¹⁾ various problems were encountered which were important enough to warrant further study. Two of these problems, which are also important in other applications of X-rays, will be discussed briefly, namely first the question of how it is possible to protect persons who work daily with X-rays against the harmful effects of the rays, and second the question of the size and shape of abnormalities (of the sort to be detected) which can be observed in the X-ray image which is always of quite low intensity.

Both questions are very complex. The measures for protection against X-rays will be quite different in the case of a doctor, for instance, from those necessary in the case of the personnel in a factory making X-ray tubes. As to the second question, the visibility of an abnormality will depend in the first place on its size and shape and on the difference in absorption of X-rays between the abnormality and the healthy tissue. But in addition the position of the abnormality in the body is very important, because it makes certain requirements as to hardness of the X-rays which must be used in order to penetrate the body at the point where the abnormality is situated.

We shall not attempt to reach any general conclusions on the problems mentioned, but shall deal mainly with the methods which have been developed for the investigation of these problems.

Protection against X-rays

Absolute protection against X-rays is impossible because every material transmits a certain percentage of X-rays. On the other hand it has been found from experience that a person can endure a certain amount of X-radiation without harm. This amount, the so-called tolerance dose, depends

upon the intervals between exposures. The problem is to protect the doctor to such an extent that the amount of X-rays to which he is exposed remains below the tolerance dose. Since the tuberculosis examination in the Philips concern usually amounts to the carrying out of 50 to 60 fluoroimage examinations per day by the same examiner, it was necessary to find out whether this could be continued without harmful results. Although the examiner is protected from the direct rays outside the effective beam of radiation by the metal container of the tube, and from the direct rays in the effective beam as well as most of the secondary rays by the lead glass of the screen and in addition by a shield of lead rubber, there was a possibility that secondary rays might strike parts of the examiner's body, and when a large number of examinations were carried out these secondary rays might exceed the tolerance dose.

In order to measure the undesired X-radiation, use was made of the fact that the blackening of an irradiated film with a given method of developing is a measure of the size of the dose of X-radiation. The blackening caused by a given dose of X-rays is also dependent on the hardness; a film is blackened more intensely by soft X-rays than by the same dose of hard rays. Since the secondary rays which occur in fluoroscopy are always soft the photographic method is very sensitive in this case.

For our purpose it was particularly important to measure the dose of rays on the most exposed parts of the body of the examiner, namely the hands. Several strips of film in light-proof wrappings were fastened to a pair of thin cotton gloves, and the blackening of this film was determined after 200 to 300 fluoroimage examinations. In different series of tests and with different doctors this was found to amount to an average of 0.02 to 0.03 r²⁾. The

¹⁾ See J. G. A. van Weel, Philips techn. Rev. 1, 339, 1936.

²⁾ The object irradiated has received the unit of dosage of X-radiation, 1 r, when a quantity of energy of 100 ergs would have been absorbed by 1 cc of water situated in the position of the object irradiated.

tips of the fingers were found to be the most exposed. From this point toward the hand the exposure decreased.

We may conclude from these results that the tuberculosis examination by the method used is not dangerous for the examining doctor. The daily dose with 60 examinations would, according to the above, amount the 0.006 r, while 0.02 r per day is given as the permissible dose³⁾. This tolerance dose moreover may be considered a minimum value; cases are known in which ten times this dose was tolerated for years without harm.

By means of the method described above, which was worked out by Bouwers and van der Tuuk in this laboratory⁴⁾, after the investigation on the doctors, it was also investigated whether there were persons in certain work-shops of the Philips factories who were exposed to too strong X-radiation during their work. Several remarkable "leaks" were actually found.

In the case of an inspector of X-ray tubes an intense blackening of the photographic film used for the test was obtained in spite of the fact that the tube to be inspected was screened by thick lead plates. The source was found to be another tube which was set up in the same room in such a way that, although the man who was using it was protected, the inspector mentioned previously was exposed to scattered rays. This condition was adequately remedied by means of a lead screen.

A second case was found in a workshop in which condensers were inspected by means of X-ray fluoroscopy. The condenser is placed on a small table and then raised by means of a pedal to a position in front of the window of the X-ray tube, which is working continuously. It was found that during the placing and removing of the condensers the hands were too strongly irradiated. This was remedied by causing the tube to be switched on and off by means of the action of the pedal. This also served to spare the tube.

From these cases it may be seen that a regular check on the dose of rays received daily is to the advantage of the employees of factories and laboratories where X-rays are used.

The observation of small objects in fluoroscopy

In order to reach a correct conclusion about the reliability of X-ray fluoroscopy as a means

of detecting tuberculosis it is necessary to be able to measure the properties of the fluoroscope image on an objective basis. Many differences of opinion which exist in the literature on the utility of fluoroscopy for X-ray examination may certainly be ascribed partly to the fact that one investigator can distinguish much more than another at the brightnesses which prevail in fluoroscopy of the lungs. This in turn may be ascribed to differences in adaptation of the vision at low intensities and of the size of the pupil. It may also be ascribed partly to the apparatus used. For an objective judgement of the quality of the fluoroscope image a method has been developed by Burger and van Dijk⁵⁾ which we shall now discuss. Since the tuberculosis examination in the Philips factories formed the stimulus for this investigation, especial efforts were made to imitate the conditions which prevail in the fluoroscopy of the organs of the chest.

An attempt was made to construct a body by means of nine "Philite" plates $0.8 \times 20 \times 20$ cm which corresponded, not only as to absorption but also as to secondary X-radiation, as far as possible with the human thorax. Contrasting objects also made of "Philite" were then glued to one of the plates. These objects differed in size, shape and thickness (and therefore in contrast) and the conditions were studied under which the objects could be recognized on the X-ray screen. The arrangement is shown in *fig. 1*.

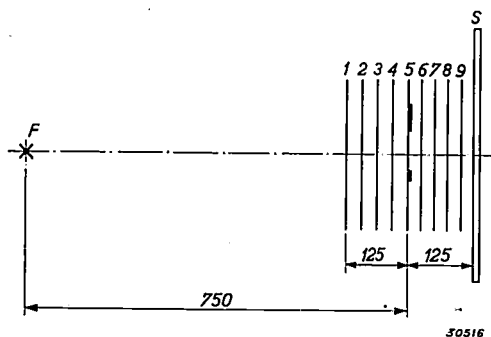

Fig. 1. Arrangement corresponding to the human thorax with respect to absorption and scattering of X-rays. 1-4 and 6-9: "Philite" plates, 5: plate with test objects, S screen, F focus of the X-ray tube. The dimensions are given in mm.

As an example of the results obtained with this arrangement, in *fig. 2* the length which the side of a square of "Philite" must have in order to be just visible is plotted as a function of its thick-

³⁾ A. Mutscheller, Amer. J. Röntgenol. 13, 65, 1925.

⁴⁾ A. Bouwers and J. H. van der Tuuk, Fortschr. Röntgenstr. 41, 767, 1930; see also C. H. J. Kütthc, T. soc. Geneesk., June 1936.

⁵⁾ B. van Dijk, Over de grondslagen en voorwaarden van optimale röntgendoorlichting (The basis of and condition for optimum X-ray fluoroscopy). Diss. Utrecht 1936. G. C. E. Burger and B. van Dijk, Fortschr. Röntgenstr. 54, 492, 1936; 55, 464, 1937; 58, 382, 1938.

ness, *i.e.* as a function of the contrast caused by the square. It is found that under the circumstances given here (voltage on the X-ray tube 54 kilovolts maximum, current 3.5 mA) the object must have a thickness of at least 1.5 mm to be observable. With increasing thickness smaller objects can be observed; the smallest observable test object has a side of about 2 mm.

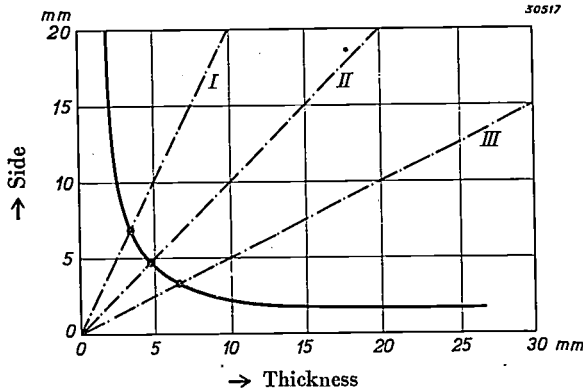

Fig. 2. Side of the smallest visible object as a function of its thickness, with an X-ray tube with a direct voltage of 54 kilovolts maximum and a current of 3.5 mA. On lines I, II and III the ratio of thickness to side is 2, 1 and 0.5 respectively.

The tests were made with contrasting objects of very different kinds: letters cut out of "Philite"; spherical objects and finally round holes in a "Philite" plate, since the latter could most easily be made with great accuracy and in great variety.

By means of such observations it was determined that a sphere with a diameter d is just as easily visible as a cube with the edge $0.8 d$; the same relation exists within the limits of accuracy of the observation between a cylindrical hole and a square object with a height equal to the depth of the hole.

On the basis of this result it was permissible to carry out the observations exclusively with the help of round holes in a "Philite" plate, which meant considerable simplification. As a further simplification it was found possible to combine the "Philite" plates which imitate the absorption and secondary radiation of the thorax to two blocks 3.5 cm thick in front of and behind the test object. In an extension of the tests already described, in which the dependence of the visibility of square objects on their thickness was investigated (fig. 2), the dependence of this visibility on the current was studied. This could be done for the whole curve by determining for each value of the current how the dimensions of the smallest visible object vary as a function of its thickness. This variation, however, proved to be sufficiently clearly characterized by three points of each curve which corre-

spond to definite geometrical shapes of the object.

In fig. 2 there are besides the curve three lines I, II, III. The points which lie on line I indicate objects with a thickness equal to twice the side, thus columnar objects; the objects on line II are cubical (thickness equal to side); the objects on line III are in the form of plates (thickness one half of the side).

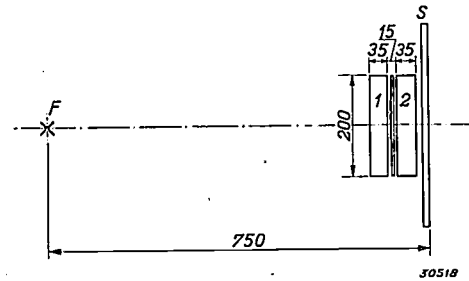

Fig. 3. Simplified arrangement for studying the visibility of the X-ray image. 1 and 2 "Philite" blocks, S screen, F focus of the X-ray tube (dimensions in mm).

In different "Philite" plates 1 to 6 mm in thickness a large number of holes were bored whose visibility in the fluoroscope picture corresponded with those of square objects of the three above-mentioned types:

I. Columns 1 : 1 : 2,

II. Cubes 1 : 1 : 1,

III. Plates 2 : 2 : 1.

The visibility of these objects was now studied as a function of the current. The results are shown in fig. 4 in which the thickness of the smallest visible object of types I, II and III is plotted as a function of the current.

Using these and other results, an attempt was made to gain an idea of the influence exerted by

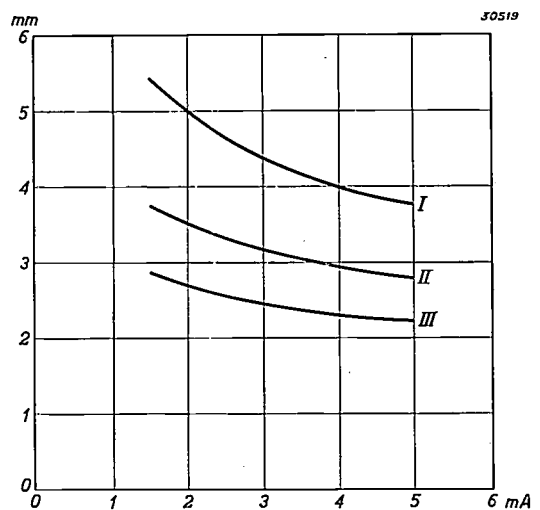

Fig. 4. Thickness of the smallest visible object made of "Philite" as a function of the current.

I: columnar object (1 : 1 : 2);

II: cubical object (1 : 1 : 1);

III: plate-shaped object (2 : 2 : 1).

different factors on the fluoroscope examination. The factors were:

1) *Adaptation and disadaptation*

The test persons were first adapted to a constant brightness and the progress of darkness adaptation was then studied. With the different test persons the time necessary for adaptation to darkness varied between 16 and 24 minutes. (The adaptation was considered complete when a continued stay of 6 to 8 minutes in the dark produced no increase in sensitivity to contrast).

2) *The brightness of the fluoroscope image*

The brightness of the fluoroscope image can be increased within certain limits by:

- a) increasing the current;
- b) raising the voltage;
- c) increasing the light yield of the screen.

a) In tests on the influence of the current strength on the visibility of the fluoroscope image it was found that the current must be at least 2 mA in order to obtain a sufficiently visible image at a voltage of 54 kilovolts. If the quality of the image is considered to be inversely proportional to the size of a cubical object which is just visible, it is found that from 1 to 2 mA the quality increases by 50 per cent, from 2 to 3 mA by 14 per cent, from 3 to 4 mA by 9 per cent, from 4 to 5 mA and from 5 to 6 mA by 6 per cent. The quality of the image thus improves steadily with increasing current, but the improvement is not proportional.

If the dose of radiation received by the patient is measured under these various circumstances, it is found that, as far as danger to the patient is concerned, the permissible limit when the exposure is repeated weekly for several years is already reached at a current of 3 to 4 mA. In the case of a single exposure or repeated exposures at longer intervals a higher current is of course permissible.

b) In the case of an increase in brightness by increasing the voltage, the results, which varied

considerably for different test persons, were less satisfactory than with the same increase in brightness by increasing the current. Upon an increase in voltage the ratios of brightnesses are usually decreased in the fluoroscope image just as in an X-ray photograph, so that the visibility is unfavourably affected. Nevertheless considerable improvement of the image can be obtained by increasing the voltage, since the brightness itself increases very sharply with increasing voltage.

c) As to the yield of light of the screen: the screen which has the greatest brightness with a given X-radiation gives the best results at the usual current and voltage.

3) *The angle of vision in the observation of an object in the fluoroscope image*

In general it may be expected that a small object which causes a certain contrast will be more easily recognizable the greater the angle of vision at which it is observed. For this reason the distance from which the screen is observed was kept as small as possible in connection with the accommodation of the eye, namely 16 cm.

Attempts were made to increase the angle of vision still more by examining the image with a magnifying glass or moving the object in the direction of the focus. In both cases the result was that with sufficient contrast in the fluoroscope image an improvement could be attained; with low contrast, however, the result was a decrease in the visibility. The cause of this decrease lies in a decrease in sharpness. The transition between bright and dark becomes less sharp with increasing enlargement, and therefore, in the case of low contrasts, less easily observable.

The influence of the sharpness of the image on the visibility was also investigated separately by comparing the images obtained with foci of different sizes. It was found that an X-ray tube with a focus of 1.4 mm gives about 25 per cent better pictures than a tube with a focus of 3.8 mm.

THE TESTING OF ELECTRIC FUSES WITH THE CATHODE RAY OSCILLOGRAPH

by J. A. M. van LIEMPT and J. A. de VRIEND.

The testing of electric fuses consists of determining their melting time as a function of the short circuit current. This measurement can be carried out very easily with the help of a cathode ray oscillograph. The measuring arrangement for this purpose is described. Melting time and short circuit current can be read off from a single oscillogram.

The melting time of electric fuses

It is important to know the time necessary for the melting through of fuses upon the occurrence of a short circuit. This time must be short enough to prevent damage to the apparatus or in the lines in series with the fuse before the fuse has melted. This is particularly so in the case of branches of a network which is protected by a main fuse when each branch contains an auxiliary fuse. The auxiliary fuse then serves to protect the main fuse, so that upon short circuit occurring in one branch of the network the other branches remain undisturbed. An example of this is the separate protection of certain pieces of apparatus, such as electric lamps, in order to prevent the melting of the main household fuse.

It is clear that the melting time t_s of a fuse will depend upon the short circuit current I_k . If t_s is sufficiently short to permit one to neglect the dissipation of the heat developed — this condition is satisfied when I_k is several times the limiting current, *i.e.* the maximum current which the fuses can carry for unlimited time — then the formula derived by G. J. Meyer¹⁾ holds for fuses which are initially at room temperature:

$$t_s = C \left(\frac{q}{I_k} \right)^2 \dots \dots \dots (1)$$

In this formula q is the diameter of the fuse wire and C the so-called absolute inertia constant which is characteristic of the material of the wire. By means of this formula the dimensions of a fuse for a given purpose may be determined. *Table I* gives the value of the constant C for a number of materials, which must be known for the determination.

If it is desired to test the usefulness of the formula for fuses of a given type, or to determine the constant C for a given material, t_s , I_k and q must be measured. For a given type of fuse q is constant. The problem is then the determination of corresponding values of I_k and t_s at which the

Absolute inertia constant C for several materials.

Material	$10^{-6} C$ (A ² sec/cm ⁴)
Copper	1000
Silver	720
Platinum	235
Monel	150
Constantan	135
Kruppin	80
Tin	45
Lead	40

product $I_k^2 t_s$ must theoretically be constant. $I_k^2 t_s$ is called the relative inertia constant. For ordinary household fuses of 15 and 6 A it has a value of about 200 and 40 A² sec. respectively. With a short circuit current of 50 A, for instance, the melting of the 15 A fuse therefore takes place within about 1/10 sec, the melting of the 6 A fuse in about 1/50 sec.

Particularly in the case of thin fuses and (or) heavy currents the melting times may thus be very short. Since the measuring instrument to be used must have a sufficiently small inertia, the cathode ray oscillograph is particularly suitable. We shall give a brief description of the measurements²⁾.

Measuring arrangement

By recording the current I at the moment of melting of the fuse as a function of the time t with the aid of the cathode ray oscillograph, I_k and t_s can be determined from the same oscillogram.

The diagram of the circuit of the measuring arrangement is given in *fig. 1*. The auxiliary or main fuse to be tested is introduced at Z . The short circuit current through the fuse causes a drop in voltage over the resistance R_1 . This voltage is applied to the plates for vertical deflection of the cathode ray (terminals 5 and 7 of the Philips oscillograph GM 3 152; the amplifier of the oscillo-

¹⁾ G. J. Meyer, *Zur Theorie der Abschmelzsicherungen*, Verlag R. Oldenburg, München u. Berlin 1906, p. 36, and further: *Elektrische Kraftbetriebe und Bahnen*, 1911, Heft 7.

²⁾ For a more detailed treatment see J. A. M. van Liempt and J. A. de Vriend, *Z. Physik* 93, 100, 1934: 98, 133, 1935. A theoretical calculation of the limiting current is given in: J. A. M. van Liempt, *Z. Physik* 86, 387, 1933.

graph is disconnected). The short circuit current is supplied by a source of direct current introduced at E , and can be adjusted by means of the variable resistance R_2 . The switching on of the short circuit current takes place by means of the relay r_3 supplied from the light mains. The resistances R_1 and R_2 are wound to be free of induction, in order to load the fuse immediately with the full current.

In order to make the current visible as a function of the time on the fluorescent screen O of the cathode ray tube, the light spot must be given a horizontal deflection proportional to the time.

discharge and at the same time the time scale of the oscillogram can be varied. By means of the potentiometer P an adjustable positive bias is given to plate 1 with respect to plate 2. The initial deflection of the light spot so obtained makes the full width of the screen available for the measurement.

A camera is placed in front of the screen of the oscillograph. The release of the shutter is coupled with the push-button S by means of a simple synchronizer such as is used by photographers for making flashlight photographs. The measure-

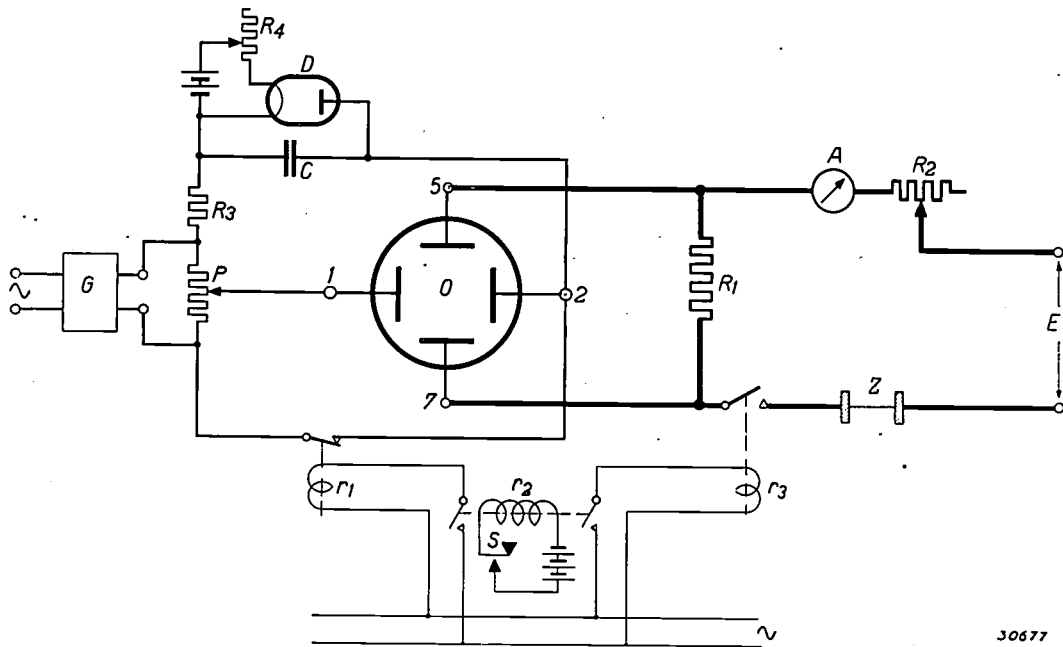

30677

Fig. 1. Circuit for the measurement of the melting time of fuses as a function of the short circuit current. The part of the circuit drawn with heavy lines is for the purpose of obtaining a voltage proportional to the short circuit current on the plates for vertical deflection of the cathode ray oscillograph O . The source of short circuit current is introduced at E , and at Z the fuse to be tested. R_1 and R_2 are constant and adjustable resistance respectively, A ammeter, 5 and 7 terminals of the oscillograph GM 3 152. — A horizontal deflection of the light spot proportional to the time is brought about by the left-hand part of the circuit. G rectifier, C condenser, D diode with variable heating current (adjustable resistance R_4). The constant resistance R_3 serves to limit the charging current. P potentiometer, 1 and 2 terminals of the oscillograph — Upon pressing the button S the two heavy current relays r_1 and r_3 are brought into action via the low current relay r_2 . These relays serve to switch on the time deflection and the short circuit current through the fuse.

For this purpose the plates for horizontal deflection (terminals 1 and 2 of type GM 3 152; the time base of the oscillograph itself is of course disconnected) are connected to a condenser which in the equilibrium state is charged by the rectifier G connected to the mains. When the charging circuit is interrupted by the setting in action of the relay r_1 , the condenser is discharged at a constant speed over the diode D , and the voltage between the deflection plates 1 and 2 falls proportionally with the time. By regulation of the heating current of the diode (resistance R_4) the rate of

ment is made by pressing this button. The low current relay r_2 is hereby put in connection at the same time that the shutter of the camera is opened; this relay in turn switches in the relays r_1 and r_3 . The relays are so adjusted that r_1 begins to work somewhat sooner than r_3 . Thus immediately after the light spot on the screen has begun its horizontal motion the short circuit current begins to flow through the fuse and the current-time diagram is traced on the screen. The shutter of the camera may be set at $1/2$ sec. for example.

In order to calibrate the scale of the current

another similar oscillogram is made on the plate in which the fuse is replaced by a strip of copper. The height of the line now traced on the screen corresponds to the current read off on the ammeter *A*. In order to calibrate the time scale a low auxiliary voltage from the mains is applied *via* a commutator to the terminals 5 and 7 of the oscillograph with the same adjustment of R_4 . The period of the sine curve traced (1/50 sec with a mains frequency of 50 c/s) is a measure of the time.

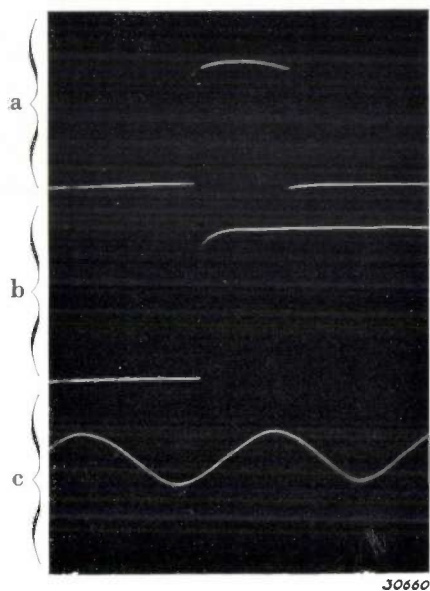

Fig. 2. a) Oscillogram showing the short circuit current as a function of the time, recorded with direct current.
b) Calibration of the current.
c) Calibration of the time.

In *fig. 2* an oscillogram recorded in this way is given of the melting through of a fuse together with the two corresponding oscillograms for the calibration.

Measurement with alternating current

The required heavy short circuit currents for the above-described measurements can be much more easily obtained with alternating current by means of a transformer than with direct current. The measurements are therefore usually carried out in practice with alternating current. In that case, however, formula (1) for direct current may not be applied directly. Instead of the relative inertia constant $I_k^2 t_s$ the following integral is used:

$$\int_0^{t_s} I^2 dt$$

From the oscillogram which gives I as a function of t the value of the integral can be found by means of a simple formula, or it may for instance be determined directly with the help of a planimeter. In two cases the working out of the oscillogram is still simpler, namely:

- a) when the melting time is large with respect to the period of the alternating current; formula (1) can then again be applied, provided that the effective value of the alternating current is taken for I_k .
- b) when the melting time is so short that the alternating voltage may be considered constant within this time; this can practically only be the case when the moment of switching on, which is not directly under control, lies in the neighbourhood of a top of the sine curve (the peak value of the alternating current must then be used for I_k).

The calibration is simplified somewhat in the measurement with alternating current, due to the fact that for the calibration of the time no separate oscillogram is necessary, but the time scale can be read off immediately from the oscillogram for the calibration of the current.

Philips Technical Review

DEALING WITH TECHNICAL PROBLEMS
RELATING TO THE PRODUCTS, PROCESSES AND INVESTIGATIONS OF
N.V. PHILIPS' GLOEILAMPENFABRIEKEN

EDITED BY THE RESEARCH LABORATORY OF N.V. PHILIPS' GLOEILAMPENFABRIEKEN, EINDHOVEN, HOLLAND

AIR-COOLED TRANSMITTING VALVES

by M. van de BEEK.

621.396.615.16.032.42

In transmitting valves with an anode dissipation of more than about 1 kW it is necessary to cool the anode. In the range between 1 and 10 kW air cooling can be used with advantage. While it is true that it is less effective than water cooling, which must be used for higher powers, it nevertheless has the advantage of entailing fewer structural difficulties in connection with the high potential of the anode. In this article the data are discussed which are necessary for the calculation of the functioning of an aircooled radiator; as a practical application of this a discussion is given of the cooler which was developed in order to replace the water cooling of the transmitting valve PA 12/15 by air cooling. (A similar system for other transmitting valves has not yet been worked out).

Introduction

A transmitting valve has the task of converting direct current energy into high-frequency alternating current energy. The technology of transmitting valves has developed along the line of generating greater and greater powers by means of a single transmitting valve. Since the conversion of direct current energy into alternating current energy is always accompanied by a loss of a few per cent¹⁾, a considerable amount of energy is lost in the valve itself, and chiefly in the form of heat at the anode. A smaller amount of heat is developed by the filament and by the grids.

In the original construction of transmitting valves in which the electrode system was placed in a glass bulb, almost all of the heat developed by the anode had to be dissipated in the form of radiation. For a given temperature of the anode the heat radiated is proportional to the surface.

A limit is set to the enlargement of the radiating surface, on the one hand by the dimensions of the glass bulb, which in a practical case cannot exceed a certain value, and on the other hand by the requirements of transmission technology which seeks a compact arrangement of all parts. For short waves it is quite impossible to use transmitting valves of large dimensions because the efficiency of an oscil-

lator falls rapidly when the dimensions of the transmitting valves are greater than for instance several per cent of the wave length.

The practical limit for transmitting valves which must dissipate by radiation the heat developed lies at a total dissipation of about 1250 W. This may, for example, consist of an anode dissipation of 1000 W and a filament dissipation of 250 W. If the dissipation of the screen grid must also be taken into account the permissible anode dissipation is even lower than 1000 W.

For very high powers the entirely glass transmitting valve has been superseded by one in which the anode is constructed in the form of a metal can closed by a glass top into which the fastenings and the leads of the other electrodes are sealed. In this construction (see Philips Techn. Rev. 2, 264, 1937) the anode can be cooled with water so that the power developed can be increased about 20 times with the same size of valve.

The application of water cooling is not, however, always possible, since in many places (on board ship, in high arid regions, etc) the necessary amount of cooling water is not available. Furthermore water cooling is accompanied by various complications, due to the fact that the anode is at a high potential while the cooling-water comes out of the mains at earth potential. A greater potential gradient along the cooling-water line than about 1 kV/m is not permissible, and since with large

¹⁾ The efficiency of a transmitting valve may amount to from 30 to 80 per cent according to the adjustment; see in this connection J. P. Heyboer, Five-electrode transmitting valves, Philips techn. Rev. 2, 257, 1937.

transmitting valves anode potentials of up to 20 kV are used, the water must be conducted to the valve through long rubber tubes. In connection with these complications the use of water cooling is justified only when very high powers must be generated with a single valve; the smallest water-cooled Philips transmitting valve (type TA 10/5 000) is constructed for a total dissipation of 8 000 W.

For powers between 1 250 and 8 000 W, where neither of the methods of cooling discussed until now is entirely satisfactory, a useful intermediate system is that of forced air cooling. While it is true that the transfer of heat between metal and air is less rapid than from metal to water, it is on the other hand also true that an installation for air cooling is considerably simpler and cheaper than a water-cooling installation, and at the same time it requires less maintenance.

In this article we shall calculate the cooling effect of a current of air, and then give a description of an actual installation for forced air cooling of a transmitting valve.

Dissipation of heat by air cooling

In the cooling systems dealt with in this article, currents of air are used which have a high velocity but a relatively small excess pressure (not more than 1 per cent of the pressure of the outside atmosphere). We may therefore assume that the heating takes place at constant pressure and that we are concerned with the specific heat at constant pressure, which amounts practically to 1 kilojoule/kg²).

If we wish to dissipate a power of p kW by means of an air current of q kg/min, then the following relation holds for the increase of temperature of the air $t_2 - t_1 = \Delta t$:

$$q \cdot \Delta t = 60 p$$

and thus

$$q = \frac{60 p}{\Delta t} \dots \dots \dots (1)$$

In *fig. 1a* the relation between the electrical energy to be dissipated p and the weight of air q necessary per minute is plotted for different values of Δt . In order to calculate the volume of air to be used, its weight must be divided by the specific weight γ of air at the temperature t_1 at which it is admitted. The relation between weight and volume for a pressure of 76 cm Hg is given in *fig. 1b* and can also easily be calculated by means of the table below.

²) The specific heat of air is $C_p = 0.241$ kg.cal/kg, while 1 kilojoule = 0.239 kg. cal.

$t_1 =$	0°	10°	20°	30°	40°
$\gamma =$	1.28	1.24	1.20	1.16	1.12 kg/cu.m.

From *figs. 1a* and *b* we may now read off directly how many cubic metres of air are needed per minute to dissipate a given amount of energy at a given admission temperature of the air and with a given temperature increase of the air.

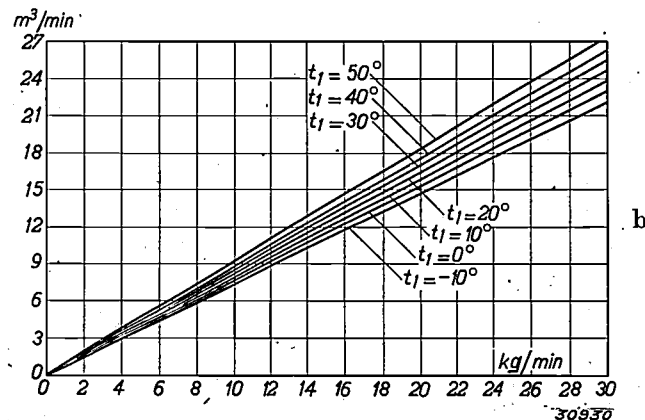
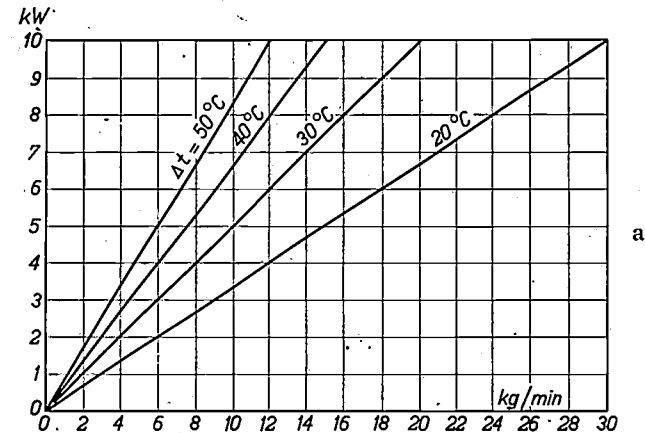

Fig. 1. a) The energy (kW) dissipated by a cooling current of air as a function of the quantity of air (kg/min) with different increases of temperature Δt of the air in the cooler.
b) Relation between volume (cu.m) and weight (kg) of air at different temperatures (°C).

Heat transfer from metal to air

When air of a certain temperature passes over a metal surface with a higher temperature, a certain transfer of heat will take place from the metal to the air. Since heat dissipation by radiation plays no part at the temperatures in question, we are only concerned with heat conduction by the air.

This transfer of heat, taken per unit of time, is proportional to the difference in temperature and to the size of the surface of contact. At the same time the heat transfer must also depend upon the nature of the contact, whereby the condition of the surface and the velocity of the air

along the surface are important factors. The influence of these last two factors is generally taken into account by an empirical coefficient of heat transfer α .

In this way we arrive at the following expression for the total heat transfer per unit of time:

$$p = a F (t - \delta), \dots \dots (2)$$

- where α = coefficient of heat transfer (see later),
- F = surface of contact of the air,
- t = temperature of the metal surface,
- δ = average temperature of the air
($\delta = t_1 + \frac{1}{2} \Delta t$).

It must be pointed out that this expression holds only for a state of equilibrium in which the temperatures are constant and the heat dissipated corresponds to the dissipation p of the transmitting valve.

When it is taken into account that according to equation (1)

$$\delta = t_1 + \frac{1}{2} \Delta t = t_1 + \frac{1}{2} 60 p/q,$$

δ can be eliminated from equation (2) and one obtains:

$$p (1 + 30 a F/q) = a F (t - t_1) \dots (3)$$

For a given cooler, through which a known amount of air of a given initial temperature is conducted, equation (3) indicates the maximum amount of energy which can be dissipated, if the outer wall of the anode may not exceed a certain temperature t .

We shall now consider in more detail the coefficient of heat transfer α . As was stated above, α depends upon the nature of the surface of contact and the speed at which the air passes over the surface. The following values of α are given in the

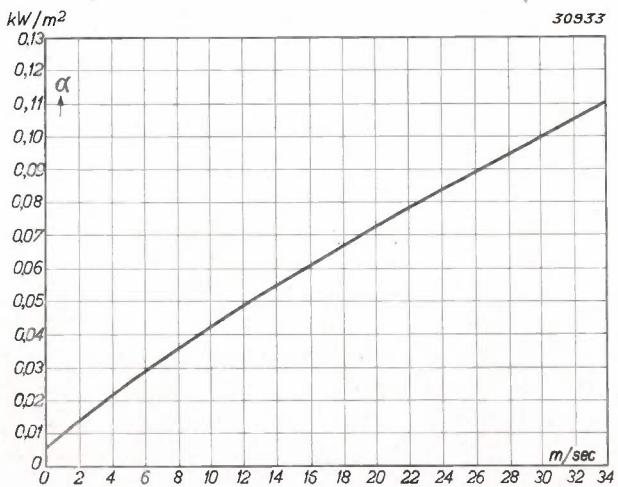

Fig. 2. Coefficient of heat transfer in kW/sq.m from a plate with rolled surface to air, as a function of the velocity of the air.

³⁾ H. Gröber, Einführung in die Lehre der Wärmeübertragung 1920, see also Hütte, vol. 1, p. 457, 1925. The values of α are given by Gröber in kg. cal/sq.m. hr, but have here been recalculated to watt/sq.m (1 W/sq.m = 0.86 kg. cal/sq. m. hr.)



Fig. 3. The transmitting valve PA 12/15 surrounded by a cooler through which a current of air is sent from bottom to top.

literature for different values of the velocity w of the air:

Nature of the surface	$w < 5$ m/sec	$w > 5$ m/sec
Polished	5.58 + 3.88 W (watts/m ²)	7.12 $w^{0.78}$ (watts/m ²)
Rolled	5.82 + 3.83 W (")	7.14 $w^{0.78}$ (")
Roughened	6.17 + 3.80 W (")	7.17 $w^{0.78}$ (")

From the above values it may be seen that the

nature of the surface for velocities greater than 5 m/sec has only a very slight effect on the capacity of dissipation. In *fig. 2* the coefficient α is plotted for a rolled surface as a function of the velocity of air w .

Calculation of a practical example

On the basis of the foregoing discussion we shall now calculate how much energy can be dissipated from a Philips transmitting valve with air cooling such as is shown in *fig. 3*. The valve is the transmitting valve PA 12/15⁴⁾, which is ordinarily cooled with water, and which in that case can dissipate 12 kW. The surrounding cylinder for water cooling is now, however, replaced by a radiator with cooling fins for forced air cooling. This cooler is shown separately in *fig. 4*.

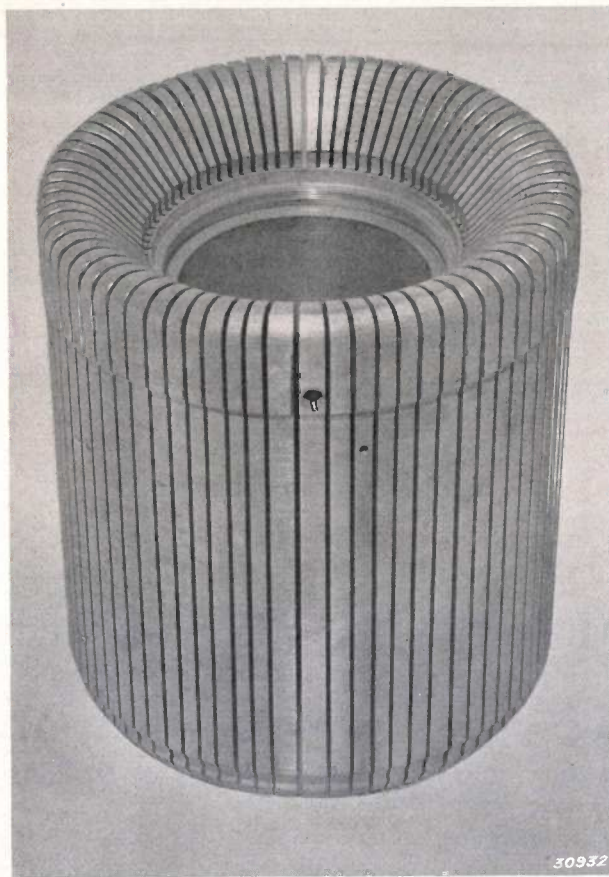

Fig. 4. Ribbed construction of the radiator.

Figs. 3 and 4 show clearly the construction of the whole. The cooling air is conducted upwards from below through the slot of the cooler and flows freely out at the top. It hereby passes over the glass

top through which the connections of the cathodes and grids are lead out.

This is a point which illustrates clearly the advantage of air cooling. The glass bulb of a transmitting valve is heated by high frequency fields which cause dielectric losses in the glass, especially on short waves. The softening point of the glass may even be reached due to this cause. Furthermore on short waves a heating up of the connections occurs due to the high capacitive currents which are a consequence of the capacities between the electrodes. Too great a difference in temperature between the connecting wires and the glass would lead to rupture of the joint between metal and glass. One or the other of these facts often sets a limit to the shortness of the waves on which a given transmitting valve can be used; in order to reach shorter waves it would be necessary to introduce special cooling for the sealing-in spots, which would present great technical difficulties because of the fact that the sealing-in spots are at a different potential than the anode.

In air cooling, on the other hand, no separate cooling is necessary because the air flowing out freely still has sufficient cooling action. The cooling is of course much less intense than that by a radiator, and the temperature of the sealing-in spots will be somewhat higher than the temperature of the escaping air.

The radiator consists of 76 ribs, between which are slits for the stream of air. Each slot is 2 mm wide, 47.5 mm deep and 220 mm long. The cross section area of the slot is thus 0.95 sq.cm and the total cross section for the air current is $76 \times 0.95 = 72$ sq.cm.

A current of air of 14 cu.m/min. is now sent through this cooler. The average velocity of the air is then $\frac{14}{60 \times 0.0072} = 32.4$ m/sec. Because of this high air velocity we are certainly concerned with turbulent and not with laminary air flow. It may therefore be assumed that the air also flows along the walls of the cooler with this velocity (while with laminary flow the velocity would decrease gradually toward the wall). From *fig. 2* we find for an air velocity of 32.4 m/sec a corresponding value $\alpha = 0.107$ kW/sq.m. The wall surface of the cooler is 210 sq.cm. per slot, thus in all $F = 76.210$ sq. cm = 1.6 sq.m. If we now assume a temperature of the air $t_1 = 20^\circ\text{C}$, the specific weight of the air is 1.2 kg/cu.m and the weight of the air used is thus $14 \times 1.2 = 16.8$ kg/min. If moreover we let the permissible temperature of the cooler t equal 106°C , then we can determine the maximum energy to be dissipated according to equation (3):

$$P = \frac{\alpha F (t - t_1)}{1 + 30 \alpha F/q}$$

With the following numerical values of the quantities:

⁴⁾ This transmitting valve has been mentioned repeatedly in Philips techn. Rev. and is shown in vol. 2, page 264, 1937.

$$\begin{aligned} a &= 0.107 \text{ kW/sq.m } ^\circ\text{C}, \\ F &= 1.6 \text{ sq.m.}, \\ t_1 &= 20^\circ\text{C}, \\ t &= 106^\circ\text{C}, \\ q &= 16.8 \text{ kg./min.}, \end{aligned}$$

$$\text{we calculate } p = \frac{14.7}{1.306} = 11.25 \text{ kW.}$$

From equation (1) we calculate the increase in the air temperature and find

$$\Delta t = \frac{60 p}{q} = \frac{60 \cdot 11.2}{16.8} = 40^\circ\text{C.}$$

and therefore $t_2 = t_1 + \Delta t = 60^\circ\text{C.}$

"Internal" temperature loss

Until now the calculations have been carried out as if the metal part of the cooler were at a uniform temperature. Actually the temperature at the outer circumference of the cooler is lower at the base of the ribs because the conduction of heat by the ribs is toward the outside. Moreover, there is also a certain temperature decrease from the inside of the anode toward the base of the ribs, *i.e.* in the anode itself, in the connection anode-cooler and in the inner cylinder of the cooler.

If we nevertheless wish to apply equation (3), t must be considered as an average temperature of the surface of the radiator; t must therefore be chosen lower than the maximum temperature permissible on the inner wall of the anode. The internal fall of temperature increases with the energy dissipated. This decreases still further the dissipation permissible, and even with the most intense cooling it could not exceed a definite limit. By using a material for the cooler which conducts heat well, the internal fall of temperature can, however, be kept quite low. In the construction here chosen the heat current flows through a cross section of 670 sq.cm on an average. The length of the lines of flow is 3 cm on an average, while the heat conduction in this way for a temperature gradient of 1°C/m is 110 kg.cal. per sq.m. per hr. If these values are used it is found that the temperature drop from the inner wall of the anode to half-way to the extremities of the cooling fins is not more than 3.5°C per kW. If we let the temperature of the anode be T , the average temperature of the cooler is

$$t = T - 3.5 p$$

and by filling in this value of t in equation (3) we obtain

$$p (1 + 30 a F/q + 3.5 a F) = a F (T - t_1). \quad (4)$$

With the help of this equation it is possible to calculate the maximum energy p to be dissipated as a function of the current of air q and the temperature of admission t_1 , as has already been done above by means of equation (3). It is, however, no longer necessary to make a quite arbitrary assumption about the maximum permissible temperature t halfway to the extremities of the fins, but a limit may be indicated for the temperature T at the inner side of the anode whose permissible value can be better estimated, because it is actually the anode temperature to which a limit must be set. If the value 145°C is chosen for this, which is on the safe side, then at $t_1 = 20^\circ\text{C}$ and $q = 16.8 \text{ kg./min.}$ a value of t is found equal to 106°C . In this way the permissible value of t used above was derived.

If the same calculation is carried out for a number of other admission temperatures and amounts of air per minute, values are found for the maximum permissible power at an anode temperature of 145°C which can be read off in *fig. 5*.

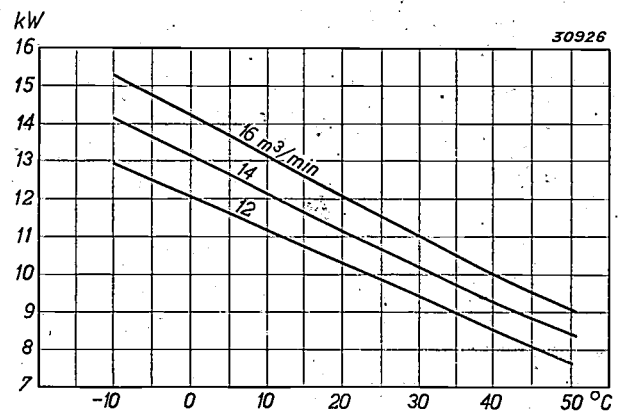

Fig. 5. The energy removed by the cooler of the transmitting valve PA 12/15 as a function of the admission temperature of the air, when the flow of air is 12, 14 and 16 cu.m./min, respectively.

Several points in the construction of the cooling system

The air resistance of the cooler

In order to transfer as much heat as possible to a given amount of air it is desirable to make the surface of contact F for the air as large as possible with a given cross section of the air channel (see equation (2)); it is for this reason that very flat narrow cross sections are the most advantageous. Furthermore, in order to make the coefficient a of heat transfer large, a fairly high air velocity is required. By taking these two points into account, however, a high resistance of the air current is obtained.

In fig. 6 the difference in pressure (mm water), occurring in the cooler is plotted as a function of the velocity of flow (cu.m of air per min). It is found that the excess pressure necessary increases almost with the square of the air velocity which means that the energy necessary for cooling is almost proportional to the third power of the air velocity. With an air current of 14 cu. m/min. an excess pressure of 115 mm water occurs; from this it follows that an energy of 264 watts is supplied to the air current ⁵⁾.

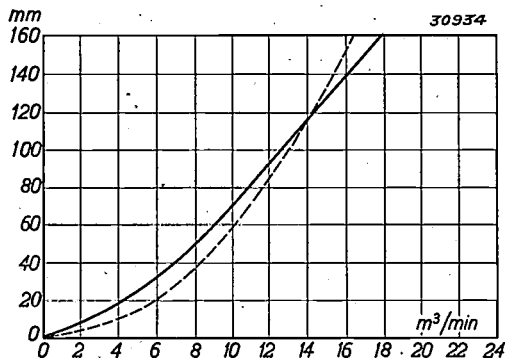

Fig. 6. The difference in pressure (mm of water) which occurs in the slits of the cooler as a function of the magnitude of the air current (cu.m/min). For the sake of comparison a quadratic curve has been indicated by a dotted line.

The fan

The air current is obtained by means of an electrically driven fan. The first requirement made of the fan is that it be able to deliver the desired volume of air at the corresponding pressure. If N is the energy supplied to the air, η_1 the efficiency of the fan and η_2 the efficiency of the electromotor, the necessary electric energy is

$$W = \frac{N}{\eta_1 \cdot \eta_2}$$

The efficiency η_1 of the fan in a suitable size is about 50 per cent, while the electromotor (a three-phase induction motor) may have in this case an efficiency of 90 per cent. With these values of the efficiencies one calculates for an air current of 14 cu.m./min. ($N = 264$ watts), that the motor must be able to deliver an energy W of 528 watts, and takes up 587 watts from the mains for this purpose.

Since several extra losses must be taken into account, such as the pressure loss in the air supply line from the fan to the cooler, it is desirable to use a somewhat stronger motor. In our case a motor of nominally 0.8 h.p. is used, which, when loaded

by the fan to which the cooler is connected, takes up just 600 watts from the mains.

A second requirement made of the combination of fan and cooler is the absence of noise. Two points are important in this connection; in the first place an aerodynamically good construction, in the second place as low a number of revolutions per minute as possible. The number of revolutions may not, however, be too low, because with a given air current the diameter of the fan must increase in the same ratio as the number of revolutions decreases. In our case an asynchronous motor with two pairs of poles was used, which on a main of 50 c/s has nominally a speed of 1 500 r.p.m. and in use about 1 430 r.p.m.

The connection between the fan and the cooler must still be considered. It must be air tight and at the same time possess a high electrical insulation, since the fan is at earth potential while the cooler is under high tension. A double natural silk "tube" about 35 cm long, which can easily withstand a high frequency voltage of about 7 kv_{max} at a frequency of 50 megacycles/sec, proves very satisfactory.

Conclusion: When is it possible to replace water cooling by air cooling?

In order to judge whether the water cooling can be replaced by air cooling in the case of the water-cooled transmitting valve PA 12/15 when used in a certain adjustment, it is only necessary to add the heating current energy, the screen grid dissipation and the anode dissipation. With the help of fig. 5 it can now be read off whether with the admission temperature of the air available this total amount of energy can be dissipated without requiring too high an air velocity. The velocity will not be chosen greater than 35 to 38 m/sec (18 to 20 cu. m/min) because the driving power and the noise increase very strongly with the air velocity.

As for the anode dissipation, one must not calculate with the carrier-wave adjustment but with 100 per cent modulation. In class B arrangement the dissipation with 100 per cent modulation is for instance 10 per cent, and with anode modulation about 50 per cent higher than with the carrier-wave adjustment.

It is also advisable to use a somewhat larger amount of air than is strictly necessary according to the calculations, in order to run no risks during a temporary sudden increase in the temperature of the outside air.

In order to give an idea of the structural simplicity of the whole combination of a transmitter

⁵⁾ The energy supplied is equal to the product of excess pressure (kg/sq.m) and air current (cu.m/sec), thus in our case 26.8 kg.m/sec = 26.8 × 9.81 watts.

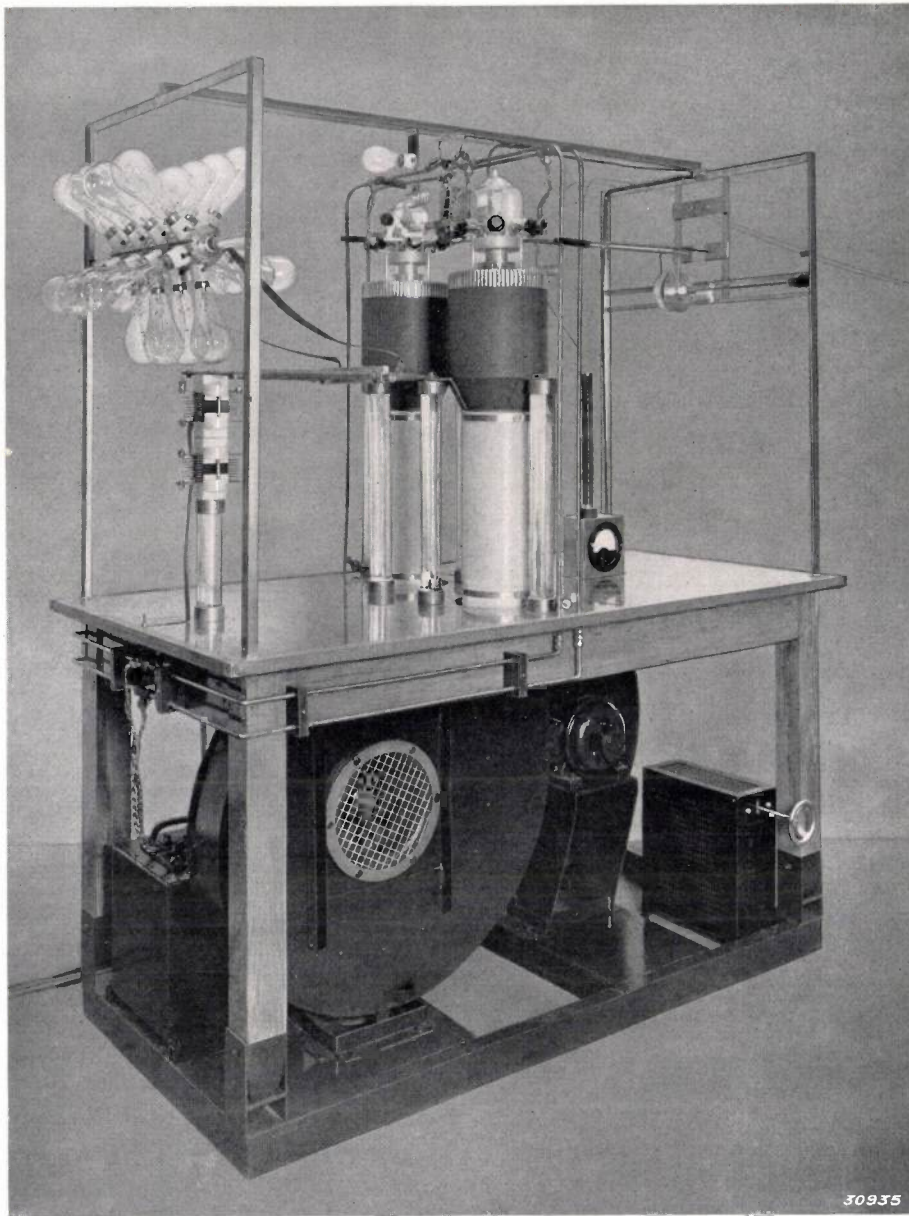

Fig. 7. Laboratory transmitter with two air-cooled transmitting valves type PA 12/15 in push-pull connection. Wave length 6 m, power delivered 6 kW. The carbon filament lamps, upper left, form an artificial aerial to which the power is supplied.

with air-cooled valves, *fig. 7* gives a view of a laboratory transmitter with two air-cooled transmitting valves, type PA 12/15 in push-pull connection. This final stage works on a wave length of 6 m and easily delivers 6 kW to the aerial with an excitation power of about 500 W. The anode dissipation is also 6 kW.

Compared to water cooling with the inevitable tube drums for dealing with the high tension, inlet and outlet connections for the water, pump for the cooling water, and in some cases pools, air cooling makes possible a considerably simpler construction.

THE MANUFACTURE OF RARE GASES

by H. C. A. HOLLEMAN.

661.93

In this article the method is described by which rare gases, oxygen and nitrogen are obtained from air in the Philips concern. The apparatus for the liquefaction of air and for the rectification of the gas mixtures is described.

Introduction

During the world war when it became more and more difficult to import the argon necessary for filling electric lamps, the Philips concern was compelled to take up the manufacture of the gas itself. The gas liquefaction plant then founded continued to grow steadily even after the war, since it was found to supply so many needs. So many different gases which can all be obtained from liquid air are used in the Philips factories, that for more than one reason it is very important to have the whole manufacture under control, and not to be dependent upon others. It seemed to us that it would be interesting to our readers if we were to give a general description of this part of the industry. Besides argon, which is used for filling electric lamps, the rare gases helium and neon are also used in gas discharge tubes. For glass blowing and in the machine shops large quantities of oxygen are used in order to reach higher combustion temperatures than is possible with air. Liquid oxygen and nitrogen are used on a large scale for cooling purposes and as aids in obtaining a high vacuum. As a protective gas in the working of metal parts for electric lamps and radio valves use is made of a mixture of nitrogen and hydrogen. Nitrogen is also used during the manufacture of electric lamps as washing gas, while it is also used to fill certain special kinds of lamps.

If the amount of air treated is determined for example only by the amount of oxygen required for use, it may not of course be expected that the amounts of the other gases obtained will correspond exactly to the needs for them. Especially in the case of nitrogen large quantities must be allowed to escape unused. In spite of this fact, however, due to the great variety of uses for the gases separated out of air, a more economical operation is possible than if only oxygen for example were taken from the air and the rest allowed to escape. Furthermore the great advantage of a private gas plant is that it is possible to take into account the special requirements of the industry more easily than is the case when the gases are supplied from an outside source. With a private gas plant a saving is also obtained due to the fact that different gases can be piped directly from the

rectifying apparatus to the places where they are to be used, so that compression into cylinders for transportation is quite unnecessary.

The separation of air into its components is at present carried out almost exclusively by liquefaction and rectification. Rectification is a kind of fractional distillation which is carried out in a column apparatus such as is also used in the preparation of alcohol and paraffin. Before we deal with the subject of rectification we shall first discuss the liquefaction of gases.

Liquefaction of gases by expansion

Due to the work of Linde, Hampson, Claude, Heylandt and others it has been possible to liquefy air on a commercial scale since 1896. The Philips rare gas plant used the method of Linde and Hampson which is based on the cooling due to expansion of air at a high pressure flowing through a needle valve (*S* in *fig. 1*) into a container at lower pressure. This so-called Joule-Thomson effect is a result of the mutual forces of attraction existing between the molecules (van der Waals and London), by which the energy content of a gas is not determined exclusively

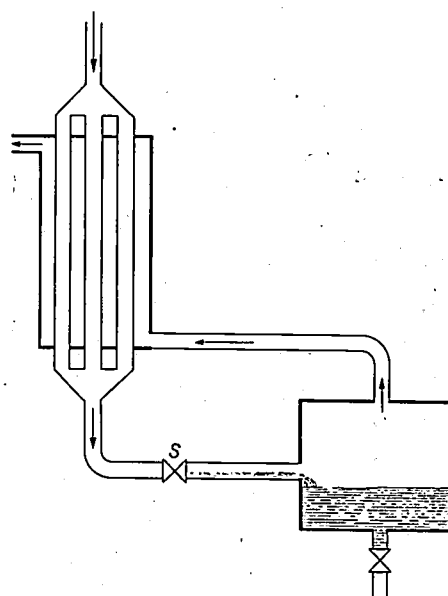

Fig. 1. Diagram of apparatus for the liquefaction of a gas by cooling in an interchanger and expansion through a needle valve *S*.

by the thermal agitation of the molecules, as in the case of an ideal gas, or in other words by the temperature of the gas, but also depends upon the mean distance between molecules, in other words, on the density of the gas. Upon expansion therefore a non-ideal gas increases its energy content due to the increase in volume, and the energy necessary for this must either be taken from the energy of motion of the molecules, which means that the temperature of the gas falls, or it must be supplied in some other way.

If air at a pressure of for instance 200 atmospheres is allowed to flow through an interchanger as shown diagrammatically in fig. 1, and then allowed to expand through a needle valve *S* and flow back through the interchanger, then with a well-constructed apparatus the air which comes out will not have a very much lower temperature than when it entered. The increase of its energy content due to expansion is obtained by the air by cooling the apparatus itself before the stationary state is reached. When the dew point of the air is finally reached the energy necessary for the expanding air is freed by the liquefaction of part of the air in the apparatus. In the liquefaction of air 90 kg. cal. of heat per kg. are obtained, while by the Joule-Thomson effect only about 0.06 kg. cal. per kg. of air per atmosphere can be removed, *i.e.* at a pressure of about 200 atmospheres not more than 12 kg. cal. By expansion alone therefore all the expanding air cannot be liquefied. For the separation by rectification, however, it is required that all the air be liquefied in this process. This is accomplished by allowing the air which has already been liquefied to evaporate while the necessary heat of evaporation is taken from the new supply of air, which is thereby liquefied. Such a process is shown diagrammatically in fig. 2.

In the working methods shown in fig. 2 between the needle valve *A* and the container *B* practically all the air flowing through is liquid. The liquid collected in the container evaporates continually and takes the necessary heat from the air which flows toward the valve through a cooling coil lying in the container, so that the gas in the coil is already partly liquefied before it reaches the valve. After the expansion at this point it flows to the container *B*, in which the liquid again evaporates. When the purpose is simply to obtain liquid air, there is no fundamental difference between the methods given in figs. 1 and 2, since they produce per unit of time the same amount of usable liquid under similar circumstances. When, however, the liquefaction of air is the preliminary to the

separation by rectification, we shall see that the second method has great advantages.

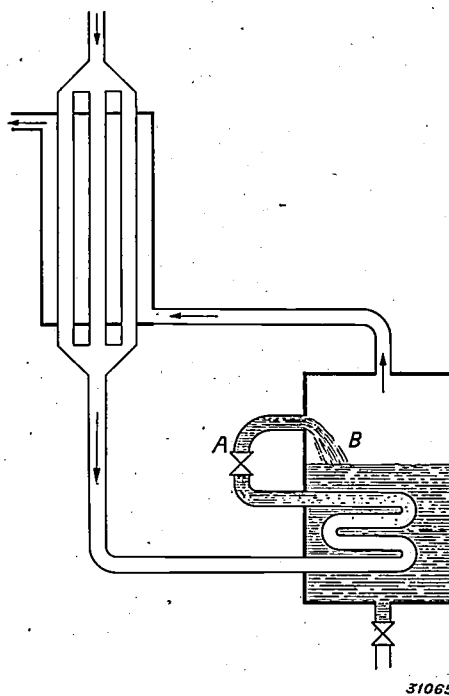

Fig. 2. Diagram of an installation in which a gas is already liquefied in the cooling coil running through the container *B* before it expands through the valve *A*.

In spite of good insulation and an efficient interchanger a certain amount of "cold" is always lost, and in liquefaction for rectification it is really a question of regulating the processes according to fig. 1 or fig. 2 in such a way that in the end no liquid air is obtained, but the supply of liquid in container *B* remains constant. "Cold" is therefore supplied only to compensate for the inevitable losses. By making the pressure at which the air is supplied lower, the production of liquid becomes smaller and merely by lowering the pressure sufficiently, for instance to 50 or 100 atmospheres, it is possible with the apparatus of fig. 1 as well as with that of fig. 2 to keep the quantity of liquid constant. With an apparatus as in fig. 1 only a small part of the air will be liquid after it passes the needle valve, while with the apparatus of fig. 2. all the air flows into the container as a liquid and then evaporates. It is this complete liquefaction and later evaporation which is necessary for rectification.

Rectification

If we have a mixture of substances with only slightly differing boiling points, which we wish to separate by boiling and condensing, rectification is the best method. For smaller amounts this is sometimes done discontinuously in successive

batches, but for the separation of air on a large scale technically only a continuous process of rectification may be considered. It is such a method which we shall discuss in the following.

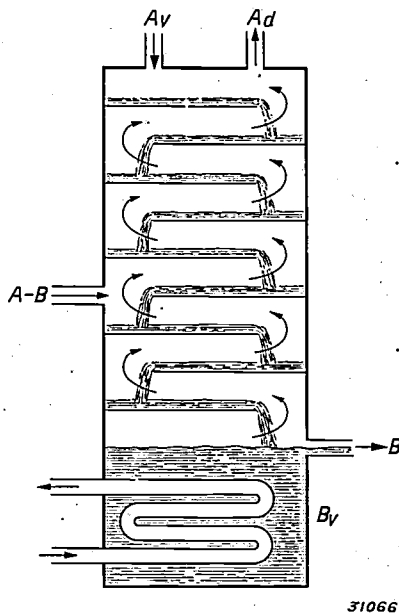

Fig. 3. Diagrammatic representation of the working of a rectification column. The component A of a mixture $A-B$ has a lower boiling point than B . At A_v component A enters the column as a liquid and drips down. At a suitable height the mixture $A-B$ is introduced into the column as a gas or a liquid. At the bottom of the column the liquid B_v collects; the substances B can be drawn off here as a liquid or a gas. The component A escapes at the top of the column as the gas A_d . The circulation in the whole apparatus is maintained because of the fact that the gas flowing through a coil in the liquid container gives off heat which causes the liquid at the bottom of the column to evaporate and rise, while at the top of the column a corresponding amount of liquid is introduced.

Fig. 3 shows the scheme of a continuous rectification. The mixture (air for example) as a liquid or a gas at the boiling point is introduced into a column consisting of many stages at a suitable height depending upon the composition of the mixture. According as the mixture contains more of one of the two components, the point of introduction should be shifted toward the extremity where the component in question is finally obtained. Within the column the liquid and gas flow in opposite directions, liquid downwards and gas upwards, and they are always in intimate contact with each other. The gas leaving the column at the top consists chiefly of the component (A) with the lowest boiling point, while the liquid collected at the bottom of the column consists chiefly of the component (B) with the highest boiling point. By heating the liquid reservoir this mixture rich in B rises again as vapour in the column; since part of the vapour which is formed at the top of the column is also readmitted to the column

after having been condensed to a liquid, there are always in the column opposing streams of rising vapour which is becoming richer in A , and falling drops of liquid which is becoming richer in B . In this way it is possible to draw off at the bottom of the column a liquid which after sufficiently intense rectification consists of very slightly impure B , while the vapour escaping at the top consists almost entirely of the substance A .

The way in which the simultaneous evaporation and condensation causes such a progressive separation into the two components can be best understood by a consideration of the phase diagram reproduced in fig. 4, in which the temperature is plotted vertically and the composition of the mixture horizontally for a given pressure.

The lower curve indicates the highest temperatures at which the mixtures of various compositions may exist entirely in the liquid phase (liquid curve), while the uppermost curve gives the lowest temperature at which for different compositions the whole can exist in the form of a vapour (vapour curve). A homogeneous mixture of a composition and at a temperature given by a point lying between the two curves cannot exist in a stable condition. If at a given temperature T there is a mixture having a composition lying between the liquid and the vapour curve, it separates into a liquid and a vapour phase, whose stable compositions are indicated by the intersections x_1 and x_2 of the horizontal line correspond-

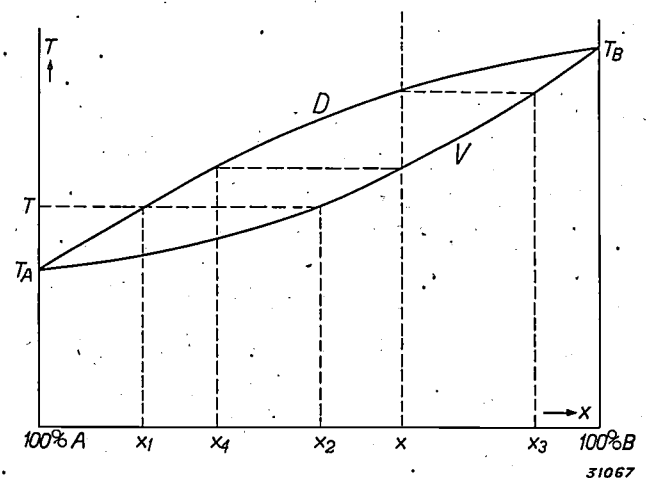

Fig. 4. Phase diagram for the substances A and B with the boiling points T_A and T_B respectively. At a given pressure the temperature T is plotted vertically and the content x (in per cent) of the component B horizontally; in other words, to the left is 100 per cent A and to the right is 100 per cent B . At a given temperature T vapour of a composition x_1 is in equilibrium with liquid of a composition x_2 . The first small amounts of liquid which can condense during the cooling of a mixture with the composition x , will have the composition x_3 , while the last small amount of vapour which remains upon further cooling will have the composition x_4 . D is the vapour curve and V the liquid curve.

onding to the temperature in question with the liquid and vapour curves respectively.

If for example a vapour with a composition x is cooled sufficiently slowly, its composition at first remains unaltered and only its temperature falls, so that therefore its point in the phase diagram of fig. 4 moves downward along a vertical line until the vapour curve is reached. If more heat is then removed from the mixture, it is able to condense a small quantity of liquid of the composition x_3 , while the composition of the vapour remains practically x . Upon further cooling the amount of liquid steadily becomes greater while at the same time it becomes richer in component A with the lowest boiling point, because the point in the phase diagram belonging to the liquid phase moves toward the left along the liquid curve until the liquid has the composition x and there is no more vapour. At the same time the vapour phase has also been cooling off and its composition has been changed in the way indicated by the motion of its point in the phase diagram along the vapour curve until the last remaining trace of vapour has reached the composition x_4 and is therefore much richer in component A with the lowest boiling point than the original mixture. The homogeneous liquid with a constant composition x then cools further while its point in the phase diagram moves vertically downward.

In the foregoing discussion we have actually assumed that the processes always occur so slowly that the complete equilibrium between vapour and liquid is never upset. In practice this cannot of course be achieved, and the compositions of the vapour and liquid phases, between which equilibrium has not been completely established, always lie in the shuttle-shaped region in the phase diagram between the vapour and liquid curves. What takes place in a rectification column can therefore be described as a long series of such steplike exchanges between vapour and liquid of different compositions, which, however, always remain within this shuttle-shaped region of the phase diagram. It will immediately be clear from fig. 4 that at temperatures half-way between the boiling points of the two components A and B considerable separation can be obtained, and that this separation takes place over only a few stages at the middle of the column, while in the neighbourhood of the extremities the compositions for successive stages do not vary very much. With a finite number of stages it is of course impossible ever to effect a complete separation, no matter how intimate one makes the contact between liquid and vapour.

In order to approach as nearly as possible the ideal case of an infinite number of stages, it was at first thought advisable to fill the column with bodies having a large surface, but it was found that the contact between vapour and liquid became too poor, so that at present the column is divided into a large number of stages as shown diagrammatically in fig. 5.

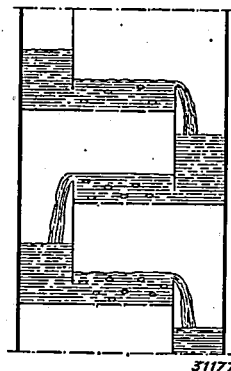

Fig. 5. Diagram of a rectification column built up in stages in which the liquid runs over overflow partitions and falls while the vapour bubbles up through the liquid through small holes in the floor plates. This arrangement is for the promotion of a very intimate contact between liquid and vapour.

When a rectification column is divided into a large number of stages one above the other (fig. 5) provision must be made by the introduction of overflow partitions that the liquid always remains at a definite height above the floor plates of the stages and runs continually over the edge into the stage below. Furthermore for the sake of good contact between liquid and vapour the vapour must be made to bubble up through the liquid through small holes in the floor plates. The number of such stages in ordinary rectification columns is from 10 to 50. The diameter and height of the stages are so chosen that the vapour carries as little liquid as possible in the form of drops, so that the whole construction depends very much upon the nature of the mixture to be separated.

Components of air

In the following table *I* are given the percentages and the boiling points of the different components of air; the 0.5 to 4 per cent of water vapour which is always present in ordinary air is assumed to have been removed from it. The table thus refers to dry air.

In this table the components of air are given approximately in the order of the proportion occurring in ordinary air. The proportion of hydrogen and methane are not accurately known, and seem to be variable, which is also the case with the carbon

Table I

Components of air	Volume per cent of dry air	Boiling point in °C
nitrogen	78	— 196
oxygen	21	— 183
argon	0.9	— 186
carbon dioxide	0.03	— 79
neon	0.0015	— 246
helium	0.0005	— 269
hydrogen	about 0.0005	— 253
krypton	0.0001	— 151
xenon	0.00001	— 109
methane	about 0.0001	— 165

dioxide content. Argon, neon, helium, krypton and xenon are the rare gases. The smallness of the amounts of these gases is illustrated by the fact that upon treatment of 1000 cu. m of air at 1 atmosphere per hour one can obtain not more than 9 cu. m of argon, 15 l. neon, 5 l. helium, 1 l. krypton and 0.1 l. xenon.

It is plain from the above table that air may in the first approximation be considered as a mixture of nitrogen and oxygen. For the separation of air into these two components rectification is the most suitable method. By combining liquefaction

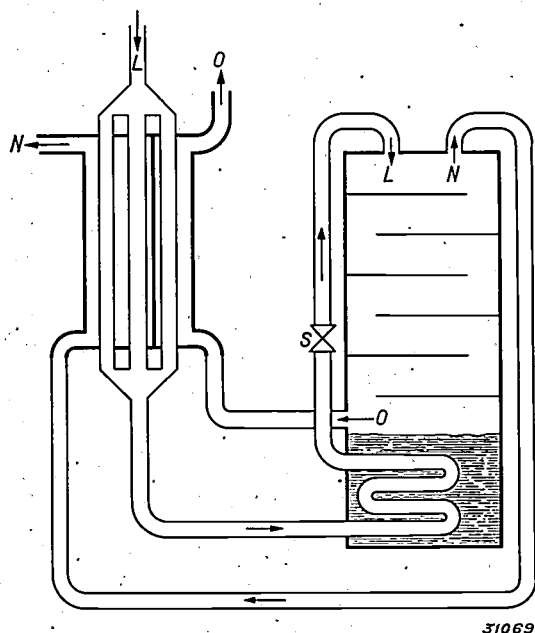

Fig. 6. Diagram of an installation for simple rectification. The air *L* flows into the top of the interchanger at an ordinary temperature. It is cooled here and then flows into a cooling coil through the liquid container at the bottom of the rectification column where it is liquefied. It then expands through the needle valve *S* and flows in liquid form into the top of the column. At the bottom of the column oxygen gas is drawn off, and at the top nitrogen with at least 7 per cent of oxygen escapes; both of these gases flow in separate lines upwards through the interchanger at the top of which they are obtained at about normal temperature.

according to fig. 2 and rectification according to fig. 3 one arrives at the oldest and simplest method of so-called simple rectification (fig. 6).

In this process the air at an ordinary temperature enters the top of the interchanger where it is cooled by the oxygen and nitrogen flowing in the opposite direction which have been separated from each other in the rectification column. The air, which although cooled is still in the gaseous form, leaves the interchanger at the bottom, flows through a cooling coil in the reservoir containing liquid oxygen below the rectification column so that it is still further cooled and liquefied. It then expands through the needle valve *S* and in the form of liquid air flows into the top of the rectification column. This does not correspond exactly to the principle of rectification are discussed in connection with fig. 3, because in that case the mixture was introduced into the column at a suitable height, while liquid nitrogen was introduced at the top. For this reason with simple rectification only very impure nitrogen gas escapes at the top of the column.

The liquid air then flows down through the column becoming poorer and poorer in nitrogen. In the container below the column practically pure liquid oxygen is collected. This is again entirely evaporated by the heat which is removed from the air flowing through the coil, and most of it ascends into the column again, while the rest is drawn off and sent up through the interchanger, at the top of which oxygen gas is finally obtained at about a normal temperature.

Because of the high degree of impurity of the nitrogen produced, we cannot obtain more than 71 per cent of the oxygen from the air in a pure form by this method. The gas which escapes at the top of the column is of course much richer in nitrogen, but must still always contain at least 7 per cent of oxygen since it is in equilibrium with liquid air containing 21 per cent of oxygen.

In order to obtain a higher yield of oxygen and nitrogen in a purer form, double rectification (fig. 7) is applied. Between the interchanger and the rectification column which works simply at slightly more than atmospheric pressure, a second rectification column is introduced which works at a pressure of about 5 atmospheres. The liquid air flowing out of the needle valve *S* is now admitted to this pressure column at a suitable height. The nitrogen vapour at about 5 atmospheres which escapes at the top of the pressure column is conducted into the condenser *C* which is situated in the container filled with liquid air below the

ordinary column. The temperature of the oxygen boiling at atmospheric pressure is just low enough to condense the nitrogen vapour at a pressure of 5

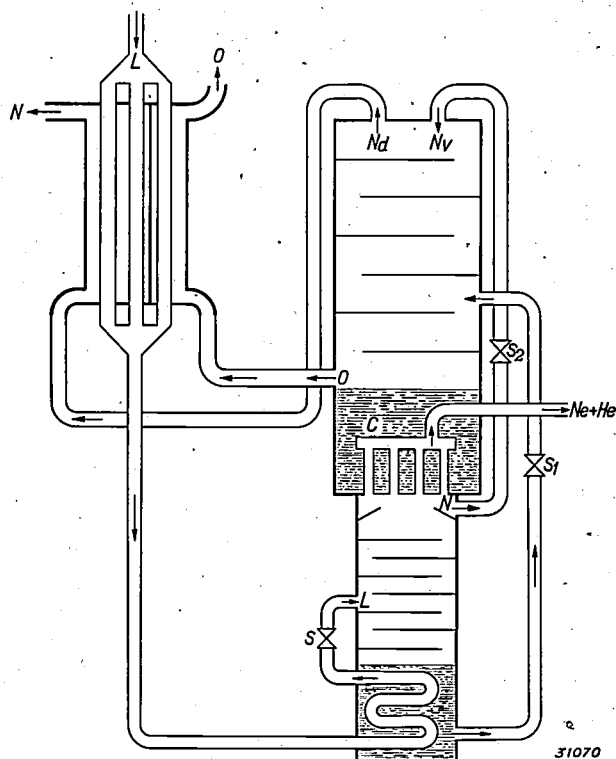

Fig. 7. Diagram of double rectification. Between the interchanger and the ordinary rectification column of fig. 6 another rectification column has been introduced which works at a pressure of about 5 atmospheres. *L* air; *N* nitrogen, pure to within several per cent, *O* pure oxygen; *S*, *S*₁, *S*₂ needle valves and *C* condenser.

atmospheres. Part of this practically pure liquid nitrogen drips down into the pressure column and is further admitted through a needle valve *S*₂ into the top of the ordinary rectification column where it again drips down. Since at 5 atmospheres the limiting curves in the phase diagram of fig. 4 lie much closer together than at 1 atmosphere, the separation in the pressure column is not very complete. The liquid container below the pressure column contains oxygen which is, still quite rich in nitrogen. This liquid is admitted into the ordinary rectification column through a needle valve *S*₁ at a suitable height, and the further separation into oxygen and nitrogen takes place there. This rectification is complete within only a few per cent. Such an installation for rectification, in use in the Philips rare gas plant, is shown in fig. 8.

It would perhaps be possible to introduce a rectification column for 20 atmospheres in front of that for 5 atmospheres. This, however, does not offer much advantage since the phase diagram at that pressure is so much narrower than at 5 atmospheres. It is therefore of little use to try to carry

the separation of a mixture further by this method.

The interchanger is a very important part of the whole installation, because it is necessary for efficient operation that the temperature difference between the air entering and the separation products obtained should be only a few degrees. This is achieved by allowing the compressed air to flow through a bunch of narrow tubes whose inner diameter is only about 5 mm and which are often made in the form of spirals of 20 or 30 metres. The outside of these tubes is bathed by the products of the separation while the currents inside and outside the tubes are more or less perpendicular, so that the occurrence of an active eddy current provides for more complete transfer of heat. All the parts of such an installation which reach low temperatures should be made of copper or brass, since these materials keep their favourable mechanical properties even at low temperatures, while most other substances quickly become brittle. Since "tin disease" does not occur at these low temperatures all soldered joints in these apparatus can be made with tin.

In the separation of air water vapour and carbon dioxide are very disturbing, since they become solid at the low temperature and may therefore stop up the connections. The air must therefore be carefully freed from these substances in advance. For drying (see fig. 9) use is made of solid potassium hydroxide. Upon taking up water this substance forms a saturated solution of potassium hydroxide which can be drawn off from the drying apparatus. This solution is then used in the washing towers where the air to be used is freed of carbon dioxide. In this way potash is formed which can be used again in the manufacture of glass in the smelting mixture. In this way the various parts of a great industry are bound closely together.

Rare gases

The most plentiful rare gas occurring in air is argon which has a boiling point lying between those of oxygen and nitrogen, so that this gas has the tendency to collect at the middle of the rectification column. The argon can be separated by drawing off the oxygen vapour which is rich in argon from the main column and then rectifying later separately in an auxiliary column. The argon is thereby freed from the main mass of the oxygen, and this is usually sufficient for practical purposes, since the last traces of oxygen can easily be removed chemically. This is, however, more difficult with nitrogen, and therefore too high a content of nitrogen is simply avoided by drawing off the

mixture for the auxiliary column somewhat nearer the oxygen end of the main column, so that almost no nitrogen is taken with it.

For a given use nitrogen with a very small con-

upon the very rapid absorption of nitrogen by metallic lithium prepared in a suitable way, which phenomenon was discovered in the previous century²⁾. In these measurements it was found that

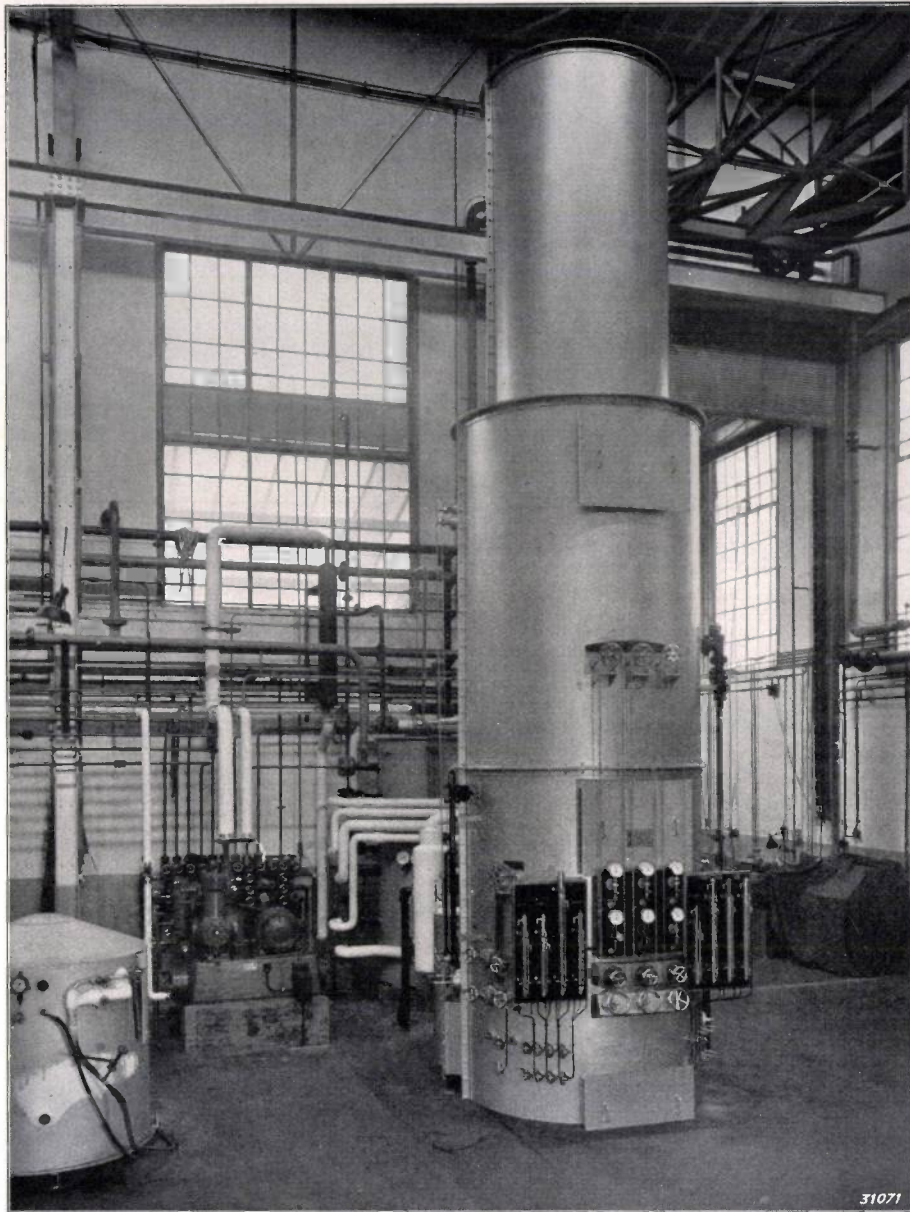

Fig. 8. A modern installation for the separation of air by the Linde method. In the large column, inside a thick layer of insulation material are four rectification columns and the necessary interchangers. On the outside may be seen various regulating taps, indicators of the liquid levels, manometers, etc. At the extreme left there is a supply tank for liquid oxygen. In the background may be seen an ammonia cooling system with which the air at a pressure of about 100 atmospheres is cooled to -20°C , which serves to dry it, and at the same time to promote a more economical working of the separation apparatus.

tent of argon was required. In order to find out how much argon the normally prepared nitrogen contained, a method of analysis has been worked out in our laboratory¹⁾. This method is based

¹⁾ J. A. M. van Liempt, *Rev. trav. chim. Pays Bas* 56, 310, 1937.

normally prepared nitrogen contains only very little argon.

Neon and helium, as may be seen from the table, have boiling points which lie far below those

²⁾ Guntz, *C. R. Acad. Sci. Paris* 120, 777, 1895.

of the other components of air. They need not therefore be separated by a special rectification, but simply escape as a volatile fraction out of the top of condenser *C* in which most of the nitrogen becomes liquid. The neon and helium drawn off at that point then still contain some nitrogen and hydrogen as impurities which can easily be re-

can only be separated from the oxygen by a special rectification. Because of the very small quantity of these rare gases this is a very elaborate process in which, however, there are no fundamentally new methods used. There is, however, one very great difficulty in this process, namely the fact that the methane which occurs in variable amounts

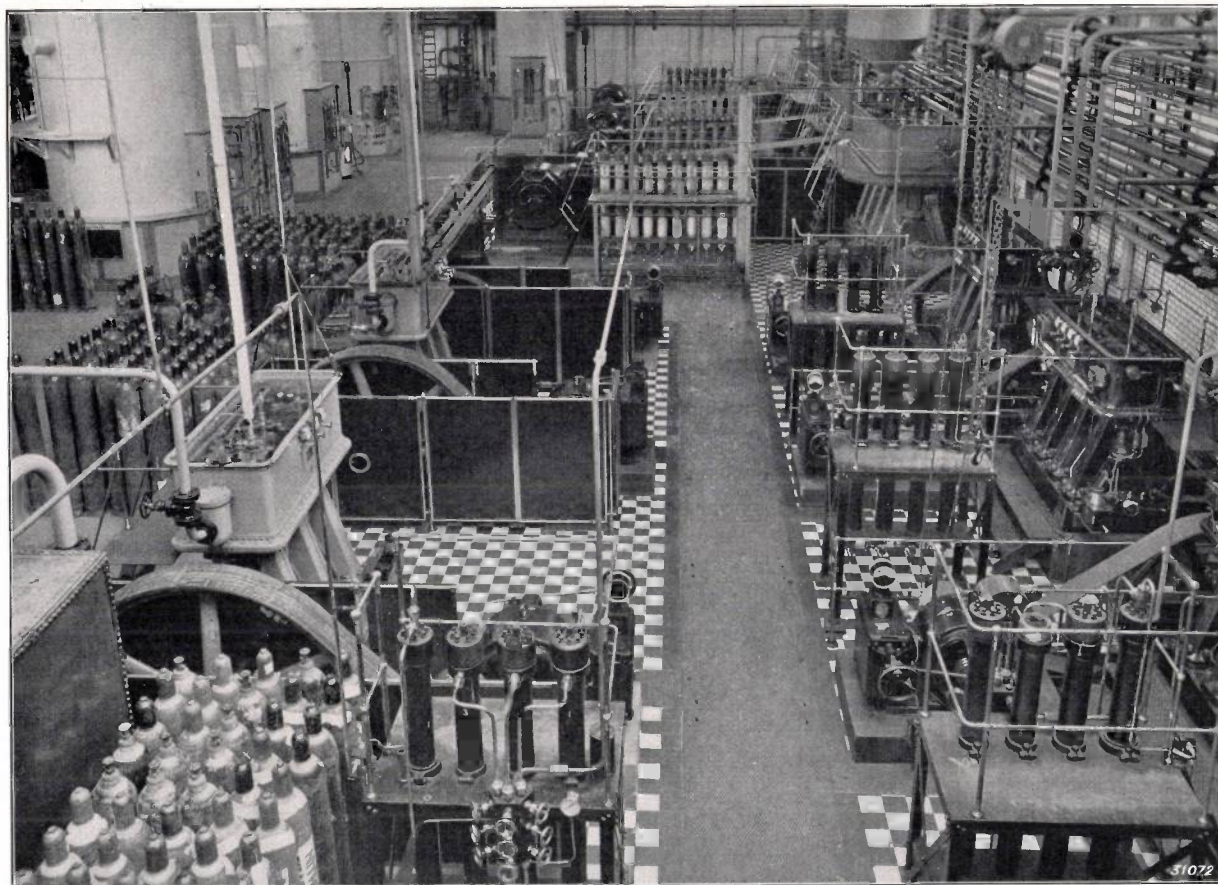

Fig. 9. View of part of the rare gas plant. In the foreground to the left and right are several smaller compressors for oxygen, nitrogen, etc. In the background to the right may be seen four large air compressors. In the centre background stand racks of steel cylinders filled with solid potassium hydroxide for drying the strongly compressed gases. To the left in the background may be seen several installations for the separation of air.

moved. Finally it is also possible to separate neon and helium from each other by absorption and desorption on active charcoal, without it being necessary to use temperatures lower than those of nitrogen boiling in a vacuum (-220°C).

Since they have relatively high boiling points krypton and xenon collect mainly in the liquid container below the main column, which contains oxygen for the most part. The krypton and xenon

in the air has about the same boiling point as krypton, so that it is collected with the krypton in the liquid oxygen. This may have serious consequences since liquid oxygen together with a combustible substance like methane can easily form an explosive mixture. In order to avoid accidents therefore the strictest precautions must be taken in the preparation of krypton and xenon.

THE EQUIPMENT OF BROADCASTING STUDIOS

621.396.712.3

A description is given of the radio technical equipment of a broadcasting station. The installations of the A.V.R.O. studio and more briefly that of the K.R.O., studio both at Hilversum (Netherlands) are discussed as examples. Special attention is paid to the construction of the central control tables and the provisions for organizing the broadcasts.

There are two main factors to be considered in the equipment of a broadcasting studio. In the first place the sound which is to be broadcast must be conducted to the transmitter in the required purity and freedom from interference, the correct intensity and the desired relative in-

Hilversum. The above-mentioned factors will serve as a guide ¹⁾.

Composition of the broadcast programme

In order to obtain an insight into the needs of a broadcasting station we shall first consider the

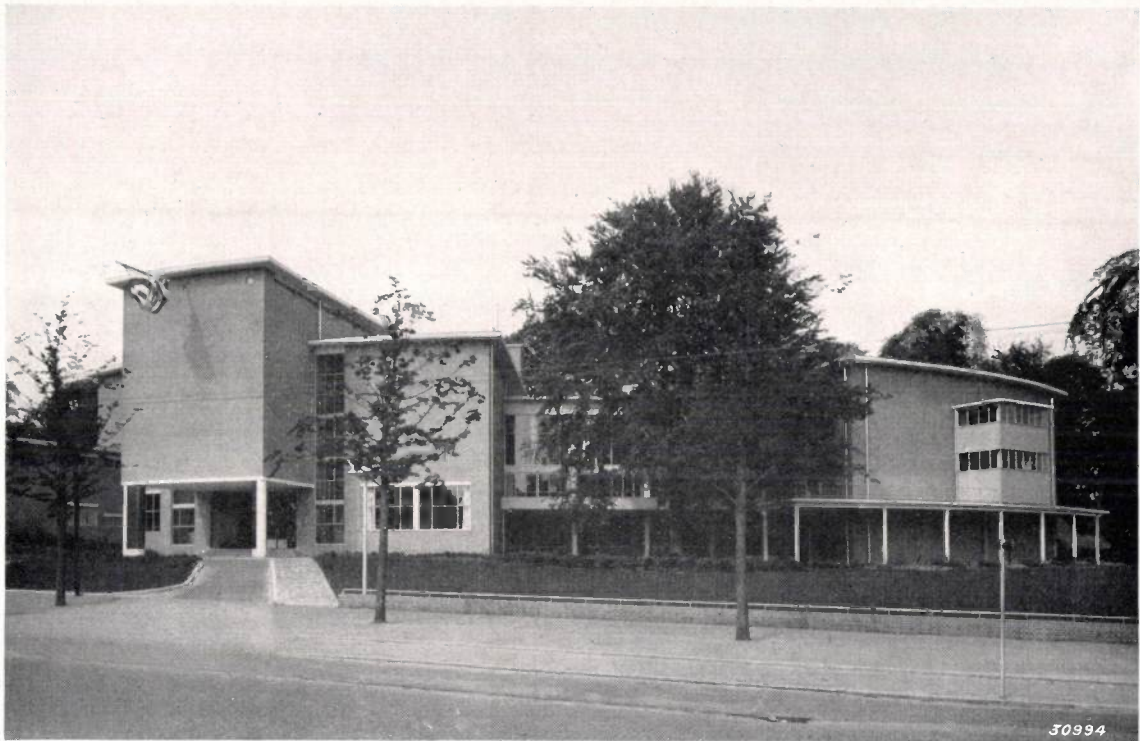

Fig. 1. The A.V.R.O. broadcasting station (1936) in Hilversum (Netherlands). The large windowless wall spaces serve to cut off the studios as much as possible from the outside world.

tensities. In the second place opportunity must be given for the preparation and the smooth carrying out of the very varied daily programmes. It is especially the first factor which is of influence on the elements of broadcasting. The second factor chiefly determines the size of the installation and makes necessary the introduction of a series of appliances concerned with organization.

In the following we shall give a description of the equipment and running of a broadcasting station, taking as example the A.V.R.O. studio in

components which make up the daily programme. In the first place there are the musical items of all kinds, orchestra music, chamber music, jazz, and solo performances. Then there are lectures, and plays in which not only the voices of the different players but also a great variety of sound effects play a part. The sound effects are intended to give the acoustic atmosphere and are heard between the dialogues or as a background; a special form of acoustic illusion is the suggestion of great empty space by means of a long reverberation. In addition gramophone music forms an important part of the programme. In addition to all this are the communications of the announcer. Furthermore there is an intermission signal and a time signal, and

¹⁾ The design of this studio installation was made according to the recommendations of Prof. Dr. Ir. W. Th. Bähler and Ir. F. R. Th. Kröner; it was executed by N.S.F.-Philips.



Fig. 2. Platform of the large concert hall in the A.V.R.O. building. Two suspended microphones hang from rails in the ceiling along which they can be moved in order to be able to place the microphones as nearly as possible at any desired spot. In the background may be seen the mixing cabin which is separated from the hall by triple glass windows.

finally it is sometimes also necessary, for instance in the case of running commentaries, that a broadcast, transmitted by telephone line to the broadcasting studio, be there prepared for the radio transmitter with or without the addition of sound produced in the station itself.

Each of the different kinds of broadcast here mentioned requires a suitable studio for its production. The A.V.R.O. studio (*fig. 1*) contains among other rooms, a large and a small concert hall, a dance music studio, a large and a small theatre studio, rooms for speakers, for the announcer, for producing

sound effects, etc. The sound produced in the studio can be provided with any desired reverberation by means of the so-called echo cellar. The latter is a room with a very long reverberation in which a loud speaker and a microphone are set up. When the loud speaker reproduces the sound coming from the studio, the microphone takes up the reverberation in the echo cellar and this can be added electrically in the required amount to the sound to be broadcast.

less sensitive to disturbing influences directly before their further journey.

The amplified microphone currents are now "mixed", *i.e.* that the currents coming from different microphones and different lines are added together by a person who in general directs the whole broadcast, and are given the required relative intensities by means of adjustable resistances (faders). The resulting current, after being amplified again, is then regulated in order to bring

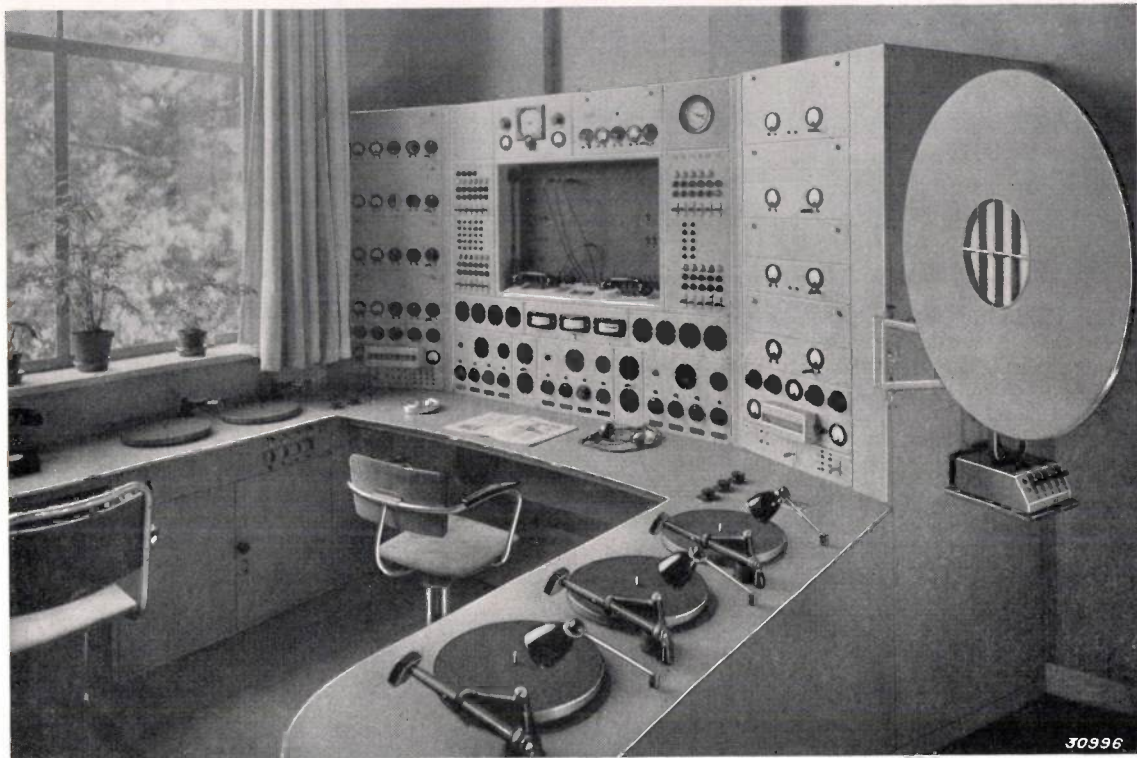

Fig. 3. A central control table of the A.V.R.O. Just above the top of the table, immediately in front of the sound mixer's place may be seen the control knobs of the three fading units; above them the three measuring instruments for the maximum, minimum and average levels; in the centre of the panel the central switchboard on which the conductor of the transmission can connect the available faders of the fading units to all the incoming connections from microphones, gramophones and telephone lines, to the signal lamps, and push buttons for light signals in the studios. To the left and right of the control panel are the racks with the amplifiers. To the extreme right the monitor loud speaker. An either side of the mixer a group of turntables for gramophone records is placed.

Amplification, mixing and regulation of the sound

We shall now follow the course of the sound in more detail from the studio to the transmitter.

Each studio, according to its size, contains several microphones which can be connected at various spots in the room. In the large concert hall of the A.V.R.O. studios (*fig. 2*) there are for example 5 microphones, while there are 10 microphone plug boxes. The microphone currents are amplified in microphone amplifiers which are set up in the neighbourhood of the plug boxes in order to make the microphone currents somewhat

it to the correct transmission line level. This level must be so chosen that on the one hand the loudest passages of the sound experience no disturbing non-linear distortion, while on the other hand the softest passages are still sufficiently far above the noise level. Considering the great variations in intensity which occur in speech and music, continual control and regulation of the material broadcast is necessary. A control table (in the A.V.R.O. studio), where the mixing and regulation takes place, is shown in *fig. 3*. To the extreme right may be seen the monitor loud

speaker, which makes it possible for the person directing the broadcast to hear it. In the regulation, however, the sound mixer does not allow himself to be led exclusively by the qualitative sound impression from the loud speaker, but by the quantitative indications of three measuring instruments (for the loudest and the softest passages in the sound and for the average sound intensity respectively), which may be seen in fig. 3 in the centre of the control panel, directly in front of the place of the mixer.

In the case of certain broadcasts, such as for example a concert with soloists, it is desirable that the mixing of the contributions by the different microphones be carried out by someone who is in visual contact with the performers. The largest studios in the A.V.R.O. station are therefore provided with small cabins in which the currents from all the microphones, after amplification, come together on a mixing table. The cabins are made soundproof by triple glass windows and the mixer receives the sound through headphones or a loud speaker which corresponds in function to the monitor loud speaker beside the central control table in fig. 3. In fig. 2 the glass mixing cabin may be seen in the background. Fig. 4 shows a mixing desk such as is used in these cabins. The microphone currents mixed in the cabin are again conducted to the central control table.

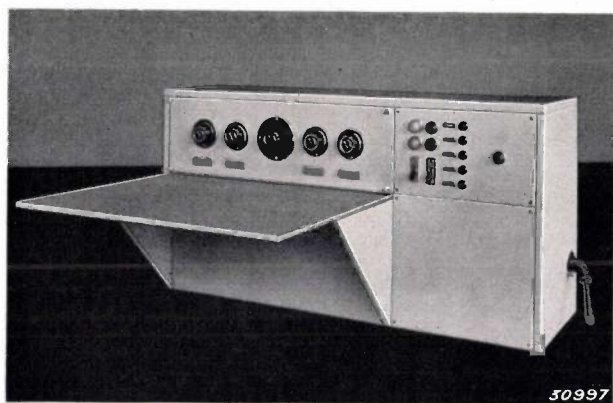

Fig. 4. Small mixing desk which is used in the mixing cabins of the A.V.R.O. studios.

Installation of the central control table

In broadcasts to which many microphones set up in different rooms contribute, it would be too complicated if all the currents had to be regulated separately every time it was necessary to regulate the currents of a few of the microphones. In a play for example in which a sound effect occurs which is made up of different sounds, the sound effect is

wanted as a whole or not at all. Therefore the regulators (faders) are arranged on the mixing table in groups of four, which can be regulated again as a single unit. The control table in fig. 3 contains three such fading units.

After mixing, the sound of each fading unit is amplified in its own amplifier *A* (fig. 5). Each *A* amplifier contains three end stages *a*, *b*, *c* in parallel, whose volume can be regulated separately. As may be seen in the diagram of fig. 5 the outputs *a* of all three *A* amplifiers are again joined, just as the three outputs *b* and *c*. The currents of the combined outputs *a* are intended for transmission. The combined outputs *b* via a common regulator serve for feeding the so-called sound effect loud speakers in the studios. In this way a sound effect can be introduced acoustically into the programme. In the performance of plays this is very desirable, in order that not only the listeners but also the performing artists themselves may feel the atmosphere which is being suggested by the background noise. In such an acoustic mixing of sound effects care must of course be taken that no acoustic feeding-back occurs. The control knobs *a* and *b* of each unit are therefore locked in such a way that *b* cannot be switched on when *a* is working; no current can be fed to the sound effect loud speakers from a microphone which is already feeding the transmitter, *i.e.* it cannot be fed to the sound effect loud speaker in the same room with the microphone. On the other hand, however, when knob *b* has been used and it is therefore known that no acoustic feeding-back occurs, the knob *a* of the same unit (sound effect unit) can be put in operation: the sound effect is then added directly by electrical means to the sound sent to the transmitter. By the division into three fading units two sound effects can be prepared simultaneously in addition to the main programme, and it is possible to pass immediately from one to the other.

The remaining outputs *c* serve, again via a common regulator and an amplifier, to feed the loud speaker in the already mentioned echo cellar, where the desired reverberation can be obtained. Because of the fact that the three outputs of each *A* amplifier can be regulated separately, it is possible to provide each of the three contributions to the whole sound from the three fading units separately with the desired reverberation. The current of the echo microphone (after amplification and regulation) is added to the currents of the *a* outputs.

The complete programme so obtained is conducted to two amplifiers (*B* and *C*) in cascade arrange-

ment. To these amplifiers also is sent the already pre-amplified microphone current from the announcer in his cabin. The sound of the whole programme can here again be regulated with respect to the sound from the announcer with a single manipulation by a main regulator. The output of amplifier C is again divided into three and sup-

With each turn-table is a so-called bas corrector, a gramophone amplifier and a volume regulator. The sound from all five gramophones is sent together to another amplifier with a filter for removing the noise of the needle, and *via* a main regulator to one of the fading units.

The connection of the different programme con-

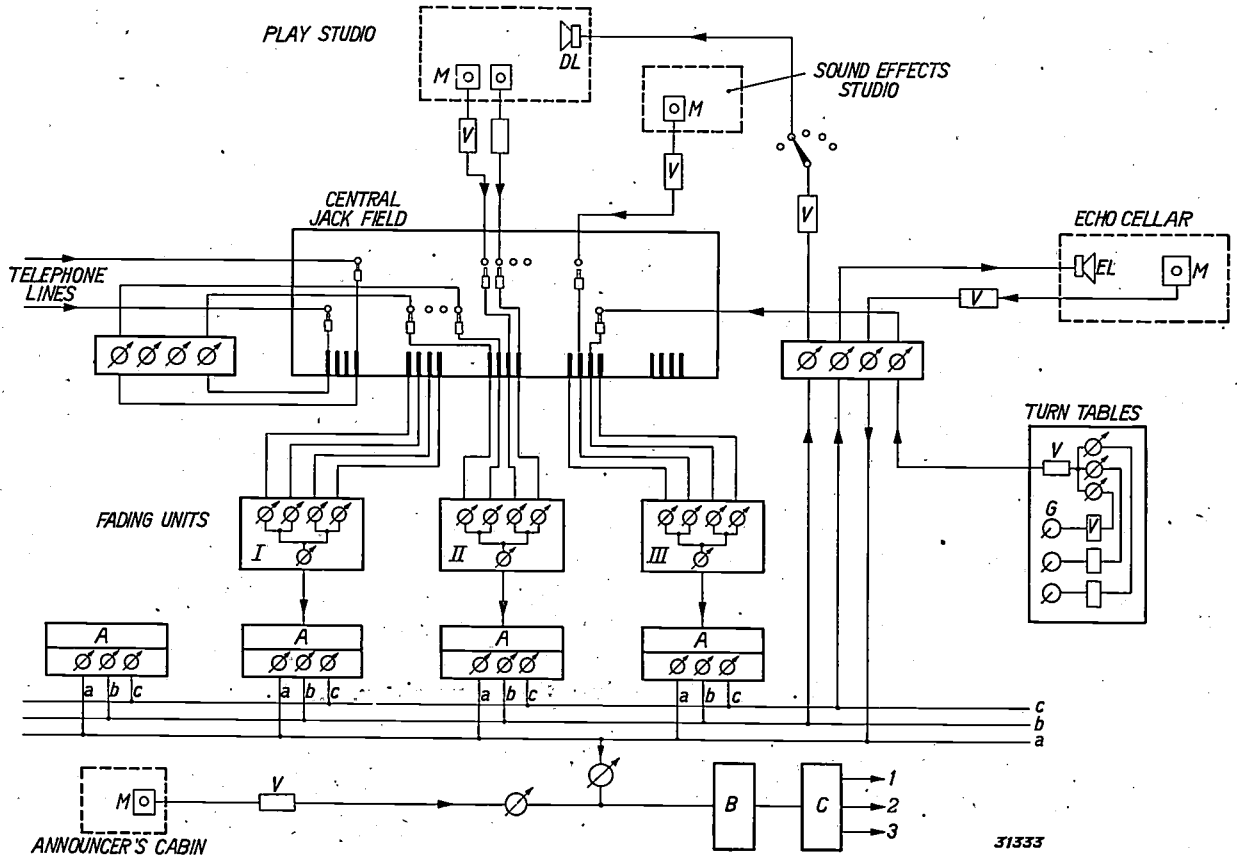

Fig. 5. Simplified diagram of the central control table. On the central switchboard several connections of the three fading units I, II and III are indicated, which may for instance occur during the performance of a play. The "programme unit" (II), in the case imagined, receives the currents from two microphones in the play studio and from two telephone lines (which have first been put through the line regulators). The "sound effect group" (III) which is in use receives currents from the sound effect studio and from the turn-tables. Each fading unit has an amplifier A with three outputs a, b and c, which are combined as shown. The b outputs feed the sound effect loud speakers (DL) in the studios, the c outputs the loud speaker (EL) in the echo cellar. The currents from the echo microphone and from the microphone in the announcer's cabin are added to the currents of the output a, and together amplified in amplifiers B and C. The three outputs 1, 2 and 3 of C serve to feed the transmitter, the monitor loud speakers and an apparatus for sound recording. V are various amplifiers, M microphones, G gramophone pick-ups.

plies as desired the telephone line to the transmitter, the monitor loud speakers in the studio (beside the control table, fig. 3, for example) *via* a power amplifier, and an apparatus for sound recording.

Amplifiers A and amplifiers B and C, with the necessary reserves, are set up to the left and right of the control panel in fig. 3. On either side of the place of the sound mixer may also be seen a number of turn-tables for gramophone records:

tributions to the fading units takes place by means of a central switchboard which may be seen in the middle of the control panel in fig. 3. The connections of all the microphones coming from the studios, of all the groups of microphones coming from the small mixing cabins, of the group of gramophone pick-ups and a number of telephone connections for music and speech coming from the outside end in sockets on this switchboard. Each fader of the fading units can by means of a cord and

jack be connected to any desired socket. The sound mixer can then place a sign beside the regulator on which is indicated the socket connected. The signs are held in place magnetically so that it is very easy to change them.

Organization of the broadcasts

The A.V.R.O. broadcasting studio contains two entirely similar and independent central control tables like the one described above. This makes it possible to supply two transmitters at the same time with different programmes, or to rehearse a

of the control tables at the same time. There is therefore a switch for each studio which connects all the microphone and other lines simultaneously with one or the other of control tables. The switch is driven by a motor. By means of a locking device care is taken that the motor can be switched on at one table only when the studio in question is not connected with the other control table. By the joining of all the connections from a studio in one switch the switching over from one table to the other takes place very quickly, and it is impossible for necessary connections to be forgotten.

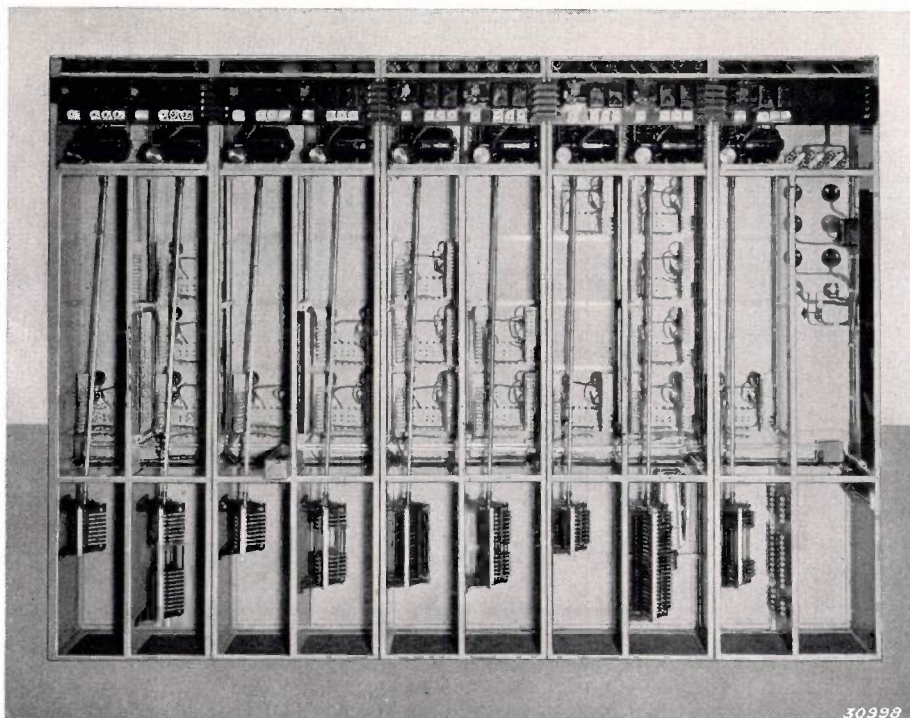

Fig. 6. Cabinet with switches, seen from the back. In order to avoid disturbances the motors (top) are kept, by means of long driving shafts, at a suitable distance from the microphone connections which lead to the switching devices mounted below.

programme while another is in progress (the small fading units can also serve this purpose), or to record a programme for later transmission.

The centralization of the direction of a broadcast on a central control table permits satisfactory oversight of the whole process, and makes possible a large number of combinations of connections. This centralization, and especially the simultaneous operation of two such centres, requires special provisions for the rapid preparation of all necessary connections, for the avoidance of errors and for the necessary contact of the director of the broadcast with the performers and the technicians. We shall briefly discuss these provisions in the case of the A.V.R.O. broadcasting studio.

One studio cannot of course be served by both

In the whole building microphone and other connections are carefully separated. This separation also is carried through in the switches by constructing the switch in two parts which are electrically shielded from each other. A similar switch provides that the telephone line to the transmitter can only be connected to the output of one of the control tables. With the same switch control loud speakers placed at different points in the building are connected to that control table. In *fig. 6* may be seen a cabinet with a group of these switches. The switches as well as all the rest of the common auxiliary apparatus of the two control tables are set up in an instrument room shown in *fig. 7*. On the line terminating bay in the centre of the panel shown here the music and speech lines

coming from outside the building are connected to the switchboard of one or the other control table by operators.

A locking device is also necessary for the echo cellar: when it is connected to one control table, the echo loud speaker must not of course reproduce any sound from the other control table, since otherwise the two programmes would be mixed together in the echo microphone.

disconnected when the control table is connected to the line to the transmitter. When the broadcast is about to begin, this fact is announced in the studio by a green light signal. From the studio a white light signal is then given to the control table as a sign that the performers are ready. A red signal in the studio then gives the signal "Begin". Five other commonly occurring instructions or warnings such as "speak louder", "five more minutes time",

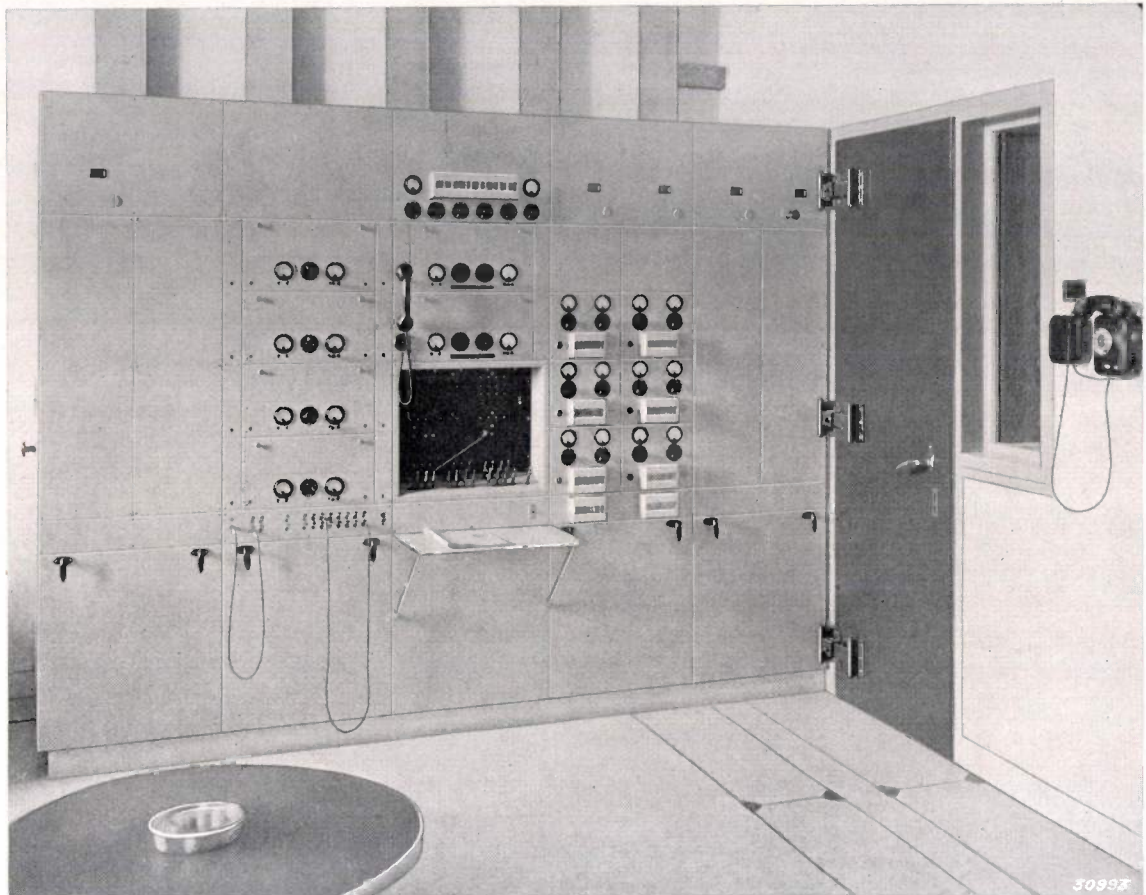

Fig. 7. Switch panel with amplifiers and line terminating bay in the instrument room of the A.V.R.O. building. This panel also contains two correction amplifiers by which the low and/or high frequencies of the sound which comes in along telephone lines can be amplified to 20 dB with respect to the average frequencies. The levels of the telephonic contributions to the program are made equal to that of the other parts of the programme by a set of line regulators on the control table (fig. 3, to the left next to the three measuring instruments under the central switchboard): all the sockets on the central switchboard then carry a level of -23 dB with respect to the transmission line level (5 mW).

The contact between the director, the performers and the technicians is guaranteed by an extensive signalling arrangement. As long as the broadcast has not yet begun the director can give spoken orders to the collaborators by means of a "talk-back" microphone on the control table which can be connected with the "talk-back" loud speaker in every studio. As soon, however, as the broadcast begins no more orders must be heard in the studio. The "talk-back" microphone is therefore automatically

etc. can be given by means of transparent signs which the director can switch on with a series of push buttons on the control table (next to the central switchboard in fig. 3).

If the small mixing cabin of a studio is in use, the signalling is done *via* this. Furthermore there are control lamps indicating, automatically on each control table which studios are connected to the one and which to the other control table, lamps which indicate that the microphone ampli-

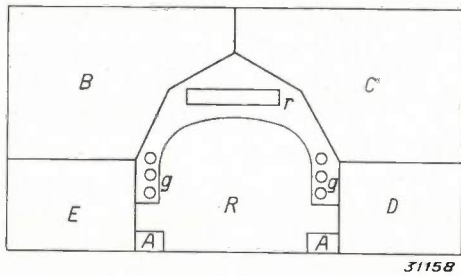

Fig. 8. Plan of the arrangement of the "dramatic control desk" in the K.R.O. building. *R*, dramatic control room with control panels *r*, amplifiers *A* and gramophone turn-tables *g*. The room is in open communication with the studio *E* where the sound effects for the plays are produced and with the small theatre studio *D*. The control room is separated from the chamber music studio *B* and the large theatre studio *C* by sound-proof triple glass partitions.

fiers in the instrument room are connected and others indicating which mixing cabins are being used for a rehearsal, red lamps which light up beside every regulator in the different mixing units as soon as it must be operated, namely when it is connected to a socket on the switchboard and the

red signal has been given in the studio. There is of course a telephone connection between all the control tables, the announcer and the larger studios. When one of the telephones on the control tables is taken up the volume of the monitor loud speaker is automatically diminished, so that the telephone conversation is not disturbed thereby.

A control table for broadcasting plays

The equipment of the control tables in a broadcasting studio depends mainly upon the items which receive most emphasis in the composition of the programme. The equipment here described of the A.V.R.O. studios provides for all necessary and desired combinations without any one type of broadcast receiving special emphasis. It would perhaps be interesting to consider an example of a different kind as a contrast. In the K.R.O. broadcasting studio in Hilversum, the radio technical equipment of which was also carried out by Philips, emphasis has been laid on greater visual

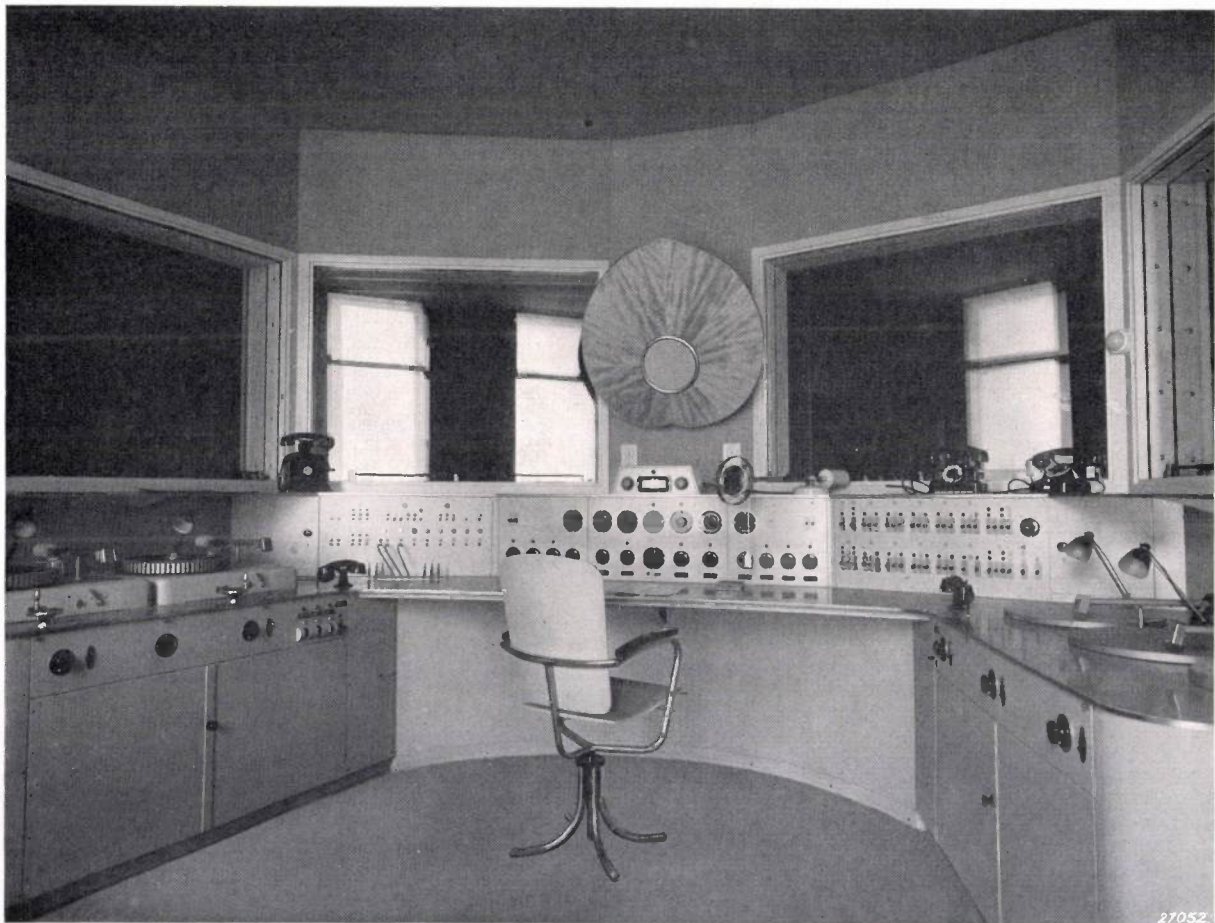

Fig. 9. Dramatic control desk of the K.R.O. Above the control panels is the monitor loud speaker, to the right below it the "talkback" microphone. The amplifiers *A* for this table are in the same, the other amplifiers for the "dramatic control desk" and for the two ordinary control tables are housed in a common instrument room.

contact in the broadcasting of radio plays. In this type of broadcasting it often occurs that various studios work together. A special "dramatic control desk" has therefore been installed which is in visual contact through triple glass partitions with two studios at the same time, namely the large theatre studio and the chamber music studio, while at the same time this control room is in direct connection with the small theatre studio and with the room where the sound effects for plays are produced. *Fig. 8* shows the plan of this arrangement, while *fig. 9* shows the control desk. The dramatic control desk, in contrast to the above-mentioned mixing cabins, is provided with all the necessities for arranging a complete broadcast; it may therefore, like the two ordinary control tables which are also present in the building, be connected directly with the line to the transmitter. The two ordinary control tables for which the need of

switching combinations is now less, due to the fact that the dramatic control desk has taken over part of their functions, are more simply equipped than those shown in *fig. 3*; they each contain only one fading unit for example. In addition to the facilitation of the performance of plays, there is another advantage in the division chosen in the case of the K.R.O. studios: if necessary three transmitters can be furnished with programme at the same time. In order not to decrease too much the number of rehearsals which can take place at once by the combining of several mixing cabins to a single control room, the two ordinary control tables are so arranged that they can be used for a simple rehearsal during a broadcast. The large concert hall again has its own mixing cabin; moreover, one of the control tables is in visual contact with the small concert hall.

Compiled by S. GRADSTEIN.

SOUND DIFFUSERS IN LOUD SPEAKERS

by J. de BOER.

534.861 : 621.395.623.7

Loud speakers have the tendency to exhibit a certain directional effect which becomes more pronounced with increasing frequency. Where such a beam formation of the high tones is undesired, *i.e.*, in small rooms, the directional effect can be neutralized by means of sound diffusers. These are bodies of definite shape and dimensions which are placed in the path of the sound waves. The required diameter of a sphere to be used as a sound diffuser can be derived theoretically. In the loud speakers of the Philips radio sets a cone and vertical partitions in front of the cone of the loud speaker are used as sound diffuser. The most suitable form and dimensions of these sound diffusers for scattering sound are determined experimentally.

When sound amplification is used in halls which have too long a reverberation time, an improvement of the acoustics of the hall can often be obtained by making use of loud speakers with a directional effect¹⁾. If these loud speakers are directed toward the part of the hall occupied by the audience, the sound intensity is there increased without an amplification of the reverberation necessarily also occurring.

Aside from such special cases, however, a directional effect is generally not desired with loud speakers. This is particularly true in the case of the loud speaker in the home. In this case the listener does not wish the fact of his listening or not listening to the radio to determine the place where he shall sit, but he wishes to be able to hear the

programme equally well from any spot in the room. Every loud speaker has a certain natural directional effect. In the following we shall discuss the extent to which this effect may be disturbing, and how it is possible to neutralize such a disturbing directional effect.

The directional effect of loud speakers

The appearance of a directional effect in sound radiation means that the distribution of intensity of the sound waves emitted deviates from spherical symmetry. The form of the distribution of the intensity of the sound wave depends upon the shape, the position and the dimensions of the radiating body. The loud speaker of a receiving set may for our purpose be considered by approximation to be a circular vibrating membrane placed in an infinitely large baffle board. The sound waves radiated from this source are spherically symmetrical only when

¹⁾ See J. de Boer, Sound Amplification, Philips techn. Rev. 3, 221, 1938, especially pages 226-227.

contact in the broadcasting of radio plays. In this type of broadcasting it often occurs that various studios work together. A special "dramatic control desk" has therefore been installed which is in visual contact through triple glass partitions with two studios at the same time, namely the large theatre studio and the chamber music studio, while at the same time this control room is in direct connection with the small theatre studio and with the room where the sound effects for plays are produced. *Fig. 8* shows the plan of this arrangement, while *fig. 9* shows the control desk. The dramatic control desk, in contrast to the above-mentioned mixing cabins, is provided with all the necessities for arranging a complete broadcast; it may therefore, like the two ordinary control tables which are also present in the building, be connected directly with the line to the transmitter. The two ordinary control tables for which the need of

switching combinations is now less, due to the fact that the dramatic control desk has taken over part of their functions, are more simply equipped than those shown in *fig. 3*; they each contain only one fading unit for example. In addition to the facilitation of the performance of plays, there is another advantage in the division chosen in the case of the K.R.O. studios: if necessary three transmitters can be furnished with programme at the same time. In order not to decrease too much the number of rehearsals which can take place at once by the combining of several mixing cabins to a single control room, the two ordinary control tables are so arranged that they can be used for a simple rehearsal during a broadcast. The large concert hall again has its own mixing cabin; moreover, one of the control tables is in visual contact with the small concert hall.

Compiled by S. GRADSTEIN.

SOUND DIFFUSERS IN LOUD SPEAKERS

by J. de BOER.

534.861 : 621.395.623.7

Loud speakers have the tendency to exhibit a certain directional effect which becomes more pronounced with increasing frequency. Where such a beam formation of the high tones is undesired, *i.e.*, in small rooms, the directional effect can be neutralized by means of sound diffusers. These are bodies of definite shape and dimensions which are placed in the path of the sound waves. The required diameter of a sphere to be used as a sound diffuser can be derived theoretically. In the loud speakers of the Philips radio sets a cone and vertical partitions in front of the cone of the loud speaker are used as sound diffuser. The most suitable form and dimensions of these sound diffusers for scattering sound are determined experimentally.

When sound amplification is used in halls which have too long a reverberation time, an improvement of the acoustics of the hall can often be obtained by making use of loud speakers with a directional effect¹⁾. If these loud speakers are directed toward the part of the hall occupied by the audience, the sound intensity is there increased without an amplification of the reverberation necessarily also occurring.

Aside from such special cases, however, a directional effect is generally not desired with loud speakers. This is particularly true in the case of the loud speaker in the home. In this case the listener does not wish the fact of his listening or not listening to the radio to determine the place where he shall sit, but he wishes to be able to hear the

programme equally well from any spot in the room. Every loud speaker has a certain natural directional effect. In the following we shall discuss the extent to which this effect may be disturbing, and how it is possible to neutralize such a disturbing directional effect.

The directional effect of loud speakers

The appearance of a directional effect in sound radiation means that the distribution of intensity of the sound waves emitted deviates from spherical symmetry. The form of the distribution of the intensity of the sound wave depends upon the shape, the position and the dimensions of the radiating body. The loud speaker of a receiving set may for our purpose be considered by approximation to be a circular vibrating membrane placed in an infinitely large baffle board. The sound waves radiated from this source are spherically symmetrical only when

¹⁾ See J. de Boer, Sound Amplification, Philips techn. Rev. 3, 221, 1938, especially pages 226-227.

the dimensions of the membrane are small compared with the wave length. When this is not the case the sound is radiated mainly in a single direction, perpendicular to the radiating membrane.

For the case in which the membrane vibrates as a whole (this condition is satisfied at frequencies which are not too high), the sound distribution can be exactly calculated. It is found that the only parameter is the quotient a/λ , in which a is the radius of the membrane and λ the wave length of the sound. Fig. 1 shows the calculated distribution

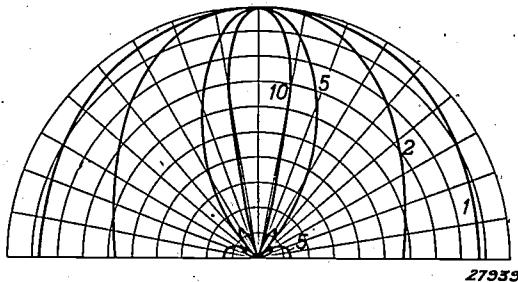

Fig. 1. Calculated directional distribution of the intensity of sound waves generated by a circular membrane vibrating as a whole in an infinitely large baffle board. The distribution is determined by a single parameter a/λ (a = radius of the membrane, λ = wave length), whose value multiplied by 2π is indicated for each curve.

of intensity for different values of the parameter a/λ . It may be seen that for

$$2\pi a/\lambda \leq \text{about } 2$$

the waves are practically spherically symmetrical, while for $2\pi a/\lambda \geq 2$ a more and more pronounced beam formation of the waves takes place. With an ordinary radio loud speaker the vibrating surface (the cone) has a radius $a = 10$ to 12 cm. The limiting value of the parameter mentioned corresponds in this case to a wave length of about 35 cm, i.e. a frequency of 1000 c/s. Tones of lower frequency are radiated by the loud speaker uniformly in all directions, tones of higher frequencies are, however, radiated mainly in the direction of the axis of the cone²⁾.

This quite universal phenomenon of sound radiation, that the low tones lack a tendency to form a beam, while the high tones show such a tendency, makes itself felt as a difficulty not only when the directional effect is deliberately sought, but also when it is undesired. For the case mentioned in the introduction, where a directional effect of the loud speakers was desired for the purpose of avoiding reverberation in a hall, it is quite difficult to obtain

a satisfactory beam formation of the low tones. Without special precautions the result may be that the non-directed part of the sound still causes a disturbing reverberation. On the other hand in the case where a directional effect is not desired, as in the living room of a private house, the problem is to avoid beam formation especially of the high tones. Such beam formation by the high tones has as result that the quality of the sound radiated to the sides becomes too dull and the sound directly in front of the apparatus too sharp, and that the latter sound suffers relatively more from background noise and interferences. The contribution of these extra sounds is namely the greatest at high frequencies.

The neutralization of the directional effect

How can beam formation with the high tones be avoided?³⁾ One possibility would be the reduction in size of the radiating surface, which would make the limiting frequency for the occurrence of the directional effect ($2\pi a/\lambda = 2$) higher. However, in order to obtain the desired volume of sound, even in the lower tones, with a smaller loud speaker, the membrane must be given very great amplitudes at low frequencies, which leads to distortion.

A very satisfactory solution of this problem of neutralizing the beam formation is obtained by placing in the path of the sound waves emitted a body which serves to scatter the waves. The effect of such a sound diffuser is illustrated in fig. 2, which represents tests carried out with a ripple tank⁴⁾. Figs. 2a and b show that with long wave lengths the "radiation" is spherical, and with short wave lengths directed. In fig. 2c two "sound diffusers" have been introduced into the path of the directed radiation, and it may be seen that instead of directed waves practically, spherically symmetrical waves are again radiated.

It is easily understood that the dimensions of the scattering body must have a definite relation to the wave length λ of the sound to be scattered. If the dimensions are very small with respect to λ ,

²⁾ This is also true for still higher frequencies, although the curves of fig. 1 cannot be directly applied in that case since the membrane then does not vibrate as a whole.

³⁾ In the previously mentioned opposite case, where it was difficult to obtain beam formation of the low tones, a solution can be found in the suppression of the waves having the undesired form of propagation (frequencies below 300 cycles); the intelligibility is in this case only slightly effected. In our case where it is the high tones (above 1000 cycles) which have the unfavourable propagation form, this method cannot of course be considered, since these tones are essential for good reproduction.

⁴⁾ Ripple tank: a tank filled with water in which waves are generated. The propagation, reflection etc. of these waves can thus be studied. Use is often made of this aid in acoustical experiments; see for example R. Vermeulen and J. de Boer, Philips techn. Rev. 1, 46, 1936, fig. 9.

the body has no effect on the propagation of the waves; if the dimensions are very large with respect to λ , a directional reflection of the waves occurs, so that the direction of the radiation is changed while the beam form is retained. The case in which a sphere is placed in the path of the waves has been dealt with by Stenzel⁵⁾, who calculated the intensity of the scattered sound as a function of

⁵⁾ H. Stenzel, *El. Nach. Techn.* 15, 71, 1938.

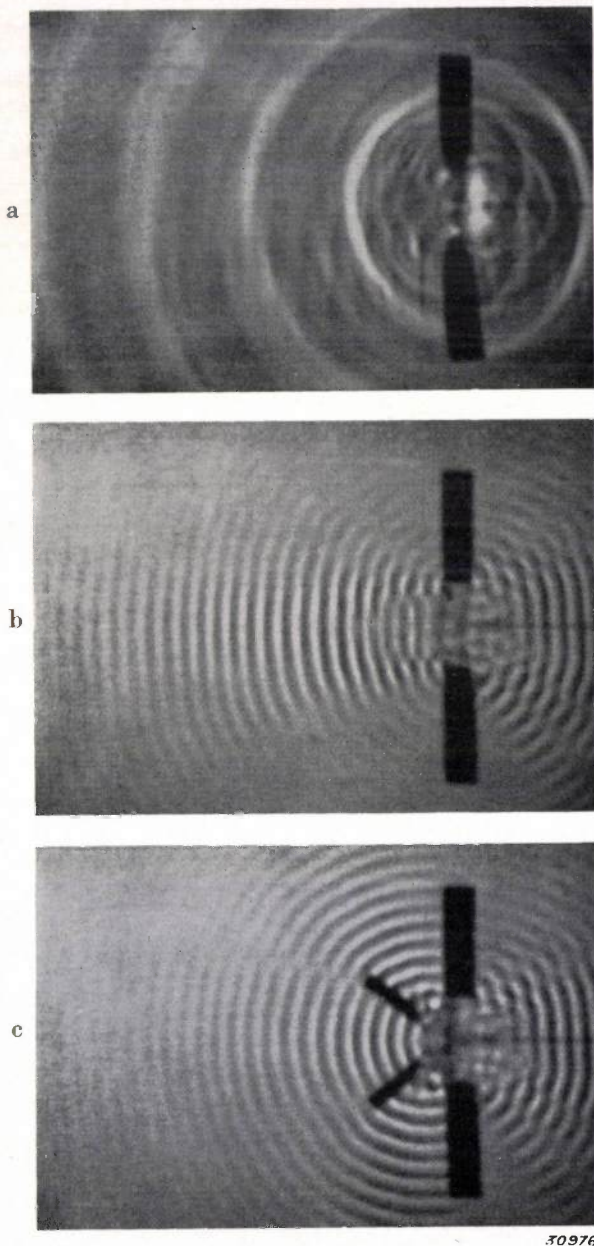

Fig. 2. Experiments with a ripple tank to illustrate the occurrence of a directional effect at high frequencies and the neutralization of this effect by means of sound diffusers.
 a) The relation between "source of sound" and wave length is the same as in a loud speaker emitting a tone of 1 000 c/s; the sound intensity is the same in all directions.
 b) The equivalent frequency is in this case 7 000 c/s instead of 1 000; the sound forms a beam in a single direction.
 c) Like b); the beam formation is neutralized by two sound diffusers.

the radius b of the sphere and the wave length λ . Again the form of this function is found to be determined by a single parameter, namely b/λ . In *fig. 3* the results of the calculations are given for different values of the parameter. In practical cases the scattering which corresponds to the curve for $2\pi b/\lambda = 2$ is sufficient. If for the frequency region from 1 000 to about 4 000 c/s for example one desires to obtain an approximately uniform scattering by means of a single scattering body, the dimensions of that body will have to be chosen to correspond to an average frequency, in this case therefore about 2 000 c/s. A sphere with the radius $b = 6$ cm may then be used as sound diffuser. Since this dimension is of the same order of magnitude as that of ordinary loud speakers, all the sound from a loud speaker could be adequately scattered with one sphere.

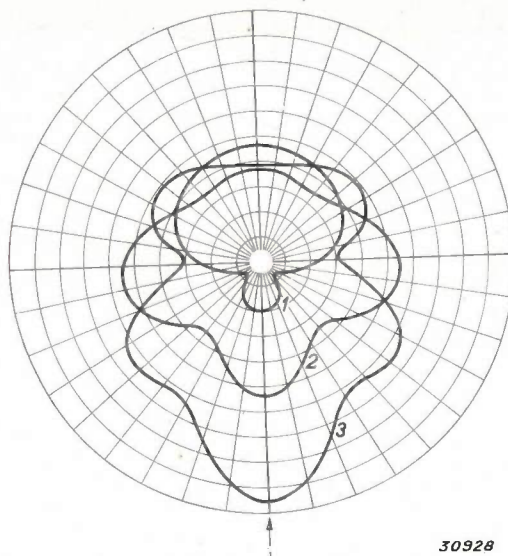

Fig. 3. Directional distribution of the sound pressure (measured at the surface of the sphere) of the wave scattered by a sphere, according to Stenzel. The sound pressure (measured at the sphere) of the plane wave incident on the direction of the arrow is set equal to unity. The scattering is determined by the parameter b/λ , whose value multiplied by 2π is indicated for each curve. At $2\pi b/\lambda = 2$ good scattering is obtained, at $2\pi b/\lambda = 3$ strong reflection already takes place.

Practical construction of sound diffusers

For structural reasons a sphere is not very suitable for use as sound diffuser in a loud speaker. If a truncated cone is used instead of a sphere the construction is very simple. This shape is used in most of the Philips loud speakers (see *fig. 4*). The best form for the cone has been determined by a large number of experiments. In *figs. 4a-d* the results of some of the measurements are given. These measurements refer to a radio loud speaker cone with an apex angle of 104° , a depth of 6.4 cm

and a radius of 10 cm. Scattering cones with an apex angle of 50° and an altitude of 6 cm (they do not extend outside of the loud speaker cone) are already found to give an appreciable result. With

a larger apex angle (larger area of base) there is the chance that the sound will be decreased too much directly in front of the apparatus. The scattering becomes appreciably better, however, when the

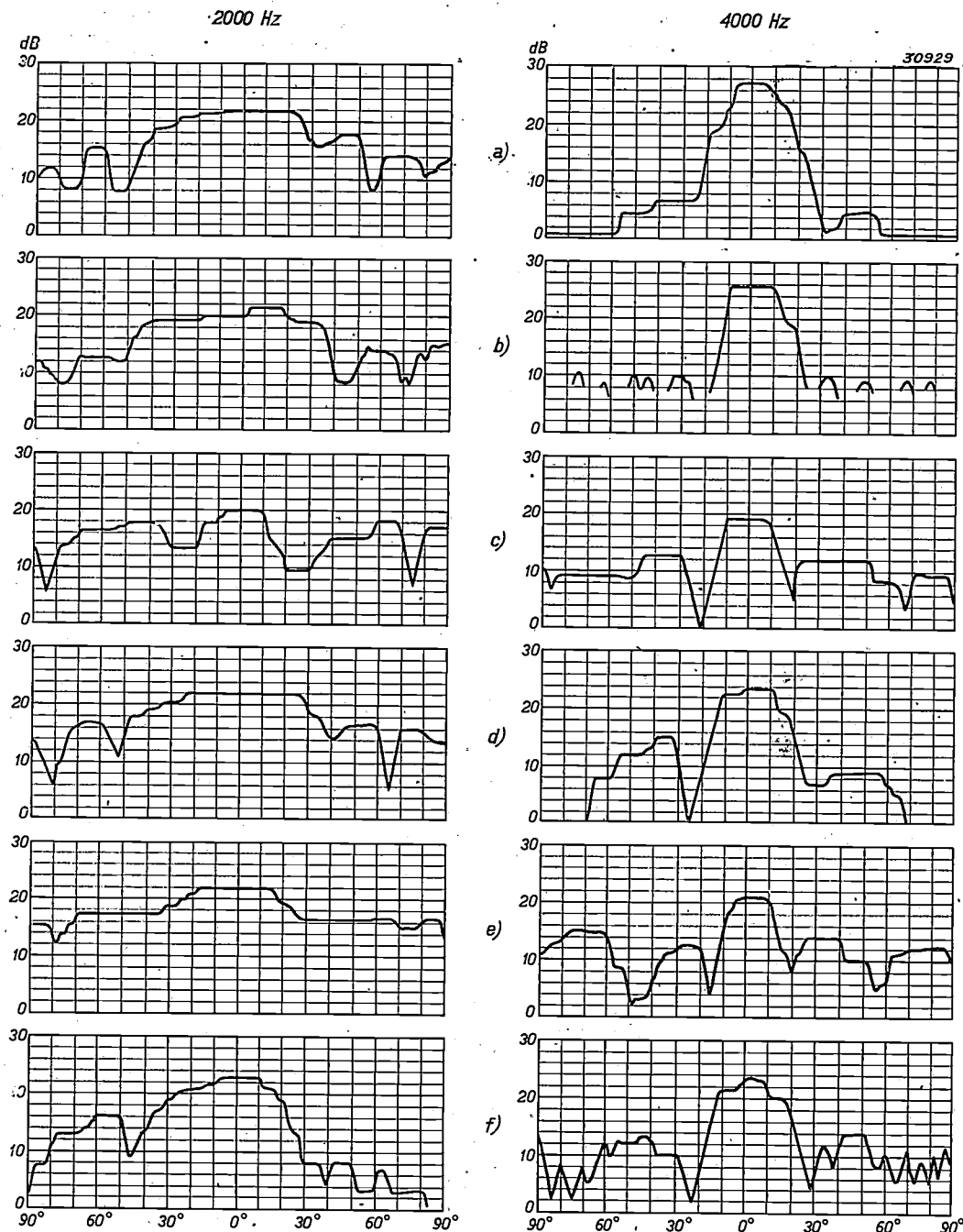

Fig. 4. Measured directional distribution of the sound intensity of a loud speaker; the intensities are measured in decibels. The recordings on the left were made at 2 000 c/s, those on the right at 4 000 c/s. The sharp minima which sometimes occur at certain angles may be ascribed to interferences which are due to the fact that at these high frequencies the membrane no longer vibrates as a whole. The measurements were made in the open air. When the loud speaker is situated in a room of a private house the minima are not noticeable, since the sound reflected from the walls is added to the direct sound.

- a) Directional distribution without diffuser.
- b) Scattering cone with apex angle 20° , 14 cm long.
- c) Scattering cone with apex angle 50° , 14 cm long.
- d) Scattering cone with apex angle 50° , 6 cm long.
- e) Scattering partitions at about 50° , 14 cm long.
- f) Scattering partitions at about 50° , 6 cm long.

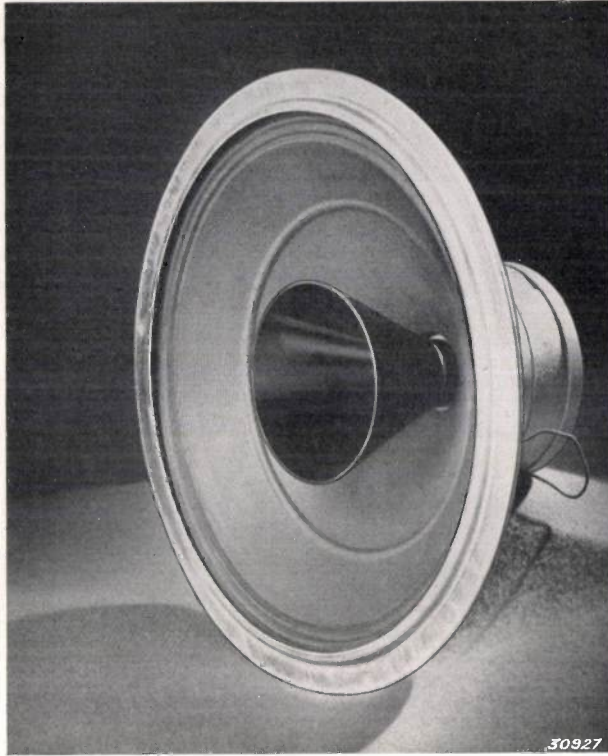

Fig. 5. Loud speaker with conical sound diffusers.

scattering cone extends farther out of the loud speaker cone (8 cm for instance).

In the construction of loud speakers for radio sets account must be taken of the necessity of housing them in a cabinet which must satisfy certain aesthetic requirements. Because of the shallowness of the space available for building in the loud speaker a scattering cone which extended very far out of the loud speaker cone would form an almost insurmountable obstacle in this respect. For this reason in the Philips loud speakers, in the

cases where an improvement on the scattering obtained by means of a small cone seemed desirable, a more intense scattering has been achieved by means of two vertical partitions placed symmetrically in front of the loud speaker cone. In this case also the most suitable dimensions and position were determined experimentally. In fig. 5e-f results of several of these measurements are given. Fig. 6 is a photograph of a loud speaker with partitions. The partitions can be incorporated into the design of the radio cabinet in a satisfactory manner.

While the form of the distribution of the intensity of the sound wave obtained when a cone is used as sound diffuser is rotationally symmetrical to the axis of the loud speaker, the sound is spread by the vertical partitions only in one horizontal plane. For use in private homes this is no objection since in this case the heads of all the listeners are at about the same height as the loud speaker.

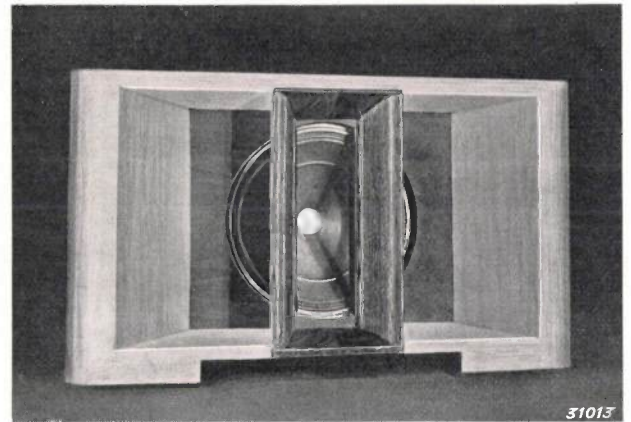

Fig. 6. Loud speaker of the receiving set 850a, with partitions in front of the loud speaker cone as sound diffuser.

THE SIGNIFICANCE OF A CONSTANT PEAK TIME IN PHOTO FLASH BULBS

by J. A. M. van LIEMPT and P. LEYDENS.

771.448.1

In a previous article in this periodical¹⁾ it was explained that certain advantages are offered in photography by flash-light, when the flash-light and the shutter of the camera can be operated simultaneously by means of a synchronizer. The latter is an apparatus which is fixed to the camera and provides that the shutter is operated at a definite (preferably determinable) moment after

the ignition of the photo flash bulb. By using a synchronizer it is for example possible to make instantaneous exposures with exposure times shorter than the flash time of the flash bulb.

In the above application of the synchronizer it is of course desirable to have the exposure take place at the moment when the flash-light is at its greatest intensity. Since the difference in time between the switching on of the flash-light and the opening of the shutter is fixed by the adjustment

¹⁾ Philips techn. Rev. 2, 334, 1937.

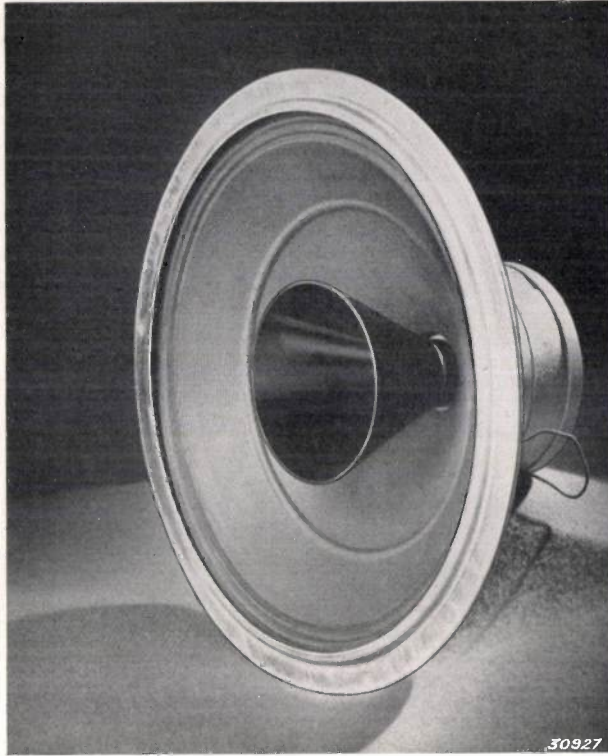

Fig. 5. Loud speaker with conical sound diffusers.

scattering cone extends farther out of the loud speaker cone (8 cm for instance).

In the construction of loud speakers for radio sets account must be taken of the necessity of housing them in a cabinet which must satisfy certain aesthetic requirements. Because of the shallowness of the space available for building in the loud speaker a scattering cone which extended very far out of the loud speaker cone would form an almost insurmountable obstacle in this respect. For this reason in the Philips loud speakers, in the

cases where an improvement on the scattering obtained by means of a small cone seemed desirable, a more intense scattering has been achieved by means of two vertical partitions placed symmetrically in front of the loud speaker cone. In this case also the most suitable dimensions and position were determined experimentally. In fig. 5e-f results of several of these measurements are given. Fig. 6 is a photograph of a loud speaker with partitions. The partitions can be incorporated into the design of the radio cabinet in a satisfactory manner.

While the form of the distribution of the intensity of the sound wave obtained when a cone is used as sound diffuser is rotationally symmetrical to the axis of the loud speaker, the sound is spread by the vertical partitions only in one horizontal plane. For use in private homes this is no objection since in this case the heads of all the listeners are at about the same height as the loud speaker.

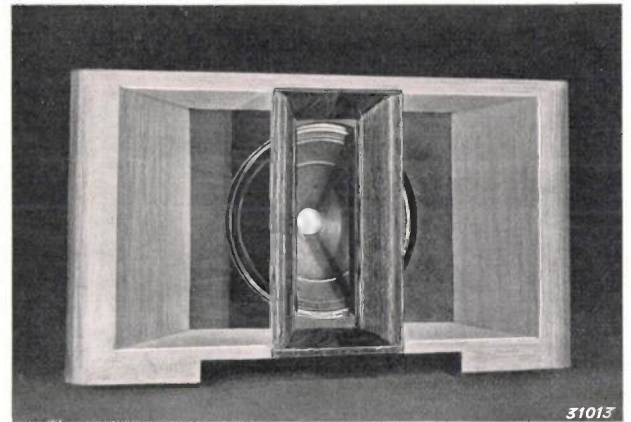

Fig. 6. Loud speaker of the receiving set 850a, with partitions in front of the loud speaker cone as sound diffuser.

THE SIGNIFICANCE OF A CONSTANT PEAK TIME IN PHOTO FLASH BULBS

by J. A. M. van LIEMPT and P. LEYDENS.

771.448.1

In a previous article in this periodical¹⁾ it was explained that certain advantages are offered in photography by flash-light, when the flash-light and the shutter of the camera can be operated simultaneously by means of a synchronizer. The latter is an apparatus which is fixed to the camera and provides that the shutter is operated at a definite (preferably determinable) moment after

the ignition of the photo flash bulb. By using a synchronizer it is for example possible to make instantaneous exposures with exposure times shorter than the flash time of the flash bulb.

In the above application of the synchronizer it is of course desirable to have the exposure take place at the moment when the flash-light is at its greatest intensity. Since the difference in time between the switching on of the flash-light and the opening of the shutter is fixed by the adjustment

¹⁾ Philips techn. Rev. 2, 334, 1937.

Phase 1: Beginning of ignition.

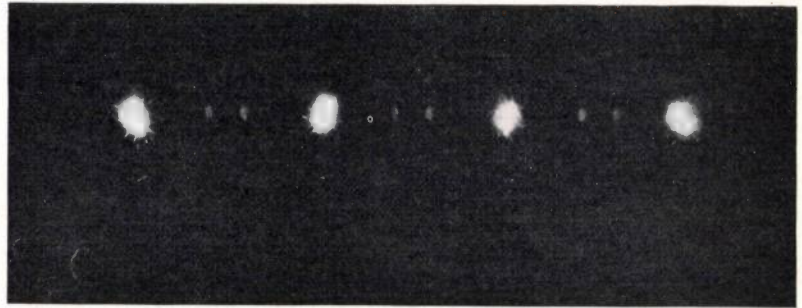

Phase 2: 0.01 sec after beginning of ignition. The light zone grows from within toward the outside.

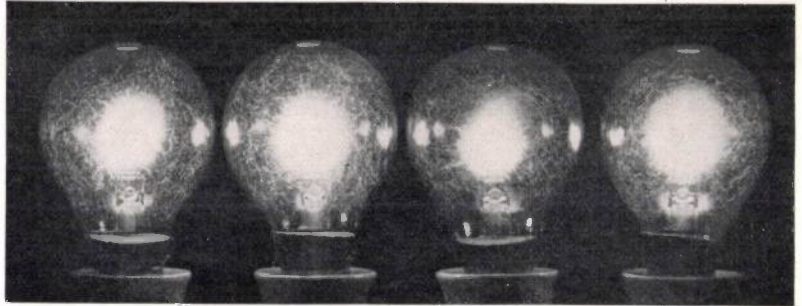

Phase 3: 0.02 sec after beginning of ignition. The light zone fills almost the entire bulb. At the wall, however, there is still a certain amount of unburned aluminium-magnesium wire.

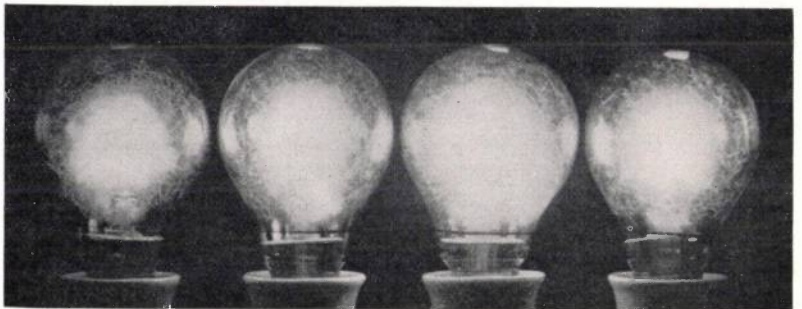

Phase 4: 0.025 sec after beginning of ignition. The light zone has reached the wall. This is approximately the moment of maximum light development.

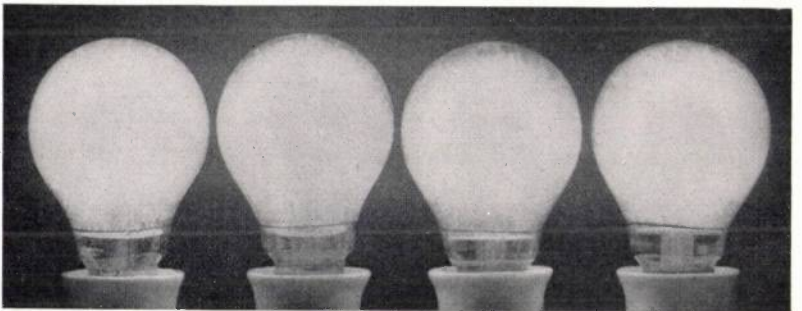

Phase 5: 0.055 sec after beginning of ignition.

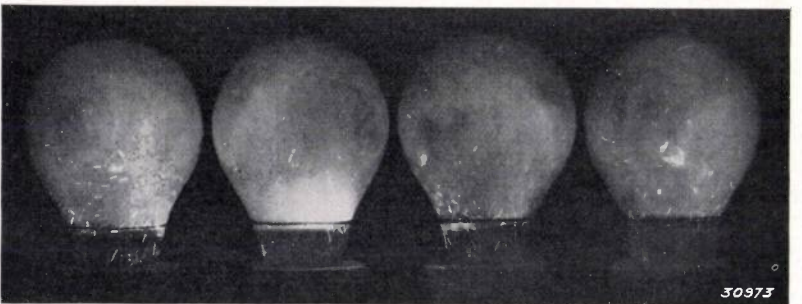

Fig. 1. Each of the five photographs shows four "Photoflux" photo flash bulbs, type II, which were ignited simultaneously and photographed after a definite time with an exposure of $1/200$ sec. The photographs show that the combustion process in all the bulbs progresses at practically the same rate.

of the synchronizer²⁾ the so-called peak time, *i.e.* the time which elapses between switching on of the flash-light and its maximum light development, must be constant³⁾.

of the 4 volt battery of an electric torch. This combination of bulbs (as subject) was photographed with an iris shutter set at $\frac{1}{200}$ sec. By means of an adjustable synchronizer different values were cho-



Fig. 2. Stream from the spout of a teapot upon pouring out a cup of tea at the moment when the stream of tea has not yet reached the cup.

Data:

Light source: 1 "Photoflux" type II;
 Distance source to object: 1.2 m;
 Diaphragm: F/11
 Exposure time: $\frac{1}{1000}$ sec, focal plane shutter
 Material: panchromatic $\frac{21^\circ}{10}$ DIN

In order to study the constancy of the process of combustion in its various stages, and therefore the constancy of the peak time, the following test was carried out. A number of flash bulbs, connected in parallel were simultaneously ignited by means

sen for the difference in time between the ignition of the bulb and the opening of the shutter.

Fig. 1 is a series of photographs obtained in this way, in each case with four "Photoflux" flash

²⁾ On the subject of setting a synchronizer for operating a Compur shutter see Philips techn. Rev. 2, 334, 1937. A method of adjustment which can be used with focal plane shutters is described in the book; *Photografie bij kunstlicht*, by J. A. M. van Liempt and P. Leydens, publisher N. V. Lecturius, which will appear shortly.

³⁾ Since shutter, synchronizer and the torch battery with which the synchronizer is set in action are subject to certain variations, it is desirable that the maximum of the light-time curve of the flash-light should not be too narrow. This curve in the case of the "Photoflux" satisfies the requirements and is shown in Philips techn. Rev. 2, 334, 1937, fig. 6.

bulbs, type II. It is clear that the different lamps behave quite similarly in all stages of the process of combustion.

Thanks to the constancy of the bulb, which has made it possible to couple shutter and bulb effective-

lumens at the moment of greatest intensity. Upon use of a reflector the intensity of illumination at a distance of 2 m corresponds approximately to that of bright sunlight in the summer. *Figs. 2 and 3* are two examples of subjects which can only be



Fig. 3. Dive photographed under the following conditions:

Light source: 1 "Photoflux", type II;
 Distance source to object: 4 m;
 Diaphragm: F/6.3;
 Exposure time: $\frac{1}{500}$ sec. Compur shutter;
 Material: panchromatic $\frac{21}{10}$ DIN.

ely, it is possible to make any desired instantaneous exposures by flash-light with short exposure times such as were previously only possible by artificial light with an ultra fast film camera. This will be clear when it is kept in mind that a "Photoflux" type II develops a light flux of more than 2 million

photographed with extremely short exposure times. As may be seen from the text under the figures, with an exposure time of $\frac{1}{1000}$ sec, there is even sufficient light to make it possible to use a relatively small diaphragm, which increases the depth of focus in the pictures.

ABSTRACTS OF RECENT SCIENTIFIC PUBLICATIONS OF THE N.V. PHILIPS' GLOEILAMPENFABRIEKEN

1364*): R. Houwink and Ph. N. Heinze: Prüfung von Kunstharzen mit dem Plastometer (Kunststoffe 28, 283-287, Nov. 1938)

For determining the quality of resins, especially of hardening artificial resins, it is very important to know the hardness or the softening point and the speed of hardening. In this article several instruments are described for the measurement of these properties, while several results obtained with the instruments are discussed.

1365: C. J. Bakker and Balth. van der Pol: Report on spontaneous fluctuations of current and potential (C.R. Union Rad.-sci. int., Venise, 5, 217-227, 1938).

In this report to the congress of the Union Radioscientifique internationale held in Venice in 1938, the causes were discussed of spontaneous fluctuations of current and potential. They are the following:

- 1) the heat motion of the electrons in the electrical circuits and
- 2) the irregular transition of the electrons in an evacuated tube. As causes of the irregular transition of electrons were mentioned: shot effect, secondary emission and the distribution of the electrical current over the different electrodes.

1366*): F. Coeterier: Demonstration of the principle of the infra-red telescope (Ned. T. Natuurk. 5, 216-218, Sept. 1938).

1367: A. C. van Dorsten: Cascade generators for high direct voltages (Ned. T. Natuurk. 5, 218-220, Sept. 1938).

1368*): W. Elenbaas: High-pressure mercury discharges (Ned. T. Natuurk. 5, 221-222, Sept. 1938).

1369*): P. H. J. A. Kleynen: Model for the investigation of the motion of electrons in two-dimensional electrostatic fields (Ned. T. Natuurk. 5, 222-224, Sept. 1938).

1370*): J. F. Schouten: The use of sound film as diffraction grating for light (Ned. T. Natuurk. 5, 224-228, Sept. 1938).

These five short contributions give a description of a series of demonstrations which were given before a meeting of the Netherlands Physical Society on June 18, 1938 in the Philips Laboratory. For 1367 we may refer the reader to: Philips techn. Rev. 1, 6, 1936 and 2, 161, 1937, for 1369*) to Philips techn. Rev. 2, 338, 1937 and for 1370*) to Philips Rev. 3, 298, 1938.

1371: A. Bouwers: Die Technik der Neutronenerzeugung und der Erzeugung künstlicher Radioaktivität (Strahlentherapie, 63, 537-544, Nov. 1938).

In this article a survey is given of the different methods of producing neutrons (cf. also: Philips Techn. Rev. 3, 339, 1938), and various apparatus are described for the acceleration of charged particles. The excitation of radioactivity by bombardment with neutrons is discussed briefly, as well as the measures necessary for protection against high tension, X-rays and neutrons.

1372: J. F. Schouten: The perception of subjective tones (Proc. kon. Ned. Akad. Wet. A'dam 41, 1086-1093, Dec. 1938).

When a purely sinusoidal tone strikes the ear, one perceives, besides the main tone, several overtones, due to non-linear effects in the ear. When a complex sound is heard from which the actual main tone has been removed so that the sound really consists only of overtones, then due to sound distortion in the ear the main tone may also be perceived, namely as the difference tone of the harmonics. With the help of artificially produced sound, the author has investigated the factors which determine the pitch of the tone perceived. This pitch is by no means determined by the lowest tone which occurs in the Fourier analysis of the sound striking the ear or excited in the ear by distortion. Even when the main tone is entirely absent in the ear, a pitch is assigned to the tone which corresponds to that of the missing main tone. This seems to indicate that the ear is actually able to observe the fundamental period of a complex sound and in this way to reach a perception of the pitch.

*) An adequate number of reprints for the purpose of distribution is not available of the publications marked with an asterisk. Reprints of other publications may be obtained on application to the Natuurkundig Laboratorium, N.V. Philips' Gloeilampenfabrieken, Eindhoven (Holland), Kastanjelaan.

Philips Technical Review

DEALING WITH TECHNICAL PROBLEMS
RELATING TO THE PRODUCTS, PROCESSES AND INVESTIGATIONS OF
N.V. PHILIPS' GLOEILAMPENFABRIEKEN

EDITED BY THE RESEARCH LABORATORY OF N.V. PHILIPS' GLOEILAMPENFABRIEKEN, EINDHOVEN, HOLLAND

A MILLION VOLT X-RAY TUBE

by J. H. van der TUUK.

621.386.1.027.7 : 615.849

In the use of X-rays in medical therapy there is at present a tendency to use higher and higher voltages. The very hard X-rays so obtained (comparable with γ -rays) have the advantage of a much higher efficiency, a higher percentage depth dose and less scattering. In this article the problems which are encountered in the construction of X-ray tubes for very high voltages will be discussed. A description is then given of a million volt X-ray tube which was developed in the Philips X-ray laboratory and is now in use in the Cancer-Institute of the Antoni van Leeuwenhoekhuis in Amsterdam. In contrast to the experimental tubes for this voltage which have for example been used in the United States, this tube works without a pumping system and has a length of only 2.40 m. The radiation dose obtained is equivalent to that of about one kilogram of radium. In conclusion several properties of the radiation, as well as the necessary protective measures are discussed.

In the application of X-rays in medical therapy, especially in the treatment of malignant growths (cancer, for example), use is made of the destructive action of the rays on tissues. The γ -rays of radium are also used for the same purpose. There is no fundamental difference between X-rays and γ -rays from the physical point of view: γ -rays are very hard X-rays (of very short wave length), which could be excited artificially if an X-ray tube for a sufficiently high voltage were available (for the hardest γ -rays of radium about 2 million volts). Since, however, the nature of the influence of the rays on the tissues is only very imperfectly known, it is reasonable to suppose that the biological action of the γ -rays may differ from that of the softer X-rays which are obtained for instance with 200 kV.

Such a specific action of very hard X-rays has not yet been convincingly proved. Very hard X-radiation has, however, various properties which allow one to expect somewhat more favourable clinical results than with the softer (200 kV) rays. The efficiency in the process of excitation of the rays increases very much with increasing voltage of the tube; furthermore the percentage depth dose in the treatment of patients, *i.e.* the ratio of the dose 10 cm below the skin for example to that at the surface of skin, shows considerable increase, while at the same time less radiation is scattered to

the sides and backwards, so that the surrounding healthy tissue and the skin are less exposed to attack. These advantages are sufficiently important to justify medical interest in X-ray tubes for very high voltages, even without any specific effect of the very hard rays. In this article we shall briefly describe the development of these tubes. A detailed description will be given of a million volt X-ray tube which is now in use at the Cancer-Institute in the Antoni van Leeuwenhoekhuis in Amsterdam.

Constructional Problems with X-ray tubes for very high voltages

If an attempt is made to load an ordinary X-ray tube, such as is used in diagnosis or structural analysis, and is intended for not more than 100 kV, with higher voltages, undesired phenomena occur inside as well as outside the tube. Outside the tube flash-over may occur in the air between the electrodes, or creeping discharge along the glass. Inside the evacuated tube independent discharges may occur, resulting in local destruction of the glass or the electrodes. These are the most important difficulties which must be overcome in the construction of X-ray tubes for very high voltages.

For the avoidance of flash-over, etc. outside the tube a certain insulation length is necessary between the parts which are at high tensions with

respect to each other. Inside the tube the situation is more complicated. The greatest difficulties experienced are due to stray electrons which may originate in two ways: by electron bombardment (secondary electrons) and by cold emission¹⁾.

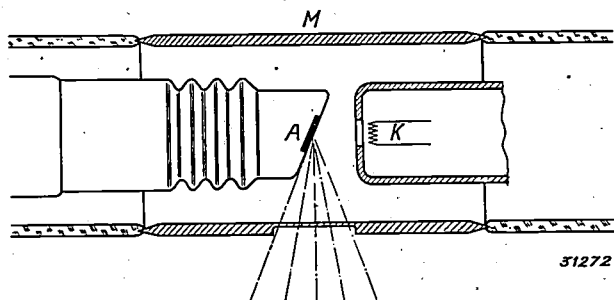

Fig. 1. Diagram of the electrode system of an X-ray therapy tube for 200 kV. The anode *A* and cathode *K* are about 1 cm apart. The glass of the tube is replaced by a metal middle section *M* at the point where the discharge takes place.

When such stray electrons reach certain places in the tube they may cause trouble in various ways. If they impinge on the glass it becomes heated and electrolysis (in the neighbourhood of sealing-in spots) or localized attack or perforation of the glass may occur. The gas atoms still present in the tube are ionized, and this may lead to a flash over between the electrodes. The metal parts, struck by the stray electrons, emit an unwanted X-radiation. In addition to these there are still other effects which are promoted by those already mentioned; for example the heated parts begin to give off gases and thus the ionization is increased; the stray electrons free new electrons from the metal parts; they may also cause a negative charge on the insulated parts of the tube which results in a distortion of the electric field and an increased chance of cold emission, creeping discharge along the surface of the tube or even breakdown through the glass.

The simplest way to give some idea of the manner in which these difficulties were solved, is perhaps to describe a series of tubes in which the voltage has been successively increased.

In *fig. 1* a schematic diagram is given of the electrode system for a tube with which voltages up to 200 kV. were reached. The tube itself is sufficiently long to keep the connection points of the high voltage sufficiently far away from each other in the air. The electrodes in the tube, however, are placed relatively close together (about 1 cm at 200 kV) This is desirable in order to prevent the electrons from meeting and ionizing too many gas atoms along their path: the shorter the path of the electrons the less the ionization. For the same reason

the tube is rigorously outgassed during construction in order to obtain the best possible vacuum. The glass of the tube is replaced by a metal middle section at the spot where the discharge proper takes place. This part of the tube is most exposed to bombardment by secondary electrons which are liberated at the anode at the same time as the X-rays are excited.

The secondary electrons, which amount to 10 to 20 per cent of the number of primary electrons, are emitted in all directions from the focus, and will for the most part be drawn back again to the anode by the electric field. Since, however, most of them have very high velocities (not much lower than the primary electrons), with the electrode configuration of *fig. 1*, part of them return only far toward the back of the anode. The tertiary electrons freed there may again prove dangerous to the glass. In order to prevent the secondary electrons from travelling so far back, the form of electrodes shown in *fig. 2* was chosen: the surfaces of cathode and anode are parallel over an area whose diameter is four times the distance between them. It may be demonstrated²⁾ that with this configuration all the secondary electrons which leave the focus at the centre of the anode fall back again on the front surface of the anode, and thus cannot leave the space between the electrodes.

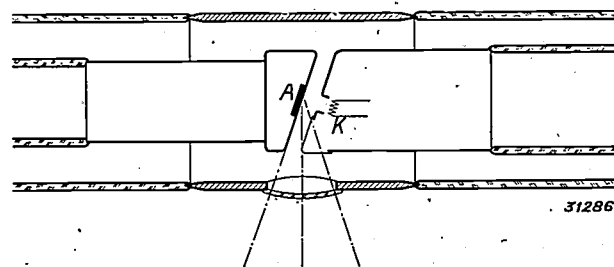

Fig. 2. If the surfaces of cathode and anode are parallel over an area whose diameter is equal to four times the distance between them all the secondary electrons which are formed at the focus are drawn back again to the front surface of the anode. The projecting corner of the cathode is made very thin so that the X-rays can pass through it almost without attenuation.

In this way, as has been stated, voltages of 200 kV were reached. The configuration of *fig. 3*, where the greater part of the secondary electrons are captured in a hollow in the anode and the rest fall upon the concave front surface of the anode, gave somewhat higher voltages (about 250 kV). Due to the gradual curvature of the surface of the cathode there are no sharp edges which could increase the density of the electric field or the field

¹⁾ On the subject of cold emission see for example Philips techn. Rev. 4, 103, 1939.

²⁾ A. Bouwers and J. H. van der Tuuk, Secondary electrons in X-ray tubes, *Physica* 12, 274, 1932.

strength, so that cold emission becomes less dangerous.

The following step was the construction of a tube which was fundamentally a proportionate enlargement of the tube for 200 kV, with double the

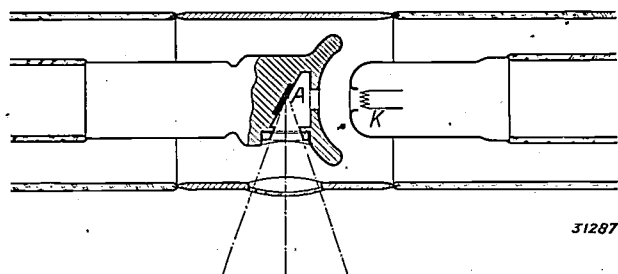

Fig. 3. Electrode configuration for capturing the secondary electrons in a hollow of the anode or on the front surface of the anode. Due to the gradual curvature of the surface of the cathode the chance of cold emission is considerably lessened.

dimensions of that tube. With twice the voltage, i.e. 400 kV, the same maximum values of the field strength were reached as with the smaller tube. In static tests this large tube was actually found to withstand 400 kV for a time. In use, however, (i.e. with current flowing) the voltage could not be raised much higher than about 300 kV for lengthy irradiations. The secondary, tertiary, etc. electrons in this case apparently had so much energy that, notwithstanding the fact that their number had been decreased in the way described, they still caused too much heat development and giving off of gas, etc. by their bombardment.

An improvement was obtained here in the first place by the introduction of a "getter". A getter is a substance³⁾ which combines with, and thus retains, the gases present in the tube or freed by electron bombardment during operation. The higher vacuum obtained in this way was accompanied by two advantages. In the first place the chance of independent discharges in the tube was diminished owing to the decreased ionization, so that the voltage could be raised to 350 kV. In the second place the emission of the hot tungsten cathode was made more stable, which is very desirable in order to be able to control the dose of the X-radiation applied. The greater stability of the emission when a getter is used may be explained by the fact that small amounts of certain gases in the tube may contaminate the hot cathode and temporarily diminish its emission.

As stated above, one of the harmful effects of stray electrons consists of a field distortion due to the negative charging of insulating parts of the tube. Such charging occurred especially in the case

of the metal middle section of the tube which surrounds the electrodes. The obvious solution of this difficulty of field distortion was to prevent the potential of the middle section from "oscillating" by giving it a constant potential. If for example anode and cathode are at equally high positive and negative potentials respectively, with respect to earth, then the surrounding middle section can be earthed. By this subdivision of the voltage the tube can never be under more than half the basic voltage, while with an "oscillating" middle section it was possible for this section to assume nearly the cathode potential. The principle of subdivision of the voltage was now carried through further by fastening a partition to the middle section (fig. 4), so that the anode and cathode are situated

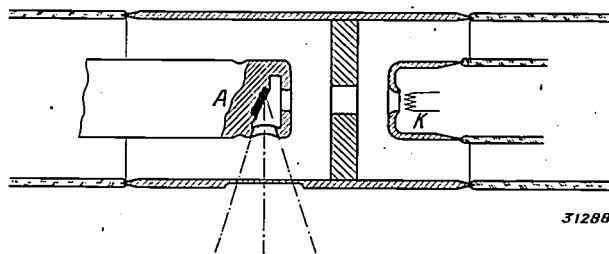

Fig. 4. Electrode system with intermediate partition. The middle section with the partition is given a constant potential which lies halfway between the potentials of anode and cathode (symmetrical division of the voltage).

in two entirely separate spaces, while the primary electron beam is allowed to pass through an opening in the partition. The action of this partition is easily understood: we have already stated that care must be taken to prevent undesired electrons from covering long distances in the tube. In order to prevent the field strengths (cold emission) from exceeding the permissible limit, tubes for higher voltages had to be larger, and at the same time the total path of the electrons was made longer. The intervening partition, however, reduces these paths to the same order as in tubes for half the voltage. Ionization, and with it the danger of breakdown in the tube, is considerably reduced in this way. Moreover the electrons freed by cold emission can no longer reach the anode, but can only bombard the partition, at which point they have only half as much energy. The X-ray tubes constructed on this principle and provided with getters were found easily to withstand voltages up to 400 kV and to attain an entirely satisfactory life at this voltage⁴⁾.

³⁾ See for example, Philips techn. Rev. 3, 296, 1938.

⁴⁾ Such tubes have been used successfully for several years in the institute of Prof. Maisin in Louvain. The tube had a life of from 2000 to 4000 hours. Cf. J. Maisin and P. Estas, Radiologica 1, 100, 1937.

By consistent application of the principle of subdivision of the voltage, technical X-ray tubes can now also be constructed for still higher voltages. Two or more tubes each suitable, for instance, for 350 kV are connected in series. In this way an X-ray tube for 700 kV was first developed. This has been described elsewhere⁵⁾. An X-ray tube for one million volts has now been constructed in the Philips laboratory according to the same principle. The details of this tube, which we shall describe briefly, will be readily understood from the explanation given above.

Construction of the X-ray tube for one million volts

Fig. 5 is a schematic diagram of the tube. It may be seen that the three units 1, 2, 3 are

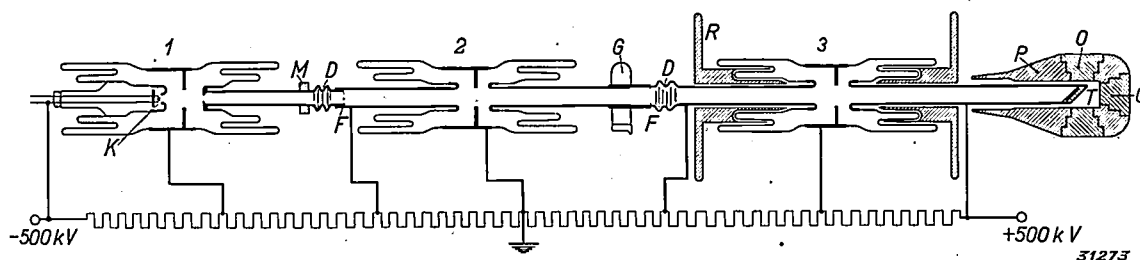

Fig. 5. Diagram of the million volt X-ray tube. The three units 1, 2, 3 are prepared separately and evacuated, and then put together. At *F* metal foil for provisional sealing, *K* cathode, *T* target, *M* focussing magnet, *D* flexible metal sections, *G* metal holder with spare getters, *P* lead jacket for screening the X-rays outside the effective beams, which are transmitted through the window *O*. The ring-shaped hollows in the double folds of the glass wall of each unit are filled with a "Philite" body *R* (indicated only in the case of the third unit). The voltage across the tube is subdivided into 6 steps which are tapped from a potentiometer.

connected in series. The anodes of all three units are perforated. Electrons emitted by the hot tungsten cathode *K* and accelerated between cathode and anode of the first tube, enter the hollow anode, travel with constant velocity through the narrow connecting piece into the second tube. They are here accelerated a second time between cathode and anode, and yet a third time in the third tube. At the end of the channel in the third anode the electrons finally strike the target *T*, where the X-radiation is excited.

The three units are prepared separately, out-gassed and evacuated; during these manipulations they are provisionally closed at the ends by thin metal foils. The ends of the tubes are then placed together, as shown in fig. 6 and soldered. The connection between the vacua in the three separate tubes is brought about simply by melting the foil by bombardment with primary electrons. The fact that it is possible to use this method is due to the use of getters, which absorb the gases freed during

⁵⁾ A. Bouwers and J. H. van der Tuuk, Brit. J. Radiology 9, 431, 1936.

soldering and perforation of the foils. Since a good vacuum becomes more and more important with increasing voltage, the ease with which the vacuum is maintained in the tube here described without pumping during operation (it remains 10^{-5} mm Hg) is one of its most important characteristics. It has even been found possible to open the tube, and replace one of the three units by a new one, after which evacuation at room temperature by means of a transportable pump was found to be sufficient to cause the tube to work perfectly again after being sealed off the pump. Several spare getters are introduced into the holder *G*. These can be brought into action when desired by evaporation.

Another practical and very welcome property

of the tube is its relative shortness, which is made possible by the double folds in the glass connections between cathode, middle section and anode of each unit. By this artificial lengthening of the glass insulation creeping discharges along the outside of the glass are prevented, while local direct sparking is prevented by filling the ring-shaped hollows between the folds with a "Philite" body (indicated in fig. 5 only in the case of the third unit). Each unit is now 40 cm long, and the total length of the tube, including the bulb-shaped shields at either end to prevent corona losses, amounts to only 2.40 m. In order to keep the primary electrons well together over the long distance between cathode *K* and

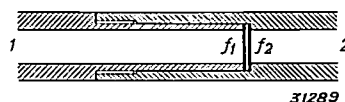

Fig. 6. The joining of the separate units. The ends of the anode tube of 1 and the cathode tube of 2 are provisionally sealed with thin metal foil, f_1 and f_2 . The ends are soldered together and only a small quantity of air is enclosed between the foils. These air residues, as well as the gases freed in the perforation and smelting of the foils, are taken up by a getter.

target T a focussing electric field is applied near the cathode and at M a focussing magnetic field (by means of a ring-shaped permanent magnet). The losses of the electron current in passing through the two narrow connecting tubes amount to not more than a few per cent.

In each unit and in the complete device the principle of the subdivision of the voltage is applied. The middle sections (with partition) of the three units and the two connecting tubes reach such potentials that the voltage between cathode and target is divided into six equal steps. The simplest and best method of giving the separate parts of the tube the required potentials consists in tapping off the voltages in question from the high tension generator. This method can only be applied when a cascade generator is used which is designed especially for this type of X-ray tube in such a way that the number of stages in cascade arrangement corresponds to the desired voltage division along the X-ray tube. In general, however, tube and generator will not have been designed for each other; in that case the desired voltages must be tapped from a potentiometer. The carbon resistances which are used as potentiometer are oil-cooled. The same circulating oil also serves to cool the target. In the apparatus of *fig. 7*, where the

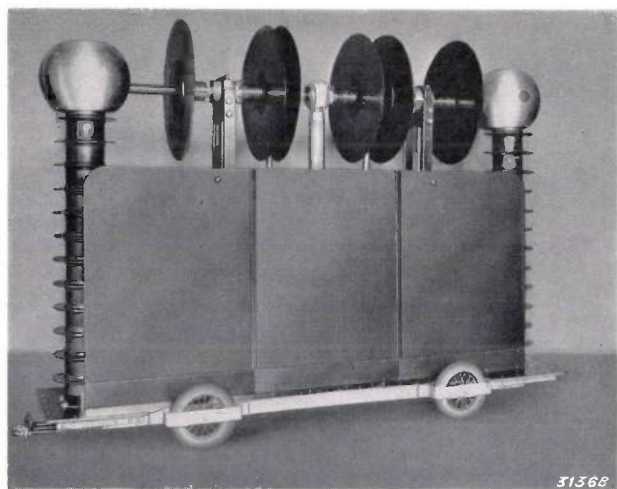

Fig. 7. Million volt X-ray tube mounted on a car. The total length, including the bulbs at each end for preventing corona losses, is 2.40 m. In the insulating columns at either side which support the tube oil-cooled potentiometer resistances are housed, from which the voltages are tapped for the different parts of the tube.

tube is mounted on a car, the resistances are housed in the two "Philite" columns at either side (200 megohms in each column) which support the anticorona bulbs of the electrodes. The middle of the tube is earthed in this case.

In each of the connecting sections between the

three units a flexible metal middle piece has been mounted, in order to make it possible to transport the tube as a whole.

Use of the tube in an installation

In the practical application of the tube the surroundings must be sufficiently screened against the X-rays which are emitted in all directions by the target. As we shall see later, lead armour nearly 10 cm thick is necessary for this purpose. The method of construction shown in *fig. 5*, where the target is at the end of a long thin tube, makes this protection very easy. The lead jacket can be applied directly to this tube so that a relatively small amount of lead is sufficient. Several windows are left open in this lead jacket, so that if necessary several patients can be treated at the same time. An arrangement of the tube similar to the one chosen in the Cancer Institute in Amsterdam is shown in *fig. 8*. The high voltage of one million volts is supplied by a bipolar cascade generator, such as has already been described in this periodical⁶⁾. The X-ray tube is mounted on top of the generator and its centre is earthed. The floor of the treatment room (above the generator) directly above the tube is vaulted; this is where the patients lie, separated by walls, when several are being irradiated at the same time. The distance of each patient from the target is at least 1 m, which is necessary as the target is at a high voltage (500 kV). The voltage across the tube is measured simply by the current which flows through the above-mentioned potentiometer resistance. This current is of the order of 1 to 2 mA. *Figs. 9 and 10* are two photographs of this installation which show other details of the method of mounting the X-ray tube.

If it is desired to bring the patient closer to the focus of the tube, the target may be earthed instead of the centre of the tube. In that case a high tension generator for one million volts with respect to earth is required. A projected installation of this type is sketched in *fig. 11*.

Properties of the X-radiation produced

The shortest wave length γ (in Å) of X-rays which can be obtained with a voltage V (in kilovolts) follows from the relation

$$V\gamma = 12.4$$

At $V = 1000$ kV the limit of the X-ray spectrum thus lies at $\lambda = 0.0124$ Å. In *fig. 12* the spectrum is given of the radiation of a million volt tube,

⁶⁾ Philips techn. Rev. 1, 6, 1936; 2, 161, 1937.

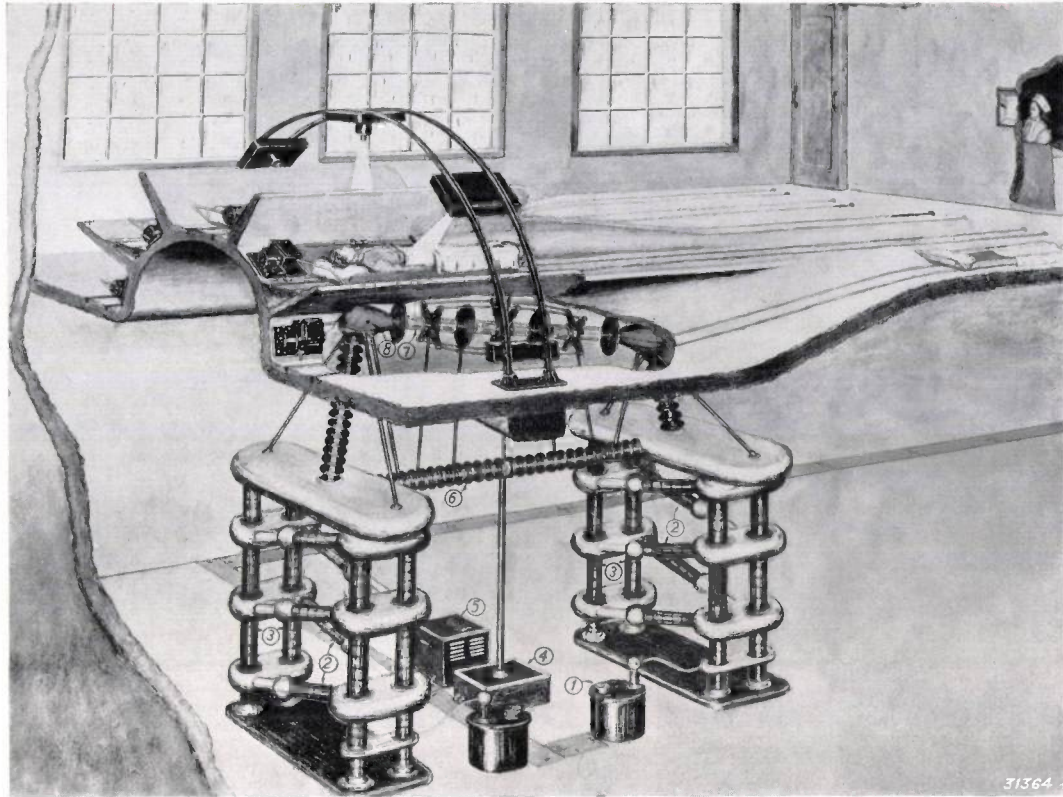

Fig. 8. Sketch of the complete therapy installation (the installation in the Cancer Institute in Amsterdam is carried out on this principle). The tube is mounted on the top of a cascade generator. Above the tube is the treatment room where several patients (in Amsterdam three) can be treated at the same time, 1 high tension transformers, 2 valves, 3 condensers, 4 oil container with pump for cooling the potentiometer resistances 6 and the target, 5 generator for the high frequency heating of the cathodes of the valves, 7 X-ray tube, 8 holes for the passage of the effective beams of radiation through the lead jacket around the target. The patient is placed by means of a beam of light so directed that it coincides with the X-ray beam at the surface to be irradiated.

and also the line spectrum of the γ -radiation of radium. The maximum of the radiation of the tubes lies at about 0.018 \AA , but at the same time a large amount of softer radiation is emitted. The maximum of the emission can be shifted toward shorter wave lengths by allowing it to pass through a suitable filter. The soft radiation is hereby absorbed to a greater extent than the hard, so that the radiation becomes harder after passing through the filter. The effect of filters consisting of plates of lead 1 and 2 mm thick respectively is shown in fig. 12.

The hardness, *i.e.* the penetration capacity of an X-radiation, is practically always indicated by the thickness of some material or other (usually copper) by which the dose is reduced by one half. In *table I* these half value layers are indicated as measured at different voltages for different filters. It may be seen that at 800 kV a suitable filter should be more than 5 times as thick as at 200 kV. For the practical application of the radiation in therapy this means that the radiation can penetrate more easily to the focus of the disease inside

Table I

Half value layers for X-rays, obtained with different voltages and different filters. The percentage depth dose at 10 cm depth is the ratio d_{10}/d_0 , the back scattering the ratio $(d-d_0)/d$, the residual radiation the ratio d_{20}/d_0 , where d_0 is the dose measured on the surface of the skin, d the dose at the surface of the skin when the object is removed, d_{10} the dose at a depth of 10 cm under the skin and d_{20} the dose at the foreside of the object. The measurements were carried out with a water phantom 20 cm thick, of which a field of 150 sq.cm of the fore side was irradiated at a distance of 100 cm from the focus.

Voltage in kV _{max}	Filter thicknesses of metal in mm	Half value layer in mm Cu	Percentage depth dose in %	Back scattering in %	Residual radiation in %
200	1 Cu	1.6	41.0	29.5	7.4
400	0.5 Sn + 3.5 Cu	4.4	44.5	16.5	10.4
600*	0.5 Sn + 3.5 Cu	5.5	45.0	13.8	11.3
800*	0.5 Sn + 3.5 Cu	5.9	45.5	12.3	12.0
800*	3Sb+0.5Sn + 3.5Cu	8.7	47.0	9.0	—

*) These voltages had a ripple of about 20%, while the others were constant direct voltages.

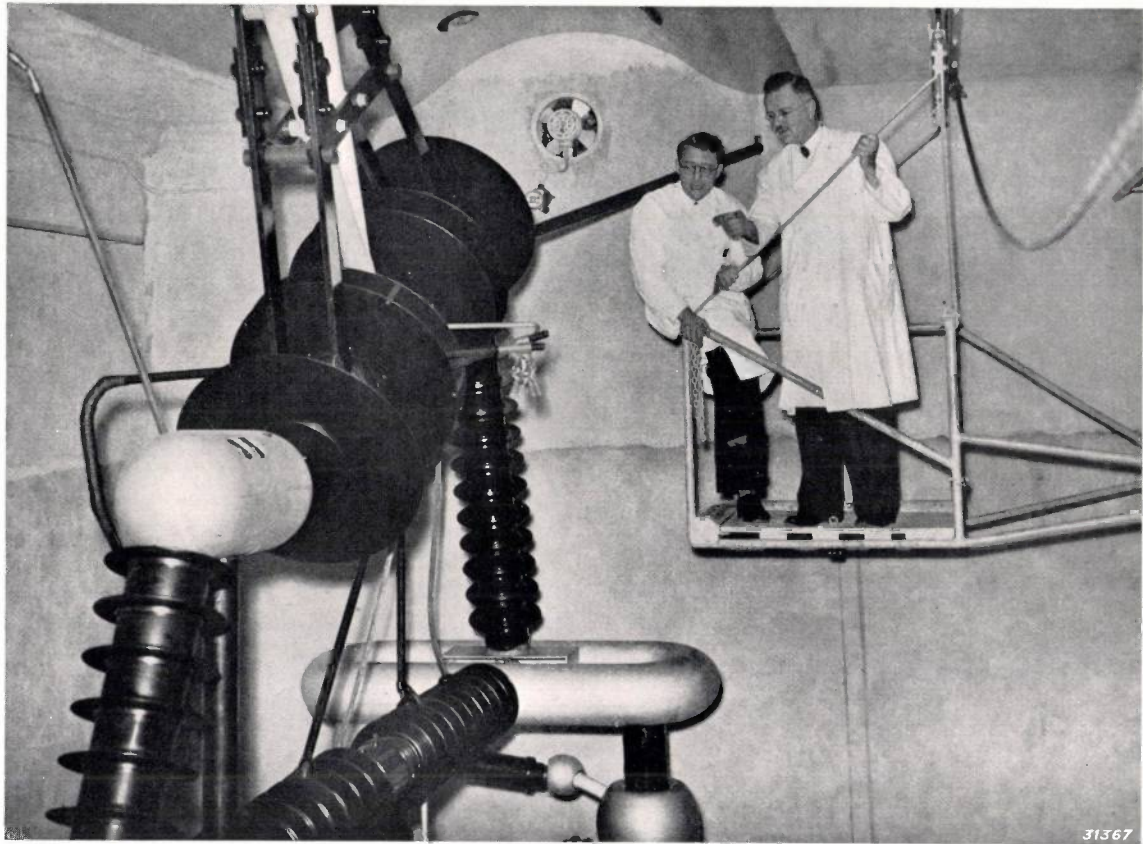

Fig. 9. Actual installation as sketched in fig. 8 in the Cancer Institute in Amsterdam.

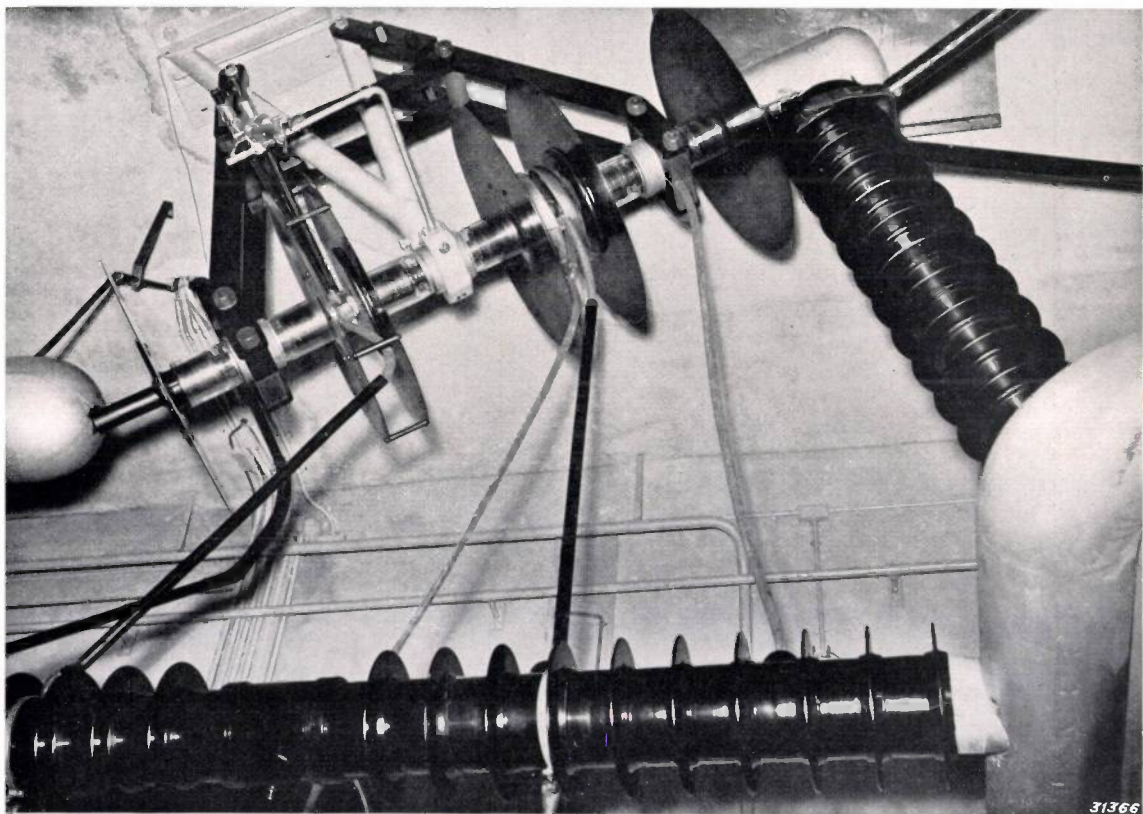

Fig. 10. Mounting of the X-ray tube in the installation of the Cancer-Institute. The centre of the tube is earthed and is suspended from the ceiling. The first and third units are borne by supports of insulating material. The different taps from the potentiometer resistances can be clearly seen.

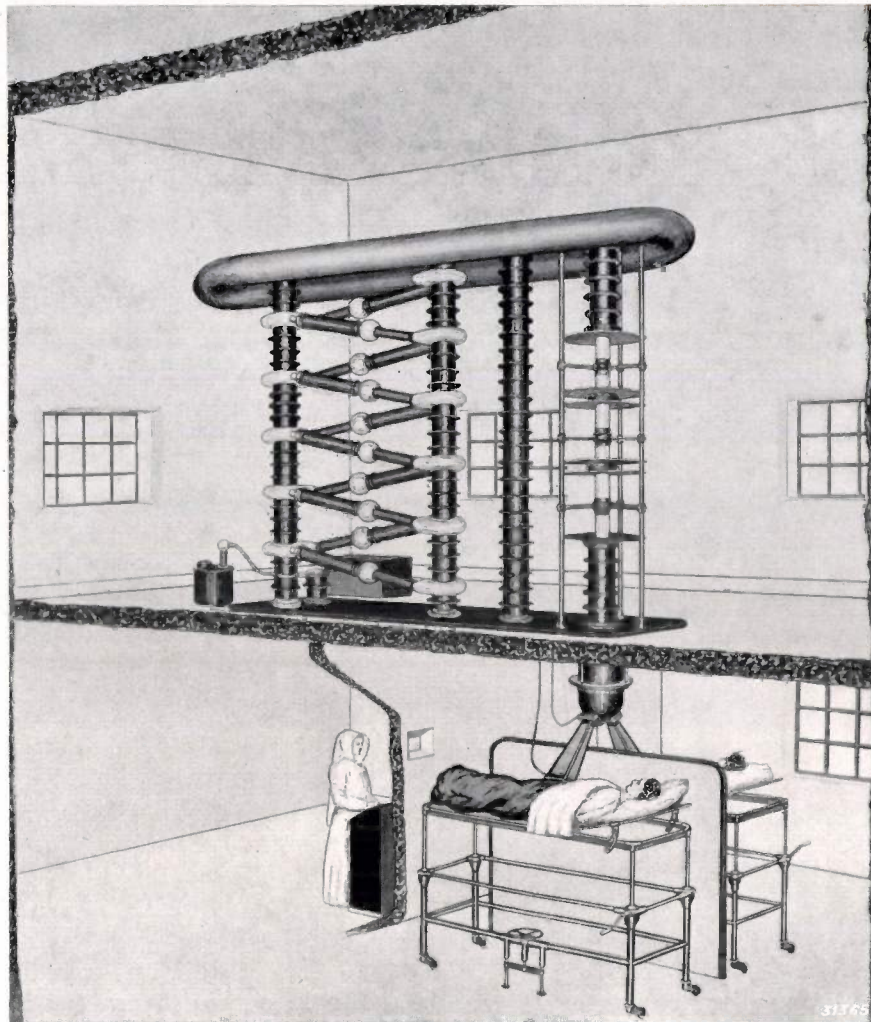

Fig. 11. Projected installation with an X-ray tube for one million volts, in which the source of rays (the target) is earthed. The cascade generator must in this case give a voltage of one million volts with respect to earth and is therefore of the single pole type.

the patient's body. The degree of this penetration is expressed by the above-mentioned percentage

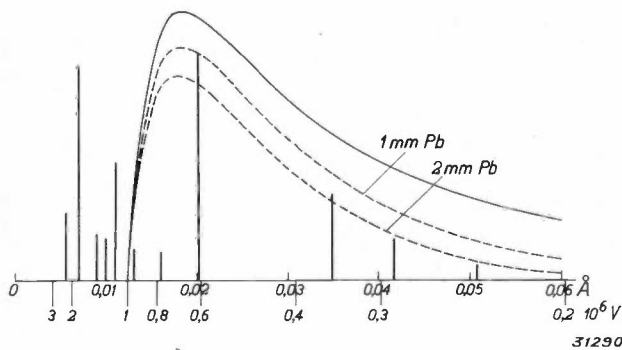

Fig. 12. The line spectrum of the γ -rays of radium and the spectrum (I) of the X-radiation of a million volt tube (according to Eve and Grimmett, Nature 139, 52, 1937). The maximum of the X-ray spectrum may be shifted toward shorter wave lengths by means of filters, as is shown from the dotted curves recorded upon the use of filters of 1 and 2 mm of lead respectively. In addition to the wave lengths along the abscissa, the minimum voltages are given in 10^6 volts, which are necessary for the excitation of X-rays of the corresponding wave length.

depth dose. Table 1 gives the percentage depth dose measured on a water phantom⁷⁾ at different voltages. The improvement obtained from 41 per cent to 47 per cent may be very important practically. In the same table the percentage back scattering is also given, *i.e.* the increase of the dose at the surface of the skin caused by the presence of the object irradiated. Back scattering, as the table shows, decreases rapidly with increasing hardness of the rays. It may in general be said that a beam of hard rays keeps its geometric form better in passing through the object than soft rays, since the hard rays are scattered less. The healthy tissues surrounding the lesion are therefore less exposed to hard rays.

⁷⁾ In order to study the absorption and scattering of X-rays in the human body, use is made of devices, which show the same behaviour in the processes mentioned. Such phantoms are often made of water, sometimes also of "Philite", paraffine and similar substances. See for example Philips techn. Rev. 4, 120-121, 1939.

Another important point is the rapid increase of the dose obtained. At 870 kV and 1 mA the tube described already yields the same dose as 1 kilogram of radium. This is important not only because of the possibility of shortening the times of irradiation, but also because the distance from the focus to the skin may be increased, whereby a larger percentage depth dose is attained⁸⁾. In *table II* the doses

Table II

Free-in-air dose at different voltages (constant direct voltage) and 1 mA tube current, measured at a distance of 1 m from the focus (perpendicular to the direction of the primary electrons) with a filter of 2.5 mm of copper. The thicknesses of lead also given are required to reduce this radiation to the tolerance dose (10^{-5} /sec).

Voltage in kV	Dosage in r/min.	Thickness of lead for protection in mm
200	0.45	3.5
400	3.5	18
600	8.1	38
800	14.0	62
1000	20.0	88

are given which were obtained under otherwise similar conditions when the above described tube was operated at different voltages. From 200 to 1000 kV the dose becomes 45 times as great with the same current. The efficiency thus increases by a factor 9. Considering this result and also the great reliability of X-ray installations for higher voltages work, it may be asked whether the application of higher voltages for obtaining the same dose

⁸⁾ In the passage of the rays through a body the dose decreases, in addition to the decrease by absorption, with the square of the distance from the focus. The further the irradiated object is from the focus, the smaller the influence of this decrease.

is not preferable for economic reasons alone over the use of tubes with voltages of around 200 kV and high currents. In this respect, however, the costs of acquisition also play a part.

Protection against the radiation

We have already mentioned incidentally the necessity of an efficient protection against the rays. The radiation outside the effective beams of rays must be reduced to the so-called tolerance dose⁹⁾ of 10^{-5} r/sec. In *table II*, next to the effective dosages obtained, the thicknesses of lead required for this protection are indicated. It may be seen that at the highest voltage a lead plate 9 cm thick is necessary. A kind of lead bulb having this thickness of wall is placed around the target.

In addition to the primary radiation outside the effective beams, the radiation in the effective beams which remains after passing through the patient must also be absorbed. This residual radiation forms a fairly large percentage of the primary radiation (see *table I*), so that thicknesses of lead of up to 7.5 cm are necessary. The secondary X-rays, on the other hand, which originate in the irradiated body and are emitted in all directions, are relatively soft and can be rendered harmless by quite thin lead plates. This is very fortunate when working with hard rays since the walls of the treatment rooms need not be too heavy. In the irradiation of a field of 150 sq.cm of the phantom at a distance of 100 cm from the focus, with a tube voltage of 800 kV, 1 mA tube current and 2.5 mm of copper as filter, 2 mm of lead were found sufficient to reduce the scattered rays at a distance of 1 m to below the tolerance dose.

⁹⁾ In the article cited in footnote⁷⁾ the tolerance dosage is given as 0.2 r/day. The day is considered to consist of 8 working hours.

A NEW PRINCIPLE OF CONSTRUCTION FOR RADIO VALVES

621.385

A radio valve is described in which the pinch type of lead-in of the connection wires is replaced by a horizontal flat base of pressed glass. In this construction the distance between the leads is greater than in the pinch type, the lengths of the leads in the glass and the lengths from the points of contact outside the valve to the electrodes inside the valve are much shorter. Moreover the construction is much stronger, while it was also possible to lead out the grid connection at the bottom while still retaining the desired value of the capacity between grid and anode. The advantages resulting from these changes are discussed. They are manifested especially clearly when the valve is operated on very short wave lengths. This is due partially to the fact that the cap of insulation material which is ordinarily used may be dispensed with.

Introduction

Consideration of the gradual development of many kinds of new technical products shows that a structural form was at first almost always chosen which had previously served other similar purposes. The first automobile resembled an old-fashioned carriage, the razor, before the transition to safety razors, resembled an ordinary knife, and the oldest electric switch resembled a gas tap.

In the same way the earlier radio valves are similar in many structural details to the electric lamp. As in the case of electric lamps an evacuated glass bulb was necessary in order to raise a wire to a high temperature and maintain it at that temperature without its being attacked. The method of pumping and the leading in of the electrical connections through the wall of the bulb were taken over practically unaltered. Evacuation was through a small glass tube, the exhaust tube, which was originally fused to the top of the bulb. A few wires, with the same coefficient of expansion as the glass which was squeezed around them after heating, served for leads through the pinch. In the same way as with an electric lamp, a cap was cemented to the bulb in order to facilitate connection in radio sets.

The technical requirements which should be met by radio valves were at first not sharply defined, and were indeed still partly unknown. During the steady progress of development, however, a continually better insight was obtained into the specific requirements of radio valves and into the extent to which these requirements were restricted by the prevailing construction of the valves.

What are the requirements which must be satisfied in the construction of a radio valve?

We shall begin by discussing several of these requirements in some detail. It was soon discovered that the mutual insulation of the electrodes, cathode, grid and anode, must satisfy very high standards. In the pinch construction taken over from the manufacture of electric lamps, however, these

electrode connections lie close together (from 0.5 to 1 mm apart). The heating up of the pinch during operation of a radio valve therefore sometimes led to electrolysis of the glass, to leakage and breaking of the valve. With the introduction of valves with several grids, such as pentodes, and especially later on in the development of octodes and other mixing valves, the number of leads through a single pinch was increased very much. Since the insulation must be very high, especially between cathode and control grid, and the capacity C_{ag} between anode and control grid must be very low in order to avoid coupling between anode and grid circuits, the lead of the control grid was transferred to the top of the valve. This precaution answered the purpose very well, but for the use of the valves

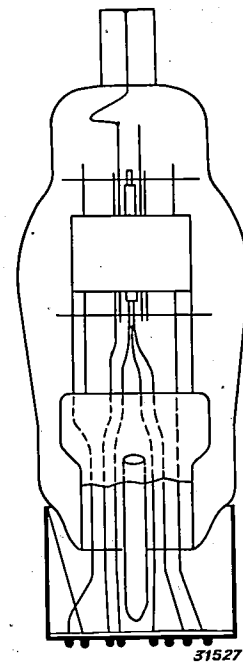

Fig. 1. Radio valve with "pinch" construction. Six wires pass through the glass pinch (broken lines); the connection for the control grid is at the top. The six wires are parallel over a great length and the lengths of the wires in the glass are considerable. The connection of the valve to the cap and the protection of the exhaust tube are shown in the figure. In this recent type of radio valve of the pinch construction already much effort has been made to keep the dimensions small.

in a radio set it would have been preferable to bring out all the leads at the same end of the valve.

The use of shorter and shorter wave lengths makes it essential to keep all the capacities between the different electrodes, the self-inductions of the different leads and their mutual inductions as low as possible. With the pinch type of construction a limit is soon reached, since the leading-in wires, run parallel and close to each other in the pinch and pinch tube for some little distance, have quite high capacities and self-inductions. In the pinch these wires are separated by glass with a fairly large dielectric constant which further increases the capacities. The width of the pinch is being continually increased (see *fig. 1*), but since the leads in such a pinch lie in a single plane, and the pinch

capacities equal in different valves of the same type, so that the set need not be readjusted when a valve is changed.

The position of the wires in one plane parallel to the flat part of the pinch is capable of being improved upon from the mechanical point of view also. The inside assembly of the radio valve, *i.e.* the grids and the anode, is mounted on the pinch by welding, and the strength of such a construction is too low for shocks perpendicular to the plane of the pinch. The inside assembly of the valve is therefore often supported against the upper part of the tube wall by mica plates.

These and similar considerations have led to the search for a different type of construction from the traditional one. We shall discuss in this article

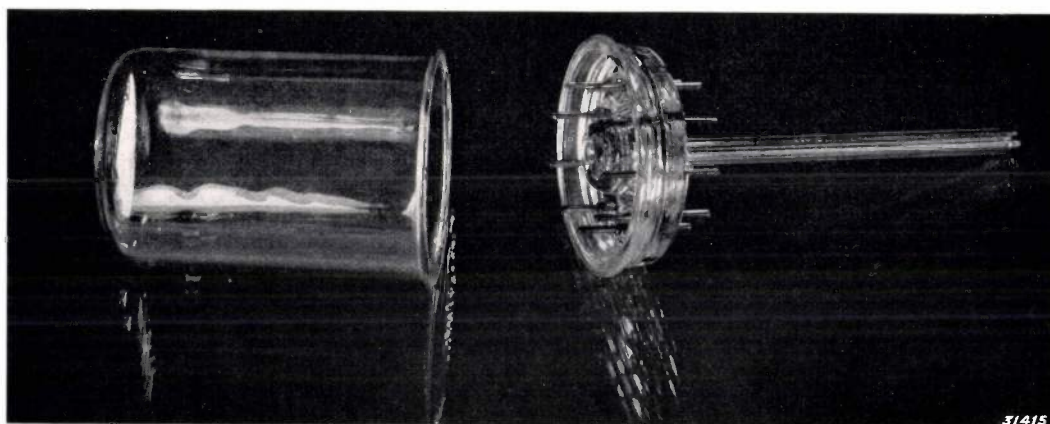

Fig. 2. Photograph of the bulb and the circular base of moulded glass which are fused together along the flange. At the centre of the base is a depression where the exhaust tube is fused on. The chrome iron pins pressed into the glass are clearly visible. Contact is made in the socket through the projecting ends of these pins. The inside assembly is mounted in the valve on these pins (see Fig. 4).

must not touch the walls of the bulb and must be able to pass through the neck of the bulb, the distance between the outermost wires in the pinch is usually not much more than half the diameter of the neck of the bulb.

It is, however, not only desirable that the capacities between the electrodes of a valve should be small, but they must also be as constant as possible. Upon switching on a radio set, the temperature of the valves increases gradually. The capacities between the electrodes therefore will only be sufficiently constant when the temperature coefficient of the dielectrics in the valve is low. This condition is fairly well satisfied by the glass of the pinch, it is much less nearly satisfied by the press material of the cap. The result is that the resonance frequencies of the two tuned circuits change to a certain extent after switching on. Furthermore it is desirable to have the value of the

a new type of glass construction worked out by Philips, and the results achieved with it.

Construction

In the new type of construction the valve consists mainly of a circular glass base upon which the inside assembly is mounted and a glass cylinder which is fused to this base along a flange. These two parts are shown in *fig. 2*. The base plate is completely moulded out of glass. This pressing of the glass can easily be done mechanically. During the process of moulding the base plate the chrome iron leads can be included in the mould and the joint between glass and leads is airtight. It was found possible to choose the leads thick enough to serve directly as contact points without danger of leakage or breakage of the glass. The construction of the socket must of course for good contact be adapted to the diameter of the pressed-in chrome iron contact pins,

The chrome iron pins are placed in the moulding in a circle with a fairly large diameter (21 mm). The distance between them is therefore great (with 9 pins it is 7 mm) and very good insulation is thus guaranteed. At the centre of the base there is a depression in which a stem is fused (*fig. 3*). Be-

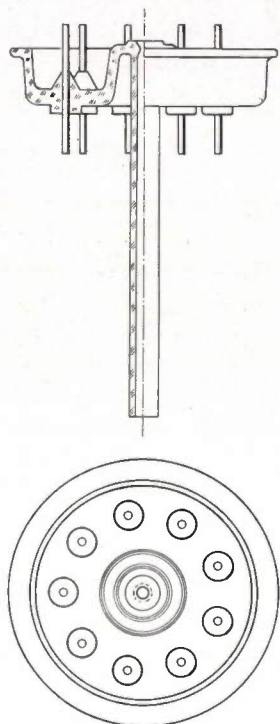

Fig. 3. Drawing showing the details of the circular pressed glass base with exhaust tube and leading-in wires of chrome iron. There is a depression in the base for attaching the exhaust tube. The length of the wires in the glass is considerably less than in the case of the pinch.

cause of this depression the length of the stem to the point of sealing off, even when the distance from the sealing off point to the base is short, is not so small that the glass will break at the joint between base and stem upon sealing off.

The inside assembly of the valve is strongly mounted on the leading-in pins (*fig. 4*), its base is broad and there is plenty of room between the different wires. All the connections including that of the modulation grid are led out at the bottom. The shortening of the length of the connections from the base to the electrodes in this type of construction is shown in *fig. 5*.

The very small value of the anode-grid capacity C_{ag} , which is necessary to prevent a capacitive coupling between the anode and grid circuits, is obtained by choosing for the grid and anode connections two lead-in pins which are far enough apart. In addition some of the electrodes are screened from each other by vertical shields placed inside the tube on the base. Several separate

sectors are thus formed through which different wires are led in without their being able to influence each other. In the photograph (*fig. 4*) these can be seen quite easily. The shielding is finally completed by a metal cap which is described below.

After assembly the glass cylinder is placed over the electrodes and fused to the base along the flange. The evacuation of the valve, the outgassing of the metal parts and the improvement of the vacuum by the evaporation of a getter is carried out in the usual way. After the stem is sealed off the valve is practically complete, but must still be finished off. A cemented cap of moulded material with contact pins is unnecessary, since the chrome iron pins may serve as contacts. Some protection is, however, necessary for the sealed-off exhaust tube which might easily be broken by a knock. A flat metal shield is therefore fastened to the underside of the valve. All the connections project through holes in this shield and can make contact in the socket. At the centre of the shield is a metal

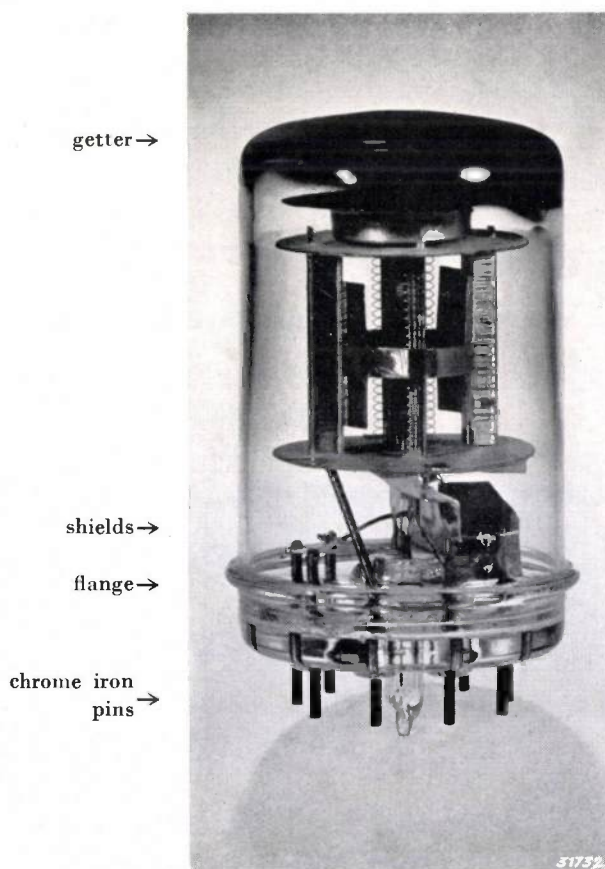

Fig. 4. Photograph of the exhausted and sealed-off valve. Directly above the flange along which the base and bulb are fused together may be seen the two mutually perpendicular shields which separate grid and anode leads from each other, making it possible to keep the grid-anode capacity C_{ag} low. The length from the sealing-off point of the exhaust tube to the base is short. The getter is deposited at the black spot in the upper part of the bulb.

tube which protects the exhaust tube (fig. 6). This metal tube fulfils another purpose at the same time. In inserting the radio valve in a suitable socket in which the pins make contact, there is only one permissible relative position of valve and socket. In order to find this position the shielding tube is provided with a pointed cam which fits into a slit in the socket. When the tube is pressed far enough into the socket the cam locks. This can be done in two ways. After the valve is pressed down in the socket it is turned slightly: the upper edge of the cam is then held against the lower side of the bottom of the socket so that the valve cannot be pulled out. During this turning the contact pins in the bottom are pressed in the springs of the socket and good contact is obtained. The ring-shaped groove at the end of the metal tube may also be used to lock the valve; it must then be caught by an appropriate fastening in the socket.

The shielding of the inside assembly of the valve against inductive or capacitive interferences from the outside can be accomplished in different ways. We shall not go into that here, however, but call attention to the fact that the metal shield provided sufficient protection at the lower side.

Properties of the valve

We shall deal one at the time with the results obtained with valves of this construction.

Temperatures of the glass at the sealing-in points

In the pinch type of construction the pinch reaches temperatures which in unfavourable cases may amount to 200 °C or even higher. The new construction reduces the temperature at the sealing-in points to 90° C. Since the conductivity of the glass varies exponentially with the temperature, this

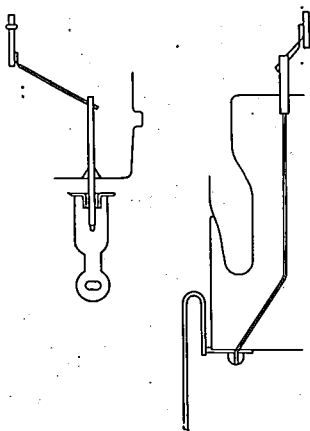

31331

Fig. 5. Detail drawing of the length of the connection wire from the cathode to the contact strip of the valve socket in the new design (left) and in the pinch construction (right).

reduction results in better insulation and less chance of electrolysis of the glass. The probability of breakage of the glass is also reduced.

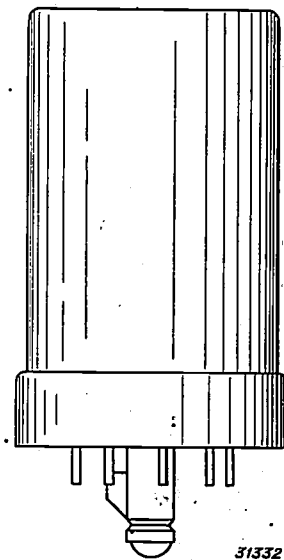
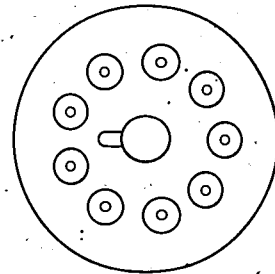

31332

Fig. 6. Drawing of the finished valve with protecting tube and pointed cam.

Change of the capacities between the electrodes due to changes in temperature

The capacity between two contact pins in a radio valve cap of the old construction is about 0.3 μμF. During heating up the increase in temperature of the cap is about 10° C. Since the temperature coefficient of the dielectric constant of the artificial resins is about 50×10^{-4} per degree, the capacity changes by 0.015 μμF. This change in capacity gives in a circuit oscillating on a wave length of 13 m and with a tuning capacity of 50 μμF a change in frequency of 3.4 kilocycles. Even greater than this is the change of capacity between leading-in wires in a glass pinch during the warming up. The temperature coefficient of the dielectric constant of glass is 5×10^{-4} per degree, thus lower than for artificial resins. The increase in temperature is here, however, greater, as we have seen, namely 150° C. The capacity between the leads is 1 to 1.5 μμF in the cold state, and the change due to heating

may amount to $0.09 \mu\mu\text{F}$. As a result of this a change in frequency of 20 kilocycles may occur under the same conditions as above, and the reception is appreciably disturbed.

Under these circumstances the omission of the cap and the maintenance of a low temperature of sealing-in points, such as are possible with the new construction are a great advantage. It was found that in the new design on a wave length of 20 m and with a tuning capacity of $75 \mu\mu\text{F}$ with a room temperature of 25°C the frequency change did not exceed 2.7 kilocycles, while with the same tube with the pinch type of lead-in connection wires it amounts to 4.4 kilocycles.

Tolerances in the capacities

When a defective radio valve is replaced by a new one, the new valve must have the same capacities between the different electrodes. The set is adjusted by means of trimmers to an average capacity, and the actual values of the capacities in different radio valves of the same type must therefore have only slight tolerances. In radio valves with the pinch construction these tolerances for the different capacities, with the exception of that between anode and control grid which has a much smaller value, had a value of about $0.6 \mu\mu\text{F}$. In the new construction on the other hand the value is only about $0.2 \mu\mu\text{F}$.

Capacity between control grid and anode

In screen grid valves, in order to avoid reaction of the anode circuit on the grid circuit, the capacity between anode and control grid must be very small. Therefore, as already mentioned, the grid connection is led out at the top of the valve in many types, and the grid and anode circuits are screened from each other inside the valve. In this way it is possible to reduce the capacity to $0.002 \mu\mu\text{F}$. This point necessitated much care in the new construction, since the anode and grid connections are now led out on the same side, they both pass through the base. By the precautions discussed it was also found possible in the all-glass construction described to reach values of from 0.002 to $0.003 \mu\mu\text{F}$ or even less if necessary.

Properties for operation on short wavelengths

Due to the shortening of the leading-in wires and the greater distances between them, it was to be expected that for operation on very short wavelengths, 5 m for example, the all-glass valve would prove more satisfactory than that with the pinch construction. The input as well as the output resistances of the new construction were actually found to have values which give the all-glass valve advantages over valves with pinch construction for operation on very short wavelengths.

The following table illustrates the difference. Since the input resistance of a valve of the earlier form of construction was always five to ten times as small as the output resistance, the value of the input resistance restricted the value which could be chosen for the impedance of the coupling circuit between two valves. In the table values of the input resistance in the cold state and in the working state are given for two wavelengths, three and ten meters, for the same type, EF 9, in the old and new form of construction. In the old form the valve was provided with a P-cap (see fig. 1).

Table

Wave length	Cold resistance (10^3 ohms)		Working resistance (10^3 ohms)	
	old	new	old	new
3 m	36	28	2	4
10 m	460	360	27	66

When in operation, *i.e.* when the valve is warm, the input resistance of the new type of construction is thus more than twice as great as in the old construction. The impedance of the coupling circuit between two valves may therefore be increased, and a greater gain per stage of amplification is possible.

It may be seen from the values given that the differences become smaller at longer wavelengths. In many respects, however, the other advantages mentioned are still of importance.

Compiled by P. G. CATH.

SYNTHETIC SOUND

by J. F. SCHOUTEN.

534.42

An apparatus is described with which synthetic sound can be produced, *i.e.* sounds with prescribed periodic wave forms. The characteristics of the apparatus are dealt with in detail. The apparatus has been employed for the investigation of different physiological acoustical problems, such as the influence of phase on sound perception and non-linear distortion in the ear.

In an earlier number of this periodical¹⁾ we described a method by which a sound recorded on a strip of film was immediately analyzed into its different sinusoidal components. We shall now describe a method whereby the reverse is done, *i.e.* a sound of prescribed character of periodic vibration, or in other words a sound consisting of sinusoidal components of prescribed amplitude and phase,

of 1 mm and at distances of 40° from each other. Behind the disc, which is driven by a motor, is a lens which focusses the light source upon the photo electric cell. The only light which can fall upon the photo electric cell is that which has passed through the part of the stencil cut away and one of the slits. When the disc is turning, the amount of light transmitted at each moment is proportional to the

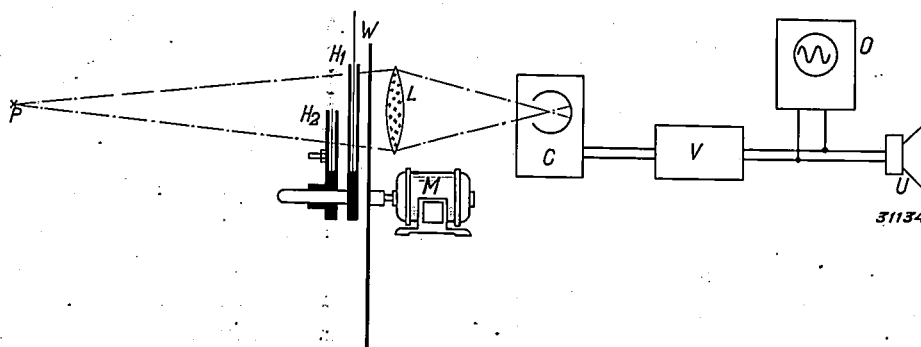

Fig. 1. Apparatus for producing synthetic sound. The wave form cut out as a stencil is placed in the holder H_1 and homogeneously illuminated by the point source of light P . The motor M drives the disc W , which is provided with slits. The light transmitted through the slits is focussed by lens L on the photo electric cell C . The photocurrents are transformed into sound *via* the amplifier V and a loud speaker U . The wave form is checked by means of the cathode ray oscillograph O . For special experiments a second holder H_2 is introduced in front of H_1 . This second holder is for a second stencil, and may be rotated with respect to H_1 .

is obtained synthetically. This method permits a closer study of a number of problems which are connected with the nature of the perception of sound.

Apparatus for the production of synthetic sound

The apparatus is based on the principle of the intensity of a light flux as a function of time being made to vary proportionally to the desired wave form. The light flux is incident on a photo electric cell and finally transformed into sound *via* an amplifier and a loud speaker. The principle is realized in the following way²⁾. The desired wave form is cut out of paper so that it can be inserted in the holder H_1 (figs. 1 and 2). This paper stencil is homogeneously illuminated by a point source of light (a tungsten arc lamp) at a great distance. Behind the holder H_1 there is a rotating aluminium disc in which 9 slits have been made, each with a width

height of the part cut away at the point behind which there is a slit at that moment. In consequence of the method of scanning the desired wave form must be traced in polar coordinates. The centre of this system of coordinates must be situated on the extension of the axle of the motor. Only one period of the vibration is drawn in such a way that the period occupies exactly the distance between two slits, *i.e.* 40 degrees, when the disc is turning and one of the slits has traversed the stencil, the following slit is just ready to begin at the other side.

Since with this arrangement negative values of the light transmissibility cannot be produced, a constant quantity is added to all the coordinates of the wave form to be reproduced, which quantity is equal to the largest negative value occurring. In the case of a purely sinusoidal vibration the height of the portion cut away is not $a \cos \varphi$, but *e.g.* $a - a \cos \varphi$ (fig. 3).

The frequency can be determined by regulating

¹⁾ J. F. Schouten, Philips tech. Rev. 3, 298, 1938.

²⁾ J. F. Schouten, Proc. Kon. Ned. Ak. Wet. 41, 1086, 1938.

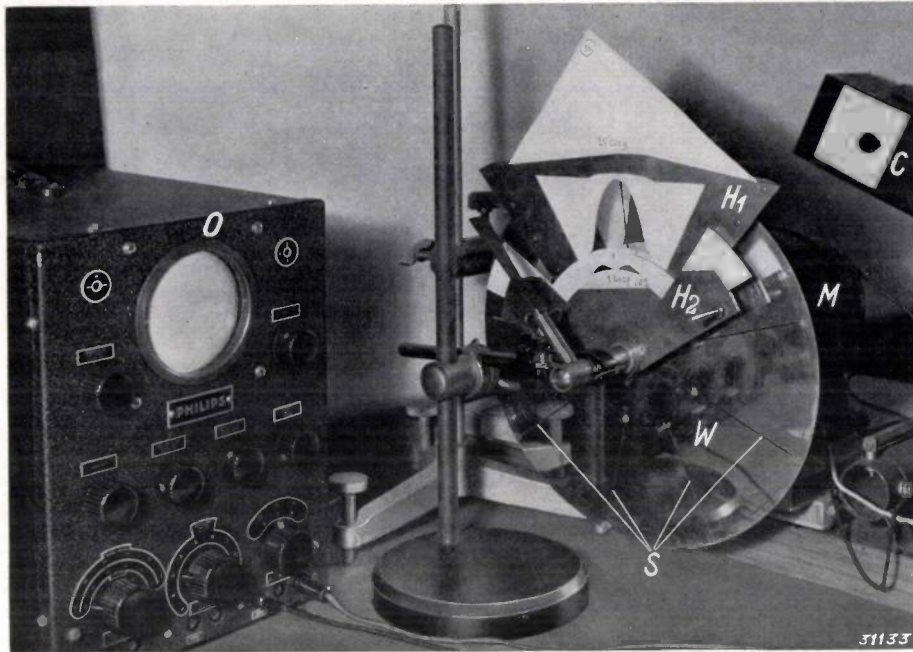

Fig. 2. Photograph of the apparatus. *S* are the slits in the disc *W*. In holders *H*₁ and *H*₂ the stencils of two different sinusoidal vibrations have been placed.

the number of revolutions per minute of the motor. This number of revolutions was usually $22\frac{2}{9}$ per sec and a fundamental tone of $9 \cdot 22\frac{1}{2} = 200$ c/s was thus obtained.

If the desired form is given as the sum of a number of sinusoidal components, the components may be added and the resultant wave form cut

out. Often, however, it is an advantage to cut out the forms separately one above the other. If it is desired to be able to change the relative phase of the components during the experiment, the components are cut out in separated models. To this end a second smaller holder *H*₂ is introduced in front of *H*₁ (see figs. 1 and 2) which can be turned about an axis in the extension of the motor axle. Altogether a region lying between radii of 65 and 130 mm in the polar coordinate system is available for the stencil cutting.

One very attractive property of the apparatus here described is that it makes it possible to study directly the influence exerted on sound perception by changes in the wave form. For example, when several components have been cut out one above the other, any one of these components can be made to disappear, simply by screening this part of the stencil from the light. Furthermore in the same way by partial screening a sinusoidal wave form can be flattened or provided with sharp indentations, and the effect of this can be heard in the sound produced.

Influence of the finite width of the slits

To what extent is the obtained displacement of the particles of air as a function of time a faithful image of the stencilled wave form? The most serious source of error of the apparatus is the finite width of the slits in the rotating disc. It is clear that this error will consist in the fact that the fine structure in the wave form of the

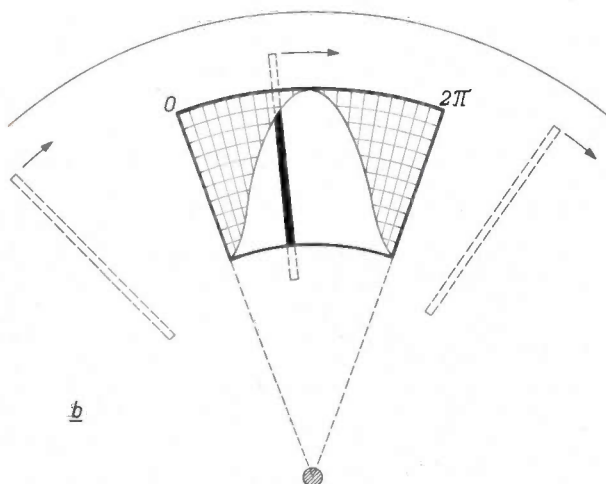
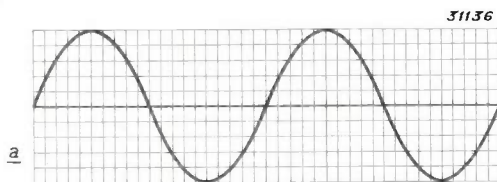

Fig. 3. A wave form (a) (pure sine) and the corresponding stencil. The latter is cut in polar coordinates in such a way that one period just fills the angle between two slits, and the greatest negative ordinate of the wave form corresponds to zero light transmission.

order of the width of the slit is not brought out; the apparatus, in optical terminology, possesses a limited resolving power. What does this mean from the acoustic point of view? If the stencil only has the n th harmonic, with an amplitude a , the amount of light transmitted would be proportional to the ordinate

$$a - a \cos n\varphi, \dots \dots \dots (1)$$

where the variable φ varies from 0 to 2π during the traverse of one slit. In the case of a slit which occupies a sector of the finite angle $\Delta\varphi = \Theta$,

the higher harmonics in gradually diminishing intensity.

In fig. 4 the variation of the function (3) is reproduced. The factor f_n equals 1 for $n = 0$, for higher values of n it falls gradually and becomes zero when n reaches the values $2\pi/\Theta$. This can also be immediately appreciated physically. The period of the n th harmonic has the value $2\pi/n$. If this length is exactly equal to the width of the slit, the average value of the transmission is exactly zero, and this harmonic is therefore not passed

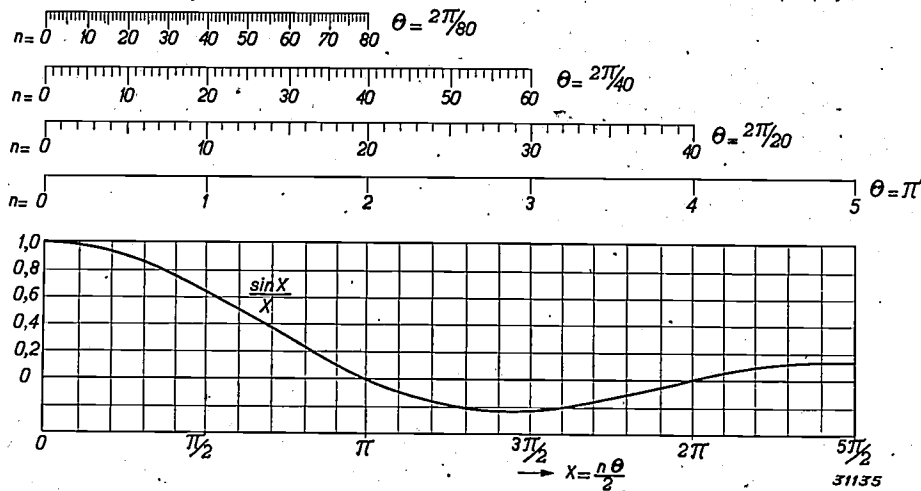

Fig. 4. Variation of the function $\sin x/x$ with the abscissa $x = n/2$. This function gives the "frequency characteristic" of the disc. In practice only the first part ($0 < x < \pi$) is used. From the accompanying n scales it may be seen that more harmonics can be rendered with fairly exact intensity, the smaller θ (the width of the slit).

the amount of light transmitted is, however, proportional to the average value of the ordinate in this sector; this is:

$$\frac{1}{\Theta} \int_{\varphi - \frac{\Theta}{2}}^{\varphi + \frac{\Theta}{2}} (a - a \cos n\varphi) d\varphi = a - \frac{2a}{n\Theta} \sin \frac{n\Theta}{2} \cos n\varphi \dots (2)$$

From this it may be seen that the n th harmonic is not reproduced with its true amplitude, but with an amplitude $f_n \cdot a$ when

$$f_n = \frac{\sin \frac{n\Theta}{2}}{\frac{n\Theta}{2}} \dots \dots \dots (3)$$

It is easy to understand that the factor f_n is not affected by the presence or absence of other harmonics on the stencil. Each harmonic is therefore reproduced with a characteristic attenuation. The finite width of the slits has the same effect as an electric filter preceding the amplifier which passes

by the disc. For higher values of n the function f_n varies in an oscillating manner; for practical purposes, however, only the first part of the curve is important.

The factors f_n have another special significance. They are equal to the components of the development of the transmission of the disc in a Fourier series. Plotted as a function of the angle, this transmission represents a periodic impulse in which the ratio of the width of the impulses to the mutual separation is equal to $\Theta/2\pi$. The Fourier coefficients of these functions are just given by formula (3).

The fact that ideal reproduction is attained with an infinitesimally narrow slit must be understood in this connection in the following way: the factors f_n in that case, see formula (3), all become equal to unity: the Fourier spectrum of a periodic, repeated, infinitesimally narrow impulse contains all the harmonics in equal intensity³⁾.

Another extreme case occurs for example when the width of the slits is made equal to that of the intervening space ($\Theta = \pi$, the "square sine"). The factors then become zero for all even values of n . No matter what the form of the stencil, only the odd harmonics will be able to occur in the sound obtained.

The factors f_n , which have been derived theoretically above, can also be determined experimentally

³⁾ See for example page 307 of the article cited in footnote 1).

in a simple way. In order to do this, the intensity of the harmonics in the synthetic sound obtained is measured with a suitable analytic instrument, *i.e.* the synthesized function is again analyzed and compared with the intensity of the components of which the stencilled wave form is built up. The factor f_n is then equal to the ratio of the "apparent" (measured) and the "true" intensity⁴⁾ of the n th harmonic. In this experimental determination two other similar effects, but smaller than that of the finite width of slit are also taken into account, namely any slight deviation from straightness in the frequency characteristic of the amplifier and the slight lack of sharpness which occurs in the projection of the stencil on the disc due to the fact that the source of light is not a perfect point. The results of several measurements are given in *fig. 5*. These measurements were carried out with stencils of three different wave forms: a. periodical repeated impulse with a width of $1/80$ (a), $1/40$ (b) and $1/20$ (c) of a period respectively. The factors f_n so determined show very good agreement (*fig. 5d*).

In the experiments on synthetic sound the filter action of the disc, which is expressed in the factors f_n , may be entirely neglected, since one is almost always confined to the lower harmonics. In the rare case where many harmonics occur, for instance when the apparatus is to be used for a Fourier analysis, the filter action may be taken into account in two ways. The first is by making allowance for the filter action beforehand in cutting the stencil of the wave form, by dividing the prescribed intensity of every harmonic by the corresponding value of f_n ⁵⁾. The harmonics then occur in the output signal in the desired intensity. The second method is by allowing the frequency characteristic of the amplifier to rise at higher frequencies in such a way that the filter action of the disc is exactly compensated. Such a frequency characteristic can be realized in a relatively simple manner.

The wave form obtained is checked with a cathode ray oscillograph which is connected to the terminals of the loud speaker (*figs. 1 and 2*).

⁴⁾ These terms are borrowed from a problem of spectroscopy which is closely related to ours, where one speaks of true and apparent intensity distribution of spectral lines. H. C. Burger and P. H. van Cittert, *Z. Physik* 81, 428, 1933.

⁵⁾ In using the experimentally found factors f_n it must be kept in mind that they represent an average value. The slits cannot be sector-shaped, as has been assumed in our considerations, but they have the same width over their whole length in order to ensure a linear relation between the amount of light transmitted and the height of the part of the stencil cut away. This has as a consequence that in the outermost part of the disc the ratio of width of slit to separation ($\theta/2\pi$) is smaller and the resolving power thus greater than in the inner part.

In *fig. 6* a number of wave forms are given together with the corresponding stencils and the oscillograms obtained. The latter were obtained without any correction being applied.

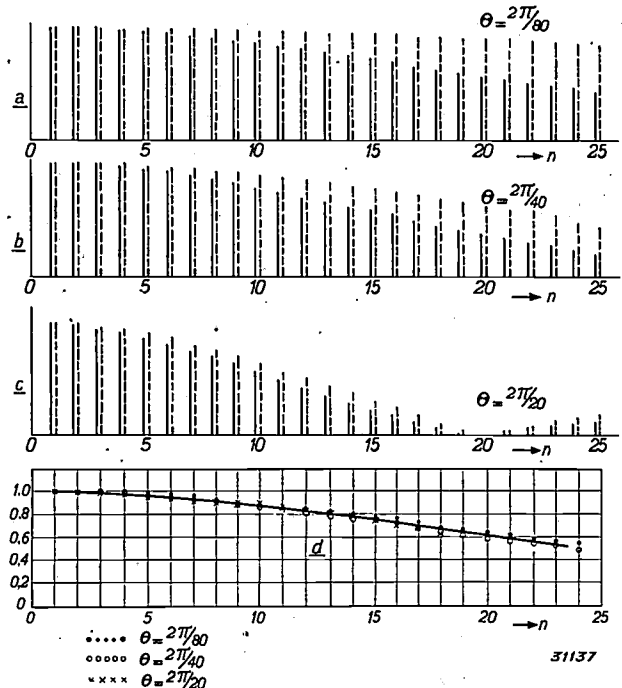

Fig. 5. True (broken line) and apparent (continuous line) intensity of the harmonics measured for three different wave forms: periodic repeated impulse with a width of a) $1/80$ period, b) $1/40$ period, c) $1/20$ period; d) the factors f_n derived from the spectra a-c.

The only obvious deviation between oscillogram and required wave form is found in the case of the "square sine" (*fig. 6b*), where the horizontal parts are not quite horizontal in the oscillogram. This is due to the fact that the amplifier used does not pass the frequency zero. When a direct voltage is suddenly applied to the input terminals, a direct voltage also suddenly occurs at the output terminals, which, however, gradually falls to zero. Over against this statement it might be maintained that as soon as one passes over from the single commutation phenomenon to the periodic one, the frequency zero no longer occurs. It must, however, be kept in mind that the failure of the amplifier to pass the frequency zero is accompanied by a slight phase rotation of the lower harmonics. When this is studied it is found that the effect of this phase rotation is manifested in a slope of the horizontal parts of the wave form as may be observed in *fig. 6b*.

The influence of the phase of the different components of a sound on sound perception

According to a law of acoustics, which was formulated by Ohm, a definite pure tone will be

observed in a synthetic sound, when a component of the frequency in question occurs in the Fourier analysis of the wave form. According to a rule proposed by Helmholtz the sound perception will further depend entirely on the relative intensity with which the different components occur and will be independent of the relative phase of these components.

These facts are accounted for in a simple way

components are placed in the two holders H_1 and H_2 . By turning the holder H_2 it is possible to change the relative phases of the components at will while listening to the sound obtained. It was never possible to discern any influence of phase on sound perception⁶⁾.

This method can no longer be applied practically for phase rotations of a large number of components. It is, however, technically as well as

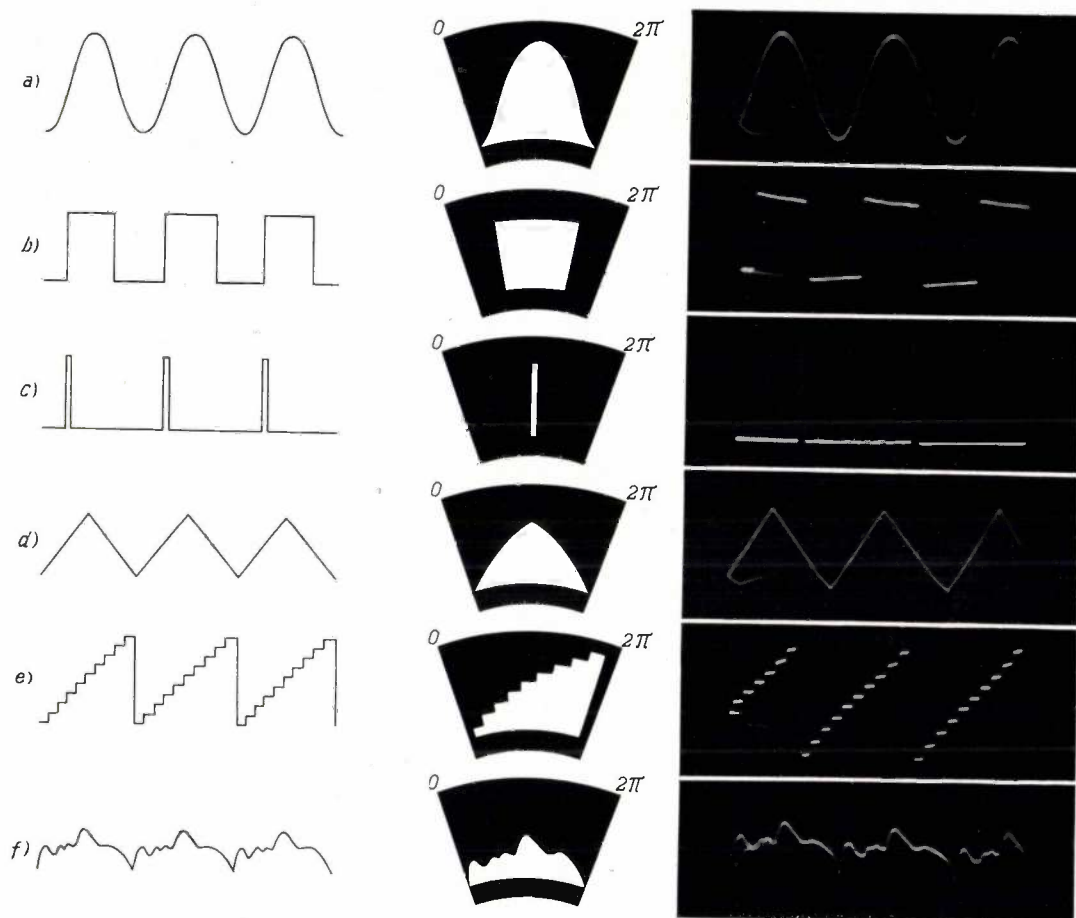

Fig. 6. Different wave forms with the corresponding stencils and the oscillograms obtained. The form a) is a pure sine curve, f) has the form of a profile of a human face.

by the assumption (which seems to be permissible anatomically also), that there are in the ear a large number of resonators tuned for different frequencies. This mechanism explains in the first place the fact that the ear carries out as it were a Fourier-analysis of the sound, while it furthermore makes it possible to suppose that the stimuli which are sent from each resonator to the brain depend exclusively upon the intensity and not upon the phase of the component in question, or at least that the phase does not finally reach consciousness.

This rule can be tested in a simple way with the help of the apparatus described above. For this purpose stencils of two different sinusoidal compo-

theoretically important to find out whether in extreme cases, with wave forms having a large number of components, Helmholtz's rule remains valid. For instance, in amplifier technology upon the occurrence of grid currents a sharp peak appears in the output signal at a definite point in each period with a purely sinusoidal input signal. Thus in addition to the desired vibration a periodic impulse occurs which, as already explained, consists of a very large number of harmonics.

In amplifier technology it is customary to characterize the non-linear distortion of the out-

⁶⁾ Except in one very special case which we shall return to later.

put signal occurring in an amplifier by the distortion factor:

$$F = \frac{1}{a_1} \sqrt{a_2^2 + a_3^2 + a_4^2 + \dots} \quad (4)$$

a_1 here represents the amplitude in the output signal of the frequency fed to the amplifier, while a_2, a_3, a_4 represent the amplitudes of the higher harmonics formed. It may be seen that the phase of the harmonics is not taken into account. The

forms which were built up of the same harmonic are shown in fig. 7b-d and explained in more detail.

It was found that these four totally different wave forms were quite indistinguishable as to their sound impression.

Helmholtz's rule is therefore also confirmed for the extreme case of a very large number of harmonics. It is therefore permissible, in the determination of non-linear distortion, to confine oneself to the measurement of the intensity of each

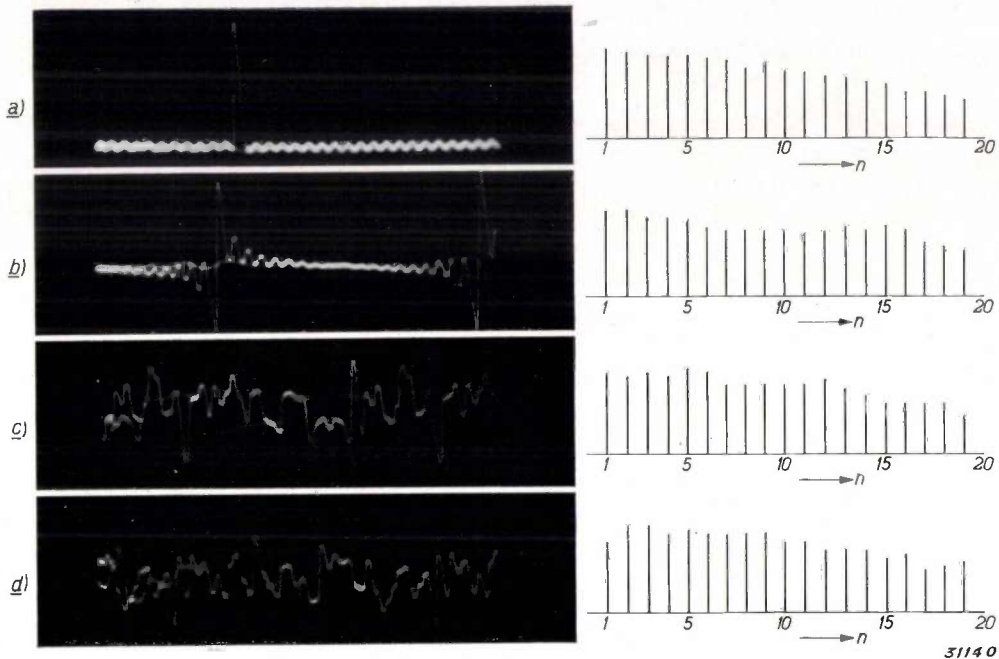

Fig. 7. Oscillograms and Fourier spectra of four different wave forms, all of which are built up of the same harmonic $\cos(n\pi + \gamma_n)$ for $n = 1$ to $n = 20$. The four wave forms cannot be distinguished by ear.

- $\gamma_n = 0$ for all values of n .
- $\gamma_n = \pi/2$ for all values of n .
- The 20 phase rotations, $\gamma_n = 2\pi/20, 4\pi/20, \dots, 2\pi$, are distributed at random over the 20 harmonics, each phase rotation, however, occurs only once.
- The phase rotations γ_n are chosen as multiples of $2\pi/40$, with an arbitrary series of numbers as factors (in our case the series of decimals of $\log 2$).

quantity F will only be a useful criterion of the change in sound perception when Helmholtz's rule has also been found correct for a very large number of components.

We have studied this problem for the above-mentioned case of the very narrow periodic impulse, and for this purpose we calculated four wave forms which were composed of the components $\cos(n\varphi + \gamma_n)$ in practically equal intensity for $n = 1$ to $n = 20$. In the first form γ_n was always taken equal to zero, so that in the first approximation a periodic repeated impulse results. In fig. 7a the oscillogram of the wave form which was obtained is represented together with the spectrum of the harmonics which were measured in the sound produced. The three other wave

of the harmonics without paying attention to their relative phase.

Non-linear distortion in the ear

Non-linear distortion occurs in the ear. This distortion is manifested in the fact that when a pure tone of sufficient intensity is heard, higher harmonics are formed in the ear (the octavo, the duodecimo, etc.); when two tones of different frequency are heard at the same time, new tones are formed with frequencies which are linear combinations of the frequencies of the two tones heard (combination tones). The most obvious combination tone is the difference tone, and this is the one which was first discovered. One speaks of objective and subjective tones according as the tones perceived are

present or absent in the sound field outside the ear. With a single tone the occurrence of subjective harmonics can be perceived practically only as a gradually increasing sharpness of the character of the sound at greater sound intensities. When a second harmonic is formed in the ear (the subjective second harmonic), by which the resonator which is tuned to it is made to vibrate, we must expect that when we add a certain percentage of second harmonic to the physically pure tone (the objective second harmonic) it will be of some concern in what phase this occurs. This is therefore a deviation from Helmholtz's rule. Depending on the phase of the objective harmonic, it will be possible that the vibration of the resonator in question caused by the subjective harmonic will be either reinforced or weakened. It may even be expected that with suitably chosen intensity and phase of the objective harmonic a complete compensation of the subjective harmonic will occur.

This phenomenon can easily be investigated with the help of synthetic sound, by adding together the fundamental tone and its second harmonic with two stencils in the holders H_1 and H_2 respectively. If with a sound intensity of 106 phons (this corresponds approximately to the sound level of the noise in a boiler factory), 8 per cent of second harmonic is added to a tone of 200 cycles/sec (this case is represented in fig. 2), then when the holder H_2 is turned a change in the sound is very clearly perceived: at a definite position of H_2 (phase A) the sound becomes purer and weaker upon the addition of the objective harmonic; at a position which is shifted a quarter of a period with respect to the main tone (phase B) the sound becomes sharper and stronger.

We thus encounter an apparently paradoxal phenomenon, that a physically less pure tone sounds purer than a physically pure one, and that a tone makes a weaker sound impression after the objective addition of a certain amount of energy.

According to the above these phenomena can immediately be understood as an interference of the objective and subjective harmonics, whereby the vibration of the resonator of 400 cycles/sec in the ear is compensated in one case (phase A) and reinforced in the other (phase B). A further test of this statement is possible by generating a pure tone of for instance 406 cycles/sec with the help of a second loud speaker. If a tone of 400 cycles is present in the ear, beats will occur between this and that of 406 cycles. These beats can now be used to ascertain whether the above-described compen-

sation actually takes place. When the objective sound is such that a tone of 400 cycles is no longer present in the ear (phase A), the beats must also disappear. This phase effect for the beats is actually found to exist.

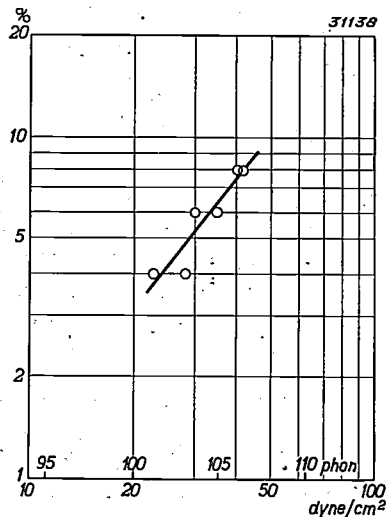

Fig. 8. Intensity of the subjective second harmonic in per cent of the intensity of the main tone, as a function of the sound intensity (sound pressure in dyne/sq.cm. and intensity level in phons).

The degree of non-linear distortion in the ear, i.e. the intensity of the subjective harmonic, depends upon the amplitude, i.e. the sound intensity of the main tone. Since the phase effect is most pronounced when objective and subjective harmonics have the same intensity, the above-described effects on the sound character, the intensity impression and the beats can be used as a method of determining the degree of non-linear distortion in the ear as a function of the sound intensity. In fig. 8 are given the results of measurements by this method of the subjective second harmonic⁷⁾.

It has been stated above that the presence of the subjective harmonics is manifested chiefly as a certain sharpness of the sound. If, however, the objective harmonic is adjusted to compensation, and it is then removed, it is found possible after some practice to bring into consciousness the subjective second harmonic separately in the physically pure tone. After several seconds, however, it seems to fade into the main tone and cannot be recalled again except after repeated comparison.

⁷⁾ The results of the measurements carried out in this laboratory agree very well with those of Chapin and Firestone (J. Ac. Soc. Am. 5, 173, 1933) and of Trimmer and Firestone (J. Ac. Soc. Am. 9, 24, 1937). Measurements by Fletcher (J. Ac. Soc. Am. 1, 311, 1929) carried out by a different method, and also those of von Békésy (Ann. Physik 20, 809, 1934) gave much larger percentages than those shown in fig. 8.

THE WELL-LIGHTED HOUSE

by L. C. KALFF.

628.972

In order to demonstrate the effect of different lighting systems, a model house was designed in which modern methods of illumination have been generously applied. The house is furnished with colourless, stylized furniture. In this way the attention is not distracted from the main feature, the lighting, and the properties of the different methods of illumination are fully brought out.

Within the last few decades the demands made of artificial lighting have steadily increased, especially in the case of street lighting, shop window illumination, workshop lighting, etc. This increase has been less noticeable in the case of the illumination of the home. This fact is understandable since better street lighting makes for safer traffic, better lighting of workshops increases the speed of working and reduces waste, better lighting of shop windows induces buying, etc. In the home, however, the favourable results of better lighting cannot be expressed in terms of money, and the harmful effects of poor lighting on the eyes are difficult to prove. It is, however, thoroughly realized that a higher current consumption, and therefore greater expense, will result from an improvement in the lighting installation.

In addition to the strong resistance which must be overcome in this respect there is a serious technical difficulty. In workshops, offices and shops

illumination for working purposes is the chief concern, and light-coloured walls and ceilings can be used in order to avoid too much contrast in brightness in the field of vision. Such contrasts in brightness are even less permissible because of the danger of glare, the higher the general level of brightness. In the home it is desirable to reach the relatively high intensities of illumination which are required for working purposes at certain spots only, while the atmosphere of the interior may not thereby be spoiled. Too high a general level of brightness, and at the same time too great contrasts must therefore be avoided. This requires much more care and offers many more difficulties than in the businesslike surroundings of our places of work.

It is impossible to give hard and fast rules for the installation of the lighting equipment in the endless variety of our living quarters. There is, however, a very great number of forms and ap-



Fig. 1. Hall of the "well lighted house". On the left the dining room and the bed-sitting room. In the background the bathroom. The hall itself is lighted by a dome and a niche in the wall to the left.

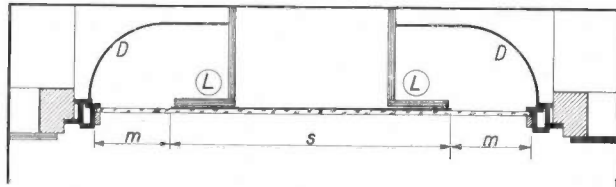

Fig. 2. Mirror with built-in illumination. S section of glass provided with a mirror, L "Spiralta" lamps of 15 Dlm (1 Dlm. = 1 dekalumen = 10 lumen), distance between lamps 23 cm, *O* diffusely reflecting white surfaces.

plications of different lighting fixtures available, which can be used in all varieties and combinations for the solution of this problem. In order to be able to avail oneself fully of these possibilities it is desirable to have several experimental and exhibition rooms in which as many as possible of the above mentioned lighting systems can be installed. As an example of such exhibition rooms a complex in the Philips demonstration halls has



Fig. 3. Hall of the "well lighted house", seen from the bathroom. In the background the kitchen. The treads of the stairs are lighted by lamps built in at the base of the bannister. The dummy figures in this house were designed by George Pál.

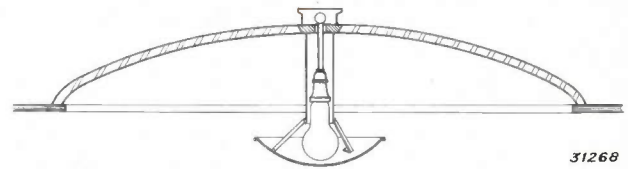

Fig. 4. Cross section of the dome in the hall. It has a diameter of 1.20 m and is made in advance of plaster and then placed on the ceiling. The bowl under the lamp (100 Dlm) is sprayed with white on the inside and dull nickel-plated on the outside. It is fastened at three points by bayonet fastenings and can therefore easily be removed for changing the lamp.

been fitted out as "The well lighted house".

In designing such exhibition rooms the difficulty is to choose an interior such that every visitor will be able to make a comparison with his own home. One person will for example find that the rooms are too luxurious, and will thereupon conclude that the lighting installation is out of the question for his own case. Another will find in a piece of furniture or a rug, a colour or a shape so much to criticize or admire that he will entirely forget to notice the illumination.

In order to avoid this distraction from the main purpose an attempt is made to make the interior as "impersonal" as possible, without using real furniture which some will admire and others despise, without using colours and contrasts, period furniture and ornamental shapes, even without pictures on the walls, which might distract the attention from the main feature, the lighting. In order to accomplish this the following method was followed.

The furnishing is carried out entirely with stylized furniture, *i.e.* the pieces of furniture are reduced to their simplest forms. For example a chair has a rectangular back and seat, the legs are also rectangular, the table is a thick board on four straight legs. Colours are all replaced by greys and white. The normal differences in light reflection from different materials and surfaces are therefore transformed into different shades of grey. Five different shades are used with reflection coefficients of approximately 75, 60, 45, 25 and 10 per cent. A desk, which would ordinarily have the colour of oak, is painted with a grey paint which reflects 25 per cent, walls were given a reflection coefficient of 60 per cent, furniture was given different shades with reflection coefficients of 45 and 25 per cent for instance.

The effect was surprising, the rooms did not appear strange or unpleasant. Many visitors were even of the opinion that such interiors would prove satisfactory for normal use. It was, however, especially gratifying to be able to ascertain that the effect of the different lighting systems was tho-



Fig. 5. Living room. General semi-indirect illumination by a central ornament made of parchment, 3 lamps of 100 Dlm (Dlm = dekalumen = 10 lm). Local illumination for reading and sewing from a standard lamp "Philihome" 50 with a lamp of 200 Dlm, 150 W. Intensity of illumination on the reading matter 300 lux. A wall illumination behind the couch decreases the contrasts in the room.

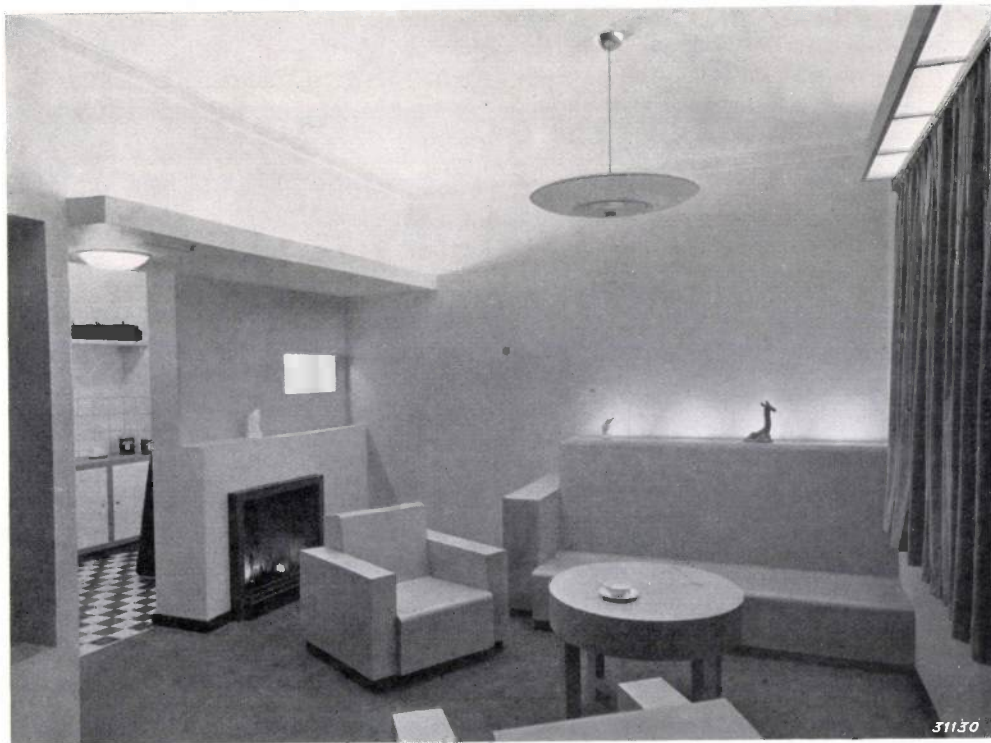

Fig. 6. The same room as in fig. 5, but with different illumination. General, completely indirect illumination by means of a trough above the hearth. There are nine "Cornalux" lamps of 60 W built into the trough. The "Cornalux" is a lamp of special shape which is partially silvered. It makes it possible to distribute the light very uniformly over the ceiling and to construct indirect illumination systems with a very high efficiency. Semi-indirect illumination by means of a trough above the curtain, provided with patterned frosted glass. Auxiliary illumination behind the couch, above the doors and in the niche above the hearth.

roughly brought out, and that this was one of the main factors in the impression made by the interiors. This makes it possible for the visitor to judge the practical and decorative result of a system of illumination.

We shall now describe several of the rooms, and in doing so we shall deal with several general factors which are important in designing a lighting system.

Everywhere in the house an attempt has been made to install the amount and kind of light which would be needed there. A good illumination of the doorstep with or without an illuminated house number has not been forgotten.

Opposite the front door in the hall a niche has been made which is lighted from both sides (see *fig. 1*). This serves as substitute for a window in this small windowless hall.

On the right of the front door, invisible in *fig. 1*, a mirror has been built into the wall. The lighting of this mirror is shown in *fig. 2*. The middle section of a large plate of glass has been given a mirror back, the two strips on either side have been frosted. Behind these strips are bent surfaces lighted by a row of lamps. Anyone standing in front of the mirror is thus illuminated indirectly and from all sides, so that no shadows can spoil the visibility.

All the lights can be switched on and off by the visitor by means of a series of switches. Beside each switch may be found a brief description of the installation which it operates, as may clearly be seen in *fig. 3*.

As an example of the attractive effects which can be obtained when it is possible to make allowance for the lighting system during the construction of the house, may be mentioned the small plaster dome (*fig. 3* and *fig. 4*) which gives indirect lighting of part of the hall, and the built-in stair lighting along the base of the stair bannister which only lights the stair treads. In more modest houses also such lighting features can be introduced without great expense, and we believe that they would considerably increase the attractiveness of such houses.

In the background of *figs. 1* and *3* may be seen the bathroom and kitchen respectively, which we shall not describe in detail.

On the right next to the kitchen is the living room which is shown in *fig. 5*. A central fixture for semi-indirect lighting, as used in this room, may give a good general illumination in such a room of modest dimensions. Since, however, the occupants ordinarily sit facing the light, it is usually insufficient for reading or sewing. One needs 150 to 200 lux on the piece of work or book, and in

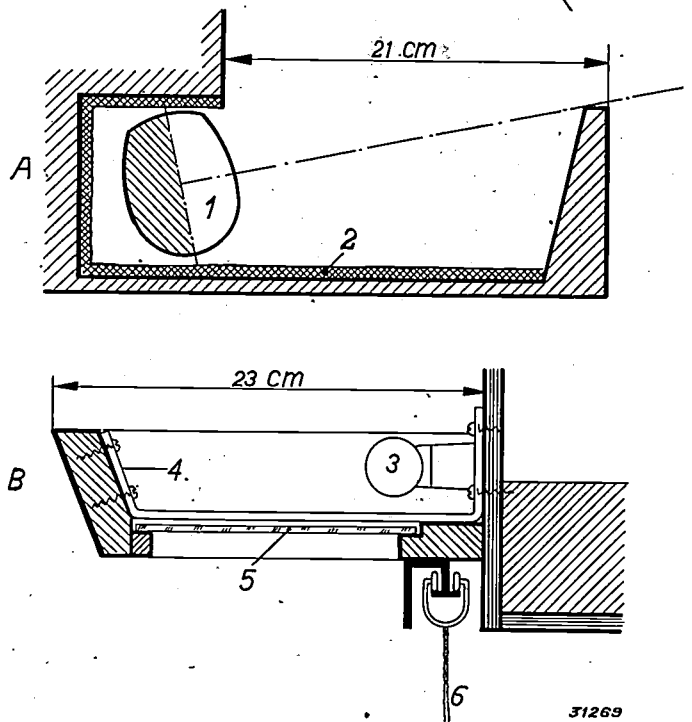
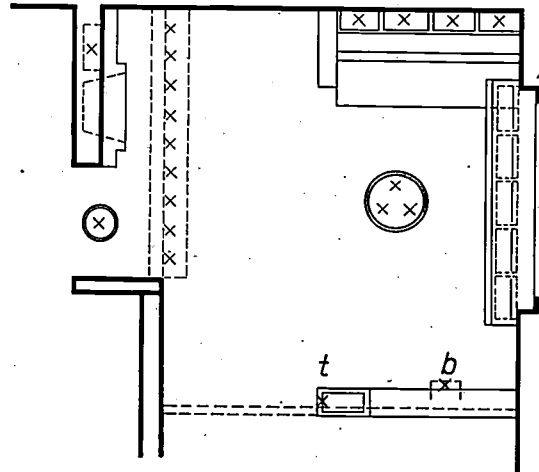
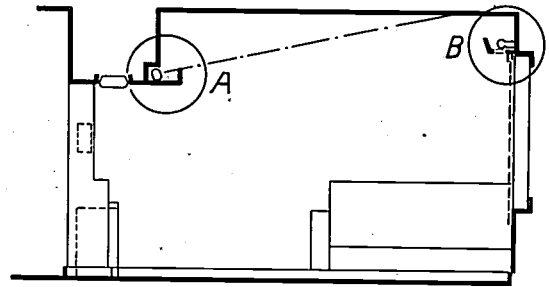

Fig. 7. Diagram of the cross section and view from above of the illumination systems in the living room. In addition to the systems shown in *figs. 5* and *6* the illumination of the bookcase (*b*) and the teatable (*t*) are indicated by crosses. The illumination over the hearth (*A*) and above the curtain (*B*) are then given in more detail. 1 "Cornalux" lamps 60 W, distance c.o.c. 33 cm; 2 asbestos; 3 "Philinea" lamps 40 W; 4 white painted surface; 5 patterned frosted glass; 6 curtain.



Fig. 8. Dining room. Indirect illumination with four "Cornalux" lamps of 60 W. Illumination above the sideboard by five lamps of 25 Dhm above a plate of frosted glass. Direct illumination, directed on to the table, from a mirror reflector "Philiray" SC 255 with an "Argenta" lamp of 200 W. The average intensity of illumination on the table is 250 lux. This light is not on in the photograph, but it may be seen in fig. 1.

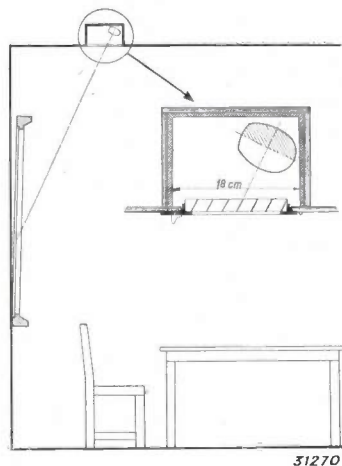

Fig. 9. Illumination of a picture in the dining room by a "Cornalux" lamp of 100 W, built into the ceiling. The lamp is hidden by a grid of steel strips. The light is directed on to the picture at a slight angle so that the latter cannot reflect.

order to attain this the central light point would have to be so large and intense that it would be disturbing.

For this reason local auxiliary lights are to be recommended. In this case a standard lamp has been placed near one of the arm chairs. Together with the centre light this gives 250 lux upon a book held in the hands of the occupant of the chair.

When the reader looks up from his book the great contrast between the bright surfaces of the book and the lighting fixture, and the relatively dark surface of the much less strongly illuminated wall will give a somewhat unpleasant impression. It is striking how much the impression of the room improves when for example the wall lighting behind the couch is switched on, or the curtain illumination which is introduced behind a simple wooden frame with frosted glass, above the wide light-grey velvet curtain.

In some cases in such small rooms the great size of the central lighting fixture is a serious obstacle in making the best use of the space available. Especially in the daytime these useless large volumes are real nuisances. Built-

in niches or light panels in pieces of furniture, light coves and niches are much smaller and can usually be constructed to be quite unnoticeable.

As an example of such a feature, in addition to the central lighting fixture, another kind of general illumination may be used in the living room. This is an indirect illumination installed in a light cove above the hearth (see fig. 6). This gives an average intensity of illumination of 90 lux. With this general illumination, local illumination for instance of the niche by the hearth, of the bookcase or the teatable, is also very convenient and attractive.

All these systems of illumination can be relatively simply made, the construction of several of them is indicated in fig. 7, and they will in many cases cost no more than a good chandelier or table lamp, with which it would be very difficult to obtain the same effect.

The dining room, which is shown in fig. 8 and fig. 1, presents quite a different problem. In the first place the table must be very well illuminated, preferably direct and with some reflexes in order to bring out the beauty of crystal and silver on the table. For this purpose a very simple wooden ornament in the ceiling which occupies little space



Fig. 10. Bed-sitting room. General illumination by a ceiling fitting (see fig. 1). Auxiliary illumination in a niche beside the bed, also under the bed and on the desk.

has been chosen. It is obvious that this ornament could be made more decorative in form and material in many ways. A silvered reflector with a large lamp is placed in a square box. This is screened by vertical louvres. The light thus falls chiefly in a vertical direction and gives an illumination of about 250 lux on the table top.

With this light alone the contrasts between the strongly illuminated table cloth and the walls would be too great. An auxiliary illumination, for instance in a niche above the sideboard, immediately

improves the atmosphere of the room. Moreover there is the advantage that any one busy at the sideboard need not work in his own shadow.

As alternative, or together with the direct illumination of the table, a light recess is made around the central reflector. An indirect illumination is built into this which gives the entire room an additional illumination of 75 lux at table height. This indirect illumination is more restful and more diffuse than the direct illumination, and will be used especially when the room is not being used as a dining room, but for childrens' home work or for reading at the table. In fig. 8 the indirect illumination is on, while in fig. 1 the direct illumination is being used.

Finally a small source of light is let into the ceiling by which the empty rear wall of the dining room can be lighted. This light (see fig. 9) is meant to be used when a picture is hung on this wall. It is a fact that the eye is always attracted to the brightest spots. When a picture hangs on a light-coloured wall, a conflict arises, because the wall is the lighter and thus attracts the eye, while the picture, which usually contains much darker colours and thus forms a less bright spot for the eye, should be receiving the attention. If now the surface of the picture is extra strongly illuminated locally, for instance by 80 lux, this conflict is removed and the picture comes out much better. In the combination bed-sitting room partially visible

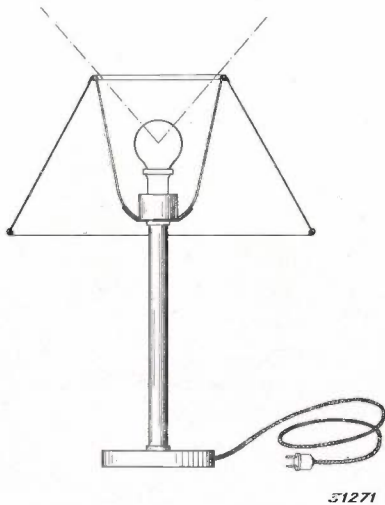

Fig. 11. Cross section of the desk lamp in the bed-sitting room. The lamp of 125 Dlm gives a diffuse illumination of the surface of the desk through a flashed opal glass reflector, and at the same time a direct illumination of the ceiling. The reflector is screened from the eye by a parchment shade.



Fig. 12. Bedroom. General illumination installed between two wall closets behind frosted glass. Auxiliary illumination of the ceiling by a reflector on the opposite wall. Illumination of the mirror by tubular lamps at either side. Illumination of the bedside tables and of the wall closets.

in fig. 1 to the right of the dining room, various lighting features have been installed which contribute very much to the comfort of such a room. The general illumination is by a ceiling fitting which, however, in order to avoid too much severity, is set in a circular depression in the ceiling. A very attractive effect can be obtained by giving the surface of this depression a very light colour.

In fig. 10 the bed-sitting room is shown separately. Next to the bed is a lighted niche with room for a clock, which makes it possible to read in bed. A small lamp has been installed under the bed which lights the floor sufficiently so that one can find ones way about the room without disturbing the sleeper. This is especially important in a child's room or a sickroom.

On the desk stands a good table lamp which is shown in cross section in fig. 11. This lamp contains a source of 125 Dlm (1 Dlm = 1 dekalumen = 10 lm) and gives on the surface of the desk at 30 cm distance an intensity of illumination of 300 lux, at 50 cm 200 lux and at 50 cm 110 lux. The light is scattered diffusely by a milk glass screen built into the shade. This milk glass screen serves at the same time as reflector and gives an indirect illumination *via* ceiling and walls, so that the whole room forms a bright pleasant background for the brightly lighted working surface.

The last room of the series, the bedroom is lighted mainly indirectly from a light trough above the bed (see fig. 12). This trough is hung between two wall closets and covered at the lower side with frosted glass. In this way there is somewhat more light at the head of the bed than the general level of illumination of the room, and the intensity is high enough to make it possible to read in bed. Nevertheless there is no light shining directly in the eyes when one lies in bed, as there would almost certainly be in the case of a hanging central ornament.

The large mirror is flanked on both sides by tubular lamps along the whole length. This provides a very generous illumination of 400 lux on the person standing before it. It is striking that the image in the mirror becomes much more satisfactory when the background, *i.e.* the wall opposite the mirror, is well lighted. This means that the contrast between the tubular lamps and the background which is reflected should be made as slight as possible.

Lamps are installed in the wall closets which are lighted automatically when the door is opened. The advantage of this closet illumination is obvious; without such illumination one always stands in one's own light when using the closet.

Philips Technical Review

DEALING WITH TECHNICAL PROBLEMS
 RELATING TO THE PRODUCTS, PROCESSES AND INVESTIGATIONS OF
 N.V. PHILIPS' GLOEILAMPENFABRIEKEN

EDITED BY THE RESEARCH LABORATORY OF N.V. PHILIPS' GLOEILAMPENFABRIEKEN, EINDHOVEN, HOLLAND

ILLUMINATION BY MEANS OF LINEAR SOURCES OF LIGHT

by N. A. HALBERTSMA and G. P. ITTMANN.

535.241 : 628.93

The differences are discussed between illumination by linear sources of light and by ordinary sources which are usually considered as point sources. The illumination, produced by a linear source of finite length on a plane parallel or perpendicular to the source, is discussed. In conclusion a description is given of the very different aspect of shadows and reflections in the case of linear objects, illuminated by parallel or perpendicular linear light sources.

Point sources and linear sources of light

The recent development of tubular sources of light, especially gas discharge lamps, justifies the expectation that they will be used to an increasing extent for the purposes of illumination. It is therefore necessary to point out, that the term "luminous intensity", so often used in illuminating engineering, is closely connected with our conception of a so-called point source of light. The luminous intensity I of a light source in a given direction is expressed as the light flux dF , which is emitted in a small solid angle about that direction, divided by the solid angle $d\omega$ itself

$$I = \frac{dF}{d\omega} \dots \dots \dots (1)$$

If this definition is to be used, it is, strictly speaking, necessary that all the rays be emitted from a single point, but in practice this ideal is sufficiently closely approximated in the case of a small luminous body, e.g. the small sphere of a tungsten arc lamp. At sufficiently great distance the propagation of the light takes place over concentric spheres, while at the same time the distribution of the light over the different directions in space shows a completely spherical symmetry. A light flux of F lumens passes through each concentric sphere; the luminous intensity in all directions is thus:

$$I = \frac{F}{4\pi} \text{ c.p.} \dots \dots \dots (2)$$

The light flux $F/4\pi r^2$ passes through 1 sq. cm of a surface perpendicular to the ray at a distance r cm; the illumination E at that point is then

$$E = \frac{F}{4\pi r^2} 10^4 \text{ lux} \dots \dots \dots (3)$$

It is therefore clear that for such a luminous point the intensity of illumination is equal to 10^4 times the light intensity in a certain direction divided by the square of the distance in cm:

$$E = \frac{I}{r^2} 10^4 \text{ lux} \dots \dots \dots (4)$$

In addition to the small luminous body with spherical light distribution, a small luminous surface element is also an example of a point source of light. The luminous intensity in this case, however, is not the same in all directions in space, but varies on one side of the surface proportional to the cosine of the angle α to the normal to the surface, while on the other side of the surface no light is emitted. The surface representing the light distribution is a sphere touching the luminous surface. If the luminous intensity perpendicular to the surface is I_m , it is therefore at an angle α

$$I = I_m \cos \alpha \dots \dots \dots (5)$$

Since we may assume in the case of this luminous surface, just as with the luminous point, that the light propagation takes place over concentric

spheres, that is to say along straight lines from a single point, the illumination E is again inversely proportional to the square of the distance, according to equation (4). This case of a point source of light, which emits light towards one side only with an intensity which follows Lambert's law (formula (5)), is well approximated by the crater of a carbon arc lamp.

If we are far enough away from a light source of any shape having a light intensity which varies in any arbitrary manner over the different directions in space, it may be considered practically as a point source with, however, a light distribution surface of an arbitrary form. The propagation of light again takes place over concentric spheres, so that formula (4) still holds for the intensity of illumination. In connection with the accuracy to be attained in photometry, such a simplification of any form of light source to a point source with an arbitrary light distribution is permissible for observations at distances greater than five times the greatest dimension of the light source. If one is not concerned with for instance, linear light sources, formula (4) is in general sufficiently approximate even for shorter distances as a description of the manner in which the propagation of light takes place.

If on the other hand one is concerned with sources of light, which have much greater dimensions in one direction than in all the others, such sources may no longer be considered as point sources at distances which are not great compared with their greatest dimension. At distances which are great with respect to the width of the linear sources of light, such a light source may be considered as an infinitely long luminous line. The characteristic difference between such a linear source and a point source consists in the fact that in the case of the former the propagation of the rays takes place over coaxial cylinders instead of over concentric spheres. The illumination E will not, therefore, be inversely proportional to r^2 , but to r only. If we introduce I_0 as the luminous intensity per unit of length for a linear light source, then the intensity of illumination at a point sufficiently near the linear source can be written as follows:

$$E = a \frac{I_0}{r} \dots \dots \dots (6)$$

In order to find the numerical coefficient a we must now investigate, how the light distribution figure changes at distances so great that the linear source may be considered as a point source.

At a great distance from a linear source of light the

luminous intensity I may be defined: in the lengthwise direction of the source it is practically zero- and perpendicular to this direction it is equal to the length l times the light intensity I_0 per unit of length. The intensity of illumination E at a perpendicular distance $r \gg l$ measured in a plane parallel to the light source therefore becomes:

$$E = \frac{I_0 l}{r^2} = \frac{I_m}{r^2}, \dots \dots \dots (7)$$

where I_m is the maximum light intensity of the linear source at a distance, at which it may be considered as a point source. In these theoretical considerations it seems obvious to assume that the luminous intensity at a great distance from a linear source of light depends according to Lambert's law on the angle to the normal to the linear source (formula (5)), which assumption is actually quite true for a diffuse linear source. The light distribution surface is then obtained by rotating a circle which touches the luminous line about that line; i.e. it is a torus with no hole. The light flux which is emitted from a point source with such a light distribution is not $4 \pi I$ as it would be according to equation (2) for a uniform luminous intensity I , for a maximum luminous intensity I_m the flux becomes equal to $\pi^2 I_m$.

This same light flux must be emitted in the direct neighbourhood of the linear source through a coaxial cylinder. According to formula (6) this light flux becomes: $2 \pi r l \cdot a \frac{I_0}{r} = 2 \pi a I_m$. Since the light flux F is the same close to the source and far away from it, the following holds:

$$F = 2 \pi a I_m = \pi^2 I_m, \dots \dots \dots (8)$$

from which it follows, that the numerical coefficient a must equal $\pi/2$. For the illumination E close to the linear source with a light intensity I_0 per unit of length we therefore obtain:

$$E = \frac{\pi}{2} \frac{I_0}{r} = 1.57 \frac{I_0}{r} \dots \dots \dots (9)$$

If the variation of the intensity of illumination is examined in a direction perpendicular to the direction of the source for distances, which are great compared with the length of the source, formula (7) will be found to be correct, but at distances, which are small compared with the length of the source, we are in the region where (9) is valid. The gradual transition between these two, which occurs at distances of the same order of magnitude as

the length of the source, is shown in *fig. 1*. In this figure the illumination E is plotted as a function of the perpendicular distance r from the centre (both on a logarithmic scale) for a linear source of light 1 m long, with a light intensity of 1 candle power per cm. At a distance of 10 m the intensity of illumination amounts to 1 lux according to equation (7) and at 10 cm it becomes 1570 lux according to formula (9); for in this formula the unit of illumination is 10^4 lux if 1 cm is the unit of length. The variation for the two limiting cases of luminous point (formula (7) and luminous line (formula (9)) is shown dotted, and the actual variation forms a continuous transition between these two dotted lines in the double logarithmic diagram. It may be seen that up to

within a distance of 2.5 m, *i.e.* to within 2.5 times the length of the source the inverse square law holds, while at distances of less than 20 cm (*i.e.* $\frac{1}{5}$ of the tube length) the inverse proportionality to the distance itself begins to hold.

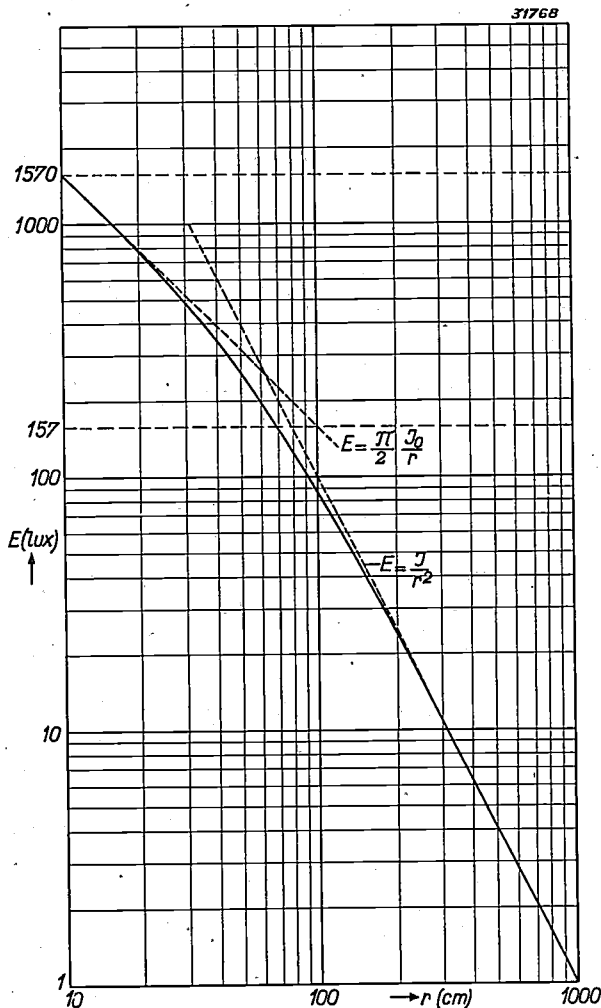

Fig. 1. Intensity of illumination E in lux produced by a linear source of light 1 m long and having a luminous intensity of 1 c.p./cm, at different distances r in cm, in a perpendicular direction from the middle of the light source plotted on logarithmic scales. The continuous line indicates the actual variation, while the two dotted straight lines in the double logarithmic diagram indicate the variation for the two limiting cases of light propagation over concentric spheres according to formula (7) and over coaxial cylinders according to formula (9), here the unit of illumination has always been 10^4 lux.

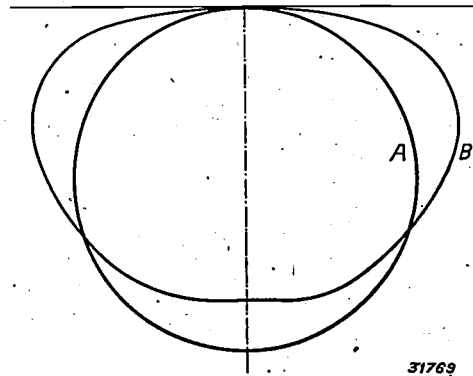

Fig. 2. The circle A gives the light distribution according to Lambert's cosine law, as found in the case of a diffusing surface and also in the case of a gas discharge with much self-absorption (sodium), while curve B represents the light distribution with little self-absorption (neon).

In practice we will be often concerned with the illumination at distances of the order of magnitude of the length of the linear source of light. For a correct calculation of the intensities of illumination it is necessary to know the actual light distribution in different directions. If one is concerned with tubes of some diffusing material such as opal glass, for instance, the light distribution actually does vary according to the cosine law of Lambert (formula (5)). This is also true with gas discharge tubes with much self-absorption, such, for example, as a sodium lamp. If on the other hand the self-absorption may be practically neglected, as for instance with a neon discharge, the light is then emitted according to the distribution curve represented by *fig. 2 B*. The luminous intensity perpendicular to the linear source is now smaller than would be the case according to Lambert's law (*fig. 2 A*), while it is greater in lateral directions.

Illumination of plane surfaces by a linear light source of finite length

In the foregoing we have chiefly dealt with the theoretical case of an infinitely long luminous line and of a luminous point. We shall now proceed to consider in particular the distribution of illumination on a plane by a linear light source of finite length. If one first examines the intensity of illumination on a plane parallel to an infinitely long linear light source, it is of course found to vary in the same way along all lines perpendicular to the lengthwise direction of the source.

By plotting this intensity of illumination perpendicular to the plane, a so-called illumination contour is obtained, of which in this case all cross sections perpendicular to the axis of the light source are alike (fig. 3). If it is desired to

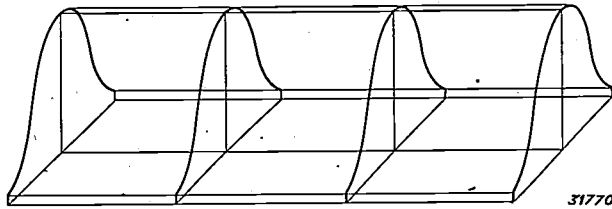

31770

Fig. 3. Variation of the intensity of illumination on a plane parallel to an infinitely long luminous tube; so-called "illumination contour".

calculate the form of the cross section, it can most simply be done by making use of the light propagation over coaxial cylinders dealt with in the foregoing. The intensity of illumination E at point P on a plane perpendicular to the radius r is then according to formula (9) given by a luminous linear element at O , where the light source cuts the plane through P perpendicular to its axis (fig. 4):

$$E = \frac{\pi}{2} \frac{I_0}{r} = \frac{\pi}{2} \frac{I_0}{h} \cos \alpha, \dots (10)$$

where I_0 is the luminous intensity per unit of length. In the horizontal plane at P it therefore becomes:

$$E = \frac{\pi}{2} \frac{I_0}{h} \cos^2 \alpha \dots (11)$$

In order to obtain the distribution of illumination for a linear source of light of finite length we first divide an infinitely long source into two parts. If the light source extends to the left to infinity, the intensity of illumination remains constant in that direction for a sufficiently great distance, but in the neighbourhood of the righthand end of the source it decreases, and just below the end of the source it reaches one half of its original value. This may easily be understood, because the right half of the infinitely long light source, which has been removed, must at that point have contributed

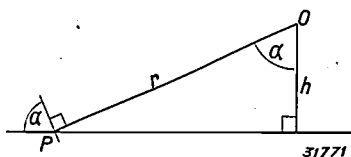

31771

Fig. 4. A linear source of light stands at O perpendicular to the plane of the drawing. h is the distance to a plane upon which the illumination E is calculated at point P at a distance r from O . The angle between r and h is α .

exactly the same amount to the intensity of illumination as the remaining lefthand half. In fig. 5 the variation of illumination is shown along the projection of the light source on a plane parallel to the source. The illumination E is indicated as a continuous line for the half of the infinitely long source which remains, while the illumination E_2 which the removed half would produce is indicated by a dotted line. The sum of these two is the same at every point. From considerations of symmetry they are mirror images of each other with respect to the plane passing through the extremity of the tubes and perpendicular to their axes.

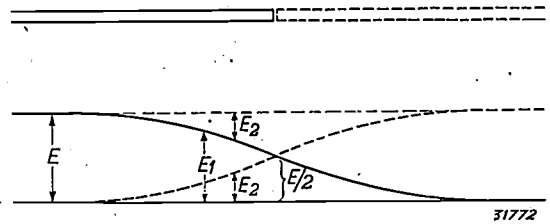

31772

Fig. 5. Variation of the illumination E produced by a linear light source in the neighbourhood of its extremity along its projection on a plane parallel to the source. The illumination which would be produced by the omitted half of an infinitely long light source is indicated as a dotted line. From considerations of symmetry it follows that just below the end of the luminous tube the illumination is one half of what an infinitely long tube would produce.

If we now consider a linear source of light of finite length, which is sufficiently long compared to its cross section and to the distance to the lighted surface, the intensity of illumination over a wide range directly under the centre of the source will be practically constant (fig. 6), but it will decrease toward the extremities of the source until it is one half directly under the ends of the tube. Since the intensity of illumination does not vary to any extent under the middle of the tube, it may be assumed that the linear source of light extends to infinity at the other end when considering the intensity of illumination in the neighbourhood of one end. In fig. 6 the illumination contours are given for a linear light source of finite length on a plane parallel to the source. For accurate calculations of the intensity of illumination with linear sources we may refer for instance to: E. L. Matthews: Das Licht I, 141 and 165, 1931: where the results are given in tables and in the form of graphs.

In practical cases one is concerned not only with the illumination of planes by parallel linear light sources, but also by linear sources which are perpendicular to the plane. This latter is the case for example when linear sources are hung vertically

above a plane, and also in the case of a vertical plane which is perpendicular to a horizontally mounted linear source of light.

This situation is represented in *fig. 7*. A light source of length L hangs with its lower end at a

$$\frac{I dz}{r^2} \cos \alpha$$

and the amount contributed to the intensity of illumination on the horizontal plane thus becomes:

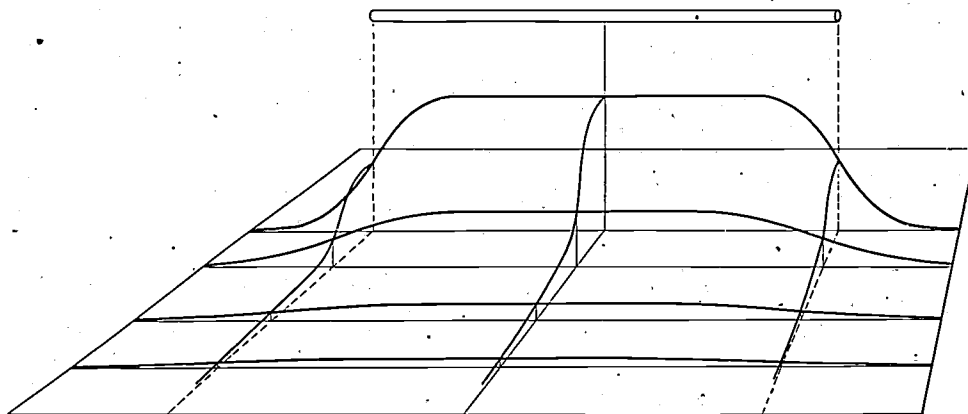

Fig. 6. "Illumination contour" for a light source of finite length on a plane parallel to it.

distance h_1 above the lighted surface and with its upper end at a height h_2 . O is the projection of the vertically suspended source on the horizontal plane, and we wish to know the illumination on the horizontal plane at a point P at a distance d from O . The luminous intensity in a horizontal direction is I candle power per cm, and at an angle α with the horizontal with a distribution according to Lambert's law it becomes $I \cos \alpha$. The element dz at the height z will thus contribute the following amount to the illumination at point P on a plane perpendicular to the ray r , according to the propagation of light over concentric spheres:

$$\frac{I dz}{r^2} \cos \alpha \cos (90^\circ - \alpha) = \frac{I dz}{d^2 + z^2} \frac{d \cdot z}{d^2 + z^2}$$

If I is expressed in candle power per cm and all distances in cm, we obtain the illumination E in lux by multiplying this amount by 10^4 and integrating along the vertical light column:

$$E = \int_{h_1}^{h_2} \frac{I dz \cdot d \cdot z}{(d^2 + z^2)^2} 10^4 \text{ lux} \dots (12)$$

This gives an intensity of illumination:

$$E = \frac{I d}{2} \left[\frac{1}{d^2 + h_1^2} - \frac{1}{d^2 + h_2^2} \right] 10^4 \text{ lux} \dots (13)$$

For the case where the light source begins at the lighted surface, h_1 becomes zero and the intensity of illumination becomes:

$$E = \frac{I}{2 d} \frac{h_2^2}{d^2 + h_2^2} 10^4 \text{ lux} \dots (14)$$

In order to assemble data which can easily be used in practice it is sufficient to make a table ¹⁾ by means of formula (14), which contains the intensities of illumination for different values of h_2 and d for a certain luminous intensity per cm. If one is concerned with a vertical source of light, which only begins at some height ($h_1 \neq 0$) above the illuminated surface, one may simply deduct the intensity of illumination which would be produced by a light source of a height h_1 above the surface from

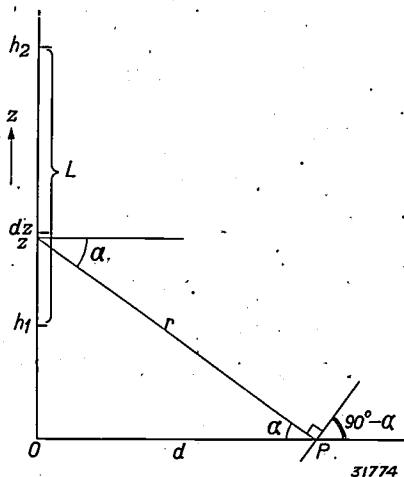
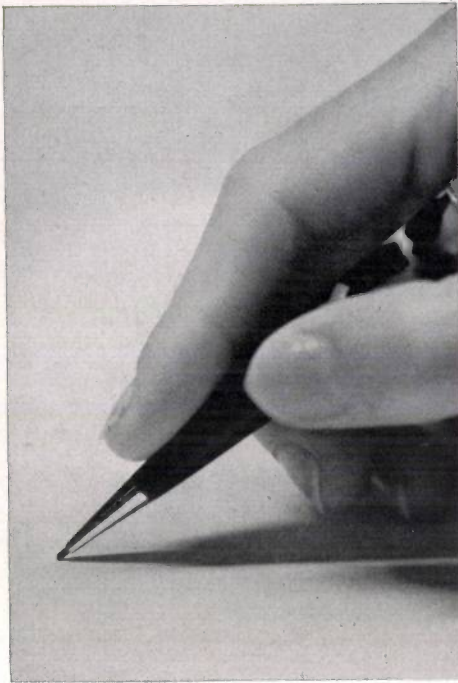

Fig. 7. A light source L in a vertical position with its ends at distances h_1 and h_2 above point O . The intensity of illumination is determined at P , which lies at a distance d from O in the same horizontal plane. An element dz of the linear light source lies at a height z above O , and at a distance r from P in a direction which makes an angle α with the horizontal plane.

¹⁾ Cf. R. R. Whipple: Trans. Ill. Eng. Soc. 30, 492, 1935.



31789

Fig. 8. The writing pencil is held approximately parallel to a linear source of light, so that a sharp shadow results.

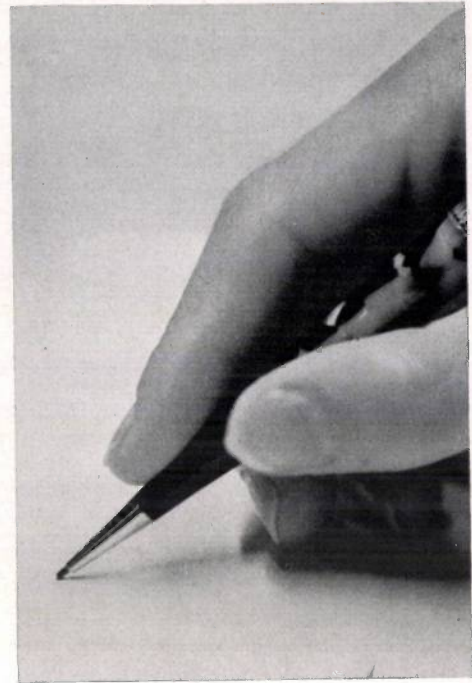

31790

Fig. 9. The writing pencil is held about perpendicular to the linear light source, so that there is practically no shadow.

the intensity of illumination produced by a source of height h_2 .

Shadows and reflections with linear sources of light

A luminous point produces shadows which are very sharp images of the object which casts the shadow.

If the dimensions of the source of light are sufficiently small compared with the distance between the source and the object casting the shadow, the shadows will only be slightly fuzzy and will be less so the closer the shadow will be to the object. For light sources whose dimensions are not much greater in one direction than in all others, the shadows will be more or less fuzzy depending upon the mutual relation between the distance from the light source to the shadow-casting objects and to the shadow itself, but they are usually still recognizable as images of the object.

The situation, however, is different with a source of light, whose dimension in a certain direction is very much greater than in all others. If in addition

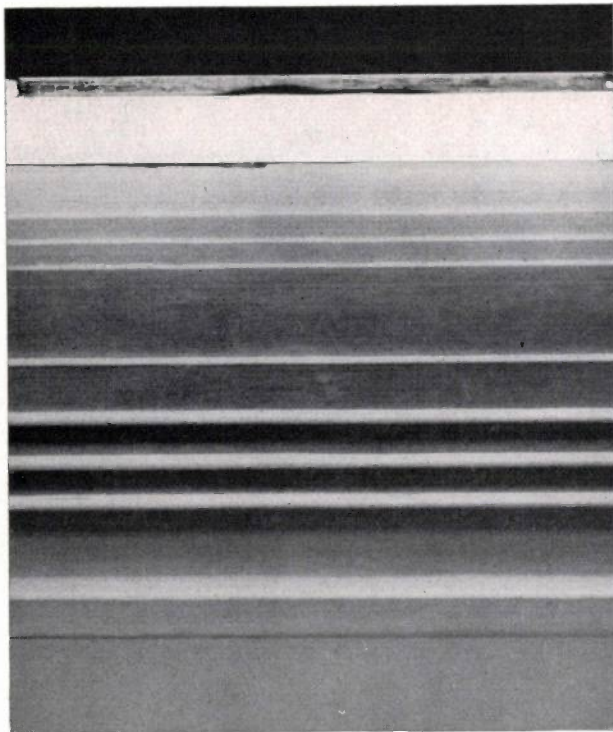

31791

Fig. 10. The linear light source is parallel to the moulding, so that the latter is pleasingly accentuated.

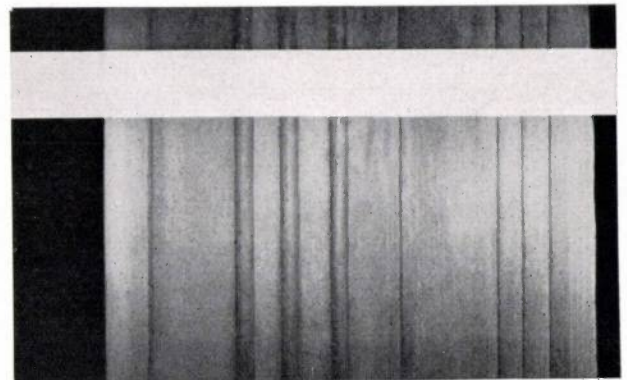

31792

Fig. 11. The moulding of the illuminated surface is perpendicular to the linear source which therefore fails almost entirely to bring it out.

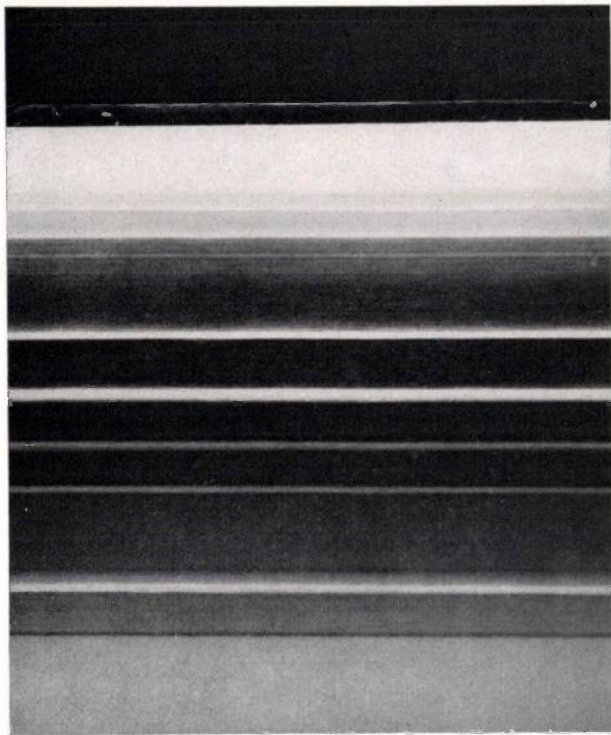

31793

Fig. 12. The light source is now placed too close to the ceiling and parallel to the moulding, so that very dark and harsh shadows are formed which destroy the plastic effect of the moulding.

the objects casting the shadow are extended in a certain direction, it is very important for the quality of the shadow whether or not the lengthwise directions of source and object are mutually parallel. For mutually parallel linear sources of light and objects the shadows are very sharp and pronounced, while with mutually perpendicular source and object there is practically no shadow at all. This fundamental difference is very clearly demonstrated by *figs. 8 and 9*, which are photographs of a hand holding a pencil in the position for writing taken under different kinds of illumination with a linear source of light. In *fig. 8* the pencil is held about parallel to the source, while in *fig. 9* it is perpendicular to the source. The difference is so striking, that in the case of the parallel position it appears as if we were concerned with a point source, while with the perpendicular position one might get the impression that the illumination is by an extended surface source.

If it is necessary to illuminate surfaces (ceilings



31794

Fig. 13. Light reflections in parallel glass rods illuminated by a linear light source parallel to them so that decorative reflexes appear.



31795

Fig. 14. A linear light source is mounted perpendicular to the direction of the glass rods, which results in unpleasant light spots.

for instance) which have plaster decorations in relief, by means of linear light sources, one is then also concerned with the phenomenon, demonstrated by fig. 8 and 9, in that the position of the linear source is of the greatest importance for the character of the shadows formed. *Figures 10 and 11* show this clearly; they give the impressions obtained from the same ceiling with different methods of illumination. In fig. 10 the linear source is parallel to the direction of the moulding, so that the latter is accentuated by sharp shadows. In fig. 11 the effect of the moulding has quite disappeared, since the linear source is now placed perpendicular to it.

Even when the light source is mounted parallel to the moulding, it is still possible that the latter is not brought out to advantage as may be seen from *fig. 12*. In this case the light source is placed too close to the ceiling, so that very dark harsh shadows are formed which destroy the plastic effect of the plaster mouldings.

In conclusion we shall consider briefly the use of the decorative effect of specular reflection in the application of linear light sources. In *figs. 13 and 14*, for example, may be seen how the same glass rods appear, when they are lighted by a linear source parallel or perpendicular to the tubes. While in the first case decorative gradations of light reflexes are obtained, in the second case there are unpleasant light spots.

In order to illustrate the fine effect which can be obtained with specular reflections of linear sources, a lighting fixture is shown in *fig. 15* consisting of seven tubular "Philinea" lamps 1 m in length. Each of these lamps is flanked by two glass rods which seem to radiate light. At the centre there is a reflecting metal cylinder which also reflects the light of the lamps.

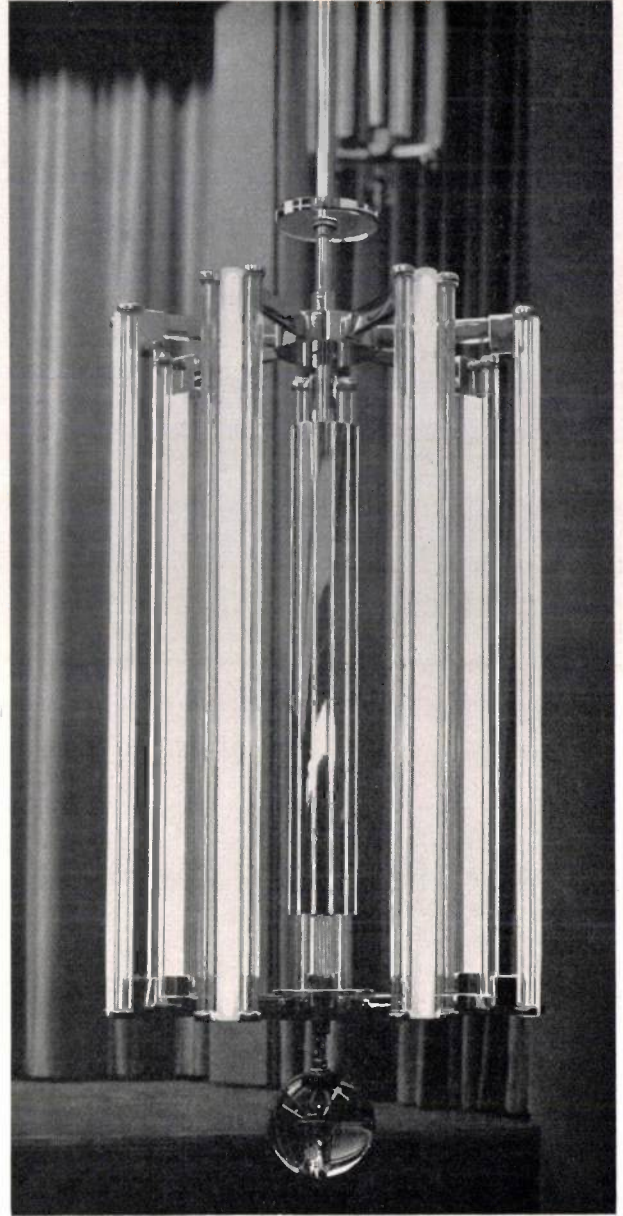

31796

Fig. 15. The ornament lighted by seven tubular "Philinea" lamps 1 m long, each flanked by two glass rods which seem to radiate light. The light of the lamps is also reflected by the polished metal cylinder at the centre.

THE MAGNETRON AS A GENERATOR OF ULTRA SHORT WAVES

621.385.16 : 621.396.615.14

A magnetron consists of a cathode filament, a cylindrical anode, usually divided into a number of sections, and a homogeneous magnetic field parallel to the filament. With such a system two main types of oscillations can be generated:

- 1) Oscillations with any relatively low frequency.
- 2) Oscillations whose frequency is determined by the periodic character of the movement of the electrons. In this case it is possible to distinguish between radial and tangential movements of electrons.

In the case of the first type of oscillations the frequency is subject to the same restrictions as in a radio valve. In the second type these restrictions do not hold, and very short waves can be obtained.

The generation of high power ultra short waves in transmitter valves of normal construction becomes more and more difficult with higher frequencies. This is due chiefly to the fact that the transit times of the electrons in the transmitter valves reach the same order of magnitude as the oscillation period of the waves to be generated. In addition, in the case of waves of several metres or decimetres, the necessary capacities and self-inductions of the oscillating circuits become so small that the required capacities and self-inductions in the transmitter valve and its connections cause unwanted differences between the desired and the actual circuit. These factors make it impossible to generate shorter and shorter waves efficiently, except by continually reducing the dimensions of the transmitter valve. When this is done, however, the voltages which may be applied to the electrodes and the power which these electrodes can dissipate also decrease very much, so that it becomes very difficult to generate reasonably high powers in the range of the decimetre and centimetre waves.

In the above-mentioned range of wave lengths, where the transit times of the electrons spoil the action of an ordinary transmitter valve, a quite different type of generator of oscillations just begins to assume satisfactory properties. In the case of these generators, which are called magnetrons, the finite transit times are put to effective use by giving the electrons an oscillatory motion by means of a magnetic field. This motion can be brought into resonance with the high frequency oscillations which we wish to generate.

A magnetron consists mainly of a straight filament as cathode, a cylindrical anode and a magnet which produces a homogeneous field parallel to the axis. The anode cylinder usually consists of a number of sections which are separated by slits parallel to the axis, but oscillations can also be generated in certain cases by a magnetron whose anode is not divided.

Fig. 1 is a magnetron constructed by Philips with four sections, which can dissipate 50 W. With other numbers of sections fundamentally analogous circuits occur.

In recent years important results have been obtained by means of magnetrons, especially in the

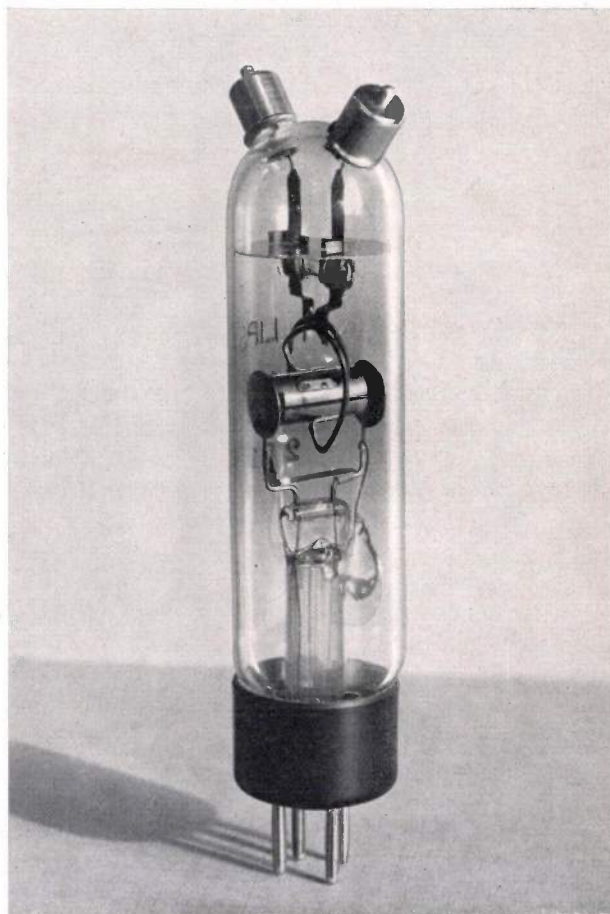

Fig. 1. A magnetron produced by Philips with four sections which can generate 50 W.

range of decimetre and centimetre waves. At wave lengths of about 80 cm powers of the order of 100 W can be generated with the same degree of efficiency as with normal transmitter valves on broadcasting waves.

The oscillation phenomena in a magnetron show great variety and are by no means completely understood in all cases. In most cases, however, one is concerned with one of three relatively simple forms of oscillation. These three forms will be described in this article and in each case it will be shown how the electron motion is able to maintain an oscillation in a connected circuit.

In order to do this, two points must first be considered. We shall first examine the general conditions for the occurrence of an oscillation and then indicate some of the laws of motion of electrons in the electric and magnetic fields which occur in the magnetron.

The excitation of oscillations

We shall begin with a very simple mechanical model, namely that of a mass hanging on a spring (see fig. 2). We assume that the mass oscillates up and down, so that the tension on the spring varies periodically. When left entirely to itself the oscillation will stop after some time. When, however, the tension of the spring is changed in the correct way by suddenly shifting the point of suspension either upwards or downwards the oscillation will not die out but will increase in amplitude. The upper curve of fig. 3 shows how the amplitude of the oscillation can be increased. Whenever the deviation of the oscillating mass is a maximum in the downward direction, the point of suspension is given a certain displacement in an upward direction and *vice versa*, so that the tension on the spring is slightly increased. In this way the amplitude of the oscillation grows steadily larger.

It is now clear where the energy comes from which is supplied to the oscillating mass. The work performed by the point of suspension at each displacement is equal to the length of the displacement multiplied by the tension of the spring in the oppo-

site direction. If the motion of the point of suspension does not take place in steps but is continuous (sinusoidal for instance) the energy supplied may be expressed by the product of the velocity of the point of suspension and the tension of the spring in the opposite direction. In order to increase the amplitude of an oscillation this energy must be positive, which means that the velocity of the point of suspension must be in opposite phase to the tension of the spring.

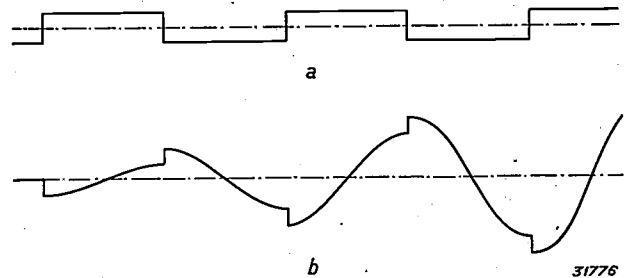

Fig. 3 a. Deviation of the handle of the model represented in fig. 2 as a function of the time. b. Tension of the spring as a function of the time.

If now we pass over to electrical oscillations, *i.e.* to a circuit consisting of self-induction coils and condensers, the tension of the spring corresponds to the voltage between the plates of the condenser. The motion of the point of suspension corresponds to a displacement of charges which changes the voltage on the condenser; the velocity of this motion thus corresponds to the current in a circuit which is connected externally to the oscillating circuit. The analogy is indicated more in detail in fig. 2. The condition for the maintenance of oscillations in electrical terms is now that the current in the external circuit must be opposite in phase to the voltage between the plates of the condenser. It must therefore be possible to consider the impedance of the external circuit as a negative resistance.

In fig. 4 it is shown by means of the well known inverse feed back amplifier connection how a negative resistance can be obtained.

When the potential of the anode obtains a positive maximum value, that of the grid is maximum negative. The grid voltage varies in opposite phase with the anode voltage. The current from the anode varies in rhythm with the grid voltage and thus in opposite phase to the anode voltage. The amplifier valve therefore actually has a negative resistance for the alternating components of the anode current.

The energy which is supplied to an oscillating circuit is manifested as a reduced heating of the

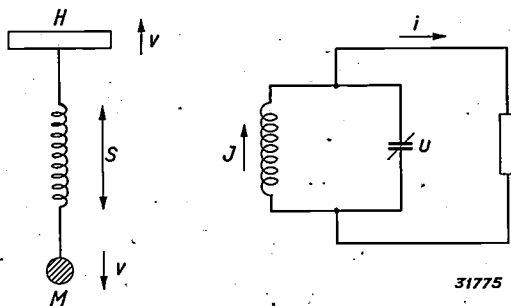

Fig. 2. Mechanical model of an oscillator consisting of a mass, *M* suspended on a spring. The mass can be made to oscillate by a suitable motion of the handle *H*. The electrical analogy is an *L-C* circuit which is made to oscillate by means of an external circuit. The velocity *v* corresponds to the current *i*, the velocity *V* to the current *I*, the tension *S* of the spring to the electrical potential *U* on the condenser.

anode. When there is an oscillation in the LC circuit, the electrons in the amplifier valve pass over to the anode chiefly at those moments when the anode voltage is lowest. The electrons are thus for the most part retarded by the alternating voltage, which immediately gives rise to an increase in the alternating voltage.

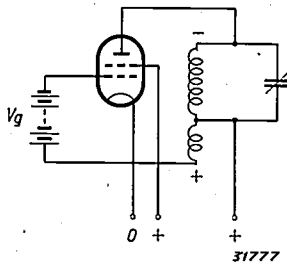

Fig. 4. Circuit of an oscillator.

In more complicated cases such as that of the magnetron, a consideration of the energy involved in the manner indicated above is the best way of judging whether an electron tube is capable of generating oscillations. The anode voltage consists of a direct voltage and an alternating voltage determined by the oscillation in a connected circuit. The electrons receive energy from the source of direct voltage. An oscillation can be maintained, if the motion of the electrons is controlled by the alternating voltage in such a way that the electrons give off part of the energy which they receive from the source of direct voltage to the source of alternating voltage. This will be the case when the majority of the electrons are moving against the electric field which is generated by the alternating voltage in the valve.

We shall apply this principle in dealing further with the different forms of oscillation of the magnetron. We must first, however, study the motion of an electron under the influence of an electric and a magnetic field.

The motion of an electron in a homogeneous magnetic field

An electron moving in a magnetic field experiences a force perpendicular to the direction of the magnetic field and to the direction of motion of the electron. Such a force normal to the direction of motion cannot change the absolute value of the velocity of the electron and can only cause a curvature of its path. Since the velocity of the electron remains constant, the curvature of the path will be the same at all points in a homogeneous magnetic field, in other words the electron describes a circular orbit.

The radius r of the circle is given by the con-

dition that the centrifugal force of the electron is equal and opposite to the force exerted by the magnetic field. This condition may be formulated as follows (see fig. 5):

$$\frac{m v^2}{r} = e v H, \dots \dots \dots (1)$$

where $e = 1.6 \cdot 10^{-20}$ coulomb, $m = 0.91 \cdot 10^{-27}$ g; H is expressed in gauss, v in cm/sec and r in cm.

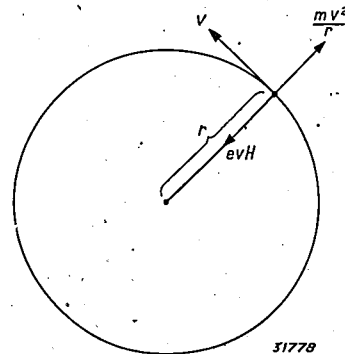

Fig. 5. Forces acting on an electron in a homogeneous magnetic field.

It follows from equation (1) that

$$r = \frac{m}{e H} v = 0.57 \cdot 10^{-7} \frac{v}{H} \dots \dots \dots (2)$$

The radius is thus proportional to the velocity v of the electron, and inversely proportional to the magnetic field. From this it follows that the frequency of the circular motion is independent of the velocity. The angular frequency is namely:

$$\omega = \frac{v}{r} = \frac{e H}{m} = 1.76 \cdot 10^7 H \dots \dots (3)$$

If a field strength of 100 gauss is taken, for example, a frequency of 280 megacycles/sec (107 cm) is obtained. This example already shows that phenomena of extremely high frequency can occur in the magnetron.

When in addition to the magnetic field there is also an electric field, the velocity of the electron is no longer constant, but is determined at every point of its path by the value of the electrical potential U ²⁾. According to the law of the conser-

¹⁾ In the ordinary circuits the voltage V is not supplied by a battery but by an R-C circuit so that the voltage V automatically assumes a suitable value.
²⁾ It is hereby assumed that the initial velocity of the electrons at the cathode ($U = 0$) can be neglected.

vation of energy the following is valid everywhere in space:

$$\frac{m}{2} v^2 = e U,$$

from which; upon substituting the numerical values of e and m , it follows that

$$v = 0.594 \cdot 10^8 \sqrt{U_{\text{volt}}}.$$

From this velocity a certain magnetic deflection follows, but in addition the electron is now deflected by the electric field.

At a great distance from the filament where the potential U is high and the electric field strength low, this additional deflection may be neglected, and one finds according to equation (2) a radius of curvature:

$$r = 3.38 \frac{\sqrt{U}}{H} \dots \dots \dots (4)$$

When the potential U is known for every point in space, then with the help of equation (4) a picture can be obtained of the motion of the electrons. Although this picture is not very accurate because of the neglecting of the deviation by the electric field, various properties of the magnetron can be explained with its help. For a complete picture, however, it is necessary to consider the electric field, at least in approximation. We shall do this by calculating the motion in the case of a homogeneous electric field perpendicular to the magnetic field. On the basis of the results we may then discuss more complex cases in a qualitative manner.

The motion of an electron in a magnetic and an electric field

Let us assume that the electron is moving in a plane defined by the coordinates x and y , and that there is a homogeneous electric field E in the y direction and a homogeneous magnetic field H perpendicular to the plane in the r direction. The equations of motion of the electron are the following:

$$\left. \begin{aligned} m \frac{d v_x}{d t} &= e v_y H. \dots \dots \dots a \\ m \frac{d v_y}{d t} &= e E - e v_x H. \dots \dots \dots b \end{aligned} \right\} (5)$$

By differentiating (5b) with respect to time we obtain:

$$m \frac{d^2 v_y}{d t^2} = - e H \frac{d v_x}{d t}$$

and if in this expression we substitute the value of $\frac{d v_x}{d t}$ from equation (5a) we obtain:

$$\frac{d^2 v_y}{d t^2} = - \left(\frac{e}{m} H \right)^2 v_y.$$

The general solution of this equation is:

$$v_y = a \cos \frac{e H}{m} (t - t_0) \dots \dots \dots (6)$$

In order to determine the other velocity component v_x we write equation (5b) in the following form:

$$v_x = - \frac{m}{e H} \frac{d v_y}{d t} + \frac{E}{H},$$

and by substituting here $\frac{d v_y}{d t}$ according to equation (6) we obtain

$$v_x = a \sin \frac{e H}{m} (t - t_0) + \frac{E}{H} \dots \dots \dots (7)$$

If we neglect the last term in equation (7), the velocity components v_x and v_y together define a circular motion with a velocity a and an angular frequency $\omega = eH/m$, which is thus independent of the electric field. The last term takes into account the influence of the electric field, and indicates that a translation with a constant velocity E/H in the x direction is superposed on the circular motion. This translation is perpendicular to the field E and thus follows an equipotential line. In fig. 6 different forms of paths are indicated which may occur in this way.

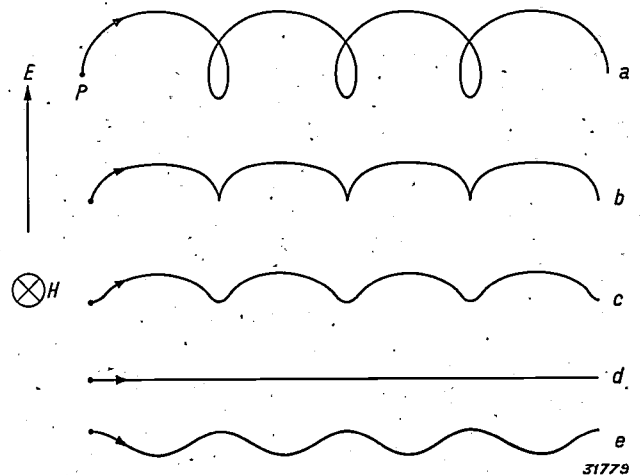

Fig. 6. Paths of an electron in mutually perpendicular homogeneous electric and magnetic field, with different initial conditions:
 a) The electron leaves point P with a vertical initial velocity.
 b) The electron leaves with zero velocity.
 c), d), e). The electron leaves with increasingly great horizontal initial velocities. In case d) the horizontal initial velocity is equal to E/H .

The equations of motion (6) and (7) appear somewhat strange because they express the fact that the velocity of translation of the electrons increases with decreasing magnetic field, and would even become infinitely great if the magnetic field should disappear. This paradox does not, however, appear if the initial conditions are taken into account in the correct way. Let us assume for example that the electron leaves at the time $t = 0$ a certain point with the velocity zero. The equations of motion are then:

$$v_x = \frac{E}{H} \left(1 - \cos \frac{eH}{m} t \right),$$

$$v_y = \frac{E}{H} \sin \frac{eH}{m} t.$$

Let the magnetic field become very small; the sine and cosine functions can then be developed and we obtain:

$$v_x = \frac{1}{2} \frac{e^2}{m^2} E H t^2 + \dots$$

$$v_y = \frac{eE}{m} t + \frac{1}{6} \frac{E e^3}{m^3} H^2 t^3 + \dots$$

At small values of H these expressions behave exactly as would be expected. When H approaches zero only one term remains which expresses the well-known acceleration of an electron in a homogeneous electric field.

If the electric field is not homogeneous the motion becomes more complex and it is impossible to give a general solution of the equations of motion. When, however, the magnetic field is sufficiently strong so that the circular paths become small, and when the electric field does not yet vary very much in the neighbourhood of the circular orbits, the electrical field may be considered to be homogeneous locally, and one may thus conclude that the electron will on the average follow an equipotential line. This is indicated in fig. 7.

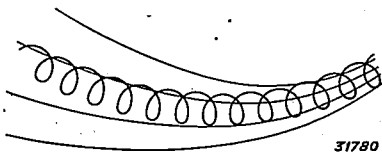

Fig. 7. Motion of an electron in a two-dimensional electric field and a homogeneous magnetic field in the direction of the third dimension. The electron follows the equipotential lines.

In the magnetron the radius of the circular motion is in many cases not so small that the electric field may be considered as homogeneous along one circle. In this case it is impossible to analyse the motion directly into a "rotation" and a "translation". This can, however, be done with sufficient accuracy for a qualitative discussion. We shall therefore make use of these terms in the following in order to characterize the circular motion and the displacement along an equipotential line.

The motion of the electron in the magnetron

In a magnetron the electrons leave the cathode with a low velocity and are accelerated by a radial field. They will be deflected by the magnetic field and curved paths will result. The curvature of their paths at every point is, as we have seen, proportional to the field strength, and inversely proportional to the velocity and thus also to the square root of the potential at the point in question. When the strength of the magnetic field is sufficiently great the electrons cannot reach the anode, and describe a path like that represented in fig. 8a.

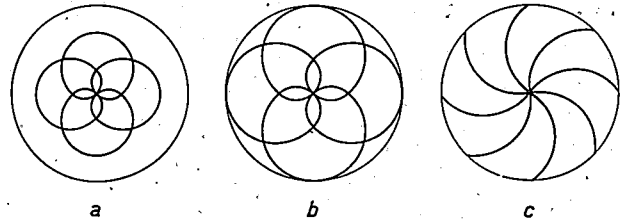

Fig. 8. Form of path of an electron in a magnetron at different intensities of the magnetic field H . a) $H > H_{kr}$; b) $H = H_{kr}$; c) $H < H_{kr}$.

With a completely symmetrical arrangement the electron emitted would return to its starting point, the cathode. Due to a slight asymmetry, however, it may occur that the electron misses its goal; in that case it describes a second loop similar to the first in shape but turned 90° , and so on, so that a closed orbit of four loops results.

When the strength of the magnetic field is made to decrease, the diameter of the loops increases until at the so-called critical field strength the electrons can reach the anode (fig. 8b and c). At that moment an anode current suddenly begins to flow, which current remains practically constant upon further decrease of the strength of the magnetic field.

When the cathode filament is sufficiently thin the critical field strength can easily be calculated. It may then be assumed that the potential is constant in the greatest part of the space and equal to the anode voltage V_a . The electron then describes a circular orbit whose diameter $2r$ at the critical field strength H_k is equal to the radius a of the magnetron. According to equation (4) the following is valid:

$$2r = 6.76 \frac{\sqrt{V_a}}{H_k} = a \quad \text{of}$$

$$H_k = \frac{6.76}{a} \sqrt{V_a} \dots \dots \dots (8)$$

It is remarkable that this formula which is derived

by approximation is satisfied exactly when the electron leaves the axis of the magnetron with zero velocity. Moreover it is independent of the variation of the potential between the cathode and the anode, and is also valid, for instance, when this potential changes due to the space charge.

When the anode cylinder is not continuous but consists of a number of sections with equal potential the paths of the electrons will be practically the same. If, however, there are differences in potential between the sections very divergent forms of orbits may appear which will be discussed in the following because of their close connection with the possibilities of oscillation of the magnetron.

Oscillations of relatively low frequency

We shall consider a magnetron with two anode sections (see *fig. 9a*), and with a given anode voltage V_a we choose a magnetic field so strong that no anode current flows. When a difference of potential is caused between the plates by the batteries b_1 and b_2 such that the average voltage remains equal to V_a , anode current is found to flow, and, remarkably enough, it flows to the plate with the lower potential. This shows directly that the magnetron is capable of generating oscillations. If one considers the circuit in *fig. 9b* consisting of a magnetron, an oscillating circuit in which there is an oscillation of a certain amplitude and a battery with the anode voltage V_a , it follows from the above that the electrons accelerated by the alternating voltage always move toward that section whereby the alternating voltage of the oscillating circuit has a retarding action. This is exactly the condition which was derived as necessary for the generation of oscillations.

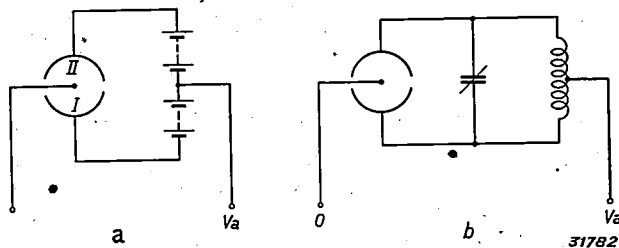

Fig. 9. a) Equivalent circuit. b). Circuit of a magnetron with two sections. When the magnetic field is greater than the critical value corresponding to the voltage of the sections, a current may flow if the voltage of the two sections is different. This current flows toward the section with lower potential.

In order to complete the explanation of the oscillation phenomenon dealt with above, we shall try to show why the electrons tend to choose the path toward the plate with the lower potential. In

fig. 10a the lines of equal potential and the paths of the electrons in a magnetron with two anode sections are given.

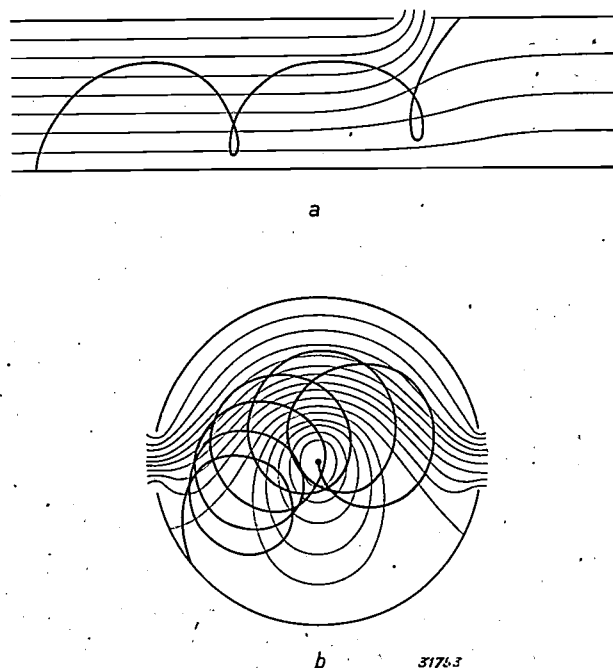

Fig. 10. Equipotential lines and electron orbits in a magnetron according to *fig. 9*.
a) Simplified scheme with flat electrodes.
b) The actual magnetron.

In order to obtain a simpler picture the cathode and the sections of the anode are drawn as flat plates, which introduces no changes in the principle of their action. Section I in *fig. 10a* has the higher potential, as may be seen from the course of the equipotential lines. Its potential is not, however, so great that an electron leaving the cathode with zero velocity could reach the plate.

The path of an electron is also given in *fig. 10a*. The electron is displaced in the direction of the equipotential lines as has already been explained in detail. When the electron approaches the slit it enters a region where the equipotential lines are bent and lie closer to the anode. The electron will follow this course, and we see that it therefore reaches the plate with lower potential although it began its journey under the plate with higher potential.

In *fig. 10b* the equipotential lines and the path of an electron are given in a cylindrical magnetron with two sections. The figure shows that the effect here is fundamentally exactly the same, although the picture is less clear.

The above-described mechanism for the generation of oscillations resembles the mechanism in radio valves inasmuch as the oscillations are

generated by means of a negative resistance. Just as in radio valves, the frequency is here also limited by the transit time of the electrons which, with strong magnetic fields, will be even longer than in radio valves, because the velocity of translation, $v = E/H$, is inversely proportional to the magnetic field.

Therefore the considered manner of generating of oscillations can only produce oscillations with relatively low frequencies.

Oscillations with very high frequency

Thanks to the fact that the motion of the electrons in the magnetron is periodic in nature, there are, however, also other possibilities of oscillation with periods which are shorter than the transit time of the electrons. These oscillations are induced by the oscillations which occur in the radial and tangential motion of the space charge in the magnetron.

The tangential motion has as fundamental period, the time necessary for an electron to run once around the cathode along an equipotential line. It is found that higher harmonics of this fundamental period also occur, particularly that period in which the electron is displaced over the angle included by one section. The frequency of the oscillation is determined by the velocity of the "translation", and thus by the quotient E/H . The oscillation appears, for example, when, by changing the magnetic field, the frequency of the tangential motion is brought into correspondence with the resonance frequency of the externally connected oscillating circuit.

The radial motion of the space charge varies periodically with the frequency of the circular motion of the electrons. This frequency, which is given in equation (3), depends only on the intensity of the magnetic field. The oscillation generated in this way is more difficult to obtain than the oscillation which is generated by the tangential motion and it has the shortest wave length which can be generated by a magnetron.

We shall now consider further the periodic motions of the electrons, and show that it satisfies the conditions for maintaining an oscillation in a connected oscillating circuit.

Tangential oscillations

Let us assume that there is an alternating voltage from an oscillating circuit on the sections of fig. 11 in addition to a direct voltage. The phase of the oscillation must be such that at the moment when the electron passes from section I to section II

along its path as given in the figure, sector I is at its maximum and sector II at its minimum potential. The electron therefore gives up energy to the electric field between the sections, and the oscillation in the electrical circuit is hereby reinforced.

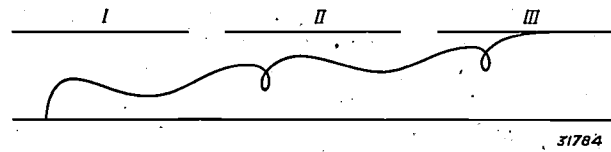

31784

Fig. 11. Electron orbits in a flat magnetron when the time necessary for the electron to pass from one slit to the next one is equal to half a period of the oscillation generated. The phase of the electron is chosen so that it passes each time from a place of maximum potential to one of minimum potential.

Because of its loss of energy the electron will no longer be able to return to the cathode, but will be further displaced along a line closer to the anode. If the time necessary for an electron to be displaced from one slit to the following slit, corresponds exactly to half a period of the oscillation the electron will again give off energy to the field and again approach the anode more closely. This process will be repeated until the electron reaches one of the sections.

We see thus that with a suitable frequency the condition for the generation of oscillations can be satisfied. Whether or not this takes place does not depend only upon the frequency, but also on the phase of the oscillation at the moment when an electron passes the slit.

When section I has the higher potential at the moment when the electron passes from section I to section II, the electron will give off energy to the oscillating circuit; if, however, the electrons pass the slit at random times no energy will be transferred on an average.

From a closer consideration it is found that the electrons do not pass the slit at random moments, but show a certain preference to pass it in the "correct" phase. In this connection we recall equation (7) from which it follows that the velocity

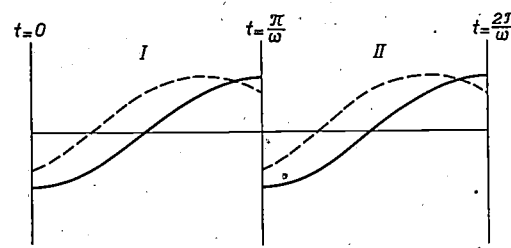

31785

Fig. 12. Continuous line: variation of the strength of the electron field as a function of time for an electron whose path is given in fig. 11. Dotted line: variation of the field strength for an electron which passes the slits slightly later. The average value of the field strength is somewhat higher.

of the displacement is proportional to the strength of the electric field.

In *fig. 12* the continuous line shows schematically how the field strength varies for an electron in the "correct" phase. At the moment $t = 0$ when the electron begins to move in section *I* this section has the highest negative value of the alternating voltage and therefore the field strength is at a minimum. When the electron is about to pass over from section *I* to section *II*, section *I* has meanwhile reached the maximum potential and the potential of section *II* is at its lowest value. In this way the variation in the field strength along the path of the electron is obtained as shown.

The dotted line shows how the field strength varies for an electron which arrives too late at the slit between section *I* and section *II*. The field strength in section *I* has already passed its maximum and is beginning to fall. The potential jump at the boundary line $t = \pi/\omega$ is therefore smaller, but in the case here represented it still has the correct direction. It is striking that the field strength in the case of the dotted curve lies higher on the average than in the case of the continuous curve. This means that the translation of an electron which arrives too late at the slits is more rapid than in the electron which arrives in the correct phase. The tardy electron will therefore overtake the electron in the correct phase.

In the same way it is easy to understand that an electron which reaches the slits too early moves more slowly than an electron in the correct phase, and is therefore also made to approach the correct phase.

The frequency of the tangential oscillations can be calculated from equation (7) for the velocity of translation. If s is the length of path which the electron must cover from one section to the next, then the time T in which this distance is covered is also equal to the time of one period. Thus:

$$T = \frac{\pi}{\omega} = \frac{s}{v}, \dots \dots \dots (10)$$

where v is the velocity of translation.

According to equation (7) $v = \frac{E}{H} = \frac{V_a}{aH}$, where a is the distance between anode and cathode. In order to find an expression for s we again assume the magnetron to be circular; s is then equal to the length of the path divided by the number of sections.

As length of path the outside circumference must not be taken, but the length of a path with an average radius which will be about equal to half the

maximum radius. Thus $s = \pi a/n$. By filling in s and v in equation (10) the angular frequency of the oscillation is obtained:

$$\omega = \frac{\pi v}{s} = \frac{n}{a^2} \frac{V_a}{H} \dots \dots \dots (11)$$

Equation (11) is very well confirmed experimentally. When with a given value of V_a the magnetic field is allowed to increase, it is found that oscillations suddenly appear at the value of H given by equation (11). The efficiency may amount to 50 per cent. When the field strength is allowed to increase still further the efficiency decreases. The variation of the efficiency can be satisfactorily explained by a detailed theoretical consideration³⁾, which lies outside the scope of this article.

Very short waves can be generated by the tangential oscillations. If V_a is measured in volts and H in gauss, it follows from equation (11) that

$$\lambda = \frac{600 \pi H a^2}{n V_a}$$

Just as with low-frequency oscillations the field strength H must have at least the critical value. If this value is substituted according to equation (8), one finds for the wave length:

$$\lambda > \frac{12740 a}{n \sqrt{V_a}} \dots \dots \dots (12)$$

If V_a is taken equal to 1500 volts, a to 0.2 cm, n to 4, one finds $\lambda = 16.5$ cm.

Radial oscillations

We shall now assume that the external oscillating circuit is tuned to the radial oscillations of the electrons, the frequency of which is given by the rotating motion of the electrons in the magnetic field. According to equation (3) the frequency of the rotation: $\omega = 1.76 \cdot 10^7 H$, and from this we find a wave length:

$$\lambda = \frac{10700}{H} \text{ cm} \dots \dots \dots (13)$$

In order to find out whether the rotating motion of the electron is able to generate an oscillation, we begin once more with a magnetron with flat parallel plates as cathode and anode. In this case the anode need not have slits.

When the anode voltage is constant an electron which leaves the cathode with zero velocity will describe an orbit like that shown in *fig. 8a*.

³⁾ K. Posthumus, *Wirel. Eng.* 12, 126, 1935.

Let us now assume that there is, in addition to the direct voltage, a small alternating voltage on the anode which corresponds in frequency to the number of revolutions of the "rotation" and whose phase is such that the total anode voltage is at a minimum at the moment when the electron is at a maximum distance from the cathode. The alternating field is then so directed at every moment that it exerts a retarding action on the motion of the electron. The electron thus passes on energy to the oscillating circuit, and would therefore in this special case reinforce the oscillation. If, however, the electron had left the cathode in the opposite phase of the alternating voltage, it would not have reinforced the oscillation, but, on the contrary it would have damped it, and the average transfer of energy over all phases would be zero.

It is actually impossible to start an oscillation directly in a magnetron of the type represented. To do this it is necessary to apply some kind of selection which provides that on the average there are more electrons in the magnetron with a "correct" phase than with an incorrect one.

Such selection can be obtained for instance by applying the magnetic field at an angle of a few degrees to the axis of the valve. The radial electric field can now be resolved into a component perpendicular to the magnetic field and a component parallel to it. The first component causes the well-known loop motion of the electron, while the second component will accelerate the electron in the direction of the magnetic field, and since the magnetic field is oblique, the electron reaches the anode after a short time.

The selection is based upon the following fact. Electrons which started in the wrong phase are captured by the anode after a shorter time than

electrons which started in the correct phase. When an electron starts in the correct phase the circular motion of the electron gives off energy to the oscillating circuit. If, however, the phase is incorrect the oscillating circuit gives off energy to the circular motion and the amplitude of this motion is thereby increased. This leads to the fact that electrons with incorrect phase reach the anode much more quickly than electrons with the correct phase (see *fig. 13*), and are thereby removed from the magnetron.

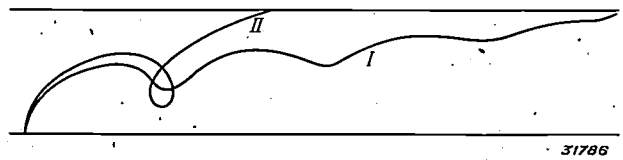

Fig. 13. Electron paths in a flat magnetron with oblique magnetic field, when there is an oscillating circuit in the external connections oscillating with the frequency of the radial oscillations.

- I. The electron is in the correct phase. The amplitude of its radial oscillation decreases.
- II. The electron is in an incorrect phase. The amplitude of its radial oscillations increases and the electron quickly reaches the anode.

When the emission of the cathode is so great that the space charge begins to play a part, the above described selection is disturbed. Since more electrons are present in the immediate neighbourhood of the cathode in the correct phase for the emission of electrons than in the wrong phase, the emission of electrons in the correct phase will also be more hindered by the space charge. The space charge thus works against the selection, and this is the explanation of the observed fact that radial oscillations can only be obtained with very weak emission currents.

Compiled by G. HELLER.

A CATHODE RAY OSCILLOGRAPH

by J. D. VEEGENS.

621.317.755

Description of the portable cathode ray oscillograph GM 3152. In this article it is chiefly the improvements which have been made on the apparatus compared with the previously described¹⁾ apparatus GM 3150 which are discussed. Special attention is paid to the focussing and deflecting system of the cathode ray tube, and to the frequency characteristic of the amplifier. In conclusion the possibility of observing or photographing single phenomena of short duration is discussed.

Introduction

An oscillograph is a suitable instrument for recording or making visible rapidly occurring phenomena. If no frequencies greater than about 5000 cycles/sec occur in the phenomenon, mechanical or mechanical-electrical instruments may be used, such as the loop oscillograph. With higher frequencies entirely or partially mechanical oscillographs are unsuitable because of the inertia of their moving parts, and a purely electrical instrument is to be preferred. In the latter case the cathode ray oscillograph is indicated.

amplifier, gives undistorted oscillograms with twice as high frequencies, and is, moreover, more sensitive than the older type. This new type has been in regular use in this laboratory and investigations performed with it have been repeatedly published in this review. A photograph of the apparatus can be found on page 206 of this number and oscillograms were given on page 171 and 172 of No. 6.

In the following we shall describe the new cathode ray oscillograph, with special emphasis

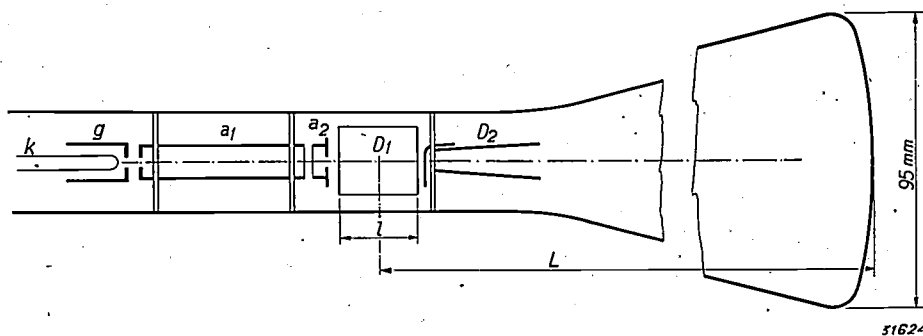

Fig. 1. The electrode system of the cathode ray oscillograph GM 3152. *k* cathode, *g* control electrode, *a*₁ anode with voltage of 275 volts, *a*₂ anode with voltage of 1000 volts.

The modern cathode ray tube makes it possible to construct oscillographs which are cheap, portable and easy to operate. For these reasons these instruments are being employed in cases where they are not strictly necessary from the point of view of the frequencies to be reproduced. In connection with the very varied possibilities of application of the cathode ray oscillograph²⁾ efforts were made to develop an apparatus suitable for producing oscillograms of voltages of very varied magnitudes and with very varied frequencies.

Several years ago such a universal cathode ray oscillograph was described in this periodical. That apparatus has meanwhile been considerably improved; the new type, GM 3152, with built-in

on the parts which were discussed in less detail in the description of the older type.

The cathode ray tube

The cathode ray tube DN 9-3 used in the oscillograph GM 3152 is of the high vacuum type. Cathode ray tubes filled with gas are not suited for following very rapid changes in voltage because of the inertia of the ions.

Fig. 1 shows diagrammatically the cathode ray tube used. The electrons which leave the cathode *k* pass through an opening in the control electrode *g*, which has a negative potential with respect to the cathode. By changing this potential the intensity of the electron current can be adjusted as desired. The electron beam transmitted is accelerated by the positive potential of the following electrodes *a*₁ and *a*₂ and focussed to a narrow ray.

This focussing is the result mainly of the electric field between the cylindrical anodes *a*₁ and *a*₂.

¹⁾ Philips techn. Rev. 1, 147, 1936.

²⁾ A series of applications in electrical and radio engineering was discussed earlier in this periodical, see Philips techn. Rev. 3, pp. 50, 148, 248, 339, 1938; 4, 90, 217, 1939.

The anode a_1 is at a potential of about 275 volts, while a_2 has a potential of 1 000 volts.

In *fig. 2* the field lines between these anodes are drawn. The arrows point in the direction from lower toward higher potential, *i.e.* in the direction of the force acting on the electrons. It may be seen from the figure that the force in the cylinder with lower potential acts toward the axis, and therefore exerts a focussing action on the beam.

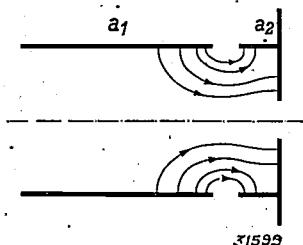

Fig. 2. Field lines between the electrodes a_1 and a_2 . This field acts to concentrate the electron beam.

The focussed electron beam passes through the space between the deflection plates D_1 and then through that between the deflection plates D_2 and its direction can be changed by means of voltages on these plates. The set of plates D_1 is connected to the amplifier of the oscillograph and gives a deflection in the vertical direction which is proportional to the voltage to be investigated, the set of plates D_2 is connected to the so-called time base and gives a deflection in the horizontal direction.

Distortions of the image

It is very important that the deflection in the vertical direction should be proportional to the voltage on the first set of deflection plates, and that it should not depend upon the voltage on the second pair of deflection plates which give the horizontal deflection.

If one plate of the first pair were earthed and a sinusoidal alternating voltage applied to the other plate (see *fig. 3a*), the deflection as a function

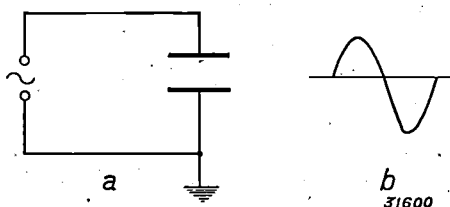

Fig. 3. a) Asymmetrical set of deflection plates. With a positive voltage on the non-earthed plate the electron beam is less deflected than with an equally large negative voltage. b) The asymmetrical oscillogram of a sine curve.

of time would not be sinusoidal. In the positive half of the period the potential on the path of the ray is higher than in the negative half. Therefore during the positive half period the ray moves more quickly through the pair of plates and it is less deflected than in the negative half period. The nature of the distortion produced is shown in *fig. 3b*.

This distortion can be removed by connecting the two plates in balance, so that the one plate is always as negative as the other is positive. The potential on the path of the ray then remains practically constant.

When this measure has been taken and a voltage is then also applied to the second pair of deflection plates, with here again one plate earthed, a new distortion is found to occur which is shown in *fig. 4a-d*. In this figure *a* represents the variation of the voltage between the plates of the first pair, *b* the variation of the voltage of the non-earthed plate of the second pair, *c* the oscillogram which would be obtained with no distortion and *d* the oscillogram which is actually obtained. The distortion may be described by saying that a rectangular oscillogram becomes trapezium-shaped, and it is called "trapezium distortion".

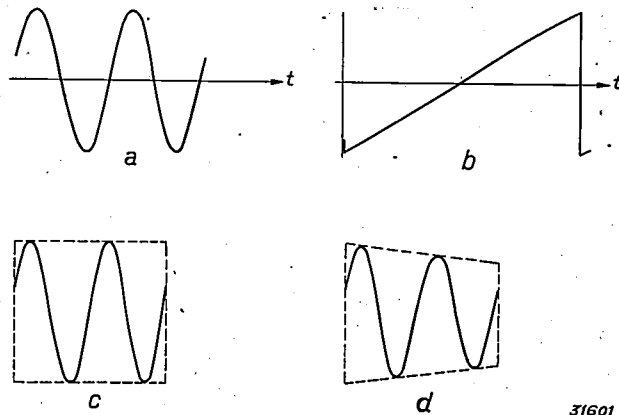

Fig. 4. Trapezium distortion: a) variation of the voltage on the first set of deflection plates. b) variation of the voltage on the second set of deflection plates. c) the oscillogram which would be obtained in the absence of distortion. d) the oscillogram obtained with trapezium distortion.

Trapezium distortion indicates that a positive voltage on the non-earthed plate of the second pair decreases the sensitivity of the first pair. This is easily understood when it is kept in mind that the second system is not in balanced connection, so that the potential on the point where the ray enters the system fluctuates in the same rhythm as the voltage on the non-earthed plate. When, for example, the latter voltage is positive, the electrons which leave the first set of deflection plates are attracted by the second set and are accelerated

thereby in an axial direction. The angle of vertical deflection is hereby reduced (see *fig. 5*) and this means that the vertical deviation on the screen also becomes smaller.

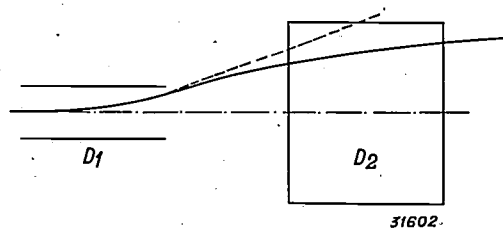

Fig. 5. Explanation of trapezium distortion. Between the second set of deflection plates the electron beam passes through a space with positive potential. It is therefore accelerated in an axial direction so that the angle of vertical deflection becomes smaller.

Trapezium distortion can be compensated for by introducing an auxiliary electrode between the two deflection systems, which is connected to the non-earthed plate of the second pair, and so constructed that it increases the deflection in the vertical direction when it is at a positive potential. *Fig. 6* shows a very simple solution of this problem as applied in the tube DN 9-3. The auxiliary electrode consists of two wires which are welded to the nonearthed plate of the second pair, and which run parallel to the plates of the first pair. When the potential of this auxiliary electrode is positive, it will actually increase the deflection in the vertical direction. A ray which has an upward deflection is attracted by the upper wire and thereby deflected more strongly in an upward direction; a ray which has a downward deflection is attracted by the lower wire and its deflection is thus also increased.

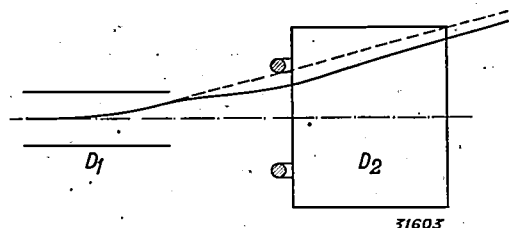

Fig. 6. Compensation of trapezium distortion. An auxiliary electrode consisting of two wires is connected to the non-earthed plate of the second set. When this plate is positive the vertical deflection is increased by the auxiliary electrode, and the trapezium distortion is thereby compensated. The figure shows the deflection of the ray very much exaggerated.

Sensitivity

The sensitivity of the deflection system, *i.e.* the deflection per unit of voltage between the deflection plates, can be calculated by the formula

$$G = \frac{1}{2} \frac{Ll}{dV_a}$$

where l is the length of the deflection plates, d the distance between them, and L the distance between the plates and the screen, while V_a represents the potential in the space between the deflection plates, calculated with respect to the cathode. Greater sensitivity could therefore be attained by lowering the anode voltage V_a . However, the brightness and sharpness of the fluorescent spot would at the same time be reduced. A compromise must therefore be found, and an anode voltage of 1000 volts was chosen. With this voltage the sensitivity of the first set of deflection plates is 0.4 mm/volt, and that of the second set 0.3 mm/volt. A sinusoidal oscillogram with a total height of 1 cm therefore requires a vertical deflection voltage of about $9V_{eff}$.

Ray modulation

In addition to a deflection in the horizontal and vertical direction the cathode ray possesses another mode of variation, namely a variation in intensity. In order to influence the intensity of the cathode ray, the cathode and control electrode of the cathode ray tube are connected *via* a switch with connection terminals mounted at the back of the oscillograph. If for example it is desired to entirely suppress the ray current, the control electrode must be made about 40 volts negative with respect to the cathode.

A possible application of ray modulation is the periodic suppression of the ray during the recording of an oscillogram with a known high frequency, so that a series of dots appears on the screen instead of a line. The number of dots between two points on the oscillogram is an accurate measure of the time interval.

The time intervals could be determined of course more simply from the distance between two points on the oscillogram and the known frequency of the time base. Such a determination is often however less accurate because the frequency of the time base is not precisely known, especially when the time base is synchronized with the unknown phenomenon.

The amplification

As stated above, a symmetrical voltage is applied to the plates for vertical deflection of the cathode ray. In order to obtain this, the voltage of the signal to be recorded is amplified by means of a push-pull amplifier. Very high requirements must be made of this amplifier with respect to the frequency range to be amplified and the freedom from distortion. As for the latter, it is not sufficient that a sinusoidal input signal of an arbitrary frequency should give

rise to a sinusoidal output signal, but the time lag of the output signal with respect to the input signal must also be small or at least independent of the frequency.

A constant amplification over a large frequency range can only be attained by choosing the coupling units such that the degree of amplification per stage becomes relatively low. On the other hand the amplification per stage may not be too low, since otherwise a large number of stages would be needed in order to reach the required amplification, which is not only undesirable for economic reasons, but to which there are also technical objections. In the first place the total degree of amplification would then depend to a greater extent on the mains voltage, and in the second place the noise of the amplifier increases with the number of amplifier valves³⁾.

By using amplifier valves with a steep slope, an amplification of 1500 times can be obtained with only two stages of resistance amplification, and the amplification is constant in the frequency range between ten and one million cycles.

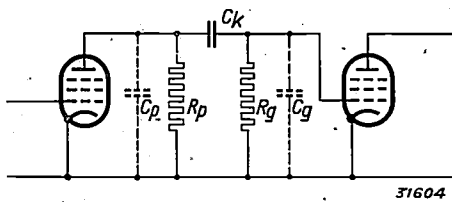

Fig. 7. Diagram of the circuit of a resistance amplifier. In addition to the resistances R_p and R_g and the condenser C_k , inevitable harmful capacities C_p and C_g are present in the circuit.

In order to attain this satisfactory result, special attention must be given to the coupling units which are introduced between the two stages of amplification, and between the second stage and the deflection plates. In *fig. 7* a diagram is given of the circuit of a resistance amplifier. The variations of the anode current of the first valve cause voltage variations on the resistance R_p which are fed to the grid of the following valve *via* the condenser C_k . At low frequencies the amplification will decrease because the impedance of the condenser C_k increases and is finally no longer small compared with R_g . When

$$2 \pi f_1 C_k R_g = 1,$$

the amplification is exactly $\sqrt{1/2} = 72$ per cent, and this may be considered as the lower limit of the frequency band amplified. It is not possible to

obtain a lower limit of 10 cycles⁴⁾ by making C_k sufficiently large.

If the circuit were built up exactly as shown in *fig. 7*, the amplification would be constant up to indefinitely high frequencies. Actually the amplification decreases for high frequencies due to the harmful capacity C_s which is the sum of the capacities of anode, grid, connections and coupling units with respect to earth. It is scarcely possible to reduce C_s to less than 15 to 20 $\mu\mu\text{F}$; in practical cases values two or three times as high must usually be counted on.

The equation

$$2 \pi f_2 R_p C_s = 1$$

determines the frequency f_2 , above which the amplification is lower than $\sqrt{1/2}$ of the maximum value. The amplified range of frequencies thus extends from f_1 to f_2 .

It is possible to attempt to compensate the influence of the harmful capacity by introducing a combination of self-inductions, resistances and capacities instead of the coupling resistance R_p , which combination together with the capacity C_s in parallel with it, forms an impedance which is independent of the frequency.

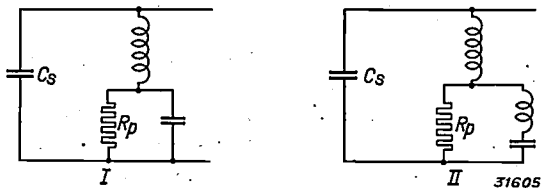

Fig. 8. Composite impedances whose value is practically constant as a function of the frequency up to a limiting frequency f which is given by $2 \pi f \sim 2/R_p C_s$. The connection II gives a still better compensation than I.

Several examples of such combinations are given in *fig. 8*. These have approximately the desired properties within a definite frequency range. The frequency characteristic of the amplifier, compared to that of an amplifier with resistance coupling, is hereby extended toward higher frequencies, as may be seen from the curves of *fig. 9*, where the amplification of two stages in cascade connection is plotted:

- a) for the case of pure resistance amplification,
- b) after introduction of the compensation connections according to *fig. 6*.

The anode resistance R_p was chosen the same in both cases, while as amplifier valves pentodes

³⁾ See in this connection the article by M. Ziegler, Philips techn. Rev. 2, 136, 329, 1937.

⁴⁾ If it is necessary to amplify very much lower frequencies, the coupling condensers are best avoided, and complicated connections result for the supply arrangement.

were used with a slope of about 5 mA/volt and an internal resistance of more than $1.5 \times 10^6 \Omega$. It may be seen from the characteristics that the frequency at which the amplification has fallen to $\sqrt{1/2}$ is increased from 400 kilocycles to 1050 kilocycles by the application of the compensation connections.

Circuit of the amplifier

In *fig. 10* the complete circuit of the amplifier is given. The last two of the three amplifier valves B_1, B_2, B_3 are in push-pull connection and each is connected with one of the deflection plates of the pair D_1 . The anode impedance of the first amplifier valve is made up according to the scheme *I* of *fig. 8*, while the anode impedances of the valves B_2 and B_3 are made up according to the scheme *II*,

be put entirely out of action, if the intensity of the signal to be recorded permits. In position *I* the signal is fed directly to the grid of the first valve. In position *II* the signal current, besides flowing through the input resistance of the first valve, also flows through a series resistance R_s ; the input impedance is therefore higher, but the sensitivity is less. In position *III* the signal voltage is applied directly to the deflection plates. In the table below the sensitivities and the input impedances are given for the three different switch positions.

The time axis voltage

The signal voltage to be recorded gives the electron ray a deflection in the vertical direction. In order to obtain an oscillogram of this voltage the

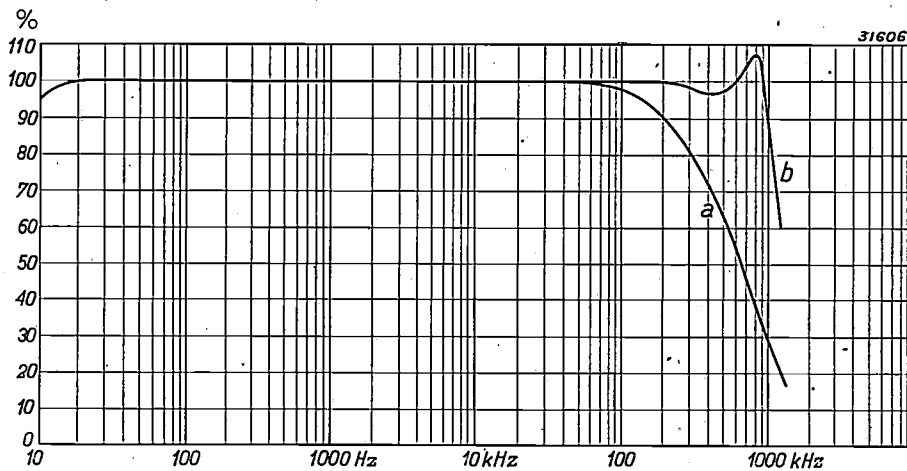

Fig. 9. Frequency characteristic of the amplifier for the cathode ray oscillograph GM 3152.
a) with resistances as coupling units
b) when the anode resistances of the first and second stages are replaced by circuits according to *fig. 8 I* and *II*, respectively.

which permits a compensation of still greater harmful capacities.

By means of the switches S_1, S_2, S_3 and S_4 which are coupled mechanically with each other, the amplification can be diminished or the amplifier may

Position of switch	Minimum *) voltage necessary for an image 1 cm high		Input impedance
	Direct voltage	Effective alternating voltage	
I	17 mV	6 mV	$10\,000 \Omega - 10^6 \Omega^*$
II	280 mV	100 mV	170 000 Ω
III	25 mV	8.8 mV	12 μF

*) The sensitivity can in the first two positions be regulated by means of a potentiometer P between zero and a maximum value. In the first position it is possible to disconnect the potentiometer; the possibility of regulating the size of image on the screen is then lost, but a very high input impedance is obtained.

electron ray must also be given a horizontal deflection depending upon the time.

If the signal voltage is sinusoidal the frequency and phase of the signal can be investigated by applying a sinusoidal voltage along the time axis also. In this way Lissajous figures⁵⁾ are obtained, which make it possible to deduce the ratio of frequencies and the mutual phase relation of signal and time axis voltage.

It is often desired to obtain an image which represents the voltage to be investigated as a function of the time. In such a case a time axis voltage is best used which has a sawtooth form as a function of time, namely a voltage which increases linearly with the time over a certain interval and then suddenly drops to its initial value.

The oscillograph GM 3152 is provided with a

⁵⁾ See Philips techn. Rev. 3, 342, 1938.

time base apparatus which gives a sawtoothed voltage (see *fig. 11*) whose frequency can be adjusted between 2 cycles and 150 kilocycles. A built-in adjustable synchronization arrangement provides that in the recording of periodic phenomena

oscillograph it is unnecessary to record the oscillogram in a permanent form, it is sufficient to observe it visually on the screen of the cathode ray tube. The observation of single, *i.e.* non-periodic, phenomena is facilitated by the fact that

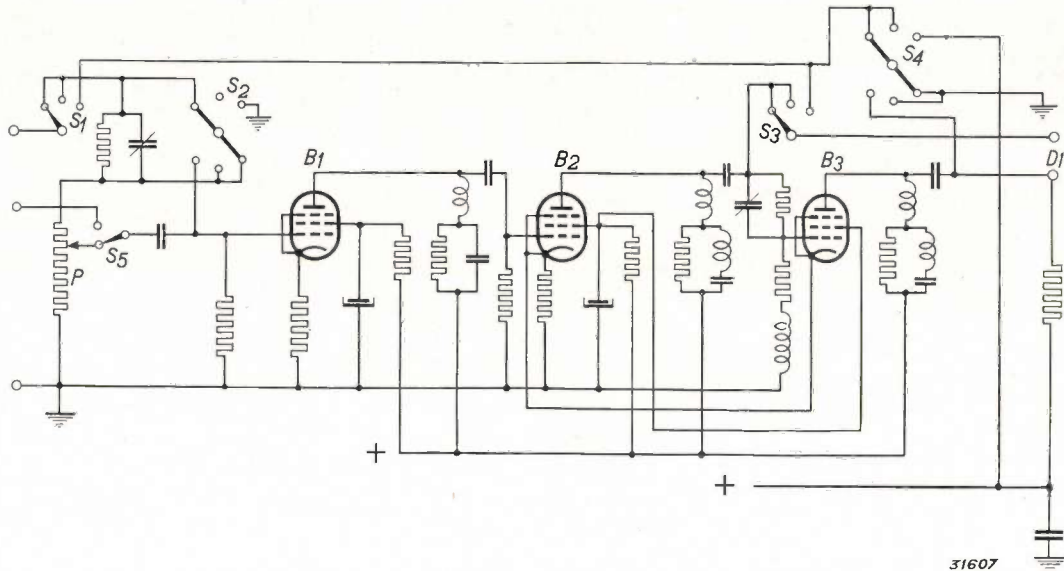

Fig. 10. Complete circuit of the amplifier of the cathode ray oscillograph GM 3152. Maximum amplification 1500 times for frequencies from 10 to 10^6 cycles. The amplifier valves B_2 and B_3 are in push-pull connection in order to obtain a symmetrical deflection of the electron beam. S_1 to S_4 are switches for regulating the sensitivity in three stages; P potentiometer for continuous regulation, S_5 switch by means of which the potentiometer can be disconnected in order to obtain not only maximum sensitivity but also a very high input impedance.

the time base period always corresponds to a definite multiple of the period of the phenomenon recorded, so that the image on the screen becomes stationary.

In addition to the voltage of the built-in sawtooth generator, an external voltage may also be applied to the horizontally deflecting plates, for example the voltage of the alternating current main. It is possible furthermore to let the synchronization of the sawtooth generator be carried out, not by the signal voltage, but by the alternating current main or by an external voltage. The different possibilities of synchronization and supplying of time axis voltages can be combined with each other at will simply by turning a switch into different positions.

The construction and the different switching possibilities of the time base are not appreciably different from those in the earlier model which is discussed in detail in the article cited in footnote ²⁾, and we shall not therefore discuss them again at this point.

The observation of the oscillogram

For most of the applications of the cathode ray

a substance is used as fluorescent material on the screen which possesses phosphorescent properties.

The practical time of phosphorescence, *i.e.* the time during which the curve can be seen on the screen, depends upon the original intensity, and thus decreases with increasing writing speed. In *fig. 12* the experimentally found relation between phosphorescence time and writing speed is given. Since it was found in these experiments that an

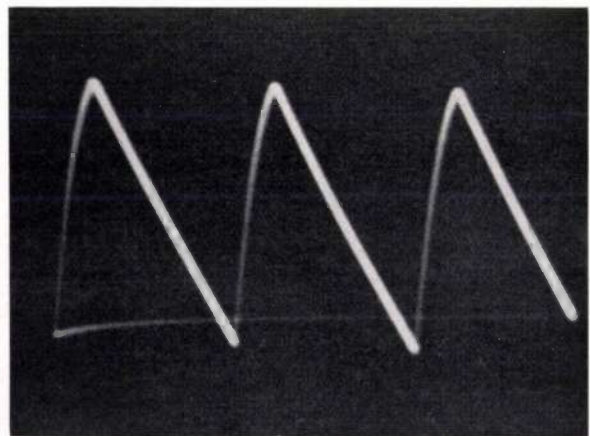

Fig. 11. Oscillogram of the shape of the time base voltage. The discharging time is $1/20$ to $1/5$ of the charging time.

observation time of 1 sec is necessary to judge an oscillogram, a maximum writing speed of 1.5 km/sec was deduced. When the total length of the curve on the oscillogram amounts for instance to 2 cm, the total duration must be 1.3×10^{-5} sec.

If it is desired to record a phenomenon of still shorter duration, the image must be photographed. A special stand has been constructed for this purpose which makes the adjustment of the camera very much easier (see fig. 13). Panchromatic material which is still sensitive to the yellow-green light of the screen is best used.

The attainable writing speed depends not only on the camera and the photographic emulsion, but

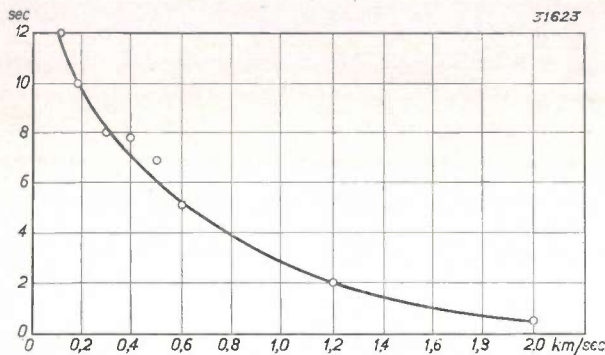

Fig. 12. Time during which the phosphorescent image is observable on the screen of the cathode ray tube as a function of the writing speed. If it is assumed that the image must be seen for 1 sec in order to observe its most important properties, a maximum writing speed of 1.5 km/sec is arrived at.

also on the intensity of the ray current. It is permissible to use a higher ray current than normal during the exposure. For this purpose the negative voltage of the control electrode may be changed



Fig. 13. The cathode ray oscillograph GM 3152 with the folding stand GM 4192 for setting up a camera.

by means of a battery with switch connected externally at the rear of the apparatus. There is, however, the disadvantage that the bright line becomes thicker with a high ray current, so that details of the image are not brought out so well.

In practical cases with a lens aperture of 1 : 2 and a film sensitivity of $\frac{18^\circ}{10}$ DIN a writing speed of about 2.5 km/sec can be reached, and single phenomena can thus be recorded with a duration of about 10^{-5} sec.

THE PITCH OF MUSICAL INSTRUMENTS AND ORCHESTRAS

by BALTH. VAN DER POL and C. C. J. ADDINK. 534.321.7.08 : 621.317.755

An arrangement is described by means of which it is possible to determine a pitch with an accuracy of 0.2 cycles within one second. It is possible with this apparatus to measure the pitch (frequency of A) of an orchestra during a performance. By means of a large number of such measurements in the case of broadcasts from different countries a statistical idea was obtained of the pitches which are at present used by musicians. The average of all measurements gives a frequency for A of very close to 440 cycles.

In the year 1885 a frequency of 435 c/s was internationally established for the tone A which is used as a standard for tuning musical instruments. Slight deviations from this standard are of little importance in the case of an instrumental solo. For most listeners a correct relative pitch of the instrument is sufficient, and even listeners who have absolute pitch will generally not consider deviations of one or several cycles in a solo performance as disturbing. When, however, several instruments play at the same time, and where therefore absolute mutual correspondence must be required, it is very important to adapt the pitch to a general standard. Only when this has been done it will be possible for any given instrument (that of a soloist for example) to be played in any ensemble. Changing the absolute pitch is only possible to a limited extent with most musical instruments, since the pitch¹⁾ is fixed during their manufacture; in the case of certain instruments, such as the harmonium, the accordion, etc. the pitch cannot be changed at all (at least not without permanent alterations).

While it is therefore desirable on the one hand that the absolute pitch should be the same for all instruments, on the other hand it has been found in practice that musicians at the present time do not keep to the pitch of $A = 435$ c/s as previously fixed. There is a very clear tendency to play in a higher pitch. Whatever the reason for this may be, it seems desirable to adapt the standard pitch to the actual situation. This necessity is the more acute since the development of broadcasting has been accompanied by a more extensive interchange of soloists and ensembles.

In order to collect statistics about the pitches used at the present time, a method of measurement has been worked out in this laboratory by which

the pitch of an orchestra can be determined during a performance. According to this method a large number of measurements have been carried out during musical programmes of different broadcasting stations, since these programmes, which may be heard daily in large numbers, lend themselves easily to the collection of statistics, and also since the broadcasting industry is one of those most concerned in a possible new regulation. We shall give here a description of the apparatus with which the measurement were carried out; the results of the measurements will then be discussed briefly.

The measuring arrangement

The determination of pitch consists in measuring the frequency of the A which occurs in the music. The ordinary methods of measuring pitch, such for example as the comparison with the tone of a tuning fork and counting the beats, are out of the question for our purpose, since they require too much time. The tones in the music to be measured last one or two seconds at the most, and generally only a fraction of a second. The necessity of very rapid measurement can be avoided by recording the performance on sound film and later counting the number of vibrations of a tone on the film. It is, however, obvious that this method is not very suitable for the collection of statistics, to which hundreds of measurements should contribute. We have therefore worked out a method which permits of a rapid direct measurement of pitch.

The arrangement is shown diagrammatically in *fig. 1*. The measurements are carried out with the help of a cathode ray oscillograph. To one set of deflection plates an alternating voltage is applied which is generated by a special oscillator and the frequency of which can be varied within certain limits around 435 c/s. The same alternating voltage is applied to the other set of deflection plates of the oscillograph, but only after it has received a phase shift of 90° in an RC circuit. A circle then appears on the screen due to the fact that the light spot traces a circle with the frequency of the applied alternating voltage.

¹⁾ It is easy to see that this is necessary. For instance with instruments with fixed holes for pitch such as flute, clarinet, etc. the relative pitch determined by the distance between the holes is only correct at a definite fixed pitch. With stringed instruments, where the strings are tuned by changing their tension, the forces which the sounding board must withstand depend upon the pitch.

Preceding the output of the radio set used to receive the music to be tested, a simple filter is inserted which only passes the tones with frequencies in the neighbourhood of 435 c/s, *i.e.* the tone

one half of its circular path, and invisible during the other half: on the screen one sees a stationary semicircle (*fig. 2*). If, however, the frequency of the *A* in the music is somewhat higher (or lower)

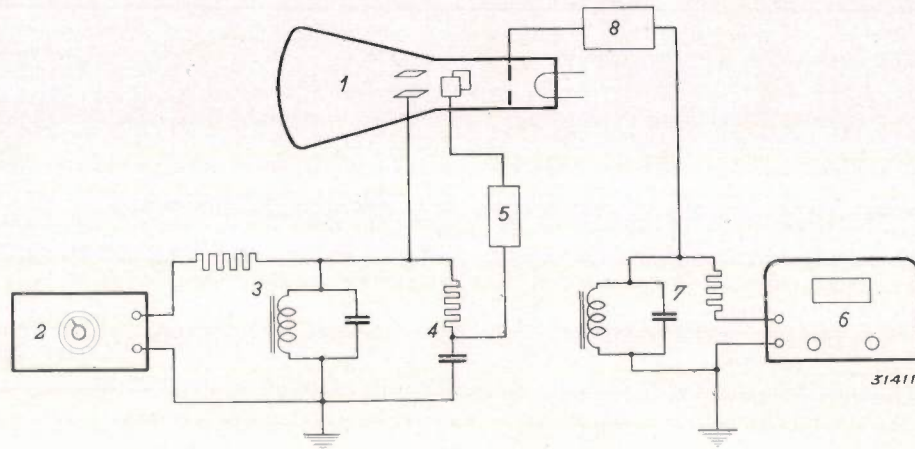

Fig. 1. Arrangement for the measurement of pitch with the cathode ray oscillograph. 1 oscillograph; 2 special oscillator which gives a frequency between 400 and 470 c/s adjustable to within 0.2 cycle; 3 filter for removing the overtones from the tone generator voltage; 4 R-C circuit by which the oscillator voltage is shifted 90° in phase; 5 amplifier for the voltage which is weakened when its phase is shifted; 6 radio receiving set; 7 filter which passes only the frequencies between 400 and 470 cycles of the music voltage; 8 amplifier for this filtered output voltage.

A correctly or incorrectly tuned. The output voltage filtered in this way is amplified and applied to the grid of the cathode ray tube. The tube current is hereby periodically interrupted with the frequency of the *A* in the music. If this latter equals the frequency at which the light spot traces the circle the spot will be visible during

than that excited in the tone generator, the extinction of the light spot in successive tracings of the circle will take place somewhat earlier (or later) than the completion of the circle, so that the semicircle will begin to rotate to the right or left on the screen with a frequency equal to the difference between the frequencies of the tone generator and



Fig. 2. Photograph of the complete apparatus. To the left the oscillator, behind it the filter for removing the harmonics. In the middle of the screen of the cathode ray oscillograph the semi-circle may be seen. To the right beside the oscillograph is the amplifier with the phase rotating circuit (4 and 5 of fig. 1), and the filter for the music voltage; on the extreme right the radio receiving set.

the A of the music. The frequency of the tone generator is now so varied that the semicircle comes to rest, and the frequency of the A in the music can immediately be read off from the calibration of the tone generator.

It is not entirely without importance whether the light spot is made to trace the circle on the screen toward the left or the right, since upon this direction depends the sense of rotation of the semicircle when the A is too high. It should be so arranged that the sense of turning the knob of the oscillator necessary to bring the rotating semicircle to rest is opposite to that rotation. The motion of the hand involved corresponds to a natural reaction which is important for rapid measurement.

the oscillation, a.o. an impractically high value of the self-induction is required. If the desired oscillation is produced as the beats between two oscillating electrical circuits of high frequency (10^8 c/s for instance), the above difficulty is avoided, it is then, however, difficult to obtain the required precision, since the permissible percentage of error in the frequency of the circuits becomes very small.

A mechanical oscillator is therefore used to generate the oscillation, namely a steel string³). This string, as shown in *fig. 3*, is stretched between two steel blocks mounted on the ends of a stiff spring. By means of a micrometer screw pressing against the middle of the spring which is supported at either end, the spring can be more or less bent,

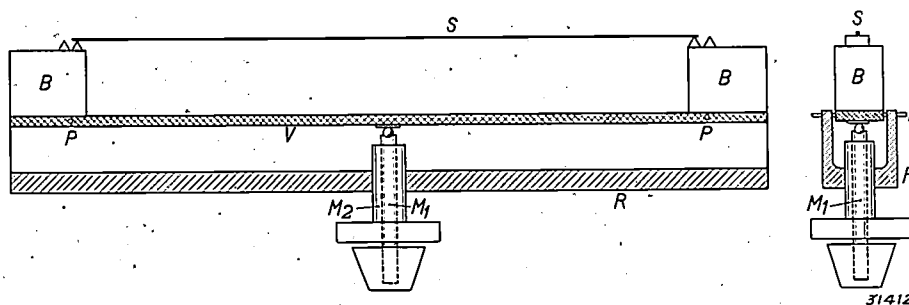

Fig. 3. The string S is stretched between two hardened steel blocks B which are fastened to the ends of a steel spring V which is supported at either end by pins P in a strong frame R . A micrometer screw M_1 presses against the middle of the spring so that the latter can be bent more or less to change the length (and tension) of the string. The points of contact are glass hard and polished. The screw M_1 passes through a concentric screw M_2 which is separately adjustable and by which the zero point of the frequency scale, over which the pointer on the knob of M_1 moves, can be corrected. In order that the settings may be reproducible the ends of the string may not slide at the clamping point. This is accomplished by means of the construction shown in the accompanying detail. The blocks B are insulated from the spring V by an intermediate layer I so that a current may be sent through the string.

The measurements are most easily carried out with pieces of music set in the key of A or D , since the A then occurs very often (as tonic or dominant). If the music is set in A flat, it would be possible to measure the A flat instead of the A which occurs only seldom. Confusion of A with A flat or A sharp need not be feared even with tones which are much off key: with $A = 435$ c/s, A flat lies at 411 and A sharp at 461 c/s.

The string oscillator

The oscillator used must satisfy very special conditions. Its frequency must be easily regulated within a range from about 400 to 470 cycles²), and must be reproducible within a few tenths of a cycle. If an oscillating electrical circuit, tuned with an ordinary variable condenser is used for generating

whereby the tension and thus the characteristic frequency of the string is varied.

Parallel to the string and at a short distance from it is an insulated wire electrode. Together with the string this wire forms a condenser to which a high direct voltage is applied. When the string vibrates the periodic change in distance between the condenser "plates" causes a variation in the capacity whereby the voltage on the condenser changes in the same rhythm. This alternating voltage is amplified in two amplifier valves.

In order to maintain the vibration of the string feed back is necessary. This is obtained by placing the string in the field of a permanent magnet and passing an alternating current (about 15 mA) through it. The current is supplied *via* a transformer by the output of the amplifier; see the cir-

²) This is desirable in order to be able to measure A flat or A sharp as well.

³) A tuning fork, such as is often used as oscillator for tone frequencies, is less suitable for our purpose since the pitch of such a fork cannot easily be changed sufficiently.

circuit diagram *fig. 5*. The voltage on the secondary of the transformer is shifted approximately 90° in phase with respect to the current in the primary.

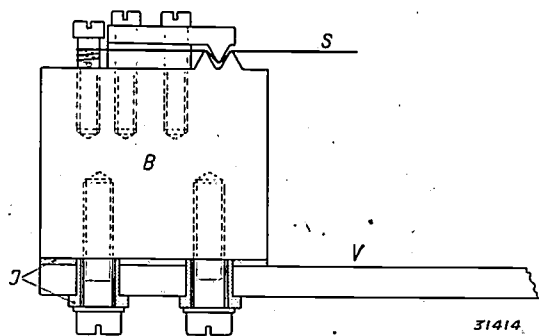

Fig. 4. Simplified circuit diagram of the tone generator. The mechanical oscillator *O* is formed by a string *S* situated in a magnetic field *M* with a wire electrode *E* stretched parallel to it. A current tapped off from the output transformer *T* flows through the string. Part of the output voltage is sent back to the grid of the first amplifier valve for automatic volume control (*A*).

The same is therefore also true of the current through the string and the voltage on the wire condenser (deviation of the string), so that the vibrations of the string are maintained electro-dynamically.

The amplitude of the string is limited by an automatic volume control. The regulating voltage to be fed back to the first amplifier valve, after rectification and smoothing, is so adjusted with a potentiometer that the string is given the desired amplitude (about 0.5 mm). In order to prevent that the automatic volume control obstructs the building up of the vibrations of the string, the circuit *i.e.* the time-constant of the smoothing-system, is dimensioned in such a way that the automatic volume control only begins to act after the string has already come into motion. With stationary string the amplification is about three times as great as when the string is

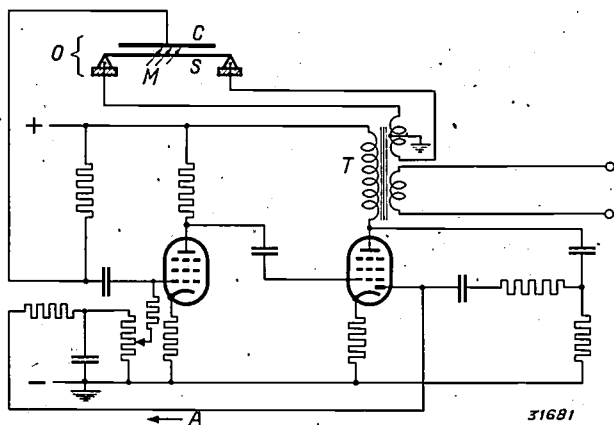

Fig. 5. The photograph shows how the mechanical oscillator is mounted in the oscillator.

vibrating; in this way the amplitude of the string passes through a maximum during the process of beginning its vibration. It is essential that the string should always vibrate with the same amplitude since the frequency of the string still depends to some degree on the amplitude. While the automatic volume control always provides for a constant stationary value of the amplitude, when the amplification varies rapidly, chiefly on account of fluctuations of the screen grid voltage of the amplifier valves due to alternations of the mains voltage, the amplitude of the string might nevertheless vary, since the automatic volume control, as explained above, is intentionally given a certain time lag. In order to eliminate this influence of the mains voltage on the frequency, besides the automatic volume control, an additional stabilization is applied to the screen grid voltage.

The calibration of the oscillator

An electrically driven tuning fork is used for the calibration of the tone generator. The frequency of this fork (1001.35 c/s at 24°C) was accurately determined by connecting the fork to a counting mechanism (synchronous clock) and comparing the indications of the counter with the interval between two time signals (this may for instance be a whole day). The alternating voltages from the tuning fork and from the tone generator were then applied to the vertical and horizontal plates, respectively, of a cathode ray oscillograph, and Lissajous figures were obtained on the screen. The ratio of frequencies between tuning fork and tone generator can be read off from these figures. The scale of the micrometer screw for changing the tension of the string can in this way be calibrated directly in cycles. Since, however, the pitch of the string is still subject to variations, namely those due to changes of temperature, the micrometer screw is composed of two concentric screws. The head of one screw bears the pointer which moves over the calibrated scale; the second screw serves only for the compensation of any changes in pitch, *i.e.* for correcting the zero point of the scale. The above mentioned calibrated tuning fork is again used for this purpose. Instead of the filtered output voltage of the radio set the voltage of the tuning fork is applied to the grid of the oscillograph. If the tuning fork gives exactly 1000 c/s and the oscillator 400 c/s the light spot on the screen is extinguished five times in two complete rotations: a stationary circle composed of five sections appears on the screen. The oscillator is thus set at 400 c/s

and the correcting knob is turned until a stationary circle composed of five sections is obtained on the screen. This zero point correction is especially necessary during the warming up of the oscillator, but it must also be repeated now and again during the measurement ⁴).

The accuracy of adjustment is 0.2 c/s. It is, however, only possible to determine the frequency of the *A* of permanently tuned instruments such as the organ, piano, harp, etc. with this degree

that the semi-circle rotates as often to the right as to the left, or alternates about a middle position. The accuracy of this adjustment is naturally less, the error amounts to about 0.5 c/s.

Results of measurements

In the measurement it is found that during a performance the *A* of an orchestra or of several instruments always varies by 1 to 2 c/s and sometimes by 4 to 5. As an example we give the

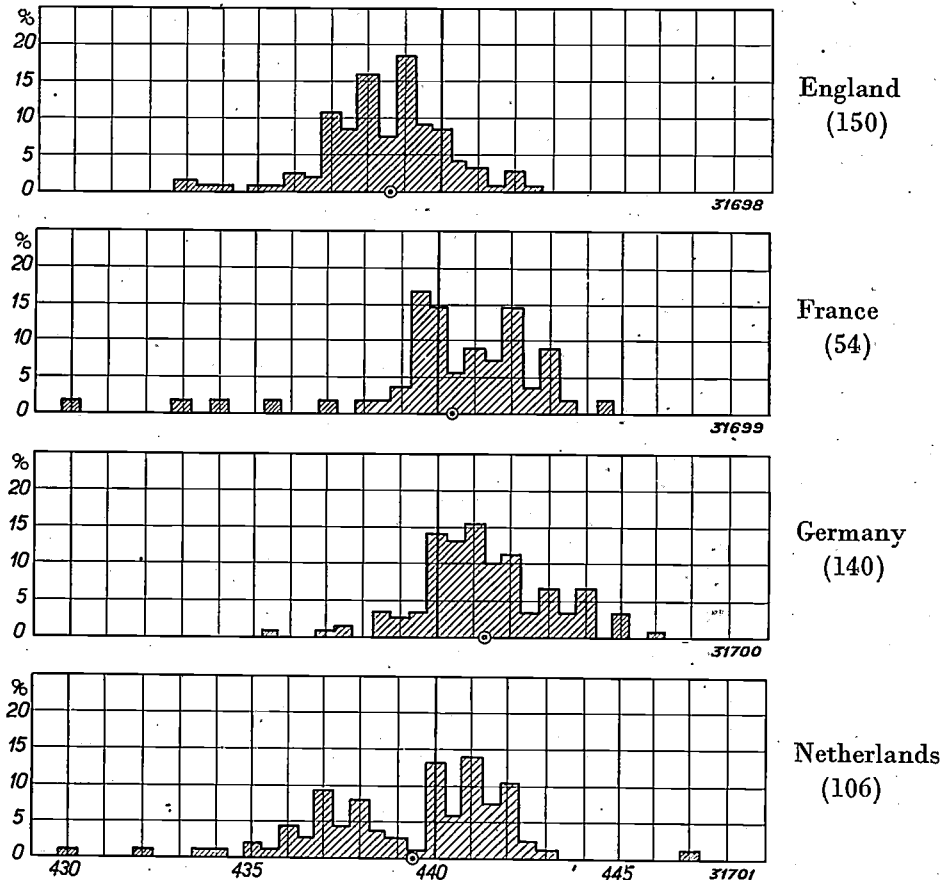

Fig. 6. Statistical graph showing the pitch which was observed in a large number of performances of broadcasting stations in four countries. The abscissae give the frequency of the *A* in c/s. The ordinates indicate how often each pitch occurred in per cent. The total number of measurements is indicated for each country. When the average is taken of all the measurements (indicated by a point for each separate country), a frequency very close to 440 c/s is found for *A*.

of accuracy. In the case of stringed instruments, the human voice, etc. the rotating circle can never be brought to absolute rest, chiefly because of the vibrato, but the oscillator must be so adjusted

⁴) With a large zero point correction the relative calibration of the scale is found to change slightly, up to about 1/2 c/s. The relative calibration is therefore carried out only after the oscillator has become warm (about 1 to 2 hours). When there is any objection to allowing the instrument to be switched on so long before the measurement, the influence of the heating can simply be eliminated by placing the string and the amplifier in separate containers. The remaining variations in room temperature may be neglected.

complete analysis of a concert given on October 27, 1938 in the Concertgebouw in Amsterdam conducted by Willem Mengelberg. Before the interval the first piano concert of Beethoven was given. During the tuning of the orchestra we ascertained that the *A* of the piano was 440 c/s, that of the orchestra, however, was an average of 441 c/s. In the tutti the orchestra showed a tendency to take the *A* 2 c/s higher; it fell again to the original pitch as soon as the piano was heard. This phenomenon is often observed. After the interval a symphony by Brahms was

played. When the orchestra tuned its instruments the frequency of 443 c/s was now observed. In the first part of the symphony the *A* of a horn could be identified: it was 444 c/s. A few minutes later the whole orchestra was at 441.5 c/s. In the second part there was an *A* from a horn of 442 c/s; the orchestra was then found to be at 442.5 c/s. In the third part the strings again had 442.5 c/s, while in the climax of the finale the horns came out with 443 c/s. This again is a quite general phenomenon, *i.e.* that the frequency is taken higher at a climax, probably because of the fact that the wind instruments rise in pitch in a fortissimo. On the other hand with notes held for some time the wind instruments sometimes fall

some cycles just before the breaking off of the note.

The average pitch was determined for a large number of performances of broadcasting stations in England, France, Germany and the Netherlands. In *fig. 6* it may be seen for each separate country how often different pitches were represented. It is obvious that the pitch is taken somewhat higher in France and Germany than in England, while the variation is greatest in the Netherlands. As an average value of all the measurements a frequency close to 440 c/s is found. This is the frequency which is to be recommended for a new standard such as is being considered at the present time under the initiative chiefly of the broadcasting companies.

ABSTRACTS OF RECENT SCIENTIFIC PUBLICATIONS OF THE N.V. PHILIPS GLOEILAMPENFABRIEKEN

1373*: Balth. van der Pol: Oliver Heaviside (1850-1925). (Ned. T. Natuurk. 5, 269-285, Nov. 1938).

In this inaugural address as extraordinary professor of the Technical High School in Delft an appreciation is given of the work of the often undervalued English investigator Heaviside, and its significance in the domain of theoretical electricity.

1374*: W. G. Burgers: Elektronoptische Jagttager af Metaloverflader (Ingeniøren 47, E 119-121, Dec. 1938).

This article on electron optical observations of metal surfaces was written on the occasion of a lecture before the Danish Engineering Society; *cf.* also: Philips techn. Rev. 1, 313 and 321, 1936).

1375: H. Bruining: Secondary electron emission, part II. Absorption of secondary electrons. (Physica 5, 901-912, Dec. 1938).

It is shown that the absorption of secondary electrons is probably the cause of the fact that with perpendicularly incident primary electrons the secondary emission is lower for metals with a large

atomic volume than for metals with a small atomic volume. The absorption can be measured indirectly by allowing the primary electrons to strike the surface in question at an angle greater than 0°.

1376: H. Bruining: Secondary electron emission, part III. Secondary electron emission caused by bombardment with slow primary electrons (Physica 5, 913-917, Dec. 1938).

When more strongly electropositive metals like barium are bombarded with very slow electrons (of about 10 volts) they produce a greater secondary emission of electrons than metals like silver. The coefficient of elastic reflection for barium is smaller than for silver. For compounds of electropositive elements both the secondary emission and the reflection are large.

1377: W. Elenbaas: Temperaturschwankungen von wechselstromgeheizten Wolframfäden (Physica 5, 929-937, Dec. 1938).

The temperature is calculated of a filament heated by alternating current. With the same effective voltage the average temperature is somewhat lower with alternating current than with direct current; for a filament 10 μ thick the difference is about 4.5° at a temperature of about 2500° K. The difference in evaporation and yield of light is calculated for the same effective voltage with direct and alternating current, and compared with the measured difference in life and light

*) An adequate number of reprints for the purpose of distribution is not available of those publications marked with an asterisk. Reprints of other publications may be obtained on application to the Natuurkundig Laboratorium, N.V. Philips' Gloeilampenfabrieken, Eindhoven (Holland), Kastanjelaan.

played. When the orchestra tuned its instruments the frequency of 443 c/s was now observed. In the first part of the symphony the *A* of a horn could be identified: it was 444 c/s. A few minutes later the whole orchestra was at 441.5 c/s. In the second part there was an *A* from a horn of 442 c/s; the orchestra was then found to be at 442.5 c/s. In the third part the strings again had 442.5 c/s, while in the climax of the finale the horns came out with 443 c/s. This again is a quite general phenomenon, *i.e.* that the frequency is taken higher at a climax, probably because of the fact that the wind instruments rise in pitch in a fortissimo. On the other hand with notes held for some time the wind instruments sometimes fall

some cycles just before the breaking off of the note.

The average pitch was determined for a large number of performances of broadcasting stations in England, France, Germany and the Netherlands. In *fig. 6* it may be seen for each separate country how often different pitches were represented. It is obvious that the pitch is taken somewhat higher in France and Germany than in England, while the variation is greatest in the Netherlands. As an average value of all the measurements a frequency close to 440 c/s is found. This is the frequency which is to be recommended for a new standard such as is being considered at the present time under the initiative chiefly of the broadcasting companies.

ABSTRACTS OF RECENT SCIENTIFIC PUBLICATIONS OF THE N.V. PHILIPS GLOEILAMPENFABRIEKEN

1373*: Balth. van der Pol: Oliver Heaviside (1850-1925). (Ned. T. Natuurk. 5, 269-285, Nov. 1938).

In this inaugural address as extraordinary professor of the Technical High School in Delft an appreciation is given of the work of the often undervalued English investigator Heaviside, and its significance in the domain of theoretical electricity.

1374*: W. G. Burgers: Elektronoptische Jagttagerler af Metaloverflader (Ingeniören 47, E 119-121, Dec. 1938).

This article on electron optical observations of metal surfaces was written on the occasion of a lecture before the Danish Engineering Society; *cf.* also: Philips techn. Rev. 1, 313 and 321, 1936).

1375: H. Bruining: Secondary electron emission, part II. Absorption of secondary electrons. (Physica 5, 901-912, Dec. 1938).

It is shown that the absorption of secondary electrons is probably the cause of the fact that with perpendicularly incident primary electrons the secondary emission is lower for metals with a large

atomic volume than for metals with a small atomic volume. The absorption can be measured indirectly by allowing the primary electrons to strike the surface in question at an angle greater than 0° .

1376: H. Bruining: Secondary electron emission, part III. Secondary electron emission caused by bombardment with slow primary electrons (Physica 5, 913-917, Dec. 1938).

When more strongly electropositive metals like barium are bombarded with very slow electrons (of about 10 volts) they produce a greater secondary emission of electrons than metals like silver. The coefficient of elastic reflection for barium is smaller than for silver. For compounds of electropositive elements both the secondary emission and the reflection are large.

1377: W. Elenbaas: Temperaturschwankungen von wechselstromgeheizten Wolframfäden (Physica 5, 929-937, Dec. 1938).

The temperature is calculated of a filament heated by alternating current. With the same effective voltage the average temperature is somewhat lower with alternating current than with direct current; for a filament 10 μ thick the difference is about 4.5° at a temperature of about 2500° K. The difference in evaporation and yield of light is calculated for the same effective voltage with direct and alternating current, and compared with the measured difference in life and light

*) An adequate number of reprints for the purpose of distribution is not available of those publications marked with an asterisk. Reprints of other publications may be obtained on application to the Natuurkundig Laboratorium, N.V. Philips' Gloeilampenfabrieken, Eindhoven (Holland), Kastanjelaan.

yield. In order to make the measurements independent of a difference in the effective voltages of the sources of direct and alternating current, comparison lamps with 35 μ filaments, which show practically no difference at the same effective voltage, are burnt at the same time on the same voltage as the lamps with 10 μ filaments. The differences measured and calculated agree very well, and amount to about 50–60 per cent longer life and 2–3 per cent less light yield for direct current with a filament 10 μ thick at a temperature of about 2500° K.

1378: K. F. Niessen und C. J. Bakker: Einige Bemerkungen zur Theorie der Brownschen Bewegung (*Physica* 5, 977-985, Dec. 1938).

In the theory of Brownian movement the derivation according to Lorentz of the Einstein formula for the displacement in a given interval of time requires further precision in the values of several time intervals occurring in it. Their required relation is derived, and at first sight seems to be in contradiction to Ornstein's correlation theory. This apparent contradiction is removed with the help of several forms of impulse functions.

1379: B. D. H. Tellegen und J. Haantjes: Gegenkopplung (*El. Nachr. Technik* 15, 353-358, Dec. 1938).

From considerations on the inverse feed-back of an amplifier by means of an octopole it is deduced that four different kinds of inverse feed-back can be distinguished, namely:

- 1) of the output voltage on the input voltage;
- 2) of the output current on the input voltage;
- 3) of the output voltage on the input current and
- 4) of the output current on the input current.

The conditions are indicated which must be satisfied, in the first place in order that the inverse feed-back amplifier may not react from the output terminals to the input terminals, not even when the amplification of the original amplifier quadrupole changes with constant input and output resistance, and in the second place in order that in the last case the input and output resistance of the inverse feed-back amplifier may not change. In this way one arrives at the circuit given by Black with two bridges in equilibrium.

1380: W. Uytterhoeven et C. Verburg: Température des électrons T_e dans une décharge à colonne positive en courant alternatif (50~). Méthode expérimentale (*C.R. Acad. Sci., Paris*, 207, 1386-1388, Dec. 1938).

By means of a probe electrode the temperature is measured of the random motion of the electrons in a positive column discharge burning on alternating current of 50 cycles. By means of a special arrangement provision is made that the measurement may be done at a phase of the alternating current which may be chosen at will, so that it is possible to determine the variation of the electron temperature with the phase.

1381: M. J. O. Strutt: Moderne Kurzwellen-Empfangstechnik (*Funktechn. Mh.* 1938, 309-313, 331-339, Oct. and Nov. 1938).

In this vacation course given for the Koninklijk Instituut van Ingenieurs in April 1938, a review was given of the technology of reception on short waves, for which we may refer to *Philips techn. Rev.* 3, 104, 1938 and to various publications by the same author referred to in that article.

1382: W. de Groot: De fluorescentie van fosforen. *Ned. T. Natuurk.* 5, 257-268, Nov. 1938).

The variation with time of the fluorescence of uranium glass and of a zinc sulfide-copper phosphor is investigated under periodic illumination with monochromatic ultraviolet light. If an absorption screen is placed alternately in the incident and the fluorescence light, then the variation of intensity with time is not affected in the case of uranium glass, while with the zinc sulfide-copper phosphor it is affected. In the second case the variation with time also depends very much upon the wavelength of the incident light. These experiments give some indication of the nature of the mechanism upon which the luminescence is based. Moreover it is possible to determine from them the relative values of the absorption coefficients. A decrease in temperature of 190°C has little or no influence on the decrease of the fluorescence with time in the case of a zinc sulfide-copper phosphor, while an increase of temperature by several hundred degrees considerably increases the speed of increase and decrease of this fluorescence. At about 400°C this luminescence disappears completely.

1383: J. H. Gisolf: Fosforen (*Ned. T. Natuurk.* 5, 289-300, Dec. 1938).

On the basis of much experimental data the following conception may be built up of the mechanism of phosphorescence. Due to ultraviolet absorption electrons are brought into a conducting state. If they return to the normal state by occupying open places a brief luminescence occurs (fluorescence). Part of the electrons do not fall

back immediately, but are bound in metastable states. They may be freed from these metastable states by heat or infrared radiation, whereby they are once more brought into the conducting state from which they can reach the normal state simply by falling back. The light which is emitted hereby is that of the long continued luminescence (phosphorescence). The electrons freed by infrared light, but producing no phosphorescence, are found, according to the experiment, not to reach the conducting state; their energy appears to be lost as heat (infrared quenching; Tilgung).

1384: Balth. van der Pol: Application of the operational or symbolic calculus to the theory of prime numbers (Phil. Mag. 26, 921-940, Dec. 1938).

By means of the operational calculus several problems in the theory of prime numbers are dealt with in a clear manner, since the operational "image" of the discontinuous functions hereby occurring is continuous. Since the "original" fully determines the "image" and *vice versa*, we can deduce the properties of the discontinuous "originals" from those of their continuous "images".

1385: A. Bouwers: Die Technik der Neutronenerzeugung und der Erzeugung künstlicher Radioaktivität. (Fortschr. Röntgenstr. (Tagungsheft) 587, 9-80, Dec. 1938).

In connection with this survey a more extended article has appeared in Strahlentherapie (cf. 1371).

1386: J. H. van der Tuuk: Messungen an Röntgenstrahlen bis 1 Million Volt (Fortschr. Röntgenstr. (Tagungsheft) 58, 84-86, Dec. 1938).

A description is given of a sealed-off symmetrical "Metallix" tube for voltages up to 1 MW. If with the same tube current and focus distance the voltage is raised from 200 kilovolts to 1 MV, the dose is found to have been increased by a factor 45 with slight previous filtering, so that the efficiency is increased 9 times. Furthermore the thicknesses

of lead were measured which are necessary in order to shield the surroundings from the direct radiation. The radiation scattered by the patient being irradiated is unable to penetrate very thin lead plates. In conclusion it is pointed out that, aside from the still unsatisfactorily answered question of whether extremely hard rays have any fundamental significance, it is now the task of X-ray technology to discover whether the greatest X-ray intensities can be obtained by increasing the current or the voltage, or perhaps by increasing both at the same time.

1387: R. Houwink and Ph. N. Heinze: Plastometry of synthetic resins (Industr. eng. Chem. 10, 680-683, Dec. 1938).

For judging the quality of resins it is important, especially in the case of hardening resins, to know the rate of hardening and the softening point. In this article the plastometer of Schopper and Houwink is described and the results obtained with it are discussed.

1388: R. Vermeulen: Mechanical recording of sound on film (Proc. 3rd Int. Congr. Phon. Sci. Ghent 1938, p. 152-156).

In this lecture a survey is given of the Philips-Miller system of sound recording; cf. 1316 and 1342, also: Philips techn. Rev. 1, 107, 135, 211 and 230, 1936.

In April 1939 there appeared:

Philips Transmitting News 6, no. 1:

M. v. d. Beek: Transmitting valves with forced aircooling.

Philips marine beacon transmitter type BRA 070/7.

Tj. Douma and P. Zijlstra: An osciloscope for determination of characteristic curves.

Abstracts of scientific publications.

Philips Technical Review

DEALING WITH TECHNICAL PROBLEMS

RELATING TO THE PRODUCTS, PROCESSES AND INVESTIGATIONS OF

N.V. PHILIPS' GLOELAMPENFABRIEKEN

EDITED BY THE RESEARCH LABORATORY OF N.V. PHILIPS' GLOELAMPENFABRIEKEN, EINDHOVEN, HOLLAND

THE RADIATION OF SOUND

by TH. van URK and R. VERMEULEN.

534.232

The radiation of sound is investigated for the simplest forms of radiating body. In the first place the differential equations are set up for a spherically symmetrical air movement, such as can be obtained by means of a pulsating sphere. The solutions of the differential equations are discussed and a mechanical model is deduced which causes by its movement the same reaction on the driving centre as the air on the pulsating sphere. By means of the model the different forms of air movement are treated, particularly sinusoidal movement with different frequencies. In practical cases the pulsating sphere may be regarded as an idealized case of a loud speaker with a large baffle board. A loud speaker without a baffle must be idealized as an oscillating rigid sphere. For this case also a mechanical model is described, by means of which the behaviour of the radiator at various frequencies may be demonstrated. Finally the radiation properties of the pulsating sphere and of the oscillating sphere are compared.

Introduction

Sound is a movement of the air which is perceptible to the ear. This definition, although it is useful and correct, is not entirely satisfactory. It does not express the fact that it is especially the fluctuations of the air pressure which accompany its motion which stimulate the ear. Moreover, the hearer is not aware of sound as a property of the air surrounding him, but as the presence of a source of sound at a certain distance away. In this article we shall study how the fluctuations in pressure are created at the spot where the listener is situated by the source of sound *via* the motion of the air. It will be found that the motion of a body is in itself insufficient to cause the air to move at great distances so that we can perceive the movement as sound. Only rapid changes of the motion of a body cause disturbances in the air which are propagated with comparatively little attenuation in all directions from the source: sound waves. The same phenomenon is indeed also encountered in electrotechnology: the field of a charged condenser or of a magnet can only be observed at short distances, by induction for example. On the other hand, upon rapid changes of charge and current radio waves occur which make possible communication over great distances. By analogy with the radiation of light waves one speaks of the radiation of radio

waves by an aerial and of the radiation of sound waves by a source of sound.

From time immemorial the builders of musical instruments have sought intuitively and empirically the shape which renders a body a good sound radiator. In our times the problem has taken on new significance in the construction of loud speakers. In this case the problem takes on a simpler form because the radiator here does not and even must not perform the function of determining the timbre.

The essence of the problem is now to determine how much energy is radiated in the form of sound with different shapes and types of motion of the radiator. For the very simplest forms the answer will be elucidated with the help of mechanical models.

The pulsating sphere

The first radiator for which we shall derive a model is the "pulsating sphere", *i.e.* a sphere whose radius increases and decreases with the time. One may imagine a rubber balloon which is more or less blown up. The motion of the air around the sphere (see *fig. 1*) will, like the motion of the sphere itself, take place only in radial directions, and will have the same velocity (v) in all directions, but it will

depend upon the distance from the centre of the sphere (r). We shall now set up the differential equations for this spherically symmetrical motion of the air and discuss their solution.

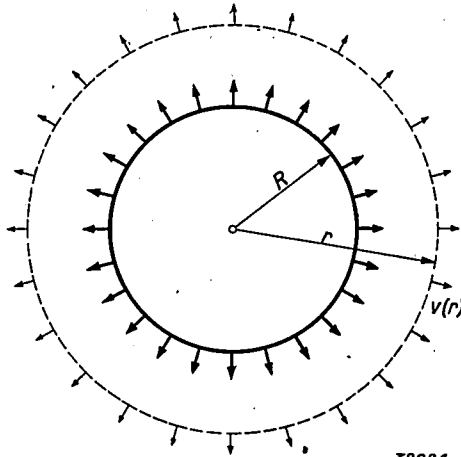

32024

Fig. 1. Pulsating sphere. In the expansion of the sphere (radius R) a spherically symmetrical motion of the air takes place with the velocity v at the distance r .

If we consider the layer of air between two spheres with radii r and $r + dr$, this layer will, after a short time dt , have been displaced as a whole over a distance $v \cdot dt$. But in the case where there is a velocity gradient $\partial v/\partial r$, the outer sphere will have moved with the velocity $v + (\partial v/\partial r)dr$, and thus the thickness of the layer of air will have been increased to $dr + (\partial v/\partial r)dr \cdot dt$. The volume of the layer, which was originally $4 \pi r^2 dr$, will after a time dt therefore be enlarged for two reasons: firstly because the radius has increased by $v dt$, and secondly because the thickness has increased by $(\partial v/\partial r)dr \cdot dt$. The relative increase dV of the volume V therefore amounts to:

$$\frac{dV}{V} = 2 \frac{v}{r} dt + \frac{\partial v}{\partial r} dt \dots \dots (1)$$

The enlargement of the volume results in a decrease in the pressure, since the amount of air enclosed remains the same. If the exchange of heat with the environment is neglected, thus if the expansion takes place adiabatically, the relation between pressure and volume is given by the well known law: $p \cdot V^\gamma = \text{constant}$, from which the change of pressure dp follows:

$$\frac{dp}{B} = -\gamma \cdot \frac{dV}{V}, \dots \dots (2)$$

where B represents the average air pressure, *i.e.* the barometric pressure. From the combination of formulae (1) and (2) the velocity at which the pres-

sure increases in the air flow is found:

$$\frac{\partial p}{\partial t} = -\gamma B \cdot \frac{dV}{V dt} = -\gamma B \left(2 \frac{v}{r} + \frac{\partial v}{\partial r} \right) \dots (3)$$

In addition to this "continuity equation" a second equation may be written which expresses the fact that a change in the velocity of the air occurs in a radial direction when there is a pressure gradient. In order to calculate this we cut out of the spherical layer of air dr in thickness, a small cylinder with a cross section dO and a height dr (see fig. 2). The pressure on the curved surface of this cylinder will produce no acceleration, but the pressure $(\partial p/\partial r)dr$ on the top surface will be greater than that on the lower surface. The retarding force $(\partial p/\partial r)dr \cdot dO$ acts on the mass $\rho \cdot dr \cdot dO$ (where ρ is the density of the air), so that

$$-\frac{\partial p}{\partial r} \cdot dr \cdot dO = \rho \cdot dr \cdot dO \cdot \frac{dv}{dt},$$

$$\frac{\partial p}{\partial r} = -\rho \frac{dv}{dt} \dots \dots (4)$$

In order to find a solution of equations (3) and (4), an auxiliary quantity Ψ may well be introduced by means of the relations:

$$p = \rho \frac{\partial \Psi}{\partial t} \dots \dots (5)$$

$$v = -\frac{\partial \Psi}{\partial r} \dots \dots (6)$$

The problem is hereby reduced to the determination of a single function Ψ :

From (5) it follows directly that

$$\frac{\partial p}{\partial r} = \rho \frac{\partial^2 \Psi}{\partial r \partial t}$$

and from (6)

$$\frac{\partial v}{\partial t} = -\frac{\partial^2 \Psi}{\partial r \partial t},$$

so that equation (4) is satisfied with an arbitrary function Ψ .

From equation (3), however, another condition

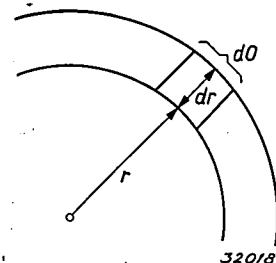

32018

Fig. 2. The element of volume which is considered for the derivation of equation (4).

for Ψ can be derived. By substituting (5) and (6) in (3) the following differential equation is found:

$$\frac{\partial^2}{\partial t^2} (r \Psi) = \frac{\gamma B}{\rho} \frac{\partial^2}{\partial r^2} (r \Psi).$$

This is the well known wave equation for the quantity $(r \Psi)$. The general solution is:

$$\Psi = \frac{1}{r} [F(r - \sqrt{\gamma B/\rho} t) + G(r + \sqrt{\gamma B/\rho} t)], \quad (7)$$

where F and G are arbitrary functions.

From the fact that the time occurs only in the combination $(r - \sqrt{\gamma B/\rho} t)$ in equation (7) it may clearly be seen that the character of this term is that of a wave directed outwards, of otherwise arbitrary form and intensity. This combination retains the same value when r increases with the velocity

$$c = \sqrt{\gamma B/\rho} \dots \dots \dots (8)$$

This is therefore the velocity of propagation of the travelling wave.

As an example we shall work out the case of a purely sinusoidal wave directed outwards. In this case we are concerned only with F , and this F must be a harmonic function of $r - ct$, so that Ψ may for instance be written in the form

$$\Psi = \frac{A}{r} \sin \frac{\omega}{c} (ct - r) = \frac{A}{r} \sin (\omega t - kr), \quad (9)$$

where A is an arbitrary constant and $k = \omega/c$. k is actually the number of waves over the length 2π .

With the help of (5) and (6) the pressure and velocity in the sound wave may be derived from Ψ given by equation (9). One obtains:

$$p = \rho \frac{A}{r} \omega \cos (\omega t - kr) \dots \dots (10)$$

$$v = k \frac{A}{r} \left[\cos (\omega t - kr) + \frac{1}{kr} \sin (\omega t - kr) \right] \quad (11)$$

The spherical wave described in this way may be excited by means of the afore-mentioned pulsating sphere. The velocity v of the pulsating surface is found by substituting the radius R of the sphere for r in equation (11). In the same way equation (10) gives the pressure on the surface of the sphere, and hence the force of reaction $4 \pi R^2 \cdot p(R)$ of the sound field on the radiator.

It may be seen from the equations that the velocity and reaction force are proportional to each other and shifted in phase to a certain amount. The relation between force and velocity therefore corresponds in character to the relation between

voltage and current in electrical circuits, and it is reasonable to represent mathematically the relation of force to velocity, by analogy with the relation of voltage and current, by a complex impedance of the radiator. This impedance Z can be calculated by dividing force and velocity at the surface of the sphere by each other (both must be written in the complex form $e^{j(\omega t - kr)}$):

$$\frac{1}{Z} = \frac{v(R)}{4 \pi R^2 p(R)} = \frac{1}{4 \pi R^2} \left(\frac{1}{\rho c} + \frac{1}{j \omega \rho R} \right) \quad (12)$$

Besides being concerned with the impedance of a radiator, we are primarily concerned with the energy dissipated. This can be calculated as the product of the velocity of the surface of the sphere and the force of reaction, or — as in electrotechnology — as the square of the maximum velocity multiplied by the real part of the impedance. The fact that the impedance also possesses an imaginary component means that there is, in addition to the energy radiated, also wattless energy, *i.e.* energy which passes back and forth periodically between the radiator and the field of sound.

In order to be able to understand the physical significance of the actual and the "wattless" power in the sound field, and to obtain in addition an idea of the behaviour of the radiator at different frequencies and with other forms of motion than the sinusoidal one, a mechanical model will be introduced which possesses the same impedance as is indicated in formula (12) for the reaction of the air (*fig. 3*). This model consists of a mass M which is driven at point A via a mechanical resistance, represented by an oil cylinder with a perforated piston. The piston can be moved with respect to the cylinder, and due to the viscosity of the oil it experiences a resistance proportional to its velocity. By this frictional resistance a force K is applied to the mass, proportional to the difference in velocity between piston and cylinder, or between the driving centre A and the mass M which amounts to the same thing. If the driving centre has the velocity v_0 and the mass the velocity v_2 , the re-

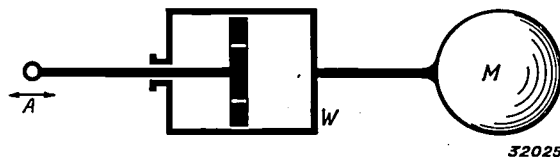

Fig. 3. Mechanical model consisting of a mass and a frictional resistance which upon motion exerts on the driving centre A the same reaction as a compressible medium (air) on the wall of a pulsating sphere. The energy dissipated in the resistance corresponds to the energy which is radiated in the form of sound. The kinetic energy of the mass is analogous to the (wattless) energy which is taken up in the flow of air.

lative velocity of piston and cylinder $v_1 = v_0 - v_2$, and a force is exerted by the mechanical resistance:

$$K = W v_1,$$

where W is the proportionality factor between velocity and friction. This force causes the acceleration of the mass:

$$K = M \frac{dv_2}{dt}.$$

The mechanical impedance is again defined as the complex relation between the force K and the velocity v_0 of the driving centre A for sinusoidal motions:

$$\frac{1}{Z} = \frac{v_0}{K} = \frac{v_1 + v_2}{K} = \frac{1}{W} + \frac{1}{j \omega M}. \quad (13)$$

This expression has the same form as formula (12), and even becomes identical with it when the following substitutions are made:

$$\left. \begin{aligned} W &= 4 \pi R^2 \cdot \rho c \\ M &= 4 \pi R^3 \cdot \rho \end{aligned} \right\} \dots \dots \dots (14)$$

The values found for W and M are independent of the frequency. This means that at any given frequency of the force on point A the reaction of the model is the same as the reaction of the air on the sphere. This also must hold with a force containing components with different frequencies, in other words, with a non-sinusoidal variation of the driving force.

It may be seen that in the model there are two elements which can take up the energy supplied at the driving centre A : the mass M which can retain the energy temporarily in the form of kinetic energy, and the resistance W which dissipates part of the energy¹⁾. In what form can we rediscover this energy in the air surrounding the radiator? In order to answer this question the motion of the air will again be considered on the basis of the model, making use of the fact, that the model is also valid for motions other than sinusoidal.

Application of the model

Stationary motion

When in the model the mass M and the driving

centre A move with the same constant velocity, the mechanical resistance W is apparently inactive and no force is transferred to the mass. Actually this corresponds to a stationary flow in the air, where the velocity is constant at every point, i.e. independent of time. The pressure will then also be constant at all points, and equal to the barometric pressure B . The same amount of air must flow through every spherical shell of radius r , thus: $v = v_0 R^2/r^2$, where v_0 is the velocity at R . A volume element dV will then possess a kinetic energy $dT = 1/2 \rho \cdot dV \cdot v^2$, so that the total kinetic energy of the air flow, calculated by integrating over space, becomes:

$$T = \int_R^\infty 1/2 \rho \cdot v_0^2 \frac{R^4}{r^4} \cdot 4 \pi r^2 dr = 1/2 4 \pi R^3 \rho v_0^2.$$

This is apparently the same expression as that found for the kinetic energy of the mass in the model, when the latter moves with the velocity v_0 . This mass therefore represents the inertia of the air flow in the air surrounding the sphere.

Motion with constant acceleration

If in the model a constant acceleration is applied at point A , the mass M will also be constantly accelerated, and the necessary constant force $K = M dv_2/dt$ must be transmitted by the resistance W . The relative velocity v_1 of the piston with respect to the cylinder will then be constant, namely

$$v_1 = \frac{M}{W} \frac{dv_2}{dt},$$

so that the acceleration of M and A also will have the same value dv_2/dt which we shall call a in the following.

It is striking that, as long as the motion is constantly accelerated, the velocity of the driving centre exceeds the velocity of the mass M by a constant amount v_1 , and the increase of the kinetic energy of M needs must be accompanied with a loss of energy in the resistance which per unit of time amounts to

$$K \cdot v_1 = W \cdot v_1^2 = \frac{M^2}{W} a^2 = 4 \pi R^4 \frac{\rho}{c} a^2.$$

To what does this correspond in reality? A constantly accelerated motion of the air at the surface of the sphere of radius R can be realized by giving the surface of the sphere a suitable acceleration. The surrounding air will then also be accelerated and the total kinetic energy of this air becomes

¹⁾ It may be noted here that in the usual manner of representation the impedance Z is divided into $Z = W' + j \omega M'$, where W' and M' are interpreted as the "radiation resistance" and the "mass in resonance" of the air. It is indeed possible to choose a resistance W' and a mass M' in such a way that the whole system exhibits the impedance Z when driven with a given frequency. The quantities W' and M' are, however, very dependent on the frequency in that case. This "model" is therefore less suitable for obtaining an objective picture of the radiation.

equal to $\frac{1}{2} Mv_2^2$, just as with stationary flow. What conception must we have of the "frictional loss" Wv_1^2 ? We have considered the air as a medium without friction, which therefore satisfies the law of the conservation of energy, and it is very remarkable that the behaviour of this medium can be described by means of a model in which energy losses occur.

The explanation of this apparent paradox lies in the fact that the sound field is infinite. It is found, namely, that the energy can be stored in the sound field in two different ways. Part of the energy remains concentrated in the neighbourhood of the radiator in the form of kinetic energy. This part of the sound field remains in contact with the radiator, and the energy which it takes up may be considered as wattless energy, because the sound field is capable of giving back this energy when the stream of air is no longer accelerated by the sphere, but retarded. This agrees with the fact that this kinetic energy in the case of the stationary flow corresponds to the energy of the mass M in the model which also takes up a wattless energy. Another part of the energy will, however, flow off to infinity with the excited sound wave. This energy will never be given back to the radiator and can therefore be considered as lost as far as its reaction on the radiator is concerned, even though it always remains within the infinite sound field.

In order to show that the sound wave actually does dissipate energy we shall calculate the pressure and velocity in the sound field from equation (7), assuming a wave of arbitrary shape, which is directed outward ($G = 0$). Then with the help of equations (5), (6) and (8) one finds

$$p = -\frac{\rho c}{r} \frac{\partial F}{\partial r}, \dots \dots \dots (15)$$

$$v = -\frac{1}{r} \frac{\partial F}{\partial r} + \frac{1}{r^2} F. \dots \dots \dots (16)$$

From these expressions may be calculated the power dissipated through a spherical shell with radius r :

$$N = 4 \pi r^2 p \cdot v = 4 \pi \rho c \left[\left(\frac{\partial F}{\partial r} \right)^2 - \frac{1}{r} F \frac{\partial F}{\partial r} \right]. \quad (17)$$

The quantities F and $\partial F/\partial r$ vary in the same way as functions of the time at all distances r from the source of sound, only with a constant displacement. From this it follows that the first term of equation (17) represents a current of energy which flows

toward infinity with unaltered intensity. The second term is an additional current of energy which dies out at great distances, which means that the corresponding energy is stored up in the neighbourhood of the radiator.

It is enlightening to consider the two parts of the sound field in the case of a very simple wave train such as occurs, when the constant acceleration of the air at $r = R$ is continued for a certain time τ , and the system is then left to itself. Fig. 4 gives the distribution of velocity in the sound wave at a number of different moments. The velocity v may be considered as the sum of two velocities $v_1 + v_2$, which were introduced in the discussion of the mechanical model. The velocity v_2 is the velocity of the "mass" M ; during the period of acceleration it is equal, at $r = R$, to $a \cdot t$, and after the conclusion of the period of acceleration it remains equal to $a \cdot \tau$. The velocity v_1 is the extra velocity which the air must have at $r = R$ in order to cause the excess pressure necessary to accelerate the air. This velocity is therefore present from the time $t = 0$ and disappears at the moment when the acceleration stops. In the model the acceleration is caused by the force of friction $Wv_1 = Ma$; the extra velocity is therefore $v_1 = Ma/W$.

The model only makes it possible to determine the pressure and velocity at the surface of the sphere $r = R$. The distribution of the velocity in space is sketched in fig. 4 on the basis of the consideration that the wave which occurs upon acceleration decreases in amplitude during propagation by $1/r$, while the velocity of the stationary flow succeeding the wave decreases by $1/r^2$.

The propagation of a spherical wave is well illustrated by the phenomena taking place in an explosion. The compression which occurs here due to the sudden liberation of a quantity of gas leads to a pressure wave which we know as the detonation. This excess pressure, however, is maintained only as long as the combustion generates gas in increasing amounts. When the development of gas is at a maximum the pressure will again be normal, but high velocities, away from the centre of explosion, will occur in its neighbourhood. With decreasing gas development a lowered pressure occurs due to the inertia of the surrounding gas. This lowered pressure travels as it were as a negative wave behind the first positive wave and brings the medium to rest again. It is usually impossible to distinguish this second wave by ear since it follows the first one too closely. Its presence, however, is proved by the well known fact that the glass of the windows which are broken in houses near the centre of an explosion does not fall into the rooms, but outward on to the street. The first wave breaks the glass and the second negative wave draws the fragments outward. This succession of positive and negative forces which act on the mass M upon rapid displacement of point A can be well visualized by means of the model.

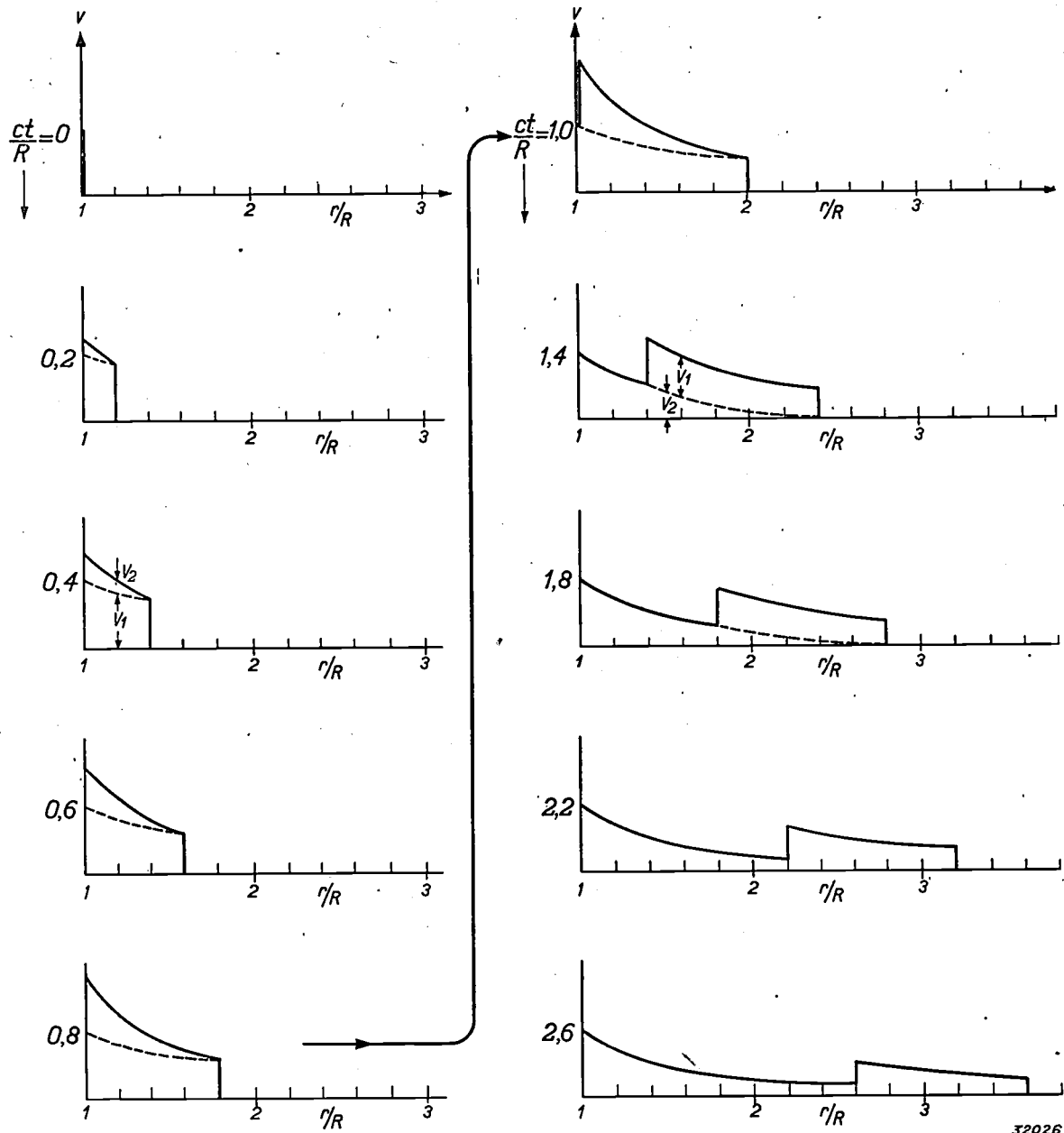

Fig. 4. The distribution of the velocity $v(r)$ in a medium at a number of successive moments upon the occurrence of a spherically symmetrical sound wave. The radius R of the sphere is chosen as unit of the distance r ; as unit of the time, the time is chosen during which the wave covers the distance $r = R$. It is assumed that an acceleration $a = 1$ is given to the air at $r = R$ during the time $t = R/c$. This means that during this time the wall of the sphere has first a velocity $v_1(R)$ which causes the compression, and thereby the increase in air pressure. By the acceleration a current of air with a velocity v_2 is built up. The total velocity v is composed from v_1 (the dotted curves in the left part) and v_2 (drawn above the dotted curves). The distribution of velocity $v_2(r)$, at the moment $t = \tau$ remains after the conclusion of the acceleration (disappearance of $v_1(R)$), the region with high pressure, however, in which the velocity $v_1(r)$ is present, now passes off to infinity as a sound wave.

32026

Sinusoidal motions with different frequencies

Let us now consider a sinusoidal motion of the driving centre A of the model. At low frequencies the forces of inertia of the mass M will be small, so that small relative motions of piston and cylinder are enough to produce these forces, and the energy loss in the piston is small. This means that the pul-

sating sphere is in this case a poor radiator: the mass of the surrounding air gives way too easily for a strong sound wave to occur. At very high frequencies, on the other hand, the mass M will remain almost entirely at rest; the motion of the driving centre is practically all taken up by the resistance. In this case therefore the sphere will not only radiate well, but the energy given off will be independent of the

frequency at a given velocity amplitude of the surface of the sphere. The influence of the size of the radiating sphere can also be judged in this qualitative consideration. According to formula (14) the ratio of the mass M to the resistance W will become greater with a larger sphere. The radiation therefore improves. With a very great radius of the sphere, *i.e.* when practically plane waves are generated, the very great mass M remains entirely at rest, the radiation impedance becomes a pure resistance with the value ρc per unit of surface, *i.e.* the so-called wave resistance of the medium.

For frequencies lying between the two extremes formula (12) for the impedance must be employed. The real part, which determines the power radiated at a given velocity v_0 of the wall of the sphere, becomes:

$$Z_r = 4 \pi R^2 \rho c \frac{(kR)^2}{1 + (kR)^2}$$

The imaginary part, which determines the "wattless" power, is

$$Z_i = 4 \pi R^2 \rho c \frac{(kR)}{1 + (kR)^2}$$

The frequency occurs only in the form $kR = R\omega/c = 2\pi R/\lambda$, *i.e.* the radiation properties depend only upon the ratio of the circumference and the wave length ²⁾.

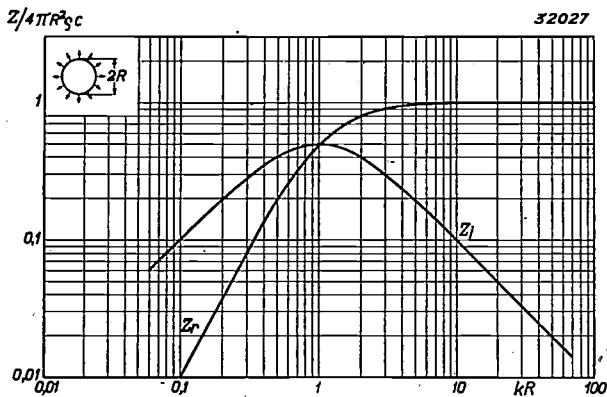

Fig. 5. Real part Z_r and imaginary part Z_i of the mechanical impedance of the air in the case of a pulsating sphere, as a function of kR . At a definite size of the sphere the abscissa therefore represents a frequency scale: one may, however, also assume that the radius R of the sphere is plotted on the abscissa for a definite frequency.

In fig. 5 Z_r and Z_i are drawn as functions of (kR) . It may be seen that at low frequencies Z_i is the dominating component, so that the impedance

possesses the character of a mass in the main, while at high frequencies Z_r becomes dominant.

If we consider particularly Z_r , the acoustic energy dissipated, we ascertain that it is independent of the frequency at high frequencies ($kR > \pi$), at lower frequencies, however, it decreases with the square of the frequency. Therefore in order to obtain satisfactory sound radiation at low frequencies, kR must be made large, *i.e.* a sphere of large radius must be used.

Practical significance of the pulsating sphere

Until now we have been concerned exclusively with the pulsating sphere. Such a radiator, called of the zero order, all points of whose surface move in the same phase, *i.e.* move simultaneously inward and outward, can scarcely be realized technically.

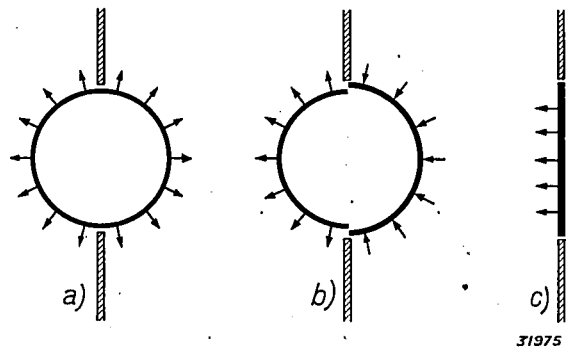

Fig. 6. The pulsating sphere is the idealized form of a loud speaker in a baffle board.

- a) The space around the sphere is divided into two halves by a baffle board.
- b) No essential change is introduced in each half of space when the phase of the motion of one half of the sphere is reversed.
- c) If the spherical boundary of the radiator is now replaced by a plane one, one arrives at the case dealt with by Rayleigh of an oscillating flat disc in a baffle board.

However, since the velocity in the case of the sphere is in a radial direction at all points, it makes no difference when space is divided into two parts by a solid wall through the centre of the sphere (fig. 6a), and since the two parts of space are entirely independent of each other, the conditions in each half of space will remain entirely unaltered when we reverse the phase of the motion of one half of the sphere (fig. 6b). The situation now begins to resemble that of a loud speaker membrane in an infinitely large baffle board. The sphere ought to be replaced by the cone which is usual in loud speakers, but then it is impossible to carry out the necessary calculations. The calculations can, however, be carried through for the case of a flat disc, moving back and forth in the opening of the baffle board, fig. 6c. The radiation impedances calculated by Rayleigh for this case are re-

²⁾ This fact has also been emphasized in this periodical in the discussion of the directional effect of loud speakers, see J. de Boer, Philips techn. Rev. 3, 225, 1938 and 4, 144, 1939.

presented in *fig. 7*. Oscillations are found to occur in the curves of the impedances which may be ascribed to the fact that the sound field is no longer spherically symmetrical, and interferences occur at certain wave lengths. Apart from these discrepancies, however, the general variation of the impedances is the same for the pulsating sphere and the plane disc in the baffle board, and this fact makes it reasonable to assume that for other forms of radiators of the zero order also (a cone in a baffle board, for instance) the character of the radiation impedances will be similar.

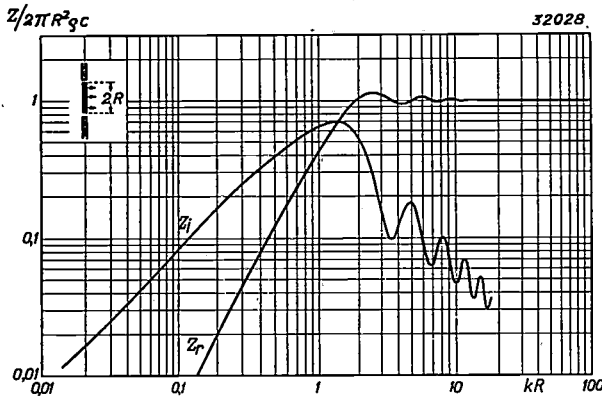

Fig. 7. Real and imaginary part of the impedance of the air upon being set in motion by the oscillating disc in *fig. 6c*, as a function of kR .

The oscillating sphere

According to the foregoing the pulsating sphere may be considered as an idealized form of a loud speaker membrane in a very large baffle board. How must we represent a loud speaker without a baffle board? In such a case it is most essential that the loud speaker membrane moves back and forth as a whole, and that phase differences in the motion in the above described two halves of space occur. If we again idealize the membrane to a sphere we must allow the sphere to oscillate back and forth as a whole, see *fig. 8*. This is called a radiator of the first order.

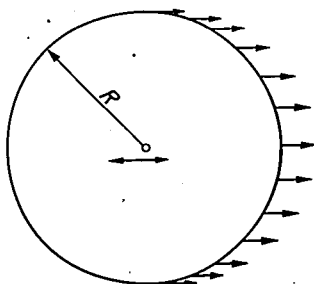

Fig. 8. Oscillating sphere. All points on the surface of the sphere have the same, mutually parallel, velocity. The velocity of the air at any point of the sphere must have a normal component which equals the normal component of the velocity of the sphere at that point.

The difference between the air movement in the case of this oscillating sphere and that in the case of the pulsating sphere lies in the fact that in the latter case there was only a radial flow, while in the former case, in addition to the radial, a tangential flow is also possible. In tangential motion along the sphere the acceleration of the air does not take place by means of a sound wave, but by a different oscillation phenomenon. Let us imagine a purely tangential flow around the fixed sphere between the wall of the sphere and an imaginary sphere somewhat larger in size, *fig. 9*. There will then be a compression of the air at the left and a lowered pressure at the right; the flow is hereby retarded, and then, due to the pressure differences occurring, it continues in the opposite direction. These oscillations of the air are quite analogous to those in an organ pipe closed at both ends having the length πR , and have the following frequency:

$$\omega = \frac{c}{R} \cdot \dots \cdot \dots \cdot (18)$$

If we now wish to investigate the reaction of the moving air on the radiator, and as in the case of the pulsating sphere, try to make a mechanical model, we must first consider the radial and the tangential flow each separately.

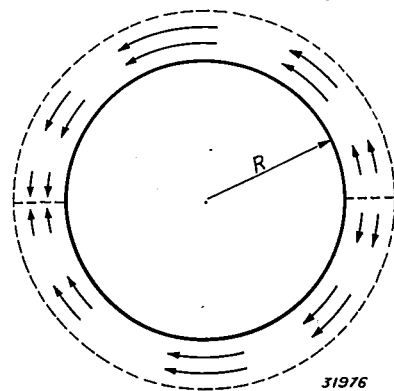

Fig. 9. Tangential motion of the air around the oscillating sphere. The air can carry out an oscillation along the circumference in the same way as in a closed organ pipe of length πR .

For the radial flow we can use the same model as in *fig. 3*. For the radial velocity of every point of the wall of the sphere we must take, however, the component of the velocity of the sphere, calculate in every point the pressure, which would exist on a pulsating sphere with this radial velocity and then find the total force by integration over the whole surface of the sphere. In the model (*fig. 10a*) this is expressed in the fact that we must give the mass M_1 and the resistance W_1 smaller values than in the case of the pulsating sphere, namely:

$$\left. \begin{aligned} M_1 &= \frac{4}{3} \pi R^3 \rho \\ W_1 &= \frac{4}{3} \pi R^2 \rho c \end{aligned} \right\} \dots \dots (19)$$

The tangential flow is represented by a mechanical model which can carry out undamped oscillations, a combination therefore of a spring and a mass, see fig. 10b. The relation between the stiffness of the spring S_2 and the mass M_2 is determined by

$$\sqrt{\frac{S_2}{M_2}} = \omega,$$

where ω is given by (18).

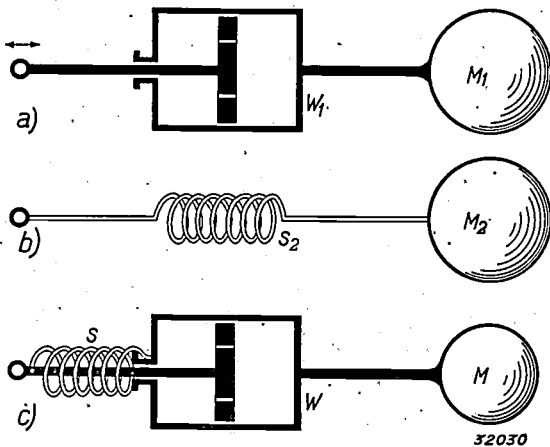

Fig. 10. For the reaction of the air on the oscillating sphere a mechanical model can be used which is composed of two parts.

- a) Model for the radial movement of the air (as in fig. 3);
- b) Model for the tangential movement of the air;
- c) Coupling of models a) and b). Both forces and masses are connected "in parallel".

By combining the two models in fig. 10a and b, the model in fig. 10c is obtained. The fact that the two parts must be coupled in the manner here shown may be explained as follows. The pressure is a scalar quantity, *i.e.* whether it occurs due to compression in radial or tangential direction it will have an accelerating action in both directions. The resistance and the spring must therefore be coupled in such a way that the sum of their forces has an accelerating action on the two masses M_1 and M_2 . The two masses together can, however, be replaced by a smaller mass M : $1/M = 1/M_1 + 1/M_2$, because they must be connected "in parallel". For the expansion of the air is the sum of the expansions in radial and tangential directions. The acceleration of the resultant mass in the model must therefore be made larger with the same force, and therefore the mass must be chosen smaller.

The reaction of the model of fig. 10c on the driving centre may again be derived simply from the equations of motion:

$$M \cdot \frac{dv_2}{dt} = K = W v_1 + S \int v_1 dt$$

and $v_0 = v_1 + v_2.$

With sinusoidal motion the following impedance is found:

$$\frac{1}{Z} = \frac{v_0}{K} = \frac{1}{W + \frac{S}{j\omega}} + \frac{1}{j\omega M} \dots (20)$$

If M_2 is chosen equal to M_1 , so that in the complete model

$$\left. \begin{aligned} M &= \frac{2}{3} \pi R^3 \rho, \\ W &= \frac{4}{3} \pi R^2 \rho c, \\ S &= \frac{4}{3} \pi R \rho c^2, \end{aligned} \right\} \dots \dots (21)$$

then the reaction of the model on the driving centre is found to be quantitatively the same as that of the air on the oscillating sphere³⁾.

If we now attempt to obtain a clear picture of the behaviour of the radiator from the model, it becomes evident that even with the driving centre fixed, this model will be able to carry out a (damped) oscillation, in which the mass is kept in motion by the spring. When the driving centre moves, the spring will, however, also make itself felt outside the "resonance frequency" by the taking up of energy. This will be appreciable especially at low frequencies, because the energy which the spring takes up is determined by its change in length, while the energy dissipated in the frictional resistance is determined by the velocity. At low frequencies therefore the spring will be able to take up much energy without great dissipation in the resistance, *i.e.* at low frequencies the tangential flow of the air around the oscillating sphere will be most disadvantageous to the sound energy, which is already small at low frequencies. At high frequencies, on the other hand, the spring will introduce no important changes in the behaviour of the model with respect to the one discussed earlier: due to the large forces of inertia only small movements of the mass occur, the spring absorbs little energy in these small movements, and due to the high velocities the greater part of the energy is again dissipated in the resistance, *i.e.* radiated as sound.

For a more accurate insight into the dependence of radiation on the frequency we may again divide

³⁾ This can be derived in a similar way as in the case of the model for the pulsating sphere. For the sake of brevity we omit the derivation at this point.

the impedance (20) into a real and an imaginary part, $Z = Z_r + j Z_i$, as was done above. Again we find that in these expressions, which indicate the acoustic energy given off and the wattless energy stored up in radial and tangential air flow, respectively, the frequency only occurs in the product kR . In fig. 11 the variation of Z_r and Z_i as a function of kR is drawn.

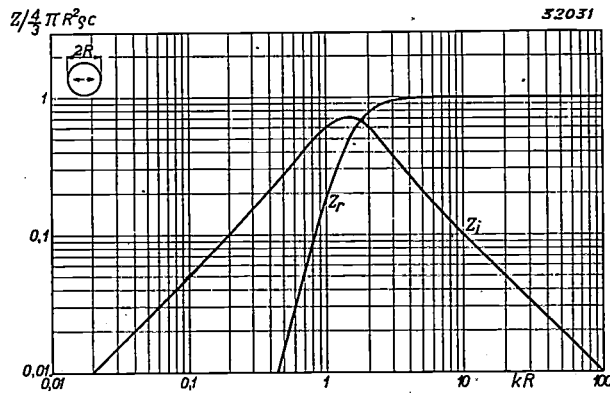

Fig. 11. Real and imaginary impedance of the air set in motion by an oscillating sphere, as a function of kR .

Since for practical purposes one is specially interested in the acoustic energy dissipated, we have in fig. 12 again given Z_r for the pulsating sphere (loud speaker with baffle board) and for the oscillating sphere (loud speaker without baffle board). The dimensions of the two radiators are so chosen that they both displace the same volume of air by their motion. The oscillating sphere then must have a radius which is $\sqrt{2}$ times that of the pulsating sphere.

From the figure it may be seen in the first place that the acoustic power in the case of the oscillating sphere falls more rapidly toward low frequencies than in the case of the pulsating sphere (namely, proportional to the fourth power of the frequency

instead of the square). Furthermore with the oscillating sphere the radiation as a whole, and especially at high frequencies, is less than with the pulsating sphere. This fact can be explained in the model by the smaller and therefore more easily movable mass, which belongs to the case of the oscillating sphere (the ratio of masses being $\sqrt{2}/3 = 0.47$) and by the spring which again absorbs a certain amount of wattless energy. Transferred to the medium the latter may be expressed by saying that the omission of the baffle board with a loud speaker cone results in a decrease of the acoustic power, due to the fact that a tangential motion of the air between the front and back of the membrane takes up part of the expansion of the compressed air. Quite in general one may say that the radiation is unfavourably affected when the air has the opportunity of moving in other directions than normal to the surface. The pulsating sphere is therefore the most satisfactory form for a sound radiator.

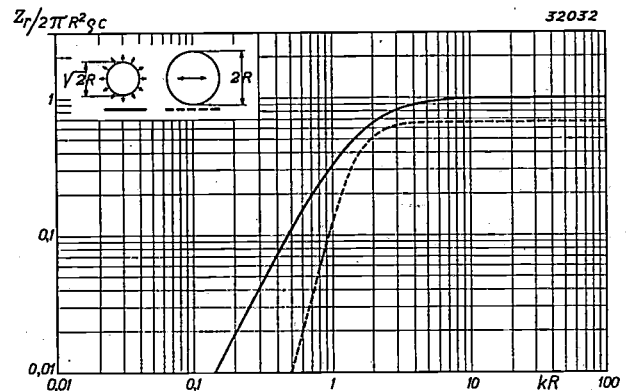

Fig. 12. Comparison of the variation of Z_r , i.e. the acoustic energy dissipated, for a pulsating sphere (continuous) and an oscillating sphere (dotted) of such dimensions that both radiators displace the same amount of air in their motion.

MEASUREMENTS OF POTENTIAL BY MEANS OF THE ELECTROLYTIC TANK

by G. HEPP.

537.213.08

If an electrode system with fixed electrode potentials is immersed in a conducting liquid the variation of potential between the electrodes will remain practically unchanged. The variation of potential in the liquid can now be measured by means of a probe electrode. An apparatus is described in this article with which potential fields can be measured and recorded on this principle with the help of enlarged models. Several applications are discussed and it is explained in particular how it is possible to reconstruct the paths of the electrons in vacuum tubes with this apparatus.

Diagrams have already been reproduced several times in this periodical representing the variation of potential between electrodes, while it has been stated, although very briefly, that these "potentiograms" can be recorded with the help of an electrolytic tank. The purpose of this article is to give a more detailed description of such an apparatus and of the methods of working with it.

In order to determine the variation of potential between two or more electrodes with the electrolytic tank, these electrodes, or proportionately enlarged models of them, are immersed in a conducting liquid. If voltages are then applied to the electrodes any given point in the liquid will take on a definite potential. This potential will depend on the place with regard to the electrodes, but will be independent of the conductivity and the dielectric constant of the liquid. If it is desired to measure this potential a metal wire is introduced into the liquid which is completely insulated except for its point by a glass tube. The potential of this probe electrode is now measured by comparing it with that of the sliding contact of a recording potentiometer. The sliding contact is so adjusted that the difference in voltage disappears, which can be ascertained with a sensitive measuring instrument.

If the electrode system to be investigated has a plane of symmetry, not only with respect to the dimensions of the electrodes but also with respect to their potentials, the potential field is also symmetrical with respect to this plane. Due to the symmetry no current will flow through this plane from the one half of the system to the other. No alteration in the current distribution will be produced therefore if an insulating plane is introduced at the symmetrical cross section. One half of the system may then be omitted without changing the situation of the remaining half.

An intensive use is made of this characteristic in working with the electrolytic tank. If for instance one has an axial symmetrical system, every

plane through the axis is a plane of symmetry. If the electrodes are now placed so that the axis just lies on the liquid surface, the variation of potential on this surface will be the same as that which would be found in a plane through the axis, if the whole model were immersed in the liquid. Now, however, the point of the probe need not be introduced to a certain depth into the liquid (with the result that the insulated connection causes some disturbance of the field), but it is sufficient to measure the potential at the surface of the liquid. The half of the electrodes which would project out of the liquid is now of course omitted. In *fig. 1* two such half electrode systems are given which represent the focusing electrodes of cathode ray tubes.

The action of non-conducting boundary planes of symmetry on the potential field does not, however, always have favourable results. This is only the case when such a plane is a plane of symmetry in the original electrode system. Since the electrolytic tank is limited, each wall and the bottom of the tank must be considered as a plane of symmetry of the potential. Instead, therefore, of measuring the variation of potential of a system isolated in space, one actually measures the potential of a system surrounded by many similar systems due to the repeated reflection at the walls. By suitable arrangement of the electrodes and the greatest possible use of the symmetries present, the disturbance of the field, produced by this effect, can be reduced to fairly small proportions.

Since in measuring the potentials it is only necessary to compare the relative voltage in the liquid with the relative voltage of the potentiometer, the absolute value and the sign of the voltage on the electrodes is unimportant. In the following, therefore, the potential at a point of the liquid means the relative potential, *i.e.* the ratio of the voltage of the probe to the voltage of the electrode with the highest potential, both calculated with respect to an electrode of zero potential.

In order to measure this relative voltage it is

not necessary for the voltage on the electrodes to be constant. An alternating voltage may also be applied, and it is even preferable because the electrolyte is not decomposed at a sufficiently high frequency of the alternating voltage.

Electrolyte and electrodes

For good results it is desirable to make the tank as large as possible. This reduces the errors caused

met satisfactorily by making the surface of the electrodes rough by means of a sand blast, which not only accomplishes an intensive cleaning but also a not inconsiderable enlargement of the surface and thus a decrease of the transition resistance.

The material of which the electrodes and probe are made is copper. Care must of course also be taken that other metals do not come in contact with the water at the same time.

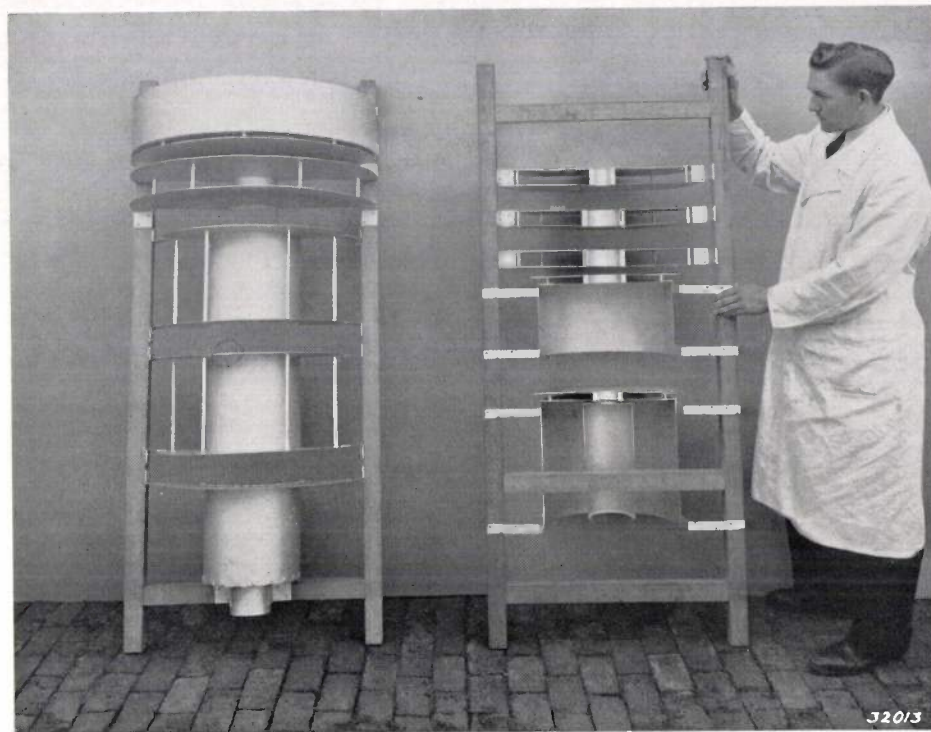

Fig. 1. Enlarged models of electrode systems for cathode ray tubes, constructed for the recording of potential fields by means of the electrolytic tank.

by the finite dimensions of the point of the probe, by the rise of the liquid surface of the electrodes, while at the same time the potentiograms obtained are larger and therefore more accurate.

If the tank has a large capacity, however, it is advisable to use a cheap and sufficiently plentiful liquid in making the electrolytic solution, and therefore not to use distilled water, but water from the mains. It has been found that it is unnecessary to add anything to the mains water, since the conductivity is already more than high enough and a higher conductivity would even be decidedly harmful, because of the transition resistance which occurs on the surface of the electrodes due to impurities or polarization, and which has a greater effect the lower the resistance of the liquid.

Mains water, with its fairly high conductivity, therefore demands a fairly high quality of the electrode surface. This demand can, however, be

Method of measuring

As already stated the potential of the probe is measured by comparing it with that of the sliding contact of a potentiometer from which the relative voltage can easily be read.

Potentiometer

In order to be able to adjust this relative voltage with sufficient accuracy, use is made of a potentiometer connection as indicated in fig. 2, which

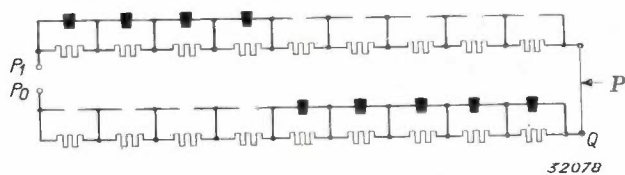

Fig. 2. Potentiometer circuit. The potentiometer consists of 19 fixed resistances, 9 of which are always short circuited by plugs, and a resistance with a sliding contact for fine adjustment.

consists of 19 resistances numerically alike, and connected in series, the first nine and the last nine of which can be short circuited by means of plugs while the middle resistance is formed by a wire over which a sliding contact can be moved. There are always nine plugs in the potentiometer, so that a total of ten non-short-circuited resistances are in series.

If P_0 is the end of the potentiometer with the potential considered as zero potential, then the relative voltage is equal to the ratio of resistances P_0P/P_0P_1 . The first decimal of this is equal to the number of resistances between P_0 and Q which are not short circuited, while the following three decimals can be read off with the help of a vernier which is fastened to the adjusting knob of the sliding contact.

accurate adjustment, because the voltage minimum cannot be indicated sharply enough.

The actual indicator is the meter FI (phase indicator) whose pointer passes the zero point in the middle of the scale when the phase difference between the supply voltage and the voltage to be measured passes through 90° , and thus when the part of the probe potential which is in phase equals the potential of the sliding contact.

The connection of the phase indicator may be seen in *fig. 3*. Currents flow in opposite directions through the meter FI during the two halves of the period of the AC voltage supply. Because of the symmetry of the connection, however, these currents are alike as long as the measuring amplifier delivers no output voltage or when this output voltage differs 90° in phase with the supply voltage,

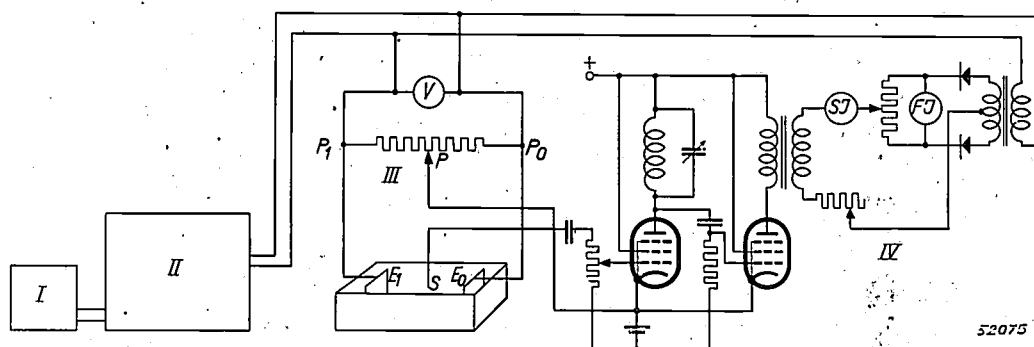

Fig. 3. Diagram of the installation for measuring potentials. *I* electric tuning fork, *II* power amplifier, *III* potentiometer, *IV* measuring amplifier. The difference in voltage between the point of the probe S and the sliding contact P is selectively amplified and rectified. The direct current obtained flows through the meter SI . The meter FI indicates whether the output voltage of the amplifier has a component which is in phase with the AC voltage supply.

Measuring amplifier and indicators

In order to compare the relative voltage in the electrolytic tank with that of the potentiometer, both are connected with the same voltage supply as indicated in *fig. 3*. Between the contact arm P and the probe S a sensitive amplifier is now connected. An output voltage given by this amplifier is rectified and the direct current so obtained causes the meter SI (voltage indicator) to register.

If the electrolyte in the tank could be considered as an ohmic conductor from electrode to electrode, one should be able to find by shifting the probe or the potentiometer arm an adjustment at which the current through the meter entirely disappears. This is, however, not the case, because, due to polarization phenomena in the electrolytic tank, there is always a small phase shift between the voltage of the probe and the voltage of the potentiometer arm. This phase difference makes it impossible for the voltage indicator to be used for an

so that in those cases the direct current meter FI does not register.

If, however, the output voltage of the measuring amplifier has a component which is in phase with the AC supply voltage, this voltage will, in the one rectifier unit, be added to the voltage from the source of supply, but in the other it will be subtracted, and, since the resistance of the rectifier unit is dependent on the voltage, the symmetry of the circuit is destroyed, so that the meter FI now moves to one side or the other according as the output voltage has a component in the same phase or in the opposite phase to the AC voltage supply.

In contrast to the voltage indicator, the phase indicator is very sensitive. Because of this sensitivity the pointer of this meter will remain off the scale¹ when there is only a small difference between

¹) The connections are made so that the currents in the meters can never become so great that the instruments could be damaged.

the two relative voltages, and in moving the contact arm or the probe it is then impossible to see on the phase indicator whether one is increasing or decreasing the input voltage of the amplifier. The rough adjustment is therefore carried out with the voltage indicator. When the two relative voltages have been made approximately equal, the pointer of the phase indicator begins to move.

As has been mentioned the current through the voltage indicator never becomes exactly equal to zero. The indication of this meter is therefore a measure of the phase difference

The AC voltage supply is provided by an electrical tuning fork, combined with a powerful amplifier.

Fig. 4 shows the whole installation. To the extreme left may be seen the electrical tuning fork, to the right of it the power amplifier, in front of the power amplifier the potentiometer and to the right of this instrument the electrolytic tank in which a model of the electrode system of a cathode ray tube has been placed. A pencil is fastened to the frame which holds the probe and which is movable along rails in two mutually perpendicular

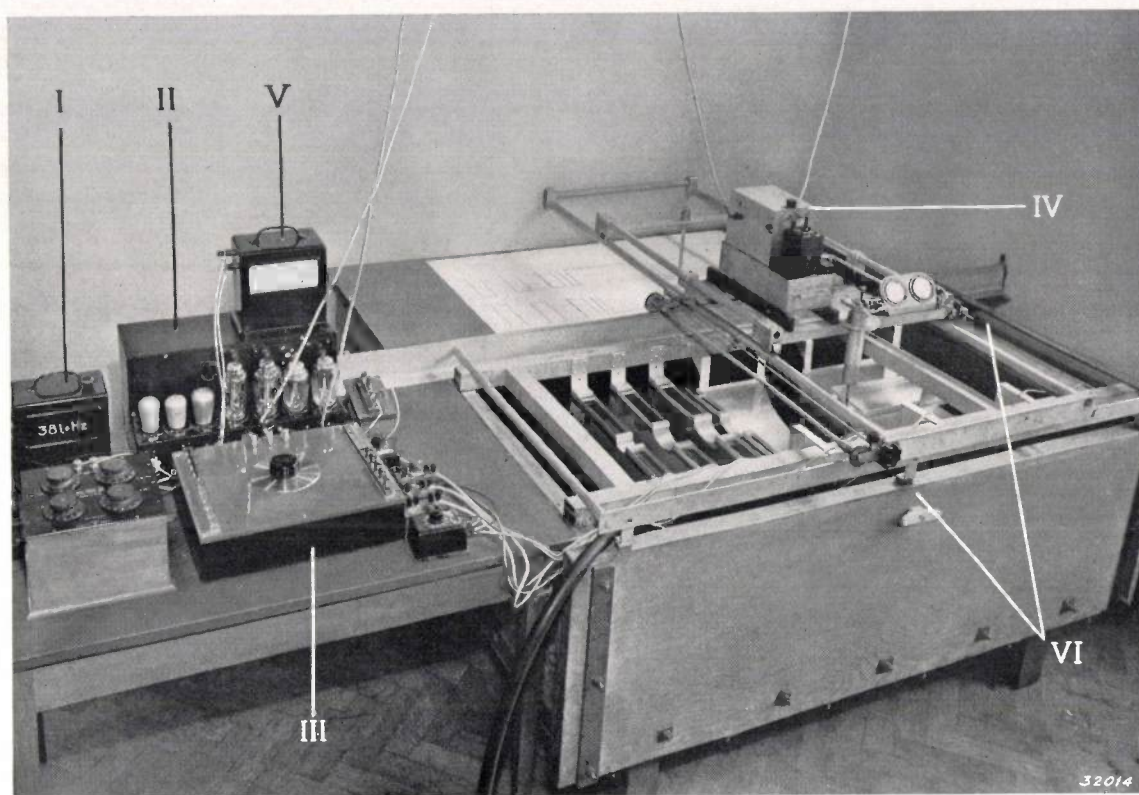

Fig. 4. View of the installation for measuring potentials. In the tank is a model of an electrode system for a cathode ray tube. *I* electrical tuning fork, *II* power amplifier, *III* potentiometer, *IV* measuring amplifier.

occurring, when the phase indicator indicates no current. Thus if the surface of the electrode should become contaminated (by the formation of a film with low conductivity), one is warned by the indication of the voltage meter that the electrode must again be treated with the sand blast before the investigation is continued.

The great sensitivity of the apparatus makes it desirable to take measures to decrease the effect of disturbances. A sharp resonance circuit is therefore introduced into the amplifier and tuned to the frequency of the supply voltage (about 380 c/s). The amplifier is therefore insensitive to the 50 period voltage of the mains or the harmonics thereof, which usually make up the interfering frequency spectrum.

directions. The pencil is held above a sheet of paper upon which the electrodes are drawn. By applying the pencil to the paper the position of the probe with respect to the electrodes can be recorded. On the carrier frame of the probe are also the measuring amplifier and the two meters for voltage and phase indication.

Fig. 5 also gives a more distinct view of these instruments, while the key *T* may also be seen, by means of which the pencil can be pressed against the paper. The most striking detail of this picture is, however, the complicated construction of the probe holder. This construction makes it possible to measure at a given point not only the potential, but also the field strength or the component of the

field in any direction. When the setting plate *Z* at the top of the probe holder is in the position shown in the photograph, the point of the probe can be moved to either side over a distance of 0.5 mm by the turning of a knob *H*. In general this will disturb the voltage equilibrium between probe and potentiometer. The whole probe holder is now turned in such a direction that the turning of the knob does not result in a disturbance of the

electrodes. After the potentiometer has been set at a certain potential, one tries by means of two turnings knobs (*K* in fig. 4) to adjust the probe so that the meters *SI* and *FI* stand at zero. The left hand knob gives a movement to the right and left, while with the right hand knob the carrier frame of the probe can be moved backward and forward. When the correct adjustment has been found the position of the probe can be marked on the paper.

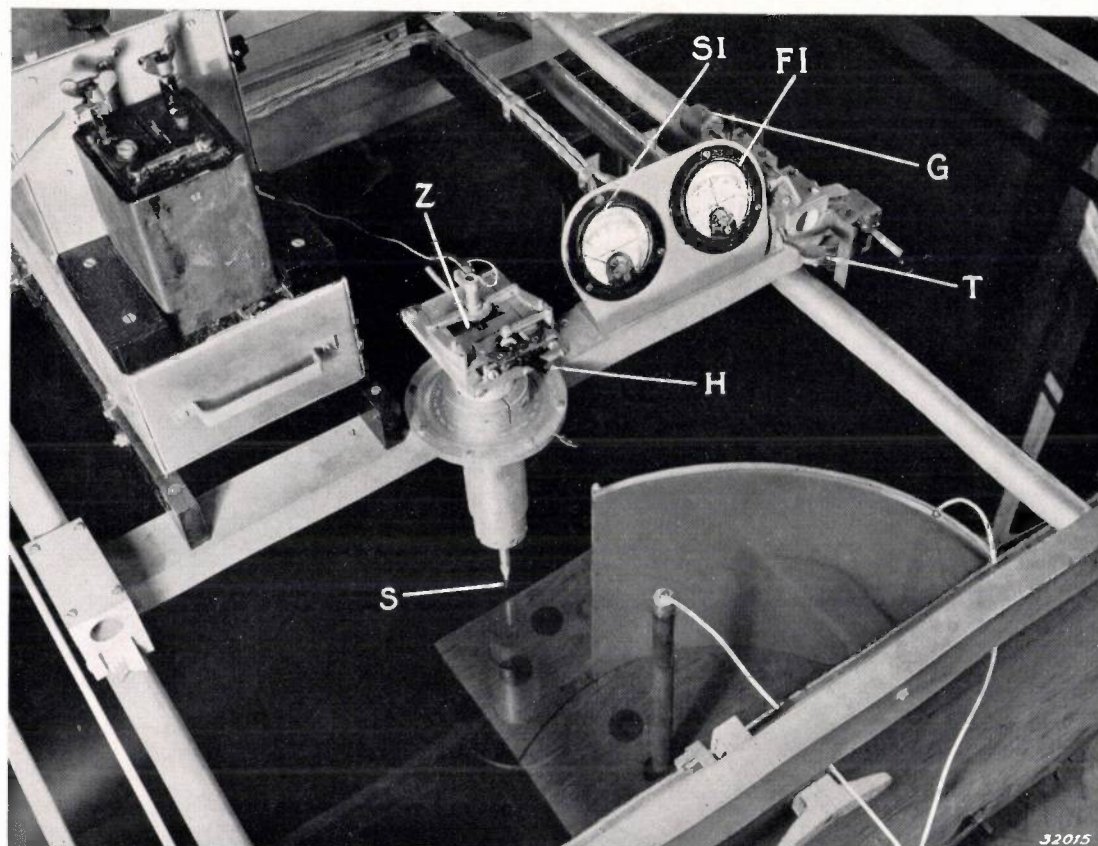

Fig. 5. Detail of the carrier frame above the electrolytic tank. The probe *S* can be moved 0.5 mm to either side by the turning of knob *H*. The direction of the motion is adjustable by turning the probe and can be read off on a scale. To the right of the probe may be seen the meters *SI* and *FI*, and next to them a key *T*, which must be pressed in order to record on a drawing a given position of the probe. If it is desired to draw continuous lines the key *T* must be held pressed, which can be accomplished by reversing a lever with a weight *G*. By moving the setting plate *Z* the amplitude of the lateral motion of the point of the probe can be increased tenfold, or the probe can be locked in its middle position.

equilibrium. The direction of motion of the point of the probe is then perpendicular to the direction of the field and can be read off from a scale, so that the field direction is also known. If the probe holder is now given a quarter turn, a maximum change in the potential is obtained upon turning the knob. From this change the field strength can be calculated.

Recording the potentiograms

Fig. 6 shows how the apparatus is operated in recording the variation of potential between the

In this way a series of points of equal potential can be determined, and these points are afterwards connected by a smooth curve. Other potentials are then chosen and the equipotential lines are constructed point by point.

In some cases the equipotential line can be drawn directly by having one knob motor driven, and turning the other one continuously by hand so that the meters remain at zero. This is of course only possible when the equipotential line has no point of inversion in the direction in which the carrier is moved by the motor. The key *T* can then remain

depressed, which is accomplished by reversing a lever with a weight (G in fig. 5).

In fig. 7 a potentiogram is given which was recorded in this semi-automatic manner. The figure relates to the focusing system of a cathode ray tube. The relative voltage increases from one line to the next by the same amount of 1 per cent, so that the density of the lines is a direct measure of the field strength at that point.

Applications of the electrolytic tank

An important sphere of application of the electrolytic tank and the potentiograms obtained by

tential lines). This line cuts circle U_2 at G . If M is the middle of FG then v_2 has the same direction as OG , while the chord $1-2$ has the same direction as OM .

The correctness of the construction can be demonstrated as follows. For an electron which obtains its velocity exclusively from the electric field, the following is valid:

$$\frac{1}{2} m v_1^2 = e U_1,$$

$$\frac{1}{2} m v_2^2 = e U_2,$$

where e is the charge and m the mass of an electron. Thus if the line OF represents the vector v_1 , then, due to the fact that

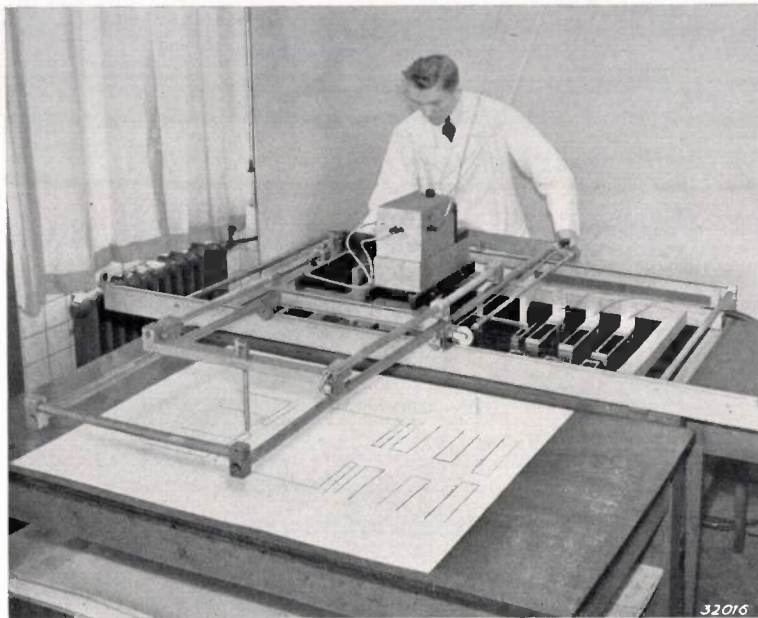

Fig. 6. The operation of the apparatus during the recording of potentiograms.

its use lies in the study of the paths of the electrons in the potential field of an electrode system.

If there are two equipotential lines (with the potentials U_1 and U_2) which lie so close together that the field between them may be considered homogeneous, and if point 1 is known at which an electron cuts the first line, and the direction of the velocity v_1 of the electron at 1 , it is possible in a simple way to find point 2 , where the electron cuts the second equipotential line and the direction of the velocity v_2 of the electron at that point.

The construction is given in fig. 8, and is carried out as follows. In an auxiliary figure two circles U_1 and U_2 are drawn from point O whose radii are equal to $\sqrt{U_1}$ and $\sqrt{U_2}$. In the first circle a radius is drawn in the direction of v_1 , and from the extremity F of this radius a line is drawn in the direction of the gradient (*i.e.* perpendicular to the equipotential lines).

$$\frac{v_2}{v_1} = \frac{\sqrt{U_2}}{\sqrt{U_1}}$$

the vector v_2 is represented by a radius of the circle u_2

Furthermore:

$$v_2 = v_1 + at,$$

where a is the mean acceleration of the electron and t the time during which the electron moves between the two equipotential lines. The vector at has the direction of the acceleration vector a and thus the direction of the gradient, and must in the figure be represented by FG , since this vector has the same starting point and direction as at , and the termination of this latter vector must also lie on u_2 .

For the path vector W the following holds:

$$W = v_1 t + \frac{1}{2} a t^2 = (v_1 + \frac{1}{2} a t) \cdot t,$$

$$(OF + \frac{1}{2} FG) t = OM \cdot t.$$

The direction of the chord $1-2$ is therefore the same as that of the vector OM .

The intersection of the path of the electron with

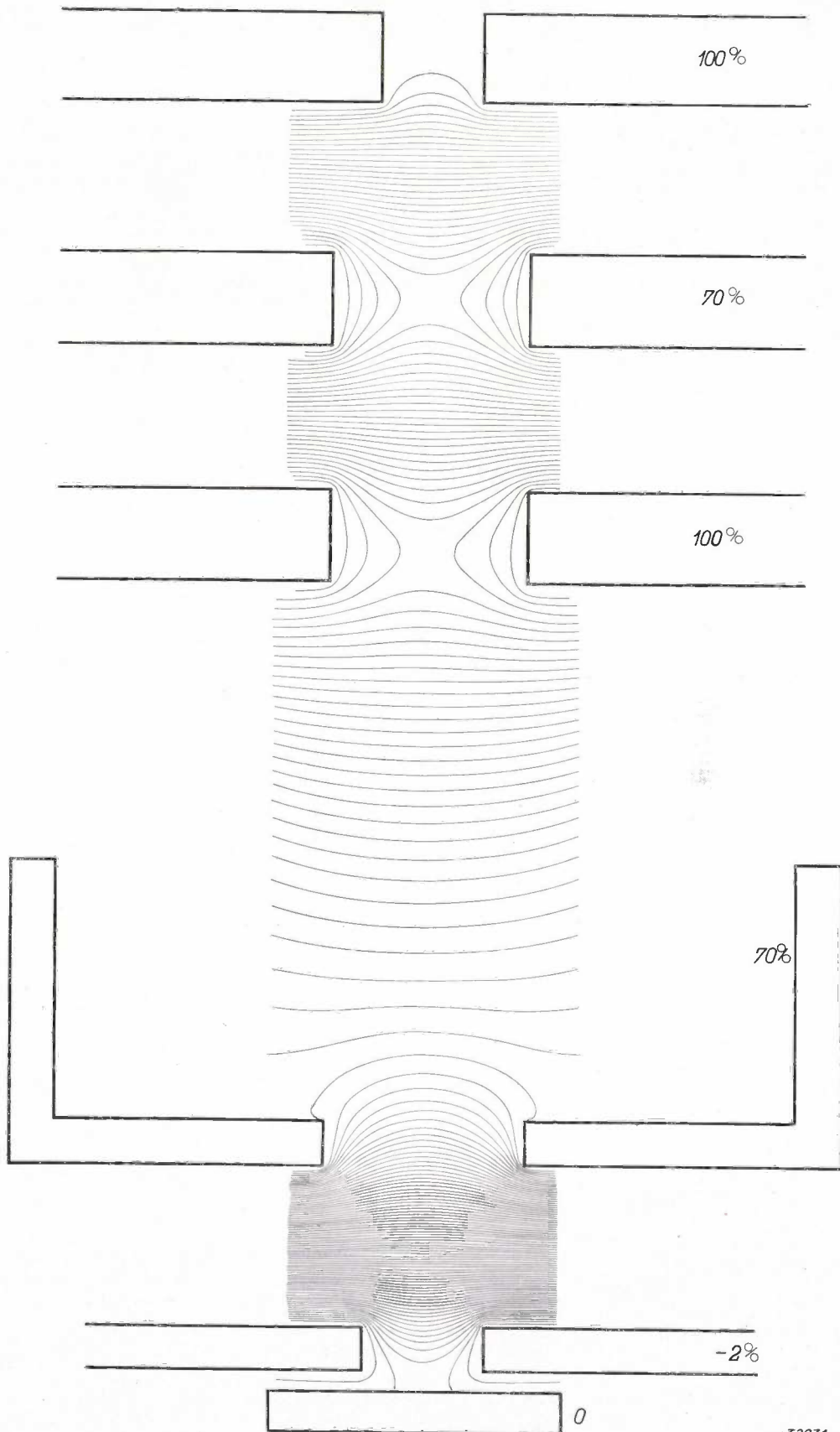

Fig. 7. Equipotential lines in the electrode system of a cathode ray tube. The voltage ratio changes 1% from one line to the next.

32074

RAPID CHEMICAL ANALYSIS WITH THE MERCURY DROPPING ELECTRODE AND AN OSCILLOGRAPH OR MEASURING BRIDGE AS INDICATOR

by J. BOEKE and H. van SUCHTELEN.

535.3 : 621.317.755

It is shown in this article how chemical analysis can be carried out considerably more rapidly with the mercury dropping electrode by the use of an cathode ray oscillograph or a measuring bridge (with the "Philoscop" for instance) as indicator than is possible with the customary recording instruments.

In recent years the electrochemistry of the dropping electrode has developed rapidly, so that at present it offers a many-sided method for the rapid chemical analysis of small quantities of material. It was first used for this purpose by Heyrovsky in the so-called Polarograph, and was later further developed by this students and others, among whom Shikata, Hohn¹⁾, Maas and Kolthoff. There already exist standardized directions for analysis by this method and precise measuring instruments which are in common use. These instruments are however expensive, and also easily damaged because of for instance the use of a galvanometer. Moreover their use involves a time-consuming recording, which, from the nature of the method, cannot be accelerated, as we shall show in this article. With a single slight change this complicated recording instrument can be replaced by a cathode ray oscillograph or a measuring bridge with a „Philoscop” as indicator. The analysis then takes place in less than a minute, while instead of the inevitably elaborate recording, indication and reading take place by means of a calibrated scale.

Electrolysis with a mercury dropping electrode

Most salts are completely dissociated in a dilute aqueous solution into their component, oppositely charged ions. If in a container with such a solution two electrodes are placed, between which an external potential difference of several volts is maintained, the cations (positively charged metal ions) move toward the (negative) cathode where they become discharged by taking up one or more electrons, so that metal atoms are liberated. The anions (negatively charged acid radicals) move toward the positive anode, where they undergo an electrochemical reaction in which they lose one or more electrons.

If such electrolysis is carried out with two mercury electrodes between which is applied an external direct voltage which is made to increase steadily from zero volts, it will be seen that in general an

appreciable electric current does not immediately begin to flow through the dilute solution of the metallic salt. This may be understood upon further consideration of the mechanism of electrolytic analysis.

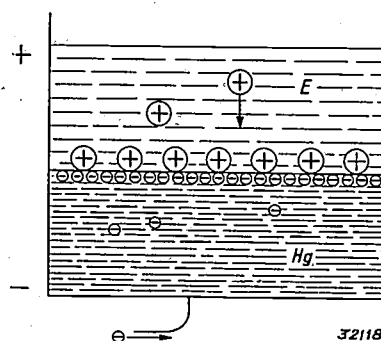

Fig. 1. Electrical double layer of electrons and positive ions at the boundary layer between mercury (Hg) and electrolyte (E).

At the boundary layer between the solution and the mercury electrode the metal ions from the solution as well as the electrons from the mercury are collected, and together form an electric double layer (fig. 1). Only at a sufficiently high voltage does an electron have an appreciable chance of penetrating from the interior of the mercury cathode through the potential barrier of the electrical surface layer and joining a metal ion to form a metal atom. The escaping electrons are then replaced from the source of voltage and in this way a current begins to flow. This current will be proportional to the number of electrons freed, and therefore to the number of available metal ions, *i.e.* to their concentration. If the electric current is plotted as a function of the voltage applied (fig. 2) it will be seen that only above a definite voltage V_k does an observable current begin to flow. In the first approximation this current increases linearly with the voltage, *i.e.* as long as the concentration of the metal ions at the cathode increases with the voltage.

If the solution is not too concentrated and if a cathode with a small surface is used, a mercury dropping electrode, for instance, upon further increase of the voltage the state is soon reached

¹⁾ For literature see: H. Hohn, *Chemische Analysen mit dem Polarographen*, Springer, Berlin 1937.

where each metal ion arriving at the cathode is immediately discharged. The electric current is then determined entirely by the speed at which the ions diffuse through the electrolyte. It might be expected

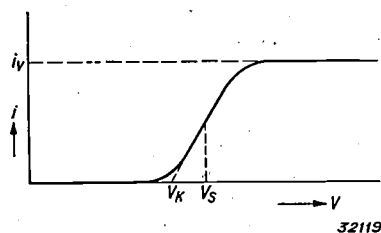

Fig. 2. Current-voltage characteristic for electrolysis with a mercury dropping electrode. V_K is the critical potential at which an appreciable current begins to flow. V_S represents the average value of the potential jump characteristic of a certain kind of ions in the solution. i_v is the saturation value of the current, which is lower, the smaller the surface of the electrode and the concentration of the ion in question.

that this velocity of diffusion would increase with the externally applied field, but this is by no means the case, because the influence of the external field is compensated in the electrolyte solution by the large excess of metal ions of a sort which can only be discharged at a higher voltage and which therefore collect around the cathode (Debye-Hückel layer) without being able to reach it. The saturation value of the current does not therefore depend at all upon the externally applied voltage, and is lower, the smaller the density of the ions in the solution and the smaller the surface of the cathode. In the electrolysis with mercury electrodes a capillary from which mercury drops fall regularly is used as cathode and a large mercury pool forms the anode. Not only is the cathode surface then small, but it is moreover formed anew after each drop, so that the boundary layer between mercury and electrolyte cannot be saturated by the metal freed.

Although analogous phenomena of the discharge of ions take place also at the anode, these phenomena do not in any way lead to saturation values of the current flowing, since the mercury pool has a much greater surface than the drop of mercury. The practical possibility of polarographic analysis therefore depends entirely on the use of the dropping electrode.

Furthermore in the case of the dropping electrode hydrogen will not so easily be dissociated from the water which is present in excess during the electrolysis. Depending on the degree of acidity of the solution the hydrogen ions of the double layer are discharged by the electrons only at about 2 volts with the formation of gaseous hydrogen. Practically all other cations, including those of the alkali and alkaline earth metals, have however

then already had the opportunity of being deposited at lower voltages.

The Polarograph of Heyrovsky

Heyrovsky and his school have already been using the current-voltage curve of the electrolysis with the dropping electrode for the chemical analysis of solutions for fifteen years. It is found that, independent of the concentration of a given ion which determines the magnitude of the increase in electric current thereby given, the average potential (V_S in fig. 2) at which this current increase occurs has an easily reproducible value which can be used as indicator for the ion in question. For the successful use of this method of analysis in practical cases extensive tables have been compiled with these average potential jumps V_A, V_B, \dots for different ions A, B, \dots

The dropping electrode consists of a narrow capillary out of which mercury drops into the solution to be analyzed with a velocity of one drop in 1 to 4 seconds; the drops have a diameter of 0.5 mm at the greatest. The solution can be very dilute, so that extremely small quantities of material can be analyzed in this way. If for example solutions approximately 10^{-5} to 10^{-3} normal are used, the saturation currents are reached already at 10^{-8} to 10^{-5} ampere, since the surface of the drop of mercury only provides a small current cross section.

In fig. 3 the arrangement of the automatic recording Polarograph of Heyrovsky is shown diagrammatically, as well as part of a polarogram obtained by means of this instrument. The voltage applied to the mercury container is tapped off from a resistance cylinder connected with a battery, which, together with the recording drum, rotates with a constant angular velocity. The voltage on the electrolyte container therefore increases pro-

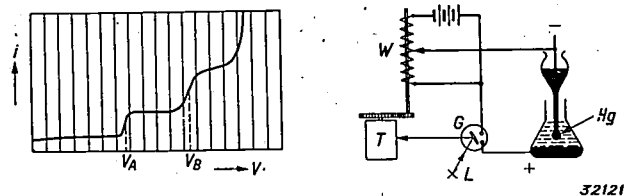

Fig. 3. Diagram showing the principle of the recording of a polarogram. The axis of the recording drum T is coupled with that of the variable resistance W in the form of a spiral which rotates at a constant angular velocity. The voltage on the electrolytic cell increases proportionally with the time, so that the angular coordinate on the recording drum is proportional to the voltage; cf. the accompanying polarogram, in which V_A and V_B represent potential jumps. The electric current flowing through the mercury electrode also passes through the galvanometer G whose mirror throws the light from lamp L on the drum.

portionally with the time and is measured by the angular coordinate on the recording drum. The current gives the galvanometer deviation which is recorded photographically on the rotating drum. In this way the composition can be determined quantitatively of solutions of a concentration at least 10^{-5} normal, and moreover (after calibration) it may be determined quantitatively from the magnitude of the current increase in question.

The photographic recording and subsequent measurement of the polarogram is perhaps no great objection in complex experiments, but for rapid analyses it is too time-consuming. One recording takes from 5 to 15 minutes, after which the polarogram must be developed, fixed and measured. Furthermore the apparatus is expensive and delicate due to the presence of a galvanometer. If an attempt is made to carry out the recording more rapidly by making the drum rotate more quickly and thus by increasing the voltage more rapidly, there is the danger of difficulties due to the intermittent interruption of the current by the falling off of the drop. This difficulty can be met by recording the polarogram with an oscillograph so rapidly that the whole process takes place in the time necessary for one drop to fall. Such a record is however quite inaccurate. Moreover the photography and measuring of the record remains a long operation, so that it is better to replace the recording of the potential jumps by a direct indication.

New methods of measurement

If one allows the direct voltage on the dropping electrode to increase uniformly during a few seconds and superposes upon it an additional small alternating voltage, the potential jumps can be observed directly, as shown in *fig. 4*. In the practically flat part of the current-voltage characteristic such a small alternating voltage does not appreciably change the conduction current, but in a rising part of the characteristic it gives a large fluctuation of the conduction current. In a flat part of the

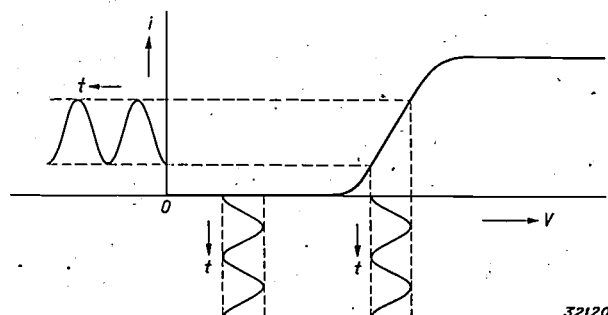

Fig. 4. A small alternating voltage added to the direct voltage has no influence on the current in a flat part of the polarogram. This is not so in a rising part of the curve.

characteristic, however, the alternating voltage gives a fluctuation in the charge on the double layer at the boundary surface, and this entails an action like that of a condenser of about $0.1 \mu\text{F}$. For this reason the alternating voltage leads in the flat parts to a capacitive current which is shifted. At a potential jump alternating voltage and alternating current differ only slightly in phase, and the resistance of the electrolyte cell undergoes a change.

The variation in phase between current and voltage and the variation in resistance and capacity in scanning the direct current characteristic of the mercury dropping electrode with a small alternating voltage may now be used for a direct indication of the potential jumps, so that rapid chemical analysis becomes possible. As indicator an oscillograph or a measuring bridge is used as we shall discuss in the following. The measurement is most easily carried out with the help of an oscillograph, but a somewhat greater accuracy can be attained with the measuring bridge.

The determination of potential jumps with a cathode ray oscillograph

For the determination of potential jumps we used a cathode ray oscillograph, type GM 3152, which was discussed in the previous number of this periodical²⁾. The circuit used is shown in *fig. 5*.

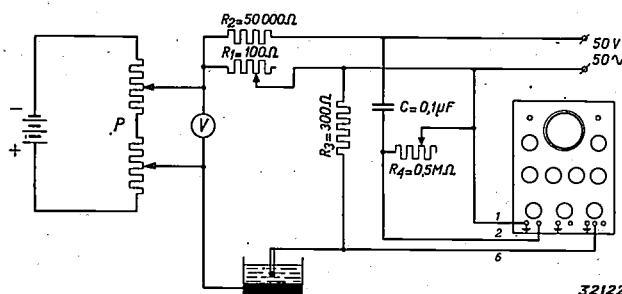

Fig. 5. Circuit for the determination of potential jumps with the cathode ray oscillograph GM 3152 as indicator. *P* is a potentiometer supplying direct voltage which can be read off on the voltmeter *V*. An alternating voltage of 50 c/s is added over the variable resistance R_1 . By means of the condenser *C* and the variable resistance R_4 the alternating voltage, with an adjustable phase shift, is applied to the plates for horizontal deflection of the oscillograph (terminals 1 and 2). The voltage given by the current through the resistance R_3 acts on the plates for vertical deflection (terminals 1 and 6).

The electrolytic cell is included in a circuit to which an accurately adjustable direct voltage is applied by the potentiometer *P*. An alternating voltage of 50 cycles, which is taken from the variable resistance R_1 , is in series with the direct voltage. When R_1 is set at its highest value of 100 ohms, the

²⁾ Philips techn. Rev. 4, 198, 1939.

alternating voltage is 0.1 volt R.M.S., which means that the voltage varies continually in the rhythm of 50 c/s over a range of $0.1 \cdot 2\sqrt{2}$ or about 0.3 volt. To the plates for horizontal deflection of the oscillograph (terminals 1 and 2 in fig. 5) the 50 period alternating voltage is applied, so that the horizontal deflection of the cathode ray is proportional to the voltage changes in the current circuit. A voltage acts on R_3 which is proportional to the current through the electrolyte cell, and after amplification it is applied to the plates for vertical deflection of the oscillograph (terminals 1 and 6 in fig. 5).

By means of the potentiometer P the direct voltage on the electrolysis vessel is slowly increased, while a small alternating voltage of 50 c/s is always superposed upon it. As long as the direct voltage has not yet reached the value of the voltage jump, and we are still on the first horizontal part of the characteristic of fig. 4, the changes in current and voltage are still symmetrical with respect to their average values, so that the oscillogram appears symmetrical with respect to its centre (fig. 6).

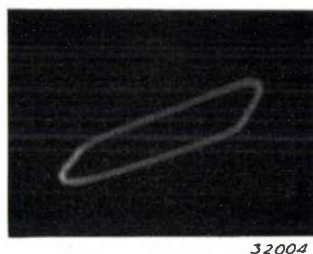

Fig. 6. Symmetrical oscillograms without an artificial phase shift being introduced between current and voltage.

If part of the region covered by the alternating voltage lies in a rising part of the curve of fig. 4, the oscillogram is no longer symmetrical (fig. 7). This serves as a warning that one is approaching a potential jump. When the direct voltage has reached the average value for the jump, then in that region the relation between current and voltage is again practically linear, so that the



Fig. 7. Unsymmetrical oscillogram such as is obtained at an arbitrary direct voltage in the neighbourhood of a potential jump.

oscillogram is again symmetrical with respect to its centre. As may be seen in fig. 6 these oscillograms are not perfect ellipses but are so deformed that their symmetry or asymmetry is difficult to discover. A linear oscillogram, such as shown in fig. 8,

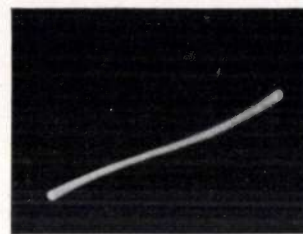

Fig. 8. Current and voltage have been brought into phase with each other so that the oscillogram is approximately a straight line.

gives a much better criterion. In order to obtain such an oscillogram the same phase shift which exists between the alternating current through the cell and the alternating voltage on the cell is caused between the voltage for horizontal deflection and the alternating voltage applied to the cell, by means of the capacity C and the variable resistance R_4 .

When a fairly symmetrical oscillogram has been obtained at a given position of the potentiometer P , the loop form is removed as well as possible by regulating R_4 . Finally the potentiometer must be very critically adjusted for the most symmetrical form of the oscillogram, as illustrated in figs. 9a and b. These figures were recorded at direct voltages which were 0.02 volt higher and lower, respec-

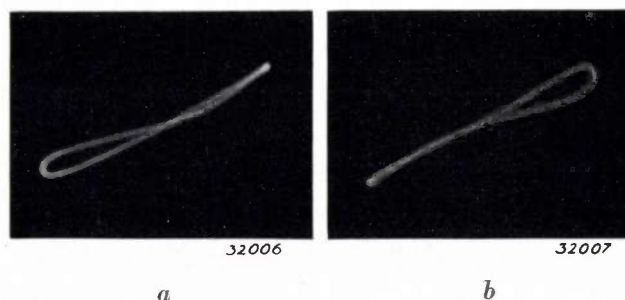

Fig. 9. Oscillograms recorded at direct voltages 0.02 volts higher (a) and lower (b) than those of fig. 8.

tively, than that of fig. 8. These values are small with respect to the intervals between two successive potential jumps for different ions, so that the ions can easily be distinguished from each other.

If the voltage of the potentiometer is adjusted correctly at the potential jump in question, but the alternating voltage used is somewhat high, an approximately symmetrical figure is indeed obtained, but it deviates very much from a straight

line, as may be seen in *fig. 10*. By improving the adjustment of R_1 and giving the oscillograph more



Fig. 10. Symmetrical oscillogram recorded with too high an alternating voltage.

carried out just before the fall of the drop. The volume of the drop increases proportionally with the time t so that its surface increases with $t^{2/3}$ and consequently changes only very slowly shortly before it falls. Since the capacity of the drop is proportional to its surface, the aspect of the oscillogram just before the drop falls is practically constant, which facilitates the observation very much and makes long practice unnecessary.

Fig. 11 is a view of the whole measuring arrangement. The large knob in the centre foreground is for the operation of the potentiometer, behind that is the electrolytic cell with the dropping electrode. On the right stands the cathode ray oscillograph

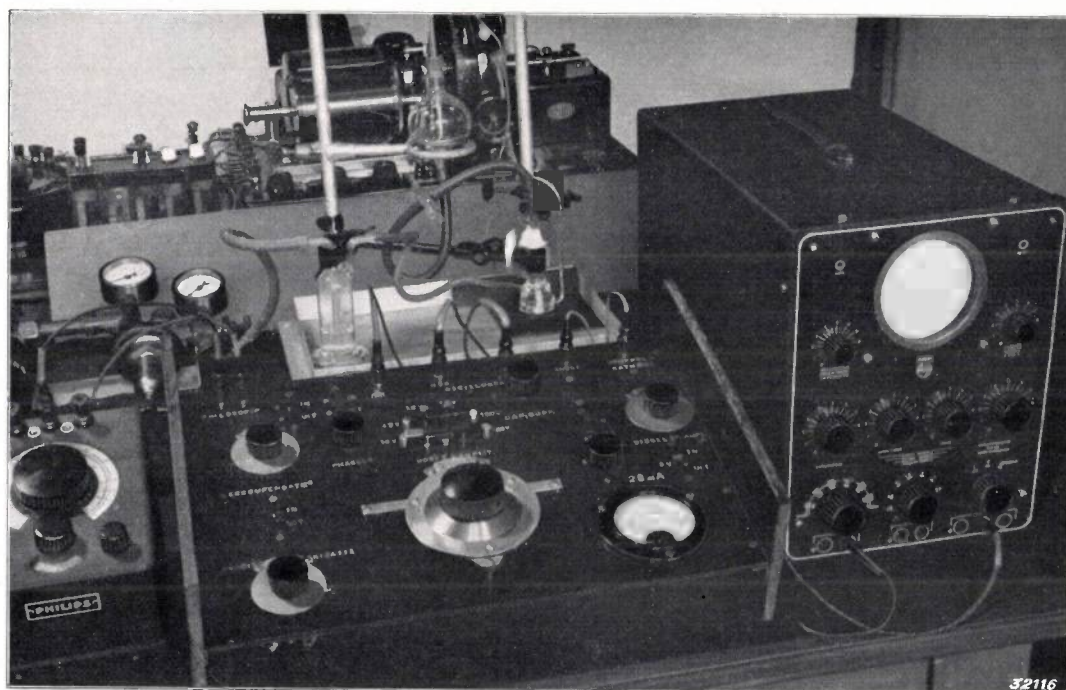

Fig. 11. View of the measuring arrangement. In the centre foreground may be seen the knob of the potentiometer for the setting of the dissociation potential. Behind that is the apparatus with the dropping electrode, while in the background Heyrovsky's Polarograph may be seen. On the right is the cathode ray oscillograph GM 3152, and on the left the "Philoscop" GM 4140, either of which may be used as indicator of the dissociation potentials.

amplification the middle portion of *fig. 10* can be recorded on a larger scale so that the oscillogram finally again takes on the form of *fig. 8*. The position of R_1 is then a measure of the concentration of the ion in question.

In carrying out the measurements account must be taken of the fact that the drop of mercury which forms one electrode grows continually and so also its capacity, so that the aspect of the oscillogram changes. The drop falls once in 1 to 4 seconds, and if the experiment is continued for some time this occurs so absolutely regularly that the observation can without difficulty be consistently

GM 3152, while on the left may be seen the "Philoscop" GM 4140, which, as we shall explain, is also a suitable instrument for indication.

The determination of the potential jumps with the aid of a measuring bridge

At average values of potential jumps the differential resistance of the electrolyte cell shows a minimum, as we mentioned in the foregoing. Since the cell acts mainly as a condenser at a frequency of 50 c/s, the direct voltage at which this minimum occurs can be determined with a bridge arrangement, two branches of which are chiefly

capacitive, while the other two branches may be pure resistances. In *fig. 12* a circuit designed for this purpose is reproduced.

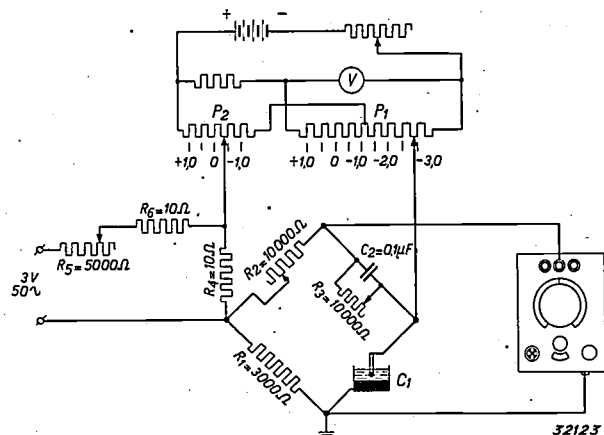

Fig. 12. Circuit for the determination of potential jumps with a measuring bridge. The direct voltage is supplied by the potentiometers P_1 and P_2 ; the added alternating voltage of 50 c/s acts over the resistance R_1 . The measuring bridge consists of an electrolyte cell with a capacity C_1 , a comparison condenser C_2 , in parallel with which is a variable resistance R_3 , a comparison resistance R_1 and a variable resistance R_2 . As zero instrument a "Philoscop" is used. On the scale of P_1 the ions corresponding to the potential jumps in question may be indicated directly; while the correction for polarization at the anode must then be introduced with P_2 .

The measuring bridge consists of the cell to be investigated C_1 , the comparison condenser C_2 and the resistance R_1 and R_2 . The direct voltage for electrolysis is taken from the potentiometer P_1 and P_2 , while the alternating voltage for the bridge is obtained as the voltage drop along R_4 . The value of this alternating voltage can be regulated with the variable resistance R_5 . Between the other two corners of the bridge an amplifier valve is connected which passes on the amplified alternating voltage to a zero indicator. For the latter an "electron ray" tuning indicator is used, such as has already been described³⁾ as a part of the "Philoscop". The higher the voltage on the control grid, the greater the surface of the luminous cross, so that the adjustment must be that at which the smallest possible luminous cross is obtained. The "Philoscop" can very well be used as indicator in this arrangement. The range selector must be set in the position \rightarrow .

For a direct voltage at which no potential jump is expected, the bridge is brought into equilibrium with a relatively small alternating voltage on R_4 . The variable resistance R_2 is thus so adjusted that the luminous cross becomes as small as possible when the drop of mercury is on the point of falling

from the capillary. The whole voltage scale may then be run through and the points at which the luminous cross reaches a maximum size noted. At these points the equilibrium of the bridge is most disturbed, and the differential resistance of the electrolytic cell therefore exhibits minima for which certain kinds of ions are responsible. If one desires in addition to have a more accurate indication of the concentration of the different kinds of ions present, the conductivity of the cell must also be determined. For this purpose a variable resistance R_3 is connected in parallel in the branch C_2 . By changing the resistance the bridge can again be brought into equilibrium, and the value of R_3 is then a measure of the conductivity of the cell at the potential jump in question, and therefore also a measure of the concentration of the ion dissociated.

In principle it is sufficient, not only for the measurement with the oscillograph, but also for that with the bridge, to supply the direct voltage with the potentiometer P indicated in *fig. 5*. In *fig. 12*, however, a somewhat more complicated potentiometer connection P_1P_2 is indicated, which can be used to advantage in both methods of measurement, since a scale can be introduced along P_1 upon which the ion in question is indicated, so that the time-consuming hunt through tables is avoided. Such a gauging is only possible after subtraction of the polarization potential at the anode. For one and the same solution this potential is practically independent of the total potential on the cell and consequently it can be compensated for each analysis by a suitable counter-potential. This is adjusted with P_2 . By means of a variable resistance care is taken previous to the experiment that a voltage of 4 volts acts over the resistance P_1 . This can be checked with the voltmeter V . The desired setting for P_2 is found by adding a known ion to the solution, and setting P_1 at the corresponding scale value; P_2 can then be set for the maximum indication.

The bridge method is somewhat more sensitive than that with the oscillograph but it is more difficult to read. It requires some practice to find the equilibrium point of the bridge at the moment just before the drop falls. The "Philoscop" is, however, a smaller and simpler instrument than the oscillograph, and can moreover well be used for various other chemical measurements such as the determination of conductivities⁴⁾.

³⁾ Philips techn. Rev. 2, 270, 1937.

⁴⁾ Philips techn. Rev. 3, 183, 1938.

COMBATING RADIO INTERFERENCES

by L. BLOK.

621.396.828

In this article it is shown how radio interferences can be suppressed in the neighbourhood of the source of interference, and how interferences can be prevented from entering the mains. The method is further discussed of combating radio interferences at the receiving set, and the article concludes with several practical examples of the removal of interferences.

Suppression of radio interferences in the neighbourhood of the source of interference

Interference which occur in radio reception due to sudden changes of currents or voltages in electrical apparatus are usually communicated by this apparatus to the radio receiver by way of the light mains. It is therefore of the greatest importance to make it impossible for the source of interference to infect the light main with an interference. How it is possible to prevent an electrical apparatus connected with the light mains from communicating disturbing interference voltage to the mains will be discussed with reference to *fig. 1*¹⁾. The inter-

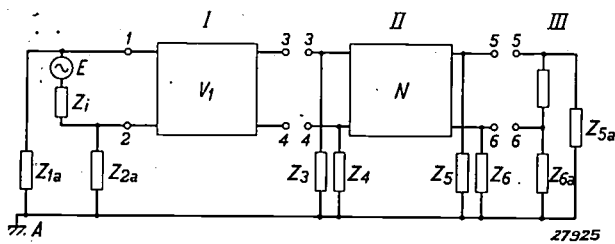

Fig. 1. Equivalent circuit of a source of interference. The source of interference voltage E with an internal impedance Z_i is situated between the terminals 1 and 2 of the quadrupole V_1 , through which it is connected with the input terminals 3 and 4 of the mains N , the output terminals of which 5 and 6 are connected with the receiving set. $Z_{1a} \dots Z_{6a}$ are earth impedances.

ference voltage which an electrical apparatus can communicate to the light mains is represented in this diagram by a randomly varying EMF E in series with an internal impedance Z_i , both of which are connected through the terminals 1 and 2 by means of a general quadrupole V_1 with the terminals 3 and 4 of the light mains N . The latter again forms a quadrupole between the terminals 3 and 4 and terminals 5 and 6 of the receiving set. Furthermore different points of this circuit are earthed over the different impedances: Z_{1a} , Z_{2a} , Z_3 , Z_4 , Z_5 , Z_6 , Z_{5a} , Z_{6a} .

In the article cited in footnote¹⁾ a discussion is also given of how the interference E can be divided into two components, namely the sym-

metrical E_s and the asymmetrical E_a . For the symmetrical component the currents flow at all times in opposite directions in the two circuits 1, 3, 5 and 2, 4, 6, and are equal in value, while it produces no flow of current through earth. For the asymmetrical component the currents always flow in the same direction at all points in the connections, while the earth here functions as return connection. Since the two mains connections usually lie close together and therefore have a large mutual capacity, the symmetrical interference voltage generally does not penetrate far into the mains, and the interferences in radio receiving sets connected with the mains are usually caused by the asymmetrical interference voltage.

A simple method of removing interference, for the case where it is possible to make the provision in front of the input terminals 1 and 2 of the quadrupole V_1 , is represented in *fig. 2a*. If the internal impedance Z_i of the interfering apparatus is not too low compared with E , a satisfactory suppression of the interference can be obtained by connecting a sufficiently large condenser C between the terminals of the source of interference. In some cases of which we shall give an example this condenser must not exceed a defined value.

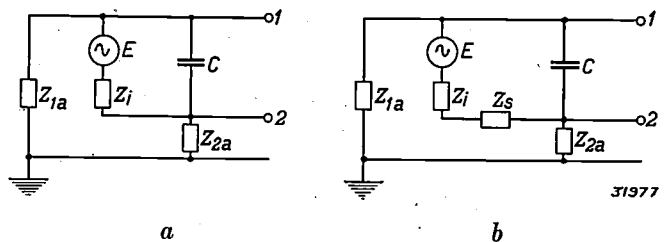

Fig. 2. Suppression of interference is obtained by introducing a capacity C between the terminals 1 and 2 in the circuit of *fig. 1*, when the internal impedance Z_i is not too low (*a*). Otherwise an impedance Z_s must be introduced in series with Z_i (*b*).

In order to attain sufficient suppression of the interference with a condenser which is not too large, the internal impedance Z_i should be artificially increased by connecting an impedance Z_s (a resistance or a high frequency choking coil, for instance) in series with it (*fig. 2b*). By choosing suitable

¹⁾ This equivalent circuit of a source of interference connected with a receiving set by means of the light mains has already been derived in Philips techn. Rev. 3, 235, 1938.

types of resistance or choke Z_s and condenser C , the interference voltage at the terminals 1 and 2 can be made much smaller than the interference voltage E produced by the electrical apparatus. With this connection therefore the whole interference is thus "nipped in the bud".

If a condenser and a choking coil must be used as above for the removal of interference, they can also be connected as indicated in *fig. 3*, and the interference is removed directly at its source. The condenser C is now connected in parallel with the interference voltage E and the internal impedance Z_i . This is only permissible when Z_i is not too small. This connection can be successfully applied when the quadrupole V_1 has an impedance between the terminals 1 and 2 which is small compared with Z_s . It is then as if a double filter were introduced, namely Z_i with C and Z_s with V_1 .

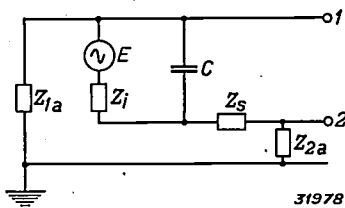

Fig. 3. Behind the interference suppressing condenser C , which together with Z_i forms a filter, another impedance Z_s has been inserted, which, together with the capacity of the quadrupole V_1 , forms a second filter between the terminals 1 and 2. The suppression of interference is thus actually achieved here by a double filter.

For the suppression of interference from alternating current sodium lamps the connection indicated in *fig. 2b* is applied, as has already been mentioned in this periodical²⁾. The element which is composed for this purpose from Z_s and C is a so-called asymmetric interference suppressing filter, since a suitable choking coil or resistance is introduced into only one of the connections, as indicated in the diagram in *fig. 2b*. For the correct functioning of such asymmetrical interference suppressing filters it is necessary that they be introduced close to the source of interference.

Some types of rectifiers can be rendered free of interference in the same way if desired. According to the diagram given in *fig. 4* a high-frequency choking coil is then introduced in each of the anode connections, while beyond the choking coil a condenser C is connected across to the cathode. Alternating and direct current mains are both rendered free of interference in this way. In the application of the scheme of *fig. 4*, however, care must be taken in choosing C , as has been remarked by the dis-

cussion of *fig. 2*. The reignition voltage V_D of a rectifier is considerably higher than its working voltage V_B , so that upon ignition a large EMF

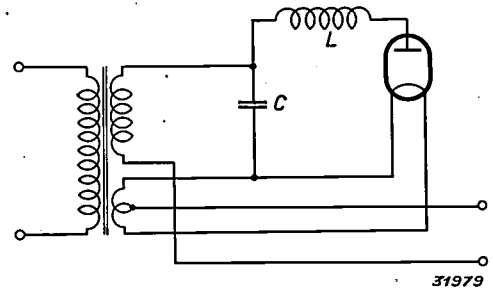

Fig. 4. Suppression of interference from a rectifier obtained by introducing a self-induction L in the anode connection and a condenser C between cathode and anode connection.

$V_D - V_B$ is suddenly released in the circuit between anode and cathode. If the condenser has been chosen too large, it causes large current surges of low frequency through the rectifier valve, which can considerably decrease its life. Especially in rectifiers which can be regulated by means of their grid voltage³⁾ $V_D - V_B$ may be very large, and it is then advisable to avoid a condenser in the connection of *fig. 4*, and to bring about the suppression of the interference in some other way, and not directly behind the rectifier.

Prevention of the penetration of interference voltage into the mains

For practical reasons it is often impossible to reach the place where the interference voltage is generated. In the connections of *fig. 1* it is then only possible to introduce the interference suppressor behind the quadrupole V_1 , for instance between the terminals 3 and 4 which form the output terminals of this quadrupole. If we introduce an

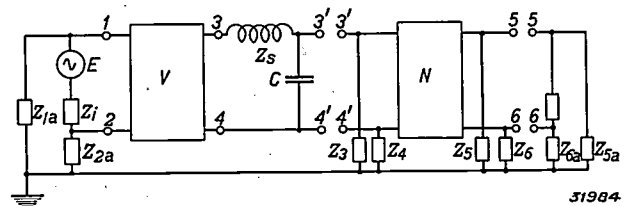

Fig. 5. Suppression of interference is obtained by introducing an element consisting of a condenser C and an impedance Z_s directly behind the quadrupole V , which connects the source of interference with the mains. This must be done when the source of interference E cannot itself be reached for the introduction of an interference suppressing element in the way indicated in *fig. 2*.

asymmetrical interference suppressing filter at that point, as indicated in *fig. 5*, the condenser C between terminals 3' and 4' forms practically a short cir-

²⁾ Philips techn. Rev. 1, 87, 1936.

³⁾ Cf.: Philips techn. Rev. 1, 161, 1936.

cuit for high-frequency voltage. Such voltage does not then occur on the input terminals 3' and 4' of the mains, but over the earth connections Z_{1a} , Z_{2a} , etc. a high-frequency interference voltage may very well reach the input terminals 5 and 6 of the receiving set with the connection 4'4 serving as return connection. In certain cases it is even possible that the interference is somewhat intensified at the receiving set by the introduction of such an asymmetrical interference suppressing filter, since the asymmetry of the mains is changed in such a way that the asymmetrical component of the interference voltage is thereby increased.

If the symmetrical component of the interference voltage plays the main part, which occurs only seldom, removal of interference can of course always be achieved with the connection according to fig. 5. If the earth impedances Z_{1a} and Z_{2a} are not large, it is advisable for the suppression of the asymmetrical component to divide the self-induction of the interference suppressing element over the two connections, as indicated in fig. 6. With such a

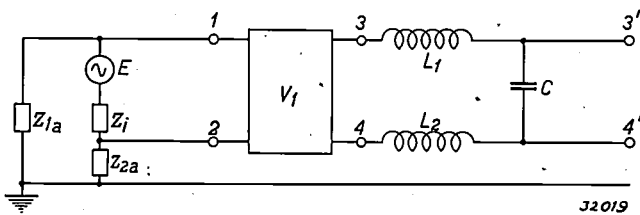

Fig. 6. The interference suppressing element introduced behind the quadrupole V_1 is made symmetrical, so that there is a self-induction (L_1 and L_2) in each of the connections. In this way the asymmetrical interference is satisfactorily suppressed.

connection the impedance of the circuit of the symmetrical interference voltage is not changed, but for the asymmetrical interference voltage, where the earth functions as return connection, the impedance is appreciably increased by the introduction of such a symmetrical interference suppressing filter since 44' now also contains an impedance. The impedances L_1 and L_2 in the two connections need not be equal to each other in this arrangement, but both of them must be sufficiently large. In order to suppress the asymmetrical interference voltage adequately, they must moreover be large with respect to the impedance of the quadrupole V .

In the case of sodium lamps fed through a leakage transformer, suppression of interference according to the scheme of fig. 6 is automatically obtained. As indicated by the broken line in fig. 7, the capacity of the supply cable then functions as condenser C in the scheme of fig. 6, while the leakage field of the leakage transformer plays the part

of the choking coils L_1 and L_2 in that scheme. Since each of the connections of the supply cable possesses in addition an appreciable capacity with respect

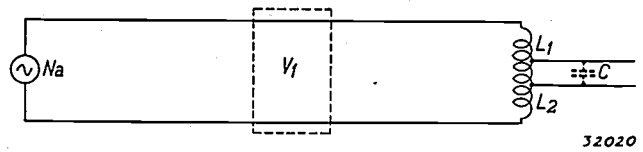

Fig. 7. Upon the use of a leakage transformer the sodium lamp Na is rendered free of interference without special precautions according to the principle of fig. 6, by the leakage reactances L_1 and L_2 and the capacity C of the mains connections.

to the earthed covering of the cable, a suppression of interference is often obtained automatically with the leakage transformer according to a still better scheme, which is given in fig. 8. In this the condenser C is divided into C_1 and C_2 which are in series, while their point of connection is connected with earth. This earth connection naturally possesses an impedance which we have indicated in the figure as Z_{Ca} . Only in the case where this earth impedance Z_{Ca} is small with respect to the impedances Z_3 and Z_4 of the earth connections of the input terminals 3' and 4' of the mains, is it effective, because it then provides that the asymmetrical circuit is connected through itself with earth, so that the high frequency current no longer penetrates into the net with disturbing intensity. The size of Z_{Ca} depends upon the length of the earth connection, which is proportional to its self-induction, and it depends also especially upon the local character of the soil by which the transition resistance is determined.

If the impedance of the quadrupole V_1 as well as Z_3 and Z_4 is not small, it is possible to omit the self-inductions L_1 and L_2 from the scheme of fig. 8, and to obtain a good suppression of interference by introducing only the condensers C_1 and C_2 with their earth connection Z_{Ca} . In such a manner a dynamo or motor with collector can be rendered free of interference, if, as is customary, each of the brushes is connected over a condenser with the earthed housing of the machine.

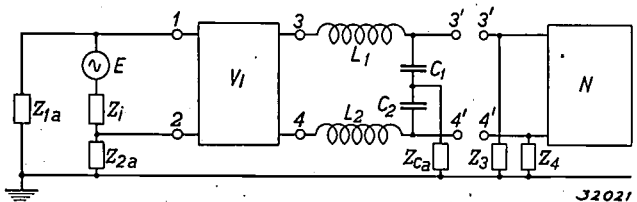

Fig. 8. The interference suppressor is made more symmetrical than in fig. 6, since the condenser is divided into C_1 and C_2 whose point of connection is connected through Z_{Ca} with earth.

In general, by introducing two condensers C_1 and C_2 with their earth connection Z_{C_a} , a satisfactory suppression of interference can be obtained. Two situations may, however, occur which make this impossible; namely when:

- 1) the earth impedance Z_{C_a} cannot be made sufficiently small, or
- 2) the earth impedances Z_3 and Z_4 of the input terminals of the mains are themselves already low and an interference nevertheless occurs.

In the first case one may with much difficulty succeed in diminishing the earth resistance by a factor 2 or 3, for instance, but this is usually insufficient for a satisfactory suppression of interference.

In order to understand the situation in the second case it is necessary to find out how the earth impedances Z_3 and Z_4 are constituted. Although they are given schematically as impedances concentrated in one point of the circuit, they are actually for the most part continuously distributed stray capacities which depend upon the length of the cables which are included in the quadrupole N . The farther the radio receiver is from the source of interference the greater will be the effective stray capacity between the two, so that the earth impedances Z_3 and Z_4 become smaller. This will in general result in the fact that receivers will suffer less from interference the farther they are from the source of interference. The second case can therefore only occur when a very strong source of interference is still found to have a disturbing influence on a far distant receiver. The asymmetrical interference current should then already have sufficient opportunity to flow off to earth over the small earth impedances Z_3 and Z_4 without condensers C_1 and C_2 with their earth connection Z_{C_a} being specially introduced for that purpose, and should therefore no longer be able to penetrate in disturbing intensity into the mains. For this, however, the inter-

ference voltage on the terminals 3 and 4 is found to be too high, nor is the scheme of fig. 8 capable of improving the situation appreciably.

In the two cases here described a connection according to fig. 9 may give the desired result. In this arrangement the condensers C_1 and C_2 form a short circuit for high frequencies between the two mains connections and earth, preceding the self-inductions L_1 and L_2 which serve to prevent the interference current from penetrating into the mains. We now have as it were the symmetrical interference suppressing filter of fig. 8 connected in the opposite way, and this suppression of interference is particularly effective when the internal impedance of the quadrupole V_1 is not too small. In that case one is actually concerned with a double filter: V_1 forms the first filter together with C_1 and C_2 , and L_1 and L_2 together with Z_3 and Z_4 , form the second filter.

Combating radio interferences at the receiving set

In the foregoing we have discussed how precautions can be taken in the more or less immediate neighbourhood of the electrical apparatus in order to prevent its giving rise to interferences in radio reception. We shall now deal with the measures which may be taken in the neighbourhood of the receiving set against radio interferences.

In fig. 10 a diagram is given of the input of a radio receiving set, accompanied by an equivalent circuit⁴⁾. Those interferences which are capable of causing the occurrence of an appreciable interference between the cathode and the grid of the receiving valve, *i.e.* over Z_1 , in the equivalent circuit, will be disturbing for radio reception. We must keep in mind here that in the practical case of a good receiver care is taken that the capacitive coupling C_t between the primary and the secondary winding of the supply transformer is made sufficiently small, so that one need not in general fear that disturbing interference voltages will act across Z_1 by way of the circuit V_a , C_t , Z_1 , C_a , A_2 , A_0 . If this should be the case the impedance of this circuit can be increased by introducing a high-frequency choking coil in series with C_t , *i.e.* in the primary connection of the supply transformer which coil has an impedance which is large with respect to that of C_t and also with respect to the earth impedance Z_{0a} , so that the interference current still flowing through C_t can easily flow off to earth (A_1) and only an extremely small fraction passes through Z_1 and C_a to A_2 .

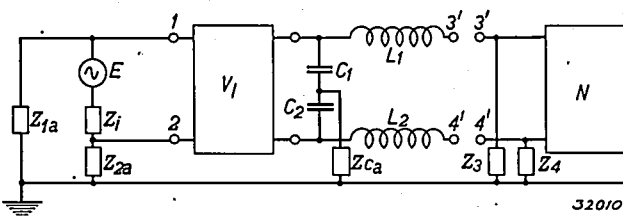

Fig. 9. The interference suppressor of fig. 8 is connected in the opposite way, since the self-inductions L_1 and L_2 are introduced behind the condensers C_1 and C_2 in the mains connections. In this way we have actually again obtained a double filter as in fig. 3. The output impedance of the quadrupole V_1 together with C_1 and C_2 forms the first filter, while the self-inductions L_1 and L_2 , together with the capacity between the input terminals 3' and 4' of the mains, form the second filter.

⁴⁾ This circuit has already been given in Philips techn. Rev. 3, 240, 1938.

For the communication of interference voltages from the mains to the grid of the receiving valve the capacitive coupling C_k between the supply mains and the leadwire of the aerial A usually, however, plays the most important part. The interference voltage in this case acts on Z_1 by way of the circuit $V_a, C_k, Z_1, Z_{0a}, A_1, A_0$. By the use of special aerials, the interference current through this circuit may be kept low, but we shall not go into this point in this article. We shall here only discuss what can be achieved by shielding the lead of the aerial along a good part of its length.

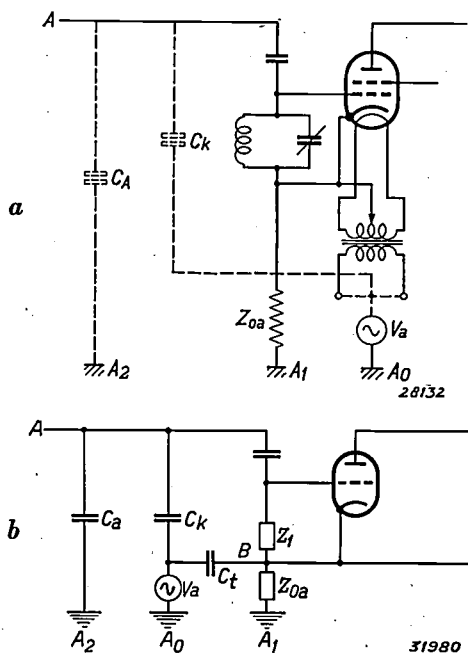

Fig. 10. Circuit of the input of a radio receiving set (a) with the corresponding equivalent circuit (b). The aerial A is loosely coupled with the tuned circuit represented by Z_1 . The aerial lead wire possesses stray capacities C_A toward earth (A_2) and C_k toward the source of interference V_a . The earth point B of the receiving set is connected with earth A_1 over the earth impedance Z_{0a} . The capacitive coupling of the source of interference V_a with the supply side of the receiving set over the supply transformer is represented by C_t .

This shielding is obtained by the use of shielded cable, whose core, which serves as aerial lead, has only a low capacity with respect to the earthed metal covering. The capacity C_0 in fig. 11 is therefore small, so that the intensity of reception is not thereby decreased disturbingly. The earthing of the metal casing is done by connecting it with the earth point B of the receiver, as indicated in fig. 11. As a result the interference voltage V_a can no longer cause an interference current to penetrate into the receiving set over the aerial input by means of a capacitive coupling (C_k in fig. 10) between supply mains and aerial input lead, because the coupling capacity C_k' in fig. 11 means only an in-

crease of the capacity C_t of the transformer windings.

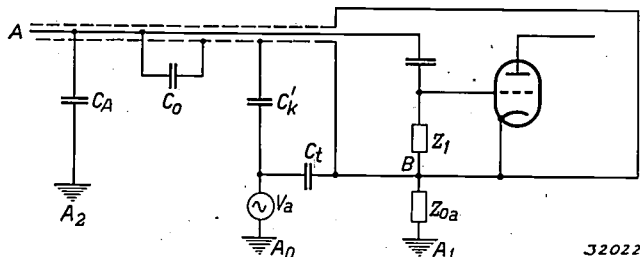

Fig. 11. Interference suppression in the radio set of fig. 10 by means of shielding the aerial (dotted line). This shielding is connected with the earth point B of the receiver which is connected with earth (A_1) via Z_{0a} . The shielding has a capacitive coupling C_0 with the aerial connecting wire and C_k' with the source of interference V_a . The latter can no longer, as in fig. 10, cause an interference to penetrate into the receiving set by way of the aerial connection.

The only circuit over which an interference current can now pass through Z_1 is: $V_a, C_t + C_k', Z_1, C_A, A_2, A_0$. Just as was noted in the discussion of the circuit over C_t and Z_1 in fig. 10, here also no disturbing interference circuits will flow in the circuit of $C_t + C_k'$ and Z_1 in fig. 11, if only the earth impedance Z_{0a} can be made small enough with respect to the impedance of the capacity $C_t + C_k'$. Practically the interference current is then immediately conducted to earth (A_1) through Z_{0a} . The suppression of interference which can be obtained with shielding is better, the smaller the earth impedance Z_{0a} compared with the impedance over the connection Z_1, C_A, A_2 .

Several practical examples of the suppression of interference

We shall in conclusion deal with several examples of the way in which suppression of interference can be obtained in practical cases. If the radio interferences are for example due to a three-phase rectifier, whose anodes can easily be reached and do not carry too heavy currents, so that a self-induction can be included in the anode supply line close to each anode, the suppression of interference can be achieved on the principle indicated in figs. 2b and 4 in the direct neighbourhood of the source of interference. In the case of the circuit given in fig. 12 the anode supply lines are connected with the zero point of the cathode through the condensers C_1, C_2, C_3 , directly outside of the self-inductions L_1, L_2, L_3 , so that the interference is then indeed "nipped in the bud" and has no chance of penetrating the mains. The condensers in this case are expressly connected with the cathode and not with earth, because in this way the interference current has not the slightest chance of penetrating

into the direct current mains. If C_1, C_2, C_3 were earthed, the interference current circuit would have to be completed over the divided capacity between the + and - connections. If it is desired to earth C_1, C_2, C_3 , then the + and - connections must be short circuited for high frequency with a condenser close to the rectifier.

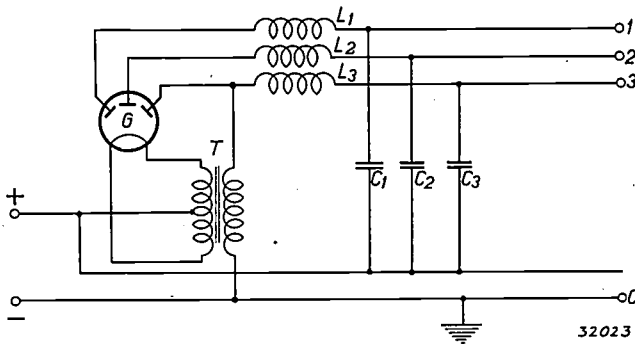

Fig. 12. Suppression of interference from a three-phase rectifier G connected directly with the mains (1, 2, 3) by the self-inductions L_1, L_2, L_3 and the condensers C_1, C_2, C_3 according to the principle indicated in fig. 2b and 4.

If one is concerned with a three-phase rectifier for high power, whose anodes are in general not connected directly with the mains, but are fed via a transformer, the anode currents are too large, and the anodes are generally too difficult to reach to make it possible to introduce self-inductions in the supply lines close to the anodes. Such a case may for instance occur in the neighbourhood of a cinema theatre in which a rectifier fed by the three-phase mains serves as source of energy for the carbon arc in the projector. In one such case where by means of measurements with a portable receiver it could be ascertained that in the neighbourhood of the cinema the light mains were infected with a disturbing radio interference, we were able to bring about an effective suppression of the interference by introducing self-inductions L_1, L_2, L_3 in the supply of the transformer and connecting these lines immediately outside of the self-inductions with earth over condensers C_1, C_2, C_3 as indicated in fig. 13. Since in this case the interference was propagated by means of the mains,

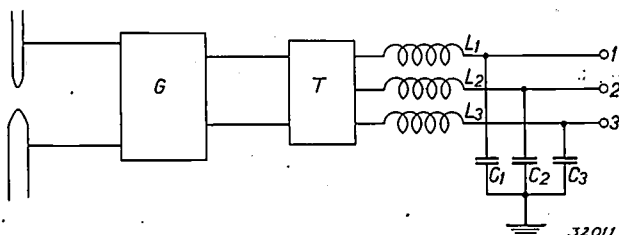

Fig. 13. Suppression of the interference from a rectifier installation G with a transformer T according to the arrangement given in fig. 8.

at some distance the asymmetrical interference voltage was the only disturbing factor, and the circuit of the asymmetrical interference voltage is closed by this arrangement directly behind the transformer, as has already been explained with reference to fig. 8.

In the case under consideration self-inductions of 0.2 mH were used which were wound as solenoids of one layer in thickness around a hollow core in order to prevent the windings from possessing too high a capacity with respect to each other. If the capacity of the coil itself is too great it would be possible that the self-induction of the coil would be short circuited for the high frequencies of the range which one wishes to render free of interference. The resonance frequency of the coil should be higher than the frequencies to be freed of interference. If we may neglect further impedances, the series impedance in the supply line, for interference waves of 300 m, i.e. 1 Mc/s is $\omega L = 2 \pi \cdot 10^6 \cdot 2 \cdot 10^{-4} = 1256 \Omega$. Since condensers of 0.1 μF were used, the impedance of the shunt on the supply line amounts to:

$$\frac{1}{\omega C} = \frac{10^{-6}}{2 \pi} 10^7 = \frac{1}{0.628} \Omega$$

The division of voltage obtained by this arrangement reduces the interference voltage which penetrates into the mains, therefore, by a factor equal to $0.628 \cdot 1256 \approx 800$, which constitutes a satisfactory suppression of the interference. As a result of the unavoidable earth impedance, in practical cases the suppression factor will be smaller.

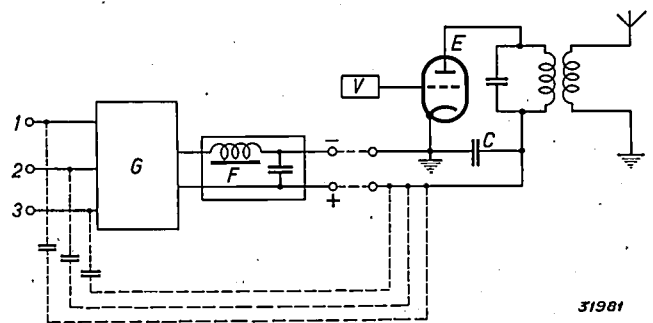

Fig. 14. Interference suppression in a radio transmitter. The six-phase rectifier G connected with the mains (1, 2, 3) supplies by means of the smoothing filter F the anode voltage for the final stage of the transmitter. The pre-stage V supplies the grid voltage for the end valve E . The connections of the supply mains are capacitatively coupled with the feed lines for the final stage, and along this connection intermediate and high-frequency interferences from the rectifier could enter the final stage. This is prevented by short circuiting the feed line for high frequency close to the final stage with a condenser C .

An unusual case of radio interference was encountered in the case of a broadcasting transmitter (fig. 14). The final stage was fed with a sixphase rectifier G for a voltage of 20 kV and a power of

60 kW, which was provided with six gas-filled rectifier valves. The supply is from the three-phase mains of 380 volts and 50 cycles. Per second therefore each valve carries 50 current impulses, so that the total number of current impulses is 300 per sec. The interference spectrum given by the rectifier has a fundamental frequency of 50 c/s, since the six rectifier valves are not exactly alike and it continues up to several hundred thousand c/s. By the smoothing filter *F* the low-frequency part of the interference spectrum is indeed cut off, but the intermediate and high-frequency part penetrates through the transformer of the rectifier installation into the supply main. The mains cables are capacitatively coupled (shown by dotted line in fig. 14) with the supply lines of the final stage, and therefore generate interference voltage between cathode and anode of the final valve *E*. In this way the part of the interference spectrum which is not of low frequency enters the final stage where it is modulated on the carrier wave and thus it is transmitted by the aerial.

If we now assume that the interference spectrum extends over a frequency range from 50 to 500 kc/s (fig. 15), after modulation on a carrier wave of 1000 kc/s (wave length 300 m) two side bands occur: 500-950 kc/s (600-316 m) and 1050-1500 kc/s (286-200 m). Since the interference voltages are low, the voltage generated in the aerial by the normal side bands will be much greater than the voltage in the side bands generated by the inter-

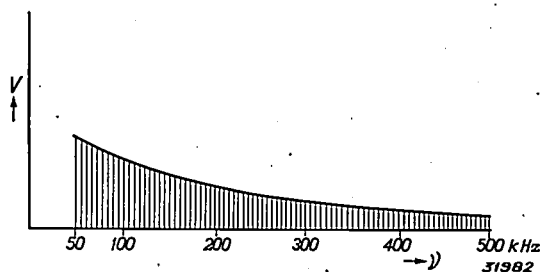

Fig. 15. Interference spectrum of the rectifier of fig. 14. *V* interference voltage, ν frequency.

ference, as is indicated in fig. 16. At a great distance from the transmitter, therefore, this interference is not observable. If one listens to the trans-

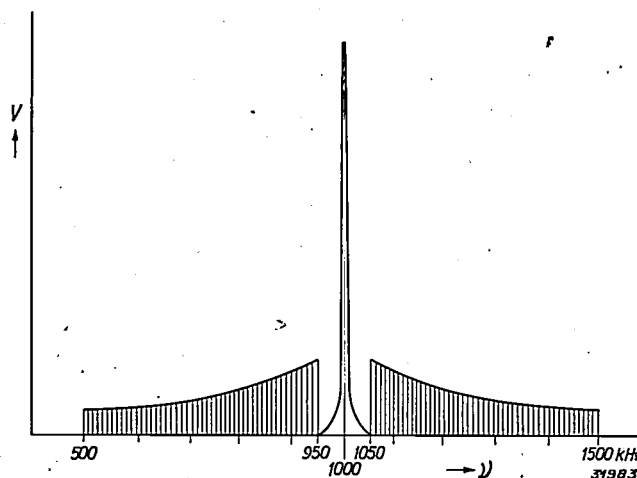

Fig. 16. The voltage *V* in the aerial as a function of the frequency ν . The carrier wave is at 1000 kc/s; the audible side bands occupy the range 1000 ± 4.5 kc/s, so that the side bands generated by the interference voltages (500-950 and 1050-1500 kc/s) fall outside of this range.

mitter in its immediate neighbourhood, one will again fail to notice the interference, because the normal band width to which a receiver is tuned is about 9 kc/s and practically no interference occurs in the frequency range of 1000 ± 4.5 kc/s. If, however, the receiver is tuned to the frequency ranges 500-950 kc/s or 1050-1500 kc/s, the modulated interference band is then received. Since it contains 6×50 wave trains per sec, this modulation will be heard in the loud speaker as a rattle. The radio reception of stations with carrier waves in the above-mentioned frequency ranges will then be seriously affected.

In this case a satisfactory suppression of interference is achieved by short circuiting the supply lines of the final stage for high frequency close to the transmitting valve by means of a condenser *C* as indicated in fig. 14.

ABSTRACTS OF RECENT SCIENTIFIC PUBLICATIONS OF THE N.V. PHILIPS GLOEILAMPENFABRIEKEN

1391: J. H. Gisolf: The absorption spectrum of luminescent zinc sulphide and zinc-cadmium sulphide in connection with some optical, electrical and chemical properties. (*Physica* 6, 84-96, Jan. 1939).

The absorption spectra of zinc sulphide and zinc-cadmium sulphide, which are activated with copper, silver and manganese, are very similar; the absorption increases at shorter wave lengths, and at a certain wave length suddenly takes on a very large value. This wave length in the case of zinc sulphide does not depend upon the crystal structure, nor to any large degree on the content of copper and silver. It is the absorption edge of the main component. The sudden great increase in the case of zinc sulphide lies at 3350 Å. With zinc-cadmium sulphide the limit is shifted approximately proportional to the content of cadmium toward longer wave lengths. With zinc-manganese sulphides no simple type of behaviour could be determined. It may be observed with zinc sulphide that the fundamental absorption causes a luminescence characteristic of the activator. The limit of absorption is found to indicate a sharp boundary between a region with luminescence times much shorter than 1 sec and that with times of seconds or even minutes. This is easily explained if the process of phosphorescence may be conceived as due to a bimolecular reaction. Due to the great absorption a high density of free electrons occurs, and the intensity therefore decreases rapidly. The limit of photoelectrical conductivity at the short wave end corresponds exactly to the limit of crystal absorption at the long wave end. This latter is also the long wave limit of the photochemical blackening of mixed crystals of zinc sulphide and zinc-cadmium sulphide when irradiated in the presence of water vapour. In conclusion an explanation of crystal absorption is also given.

1392: J. van Slooten: The stability of a triode oscillator with grid-condenser and leak (*Wirel. Eng.* 16, 16-19, Jan. 1939).

Especially at short waves and with strong back-coupling, triode oscillators with grid-condenser and leak may exhibit a relaxation phenomenon in which the oscillation is interrupted periodically. The phenomenon must be regarded as a lack of stability of the normal oscillation state. The stability is investigated by means of the method of

small oscillations, namely by examining the behaviour of slight fluctuations of the amplitude about its stationary value. A condition for stability is found in this way.

1393: J. van Niekerk and Maria S. C. Bliëk: On the vitamine-D content of cow's colostrum (*Act. brevia Neerl.* 9, 25-26, Jan. 1939).

English investigators have found the vitamine-D content of the milk of a cow the first day after calving (colostrum) to be about three times the value of that of ordinary milk. During the following days the vitamine-D content decreases, and after five days it is equal to that of ordinary milk. The authors have determined with the help of young rachitic rats, that the antirachitic action of the milk of three Friesian cows the first day after calving is six to ten times as great, expressed in international units, as that of ordinary milk.

1394: N. F. Moerman† und H. H. Kraak†: Das Fluoreszenschema der Uranylsalze (*Rec. trav. chim. P. B.* 58, 34-38, Jan. 1939).

The absorption spectrum of uranyl compounds at -180°C has one band in common with the emission spectrum. At room temperature, however, a band is found to be added to the absorption spectrum at the red end, which band corresponds in wave length to the most important of the emission spectrum, while at the violet end of the emission spectrum a band is also added which has the same wave length as the most important absorption band. By means of the potential curve for the uranyl ion as a function of the distance between the uranium and oxygen atoms this behaviour may be explained. At -180°C absorption takes place only from the ground state, while at higher temperatures higher states also begin to play a part. Temperature equilibrium is reached within 10^{-6} sec.

1395: W. J. Oosterkamp: Problems in the construction of technical X-ray tubes (*Dissertation, Delft* 1939).

In this dissertation the requirements are examined which must be satisfied by X-ray tubes if they are to be suitable for: medical photography, medical fluorescence, medical therapy, macroscopic examination of materials, or the investigation of crystal structures. Furthermore the permissible thermal loading is investigated for short or continuous loading, and finally several problems are dealt with which occur in working with high tension.

Philips Technical Review

DEALING WITH TECHNICAL PROBLEMS

RELATING TO THE PRODUCTS, PROCESSES AND INVESTIGATIONS OF

N.V. PHILIPS' GLOEILAMPENFABRIEKEN

EDITED BY THE RESEARCH LABORATORY OF N.V. PHILIPS' GLOEILAMPENFABRIEKEN, EINDHOVEN, HOLLAND

THE PROPAGATION OF WIRELESS WAVES ROUND THE EARTH

By BALTH. van der POL and H. BREMMER.

621.396.11

This article discusses the results of calculations made to investigate the effect of the curvature of the earth on the propagation of radio waves, with special reference to the effect of the height of the transmitter and the receiver above ground level, the wave length, the electrical constants of the soil, and the distance traversed. The atmosphere is regarded as a homogeneous dielectric, thus neglecting reflexion at the ionosphere and refraction in the troposphere. It is found that the diffraction of wireless waves is so pronounced that it is almost immaterial whether the receiver is a short distance in front of or somewhat behind the optical horizon. Only for waves below 1 cm are there definite indications of a sharp cut-off limit in the distribution of field strength.

Introduction

When, in 1901, Marconi after several fruitless attempts succeeded in picking up on the Coast of Newfoundland wireless signals which had been sent out from Ireland, a distance of 2100 miles away, the question naturally arose as to the means by which electromagnetic waves were able to traverse such a long distance, since the curvature of the earth prevented a straight path being followed between the transmitting and receiving stations (see *fig. 1*).

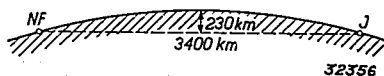

Fig. 1. The elevation of the earth between Ireland and Newfoundland appears to be equivalent to a mountain 144 miles high.

The problem soon attracted the attention of several leading mathematicians and physicists, including Poincaré, Macdonald, Nicholson Love and Sommerfeld, for the ease with which the waves were able to overcome the curvature of the earth appeared inexplicable, since in optical terms the receiving station was located well within the "shadow region". Heaviside and Kennelly had readily suggested that at a high level the atmosphere contained a conducting layer which assisted the waves to overcome the curvature of the earth. We now know that this explanation was right, but at the time it was advanced it was re-

garded with very grave doubt by many authorities. The easiest way of deciding the question was to compare the actual field strength of the waves at a considerable distance from the transmitter with the field strength obtained theoretically on the assumption of pure diffraction of the waves round the surface of the earth, *i.e.* without assuming a reflecting layer as proposed by Kennelly and Heaviside. For years, the investigators mentioned above devoted the closest study to this theoretical problem, which may be formulated as follows: Given a radio transmitter with a known output, to determine the field strength at any arbitrary point beyond the station on or above the earth's surface, assuming the atmosphere to be perfectly homogeneous and non-conducting, *i.e.* in the absence of the layer which is now distinguished as the ionosphere. Years of research were needed before this field strength could be calculated, because the solution of the problem obtained by classical analysis, assumed a form unsuited to numerical computation.

The general solution, in which the conductivity of the earth may have an arbitrary value, can be expressed by an infinite series of spherical harmonics, in which each term has an expression containing 12 Bessel functions as coefficient. Moreover, the nature of this series is such that each term roughly cancels out the one preceding it by reversal of the algebraical sign, so that the sum of the

small differential remainders actually determines the final value sought. It is also found that the final value is not determined in the main by the initial terms of the series, but by those terms whose order in the series lies in the region of the ratio of the earth's circumference to the wave length used, *i.e.* in the region of the 100 000th or millionth term.

Although from the very outset there was general agreement as to the composition of this extremely complex series, opinions as to its numerical interpretation were so divergent that two distinct schools of thought developed. According to one school, diffraction of the waves round the earth accounts for the experimental results obtained, while the other school considered diffraction as inadequate alone and believed that the assumption of a conducting ionosphere was essential. The views of mathematicians on this problem differed so widely that in 1910 Nicholson stated that in the whole field of mathematical analysis there was no other problem, upon the solution of which such divergent opinions had been advanced.

One of the fundamental difficulties of the problem was that of finding satisfactory approximations for the Bessel functions occurring in the coefficients of the terms of the series; in 1918, Watson applying a new method succeeded in integrating the series, which brought the problem considerably nearer to a numerical solution. A critical investigation made by one of the present authors in 1919, in the course of which the whole of the available experimental and theoretical evidence was carefully sifted and compared, led to the definite conclusion that in radio-transmission experiments over long distances the presence of a conducting ionosphere was imperative and had a very helpful effect. This did not signify that all interest in the theoretical problem of pure diffraction of the waves about the surface of a sphere was vitiated, for it soon appeared that the action of the ionosphere was mainly operative during the night, and that during the day waves from 200 to 2 000 m were largely absorbed by the ionosphere and not reflected back to the earth's surface; a behaviour due to the change in the distribution of ionisation under the action of solar rays. Thus for the waves in question conditions during hours of daylight are roughly those obtaining in the absence of the ionosphere. Calculation of the field strength during the day at long distances and for the wave band in question is in fact still carried out by methods which neglect the presence, and hence the action, of the ionosphere.

Subsequently, the suitability of still shorter

waves for radio communication was discovered, *viz.*, those with wave lengths between 10 and 100 m, and it appeared that their propagation was promoted, during the day also, by still higher ionised layers, which were actually found by Appleton. On passing over to ultra-short waves with wave lengths below 10 m, as used nowadays for television, a range is reached in which the ionosphere exercises no influence either during the day or the night, so that the problem was again reduced to pure diffraction phenomena, which form the subject of the present article. The technical application of waves below 10 m, which will apparently be employed on an increasing scale in the future, led us to take up this problem again, in order to make a computation of the propagation of these short waves round a television transmitter to distances up to the visible horizon and beyond.

The purpose of the present article is to give an abstract and a review of the numerical results of our calculations which have been published elsewhere¹⁾. In these calculations, the earth has been regarded as perfectly spherical, all topographical inequalities thus being neglected. It was also assumed that the earth is electrically homogeneous, *i.e.* composed of the same soil or covered with water over its whole surface.

The third simplification made in the simple analysis to which principal attention will be directed here, is that the atmosphere, too, is homogeneous. Two phenomena have, therefore, been neglected; *viz.*, the effect of the ionosphere and the diffraction occurring in the lower layers of the atmosphere, where diffraction is produced, as in optics, as a result of variations in density and temperature, and hence in electrical characteristics, with increasing height in this lower atmosphere or troposphere. Owing to this phenomenon, short waves in particular have a greater range than in a homogeneous atmosphere. This assumption of a homogeneous atmosphere imposes a very far-reaching restriction which, however, as already pointed out, is tolerable in many cases. In radio practice, the presence or absence of atmospheric action becomes mainly apparent by the occurrence or absence of fading phenomena.

The significance of the simplifications made here to the mathematical treatment of the problem is that the earth is replaced by a sphere whose electromagnetic behaviour can be represented by two constants, which have the same value at all points

¹⁾ Balth. van der Pol and H. Bremmer *Phil. Mag.* 24, 141 and 825, 1937; 25, 817, 1938; 27, 261, 1939. Cf. also bibliography at the end of this paper.

over its surface; these constants are the electrical conductivity σ and the dielectric constant ϵ . In other words, the earth is regarded as a medium which can act simultaneously as a conductor and as a dielectric, exactly as, for instance, in a cable with surface leakage currents in the transverse direction the medium between the sheath and the conducting core behaves as a dielectric and as a conductor at one and the same time.

The small conductivity of the troposphere, has practically no influence on wave propagation, whilst the dielectric constant differs only little from unity. Thus if the action of the ionosphere may be neglected we can substitute the ether for the troposphere and take $\epsilon = 1$ and $\sigma = 0$.

Analogy to Similar Problems

With the assumptions made above, the problem of wave propagation may be formulated as follows: Given a source of electromagnetic waves (a transmitter) situated outside a sphere, to determine the intensity of the electromagnetic field on the sphere or at a point a short distance above it (*i.e.* at the point of reception). Various phenomena are known which may be regarded as mathematically analogous to this problem, *viz.*, all such phenomena in which the path of wave propagation suffers interference at a spherical obstruction; examples of these phenomena are the scattering of light by small spherical particles as in a colloidal solution, the dispersion of sunlight by spherical raindrops, as in the formation of rainbows, and the dispersion of acoustic waves by a spherical obstruction, *e.g.* a microphone. While the strict mathematical solutions of these problems are more or less similar, differences appear in the numerical results mainly because two classes of magnitudes differ in each problem; firstly, a geometrical magnitude, *viz.*, the ratio of the circumference of the spherical obstruction to the wave length, and, secondly, two physical magnitudes: the manner in which the waves are reflected at the surface as well as the way in which the waves penetrating the sphere are absorbed. Thus, in a geometrical sense, there is a great similarity between wave propagation in radio and in the optical phenomena in the case of the rainbow ²⁾, the ratio of the earth's circumference to the mean wave length of wireless waves being of the same order of magnitude as the ratio of the

circumference of the raindrop to the wave length of visible light. Owing to the great value of this ratio, only a very small proportion of the waves is bent round the sphere in both cases. Yet, all other physical conditions in the two cases are entirely different, since a wireless wave on penetrating the earth is very rapidly absorbed, while a ray of light can pass practically without hindrance through a raindrop. In consequence, several rays are produced from a single incident light ray in a rainbow, because a ray entering a raindrop gives rise to new rays by reflection at the surface, while in radio propagation reflected waves have such a weak intensity that they become insignificant. Apart from directly incident radiation, the only other rays of importance in practice are those produced by direct reflection; all other wireless waves (shown by broken lines in *fig. 2*) are so weak that they are not detectable.

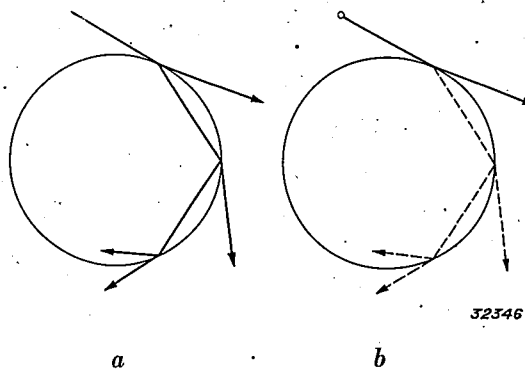

Fig. 2. a. Reflexion and refraction of a ray of light by a raindrop. *b.* Reflexion and refraction of a wireless wave at the earth's surface. In the second case the penetrating ray is strongly absorbed, so that only the once-reflected ray is important.

Calculations for Points of Reception Close to or Beyond the Optical Horizon of the Transmitter

In the case of wireless waves, the practical evaluation of the infinite series referred to above gives fundamentally different formulae, if the point of reception is close to or within the optical horizon of the transmitter, or if this point is beyond the horizon. The series of spherical harmonics forming the starting point of all calculations can be transformed into a new, more rapidly converging series when the point of reception is beyond the optical horizon, and if the point of reception is far enough beyond the horizon only a single term is required. If, moreover, the transmitter and receiver are both situated at ground level calculation is fairly simple. The field strength in milli-volts per metre at a receiving point distant D km from a transmitter radiating on a power level of P kilowatts, is then expressed by:

²⁾ This analogy has also enabled us to develop from the theoretical analysis of the radio problem a corresponding new and strict theory of the rainbow. This theory shows, *inter alia*, that on observing the rainbow through polaroid spectacles that part of the bow disappears which is directed vertically to the direction of polarisation.

$$E_{mV/m} = \frac{300 \sqrt{P_{kW}}}{D_{km}} \cdot f(\lambda, \sigma, \epsilon, D), \dots (1)$$

where f is a function dependent on the wave length λ , the conductivity σ and the dielectric constant ϵ of the soil and on the distance³⁾. In the case under consideration function f has approximately the form:

$$f(\lambda, \sigma, \epsilon, D) = 0.2905 \frac{\sqrt{D_{km}}}{\lambda_m^{1/6}} \frac{e^{-0.0537 \beta D_{km}/\lambda_m^{1/3}}}{\sqrt{\alpha^2 + \left(\beta - \frac{9.75 \cdot 10^{-9}}{\sigma_{EMU} \lambda_m^{2/3}}\right)^2}}, \dots (2)$$

where α and β are magnitudes which can be derived from the graph in *fig. 3* for given values of σ and λ . Although α and β depend on σ , they are not dependent on ϵ , so that the dielectric constant does not appear in the approximation of function f given here. This means that the earth has been regarded as a conductor or the displacement currents, generated in the earth, have been neglected with reference to the conduction currents, as expressed by the second condition given below. The difference between the exact solution and equation (1) is less than 10 per cent if the following conditions are satisfied:

- 1) The distance D_{km} of the transmitter from the point of reception is greater than $40 \lambda_m^{1/3}$;
- 2) This distance D_{km} is smaller than

$$0.6 \cdot 10^{14} \cdot \frac{\sigma_{EMU} \lambda_m^{4/3}}{\epsilon}$$

This restriction applies particularly with long waves in propagation over water (where ϵ has the very high value of 80), as well as with short waves in propagation over low-conducting ground (σ_{EMU} of the order of 10^{-14}); and

- 3) Both transmitter and receiver are at ground level.

The factor $300 \sqrt{P_{kW}}/D_{km}$ which occurs in equations (1) and (3) gives the field strength obtaining with a flat earth possessing infinite conduc-

³⁾ The form of this equation has been adapted to the equation already derived by one of the present authors (Balth. van der Pol *Hochfrequenztechn.* 37, 152, 1931) for a flat earth. In this case, instead of (1), we get

$$E_{mV/m} = \frac{300 \sqrt{P_{kW}}}{D_{km}} \cdot f(\varrho), \dots (1^*)$$

where the "numerical distance" is given by the expressions:

$$\left. \begin{aligned} \varrho &= \frac{\pi \cdot 10^{-9} D_{km}}{6 \sigma_{EMU} \lambda_m^2} \\ \text{and} \quad f(\varrho) &= \frac{2 + 0.3 \varrho}{2 + \varrho + 0.6 \varrho^2} \end{aligned} \right\} \dots (1^{**})$$

tivity, which means that reflection losses can be neglected. The factor $f(\lambda, \sigma, \epsilon, D)$ expresses the deviations caused by the spherical shape of the earth and due to the fact that not the whole of the radiation incident on it is reflected, but a portion refracted towards the earth's core. In view of this spherical shape, the field with the transmitter and receiver both at ground level, as assumed here, can only reach the point of reception by diffraction of the waves radiated from the transmitter. Yet, in general, the reduction in field strength with increasing distance due to absorption exceeds the reduction due to the increasing diffraction of the waves necessary in order to reach the point of reception. For short waves, one may state that the curvature of the earth has practically no influence upon wave propagation within the whole range of the transmitter, which practically is determined by absorption alone.

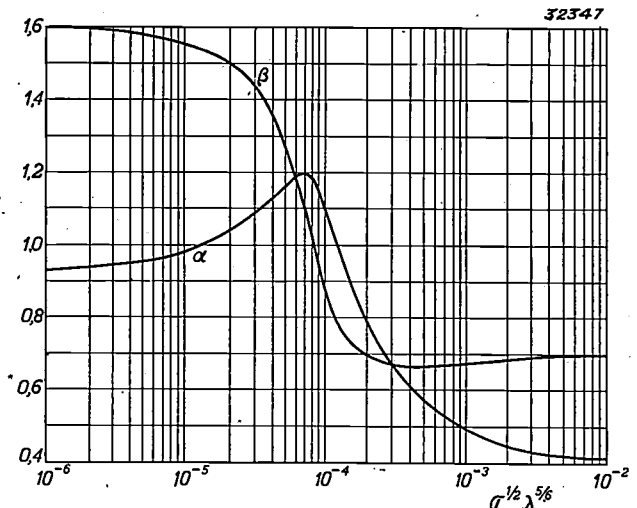

Fig. 3. Coefficients β of equation (1) plotted as a function of $\sigma_{EMU}^{1/3} \lambda_m^{2/3}$, where σ is the conductivity of the soil and λ_m is the wave length in m.

The alteration in the field strength when either the transmitter or receiver is raised above the surface, their distance apart remaining the same, can also be investigated. At distances far beyond the horizon of the transmitter, the field strength then to a first approximation increases by a factor which is independent of the distance D and is determined solely by the height of the transmitter and receiver above the surface. This height-gain factor is the product of a factor expressing the effect of raising the transmitter, and a corresponding factor applying to the receiver. An appropriate example is given in *fig. 4*, where the field strength in microvolts per m is shown for a transmitter radiating 1 kilowatt on a 7-m wave length and taking earth constants of $\sigma_{EMU} = 10^{-13}$ and $\epsilon = 4$

(corresponding to an average soil), and the ideal case for $\sigma = \infty$. This curve was not calculated by means of the approximation formula, given in equation (1), but by strict expansions of series, which owing to their complexity have been omitted in this article. The curves $h_1 = 0$ refer to the transmitter and receiver both on ground level, and curves $h_1 = 100$ m to one station at a height of 100 m. with the other again at ground level. According to a general principle, the same field strength is obtained if the positions of the transmitter and receiver are interchanged; so that it is immaterial here whether the transmitter or the receiver is assumed to be raised to 100 m.

This figure brings out clearly three general characteristics regarding the propagation of electric waves:

- 1) *The occurrence of the height-gain factor*, which means that for long distances D the ratio of the field for $h_1 = 100$ m and the field for $h_1 = 0$ is independent of the distance D , to a first approximation; in the fully calculated example given here this ratio varies only within the narrow range of 25 and 35 for all distances of D_{km} greater than 2.
- 2) *The effect of the earth's resistance*. The field strengths, which would be obtained with the same 1-kilowatt transmitter and the same wave length of 7 m if the earth possessed infinite conductivity or were a perfect reflector, are given at the top of the

graph. Here again, we have plotted the curves next to one another for transmitter and receiver both at ground level ($h_1 = 0$) and for one station at a height of 100 m ($h_1 = 100$ m). It is apparent that the gain in field strength by raising the receiver or transmitter is much less marked in this case, although the field strengths itself have become much greater. This can be explained by the fact that now, the earth's absorption being absent, it cannot be diminished by raising the sender. Therefore this has only the effect of reducing reflection losses which, as already pointed out, are generally much smaller.

- 3) *The horizon effect*: the curves for $h_1 = 100$ m are continuous up to the point $D_{km} = 35.7$, i.e. the point where the optical horizon of the transmitter is intercepted. Thus with these ultra-short waves no sudden and marked reduction in the field strength occurs at all, if the receiver is located below the optical horizon of the transmitter, i.e. no marked shadow effect is produced by the earth. It must be remembered that even the shortest waves used in wireless are still very long as compared to optical wave lengths, which naturally produce a pronounced shadow effect. Theoretically, in the optical case the precise shadow effect can be deduced by adding a sufficient number of terms in the neighbourhood of the optical horizon to the series obtained on transformation of the original

series of spherical functions; equation (1) which corresponds to the first term of this series will then no longer represent a satisfactory approximation.

To bring out clearly that a pronounced shadow effect would indeed be obtained with waves of the order of 1 cm, the factor E/E_{pr} has been plotted in fig. 5 as a function of the distance D for an earth of perfect conductivity, again assuming the transmitter to be at a height of 100 m; this factor expresses how many times the field strength E_{pr} of a transmitter located in the open is increased or diminished by the presence of the earth. In the immediate neighbourhood of the transmitter this ratio is 2, as the interaction of the direct waves and those reflected by the earth doubles the field strength. Where a marked shadow effect is obtained, the curves behind the point on the horizon at $D_{km} = 35.7$ should diminish very abruptly and considerably, but this is seen not to be the case for wave lengths

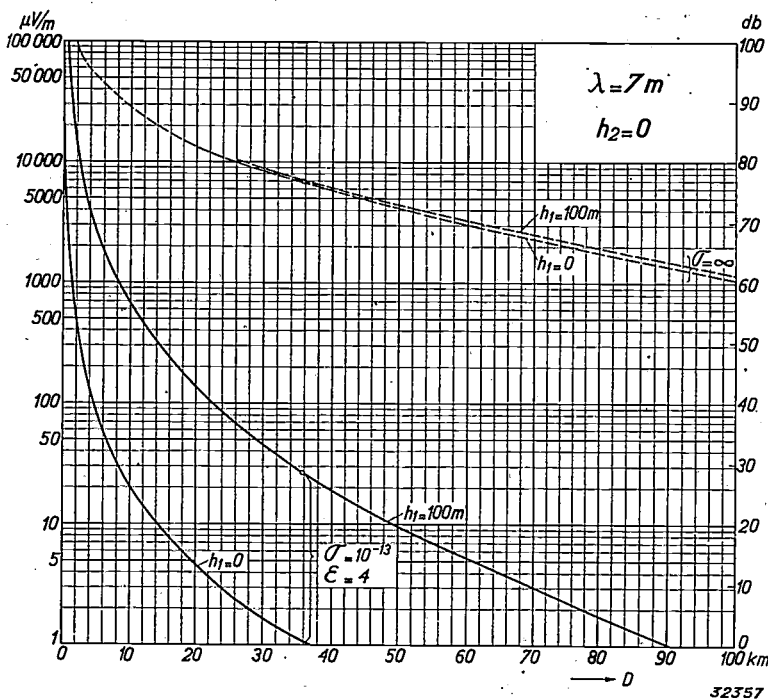

Fig. 4. Field strength surrounding a transmitter over the earth's surface as a function of the distance, for a 1-kilowatt transmitter radiating on a wave length of 7 m. h_1 is the height of the transmitter above the surface, and σ and ϵ are the conductivity and dielectric constant of the soil respectively.

of 7 m and 0.7 m as used in radio transmission. For still shorter waves, the field is indeed cut off very sharply beyond the horizon, as shown in the figure, and it then exhibits a behaviour as normally found with optical waves. If the finite conductivity of the earth were taken into consideration, the shadow effect would become less marked owing to the intervention of other similar phenomena resulting from the absorption due to the earth. On the other hand, the shadow effect becomes sharper if transmitter and receiver are both raised above ground level, as may be also gathered from a comparison of *figs. 7 and 8*. First consideration will, however, be given to the field strength in front of the horizon.

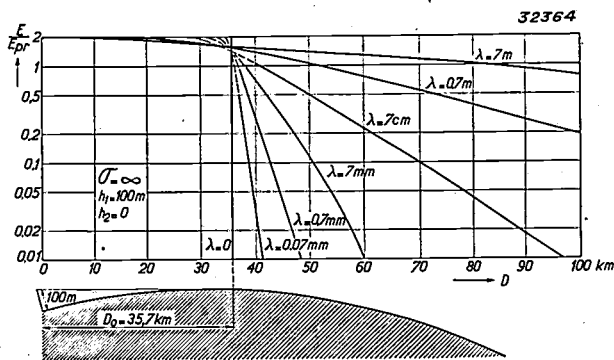

Fig. 5. Ratio of the field strength E at the surface to the field strength E_{pr} , which would obtain in the absence of the earth, plotted for various wave lengths as a function of the distance D from the transmitter. In the case under consideration with a transmitter at a height of 100 m and assuming infinite conductivity of the soil, a shadow boundary (horizon) only becomes apparent at wave lengths less than several millimetres.

Evaluation of the Field Strength at Short Distances from the Transmitter (In front of and beyond the Horizon)

The propagation of wireless waves can be analysed by similar principles to those employed with light waves, for which very good approximations are given by geometrical optics assuming the rectilinear propagation of light rays, provided points close to or in the shadow of the light source are left out of consideration. Very close to the transmitting

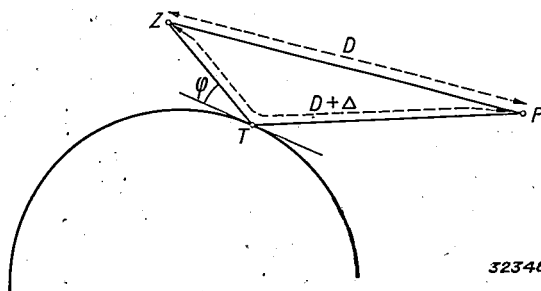

Fig. 6. The field strength at the point P due to the transmitter Z is created by the direct wave and by a wave which is reflected at T on the earth's surface.

station, *i.e.* a long way in front of the optical horizon, the field strength may be regarded as compounded from a ray ZP (*fig. 6*) travelling directly from the transmitter Z to the point of reception P , and a ray ZTP which in its travel has been reflected once at a point T on the earth's surface. In reality rays also penetrate the earth at T , but these are very rapidly absorbed and can, therefore, be neglected (*cf. fig. 2*).

In the geometric-optical approximation, the field strength due to the reflected wave should be added to that due to the direct wave, but the former arrives at P with a displacement in phase relative to the direct wave, since it has to traverse a distance which is longer than that of the direct wave by the amount $ZT + TP - ZP = \Delta$. In addition its intensity is reduced by reflexion and has to be multiplied by the usually complex coefficient of reflexion R ; hence the ratio of the field strength in the presence of the earth to that in its absence is given by the expression:

$$\frac{E}{E_{pr}} = |1 + R \cdot e^{2\pi i \Delta / \lambda}| \dots \dots (3)$$

The complex coefficient of reflexion R occurring in this expression depends on the magnitude of the angle of incidence φ which the wireless wave makes with the earth's surface, and also on the electric constants of the earth. On displacing point P the position of T is also altered, as well as the value of φ and hence the coefficient of reflexion. If the receiver is not too close to the transmitter, φ will be very small and a coefficient of reflexion corresponding to grazing incidence ($\varphi = 0$) can be assumed; furthermore, the strong absorption of the earth allows R to be put approximately equal to -1 , *i.e.* the earth reverses the phase of the incident wave (note that, on the other hand, with a perfectly reflecting earth, $R = +1$).

This analysis, however, cannot allow for the spherical shape of the earth. But, on starting from the original series of spherical harmonics, the geometric-optical approximation can be regained by applying another transformation other than that used for long distances, (*viz.*, a multidimensional application of the method of steepest descent), and thus the influence of the curvature of the earth can be calculated. One obtains the following results:

- 1) Owing to the spherical shape of the earth the reflexion coefficient R is altered slightly to a new value R' , and
- 2) The strength of the reflected wave must be further multiplied by a supplementary factor δ , the divergence factor. This factor has a value less

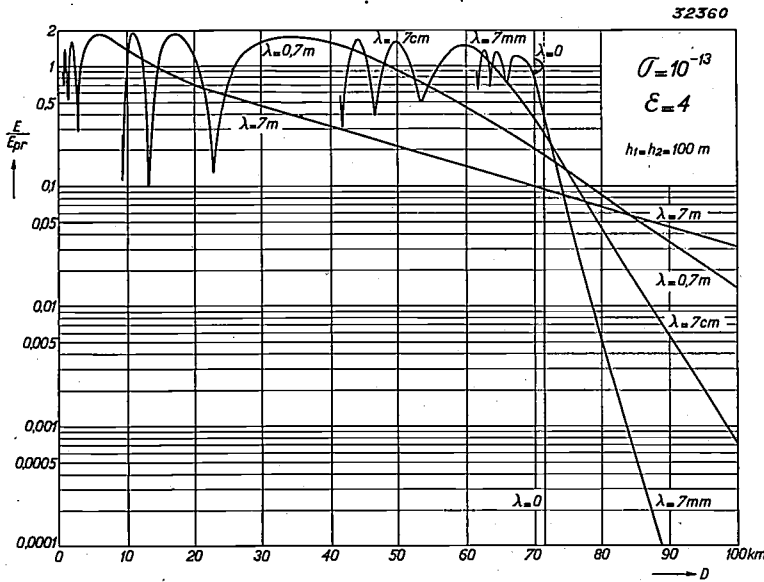

Fig. 7. Ratio of the field strength E along a line drawn through the transmitter parallel to the earth's surface, to the field intensity E_{pr} which would obtain in the absence of the earth. The wavy nature of the curve is due to interference between the direct and reflected waves. With waves below 1 cm, the effect of the optical horizon is clearly apparent. The curves are for average electrical properties of ordinary soil ($\sigma_{EMU} = 10^{-13}$, $\epsilon = 4$).

than unity and accounts for the increase in dispersion after reflexion of a small pencil of rays reflected by a spherical earth as compared with a pencil reflected at the same point on a flat earth; the divergence factor is thus a pure geometrical magnitude and does not depend on the wave length or the electrical characteristics of the earth. The geometric-optical approximation corrected in this way hence assumes the following form in place of (3):

$$\frac{E}{E_{pr}} = |1 + \delta \cdot R' e^{2\pi i \Delta / \lambda}| \dots (4)$$

If both transmitter and receiver are at ground level, this additional divergence of the reflected wave does not occur and δ must then be taken as unity.

Entirely new phenomena appear when both the transmitter and receiver are raised above the earth's surface, for then interference between the waves can take place since the direct and the reflected waves can arrive at the point of reception in phase or with opposing phases; in this case they either partially reinforce or weaken each other. If the effect of divergence is neglected, as is frequently done in elementary analysis of the problem, and the coefficient of reflection is taken as -1 , interference maxima are obtained at points where $\Delta = \frac{1}{2} \lambda, \frac{3}{2} \lambda, \dots$, and minima where

$\Delta = \lambda, 2\lambda, \dots$ the field strength would then be zero at the minima. Since the coefficient of reflexion is not exactly -1 , and since the divergence factor is less than unity, the direct and the reflected waves never completely cancel each other out, (not even if the geometric-optical approximation given above represented a strict expression of the field strength). The cumulative effect of the two phenomena is that, on the one hand, the maxima and minima are less pronounced and, on the other, that they are slightly displaced in position.

As a special case, we may take the transmitter and receiver as raised to the same fixed height above the earth's surface, and then study the field strength as a function of their distance apart. If the receiver is located close to or beyond the horizon, the series must be taken in which the first term is given by equation (1); in the range before

the shadow region a gradual transition is found from this series into the geometric-optical formula 5a, and for still shorter distances computations can be made with the equation. The authors have performed this computation for a height of 100 m for both transmitter and receiver and for earth constants of $\sigma_{EMU} = 10^{-13}$ and $\epsilon = 4$, corresponding to average soil. In fig. 7 the values for the ratio E/E_{pr} have been plotted for various wave lengths, the maximum value of this ratio being 2 as already indicated (assuming the earth as flat and

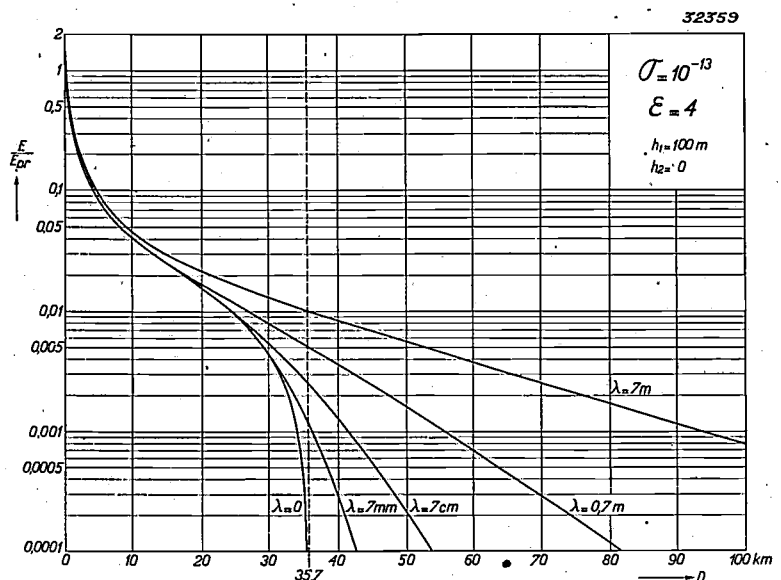

Fig. 8. Ratio E/E_{pr} over the earth's surface with the transmitter at a height of $h_1 = 100 \text{ m}$ for an ordinary soil ($\sigma_{EMU} = 4 \cdot 10^{-13}$, $\epsilon = 80$) for distances up to 2 000 km for a radiated output of 1 kilowatt.

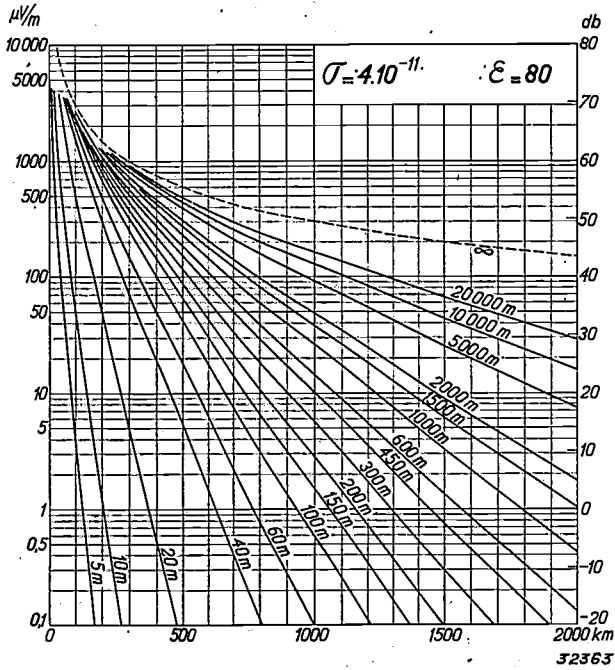

Fig. 9. Field strength of a transmitter above sea level ($\sigma_{\text{EMU}} = 4 \cdot 10^{-11}$, $\epsilon = 80$) for distances up to 2 000 km with a radiated output of 1 kilowatt (transmitter at sea level).

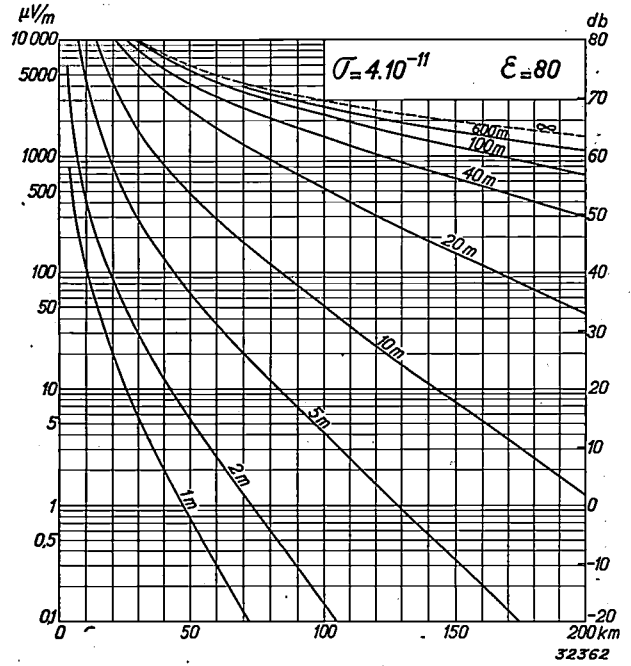

Fig. 10. The same as fig. 9, but drawn on a larger scale for distances up to 200 km.

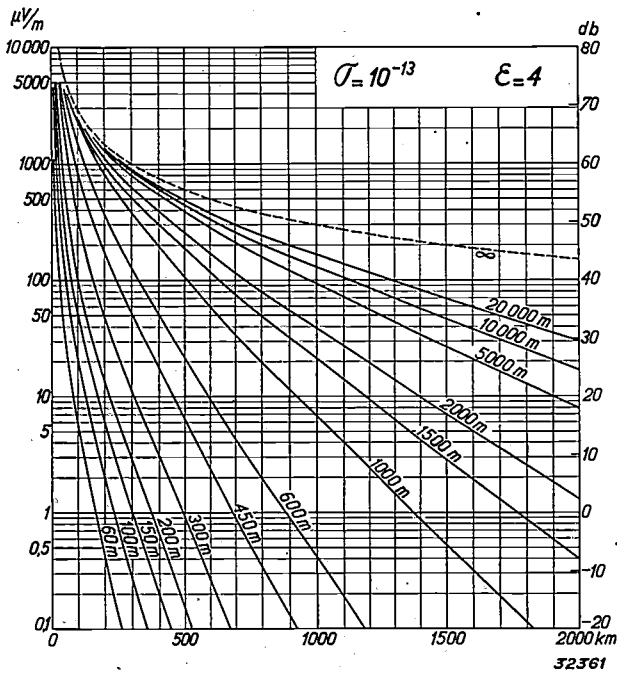

Fig. 11. Field strength of a transmitter on the surface with an average soil ($\sigma_{\text{EMU}} = 10^{-13}$, $\epsilon = 4$) for distances up to 2 000 km with a radiated output of 1 kilowatt.

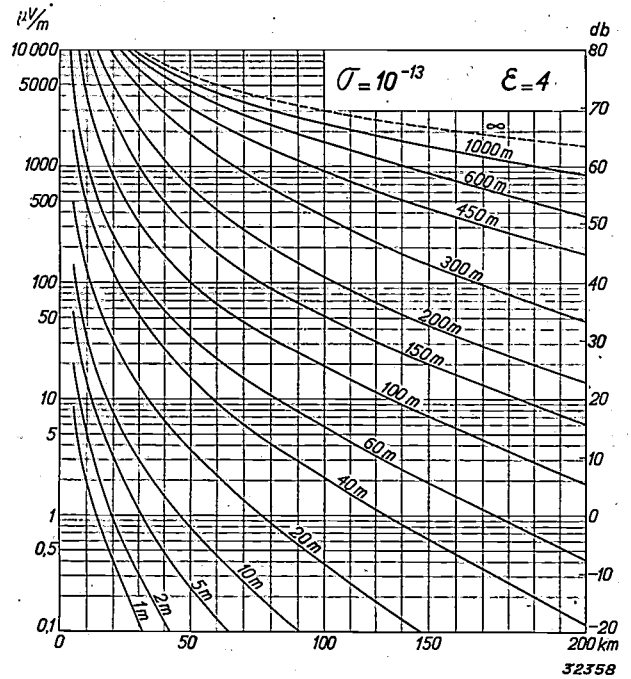

Fig. 12. The same as Fig. 10, but on a larger scale for distances up to 200 km.

giving specular reflection). This graphical representation clearly shows interference maxima and minima in the region in front of the optical horizon, which is now located at a distance of $2 \times 35.7 = 71.4$ km as both transmitter and

receiver are at elevations of 100 m. It is seen again here that, contrary to many assertions, there is no question of a sharp shading on passing through the optical horizon, even with the shortest wireless waves used. The rapid diminution of the field

strength beyond the horizon appears to commence already in front of the horizon, in fact at the last interference maximum, *i.e.* the maximum nearest to the horizon, while the slope of the curve changes only very slightly on entering the shadow region. This last-named maximum will be the closer to the horizon, the shorter the wavelength; in the limiting case of zero wave length the field would disappear at the horizon.

Finally, *fig. 8* shows for the same electric constants of the earth and the same wave lengths the corresponding curves with the transmitter at a height of 100 mm. and the receiver on ground level. In this case, interference phenomena naturally do not occur, since the direct and the reflected waves arrive at the point of reception without any difference in phase. This graph represents the same function as *fig. 5* which, however, has been calculated for infinite conductivity.

General Results with both Transmitter and Receiver at Ground Level (complete wave range and distances up to 2 000 km)

The field strengths were calculated as a function of the distance *D* for 19 different wave lengths between 1 m and 20 000 m, for propagation over the water (electrical constants: $\epsilon = 80$ and $\sigma_{EMU} = 4 \cdot 10^{-11}$). The curves were calculated using different series expansions for different distances. *Figs. 9, 10, 11* and *12* give the field strengths expressed in micro-volts per m for a transmitter radiating 1 kilowatt. *Figs. 9* and *11* give the field strengths up to the distances of 2 000 km from the transmitter, while *figs. 10* and *12* show on a larger scale the field strengths up to distances of 200 km only. The broken line at the top of the graphs represents the field strength which would be obtained with the earth flat and exhibiting specular reflection.

These graphs show clearly that particularly with shorter waves the field strength diminishes much more rapidly in propagation overland than in propagation over water, a result mainly due to the fact that in the former case the waves are much more strongly absorbed during their travel. As already pointed out, the effect of this absorption is usually much greater than that due to the curvature of the earth. The higher the conductivity of the soil the lower will this absorption be as a rule, and

hence the greater the field strength, other conditions being equal. An exception to this rule is obtained only when very long waves travel over considerable distances, and where propagation may suffer slightly with a higher conductivity. It may be seen from *figs. 8* and *10* that *e.g.* for *D* = 2 000 km the field strength at $\lambda = 20$ km in propagation over land is 4 per cent greater than in propagation over water. In general, for a given wave length, there is a specific value of conductivity which gives the optimum propagation over long distances and which is given by the equation:

$$\sigma_{EMU} = \frac{2.25 \cdot 10^{-7}}{\lambda_m^{2/3}}$$

Both with constant wave length and distance, the field strength is reduced if the conductivity is made smaller or larger than this value, but this maximum field strength is by no means sharply defined. Where the wave length is not too great, the conductivity values actually obtaining are usually below this value and hence an improvement in propagation would result if the conductivity of the soil could be enhanced.

In conclusion, it should be emphasised that, although fairly extensive simplifications have been introduced in all calculations made here, experimental measurements of the field strength are in the majority of practical cases in agreement, at least as regards order of magnitude, with the theoretical results set out above.

BIBLIOGRAPHY

In addition to the papers contributed by the authors, computations of the propagation of wireless waves round the curved surface of the earth have also been published recently in the following papers:

Eckersley and Millington, *Proc. Roy. Soc., London*, A 136, 499, 1932; *Phil. Trans.* 237, 273, 1938; *Phil. Mag.* 27, 517, 1939.

Wwedensky, *Techn. Phys. U.S.S.R.*, 2, 624, 1935; 3, 915, 1936, and 4, 579, 1937.

A survey of theoretical principles and experimental data covering the whole field of wireless wave propagation is also given in the Report of the Committee on Radio-Wave Propagation, issued by the International Consultative Committee for Radio Communication (C.C.I.R.), which has also been published in *Proc. Inst. Rad. Eng.*, 26, 1193, 1938.

PRESSURE CONDENSERS

by C. de LANGE.

621.319.46

In alternating-current condensers with a dielectric of oil-impregnated paper, the permissible field strength can be increased by applying a pressure to the oil, thus raising the reactive power per unit of volume which the condenser can absorb. The effect of increasing the pressure is explained and the construction of pressure condensers is discussed in this article.

In a previous article in this Review ¹⁾, an outline was given of the construction of heavy-current condensers, which are used principally for improving the power factor in alternating-current systems. These condensers are made up of reels composed of aluminium foil with intermediate layers of thin paper. The maximum voltage V which can be impressed on the reels depends on the thickness d of the dielectric, for V/d must not exceed the maximum field strength permissible with the particular dielectric used. For a given volume of reel the thickness d of the dielectric also determines the capacity C . With an alternating current of angular frequency ω the reel can absorb a reactive power of:

$$W = V^2 \omega C \dots \dots \dots (1)$$

In practical designs of these condensers, reels are made with a dielectric of 20 to 60 μ thickness, a capacity of 1 to 2 μ F and a power rating W of some tens of VA.

The greater the reactive power to be taken up the more important does it become to increase the power rating W per reel to a maximum value, in order to make do with a reasonable number of reels, *i.e.* to arrive at a battery of condensers of reasonable size and which does not occupy too much space. An increase of W in a reel of given dimensions may be obtained for a given dielectric constant by raising the permissible field-strength of the dielectric; for, with the same thickness of dielectric (capacity C), this will increase the permissible voltage V and in accordance with equation (1) give a quadratic increase in W .

In paper-insulated condensers working in an alternating-voltage system, as increase in the permissible field strength, which is normally about 10 volts per μ , can be obtained by placing the whole condenser under pressure. This method is discussed below, together with a short description of "pressure condensers" which have been designed on this principle.

Limitation of the permissible field strength

Paper is not a homogeneous material but a complex conglomeration of fibres separated by innumerable microscopic spaces and grooves. In the ordinary state the fibres enclose considerable quantities of air and moisture in these many cavities, which before using the paper in the manufacture of condensers must be carefully removed. This is necessary as the oxygen in the air may attack the "coatings" of the condenser as well as other components, while the moisture adversely affects the insulation and causes dielectric losses, apart from giving rise to the production of gases by electrolysis. The air and moisture are removed by a thorough degassing of the paper *in vacuo*, after which the paper is impregnated, *i.e.* the cavities are filled with a suitable material, in our case with oil.

In spite of this thorough pre-treatment, gas residues are still left in cavities of the dielectric, with the result that the maximum permissible field strength in the dielectric cannot be determined directly from the disruptive voltage of the paper fibres or from that of the oil. For this field strength depends on the weakest places in the dielectric, and in the gas inclusions undesirable phenomena, such as ionisation and electrical breakdown, may occur in the cavities at voltages which are much lower than necessary to produce similar effects in other parts of the dielectric. These reactions produce local overheating, which may result in carbonisation, the dielectric becoming progressively weaker until complete breakdown of the insulation occurs ²⁾. It is essential, therefore, to keep the field strength at a safe low value in order to avoid these undesirable phenomena.

Effect of Pressure

The field strength at which breakdown occurs in a mass of gas depends among others on the pressure

¹⁾ Philips techn. Rev. 1, 178, 1936.

²⁾ These considerations apply only to alternating-current loads. With direct-current loads, these phenomena are absent so that the permissible field strength is considerably higher.

of the gas. It has been found, however, that in a homogeneous field the disruptive voltage V_D is already determined by the product of the pressure p and the thickness h of the gas inclusion (thickness of cavity). The relationship between V_D and ph is represented by the Paschen curve shown in fig. 1. The curve has a minimum³⁾ at which $V_D = V_I$; for air $V_I =$ about 345 volts.

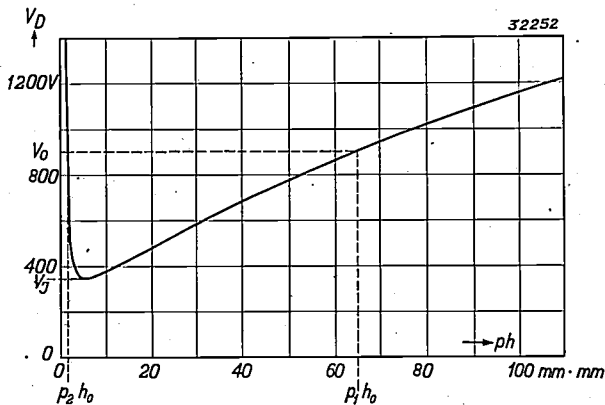

Fig. 1. Paschen curve for air (practically the same curve applies to nitrogen). This curve gives the relationship between the disruptive voltage V_D and the product ph of the pressure p and the distance h between the electrodes (thickness of cavity). For a given value h_0 and a voltage $V_0 > V_I$ breakdown occurs if the pressure is between p_1 and p_2 .

At voltages below V_I , breakdown cannot occur at whatever value of ph , but if the voltage rises above V_I breakdown may take place at any pressure between two different pressures p_1 and p_2 , assuming a constant thickness of layer h_0 (see fig. 1). This breakdown may be avoided, for that particular voltage and layer thickness, by reducing the pressure of the gas below p_2 or making it greater than p_1 . In this way the permissible field strength at the gas inclusions and hence in the whole of the dielectric can be raised.

The first method, that of reducing the pressure sufficiently low, is not feasible in practice, as it cannot be ensured that no gas inclusions remain which are at a higher and hence dangerous pressure. The second method is, therefore, adopted and a high pressure applied in order to avoid a breakdown occurring in any and every gas-filled cavity. That portion of the Paschen curve to the left of the minimum can be neglected in what follows.

Determination of the required pressure

Take a specific case in which the voltage V applied to the condenser reel and the thickness d of the dielectric are known. The thickness h of

³⁾ For the explanation of the increase of V_D with decreasing ph , in the left part of the curve, cf. this Review 1, 10, 1936 or 3, 333, 1938.

any gas layer occluded in a cavity of the dielectric may vary between 0 and d . The pressure must therefore be made so high that for every cavity $0 < h < d$ the disruptive voltage V_D will be greater than the voltage V_h impressed on the cavity.

As the maximum possible voltage $V_h = V$ is impressed on a cavity which occupies the whole space between the coatings of the condenser ($h = d$), one might be inclined to assume that this cavity is most susceptible to a breakdown, i.e. the greatest pressure would be necessitated by this case. It is found, however, that for a cavity of thickness $h_m < d$ the pressure required to prevent breakdown has a maximum value. This maximum may be determined as follows:

At the boundary between the dielectric and a cavity the field strength changes abruptly, because the dielectric constant ϵ is not the same on both sides of this surface. In the paper $\epsilon = \epsilon_p$, for which we may take the value 4.2, while in the gas inclusion $\epsilon = 1$. The potential distribution can be readily calculated with the aid of fig. 2. The two components

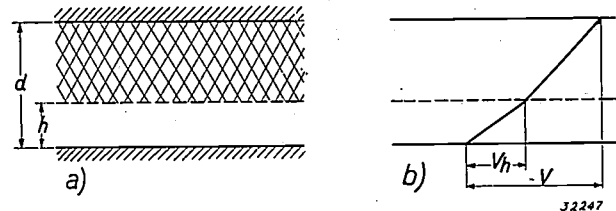

Fig. 2. a) To calculate the voltage V_h which, at a voltage V between the coatings of the condenser and a thickness d of the total dielectric, is impressed on a cavity of thickness h in the dielectric, the parts of the dielectric filled respectively with paper and gas are regarded as two condensers in series. b) At the boundary surface the potential between the coatings shows a sharp change (the field strength changes abruptly).

with thicknesses $d-h$ and h respectively are regarded as two condensers in series with capacities C_p ($\epsilon_p/(d-h)$) and C_h ($1/h$) respectively. Since the same displacement current must flow for both condensers, we have:

$$(V - V_h) \frac{\epsilon_p}{d - h} = V_h \frac{1}{h},$$

hence:

$$V_h/V = \frac{\epsilon_p \cdot h/d}{1 + (\epsilon_p - 1) h/d} \dots (2)$$

In fig. 3, the ratio V_h/V is plotted as a function of the ratio h/d . If concrete values for a particular case are taken for the parameters V and d , the curve representing V_h as a function of h can be derived from fig. 3 by altering the scales along the coordinate axes. This curve can then be combined

with the Paschen curve in fig. 1 and for every thickness of cavity h , the minimum value of ph can be found for which the disruptive voltage V_D is greater than the impressed voltage V_h . The required

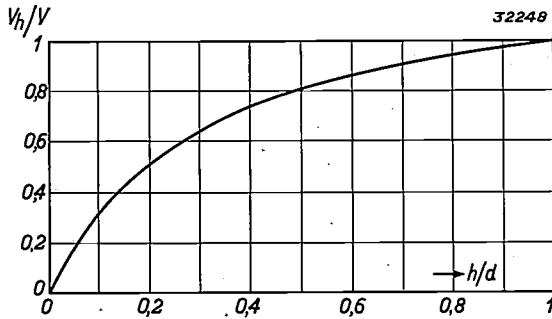

Fig. 3. The ratio of the voltages V_h/V plotted as a function of the ratio h/d . The curve shows V_h as a function of h , if the axes are scaled in terms of the parameters V and d .

pressure p_1 then follows from h and the value of $(ph)_1$ thus found. In fig. 4 the value of p_1 found in this way is plotted as a function of h for $d = 30 \mu$ and for different values of V (crest value of alternating voltage). It is stated that each of the curves passes through a maximum. The curve for $V = 800$ volts, e.g., has a maximum at $h_m = 9.6$, where p_1 has a value of $p_{1m} = 2520$ mm Hg or 3.45 atm. If, therefore, the pressure is made greater than 3.5 atm., then in the case under consideration with $d = 30 \mu$ and $V = 800$ volts neither ionisation nor breakdown can occur in any cavity which might be present in the dielectric.

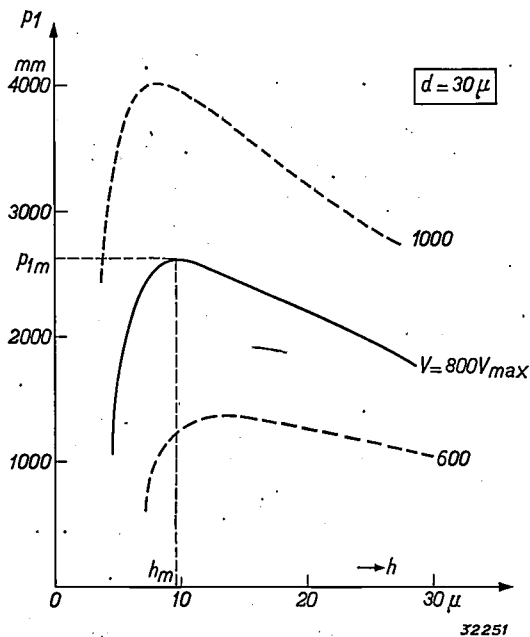

Fig. 4. By applying the equality $V_h = V_D$ the curves in fig. 1 and fig. 3 give the pressure p_1 required with different cavities (h) in order to prevent breakdown. This pressure is plotted here for $d = 30 \mu$ and different values of V as a function of h . In each curve for a certain value of $h = h_m$, p_1 has a maximum value p_{1m} .

If for a given value of d (e.g. 30μ) the required pressure p_{1m} is plotted as a function of V , a curve of the type shown in fig. 5 is obtained, which shows how high the pressure must be made to allow a condenser reel with that particular thickness of dielectric to sustain safely an impressed voltage V . For other values of the thickness d , the required pressure follows directly from the fact that for a given value of V the product of $p_{1m} \cdot d$ is constant. The figure reproduces the curves for four different values of thickness of dielectric.

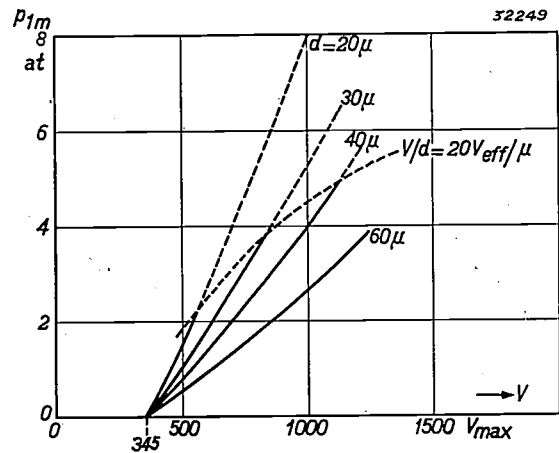

Fig. 5. The required pressure p_{1m} plotted as a function of the voltage V (effective value) between the coatings, for different thicknesses d of the dielectric. The parts shown by broken lines do not enter into practical consideration, as here the field strength of $20 V_{eff}/\mu$ (see below) is exceeded.

Pressure differences in the dielectric

In practice, the required increased pressure is obtained by immersing the condenser reel in oil in a suitable casing and applying a pressure to the oil. This does not, however, ensure that the same pressure will be obtained in every cavity present in the dielectric; this equality would only occur if an equilibrium were established, which, however, is continually disturbed while the condenser is in service. The temperature of the condenser varies owing to the heat evolved as a result of dielectric losses, and the paper and oil in the dielectric expand not entirely uniformly, so that local pressure gradients may arise which are only removed again when the oil has had a chance to flow into any low-pressure area created. To ensure that this flow takes place as quickly as possible, an oil must be selected which has a sufficiently low viscosity, even at the lowest temperatures likely to occur in practice. Furthermore the paper ought to be to the highest possible degree permeable to the oil. But this is in opposition to the need for realising as high a dielectric constant and disruptive voltage in the dielectric as possible. Satisfactory permea-

bility demands a low filling factor for the paper, *i.e.* a loose fibrous structure fitted with a large number of pores, while for a high disruptive voltage and a high average dielectric constant the filling factor must be high⁴).

This difficulty is avoided by dissolving in the oil a gas, such as nitrogen, which will not attack the coatings of the condenser or the dielectric. The quantity of gas dissolved depends to a large extent on the pressure in the liquid. Should the pressure fall in a cavity owing to delay in the oil flow, nitrogen is then immediately liberated in the cavity which it fills temporarily, becoming dissolved again as oil flows back into the cavity.

Nevertheless, in every case, it is essential to make the pressure applied externally much greater than the value derived theoretically, so as to maintain a sufficient pressure in all cavities, even during a temporary local fall in pressure.

If a breakdown due to ionisation in the gas inclusion is completely inhibited by this means, the field strength in the dielectric can be increased and will no longer be determined by the cavities, but now *e.g.* by the properties of the oil. This field strength is found by experiment, measurements having shown that in practical cases where the pressure has been raised to between 8 and 15 atm. the maximum permissible field strength in the dielectric could be roughly doubled, *e.g.* about 20 volts per μ (this limitation is also indicated in *fig. 5*). This result signifies that by the application of pressure the voltage impressed on a condenser reel can be doubled, so that only a quarter of the number of reels are required to obtain the same capacity than when no pressure is applied. In practice this potential improvement is not entirely utilised, a portion being reserved for increasing the safety factor.

Construction of pressure condensers

The manner in which a pressure is applied to the dielectric has already been indicated above; the pressure is impressed on a totally-enclosed mass of oil which surrounds the batch of condenser reels. This principle can be translated into practice in various ways. Thus the pressure can be communicated to the oil over a diaphragm. In this case, how-

ever, the oil must be given facilities for expansion on fluctuations in temperature. The casing has then to be fitted with an expansion unit, which will make the general design much more complicated. Another method was therefore adopted in Philips pressure condensers; only part of the condenser tank is filled with oil and the space above the oil filled with compressed nitrogen; this method also provides for the requisite solution of the nitrogen in the oil. A few details of general interest regarding the construction of these condensers are given here.

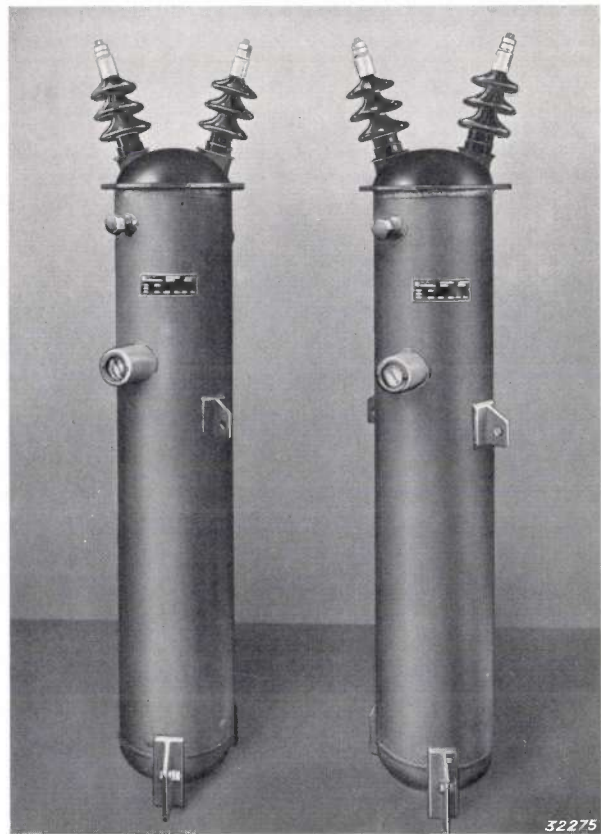

Fig. 6. Pressure condensers for 50 kVA and a working voltage of 10 000 volts effective, two-phase, 50 cycles. The condenser reels are enclosed in a seamless steel tube, a manometer being inserted at half the height of the condenser to measure the pressure. The initial pressure is here about 20 atm. Just above the pressure gauge is the pressure release, which is protected on the outside by a nut.

The tank or casing enclosing the condenser reels is a seamless steel tube to which a base and a cap are welded (*fig. 6*). This longitudinal shape facilitates the dissipation of the heat evolved in the condenser, since a large surface per unit of volume is provided (this ratio is a minimum with a sphere). The gastightness of the tube and particularly of the glands through which the electrodes are passed and the various connections must naturally satisfy severe specifications. The general standard of gastightness adopted is that the pres-

⁴) The fibres have a dielectric constant of approximately 6, while the mineral oil used for impregnation (filling of the pores) in Philips' condensers has a dielectric constant of about 2 only. Synthetic oils for impregnation which have a higher dielectric constant are available, and therefore allow a lower filling factor to be realised. But these oils have the undesirable property that they attack the skin, a danger which is avoided by using mineral oil.

sure must be maintained above the minimum value of 8 atm. over a period of three years. All connections on the tube are, therefore, welded or soldered and carefully tested for leakage.

The life of the condenser reels is practically unlimited, thus a condenser becomes equivalent to new if nitrogen is recharged at regular intervals. Filling and recharging of gas are done through a rubber valve, similar to that used on motor-car tyres. A valve of this type is naturally unsuitable as a seal; moreover the rubber is attacked by the oil. A reliable seal is, therefore, obtained with a cap which, after charging the condenser with gas, is placed over the valve and soldered. To recharge, the seal is unsoldered and the valve disc which has become useless in the meantime is then renewed.

As the temperature of the condenser rises, the pressure also increases; the maximum increase in pressure found in practice is 20 per cent (with a temperature rise of about 40 deg.), which can be withstood by the condenser tank in perfect safety. Of course, precautions are taken to deal with any excessive increase in pressure which might be created when electrical damages in the condenser occur, for instance as a consequence of surges. A thin copper diaphragm has been welded in the side of the tube close to the cap to provide a release at pressures below 100 atm. As the glands fail only

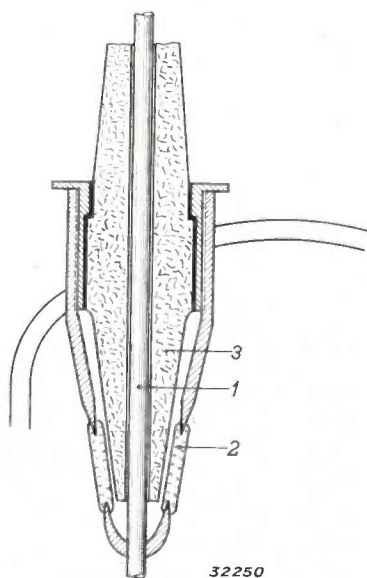

Fig. 7. Section of an electrode gland. The electrode stem 1 is fused into a glass insulator 2 with a chrome-steel liner, the glass insulator in its turn being welded into the cap of the condenser tube with a similar liner. On the outside, the electrode stem is supported by a ceramic insulator 3.

when the pressure rises above 250 atmos. while the critical pressure of the tube is much higher still, this form of pressure release provides adequate

protection. Similar to the precautions with oil-immersed transformers, a wide length of pipe may be mounted in front of the release disc so that any oil ejected when the diaphragm is ruptured can be collected in a suitable tank.

The glands referred to above are shown in section in fig. 7 and the glass insulators fixed inside the tube in fig. 8. The high compressive strength of

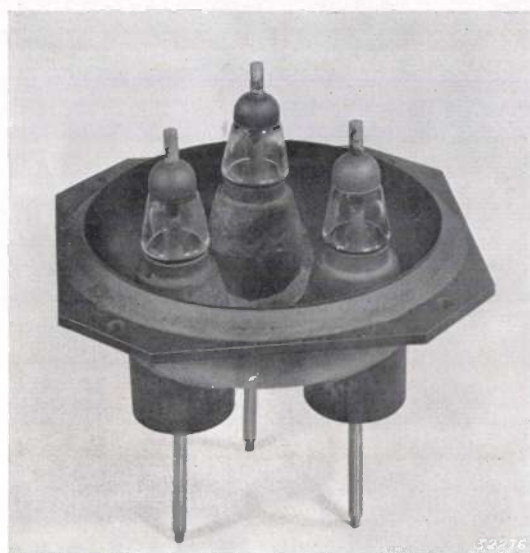

Fig. 8. Glass insulators of electrode glands in the cap of a three-phase condenser.

250 atm. for the glass insulators is obtained by very slowly cooling them after sealing into the tube, so that maximum stress relief is obtained. A gastight and heat-resisting seal between the glass and the electrode stems and the tank is obtained with the aid of chrome-steel liners. On the outside of the tank the electrode stem is supported by a ceramic insulator, in order to avoid torsional and bending stresses being communicated to the gland. A special point was made in the design of these insulators to provide complete protection for the glass in the event of an insulator breaking, as well as to enable the insulators to be renewed easily.

Pressure condensers are made for power ratings from 10 to 100 kVA and for effective voltages from 380 to 10 000 volts. No appreciable gain is realised by adopting a pressure design in condensers with ratings below 10 kVA, since the economy effected in the number of condenser plates does not make up for the complications by the high-pressure design.

In fig. 6, two pressure condensers have already been shown, which are built for 50 kVA and 10 000 volts and which also are suitable for an open air mounting. Generally, pressure condensers may well be used in this kind of mounting owing to the en-

tirely tight enclosure of the reels, the latter being thus protected against atmospheric influences.

A battery of pressure condensers, rated for a reactive power of 80 kVA each at a working voltage of 2 000 volts effective (three-phase, 50 cycles), is shown in *fig. 9*.

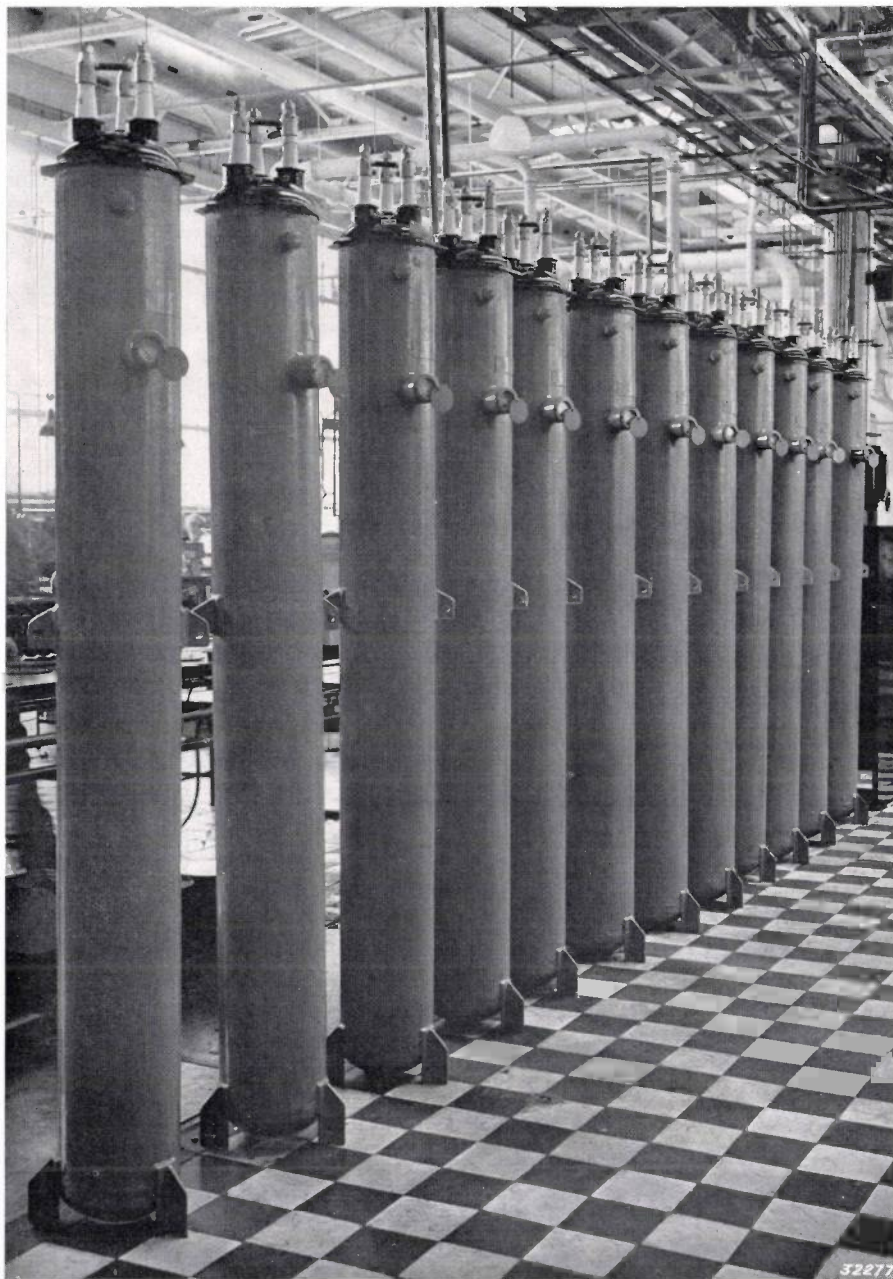

Fig. 9. Battery of pressure condensers rated for a reactive power of 1 000 kVA and a working voltage of 2 000 volts effective.

PHYSICAL PHOTOMETRY

by J. VOOGD.

535.247

This article discusses in how far it is possible to conduct photometric measurements entirely by physical means. The chief problem here lies in the accommodation of the spectral sensitivity of the apparatus to the international ocular sensitivity curve. This accommodation may be realised by using filters or by resolving the light into a spectrum and placing a suitable diaphragm in the path of the resolved rays. An analysis of the sensitivity and potential errors due to scattered light indicates that a combination of both methods offers the most satisfactory solution. A photometer developed in this Laboratory is described, with special reference to its calibration, accuracy and sensitivity.

The development of gas discharge lamps has brought the problem of heterochromic photometry to the forefront of interest. The fact that these lamps are selective radiators raises numerous knotty questions in visual photometry. A previous paper published in this Review has already called attention to these difficulties, and also gave an indication how they could be overcome by means of a physical photometer¹⁾. The experience gained in the construction of a physical photometer in this laboratory is dealt with in the present article.

The basic problem in the application of photometry to a given source of light is to compare this source with a standard lamp which has itself been directly or indirectly calibrated against the light standard. All such comparisons must be carried out on the basis of the international luminosity curve; if, therefore, $E_1(\lambda)$ and $E_2(\lambda)$ are the energy fluxes which are emitted respectively by the light source under examination and by the standard lamp at the wave length λ per unit of wave band,

per unit solid angle and per unit of time, a physical photometer must permit measurements, entirely by physical means, of the ratio of the candle powers as given by the expression:

$$\frac{I_1}{I_2} = \frac{\int E_1(\lambda) V(\lambda) d\lambda}{\int E_2(\lambda) V(\lambda) d\lambda}, \dots (1)$$

where $V(\lambda)$ is the relative luminosity factor for the wave length λ . The physical photometer must carry out the integration occurring in equation (1), and in particular its spectral sensitivity curve must be identical with the international luminosity curve within narrow limits.

In the construction of a physical photometer, a receptor, e.g. a photo-electric cell, must be used, whose spectral sensitivity curve, of course, never will entirely coincide with the international luminosity curve. To obtain this correspondence, an accommodator must be placed in front of the receptor having an appropriate spectral transmission curve. This accommodation may be provided for in two ways:

1) Optical filters can be used, or

¹⁾ Philips techn. Rev. 1, 120, 1936.

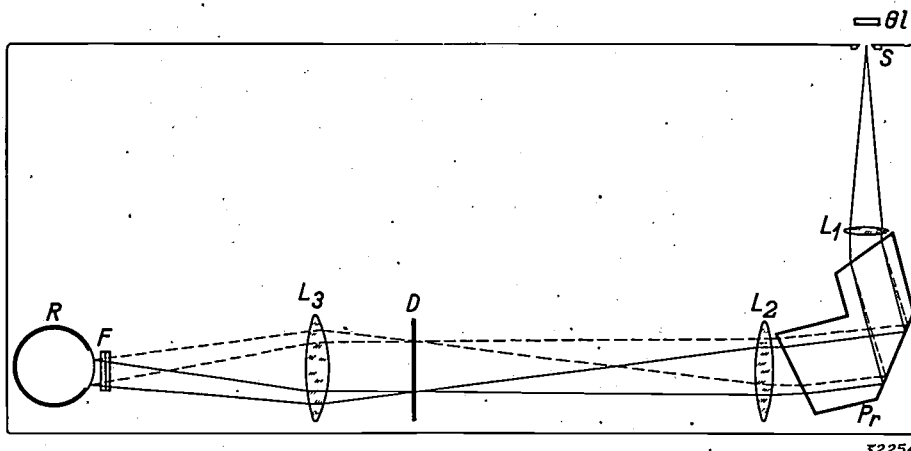

Fig. 1. Layout of a physical photometer. The light source whose candle power is to be measured, illuminates a depolished glass Gl in front of the slit S . A spectrum is produced from the light passing through the slit by means of the lenses L_1 and L_2 and the prism Pr and the spectrum is screened by the diaphragm D in such a way, that at every wave length the required fraction of the radiation is transmitted. An image of the collimator lens L_1 is projected by the lens L_3 through the filter F on the window of a photo-sensitive receptor R .

2) The light before falling on the receptor can be resolved into a spectrum and the height of the spectrum can be lowered by means of a suitable diaphragm to the required fraction at each particular wave length.

Both methods have their own advantages and disadvantages. While optical filters provide a simple and sensitive apparatus if a rough correspondence is considered sufficient, great difficulties are encountered where the accommodation has to be rather exact. Spectral accommodation has the disadvantage that the sensitivity is low, for a spectrum must be produced and the only light available is the luminous flux which passes through the first slit on to the collimator lens (L_1 in fig. 1).

The limitation of the luminous flux conditioned by spectral adaptation becomes the more onerous, the more the spectral sensitivity curve of the receptor differs from the international luminosity curve. This will be analysed in greater detail.

An appropriate apparatus for the spectral adaptation is shown in fig. 1.

A depolished glass G_1 is illuminated by the light source under investigation. Behind G_1 is the slit S through which the light transmitted by G_1 enters the apparatus. A spectrum is obtained by one of the usual methods, for instance by means of the two lenses L_1 and L_2 and a prism Pr . The diaphragm D is placed in the plane of this spectrum, and transmits the required fraction of the light of every wave length. The light is then concentrated by a lens L_3 on to a receptor R , in the present case a photo-electric cell. (The filter F shown in the diagram may be neglected for the moment).

Assume that a receptor has been chosen with a spectral sensitivity as given by line a in fig. 2. To obtain the international luminosity curve (line b), the screening produced by the diaphragm must vary with the wave length as indicated by line c in fig. 2. The form of this screening curve is most important, as it determines the maximum permissible width of slit and hence also the sensitivity of the photometer.

To comprehend this fact, consider the case where the width of the slit and the dispersion of the spectrum have been so chosen that the image of the slit when illuminated with monochromatic light subtends a constant wave band of 200 \AA . The transmissibility for light with a wave length λ is then not determined by the height of the curve c at the point λ , but by the average value of curve c over a range from $\lambda - 100 \text{ \AA}$ to $\lambda + 100 \text{ \AA}$. The error resulting herefrom will be the higher, the greater the curvature of line c . Conversely, for a given maximum

error of e.g. 1 per cent, the width of the first slit and hence the sensitivity of the apparatus may be made the greater, the straighter the shape of the screening curve. In the example illustrated the transmissibility with a slit image of 200 \AA width is 1 per cent too low at 5800 \AA , while at 5000 \AA it is 5 per cent too high. The slit should be about 2.5 times smaller in order to obtain an accuracy of 1 per cent at all points.

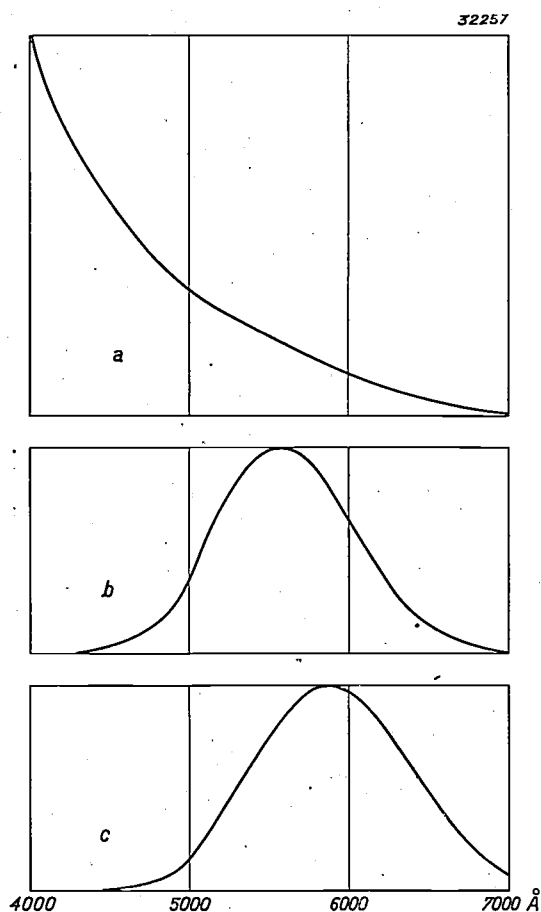

Fig. 2. a) Spectral sensitivity curve of a vacuum photo-cell with potassium cathode.
 b) International ocular-sensitivity curve.
 c) Transmission factor of a diaphragm which adapts the sensitivity curve of the photo-cell to the international ocular sensitivity curve, as a function of the wave length.

Apart from determining the maximum permissible width of the slit and hence the sensitivity of the photometer, the shape of curve c also determines in how far it is possible to eliminate errors resulting from the scattering of light in the optical system. Each point of the spectral plane receives not merely radiation of the corresponding wave length, but also a certain amount of scattered light, whose spectral composition may, to a first approximation, be assumed to be equal to that of the incident light. As a result of this, in addition to the fraction of each particular wave length of the light

flux falling on L_1 which by normal optical means is projected on to the diaphragm (curve c), there is a certain constant percentage (in our photometer about 0.3 per cent) distributed over the whole diaphragm in the spectrum which is also transmitted.

The error, which results when the diaphragm is designed without taking this scattered light into consideration, will be the greater, the greater the variations of curve c . If the height of the diaphragm were the same for all wave lengths (*i.e.* were the diaphragm rectangular in shape), the scattered light would at all wave lengths be the same percent-

tribution can then naturally not be compensated by lowering the height of the diaphragm in the blue.

König²⁾ suggested in 1934 that spectral adaptation be combined with rough accommodation by means of filters, which would reduce the variations within the screening curve. This would give a more rectangular cut-off of the spectrum. The slit can then be made wider, so that with a given spectral accommodation a greater sensitivity is obtained, and at the same time the difficulties due to scattered light are largely diminished.

This principle used by König also has been adopted for the physical photometer which has

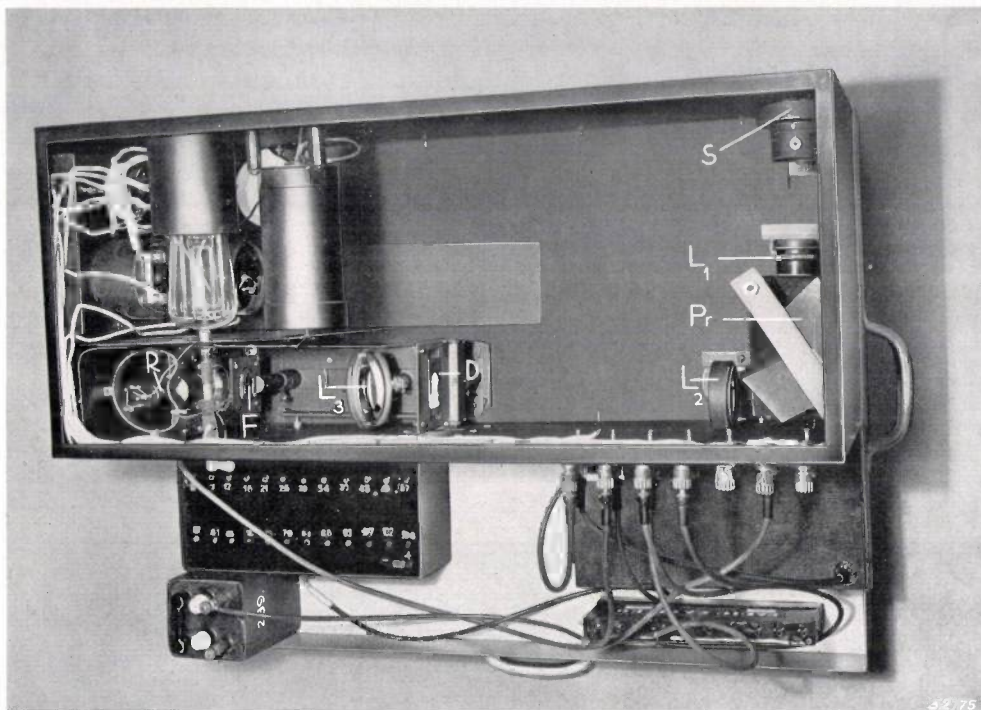

Fig. 3. View of the physical photometer from above, with lid removed. The letters S , L_1 , Pr , L_2 , D , L_3 , F , R have the same signification as in fig. 1.

age of the total light which is projected optically on to the receptor. No errors due to the scattered light would then accrue.

If the diaphragm is not rectangular, it is principally necessary to compensate for the effect of scattered light, by lowering the screening curve c throughout by the same amount. But this can only be done if it does not lead to negative values for the height of the diaphragm. That this case would be likely to occur, may be seen from fig. 2 when considering the blue part of the spectrum:

Since the eye is very insensitive to blue wave lengths, while the photo-cell exhibits a high sensitivity in this range, the scattered blue light alone might already contribute more to the photocurrent, than is wanted from the blue, which con-

been constructed in this Laboratory. The general layout of the instrument has already been given in fig. 1; to the details previously stated, it should be added that a combination of filter F , which roughly accommodates the spectral sensitivity curve of the cell to the international luminosity curve, is placed directly in front of the photo-electric cell. The lens L_3 is placed in such a position that the image of the collimator lens L_1 and not the spectrum is projected on to the receptor, a substitution which prevents a variation in the distribution of light over the surface of the cell with an alteration in the shape of the diaphragm superimposed on the spectrum. This precaution is desirable as the spectral

²⁾ H. König, *Helvetica Physica Acta* 7, 433, 1934.

sensitivity of a photo-sensitive layer is frequently subject to local variations, so that a change in the light distribution might also lead to an alteration in the spectral sensitivity curve. The general appearance of the measuring arrangement may be gathered from *fig. 3* and *4*.

The various parts of the apparatus will now be described separately.

Photo-cell, combination of filters and electrical method of measurement

The choice of the receptor has been regarded by us as the most important feature in the design of

maximum. The variation of spectral sensitivity is shown in the curves in *fig. 2* already discussed and compared with the international luminosity curve. As may be seen from curve *c* in *fig. 2* the sensitivity must be reduced not only in the blue and blue-green but also in the red. For a rough correction of the sensitivity curve a combination of the following filters has been used:

Corning Signal Yellow	2.5 mm thick
Corning Noviol A	1.0 mm thick
Schott B G 18	0.75 mm thick

This combination of filters was fixed directly in

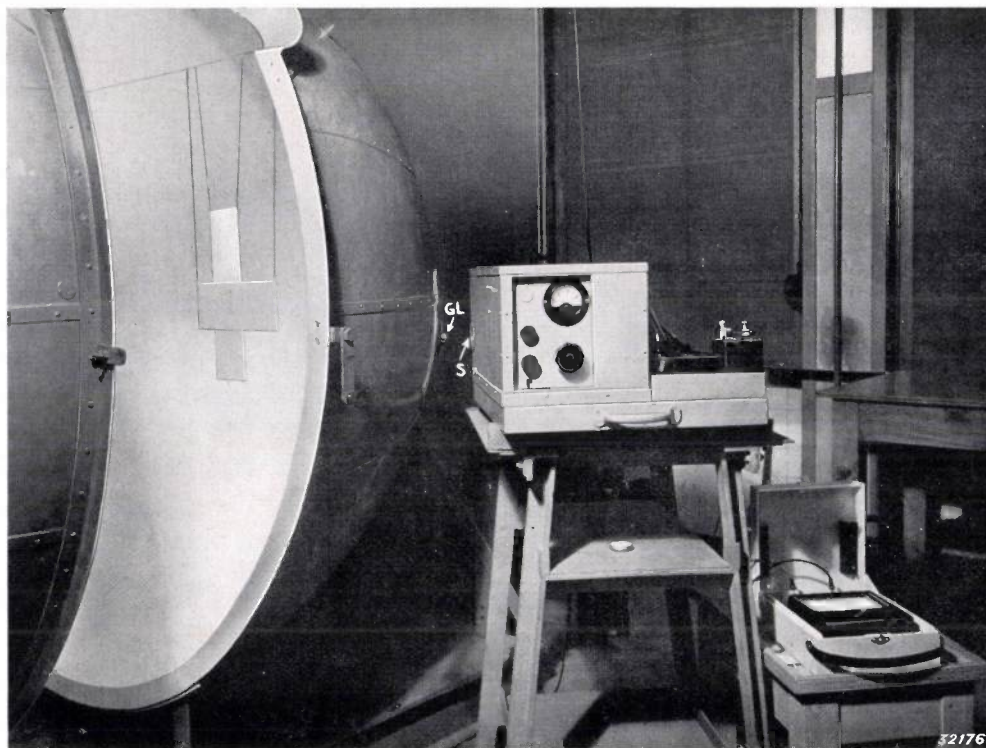

Fig. 4. Rear view of the physical photometer in an arrangement for measuring light fluxes with the aid of an integrating sphere.

the apparatus. This receptor must satisfy the following requirements:

1. It should permit a measurement of very small photo-currents; and
2. The relative spectral sensitivity curve should remain sufficiently constant over long periods of time.

The vacuum cell with potassium cathode, Philips 3510 type, satisfies both requirements and this cell has, therefore, been used by us as a receptor. The spectral sensitivity of these cells varies slightly in different specimens and may exhibit a more or less pronounced maximum. To facilitate accommodation to the international luminosity curve, we selected a cell which did not have an appreciable

front of the window of the photo-cell, which is depolished in order to make the distribution of light over the surface of the cell as uniform as possible and hence more constant still than would be achieved by projecting an image of the collimator on the cell window. A good approximation to the international luminosity curve is obtained by the spectral sensitivity of the photocell when combined with the filters, such that the correction of the sensitivity curve by placing a diaphragm in the spectrum needs not be very great, and hence the scattered light does not cause any serious error.

The photo-electric currents must be measured by a very sensitive method, as in measurements

with an integrating sphere only photo-currents of the order of 10^{-6} lumens pass through the collimator lens. The application of an electrometric method suggests itself here; an electrometer triode was used as a static voltmeter and the current was measured by electrostatic compensation of the charge liberated by the photo-electric effect from the cathode and which charges the anode of the cell and the grid of the electrometer triode connected to this anode. This method has already been fully described in this Review³⁾, so that a detailed description can be dispensed with here.

Production of spectrum

The spectrum required can be obtained in two different ways, either with a reflecting grating or with a dispersing prism. Compared to the prism, the grating offers the advantage that the deflection of the light ray is proportional to its wave length throughout the whole spectrum. In the prism, however, the dispersion is not uniform, and the important spectral region, for instance, between 6000 and 7000 Å occupies only a small part of the spectrum. As will be seen later, uniform dispersion as obtained by the grating is particularly valuable in calibration. In the first design of the apparatus a grating was chosen for this very reason and a satisfactory accommodation to the international luminosity curve was arrived at. Nevertheless, a serious drawback of the grating soon appeared, viz., that the reflexion properties of the grating which was ruled on speculum metal did not remain constant, so that the whole apparatus had to be recalibrated at short intervals. Setting up the grating in an inert atmosphere did not improve matters, and the grating was therefore replaced by a prism, whose transmission characteristics remained practically constant if a suitable kind of glass was selected. A higher sensitivity can, moreover, be realised with the prism, for with it practically the whole of the light which passes through the slit on to the collimator lens is utilised in producing a single spectrum, while with the grating the light is distributed over the directly-reflected image and the different-order spectra.

Determination of the required shape of diaphragm

In order to determine the required shape of diaphragm, the spectral sensitivity curve of the apparatus in the absence of the diaphragm was investigated experimentally. This could be done most easily by illuminating the slit with light of a known

continuous distribution of spectral energy. For this purpose we used a tungsten ribbon lamp burning at a known temperature, an image of the ribbon being projected on the entrance slit by a photographic lens placed behind a water filter. From the known temperature of the ribbon and the spectral transmission factors of the filter and the lens, of which the last two were measured separately, the relative radiant energy $E(\lambda)$, which passed through the slit per unit of wave band on to the collimator lens could be calculated as a function of the wave length.

To determine the spectral sensitivity, a slit was placed in the plane of the spectrum, this slit being somewhat wider than the monochromatic image of the entry slit, but having the same shape as this (curved) image. This slit could be shifted in the plane of the spectrum. If now $G(\lambda)$ is the sensitivity of the apparatus for light of wave length λ , the photo-current $i(\lambda)$ obtained when the slit is adjusted to transmit the wave length λ will be given by the expression:

$$i(\lambda) = C \cdot E(\lambda) G(\lambda) \Delta\lambda, \dots \dots (2)$$

where C is determined by the apparatus independent of the wave length and $\Delta\lambda$ is the wave band cut-out from the spectrum by the spectral slit and which varies with the wave length.

It follows from equation (2) that:

$$G(\lambda) = \frac{1}{C} \frac{i(\lambda)}{E(\lambda) \Delta\lambda} \dots \dots (3)$$

To determine from the above equation the sensitivity $G(\lambda)$ as a function of the wave length, the photo-current $i(\lambda)$ must be measured, while the wave length $\lambda(s)$, the corresponding intensity $E(\lambda)$ of the ribbon lamp and the transmitted wave band $\Delta\lambda$ must be known for every position of the slit, which will be defined by an abscissa s . The determination of each of these magnitudes is described below.

The determination of λ and $\Delta\lambda$ as a function of s

If λ is accurately determined as a function of s , the transmitted wave band $\Delta\lambda$ may be calculated. If b is the width of the slit, then to a reasonable approximation we have

$$\Delta\lambda = b \frac{d\lambda}{ds} \dots \dots (4)$$

λ must be determined very accurately as a function of s , since in certain wave bands the ocular sensitivity varies considerably with the wave length, e.g. from 6000 Å to 6010 Å by 2 per cent. To

³⁾ Philips techn. Rev. 4, 71, 1939.

measure within 1 per cent, the error in wavelength measurement must be less than 5 Å. For this the abscissal values s must also be measured very accurately, especially as the dispersion in the red is comparatively small. An accuracy to within 5 Å in the red corresponds to an accuracy of about 0.01 mm in measurement of s . The determination of $d\lambda/ds$ from the function connecting λ and s by differentiating makes the need for a high accuracy still greater: $d\lambda/ds$ has been found by measuring the distance apart of spectral lines situated very close together. The spectra of neon, helium and mercury contain a sufficient number of line pairs suitable for this purpose, the difference in wave length being known for these pairs with sufficient accuracy. To be able to measure the distance of these lines with an accuracy of 1 per cent, the position of each line must be determinable to within 2 microns. The requisite degree of accuracy could be obtained by using a comparator.

After having determined λ and $d\lambda/ds$ in this way, the wave band $\Delta\lambda$ in the spectrum transmitted by the slit could be calculated in a relative measure with the aid of equation (4). The width of the slit was varied for measurements in different parts of the spectrum, such that $\Delta\lambda$ was never greater than 40 Å.

Determination of $E(\lambda)$

The colour temperature of the ribbon lamp was 2 725 deg. abs. with an accuracy of ± 25 deg. The effect of this potential error on the distribution of spectral energy $E(\lambda)$ may be gathered from the accompanying table, which gives for a black-body

Wave length Å	Energy flux at a temperature of	
	2 700 deg. abs.	2 750 deg. abs.
7 000	218.5	211
6 500	176.5	172.5
6 000	133.3	131.8
5 500	92.0	92.5
5 000	56.5	57.6
4 500	29.3	30.6
4 000	12.1	12.9

radiator at 2 700 deg. abs. and 2 750 deg. abs. the relative spectral energy flux per unit of time and per unit of wave band for various wave lengths, the flux at 5 600 Å being put equal to 100 at both temperatures. It is seen that only in the extreme red and in the blue an error of 25 deg. in the colour temperature will cause a deviation of more than 1 per cent in the relative distribution of spectral

energy. In these parts of the spectrum, the ocular sensitivity is, however, so small that the resulting uncertainty has no practical significance whatever.

Measurement of $i(\lambda)$

The photo-current $i(\lambda)$ is the photo-current produced by radiation in the wave band $\Delta\lambda$. As already indicated part of this radiation is scattered, and in calibration this part will not pass through the slit in the spectrum and hence makes no contribution to the value of $i(\lambda)$. It is, however, equal to a constant percentage of the radiation which does pass through, so that its absence alters $i(\lambda)$ only by a factor not depending on λ . As in arriving at the design of the diaphragm, $G(\lambda)$ needs only be known relatively, a correction for this reduction can be dispensed with.

Yet, in calibration, scattered light of other wave lengths also appears, and a portion of this scattered light passes through the slit, giving rise to part of the measured photo-current, so that some correction must be made for it. Take for instance the case when the slit is located in the blue, where the ribbon lamp used for calibration has only a weak radiation intensity. It is evident that then the scattering of the strong red and yellow radiation passing through the slit will produce a serious error, which must be ascertained. This may be done by measuring the photo-currents produced by the scattered red and yellow light separately, using a filter which transmits red and yellow but not blue.

After careful measurement of these corrections for scattered light, the measured photo-currents were corrected. The corrected values of $i(\lambda)$ were used in conjunction with $E(\lambda)$ and $\Delta\lambda$ for calculating $G(\lambda)$.

Having determined the sensitivity, a diaphragm was designed with an aperture at every point of the spectrum which was proportional to $V(\lambda)/G(\lambda)$. This diaphragm is shown in *fig. 5*.

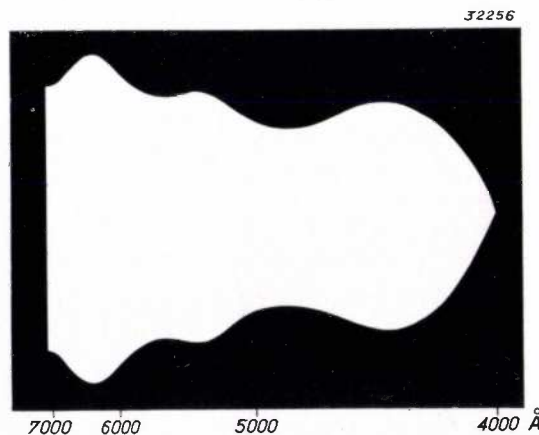

Fig. 5. Shape of diaphragm D used in the physical photometer.

The diaphragm was filed out of a brass plate; to do this accurately a tenfold magnification of the plate was projected on to a sheet of paper on which the diagram was carefully drawn also in a tenfold enlargement. The required shape of diaphragm could then be produced by means of a small file. Using an index for the green mercury line, the diaphragm was then adjusted to the correct point in the spectrum.

Testing the photometer

The photometer can be tested by measuring the intensity ratios of monochromatic light sources with a thermopile and comparing the ratios of luminous intensities calculated from these observations with the results obtained from the photometer. The monochromatic light was produced with the aid of a double monochromator, which in conjunction with a tungsten ribbon lamp furnishes monochromatic radiation of sufficient intensity at wave lengths above 6000 Å to enable measurements with the thermopile to be carried out. Measurements with the photometer can be made without the diaphragm over the spectrum. The maximum differences in comparative measurements at five different wave lengths did not exceed 3 per cent.

To enable measurements to be made also in the yellow and green, the yellow and green mercury lines were filtered out with suitable filters and again measured by both the photometer and the thermopile. At these wave lengths the calibration of the photometer was found to be accurate to within 1 per cent.

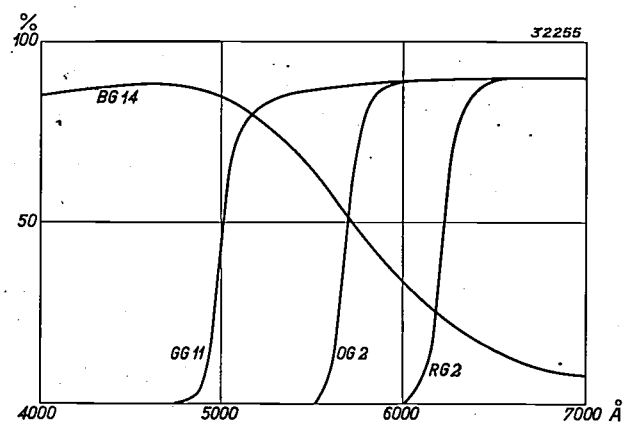

Fig. 6. Spectral transmission curves of the filters used for check measurements.

Finally, to afford a further test of the accommodation to the international luminosity curve, the total transmissibility of several filters for the light of a ribbon lamp, burning at a known colour temperature, was measured with the photometer. In addition, with a double monochromator and a photo-cell the spectral transmission curves of these filters were determined and the theoretical values of the total transmission were calculated from these transmission curves in conjunction with the colour temperature and the international luminosity curve.

The results are given in the following table, which shows that agreement between the measured and the calculated transmission values is very close. Fig. 6 reproduces the spectral transmission curves of these filters, indicating that this test ensures that correct accommodation has been realised.

Filter	Transmissibility	
	Calc.	Measured
Schott BG 14	49.4	49.2
Schott RG 2	11.8	11.9
Schott OG 2	49.5	50.0
Schott GG 11	85.7	86.3

Sensitivity

In visual photometry, it is essential to have a minimum brightness over the field of vision of 8 candles per sq. m. To measure the photo-current with the apparatus described here with an accuracy of 1 per cent, the brightness of the illuminated surface placed in front of the slit must be 130 candles per sq. m. The physical photometer described is, therefore, 16 times less sensitive than the eye, a comparison applying for a slit width of 0.3 mm and a collimator lens with an aperture $f/6.8$. Although the sensitivity is sufficient for practical purposes, it can quite easily be improved eight times by making the slit wider and by using a more powerful collimator lens. The apparatus in question hence satisfies the requirements which must be met by a precision physical photometer, both in affording accurate accommodation of its spectral sensitivity curve and in affording a sensitivity comparable to that obtained in visual photometry.

AN ELECTRON SWITCH

by C. DORSMAN and S. L. de BRUIN.

621.317.755.06

An apparatus is described with which the time function of two different magnitudes can be observed simultaneously on the fluorescent screen of a cathode-ray oscillograph. A number of practical examples are discussed where such investigation is of value, *inter alia*, the simultaneous registration of vibrations at different points of a mechanical system or of the current and voltage conditions in a transformer.

With the aid of a cathode-ray oscillograph, such as the GM 3 152 recently described in this Review¹⁾ the image of an electrical tension can be represented on the fluorescent screen of a cathode-ray tube in relation to a second voltage. If a linear time base is used, the curve of the variation of the voltage with time can then be projected on the screen. In addition, a third variable is available, *viz.*, the intensity of the cathode beam which can be modulated in relation to a third magnitude. In this way two magnitudes can be simultaneously represented as a function of the time, displacements in phase in the magnitudes under measurement being revealed in the projected images. But this method does not reveal any small variations in the third magnitude, so that it becomes essential to devise an apparatus for registering two curves simultaneously showing the variation with time of two different voltages. Apparatus designed for this purpose have often

been described in the literature, and their underlying principle has also been discussed in this Review²⁾. The present article gives a description of an apparatus, the so-called electron switch GM 4 196, which has been devised for this purpose, together with details of certain of its applications. A view of the measuring outfit, consisting of the electron switch and its associated cathode-ray oscillograph GM 3 152, is shown in *fig. 1*.

Method of operation of the electron switch

A circuit is shown in *fig. 2* with which the time functions of two electrical tensions V_A and V_B can be represented simultaneously. These two voltages are impressed on the control grids of the two pentodes L_A and L_B , and an alternating voltage of

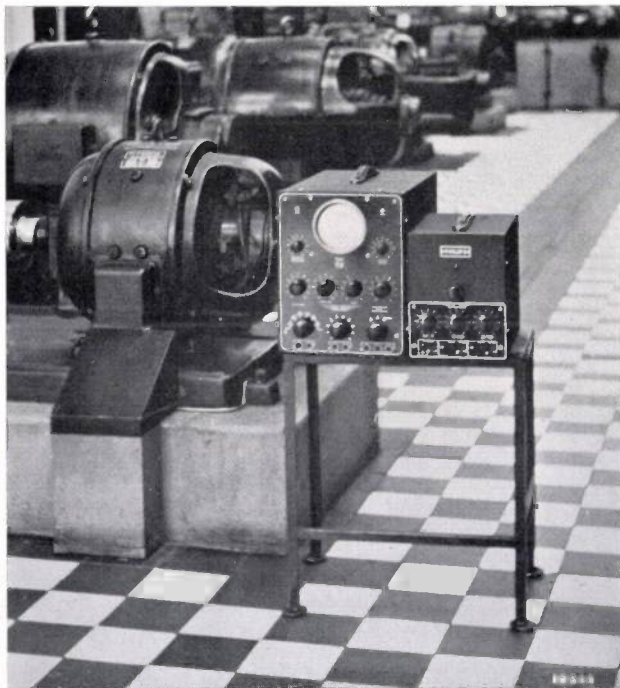

Fig. 1. Measuring arrangement comprising an electron switch, Type GM 4 196, and the associated cathode-ray oscillograph, Type GM 3 152.

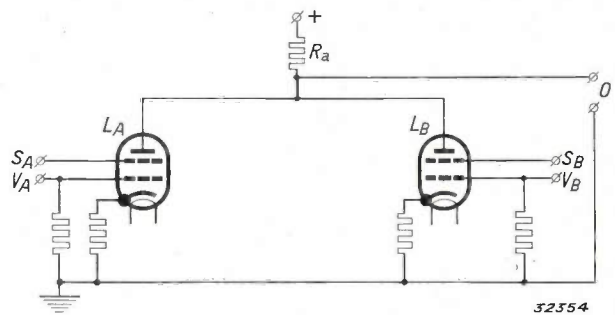

Fig. 2. The two voltages V_A and V_B to be observed simultaneously by the cathode-ray oscillograph O are applied to the control grids of the pentodes L_A and L_B . The switching voltages S_A and S_B varying rectangularly with time are applied to the screen grids. The anodes of L_A and L_B are connected through a common anode resistance R_a to a constant positive voltage.

10 000 cycles frequency varying rectangularly with time is applied between the two screen grids. This voltage is of such a magnitude that the two valves L_A and L_B alternately either function in the normal way or are in such a state that no anode current passes through the valve. In consequence of this, a current passes through the common anode resistance R_a which flows alternatively through L_A and L_B and is hence controlled in turn by the tensions V_A and V_B at the control grids of L_A and L_B . The voltage through R_a thus fluctuates with a fre-

¹⁾ Philips techn. Rev. 4, 210, 1939.

²⁾ Cf. also Philips techn. Rev., 3, 154, 1938.

quency of 10 000 c/s between two values which are determined by V_A and V_B respectively. If, now, the anode voltage is applied to the first pair of deflecting plates of the cathode-ray oscillograph O , while a linear time base is applied to the other pair of plates, an image of the type shown in fig. 3 will be projected on the screen.

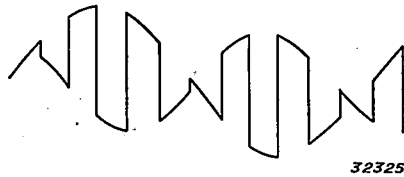

32325

Fig. 3. Oscillograph image obtained when two oscillograms are registered simultaneously with the aid of the electron switch. Actually the number of impulses is, of course, much greater than sketched here.

To ensure that the light spot travels sufficiently swiftly between the projected curves (fig. 3) of V_A and V_B , the amplifier must be suitable for amplifying a rectangular oscillation of 10 000 cycles per sec. It must, therefore, be able to amplify not only the fundamental wave of 10 000 cycles but also have roughly the same gain for a large number of harmonics of this fundamental wave. In the cathode oscillograph GM 3152 the gain remains practically constant up to 10^6 cycles, so that the hundredth harmonic is not yet severely attenuated.

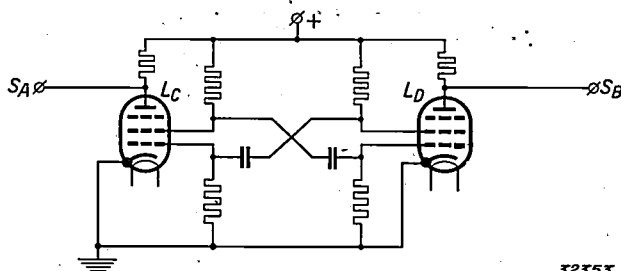

32353

Fig. 4. Circuit for generating the switching voltages S_A and S_B varying rectangularly with time, at the anodes of the pentodes L_C and L_D , whose control and screen grids are capacitively coupled with each other.

Fig. 4 shows the circuit used for obtaining the alternating voltage varying rectangularly with time and which is required for the screen grids of L_A and L_B . In principle this circuit represents a multivibrator as designed by Abraham and Bloch. Between the two corresponding pentodes L_C and L_D two condensers are connected which link the control grid of each of these valves with the screen grid of the other valve of the pair. The state of equilibrium, which would be obtained if the voltages of the control grids for the two valves were equal, and likewise those of the screen grids for the two valves, is found not to be stable. If, for instance, at a certain moment the voltage at the

control grid of L_C is too high the current through L_C will increase, so that a greater amount of current will have to be dissipated by the screen grid resistance of L_C , which will reduce the screen grid voltage of L_C and owing to the capacity coupling also cut down the control grid voltage of L_D . A lower current will then flow through L_D and the screen grid current of L_D will fall, and hence the voltage at the screen grid of L_D will rise. The presence of the capacity coupling will then also raise the voltage at the screen grid of L_C . The condition of the circuit hence will be labile, since we started with the assumption that the control grid voltage at L_C was already too high. The increase in the voltage at the screen grid of L_D is limited by the anode voltage to which the screen grid is connected over a resistance. If the screen grid voltage of L_D cannot increase further, the control grid of L_C will discharge itself through its resistance leak, with the result that the whole process will be repeated in the opposite direction. The relaxation time of this oscillation is hence determined by the capacity and the leak resistance of the control grid.

If now the anode voltages of L_C and L_D , which vary roughly rectangularly with the time, are applied to the screen grids of L_A and L_B , these valves will be working or idle in turn, so that the amplified voltage V_A and V_B are applied alternately to the deflecting plates of the cathode-ray tube. Since the oscillator circuit lies between the screen grids of L_C and L_D , while the reversing voltages are taken from the anodes of these valves, the oscillator is practically unaffected by the voltages which may be applied to the valves L_A and L_B and which are to be registered by the oscillograph.

Assume that the voltages V_A and V_B to be registered have constant values and are equal to one another and that changing-over takes place instantaneously by means of pure rectangular anode voltages of L_C and L_D , the total anode voltage of

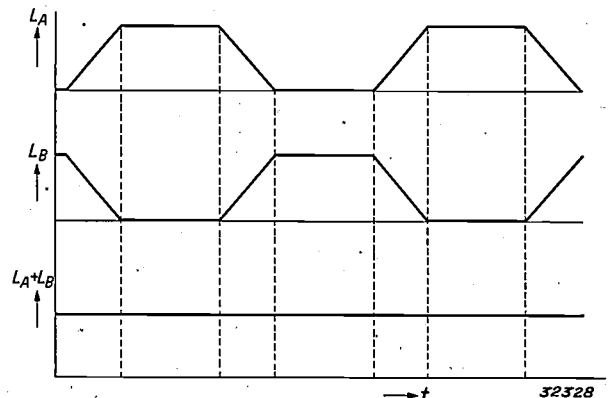

32328

Fig. 5. Anode currents of the pentodes L_A and L_B if they are increased and decreased linearly with time.

L_A and L_B will then also be constant and there will be no indication on the screen of the changing-

smooth curves become visible on the screen. To obtain this result it is not enough to make the switching signals purely rectangular, so as to obtain a swift change-over from one image to the other, but, in addition, the frequency of reversal per second must be made so great that the large number of small dashes appear to the eye to merge into a smooth and continuous curve. If a switching frequency of 10 000 cycles per sec. is employed, the oscillogram of a function with a periodicity of 50 will show practically no breaks, as may be seen from fig. 8. Furthermore, the tenth harmonic of 50 cycles, whose frequency is 1/20 of the switching frequency, will also still have a satisfactory outline. If a switching frequency lower than 10 000 cycles were used, the subdivision of the oscillation of 500 cycles would become too coarse, while if the periodicity were made very much greater than 10 000 c/s difficulties would arise in obtaining switching signals with a sufficiently rectangular

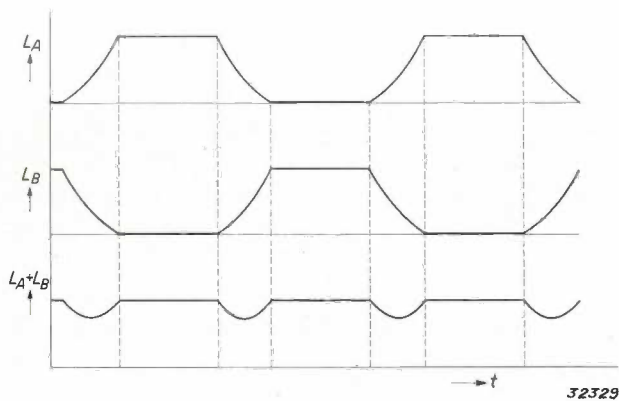

Fig. 6. Actual shape of the time functions of the anode currents of L_A and L_B and of $L_A + L_B$.

over operation. This would still be the case if the anode currents of L_A and L_B during changing-over varied linearly with the time as shown in fig. 5.

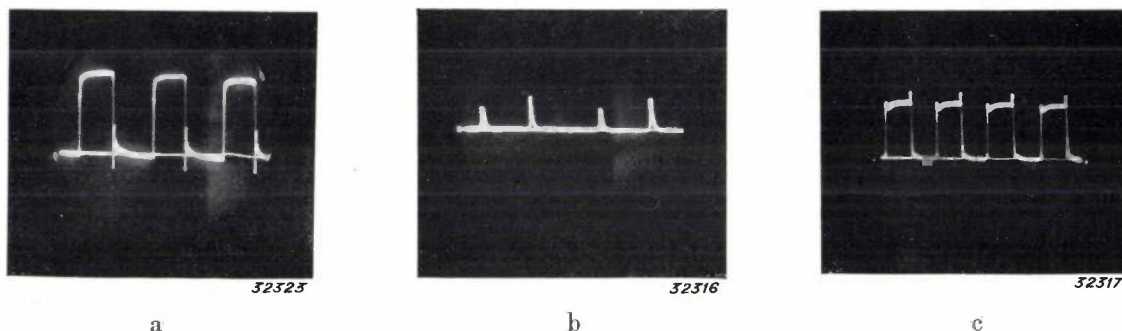

Fig. 7. The shape of the switching voltages S_A and S_B is shown in fig. a). The shape of the oscillogram for $V_A = V_B$ is shown in fig. b), and for $V_A \neq V_B$ in fig. c).

Actually, however, the flanks of the anode current impulses of L_A and L_B are always curved (fig. 6), so that the total anode current which passes through R_a , and hence the tension across R_a , will show small troughs. The voltage between anode and earth, which is passed to the oscillograph, will therefore reveal small peaks at the moments of changing over from one of the voltages to be registered to the other, both when the two voltages are equal and when they differ (fig. 7). These unavoidable irregularities can, however, be minimised by making the current impulses as steep as possible, when the peaks are barely visible, as shown in fig. 8.

time function, since the capacity of the current-carrying parts gives too low an impedance for these high frequencies.

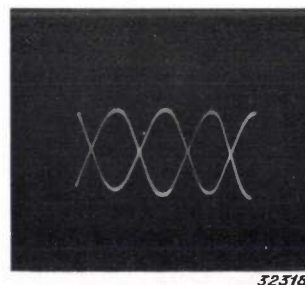

Fig. 8. With the electron switch two curves are obtained which to the eye appear to have a continuous outline.

Shape of projected curves

The curves registered simultaneously by the oscillograph when using the electron switch are made up of short dashes which must follow each other in such close succession that fairly sharp and

Registration of mechanical oscillations

To register mechanical oscillations with a cathode-ray oscillograph, these must first be converted into electrical voltages, for which e.g. an electrodynamic system can be employed: an electrical coil moves

in the field of a permanent magnet (*fig. 9*), the coil being attached to the object whose vibrations are under investigation.

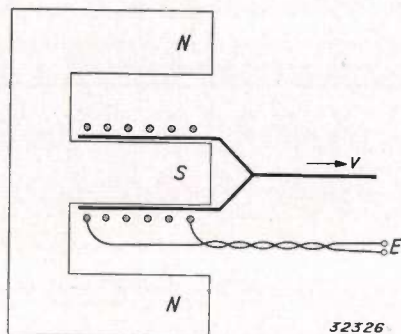

Fig. 9. A coil oscillates in the field of a stationary magnet with north-pole *N* and south-pole *S*. In the moving coil electrical tensions *E* are induced which are proportional to the velocity of deflection *v*.

In the moving coil an electrical voltage is induced which is proportional to the velocity provided the deflections sustained are not too great. If the oscillations at two different points of a mechanical system are imparted to two different coils, both oscillations can be registered simultaneously by a cathode-ray oscillograph with the aid of the electron switch, thus permitting direct visual comparison with respect to amplitude and phase.

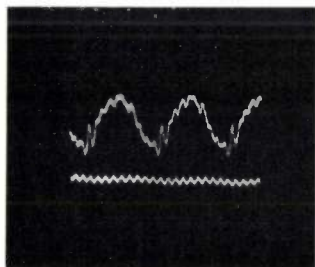

Fig. 10. The large amplitude represents the mechanical vibration of an electric motor, while the small amplitudes reproduce an alternating voltage with a standard frequency of 500 cycles per sec.

The voltage induced by a mechanical vibration can also be registered in conjunction with another magnitude on the screen of the cathode-ray tube; thus in *fig. 10* the vibrations of an electric motor (with a large amplitude) are compared with an alternating voltage of 500 cycles as normal frequency (small amplitude). This comparison shows that the frequency of the fundamental wave of the vibration is 53 cycles, so that the motor is running at a speed of about 3 200 r.p.m. The fundamental wave of the oscillation also contains a number of notches; this oscillation of much higher frequency has been produced by one of the moving parts rubbing at some point or other. The frequency of this disturbance is 530 cycles.

Phase displacements between currents and voltages

It is frequently important in the examination of electrical plant to determine not only the time functions of various currents and voltages but also to know the phase relations of these magnitudes. With the aid of the electron switch, both current and voltage may be projected simultaneously on to the screen of an oscillograph, so that the phase relations are directly visible. In an issue of this Review which appeared last year, the combined oscillograms of currents and voltages of a gas discharge lamp were reproduced and discussed. Another example may be mentioned here, *viz.* the current and voltage conditions in a circuit containing a transformer with an iron core so highly saturated that the secondary voltage remains practically constant when large variations occur in the primary voltage. The principle of operation of a stabiliser of this type (*fig. 11*) has already been

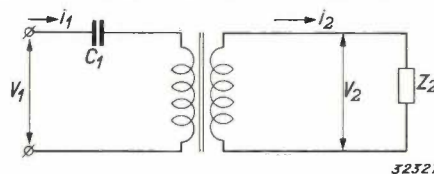

Fig. 11. Circuit of a transformer with a highly-saturated iron core, as a result of which the secondary voltage remains practically constant, although the primary voltage may fluctuate widely. V_1 and V_2 are the primary and secondary voltages respectively, and i_1 and i_2 the primary and secondary currents. Z_2 is the load, which is principally capacitive (an apparatus for anode-volts).

described in this Review⁴). If a pure sinusoidal voltage is applied to the primary side, a voltage which is heavily flattened (*fig. 12a*), *i.e.* with a considerable amount of third harmonic, is obtained on the secondary side owing to the high saturation of the iron. The curve of the primary current also indicates a pronounced third harmonic, which,

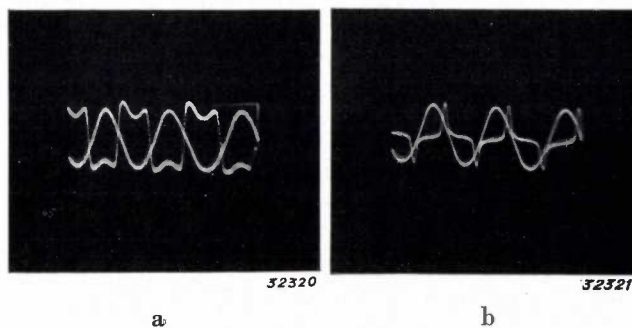

Fig. 12. The sinusoidal curve represents the primary voltage impressed on the transformer; the flattened curve in *a*) is the secondary voltage, and the peaked curve in *b*) the primary current, which both have a pronounced third harmonic.

³) Philips techn. Rev. 3, 156, 1938.

⁴) Philips techn. Rev., 2, 279, 1937.

however, augments the maxima, as may be seen clearly in fig. 12*b*. Furthermore the figure reveals that both primary current and secondary voltage are somewhat delayed with respect to the primary voltage.

Registration of pulsating direct voltages

As ordinary electrical amplifiers only amplify alternating voltages, an oscillograph will usually reveal only the A.C. component of pulsating direct voltage. One of the main advantages of the electron switch is that it enables us to study also the direct-voltage component with the oscillograph, since it converts the direct voltage into an alternating voltage of the switching frequency used, and for which the amplifier of the oscillator happens to be particularly suitable.

In the oscillograms in fig. 13 the two curves show the zero line of the voltage and the pulsating direct voltage of a source of anode voltage. With a low

load of 100 milliamps the ripple of this direct voltage is obviously only small (fig. 13*a*), while a pronounced pulsation is shown with a heavy load of 500 milliamps (fig. 13*b*).

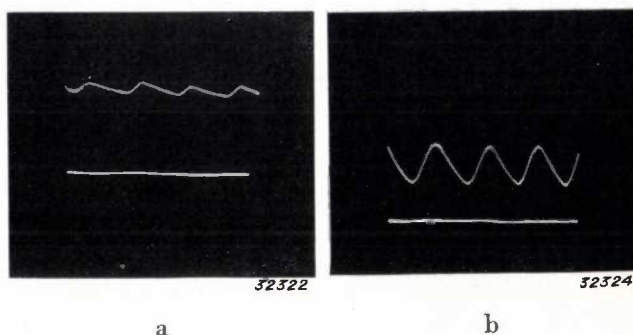

Fig. 13. The oscillogram of a pulsating direct voltage as well as the zero line can be registered with the electron switch. a) The voltage of an anode-volts supply reveals a small ripple at a load of 100 milliamps. b) At a load of 500 milliamps the curve shown in a) acquires a heavy pulsation.

AN ELECTRICAL MEGAPHONE

by J. de BOER.

621.395.61

A portable electrical voice amplifier, the "Portaphone" Type No. 2 831, has been devised to obtain a greater range of the human voice than when speaking normally without directive aids or when using an ordinary megaphone. This apparatus increases the intensity of the sound energy 30 to 100 times the gain realised with an ordinary megaphone. Hence, the range of the voice is 5 to 10 times larger with the "Portaphone" than with an ordinary megaphone.

In ordinary speech the range of the human voice is not very great, and various means have therefore been devised for increasing the range to which the voice will carry. The oldest of these aids is the speaking tube or megaphone which was invented about the middle of the seventeenth century by the German divine Kircher and the Englishman Morland. Its action consists in imparting a directivity to the sound waves so that they are concentrated into a narrow beam with a small solid angle. Recent developments in amplifying technology have, however, raised the question whether better results in the transmission of the human voice over great distances could not be realised with the aid of a simple electrical amplifier. While retaining the concentrating effect of the megaphone horn, an apparatus of this type would moreover provide a source of sound which is more powerful than the human voice.

In constructing such a simple voice amplifier, the first requirement is to arrive at maximum convenience in use. The loudspeaker, horn, and microphone should form a compact unit which can be conveniently carried in the hand, while the electrical amplifier may be accommodated in a separate case. The "Portaphone", Type No. 2 831, which has been designed on these general lines, is shown in fig. 1; the carbon microphone is mounted in the loudspeaker which also carries a horn and a handle with switch. The flat case containing the electrical amplifier is carried by a strap; its total weight is 6.8 kg. and in addition to the amplifier also holds a 2-volt accumulator to furnish the filament current and to feed the microphone, as well as dry batteries for the grid and anode voltages up to 150 volts. The electrical gain is approximately 40 decibels. The acoustical gain is somewhat lower owing to losses in microphone and loudspeaker (*cf.* at the end of

however, augments the maxima, as may be seen clearly in fig. 12*b*. Furthermore the figure reveals that both primary current and secondary voltage are somewhat delayed with respect to the primary voltage.

Registration of pulsating direct voltages

As ordinary electrical amplifiers only amplify alternating voltages, an oscillograph will usually reveal only the A.C. component of pulsating direct voltage. One of the main advantages of the electron switch is that it enables us to study also the direct-voltage component with the oscillograph, since it converts the direct voltage into an alternating voltage of the switching frequency used, and for which the amplifier of the oscillator happens to be particularly suitable.

In the oscillograms in fig. 13 the two curves show the zero line of the voltage and the pulsating direct voltage of a source of anode voltage. With a low

load of 100 milliamps the ripple of this direct voltage is obviously only small (fig. 13*a*), while a pronounced pulsation is shown with a heavy load of 500 milliamps (fig. 13*b*).

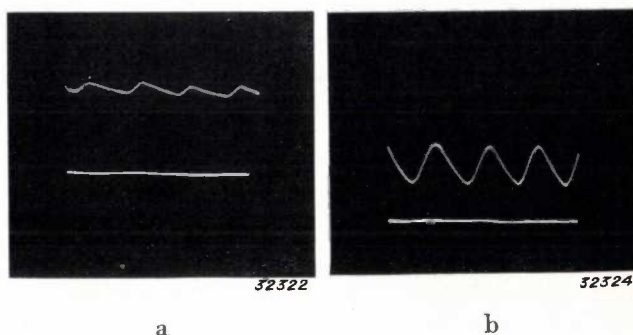

Fig. 13. The oscillogram of a pulsating direct voltage as well as the zero line can be registered with the electron switch.
 a) The voltage of an anode-volts supply reveals a small ripple at a load of 100 milliamps.
 b) At a load of 500 milliamps the curve shown in a) acquires a heavy pulsation.

AN ELECTRICAL MEGAPHONE

by J. de BOER.

621.395.61

A portable electrical voice amplifier, the "Portaphone" Type No. 2 831, has been devised to obtain a greater range of the human voice than when speaking normally without directive aids or when using an ordinary megaphone. This apparatus increases the intensity of the sound energy 30 to 100 times the gain realised with an ordinary megaphone. Hence, the range of the voice is 5 to 10 times larger with the "Portaphone" than with an ordinary megaphone.

In ordinary speech the range of the human voice is not very great, and various means have therefore been devised for increasing the range to which the voice will carry. The oldest of these aids is the speaking tube or megaphone which was invented about the middle of the seventeenth century by the German divine Kircher and the Englishman Morland. Its action consists in imparting a directivity to the sound waves so that they are concentrated into a narrow beam with a small solid angle. Recent developments in amplifying technology have, however, raised the question whether better results in the transmission of the human voice over great distances could not be realised with the aid of a simple electrical amplifier. While retaining the concentrating effect of the megaphone horn, an apparatus of this type would moreover provide a source of sound which is more powerful than the human voice.

In constructing such a simple voice amplifier, the first requirement is to arrive at maximum convenience in use. The loudspeaker, horn, and microphone should form a compact unit which can be conveniently carried in the hand, while the electrical amplifier may be accommodated in a separate case. The "Portaphone", Type No. 2 831, which has been designed on these general lines, is shown in fig. 1; the carbon microphone is mounted in the loudspeaker which also carries a horn and a handle with switch. The flat case containing the electrical amplifier is carried by a strap; its total weight is 6.8 kg. and in addition to the amplifier also holds a 2-volt accumulator to furnish the filament current and to feed the microphone, as well as dry batteries for the grid and anode voltages up to 150 volts. The electrical gain is approximately 40 decibels. The acoustical gain is somewhat lower owing to losses in microphone and loudspeaker (*cf.* at the end of

this article). The amplifier furnishes an output of 3 watts with a non-linear distortion factor of 5 per cent, and an output of 4 watts with a non-linear distortion factor of 12.5 per cent. The accumulator requires recharging after every five-hours use.

An important factor in the construction of a simple voice amplifier of this type is the method of fixing the microphone on the loudspeaker; for, if suitable precautions are not taken, the mechanical or acoustic coupling between these components may be made too rigid. A mechanical coupling may result by the loudspeaker frame im-

$\omega/2\pi$, x may be represented by the expression:

$$x = a \sin \omega t. \quad (1)$$

Neglecting damping the deflection of the microphone will then be:

$$y = \frac{a \sin \omega t}{1 - \left(\frac{\omega^2}{\omega_0^2}\right)}, \quad (2)$$

where $\omega_0/2\pi$ is the resonance frequency for a mass M attached to a spring with rigidity S . If a sufficiently slack spring is used to make this resonance frequency much lower than the lowest frequency

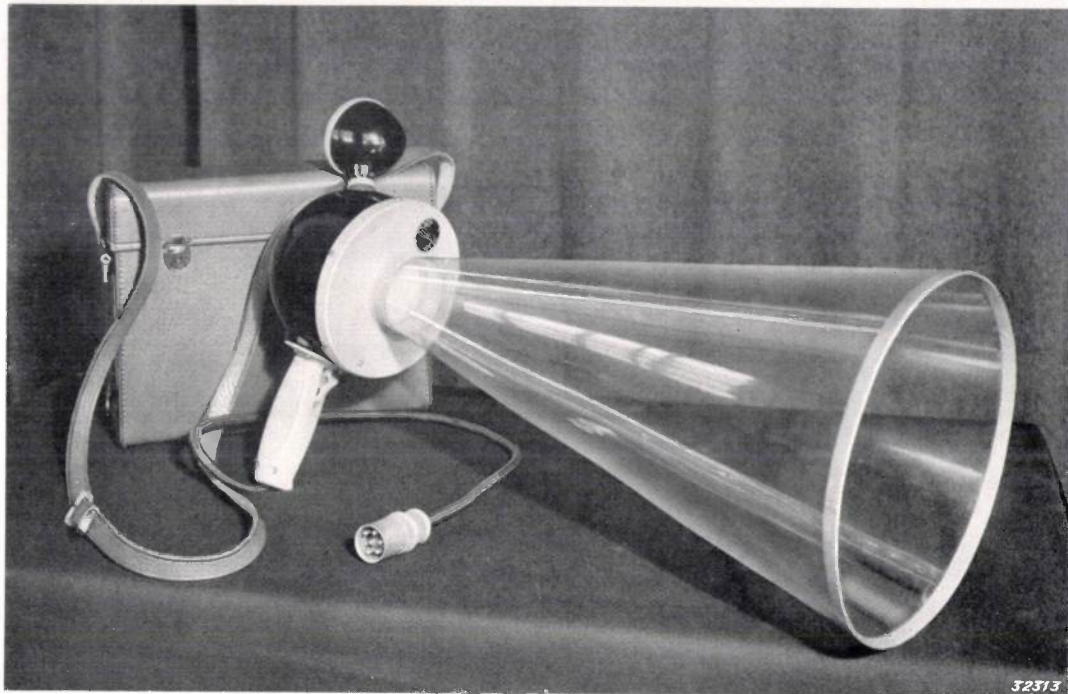

Fig. 1. The "Portaphone", Type No. 2831, consisting of a microphone attached to a horn loudspeaker mounted on a handle, and an electrical amplifier in a flat case carried by a strap.

parting vibrations to the microphone, and an acoustic coupling by the sound waves on leaving the horn being deflected to such a degree that part of them again strike the microphone. The two couplings must be sufficiently reduced, so that the whole system, with a given sensitivity, remains stable.

To reduce the mechanical coupling the microphone is given a spring suspension, whose action may be discussed with reference to *fig. 2* in which the principle of the arrangement is shown. The amplitudes y produced in the microphone with mass M should be small as compared with the deflections x of the frame C to which the microphone is attached by a spring with a rigidity S . If the frame is subject to harmonic oscillation with a frequency

at which it is sought to avoid mechanical coupling ($\omega_0 \ll \omega$), the amplitude y of the microphone will be much smaller than that of the frame. In fact at very high frequencies the amplitude y will diminish with the square of the frequency: $y \sim -(\omega_0/\omega)^2 x$.

The acoustic coupling can be limited in magnitude by making the horn not too short, so that the mouth of the horn and the microphone are placed far enough apart; on the other hand if the horn is made too large the apparatus becomes too clumsy to handle and acoustic coupling must then be avoided by other means. A very important factor here is the point at which the microphone must be attached to the loudspeaker. The sound pressure is the same in all spacial directions behind the loudspeaker when the wave length is large

compared to the dimensions of the loudspeaker, *i.e.* for sufficiently low-pitched notes; thus, for these notes it is immaterial where the microphone is attached to the loudspeaker. For high-pitched notes, however, the sound pressure behind the

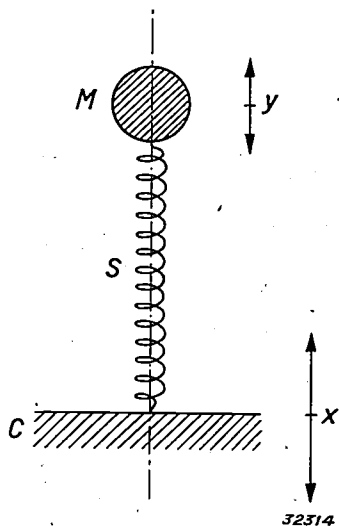

Fig. 2. Sketch of the spring suspension of the microphone of mass M at a spring with a rigidity S , which is attached to the frame C . A displacement x of the frame causes a displacement y of the microphone, which must be much smaller than x .

loudspeaker is by no means constant, and the microphone preferably must be fixed in a point, where the sound pressure is a minimum. Except for simple geometrical bodies, such as a sphere or a cylinder, a calculation of the pressure at the rear of the speaker is usually not practicable. It may only be stated that in the case of a solid of rotation the sound pressure is a maximum along the rear axis. On a model of our loudspeaker, the distribution of sound pressure was therefore measured at different frequencies, the results being shown in *fig. 3* with frequencies of 1 000 (*A*) and 2 000 cycles per sec (*B*). The best position for the microphone is roughly at an angle of 45 deg. to the rear and is marked with a circle.

To limit the acoustic coupling at low frequencies, the sensitivity of the amplifier must be reduced for these frequencies, which can be done without affecting the intelligibility (*cf.* R. Vermeulen, Philips techn. Rev. 3, 140, 1938). This cutting-off of the low-pitched notes may be done in either

the amplifier, the loudspeaker (by introducing a high resonance frequency), or the horn: according to the dimensions of the latter, notes below a certain frequency will be radiated with a lower intensity. In our design we used a conical horn with an angle at the apex of approximately 20 deg., the limiting frequency being in the region of 300 cycles. The electrical amplifier and the loudspeaker, also, are less responsive to tones below 300 cycles than to higher tones.

The electrical megaphone, shown in *fig. 1*, amplifies the human voice by 25 or 30 decibels, according as the electrical gain is partly or wholly utilised. This efficiency is quite satisfactory, if it is remembered that an ordinary megaphone gives a gain of only 10 decibels corresponding to an increase of the range of the human voice by about three times. With the "Portaphone", however, this range is increased 15 to 30 times. If there is little extraneous noise in the vicinity, the voice can thus be heard intelligibly to a distance of over 300 m when speaking normally.

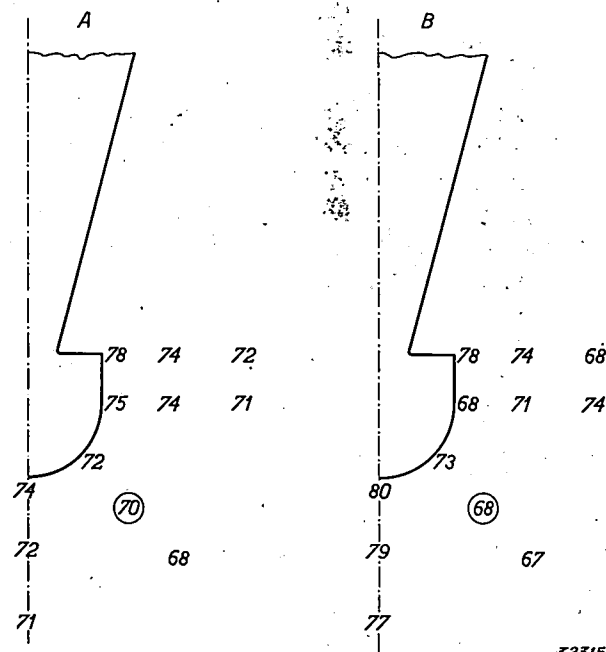

Fig. 3. Measurements of the sound pressure in the neighbourhood of the "Portaphone", this pressure being expressed in decibels above an arbitrary base level, *A* at 1 000 and *B* at 200 cycles per sec. The best position for the microphone is marked by a small circle.

ABSTRACTS OF RECENT SCIENTIFIC PUBLICATIONS OF THE N.V. PHILIPS' GLOEILAMPENFABRIEKEN

1396*: F. A. Heyn: The reaction between neutrons and matter (1). (in the Dutch periodical: Ned. T. Natuurk. 6, 25-50, Feb. 1939).

This article gives a survey of the different reactions which may take place between neutrons and atomic nuclei.

1397: W. Uytterhoeven et C. Verburg: Température des électrons T_e dans une décharge en colonne positive à courant alternatif (50 périodes par seconde). Résultats pour le néon. (C. R. Acad. Sci. Paris 208, 269-271, Jan. 1939).

According to the method described in 1380 at each phase of the 50 period alternating current the electron temperature is measured in neon in a positive column discharge. The current-voltage characteristics of the probe electrodes have the same form as for direct current. The variation of the electron temperature with time is found analogous to the variation of voltage at the terminals of the lamp. The electron temperature with an alternating current discharge at a pressure of 70 mm is not constant over the whole cross section, but is higher along the axis than at the circumference, while with a direct current discharge the electron temperature does not depend upon the distance from the axis. In order to obtain the necessary homogeneity and stability of discharge for the measurement, low tension arcs were introduced at the electrodes as auxiliary discharges.

1398*: W. G. Burgers: Metallographic investigation with the electron microscope (in the Dutch periodical: Polytechn. Wkbl. 33, 17-18, Jan. 1939, and 38-40, Feb. 1939).

This is a survey of the material contained in earlier publications of the same author, for which we may refer to: Philips techn. Rev. 1, 312, 321, 1936.

1399: J. L. Snoëk: Magnetic aftereffect and chemical constitution (Physica 6, 161-170, Feb. 1939).

*) An adequate number of reprints for the purpose of distribution is not available of those publications marked with an asterisk. Reprints of other publications may be obtained on application to the Natuurkundig Laboratorium, N.V. Philips' Gloeilampenfabrieken, Eindhoven (Holland), Kastanjelaan.

By means of a series of heat treatments in an atmosphere of a precisely determined composition it is proved that the ferromagnetic retardation phenomena described in 1339 (dependence on time, not only of the induction but also of the permeability) were caused by the presence of a small amount of carbon (about 0.008 %) in the otherwise very pure iron. Entirely analogous phenomena occur when equal quantities of nitrogen are added to the same iron. The constant r_1 from the formal theory of 1339 is found to be proportional to the concentration of nitrogen (carbon). A tentative theory of the specific action of these two elements is proposed, which is based on the great mobility of these atoms. It is assumed that the atoms of nitrogen (carbon), under the influence of magnetostrictive forces, diffuse out of or into the boundary layers between the elementary ferromagnetic regions.

1400*: M. J. Druyvesteyn und J. G. W. Mulder: Fortschritte auf dem Gebiete der Lebensdauer von Gleichrichterröhren mit Oxydkathode und Gasfüllung (in the Czech periodical: Slaboproudý Obzor 4, 1-4, Jan. 1939).

A survey is given of experiments on cathode sputtering and the disappearance of gas during discharge with different forms of hot cathode and different kinds of gas filling. It is found that at pressures of less than 1 mm, discharge tubes filled with krypton and xenon have a surprisingly long life and are particularly adapted for use as rectifier valves.

1401: W. Uytterhoeven et C. Verburg: Température des électrons T_e dans une décharge en colonne positive à courant alternatif (50 périodes par seconde). Mesures dans un mélange Ne-Na (lampes à vapeur de sodium). (C. R. Acad. Sci. Paris, 208, 503-505, Feb. 1939).

According to the method described in 1380 the electron temperature is measured at each phase of the alternating current of 50 periods in a mixture of sodium and neon such as exists in sodium lamps. The terminal voltage and the electron temperature at different distances from the axis are given as a function of the phase. At the beginning of a phase the sodium atoms are still distributed uniformly over the whole cross section of the tube, so that

the electron temperature then has practically the same low value throughout the entire tube. As the current increases the available sodium atoms disappear due to ionization; the electron temperature thus rises, beginning at the axis of the discharge, since the current density is greatest at that place. When the current is at a maximum, the electron temperature is much higher along the axis of the tube than at its circumference.

1402: J. D. Fast: The preparation of pure titanium oxides (Rec. Trav. chim. Pays Bas **58**, 174-180, Feb. 1939).

A method is described for the preparation of the pure tetra, tri and diiodides of titanium. Upon heating the triiodide above 350°C in a high vacuum it decomposes into di and tetraiodide. If the diiodide is heated in a high vacuum above 480°C it decomposes partially into titanium and the tetraiodide of titanium, while at the same time part of it evaporates without decomposing. The gas phase in equilibrium with solid titanium iodide therefore consists of a mixture of tetra and diiodide. Several other properties of the iodides are discussed.

1403: C. J. Bakker and G. Heller: On the Brownian motion in electric resistances (Physica **6**, 262-274, Mar. 1939).

It is shown in this article how it is possible to derive from very general statistical considerations that the variation in the mean square of the voltage V on a resistance R in a frequency region $\Delta\nu$ at the absolute temperature T can be represented by the well known expression: $\Delta V^2 = 4 k TR \Delta\nu$. The influence of the chance of collision of the electrons is further dealt with making use of Fermi and Boltzmann statistics.

1404: W. Elenbaas: Ueber das kontinuierliche Spektrum des Quecksilberbogens (Physica **6**, 299-302, Mar. 1939).

The expression derived by Unsöld for the intensity of the continuous spectrum of the high-pressure mercury arc is tested carefully by measurements. The intensity measured is found to be about ten times as great as that calculated. Due to the inaccuracy of various quantities used in the calculation, an inaccuracy of this order of magnitude can, however, be fully explained, so that it is still possible that Unsöld's formula is quite correct.

1405*: M. J. O. Strutt: Etages à haute fréquence, étages changeur de fréquence et détecteur des récepteurs de télévision (Onde él. **18**, 14-26 and 83-91, Jan. and Feb. 1939).

It is shown that the input signals in television must be at least 1 or 2 millivolts in order that they may be higher than the noise level. This fact necessitates an amplification of about 5 000 between the aerial and the second detector. A scheme for a receiver used by Philips in 1936 is described and two newly developed schemes are discussed. Direct high-frequency amplification is described in which two new valve types are used in the three stages between aerial and second detector. The construction of an experimental installation is discussed as well as measurements carried out on this installation. The calculations and measurements led to a general study of the conditions which the valves in television receivers must satisfy. A mixing stage is then described and a corresponding superheterodyne television receiver in which the newly developed valves are used. In conclusion the conditions are studied which must be satisfied by a diode used as second detector in a television receiver. A new diode is described which is suitable for this purpose.

A similar article (1427) by the same author has since appeared in the *Wireless Engineer* **16**, 174-187, Apr. 1939, reprints of which are available, and to which we may refer for further information.

1406: W. Elenbaas: The temperature in the high pressure mercury discharge tube (Phys. Rev. **55**, 294-296, Feb. 1939).

Various arguments are presented which confirm the opinion that the temperature of the gas and of the electrons in a high pressure mercury discharge decreases very gradually from the centre toward the walls, and does not, as indicated by Adams and Barnes, remain constant over a large part of the cross section and decrease very rapidly close to the wall. It is shown moreover that the difference between gas temperature and electron temperature is considerably smaller than Adams and Barnes assume.

1407-1408: J. M. Stevels: New aspects on the cohesion of simple compounds (Rec. Trav. chim. Pays Bas **58**, 229-243 and 244-256, Mar. 1939).

It is shown that the contribution of the partial dipole moments to cohesion can better be described as a Keesom effect in a general sense, as was recently proposed by Staverman. The Debye effect must then be considered as mainly due to the total dipole moment of the molecules. On this basis various difficulties, which were until now encountered in the theory of boiling points, can

be solved. A complete survey is given of all the phenomena which influence the boiling point. Theoretically the sum of the contributions of the Debye and Keesom effects to the boiling point of halogen compounds of methane, ethane and ethylene must be about constant. It is shown that this is also true experimentally. A complete list of boiling points is given of the compounds of ethane and ethylene, and those of the methane compounds are given in so far as they have not been published by van Arkel and his collaborators. The boiling points are divided into different parts due to the different kinds of cohesion effects. The so called anomalies in the boiling points of the two 1,2 isomers of $C_2H_2J_2$ and C_2H_2ClJ can now also easily be understood.

1409: J. D. Fast: Über die Darstellung der reinen Metalle der Titangruppe durch thermische Zersetzung ihrer Jodide. V. Titan (Z. anorg. allg. Chem. 241, 42-56, Mar. 1939).

A description is given of the preparation of ductile titanium by thermal decomposition of titanium iodide on a hot wire, and of the preparation of the necessary crude titanium. When porous lumps of titanium with dimensions of several centimetres are used, such as can be obtained by the reduction of titanium tetrachloride with sodium, and with the core wire heated to a suitable temperature (1300 °C for instance), the metal is not deposited on the core at any desired high temperature of the Pyrex glass reaction vessel. Between 50 and 250 °C and above 470 °C the metal is formed on the wire, but between 250 and 470 °C the core wire does not grow. When the reaction vessel has once been heated above 400 °C the reaction can no longer take place at any temperature under 470 °C. This is due to the reaction occurring above 100 °C between titanium tetraiodide and excess titanium in which one or two lower iodides are formed. In the low temperature range the vapour consists only of TiI_4 , but at higher temperatures it also contains TiI_2 . Small quantities of oxygen and nitrogen which may be present in considerable amount in solid solution, destroy the ductility of titanium. For various other impurities, such for example as iron, the ductility is not so sensitive. If one begins with crude titanium con-

taining 3.5% of iron, titanium rods can be obtained in the high temperature range which contain so little iron and silicon that they can only be detected spectroscopically.

1410: F. A. Heyn, A. H. W. Aten jr. and C. J. Bakker: Transmutation of uranium and thorium by neutrons (Nature 143, 516-517, Mar. 1939).

With the aid of the extremely strong source of neutrons of the Philips X-ray Laboratory the experiments of Hahn and Straßmann were continued. It was found that with a bombardment by slow neutrons a radioactive gas was formed from uranium. Nitrogen was allowed to bubble through a saturated solution of uranyl nitrate which was being irradiated. The nitrogen was then led through a vessel containing water. When salts of caesium, rubidium, barium, strontium and lanthanum are added afterwards to the water, radioactive substances are found to be precipitated together with caesium, rubidium and barium. The half lives of these substances were determined. The results led to the conclusion that the nucleus of the uranium atom can disintegrate in at least two different ways with the formation of xenon and krypton respectively. Several reactions are indicated.

The authors also bombarded thorium with fast neutrons from a lithium-deuterium source and found various radioactive components to be present in the alkali metal and alkaline earth metal precipitate.

1411: J. L. Snoek: Magnetic studies in the ternary system Fe-Ni-Al (Physica 6, 321-331, Apr. 1939).

Measurements of the internal demagnetization show that alloys of different compositions upon slow cooling become heterogeneous and change from the composition two atoms of iron against one of Ni and one of Al to practically pure Ni-Al. After quenching at 1200 °C and annealing at 500 °C the magnetic saturation is practically proportional to the iron content. When the alloys are cooled slowly to 500 °C and annealed at that temperature, a disturbance occurs between 10 and 60 atom per cent of iron which may be ascribed to a facecentred phase.

Philips Technical Review

DEALING WITH TECHNICAL PROBLEMS
RELATING TO THE PRODUCTS, PROCESSES AND INVESTIGATIONS OF
N.V. PHILIPS' GLOEILAMPENFABRIEKEN

EDITED BY THE RESEARCH LABORATORY OF N.V. PHILIPS' GLOEILAMPENFABRIEKEN, EINDHOVEN, HOLLAND

RADIO RECEIVING SETS WITH LINEAR ACTION TUNING CONDENSERS

621.396.662.1 : 621.396.662.6

For the sake of commodity in direct tuning by push-buttons a new type of tuning condenser has been developed, in which the variation of the capacity is obtained, not by the rotation of two sets of plates, but by a linear displacement of one set with respect to the other. Particulars of these linear action tuning condensers are given in this article, as well as a description of a system of push-button tuning in which this type of condenser is used. Upon repeated pressing of a button the required tuning is reproduced accurately to within 0.5 kc/sec on an average, and in the most unfavourable wave-length range to within 1 kc/sec. The means by which this great accuracy is obtained are discussed in conclusion.

In addition to the ordinary hand tuning, radio sets are now being provided to an increasing extent with push-button tuning, whereby certain stations need not be found but simply switched on. An article appeared a year ago in this periodical¹⁾ describing the different systems of push-button tuning. It was shown that for various reasons a mechanical system is preferable, *i.e.* a system in which the electrical part remains entirely unaltered, and in which the push-buttons only determine the position of the tuning condenser by means of a stop. There are two possibilities: the tuning condenser may be brought directly into its final position by the movement of the push-button, or the push-button may switch on a motor which moves the tuning condenser. The second method permits a somewhat greater accuracy but requires more elaborate auxiliary apparatus than the first. In the following we shall concern ourselves only with the first method in which the push-buttons bring the tuning condenser into motion directly.

When ordinary rotating condensers are used there is a certain amount of difficulty due to the fact that the condenser plates must describe a large angle (generally 180°) in order to increase the capacity from the minimum to the maximum value. Therefore the push-button must either cover considerable distance in its movement, or, when the distance is shortened by means of a system of levers, its movement requires considerable force. The neces-

sary angle of rotation for maximum capacity could be made smaller by decreasing the distance between the condenser plates. The required maximum capacity would then be obtained with a smaller surface so that the plates would only need to overlap over a smaller angle. A limit is, however, set by the bending which may occur in the condenser plates and which might lead to short circuit with too small a separation between the plates.

A new type of tuning condenser has been developed by Philips which is in principle much less subject to the above-mentioned restriction. The "plates" of this new condenser are not flat but curved, and they therefore have a much greater resistance to bending in a certain direction. Variation of the effective surface of the condenser is brought about in this case, not by rotation, but by linear displacement of the sets of plates relative to each other. This linear action condenser and its application in a push-button tuning system will be described in this article.

The linear action tuning condensers

The two sets of plates of the linear action condenser are shown in *fig. 1*. Each set consists of a brass strip 0.1 mm thick wound in the form of a spiral of Archimedes and soldered to a base plate. If one of two such identical spirals is turned through 180°, the windings of the one spiral fall exactly midway between those of the other (*fig. 2*). This follows directly from the fact that in the case of the spiral of Archimedes the radius vector is proportional to the angle. Two bodies with such

¹⁾ A. Horowitz and J. A. van Lammeren, Radio receivers with push-button tuning, Philips techn. Rev. 3, 253, 1938.

a spiral cross section can therefore be fitted together without making contact. The distance between the two spirals is equal to one half the

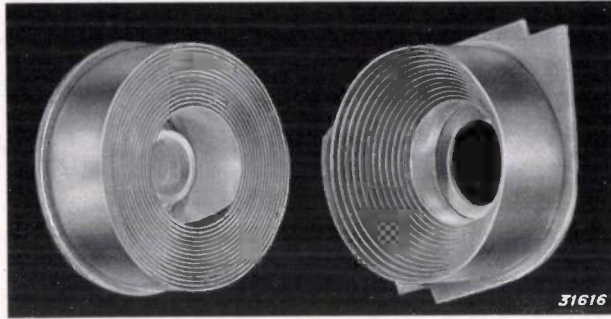

Fig. 1. The two sets of plates fitting into one another of the linear action tuning condenser. Each set consists of a strip wound in the form of a spiral of Archimedes.

distance between the windings of one spiral less the thickness of the material, and in the case in question it is 0.2 mm. This very small distance is attainable thanks to the above-mentioned fact that the curved "plates" are extremely stiff in a radial direction, and the bending at the free edge (that not soldered to the base plate) remains small enough to be neglected even upon powerful shocks. Moreover due to the light and compact construction no great mass forces occur. The lower limit for the permissible distance between the plates in this type of construction is rather prescribed by the necessary play in the bearings and the inevitable variations in the thickness of the brass strip. For a plate distance of 0.2 mm these variations must not surpass 0.003 mm.

The sets of plates have a maximum diameter of about 35 mm. Because of the smallness of the separation between the plates the maximum capa-

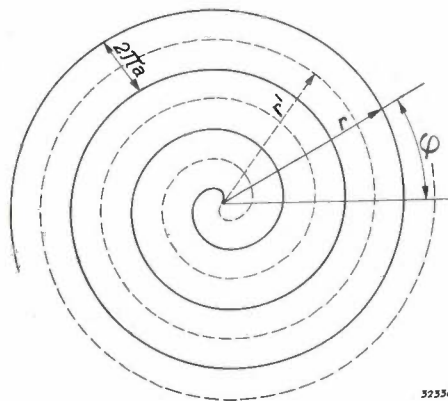

Fig. 2. In the spiral of Archimedes the radius vector r is proportional to the angle $\omega : r = a \cdot \omega$, where a is a constant. The successive windings are the constant distance $a \cdot 2\pi$ apart. A second identical spiral which is rotated one half a turn has the equation $r' = a(\omega + \pi)$. The windings of this spiral therefore lie exactly midway between the windings of the first.

city of about 500 $\mu\mu\text{F}$ necessary for a frequency range of 500 to 1700 kc/sec is already obtained when the two sets of plates overlap by about 10 mm. A relative displacement of the two parts of the condenser of only 10 mm is therefore sufficient for the command of the wave-length range mentioned.

The smallness of the maximum displacement makes it possible to set the condenser by means of a push-button with a slight depression and requiring only a small force. It also, however, makes it necessary that the relative position of the sets of plates be very accurately determined for a definite frequency. If the requirement is made that the tuning shall be reproducible with a deviation of 0.5 kc/sec — it has been found that this accuracy is quite sufficiently in practical cases —, then, with a linear relation between frequency and displacement, the

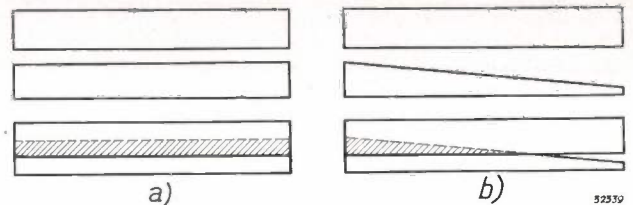

Fig. 3. a) If both of the strips which are wound to form the spirals are cut off straight, the capacity of the condenser is proportional to the length over which the two parts overlap. b) If one of the two strips is cut off obliquely the capacity varies with the square of the relative displacement as long as the resulting conical part (see fig. 1) of the spiral body is not yet completely overlapped by the other spiral.

position of the moving part of the condenser must be accurately defined within

$$10 \cdot 0.5 / (1700 - 500) \approx 0.004 \text{ mm.}$$

The requirement becomes higher when the relation between frequency and displacement is not linear, so that in a certain part of the scale the transmitters equidistant in frequency fall closer to one another. If the two strips of brass making up the sets of plates are cut off straight (fig. 3a) such a crowding of stations is actually obtained in the region of shorter wavelengths. This is illustrated by means of fig. 4a. If, however, one of the condenser spirals is given a conical cavity (visible in fig. 1 at the right), by cutting one edge of the strip obliquely (fig. 3b), the relation between frequency and displacement can be made fairly approximately linear, and the stations are distributed quite uniformly over the entire scale (fig. 4b). In this way, with an accuracy of 0.005 mm in the position of the condenser, the deviation in frequency is less than 0.5 kc/sec in the greatest part of the whole frequency range and less than 1 kc/sec

in the most unfavourable frequency range. At the end of this article we shall discuss the measures which made it possible to obtain the required accuracy in the setting of the condenser.

For the simultaneous tuning of different circuits a number of similar condensers are mounted on the same shaft, just as in the case of the rotating condenser. In *fig. 5* such a system of three linear action condensers is shown. The stationary parts of the three condensers, fastened into the frame with insulators, have a central opening through which passes the steel shaft which carries the three

two spirals with respect to each other. The windings of the one spiral then no longer fall exactly midway between the windings of the other. If for example in *fig. 2* the dotted spiral is turned in a clockwise direction through a small angle, then starting at the centre of that spiral it will be seen that it is now closer to the other spiral on the right and farther away from it on the left. A change in the capacity is hereby obtained like that obtained in the simple case of a plate condenser (see *fig. 6a*) where a middle plate is displaced with respect to two connected outer plates. This case is indicated

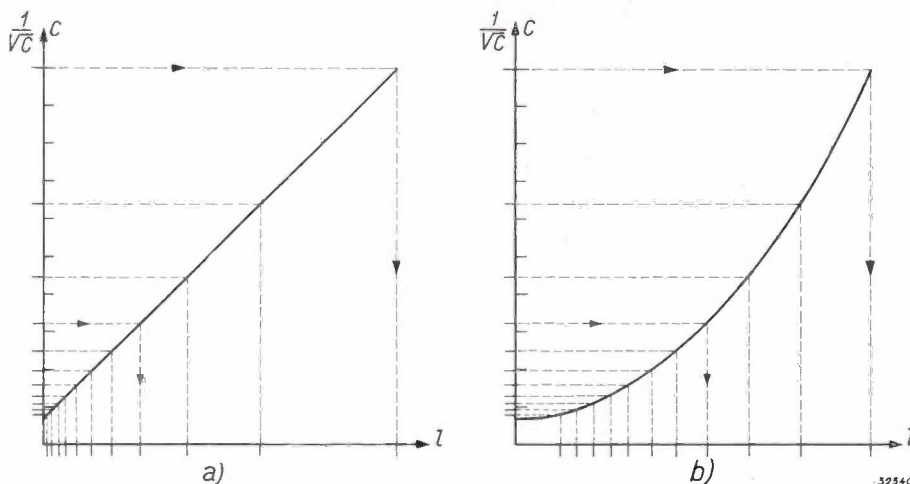

Fig. 4. a) The capacity C is plotted as a function of the displacement l for the case of *fig. 3a*. On the C axis a number of aequidistant values of $1/\sqrt{C}$ (i.e. a series of transmitters with a constant difference in frequency) is indicated. If this distribution is projected on the l axis it will be seen that the transmitters become crowded together at one end of the scale.
 b) Same as a) drawn for the case of *fig. 3b*. All the transmitters are now distributed uniformly over the scale.

moving sets of plates. In a practical case it is important that the maximum capacity (capacity when the sets of plates are completely overlapping) of each condenser should have exactly the prescribed value. This adjustment can be carried out very simply during assembly by slightly rotating the

in *fig. 6b*. It is clear that the capacity can be accurately regulated by means of slight displacements (rotation of the spiral) about the middle position.

The three moving sets of plates need not be insulated from each other for most connections. They are then soldered directly to the common shaft. The current connection is by means of flexible copper strips connected with the frame. Without special precautions there would also be a second current connection from the frame to the sets of plates through the shaft and the bearings, and the conductivity of this connection would vary due to the occurrence of varying boundary resistances. This is undesirable in the reception of short waves. The bearings in which the condensers slide are therefore electrically insulated from the frame.

If the three moving sets of plates must be insulated from each other, as is the case for instance in special connections for short wave reception, then each set is mounted on a tube of insulation material; by covering this material with a thin

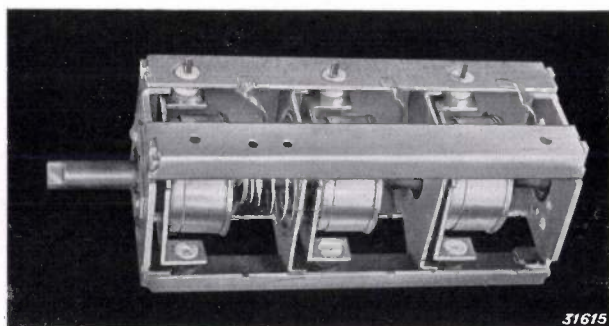

Fig. 5. Three linear action condensers combined to a single unit. The three moving sets of plates are mounted on a common shaft which is continually pressed by a strong spring (visible on the left between the first and second condensers) toward the position of maximum capacity.

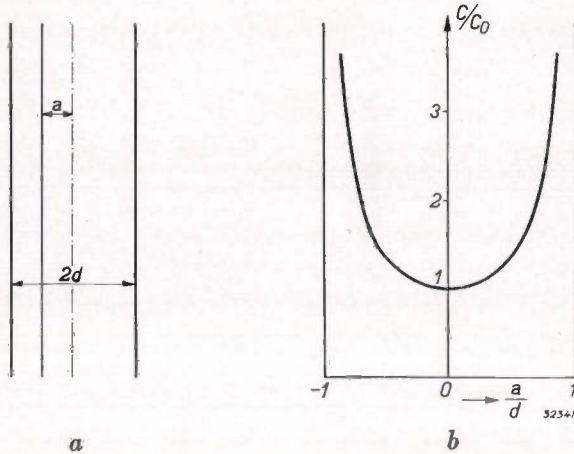

Fig. 6. a) Plate condenser consisting of two parallel connected plates with a separation of $2d$ and a movable middle plate (deviation a from the middle).
 b) Variation of the capacity C upon displacement of the middle plate. If C_0 is the capacity when $a = 0$, then $C/C_0 = 1/(1 - a^2/d^2)$. By a slight displacement of the middle plate (equivalent to a slight rotation of one of the spirals of the linear action condenser) the capacity of the plate condenser (the maximum capacity of the linear action condenser) can be very accurately adjusted.

layer of metal it can be soldered, so that the plates can be firmly fastened to the shaft.

The mechanism of the push-button tuning

Fig. 7 shows the entire tuning mechanism. We shall discuss briefly the most important details. The linear action condenser is driven in the way

represented in fig. 8. A strong spring continually presses the shaft with the three moving condenser parts in the direction of the position for maximum capacity. The extremity of the shaft is rounded, and presses against a bar which is fastened to a shaft carrying a long swing. In front of the swing is a row of keys. When a key is pressed, the swing is moved backwards through a certain angle, and the bar pushes the condenser shaft into a definite position corresponding to the desired station. The shaft of the swing carries another bar which moves the pointer of the station scale. Hence the linear action condenser and the pointer are, as far as their position is concerned, closely coupled.

Fig. 9 is a simplified sketch of one of the push-buttons. After being pressed down the button is held by a catch in an accurately determined final position. The stop which then determines the position of the swing and hence that of the condenser consists of the point of a screw. With the help of a screw driver the listener may turn the screw farther in or out and in this way set the available push-buttons on the stations to which he most often listens.

While in the push-button system previously described¹⁾ the listener had to operate a separate switch in order to choose the wave-length range, the throwing of this wave-length range switch now takes place automatically upon depression of the

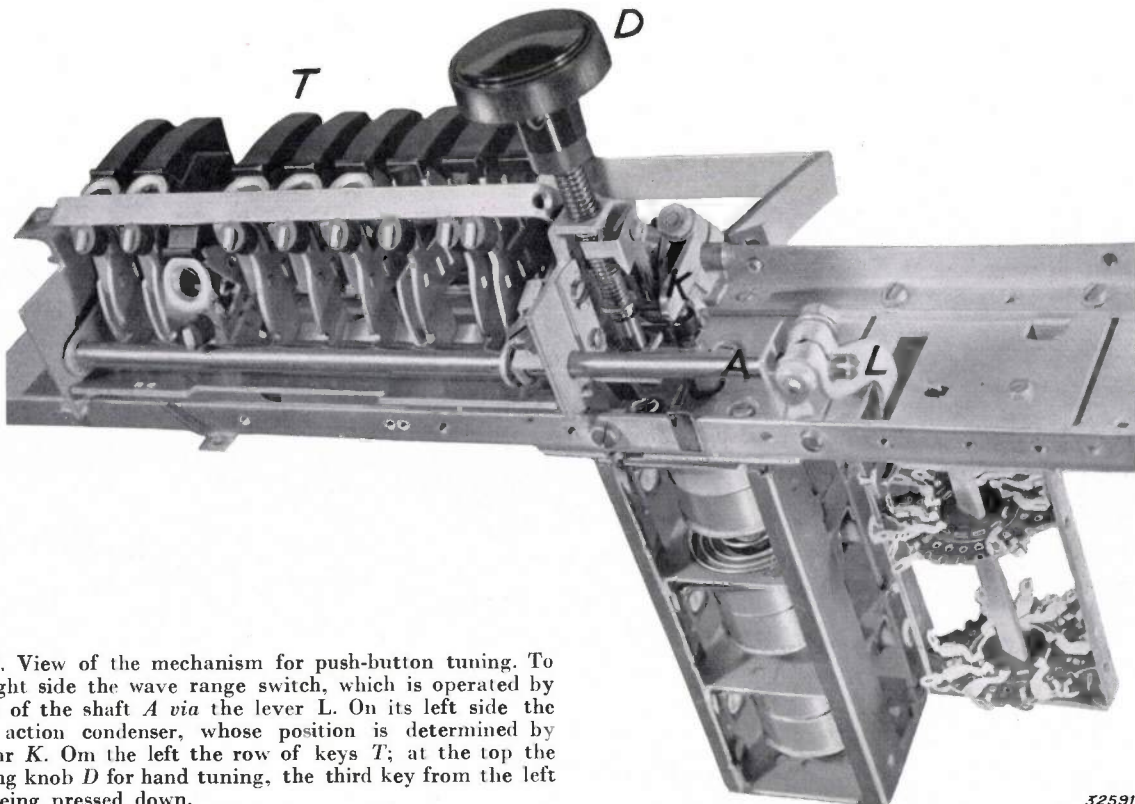

Fig. 7. View of the mechanism for push-button tuning. To the right side the wave range switch, which is operated by means of the shaft A via the lever L . On its left side the linear action condenser, whose position is determined by the bar K . On the left the row of keys T ; at the top the rotating knob D for hand tuning, the third key from the left side being pressed down.

station key. The mechanism by which this is accomplished is represented and explained in *fig. 10*. Part of the keys are so constructed that they can be set not only on long wave but also on medium wave. The construction is shown in *fig. 11*.

shall not go deeper into the mechanism of hand tuning at present.

Reproducibility of the push-button tuning

We have already stated that the desired repro-

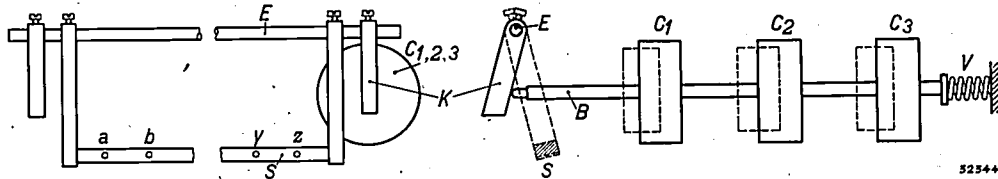

Fig. 8. The rounded end of the shaft *B* of the linear action condenser is pressed by a spring *V* against the bar *K*. This bar is attached to a shaft *E* which carries a swing *S*. In front of this swing is a row of push-buttons, each of which can push the swing back through a definite angle by means of a stop (at the points *a*, *b*, ..., *y*, *z*). The angle corresponds to a definite position of the condensers *C*₁, *C*₂, *C*₃.

In addition to the push-button tuning, hand tuning is also possible for the case where the user wishes to hear stations other than those which can be switched on by means of the keys. When hand tuning is used the wave range must first be chosen and this is again done with push-buttons which function in the same way as described in *fig. 10*, which have, however, no stop for the swing. We

ducibility of the tuning is obtained if the position of the linear action condenser is determined accurately to within 0.005 mm. In order to obtain such accuracy the first requirement is that there shall be no play in the whole tuning mechanism. This is realized by causing a spring to act on every element of the mechanism, which continually draws the element in one direction and provides

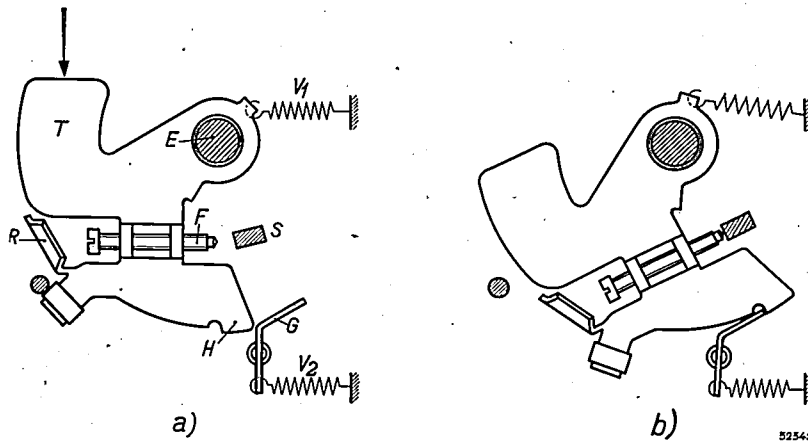

Fig. 9. Simplified sketch of the construction of one of the keys. The key turns about the axis *E* and is drawn into the resting position (*a*) by the spring *V*₁. When the key is pressed down in the direction of the arrow the point of the screw *F* pushes the swing *S* backwards. The final position (*b*) of the key is determined by the catch *G*. Upon pressing the key the elbow *G* is first turned back somewhat so that any key previously pressed is released. When the key has been pressed far enough the elbow *G*, drawn by the spring *V*₂, slides behind the projecting edge *H* and fastens the key in this position. By turning screw *F* in one direction or the other the key can be set on any station. With the key depressed the listener himself can adjust the screw with the help of a small screw driver, the point of which is introduced through an opening in the apparatus and guided to the head of the screw by the ring *R*.

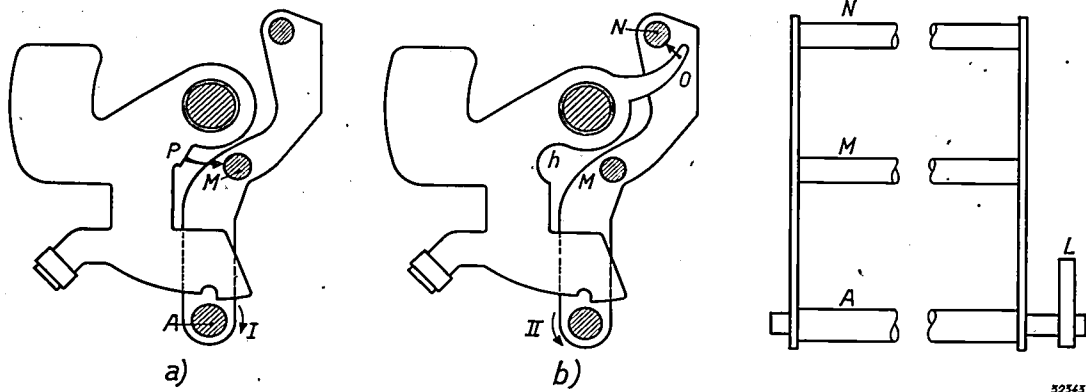

Fig. 10. Mechanism of the automatic switching from one wave range to another. The switch is driven by the shaft *A* through the lever *L*. The shaft *A* runs parallel to the previously mentioned swing (*S* in figs. 8 and 9) and bears at either end a bar in which two long pins *M* and *N* are fastened parallel to the shaft. The pin *M*, upon the depression of a key of the shape (a), is pushed back by the surface *P*, whereby by means of the shaft *A* the wave range switch is turned to the position for medium waves (I). When, however, a key having form (b) is pressed, the arm *O* pulls the pin *N* forward (where *P* was in (a) there is now a depression *h* in which the pin *M* falls), and the wave range switch is turned to the position for long waves (II).

that every stop is continually subject to a certain pressure. This is true particularly for the stop which determines the final position of the keys, for the contact between the swing and the screw point of every key and for the contact between the end of the condenser shaft and the bar, as may clearly be seen in figs. 8 and 9.

The forces exerted by the different springs cause microscopic deformations in the components of the mechanism, especially in the swing which experiences a torsion couple. These deformations may be of the order of magnitude of the above-

mentioned 0.005 mm, they have, however, by themselves no unfavourable effect on the reproducibility when the condition is satisfied that the pressing of a button always causes exactly the same deformations. The deformations depend upon the forces and the stiffness of the system, therefore care must be taken that the elastic and frictional forces occurring always remain the same (the stiffness may be considered as unchanging). This means practically that there must be no friction because frictional forces depend upon the direction from which the resting position is reached, and this

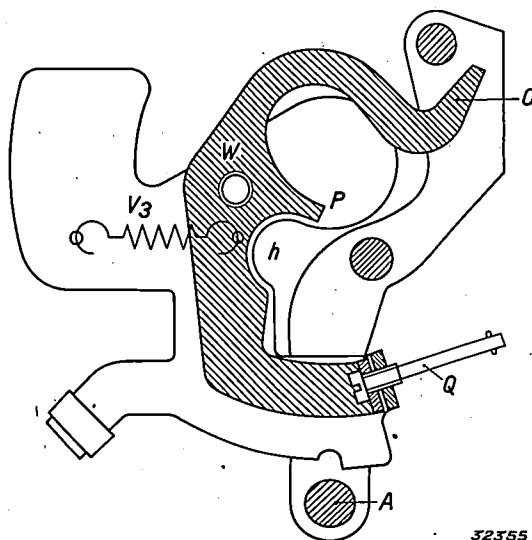

Fig. 11. A push-button which can be set not only on stations with long waves but also on medium wave stations. When the screw *Q* is made fast, the arm *O* comes into action and the key switches over to long waves (see fig. 10b). When, however, the screw is loosened the spring *V*₃ draws back the arm *O* which rotates around the axle *W* and at the same time the projection *P* fills the depression *h* so that the key now switches over to medium wave (see fig. 10a). The screw *Q* may be reached by the listener in the same way as screw *F* in fig. 9, without, however, the depression of the key.

direction is not under control in the pressing of a key because of the possible occurrence of slight oscillations. In the mechanism here described the frictional forces, which may occur especially in moving the condenser and the scale, are made as small as possible by careful construction of the bearings. The influence of the remaining friction is reduced to a minimum by giving the system, and particularly the swing great rigidity. This makes the deformations small and hence also reduces the influence of any variations in the same.

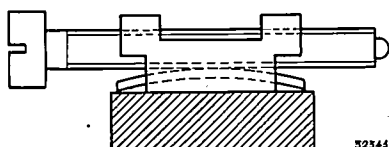

Fig. 12. Construction of the screw (F in fig. 9), which forms the stop for the swing. The screw turns in two half nuts into which it is pressed by a spring.

Torsional and bending forces, which might be transferred from the outside to the frame upon which the push-button mechanism is mounted, must of course also be carefully avoided. Since in practical cases such forces could only be transferred *via* the cabinet of the radio set and the chassis upon which the frame is fastened, this requirement was satisfied by mounting the chassis

in the cabinet so that it can undergo no torsion. For this purpose the set is fastened into the cabinet at only two points and is elsewhere supported on rubber studs which can undergo a certain (plastic) deformation without transferring any force²⁾.

In addition to the elastic deformations considered until now, permanent deformations must also be avoided, such as might occur at the different contact points. In order to avoid the occurrence of a gradual flattening of the material in the above-mentioned points of contact upon repeated pressing of a key (which would cause a gradual decrease in frequency switched on), the material at all these points has a hardened surface.

A quite different cause of gradual detuning upon repeated pressing of a key might be found in the turning of the screw which forms the stop for the swing. This is avoided by the construction shown in fig. 12; the screw turns in two half nuts into which it is pressed by a spring. The screw therefore does not turn upon receiving a shock, while on the other hand neither is it difficult to turn it when desired, so that the listener can easily readjust it when required.

Compiled by S. GRADSTEIN.

²⁾ For transportation the chassis is of course fastened more securely.

RADIO SETS WITH STATION DIALS CALIBRATED FOR SHORT WAVES

621.396.662 : 621.396.62.029.58

The tuning of a radio receiver in the region of short waves is much more difficult than in the normal broadcasting range because the relative difference in frequency between neighbouring stations becomes very small so that very high requirements must be made of the precision and stability of the tuning mechanism. It is explained in this article how the problems encountered in this connection are solved so that at present it is possible to fix the short wave stations on a calibrated scale with the same accuracy as that to which we are accustomed in the case of ordinary broadcasting transmitters.

In the amplification of radio signals in a receiving set a number of problems occur which are more difficult to solve the higher the frequency. Some of these problems, particularly those concerned with the receiving valves, have already been dealt with in detail in this periodical¹⁾. Other parts of a radio set, however, such as coils and condensers are also subject to requirements which become increasingly difficult to fulfil with increasing frequency. It is therefore natural that when broadcasting first began there was a preference for the use of long waves of the order of 1 000 m, and shorter waves only gradually began to be used when the number of stations and with it the necessary frequency range steadily increased. It was at first found impossible to use waves of less than 200 m, because shorter waves exhibit very unfavourable propagation characteristics. Later, however, it was discovered that the propagation of radio waves below the 50 m limit again becomes satisfactory. This discovery has been put into common use in recent times so that there are now regularly working broadcasting stations in a wave length range extending from 13 to 2 000 m.

Due to the increasing use of short waves, by which we understand particularly waves below about 40 m, it became desirable to make the tuning arrangements of receiving sets suitable for these short wave lengths, so that transmitters on these wave lengths could be found by moving a pointer on a station scale just as easily as transmitters of the ordinary broadcasting range (200—2 000 m).

The tuning of a receiving set

The tuning of a receiving set generally takes place by the switching over of self-inductions (choice of wave range) and then by the continuous alteration of capacities. The values which the capacities of the oscillating circuits can assume in the two extreme positions of the tuning condenser are approximately in the ratio 1 : 12, so that for a wave range which can be continuously commanded, the

longest and the shortest wave lengths are in the ratio of $1 : \sqrt{12} = 1 : 3.5$. All wave lengths can then be commanded by the following division into four wave ranges, each of which can be continuously scanned by the motion of the tuning condenser.

Table I

Wave range	λ	ν
short waves I	14 - 45 m	6 700 - 23 100 kc/sec
short waves II	45 - 160 m	1 900 - 6 700 "
normal waves	160 - 560 m	550 - 1 900 "
long waves	560 - 2 000 m	150 - 550 "

The shortest permissible distance between the frequencies of two transmitters is determined by the modulation frequency which the transmitter must be able to transmit, and has been determined internationally at 9 kc/sec. The frequency difference between two neighbouring transmitters is therefore independent of the frequency itself. From this it follows that the short wave region offers space for a considerably greater number of stations than the ordinary broadcasting region. From *table I* the following *table II* may therefore be deduced:

Table II

Wave range	Width of frequency band	Number of transmitters possible
short waves I	16 400 kc/sec	1 800
short waves II	4 800 "	530
normal waves	1 300 "	145
long waves	400 "	45

By the same motion of the tuning condenser one therefore commands twelve times as many stations in the ultra short wave region as in the normal broadcasting region. In order to find a given station therefore the tuning motion must take place with twelve times the precision necessary in the normal region. If for example the required precision is set at 2 000 c/s, *i.e.* more than 1/5 of the distance between two stations, this means that the adjustment of the condenser must be reproducible with an accuracy of $1 : (5 \cdot 1 800) \sim 0.1$ per thousand.

¹⁾ C. J. Bakker, Philips techn. Rev. 1, 171, 1936. M. J. O. Strutt and A. van der Ziel, Philips techn. Rev. 3, 104, 1938.

How is this great precision attained?

In order to attain the required precision the motion of the tuning mechanism upon passing from one station to the following must be brought about by a sufficiently great motion of the scale pointer. Furthermore the driving mechanism must be so constructed that with a given setting of the tuning knob it reproduces the position of the tuning elements with an accuracy of 0.1 per cent. Finally it is found that the required precision can only be attained when special measures are taken to provide that with a given adjustment of the set the properties of the tuned circuits do not change due to the heating up of the set when in use or to a change in temperature in the room.

The fulfilment of the first requirement is facilitated by the fact, that the stations with short waves are not spread over the whole range but are concentrated in so-called wave lengths bands, lie in the neighbourhood of the wave lengths 13, 16, 20, 30 and 50 m. This makes it advisable to carry out the tuning in the following way. One first tunes in to the middle of one of the bands with fixed switch elements and then uses small variable elements in order to tune in on the desired stations. These variable elements need only to change the tuning by about 5 per cent by their entire deviation instead of by a factor 3.5, so that the adjustment of these elements may be much less precise. The variable elements need not be introduced in all the tuning circuits, but only in the most selective ones. Their position is indicated in the usual way by a pointer on a dial. The stations of a band are in this way, as it were, spread out over a separate scale. The method of tuning to be discussed in this article is indeed called band spread.

As fixed switch elements, a series of condensers can be included in the circuit instead of the variable condenser. But it is also possible to give the variable condenser a number of predetermined positions, for instances by means of a mechanism similar to that used in push-button systems. As variable elements, small variable capacities may be used which are connected in parallel with the main capacity, or small variable self-inductions in series with the main self-induction. There are a number of different possibilities for the variation of a self-induction which will be discussed in the following.

Advantages and disadvantages of various systems

An advantage of the use of a series of fixed condensers over the use of predetermined positions of the tuning condenser is that those parts which

must be constructed with great precision are immovable. Another advantage is that in this system the influence of the temperature on the resonance frequency can be compensated very easily. This will be discussed later. On the other hand a disadvantage is the large number of switch elements; in addition to the variable element for every oscillating circuit, which must be accurately adjusted, just as many fixed condensers are needed as there are bands.

As variable element a variable condenser can more easily be constructed with the required accuracy than a variable coil. The latter has, however, the advantage that the distribution of the stations on the scales for the different bands is more favourable, as will be seen from the following consideration.

If L and C are the fixed self-induction and capacity, Δl and Δc the variable self-induction and capacity, then the tuning frequency is

$$\nu + \Delta\nu = \frac{1}{2\pi\sqrt{L(C + \Delta c)}} \approx \nu \left(1 - \frac{1}{2} \frac{\Delta c}{C}\right), \quad (1)$$

or

$$\nu + \Delta\nu = \frac{1}{2\pi\sqrt{(L + \Delta l)C}} \approx \nu \left(1 - \frac{1}{2} \frac{\Delta l}{L}\right). \quad (2)$$

We have seen from table I that the wave length bands $\lambda = 13, 16, 20, 25$ and 30 m can very well be commanded by a single coil. When this is done L is constant and

$$C = \frac{1}{4\pi^2\nu^2 L}$$

By substituting this value in (1) it follows for a variable condenser that:

$$\Delta\nu = -2\pi^2\nu^3 L \Delta c, \dots \quad (3)$$

while for the variable coil:

$$\Delta\nu = -\frac{\nu}{2L} \Delta l \dots \dots \quad (4)$$

One would prefer to have the stations evenly spread out over the scale in all wave-length bands, and this would mean that $\Delta\nu/\Delta c$ or $\Delta\nu/\Delta l$ was independent of ν . It will be seen that this ideal is not attained in either case; the tuning with variable coil (equation (4)), however, approaches the ideal more closely than tuning with variable condenser.

A constant sensitivity of tuning, for example $\Delta\nu/\Delta C = \text{const.}$, could be attained by taking for each of the six bands another fixed coil in addition to another fixed condenser. The following condition then follows from equation (1):

$$\frac{\Delta\nu}{\Delta c} = -\frac{1}{2} \frac{\nu}{C} = \text{const.},$$

and therefore:

$$C_\nu = \frac{\nu}{2 \cdot \text{const.}}; L_\nu = \frac{1}{4 \pi^2 \nu^2 C_\nu} = \frac{\text{const.}}{2 \pi^2 \nu^3} \quad (5)$$

From equation (5) it may be seen that when we wish to make $\Delta\nu/\Delta C$ the same for all bands the circuit capacity at short waves must be taken abnormally high. It must, indeed, contrary to its usual behaviour, increase with the frequency. From the point of view of the requirement of a constant resonance frequency this must be regarded as an advantage. The small parasitic capacities between the electrodes of the radio valves and their leads are just the ones which change sharply with temperature. When there is in addition a large fixed capacity, these changes have little influence on the tuning frequency.

We shall now describe two types of band spread which have been developed by Philips: The first with a number of fixed condensers for tuning to the middle of the bands and a variable condenser for variation within the band, and the second with a number of predetermined positions of a variable condenser for tuning to the band and a variable self-induction for variation within the band.

1. Band spread with variable condenser

The first system has been applied in a receiving set with six wave ranges distributed in the way indicated in table III.

Table III

I	11 - 19 m	(13 m, 16 m)
II	18 - 31 m	(20 m, 25 m)
III	30 - 54 m	(30 m, 50 m)
IV	52 - 174 m	
V	170 - 570 m	
VI	750 - 2 200 m	

It is clear that the wave ranges have been so chosen that the first three each contain two of the bands to be spread. For each band a separate fixed condenser has been chosen, while the two bands which lie in the same wave range have a common coil. In fig. 1 the circuit is given, the text below it gives a more detailed explanation. As may be seen band spread is applied only to a single tuning circuit, namely that of the oscillator. The other oscillating circuits must therefore be sufficiently accurately tuned in the ordinary way. The adjustment of the apparatus takes place in the following way.

The desired band is at first roughly chosen with the ordinary tuning mechanism of wave switch and three coupled linear action tuning condensers.

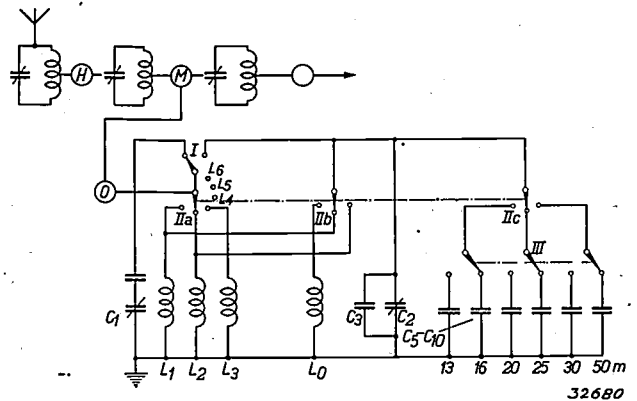

Fig. 1. Circuit for band spread: H high-frequency amplification, M mixing stage, O oscillator of mixing stage. The oscillating circuit of the oscillator can be tuned in the ordinary way with the condenser C_1 and the coils L_1 to L_3 depending on the wave switch I . When switch I is reversed, band spread is applied. The following serve as tuning coils for the first three wave ranges: $L_0||L_1$; $L_1||L_2$; $L_2||L_3$, while the corresponding tuning condensers are chosen by the switches I and III . In parallel with these condensers is the condenser C_3 for temperature compensation, and the variable condenser C_2 for the final tuning when band spread is applied.

The correctness of the adjustment is indicated by a green lamp which is lighted by means of sliding contact when the scale pointer falls on the scale division within the band in question. Band spread is then applied by drawing out a second turning knob. The linear action condenser of the oscillator circuit is hereby replaced by a larger fixed condenser, while at the same time the oscillator coil is reduced by connecting a second coil in parallel with it. By turning this second knob the variable condenser (also a linear action condenser) can now be moved and the desired station found. The position of the variable condenser is indicated by a separate pointer and a separate calibrated scale division on the tuning scale.

When the desired station has been found, its reception can often be further improved by adjusting the condensers of the first two circuits more accurately by means of the first knob, than was originally possible with the help of the green lamp.

As may be seen from fig. 1 five switches are used for the switching operations in the mechanism for band spread. Switch I determines whether or not band spread is applied, and is, as noted above, operated by the pulling out or pressing in of a knob. Switch IIa is the ordinary wave range switch; switch IIb serves for choosing the desired coil of the fixed oscillator circuit when band spread is applied; switch IIc serves in the same way for choosing the fixed condenser of that circuit. Since the last two

switches are moved together with the wave switch a certain oscillator circuit would also be put into circuit in every wave range. This is, however, not sufficient, since, as we saw above, two bands to which spread must be applied lie in a single wave range. Therefore switch *III* has been introduced to make it possible to choose between two condensers in every wave range. This is accomplished by a mechanical coupling between the switch and the turning knob for ordinary tuning. The position at which the reversal takes place is indicated in *fig. 2*. It may be seen that in each of the first three wave ranges one band has been passed while the other has not yet been reached.

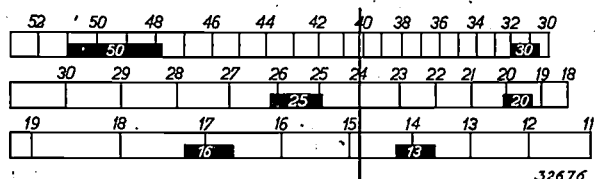

Fig. 2. When one passes from 13 to 16 m or from 20 to 25 m or from 30 to 50 m the switch *III* in *fig. 1* must be reversed. This can always be done at the same position of the ordinary tuning condenser, at which point the scale indicator is at the position shown in this figure.

The constancy of the tuning

As mentioned above certain variations in the tuning frequency occur which are due mainly to the fact that different capacities in the set change with the temperature while the set is heating up. The consequence of this heating is in the first place a thermal expansion of the different elements, whereby not only the capacities become somewhat greater, but also the self-inductions of the coils. This increase in the self-induction can for the purpose of our discussion be replaced by an equivalent increase in the capacity, *i.e.* by a variation in capacity which would cause the same change in tuning.

In addition to these variations in capacity due to thermal expansion, capacity changes may also occur due to the change of dielectric constants with the temperature. This is true particularly for parts made of glass or plastics such as the stems of radio valves, the valve sockets, switches, etc. As to the order of magnitude, an increase of the circuit capacity of about 0.1 $\mu\mu\text{F}$ may be expected due to the increase in temperature.

In order to keep the effect of this change small two precautions have been taken. Firstly the fixed

circuit capacity has been chosen high; its value is of course different for each band, but it is always several hundred $\mu\mu\text{F}$, so that by this means alone the variation of the capacity is already reduced to several tenths per thousand. Secondly a fixed condenser of 50 $\mu\mu\text{F}$ is connected in parallel with the variable condenser. This condenser has a special ceramic dielectric whose dielectric constant decreases with increasing temperature. The capacity of this condenser (C_3 in *fig. 1*) therefore decreases during heating up, and compensates for the increase of other capacities. In this way the required constancy of 0.2 per cent could be attained. This means an accuracy of 0.1 per cent in the tuning frequency.

2. Band spread with correction coil

The second system of band spread was employed in a set with only four optional wave ranges which are distributed approximately as shown in table I. Band spread was applied to five bands, 13, 16, 20, 25 and 30 m, while the stations which lie in the 50 m band must be found by tuning in the ordinary way. The spread bands therefore all lie in the same wave range (short waves I).

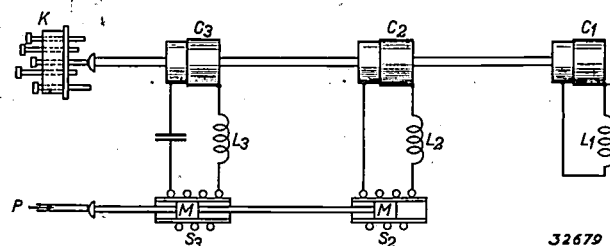

Fig. 3. Diagram of a band spread system with variable self-induction. *K* revolver head which serves to determine one of five fixed positions of the rigidly coupled linear action condensers C_1, C_2, C_3 . *P* pin of the band spread mechanism by which the self-induction of the coils is altered by displacement of the iron cores *M*. The tuning of the circuit C_1L_1 (aerial circuit) is variable in this case.

The scheme of band spread is shown in *fig. 3*. By means of a revolver head *K* the triple linear action condenser can be set at five different fixed positions which correspond exactly to tuning points in the middle of the bands to be spread. This adjustment must be done with an accuracy of 0.1 per cent, which corresponds to an accuracy of 1 micron in the motion of the condenser. After the band has been chosen, tuning to the different stations on the band takes place by altering the self-inductions L_2 and L_3 in the second oscillating circuit or in the circuit of the oscillator. (In the previously described system only the oscillator circuit was sharply tuned).

²⁾ Two neighbouring bands therefore have a common ratio which thus cannot be chosen exactly according to equation (5). The sensitivity in the different bands is not exactly the same but increases and decreases alternately in successive bands.

There are various possibilities for the constitution of the variable self-inductions L_2 and L_3 , for example:

- 1) A winding is connected in series with the tuning coil, whose length is altered by means of a sliding contact (fig. 4a).

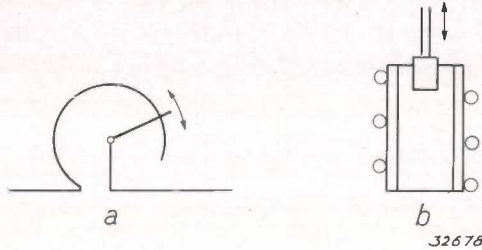

Fig. 4. Different methods of varying the self-induction of a coil. *a* Variation of the length of a winding by means of a sliding contact. *b* Variation of the self-induction of a small coil by displacement of the core of the coil. This core may be of copper in which eddy currents occur which reduce the self-induction, or of powdered iron which increases the self-induction by its magnetic induction.

- 2) A coil of several turns is connected in series with the tuning coil. A copper core can be inserted into the coil (fig. 4b). The eddy currents in the core produce a decrease in the self-induction which depends upon the position of the core.
- 3) Instead of the copper core a core of powdered iron is used. By its permeability this influences the self-induction in a sense opposite to that of the copper core.

The first system has the objection that sliding contacts must be introduced into the tuning circuits, which contacts may lead to noises during tuning. The second system is less satisfactory than the third in electrical respects because the eddy

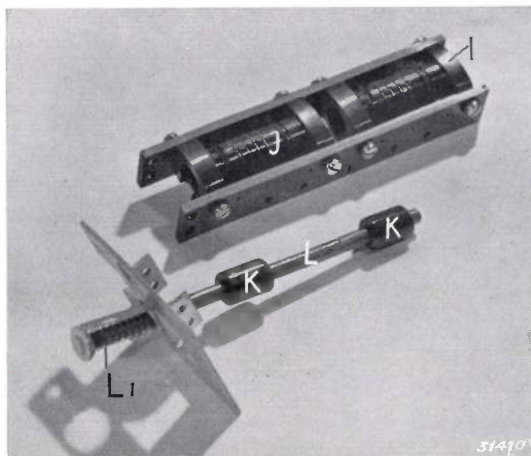

Fig. 5. Coil with variable self-induction. In two "Philite" tubes mounted in one line a screw thread of four turns has been cut. In this groove a copper wire is laid. The form of the coil is accurately fixed in this way. A rod *A* with two cores of pressed iron powder slides in the tubes.

currents always cause an increase in the damping. On the other hand the third system is more difficult to construct with the necessary accuracy because it is difficult to produce iron cores with very precisely determined magnetic properties. It was found, however, that this objection could be met by a suitable construction of the driving mechanism for the motion of the core in the coil; the third system was therefore chosen.

In fig. 5 the coil with movable iron core is reproduced; several structural particulars are given in the text below the figure.

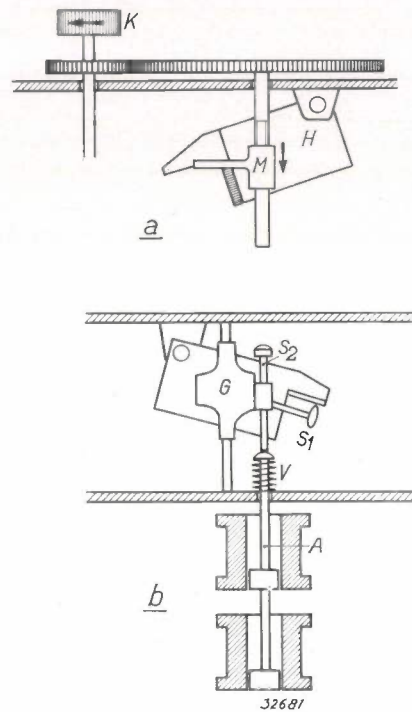

Fig. 6. The operating mechanism for band spread with variable self-induction, seen from two opposite sides. The position of the parts does not correspond exactly to that in the actual model, but has been so chosen here that all the important functional elements may be visible.

In fig. 6a and b a diagram is given of the driving mechanism. When the knob *K* is turned in the direction of the arrow, the nut *M* is also moved in that direction. In the diagram, *M* is shown at the position of maximum deviation in the direction of the arrow. *M* depresses the lever *H*, which is therefore also shown in its lowest position. The lever is coupled with the slide *G* which can be moved up and down in a vertical direction, and which by means of the screw *S*₂ depresses the shaft *A* bearing the iron core. A spring *V* prevents the occurrence of play in the whole mechanism.

It may be seen that the motion of the iron core can be regulated in two respects, namely in its initial position and in the magnitude of its displacement. The initial position is altered by turning

the screw S_2 . The adjustment of the displacement is carried out by means of screw S_1 . This screw is fastened into the slit G , while its head presses against the lever H . When it is screwed in, the effective length of the lever becomes shorter and the displacement therefore smaller. By means of this regulation of the initial position and displacement the mutual differences in the magnetic properties of the cores can be adequately compensated.

Constancy of the tuning

The variations of the tuning with the temperature may be much greater in the above-described system with variable self-induction than in the previously described system, because only small capacities are present in the oscillating circuits at short waves, so that any compensating condenser may also have only a small capacity.

If in this compensating condenser one wishes to use a dielectric with a negative temperature coefficient of the dielectric constant, one would have to construct for example a condenser which combines a low value of the capacity ($\leq 4 \mu\mu\text{F}$) with a high value of the change of capacity with temperature (up to $20 \times 10^{-3} \mu\mu\text{F } ^\circ\text{C}$). There exists no such dielectric.

It is, however, possible to realize such a compensating condenser by means of a construction shown in *fig. 7*. This is based on the difference in thermal expansion between the aluminium cylinder A , which forms one electrode of the condenser, and the rod C of a ceramic material which bears the other electrode B^3 .

³⁾ The coefficient of expansion of aluminium is 24×10^{-6} , that of the ceramic used is 1.5×10^{-6} .

When the temperature increases, the distance between the electrodes A and B becomes greater and the capacity therefore decreases.

The temperature coefficient of the capacity can be fixed at a desired value by sliding the rod C in a lengthwise direction in the cylinder. When the capacity is increased the temperature coefficient is also increased, and its increase is proportional to the square of the capacity ⁴⁾.

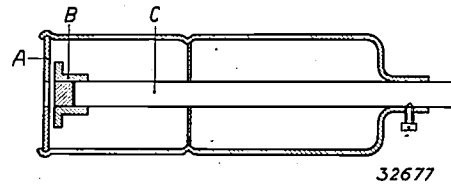

Fig. 7. Condenser for compensation of the variation of the tuning with temperature. In an aluminium cylinder A , which forms one electrode of the condenser, there is a rod C made of a ceramic material, which bears the other electrode B . Due to the difference in thermal expansion between the aluminium and the ceramic material the capacity decreases with increasing temperature.

By a correct setting of the compensating condenser the variation of the oscillator frequency can be reduced in every set to a value of a few kc/sec, this residual value is to be ascribed to the fact that different parts of the apparatus do not reach their final temperature with the same speed when the apparatus is heating up.

Compiled by G. Heller.

⁴⁾ When d is the distance between the plates the capacity

$$C = \frac{F}{4\pi d}$$

and the variation in capacity upon change in d is

$$\Delta C = -\frac{F}{4\pi d^2} \Delta d = -\frac{4\pi}{F} C^2 \Delta d.$$

AN ACOUSTIC SPECTROSCOPE

by J. F. SCHOUTEN.

535.33.071 : 534.44 : 778.534.45

It has already been explained in this periodical ¹⁾ how it is possible with the help of strips of sound film to bring about light diffraction phenomena which enable one to analyse the recorded sound into its various sinusoidal components directly and comprehensively. For demonstration purposes a spectroscope has been constructed on the principle described in the article referred to which makes it possible for the observer to examine successively ten different sound spectra by the turning of a knob. Fig. 1 is a photograph of the apparatus, and figs. 2 - 11 are tenfold enlargements of the strips of film used and reproductions of the spectra obtained from them.

In interpreting these spectra it must be kept in mind that with the amplitude-modulated sound film here used very complicated diffraction patterns are obtained, which by their position and intensity along the horizontal axis only are a measure of the pure tone of which the total sound is composed. The distance of the lines to the centre of symmetry is in linear proportion to the frequency (in figs. 2 - 11, 1 mm corresponds to about 200 c/s), the intensity is proportional to the square of the amplitude of the individual tones.

¹⁾ J. F. Schouten, The diffraction of light by sound film, Philips techn. Rev. 3, 298, 1938.

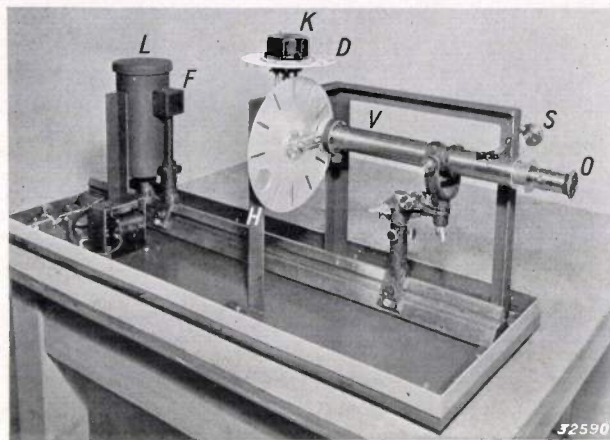

Fig. 1. The acoustic spectroscope. A brass plate in which is a hole 30 μ in diameter is illuminated by a mercury lamp *L* (type HP 75) placed directly in front of the plate. The hole is in line with the axis of a telescope *V* with a magnification of fifteen times. In front of the objective of the telescope there is a positive lens of $2\frac{1}{2}$ dioptrics by which the image of the hole is sharply focussed at the focus of the telescope objective. The light is rendered monochromatic by a filter *F* which transmits only the light of the green mercury line ($\lambda = 5461 \text{ \AA}$). In front of the telescope is placed a rotating aluminium disc *H* which can be brought by means of the knob *K* into twelve different positions indicated on the scale *D*. By this means eleven strips of film fastened around the circumference of the disc can be brought successively into the path of the light ray. The twelfth position of the disc brings a circular opening before the objective. This position is used during the adjustment of the apparatus. When a strip of film is placed in front of the objective a diffraction pattern is obtained at the focus which can be accurately observed by means of the ocular *O* which can be adjusted with the setting screw *S*.

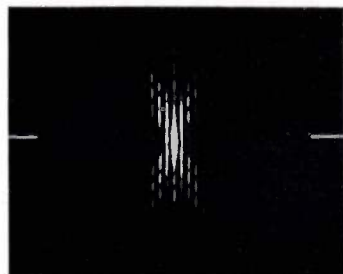
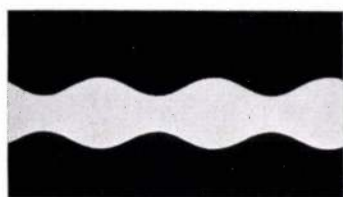

Fig. 2

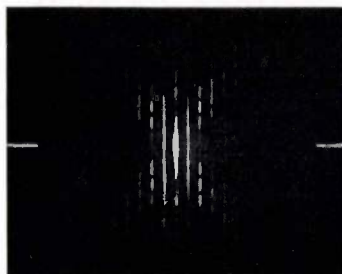
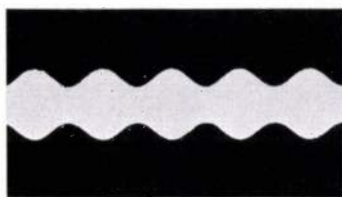

Fig. 3

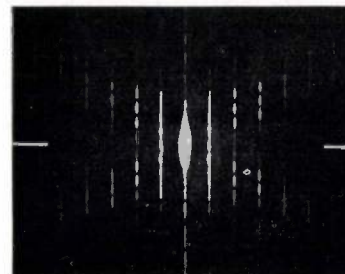
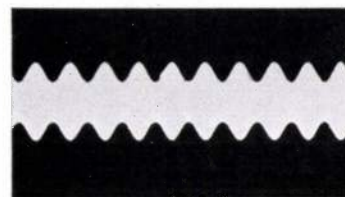

Fig. 4

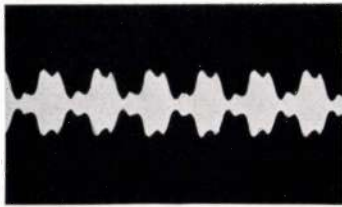

Fig. 5

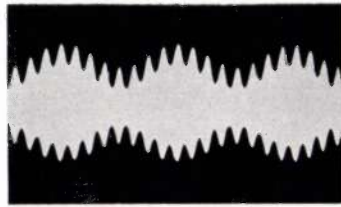

Fig. 6

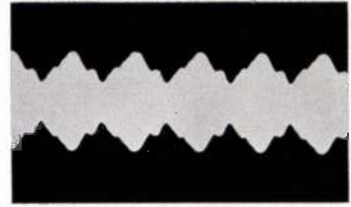

Fig. 7

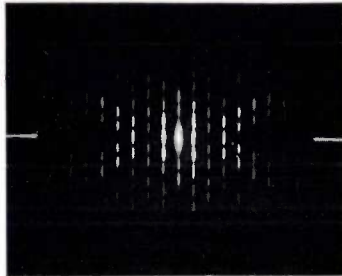

Fig. 8

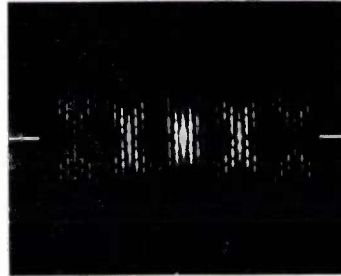

Fig. 9

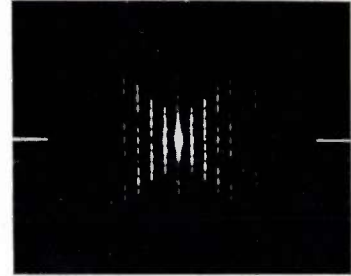

Fig. 10

32587

32588



Fig. 11

Fig. 2. Pure tone of 23 periods. On the horizontal axis the diffraction images of the zero and first orders only can be seen. The tone is therefore pure.

Fig. 3. Pure tone of 350 periods.

Fig. 4. Nearly pure tone of 700 periods. The second order is now also visible on the horizontal axis. The tone, therefore, contains a small proportion of second harmonic.

Fig. 5. Tone of 400 periods with strong second harmonic.

Fig. 6. Sound consisting of 1 600 and 210 periods. The 1 600 and 210 periods are visible on the horizontal axis. The diffraction pattern also contains all the combination tones which have however a zero intensity on the horizontal axis and thus do not occur in the sound.

Fig. 7. Clarinet. Pitch G = 391 periods. The great intensity of the third harmonic is characteristic of the sound of the clarinet, while the second harmonic is almost entirely missing.

Fig. 8. Vowel A. Pitch G = 196 periods. The almost complete absence of the fundamental is characteristic of this tone.

Fig. 9. Violin. Pitch G = 196 periods. Characteristic of the violin is the great number of harmonics and, for this low tone, the very low intensity of the fundamental.

Fig. 10. Violin. Pitch D = 293 periods (played on the G-string). The fundamental is now present in great intensity.

Fig. 11. Triangle. In the case of all the sounds reproduced until now the components were equidistant, which is shown by the fact that all the partial frequencies were multiples of a fundamental. In the case of the triangle this is not the case, the partials are not harmonics.

32589

MEASUREMENTS CARRIED OUT ON ROAD LIGHTING SYSTEMS ALREADY INSTALLED

by P. J. BOUMA.

535.24 : 628.971.6

In the first part of this article measurements on road lighting installations are described (horizontal and vertical intensity of illumination, distribution of brightness, reflection coefficients, visibility). The illumination of the road between Vught and Tilburg is chosen as an example and studied in detail. In the second part a number of conclusions are drawn, on the basis of all the material collected, about *a*) the visibility with different kinds of light, with different kinds of road surface, with different degrees of moisture of the road surface, etc.; *b*) the degree of shininess (specular reflection) of the various road surfaces in dry as well as wet states; *c*) average reflection coefficients of the various road surfaces, etc. In the third part certain items are chosen from the experimental material for the purpose of illustrating certain peculiarities of vision on artificially lighted roads.

Introduction

Several times in this periodical general guiding principles have been given for the illumination of roads with gas discharge lamps from the point of view of the properties of the eye. In connection with this it seemed desirable to collect certain data on the state of illumination which is actually obtained in the case of road lighting systems with gas discharge lamps which have already been installed. In addition to technical data, such as the power consumed per running meter, we shall in the first place attempt to determine how the light falls upon the road. For this purpose a knowledge of the horizontal and vertical intensity of illumination is required. In order to judge the quality of the installation, however, it is more important to know how the lighted road surface reflects the light in the direction of the eye of the observer. For this purpose the distribution of brightness on the road surface must be determined. The relation between intensity of illumination and brightness is given by the reflective properties of the road surface, which are in turn strongly influenced by the amount of moisture on the road.

As an important criterion of the quality of road illumination we mention finally the visibility, especially that at the most favourable and least favourable spots on the road surface.

The quantities mentioned are determined, partly by calculation and partly by measurement for a number of systems already installed¹⁾.

Description of the measurements

In the following we shall give all the numerical data for one of the installations studied: namely

the sodium lighting system of the road Vught - Tilburg, which may be considered as representative of the average sodium lighting system. The lamps are mounted in a zig-zag pattern as indicated in *fig. 1*. The height of the lamps is 8 meters. Sodium lamps of the type SO 650 (105 watts, 6 500 lumens) placed in enamelled reflectors, type SORA²⁾, are used. The axis of the lamp is horizontal to the ground and perpendicular to the direction of the road. The power consumed is 3.24 kilowatts per kilometer, and an amount of light of 200 lumens per running meter is provided. The road surface consists of a fairly light-coloured kind of asphalt. The installation was studied in the dry state.

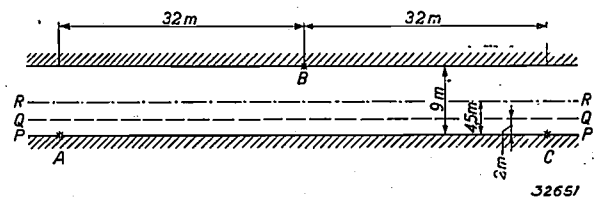

Fig. 1. Road from Vught to Tilburg. Sketch of the lighting installation. *A, B, C* represent light sources. *RR* is the middle of the road. *QQ* is the middle of the right hand half.

Horizontal intensity of illumination

The horizontal intensity of illumination at different spots on the road surface was calculated from the curves for light distribution measured in the laboratory from the combination of sodium lamp and reflector. The result is given in *fig. 2*. *A* and *B* represent two lamps. The highest and the lowest values are 15.9 and 2.1 lux, respectively, the average value is 5.5 lux. Several control measurements were carried out on the road itself. It was found that the calculated values were actually

¹⁾ The measurements were carried out by the author with the collaboration of Messrs. Bergmans and Keitz, while the last mentioned took upon himself the photography and the measuring of the photographs.

²⁾ See also the article: Sodium lamps, Philips techn. Rev. 2, 353, 1937, figs. 2 and 10.

attained³⁾. The measurements were carried out as close as possible to the ground (about 6 cm).

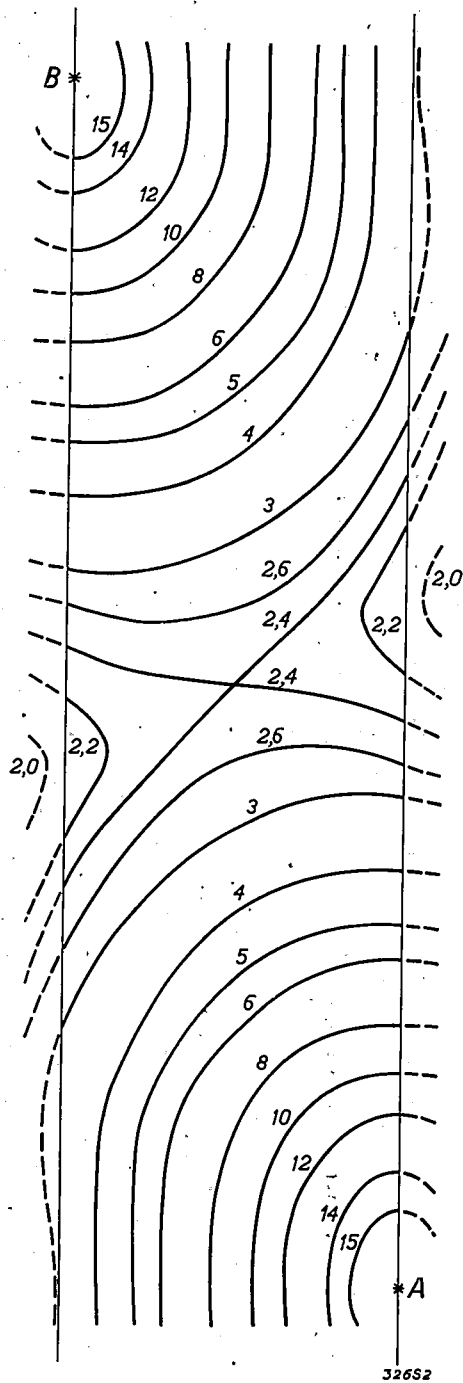

Fig. 2. Road Vught-Tilburg. Horizontal intensity of illumination calculated in lux. A and B represent light sources.

Vertical intensity of illumination

The variation of the vertical intensity of illumination in the direction of length of the road was calculated along the three lines given in fig. 1: PP along one edge directly under the lamps, QQ

³⁾ Due to the failure to clean the reflectors and exchange the lamps promptly, values lower than those calculated were found in the case of various installations.

along the middle of the right-hand half, and RR along the middle of the road, assuming that the window of the luxmeter was standing perpendicular to the direction of length of the road, and facing left in fig. 1. Fig. 3 gives the results. Each curve shows two maxima; the first is due to lamp A, the second to lamp B. As one approaches more nearly the middle of the road, the height of the maxima becomes more and more nearly equal; from considerations of symmetry it is immediately clear that in the case of curve R the two maxima must be equal. Fig. 4 gives a comparison between the values calculated (for the line PP) and the values measured on the road. The measured points are in general found to coincide satisfactorily with the calculated curve. From this the conclusion may be drawn that the influence of illumination on the vertical intensity of the light reflected by the road, which influence was neglected in the calculation, is actually very small. In the case of a road surface like the one in question this was indeed to be expected.

Average coefficient of reflection

If by the term "reflection coefficient of a road surface" we wished to describe a numerical factor which would enable us to calculate immediately the brightness occurring at any spot on the road surface from the horizontal intensity of illumination on the road, it must immediately be stated that such a universal numerical factor does not exist. The relation between intensity of illumination and brightness is, in the case of most road surfaces, very dependent on the direction of the incident light and on the direction from which we view the surface⁴⁾.

In order, however, to give some idea of whether we are concerned with a "dark" or a "light" road surface, we shall introduce the concept of an "average reflection coefficient". By this term we mean the reflection coefficient which the road surface has when the light is incident perpendicularly and the direction of viewing makes an angle of 45° with the normal⁵⁾. This average reflection coefficient is easily measured by laying a number of different dull grey pieces of paper under one of the sources of light, and observing them at

⁴⁾ Cf. for instance J. Bergmans, The Reflection of Light by Road Surfaces, Dissertation, Delft 1938, and the literature there mentioned. See also Philips techn. Rev. 3, 321, 1938.

⁵⁾ More precisely defined: the value which the quantity $\rho = B/E \cdot 100 \pi$ assumes under these circumstances, when ρ is expressed in per cent, the brightness B in c.p./sq.m, the intensity of illumination E in lux.

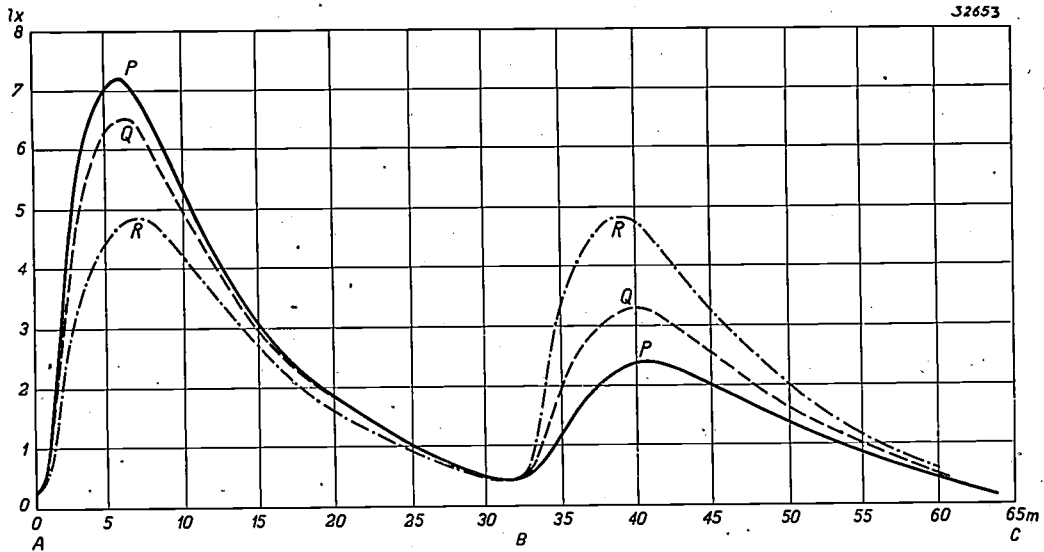

Fig. 3. Road Vught-Tilburg. Vertical intensity of illumination (calculated).
 Curve P: along the edge of the road (PP in fig. 1).
 Curve Q: along the middle of the right hand half (QQ in fig. 1).
 Curve R: along the middle of the road (RR in fig. 1).
 The window of the luxmeter is considered perpendicular to the length of the road and facing left: A, B and C represent the same light sources as in fig. 1.

angle of 45° in order to see which is of the same brightness as the road surface. For dry road surfaces the values found give a direct impression of how bright or how dark the different road surfaces will appear in the daytime with a clouded sky. For the road chosen as example here the average reflection coefficient $\rho = 11\%$, which is a fairly high value for asphalt roads.

Distribution of brightness over the road surface

As we have already mentioned; a knowledge of the average reflection coefficient is inadequate for the calculation of the distribution of brightness

from the intensities of illumination on the road. The distribution of brightness must be measured separately, and in our case it was done photographically.

For this purpose a photograph of the road was made at the height of the eye on a rapid panchromatic plate upon which a horizontal strip was covered and thus unexposed. Later on in the laboratory an exposure was made on this strip with the same kind of light and the same exposure time of a light box covered with a stepped density wedge ("Stufen Graukeil"), i.e. a glass plate divided into a number of sections with accurately known light

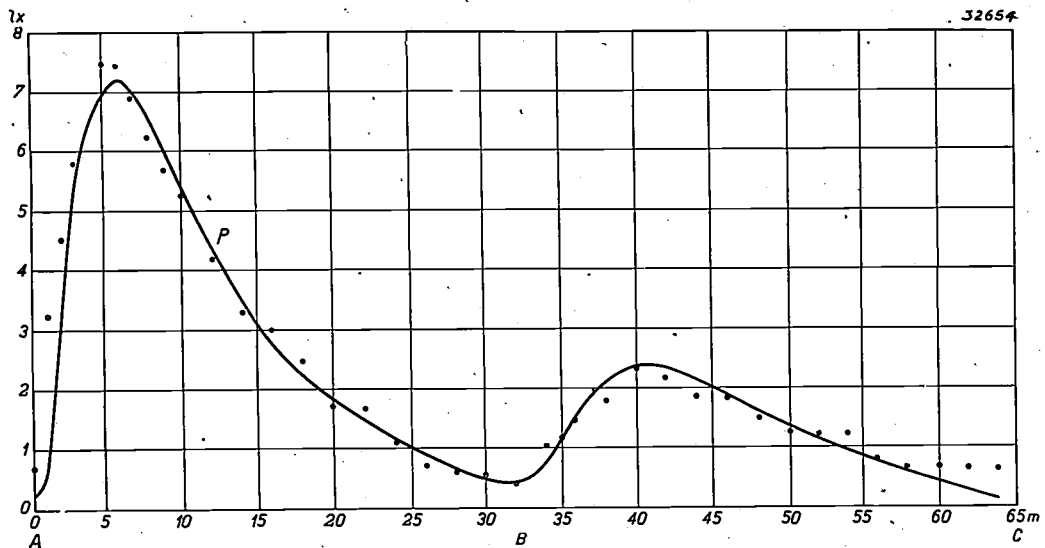

Fig. 4. Road Vught-Tilburg. Vertical intensity of illumination. The curve represents the calculated value (curve P of fig. 3), the points the measured values.



Fig. 5. Photograph of the road Vught-Tilburg used for the measurement of the distribution of brightness given in fig. 6. The observer (the camera) is situated on the line *QQ* in fig. 1 at such a point that the black stripes bound the part of the road lying between 23 and 63 m from the observer. In this section the distribution of brightness was measured. At the top may be seen the density marks used.

transmissions. By comparing the blackening of the different parts of the photograph of the road with that of the sections of known brightness, we can determine the brightness of the road surface.

Fig. 5 is a copy of the negative used for the Vught - Tilburg road with the density marks at the top of the photograph. Fig. 6 gives the distribution of brightness on the road surface deduced from the photograph. Since the brightnesses to be measured do not vary by more than a factor 15, and the density curve of the material used has an almost linear form over a much greater range, we were able to include the whole range of brightnesses in a single photograph.

In the measurement of the plate the average blackening of circular spots which have a diameter of 0.1 mm on the negative was determined photoelectrically. These spots would be observed on the road within a visual angle of more than 2 minutes, so that practically all the details which can be observed by the eye can also be recognized on the photograph.

If one now compares the distribution of brightness found (fig. 6) with the distribution of intensity of illumination (fig. 2) the following points of difference become obvious:

- 1) The regions of great brightness near the lamps have a much more linearly extended form than the regions with high intensity of illumination. In the perspective picture of the road this means: the regions of high intensity of illumination would appear to the eye as narrow stripes perpendicular to the length of the road; the regions

with great brightness would be seen as much less narrow spots.

- 2) The greatest brightness is not directly beneath the lamps, but closer to the observer; with more distant lamps this effect is more pronounced than with those closer to the observer. The two

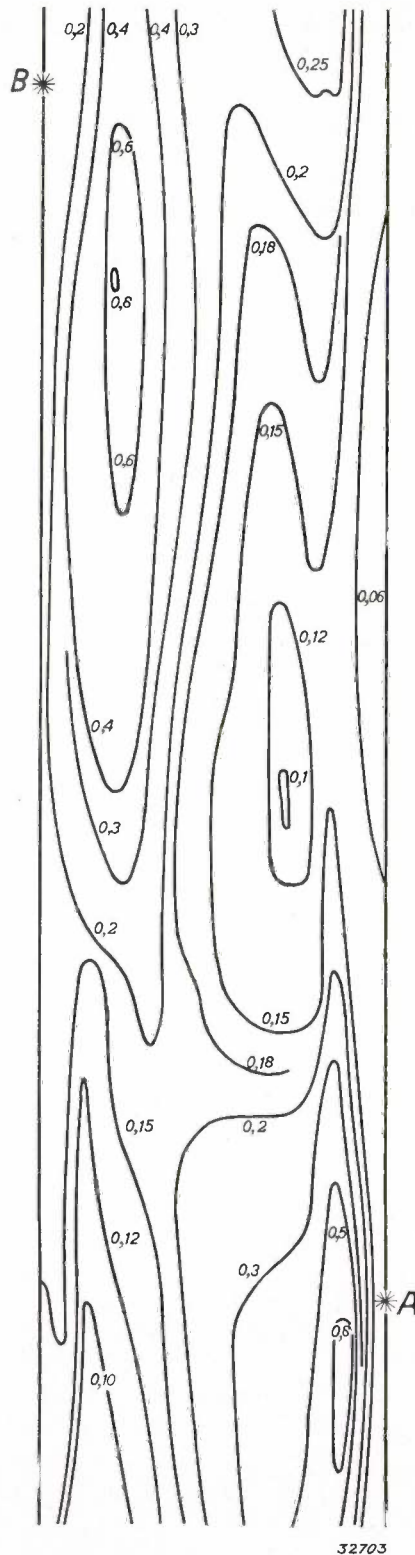

Fig. 6. Road Vught-Tilburg. Distribution of brightness over the road surface (in c.p./sq.m).

differences mentioned occur in extreme forms when the road is wet.

- 3) Fig. 6 shows many small irregularities due to the lack of homogeneity of the road surface; with diffuse illumination in the daytime spots can be observed in almost every road surface. In fig. 6 also it may be seen that the fact is confirmed that a pedestrian almost always appears dark against the background of the road surface. If he is wearing an overcoat with a reflection coefficient of 4 per cent (most overcoats are much darker) he will exhibit no greater brightness than 0.09 c.p./m^2 even at the point of highest vertical intensity of illumination, and he will therefore appear dark against practically the whole road surface.

The complete distribution of brightness was not determined for all the installations studied; in a number of cases we confined ourselves to determining the highest and lowest brightnesses in a visual way.

Visibility measurements

The visibility measurements were carried out with the visibility meter described elsewhere in the periodical ⁶⁾. This instrument enables one to observe simultaneously a large part of the road surface and a number of test objects (round spots of different brightnesses). By finding out which of the spots is just barely visible against the background of the road surface we can determine the contrast visible on the road. In the case of the installation in question the contrast was 16.4 per cent for the most favourable part of the road surface and 33.3 per cent for the least favourable part. Both values agree very well with the average values obtained for sodium lighting installations.

General conclusions from all the experimental material

Visibility with different kinds of light ⁷⁾

Visibility measurements were carried out on 24 sodium lighting systems, 6 mercury lighting systems and 3 mixed lighting systems, all in the dry state, and finally on 7 sodium lighting systems in a moist state ⁸⁾. Table I gives the average results, namely the visibility Z (as the lowest contrast observable in per cent) at the most favourable spot, the visibility z at the least favourable

spot, the average power installed (kW/km) and the average number of lumens per meter of the installation.

Table I

Kind of light	Condition of the road	Z %	z %	kW/km	lm/m
Sodium	} dry	17.2	31.2	3.30	200
Mercury		26.0	35.4	6.43	217
Mixed light		21.4	35.3	10.82	233
Sodium	damp	24.1	44.3	3.42	211

The installations which led to these averages were in most respects comparable. All of them had shielded lamps. The height from the ground and distance apart varied relatively little. The number of lumens per meter for the different kinds of light is also almost the same ($217 \pm 8\%$), so that the difference in results obtained with the visibility meter must be ascribed almost entirely to the specific properties of the kind of light used.

It may be seen that the results for the sodium lighting installations are considerably better than those for the other kinds of light, not only with respect to the value of Z but also with respect to that of z .

When we recall that it has been found in previous experiments that for safe rapid traffic it is generally necessary that contrasts of 25 - 30 per cent should be easily observable on the greatest portion of the road, it will be clear that only the sodium lighting systems satisfy this requirement well, while in the case of the other kinds of light the situation is often quite doubtful. It may furthermore be seen that as soon as the road becomes slightly damp the visibility decreases considerably: z becomes very much worse due to the occurrence of dark patches, while, in spite of the occurrence of parts with quite a high brightness, Z also becomes worse due to the greater lack of uniformity in the distribution of brightness.

Visibility measurements were also carried out on roads lighted by ordinary electric lamps, gas lamps or less carefully shielded gas discharge lamps. Since however there are in this country (the Netherlands) too few of such installations which are comparable in other respects to the cases used for the compilation of Table I, it is at present difficult to give a true comparison.

Visibility and average reflection coefficient ρ

The average reflection coefficient ρ indicates whether we are concerned with a dark or a light surface. For 8 concrete road surfaces we found an

⁶⁾ See Philips techn. Rev. 1, 353, 1936.

⁷⁾ For the number of observers, individual differences etc. see the end of this article.

⁸⁾ On the degree of moisture see in the following "The shininess of damp and wet roads".

average $\rho = 23$ per cent, for 11 granite block surfaces, average $\rho = 9$ per cent, for 6 asphalt road surfaces average $\rho = 8$ per cent. Among the granite block pavements the greatest variation of reflection coefficient was found (5-12%); the highest average reflection coefficient observed was that of a concrete road surface (29%).

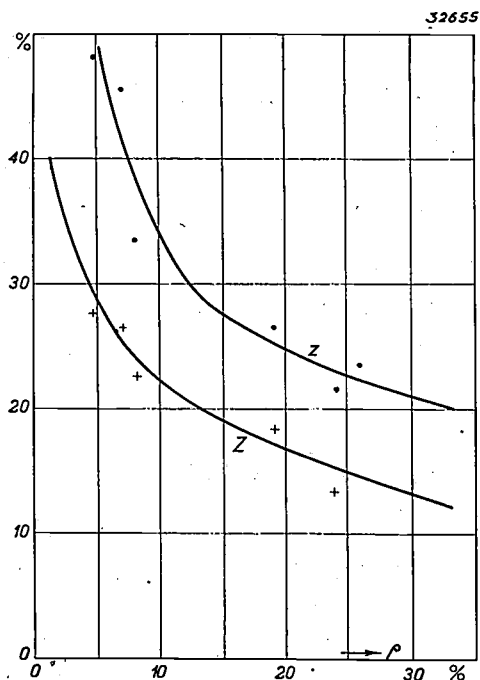

Fig. 7. Visibility as a function of average reflection coefficient of the road surface expressed as the smallest observable contrast in per cent. Z is the contrast at the most favourable, z that at the least favourable spot on the road surface. The measurements were carried out on different parts of the Brussels-Antwerp road.

In general it may be said that with similar installations and with a dry and not too unusual kind of road surface, the higher the value of ρ the higher the average level of brightness, and the better the visibility. This statement could be tested in the case of the road between Brussels and Antwerp the whole of which is lighted with the same kind of sodium lamps, but which has a number of sections which differ as to the nature of the road surface..

In fig. 7 the visibility on this road is drawn as a function of the average reflection coefficient of the road surface (z at the least, Z at the most favourable spot).

It may be seen that especially with reflection coefficients below 10 per cent the visibility becomes rapidly worse with decreasing reflection coefficient. The fact that this actually does illustrate the effect of the influence of the average level of brightness on the visibility may be seen from fig. 8 which gives the visibility Z as a function of the intensity

of illumination E , measured on a concrete road while darkness was falling and without artificial illumination. This curve is quite similar in shape to those of fig. 7.

The "shine" of a road in dry state

If the road were absolutely "dull", in other words if it were perfectly diffusely reflecting so that the reflection coefficient was independent of the direction of incidence and observation, one could calculate the brightness directly from the intensity of illumination of a given point on the surface by means of the following:

$$B = \frac{E \rho}{100 \pi}$$

(B brightness in c.p./sq.m; E horizontal intensity of illumination in lux; ρ average reflection coefficient in percent). One could in particular calculate the greatest brightness existing, B_M from the highest intensity of illumination, E_M :

$$B_M = \frac{\rho E_M}{100 \pi} \dots \dots \dots (1)$$

Actually the road is not absolutely dull, so that equation (1) must be replaced by:

$$B_M = K \frac{\rho E_M}{100 \pi}$$

K is here a quantity dependent upon the reflective properties of the road surface and on the nature of the lighting system, and it gives an idea as to the magnitude of the differences between the bright-

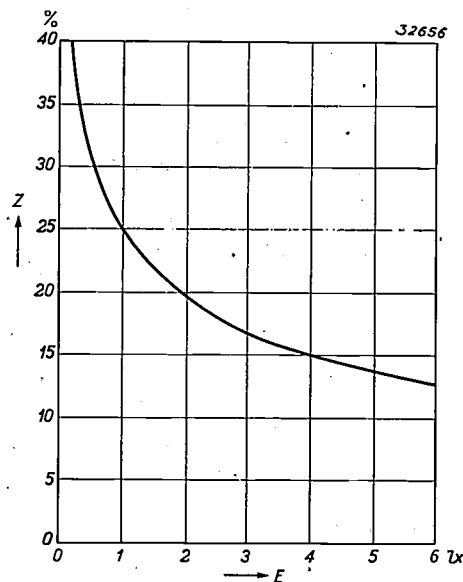

Fig. 8. Visibility Z as a function of the intensity of illumination E on a road without artificial illumination measured while darkness was falling. The shape of the curve is similar to that in fig. 7.

nesses actually occurring and the brightnesses which would be expected with a diffusely reflecting road surface. For a perfectly diffusely reflecting road surface $K = 1$.

In general the deviations of the reflective properties of a road surface from those of a diffusely reflecting surface consists in the fact that the road surface reflects more strongly in the direction of the observer rays which are incident almost horizontally, usually at the expense of the amount of light which is reflected from other directions. The first result of this is the appearance of the phenomenon that the region of greatest brightness no longer coincides with that of greatest intensity of illumination (see figs. 2 and 6).

In the case of very shiny road surfaces (for instance when wet) spots with great brightness will occur. K is considerably greater than unity. In the case of dull surfaces one may encounter the phenomenon that while the spot with greatest brightness has been displaced to a spot with a lower value of E , the reflective capacity at that spot has not however yet increased so much that a higher value of B_M occurs than would be expected from equation (1). Under these circumstances therefore K may assume values which are smaller than unity. In the case of the system of lighting commonly used in the Netherlands (concentrating armature with a cut-off angle of about $2 \times 75^\circ$), this is the case for most concrete roads.

For the most commonly occurring road surfaces the following average values of K were found: concrete: $K = 0.72$; granite blocks: $K = 1.12$; asphalt: $K = 1.48$.

It must be noted that the quantity K must be used with some care. It will depend partly upon the nature of the lighting system as to the extent to which the special reflective properties of the road surface will give rise to the appearance of great brightnesses, so that K is actually a quantity which characterizes the state of a given road surface when a given lighting system is applied, in other words K gives us an impression of the brightness phenomena actually occurring. With entirely different lighting systems (for example where much light is emitted at small angles to the horizon) different values of K will be found. The values given here are valid for the most commonly used system in the Netherlands (the light source radiates practically no light at angles greater than 75° with the vertical).

Another quantity which is closely dependent upon the degree of shininess of the road surface is the ratio $B_M : B_m$ of the highest and the lowest

brightnesses occurring: with very shiny road surfaces this ratio will assume high values. It is however clear that this quantity is even more dependent than K on other factors, such as the lighting system, width of the road, etc. As average values for the installations measured (several installations of a strongly diverging type were omitted) we found for: concrete $B_M : B_m = 4.8$; granite blocks $B_M : B_m = 8.1$; asphalt $B_M : B_m = 10.4$. The shinier the road the more K and $B_M : B_m$ increase. An attempt was therefore made to discover any possible simple relation between the two quantities. In fig. 9 the two quantities have been plotted against each other. The simple points refer to installations with different dry road surfaces, the points surrounded by circles refer to the above mentioned averages for the three types of road surfaces, the crosses to several installations under moist conditions. Except for a rather wide scattering of the points, which was to be expected, it may be seen that there exists a fairly close connection between the two factors. $B_M : B_m$ increases more rapidly than K , which is to be understood: when

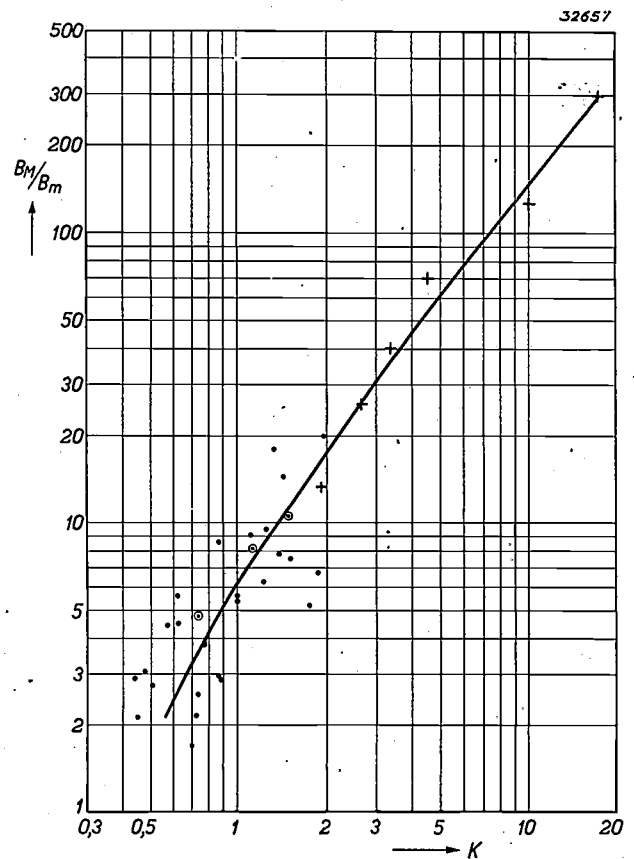

Fig. 9. Correlation between the two quantities $B_M : B_m$ and K , both of which give an idea of the degree of shininess of the road.
 ● Different installations, dry condition.
 ○ Average values for concrete, granite block and asphalt surfaces.
 + Different installations, damp condition.

the road surface becomes more shiny B_M increases, but at the same time B_m decreases.

The "shininess" of damp and wet roads

As soon as the road surface becomes damp, it becomes more shiny, K and B_M/B_m increase sharply. It is difficult to express the degree of dampness in figures. We have therefore confined ourselves to an estimation of the degree of dampness according to the following scale:

1. Dry
2. Slightly damp (occurs for example as the result of mist)
3. Damp
4. Very damp
5. Wet (not during rain, there is as yet no formation of puddles)
6. During moderate rain (formation of puddles)
7. During heavy rain (inundation of the road surface)

The data given until now about damp road surfaces have referred exclusively to the conditions 1 to 4.

Data for all these conditions of dampness are given in table II. It must be noted that all values for concrete road surfaces refer to the same installation (the Boschdijk in Eindhoven), while the data for asphalt are for different installations (Eindhoven, Haarlem and surroundings).

Table II

Condition of dampness	B_M/B_m		K	
	concrete	asphalt	concrete	asphalt
1	4,4	7,6	0,60	1,50
2		13,4		1,90
3	26	40	2,7	3,4
4	70	126	4,5	10
4 - 5		300		17
5			12 - 96	34 - 220
6			65 - 740	

Two values are given for K for the conditions 5 and 6 (wet and very wet). The first is valid when we do not take into consideration the brightness of the light spot caused by the nearest light source (which is at a distance of less than 30 m), the second is for the case when this light source is taken into consideration. The fact that one sees the image of the light source itself reflected on the road surface in the case of the nearest lamp thus has an enormous influence. This is made impossible in the case of more distant lamps by their shields. With installations having unshielded sources of

light the first values are almost as high as the second. For a concrete road surface with such an installation measured in condition 6, $K = 410 - 660$.

Fig. 10 illustrates the increase in K and $B_M : B_m$ with the degree of dampness for concrete (curve 1) and for asphalt (curve 2). It is clear that the difference between the two kinds of road surface remains even at high degrees of dampness. This difference may be expected to disappear for the quantity $B_M : B_m$ in condition 7 (flooding).

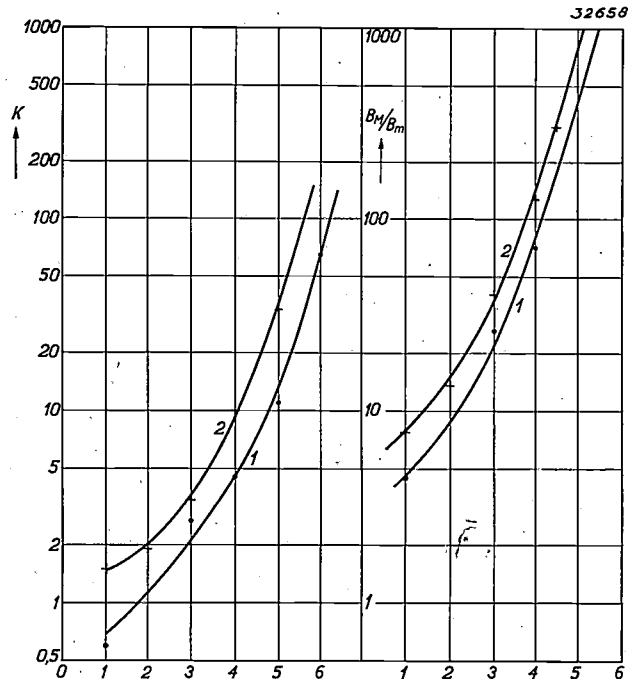

Fig. 10. The quantities $B_M : B_m$ and K (both of which give an idea of the degree of shininess of the road) with increasing degree of dampness: 1 for concrete; 2 for asphalt. See text for the significance of the numbers 1-6.

Visibility on damp and wet roads

During rain (conditions 6-7) measurements with the visibility meter are of little use: a large part of the road surface is so black that one can no longer observe even the darkest points on the meter. It is also out of the question that small objects would appear dark against the lighter road under such circumstances. Vision on thoroughly wet roads takes place in a different way, and is based on the following considerations:

- 1) The edge of the road is often indicated by the light spots on the road; illuminated trees and the like may be useful here.
- 2) Objects on the road often cast a shadow across such a light spot.
- 3) Objects on the road are more brightly illuminated by car headlights than the dark road surface.

As to the visibility at the other degrees of damp-

ness (1 - 5), we have collected the following among other data:

Table III

Condition of dampness	Concrete		Asphalt	
	Z (%)	z (%)	Z (%)	z (%)
1 (dry)	8	26	15	26
2			24	43
3			28	48
4	26	48		
5 (wet)	34	62	36	

The visibility is again expressed as the lowest observable contrast in per cent, Z for the most favourable and z for the least favourable spot on the road surface.

It is clear that the visibility at the most favourable spot decreases rapidly in spite of the increasing brightness as the road becomes wetter, while with really wet roads the visibility at the most unfavourable spot is practically no longer measurable.

Several special cases

In conclusion we shall present several instructive points in connection with visibility measurements.

Visibility and density of traffic

Dense traffic on the road, when numerous points of light are visible in the distance, and even without the disturbing influence of undimmed automobile headlights and poorly directed bicycle lamps, has a very unfavourable influence on visibility. All the results given until now were obtained at times when there was very little traffic on the road (usually between 1 and 3 o'clock in the morning).

Table IV gives a comparison of the visibility on several dry roads chosen at random, with and without dense traffic.

Table IV

Road	Z		z	
	with dense traffic	without dense traffic	with dense traffic	without dense traffic
a	29½	16½	39	25½
b	44	12½	55	32½
c	25	14½		21
d	28½	10		21½

Visibility and non-uniform distribution of brightness

Great local brightness does not always produce better visibility. The truth of this statement for the case of wet roads has already been shown above (see Table III). In the case of dry roads also we

encountered several typical cases in which great local brightness is of no advantage.

The first case was encountered on a sodium lighted part of the road Brussels—Antwerp, where the road is divided into two separate halves, one of which has a concrete surface and the other is paved with dark but quite shiny granite blocks. The general level of brightness was considerably lower on the granite-paved part, the maximum brightness was however almost the same in both cases. In spite of the latter fact the visibility at the most favourable spot on the granite paved half was much poorer than that on the concrete half (27 against 14 per cent): the non-uniformity of the distribution of brightness on the shiny granite renders the visibility poorer. An even more telling example was encountered near Haarlem where two halves of a slightly damp asphalt road (condition 2) were lighted in the same way with sodium lamps, the only difference between the two sides being the employment of different types of fixtures which made the distribution of brightness different. Table V gives some of the results of measurements on this road.

Table V

	1st part	2nd part
Greatest brightness B_M	0.47	2.45
Least brightness B_m	0.062	0.044
Visibility } Z	13 ^s	19 ^s
	z	36

It is obvious that z is more unfavourable on the second — less uniform — part. It is however somewhat surprising that the visibility at the brightest place on the second part is also more unfavourable than for the first part: the lack of uniformity in the distribution of brightness has such a disturbing effect that the advantage of the greater local brightness is entirely destroyed. It must be noted that the brightest spots on the second part of the road were of somewhat smaller area than on the first part. This striking phenomenon was observed by three independent observers.

Visibility and individual differences

In order to make the subjective factor, which is characteristic of every visibility measurement, as small as possible, the results obtained by different observers were included in the material discussed in the foregoing. Three observers usually worked together; in many cases previous measurements by other observers were available. These

observers had often used visibility meters with a slightly different calibration.

In order to be able to compare all these measurements with confidence, they must be corrected for individual differences of observers and instruments. This was done by making a table of all the cases where the measurements were carried out by several persons or with different instruments. From this table a fixed correction could be determined for every combination of observer and visibility meter, which correction brought all the measurements

to the same average level. In almost all cases the correction amounted to only 1 or 2 points of the visibility meter.

After this fixed correction had been applied the measurements of the various observers showed satisfactory agreement in the case of every installation, so that we could take their average without hesitation and could at the same time draw the conclusion that the phenomena described in this article were valid for all the observers who contributed.

THE EFFICIENCY OF LOUD SPEAKERS

by J. de BOER.

621.395.623.742

A discussion is given of the distribution of the energy supplied in an electrodynamic loud speaker, and an equivalent circuit is devised for the purpose of studying this energy distribution and at the same time the efficiency of the loud speaker. An estimation of the efficiency for a practical example indicates the reason why a value of only a few per cent is obtained for the efficiency. The fundamental limitations which prevent the attainment of appreciably higher efficiencies are explained.

Considered from the point of view of energy the loud speaker, that for instance built into a radio set, plays the part of a transformer which converts electrical energy into acoustic energy. This point of view is of practical importance when it is desired to know the energy which must be delivered by the amplifier in order that the loud speaker connected with it may produce sound of a certain intensity. Just as in the case of transformers of other types such as power transformers, in this case also one may speak of the efficiency of the energy conversion in the loud speaker, and one means in this case the fraction of the (electrical) energy supplied, which is converted into useful (acoustic) energy. In the case of good loud speakers a value of several per cent is found for the acoustic efficiency. Compared with other methods of sound excitation this value is not low: Jeans (in his book "Science and Music") states that a church organ converts only 0.13 per cent of the energy supplied into sound. The "efficiency" of a pianist seems to be about 0.2 per cent. In technology, however, especially in the case of "transformers" in the narrower sense of the term, one is accustomed to efficiency values of more than 90 per cent. Why does the energy conversion in the loud speaker compare so unfavourably with these values? What becomes of the rest of the energy supplied? What factors influence the efficiency? These are a few questions

which we shall consider in this article. We shall confine ourselves to loud speakers of the electrodynamic type, which are the most important for practical cases since they give the best quality of reproduction.

Energy balance of an electrodynamic loud speaker

Fig. 1 is a photograph of an electrodynamic loud speaker system, while *fig. 2* is a diagram of a cross section of such a system. In the cylindrical air gap between the pole pieces of a magnet is a moving coil to which is fastened a conical membrane. When currents modulated according to the vibrations of speech or music are sent through the coil, it moves in the same rhythm, and the cone, which moves with it, communicates the motion to the air. If one considers the different ways in which the electrical energy supplied can be taken up in the system the following conception is reached.

The coil has a certain electrical resistance by which energy is dissipated in the form of heat¹).

¹) We shall neglect the self-induction of the coil. In order to prevent the self-induction from becoming large due to the fact that the lines of force of the coil would pass through the iron of the pole piece over the greater part of their course, a copper ring is often placed around the inner and outer circumferences of the cylindrical air gap. When this measure is taken the self-induction only becomes appreciable at frequencies of the order of 10 000 c/sec.

observers had often used visibility meters with a slightly different calibration.

In order to be able to compare all these measurements with confidence, they must be corrected for individual differences of observers and instruments. This was done by making a table of all the cases where the measurements were carried out by several persons or with different instruments. From this table a fixed correction could be determined for every combination of observer and visibility meter, which correction brought all the measurements

to the same average level. In almost all cases the correction amounted to only 1 or 2 points of the visibility meter.

After this fixed correction had been applied the measurements of the various observers showed satisfactory agreement in the case of every installation, so that we could take their average without hesitation and could at the same time draw the conclusion that the phenomena described in this article were valid for all the observers who contributed.

THE EFFICIENCY OF LOUD SPEAKERS

by J. de BOER.

621.395.623.742

A discussion is given of the distribution of the energy supplied in an electrodynamic loud speaker, and an equivalent circuit is devised for the purpose of studying this energy distribution and at the same time the efficiency of the loud speaker. An estimation of the efficiency for a practical example indicates the reason why a value of only a few per cent is obtained for the efficiency. The fundamental limitations which prevent the attainment of appreciably higher efficiencies are explained.

Considered from the point of view of energy the loud speaker, that for instance built into a radio set, plays the part of a transformer which converts electrical energy into acoustic energy. This point of view is of practical importance when it is desired to know the energy which must be delivered by the amplifier in order that the loud speaker connected with it may produce sound of a certain intensity. Just as in the case of transformers of other types such as power transformers, in this case also one may speak of the efficiency of the energy conversion in the loud speaker, and one means in this case the fraction of the (electrical) energy supplied, which is converted into useful (acoustic) energy. In the case of good loud speakers a value of several per cent is found for the acoustic efficiency. Compared with other methods of sound excitation this value is not low: Jeans (in his book "Science and Music") states that a church organ converts only 0.13 per cent of the energy supplied into sound. The "efficiency" of a pianist seems to be about 0.2 per cent. In technology, however, especially in the case of "transformers" in the narrower sense of the term, one is accustomed to efficiency values of more than 90 per cent. Why does the energy conversion in the loud speaker compare so unfavourably with these values? What becomes of the rest of the energy supplied? What factors influence the efficiency? These are a few questions

which we shall consider in this article. We shall confine ourselves to loud speakers of the electrodynamic type, which are the most important for practical cases since they give the best quality of reproduction.

Energy balance of an electrodynamic loud speaker

Fig. 1 is a photograph of an electrodynamic loud speaker system, while *fig. 2* is a diagram of a cross section of such a system. In the cylindrical air gap between the pole pieces of a magnet is a moving coil to which is fastened a conical membrane. When currents modulated according to the vibrations of speech or music are sent through the coil, it moves in the same rhythm, and the cone, which moves with it, communicates the motion to the air. If one considers the different ways in which the electrical energy supplied can be taken up in the system the following conception is reached.

The coil has a certain electrical resistance by which energy is dissipated in the form of heat¹).

¹) We shall neglect the self-induction of the coil. In order to prevent the self-induction from becoming large due to the fact that the lines of force of the coil would pass through the iron of the pole piece over the greater part of their course, a copper ring is often placed around the inner and outer circumferences of the cylindrical air gap. When this measure is taken the self-induction only becomes appreciable at frequencies of the order of 10 000 c/sec.

When moving the mass of the coil and cone has a certain kinetic (wattless) energy; potential energy (also wattless) is taken up in the elastic suspension of the system, and energy is dissipated by friction

of the energy supplied over the various energy reservoirs we shall introduce an equivalent electrical circuit for the loud speaker, *i.e.* a circuit in which each of the reservoirs mentioned is represen-

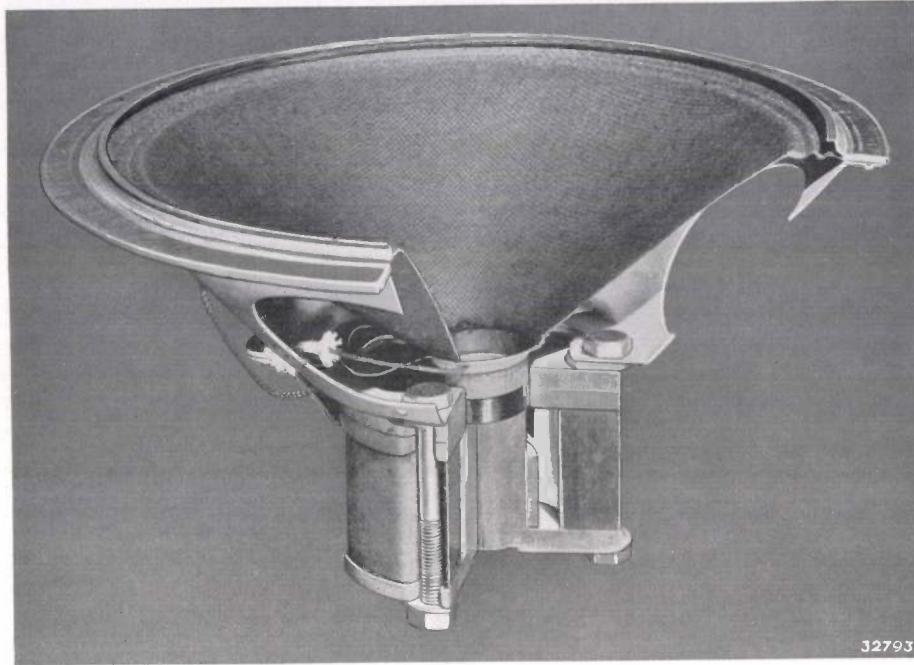

Fig. 1. Photograph of an electrodynamic loud speaker system (the system is cut open).

in this suspension. Finally energy is also given off to the air, and we have seen in a former article ²⁾ that this energy consists of two components: a wattless energy which can be given back to the radiator by the air, and the useful acoustic energy ³⁾.

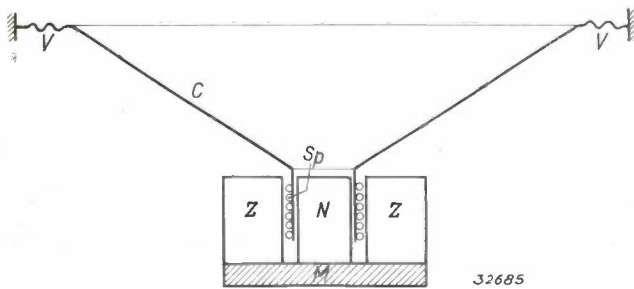

Fig. 2. Diagram of an electrodynamic loud speaker. In the air gap between the pole pieces *N* and *S* of the magnet *M* (pole *S* is in the form of a ring) is the moving coil *Sp* to which is fastened the cone *C* suspended from springs *V*. The currents modulated by the sound are conducted through *Sp*.

Introduction of an equivalent circuit

In order to obtain an idea of the distribution

²⁾ A. Th. van Urk and R. Vermeulen; The radiation of sound, Philips techn. Rev. 4, 225, 1939.
³⁾ We assume that the cone is placed in a large baffle, so that no potential energy can be taken up by a tangential motion of the air; see the article cited in footnote ²⁾. The loud speaker radiates toward both sides of the baffle.

ted by an electrical element which takes up the same energy as the corresponding reservoir in the original system at any frequency of the voltage acting on the circuit. In *figs. 3a* and *b* the mechanical models are first indicated for

a) the moving mechanical system. This consists of the mass M_M of coil and cone together which is fastened to a spring with the stiffness S . When the mass is moved at a velocity v it

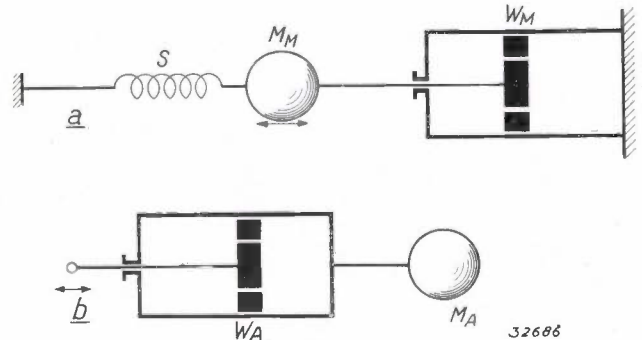

Fig. 3. Models for the mechanical parts of the system.
a) The mass M_M of coil and cone together is suspended on a spring having the stiffness S , and in its motion experiences a frictional force proportional to its velocity (proportionality factor W_M).
b) Mechanical model for the radiation of sound. The mass M_A represents the inertia of the air, the resistance W_A the "energy loss" due to the occurrence of a sound wave. The energy dissipated in W_A is the useful acoustic energy.

experiences a frictional resistance $W_M \cdot v$.
 b) the air. This model is derived in the article cited²). The acoustic energy radiated corresponds to the energy dissipated in the mechanical resistance W_A when an acceleration is given to the mass M_A . The kinetic energy of the mass M_A is the (wattless) energy which is taken up in the flow of air.

These two models can, with the electrical resistance R_E of the coil, be combined to give the entirely electrical circuit given in fig. 4, where it must be assumed that:

$$\left. \begin{aligned} L_M &= H^2 l^2 \frac{1}{S} \\ C_M &= \frac{1}{H^2 l^2} M_M \\ R_M &= H^2 l^2 \frac{1}{W_M} \end{aligned} \right\} \dots \dots (1)$$

$$\left. \begin{aligned} C_A &= \frac{1}{H^2 l^2} M_A \\ R_A &= H^2 l^2 \frac{1}{W_A} \end{aligned} \right\} \dots \dots (2)$$

H stands for the magnetic field (assumed to be homogeneous) in the air gap, and l for the length of the wire of the coil.

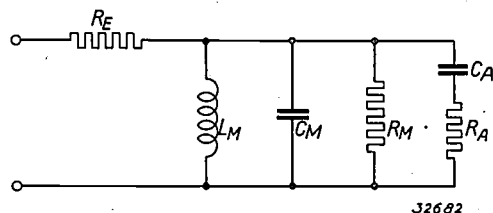

Fig. 4. Entirely electrical equivalent circuit, in which each of the energy reservoirs in the loud speaker system (figs. 3a) and b)) is represented by an element, and in which the energy distribution among the elements is identical with that among the reservoirs in question.

Justification of the equivalent circuit

The fact that the equivalent circuit satisfies the requirement made of it can be shown in the following way. We assume that the system executes an harmonic vibration. For the motion of the electrodynamic system (fig. 2) two equations are valid. The first, electrical, equation expresses the fact that the voltage V across the ends of the coil is equal to the sum of the voltage drop along the resistance R_E and of the counter EMF which is induced in the coil in its motion at the velocity v :

$$V = R_E \cdot i + H l v \dots \dots (3)$$

where i is the current in the coil. The second, me-

chanical, equation expresses the fact that the motive force $H l i$ on the coil is equal to the reaction of the mechanical system:

$$H l i = Z_M \cdot v \dots \dots (4)$$

Z_M is here the (complex) mechanical impedance, i.e. the relation between the force and the velocity of movement of the mechanical system.

From equations (3) and (4), by the elimination of v ,

$$V = i \left(R_E + H^2 l^2 \frac{1}{Z_M} \right) \dots \dots (5)$$

Both the systems represented in fig. 3 contribute to the mechanical impedance Z_M .

For the mechanical impedance Z_M , of the system a one finds with the help of the equations of motion:

$$Z_{M1} = \frac{K_1}{v} = W_M + j\omega M_M + \frac{S}{j\omega}$$

For the mechanical impedance Z_{M2} of the air (system b) in fig. 3) one finds⁴):

$$\frac{1}{Z_{M2}} = \frac{v}{K_2} = \frac{1}{W_A} + \frac{1}{j\omega M_A}$$

The total force on the system is the sum of the forces K_1 and K_2 , and therefore the total mechanical impedance is:

$$Z_M = \frac{K_1 + K_2}{v} = W_M + j\omega M_M + \frac{S}{j\omega} + \frac{1}{\frac{1}{W_A} + \frac{1}{j\omega M_A}}$$

This is substituted in a somewhat different form in equation (5):

$$\frac{V}{i} = R_E + \frac{1}{\left[\frac{1}{\frac{H^2 l^2}{W_M} + \frac{1}{j\omega M_M} + \frac{1}{H^2 l^2 j\omega}} \right] + \frac{1}{\frac{H^2 l^2}{W_A} + \frac{1}{j\omega M_A}}} \dots \dots (6)$$

The denominator of the second member has the form of the reciprocal of the impedance of the connection in parallel of four elements: a self-induction L_M , a capacity C_M and a resistance R_M which are defined by equation (1) and an element which consists of a resistance R_A and a capacity C_A defined by equation (2) connected in series. Formula (6) expresses the fact that this combination of four elements in parallel is connected in series with the resistance R_E . This is, however, exactly what is represented in the equivalent circuit, the

⁴) See equation (13) on page 288 of the article cited in footnote²).

circuit is therefore a faithful representation of the system as far as the impedances are concerned and therefore also as far as the energy distribution is concerned.

Application of the equivalent circuit

Since the resistance R_A in fig. 4 represents the equivalent of the mechanical resistance W_A of the air in fig. 3b, in applying a voltage to the circuit of fig. 4, we must consider the energy, which is dissipated in the resistance R_A as the useful energy given off. The ratio between this energy and the total energy taken up in the circuit is the efficiency. This ratio is determined by the current distribution in the circuit; this distribution, however, clearly depends upon the frequency. For a certain frequency a resonance occurs between the self-induction L_M and the capacity $C_M + C_A$ (the resistance R_A in series with C_A may here be neglected, since at the resonance frequency $R_A \ll 1/\omega C_A$). As we shall see this gives rise to a maximum in the efficiency of the loud speaker at the resonance frequency: $\nu_0 = 1/2 \pi \sqrt{L_M (C_M + C_A)}$. No advantage can be taken of this maximum in practical cases, because a "straight" characteristic is required of the loud speaker for the sake of the quality of reproduction, i.e. a constant variation of the energy radiated as a function of the frequency when the energy supply is constant. Such a characteristic is obtained approximately by making the resonance frequency of the loud speaker as low as possible, so that practically the whole range of frequencies to be reproduced acoustically lies above the resonance frequency.

Estimation of the acoustic efficiency in a practical case

On the basis of the equivalent circuit we shall now examine the efficiency obtained at different frequencies for a practical case. In table I the quantities required for the composition of the circuit for the case of a given loud speaker (Philips radio loud speaker 9 602) are given.

The electrical resistance R_E , the stiffness S of the suspension, the mass M_M of coil and cone together and the frictional resistance W_M are determined by measurement. The mass M_A and the resistance W_A of the model of fig. 3b for the radiation may be derived theoretically by idealizing the loud speaker membrane, for example to a pulsating sphere. In the previously cited article ²⁾ this calculation has been carried out with the following result (see equation (14) of that article):

Table I
Data for a radio loud speaker (type 9 602)

Actual quantities	Corresponding elements in the equivalent circuit
$H = 7\ 000$ oersted $l = 523$ cm	Transformation factor $H^2 l^2 = 13.4 \times 10^{12}$ dyne
measured $\left\{ \begin{array}{l} R_E = 4 \text{ Ohm} \\ S = 1,44 \cdot 10^6 \frac{\text{Dyn}}{\text{cm}} \\ M_M = 5,2 \text{ g} \\ W_M = 260 \frac{\text{Dyn sec}}{\text{cm}} \end{array} \right.$	$R_E = 4 \text{ Ohm}$ $\frac{H^2 l^2}{S} = L_M = 9,3 \text{ mH}$ $\frac{M_M}{H^2 l^2} = C_M = 0,39 \text{ mF}$ $\frac{H^2 l^2}{W_M} = R_M = 52 \text{ Ohm}$
Derived theoretically for a pulsating sphere, radius $a = 6$ cm $\left\{ \begin{array}{l} M_A = 3,5 \text{ g} \\ W_A = 1,9 \cdot 10^4 \frac{\text{Dyn sec}}{\text{cm}} \end{array} \right.$	$\frac{M_A}{H^2 l^2} = C_A = 0,26 \text{ mF}$ $\frac{H^2 l^2}{W_A} = R_A = 0,7 \text{ Ohm}$

In the conversion of the mechanical into electrical quantities according to equations (1) and (2) by means of the "transformation factor" $H^2 l^2$ it must be noted that in the measurement of H in oersted and l in cm the electrical quantities are obtained in absolute electromagnetic units. In order to express the quantities in the practical units the factor $H^2 l^2$ must be multiplied by 10^{-9} .

$$\left. \begin{array}{l} M_A = 4 \pi a^3 \rho \\ W_A = 4 \pi a^2 \rho c \end{array} \right\} \dots \dots \dots (7)$$

where s is the radius of the sphere, ρ the density of the air and c the velocity of propagation of the sound in air. For the loud speaker in question the radius of the equivalent pulsating sphere may be taken as 6 cm (i.e. about 0,7 times the radius of the opening of the cone). The values of M_A and W_A given in the table then follow. These values, and the following remarks in general, are, however, valid only at those frequencies at which the cone of the loud speaker vibrates as a whole, which is the case up to frequencies of 1000 c/s.

In fig. 5 may be seen the equivalent circuit with the values of the different elements indicated. As an example we shall determine the efficiency at a frequency of 160 c/s, i.e. when $\omega = 1000$. At this frequency the impedances of the various elements have the values given in table II.

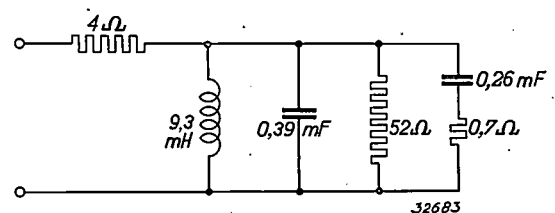

Fig. 5. The equivalent circuit for a practical case.

Table II

Impedances occurring in the equivalent circuit at $\omega/2\pi = 160$ c/s.

R_E	=	4	Ohm
ωL_M	=	9,3	"
$1/\omega C_M$	=	2,6	"
R_M	=	52	"
$1/\omega C_A$	=	4	"
R_A	=	0,7	"

The shunts ωL_M and R_M may be neglected here compared with $1/\omega C_M$. For a rough estimation of the current distribution we shall also neglect R_A compared with the impedance $1/\omega C_A$ in series with it. The fraction $2.6/(4 + 2.6) = 0.4$ of the total current i through R_E then passes through the elements $C_A R_A$. In R_A the energy $(0.4 i)^2 R_A$ is dissipated, in R_E the energy $i^2 R_E$. The efficiency η_a is therefore the following:

$$\eta_a = \frac{(0,4 i)^2 \cdot 0,7}{i^2 \cdot 4 + (0,4 i)^2 \cdot 0,7} = 2,7\%$$

From this estimation the reasons why the efficiency is so low become evident. In the first place it is due to the fact that R_E is considerably larger than R_A . If the full current passed through R_A the efficiency would still only amount to $0.7/4 = 17$ per cent. In the second place the shunt formed by C_M takes up a high wattless current which also flows through R_E and there causes considerable loss. Turning from theory to reality, this means that a large force is necessary to start the motion of the coil and the cone which of itself requires no energy. This force is obtained by a large current through the coil which develops considerable Joule heat in the resistance of the coil.

When in resonance the motion of the mechanical system requires only enough force to overcome friction, the coil then need not conduct wattless current for this purpose, and the efficiency of the loud speaker is considerably higher. In the example in question the resonance frequency lies at 65 c/s. At this frequency one finds an efficiency of 25 per cent. Passing on to still lower frequencies, the impedance ωL_M in the shunt becomes the most important one. This impedance falls with decreasing value of ω , while the impedance $1/\omega C_A$ rises. The fraction of the total current passing through R_A therefore decreases approximately with the square of ω . The efficiency, which is proportional to the square of this fraction, therefore decreases with the fourth power of the frequency at frequencies lower than the resonance frequency. This is the

reason why the resonance frequency of a loud speaker is made as low as possible.

Above the resonance frequency we may, as was done above in the estimation of the efficiency for a given frequency, neglect the impedance ωL_M and R_M compared with $1/\omega C_M$. We therefore actually make use of the simplified equivalent circuit shown in fig. 6. The current distribution in the two

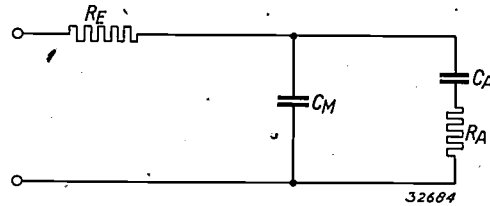

Fig. 6. Simplified equivalent circuit for the frequency range above the resonance frequency.

branches in parallel is independent of the frequency when R_A is small compared with $1/\omega C_A$. Under this condition, therefore, the efficiency is constant, which means at the same time that the characteristic of the loud speaker has the desired straight form. At high frequencies, however, R_A gradually becomes comparable to $1/\omega C_A$; with increasing frequency the impedance of the shunt C_M then falls more rapidly than that of the circuit $C_A R_A$, the current distribution becomes less favourable and the efficiency falls. In the example discussed, from the condition that $R_A = 1/\omega C_A$, a value in round

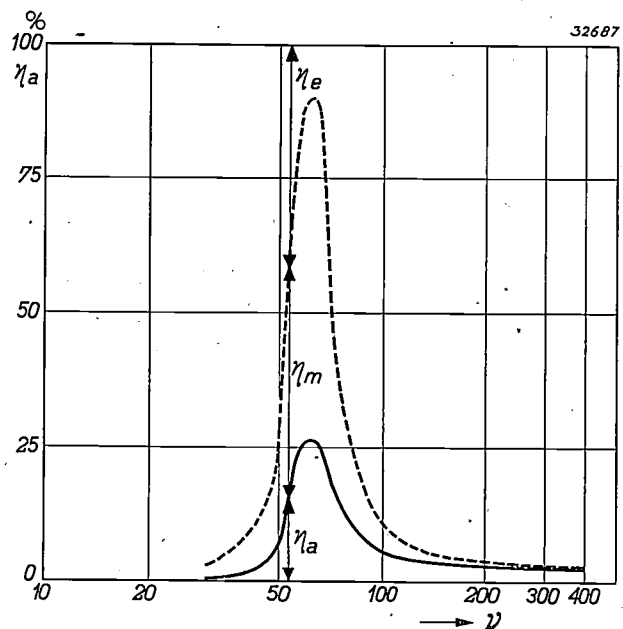

Fig. 7. Variation of the acoustic efficiency η_a (full line curve), of the loud speaker used as practical example, as a function of the frequency ν in c/s. The distance between the dotted curve and the line $\eta_a = 100\%$ gives the electrical efficiency η_e (the fraction of the energy dissipated in R_E). The distance between the two curves at every point along the ν -axis gives the fraction η_m of the energy supplied which is dissipated in the mechanical resistance (W_M in fig. 3a).

numbers of $\omega/2\pi = 900$ c/s is found for the frequency where the fall in efficiency begins. In practical cases, however, new resonances begin to be noticeable just in this region, which are due to modes of vibration of the cone in which it no longer moves as a whole.

By making use of these resonances a fairly constant efficiency (straight characteristic) can be obtained up to considerably higher frequencies.

The precise calculation of the acoustic efficiency η_a from the data of table I gives the curve shown in fig. 7. The distance between the broken line curve and the line $\eta_a = 100\%$ gives the "electrical efficiency" η_e , i.e. the fraction of the energy supplied which is dissipated in the electrical resistance R_E . The distance between the two curves is then the remainder of the energy which is dissipated in the frictional resistance of the mechanical system.

The fundamental limitations of the efficiency

It has already been pointed out that the low efficiency is due in the first place to the fact that R_E in the equivalent circuit is unsatisfactorily large. One might therefore attempt to make the resistance R_E of the coil smaller in order to obtain a higher efficiency. The resistance R_E is given by:

$$R_E = \frac{l}{q \cdot \sigma}, \dots \dots \dots (8)$$

where l is the length, q the area of the cross section of the wire and σ the conductivity of the material of the wire. The following holds for the mass of the winding:

$$m_s = l q \rho_s, \dots \dots \dots (9)$$

where ρ is the specific weight of the wire material. This mass contributes in the equivalent circuit an important amount to the capacity C_M which is of course derived from the mass m_s and the mass m_c of the cone in the following way:

$$C_M = \frac{M_M}{H^2 l^2} = \frac{m_s + m_c}{H^2 l^2}$$

If C_M is divided into two capacities: $C_s = m_s/H^2 l^2$ and $C_c = m_c/H^2 l^2$, it follows from (8) and (9) that

$$R_E \cdot C_s = \frac{\rho_s}{H^2 \sigma} \dots \dots \dots (10)$$

With a given field strength and kind of material, therefore, a reduction of R_E , for example by increasing the diameter of the wire while keeping its length the same, is accompanied by an increase in

C_M . This means that when we attempt to improve the efficiency of the loud speaker in the manner described by decreasing the energy dissipated in R_E , the current distribution in the circuit is affected in such a way that the efficiency becomes lower. When the optimum existing between these two opposing influences has been found, then according to equation (10) further improvement can only be obtained by increasing the strength of the magnetic field or by the choice of another material for the coil.

In the method described for the reduction of R_E the volume of the windings of the coil and at the same time that of the necessary air gap increases. This means that for the same field strength H a greater magnetic energy is needed (the latter is given by H^2 times the volume of the air gap), this means therefore a greater quantity of the magnet steel. If for the sake of these practical considerations the condition is made that the air gap is not be altered in an attempt to decrease R_E , i.e. that the product $l \cdot q$ must remain constant, then instead of equation (10) a still stricter limitation holds; the length and diameter of the wire now have absolutely no effect on the efficiency, According to (2) and (8) $R_A/R_E = \text{const. } l \cdot q$, therefore, upon simultaneous alteration of l and q under the condition $l \cdot q = \text{const.}$, the ratio R_A/R_E remains unaltered, while at the same time the current distribution in the circuit also remains unaltered, since the impedances $R_A, R_M, j\omega, L_M, 1/j\omega C_M$ and $1/j\omega C_A$ all vary in the same way (proportionally with l^2).

In the above we began with an attempt to improve the efficiency by decreasing R_E and arrived in our attempt at a fundamental limitation. Going back to the above estimation and the reasons therein discovered for the low value of the efficiency, an attempt might now be made to improve the efficiency by increasing R_A (i.e. by decreasing the resistance W_A in the acoustic model fig. 3b). This would indeed lead to the desired result if the, relatively small, capacity C_A were not present, i.e. if the occurrence of the sound were not connected with the acceleration of the mass of air which unfortunately is very easily set in motion. Due to the presence of this capacity an opposition of different influences is again encountered which makes any essential improvement of the efficiency impossible. According to equations (2) and (7) R_A is given by:

$$R_A = \frac{H^2 l^2}{4\pi a^2 \rho c} \dots \dots \dots (11)$$

It is obvious that R_A can be increased by reducing the radius of the cone which is proportional

to the radius a of the equivalent pulsating sphere. Then, however, the capacity C_A becomes smaller, since, according to (2) and (7):

$$C_A = \frac{4\pi a^3 \rho}{H^2 l^2}, \dots \dots \dots (12)$$

and the current distribution in the circuit (fig. 6) is influenced in such a way that the improvement in the efficiency is again opposed. This influence is indeed partially compensated by the fact that the part C_c of the capacity C_M in the shunt falls; C_c is of course proportional to the mass of the cone, which also becomes smaller upon a decrease in the radius. Since the efficiency depends in different ways upon the three quantities mentioned, R_A , C_A and C_c , and since these quantities in turn again vary with different powers of a , it is impossible to foresee in this qualitative consideration just what effect a change in a will finally produce upon the efficiency. Further consideration shows that when the relation between R_E and C_s is kept at the above-mentioned optimum value (which depends upon C_c and C_A and therefore upon a !), the efficiency increases slowly with the radius a . We have, however, seen that in order to obtain a straight characteristic for the loud speaker it is necessary that the impedance of the two branches connected in parallel in fig. 6 vary in the same way throughout a large frequency range, so that the current distributions remains constant. Because of this the condition $R_A \ll 1/aC_A$ had to be satisfied.

For the limiting frequency ω_1 of the straight part of the characteristic we may therefore set up the equation

$$R_A C_A = \frac{1}{\omega_1} \dots \dots \dots (13)$$

Upon combination of (11) and (12) it follows that

$$R_A C_A = \frac{a}{c} \dots \dots \dots (14)$$

and it therefore follows that an increase in the diameter of the cone would lead to a shortening of the straight part of the frequencies characteristic. Since the efficiency varies only slowly with the radius a , a limit is soon reached in this direction.

The only method of improving the efficiency without encountering a fundamental limitation is to increase the intensity of the magnetic field H while keeping all the other quantities including the volume of the coil constant. This method was already mentioned in the discussion of equation (10). This can also be perceived immediately upon the following consideration: the "transformation factor" $H^2 l^2$ in equations (1) and (2) increases with the square of H ; all impedances in the circuit in series with R_E (fig. 4) are increased in proportion. The current distribution (and therefore the frequency characteristic) remains unaltered, but R_A becomes larger compared with R_E . In modern loud speakers the magnetic field is indeed made as strong as is practically possible.

**ABSTRACTS OF RECENT SCIENTIFIC PUBLICATIONS OF THE
N.V. PHILIPS' GLOEILAMPENFABRIEKEN**

1412: F. A. Kröger: Luminescence and absorption of ZnS-MnS mixed crystals (*Physica*, 6, 369-379, April, 1939).

Mixed crystals of zinc sulphide and manganese sulphide obtained by activating zinc sulphide phosphors with manganese exhibit luminescence in two bands with maxima at 5 850 Å and approximately 6 200 Å, the latter probably being the still-unexplained red band of zinc sulphide phosphors. The emission of phosphors activated with manganese may be ascribed to two electronic transitions in the bivalent manganese ion, which also occur on absorption. In addition to the absorption bands of pure ZnS, mixed crystals of zinc and manganese sulphide also exhibit a third absorption region consisting of a system of bands which may probably be ascribed to certain

electronic transitions in the bivalent Mn ion. On irradiation with light from one of the three absorption regions, luminescence of the known Mn bands is always obtained, and on exposure to light from the two firstnamed absorption regions both phosphorescence and fluorescence are obtained, while irradiation with the bands in the third region characteristic of Mn results in fluorescence only. In conclusion, measurements were made of the connection between the intensity of luminescence and the temperature as well as the Mn content of the phosphor.

1413: W. Elenbaas: Über eine Kombination der hydrodynamischen Theorie des Wärmeübergangs und der Langmuirschen Theorie II (*Physica*, 6, 380-381, April, 1939).

to the radius a of the equivalent pulsating sphere. Then, however, the capacity C_A becomes smaller, since, according to (2) and (7):

$$C_A = \frac{4\pi a^3 \rho}{H^2 l^2}, \dots \dots \dots (12)$$

and the current distribution in the circuit (fig. 6) is influenced in such a way that the improvement in the efficiency is again opposed. This influence is indeed partially compensated by the fact that the part C_c of the capacity C_M in the shunt falls; C_c is of course proportional to the mass of the cone, which also becomes smaller upon a decrease in the radius. Since the efficiency depends in different ways upon the three quantities mentioned, R_A , C_A and C_c , and since these quantities in turn again vary with different powers of a , it is impossible to foresee in this qualitative consideration just what effect a change in a will finally produce upon the efficiency. Further consideration shows that when the relation between R_E and C_s is kept at the above-mentioned optimum value (which depends upon C_c and C_A and therefore upon a !), the efficiency increases slowly with the radius a . We have, however, seen that in order to obtain a straight characteristic for the loud speaker it is necessary that the impedance of the two branches connected in parallel in fig. 6 vary in the same way throughout a large frequency range, so that the current distributions remains constant. Because of this the condition $R_A \ll 1/aC_A$ had to be satisfied.

For the limiting frequency ω_1 of the straight part of the characteristic we may therefore set up the equation

$$R_A C_A = \frac{1}{\omega_1} \dots \dots \dots (13)$$

Upon combination of (11) and (12) it follows that

$$R_A C_A = \frac{a}{c} \dots \dots \dots (14)$$

and it therefore follows that an increase in the diameter of the cone would lead to a shortening of the straight part of the frequencies characteristic. Since the efficiency varies only slowly with the radius a , a limit is soon reached in this direction.

The only method of improving the efficiency without encountering a fundamental limitation is to increase the intensity of the magnetic field H while keeping all the other quantities including the volume of the coil constant. This method was already mentioned in the discussion of equation (10). This can also be perceived immediately upon the following consideration: the "transformation factor" $H^2 l^2$ in equations (1) and (2) increases with the square of H ; all impedances in the circuit in series with R_E (fig. 4) are increased in proportion. The current distribution (and therefore the frequency characteristic) remains unaltered, but R_A becomes larger compared with R_E . In modern loud speakers the magnetic field is indeed made as strong as is practically possible.

**ABSTRACTS OF RECENT SCIENTIFIC PUBLICATIONS OF THE
N.V. PHILIPS' GLOEILAMPENFABRIEKEN**

1412: F. A. Kröger: Luminescence and absorption of ZnS-MnS mixed crystals (Physica, 6, 369-379, April, 1939).

Mixed crystals of zinc sulphide and manganese sulphide obtained by activating zinc sulphide phosphors with manganese exhibit luminescence in two bands with maxima at 5 850 Å and approximately 6 200 Å, the latter probably being the still-unexplained red band of zinc sulphide phosphors. The emission of phosphors activated with manganese may be ascribed to two electronic transitions in the bivalent manganese ion, which also occur on absorption. In addition to the absorption bands of pure ZnS, mixed crystals of zinc and manganese sulphide also exhibit a third absorption region consisting of a system of bands which may probably be ascribed to certain

electronic transitions in the bivalent Mn ion. On irradiation with light from one of the three absorption regions, luminescence of the known Mn bands is always obtained, and on exposure to light from the two firstnamed absorption regions both phosphorescence and fluorescence are obtained, while irradiation with the bands in the third region characteristic of Mn results in fluorescence only. In conclusion, measurements were made of the connection between the intensity of luminescence and the temperature as well as the Mn content of the phosphor.

1413: W. Elenbaas: Über eine Kombination der hydrodynamischen Theorie des Wärmeübergangs und der Langmuirschen Theorie II (Physica, 6, 380-381, April, 1939).

Continuation of the investigation outlined in Abstract No. 1255, which discusses a functional relationship between two magnitudes purely on graphical lines.

1914: Balth. van der Pol and H. Bremmer: Further note on the propagation of radio waves over a finitely conducting spherical earth (Phil. Mag., 27, 261-275, March, 1939).

It was shown in the paper referred to in Abstract No. 1338 that the Bessel functions which occur in the analysis of the distribution of field strength over the earth can be approximated in two different ways, *viz.*, either by the more simple tangent approximation or by the more accurate Hankel approximation. The calculations outlined in Abstract No. 1264 are repeated in this paper by applying the Hankel approximation, the results being closely comparable to the geometric-optical approximation applying for points in front of the horizon, so that the variation of field strength can be determined from the immediate neighbourhood of the emitter up to points in the "shadow region".

1415: W. Elenbaas: Energieafgifte aan het gas en verdampingssnelheid van een gloeidraad als functie van de druk (Ned. T. Natuurk., 6, 77-88, 1939).

For details of the contents of this paper see Abstracts Nos. 1255 and 1413.

1416: M. J. O. Strutt and A. van der Ziel: Some dynamic measurements of electronic motion in multigrad valves. (Proc. Inst. Rad. Eng., 27, 218-225, March, 1939).

The authors describe modern methods for measuring the admittance on short waves, dealing with the admittance between the input grid and cathode as well as the complex transconductance A pentode with negative first grid, positive second grid, negative or positive third grid and positive anode is discussed in detail. A calculation is given of how the admittance at the input grid is affected by the electrons which turn back in front of the third grid. Comparison of these calculations with measurements on pentodes, hexodes, heptodes and octodes enables the number of returning electrons to be calculated in various ways, so that an overall check is provided. Formulae are also given for the effect of the returning electrons on the complex transconductance and these are applied to the measurements made.

1417: F. A. Kröger: Formation of solid solutions in the system zinc-sulphide/manganese-sulphide (Z. Kristallogr., (A), 100, 543-545, March, 1939).

By heating a mixture of zinc sulphide and manganese sulphide using potassium chloride as a flux, mixed crystals of zinc/manganese sulphide are obtained. At 1180 deg. C. mixed crystals are obtained containing 0 to 52 molecular per cent of manganese sulphide. With higher percentages of manganese sulphide pure green manganese sulphide separates out as a second phase. According to the temperature to which the mixture is heated, the mixed crystals with low manganese sulphide are either of the Wurtzite or Sphalerite type. With a higher content of Mn a Wurtzite structure is always obtained.

1417A: J. W. M. Roodenburg: Tien jaar plantenbestraling (1928-1938). (Vakbl. Biol., 20, 137-148, April, 1939).

A survey is given of the results obtained in the irradiation of plants in glasshouses using electric light. These investigations have shown that the light needs of plants can be resolved into at least three different processes: Assimilation of carbon dioxide, effect of the length of daylight, and the action of blue light. These processes can be promoted by irradiation with neon, incandescent mercury-vapour lamps.

1418: J. A. M. van Liempt and J. A. de Vriend: Studien über das Verbrennungslicht einiger Metalle und Legierungen II. (Rec. Trav. chim. Pays Bas, 58, 423-432, April, 1939).

Determinations are made of the quantity of light, light yield and duration of flash produced by the combustion of pure thorium and titanium, as well as of aluminium alloys containing zirconium, titanium, calcium, lithium or zirconium/magnesium. The term, a "photographic" lumen-second, is proposed as a unit for measuring the quantity of light furnished by flashlights.

1419: J. A. M. van Liempt and J. A. de Vriend: Die Lichtausbeute von Steichhölzern (Rec. Trav. chim. Pays Bas, 58, 433-434, April, 1939).

The quantity of light emitted by the head of an ordinary safety match is approximately 150 lumen-secs., and the yield of light 3 lumen-secs. per watt. The duration of the flash with a bundle of 60 matches is 1 sec.

Philips Technical Review

DEALING WITH TECHNICAL PROBLEMS
RELATING TO THE PRODUCTS, PROCESSES AND INVESTIGATIONS OF
N.V. PHILIPS' GLOEILAMPENFABRIEKEN

EDITED BY THE RESEARCH LABORATORY OF N.V. PHILIPS' GLOEILAMPENFABRIEKEN, EINDHOVEN, HOLLAND

THE PREPARATION OF METALS IN A COMPACT FORM BY PRESSING AND SINTERING

by J. D. FAST.

621.775.7

The metals tungsten, molybdenum, tantalum etc. can be relatively easily prepared in powder form. The powder, however, due to the high melting point of the metals, cannot be converted into compact form by melting and casting. The preparation of the compact metals must therefore be carried out by the methods of powder metallurgy, the main particulars of which we shall here discuss. A general discussion is then given of the preparation and working of ductile tungsten for the electric lamp industry, and the preparation and application of so-called "hard cemented carbides". In certain applications use is also made of the great porosity which sintered metals may possess.

The development of the electric lamp industry brought up the problem of the preparation in wire form of metals with very high melting points such as osmium, tantalum, molybdenum and tungsten. The preparation of these metals in powder form presented no great difficulties, but the conversion of the powder into a compact form met with great difficulties. The high melting points made it impossible to achieve this end by the ordinary methods of melting and casting, and led to attempts to cement or bake together the particles of which the metals in powder form consist, at temperatures below the melting point. In the practical application of this method two operations are found necessary in most cases: a treatment at ordinary temperature by which the particles are made to form a cohering mass, and a heating of this mass at a high temperature, the so-called sintering process, the purpose of which is to considerably increase the strength and cohesion of the mass.

The treatment at ordinary temperature, in the case of the preparation of the earliest osmium and tungsten wires, consisted in the cementing together of the particles with the help of an adhesive substance. It was, however, quickly realized that the desired result can be obtained without the use of a binder, by pressing the pure powder in a mould.

The pressing of the dry metal powders to give coherent masses

Compact metals are not in general single crystals

(even when they are obtained by way of the molten state), but conglomerations of many larger or smaller crystals which are held together by cohesive forces. These forces are in many cases of the same order of magnitude as the forces which hold a single crystal together. In principle it must be possible to cause these cohesive forces to act by bringing the particles which make up the metal powder into close enough contact with each other. The action of these forces only becomes appreciable at very short distances.

As to the practical execution of this process, the following difficulties must be noted:

1. The particles will generally have such a shape that the surface of mutual contact is very small and the porosity therefore large.
2. The metals in the air are covered with oxide films which are often only one molecule thick, but which hinder the action of the cohesive forces.
3. The structure of the outer layers of atoms of a bare metal surface will be different from that of the outer layers of atoms of a crystallite in the interior of a cast metal object. After bringing of the particles into more intimate contact (even in the absence of oxide films) the cohesive force will therefore in general be smaller per unit of surface of actual contact than that between the crystallites in a cast metal.

These objections are partially met when high pressures are applied in making the separate par-

ticles cohere. A not inconsiderable deformation of the particles occurs which appreciably increases the total surface of contact. Moreover, many particles rub against each other during the pressing, whereby the oxide films are rubbed off at many points, and local temperature increases of very short duration occur which make possible a partial regrouping of the metal atoms at the points of contact. It is indeed found to be possible to press articles from dry metal powders by the application of high pressures, which articles do not fall to powder again after the pressure is lowered. The strength is in most cases, however, only small, because the three above-mentioned opposing factors are rendered only partially inactive by the pressing: the total surface of contact after pressing is still relatively small, while in addition the cohesion per unit of surface of contact is smaller than between the crystallites in a cast metal, due to the fact that the surface films are still present between the particles at many spots, and at other spots where this is no longer true, that atom arrangement has not yet been attained which occurs at the boundary between two grains in a cast metal. A heat treatment is necessary in order to cause the structure to approach more nearly that of a cast metal.

The heating of pressed objects

When pressed objects are heated considerable strengthening occurs already at a relatively low temperature. Rods of tungsten, for example, which were so weak after being pressed from the powder that they could not be handled without breaking, already have such a great strength after being heated in hydrogen at 1 000° C, that they can be clamped into the current supply terminals for the actual sintering process. The cause of this strengthening must be sought in a rearrangement of the atoms at the points of contact and in a reduction of the oxide films still present.

The actual sintering, which takes place at a much higher temperature, is accompanied by considerable shrinkage and a corresponding decrease of the porosity (during the preliminary sintering at 1 000 °C no appreciable shrinkage takes place). The mechanism of the shrinking may be conceived in two ways. In the first place it is reasonable to suppose that the influence of the large amount of free surface is manifested in such a way that under the influence of the surface tension as driving force a plastic deformation of the grains occurs, whereby they are as it were "sucked" into the open spaces. The resistance which metals offer to

plastic deformation becomes smaller with increasing temperature, and in agreement with the foregoing it is found that the temperature at which sintering occurs is higher, the less deformable (harder) a metal is. It may, however, also be supposed that the presence of the large internal surface in the pressed objects results in a transfer of material at sufficiently high temperature by surface diffusion, whereby the metal atoms move over the surfaces of the particles to spots where their potential energy is the lowest. It is indeed known that the atoms in the surface of a metal already possess considerable mobility in that surface at temperatures lying below those at which the metal melts or evaporates to any noticeable degree, because these movements require a much smaller amount of energy than evaporation. It is probable that both of these phenomena play a part in the sintering of metals.

If the particles of which a pressed object is made up were grains without faults, the sintering would probably proceed in a quite uncomplicated manner, and would perhaps only be accompanied by or followed by a shifting of the crystal boundaries due to the fact that during and after the sintering some grains grew at the expense of others¹⁾. We have, however, already seen that the particles are deformed during the pressing. Moreover, their previous history (method of preparation) is in some cases of such a nature that even before the pressing they have an unstable structure. The result is that upon heating the pressed objects recrystallization phenomena occur, *i.e.* in the particles or at the boundary between two particles new crystal nuclei occur which grow at the expense of the deformed or otherwise structurally unstable metal until they encounter other newly formed crystallites. Coalescence of the new crystals formed to give larger units often follows this recrystallization. In many cases the beginning of recrystallization seems to introduce the sintering process, in other cases the sintering entirely or partially precedes the recrystallization.

As a result of the recrystallization process and the

¹⁾ This phenomenon whereby in a metal without tensions certain crystals grow at the expense of others, and where the internal energy decreases by reduction of the surface of the crystallite boundaries, is usually called coalescence. In order to avoid confusion between the ideas of sintering and coalescence, it must be emphasized that sintering can only occur in a porous substance, and need not necessarily be accompanied by an increase in size of the grains, but by a change in their shape. Coalescence or grain growth can occur not only in compact but also in porous metal, and need not in the latter case be accompanied by a decrease in the porosity; the phenomenon is characterized only by a decrease in the number of individual grains.

grain growth mentioned above, the size of the crystallites in the sintered products is often very much greater than the size of the particles of the original powder. The pores which are still present now lie for the most part within the crystallites. This remaining porosity can only be removed by very strenuous mechanical working.

The influence of gases on the process of sintering

The phenomena which occur during the heating of masses of pressed metal powder can in many cases be influenced by the gases freed from the metal and by gases expressly introduced from the

- d) dioxide and carbon monoxide are formed, and these gases are liberated in large quantities.
- f) Gases freed from layers of grease on the metal surfaces.

If the objects are pressed at a very high pressure, it may be (especially in the case of soft metals) that the metal is compressed in such a way that many cavities are entirely closed to the outside or that they are connected to the outside only by very narrow channels. The gases freed may then cause very high internal pressures, and thereby oppose the sintering process and sometimes even cause swelling instead of shrinking.

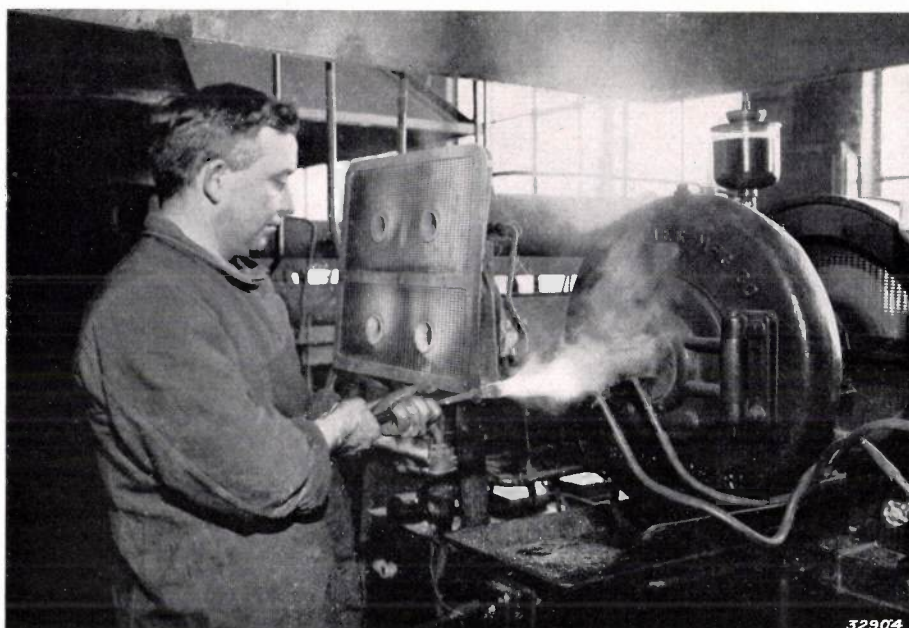

Fig. 1. After sintering the tungsten rods are first treated in a hand swaging machine. The rod, heated to a high temperature, is gripped with tongs and introduced between the rapidly moving hammers (see fig. 2). This treatment brings about a decrease in the thickness and an increase in length. As soon as the length has increased sufficiently the rod is worked by a more automatic swaging machine. Beside the hand swaging machine in the photograph may be seen the electric furnaces in which the rods are heated.

outside. The gas liberated from the metal may come from one or more of the following sources:

- a) Gas adsorbed on the surface of the particles
- b) Gas dissolved in the metal
- c) Chemically bound gas
- d) Gases enclosed between the metal particles during pressing
- e) Gases formed by a chemical reaction between foreign substances present in the metal. Technical iron and nickel, for instance, which are also used in certain cases for the preparation of sintered products, always contain appreciable amounts of carbon in a free state or in the form of carbides as well as oxygen, dissolved and in the form of oxides. Upon heating, carbon

Gases introduced from the outside serve to protect the pressed objects against oxidation during heating. Thus for example the sintering of tungsten and molybdenum is carried out in pure hydrogen, whereby the hydrogen also carries out the important function of reducing the oxide films. Metals which form such stable oxides that the oxide films cannot be reduced to metal by any gas, can only be obtained in a pure form by sintering when the oxide has a higher vapour tension than the metal, or when it has an appreciable oxygen dissociation pressure at the temperature of sintering. These conditions are fulfilled by tantalum which can therefore be obtained in pure state by sintering in a high vacuum. Thorium, on the other hand, forms

an oxide which again cannot be reduced to the metal by hydrogen, but which moreover has a lower vapour tension than the metal, and does not dissociate appreciably below the melting point of thorium. The result is that while this metal can be obtained in a ductile form by the methods of powder metallurgy, it cannot be obtained in an oxygen-free state. After the sintering the oxide is present in the form of mechanical inclusions in the metal. Still more unfavourable are the relations in the case of titanium, zirconium and hafnium, whose oxides, moreover, dissolve in the excess metal at the sintering temperature, so that the metal loses the greater part of its workability. It was indeed necessary to apply quite different methods in order to obtain these latter metals in a completely ductile form (see Philips techn. Rev. 3, 345, 1938.)

After the foregoing general considerations on powder metallurgy we shall in the following deal with several of the most important applications.

The preparation of ductile tungsten

The tungsten in powder form which is used as raw material is prepared by reducing tungsten oxide WO_3 with hydrogen. This reduction is carried out under conditions such that the metal is obtained in the form of particles only a few microns in diameter (1 micron = 10^{-3} mm). The powder is pressed in steel forms by means of a hydraulic press to rods with a square cross section. After the previously mentioned preliminary sintering process in hydrogen at a relatively low temperature, follows the actual sintering in which the rods are heated by the passage of current to above 3000°C (the melting point of tungsten lies at about 3400°C). Such great shrinkage occurs during this process that the specific weight rises from about 12 to about 18, and the length after sintering is only about 85 per cent of the original length. In the mechanical working (see below) further compacting of the metal occurs, whereby the specific weight finally rises to that of non-porous tungsten, namely 19.35. The size of the crystals in the rods after sintering is considerably greater than that of the particles of the original powder. Important crystallization phenomena thus take place in the rods in the manner described above.

The sintered rods are already very strong, but are still extremely brittle, at least at an ordinary temperature. At high temperatures, on the other hand, they are found to possess satisfactory ductility so that it is possible to work them into wire. In the first treatment, use is made of swaging machines (fig. 1) in which two hammers, having semi-cylindrical

depressions rotate about the axis of the rod and strike it about 10 000 times per minute (fig. 2).

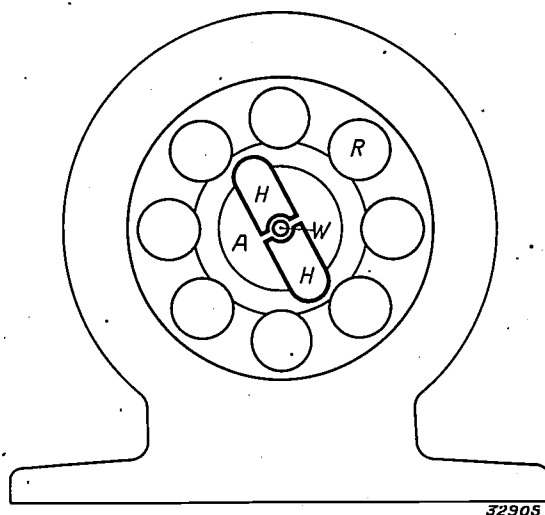

Fig. 2. Diagram of a swaging machine. In the hammer head *A* is a groove in which the hammers *H* can move in a radial direction. When in use the head *A* rotates with great velocity, with the result that the hammers are forced away from each other by the centrifugal force. In doing this they strike the rollers *R*, an even number (usually 8 or 10) of which are situated in a ring around the hammer head. The hammers are hereby thrown forcibly against each other 8 or 10 times per revolution. The heated tungsten rod *W* is introduced between the hammers and thus receives blows whose number is determined by multiplying the number of revolutions by the number of rollers. By using a series of hammers with increasingly smaller bore the rod can be hammered thinner and thinner.

The sintered rods are heated in an electric oven and then passed slowly between the hammers whereby the thickness decreases and the length increases correspondingly. In order to convert the rods, which originally have, for example, a square cross section of 15.15 mm^2 , into wire 1 mm thick, this treatment must be repeated many times. Hammers, with steadily decreasing size of depression, are used. In contrast to practically all other metals tungsten becomes more ductile the more it is worked. The explanation of this must be sought in the weakness of the crystal boundaries which causes the crystals in a sintered rod to break away from each other upon attempts to deform it at low temperatures. By the working, however, the crystals, which originally had approximately equal dimensions in all directions, are stretched in the direction of the axis of the rod. As the rod becomes thinner, it assumes more and more a fibrous structure, and it is this change in structure which gives the wire its increasing ductility.

Because of the increase of ductility the working temperature can be steadily lowered. This is also essential in order to avoid a recrystallization which would give back to the wire its original brittleness,

and the temperature at which recrystallization occurs decreases with increasing deformation.

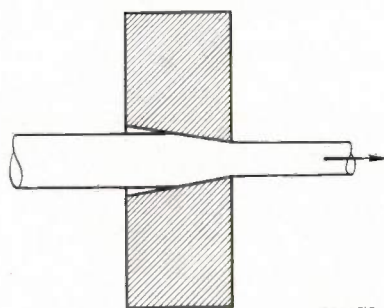

Fig. 3. Diagram of the wire drawing process.

After the swaging the tungsten wire is converted by a drawing process into still thinner wire. The dies possess a conical bore whose smallest diameter is of course somewhat smaller than that of the wire. Fig. 3 shows a diagram of such a die. The wire is drawn through it by means of a spool, which is fastened to a shaft driven by electric power, and upon which the wire is wound (fig. 4). For the larger

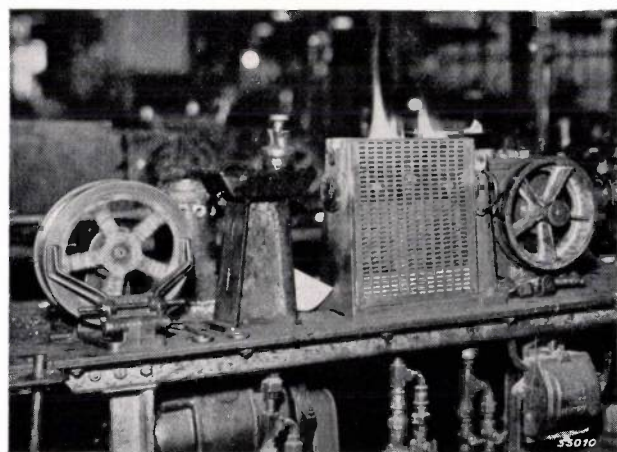

Fig. 4. The photograph shows a drawing bench as used in the manufacture of tungsten wire. On the left is the spool from which the wire is unwound. The wire passes first through a container with graphite lubricant (suspension of graphite in water). It is then heated by a gas burner so that the water evaporates and part or all of the graphite remains on the wire. When hot the wire passes through the die to the spool shown on the right.

thickness use is made of dies of so-called tungsten carbide, which material like tungsten is also prepared by pressing and sintering (see below). For the smaller thickness diamond dies must be used. As a result of the drawing the ductility of tungsten increases to a still greater extent, so that it is possible to reduce still further the working temperature. In the way described it is possible to make tungsten wire with a thickness of only 8 microns (0.008 mm). The wire must pass through a large number of

dies before such a final diameter is reached, because, due to the limited tensile strength of the wire, the diameter can be only relatively slightly reduced by a single drawing. Directly before the passage through each die the wire is heated with gas burners to the desired temperature. Graphite is used as lubricant in the drawing and also serves to protect the tungsten surface from oxidation.

In the manner described, from a pressed and sintered tungsten rod weighing 1.5 kg about 1 000 km of wire 10 microns thick is obtained.

When the tungsten wires obtained by hammering and drawing are used in electric lamps, recrystallization phenomena occur at the first heating to a high temperature. The structure to which this recrystallization leads, and which determines for a large part the life and quality of the lamp, can be influenced by adding certain chemicals to the tungsten powder.

The preparation of molybdenum and tantalum in a ductile form

Several other metals with a high melting point besides tungsten, which are also used technically, are also prepared in compact pieces by the methods of powder metallurgy.

The most important of these are molybdenum with a melting point of 2 600° C and tantalum with a melting point of 3 000° C. These melting points are too high for the successful preparation of the compact metals by melting and casting.

The preparation of molybdenum powder and molybdenum rods takes place in practically the same way as described above for tungsten. The rods can also be worked to wire and sheet. Molybdenum is extensively used in the manufacture of electric lamps and radio valves: in wire form chiefly as support wires for the tungsten wires and coils of electric lamps, in sheet form chiefly as anode of transmitting valves. A very well known use of molybdenum wire is as heating element in electric furnaces for very high temperatures.

Metallic tantalum can be obtained in powder form, for example by the reduction of potassium tantalum fluoride with sodium or by electrolysis of this compound in the molten state. The rods pressed from the powder are sintered in a high vacuum because, among other reasons, tantalum forms hydrides with hydrogen. During the sintering the driving off of the dissolved hydrogen present in the powder and of chemically bound oxygen is very important. Like molybdenum tantalum is used in discharge tubes, for instance in the form of anodes in transmitting valves. Furthermore it is used as a

corrosion resistant material in the artificial silk industry, for example.

The preparation of hard cemented carbides

Various metal carbides possess a very great hardness. One of the hardest is tungsten carbide, having the composition WC. Its hardness is not very much less than that of the diamond. When the electric lamp industry was seeking a suitable material to replace the expensive diamond in the manufacture of dies, this material was chosen. In a pure state it was found to be unsuitable because, like metallic tungsten, the boundaries of the crystallites are not stable and the material is therefore brittle. Better results could be expected if it were possible to prepare the material in the form of large single crystals. The solution of the difficulty was, however, sought in a different direction, and usable articles have successfully been made by beginning with very fine tungsten carbide powder and cementing the particles of this together with a metallic binder by the methods of powder metallurgy. In other words the grain boundaries were replaced by a layer of a binder which possesses a sufficient degree of ductility and strength. The hard cemented carbides are therefore strictly speaking no metals, since they consist almost entirely of carbide to which a small amount of free metal has of necessity been added. The carbides in question have, however, metallic characteristics in many respects (electrical conductivity, to name an example). As binder a metal is used which has only a very slight affinity to carbon (cobalt, for instance).

Tungsten carbide is obtained by heating intimate mixtures of fine tungsten powder and carbon in a suitable gas atmosphere. The carbide formed is mixed with the auxiliary metal serving as binder, and pressed into larger pieces in a steel mould. The objects pressed in this way are usually presintered in hydrogen at a relatively low temperature. This presintering serves to make the cohesion of the pieces so much greater that they may be given the desired form. In this condition the material can for example be worked on a lathe. After the pressing alone the cohesion is still too low for this, while after the final sintering the hardness renders such working impossible. At this stage, however, the articles cannot be given their exact final shape since a shrinkage of nearly 20 per cent occurs during the actual sintering. This sintering takes place at a temperature below the melting point of the pure binder metal. The hardness is so great after the final sintering that the shape can only

be changed by grinding or polishing with the hardest abrasives.

From experiments by various research workers it has, moreover, been found that when cobalt is used as binder the case is not one of ordinary sintering, since this binder melts during the heating. A small amount of the tungsten carbide dissolves in the metal during sintering, and causes a lowering of the melting point. The relatively small amount of liquid formed is taken up as by a sponge by the porous mass, with simultaneous decrease in volume, so that the porosity after sintering is so low as to be inappreciable. This is demonstrated by *fig. 5*, while the structure of the hard cemented carbide is shown in *fig. 6*²⁾.

In this case, where sintering temperature is not

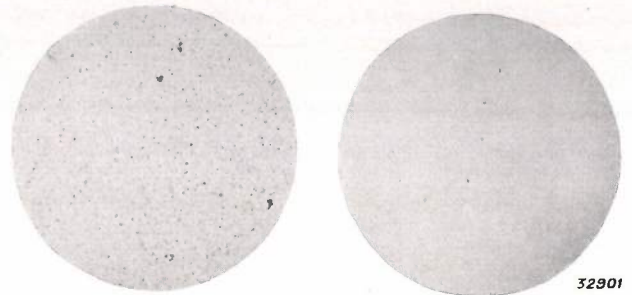

Fig. 5. In order to examine the porosity of tungsten carbide alloys, a plane surface is ground on a sample in much the same way as is customary in the grinding of diamonds. The polished surface is examined under a microscope with a magnification of 50 times. To the left may be seen a photomicrograph of a product sintered at too low a temperature, which has great porosity. On the right is that of a product sintered at the correct temperature which has almost no pores.

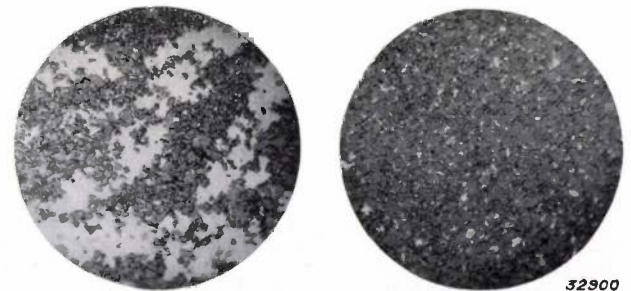

Fig. 6. By etching the polished surface of a piece of a tungsten carbide alloy in a suitable bath, the microstructure can be made visible under a magnification of, for example, 500 times. On the left is shown the structure of an alloy with too low a content of carbon (i.e. an alloy in which the tungsten carbide consists of a mixture of WC and W_2C). The tungsten carbide particles are here not distributed uniformly throughout the auxiliary metal in which at the sintering temperature an abnormally large amount of the tungsten carbide has dissolved. On the right may be seen the microstructure of an alloy with the correct amount of carbon (i.e. an alloy in which the tungsten carbide consists exclusively of WC). The carbide particles are regularly distributed throughout the base metal which acts as binder and which contains only little tungsten carbide in solution.

²⁾ The samples and the photomicrographs were prepared by Mr. J. Romp.

high, it is also possible to combine pressing and sintering by pressing the mixture at the sintering temperature. Moreover this method offers the possibility to evite the preparation of tungsten-carbide by starting the pressing on sintering-temperature with a perfect mixture of tungsten, bindermetal and carbon. In this way the preparation of carbide, the pressing and the sintering are combined into one operation.

The most important applications of the above described hard cemented carbides lie in the sphere of metal working, where it is used in wire manufacture (see *fig. 7* and *8*) and in cutting, milling and boring operations. The composition depends upon the purpose for which it is to be used. The strength (tensile) increases with the content of binder, but the hardness decreases. In all of its applications, due to its relatively high price, only that part of the tool is made of carbide which is subject to wear during use.



Fig. 7. Dies with a core of "hard cemented carbide".

When used as cutting tools tungsten carbide alloys are very suitable for the working of non-ferrous metals and also of cast iron. In the working of steel better results are obtained when the tungsten carbide is partially replaced by titanium carbide.

Different other hard carbides and also some borides, silicides and nitrides can be used in addition to the two mentioned carbides.

Several additional applications and possibilities of powder metallurgy

In the earliest applications of powder metallurgy (tungsten, molybdenum, etc.) the only aim was the best possible approximation of the results which would have been obtained by melting and casting if the melting points had not been too high. It was, however, quickly discovered that this new method, far from being merely a substitute for the older method, also offers possibilities which cannot

be realized by melting and casting. As an example of such possibilities we have already mentioned the introduction of foreign chemicals into metallic tungsten with the object of influencing the crystal growth. In the case of metals which are obtained by way of the molten state it would be very difficult, if not impossible, to introduce such insoluble, non-metallic additions in fine and uniform dispersion. The cemented carbides discussed also constitute an example of products with a dispersion of the components which could not be obtained by melting and casting. The structure deviates so much from the equilibrium state that too long a sintering or too high a sintering temperature already produces a different (less favourable) final state which can no longer be converted into the desired one.

There are also examples of applications where use is made of the porosity which the sintered products all possess to a greater or less degree. (This porosity is an undesired phenomenon in the preparation of metals of high melting points, and attempts are made to reduce it to a minimum by mechanical working). The most important application in which advantage can be taken of the porosity is formed by the so-called self-lubricating bearings. These are bearings, which are usually pressed from a mixture of copper and tin powder (for example 90 per cent copper + 10 per cent tin), and which after sintering have such a degree of porosity that they can absorb large quantities of oil (25 to 40 per cent by volume), and thereby obtain self-lubricating properties. It is clear that the porosity of these bearings must not only be great, but it must in addition be of such a nature that the pores are interconnected. This is achieved by beginning with powders prepared by electrolytic methods, whose particles are rather large and irregular in shape, and by mixing these powders with substances (stearic acid, for example) which evaporate during sintering and leave cavities. In addition to copper and tin the porous bearings often contain graphite, which is added to the powder mixture before pressing, in amounts of 1.5 to 4.5 per cent. The impregnation with oil takes place in heated oil baths. Especially when bearings must be installed in places which are difficult to reach, or when they must function under water, these products of sintering offer great advantages. The oil consumption, moreover, is much less than with ordinary bearings. A small increase in temperature or pressure exerted on the bearing causes the oil to come out of the bearing. Self-lubricating bearings have been manufactured in very large quantities

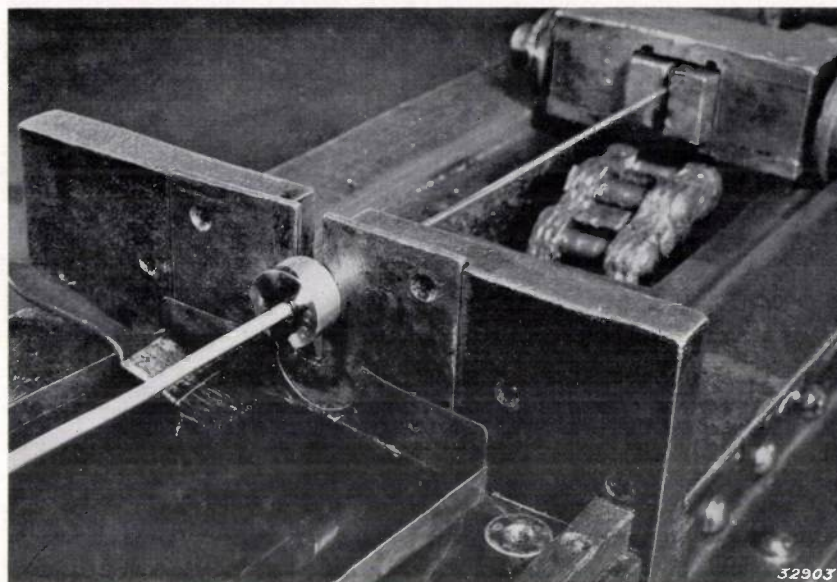

Fig. 8. A die with a "hard cemented carbide" core in use. It may clearly be seen in the photograph, that the wire has a smaller diameter after passing through the die.

in recent years, especially for the automobile industry.

The porosity of sintered metals also makes it possible to prepare new materials in which the properties of various metals are combined. This possibility is already in practical application in different types of electrodes for spot welding, where great strength at high temperatures and at the same time good electrical conductivity is required. Tungsten powder of a suitable particle size is pressed and

sintered in such a way that very porous, but strong rods are obtained. These are heated in an atmosphere of hydrogen or in a vacuum and brought into contact with molten copper. The pores become filled with the copper. The copper content after this treatment is about 40 per cent. The electrodes obtained possess very great strength at high temperatures due to their tungsten framework, and due to their copper content they have a high conductivity for electric current.

ON IMPROVING OF DEFECT HEARING

by K. de BOER and R. VERMEULEN.

534.773

An apparatus is described which was developed for a particular case of partial deafness, and which satisfies very high requirements as regards the quality of reproduction. The requirement that the apparatus should be portable was not made. The frequency characteristic of the apparatus was adapted to the curve for the defective ear of the individual user. By making use of two microphones placed in an "artificial head", each of which supplies one head-phone, directional hearing has also been made possible. This is of great practical value in following general conversations and preventing disturbance by extraneous sounds.

In order to compensate for the decreased sensitivity of the ear of a partially deaf person one may speak more loudly to him, he may bring his ear closer to the source of sound or attempt to capture more of the sound energy by putting his hand behind his ear. These obvious methods are, however, useless when the threshold of the sense of hearing of the person in question lies too high, and moreover they usually have the undesired result that the remarks of those with normal hearing assume an unnatural character. After the in-

vention of the telephone, technology was able to offer a more satisfactory method of increasing the intensity of sound: a combination of a head-phone and a carbon microphone, fed by a dry cell carried in the pocket. This instrument however has often proved disappointing. The increase in the level of intensity is here obtained at the expense of the quality of the sound heard: in order to make the telephone sufficiently sensitive for the very weak microphone currents, use must be made of resonances in the oscillating system, which means that

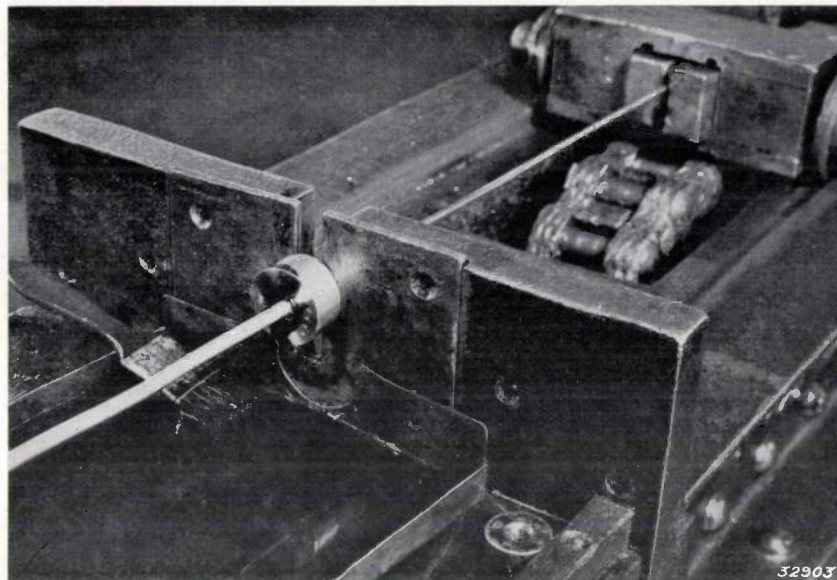

Fig. 8. A die with a "hard cemented carbide" core in use. It may clearly be seen in the photograph, that the wire has a smaller diameter after passing through the die.

in recent years, especially for the automobile industry.

The porosity of sintered metals also makes it possible to prepare new materials in which the properties of various metals are combined. This possibility is already in practical application in different types of electrodes for spot welding, where great strength at high temperatures and at the same time good electrical conductivity is required. Tungsten powder of a suitable particle size is pressed and

sintered in such a way that very porous, but strong rods are obtained. These are heated in an atmosphere of hydrogen or in a vacuum and brought into contact with molten copper. The pores become filled with the copper. The copper content after this treatment is about 40 per cent. The electrodes obtained possess very great strength at high temperatures due to their tungsten framework, and due to their copper content they have a high conductivity for electric current.

ON IMPROVING OF DEFECT HEARING

by K. de BOER and R. VERMEULEN.

534.773

An apparatus is described which was developed for a particular case of partial deafness, and which satisfies very high requirements as regards the quality of reproduction. The requirement that the apparatus should be portable was not made. The frequency characteristic of the apparatus was adapted to the curve for the defective ear of the individual user. By making use of two microphones placed in an "artificial head", each of which supplies one head-phone, directional hearing has also been made possible. This is of great practical value in following general conversations and preventing disturbance by extraneous sounds.

In order to compensate for the decreased sensitivity of the ear of a partially deaf person one may speak more loudly to him, he may bring his ear closer to the source of sound or attempt to capture more of the sound energy by putting his hand behind his ear. These obvious methods are, however, useless when the threshold of the sense of hearing of the person in question lies too high, and moreover they usually have the undesired result that the remarks of those with normal hearing assume an unnatural character. After the in-

vention of the telephone, technology was able to offer a more satisfactory method of increasing the intensity of sound: a combination of a head-phone and a carbon microphone, fed by a dry cell carried in the pocket. This instrument however has often proved disappointing. The increase in the level of intensity is here obtained at the expense of the quality of the sound heard: in order to make the telephone sufficiently sensitive for the very weak microphone currents, use must be made of resonances in the oscillating system, which means that

certain frequencies are favoured and considerable distortion of the sounds taken up by the microphone occurs. In *fig. 1* an example is given of the frequency characteristic of a telephone such as is used in the combination in question. The carbon microphone itself also has an irregular frequency characteristic which adds to the distortion. Due to the distortion, the intelligibility is very much decreased, a fact which is confirmed by the common experience that much more concentration is needed to follow a telephone conversation, especially in a foreign language, than a direct conversation. In addition to this mental fatigue of the deaf person there is also the fact that the ear tends to become overloaded by the peaks in the intensity at the resonance frequencies of the characteristic, which may, especially, for weak ears, be very painful, and is quite undesirable.

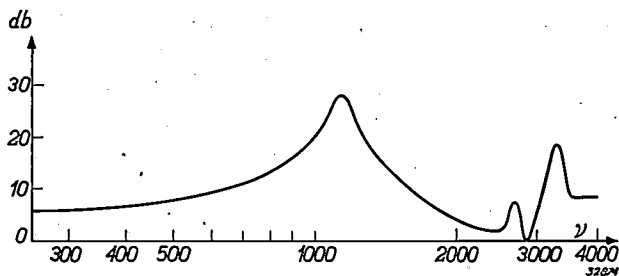

Fig. 1. Frequency characteristic of a telephone which is sufficiently sensitive to be connected directly to a carbon microphone with pocket battery. The great sensitivity is obtained by means of resonance peaks, and thus at the expense of the quality of the sound reproduction. (The curve is drawn according to a characteristic measured by W. West and D. Mc. Millan: J.I.E.E. 75, 328, 1934, fig. 8).

The application of an amplifier

These difficulties can be avoided when very good quality microphones and telephones are employed. Such instruments are at present available. Their much lower sensitivity, however, which is the inevitable result of the desired flat form of the frequency characteristic, makes the use of an amplifier necessary. Moreover, the use of an amplifier is also advisable because it makes possible other improvements in the apparatus. We shall discuss these improvements in the following on the basis of an apparatus designed and constructed in the Philips laboratory at the suggestion of Dr. Köster, ear specialist in the Hague, for one of his patients. The requirement that the apparatus should be portable was given up, so that it was possible to start from ordinary amplifiers.

The sensitivity of the ear of deaf persons is lower than that of those with normal hearing. The decrease in sensitivity is generally however not the same for all frequencies. The sense of hearing may

for example be less acute for low frequencies only, or for high frequencies only. Instead of the normal variation of frequency of the threshold of hearing, which is reproduced in *fig. 2*, a different curve is

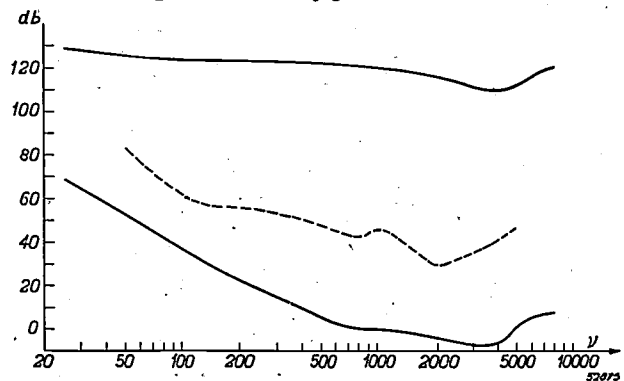

Fig. 2. The auditory range of the normal ear (full lines). The lower line gives, as a function of the frequency in c/s, the minimum intensity in decibels which can be observed (threshold value, the threshold for the frequency 1 000 c/s is put equal to zero decibels). The upper line gives the pain limit. In the case of a deaf person the sensitivity of the ear is decreased for some or all frequencies, i.e. the threshold is higher. In one individual case the threshold curve indicated by the broken line was found.

found. The ear specialist measured the difference between the threshold values of the person in question and those of a person with normal hearing. The difference has been plotted above the normal threshold in *fig. 2*, and the broken line threshold curve was obtained. If it is desired to match the auditory impressions of the deaf person as closely as possible to those of the normal person, it is obvious that the amplification for the different frequencies should correspond to the measured difference in sensitivity. This may be realized in a relatively simple manner, since the frequency characteristic of the amplifier to be used can be given any desired form by suitable connections. The frequency characteristic of the amplifier is reproduced in *fig. 3*.

It must be noted that the patient himself does not always

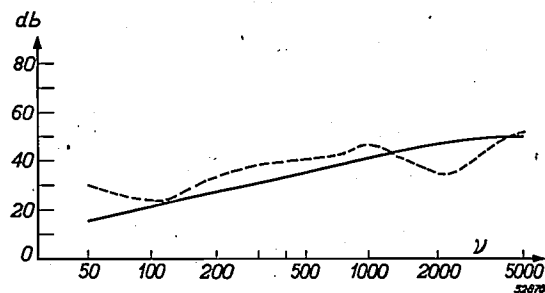

Fig. 3. Decrease in the sensitivity of the ear (broken line) of the deaf person for whom the apparatus described was designed. (The curve refers to the broken threshold curve in *fig. 2*; the measured difference between the full line curve and the broken line threshold curve is here plotted). The full line curve is the frequency characteristic of the amplifier used. The decrease in sensitivity of hearing is satisfactorily compensated.

accept as an improvement such an adaptation of the amplifier to his individual hearing deficiency. Sometimes this is even felt to be unpleasant. This must probably be ascribed to the fact that the partially deaf person who has for years been compelled to hear without correction has become accustomed to a certain distortion of the sound, and therefore finds "unnatural" the quality of sound which is natural for normal ears. The decision whether in such a case an adaptation is nevertheless desirable in order to accustom the patient to normal sound once more must of course be left to the specialist in charge.

Moreover, there are also cases of deafness where the hearing deficiency at normal intensities differs from that at intensities in the neighbourhood of the threshold value. In such cases it is even more necessary to consult the ear specialist before attempting to use an amplifier.

Due to the narrow margin between the threshold of ear sensitivity and the pain limit in the case of the deaf, it is very important that the amplifier currents fed to the amplifier should not exceed a certain limit. For this purpose an automatic volume control may be introduced, by which the sound intensity to which the ear of the patient is exposed can be limited for example to 20 or 30 dB above the threshold.

Possibility of directional hearing

In the apparatus in question special care has been taken that the deaf person is not robbed of the possibility of directional hearing. Many people are unaware of the practical significance of this possibility, which is based on the simultaneous observation with both ears. It is however easy to convince oneself of the importance of directional hearing by temporarily covering one ear. In a room in which several different conversations are being carried on at the same time it will now be found practically impossible to follow one of them, while under normal circumstances this requires only slight concentration: by directional hearing one is able



Fig. 4. The sphere used as "artificial head". It has a diameter of about 22 cm. The two microphones are mounted at the extremities of a horizontal diameter. (In order to make visible both microphones the sphere has been placed before a mirror.)



Fig. 5. The model with which the influence of the details of the shape of the head were studied. The microphones are mounted in the ears and feed the head-phones of the user.

to concentrate one's attention in a given direction and the stimuli from other directions can be psychologically pushed into the background. This phenomenon plays an important part when there are disturbing noises. In "binaural" hearing only that sound is observed which comes from the direction on which the attention is concentrated. In "monaural" hearing on the other hand disturbing noises from all directions are active at the same time. This is the reason why users of instruments for the deaf so often complain of the "noise": in a combination of for example a microphone worn on the breast and two head-phones connected to it, the sound is received by only one "ear" (the opening of the single microphone). This is also a reason why the greatest possible quiet must be maintained in broadcasting studios, and the reverberation must in such cases be less than normal: the listener receives the sounds, which strike the microphones from all directions in the studio, from only one direction, namely from the opening of the loudspeaker.

The method by which directional hearing can be retained when hearing takes place through microphones is obvious. Two microphones must be used,



Fig. 6. View of the apparatus during use. The artificial head is placed on the table. The two amplifiers are set up under the table.

each of which feeds one telephone *via* a separate amplifier adapted to the ear in question¹). In order to provide that the intensity and time differences between the sounds caught by the two microphones, which give the sense of direction, shall correspond to those in normal hearing with both ears, the microphones must be mounted on an "artificial head" which causes a distortion of the sound field similar to that caused by the human head. As artificial head it is sufficient to take a sphere which has about the same dimensions as the head, see *fig. 4*. The microphones are mounted on the sphere at the extremities of a horizontal diameter.

All the phenomena of directional hearing cannot be explained by the above-mentioned differences in intensity and time. These differences are for instance the same for two sources of sound one of which stands to the right in front of the listener and one to the right behind him. It is however possible to localize sounds "in front of" and "behind" one even with the eyes closed. It was not unreasonable to suppose that the details of the shape of the head played their part in this phenomenon. We therefore carried out listening tests

with a set of microphones in which the head was approximated, not by a sphere, but by an artificial head with more natural detail (*fig. 5*). There was however no appreciable difference with respect to the same observations with the sphere. The distinction between "in front of" and "behind" when visual observation is impossible, seems rather to be obtained by slight movements of the head — a means which is of course lacking in the arrangement for binaural hearing here described²). In order to make this possible, the microphone would have to be mounted directly on the headphones, which is at present impossible due to the great weight of the available microphones. The mounting of the microphones on the telephones would moreover also produce the advantage that the user would be able to move his head freely without the occurrence of a contradiction between the acoustically and visually observed directions. When an artificial head is used it must not be placed too far from the user if the acoustic and visual directions are to coincide approximately (*fig. 6*).

¹) Since in the case in question the hearing deficiency of the left ear had almost the same characteristic as that of the right ear, the same frequency characteristic, shown in *fig. 3*, was chosen for both amplifiers.

²) The following experiment is of interest in this connection. When the artificial head is in a different room from that in which the person using the telephones is situated, the latter localizes a speaker in the correct direction, *i.e.* at that angle at which the speaker is standing with respect to the artificial head, but however always in the direction to the rear. The perception is here apparently influenced by the conviction that a speaker who stands in front of one ought also to be visible.

RECEIVING AERIALS

by J. van SLOOTEN.

621.396.67

A discussion is given of the different factors which must be taken into account in designing a receiving aerial in order to keep the interference level low. A description is then given of the way in which the knowledge of these factors is applied in the design of the "Philistatic" aerial system so that less disturbance from interference is experienced on normal as well as on short waves.

Introduction

A receiving aerial is an electrical conductor or a system of such conductors in which voltages are induced by local electromagnetic fields which may be due to various sources. The function of the receiving set is to amplify only those voltages from the desired transmitter and to convert them into sound. The possibility of this selection is based on the fact the transmitting stations all work on different frequency bands.

If in the aerial undesired voltages are induced (interferences due to electrical apparatus, for example) whose frequencies fall within the frequency range of the transmitter which is being received, then generally speaking interference-free reception is no longer possible even with the best receiving set.

The avoidance of such undesired voltages must therefore be considered as belonging to the function of the aerial. In addition the aerial also of course has the task of capturing the desired signals in adequate intensity.

At the beginning of the development of radio technology when receivers were much less sensitive and transmitters much weaker than at present, the latter function of the aerial was the most important one. At present, however, the sensitivity of aerial and receiver together is almost always great enough to reproduce an interference-free transmitter with the desired intensity. It is now worthwhile therefore to apply measures for increasing the ratio between signal and interference even though this takes place at the expense of the signal intensity itself¹⁾.

The possibility of choosing between desired signal and interference signal lying in the same frequency band by suitable construction of the aerial is due to the following points of difference which may exist between the two signals:

1) *The direction of propagation of the electromagnetic wave.*

Most aerials receive signals coming from different directions with different intensities. This effect is very pronounced in the case of the loop antenna, which can therefore in certain cases be used to weaken interferences.

2) *The electromagnetic character of the wave.*

It may be stated that, in the neighbourhood of a source of interference, the electric field is caused by the voltages and the magnetic field by the currents present in the source of interference. It therefore depends entirely on the nature of the source of interference whether the electric or the magnetic field is the stronger. At a distance which is large compared with the wave length, however, the nature of the transmitter no longer has any influence on the electromagnetic field; the electric field strength is then induced by the change in the magnetic field and *vice versa*. This phenomenon is expressed in Maxwell's famous equations. Electrical and magnetic fields then have a fixed relation to each other, and when expressed in certain units are numerically equal (the electric field in volts per metre is 30 000 times the magnetic field in oersteds).

The ratio between the intensities of the signals of the source of interference and the transmitter may therefore be quite different for the electrical field strengths than for the magnetic field strengths. In the neighbourhood of a source of interference the electric field is usually the greater; if one then for example makes use of a loop antenna which is mainly sensitive to magnetic fields, the ratio between the intensities of interference and signal will be smaller than when an ordinary T-aerial is used.

3) *The distribution in space of the intensity of the field of the transmitter and of that of the interference.*

The field of the transmitter which is excited at a great distance from the receiver will be

¹⁾ This may not of course be carried too far, because the useful sensitivity of a receiver is limited by the noise which is excited in the first amplifier stages. In the case of an aerial signal stronger than about 1 millivolt the influence of this noise is as a rule unnoticeable. See in this connection Philips techn. Rev. 3, 189, 1938.

stronger out of doors than indoors. The interference signals, which are usually present on the electrical conductors of the light mains, will, on the contrary, be stronger indoors than out of doors. By constructing the aerial in such a way that a certain part of it, in our case the part inside the house, is not sensitive, the ratio of intensities of interfering signal to receiving signal can be reduced. On this effect is based the action of the aerial with shielded connections, which is called "shielded aerial" for the sake of brevity. We shall discuss this in the following.

The shielded aerial

We shall examine in this chapter how a nearby source is received by an aerial with and without shielded leading in wire.

In *fig. 1a* is shown an aerial consisting of a vertical and a horizontal wire. The source of interference is represented as a sphere *S* on which there is an interference voltage. The interferences are transferred from the sphere *S* to the aerial capacitatively. In the figure the divided capacity between the source of interference and the aerial is represented by the four capacities C_1-C_4 . The capacities C_3 and C_4 toward the vertical wire close by will be the largest.

If we now place an earthed shield around the vertical wire, as indicated in *fig. 1b*, the capacities C_3 and C_4 will become ineffective, since the course of the lines of force between the shielded wire and the source of interference is intercepted by the earthed covering. As a result the greatest part of the interference will disappear.

Let us now examine the influence of the shielding on the signal voltage which is excited in the aerial

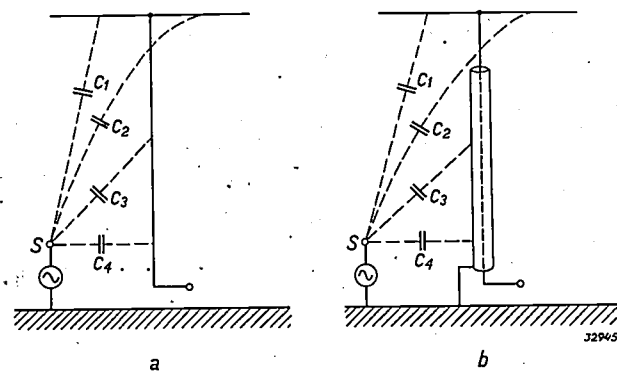

Fig. 1. The voltage of a source of interference *S* in partially transferred to the aerial by means of the divided capacity which is represented by the condensers C_1 to C_4 . In case *a* of the non-shielded aerial the capacities C_3 and C_4 toward the supply line are the most important ones. In the case *b* of the shielded aerial these capacities become ineffective, so that the interference can be considerably reduced.

by a distant transmitter. For the sake of simplicity we shall do this somewhat roughly.

The electrical component *F* of the field (*fig. 2a*) has a vertical direction and excites in the aerial a voltage equal to this field strength multiplied by the height of the aerial. The voltage excited is therefore equal to the electrical potential at the height of the horizontal section.

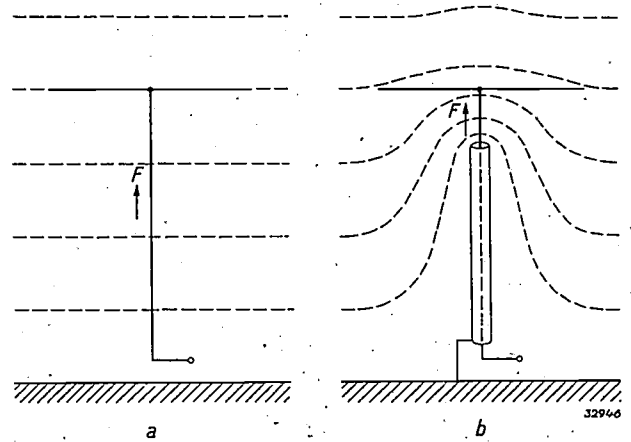

Fig. 2. Equipotential surfaces of a transmitter field: *a*) with a non-shielded aerial, *b*) with a shielded aerial. Although the equipotential surfaces are very severely distorted locally by the shielding, the potential at the position of the horizontal aerial wire has retained practically its original value, which means that the signal is only slightly weakened. The action of the aerial wire itself on the form of the equipotential surfaces has been neglected in the drawing.

If we now apply shielding (*fig. 2b*), the field is locally distorted. The earth potential is raised and the potential drop on the field strength is very much increased at the upper edge of the shield. If we go still higher we see that the disturbance of the potential field decreases rapidly so that at the position of the horizontal wire of the aerial the potential is again about the same as when the earthed shielding is absent. (see *fig. 2b*). If the free part of the aerial is not too small with respect to the shielded part, we may therefore state that the induced voltage is only slightly decreased by the shielding.

Summing up, therefore, we may say that due to shielding the voltages coming from nearby sources of interference are considerably weakened, while the voltages from distant broadcasting transmitters experience only a slight attenuation.

Until now we have considered only the voltage which is induced in the aerial. If we now examine what part of this voltage acts across the input terminals of the receiving set, we find that an additional weakening occurs due to the shielding.

In order to explain this more fully an equivalent circuit diagram is given in *fig. 3* for an aerial with a receiver having an input impedance of *z*. If E_a

is the voltage excited in the aerial, a current will flow through the receiving set which, in the case of a non-shielded aerial (fig. 3a) is given by:

$$I = \frac{E_a}{z + 1/j\omega C_a} \dots \dots \dots (1)$$

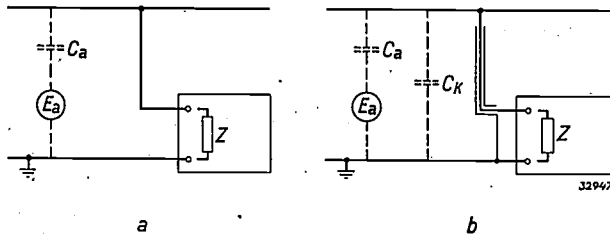

Fig. 3. Equivalent circuit: a) of a non-shielded aerial, b) of a shielded aerial. E_a aerial voltage, C_a aerial capacity, z input impedance of the receiving set, C_k capacity of the aerial supply line toward the earthed mantel of the shielding.

It is hereby assumed that the capacity C_a is concentrated in the horizontal section of the aerial. If that is not the case, equation (1) must be replaced by a more complicated expression. This is, however, unnecessary for our purpose. The voltage on the impedance z is equal to the current I multiplied by z and thus given by:

$$E = \frac{E_a z}{z + 1/j\omega C_a} = \frac{E_a}{1 + 1/j\omega z C_a} \dots \dots (2)$$

Therefore when the impedance z is large with respect to that of the aerial capacity, the voltage on the impedance z remains practically equal to E_a .

If we now replace the vertical wire by a concentric cable with an earthed mantel the internal capacity of this cable is connected in parallel with the impedance z (see fig. 3b). If we consider z to be very large with respect to the impedance of the aerial capacity, and if we call the internal capacity of the cable C_k , the voltage over the input terminals of the receiving set becomes:

$$E_k = \frac{E_a C_a}{C_k + C_a} \dots \dots \dots (3)$$

When C_k is larger than C_a , which is usually the case, considerable attenuation of the aerial signal occurs. The remaining interferences are in this case weakened to about the same extent as the desired signal, so that the ratio of signal to interference is not altered by the presence of C_k .

In order to keep this undesired attenuation small it is necessary to make C_k small and therefore the cable lead as short as possible and to use for this purpose cable with as low internal capacity per unit of length as possible, i.e. cable with a very thin

core. The decrease in cable capacity hereby attainable is however limited, because one cannot use wire thinner than about 0.25 mm in connection with its mechanical strength. If for reasons of practical or aesthetic nature a small aerial is used, then, in spite of the use of a cable of low capacity, the signal may be weakened more than is permissible.

In such cases considerable improvement can be obtained by including a transformer between the free portion of the aerial and the cable lead. The primary of this transformer is connected between the aerial and the earthed mantle of the cable; the secondary between the mantle of the cable and the lead wire. By means of this transformer the aerial is as it were "adapted" to the loading by the undesired cable capacity. The fundamental scheme of the transformer is given in fig. 4; a shows the connection and b the equivalent circuit.

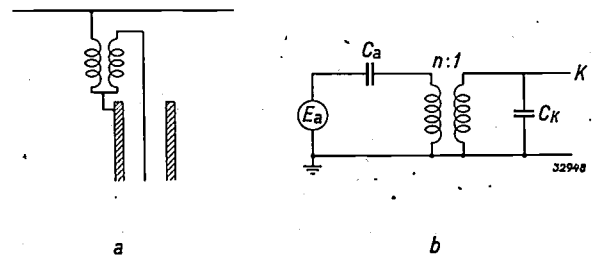

Fig. 4. a) Connections, b) equivalent circuit of an aerial with a transformer connected between the free end and the shielded supply wire. By transforming the aerial voltage downward, the harmful action of the capacity between supply wire and shielding can be reduced.

If the transformer attenuates the voltage which is supplied by the aerial to the core of the cable in the ratio $n : 1$, we find for the voltage on the terminal K:

$$E_k = \frac{1}{n} E_a \frac{C_a}{C_a + \frac{C_k}{n^2}} \dots \dots \dots (4)$$

This expression reaches a maximum when we choose for the transformation ratio:

$$n = \sqrt{\frac{C_k}{C_a}}$$

and then

$$E_k = \frac{E_a}{2} \sqrt{\frac{C_a}{C_k}} \dots \dots \dots (5)$$

When equations (3) and (5) are compared, it is found that the introduction of the transformer in the case where $C_k \gg C_a$, can produce considerable gain.

In the foregoing consideration an ideal transformer is assumed, i.e. a transformer without leakage and with very high values of primary and secondary

self-induction. In practice leakage is present, and the practical values of these selfinductions, which form resonance circuits with the capacities C_a and C_k must be considered. By giving the transformer suitable dimensions, a more satisfactory result can be obtained with the help of this resonance in the wave length range with which we are concerned in practice than is indicated by equation (5).

The "Philistatic" aerial systems

The "Philistatic" aerial systems 7 323 and 7 314 have been developed with the foregoing considerations in view, and a brief description is therefore sufficient.

In the system 7 323 the aerial proper consists of two straight wires in V form, connected in parallel. A large capacity with small dimensions of the aerial is hereby obtained. The wires are fastened to an insulator which screws together, in which the intermediate transformer is housed and to which the beginning of the low capacity lead cable is also fastened.

The length of the cable may be up to about 60 m, and as many as six receiving sets may be connected to it.

In the system 7 314, whose action is entirely analogous the aerial proper consists of a vertical rod $3\frac{1}{2}$ m long. This rod is fastened, *via* an insulating intermediate section which includes the adapting transformer, to a supporting rod which is fastened for instance to a chimney. *Fig. 5* shows such a system installed. Both of these systems are suitable for the reception of all wave lengths between 10 m and 2 000 m, although in their design primary attention was paid to the best possible reception of medium and long waves (200—2 000 m).

There are in addition two other "Philistatic" aerial systems in which primary attention has been given to the reception of short waves (15—50 m).

The action of these systems (types 7 320 and 7 313) is very different from that of the previously described system. Their construction is indicated diagrammatically in *fig. 6*. The aerial consists of two horizontal sections 7 m long; it is therefore a so-called dipole. By a "transmission line" consisting of the wires *a* and *b*, this dipole is connected with the receiving set.

It is found that, thanks to the symmetry of the arrangement, the transmission line is insensitive to interferences so that it need not be shielded. Since the two wires of the transmission line run close to each other, any source of interference will have the same capacity toward both conductors.

Consequently currents will occur in both conductors which are equal in magnitude and phase and flow off to earth *via* the coils 1 and 2 respectively, and the circuit elements *L*, *R* and *C* which we think substituted by a short-circuit. The receiving set is connected to the secondary coil 3 of the trans-

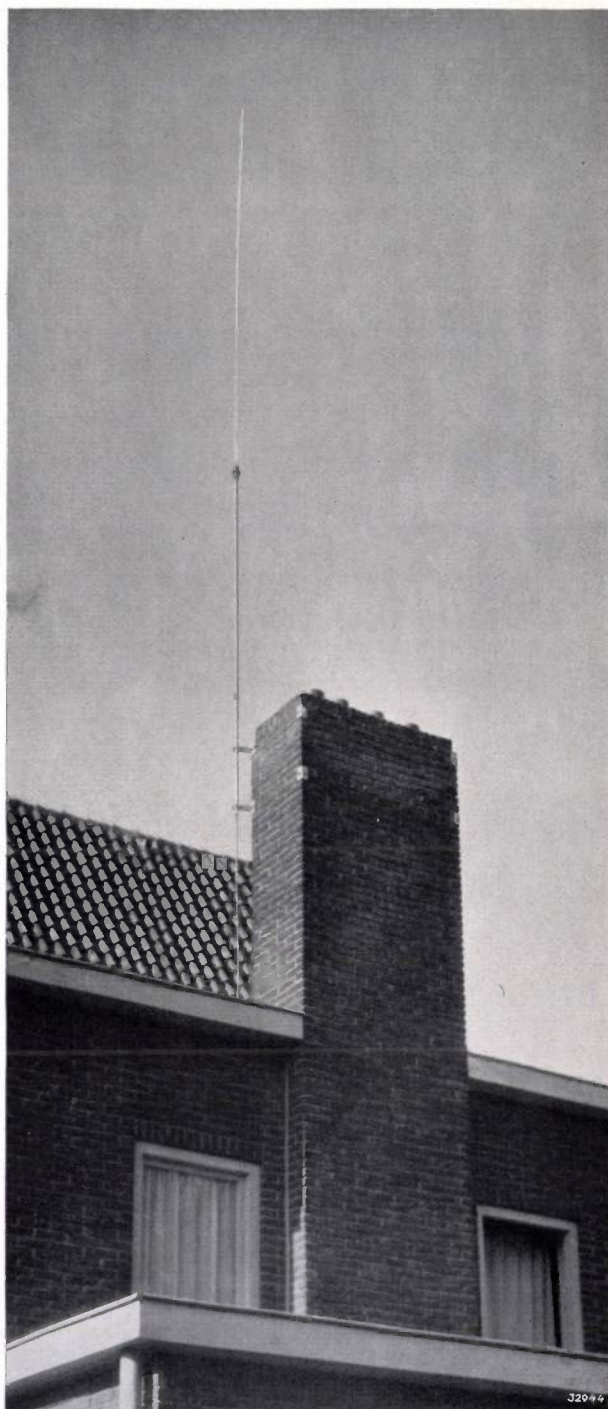

Fig. 5. A "Philistatic" aerial, type 7 314 mounted on a chimney. From the upperside to the bottom: the aerial rod; the transformer; a hollow tube, fastened with two isolators to the chimney, on which the transformer is mounted; the shielded cable, which is conducted vertically downward through the hollow tube.

former. In this coil inverse voltages are induced through the coils 1 and 2, which voltages exactly neutralize each other in the case in question, so that no interference signal occurs.

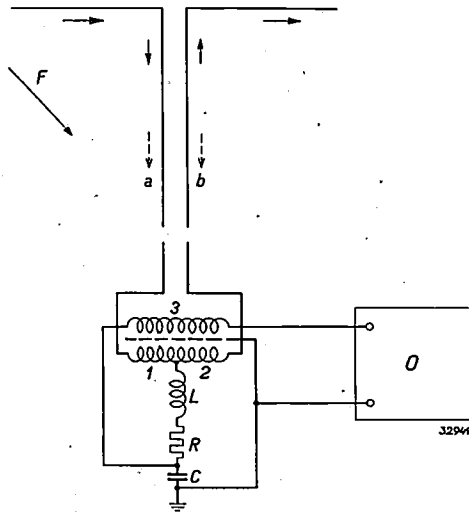

Fig. 6. A "Philistic" aerial system which is especially suitable for short waves. On short waves the aerial acts as a dipole and the signal causes voltage differences between the wires *a* and *b*. An interference would excite no voltage between the two wires themselves, but between the wires and earth, the input signal produced in this way is however very much reduced by the choke *L* and the capacity *C*. On long waves this *L-C* circuit is less effective, and the whole acts as an ordinary T-aerial.

If the electric field of the transmitter were exactly perpendicular to the arms of the dipole it would, as well as the disturber have no effect on the receiving set. Generally, however, the electric-force (*F* in fig. 6) has a component in the direction of the dipole and in the given case this component will cause a current in the arms of the dipole in the

direction of the arrows. This current flows through the two wires of the transmission line in opposite directions. It flows through the primary winding of the transformer (coils 1 and 2) and thereby induces a reception signal in the secondary winding (3).

This design is quite correct for short waves, but with wavelengths above 200 m it works less favourably than a normal T aerial. In the design of the "Philistic" dipole aeriels care therefore was taken that they should work on long wave lengths as T aeriels. For this purpose the middle tap of the transformer has been earthed *via* the condenser *C*. The voltage on the condenser increases with the wavelength and at long wavelengths it works as the reception signal.

The described change has the consequence that the aerial is not free from disturbances on short waves. The disturbing currents will induce at the condenser a small voltage, which quite as the reception signal on long waves is passed to the receiving set. For the elimination of this disturbing current a choking coil (self-induction *L*, resistance *R*) has been inserted in the middle tap. To prevent that this will become short circuited with high frequencies by the capacity between the primary and secondary windings of the transformer these windings are separated electrostatically. In this manner — as far as are short waves concerned — a good reception is obtained.

If the removal of interference is also desired on broadcasting waves, the transmission line must be shielded. This has been done in system 7 313. In system 7 320 shielding is not present, and the removal of interference is therefore only valid for short waves.

AN APPARATUS FOR ARTIFICIAL RESPIRATION ("IRON LUNG")

by J. B. ANINGA and G. C. E. BURGER.

614.888.5

In the case of a disturbance in the functioning of the respiratory muscles, for instance in cases of suspended animation or paralysis, artificial respiration must be applied. This is made possible even when the condition is of long duration by an apparatus which causes a periodic expansion of the lungs ("iron lung"). On the principle of Drinker the patient's body is enclosed in an air-tight chamber in which alternations of pressure are generated, while the patient's head remains outside the air-tight chamber. In the apparatus on this principle developed by Philips the chamber is made so large that there is space for the doctor or nurse in addition to the patient, for the purpose of carrying out the operations necessary for the treatment. The way in which the alternations of pressure are brought about in the fairly large chamber (volume 1.5 m³) is described. The driving mechanism is balanced in such a way that upon any interruption of the current from the mains which supply the motor, the apparatus can easily be operated for many hours by hand.

The problem of resuscitation by artificial respiration in cases where the normal respiratory movements have ceased is an old one. Such cases of apparent death, where artificial respiration is indicated, occur especially in the case of victims of drowning or electrical shock or in cases of poisoning by carbon monoxide, etc. The methods of artificial respiration which are usually applied are based on attempts to cause an expansion of the thoracic cavity (inspiration) by movements with the arms of the patient, which by means of the upper arm muscles attached to the chest are able to exert a pulling force on the pectoral wall. Another method is to attempt by direct pressure on the chest to press the air out of the lungs and to allow them to suck in air by means of the elasticity of the pectoral wall. All these methods are fairly primitive, they require great exertion on the part of the person applying them, and they are practically only suitable for use during a few hours. In many of the above-mentioned cases the latter is no objection since the purpose is to remove a condition which is of short duration only. There are, however, also cases where the condition of disturbed natural respiration may last for weeks or months. The most familiar example is the paralysis of the respiratory muscles which may occur as a result of epidemic infantile paralysis. With such cases in view attempts were made to construct an automatically working apparatus which can assume the functions of the respiratory muscles for any length of time desired. With the help of such an apparatus it is in the above-mentioned cases of infantile paralysis not only possible to keep the patient alive, but often to effect a cure. It often happens that the initially occurring disorder is very extended, and that for instance the muscles of arm, leg and respiration are paralyzed, while in the course of weeks a recovery

of function occurs due to cure of the inflammation process in the central nervous system which had caused the paralysis.

Mechanization of artificial respiration

Among the different methods for the mechanization of artificial respiration that of Drinker¹⁾ has proved the most satisfactory. The body of the patient is introduced into an air-tight chamber, while his head remains outside. In this chamber a periodic alternation of pressure is caused. Since the lungs, by way of the mouth, remain in connection with air at normal pressure outside the air-tight space, a movement of inhalation takes place upon decrease of the pressure on the chest and abdominal wall, while upon recovery of the normal pressure or the exertion of extra pressure on the chest, an exhalation movement is carried out.

In principle, the air-tight chamber in which the body of the patient is enclosed, needs only to be large enough for the patient's body. In the first instance it would seem advisable not to make the chamber any larger than necessary since the required alternation of pressure is easier to bring about in a small chamber than in a large one. If, however, the body of the patient is enclosed in a narrow box (as was done in the first apparatus built on the Drinker principle), there are very undesired consequences in connection with the care of the patient. It is obvious that the treatment requires other things besides artificial respiration. For all kinds of daily occurrences such as care of the skin, massage and exercise of paralyzed limbs, the patient must be removed from the apparatus. When this is done artificial respiration ceases, and the patient begins to suffocate. Attempts have been made to

¹⁾ In the choice of the method to be used, we were advised by Prof. Dr. A. K. M. Noyons of Utrecht.

find a solution for this difficulty by allowing the patient to breathe in a certain amount of oxygen so that the lungs will have a reserve available. In spite of these precautions it is still found necessary to let the "iron lung" resume its function as quickly as possible. It is obvious that this circumstance is very unpleasant and even terrifying for the patient, and requires a high standard of skill of the personnel

Driving power of the "iron lung"

The most important problem in the construction of the "iron lung" was the excitation of the required alternations of pressure in the chamber. This is accomplished by periodically increasing and decreasing the volume of a container (air bellows) connected with the chamber. The prin-

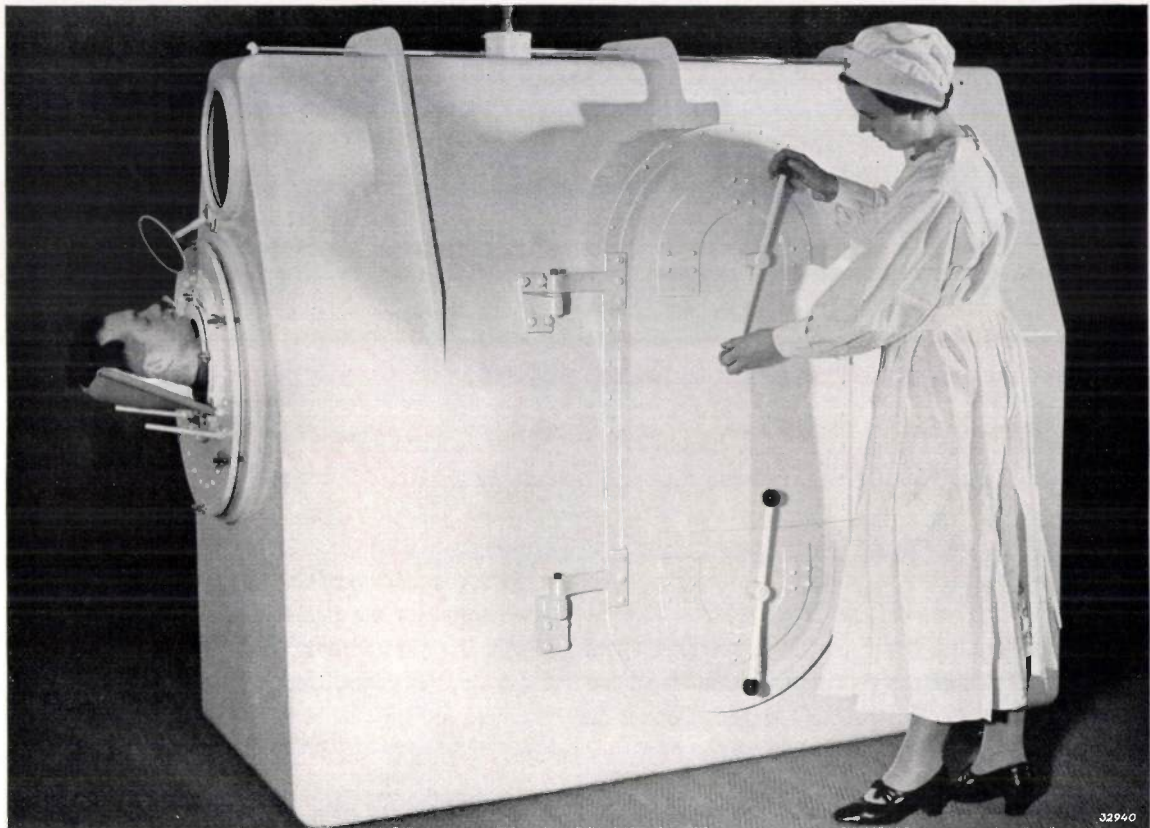

Fig. 1. The "iron lung" in action.

in charge. Serious doubt may even be felt whether in this way adequate care can be given, especially since it is a question of careful nursing in many cases of infantile paralysis which makes it possible to save the patient.

It was this consideration which led in the construction of the Philips apparatus for artificial respiration to the decision to deviate from the ordinary design. The chamber into which the patient's body is introduced is made so large (see *fig. 1*) that the doctor or nurse can take his place in the chamber beside the patient. Artificial respiration is now only interrupted for a few seconds when some treatment or other is necessary, namely only long enough for the door of the chamber to be opened for the entry of the one giving the treatment.

ple of this process is shown in *fig. 2*, while *fig. 3* is a photograph of the driving mechanism. In order to be able to adapt the magnitude of the pressure differences, as well as the rhythm in which they occur, to the age and condition of the

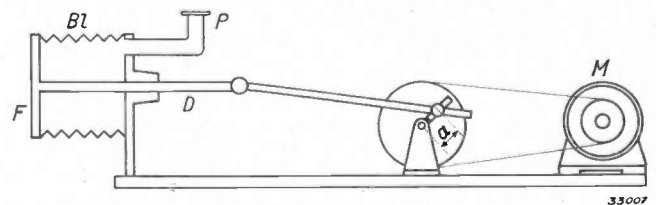

Fig. 2. Diagram showing the principle of the mechanism for generating the pressure alternations in the "iron lung". The bellows *Bl* are connected with the chamber via the tube *P*. The rear flange *F* of the bellows is moved back and forth by the driving rod *D* which is moved via a lever by the motor *M*. The arm *a* is adjustable in length so that the stroke of the bellows can be regulated.

patient, the length of the arm a (and thus the stroke of the bellows) can be varied, and the shaft is driven *via* a pulley with five sheaves of different diameters which permits adjustment at different rates of breathing.

The required dimensions of the bellows are calculated in the following way. The difference Δp between the highest pressure p_1 and the lowest pressure p_2 in the chamber must amount to 0.03 atmosphere in the most extreme case. When we assume

to expansion of the bellows, the following is true:

$$p_1 v_1 = (p_1 - \Delta p) (v_1 + \Delta v)$$

and by approximation

$$\Delta v = \frac{v_1}{p_1} \Delta p \dots \dots \dots (1)$$

In our case $v_1 = 1.5 \text{ m}^3$ and $p_1 = 1$ atmosphere approximately, so that one finds with $\Delta p_{\text{max}} = 0.03$ atmospheres

$$\Delta v_{\text{max}} = 45 \text{ litres.}$$

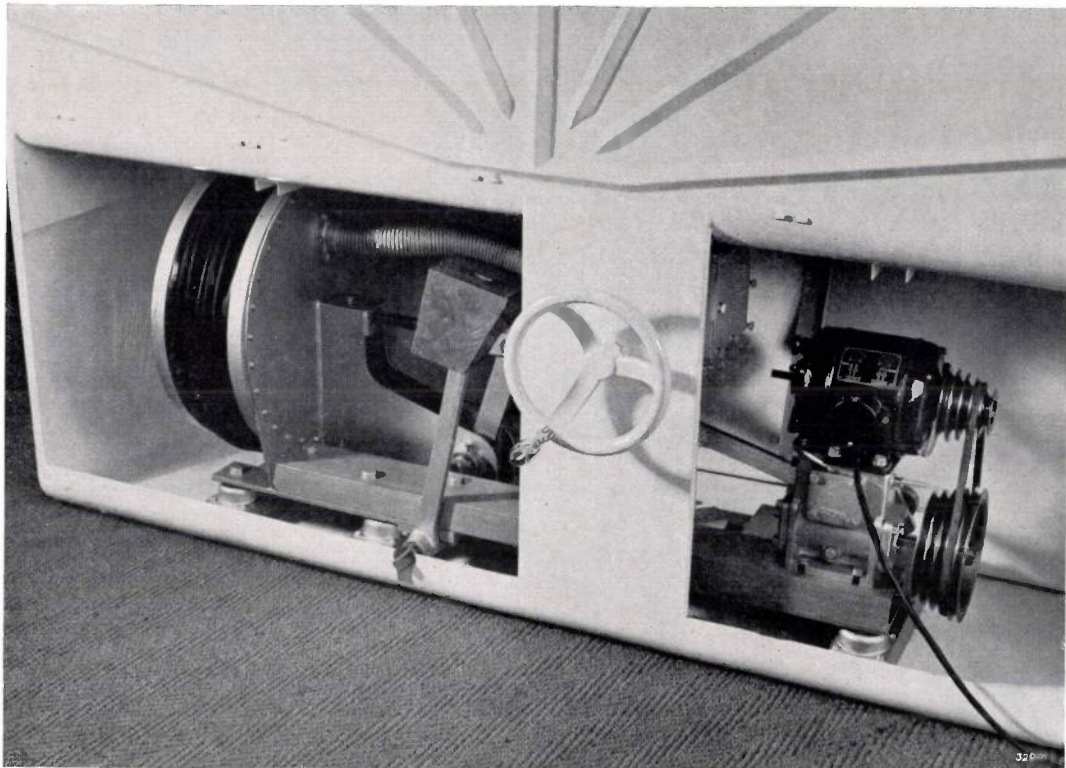

Fig. 3. The mechanism of the "iron lung". On the left the chrome leather bellows, whose expansion causes a decrease in pressure in the chamber. On the right hand the motor which moves the driving rod of the bellows *via* a pulley with five sheaves of different sizes, a worm drive and a lever. By means of the fivefold pulley the breathing rate can be adjusted.

that the pressure alternations take place isothermally in the chamber ²⁾, the product of pressure times volume is constant. Therefore if v_1 is the volume of the chamber and Δv the increase of volume due

²⁾ Actually, at the frequencies of respiration (15 to 30 per minute), a temperature equilibrium between the volumes inside and outside the chamber will not continually be established. With perfect heat insulation, the pressure variations would take place adiabatically, and $p v^\kappa$ instead of $p v$ would be constant with $\kappa = 1.4$. In practice a polytrope with $1 < \kappa < 1.4$ will best approximate the truth. One then in any case obtains a certain change of pressure with a smaller volume change than in the case of an isothermal variation. The capacity of the bellows, which is calculated in the following, is therefore larger than is theoretically necessary. The reserve, which is available in this way is of practical advantage since the pressure variations are decreased by different leaks in the chamber which will be discussed.

This volume of air must be added and removed from the chamber at each respiration. The cross section area of the bellows is about 1600 cm^2 ; the movable flange of the bellows must therefore be able to be moved a distance $s = \Delta v/q = 28 \text{ cm}$ back and forth.

Upon expansion of the bellows considerable work must be done in opposing the external atmospheric pressure: at the greatest expansion of the bellows, when the chamber is at a decreased pressure of 0.03 atmosphere, the atmosphere presses against the movable flange with a force of $1600 \times 0.03 \times 1.033 = 50 \text{ kg}$. The energy supplied during the expansion of the bellows can, however, be recovered when the external atmospheric pressure is

allowed to do work during the contraction of the bellows, for instance by causing it to raise a weight which produces energy again as the bellows expand. In this way it is possible to use a low-powered electromotor ($\frac{1}{4}$ h.p. in our case). It is, however, of greater importance that this method of balancing makes it possible to work the bellows by hand without appreciable exertion. This latter factor is essential, since upon any disturbance in the electric mains which feed the motor, artificial respiration must not stop, and the "iron lung" must be able to be kept in action for several hours by a nurse.

The method of balancing the external pressure will be examined in more detail. For the sake of comparison one may recall the way in which a lift is balanced; the lift is coupled with an equal counter weight which moves the same distance downward as the lift moves upward. In the ideal case the couples which act on the axis of the cable drum are in equilibrium at every moment, so that the motive force needs only be enough to overcome the frictional and mass forces. In the "iron lung" mechanism also the aim will be to provide that at every position of the bellows the air pressure is kept in exact equilibrium. In this case, however, in contrast to the example of the lift, the force to be balanced is not constant during the motion of the bellows. With the help of equation (1) one finds for the force $q \times \Delta p$ on the movable flange of the bellows

$$q \cdot \Delta p = q \cdot \frac{P_1}{v_1} \Delta v = \frac{q^2 P_1}{v_1} \cdot x, \dots (2)$$

where x represents the displacement of the flange. The mechanism shown in *fig. 4* serves to balance this force. The driving rod D of the bellows is coupled with the shaft A via a sliding block B and a slotted bar K . By a gear transmission in the ratio $n : 1$ the shaft C is coupled with A , and to C is fastened a lever H with the variable length h

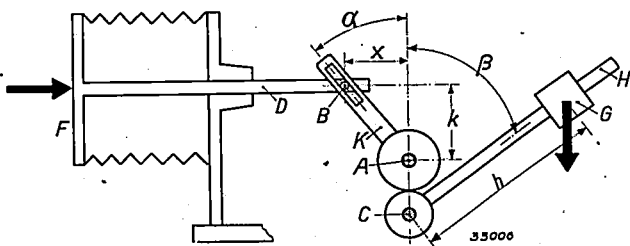

Fig. 4. Balancing the atmospheric pressure which acts on the flange F of the bellows. The driving rod D which is moved by the mechanism of *fig. 2* (not shown here), brings into motion the lever H , via the sliding block B , the slotted bar K and a gear transmission between the shafts A and C . Lever H bears the sliding counter weight G (clearly visible in *fig. 3*).

and a weight G . At the initial position of the bellows when the same pressure holds inside and outside the chamber, the lever H stands vertical and the weight G is therefore at its highest position, while upon expansion of the bellows the weight G turns toward a lower position.

It is easy to calculate to what degree the ideal of equilibrium at every moment is approached by this mechanism. We must consider the couples M_L and M_G which are exerted by the air pressure and the weight G respectively on the shaft A . It follows from equation (2) that:

$$M_L = \frac{q^2 P_1}{v_1} \cdot x, \dots (3)$$

where k is the perpendicular distance between the driving rod D and the shaft A (in the case of an adiabatic pressure alternation M_L is simply multiplied by a factor $\kappa = 1.4$). When we call the angles α and β through which the slotted bar K and the lever H respectively are turned, then

$$M_G = n \cdot G \cdot h \cdot \sin \beta,$$

and when we take into account the relations:

$$\beta = n \cdot \alpha, \\ \text{tg } \alpha = \frac{x}{k},$$

it follows that:

$$M_G = n G h \sin \left[n \text{tg}^{-1} \frac{x}{k} \right] \dots (4)$$

Table I

q	$= 1590 \text{ cm}^2$
p_1	$= 1 \text{ atmosphere} = 1.033 \text{ kg/cm}^2$
v_1	$= 1.5 \text{ m}^3$
k	$= 22 \text{ cm}$
n	$= 1.5$
G	$= 20 \text{ kg}$
h	$= \text{varies between } 20 \text{ and } 40 \text{ cm}$

In *table I* the data necessary for the calculation will be found. In *fig. 5* the couples M_L and M_G calculated from (3) and (4) are plotted as functions of x for different values of the parameter h . It may be seen that by a suitable choice of h , the position of the moving weight G , the curve M_G can be made to coincide almost exactly with the curve M_L at small values of x . Only in the most extreme positions of the bellows ($x > 20 \text{ cm}$) does the shape of the two curves remain very different. In practice, however, no greater stroke of the bellows is required than about 18 cm (corresponding to a difference in pressure of 0.2 atmospheres, with isothermal variation). The optimum position of the weight G depends upon the

necessary stroke. At $s = 18$ cm, for example, h would have to be taken equal to about 23 cm in the case of isothermal variations. The personnel in

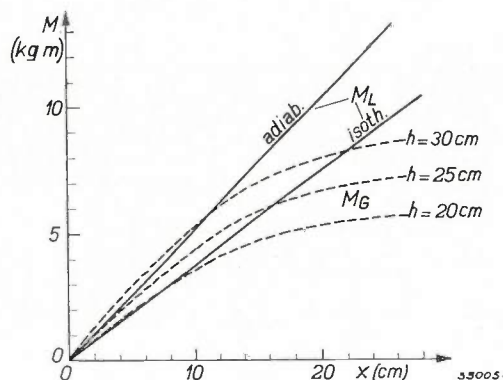

Fig. 5. The couples M_L and M_G exerted by the air pressure and the counter weight respectively on the shaft A should be exactly equal for each position x of the bellows in an ideal case. The actual curves of M_L and M_G coincide fairly well when the stroke of the bellows is not too large (when, for instance, $x < 18$ cm), and when for the parameter h (position of the sliding weight G in fig. 4) a suitable value is chosen which is adapted to the stroke. M_L is here shown for both adiabatic and isothermal pressure variations. The actual curve will lie between these two.

charge can determine the optimum position of the weight most easily by experiment.

It must still be noted that respiration with the "iron lung" can take place in different ways: the pressure in the chamber can be alternated between normal pressure and a lower pressure; or it may be made alternately higher and lower than normal³⁾. In the first case force is only used for the inspiration, in the second case for in- and expiration. In the foregoing and in fig. 5 we have assumed the first case. If the physician chooses the second method, the lever H bearing the counter weight Q is set at a different angle, so that it becomes vertical when the bellows are in the middle of the full stroke. The curves for the balancing in fig. 5 are then prolonged symmetrically for negative values of x .

For working the apparatus by hand a long lever

³⁾ In the first case, where the pressure in the chamber must never be higher than the external pressure, this is guaranteed in a simple way by means of a valve on the top of the chamber which allows air to escape when there is an excess pressure in the chamber. In working according to the second method this valve is fixed.

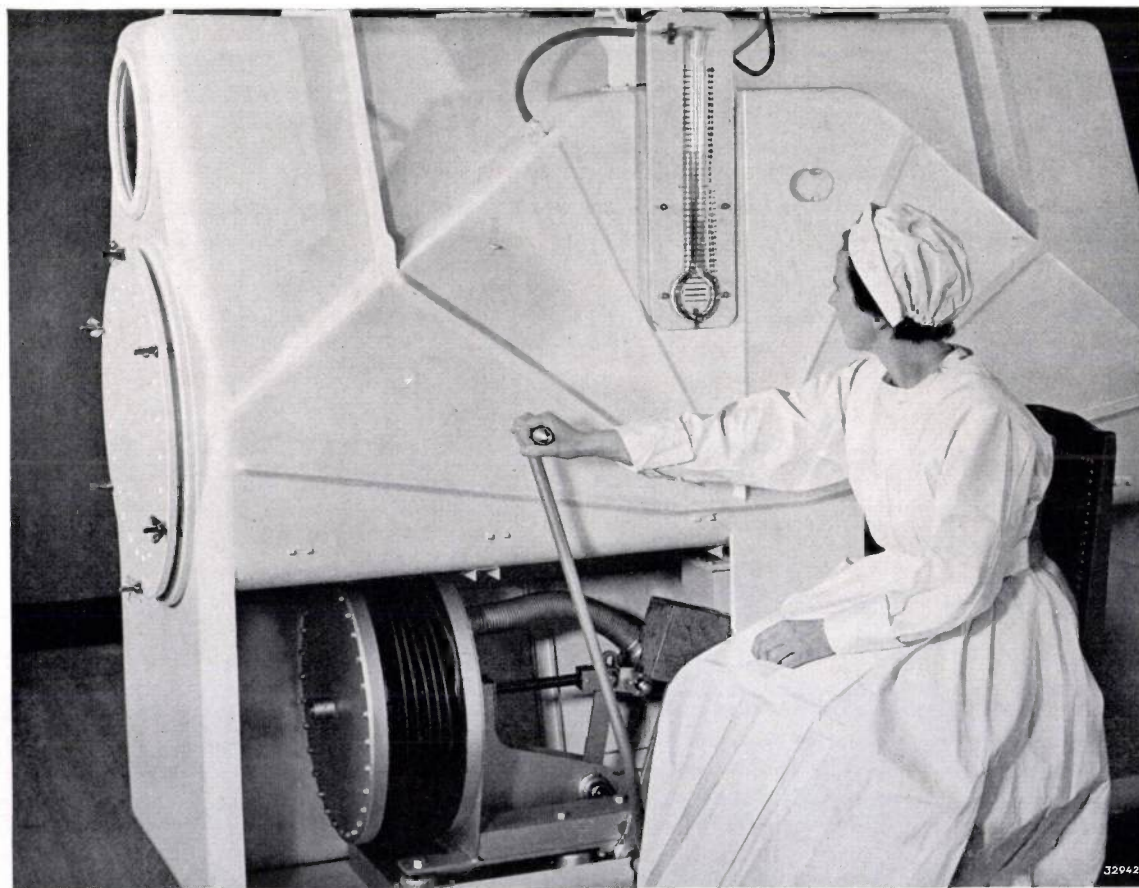

Fig. 6. The "iron lung"³⁾ worked by hand. The person moving the handle can read off on the manometer the magnitude of the pressure alternations, and regulate the motion accordingly.

with a handle is attached to the end of shaft C, see *fig. 6*. The person moving the handle can read off on a manometer the magnitude of the pressure changes, and regulate the motion accordingly.

Further details of the construction

The chamber must be strongly built since it must resist large forces (several tons) during the pressure changes. It is welded from 1.5 mm steel sheet. Steel reinforcements have been entirely avoided on the inside in order to have smooth walls which can easily be cleaned. The chamber is mounted on four rubber wheels and is thus easily moved about. It is so narrow that it can pass through a door 90 cm wide. The bellows are connected by means of a flexible tube with the chamber, and together with the driving mechanism rest upon pieces of rubber so that any vibrations of the mechanical parts are not transmitted to the chamber. The body of the patient is introduced through an opening into the chamber. This opening is then closed with a cover (see *fig. 1*). Instead of one adult patient, two children can be treated at once in the apparatus. For this purpose two beds are placed end to end in the chamber and there is an opening for the patient's head at both ends. In the treatment of the patients great value is attached to the possibility of placing them in the so-called von Trendelenburg position, *i.e.* sloping, with the head low. A better drainage of saliva is hereby guaranteed and choking prevented and thus the occurrence of complicating inflammations of the lungs. The two beds can therefore be given a slope of 20° by means of the hand wheel visible in *fig. 3*. For an adult the two beds are coupled together to give a single bed which can be given a slope of 15° .

It is obvious that the chamber must be air-tight in order to obtain the necessary pressure alternations. Since the patient's head must remain outside the chamber, an air-tight seal is necessary around his neck. This is achieved by means of a collar whose construction is shown in *fig. 7*. The two thin rubber rings 1 have a slightly smaller diameter than the neck, and

the edge of one is stretched upward and that of the other downward along the neck so that the seal is satisfactory for lowered as well as for excess pressure, without any discomfort to the patient. The leather supporting rings 2 are provided with four radial slide fasteners which are opened for the easy insertion of the head into the collar. The collar is not fixed in a permanent position in the cover of the chamber but it can be adjusted in any desired position by means of screws which slide in grooves. This may clearly be seen in *fig. 8*. The patient can therefore for example be laid on his side without it being necessary to turn his neck in the rubber rings.

The door which permits entry into the chamber is also sealed with rubber. Leaving or entering the

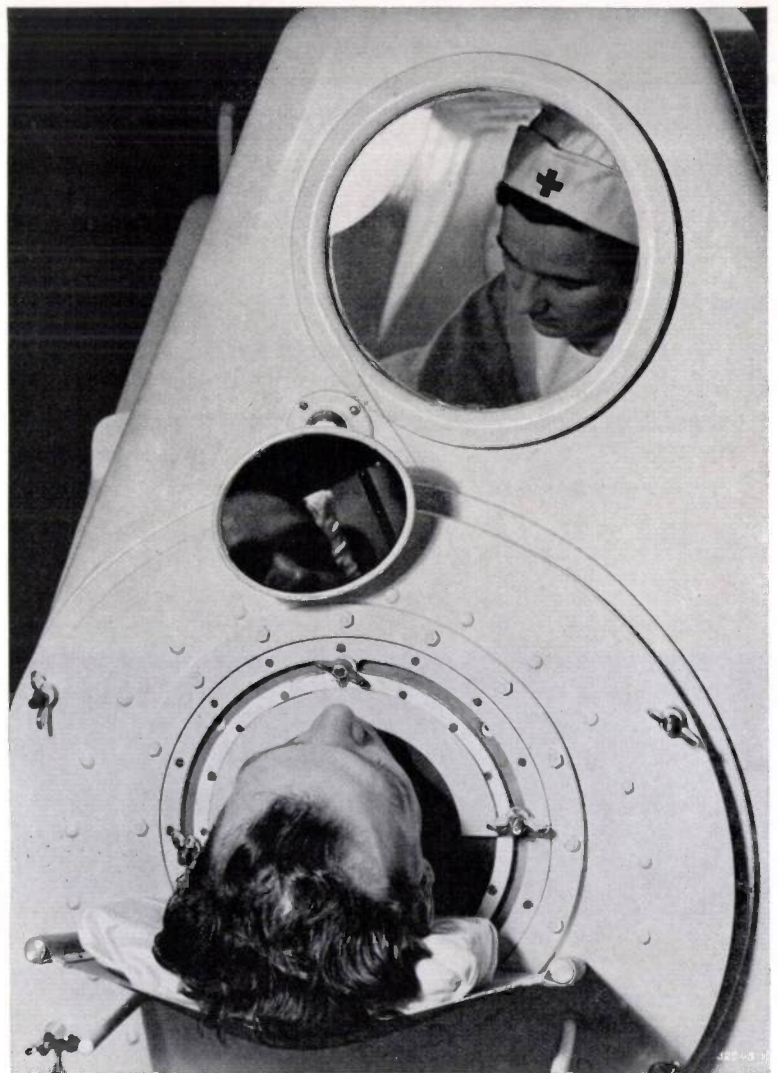

Fig. 7. The patient's head rests on a cushion supported by two iron bolts. When the patient's bed is made to slope (von Trendelenburg position) the cushion is suspended between two lower bolts. The nurse inside the chamber can see the patient's face through a window. Above the patient's head is a turning mirror in order to give the convalescent patient more contact with the outside world.

chamber costs the patient only two to three respirations. The nurse experiences no discomfort at all from the alternations of pressure in the chamber, the only sensation is a feeling of slight "fluttering" of the ear drums, which is decreased by swallowing, and which can be combatted if desired by cotton in the ears.

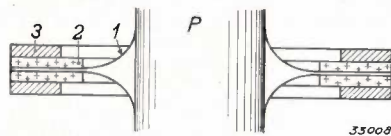

Fig. 8. Construction of the collar for sealing off the air-tight chamber around the neck of the patient. *P* neck of the patient, 1 thin rubber rings, 2 chrome leather supporting rings with slide fasteners, 3 metal rings for clamping, with which the whole arrangement is fastened so that it can be rotated in the cover of the chamber which opens to the side.

In one place a "leak" has expressly been introduced into the chamber wall, namely a small circular opening which can be more or less closed with a slide (visible in fig. 6 above the nurse's head). Fine regulation of the pressure alternations is hereby made possible, while by the successive escaping and sucking in of a small quantity of air, ventilation of the chamber is also obtained.

In order to control the working of the apparatus a signal lamp (visible on fig. 1) has been installed above the chamber, which is switched on and off in the rhythm of the respiration by a membrane moving under the influence of the pressure variations.

Through a window in the chamber (see fig. 8) the nurse can see the patient's face while she is attending to his needs in the chamber. In order to give the convalescent patient more contact with his environment, a mirror is mounted above his head,

which is fastened with a ball and socket joint in the wall of the chamber and which can be turned in all directions by the patient's hands inside the chamber.

The effect of the "iron lung" can be made directly visible by recording the patient's breathing. Fig. 9 is an example of such a record. The force of the "iron lung" is so great that it is practically impossible even for a healthy person to breath in opposition to the "iron lung" by the use of his respiratory muscles. This is clearly shown in fig. 9.

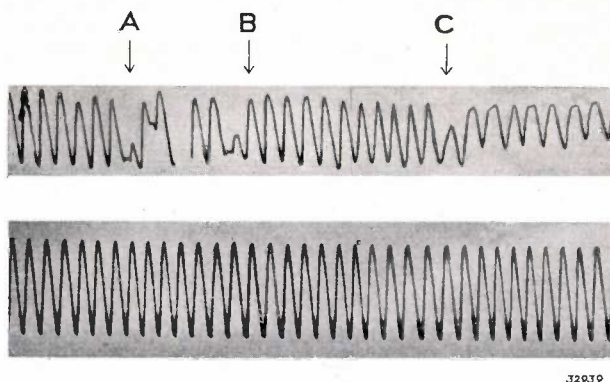

Fig. 9. Record of breathing in the "iron lung". The lower strip gives the strokes of the "iron lung", i.e. the movement back and forth of the driving rod of the bellows. On the upper strip the amount of air is registered which is sucked in and breathed out through the patient's mouth. On the left may be seen how the respiration of the "patient" (a healthy person was used for this test) takes place in the rhythm of the "iron lung". At *A* the patient tried to breathe in against the force of the "iron lung". This was found to be practically impossible: the patient can at the most hold the breath in to some extent and in this way skip a stroke of the "iron lung". Even this cannot be done for very long. At *B* the patient gives up the attempt, and gives himself up to the breathing of the "iron lung" again. At *C* the "iron lung" was stopped, and it may be seen that the patient now continues to breathe at his own slower rate and with less depth.

THE ELECTRICAL RESISTANCE OF METAL CONTACTS

by J. J. WENT.

537.311.4

The electrical resistance of contacts depends in the first instance upon the specific resistance of the material of the contacts, the hardness of the material and the contact pressure. In addition the properties of the surface of contact are also important. On the basis of these facts a study is made in this article of the methods by which a contact with a high resistance may be improved.

The interest in contact resistances is practically as old as the interest in current electricity itself. Contacts exist at numerous points in every electrotechnical apparatus, for example the contact pins of radio valves, the contact springs of switches, etc. In this article we shall discuss only permanent contacts, and shall therefore not consider such contacts as those in a relay which may be burned by sparking upon breaking the contact¹⁾.

Convergence resistance and transition resistance

When two completely clean pieces of metal are brought into contact with each other, there will be electrical contact at not more than three points when the contact pressure is extremely small. When the pressure is increased the material becomes elastically deformed and the contact points become contact surfaces, and their number may be greater than three. Upon further increase of pressure a plastic deformation is obtained in addition to the elastic one, so that the area of the surface of contact increases until the pressure per unit of surface remains constant, namely equal to the yield value of the material. Therefore for a given material a definite size of area of mutual contact follows from the force of pressure.

Fig. 1a shows a cross section of a circular surface of contact with a series of equipotential lines (dotted) and a number of current lines (full lines). The area of contact itself is considered in the first place as an equipotential surface. The other equipotential surfaces have the form of ellipsoids which approach the sphere form with increasing distance from the area of contact.

The resistance which occurs due to the concentration of the current lines in the vicinity of the area is called the convergence resistance. This convergence resistance is composed from the two parts R_A and R_B which arise in the two blocks A and B .

If ρ_A and ρ_B are the specific resistances of the contact materials, and a is the radius of the area of contact then one finds for the convergence resistance:

$$R_A = \frac{\rho_A}{4a}; R_B = \frac{\rho_B}{4a} \dots \dots (1)$$

The derivation of the above requires a rather elaborate integration. A more specialized picture of the area of contact, as given in fig. 1b, can, however, be treated very simply, and gives the same result except for a numerical factor. Let us assume that the material B projects into A , so that the surface of contact has the form of a hemisphere. Let us further assume that the specific resistance of material B is so small in comparison with that of A that it may be neglected, so that the spherical surface of contact may be considered as an equipotential surface. These two assumptions will have a merely minor influence on the convergence resistance in material A .

In order to calculate the resistance of this model we must know the course of the current lines. Because of the symmetry of the model these lines have a very simple course; they

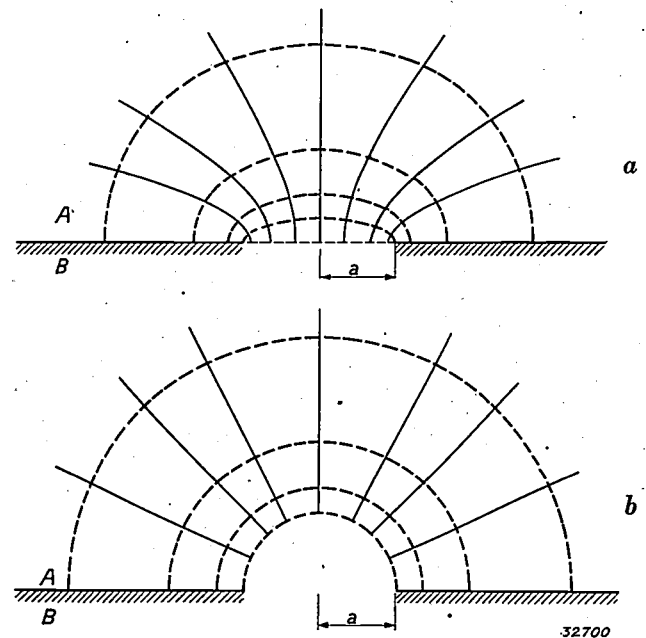

Fig. 1. a) Cross section through a contact of two metal blocks A and B which touch each other over a circular area with radius a . Dotted lines, equipotential surfaces; full lines, current lines.
b) Cross section through a contact of two blocks which touch each other over a hemispherical surface which is assumed to be an equipotential surface. The course of the current lines and equipotential lines in A is now much simpler.

¹⁾ A large amount of data on contact resistances will be found in the literature spread over many years. A very complete investigation, in which general theoretical considerations on contact resistances are also given, will be found in an article by R. Holm, *Wiss. Ver. Siemens Konz.* 7, 217, 1929. This article also includes an extensive review of the literature.

radiate as straight lines from the centre of the spherical surface. The equipotential surfaces are perpendicular to the current lines and will therefore also be hemispheres concentric with the hemisphere of the surface of contact. The resistance between two of these equipotential surfaces with radii r and $r + dr$ is:

$$dR = \rho_A \frac{dr}{2\pi r^2} \dots \dots \dots (2)$$

The part of the convergence resistance in material A is obtained by integrating dR between the limits $r = a$ and $r = \infty$, as follows:

$$R_A = \rho_A \int_a^\infty \frac{dr}{2\pi r^2} = \frac{\rho_A}{2\pi a}$$

This result agrees with equation (1) except that the factor π must be replaced by 2.

As has already been explained above, the area of contact depends upon the force of pressure and on the mechanical properties of the material. If one assumes that the softer of the two contact materials, in as far as it makes contact, would also be loaded up to its yield value f , and that the contact takes place over a circular area with a radius a then the total force of pressure

$$F = f \cdot \pi a^2.$$

When a is determined and substituted in equation (1), one finds for the convergence resistance (the sum of R_A and R_B):

$$R_u = \frac{\rho_A + \rho_B}{4} \sqrt{\frac{f\pi}{F}} \dots \dots \dots (3)$$

The yield value f is a material constant which is not easily determined and it is therefore better to use the easily measured hardness instead. The latter quantity is defined as the quotient of the force of pressure and the area of surface depressed when a hard steel ball or a diamond of a special shape is pressed into the material. If one neglects hardening by cold working and possible elastic deformation, hardness and yield value are equivalent ²⁾.

From equation (1) it follows that it is a matter of importance whether at a given pressure a single surface of contact is obtained or a number of small surfaces which together possess just as great an area as the single surface. If for example the surface of contact is divided into n equal surfaces, the

total resistance is the n^{th} part of the resistance of each of the smaller surfaces of contact. Since the resistance of a single surface of contact is inversely proportional to the radius (not to the area), the resistance of each of the small surfaces is only \sqrt{n} times as great as the original resistance. The total resistance has therefore been reduced by a factor \sqrt{n} . Our considerations therefore give a maximum value of the convergence resistance. This will, however, be quickly reached with increasing pressure since the different surfaces of contact flow together to give a single surface of contact.

In addition to the convergence resistance there is in general also a transition resistance R_0 at the surface of contact. With poorly cleaned contacts this transition resistance may completely dominate the convergence resistance, but even with well cleaned contacts there is still an R_0 , which will indeed be low at room temperature generally, but which can only be removed by very long heating in a vacuum ³⁾.

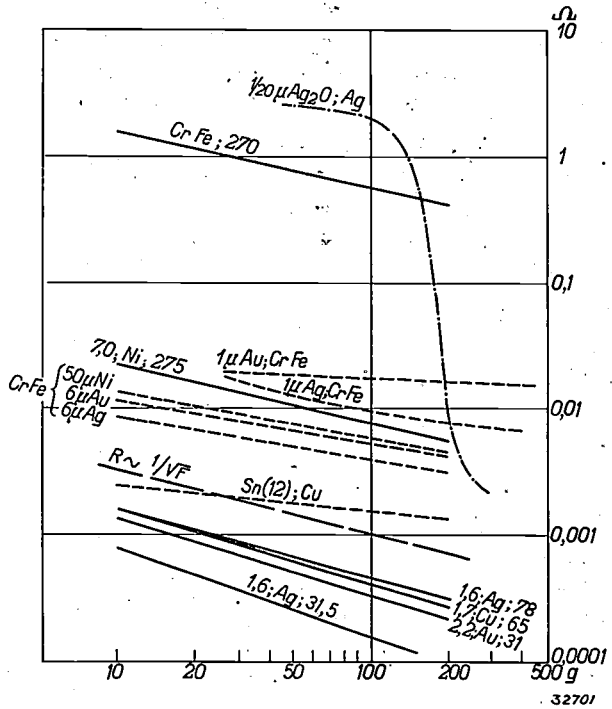

Fig. 2. Relation between contact pressure and contact resistance. Full lines, pure metals; dotted lines, metals with covering layers of another metal; dot-dash lines, silver covered with silver oxide. The number given after the symbol for the metal indicates its hardness in Vickers units; the number in front of the symbol gives the specific resistance in μ ohms cm. The heavy broken line gives the slope which is to be expected according to equation (3).

²⁾ On the measurement of hardness see Philips techn. Rev. 2, 177, 1937. An exact numerical correlation between hardness and yield value cannot be attained because the material is loaded in a somewhat different way in hardness measurements and in the direct determination of a yield value. It may, however, be expected that by using the hardness instead of f , the truth will be more nearly approached than by use of the yield value, since the loading of a point of contact closely resembles the loading applied in the measurement of hardness.

Let us for the moment assume that R_0 may be neglected in comparison with R_u . Then all the requirements for a good contact may be deduced

³⁾ R. Holm and W. Meissner, Z. Phys. 74, 715, 1932.

from equation (3). A material must be chosen with low specific resistance and slight hardness, while the construction of the contact must allow the use of high contact pressures (100 to 300 g for example).

In *fig. 2* several measurements on such contacts are given (full lines). The same kind of material was chosen for the two parts of the contacts. The measured contact resistance and the pressure are plotted logarithmically against each other. According to equation (3) the results must be straight lines with a slope of $-1/2$, which is actually found to be approximately true. It may furthermore be seen from the figure that not only the specific resistance but also the hardness of the contact materials has the expected influence on the contact resistance. For instance the line for hard silver lies above that for soft silver, while copper, which is somewhat softer than hard silver but a poorer conductor, coincides with hard silver. Gold which is soft is somewhat less satisfactory than soft silver, etc.

Covering layers of soft materials with high conductivity

If for some reason it is necessary to use as contact material a material having great hardness and high specific resistance, as for instance for the pins of the all glass radio valves⁴⁾ where chrome-iron is desirable for the fusing in, such a contact can easily be improved by covering it with a thin layer of a more suitable material.

The thickness of such covering layers must be chosen so great that the greatest part of the convergence resistance is found in this layer with its low specific resistance, *i.e.* covering layers must be made which have a thickness of at least the radius of the surface of contact⁵⁾. This is usually 10 to 50 microns.

In *fig. 2* a number of examples of this sort may be seen (dotted lines). Gold and silver layers of 1 and 6 μ on chrome-iron were actually found to decrease the contact resistance very considerably, and silver, due to its low specific resistance gives somewhat better values than gold. These layers, however, are not thick enough to attain the values for pure silver and gold; the convergence resistance not only extends to greater thickness than 6 μ , but the mechanical properties of the material beneath also play a part at these thicknesses. With a nickel layer of 50 μ the influence of the layer below entirely disappears; contact resistances are even found

in this case lower than those of pure nickel, due to the fact that the pure nickel in these experiments was harder than the annealed covering layer of nickel on chrome-iron. A thick layer of tin (tinned copper) is also a fairly good contact material, due to the unusual softness of tin and in spite of its fairly high specific resistance.

There is still another reason why soft materials are preferable to hard for contacts. In addition to a low contact resistance a satisfactorily constant resistance is also desired, and thus constancy must be proof against vibrations, mechanical shocks, etc. Softer materials with greater surfaces of contact for the same contact pressure are also at an advantage in this connection.

Heating of the contacts

In general the contacts will be given dimensions such that no difficulties arise from Joule heat which is developed in the surface of contact due to the convergence resistance. If, however, such difficulties should arise, then it can be deduced from equation (1) what will be the results. Upon increase of temperature the specific resistance increases, while the hardness decreases and any hardening process is reversed. It depends entirely upon the circumstances as to which of the two effects will dominate.

Fig. 3 shows for the case of chrome-iron what may happen when the current is increased and the pressure on the contact kept constant. Taking the case of a load of 20 g, the contact resistance is

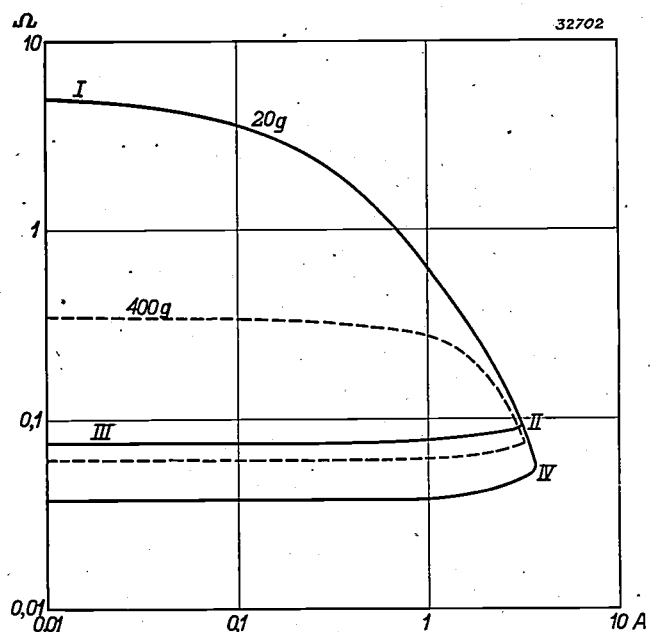

Fig. 3. Variation of the contact resistance as a function of the current at constant contact pressure of 20 g to 400 g for chrome-iron as contact material.

⁴⁾ See Philips techn. Rev. 4, 162, 1939.

⁵⁾ If equation (2) is integrated between the limits a and $2a$ the result is exactly one half the convergence resistance.

fairly high and much heat will therefore be developed. As a consequence the contact resistance begins to decrease at low currents already (*I* to *II*); in this case therefore the decrease in hardness dominates over the increase in the specific resistance. If beginning at *II* the current is again allowed to decrease, a curve is found which is determined solely by the temperature coefficient of the specific resistance (*II* to *III*), and which is therefore also reversible (*III* to *II*). Between *I* and *II*, therefore, practically the only change is a plastic deformation which remains upon fall in temperature. If the current is increased from *II*, the contact resistance decreases further (*II* to *IV*) and one finally reaches the melting point of the contact material where the phenomenon becomes that encountered in spot welding.

Oxidized contacts

Until now we have spoken only of clean contacts upon which there have been no oxide films. If there is such an oxide film the transition resistance R_0 may become much greater than the convergence resistance, so that the total contact resistance reaches quite a different order of magnitude. The results are not, however, always as bad as

might be expected. One must not of course attempt to construct contacts of strongly oxidizing materials such as aluminium or lead, but an oxide film on silver does not at all prevent the attainment of a good contact. This is shown by the following experiment (see the dot-dash line in fig. 2). A silver contact is covered with a layer of silver oxide which is made thicker than can generally be expected in practical cases. With low pressures a contact resistance is found which is about 10^4 times as high as that of pure silver, but with a contact pressure of 100 to 200 g this resistance rapidly decreases. The opposite contact appears to break through the oxide layer at a number of points and one therefore obtains local contact of more or less pure metals. Although only a few per cent of the surface now makes metallic contact, quite a low value of the resistance is already reached.

It has long been known that a contact resistance can be made smaller by lubricating the contact with paraffin or oil. The most surprising results are obtained in the case of dirty or oxidized contacts because the action of the oil is based entirely on the cleaning and the keeping clean of the surfaces of contact; a perfectly clean contact is not improved by oiling.

ABSTRACTS OF RECENT SCIENTIFIC PUBLICATIONS OF THE N.V. PHILIPS' GLOEILAMPENFABRIEKEN

1420: A. H. W. Aten jun., C. J. Bakker and F. A. Heyn: Transmutation of thorium by neutrons. (*Nature*, London, 1436, 679, April, 1939).

Continuing the experiments referred to in Abstract No. 1410 on the production of radio-active rare gases on the disintegration of uranium nuclei by slow neutrons, a parallel investigation has been carried out with thorium, the results of which are dealt with in this paper. To obtain higher activities, the active gases are now passed over absorbent carbon instead of through water. The nature and half-life periods of the radio-active products produced from the active gases are comparable to those found with uranium. The same disintegration schemes, already given in Abstract No. 1410 for uranium, also hold for thorium.

1421: A. Bouwers and W. J. Oosterkamp: Recent Metalix tube developments. (*Amer. J. Roentgenol. Radium Ther.*, 41, March, 1939).

In this lecture the latest advances in the design of X-ray tubes are discussed, with special reference to a tube in which a new anode-cooling system is employed. In this tube, cooling is effected by radiation towards the middle of the tube; in tubes for diagnostic purposes which are always operated for short periods only, further cooling is effected by air convection, while in tubes used for therapeutic purposes which must be capable of running for long periods without interruption secondary cooling is provided by a current of water. For further details, reference should be made to several articles which have already appeared in this Review: The "Rotalix", *Phil. techn. Rev.*, 3, 292, 1938; A million-volt X-ray tube, *Phil. techn. Rev.*, 4, 153, June, 1939; X-ray tube for the analysis of crystal structure, *Phil. techn. Rev.*, 3, 259, 1938.

1422: S. Kaplan: Break-in telephony with carrier suppression (*Q.S.T. Amer.*, 23, 36-39, February, 1939).

fairly high and much heat will therefore be developed. As a consequence the contact resistance begins to decrease at low currents already (*I* to *II*); in this case therefore the decrease in hardness dominates over the increase in the specific resistance. If beginning at *II* the current is again allowed to decrease, a curve is found which is determined solely by the temperature coefficient of the specific resistance (*II* to *III*), and which is therefore also reversible (*III* to *II*). Between *I* and *II*, therefore, practically the only change is a plastic deformation which remains upon fall in temperature. If the current is increased from *II*, the contact resistance decreases further (*II* to *IV*) and one finally reaches the melting point of the contact material where the phenomenon becomes that encountered in spot welding.

Oxidized contacts

Until now we have spoken only of clean contacts upon which there have been no oxide films. If there is such an oxide film the transition resistance R_0 may become much greater than the convergence resistance, so that the total contact resistance reaches quite a different order of magnitude. The results are not, however, always as bad as

might be expected. One must not of course attempt to construct contacts of strongly oxidizing materials such as aluminium or lead, but an oxide film on silver does not at all prevent the attainment of a good contact. This is shown by the following experiment (see the dot-dash line in fig. 2). A silver contact is covered with a layer of silver oxide which is made thicker than can generally be expected in practical cases. With low pressures a contact resistance is found which is about 10^4 times as high as that of pure silver, but with a contact pressure of 100 to 200 g this resistance rapidly decreases. The opposite contact appears to break through the oxide layer at a number of points and one therefore obtains local contact of more or less pure metals. Although only a few per cent of the surface now makes metallic contact, quite a low value of the resistance is already reached.

It has long been known that a contact resistance can be made smaller by lubricating the contact with paraffin or oil. The most surprising results are obtained in the case of dirty or oxidized contacts because the action of the oil is based entirely on the cleaning and the keeping clean of the surfaces of contact; a perfectly clean contact is not improved by oiling.

ABSTRACTS OF RECENT SCIENTIFIC PUBLICATIONS OF THE N.V. PHILIPS' GLOEILAMPENFABRIEKEN

1420: A. H. W. Aten jun., C. J. Bakker and F. A. Heyn: Transmutation of thorium by neutrons. (*Nature*, London, 1436, 679, April, 1939).

Continuing the experiments referred to in Abstract No. 1410 on the production of radio-active rare gases on the disintegration of uranium nuclei by slow neutrons, a parallel investigation has been carried out with thorium, the results of which are dealt with in this paper. To obtain higher activities, the active gases are now passed over absorbent carbon instead of through water. The nature and half-life periods of the radio-active products produced from the active gases are comparable to those found with uranium. The same disintegration schemes, already given in Abstract No. 1410 for uranium, also hold for thorium.

1421: A. Bouwers and W. J. Oosterkamp: Recent Metalix tube developments. (*Amer. J. Roentgenol. Radium Ther.*, 41, March, 1939).

In this lecture the latest advances in the design of X-ray tubes are discussed, with special reference to a tube in which a new anode-cooling system is employed. In this tube, cooling is effected by radiation towards the middle of the tube; in tubes for diagnostic purposes which are always operated for short periods only, further cooling is effected by air convection, while in tubes used for therapeutic purposes which must be capable of running for long periods without interruption secondary cooling is provided by a current of water. For further details, reference should be made to several articles which have already appeared in this Review: The "Rotalix", *Phil. techn. Rev.*, 3, 292, 1938; A million-volt X-ray tube, *Phil. techn. Rev.*, 4, 153, June, 1939; X-ray tube for the analysis of crystal structure, *Phil. techn. Rev.*, 3, 259, 1938.

1422: S. Kaplan: Break-in telephony with carrier suppression (*Q.S.T. Amer.*, 23, 36-39, February, 1939).

A circuit containing thermionic valves is described permitting instantaneous duplex operation between two radio transmitters operating on the same carrier wave. On beginning to speak, the transmitter is automatically set in operation and the receiver switched off. A short interval in speech cuts out the transmitter and at the same time put the receiver back into service again. The system employs low-power stages, no relays being used.

1423: J. van Niekerk en H. Hofstra: De invloed van dierlijk vitamine-D bij koeien op de anti-rachitische werkzaamheid van de melk (T. Diergeneesk., 66, 454-459, May, 1939).

Six cows received daily provitamin D of animal origin irradiated with 3 200 international units per litre of milk yield. During the fourth and fifth weeks of this diet, experiments with young rachitic rats indicated that the milk contained an average of 84 international units of antirachitic vitamin per litre. During the sixth and seventh weeks, the average vitamin content was 63 international units per litre, while ordinary milk in this area and at this season of the year contained about 20 international units per litre. On the average, therefore, 1.7 per cent of the vitamin D fed to the cows reappeared in the milk. A diet of irradiated provitamin D of animal origin is hence much more effective for increasing the vitamin-D content of the milk produced, than with irradiated ergosterin according to the literature and has roughly the same effect as with a diet of irradiated yeast.

1424: J. F. Schouten: Het mechanisme van het zien in verband met het vraagstuk der verblindings (De Auto, 36, 750-752, May, 1939).

The principal causes of glare are discussed in this paper; viz., that the eye is not a perfect camera but disperses light which results in glare, and that the sensitivity of the retina varies very considerably with the intensity of illumination falling on it, resulting in physiological or adaptative glare.

1425: W. de Groot: Luminescence decay and related phenomena (Physica, 6, 275-290, March, 1939).

The variation of the photo-luminescence of zinc sulphides (e.g. ZnS-Cu) with time on periodical illumination for intervals of 5 milliseconds, is investigated with the aid of a secondary electron multiplier and a cathode-ray tube. The light source consisted of a mercury-vapour capillary lamp fitted with a monochromator, and the ultra-violet radiation

intensity obtained was about 0.5 watt per sq. cm. A bimolecular mechanism of luminescence in conjunction with metastable states is discussed. In conclusion, some observations concerning uranium glass are described.

1426: W. de Groot: Saturation effects in the short-duration photo-luminescence of zinc-sulphide phosphors (Physica, 6, 393-400, May, 1939).

The intensity of the fluorescent light of several sulphide phosphors (ZnS-Cu, ZnS-Ag, ZnS/CdS-Ag and ZnS-MnS) was measured as a function of the intensity of the energising ultra-violet light. It was found that with the same total energy, the fluorescent light emitted by these substances is 5 to 10 per cent lower for a radiation energy of approximately 5 watts per sq. cm. than with a radiation density 100 times smaller. This phenomenon is not observed with uranium glass, crystals of potassium uranyl sulphate and fluorescein solution.

1427: M. J. O. Strutt: High frequency mixing and detection stages of television receivers (Wireless Eng., 16, 174-187, April, 1939).

For details of this article, see Abstract No. 1405.

1427A: L. W. M. Roodenburg: Vervroeging van de bloei bij Kalanchoe Blossfeldiana (Kon. Ned. Mij. Tuinb. Plantk., 13, 145-148, 153-155 and 162-164, May, 1939).

If from the middle of August, the daily exposure to daylight of a Kalanchoe is reduced to 10 hrs. for several weeks, these pot-plants which normally only blossom during the latter half of the winter will already be in full bloom about Christmas.

1428: F. Prakke, J. L. H. Jonker and M. J. O. Strutt: A new "All glass" valve construction (Wirel. Eng. 16, 224, May 1939).

For the contents of this article refer to Philips techn. Rev. 4, 162, June 1939.

In September 1939 appeared:

Philips Transmitting News 6, No. 2:

K. Posthumus and Tj. Douma: Frequency Stability.

Shortwave telegraphy transmitter KVC 1,5/14.

W. Albricht: Pentodes on short wavelengths.

Philips Technical Review

DEALING WITH TECHNICAL PROBLEMS
RELATING TO THE PRODUCTS, PROCESSES AND INVESTIGATIONS OF
N.V. PHILIPS' GLOEILAMPENFABRIEKEN

EDITED BY THE RESEARCH LABORATORY OF N.V. PHILIPS' GLOEILAMPENFABRIEKEN, EINDHOVEN, HOLLAND

TUBULAR LUMINESCENCE LAMPS

by P. SCHOUWSTRA and G. ZECHER.

By the application of luminescent substances a satisfactorily efficient light source (30 lm/W including losses) has been developed from the low-pressure mercury discharge, which by itself has a low light yield. Distinctive of this light source, whose development and properties are discussed in this article, is the linear form and the low brightness, which makes it specially suitable for decorative illumination. As an example of its use, a circuit is described in which nine lamps with a total length of 18 m are connected in series with a high-tension transformer. Lamps working on low tension will be discussed later. The lamps are made in two types, one of which gives a light which may be compared with electric light while the other more nearly approaches daylight.

The column discharge in mercury lamps at low pressure has long been used in the familiar blue tubular lamps for advertising. At the very low mercury pressure prevailing in these tubes (less than 0.01 mm) the radiation emitted consists chiefly of the ultraviolet resonance line 2537 Å, while the spectral lines in the visible region are only relatively weakly developed. The fact that as a result of this the efficiency of the tubes is low, was of no importance in their use for advertising purposes, since it was not a question of illumination, but of the attraction formed by the striking colour and the possibility of giving the lamp any desired shape.

In a previous article it was explained¹⁾ how it is possible with the help of luminescent substances, such as certain silicates, tungstates and borates, to convert the ultraviolet radiation into a broad continuous band in the visible region of the spectrum. By this method the light yield of the low-pressure mercury discharge can be so much improved that a light source is obtained which is also useful for purposes of illumination. We shall describe the luminescence lamps which have been developed on these lines.

Design and construction

The luminescent substances used in these lamps

are caused to fluoresce particularly by radiation in the spectral region of the above-mentioned mercury line 2537 Å. The mercury pressure must therefore be chosen such that this line is emitted in maximum intensity, and it is found that the desired optimum mercury pressure is obtained in saturated mercury vapour at about 40° C. A possible method of realizing the desired mercury pressure would be to provide for the presence of a coldest spot in the lamp having the temperature mentioned. In the case of the column discharge, which is particularly favourable for the excitation of the resonance line, and which is naturally of a linear form, it may not immediately be assumed that the coldest spot in the lamp determines the mercury pressure. Due to the adsorption on the large internal surface of the luminescent powder, the velocity of diffusion of the mercury through the column is very low. Care must therefore be taken, by giving the lamp suitable dimensions, that not one spot only, but the entire wall of the column has the desired low temperature of 40° C.

The improvement in efficiency compared with the older advertising tubes is by itself not yet enough to give an economical source of light: a certain minimum light flux per lamp is also necessary, so that the number of sources of light for a given total light flux may not be too great. The current and thus the power consumed are therefore increased as compared with the advertising tubes which give little light (60 lm/m).

¹⁾ W. Uytterhoeven and G. Zecher, Low pressure mercury discharge with luminescent tube wall, Philips techn. Rev. 3, 272, 1938.

In connection with the required relatively low wall temperature, the greater power makes it necessary to take measures for the satisfactory dissipation of heat by the walls, which means that the heat dissipating surface must be sufficiently large. An attempt might be made to achieve this purpose by increasing the diameter; objections from the point of view of glass technology are however soon encountered, and moreover the working voltage falls, which is undesirable in connection with the adaptation to the given mains voltage. The necessary surface area must therefore be obtained by increasing the length of the column. In this way one again arrives at the solution of making the lamps very long, although for different reasons than in the case of the advertising lamps. Such long tubular sources of light are already well-known to the interior decorator, and are often used for ornamental illumination. Since in the first instance this type of application was considered for the luminescence lamps, and since in this case a low brightness of the light source is in general desired, they were constructed to have a low brightness. This condition results in the limitation of the current (see above). The brightness obtained amounts to 0.3 c.p./sq.cm with a current of 250 mA (In the advertising tubes the current is only 50 mA).

The ordinary type of these lamps is of the shape shown in *fig. 1*. This lamp is 2 m long and 35 mm in diameter. The very finely divided fluorescent powder mixed with a binder is deposited in a very uniform continuous layer on the inner surface of the tube, so that the appearance is that of a milk glass tube. The electrodes for the current are in this case introduced into side tubes so that when several tubes are used (see below) long continuous lines can be formed.



Fig. 1. The luminescence lamp type HTL 200 is 2 m long and has a diameter of 35 mm. The electrodes are in side tubes.

One of the important details in the construction of the tube is the type of cathode. In the older advertising tubes the cathode was a metal cylinder upon which a glow occurred upon discharge. Directly in front of the cathode there occurs a potential jump, the cathode drop²⁾, which, due to the ion bombardment involved, may have unfavourable results on the life of the lamp, especially

²⁾ See in this connection M. J. Druyvesteyn and J. G. W. Mulder, *Physical principles of gas-filled hot-cathode rectifiers*, Philips techn. Rev. 2, 122, 1937.

in the region of the so-called anomalous cathode drop. This may be avoided by limiting the current density, *i.e.* by giving the cathode a large surface, and by adding to the mercury vapour a rare gas with a pressure of about 1 cm. Both of these measures are employed in the advertising tubes, but they are not very suitable for the new source of light. The first would lead to awkwardly large dimensions of the cathode, since the current in these tubes is so much higher than in the old ones; the second has an unfavourable effect on the development of the resonance line of the mercury.

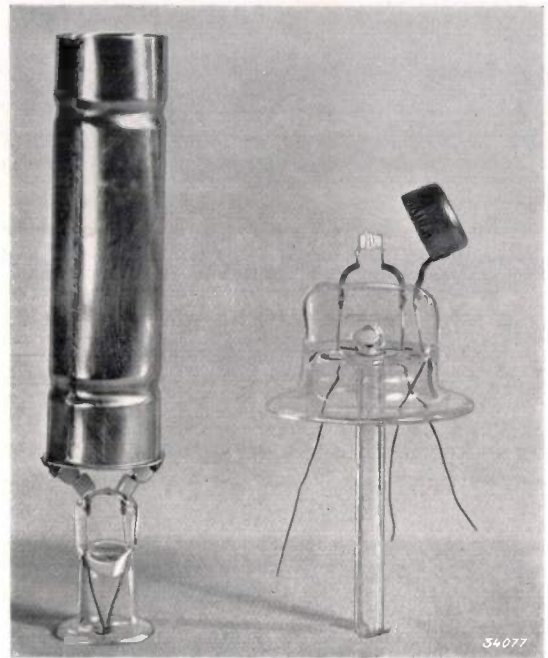

Fig. 2. Cathode of a tube for illuminated advertising signs (left) and that of the HTL 200 lamps. The cap surrounding the spiral has been bent slightly to one side in order to take the photograph.

In the luminescence lamps therefore a cathode is used in the form of a spiral covered with barium oxide, which is heated by the ion bombardment in the cathode drop and caused to emit electrons, so that the cathode drop decreases considerably. In this way the cathode may be kept small (see *fig. 2*), and the pressure of the rare gas filling can be chosen considerably lower.

Application of the lamps connected in series

Since such linear sources of light as already pointed out, are particularly suitable for illuminations where an ornamental effect is desired, the luminescence lamps are especially useful in halls, restaurants, shops, etc. Their use in such cases generally means that a number of tubes are used simultaneously, for instance to form long luminous

lines (see *fig. 3*). For such installations connection of the lamps in series may be used. The low pressure mercury discharge, like all other gas discharge lamps, requires an auxiliary apparatus to limit the current when connected with the mains. If a number of lamps are connected in series only one auxiliary apparatus is needed for all the lamps. For the use mentioned therefore a high-tension transformer (leakage transformer) has been designed, the secondary of which gives a no load voltage of 6 000 volts. The middle point of the winding is earthed, so that the maximum voltage with respect to earth is 3 000 volts. Nine lamps with a total

Since each 2 m lamp gives a light flux of 2 000 lm, the yield upon full use of the transformer is 30 lm/W. For the sake of comparison it may be recalled that the yield of an electric lamp of 2 000 lm is about 13.5 lm/W. With less than 18 m of lamps connected the efficiency is lower. For small installations and for only a single lamp some other solution is therefore to be recommended, and this problem will be discussed shortly in this periodical.

Properties of the source of light

Colour of the light

The use of fluorescent substances provides not



Fig. 3. Installation of a series of luminescence lamps in a shop.

length of 18 m may be connected in series with this transformer. The ignition of these discharges requires no special measures since the necessary ignition voltage under the most unfavourable circumstances (low temperature of the surroundings) can only increase to 600 volts per lamp at the most. The working voltage is 260 volts per lamp.

Fewer than nine lamps can also be connected with the transformer. A number of taps on the primary have been introduced for this purpose, and the discharge current is also in this way kept within the required limits. The total consumption of an installation with 18 m of lamps and with a lamp current of 250 mA is 600 W, *i.e.* 33.5 W per meter.

only an increase in the yield of light, but it also permits control of the colour of the light obtained. The great diversity in the emission spectra of fluorescent substances — the fluorescence light of cadmium silicates and borates for example is rose, that of zinc beryllium silicates yellow to rose, of zinc silicate green, of magnesium tungstate blue, etc., — and the possibility of depositing a mixture of the powders of these substances in any desired proportions on the inner wall of the tube make it possible to obtain a much greater variation of colours than with any other known source of light. "White" light can for instance be obtained without it being necessary to destroy

some spectral part of the effective light flux by means of absorption filters. Of the numerous tints which can be realized between "cold" daylight, rich in blue, and the "warm" yellow or red of living-room lamps, two kinds of light have been chosen for the present: a yellowish white light which resembles the light of electric lamps, and a light which resembles daylight.

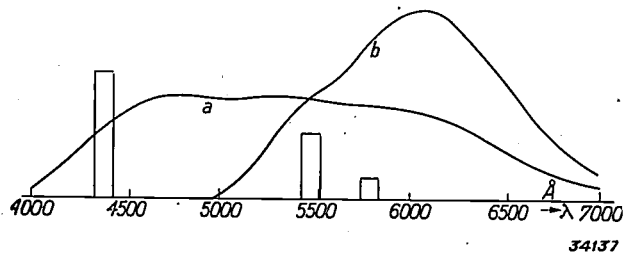

Fig. 4. Spectral distribution of energy in the two types of HTL lamps. The width of the lines of the mercury spectrum is arbitrary. Their surface indicates the energy. a) Daylight lamp. b) Yellowish white lamp.

In *fig. 4* the spectral energy distribution is shown for the two kinds of lamps. *Fig. 5* shows the light distribution curves which result from the curves of *fig. 4* by the multiplication of each ordinate by the eye sensitivity corresponding to that wave length. In both figures the contribution of the fluorescence spectrum and of the mercury lines is drawn separately. (The absolute contribution of the mercury lines is about the same for both lamps.) The light of the mercury lines represents only about 10 per cent of the total light. In order to be able to judge the colour the light distribution found upon applying the block division of the spectrum, which has repeatedly been used and explained in this periodical³⁾, is given in the table below.

One advantage of the luminescence lamps is the lack of any disturbing flicker. While the older advertising tubes, which have already been mentioned for comparison, are entirely extinguished and reignited in the rhythm of the alternating current used for supply, the period of the extinction of the discharge is adequately bridged over

³⁾ On the method of measurement and application see P. M. van Alphen, A photometer for the investigation of the colour rendering reproduction of various light sources, Philips techn. Rev. 4, 66, 1939.

by the fluorescence of the luminescent powders in the luminescence lamps. Flicker in these lamps is hardly more noticeable than in the case of an ordinary electric lamp (see also the article cited in footnote¹⁾).

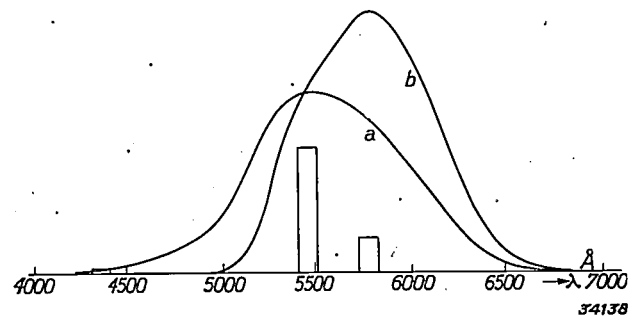

Fig. 5. Spectral distribution of the light of the two types of lamps HTL 200. a) Daylight lamp. b) Yellowish white lamp.

Sensitivity to change in working conditions

As already mentioned, for the most efficient excitation of the resonance line 2 537 Å of mercury a temperature of the glass wall of about 40 °C is desired. If this temperature changes, the intensity of the line mentioned varies according to the curve given in *fig. 6*. It may be seen that a fluctuation of the temperature of the glass wall by 10 or 20° already causes considerable decrease in the intensity of the resonance line, and consequently in the light yield. The lamp has been so constructed that with a temperature of the surroundings of 20 °C the glass wall assumes a temperature of 40 °C. Upon a change in the temperature of the surroundings however,

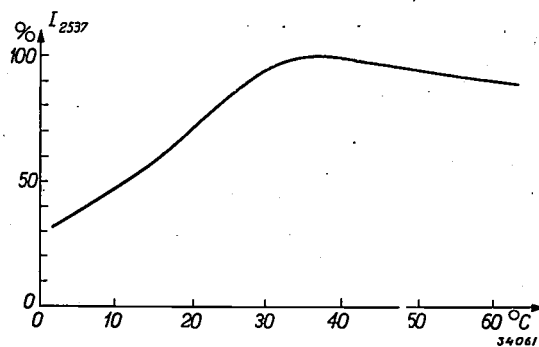

Fig. 6. Emission of the mercury line 2 537 Å in the HTL 200 lamp as a function of the temperature of the glass wall. For these measurements the lamp was placed in a thermostat; the emission was observed through an opening in the luminescent layer. The optimum emission (assumed to be equal to 100 per cent) occurs at about 40 °C.

Block (boundaries in Å)	4 000	1	4 200	2	4 400	3	4 600	4	5 100	5	5 600	6	6 100	7	6 600	8	7 200
Daylight		0.025		0.26		0.91		11.1		40.8		36.2		9.9		0.73	
HTL daylight		0.015		0.30		0.65		9.4		4.70		33.0		7.6		2.03	
Electric lamp		0.005		0.058		0.25		5.4		33.5		42.7		16.6		1.54	
HTL yellowish white		0.003		0.15		0.05		0.46		33.0		50.6		15.2		0.58	

the temperature of the glass wall varies to a much smaller degree, as shown in *fig. 7*. In this figure the light delivered by the lamp is plotted as a function of the temperature of the surroundings. When the latter has fallen to 5 °C the light yield is still 80 per cent of its normal value. The curve is valid for the case where the heat dissipation takes place only by radiation and conduction. If convection

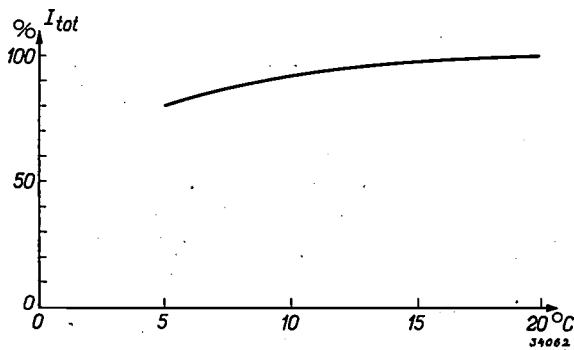

Fig. 7. Light intensity of HTL 200 as a function of the temperature of the surroundings recorded indoors. The temperature of the glass wall varies much less than that of the surroundings as long as no heat is dissipated by convection.

is also active, due for instance to the lamp being exposed to the wind, the temperature of the glass wall then follows the fluctuations of the temperature of the surroundings much more closely, and the light flux may fall sharply. This is the reason why luminescence lamps are intended chiefly for indoor use alone.

Immediately after ignition the mercury pressure is lower than the optimum value. From *fig. 6* it may be deduced that at this moment, with a wall temperature of about 18 °C, the light flux is about 60 per cent of the maximum value. After 1/2 minute it has already reached 90 per cent, while the final value is reached in about 3 minutes.

One important advantage of the luminescence lamps compared to the ordinary electric lamp is its slight sensitivity to fluctuations in the mains voltage. *Fig. 8* shows the variation of the different properties with the mains voltage. With increased mains voltage the lamp current rises, the working voltage however falls, so that the power consumed increases only relatively little. The yield is practically constant in the normal range, so that the light flux also varies only slightly: increase or decrease of the mains voltage by 10 per cent causes an increase or decrease, respectively, of the light flux also by 10 per cent. In the case of the ordinary electric lamp the corresponding fluctua-

tions of the light flux would be about 40 per cent.

Such fluctuations in the voltage have no effect on the life of the lamps, contrary to the case of ordinary electric lamps. The life of the lamp is limited only by the two following phenomena. In the first place the emitting layer of the cathode is consumed. Repeated switching on and off has a particularly unfavourable effect in this respect.

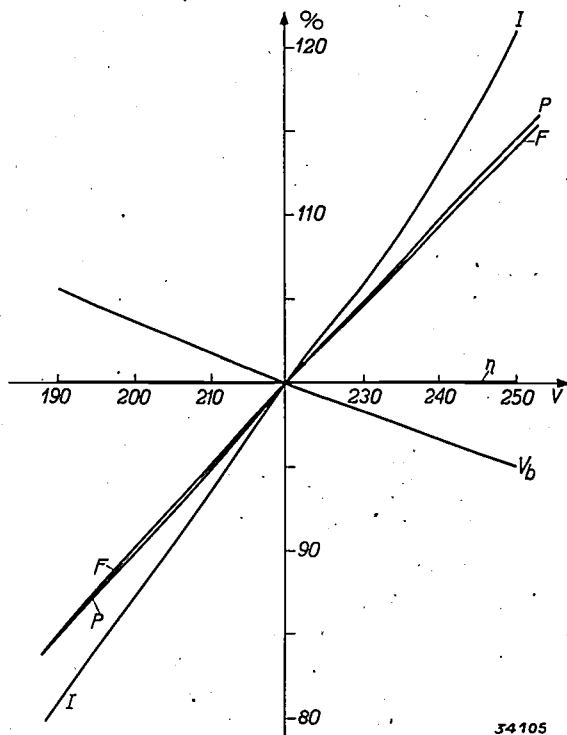

Fig. 8. Relative change of lamp current *I*, working voltage *V_b*, power consumed *P*, efficiency η and light flux *F* as a function of the mains voltage (normal 220 volts).

As far as the electrodes are concerned a life of 2 000 hours may be counted on with a normal amount of switching on and off. During this time however a certain decrease in the light flux takes place due to blackening similar to that observed in electric lamps. In the luminescence lamps this blackening is due to the deposition of mercury ions from the discharge on the fluorescent layer which covers the inner wall of the tube. The mercury deposit absorbs part of the ultraviolet radiation which excites the fluorescence and thus causes a loss of light. The process of blackening which takes place more rapidly at the beginning, and which is therefore largely completed after the customary testing of the lamps, depends upon the nature of the fluorescent powder. In the case of the lamps for daylight colour blackening is lowest.

TELEVISION RECEIVERS

621.397.62

The previously described television receiver has been improved and simplified by the use of components of a new type, among which are amplifier valves with secondary emission, relay valves and cathode ray tubes with magnetic deflection. The most important details of the new type of receiver are here described.

About two years ago a television receiver was described in this periodical¹⁾ which was designed for reception of the programmes transmitted by the B.B.C. in London. The development of this apparatus has been continued, and it has been found possible to simplify the circuit considerably by the use of components of an improved type, and to make the apparatus suitable for series manufacture.

The new television receivers which will be described in the following are tuned to the London transmitter (carrier wave of the picture 45 megacycles, carrier wave of the sound 41.5 megacycles) or to the Paris transmitter (carrier wave of picture 46 megacycles, of sound 42 megacycles). Both of these transmitters use interlaced scanning. The picture transmitted by the London station has 405 lines, that of the Paris transmitter 455 lines.

¹⁾ Philips techn. Rev. 2, 33, 1937.

The television signal

The television receiver must amplify and rectify the incoming signal, and break it up into four parts: the picture signal, the sound signal, the picture synchronization signal and the line synchronization signal. The picture signal is fed to the control electrode of a cathode ray tube, the sound signal goes to a loud speaker, the synchronization signals serve to synchronize two saw tooth wave generators which provide the currents necessary for the horizontal and vertical deflection of the electron beam to scan the whole surface of the screen.

We shall first examine the way in which the different signals are dealt with in the modulation of the television transmitter. We need only consider the picture voltage, since the sound is modulated in the ordinary way on a separate carrier.

In *fig. 1* the modulation is given of the picture signal of the London transmitter. The ordinate

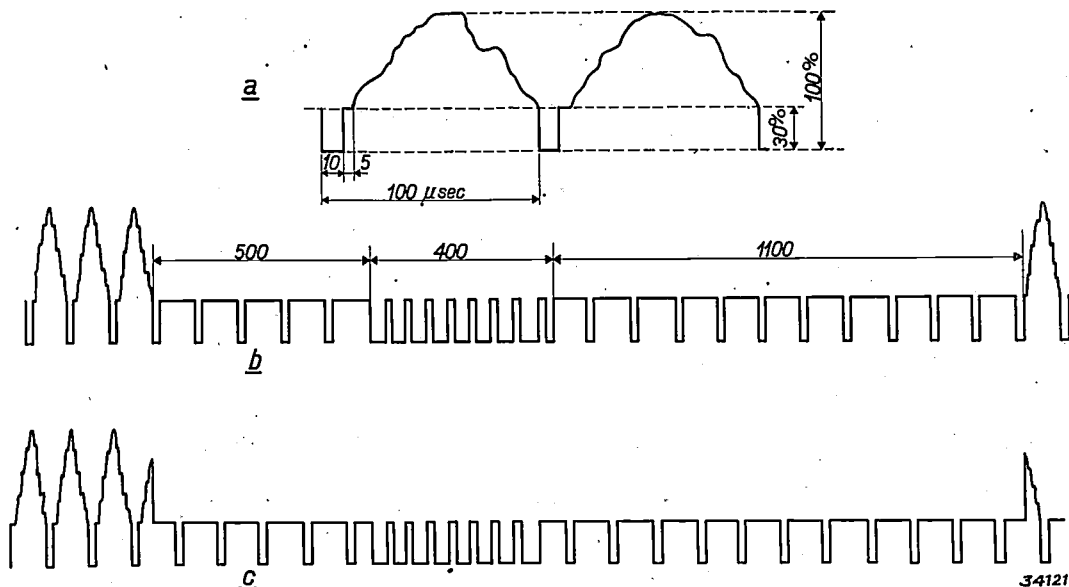

Fig. 1. Modulation of the television signal. The range of brightnesses from black to white is reproduced by a change of the amplitude between 30 and 100 percent. In *a* may be seen the line synchronization signal which consists of a total suppression of the signal during 10 micro seconds and a "black" signal of 5 μ sec. In diagrams *b* and *c* the even and odd picture synchronization signals, respectively, are given. The duration of these signals is 400 μ sec, while the picture modulation is suppressed throughout an interval of 2 000 μ sec each time. The picture synchronization signal is interrupted by a number of impulses which provide the line synchronization. As may be seen there are twice as many impulses during the picture synchronization signal as is necessary for line synchronization. In this way the odd and the even signals are made to appear practically the same, which is desirable since otherwise there is danger that the two line patterns of the interlaced image may be mutually displaced.

gives the amplitude of carrier in per cent of the maximum amplitude. At moments when the screen is dark the carrier has an amplitude of 30 per cent. With increasing brightness the amplitude increases to 100 per cent. At the end of each line of the

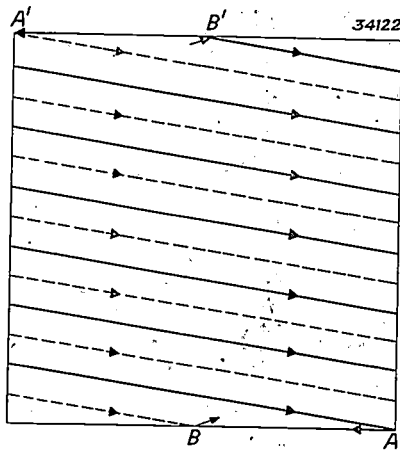

Fig. 2. Synchronized scanning. The "even" picture synchronization signal begins at the end of a line, the "odd" one begins in the middle of a line.

picture the amplitude of the carrier falls to zero for an instant (line synchronization). This takes place $405.25 \sim 100\,000$ times per second. In addition, picture synchronization takes place 50 times per second and a distinction must be made between odd and even picture synchronization, in connection with the interlacing (see fig. 2). An even picture synchronization is shown in fig. 1b, an odd one in fig. 1c. Both of these consist mainly of an interruption of the carrier like the line synchronization signal, but they are in this case, of longer duration, namely long enough for four lines to be scanned. For further details refer to the text under fig. 1.

Circuit arrangements of the receiver

In fig. 3 a very much simplified diagram is given of the circuit of the television receiver. Each valve is indicated by a circle, while the other elements of the circuit are emitted. Picture and sound signals are picked up by the aerial *A* and amplified together in the first amplifying stage. The signals are then sent to the mixing stage consisting of two triode-hexodes.

The signals on the intermediate frequency carrier are separated into sound signals, with a frequency of about 9.7 megacycles, and the band of picture and synchronization signals, which extends from 10.4 to 13.2 megacycles.

The sound signals are amplified and rectified on the intermediate frequency carrier, amplified on a low-frequency carrier and fed to the loud speaker *L*.

The picture and synchronization signals are amplified by a broad band amplifier in two stages (*Sp*₁, *Sp*₂). They are rectified by means of the diode *D*_b and then immediately passed to the control electrode *g* of the cathode ray tube. The synchronization signals are separated by means of the stage *P*_s *D*_s from the picture signals, and are then sent to the saw tooth generators for line and picture, each of which consists of two stages. The output signals from these supply the coils *Sp*₁ and *Sp*₂ for horizontal and vertical deflection, respectively.

If the circuit is compared with the one given two years ago for the television receiver, the most striking difference is the great decrease in the number of valves. The intermediate frequency picture signals which were previously amplified in three stages are now amplified in two stages. The intermediate frequency sound signals are now amplified

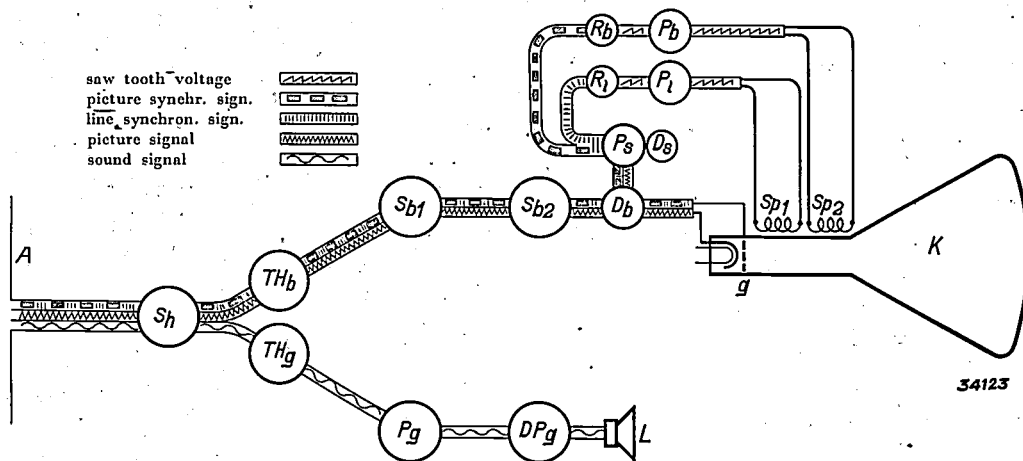

Fig. 3. Amplification of the television signal and gradual separation into sound, picture, line synchronization and picture synchronization signal. *S* amplifier valves with secondary emission, *TH* triode-hexodes, *P* pentodes, *D* diodes, *R* relay valves, *Sp* coils, *K* cathode ray tube, *L* loud speaker.

by only one stage, while previously two stages were needed. In the amplification of the synchronization signals also, as well as in the construction of the saw tooth generators, the number of valves has been decreased.

This saving has been made possible in the first place by the use of amplifier valves with secondary emission. These valves have a slope of 13 mA/Volt, a value which is not so easily reached without secondary emission²⁾. A further saving in valves was achieved by using relay valves in the saw tooth generators, while finally the circuit which separates the synchronization signals from the picture signals requires fewer valves than the one designed two years ago.

In the following we shall examine a few important details of the circuit.

The mixing stage

The mixing stage serves the purpose of transferring the modulation of the sound and the picture to a new carrier wave. It is desirable to separate picture and sound from each other at the same time. In the circuit for the sound selective resonance circuits can then be applied so that a much higher amplification factor can be reached than in the amplification of the broad frequency band which the picture signals occupy.

Fig. 4 shows how this separation is brought about. The input circuit, consisting of the coils L_1 , L_2 and the condenser C , forms a bandfilter whose elements are so chosen that only the broad frequency band of the picture signals are passed to the triode-hexode TH_b , while the sound signals are very much weakened. This filter is followed by the blocking circuit lc which is adjusted to the carrier of the sound signal and thus suppresses this carrier even more. The coils L_1' , L_2' and the condenser C' form a second band filter tuned to the narrow frequency band of the sound signal, which passes this signal to the grid of the second triode-hexode TH_g .

The oscillator parts of the two triode-hexodes are brought into oscillation by means of the same oscillating circuit. The connections are shown in the figure, and it may be seen that the voltages on the oscillator grids vary in opposite phase.

The anode circuits of the hexode parts, in which the mixing frequency is generated, are different for picture and sound. The picture signal, which occupies a broad frequency band, is transmitted to the following stage by means of a transformer. The sound signal is amplified selectively by means of a tuning circuit which, together with the circuit coupled with it, forms a filter passing a band 40 kilocycles in width.

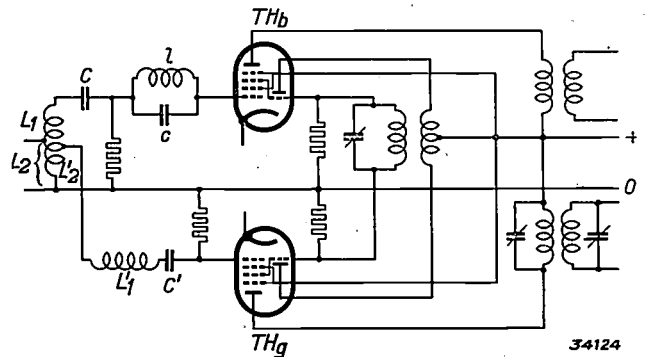

Fig. 4. Circuit of the mixing stage. The elements L_1 , L_2 , C , l , c , L_1' and C' serve to separate the sound signals which are passed on to the grid of the triode-hexode TH_g from the picture signals which are passed on to the grid of the triode-hexode TH_b .

The intermediate frequency amplification

In general it may be said that it is more difficult to obtain good amplification with a single valve, the greater the frequency range to be amplified. In an earlier article in this periodical³⁾, in which the amplifier of a cathode ray oscillograph was described, parasitic capacities (mainly the input and output capacities of radio valves) were indicated as causes of the difficulties which occur in the amplification of a broad frequency band. In the same article a discussion was given of the method of choosing coupling elements between two valves in order to obtain the highest possible amplification which is constant for frequencies from about 10 cycles to 1 megacycle.

We are here concerned with a slightly different case: the amplification must also be constant over a broad frequency band which, however, lies between two high frequencies of about 11 and 13 megacycles. We can however profit by the results there found by making use of the following proposition.

Given, a network consisting of capacities C_1 , self-inductions L_1 and resistances R_1 . If in this network we connect a self-induction L_2 in parallel with every capacity C_1 and a capacity C_2 in series with every self-induction L_1 , choosing the quan-

²⁾ On the subject of valves with secondary emission see Philips techn. Rev. 3, 133, 1938. The application of secondary emission offers as principal advantage the possibility of obtaining a given anode current with a smaller cathode than when the current must be generated entirely by thermionic emission. By the reduction of the dimensions the input capacity is also lowered, which is a great advantage in the amplification of broad frequency bands.

³⁾ Philips techn. Rev. 4, 198, 1939.

ties L_2 and C_2 such that the sections are tuned to a frequency ν_0 in the following way:

$$C_1 L_2 = L_1 C_2 = \left(\frac{1}{2\pi\nu_0} \right)^2,$$

Then the newly formed network, at the frequencies,

$$\left. \begin{aligned} \nu_1' &= \sqrt{\nu_0^2 + \frac{\nu^2}{4}} + \frac{1}{2}\nu \\ \nu_2' &= \sqrt{\nu_0^2 + \frac{\nu^2}{4}} - \frac{1}{2}\nu \end{aligned} \right\} \dots (1)$$

has the same absolute values of the impedances as the original network at the frequency ν .

In order to prove this it is sufficient to calculate the impedance of a section which in the original network contains only a self-induction or a capacity (the resistances remain unaltered). The self-induction is changed to a self-induction and a capacity in series, tuned to ν_0 . Then at a frequency ν , one finds for the absolute value of the impedance

$$|Z| = 2\pi \left| \left(\nu' - \frac{\nu_0^2}{\nu'} \right) L \right|$$

and when ν' is substituted in this equation according to equation (1), one obtains

$$|Z| = 2\pi\nu L,$$

or the same value as in the original network at the frequency ν . A similar calculation can also be carried out for the capacitive sections of the original network; it is better in this case to calculate the admittance instead of the impedance.

When the original network has a frequency characteristic, which is flat up to a maximum frequency ν , the frequency characteristic of the new network will be flat between two frequencies ν_1 and ν_2' , which have the following relation according to equation (1)

$$\nu_1' - \nu_2' = \nu.$$

The extent of the flat frequency region remains thus unaltered, the region is merely shifted to higher frequencies.

On the basis of *fig. 5* we shall explain the coupling of two successive amplifier valves in the broad band amplifier with the help of this proposition. *Fig. 5a* is in principle a resistance-coupled amplifier having a flat characteristic in a frequency range which begins at very low frequencies, and whose upper limit is given by the electrode capacities of the radio valves which short circuit the resistance R for very high frequencies. The self-induction L prevents to some extent the decrease in the amplification with increasing frequency, by increasing the anode impedance with increasing frequency.

Fig. 5b is a diagram of an equivalent circuit for the coupling elements of the resistance amplifier. *Fig. 5c* is the equivalent circuit deduced therefrom of the broad band amplifier in which C_1 and M are self-inductions. *Fig. 5d* is the arrangement corresponding to this equivalent circuit.

There are two points of difference between the circuit and its equivalent, which, however, do not destroy their electrical equivalence. In the first place the self-induction M is replaced by the mutual induction between the coils of a transformer; in the second place the circuit L, R, C_1 is not connected in parallel with the entire secondary winding of the transformer, but only with a part of it. This is done because otherwise the capacity C_1 should have an impractically small value. In the case shown this capacity is 4 $\mu\mu\text{F}$.

The anode impedance of the whole circuit has the fairly low value of 4 000 ohms, with which an amplification per stage of 50 times is obtained, thanks to the steep slope of the valves. The amplification is constant in a frequency range of two megacycles.

The rectification of picture and synchronization signals

The picture signals are rectified in the ordinary way with a diode as shown schematically in *fig. 6a*.

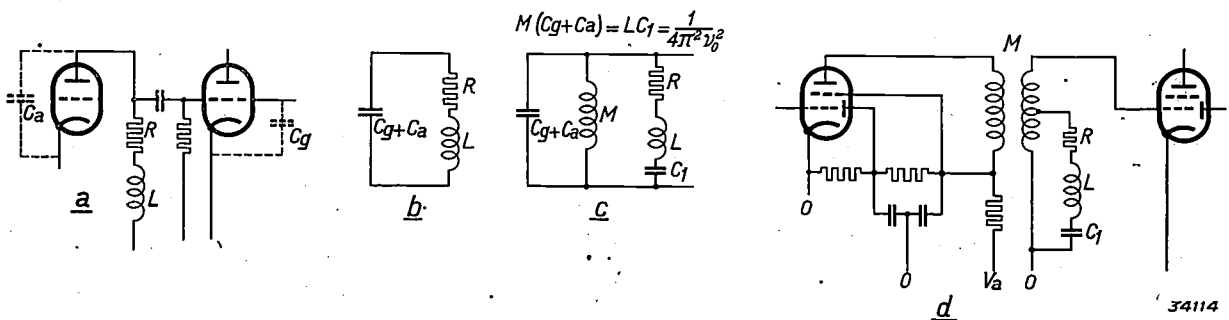

Fig. 5. *a* Diagram of a resistance-coupled amplifier, the amplification of which for high frequencies is raised by the self-induction L . *b* Equivalent circuit of the resistance amplifier, *c* equivalent circuit of a broad band amplifier derived from *b*, *d* circuit of the broad band amplifier.

The "video frequency voltage" obtained, which fluctuates in the rhythm of the amplitude of the

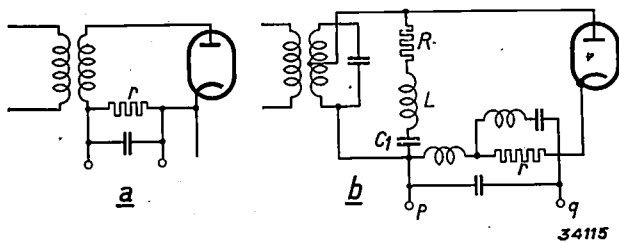

Fig. 6. a Principle, b circuit of the diode for rectifying the video frequency signals. By means of several elements in series, connected in parallel with the resistance r , an effort is made to render the impedance between the points p and q as constant as possible for the video frequencies occurring. The circuit element R, L, C_1 have the same significance as in fig. 5.

picture signal, is passed directly to the control electrode of the cathode ray tube. In fig. 6b may

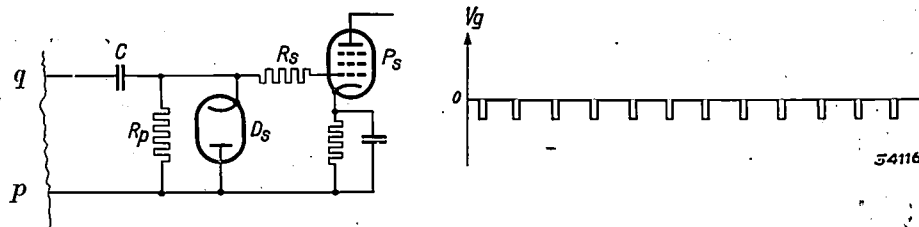

Fig. 7. Amplification of the synchronization signals and their separation from the picture signals. a Principle of the amplifier stage which is connected with the rectifier stage of fig. 6b. By connecting a diode D_s in parallel with the resistance R_p the bias of the control grid is kept at such a value that its total voltage with respect to the anode of the diode D_s is exactly zero at the lowest point of the synchronization signals, and otherwise positive. The diagrams beside the circuits a and b show the corresponding variation of the grid voltages with respect to the cathode of the pentode.

be seen the actual circuit which is explained in the text beneath the figure.

The synchronization signals which are also present in the rectified voltage are not yet sufficiently strong to be able to drive the saw tooth generators. They are therefore amplified once more and at the same time separated from each other. This is represented schematically in fig. 7. The rectified picture- and synchronization signals are sent to the grid of the pentode P_s via a coupling condenser C . The resistance R_s and the diode D_s need not to be considered. The control grid of the pentode P_s has a negative grid bias, which is obtained by inserting a resistance in the cathode circuit.

Now we can first consider the case, that the plane of the image is dark and that between p and q only a synchronisation signal exists, which equals the just mentioned negative grid bias. Between two synchronisation signals, however, the grid bias equals zero and at every signal a sharp peak occurs, as indicated in fig. 7.

If a picture signal exists, together with the syn-

chronisation signal, we want quite the same behaviour of the grid bias. This is obtained by means of the resistance R_s . The picture signal gives a positive voltage to the control grid, and a grid current flows. This means that the resistance between cathode and control grid becomes small with respect to the resistance R_s , so that only a small part of the voltage remains between p and q on the control grid. This grid current would cause the originally chosen grid bias of the pentode P_s to disappear. Every time the grid bias is becoming positive, a current starts which charges condenser C negatively and continually lowers the mean grid bias. In order to eliminate this difficulty a diode D_s is put in parallel with the resistance R_p which at once conducts away the charge of the right condenserplate, if the potential of this plate becomes negative with respect to the anode of the diode.

In this manner the influence of the picture signal on the grid bias is completely eliminated.

The saw tooth generators

The saw tooth voltage is excited by means of a so-called relay valve; that is a gas-filled triode in

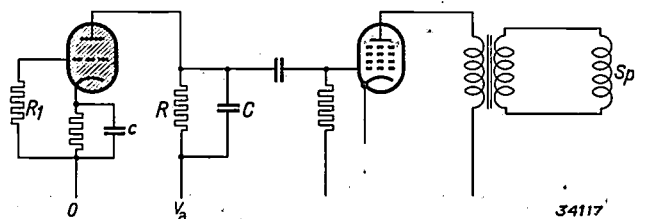

Fig. 8. Diagram showing the principle of a generator causing a saw tooth current through the deflection coil Sp . By means of a relay valve a relaxation oscillation is generated. A saw tooth voltage hereby occurs over the condenser C , which is amplified with the help of a pentode.

which a gas discharge takes place at a certain anode voltage which depends upon the voltage on the grid⁴⁾.

⁴⁾ On the action of relay valves see Philips techn. Rev. 1, 11, 1936.

The circuit of the saw tooth generator is represented in *fig. 8*. When the voltage V_a (about 300 volts) is applied, the condenser C is charged. The charge flows off gradually over the resistance R , so that the voltage of the anode increases proportionally to the time. At a voltage of several tenths of a volt the relay valve breaks down; the charge of the condenser then flows *via* the relay valve to the condenser F , so that the anode voltage falls very rapidly and at the same time the cathode voltage suddenly rises. The potential difference between cathode and anode quickly becomes zero; at that instant the discharge is extinguished, and the process begins again.

The saw tooth voltage on the condenser C so obtained is amplified by means of a pentode, which provides a saw tooth current which is fed to one of the deflection coils of the cathode ray tube.

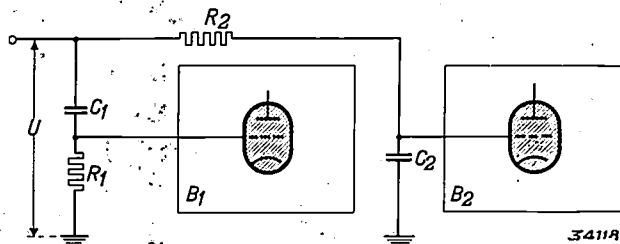

Fig. 9. Synchronization of the saw tooth generators B_1 and B_2 which generate the line and picture saw tooth voltages, respectively. The synchronization is carried out by means of voltage impulses on the control grids of the relay valves. These voltages are derived from the voltage U (output voltage of the pentode P_s in *fig. 7*) by means of the circuits C_1R_1 and R_2C_2 , respectively.

The synchronization of the saw tooth voltage is obtained by increasing the grid voltage of the relay valve suddenly at certain moments and in this way initiating a breakdown. This takes place in the rhythm of the synchronization signals, and provision must be made, by the use of suitable switching elements, that the one saw tooth generator is synchronized by the line synchronization signals and the other by the picture synchronization signals.

The possibility of separating line and picture synchronization signals is based upon the fact that the duration of the latter is 40 times that of the former (see *fig. 1*). If a condenser and a resistance are connected in series, a voltage which is suddenly applied to this circuit and then immediately withdrawn, will only act on the resistance. If however the voltage remains constant for some time, the condenser becomes charged over the resistance, so that finally the whole voltage acts on the condenser.

In *fig. 9* it may be seen how the saw tooth generators B_1 and B_2 for the horizontal and vertical

deflection, respectively, of the electron beam, are activated by means of the voltage U . The horizontal deflection is synchronized by the voltage

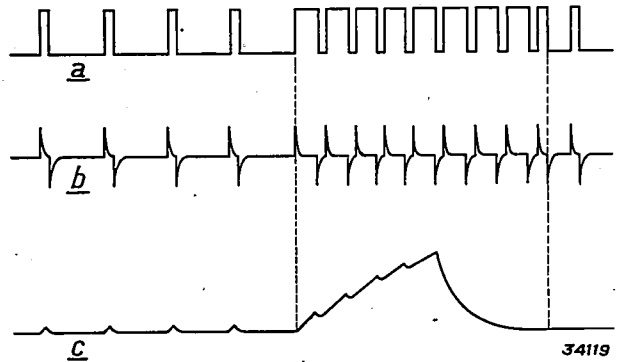

Fig. 10. Variation *a*) of the output voltage U , *b*) of the grid voltage of the valve B_1 , *c*) of the grid voltage of the valve B_2 . At each line synchronization signal *b* exhibits a voltage peak which ignites the valve B_1 . During the picture synchronization signal the number of peaks is twice as great; only every other peak, however, initiates a breakdown. (At each breakdown the condenser c in *fig. 8* is charged, so that the voltage of the cathode becomes positive with respect to the grid. At the following peak this voltage has not yet fallen back so far that the valve can break down). Curve *c* exhibits only unimportant voltage peaks at the line synchronization signals; the picture synchronization signal however gives such an increase in voltage that the valve breaks down.

peaks which the line synchronization signals excite on the resistance R_1 ; the vertical deflection is synchronized by the voltage caused by the picture synchronization signals on the condenser C_2 .

The variation of the voltages is indicated by curves *a*, *b* and *c* of *fig. 10*. Curve *a* represents the variation of the synchronization signal proper, *i.e.* the anode voltage of the pentode P_s in *fig. 7*. Curve *b* gives the variation of the voltage on the grid of the relay valve B_1 , which is coupled with the output voltage of the pentode P_s by means of the elements C_1 and R_1 . It is clear that a sufficiently sudden change of voltage, like the front of the line

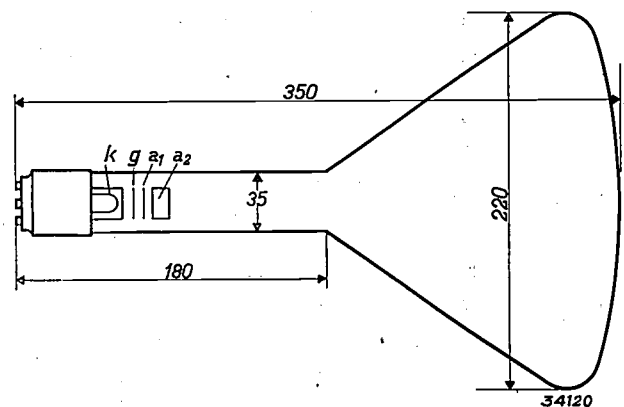

Fig. 11. Cathode ray tube with magnetic deflection of the electron beam. k cathode, g control electrode, a_1 , a_2 anodes. Dimensions in mm.

synchronization signal, is passed on practically

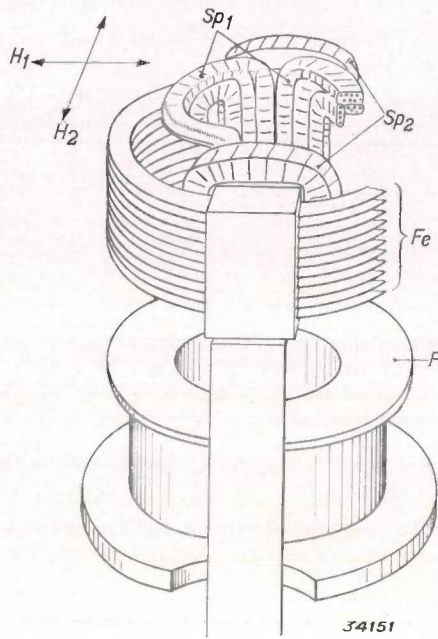
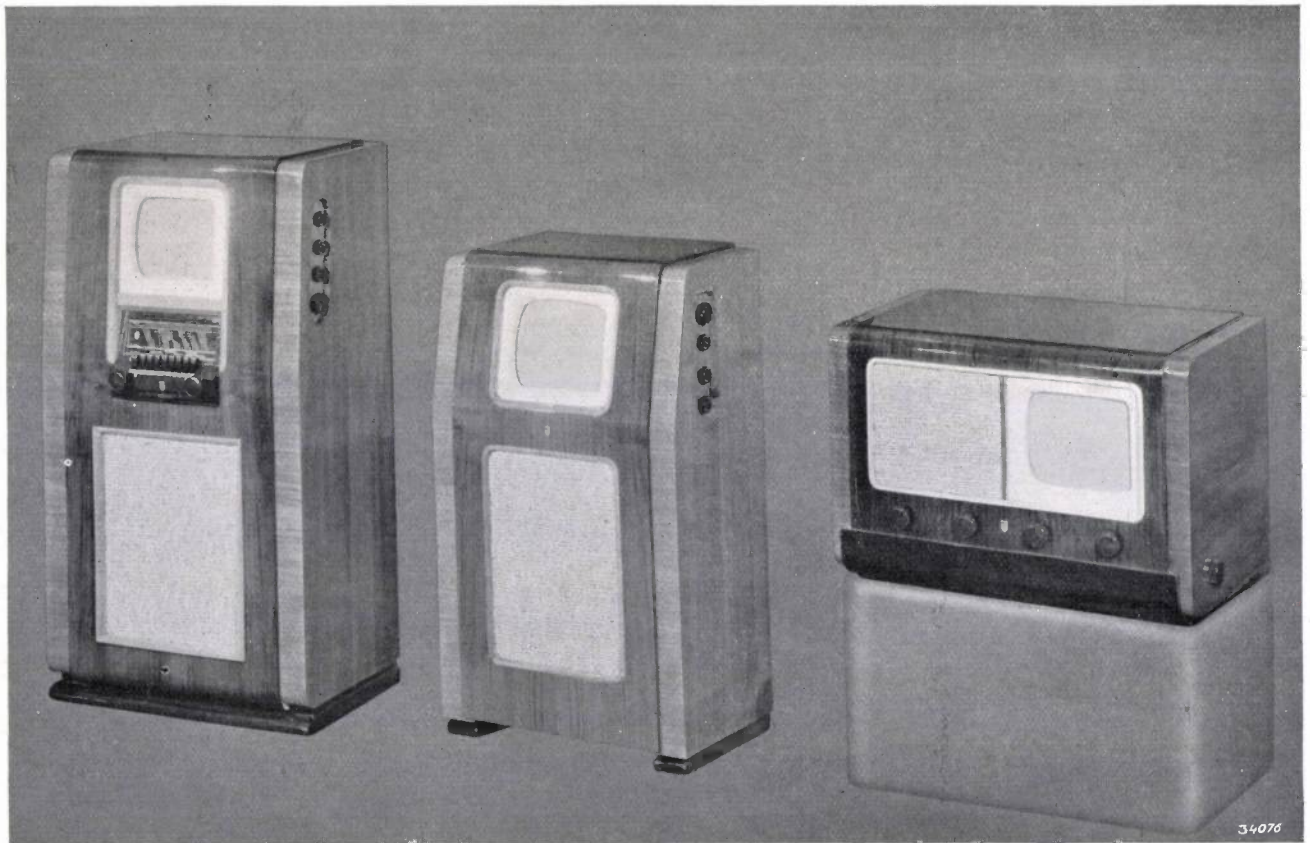

Fig. 12. Coils for focussing and deflection of the electron beam. *F* focussing coil, *Sp₁* deflection coil for the line saw tooth voltage (direction of the magnetic field *H₁*), *Sp₂* deflection coil for the picture saw tooth voltage (direction of field *H₂*). *Fe* series of iron rings for reinforcing the field *H₂*.

unweakened by the condenser *C₁* to the grid of the relay valve. The *R-C* time of the circuit *C₁-R₁* is however so short that the voltage falls again practically to zero within the duration of the synchronization signal; the end of the synchronization signal then causes a peak in the opposite direction (fig. 10*b*). The positive peaks cause breakdown in the relay valve, the negative peaks are without significance. It may be seen how the synchronization of the line saw tooth generator is also maintained during the picture synchronization signal (which lasts for four line periods); further particulars are given in the text under the figure.

Curve *c* shows the variation of the voltage on the grid of the valve *B₂*, which is controlled by the picture synchronization signals. The circuit *R₂C₂*, through which this valve is coupled with the synchronization signals, is connected in a way opposite to that of the circuit *C₁R₁*, so that the voltage of the condenser instead of that of the resistance acts on the grid, and this voltage only increases sufficiently to cause breakdown in the relay valve at a given moment after the longer duration of the picture synchronization signals.



a

b

c

Fig. 13. Various television receivers. *a* Console model with built-in radio receivers; *b* console model for television alone; *c* table model.

The cathode ray tube

After having discussed in the foregoing the formation of the picture voltages and the saw tooth currents, we shall now study how a picture is formed on the screen of the cathode ray tube (*fig. 11*) by means of these voltages and currents. The electrons which leave the cathode are accelerated by the anodes a_1 and a_2 . The control electrode g receives the picture voltages and regulates the intensity of the electron beam and thus the bright-

ness of the electron beam in the direction of the lines scanned. This coil, which causes a magnetic field in the direction of the arrow H_1 , has a somewhat distorted form due to the fact that two originally flat coils were bent as closely as possible around the neck of the cathode ray tube. This has been done in order to make the field inside the neck as strong as possible by shortening the lines of force. It is desirable to keep the length of the cathode ray tube small, since this determines the dimensions of the appa-

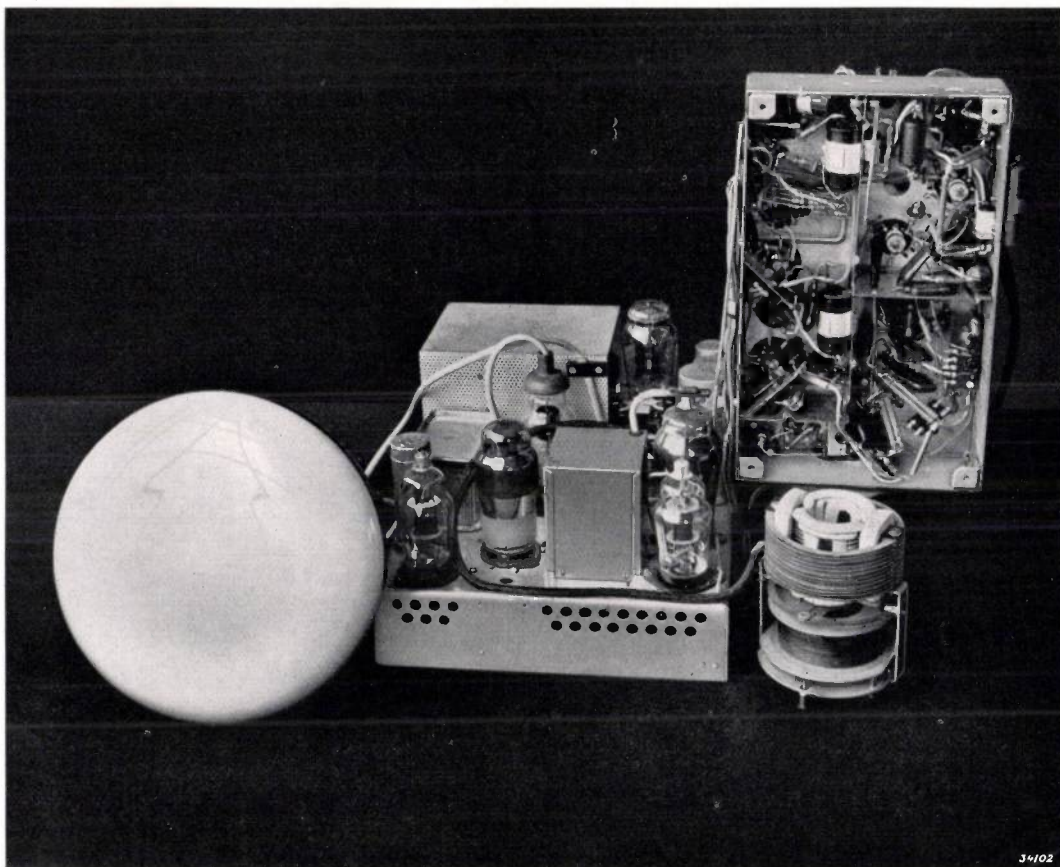

Fig. 14. The two chassis of a television receiver (console model). To the left may be seen the screen of the cathode ray tube, next to it a chassis with the power pack and the saw tooth generators and next to that — mounted in a vertical plane — a chassis with the amplifier stages for picture and sound signals. Below this chassis there is a system of coils for the focussing and deflection of the electron beam.

ness of the fluorescence spot moving across the screen. Furthermore the electron beam must be focussed and deflected in two perpendicular directions proportionally to the currents from the saw tooth generators. This is done magnetically by a system of coils shown in *fig. 12*. The coil F causes a field in the direction of the axis of the tube. This field is adjusted to a constant intensity and serves to focus the electron beam.

The coils S_{p1} and S_{p2} cause magnetic fields which are mutually perpendicular and also perpendicular to the axis of the tube. The coil S_{p1} deflects the

ratus, and to make the area of the screen as large as possible. As may be seen from the figure the diameter of the screen is almost two thirds of the total length of the cathode ray tube. In the tube represented the picture on the screen is 17.5 cm wide and 15 cm high. Television receivers are also made with a somewhat larger cathode ray tube giving a picture 25 cm wide and 20 cm high. The attainment of such large screens with relatively short cathode ray tubes has only been made possible by changing over from electrostatic to magnetic deflection, and this advance has contributed very

much to the decrease in the size of television receivers.

The complete apparatus

The parts are assembled in two chassis, one of which contains the power pack and the saw tooth generators and the other the amplifying stages for picture, sound and synchronization signals. As to the position of the two chassis in the apparatus, there are various types. In the table model, shown in *fig. 13c*, the two chassis are side by side. The loud speaker is mounted above the power pack,

the cathode ray tube above the amplifier. In the different cabinet models the amplifier chassis is assembled in a vertical plane (*fig. 14*). The two chassis are at the bottom of the cabinet, above the power pack is the loud speaker and at the top the cathode ray tube. The result is a cabinet 80 cm high, which is shown in *fig. 13b* next to the table model. In addition to these two models there are a number of larger models (*fig. 13a*, for example) in which, in addition to a television transmitter, any desired broadcasting station can be received.

Compiled by G. HELLER.

THE DRY SHAVING APPARATUS "PHILISHAVE"

by A. HOROWITZ, A. van DAM and W. H. van der MEI.

672:715 : 621.312

Dry shaving with an electrical shaving apparatus offers the advantage over shaving with soap and razor that the skin is less damaged and cuts are impossible. In this article the action and construction of the dry shaving apparatus "PhiliShave" developed by Philips are discussed.

Introduction

Dry shavers are so called because the hairs of the beard are cut off mechanically without any previous treatment with soap or cream. Although the idea is an old one (one such apparatus was proposed in the previous century), it has only recently been possible to find a satisfactory method of construction.

In designing a dry shaver the obvious starting point was the hair clipper used by hair dressers. The cutting element of this apparatus consists of two steel combs with perfectly plane surfaces lying together (see *fig. 1*). The upper comb is moved back and forth over the lower one and the

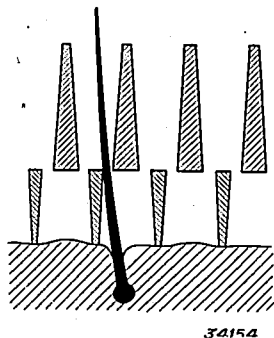

Fig. 1. Sketch showing the principle of a hair clipper. The hairs are cut off by means of two combs sliding over each other.

hairs are caught and cut off between the teeth of the two combs as they slide over each other.

If this principle is applied in the correct way to the problem of shaving the beard, then in addition to the convenience of dry shaving, is the advantage that the skin is much less damaged. In connection with this latter point it is important to know something about hair growth. The hairs grow from pores. These pores may in general be of two types.

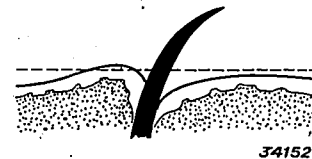

Fig. 2. The skin on one side of a hair often forms an elevation, as shown in the figure. The dotted line shows how the skin is damaged when such a hair is cut by an ordinary razor.

In one case the pore is a craterlike depression surrounded by fairly smooth skin, while in the other case there is a tiny elevation of the skin at one side of each hair (see *fig. 2*). Both forms occur simultaneously in most cases. In shaving with a razor the cutting edge passes directly over the skin and these tiny elevations are partially cut off with the result that numerous tiny wounds

much to the decrease in the size of television receivers.

The complete apparatus

The parts are assembled in two chassis, one of which contains the power pack and the saw tooth generators and the other the amplifying stages for picture, sound and synchronization signals. As to the position of the two chassis in the apparatus, there are various types. In the table model, shown in *fig. 13c*, the two chassis are side by side. The loud speaker is mounted above the power pack,

the cathode ray tube above the amplifier. In the different cabinet models the amplifier chassis is assembled in a vertical plane (*fig. 14*). The two chassis are at the bottom of the cabinet, above the power pack is the loud speaker and at the top the cathode ray tube. The result is a cabinet 80 cm high, which is shown in *fig. 13b* next to the table model. In addition to these two models there are a number of larger models (*fig. 13a*, for example) in which, in addition to a television transmitter, any desired broadcasting station can be received.

Compiled by G. HELLER.

THE DRY SHAVING APPARATUS "PHILISHAVE"

by A. HOROWITZ, A. van DAM and W. H. van der MEI.

672:715 : 621.312

Dry shaving with an electrical shaving apparatus offers the advantage over shaving with soap and razor that the skin is less damaged and cuts are impossible. In this article the action and construction of the dry shaving apparatus "PhiliShave" developed by Philips are discussed.

Introduction

Dry shavers are so called because the hairs of the beard are cut off mechanically without any previous treatment with soap or cream. Although the idea is an old one (one such apparatus was proposed in the previous century), it has only recently been possible to find a satisfactory method of construction.

In designing a dry shaver the obvious starting point was the hair clipper used by hair dressers. The cutting element of this apparatus consists of two steel combs with perfectly plane surfaces lying together (see *fig. 1*). The upper comb is moved back and forth over the lower one and the

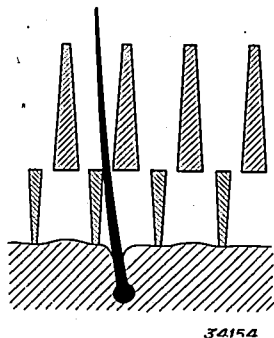

Fig. 1. Sketch showing the principle of a hair clipper. The hairs are cut off by means of two combs sliding over each other.

hairs are caught and cut off between the teeth of the two combs as they slide over each other.

If this principle is applied in the correct way to the problem of shaving the beard, then in addition to the convenience of dry shaving, is the advantage that the skin is much less damaged. In connection with this latter point it is important to know something about hair growth. The hairs grow from pores. These pores may in general be of two types.

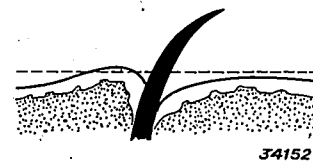

Fig. 2. The skin on one side of a hair often forms an elevation, as shown in the figure. The dotted line shows how the skin is damaged when such a hair is cut by an ordinary razor.

In one case the pore is a craterlike depression surrounded by fairly smooth skin, while in the other case there is a tiny elevation of the skin at one side of each hair (see *fig. 2*). Both forms occur simultaneously in most cases. In shaving with a razor the cutting edge passes directly over the skin and these tiny elevations are partially cut off with the result that numerous tiny wounds

are made. With a dry shaver the lower comb can be so constructed that it runs smoothly over the inequalities of the skin. When slight pressure is exerted on the apparatus the elevations are pushed flat so that the hairs can be cut very short without harm to the skin. It is obvious that pimples etc. give rise to further small wounds in shaving with a razor, and that this again may be avoided by the use of an instrument on the principle of the hair clipper.

Before entering into the details of the dry shaver developed by Philips, the action of which exhibits certain analogy with that of a hair clipper, we shall first consider the factors which effect the action of a hair clipper.

Requirements which must be satisfied by the clipper of a shaving apparatus.

If a hair clipper is to be constructed so that it is suitable for shaving it must first satisfy the following requirements:

- 1) The thickness of the lower comb must be as small as possible. With a thickness of even several tenths of a millimeter the hairs could no longer be cut short enough.
- 2) The two combs must fit together perfectly. A distance of several hundredths of a millimeter between them would already cause pulling of the hairs, and the finest hairs would fail to be cut.
- 3) The cutting speed must be very high. This is not only necessary for rapid shaving, but it is found that the hairs are more easily cut at high cutting speeds. When the cutting speed is sufficiently high a slight dullness of the cutting teeth after long usage is found to have no unfavourable effect on the action of the clipper, if care is taken that the sliding surfaces of the two combs continue to fit perfectly against one another. The material of the teeth then also becomes of only secondary importance so that it may be chosen according to other requirements than that of the greatest possible hardness.

It will appear later how these points have been taken into account in the construction of the Philips dry shaver.

Construction of the Philips dry shaver

The cutting mechanism of the Philips dry shaver "PhiliShave", like that of a hair clipper, consists of two parts, the stationary part which is pressed against the skin and the moving part which cuts off the hairs. The latter part does not execute an

oscillating motion as in a hair clipper, but a rotating motion. Moreover it does not have the form of a comb with a large number of cutting teeth, but that of a fraise with only three knives, which rotates at a high speed and which can be easily pressed against the surface of the stationary comb (see *fig. 3*).

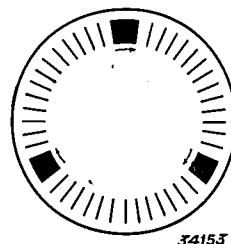

Fig. 3. Diagram of the rotating cutting element of the Philips dry shaver "PhiliShave". Three knives rotate around a circular comb.

The rotating construction has the advantage over the oscillating construction according to *fig. 1* that a considerably greater speed can be obtained, while the presence of only three knives makes possible a statically determined construction in which the knives lie against the running surface with a constant pressure, even when the wear on the different knives is not exactly the same.

The way in which this statically determined construction is obtained will be explained in the description of the driving mechanism. We shall however first study the shaving element itself in more detail.

The shaving element

A cross section of the shaving element is shown in *fig. 4*. The stationary part consists of a cylindrical cap with a raised bottom. The lower edge thus forms a ring with a U-shaped cross section. The cap is made of very high quality steel and has a rigid shape, so that it is possible to give it a thickness

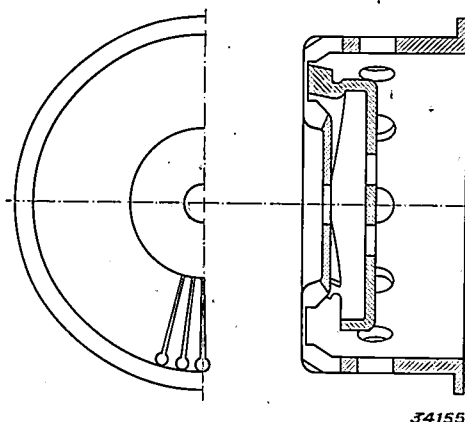

Fig. 4. Cross section of the cap and fraise. The form of the slits is indicated on the left.

of less than 1/10 mm at the apex of the U-shaped ring. The ring is provided with a large number of radial slits, into which the hairs are guided during the shaving process.

The slits are not only found on the under surface, but they are continued up both sides of the ring. On the outer side they are somewhat wider toward the outside surface so that the hairs enter more easily. The continuation of the slits on the inner side of the ring also helps to catch the hairs: the skin is stretched taut by the depression in the cap so that the hairs stand erect and enter the slits more easily.

The fraise is kept centred by the ring-shaped track; any other centring device was found to be unnecessary and even detrimental. In designing the fraise every attempt was made to keep the friction small so that a small motor could be used and in that way the weight of the apparatus could be kept low. For that reason bronze was chosen as material for the knives. Because of the high speed the use of this relatively soft material presents no difficulties. It was found by experience that the knives undergo no appreciable wear when care is taken that they have slight play in a radial direction. The knives are therefore made slightly shorter than the width of the ring-shaped track.

The fraise turns at a speed of 10 000 r.p.m. Since the mean diameter of the circle on which the knives lie is 12 mm the velocity of the knives is

$$v = \frac{10\,000}{60} \cdot \pi \cdot 0.012 = 6.3 \text{ m/sec.}$$

This must be considered as a very high speed when it is noted that the maximum cutting speed of shaving apparatus with oscillating combs is 1 m/sec, and usually no higher than 0.5 m/sec.

The driving mechanism

Fig. 5 shows the driving mechanism of the fraise.

The rounded knob of a coupling piece *K* of "Philite" is pressed against the centre of the fraise by the spring *V*. The driving force of the motor shaft *M* is transmitted by means of the two pins *S* of the coupling piece which fit loosely into two holes in the fraise.

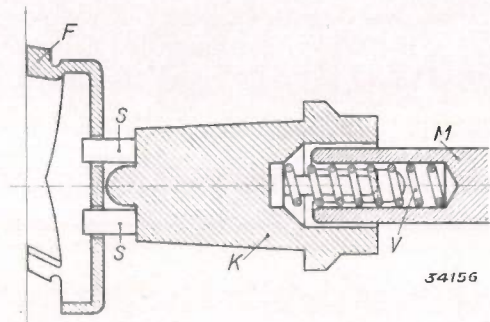

Fig. 5. Driving mechanism of the fraise *F* with motor shaft *M*. *V* spring, *K* coupling piece of "Philite", *S* pins.

As may be seen the transmission has been kept very flexible, which was necessary in order not to hinder the radial play of the fraise. The coupling piece *K* is flexibly coupled to the motor shaft *M*, while the fraise is flexibly coupled with the coupling piece. The result is that the coupling between the motor shaft and the fraise has the character of a cardan joint. The pressure of the spring *V* is about 20 g., and it is equally divided among the three knives, due to the flexible transmission.

A clear view of the different parts of the driving mechanism and their coupling is given in the photographs of figs. 6 and 7 of the separate parts and of the whole apparatus cut open. It may also be seen from these photographs how the use of "Philite" as a structural material makes possible a neat and compact unit.

The motor

In order to keep the apparatus as small as possible the "Philite" housing serves as grip and at the

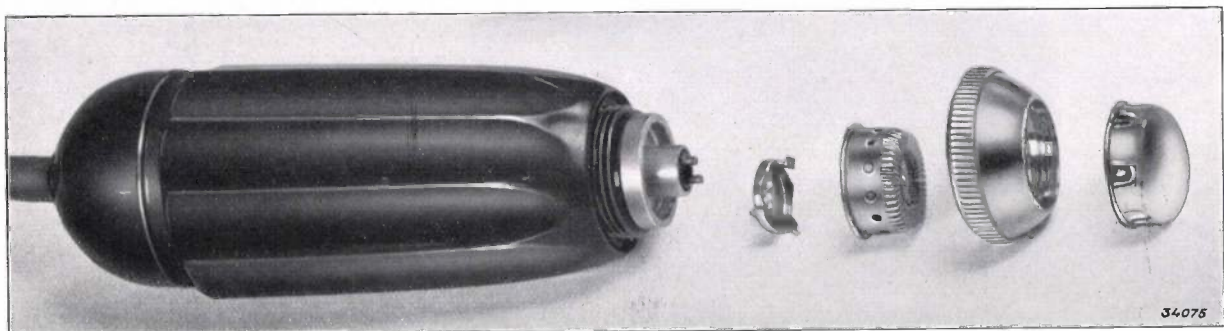

Fig. 6. Parts of the Philips dry shaver "PhiliShave". Left to right: the motor in a "Philite" housing with the projecting pins of the coupling piece, the fraise, the cap, a fastening nut, a cover for protecting the cap when not in use.

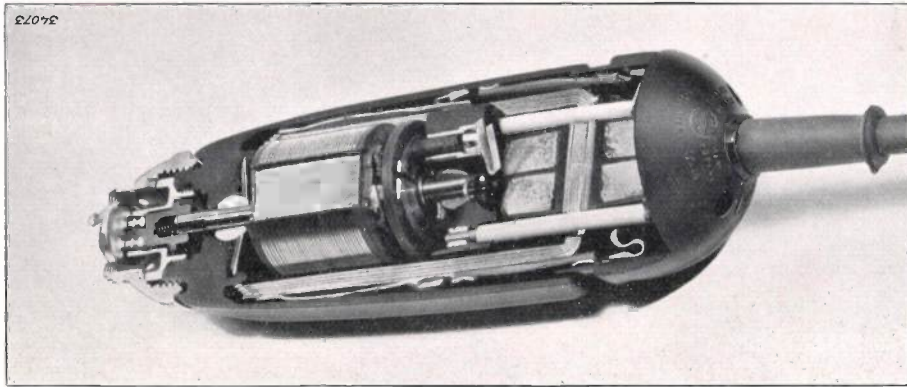

Fig. 7. Cross section of the Philips dry shaver.

same time as a frame for the motor. A collector motor is used which is suitable for direct and alternating current. The collector is in the form of a disc with three segments and may clearly be seen in fig. 7. It is also clear from this figure that the characteristic of flexibility is again present in the bearings, which are of the so-called self adjusting type; the bushings are spheres with a hole bored through them, and can thus easily turn in the corresponding depressions of the housing. In this way provision is made that any slight inaccuracy in the shape of the housing cannot cause the motor to run heavily, which is very important with the high speed of 10 000 r.p.m. The bearings are of a porous self-lubricating bronze¹⁾. Near each bearing there is also a small piece of oil-soaked felt. Together with the self-lubricating bronze a system is thus obtained which needs no attention.

The whole construction is such that the necessary electrical connections are automatically made in assembling the motor. The motor consumes about 8 W and is suitable for direct and alternating current from 100 to 135 volts. Higher voltages may also be used by connecting a resistance in series with the motor. A variable resistance is built into the plug-in contact for this purpose, and it can be adjusted by means of a turning switch. The axis of this switch projects between the pins of the contact and is provided with a groove so that it can be turned with a screw driver or other suitable instrument (a coin for instance). The following voltages can be used:

- 100—135 volts (125 volts nominal),
- 140—190 volts (165 volts nominal),
- 200—260 volts (225 volts nominal).

The nominal voltage may be read off through a small opening in the plug (see fig. 8).

¹⁾ Cf. Philips techn. Rev. 4, 328, 1939.

Use of the dry shaver

The apparatus is pressed directly against the skin and moved over the surface of the skin with a circular motion. Since there are slits in all directions it is not necessary to turn the apparatus. The hairs are as it were "approached" from all directions and are thus surely led into the slits.

The hairs which have been cut off are collected inside the cap and thus do not fall upon the clothing. This makes it possible to shave after dressing without taking any special precautions. The hairs can easily be removed from the cap simply by blowing through the openings.

After the apparatus has been in use for some time it becomes necessary to clean the cap from the deposit caused by perspiration etc. The fastening screw of the cap must be loosened and cap and knives cleaned with a soft brush or disinfected with a little alcohol. The running surface need not be lubricated after this treatment. The oil always present on the skin provides sufficient guarantee that the moving parts will never become dry.

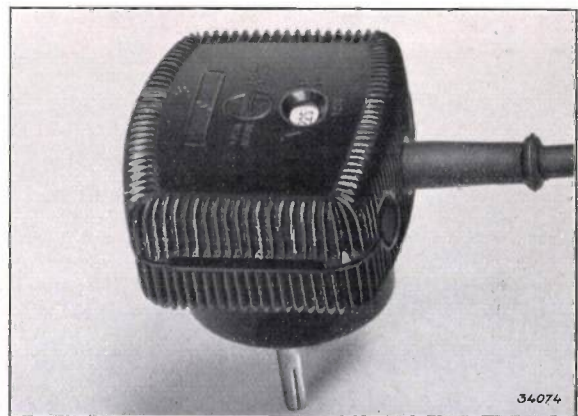

Fig. 8. Plug-in contact of the Philips dry shaver. The contact contains a built-in variable auxiliary resistance. The latter is here shown adjusted, so that the apparatus can be used with a mains voltage of 225 volts.

Safety

Since the apparatus is connected with the mains and brought into contact with the skin, the greatest care has been taken that there shall be no danger in the use of the apparatus, in case certain parts should become out of order. It might for example occur, due to the breaking of a wire, that the body of the motor was under a tension. Even such a defect would not bring the user into contact with the mains, because the motor is completely surrounded by a "Philite" housing, while the cutting element itself, which is in contact with the skin, is connected with the motor axle only through an insulating coupling piece of "Philite".

Another point to which attention has been given is that of radio interference which might be caused by the motor, as by all other collector motors. The

motor itself can relatively easily be rendered free of interference by the well-known method²⁾. When however the apparatus is taken in the hand new interferences appear. They are caused by a capacitative coupling between the collector (which is under the highest interference voltage) and the hand which is practically earthed for high-frequency voltages.

This interference can be removed by shielding the collector. The stator already fulfils this function to a certain extent, but this is not sufficient. Adequate shielding is obtained by an extra pair of plates connected electrically with the stator and forming with it a closed network around the collector and armature.

²⁾ Cf. Combating radio interferences, Philips techn. Rev. 4, 237, 1939.

THE TESTING OF LOUD SPEAKERS

by R. VERMEULEN.

621.395.623.7

For judging the quality and for comparing different loud speakers it is desirable to make use of quantitative data, such as the distortion and the frequency characteristic. The methods used in the Philips laboratory for the rapid determination of these factors make up the subject of the first part of this article. In the second part the fundamental problem of the conditions under which the measurements on the loud speaker must take place is dealt with. The measurement of the direct sound alone is discussed as well as the measurement of the total sound radiation and a measurement in which a certain combination of direct and indirect sound is used as a basis.

The highest instance in the judging of the quality of reproduction of a loud speaker is the ear of the listener. The most natural method for the testing and comparison of different loud speakers consists simply in listening to the music or speech reproduced. This method has however the obvious imperfection, that the judgment can only be of a qualitative nature, and that any slight deviations are either entirely unnoticed or observed in such a way that it is difficult to draw any conclusions about their cause. It is therefore desirable to supplement the listening tests with measurements which permit a more accurate and objective judgment of the quality of the reproduction.

The first question which arises is, what must we measure? Or in other words, by what quantities is the quality of the reproduction determined? In the main there are two such factors:

1) The distortion, which constitutes a measure of the non-linear distortion in the loud speaker.

It is usually defined by the equation:

$$F_1 = \sqrt{\frac{a_2^2 + a_3^2 + a_4^2 + \dots}{a_1^2}}, \dots \quad (1)$$

where a_1 and $a_{2,3,4\dots}$ indicate the amplitude of the fundamental and of the overtones occurring in the loud speaker, respectively.

2) The frequency characteristic, which indicates the sound intensity produced by the loud speaker when alternating voltages of different frequencies are applied to its terminals.

For ideal reproduction $F_1 = 0$, and the frequency characteristic must be flat, i.e. the sensitivity of the loud speaker must be the same for all frequencies. The deviations from these conditions found in practical cases, while they do not permit the drawing of any conclusion about their effect on the reproduction without the aid of listening tests, do however make possible a comparison of different loud speakers and particularly an estima-

Safety

Since the apparatus is connected with the mains and brought into contact with the skin, the greatest care has been taken that there shall be no danger in the use of the apparatus, in case certain parts should become out of order. It might for example occur, due to the breaking of a wire, that the body of the motor was under a tension. Even such a defect would not bring the user into contact with the mains, because the motor is completely surrounded by a "Philite" housing, while the cutting element itself, which is in contact with the skin, is connected with the motor axle only through an insulating coupling piece of "Philite".

Another point to which attention has been given is that of radio interference which might be caused by the motor, as by all other collector motors. The

motor itself can relatively easily be rendered free of interference by the well-known method²⁾. When however the apparatus is taken in the hand new interferences appear. They are caused by a capacitative coupling between the collector (which is under the highest interference voltage) and the hand which is practically earthed for high-frequency voltages.

This interference can be removed by shielding the collector. The stator already fulfils this function to a certain extent, but this is not sufficient. Adequate shielding is obtained by an extra pair of plates connected electrically with the stator and forming with it a closed network around the collector and armature.

²⁾ Cf. Combating radio interferences, Philips techn. Rev. 4, 237, 1939.

THE TESTING OF LOUD SPEAKERS

by R. VERMEULEN.

621.395.623.7

For judging the quality and for comparing different loud speakers it is desirable to make use of quantitative data, such as the distortion and the frequency characteristic. The methods used in the Philips laboratory for the rapid determination of these factors make up the subject of the first part of this article. In the second part the fundamental problem of the conditions under which the measurements on the loud speaker must take place is dealt with. The measurement of the direct sound alone is discussed as well as the measurement of the total sound radiation and a measurement in which a certain combination of direct and indirect sound is used as a basis.

The highest instance in the judging of the quality of reproduction of a loud speaker is the ear of the listener. The most natural method for the testing and comparison of different loud speakers consists simply in listening to the music or speech reproduced. This method has however the obvious imperfection, that the judgment can only be of a qualitative nature, and that any slight deviations are either entirely unnoticed or observed in such a way that it is difficult to draw any conclusions about their cause. It is therefore desirable to supplement the listening tests with measurements which permit a more accurate and objective judgment of the quality of the reproduction.

The first question which arises is, what must we measure? Or in other words, by what quantities is the quality of the reproduction determined? In the main there are two such factors:

1) The distortion, which constitutes a measure of the non-linear distortion in the loud speaker.

It is usually defined by the equation:

$$F_1 = \sqrt{\frac{a_2^2 + a_3^2 + a_4^2 + \dots}{a_1^2}}, \dots \quad (1)$$

where a_1 and $a_{2,3,4\dots}$ indicate the amplitude of the fundamental and of the overtones occurring in the loud speaker, respectively.

2) The frequency characteristic, which indicates the sound intensity produced by the loud speaker when alternating voltages of different frequencies are applied to its terminals.

For ideal reproduction $F_1 = 0$, and the frequency characteristic must be flat, i.e. the sensitivity of the loud speaker must be the same for all frequencies. The deviations from these conditions found in practical cases, while they do not permit the drawing of any conclusion about their effect on the reproduction without the aid of listening tests, do however make possible a comparison of different loud speakers and particularly an estima-

tion of the influence which may be expected from any change in the construction.

In this article we shall concern ourselves with the manner in which the factors mentioned are obtained. In addition to the apparatus necessary for this purpose, the problem of the conditions under which the measurements must be carried out also deserves attention. This question will also be discussed in detail.

The measurement of sound

The simplest method and the one most often applied for the determination of sound intensities makes use of a microphone introduced into the sound field. If the microphone is calibrated, *i.e.* if the relation is known between the sound pressure and the microphone voltage generated thereby, the measurement of sound is reduced to the measurement of an electric voltage, which can be done with an amplifier and a voltmeter.

A condenser microphone (*fig. 1*) is usually used as measuring microphone, one of the reasons being that the calibration can in this case be carried out in a simple way, namely, by allowing an electrostatic force instead of the sound pressure to act on the membrane. In an earlier article in this periodical¹⁾ this calibration was discussed in detail. It is sufficient now to point out that the calibration



Fig. 1. Diagram of a condenser microphone. The membrane 1 is placed at a very small distance (16 μ) from the rigid plate 3. The separation is determined by the thickness of the ring 2 lying between 1 and 3 together form a condenser whose capacity varies upon vibration of the membrane. With constant charge voltage variations hereby occur between 1 and 3, which after amplification may be measured. Plate 3 is provided with a number of holes in order to prevent the rigidity of the cushion of air between 1 and 3 decreasing the sensitivity of the microphone.

takes place in two steps. We first determine the voltage which the microphone produces when an alternating force of a given amplitude and frequency acts on the membrane. A correction must then however be introduced, due to the fact that the microphone itself causes a distortion in the sound field, so that the variations in pressure found by measuring the voltage, are not exactly the same as in the undistorted sound field. This correction depends only on the shape and dimensions of the microphone, and need therefore only be determined once for a given type of microphone.

The determination may be by calculation or experimentally, by comparison of the results of the measurement with those obtained with a Rayleigh disc (see the article cited in footnote 1).

In *fig. 2* some measuring microphones are shown. The microphone amplifier is set up at some distance from the microphone, in order to avoid disturbance of the sound by the amplifier cabinet. The amplified voltage of the microphone can be measured with a voltmeter.

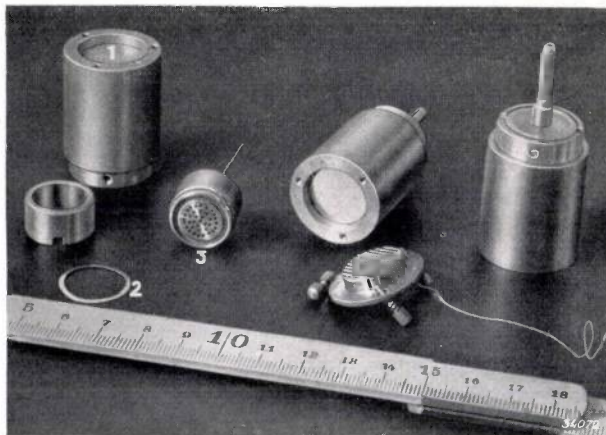

Fig. 2. Condenser microphone. Among the parts on the left may be seen the rear electrode 3, the intermediate ring 2 and the membrane stretched in its housing 1 (see *fig. 1*). In front of the middle microphone lies an auxiliary electrode in the form of a grid, which is used in the calibration of the microphone to exert an electrostatic force of known magnitude on the membrane.

Determination of distortion

The condenser microphone causes no appreciable non-linear distortion of the signal. If a pure sinusoidal voltage is fed to the loud speaker (fundamental), any overtones which appear in the microphone voltage, and whose intensity can be measured separately with a suitable analysing instrument, must be ascribed exclusively to the distortion in the loud speaker. From the individual measurement of each overtone the distortion F_1 can be calculated according to equation (1). The factor F_1 can also, however, be measured directly when the microphone voltage is divided into two parts by means of filters, one of which parts contains only the fundamental and the other only the overtones. The energy of these two signals can be measured with the aid of thermocouples. By means of a compensation circuit, the principle of which is given in *fig. 3* and is explained in the text beneath, F_1 can be read off directly from a scale.

It must be mentioned in passing that the degree of distortion is indicated not only by the factor F_1 , but also by a factor defined by the formula:

¹⁾ J. de Boer, Absolute sound pressure measurements, Philips techn. Rev. 1, 82, 1936.

$$F_2 = \sqrt{\frac{2a_2^2 + 3a_3^2 + 4a_4^2 + \dots}{a_1^2}} \quad (2)$$

In this formula greater weight is assigned to the higher harmonics, in agreement with the physiological fact that the higher harmonics lead more quickly to an unpleasant lack of purity than to the low ones. F_2 like F_1 can be determined from the separately measured overtones, or directly by means of an arrangement like that of fig. 3, when an amplifier V is used whose amplification increases proportionally with the frequency.

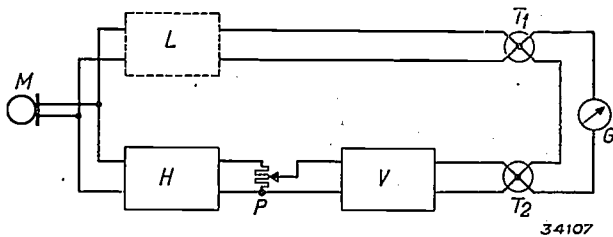

Fig. 3. Sketch showing the principle of the compensation circuit for direct measurement of the distortion factor F_1 . The filter L which passes only low frequencies passes only the fundamental (a_1) of the voltage of the microphone M . The energy of this voltage is measured by the thermocouple T_1 . The overtones of the microphone voltage are sifted out by the filter H passing only high frequencies, and they are then brought to about the same intensity as the fundamental in the amplifier V . The potentiometer P is so adjusted that the output voltages of T_1 and T_2 exactly compensate each other, which is ascertained by means of the galvanometer G . The setting of P then provides a measure of the ratio of $(a_2^2 + a_3^2 + a_4^2 + \dots)$ and a_1^2 . The filter L can also be omitted. One then actually measures the ratio of

$$(a_2^2 + a_3^2 + a_4^2 + \dots) \text{ and } (a_1^2 + a_2^2 + a_3^2 + \dots),$$

by which the value of F_1 is also determined unambiguously.

Recording the frequency characteristic

In order to record the frequency characteristic the voltage of the measuring microphone is measured while the frequency of the voltage on the loud speaker is varied. The voltage measured will at any frequency be proportional with the electrical energy supplied to the loud speaker. One would therefore prefer to keep this energy constant during the recording of the characteristic. This, however, requires rather elaborate measures, since the impedance of the loud speaker changes with the fre-

quency. In practice therefore either the amplitude of the voltage or that of the current is kept constant during the measurements, and one then obtains two frequency characteristics which will in general be different. The characteristic recorded at a constant voltage amplitude is important when the loud speaker is to be connected with an amplifier which gives a constant output voltage, as for example for radio distribution. If however the final amplifier gives a constant current (as in ordinary receiving sets with pentode) it is clear that the loud speaker to be used must be judged according to the characteristic recorded with constant current.

The voltage with variable frequency required for recording the characteristic is produced by a tone generator, the frequency of which can be varied within very wide limits (25 to 16 000 c/s.) by means of a rotating condenser. The voltage of the tone generator is supplied to the loud speaker via an amplifier. This amplifier must not of course falsify the loud speaker measurement, and must therefore have a perfectly flat frequency characteristic and only very slight distortion. Furthermore it must be able to give, as desired, a practically constant output voltage or output current, which means that the internal resistance must practically be made zero or infinite.

The point-by-point determination of a frequency characteristic is a time-consuming operation, since, because of the sudden variation which may occur in the curve, it is necessary to measure very many points. Since such measurements must be carried out repeatedly in the Philips Laboratory, an installation is used which automatically records the required frequency characteristics. The principle of the apparatus is very simple (fig. 4). A synchronous motor turns the variable condenser of the tone generator so that the frequency of the loud speaker current varies continuously, while the amplified voltage of the measuring microphone is recorded by a recording voltmeter on a band moving at a constant velocity. It is however desirable to draw the frequency characteristic in logarithmic coordinates in order to do justice to all parts of the

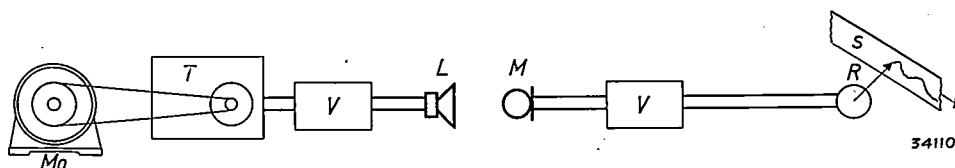

Fig. 4. Diagram of the apparatus for the automatic recording of frequency characteristics, M microphone, T tone generator, V amplifier, L loud speaker, R recording voltmeter, S moving band.

extensive frequency and intensity range²⁾. As to the frequency, a logarithmic scale is obtained by arranging that the driving mechanism of the tone generator is such that the angle between any two positions of the mechanism is always proportional to the ratio between the two corresponding frequencies. In other words, with motion at constant velocity the frequency passes through an equal number of octaves in equal time intervals, and an octave thus always has the same width on the measuring band.

For the voltages to be measured, logarithmic registration is obtained in the following way³⁾. The voltage to be measured is supplied to an amplifier whose amplification can be regulated by a so-called logarithmic potentiometer. This is a potentiometer in which the resistances between the successive contacts form a geometrical progression (see fig. 5); a rotation of the contact arm through a given angle is always followed by a change of the output voltage by the same factor, no matter what the initial position may be. With a given input voltage of the amplification there is therefore proportionality between the angle of rotation of the potentiometer and the logarithm of the output voltage delivered. The converse is also true: in order to obtain a constant output voltage the potentiometer must in each case be set, so that its po-

sition is proportional to the logarithm of the input voltage. This "volume control" is automatically obtained by causing the shaft of the potentiometer

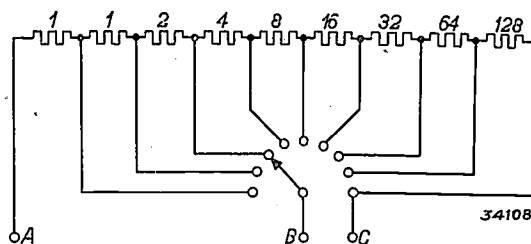

Fig. 5. Logarithmic potentiometer. At each jump of the contact arm the resistance between A and B increases by the same factor f (here assumed to be 2). The potentiometer in the apparatus described has 60 steps. There are four such potentiometers with $f = 1.122, 1.059, 1.029$ and 1.011 respectively. The voltage scale then covers $60 \times f = 60$ db; 30 db, 15 db and 6 db respectively. Moreover such potentiometers are in general use as volume regulators, in radio sets for example, for the purpose of obtaining a uniform variation of the subjective sound intensity according to the law of Weber and Fechner.

to be driven simultaneously by two magnetic couplings which turn in opposite directions at a constant velocity (see fig. 6), one of which is more strongly magnetized when the output voltage of the amplifier is greater, the other when it is smaller than a constant comparison voltage serving as zero level. In the first case therefore coupling 1 dominates and carries the potentiometer shaft along with it, so that the output voltage is lowered until it reaches the value of the comparison voltage. At that moment the two couplings have the same magnetization, the two couples are in equilibrium and the potentiometer remains

²⁾ R. Vermeulen, Octaves and decibels, Philips techn. Rev. 2, 47, 1937.

³⁾ Cf. also: E. C. Wente, E. H. Bedell, K. D. Swart jr. J. Acoust. Soc. Am. 6, 121, 1935; E. Meyer and L. Keidel, E.N.T., 12, 37, 1935; H. J. von Braunmühl and W. Weber E.N.T. 12, 221, 1935.

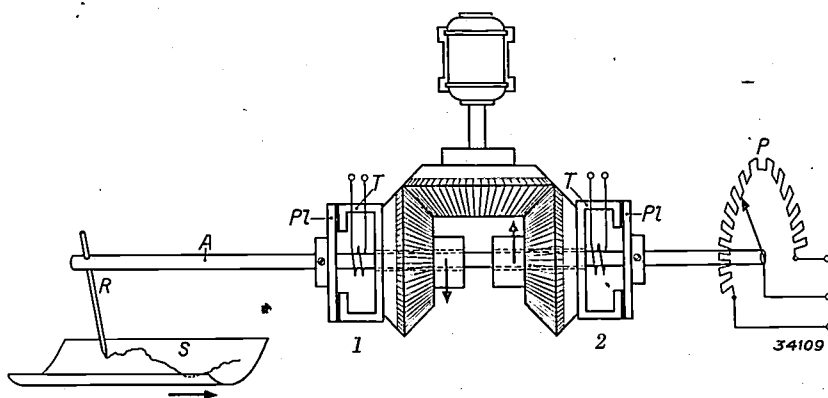

Fig. 6a. Driving mechanism of the logarithmic potentiometer⁴⁾ by means of two magnetic couplings 1 and 2. The iron discs Pl are rigidly fastened to the shaft A , which bears the arm of the potentiometer P and the recording style R , and lie in slight frictional contact with the drums T which turn continually in opposite directions. When the magnet in coupling 1 is more strongly magnetized than that in 2 the shaft A is carried around in one direction due to the greater pressure and the consequent increased friction between T and Pl of coupling 1, and vice versa. On the recording film S the position of the potentiometer is registered. The mechanism reacts extremely rapidly. When the drums T are allowed to rotate at their maximum velocity the whole voltage scale (60 steps of the potentiometer, see fig. 5) is passed over in $1/10$ sec. In ordinary cases, in order not to subject the couplings to unnecessary wear, a velocity of $1/10$ of the maximum is used.

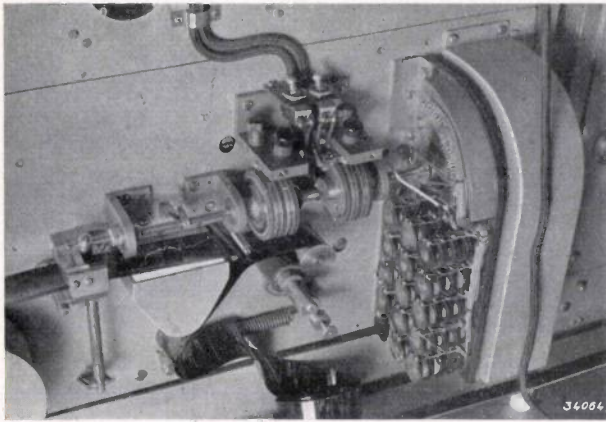

Fig. 6b. Photograph of the mechanism sketched in fig. 6a. On the right may be seen two of the potentiometers of fig. 5 for a scale of 60 and 30 db, respectively.

stationary. When the output voltage is lower than the comparison voltage, coupling 2 takes over and the potentiometer is taken along in the opposite direction until once more the output voltage is equal to the comparison voltage. The arrangement works very rapidly, so that rapid variations of the input voltage of the amplifier (steep parts of the frequency characteristic to be measured) are followed.

A style is attached to the shaft of the potentiometer, which records the position of the potentiometer on the above mentioned band, which moves in the direction of the shaft (fig. 6). The band is a piece of "Philimil" film⁴), in the black covering layer of which a transparent line is scratched by the recording style. The record obtained is reproduced by photographic printing, and the scale of frequencies and voltages is introduced on the positive.

In fig. 7 is a photograph of the complete installation which clearly shows the different parts here discussed.

Further consideration of the conditions of measurement

In the above we have continually spoken of "the" distortion and "the" frequency characteristic of a loud speaker. Actually however the determination of these factors for a single loud speaker may produce very varied results. In the first place

⁴) This film is used in sound recording by the Philips-Miller system (Philips techn. Rev. 1, 230, 1936). The "Philimil" film has for our purpose the advantage that it is very easy to work with.

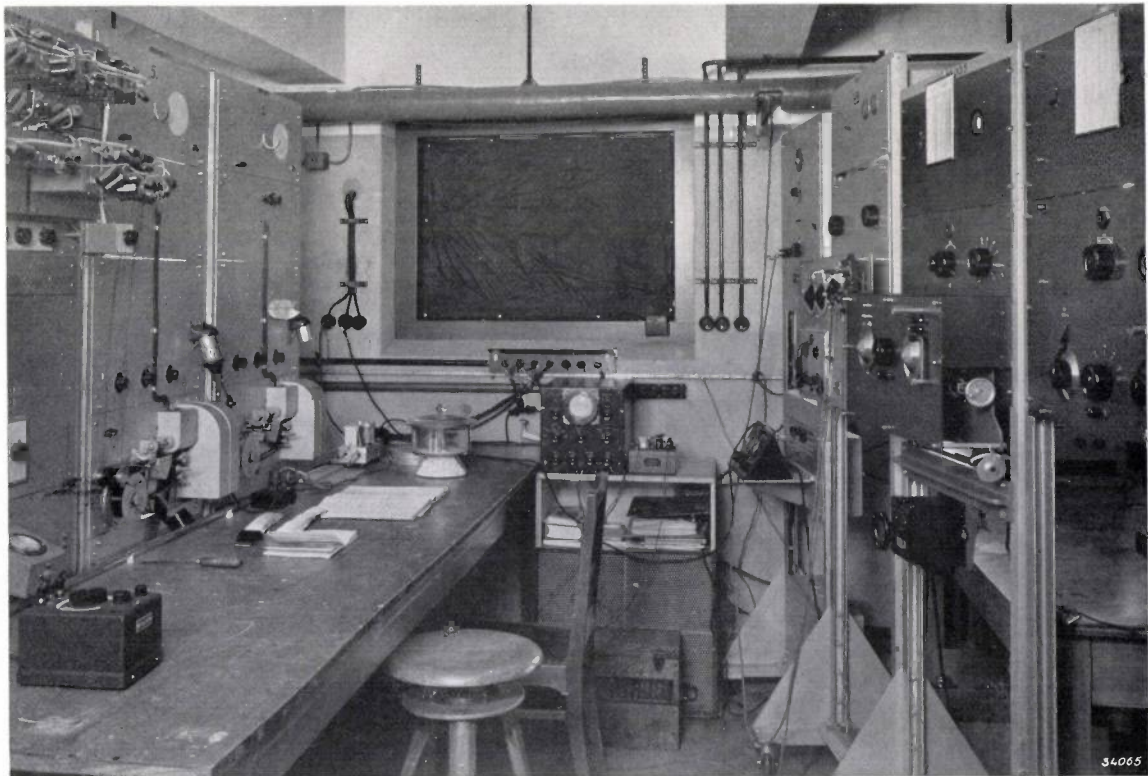

Fig. 7. The complete installation for automatic recording of frequency characteristics. On the left the recording apparatus proper, in duplicate. On the right two tone generators which supply the voltage for the loud speaker, and behind them the amplifier for this voltage. On the wall to the right and left of the window a series of contacts and binding posts which provide connections with other rooms where loud speakers may be set up for measurement.

the sound radiation of the loud speaker is not the same in both directions, and in the second place, under ordinary circumstances, in addition to the direct sound of the loud speaker, there is also the indirect sound, which reaches the microphone only after one or more reflections against the walls, etc. How must the measurements be arranged in order to obtain results which really do form a measure of the usefulness of the loud speaker?

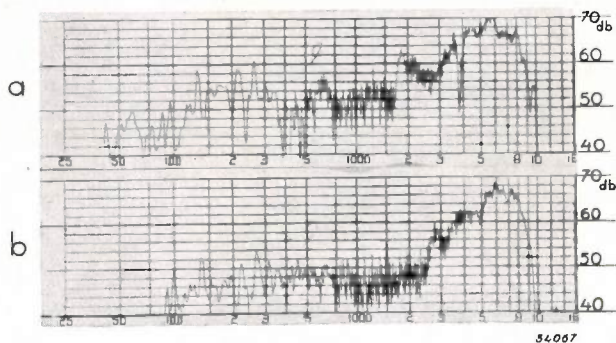

Fig. 8. Frequency characteristics of two different loud speakers recorded in an ordinary living room. The combination of direct and indirect sound causes numerous irregularities which render the interpretation of the curve practically impossible.

It would seem obvious that the measurements should be carried out under the same conditions as those under which the loud speaker is used in practice, thus, for example in an ordinary living room. The result of such a measurement is given in *fig. 8*. Due to the interference of direct and indirect sound numerous irregularities are obtained in the frequency characteristics, and the resulting diagram is so little characteristic of the loud speaker used that one could say with some truth that *fig. 8* represents a measurement of the properties of the room rather than of the loud speaker.

Measurement of the direct sound

In the open air

In order to gain some information about the loud speaker itself, it is thus necessary in the first place to measure the direct sound alone. All reflecting walls must be removed from the sound field, which makes it advisable to carry out the measurements out of doors. When this is done only the ground remains which might still cause unwanted reflections. This difficulty can however be met by placing the loud speaker and microphone very high, for instance projecting over the edge of a high roof. Such an arrangement is shown in *fig. 9*.

Because of the above-mentioned dependence of the sound radiation on the direction, the frequency

characteristic and the distortion must be measured not only at the axis of the loud speaker, but also in directions at different angles to the axis. The loud speaker must therefore be placed on a turntable so that it can be set at different angles with respect to the fixed connecting line between the microphone and the centre of the turn-table.

For a complete record the measurements should be done in all possible directions. The investigation would however thus become extremely elaborate, and moreover the result (a whole series of characteristics) would be very difficult to judge. For these reasons it is very often considered sufficient to take a measurement on the axis of the loud speaker and one in a direction at 45° to this axis. Two such frequency characteristics are reproduced in *fig. 10*. These measurements are supplemented

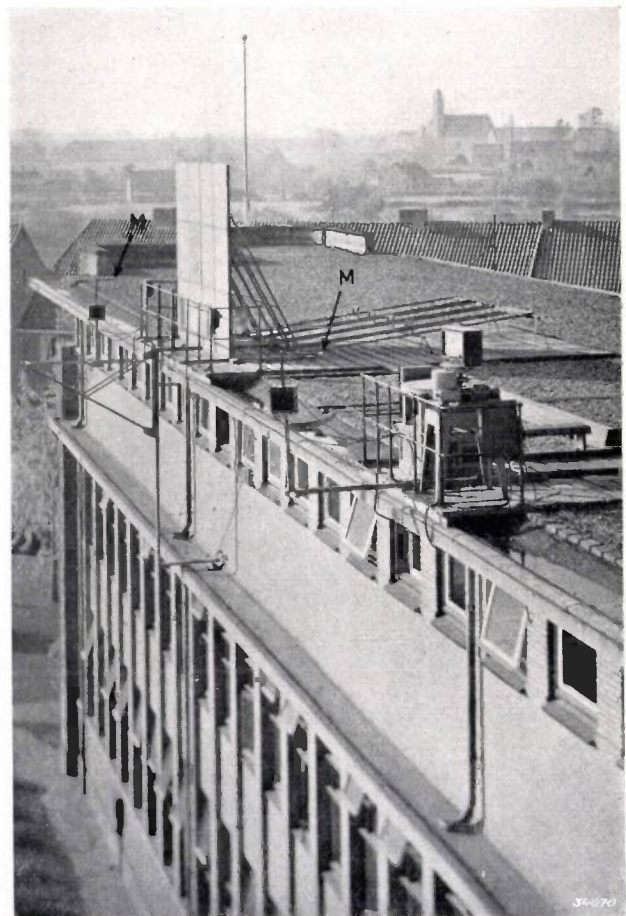

Fig. 9. Set up of loud speaker and measuring microphone (*M*) in the open air. The loud speaker (radio set) is placed on a turntable. In front of it is the microphone amplifier. For the avoidance of interferences due to induction the connections from the microphone to the amplifier are shielded by a tube. The large plate seen in the background is used as an "infinitely large" baffle in the investigation of separate loud speaker systems, i.e. when the effect of cabinet or baffle of the loud speakers must be excluded. In order in such cases also to be able to measure in different directions, the measuring microphone with its amplifier is fastened to a rotating arm.

by a determination of the sound intensity, keeping the frequency constant and varying the direction continuously. In this way a diagram is obtained

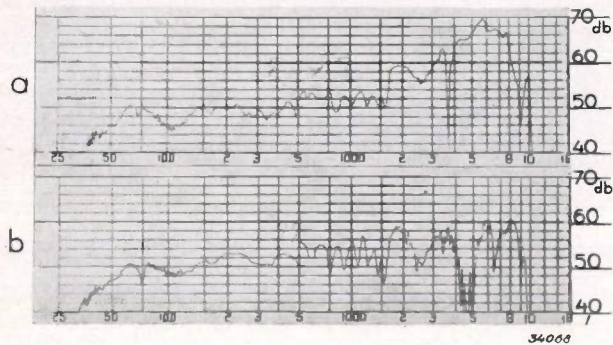

Fig. 10. Frequency characteristics of a single loud speaker measured in the open air at angles of 0° and 45° , respectively. The loud speaker is the same as in the case of fig. 8a, but was here placed in the large baffle of fig. 9.

of the directional distribution of the sound intensity which may be compared with light distribution curves such as are customarily recorded for sources of light. The directional diagram must be recorded for different frequencies (for instance 1 000, 2 000 and 4 000 c/s), since loud speakers generally show a selective directional effect⁵⁾. The direction diagrams are recorded with the same recording apparatus as the frequency characteristics, whereby only the adjustment of the tone generator remains unaltered while the loud speaker is turned continuously.

The "soft chamber"

Measurement out of doors has two objections. The results are influenced by extraneous noise, and one is dependent upon the weather. As for the first objection, it may be met by introducing a filter behind the microphone, which only passes the frequency which is supplied to the loud speaker. There is however no solution to the difficulty of rain and wind. There have therefore been made numerous attempts to imitate out-of-doors conditions in a room, a so-called "soft chamber". For this purpose the walls of the room to be used must be covered with a material which absorbs sound as completely as possible. The available technical damping materials have been found inadequate. With the very best materials of this kind it is scarcely possible to attain absorption coefficients higher than 70 per cent. The effect of the remaining reflections on the measurements can be roughly calculated in the following way. The variations in pressure

in a reflected sound wave, with the absorption coefficient mentioned, amount to $100/\sqrt{1-0.7} = 55$ per cent of those in the original wave. Let us assume that the path of a reflected beam which strikes the microphone is on the average five times as long as the path of the direct beam; as the intensity of the sound decreases with the square of the distance and the sound pressure proportionally to this distance, the variation in pressure at the microphone in the reflected wave is $\frac{1}{5} \times 55 = 11$ per cent of the direct beam. In an ordinary rectangular room there are six reflecting surfaces, and thus the same number of beams reflected once. In the most unfavorable case all reflected rays can be in phase with the direct ray at the microphone, or all of them will be in the opposite phase at that point. The variations in pressure measured may then in the first case amount to $100 + 6 \times 11 = 166$ per cent of the undisturbed value, and in the other to $100 - 6 \times 11 = 34$ per cent.

One must therefore have a much higher absorption coefficient than 70 per cent. It may be seen in fig. 11 how the wall covering of the "soft chamber" is actually constructed. An absorption coefficient of about 97 per cent has been reached in this case.

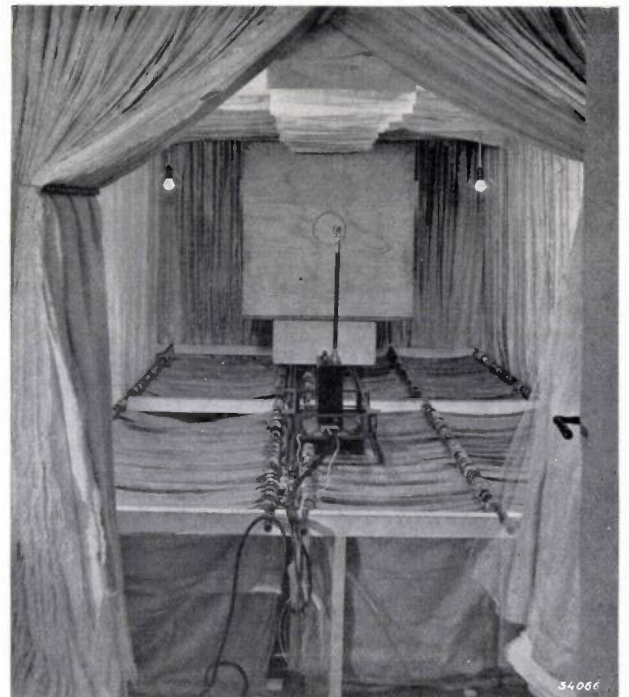

Fig. 11. The "soft chamber" in the Philips laboratory. In order to make the walls as sound absorbent as possible they are first covered with a layer of a technical absorbent material (slag-wool). In front of this layer and perpendicular to the walls strips of crepe paper $\frac{1}{2}$ m wide are hung $1\frac{1}{2}$ cm apart. On the floor this covering is replaced by a series of curtains hung close to each other, which can be pushed to one side when it is necessary to enter the room in order to set up the measuring microphone.

⁵⁾ J. de Boer, Sound diffusers in loud speakers, Philips techn. Rev. 4, 144, 1939.

If the above estimation is repeated with this value maximum deviations of 20 per cent are found, which means therefore about 2 db too much or too little. This is still rather high but it is nevertheless permissible for many measurements.

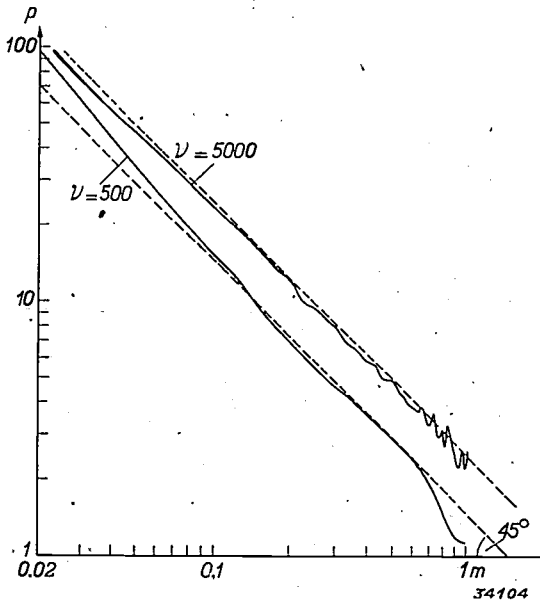

Fig. 12. Decrease of the sound pressure with increasing distance from a point source of sound measured in the chamber of fig. 11 for frequencies of 500 and 5 000 c/sec, respectively. The theoretical decrease (with an absorption by the walls of 100 per cent) is indicated in each case by a broken line.

The residual influence of the walls can also be controlled directly in a simple way, by studying the distribution of pressure around an approximately point source of sound. The sound pressure in that case, in the entire absence of indirect sound, would be independent of the angle and would decrease proportionally with the distance. In fig. 12 is a diagram of the distribution of pressure measured. As may be seen the theoretical variation is fairly closely approached.

We may mention a general consideration for all measurements of the direct sound from loud speakers. In order to render the influence of disturbances as small as possible, it is desirable to measure at high intensities, and it would therefore seem advisable to place the microphone close to the loud speaker. This is, however, impossible for the following reason. Since an ordinary loud speaker is anything but a point source, interferences may occur between the waves which are radiated by different parts of the cone. If therefore the microphone is shifted along the axis of the loud speaker, successive minima and maxima of intensity are observed. Only at distances greater than two or three times the diameter of the radiator is this effect diminished to such a degree that the

measurements experience no appreciable effect. For the investigation of ordinary radio loud speakers, therefore, it is a general rule that the microphone must stand at least 1 m from the loud speaker.

Total sound radiation of a loud speaker

In certain respects analogous concepts can be used in the study of sources of sound as in that of sources of light. This was noted above in the discussion of directional distribution. Another quantity which is always used in light technology and for which an analogue can be conceived in acoustics is the total light flux. The analogue is obviously the total sound radiation produced by a loud speaker. This quantity is particularly important when it is a question of "filling a room with sound", i.e. when the indirect sound contributes a considerable portion to the formation of the sound field. In the extreme case when the indirect sound dominates completely over the direct (i.e. when there is a very long reverberation), even the average density E_m of the sound energy in the room is still dependent only on the total sound radiation W :

$$E_m = 0,072 \frac{T}{V} \cdot W \dots \dots (3)$$

T and V are the reverberation time and the volume of the room, respectively⁶⁾. The total sound radiation can be determined in different ways. The most direct method consists in recording the sound intensity I_a in the above-described way as a function of the angle a to the axis, and calculating the total sound radiation W by means of the following formula (see fig. 13 for its derivation):

$$W = 2 \pi r^2 \int_0^\pi I_a \sin a \, da \dots \dots (4)$$

It is unnecessary to state that this method is quite elaborate. Another method is the following. The electrical power taken up by the loud speaker is determined a) under normal conditions, i.e. when it is radiating sound, and b) when radiation has been made impossible by fixing the loud speaker coil. The difference may be considered as the acoustic power radiated. Apart from the lack of accuracy of such a differential measurement (the acoustic power amounts to only a few per cent of the total⁷⁾) there is also the objection that the

⁶⁾ The equation may easily be derived from equations (4) and (5) in the article by A. Th. van Urk, Auditorium acoustics and reverberation, Philips techn. Rev. 3, 65, 1938.

⁷⁾ J. de Boer, The efficiency of loud speakers, Philips techn. Rev. 4, 301, 1939.

mechanical losses which occur during the movement of the coil and which are not accurately known, are also included in the difference of power found.

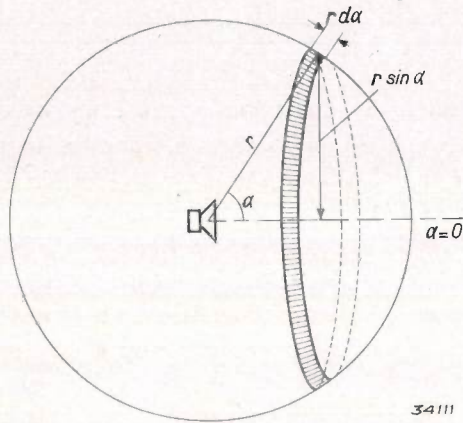

Fig. 13. Since we may consider the axis of the loud speaker ($\alpha = 0$) as the axis of symmetry of the sound field, the same sound intensity I_α will be found at all points on the shaded segment of the sphere. The area of the segment amounts to $2\pi \cdot r \sin \alpha \cdot r da$. The energy incident on the segment is $I_\alpha \cdot 2\pi \cdot r \sin \alpha \cdot r da$, and the total sound energy radiated by the loud speaker is found by integrating over all values of α . The result is formula (4).

The simplest method of determining the total sound radiation makes use of the relation given by equation (3). The conditions under which this equation is valid are realized in a so-called "hard chamber" *i.e.* a room in which the walls absorb little sound. Due to the repeated reflection of the sound waves, the sound field in this case, as is required by the formula, is practically entirely determined by the indirect sound, and in the ideal case the average energy density E_m is the same at all points in the room. To use again the analogy with light, the "hard chamber" may be compared to an Ulbricht sphere. In the acoustic example however there is an additional difficulty to be met, which does not occur in the optical case, namely the occurrence of standing waves: although the average energy density E_m which is to be measured is constant, the sound pressure nevertheless exhibits strong local maxima and minima⁸⁾ due to interference phenomena. If it is desired to know the true average, the microphone must be moved rapidly through the chamber a distance of

⁸⁾ The uniform distribution of energy forms no contradiction to the observation of such maxima and minima in the sound measurements. The energy at every point is composed of a potential and a kinetic part. In the loop of a standing wave the potential part (the pressure amplitude) is at a minimum and the kinetic part (the velocity amplitude) at a maximum; at a node the reverse is true. With the condenser microphone we measure only the pressure amplitude; the kinetic part of the energy thus remains unobserved.

at least one wave length during the measurement. One may also keep the microphone stationary and cause the maxima and minima (the loops and nodes of the standing waves) to change their position rapidly and continuously. Since the positions of these maxima and minima are determined by the dimensions and shape of the chamber, by the frequency and by the directional distribution of the loud speaker, the purpose in view can be achieved in three ways. The dimensions (shape) of the chamber can be varied by means of moving reflecting surfaces (*fig. 14*); the frequency of the loud speaker current can be varied quickly over a given interval, and the directional distribution of the direct sound in the chamber can be varied, for instance by allowing the loud speaker to rotate about a vertical axis. Actually several of the possibilities mentioned are used simultaneously in the measurement.

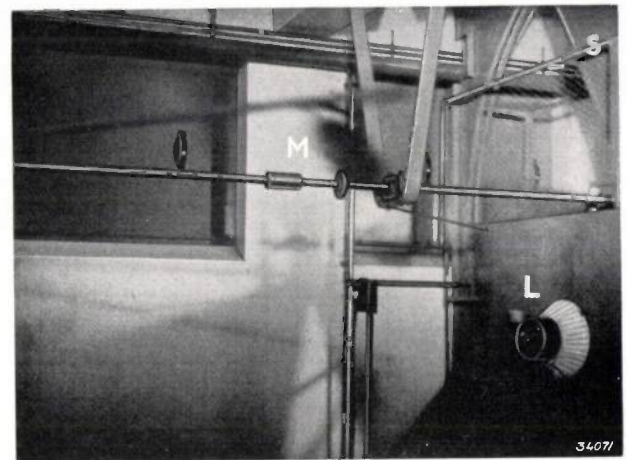

Fig. 14. A view of the "hard chamber" during a measurement. On the extreme right may be seen the reflecting surfaces in the form of sector-shaped partitions S , which rotate in their own planes. Because of its rapid motion in a wide circle the measuring microphone is badly blurred. This is also the case with the rotating loud speaker L .

Combination of direct and indirect sound

The material which has been discussed until now could be summarized briefly in the following way. The measurement of a loud speaker in an ordinary room gives a result which is too complicated due to the incalculable superposition of direct and indirect sound. In the extreme cases of a "soft chamber" and a "hard chamber" simple results are obtained, since in the one case only the direct and in the other only the indirect sound determines the result. One may now attempt to approximate a "normal chamber" (ordinary room) to some extent when the measurements are done under out-of-door conditions, while allowing the loud

speaker to rotate rapidly about a vertical axis. What is then measured is the average value of the sound intensity in all horizontal directions:

$$I_d = \frac{1}{2\pi} \int_0^{2\pi} I_\alpha \, d\alpha \quad \dots \quad (5)$$

Compared with the measurements of I_0 alone (soft chamber), this measurement differs by the fact that the values of I_α in directions other than $\alpha = 0$ and $\pi/4$, which manifest their presence as indirect sound in an ordinary room, are also included. With respect to the measurement of the total sound radiation (hard chamber) the difference is, as may be seen from equation (4), that the same weight is assigned to all values of I_α , while in equation (4) the term I_0 (the direct sound on the axis of the loud speaker) was determined by the relation $\sin \alpha = 0$. It is therefore clear that the measurement of the

integral (5) represents a certain compromise between a measurement of I_0 alone and a measurement of the total sound. A frequency characteristic measured in this way is reproduced in *fig. 15*.

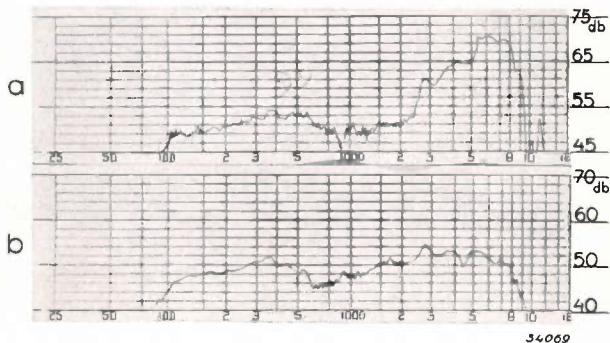

Fig. 15. Frequency characteristic recorded out of doors, a) with a stationary loud speaker at an angle of 0° , b) with a rapidly rotating loud speaker. (The loud speaker is the same as in Fig. 8b).

ABSTRACTS OF RECENT SCIENTIFIC PUBLICATIONS OF THE N.V. PHILIPS' GLOEILAMPENFABRIEKEN

1429: Balth. van der Pol and C. C. J. Addink: *Orchestral Pitch. A cathode ray method of measurement during a concert* (Wirel. World 44, 441-442, May 1939).

A detailed article has since appeared in this periodical on the same subject: Philips techn. Rev. 4, 205, July 1939).

1430: M. J. O. Strutt and K. S. Knol: *Messungen von Strömen, Spannungen und Impedanzen bis herab zu 20 cm Wellenlänge* (Hochfrequenztechn. u. Elektroakust. 53, 187-195, June 1939).

Due to the inductive and capacitive coupling between supply lines and electrodes of the measuring instruments for currents and voltages — in connection with the occurrence of skin effect in connections and finite transit times of the electrons in high vacuum tubes — great difficulties occur in the measurement of alternating currents and voltages as well as impedances for waves shorter than a few metres. These difficulties are overcome by using diodes, thermocouples and hot wire ammeters of a special construction working with air expansion. Furthermore these new instruments are employed in measuring impedances of several ohms to several thousand ohms at wave lengths down to 20 cm.

1431*: A. Bouwers: *Elektrische Höchstspannungen* (333 pages; Springer, Berlin 1939).

In this first volume of *Technische Physik in Einzeldarstellungen* subjects are dealt with connected with the generation and application of electrical voltages of at least several hundred kilovolts. After a description of the different methods used for the excitation of high tensions, follows a discussion of the calculation of the electric fields which occur with various simple forms of electrodes. On page 132 a summarizing table is given of a number of field formulae hereby obtained. In addition the properties of insulating media are discussed and the different parts of which a high tension installation is composed. In a separate chapter direct and indirect methods are described for the precise measurement of high voltages, and in conclusion the most important applications are discussed. The bibliography, which consists of 324 items, makes no claim to completeness, but it does contain all the articles which were consulted in writing the book.

*) An adequate number of reprints for the purpose of distribution is not available of those publications marked with an asterisk. Reprints of other publications may be obtained on application to the Natuurkundig Laboratorium, N.V. Philips' Gloeilampenfabrieken, Eindhoven (Holland), Kastanjelaan.

speaker to rotate rapidly about a vertical axis. What is then measured is the average value of the sound intensity in all horizontal directions:

$$I_d = \frac{1}{2\pi} \int_0^{2\pi} I_\alpha \, d\alpha \quad \dots \quad (5)$$

Compared with the measurements of I_0 alone (soft chamber), this measurement differs by the fact that the values of I_α in directions other than $\alpha = 0$ and $\pi/4$, which manifest their presence as indirect sound in an ordinary room, are also included. With respect to the measurement of the total sound radiation (hard chamber) the difference is, as may be seen from equation (4), that the same weight is assigned to all values of I_α , while in equation (4) the term I_0 (the direct sound on the axis of the loud speaker) was determined by the relation $\sin \alpha = 0$. It is therefore clear that the measurement of the

integral (5) represents a certain compromise between a measurement of I_0 alone and a measurement of the total sound. A frequency characteristic measured in this way is reproduced in *fig. 15*.

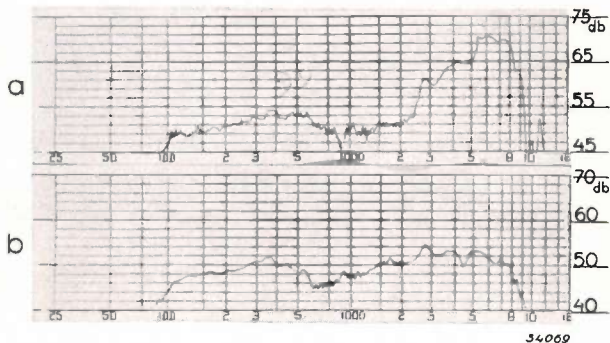

Fig. 15. Frequency characteristic recorded out of doors, a) with a stationary loud speaker at an angle of 0° , b) with a rapidly rotating loud speaker. (The loud speaker is the same as in Fig. 8b).

ABSTRACTS OF RECENT SCIENTIFIC PUBLICATIONS OF THE N.V. PHILIPS' GLOEILAMPENFABRIEKEN

1429: Balth. van der Pol and C. C. J. Addink: *Orchestral Pitch. A cathode ray method of measurement during a concert* (Wirel. World 44, 441-442, May 1939).

A detailed article has since appeared in this periodical on the same subject: Philips techn. Rev. 4, 205, July 1939).

1430: M. J. O. Strutt and K. S. Knol: *Messungen von Strömen, Spannungen und Impedanzen bis herab zu 20 cm Wellenlänge* (Hochfrequenztechn. u. Elektroakust. 53, 187-195, June 1939).

Due to the inductive and capacitive coupling between supply lines and electrodes of the measuring instruments for currents and voltages — in connection with the occurrence of skin effect in connections and finite transit times of the electrons in high vacuum tubes — great difficulties occur in the measurement of alternating currents and voltages as well as impedances for waves shorter than a few metres. These difficulties are overcome by using diodes, thermocouples and hot wire ammeters of a special construction working with air expansion. Furthermore these new instruments are employed in measuring impedances of several ohms to several thousand ohms at wave lengths down to 20 cm,

1431*: A. Bouwers: *Elektrische Höchstspannungen* (333 pages; Springer, Berlin 1939).

In this first volume of *Technische Physik in Einzeldarstellungen* subjects are dealt with connected with the generation and application of electrical voltages of at least several hundred kilovolts. After a description of the different methods used for the excitation of high tensions, follows a discussion of the calculation of the electric fields which occur with various simple forms of electrodes. On page 132 a summarizing table is given of a number of field formulae hereby obtained. In addition the properties of insulating media are discussed and the different parts of which a high tension installation is composed. In a separate chapter direct and indirect methods are described for the precise measurement of high voltages, and in conclusion the most important applications are discussed. The bibliography, which consists of 324 items, makes no claim to completeness, but it does contain all the articles which were consulted in writing the book.

*) An adequate number of reprints for the purpose of distribution is not available of those publications marked with an asterisk. Reprints of other publications may be obtained on application to the Natuurkundig Laboratorium, N.V. Philips' Gloeilampenfabrieken, Eindhoven (Holland), Kastanjelaan.

1432: J. H. de Boer, H. C. Hamaker and E. J. W. Verwey: Electro-deposition of a thin layer of powdered substances (Rec. trav. chim. Pays Bas 58, 662-665, June 1939).

A simple method is described of depositing thin, uniform, adhering layers of great density of powdered substances on metallic or electrically conducting underlayers. The substance is deposited electrophoretically and the method is based on:

- 1) the use of suspensions of the substance which has been finely divided by mechanical means, instead of colloidal solutions, and on
- 2) the application of suitable polar organic liquids as media of dispersion.

1433: J. L. Snoek: Mechanical after-effect and chemical constitution (Physica 6, 591-592, July 1939).

In connection with 1399, in which it was shown that small amounts of carbon and nitrogen can cause pure iron to have a strong magnetic after-effect, an attempt was now made to discover whether a mechanical after-effect connected with the former magnetic one could be ascertained. An iron wire carefully freed from carbon by means of hydrogen was found to exhibit only a slight damping of the torsional oscillations between -50° and $+100^{\circ}$ C, which damping is moreover independent of the temperature. After taking up 0.02% of nitrogen the damping clearly shows a maximum at $+9^{\circ}$ C. Upon taking up carbon the torsional damping shows a maximum at $+24^{\circ}$ C. When an iron wire saturated with nitrogen is heated successively to 58° , 100° and 150° C, part of the nitrogen leaves the solid solution and forms a nitride. The maximum of the damping is very much lowered by this treatment. It is therefore very probable that the damping is entirely determined by the amount of nitrogen or carbon in solid solution.

1434-1435: K. F. Niessen and G. de Vries: Ueber die Empfangsimpedanz einer Empfangsantenne. I. Strahlungswiderstand. II. Reaktanz und Abbildungen (Physica 6, 601-616 and 617-627, July 1939).

The radiation impedance is discussed of an aerial assumed not under load, with a current distribution which, according to von Korshenewsky, will be established upon the incidence of a flat signal wave whose electrical vector oscillates parallel to the aerial. The current distributions are given for several receiving aerials and for several transmitting aerials fed at the centre; they are due to von

Korshenewsky and Labus. The reception resistance as a function of the length of the receiving aerial in wave lengths is worked out in detail.

Under the above-mentioned circumstances the reactance of the receiving aerial is calculated in the second article. Reception resistance and reactance are then expressed as the ratios of the thickness and the length of the receiving aerial to the wave length in question. For a given thickness of wire they are compared with the same quantities for the case of a transmitting aerial fed at the centre.

The reception resistance of the wire is usually greater than the radiation resistance in the case where the same wire is used as in a centre fed transmitting aerial, although the minima and maxima lie at about the same lengths.

1436: J. E. de Graaf: Industrial radiography on the continent of Europe (J. Inst. electr. Eng. 84, 545-551, May 1939).

A short survey is given of the possibilities of application of the röntgenographic examination of the macrostructure of raw materials and products, on which subject a series of articles has already appeared in this periodical: Philips techn. Rev. 2, 314, 350, 377, 1937 and 3, 92, 186, 1938. In addition the X-ray apparatus to be used for this macroscopic material inspection is described. This will be discussed shortly in this periodical.

1437: J. L. H. Jonker: Pentode and tetrode output valves (Wirel. Eng. 16, 274-286 and 344-349, June and July 1939).

The static and dynamic characteristics of screen grid valves are examined in order to find the conditions which must be satisfied by the static characteristic of such a valve in order to guarantee minimum distortion under all circumstances. In order to accomplish this the secondary emission must be suppressed and the deviations to which trajectories of the electrons are subject in the neighbourhood of the grids must be made as small as possible. The manner is further investigated in which secondary electrons pass between two electrodes, and two methods of suppressing this phenomenon are tested: the introduction of a space charge and of a suppressor grid. The best result was obtained by the combination of the two methods and the suppressor grid was found to be the more effective of the two. By careful design of shape and position of the electrodes provision can be made that the electron trajectories have only slight deviations.

GENERAL SURVEY OF THE PHILIPS PRODUCTS

INCANDESCENT LAMPS for

general lighting purposes

roads, streets, grounds, platforms, houses, offices, factories, ships, schools, churches, shops, show-windows, exhibitions, museums, barracks, air-raid protection

projectors

frontages, show-windows, stage, photographic studios, film studios, aerodromes, light-houses and other beacons, aeroplanes, locomotives, military searchlights, motor-cars, motor cycles, bicycles

projection purposes

standard and sub-standard film, picture scanning in sound-film installations, projection of stationary images (*slides*), micro-projection (*tungsten arc and tungsten ribbon lamps*)

publicity and festive lighting

decorative lighting (*long and short tubular lamps*) in theatres, restaurants, ships

miscellaneous special purposes

telephone exchanges, mines, rail- and tramways, army

various apparatus and instruments

workbenches, sewing machines, vacuum cleaners, measuring apparatus, switchboards, wireless receivers, medical instruments

GAS-DISCHARGE LAMPS AND THEIR GEAR

sodium lamps for

outdoor lighting (*roads, grounds, frontages, publicity hoardings, aerodromes*)
indoor lighting (*industrial, photographic studios*)
scientific purposes

mercury lamps, with ordinary or fluorescent bulb, either separately or together with incandescent lamps, for outdoor lighting (*streets, grounds, platforms, advertising hoardings*)

indoor lighting (*industrial, offices, shops, show-windows, photographic studios*)

photography (*printing, copying films*)

projection (*standard and sub-standard film, microphotography, meteorological purposes*)

irradiation (*biological and chemical processes*)

projectors (*aviation grounds, aeroplanes, searchlights*)

ultraviolet irradiation (*producers of fluorescence*)

fluorescent mercury lamps (*tubular shape*)

for decorative and architectonic indoor lighting

neon tubes for

publicity purposes

plant irradiation

the lighting of aviation grounds

discharge tubes for

demonstration purposes (*instruction*)

transformers, choke coils and condensers

for gas discharge lamps

FITTINGS FOR INCANDESCENT AND GAS-DISCHARGE LAMPS, also bicycle reflectors and dynamos

TUBES AND VALVES

oscillator tubes

triodes and pentodes with high and low outputs, for connection to D.C. mains, A.C. mains and batteries for transmitters and receivers (radio and television), high-frequency furnaces, measuring apparatus, apparatus for diathermy and ultra-short wave therapy

amplifier tubes

triodes, tetrodes, pentodes, hexodes. Special amplifier tubes for sound-amplifiers and measuring amplifiers (*for instance electrometer triodes*)

valves with combined functions

triode-hexodes, heptodes, triode-heptodes, octodes, other combined systems

rectifier valves with high vacuum and with gas-filling for receivers, amplifiers, transmitters, H.T. installations, industrial and other rectifier installations

relay valves for

television purposes, measuring apparatus, rectifier installations with adjustable voltage output

regulating tubes

voltage stabiliser tubes in the form of gas discharge tubes

current regulator tubes in the form of iron wire resistances and with gasfilling for *wireless receiving and transmitting apparatus, amplifiers, measuring instruments, and for the charging of batteries*

photo-electric cells with glass bulbs and quartz bulbs with gasfilling, with high-vacuum and amplification by secondary emission (*for instance electron multipliers*) for *soundfilm installations, television installations, supervisory installations, industrial and scientific purposes*

cathode ray tubes with

electrostatic, magnetic, and half-electrostatic

half-magnetic deflection, with screen diameters of from 3 to 39 cm, for *photographic recording and visual observation of oscillograms and for television purposes*

X-ray tubes, (see X-ray installations)

rare gas cartridges for protection against over-voltages in heavy current mains, low voltage mains, aeriads and parts of a circuit

tubes for special purposes

iconoscopes for *television transmitters*

magnetrons
acorn valves } for *generating decimetre waves*

thermo-couples

counting tubes for *alpha, beta, gamma and cosmic rays*

TRANSMITTING APPARATUS

broadcasting installations

stationary transmitters

installations for aviation

aircraft transmitting-receiving equipments

direction-finding equipments

radio compasses

ultra-shortwave and medium wave radio beacons

aerodrome transmitters and receivers

marine installations

coastal transmitters

ship's transmitters and receivers

direction-finding installations

radio beacons

studio and reporting car installations

transportable and portable transmitting-receiving equipments

receivers for special purposes

ultra-short wave radio links

WIRELESS RECEIVERS AND THEIR PARTS

wireless receivers for

connection to A.C. mains

feeding by batteries

feeding by D.C. as well as A.C.

radio gramophones

electric gramophones (*for connection to wireless sets*)

loudspeakers in cabinet, for use as extension speakers

car radio

aerial protection devices

aerial systems for interference-free reception, for connection to one wireless set

collective connection to a large number of sets

pick-ups

condensers (*dry and wet electrolytic condensers, also mica, paper and ceramic condensers*)

fixed condensers

variable condensers

trimmer condensers

loudspeakers

resistances (*wire resistances and high-ohmic resistances*)

potentiometers

choke coils, loudspeaker transformers

waveband switches

converter units

TELEVISION TRANSMITTING INSTALLATIONS

fixed and transportable types

X-RAY INSTALLATIONS AND ACCESSORIES

for medical purposes (*diagnostics, therapy*) and material research (*macroscopic and microscopic examination*)

X-ray apparatus for all purposes

X-ray tubes (*with protection against undesired radiation and high tension*) for diagnostics (*stationary and rotating anode*) therapy

contact therapy (*50 kV*)

superficial therapy (*100 kV*)

deep therapy (*up to 1000 kV*)

material research

valve tubes, with high-vacuum and with gas-filling, for diagnostics, therapy and material research

condensers

tube stands, couches and other auxiliary apparatus accessories for X-ray work

HIGH TENSION INSTALLATIONS for

nuclear research (2 MV and higher)

production of neutrons (at 600 kV equivalent to 300 g Ra + Be)

testing of insulation

with high direct voltages

with impulse voltages (4 MV stationary and up to 1.2 MV transportable ready for operation)

HIGH FREQUENCY FURNACES

MEASURING APPLIANCES AND THEIR AUXILIARY APPARATUS

cathode ray oscillographs for

making all oscillations visible

vibration pick-ups for

studying mechanical and acoustical vibration phenomena

cathode ray pressure indicators (Philips and Shell) for

the study and inertialess recording of pressure phenomena (*indication of internal combustion engines, examination of pumping installations, pressure surges in pipes for liquids*)

wave meters

recording field strength meters for examining

the field strength of transmitters
the radiation of receivers
fading phenomena

measuring bridges for measuring all impedances (*faults in cables, earth resistances, armature windings*)

measuring cells and L.F. oscillators for

the measurement of the specific resistance of liquids with the measuring bridge
the establishment of the ash content of sugar juices with the measuring bridge

generators for

all L.F. and H.F. measurements in wireless receivers and amplifiers in laboratories, factories and workshops

frequency modulators for

making visible the selectivity curves of wireless receivers

output meters for

receivers and amplifiers

universal apparatus for complete examination of

wireless receivers
radio valves

phonometers for

demonstrating difference in quality of power valves and rectifier valves in wireless receivers

ammeters

moving coil instruments for measuring direct current

alternating current (frequency up to 1000 c/s), with metal rectifier cell

alternating current (radio frequency), with thermo-cross

voltmeters

moving coil instruments for measuring D.C. voltages

A.C. voltages (frequency up to 1000 c/s), with metal rectifier cell

A.C. voltages (radio frequency), with thermo-couple

temperatures, with thermo-couple

valve voltmeters (*frequency up to 15 Mc/s*)

apparatus for determining the colour-fastness of textiles

FILM APPARATUS, PARTS AND ACCESSORIES

complete sound recording installations for film studios (35-mm film)

photographic sound recording apparatus
mixing and post-synchronising apparatus with interlock system
microphones, amplifiers
apparatus for sound reproduction (*Film-phonos*)

Philips-Miller sound recording apparatus for radio broadcasts (7-mm film)

twin recording and reproducing machines
twin reproducing machines
editing tables
amplifiers
cutting tape

complete soundfilm reproducing equipments

complete cinema equipments
projectors, sound-heads, lamp-houses, devices for slide projection, twin projectors with super high-pressure mercury lamps
amplifiers
loudspeakers, loudspeaker horns, baffle-boards, rectifiers, saving-stabilisers, arc-lamp resistances, projection screens
transportable reproducing equipments

INSTALLATIONS FOR SOUND-AMPLIFICATION AND IMPROVEMENT OF ACOUSTICS

permanent installations for

buildings, ships, large grounds, etc.
communication between rooms

transportable installations for

meetings, demonstrations, races, etc.

microphones

carbon microphones
ribbon microphones
crystal microphones

amplifiers

push-pull amplifiers in class A, AB and B connection

loudspeakers

moving coil with permanent magnet
cone loudspeakers
diaphragm loudspeakers
crystal loudspeakers

stands, preamplifiers, mixers, matching elements

horns, baffle-boards, sound diffusers, units for panel construction, combination cabinets, petrol aggregates, converters

APPARATUS FOR V.F. AND H.F. LONG DISTANCE TELEPHONY AND TELEGRAPHY VIA CABLES, OVERHEAD LINES OR WIRELESS COMMUNICATIONS

- installations for carrier telephony
- loading coils for
 - V.F. and H.F. telephony and telegraphy lines
- line amplifiers
 - 4-wire, 2-wire and programme amplifiers
- repeater valves
 - indirectly and directly heated
- transformers
- signalling converters
- secrecy equipment
- echo suppressors
- measuring apparatus for telephone purposes
- supply systems for telephone repeater stations

ARTICLES FOR HEAVY CURRENT ENGINEERING

- rectifiers (*oxide cathode, mercury pool and selenium rectifiers*) for industrial applications (*D.C. motors, excitation of magnetic chucks, magnets, etc.*)
- charging of batteries
- cinema installations
- welding machines with accessories for
 - arc welding
 - D.C. welding (welding rectifiers)*
 - D.C. and A.C. welding (dual-current plant)*
 - A.C. welding (welding transformers)*
 - resistance welding (*spot welding, seam welding and butt welding machines*)
- automatic switches for resistance welding machines
- spot lights for spot welding machines
- coated welding electrodes for
 - welding wrought iron, mild steel, cast iron, stainless and heat-resisting steels, aluminium, depositing wear-resisting bronze and copper surfaces

- automatic voltage regulators for precision control of the output voltage of generators
- condensers
 - for improving the power-factor
 - for starting up single-phase motors
 - for applications in the field of high tension engineering
- magnetic oil filters

PRODUCTS OF THE ALLIED INDUSTRIES

- corrugated cardboard, single and double pasted in rolls and sheets
- corrugated cardboard containers
- packing paper in rolls
- diamond dies
- articles of artificial resin:
 - moulded pieces for industrial purposes
 - constructional and insulating material
 - house fittings and sanitary articles
 - packing, advertising and luxury articles
 - household articles
- glass for industrial purposes, in the form of
 - bulbs and glass containers
 - cane- and tubing glass
- gases
 - hydrogen, air, nitrogen, oxygen, helium, neon, argon, krypton and xenon
- objects made of ceramic material (*magnesium, aluminium, zirconium oxide, soapstone*) in the form of tubes, bars, sheets, rings, crucibles
- metals
 - wear-resisting steel (*sand blasting installations*)
 - fireproof steel (*boiler grids*)
 - hafnium, zirconium, titanium, molybdenum, tungsten
- joints (*between two parts of an apparatus which are made of different materials*)
 - glass—chrome—iron
 - heat-resisting glass—quartz