

PHILCO

TECHREP DIVISION BULLETIN

Volume 7 November-December, 1957 No. 6

In This Issue...

Editorial	<i>John E. Remich</i>	1
The Frequency-Response Analysis of Feedback Systems (Part 2)	<i>Robert D. Hunter</i>	3
Tech Info Mail Bag		15
VHF Point-to-Point Communications Field Tests from Light Aircraft	<i>Bud M. Compton</i>	16
Solution to September-October "What's Your Answer?"		22
Janet Meteor Communication System	<i>James R. Spencer</i>	23
Technical Sketch of Michael Faraday		29
Computing Parabolic Reflector Gain		30
Errata for September-October Issue		31
A New Philco Publication—"Small Signals"		31
"What's Your Answer?"		31
Index for Volume 7, Philco TechRep Division Bulletin		32

PHILCO
TECHREP DIVISION
BULLETIN

Published bimonthly by

The TechRep Division of Philco Corporation
Philadelphia, Pennsylvania

Editor John E. Remich
Managing Editor Francis R. Sherman
Technical Editors Harvey W. Mertz
James R. Spencer

Editorial Office:

Technical Information Section
Philco TechRep Division
22nd St. and Lehigh Avenue
Philadelphia 32, Penna.

If any information contained herein conflicts with a technical order, manual, or other official publication of the U.S. Armed Forces, the information in the official publication should be used. Views expressed in this publication are the opinions of the authors and do not necessarily represent those of Philco Corporation. All technical information and circuits are presented without responsibility as to patent infringement.

Editorial . . .

by John E. Remich

Manager, Technical Department

THE CRISIS IN SCIENTIFIC MANPOWER

It is becoming increasingly clear, especially in the light of recent events, that more and better scientific training is mandatory if our nation is to maintain its security in the "space" age. This fact has been brought home forcibly by the successful launching of the earth satellites now orbiting around the earth.

That activity in the direction of scientific training has been stepped up is evidenced by the recent government moves to consolidate scientific endeavor and to obtain top-ranking scientists.

The extensive use of well trained scientific technicians to supplement the creative ability of the scientist and engineer is one method of substantially increasing the nation's scientific manpower. However, recent statistics indicate that our national production of competent technicians is only about one-half technician per engineer. Correspondence schools, in addition to technical schools, colleges, Armed Forces technical training, and courses provided by industry, are helping to supply the growing demand for trained technicians. Here at Philco, the Philco Technological Center is supplying completely implemented courses of study to the public schools and government agencies, as well as the especially developed correspondence courses available to all persons in the technical field.

The need for technically trained manpower will steadily increase in the years to come, but there will probably be false indications of a decreased requirement from time to time. It would be tragic indeed if, based on this apparent overabundance, we were to relax our efforts in technical education.

Season's
Greetings

*Best Wishes for a Happy Year
Bulletin Staff*

THE FREQUENCY-RESPONSE ANALYSIS OF FEEDBACK SYSTEMS

(Part 2)

by Robert D. Hunter
Headquarters Technical Staff

Editor's Note: This article concludes the discussion initiated in the September-October issue of the BULLETIN under the title above.

DECIBEL-GAIN AND PHASE DIAGRAMS

THE MEANINGS OF THE TERMS *gain margin* and *phase margin* were discussed in the previous article employing the output vector (Nyquist) locus. While this method of graphically illustrating the open-loop response of a feedback system is commonly employed to investigate stability, etc, a second method known as the *decibel-gain and phase diagram*, also known as the *logarithmic plot*, or the *decibel log-frequency plot*, is also commonly employed for the same general purposes. While this second method is more amenable to synthesis, it is also a valuable method for analysis, and hence is presented here.

The decibel-gain and phase diagram for the transfer function of the lead network (derived previously) is shown in figure 1. In this diagram the logarithm of the magnitude of Y_0 is plotted against the logarithm of the "angular frequency" (where $\omega = 2\pi f$), and the phase angle of the Y_0 function is plotted as shown on a linear scale against the same axis. Since the lead network described earlier does not have a voltage gain, the "gain" (expressed in decibels) is negative over the entire frequency range. The practice of employing the quantity $20 \log_{10}$ times the magnitude of the voltage gain appears to have sprung from the practice of specifying in this manner the gain of amplifiers, filters, and so on, employed for communications purposes where the impedances are ordinarily matched (this

is clearly the only case where the power gain and the gain expressed as above are identical).

At low frequencies (in the case of the lead circuit) where ωT is considerably less than unity, the output voltage of the lead network is very small because of the high reactance of the capacitor. As the frequency is increased, the output voltage increases to 0.707 of the value of the input voltage at the frequency where ωT is equal to unity. As shown on the graph of figure 1, the attenuation at this point is 3 db. As the frequency is increased still further, the output voltage continues to rise slowly, approaching the value of the input voltage (corresponding to an attenuation, or gain, of zero db).

Because the reactance of the capacitor is so large at low frequencies (compared to the resistance), the phase angle of the output voltage with respect to the input

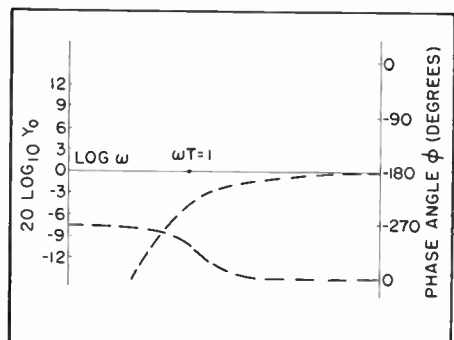

Figure 1. Decibel-Gain and Phase Diagram for Lead Circuit

voltage is very nearly 90 degrees leading. This phase angle is shown on the graph (-270 degrees is the same as $+90$ degrees). As the frequency is increased to the point where ωT is equal to unity, the output voltage leads the input voltage by only 45 degrees (-315 degrees) as shown. As the frequency is increased still further, the output voltage becomes nearly in-phase with the input voltage. A comparison of the decibel-gain and phase diagram of figure 1 with the circle diagram shown previously for the same transfer function illustrates the manner of presentation of the magnitude and phase angle of the output with respect to the input.

Although it is true that no information is available from the decibel-gain and phase diagram which is not also available from the Nyquist plot, the decibel-gain and phase diagram has certain properties which lend themselves to easy chart construction. A simplified statement of the Nyquist stability criterion may also be made in terms of this chart.

Returning to the expression for the relative magnitude of the output voltage of the R-C lead network described earlier,

$$A = \left| \frac{E_o}{E_i} \right| = \frac{1}{\sqrt{1 + \frac{1}{\omega^2 C^2 R^2}}}$$

It may be seen that the decibel voltage gain of the circuit is given by:

$$\begin{aligned} \text{Voltage Gain (db)} &= 20 \log \left| \frac{E_o}{E_i} \right| \\ &= -20 \log \sqrt{1 + \frac{1}{\omega^2 C^2 R^2}} \end{aligned}$$

where the expression *log* is understood to mean the logarithm to the base 10. If the frequency is sufficiently low, so that

$$\frac{1}{\omega^2 C^2 R^2} \gg 1$$

i.e., if the capacitive reactance is considerably larger than the resistance, then

the first term (1) under the radical sign may be ignored without appreciable error. This gives the decibel voltage gain to a good approximation as:

$$\begin{aligned} \text{Voltage Gain (db)} &= -20 \log \frac{1}{\omega CR} \\ &= 20 \log \omega CR \end{aligned}$$

Suppose that both of two frequencies, corresponding to ω_1 and ω_2 , where

$$\omega_2 = 2\omega_1$$

satisfy the condition above. Then the voltage gain at ω_1 , $\text{db}(\omega_1)$, is

$$\text{db}(\omega_1) = 20 \log \omega_1 CR$$

Similarly, the decibel voltage gain at the higher frequency is

$$\text{db}(\omega_2) = 20 \log \omega_2 CR$$

Expressing ω_2 as $2\omega_1$ and using an elementary property of logarithms (the logarithm of a product is equal to the sum of the logarithms of the individual factors) results in

$$\begin{aligned} \text{db}(\omega_2) &= 20 \log 2 + 20 \log \omega_1 CR \\ &= 6\text{db} + \text{db}(\omega_1) \end{aligned}$$

It may thus be seen that, subject to the conditions stated above, the low-frequency gain of the lead circuit changes with frequency at a constant rate of approximately 6 db per octave (an octave is a two-to-one frequency ratio). This means that a straight line (asymptote) may be drawn as shown in figure 2 on the decibel-gain and phase diagram to approximate the actual gain characteristic of the lead network at low frequencies.

This line passes through the zero-db line on the graph at a frequency corresponding to $\omega T = 1$. At $\omega T = 1$, the actual gain is equal to -3db ; hence, it may be seen that the straight-line approximation to the curve is in error by 3 db at this point (this error, incidentally, is the *maximum* error in this case). It may also be seen from the equations above that a rate of change of gain of 6 db/octave is the same as the rate of 20 db/decade, where a decade is a 10-to-1 frequency ratio.

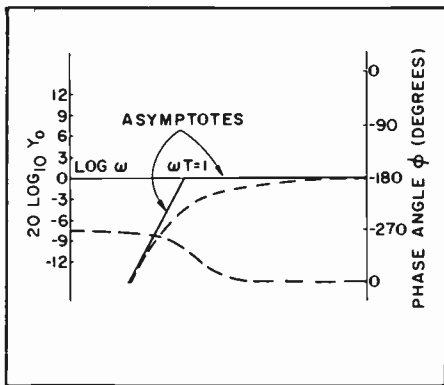

Figure 2. Decibel-Gain and Phase Diagram for Lead Circuit with Asymptotes for Gain

Returning to the complete expression for voltage gain; if the frequency is sufficiently high, so that

$$\frac{1}{\omega^2 C^2 R^2} \ll 1$$

then the term $1/\omega^2 C^2 R^2$ under the radical sign may be neglected without very much error. For this condition, the resulting approximate value of the decibel voltage gain is

$$\begin{aligned} \text{Voltage Gain (db)} &= -20 \log 1 \\ &= -20 (0) \\ &= 0 \end{aligned}$$

The high-frequency gain of the lead network is thus seen to be equal to zero db (approximately), and may be represented by a straight line (asymptote) which is coincident with the zero-db line on the decibel-gain and phase diagram. The high-frequency-gain asymptote intersects the low-frequency-gain asymptote at $\omega T = 1$, as shown in figure 2, and the frequency at which $\omega T = 1$ is referred to (for rather obvious reasons) as the *corner frequency*. A similar diagram for the lag circuit previously discussed is shown in figure 3.

The use of asymptotes to approximate the gain illustrates one of the primary advantages of the decibel-gain and phase diagram method for illustrating transfer functions. The gain characteristic may be quickly and easily approximated by a series of asymptotes, and it

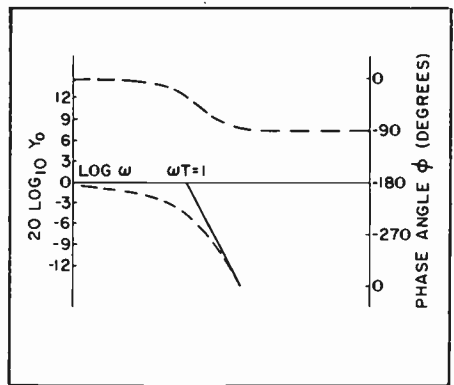

Figure 3. Decibel-Gain and Phase Diagram for Lag Circuit with Asymptotes for Gain

can be shown that the maximum error involved in using the asymptotes rather than the actual gain curve, in this particular case, is 3 db (at the corner frequency). Further investigation shows that the error is only 1 db at frequencies an octave higher and an octave lower than the corner frequency (refer to reference 9 listed in Part 1 of this series). If a more precise representation of the gain characteristic than that furnished by the asymptotes alone is desired, the curve may be easily sketched using the asymptotes and a knowledge of the errors at the corner frequencies.

A system or element with a single energy storage element will always have a single time constant and a high-frequency (or low-frequency) slope of 6 db/octave in its gain asymptote. Those with two energy storage elements will have two time constants and (ultimately) a slope of 12 db/octave in their gain asymptotes. In this manner, the maximum slope of the gain asymptotes is equal to 6 db/octave times the number of energy storage elements in the system or component. It was shown above that the ultimate phase shift associated with an element having a gain asymptote with a slope of 6 db/octave is 90 degrees. In a similar manner it can be shown that the ultimate phase shift is 180 degrees for systems with gain asymptotes of 12 db/octave, etc.

The steady-state transfer function is, in essence, a complex quantity; i.e., it has both magnitude and a phase angle. The absolute value (magnitude) of the quantity is expressed logarithmically in the decibel-gain and phase diagram; hence, it is only necessary to add the gains (in db) of the elements in series in order to obtain the over-all gain at a specified frequency of the system. This method of determining the total gain of a system is far easier than the use of the complex plane locus (Nyquist locus) discussed in Part 1 of this series. Also, since phase angles are represented in a linear manner, it is a simple matter of adding the phase angles of all of the elements (at a specified frequency) to determine the over-all phase shift of the system. In addition, the "compression" effect resulting from plotting logarithms of the magnitude makes it more feasible to exhibit large ranges accurately on a reasonably small graph.

PRACTICAL LEAD AND LAG CIRCUITS

The outputs of simple lead and lag circuits consisting of only a resistor and capacitor in series were discussed previously. A reference to this discussion shows that the output voltage of the simple lead circuit is zero for frequencies sufficiently high. Since these properties are usually undesirable for practical use, actual lead and lag circuits usually take the forms shown in part A of figures 4 and 5, respectively. The output vector loci are shown in part B of figures 4 and 5, and the decibel-gain and phase diagrams for these circuits are shown in part C of the figures. It may be seen that, at sufficiently low frequencies, the lead circuit of figure 4 operates as a resistive voltage divider, because the reactance of the capacitor is exceedingly large compared to the resistance shunting it. The phase shift of the output voltage with respect to the input voltage is nearly zero for this condition. Thus, as shown by the output vector

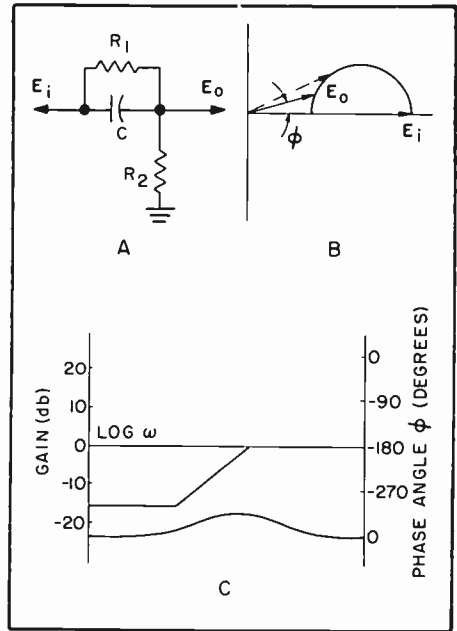

Figure 4. A Practical Lead Network (A), Its Output Vector Locus (B), and Its Decibel-Gain and Phase Diagram (C)

locus (part B of figure 4), the phase angle (ϕ) varies from zero at low frequencies, to some maximum value (leading) when the output vector is tangent to the circle, and then to zero again at the higher frequencies.

The output vector locus for a lag circuit whose output does not go to zero at high frequencies is shown in part B of figure 5, and the corresponding decibel-gain and phase diagram is shown in part C. These diagrams may be verified generally in a manner similar to that employed above. Here, the output voltage is in phase with the input voltage at sufficiently high and sufficiently low frequencies, and has some maximum value (depending on the circuit parameters) at the frequency where the output vector is tangent to the circle. While lead and lag circuits may take different configurations, the general principle of their operation is as illustrated. When these circuits are employed in feedback systems, the circuit of figure

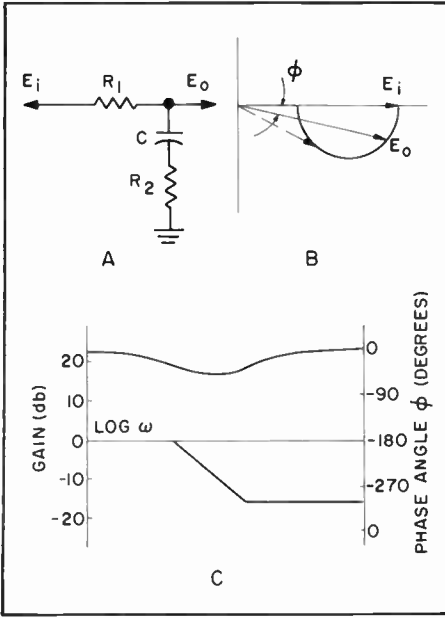

Figure 5. A Practical Lag Network (A), Its Output Vector Locus (B), and Its Decibel-Gain and Phase Diagram (C)

4 is sometimes said to produce "proportional plus derivative control" while that of figure 5 is sometimes said to provide "proportional plus integral control."

STABILITY IN TERMS OF DECIBEL-GAIN AND PHASE DIAGRAMS

The feedback transfer function of a hypothetical servomechanism is plotted on the decibel-gain and phase diagram shown in figure 6. As before, this function takes the form of an attenuation or gain plot versus the logarithm of the frequency variable (ω) and a plot of the phase angle of the output with respect to the input. As shown in the figure, the gain falls off as the frequency is increased and becomes unity (zero db) at a frequency ω_1 , known as the *gain crossover*. It may be seen that at this frequency the phase angle has not changed to -180 degrees (from its low-frequency value of zero degrees), and hence the system is stable. The phase margin,

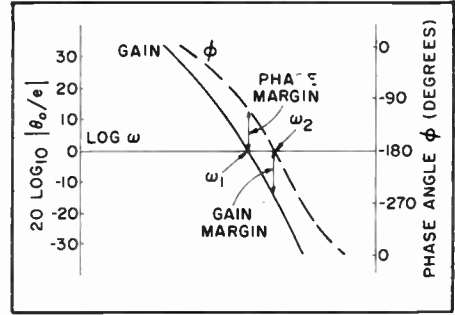

Figure 6. Decibel-Gain and Phase Diagram for a Hypothetical Servomechanism

shown on the diagram, is the difference between the phase shift of the output at the gain crossover frequency and the phase angle of -180 degrees, which is drawn, as before, to coincide with the zero-db axis of the diagram. A further increase in the frequency finds the gain still falling and the phase angle increasing until the frequency ω_2 is reached. At this frequency the phase angle is -180 degrees. The amount by which the loop gain has fallen below unity (zero db) at this frequency is the gain margin, and is specified in decibels. Thus the Nyquist stability criterion may be formulated (in simplified form) for the decibel-gain and phase diagram just as it was for the output vector locus diagram described earlier. A comparison of the phase margin, gain margin, etc, in these two types of diagrams will make their relationship apparent. As before, the relative stability or degree of stability may be specified in terms of a definite gain margin and an accompanying phase margin. Typical values for a satisfactorily stable servomechanism are a 45-degree phase margin and a 12-db gain margin.

The transfer function of a system which is on the verge of instability is shown in figure 7, where both the gain margin and the phase margin are zero. This is the same situation as the one in which the Nyquist plot passed through the critical point $(-1 + j0)$. The trans-

fer function of a system which is definitely unstable is shown in the decibel-gain and phase diagram of figure 8.

EFFECT OF GAIN ON STABILITY—STABILIZATION BY REDUCTION OF GAIN

The unstable servomechanism whose transfer function is shown in figure 8 could be made stable by reducing the

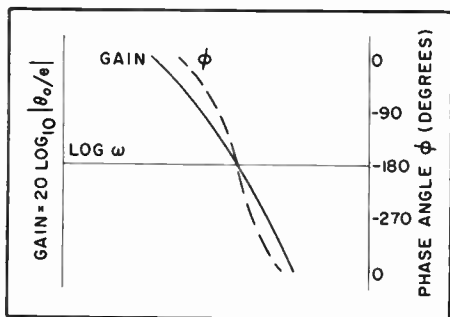

Figure 7. Decibel-Gain and Phase Diagram for a Servomechanism on the Verge of Instability

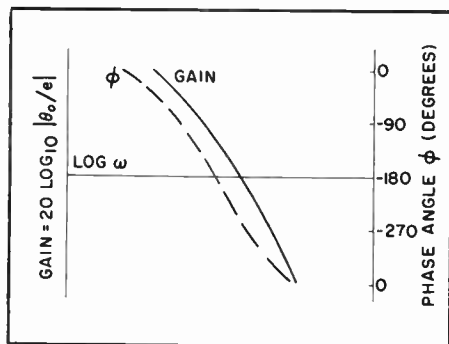

Figure 8. Decibel-Gain and Phase Diagram for a Definitely Unstable Servomechanism

gain sufficiently. Reducing the gain is equivalent to shifting the gain curve bodily downward on the graph of figure 8, as shown in figure 9. If the shift is sufficient, the stable condition results, because the gain falls to unity before the phase angle reaches -180 degrees. The primary disadvantage of this method of stabilizing a servomechanism (or other feedback control system) is the fact that the positional accuracy suffers when the static (zero-frequency) gain is reduced. Hence, in order to satisfactorily stabilize the servomechanism whose transfer function is shown in figure 8, it is necessary to reshape the gain function curve and the phase angle function curve to satisfy the stability criterion.

LEAD NETWORK STABILIZATION OF A SERVOMECHANISM

The insertion of a lead network into the servomechanism loop at the amplifier input, as shown in figure 10, is a

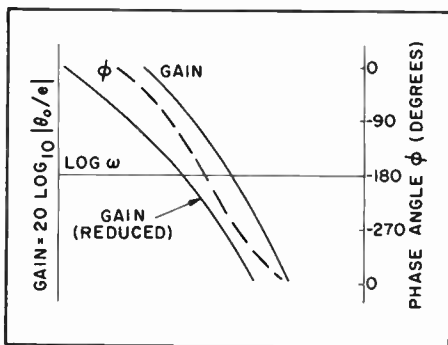

Figure 9. An Illustration of How Gain Reduction Stabilizes a Servomechanism

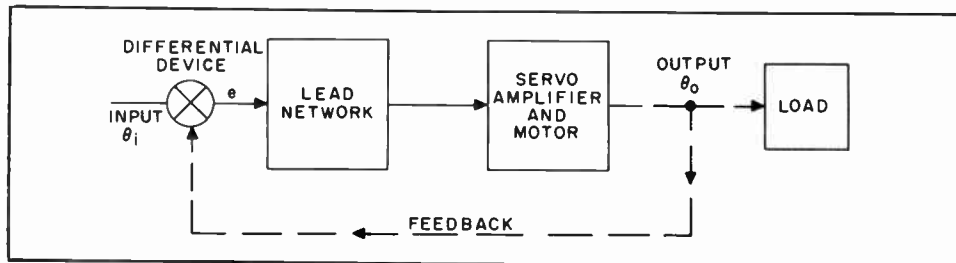

Figure 10. Stabilization of a Servomechanism by Insertion of a Lead Network

common expedient employed to stabilize it. A lead network similar to that shown in figure 4, and having the response shown there, modifies the gain response as well as the phase response, but its insertion produces an increase, or phase lead, in the phase angle function ϕ so that the gain is permitted to fall to unity *before* the phase angle reaches -180 degrees.

Hence, the servo is stabilized by the insertion of a lead network, as illustrated in the decibel-gain and phase diagram of figure 11. This figure shows the gain and phase curves for the uncompensated (and unstable) servo, the gain and phase-response curves for the lead network alone, and the gain and phase curves for the combination (the compensated servo). The amplifier gain has been increased by just the amount required to compensate for the low-frequency attenuation of the lead network, so that the low-frequency gain of the compensated servomechanism is the same as that of the uncompensated one. As explained previously, the gain and phase responses of the compensated servo are found by merely adding the ordinates of the phase angles to obtain the over-all phase angle function. This

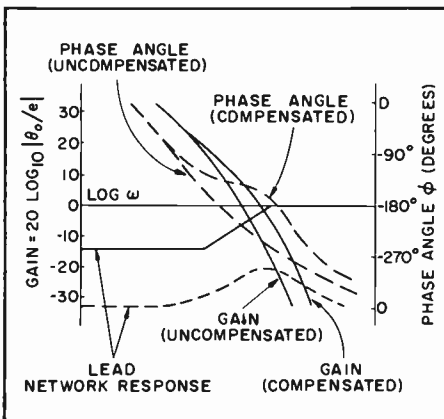

Figure 11. Stabilization of an Otherwise Unstable Servomechanism by Means of a Lead Network in the Amplifier Input Circuit

illustrates the manner in which the decibel-gain and phase diagram may be used to demonstrate the stabilization of a servomechanism.

It has been shown that, although the lead network tends to stabilize a servomechanism, it also tends to introduce a certain amount of attenuation at the low frequencies, thus detracting from the static accuracy of the device. This problem is often handled by placing a suitably designed lag circuit, like the one of figure 5, in the loop so that the static gain would again be increased. The insertion of a lag circuit has an unstabilizing effect, because its high-frequency phase response is such that it tends to oppose action of the lead network; however, the proper combination of the two networks may be employed to reshape the transfer function so that both stability and high gain at low frequencies are achieved.

LEAD NETWORK STABILIZATION OF D-C AMPLIFIERS

The high-gain d-c amplifiers employed in analog computers to form operational amplifiers usually have an odd number of stages (often three), so that feedback from the output to the input is negative (at d-c and low frequencies) as explained previously. Although the gain of the amplifier falls off at the higher frequencies, the amplifier may become unstable (oscillate or "sing") at these frequencies unless some precautions are taken to avoid such instability.

The stability criterion may be applied as before and interpreted in terms of the decibel-gain and phase diagrams in a manner identical to that employed in determining the stability of the servomechanism.

Lead network stabilization of such an amplifier usually takes the form of simple modifications to the interstage coupling networks. This is illustrated in figure 12, where capacitors C_1 and C_2

are added to the resistive interstage connecting networks to convert them into the equivalent of lead networks (when the distributed capacitance indicated by the dashed-line capacitors is ignored). In reality, the addition of the "anti-sing" capacitors across the upper resistors of the coupling circuits tends to compensate for the lagging effect produced by the distributed capacitance as described earlier. Although the phase angle of the amplifier output (with

respect to its d-c or low-frequency value) may eventually reach -180 degrees at some frequency, oscillation will not result if the frequency is sufficiently high that the amplifier gain has dropped to less than unity. The decibel-gain and phase diagram for the position servomechanism (figure 11) may be employed to explain this stabilization process, except that in the case of the d-c amplifier, an increase in amplifier gain to accompany the addition of the lead network is not required.

TACHOMETER STABILIZATION OF POSITION SERVOMECHANISM

An important means for increasing the stability of a servomechanism without affecting its static accuracy (gain at zero frequency) is the use of tachometer stabilization. A simplified block diagram of a tachometer-stabilized servo is shown in figure 13. This diagram shows a shaft input variable (θ_i); however, the same arrangement may be employed with voltage inputs by making the output (or comparison) transducer produce a suitable voltage for feedback.

Suppose that both the main feedback and the tachometer feedback loops are opened, and that a sinusoidally varying input (θ_i) produces a sinusoidally varying error voltage (e) which, in turn, produces a sinusoidally varying output (θ_o), as in the cases previously discussed. The gain response of the servo under these conditions is shown by the curve labeled *without tach* in figure 14.

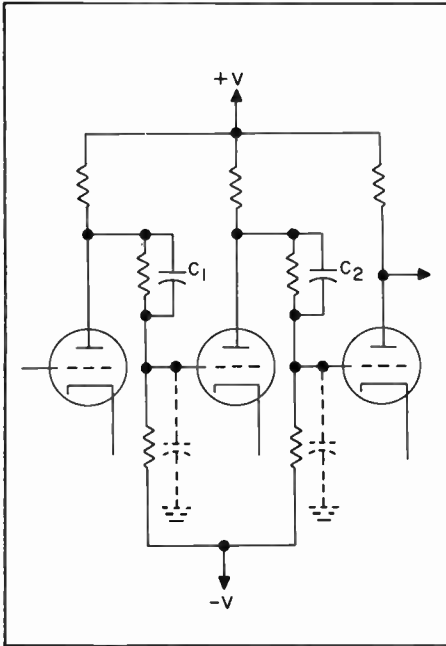

Figure 12. Stabilization of D-C Amplifier by Insertion of Capacitors to Provide a Lead Network

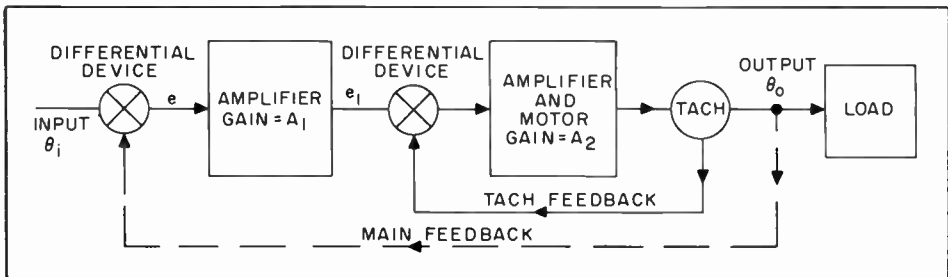

Figure 13. Simplified Block Diagram of Servomechanism with Tachometer Stabilization

The action of the tachometer voltage which is fed back to the input of amplifier No. 2 is to *oppose* the amplified error voltage (e_1), which would otherwise be the input voltage to this amplifier. Thus the closing of the tachometer feedback loop reduces the gain (for steady-state sinusoidal signals) of the active part of the servomechanism. The amount by which the open-loop gain is varied (where only the main feedback loop is open) by this action of the tachometer feedback loop depends upon the frequency of the sinusoidal oscillation, as shown in figure 14.

The tachometer produces an output which is proportional to the angular velocity of the output shaft. Thus, the greater the frequency of the "signal" becomes, the greater the output of the tachometer and the greater the reduction of the open-loop gain of the servo. This effect reduces the open-loop gain of the servo to unity (zero db) at a lower frequency than would otherwise be the case, as shown in figure 14, but does not reduce the static gain of the servo because the tachometer output is zero for a zero-velocity output.

An inspection of figure 14 shows that since the gain has been reduced to zero db at a lower frequency than before, the gain margin has been increased and hence the stability of the servomechanism has been improved. Many other

methods are employed for stabilizing servomechanisms, including the use of amplifiers and filter networks in the feedback path, but these are beyond the scope of the present discussion. It should be noted, however, that most of these methods may be analyzed by means of the frequency-response method.

OSCILLATORS—OSCILLATION OF CONVENTIONAL AMPLIFIERS

It is significant that the same feedback theory (based upon sinusoidal analysis) which is valuable in the analysis of feedback control is also of value in the analysis of feedback oscillators. In the case of the feedback oscillator, the open-loop gain is ordinarily made considerably greater than unity, to insure that oscillation will result. Since an open-loop gain greater than unity is required for the oscillation of a feedback oscillator, an amplifying device is a necessary part of such a device. Thus the analysis of a feedback oscillator is frequently approached in terms of an amplifier which supplies its own input signal by feedback, as illustrated in figure 15. In this case the feedback voltage will result in oscillation if it is of the same amplitude and phase as the "input voltage" of the amplifier.

Since the open-loop gain in such an oscillator is ordinarily greater than

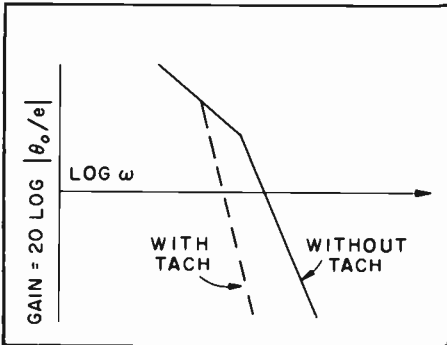

Figure 14. Illustration of Tachometer Stabilization of a Servomechanism

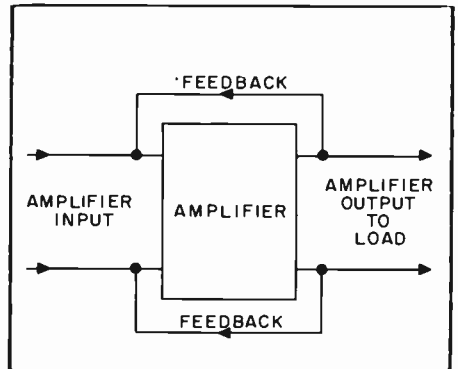

Figure 15. Representation of an Oscillator as an Amplifier with Output Returned to Input

unity, it is clear that an oscillating signal would grow in amplitude indefinitely, as it repeatedly traversed the closed loop, if some amplitude-limiting means were not provided to limit the amplitude of the feedback voltage to that of the amplifier input voltage. Therefore, the use of such a limiting device is implied in the operation of a feedback oscillator, and the limiting device is often (but not always) inherent in the amplifier itself. In some cases, the limiting function may be performed by elements outside of the amplifier proper, in order to avoid nonlinear operation of the amplifier.

One of the primary disadvantages of the use of feedback-system theory for oscillators in general is that it cannot be applied to the class of oscillators known as two-terminal or negative-resistance oscillators. While this limitation must distinctly be recognized, it does not interfere with the use of the theory in the cases to which it does apply. The requirement that only sinusoidal signals may be used in the analysis is not a severe limitation, because an oscillator which will not meet the necessary conditions for oscillation at some sinusoidal frequency will not oscillate. The application of feedback system theory to feedback oscillators is covered rather extensively in reference 8, listed in Part 1 of this series.

The theory of feedback amplifiers is discussed at length in reference 7 (see Part 1 of this series). This reference describes the advantages accruing from the use of negative feedback in ordinary R-C coupled amplifiers and shows that, in general, its use results in a more predictable mode of operation when the gain of the amplifier without feedback is made sufficiently large.

Reference to the d-c amplifier discussed in the first article of this series shows that the presence of the coupling capacitors in the ordinary R-C coupled amplifier adds a complicating factor to

the mode of operation discussed for the d-c amplifier itself. The presence of the coupling capacitor not only causes the gain to fall off at lower frequencies, but also produces a leading phase angle at these frequencies, because the capacitor is essentially a "lead network" similar to the one discussed previously.

Thus the discussion of the general R-C coupled amplifier may be based upon the previous discussion of the d-c amplifier, since both behave in the same general manner at high frequencies; i.e., the gain falls off and the phase angle of the output increases in a lagging direction as the frequency is increased. The variation in gain of the R-C amplifier with frequency is compared with that for the d-c amplifier in the diagram of figure 16.

The feedback is nominally negative over the mid-frequency range of the R-C coupled amplifier in most instances so that mid-frequency operation of this type of amplifier is analogous to d-c and low-frequency operation of the d-c amplifier. Therefore, it is apparent that the feedback in the R-C amplifier may become positive at some low frequency, as well as at some frequency higher than the mid-band frequency. A possibility of low-frequency oscillation of the R-C coupled amplifier is usually indi-

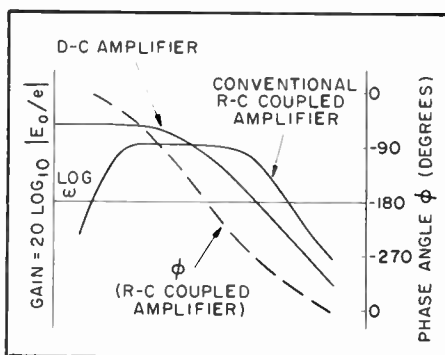

Figure 16. Comparison of Gain Responses of D-C and Conventional R-C Coupled Amplifier, Showing Phase Response of the Latter

cated when the rate of change of gain with frequency becomes equal to or exceeds 12 db/octave, because a phase shift approaching 180 degrees (leading) is associated with such a gain characteristic. (A leading condition of the phase angle is indicated by the fact that the slope of the gain function is positive for the low-frequency case, instead of negative as was the case for a high-frequency gain function described earlier.) Thus, high gain R-C coupled amplifiers in which feedback is employed may become oscillatory at some low frequency for which the conditions of oscillation are satisfied if special precautions are not taken to avoid such oscillation. This problem is aggravated by the frequent necessity to extend the mid-band gain of such an amplifier to very low frequencies.

It frequently happens that a high-gain R-C coupled amplifier (as well as other types) will oscillate spontaneously even though no feedback is intentionally supplied. The feedback may occur in many different ways, but it is frequently due to the common connection of the stages of the amplifier to the tube operating potentials. This problem becomes progressively more acute as the number of stages (hence the gain and phase shift) is increased. In amplifiers of this type,

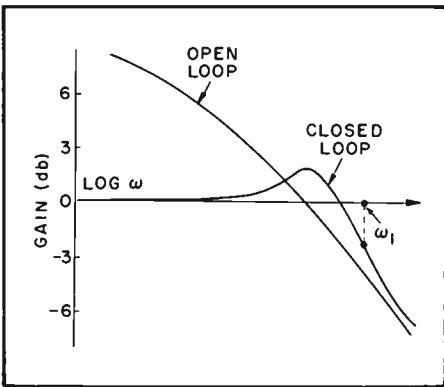

Figure 17. Gain Diagram for Open-Loop and Closed-Loop Conditions of Hypothetical Servomechanism

R-C and R-L decoupling networks are often employed in the plate, screen, and filament circuits to reduce the coupling between successive stages and thus eliminate possible feedback loops.

FREQUENCY-RESPONSE TESTING

Either open-loop or closed-loop operation of a feedback system may be employed in testing it by means of the frequency-response method (except that unstable control systems may not be tested under closed-loop conditions). In general, a sinusoidal input of voltage or some other physical quantity such as shaft angle is applied to the input, and the amplitude and phase of steady-state sinusoidal output variations are plotted as a function of the frequency. This may require the use of special transducers as a part of the test equipment. Very-low-frequency sinusoidal voltage generators have recently been developed to facilitate this type of testing for servomechanisms and other systems.

The open-loop and closed-loop gain responses of a hypothetical servomechanism are shown in figure 17. As shown in the figure, the closed-loop gain falls off rather rapidly as the frequency is increased above a certain limit, and it has a value of -3 db at a frequency corresponding to ω_1 . Since this frequency-response curve resembles that of a low-pass electrical filter, it is frequently stated that, in effect, a servomechanism is a low-pass filter having a limited response to high-frequency variations in the input. The "bandpass" of such a filter is frequently specified in terms of the half-power (-3 db) points, as it is in electrical filters. This filtering property of servomechanisms and other feedback systems is important in control systems which must have a large "bandwidth" in order to have a satisfactory transient response.

OTHER APPLICATIONS

Space does not permit further discussion of specific feedback systems of great

interest or even an indication of the many specific cases where the frequency-response method could be employed. The following few paragraphs attempt to extend somewhat the range of applications indicated above.

A human operator is often included in the loop of a feedback control system, sometimes to its advantage and sometimes to its detriment. Since the frequency response of a human operator is distinctly limited by his reaction time (in the neighborhood of 0.1 second), the inclusion of a human operator in systems requiring extremely fast responses is clearly a disadvantage. On the other hand, the adaptability and nonlinearity of the "human transfer function" is frequently employed to advantage in feedback control systems.

In the realm of manned flight vehicles, for example, the problems of stability and control of the craft (especially at high altitudes) have been extensively studied by means of the frequency-response method. The aircraft transfer functions which can be stably controlled by a human operator have been identified and studied, and the data obtained have served as a valuable guide in the analysis and design of aircraft flight controls.

The human transfer function itself has been analyzed by means of flight simulator studies so as to facilitate the design of suitable control systems.

Many other familiar feedback systems may be analyzed in terms of their frequency responses. The conventional a-v-c circuit, for example, is analyzed in terms of feedback-system theory based upon sinusoidal signals in reference 11 (see Part 1 of this series). Moreover, virtually any type of automatic control system employing a closed-loop feedback system, such as a-f-c circuits, etc, may be analyzed in these terms as regards performance in closed-loop operation, as well as their stability in terms of open-loop operation.

A great many computing circuits (analog as well as digital) involve feedback loops to effect the solution of the problem. These may be analyzed in terms of closed-loop frequency responses to determine their performance, as well as in the open-loop mode to determine their stability.

Process control usually involves a closed loop whose (open-loop) transfer function depends upon the peculiarities of the process, as well as the characteristics of the controller. In all of these cases, time lags, which tend toward unstable operation, may be quickly and easily identified by means of sinusoidal analysis.

CONCLUSIONS

Feedback systems exist almost everywhere. It is difficult to carry out an investigation of any extent without encountering one or more feedback systems in one guise or another. An attempt to indicate the essential unity of these systems, via sinusoidal analysis, has been attempted above, but the space and time limitations are severe. Further reference to the literature of feedback-system theory will indicate the extent of this unity of viewpoint. Thus frequency-response analysis has become a common meeting ground for scientists working in the various phases of feedback systems, as well as a potent method of attack upon specific problems.

While a number of different notations and diagram conventions are currently employed in feedback-system theory, these differences have been minimized above in order to avoid detracting from the unity of the subject. The open-loop gain of a system, for example, is variously referred to as the quantity, μ , A , or, particularly for servo work, as KG . In the latter case, K represents the part of the loop gain, which is independent of frequency, and G represents that part which is frequency dependent.

The transient response of a feedback system to a sudden change in an input

quantity is often a desired or necessary part of the complete analysis of the system. While this may be calculated directly by means of the differential equation governing the system, it may also be obtained (in some cases with more ease) by a determination of the transient response from the frequency response. Several specific means for doing this are described in the literature cited and elsewhere.

When a system involves distinct nonlinearities, the differential equation describing its behavior is also nonlinear,

thus making an analytical solution of the problem formidable. The frequency-response method of analysis of linear systems has been extended to include nonlinear systems by the use of Fourier analysis, as well as other methods. This method of analysis is analogous to the Fourier series analysis of nonlinear electrical circuits in the steady state.

Altogether, the frequency-response method of analysis has much to commend it. It is hoped that the objectives set forth have been attained with a small measure of success.

TECH INFO MAIL BAG

The problem of birds nesting in a hangar, submitted by Eugene R. Dine and published in the September-October 1957 issue of the BULLETIN, has aroused considerable interest. The majority of the replies suggested solutions which are only partially effective. However, the following letter indicates an approach which appears to offer a solution.

"A very easy and cheap way to discourage the birds from gathering and nesting in the hangar is to get them all gummed up with Tanglefoot. Tanglefoot is a product sold to owners of sweet cherry trees, etc; it is a honey-like substance, only much more sticky. Directions for use are on the can. Make the birds some wooden T-type perches from scrap lumber, using round sticks that will fit their feet for the horizontal portion. Place these perches in the congregation area in the upper parts of the hangar, and then coat them liberally with Tanglefoot. The birds like nice round perches and will use them in preference to a steel structure or wooden timbers. They promptly get stuck, get their feathers gummed up or pulled out, hang upside down, and get plastered all over the place. You won't get 50 dbm of squawks and flutters, but I am sure from experience with cherry trees that the untangled birds will hold a staff meeting and bring it to someone's attention that the hangar was not built for feathered birds. Overhead and maintenance of this project is low. Someone, of course, will have to climb up to the perches from time to time to replenish the coating of Tanglefoot.

"Your worst problem will probably be justifying to your Purchasing Division the local purchase of a can of this gummy, sticky stuff."

GEORGE F. FOOTE
Cuyamaca Rancho State Park
Descanso, Calif.

VHF POINT-TO-POINT COMMUNICATIONS FIELD TESTS FROM LIGHT AIRCRAFT

by Bud M. Compton

Philco Site Engineer

This article describes the use of a light aircraft in the measurement and computation of radiated field patterns in a particular case. The methods and techniques may be easily adapted to other cases, and a helicopter could be used in obtaining the required data.

AIRBORNE FIELD TESTING of NAVAIDS has been practiced for years, and similar methods are occasionally used to map the strength of television signals. In a study of a VHF point-to-point communications system, such a method was adopted by necessity, as well as for effectiveness. In this study, the terrain precluded surface transportation, and other considerations, including time, all pointed toward the use of aircraft.

Though this material reports a particular project, there are many aspects that have carryover value into other related systems of communications and radar. The emphasis is therefore on procedure, and the results have been sufficiently generalized to be widely applicable.

BACKGROUND OF PROJECT

The background which led to this project was a need for improving VHF

communications over certain paths in a radio net which included other paths that provided consistently good communications. The problem, therefore, was to determine the reasons for poor performance along some of the paths so that the proper remedial measures could be applied. Identical equipment was used at each site, but there were variations in site topography, path terrain, type of antenna, and hop distances. These variations are summarized in Table 1.

Antenna X listed in the table consisted of three stacks of two-element parasitics (one element driven, one reflecting). Refer to figures 1 and 2. Antenna Y consisted of a broadside array composed of eight horizontal dipoles situated two wide and four high (all driven) in front of a heavy wire mesh reflector. The latter type of antenna is commonly called a "bedspring antenna."

TABLE 1

<i>Path</i>	<i>Site</i>	<i>Distance (miles)</i>	<i>Path Terrain</i>	<i>Site Topography</i>	<i>Antenna</i>	<i>Signals</i>
1	A	91	Flat	Flat and Obstructed	X	Unsat.
	B			Flat and Clear	X	Unsat.
2	C	171	Complex	Flat and Clear	Y	Fair
	D			Mountain Top	Y	Fair
3	D	202	Diffractive	Mountain Top	Y	Good
	E			Mountain Side	Y	Good

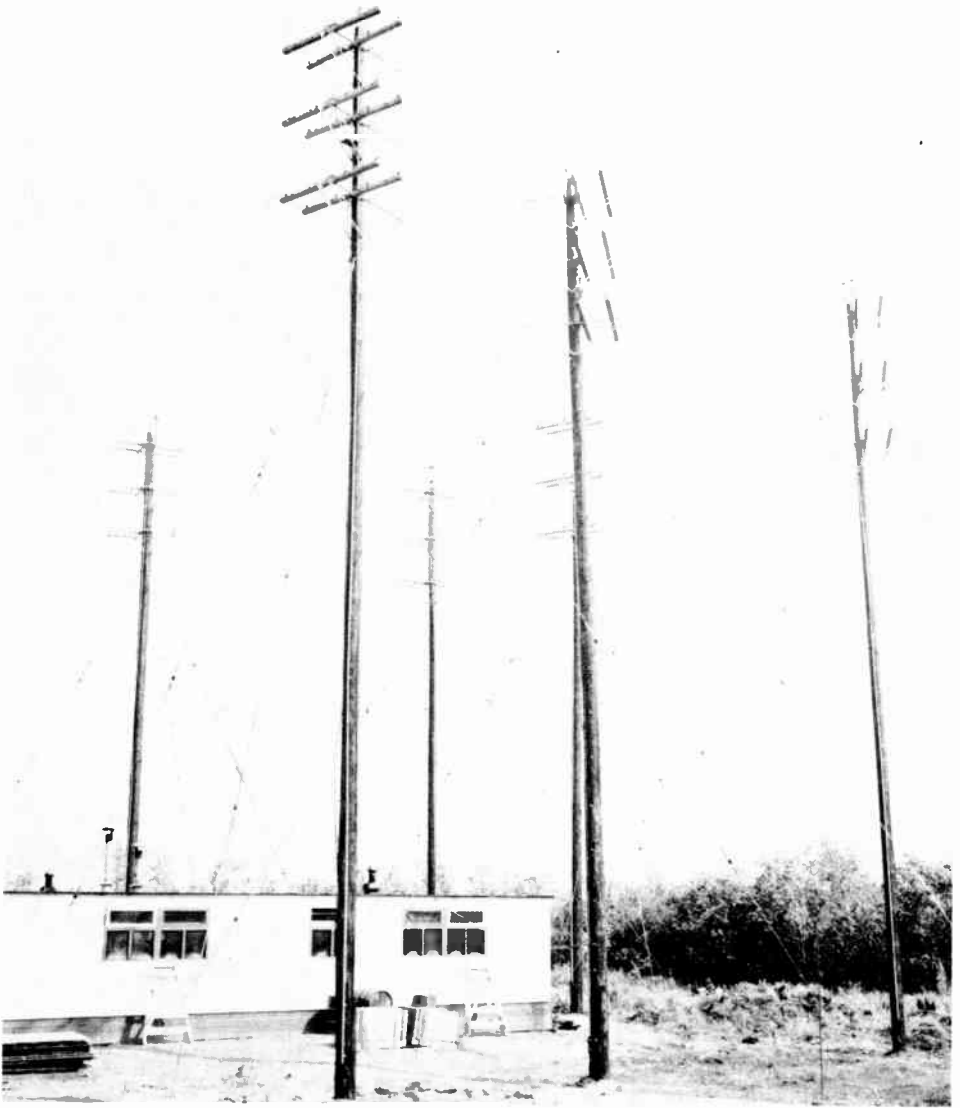

Figure 1. Stacked Parasitic Antennas at Site A

Two experimental antennas were also tested at site C, path 2. The first of these was a rhombic having a length of eight wavelengths per leg, two wires high spaced $\frac{1}{2}$ wavelength apart. The second was a "V" of 10 wavelengths, three wires high, with each wire backed by another wire spaced $\frac{3}{4}$ wavelength to act as a reflector.

PREPARATIONS FOR FIELD TESTS

Preparations for the project included: (1) A study of signal strength recordings from the terminal sites of the selected radio paths. This study provided some knowledge of the types of fading prevalent. (2) A study of beyond-the-horizon propagation literature, since all subject paths were of the over-the-

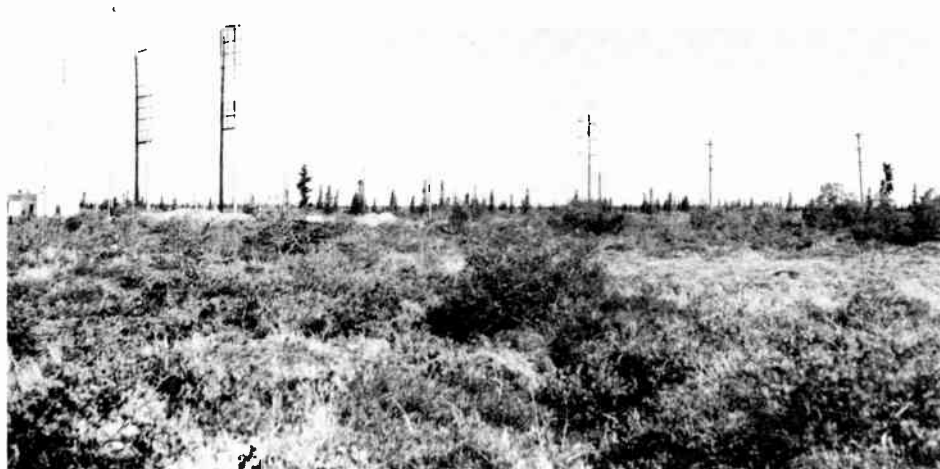

Figure 2. Antennas at Site C, Showing Bedspring Antennas at Left Foreground and Experimental "V" and Rhombic in Background

horizon type. As can be seen from the table, the distances involved indicate that tropospheric scatter is the means of signal propagation and that, where mountains are located between the sites, diffraction must also be considered. (3) The plotting of each path on 4/3 earth profile charts. (4) Selection of the equipment needed for the tests and making of necessary modifications. (5) Analyzing and planning of operating procedures in order to provide adequate information with minimum expense. (6) Coordination with site personnel.

In order to determine the radiation from each site, it was necessary to sample the signal in such a way as to evaluate both the horizontal and vertical dimensions. Flights were made along the radio path extending behind the antenna, to provide information regarding both the vertical radiation pattern and the front-to-back ratio. Flights across the radio paths enabled the measuring of the horizontal pattern relative to the path. Several altitudes were flown in each case, consistent with project objectives.

Since the communication system was in normal operating condition during the tests, the resultant findings were

much more reliable than they would have been had the tests been made by the use of mock-ups or other approximation methods. Furthermore, since the procedure provided a comparison between good paths and poor paths, the data could be in relative values rather than absolute values. For the latter reason, data processing was extremely simple and rapid. In fact, the raw tape from the Esterline-Angus recorder used to record the signal strength measurements provided the direct answer to the problem almost immediately.

CONCLUSIONS DRAWN FROM TEST RESULTS

Referring to figures 3 and 4, it can be seen that the poorest path (No. 1) lacked all the advantages of the best path. The antennas at its terminals were poorly adjusted, as can be seen from the back radiation. Site A of this path had serious obstructions consisting of buildings, overhead wires, and vegetation which caused a "hole" at the path's center. The poorest path also had no advantage from either high siting or diffraction. Note how the signal strength is maintained at low angles from the high sites. This low-angle signal is of

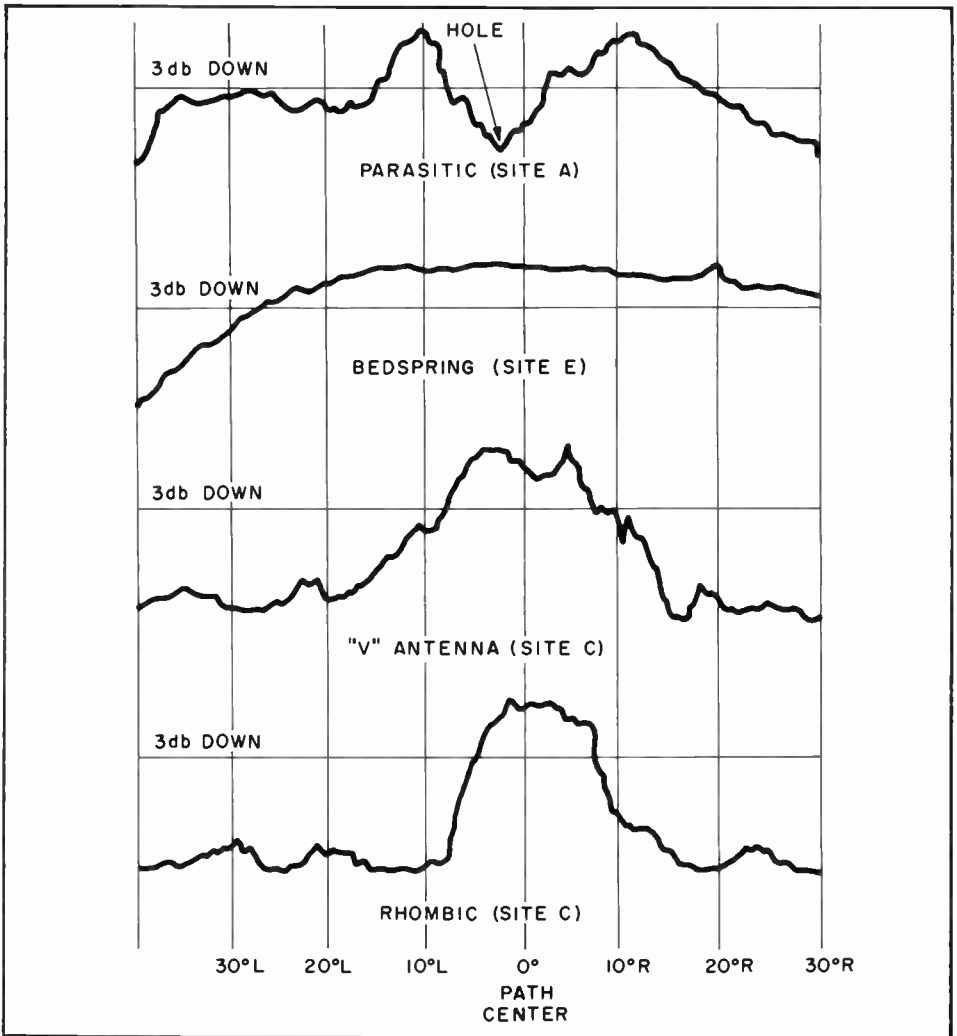

Figure 3. Horizontal Beam Patterns Taken Across the Radio Path

major importance for tropospheric-scatter and diffraction paths.

Superior horizontal beam properties of the "V" and rhombic antennas are clearly seen. However, these antennas require far more space and material than the parasitic and bedspring types. From such an analysis specific decisions can be made regarding fixes.

Finally, in summarizing, the advantages of airborne testing should be emphasized. The great ease of movement and rapidity of space coverage provided

by this method conserve time, and thereby reduce expense and hasten the application of improvements. Also the density of sampling per unit of time and money cannot be equaled by other means.

SUPPLEMENTARY INFORMATION ON EQUIPMENT MODIFICATION AND ADJUSTMENT

For the field tests, Receiver R-19H/TRC-1 was modified for use with an Esterline-Angus recorder to serve as

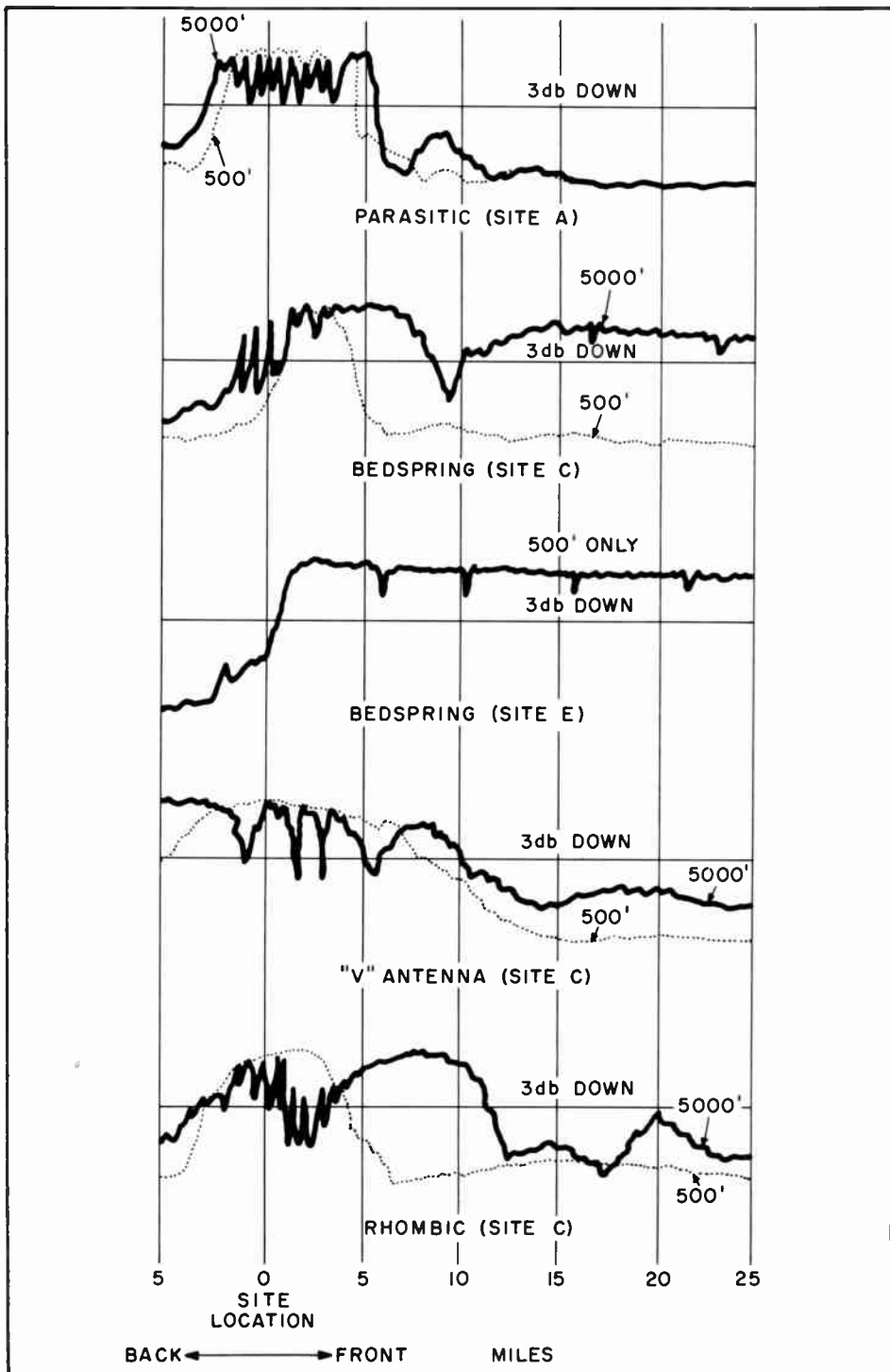

Figure 4. Vertical Beam Patterns Taken Along the Radio Path

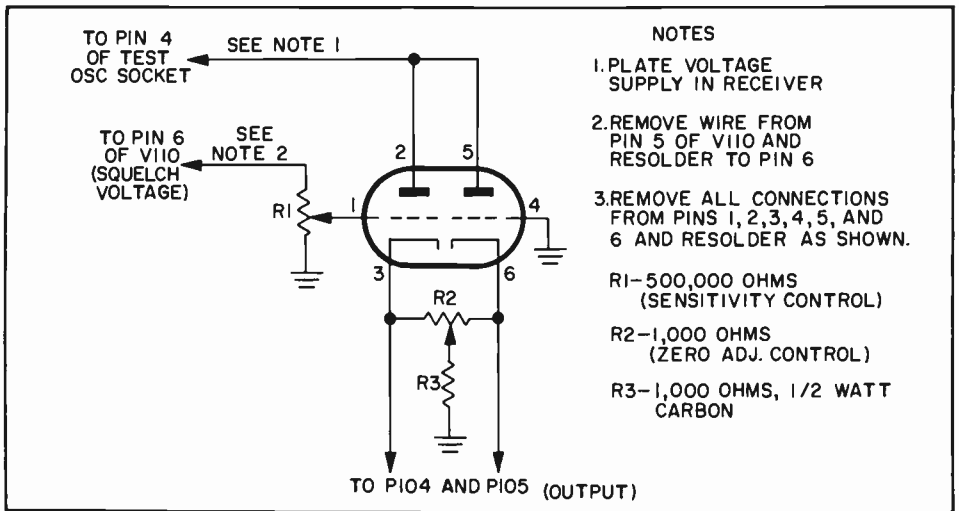

Figure 5. Modification of V-113 to a D-C Amplifier

a continuous-recording-type signal-strength meter operating from a 12- or 24-volt power source. This receiver was selected for the 70-to-100-mc range because it possesses the following characteristics:

- Easily modified to provide a d-c output for recorder
- Fixed tuning (crystal controlled) and high stability
- Adequate selectivity
- Portability

Test oscillator TS-32, which is required for adjusting the receiver, was also modified for 12- or 24-volt operation.

To modify these equipments, proceed as follows:

1. Rewire filament circuits of receiver and TS-32 Test Oscillator for 12- or 24-volt operation, as required.
2. Install 12- or 24-volt dynamotor. The dynamotor may be installed in the space made available by removal of T-116, CH-101, C-162, C-164, V-116, and V-117. A separate line fuse should be supplied.
3. Convert audio and relay amplifier V-113 to a d-c amplifier for actuating the Esterline-Angus recorder by modify-

ing the circuit of V-113 as shown in figure 5.

4. Utilize a-c line cord for power cable. Disconnect line cord from PUSH FOR LINE CHECK switch and P-108, and reconnect to filament and dynamotor fuse. Remove male plug and replace with suitable lugs.

To adjust the d-c amplifier for "line-up" with the Esterline-Angus recorder, proceed as follows:

1. Connect recorder to RECEIVER OUTPUT terminals.
2. With the receiver off, adjust meter on recorder to zero.
3. Turn sensitivity control of d-c amplifier to extreme left-hand position.
4. Turn receiver on, and allow it to warm up for 10 minutes.
5. Adjust zero control on d-c amplifier to read 0.1 on recorder chart.
6. By use of the TS-32 Test Oscillator or signal generator, feed signal into antenna terminals of receiver, and adjust output of signal generator for maximum received-signal strength as read on receiver meter with meter switch in position 2.
7. Advance sensitivity control of d-c amplifier from left to right until meter on recorder reads 0.8 on recorder chart.

Solution to . . .

September-October "What's Your Answer?"

The circuit given in this problem has been slightly rearranged below and the components numbered for ease of explanation. The required output waveform is also shown.

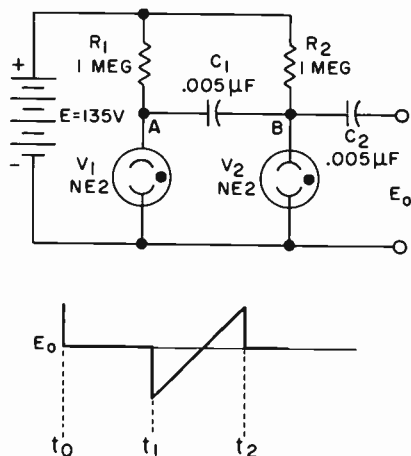

Before an explanation of the circuit is given, it should be noted that a gas-filled lamp such as the NE2 ionizes at a certain voltage and deionizes at a somewhat lower voltage. The voltage across the lamp when ionized depends upon circuit component values and the applied voltage.

Since no two lamps are exactly identical, one of the lamps (V_2 , for example) will ionize before the other when voltage is applied. The output voltage at point B is thus determined by the voltage-divider action of R_2 and V_2 . This voltage is coupled through C_1 and appears instantaneously at point A, preventing V_1 from ionizing and creating a voltage drop across R_1 . C_1 now charges through R_1 , and the voltage at point A rises along an exponential capacitor charge curve. At time t_1 , this voltage reaches the ionization point of V_1 , and V_1 ionizes.

The voltage at point A then drops sharply to a value determined by R_1 , and V_2 deionizes. C_1 then charges in the opposite direction, and the voltage at point B rises until the ionization point is reached. At this time (t_2), V_2 ionizes, extinguishing V_1 , and the process is repeated.

Thus the circuit acts as an oscillator to produce the waveform shown. The waveform is symmetric because R_1 is equal to R_2 . Although the rise is shown as being linear, it may vary slightly from this condition depending on the value of the R-C time constant.

JANET

METEOR COMMUNICATION SYSTEM

by James R. Spencer
Headquarters Technical Staff

This article describes a promising new communications technique which uses the reflection properties of meteor ionization trails to transmit messages over long distances.

ONLY A FEW SHORT YEARS AGO it was generally believed that reliable radio transmissions in the v-h-f and u-h-f spectrum were limited to line-of-sight distances. Since 1950, considerable scientific effort has been directed toward the development of beyond-the-horizon "scatter" propagation techniques. As a result of this effort, reliable over-the-horizon, point-to-point communications systems operating in the u-h-f and v-h-f region of the radio spectrum have been developed and are now in operation. These systems are characterized by their high-powered transmitters, supersensitive receivers, and huge antenna systems.

In 1952, while experiments were underway in the United States to develop such systems, physicists engaged in

upper-atmosphere research at the Radio Physics Laboratory near Ottawa, Canada received sporadic signals from a distant American transmitter. At times these signals were very strong and lasted for periods of several seconds. Figure 1 shows a recording of receiver signal strength made during one of these periods. This chart indicates the highly erratic characteristics of the received-signal amplitude. In figure 2, which shows another recording made with better resolution in time, the individual amplitude characteristics of the signal can more easily be seen. What appears to be a continuous signal in figure 1 is thus revealed as a composite signal, made up of short-term "bursts" of clear reception.

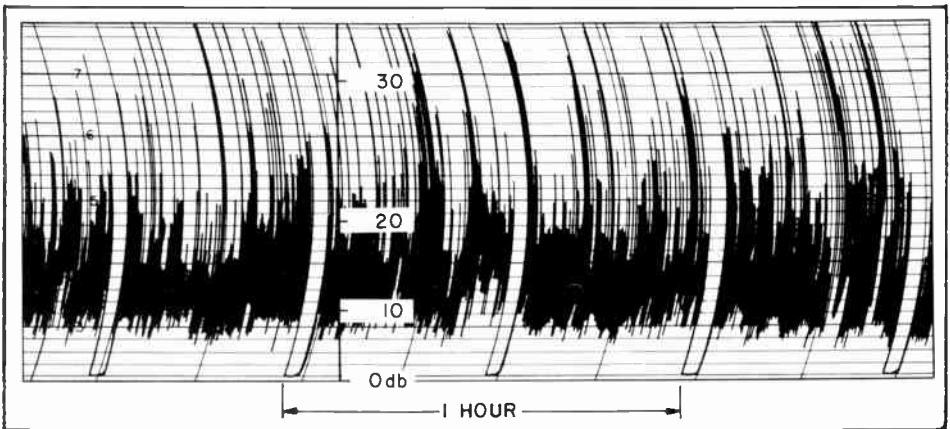

*Figure 1. Characteristic Recording of Received Signal Amplitude
(Photograph Courtesy of the Canadian Defence Research Board)*

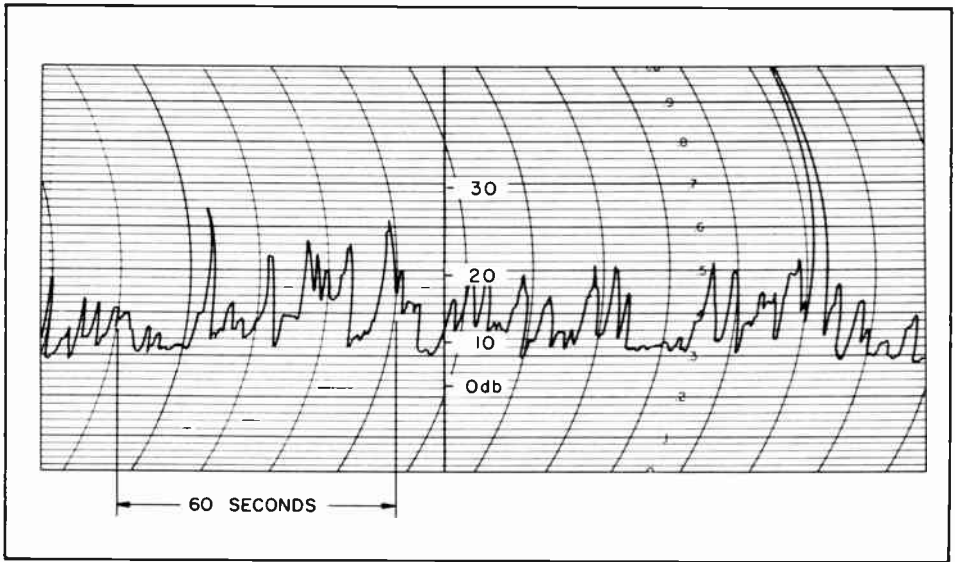

Figure 2. Fast Run Illustrating Fine Structure in V-H-F Signal (Photograph Courtesy of the Canadian Defence Research Board)

The characteristics of the individual signal bursts led Dr. Peter Forsyth, a physicist at the Radio Physics Laboratory, to conclude that the signals from a side lobe of the American antenna were being reflected from the trails of ionization formed each time a meteor entered the earth's atmosphere. Referring again to figure 2, it can be seen that these bursts have certain common characteristics. They have a distinct beginning in time with a rapid increase to peak amplitude, the result of the meteor's entering the atmosphere and forming an ionization trail. As the trail decays, the charged particles diffusing into the surrounding atmosphere cause the fall-off from peak amplitude to follow an exponential curve. Although the bursts may overlap frequently at low signal levels, they rarely do at the higher levels.

BASIC SYSTEM

Dr. Forsyth, visualizing the potential applications of radio signals reflected from meteor trails, proposed the JANET communications technique. The project

was called *JANET* after the Roman god Janus, who looked both ways. The system proposed, shown in block diagram form in figure 3, employs a receiver and a relatively low power transmitter, both operating continuously, at each of two widely separated stations. When a suitably located meteor trail occurs, transmission takes place in both directions and the output of the receiver triggers the co-located modulator. The message, which has been previously stored, is then transmitted automatically and rapidly to the other end of the circuit. By continuously monitoring the signal-to-noise ratio of the carrier from the far station, it is possible to gate the modulator when the ratio exceeds a certain predetermined level. To transmit sufficient information during the short life of a meteor trail to make the method practicable, high instantaneous transmission rates are required. This burst transmission technique requires that the information be stored to await transmission and also that it be stored upon reception and printed out at normal

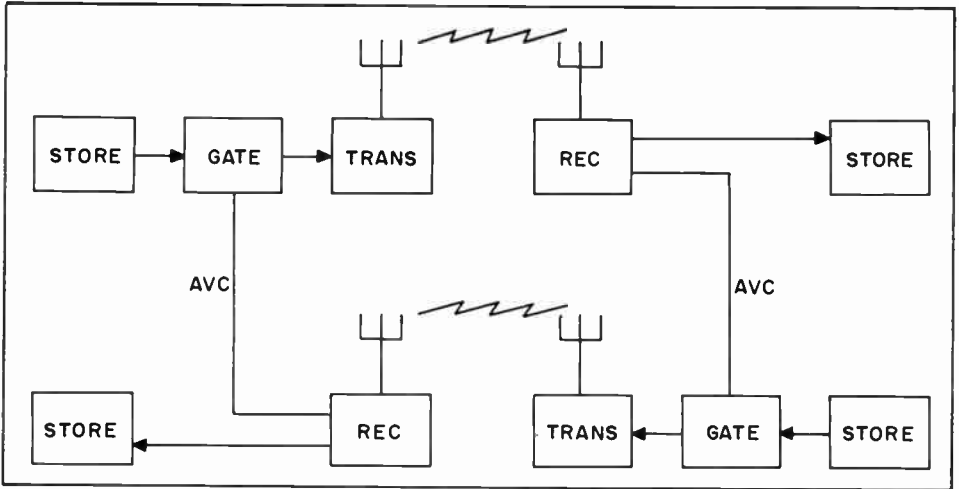

Figure 3. Basic Janet System, Block Diagram

speeds. As the signal decays, the signal-to-noise ratio decreases and at a pre-determined level closes the modulator gate, thus stopping the transmission of information.

METEOR TRAIL SCATTER CHARACTERISTICS

Up until the time of Dr. Forsyth's observations, practically all of the studies of radio reflections from meteor trails were made with radar, using a transmitter and receiver at the same location. The JANET system, with its widely spaced stations, required that the meteor trail exhibit a reciprocity of reflection. Accordingly, tests were conducted by Dr. Forsyth and Dr. Vogan between Ottawa and Port Arthur, Canada, to determine whether the meteor trails would reflect radio waves sent from both directions. The test substantiated the theoretical calculations. Theoretically, only those trails tangential to an ellipsoid, drawn about the terminal stations as foci, will have reciprocal reflection characteristics. Figure 4 is a plot of those areas in which the meteor trails meet the reciprocity criteria. It can be seen that the areas which produce the greatest number of useful meteor trails lie to either side of

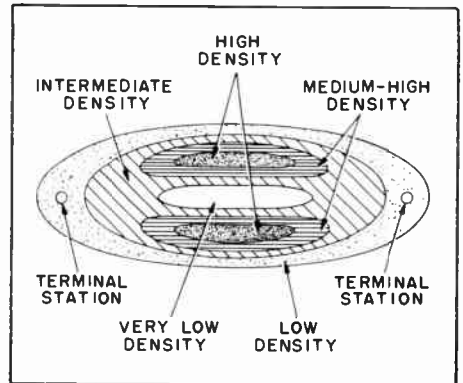

Figure 4. Plot of Volume Density of Meteor Trails Suitably Oriented to Produce Reciprocal Reflection Characteristics, Showing Areas Which Produce Greatest Number of Useful Trails

the great-circle course between the two terminal stations and that there is almost a complete lack of useful trails directly on the great-circle course. Because the greatest number of useful trails occurs in an area rather than at a point, the use of extremely narrow-beam antennas is not required. Successful circuit operation can be achieved using only two yagi antennas fed in antiphase and spaced four wavelengths apart. Identical but separate antenna systems are used for transmitting and receiving.

Another characteristic of the transmission path is the density of useful trails, i.e., the number of useful trails occurring within a given time. The more trails occurring, the denser the path. Figure 5 shows two pen recordings of the receiver a-v-c voltage, one for an underdense trail and the other for an overdense trail. The underdense trail exhibits the same type of structure as that of figure 2. The overdense trail, although it has a higher signal level, is subject to very rapid fades caused by interference as the trail diffuses.

THE JANET SYSTEM

The meteors and their ionized trails, which provide the reflections, occur in a random fashion, and thus require that the equipment be capable of utilizing the few tenths of a second which each

trail provides. The system equipment, designed by Ferranti Electric, Limited, has a sending and receiving rate of 1200 words per minute. Assuming that communication between the stations would be possible at least 5% of the time, it may be seen that the average sending and receiving rate would be 60 words per minute. As shown in figure 6, the incoming message is coded on punched paper tape by a reperforator and then stored to await transmission. The punched tape is stored in a narrow box capable of holding approximately 150 feet of punched tape. The storage box is equipped to indicate whether it is full or empty; if full, it stops the incoming message sender to prevent an overflow, and if empty, it energizes the reperforator to print sufficient blank tape to

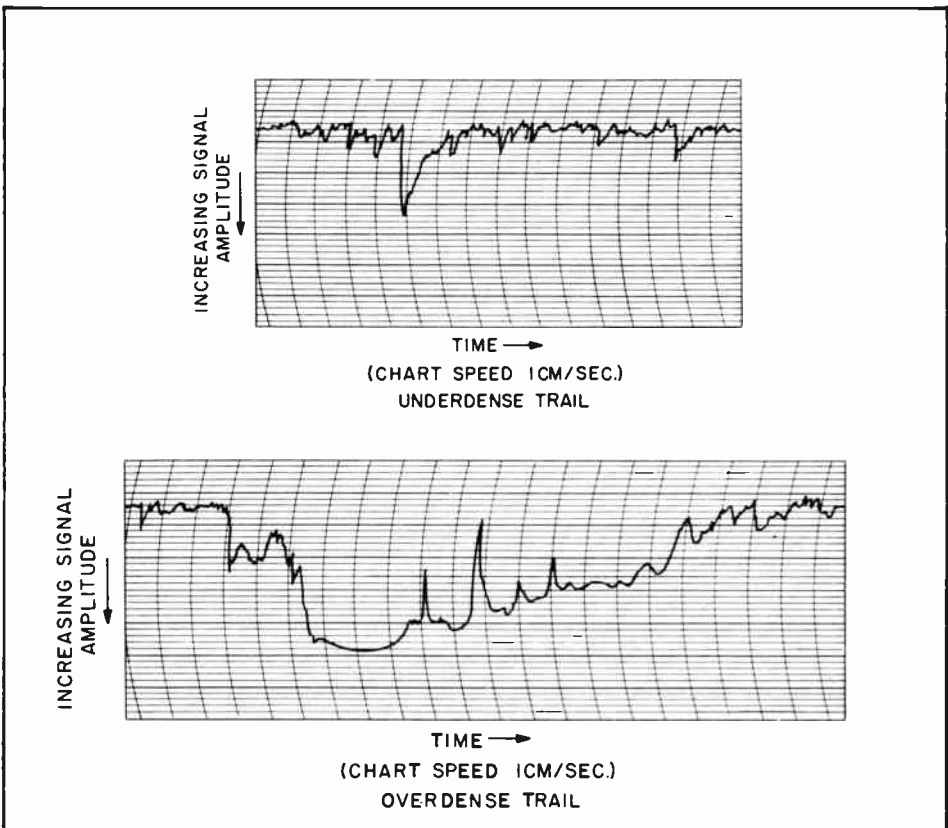

Figure 5. Pen Recordings of Receiver A-V-C Voltage (Courtesy of Ferranti Electric, Limited)

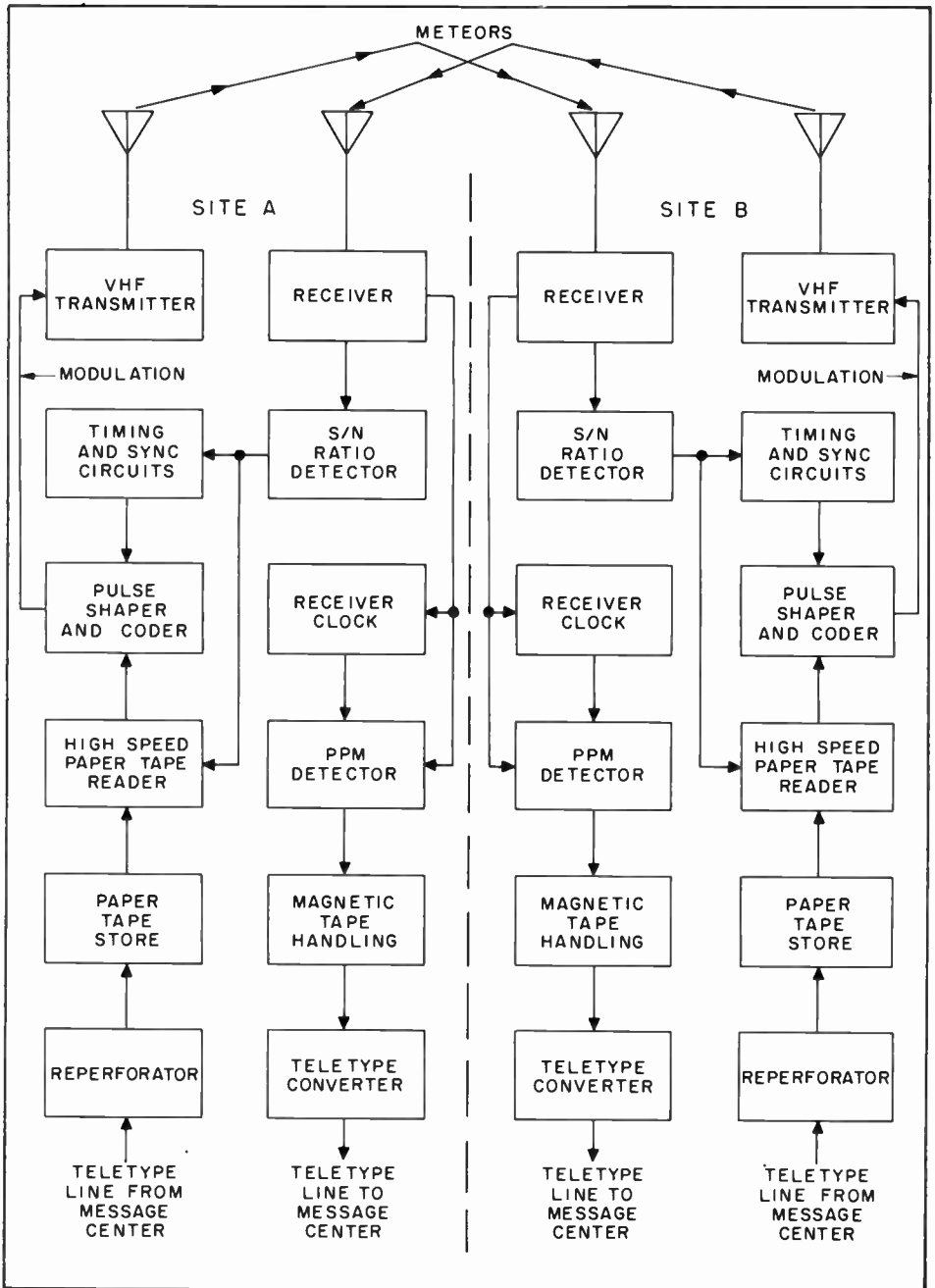

Figure 6. Block Diagram of Janet System. The outgoing teletypewriter messages are stored on paper tape to await transmission. Incoming radio signals are detected and stored on magnetic tape before being fed to the teletype line (Courtesy of Ferranti Electric, Limited)

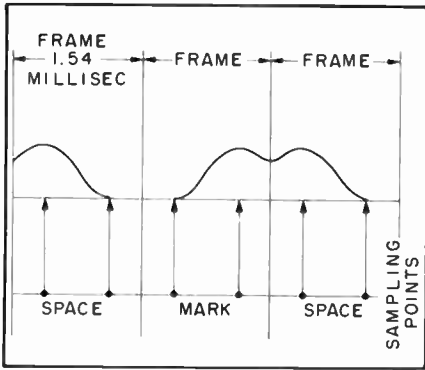

Figure 7. Janet Pulse Position Modulation Waveform (Courtesy of Ferranti Electric, Limited)

ensure that the last message can be completely withdrawn from the storage box and transmitted.

Pulse position modulation is used, with two possible pulse positions. A space is indicated by a pulse in the first position, and a mark by a pulse in the second position. The pulse repetition rate is 650 pulses per second. A 1300-cps synchronizing signal modulates the pulse amplitude, resulting in the waveform shown in figure 7.

During the periods when communication is not possible over the path, both transmitters send a continuous unmodulated signal. When communication conditions become favorable, the receiver detects the distant-transmitter carrier, and keys the accompanying modulator to send a continuous series of marks, which are amplitude-modulated with the 1300-cps timing signal. The continuous series of marks basically constitutes a 650-cps sine wave. This same action simultaneously takes place at the distant station. The detection of the 650-cps signal by the receiver at either end indicates that the other station is about ready to accept and transmit information. With the detection of the 650-cps signal, the 1300-cps synchronizing signal is also detected and utilized

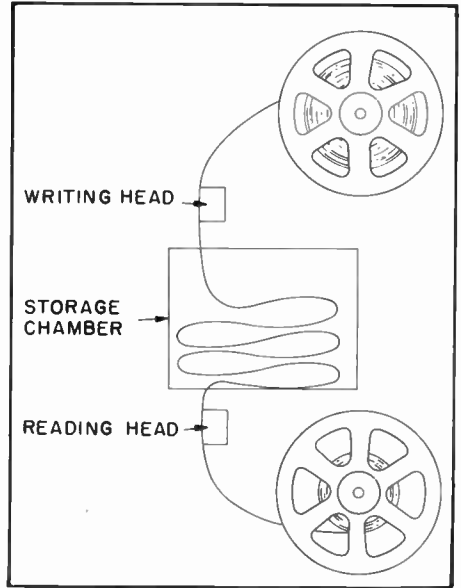

Figure 8. Magnetic Tape Recording Unit

to lock in both the receiver coder and transmitter coder. At the start of each message a synchronizing character is transmitted by each station. At the receiver end this synchronizing character is decoded and then the text of the message is received. If the synchronizing character is improperly decoded or not received at all, the receiver is disabled, and four X's are printed to indicate that a portion of the message may have been missed. At the same time the receiver is being disabled, the transmitter sends a stop signal to the distant station which closes down the circuit until the next meteor trail is detected.

The tape recorder, illustrated in figure 8, has the unusual ability to write at 1200 wpm and read at 60 wpm. During reception, the tape is withdrawn from the top reel at high speed, and the incoming message is recorded by the writing head. After passing the writing head, the tape is placed in the storage chamber. The lower reel then withdraws the tape from the storage chamber, and

the message is read at 60 words per minute.

The discovery of the principle and the successful development of the ingenious equipment to utilize it provide a highly reliable low-power form of over-the-horizon communications.

ACKNOWLEDGEMENTS

The author wishes to thank the staff of the Canadian Defence Research Board and Mr. G. W. L. Davis, Chief Engineer, Ferranti Electric, Limited, for assistance in providing reference material for the preparation of this article.

TECHNICAL SKETCH OF MICHAEL FARADAY (1791-1867)

EDUCATION AND EARLY BACKGROUND

Michael Faraday was born at Newington, Surrey, on September 22, 1791. Faraday was reared in London and made apprentice to a bookbinder at the age of fourteen. He attended lectures given by Sir Humphrey Davy, professor of chemistry at the Royal Institution. Faraday carefully prepared the lecture notes he had taken, bound them, and sent them to Davy with a request to be appointed to the Royal Institution. His proposal was accepted and he began his career. He was, for the most part, self-educated.

MAJOR SCIENTIFIC CONTRIBUTIONS

Faraday was better known, in his early years, as a chemical experimenter. For example, he discovered two new chlorides of carbon, liquefied several gases, and improved contemporary laboratory practice.

Faraday then turned to electrical experiments where he established the identity of electrification produced by different methods, established the laws of electrolytic processes, introduced such terms as anode, cathode, ion and electrolyte, discovered electric induction (certainly his most outstanding achievement), devised a scheme showing the effect of magnetism on polarized light, and initiated the use of the term and idea of an electric field.

His work in electric induction was part of the groundwork for Maxwell's mathematical treatment of electricity. The stature of Faraday is evident from the fact that two electrical units are named in his honor (he is the only man so honored). They are the Farad and the Faraday.

PROFESSIONAL CAREER

Faraday was an assistant to Davy for ten years, after which he was appointed Director of the Laboratory. In 1833 he was appointed Fullerian professor of chemistry. He remained with the Royal Institution for the rest of his life. In addition to his excellence in the experimental field, Faraday was probably the best liked of all popular lecturers on science. Some of his lectures are reproduced in the Harvard Classics; they are without doubt among the clearest and most interesting of popular material on science. Possibly the most famous popular lecture series are Faraday's Christmas Lectures for Children.

PUBLISHED WORKS

1. Chemical Manipulation, being Instructions to Students in Chemistry, 1827.
2. Experimental Researches in Electricity—Three volumes, 1844.
3. Experimental Researches in Chemistry and Physics, 1859.
4. Lectures on the Chemical History of a Candle, 1861.
5. On the Various Forces in Nature. (No date)

H. W. MERRIHEW
Headquarters Technical Staff

COMPUTING PARABOLIC REFLECTOR GAIN

THE ACCOMPANYING CHART has been devised to facilitate the computation of the gain of a parabolic reflector when either the diameter of the reflector or its beamwidth is known. Since the chart interrelates gain, diameter, and beamwidth, it is possible to find any two of the quantities if the third is known. The method of using the chart is given below.

If the beamwidth is the known quantity, find, on the beamwidth scale, the beamwidth (at one-half power) in de-

grees. From this point set up a perpendicular which intersects the beamwidth curve on the chart (this is illustrated on the chart for a beamwidth of approximately 20 degrees). From the intersection point, draw a line perpendicular to the diameter scale. The intersection of this line with the scale indicates the reflector diameter in half-wavelengths. (In the example illustrated, the reflector diameter would be approximately 3.4 half-wavelengths.) To find the power gain of the reflector in db, drop a perpendicular from the intersection point

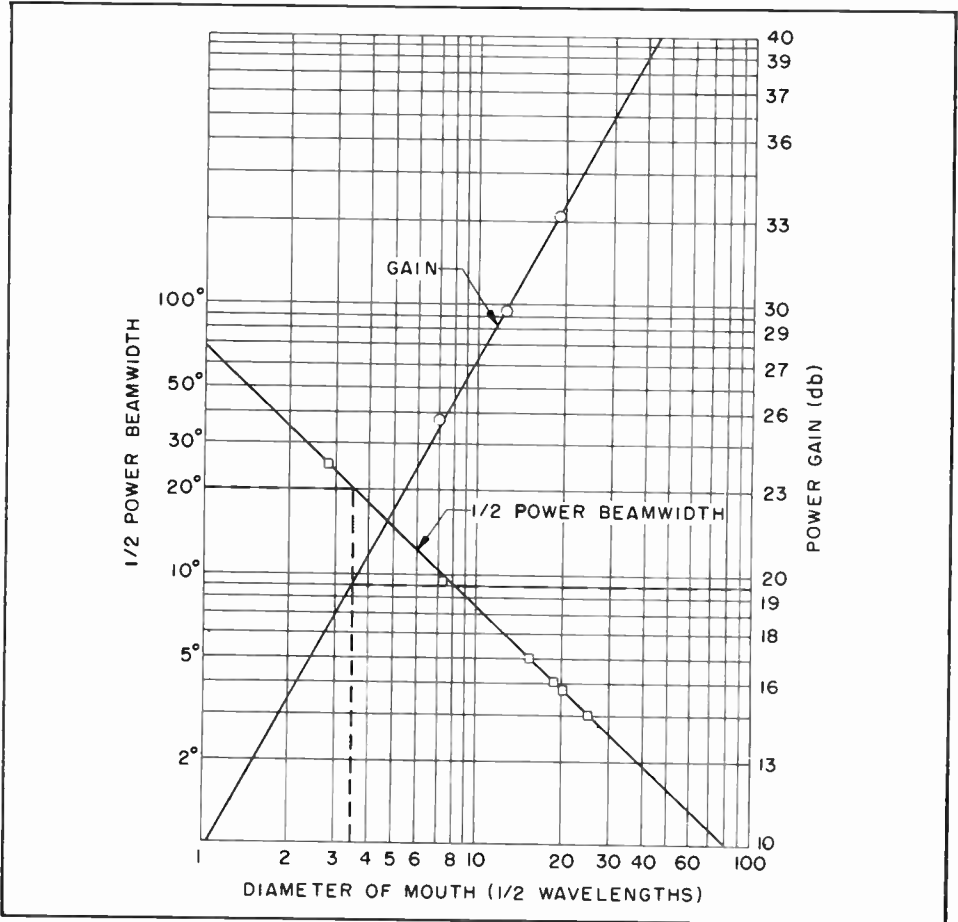

of the line indicating diameter and the gain curve to the power gain scale. This scale will indicate the power gain of the reflector. (In the example, the power gain would be 19.5 db.)

In a similar manner, the beamwidth and power gain may be found if the diameter is known, or the diameter and beamwidth may be found if the power gain is known.

It should be emphasized that the chart was constructed with the aid of the mathematical relationships between gain, beamwidth, and diameter, and should not be used if extreme accuracy is required. (The actual formulas should be used in this case.) However, the chart provides a quick method for finding a good approximation, and should be useful in many instances.

SERGE MANFANOVSKY

~~~~~

### Errata for September-October, 1957 Issue

A square root sign was inadvertently omitted in formula 5 on page 12. The formula should read as follows:

$$Y_o = \frac{1}{\sqrt{1 + \frac{1}{\omega^2 C^2 R^2}}} \quad \angle \tan^{-1} \frac{1}{\omega CR}$$

~~~~~

"Small Signals" - A new Philco publication

Starting in October, 1957, a new publication appeared on the Philco scene. Known as *Philco Small Signals*, the publication will be issued bimonthly by the Lansdale Tube Company, Division of Philco Corporation. The purpose of *Small Signals* is to disseminate information on advances in the transistor art made at Philco's Transistor Center in Spring City, Pa. New developments in transistors and transistor applications will be featured.

Subscriptions are on a complimentary basis, and may be obtained by writing to:

Mr. George F. Watson
 Advertising Assistant
 Lansdale Tube Co.
 Lansdale, Pa.

"What's Your Answer?"

A quarter-wave vertical radio transmitting antenna is being erected using a tower 322 ft tall (a quarter wavelength at a frequency of approximately 764 kc). Since this constitutes a hazard to air navigation, it must be painted in alternate uniform bands of orange and white, with each orange band twice the height of a white band. Each white section must be between 6 and 9% of the tower height, and both the top and bottom bands must be orange. What is the height of each orange band, and how many are there?

Index for Volume 7, Philco TechRep Division BULLETIN

	A	Month	Page
AN/GRC-27, Remote Control Channel System for		Jan.-Feb.	27
Antenna Manual Availability		Jan.-Feb.	13
Apple Receiver Circuits and Components, Current Status of		Mar.-Apr.	3
Apple Tube—A Beam Indexing Color Picture Tube		Jan.-Feb.	3
B			
Beam Indexing Color Picture Tube—The Apple Tube		Jan.-Feb.	3
BULLETIN Binders		Jan.-Feb.	23
C			
Cables and Pipes, Underground, Radio Location of		May-June	27
Calculus, Differential, Application of		Mar.-Apr.	26
Chart, Polar Impedance		May-June	20
Charts, Earth Profile, Construction of		Jan.-Feb.	17
Communications Systems, Meteor		Nov.-Dec.	23
Communications Systems, VHF Point-to-Point Field Tests by Light Aircraft		Nov.-Dec.	16
D			
Differential Calculus, Application of		Mar.-Apr.	26
E			
Earth Profile Chart, Construction of		Jan.-Feb.	17
Earth Satellite—Unique Research Tool		Sept.-Oct.	3
Editorial			
Single Sideband Transmission		Jan.-Feb.	1
Miniaturization		Mar.-Apr.	1
EXICON—The New X-Ray Technique		May-June	1
A New Weapon in Cancer Research		July-Aug.	1
Digital Computers and Field Engineering		Sept.-Oct.	1
The Crisis in Scientific Manpower		Nov.-Dec.	1
Errata for May-June 1957 Issue		July-Aug.	31
Errata for September-October 1957 Issue		Nov.-Dec.	31
F			
Feedback Circuits, Frequency Response Analysis of, Part 1		Sept.-Oct.	10
Part 2		Nov.-Dec.	3
Ferrites for Waveguides		May-June	9
Frequency Standard, Portable		July-Aug.	32
G			
Gain of Parabolic Reflector, Computation of		Nov.-Dec.	30
Gyro Stabilization, Practical Aspects of		July-Aug.	5
H			
Height Finder Alignment		May-June	5
J			
Janet—Meteor Communications System		Nov.-Dec.	23
K			
Klystron		Mar.-Apr.	11
L			
Letters to the Editors Column		Jan.-Feb.	2
		Mar.-Apr.	2
		May-June	2
		July-Aug.	2
		Sept.-Oct.	2
Lin-Log Curve Check		May-June	3
L-Type Matching Networks, Design of		Sept.-Oct.	23
M			
Magnetic Measurements, High-Frequency		Sept.-Oct.	29
MD-83 Omni-Signal Modulator, Operation on 50 Cycles		Mar.-Apr.	23
Meter Internal Resistance, Determination of		May-June	8
Mutual Inductance Transducers, Design Criteria for		May-June	16
MW Transmitters, Westinghouse, Keying for Air/Ground Use		Jan.-Feb.	11

Index (Cont.)

	Month	Page
O		
Omni-Signal Modulator MD-83, Operation on 50 Cycles	Mar.-Apr.	23
P		
Parabolic Reflector Gain, Computation of	Nov.-Dec.	30
Philco New Publication—"Small Signals"	Nov.-Dec.	31
Philco Technical Publications Price Schedule Training and Trouble-Shooting Manuals	Mar.-Apr.	33
Polar Impedance Chart and Its Use	May-June	20
Power Units, Parallel Operation of	July-Aug.	11
Q		
Quality Control of Vacuum Tubes	May-June	30
R		
Racon Power Checks	July-Aug.	3
Radio Location of Underground Cables and Pipes	May-June	27
S		
Single Sideband Communications Manual	Sept.-Oct.	33
Stabilization, Gyro, Practical Aspects of	July-Aug.	5
T		
T-17 Microphone Test Set	Jan.-Feb.	14
Tech Info Mail Bag		
Phase Shift Measurement	Jan.-Feb.	25
Hammond Organ Solution	Mar.-Apr.	32
APN-9 Problem and Solutions	May-June	32
Another APN-9 Solution, Bird Problem	Sept.-Oct.	20
Solution to Bird Problem	Nov.-Dec.	15
Technical Sketch, George Boole	May-June	33
Technical Sketch, Michael Faraday	Nov.-Dec.	29
Technical Terminology	Jan.-Feb.	10
Teletype Reception, Reliable	Mar.-Apr.	29
Television		
A Beam Indexing Color Picture Tube—The Apple Tube	Jan.-Feb.	3
Current Status of Apple Receiver Circuits and Components	Mar.-Apr.	3
Test Set, T-17 Microphone	Jan.-Feb.	14
Tone Keyers, Northern Radio, Adjustment of Output Frequencies	Jan.-Feb.	24
Transducers, Mutual Inductance, Design Criteria for	May-June	16
Transistor, Transmitter, Powered by Flashlight Cells	Jan.-Feb.	20
Transmission Lines, Reflected Pulse Testing of	Sept.-Oct.	26
Transmitters, Westinghouse MW, Keying for Air/Ground Use	Jan.-Feb.	11
Transmitter, Transistor, Powered by Flashlight Cells	Jan.-Feb.	20
Traveling-Wave Tubes and Related Devices, Introduction to	July-Aug.	23
V		
Vacuum Tubes, Quality Control of	May-June	30
Vanguard Project	July-Aug.	15
VHF Communications Systems, Point-to-Point, Field Tests by Light Aircraft	Nov.-Dec.	16
W		
Waveguides, Ferrites for	May-June	9
"What's Your Answer?"		
Solution to Nov.-Dec., 1956 Problem	Jan.-Feb.	33
Resonant Frequency	Jan.-Feb.	19
Solution	Mar.-Apr.	31
Capacitor Voltage	Mar.-Apr.	10
Solution	May-June	19
Batteries	May-June	4
Solution	July-Aug.	22
Conversion Factor	July-Aug.	14
Solution	Sept.-Oct.	28
Neon Lamp Circuit	Sept.-Oct.	32
Solution	Nov.-Dec.	22
Antenna Tower	Nov.-Dec.	31

**CONSULTING, PROJECT, AND FIELD ENGINEERING
CONTRACT AUGMENTATION**

**ELECTRONICS • COMMUNICATIONS
POWER PLANT • REFRIGERATION
ELECTROMECHANICAL AND SPECIAL SYSTEMS**

STANDARDIZED TRAINING

**COURSES • TRAINING DEVICES
INSTRUCTORS
for
EDUCATIONAL INSTITUTIONS
ARMED FORCES • INDUSTRY**



**COMPLETE PUBLICATIONS FACILITY FOR PREPARATION
OF TECHNICAL MANUALS such as—**

**MAINTENANCE HANDBOOKS • OPERATIONAL HANDBOOKS
ILLUSTRATED PARTS BREAKDOWNS • CATALOGS
ENGINEERING REPORTS • SPECIAL PROJECTS**