

SEPTEMBER 1979

HEWLETT-PACKARD JOURNAL



Contents:

- 3 SOS Technology Yields Low-Cost HP 3000 Computer System**, by *Richard C. Edwards*
Now it's easier than ever for a user to get into HP's most capable computer family.
- 7 Adapting the Multiprogramming Executive to a New Hardware Environment**, by *Claude Robinson, Jr.*
The new low-cost SOS hardware runs the same operating system and application programs as other HP 3000s.
- 9 A Friendly, Easy-to-Service Computer**, by *Yas Matsui and Manmohan Kohli*
The quiet, desk-like HP 3000 Series 33 fits easily into the office environment.
- 13 A Remote Computer Troubleshooting Facility**, by *David L. Nelson*
Problems can be investigated before a service person is sent to the site.
- 15 Philosophy of HP 3000 Series 33 Diagnostics**, by *James H. Holl*
A combination of self tests, the remote facility, and off-line diagnostics reduces down time.
- 17 Controlling Electromagnetic Interference Generated by a Computer System**, by *Daniel T.Y. Wong*
The HP 3000 Series 33 meets worldwide regulatory agency requirements.
- 20 Automated Pulmonary Function Measurements**, by *Maurice R. Blais and John L. Fanton*
A desktop computer improves accuracy and saves time in lung-function tests.
- 25 Triggered X-Y Oscilloscope Displays**, by *P. Guy Howard*
A new oscilloscope option provides a new way to look at dynamic phenomena.

In this Issue:



The HP 3000 is Hewlett-Packard's most powerful business computer product line. At the top of the line is the HP 3000 Series III, a step ahead of its predecessor, the Series II. Under control of the advanced MPE-III Multiprogramming Executive operating system (an operating system is the master program that gives a computer its basic personality), the Series II/III can run multiple concurrent application programs written in six high-level languages and handle up to 64 user terminals. These systems offer on-line transaction processing, data base management with HP's IMAGE software, virtual memory, and networking capability.

However, this issue isn't about the Series II/III. Most of it is about a brand-new HP 3000 Computer System, the Series 33, that costs only about half as much as its big brothers. It's a real HP 3000 that runs under the same MPE-III operating system and will run the same application programs as the Series II/III (except those written in the APL language). It'll handle up to 32 terminals and large computer peripherals like those shown on the cover—tape drives, large-capacity disc memories, and line printers. On the other hand, it doesn't have networking capability and isn't quite as fast as the larger HP 3000s.

The main reason we can offer an HP 3000 at the System 33's low price is an advance in technology, HP's silicon-on-sapphire integrated circuit process. Most of the Series 33's central processing unit is on three SOS chips, the same three chips, in fact, that made the new HP 300 Computer possible (see our recent June and July issues). The chips are wired differently to run the different HP 300 and HP 3000 operating systems.

Also in this issue is an article on HP's automated pulmonary function test system (page 20). The main contribution of this system is its desktop computer. By controlling all valving, measuring, computing, printing, and plotting, checking the hardware, and cueing the operator, the computer greatly reduces the chances of error in lung-function measurements and gives the operator more time to concentrate on the patient.

The article on page 25 describes a new option for one of HP's storage oscilloscopes. Usually an oscilloscope is used to show how some changing voltage (Y) varies as a function of time (X), and there are built-in facilities to select the time window that the user wants to look at. The new option gives the user a similar select-the-window capability when another voltage, rather than time, is the X-axis variable.

-R. P. Dolan

SOS Technology Yields Low-Cost HP 3000 Computer System

The new Series 33 is software compatible with the Series II and Series III, HP's most powerful computer systems.

Thanks to silicon-on-sapphire technology, its cost is surprisingly low for HP 3000 performance.

by Richard C. Edwards

HEWLETT-PACKARD'S new HP 3000 Series 33, Fig. 1, is a powerful, multiple-terminal, interactive business data processing system designed for use as an organization's complete EDP system. The HP 3000 Series 33 is the first application of HP's silicon-on-sapphire (SOS) technology to the top of the HP computer systems product line. The use of three proprietary large-scale-integrated SOS chips enabled the system designers to produce the HP 3000 CPU (central processing unit) on two printed circuit boards, a major reduction from the nine boards in the HP 3000 Series II/III. A new desk-sized mainframe package was made possible because of the SOS circuits' low power consumption, low heat dissipation, and small size.

Since the HP 3000 was first introduced in 1972, more advanced HP 3000 systems (HP 3000CX, Series II, Series III) have been introduced with successively higher performance. In contrast, the main design objective for the Series 33 was to deliver HP 3000 performance at a greatly reduced price. Fig. 2 illustrates price/performance curves for the HP 3000 for the past five years. The computer industry in general has been able to deliver either more performance at the same price or the same performance for a lower price each year (in contrast with the persistent inflation in the world economy over the past few years). At Hewlett-Packard we

have been able to deliver equivalent HP 3000 performance at a price approximately 25% less each year for the past five years. The Series 33 accelerates this trend in the direction of greatly lowered price, yet this entry-level HP 3000 has many of the features of its larger relatives and is software compatible with them.

Like other HP 3000 Systems, the Series 33 runs under the Multiprogramming Executive (MPE III) operating system, including the recent additions of a new, friendlier user interface and private disc volumes. A new, easy-to-use data entry subsystem, VIEW/3000, is supported on both the HP 3000 Series 33 and the HP 3000 Series II/III.

All non-privileged HP 3000 Series II and Series III programs—both source code and object code—written in COBOL, RPG, BASIC, FORTRAN, or SPL will run without any modification on the new HP 3000 Series 33. The Series 33 runs all HP 3000 Series II/III software subsystems except APL/3000 and the data communications subsystems (DS/3000, RJE/3000, MRJE/3000, and MTS/3000), which are not offered on the Series 33.

The basic HP 3000 Series 33 consists of a central processing unit (CPU), cartridge disc storage of 20 megabytes, a double-sided flexible disc drive with a capacity of 1.2 megabytes, and a microprocessor-based system console/maintenance console. It also includes 262,144 bytes of fault



Fig. 1. HP 3000 Series 33 Computer System. Base model includes a 20M-byte cartridge disc drive, 256K bytes of fault-control memory, seven ports for 2400-baud asynchronous terminals, two general I/O channels, and a one-megabyte double-sided flexible disc drive. The Series 33 runs the same Multiprogramming Executive operating system (MPE III) as the more powerful HP 3000 Series II and Series III systems, and will execute Series II and Series III application programs without changes or recompilations.

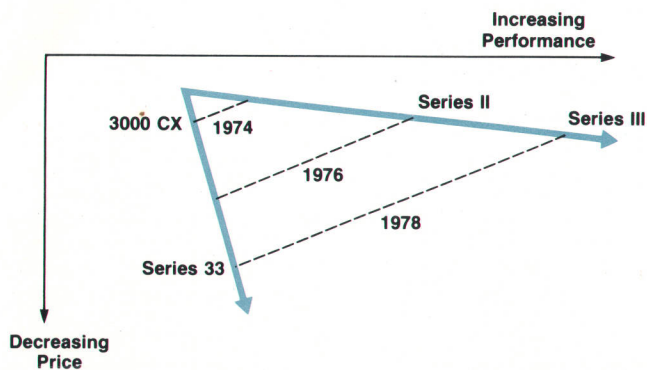

Fig. 2. HP 3000 Computer systems have steadily increased in computing power and decreased in price. Series 33 is designed to deliver HP 3000 performance at a dramatic reduction in price.

control main memory, two general I/O channels, and two asynchronous data communications controllers (one main, one extender) for connecting the hardwired system console and up to seven asynchronous terminals (hardwired or connected through modems). Remote diagnostic capability is also standard.

The basic HP 3000/33 can be expanded at the factory or in the field up to 1,024,000 bytes of fault control main memory, 960 megabytes of disc storage, three general I/O channels, and eight asynchronous data communications controllers that support up to four terminals each.

A Series 33 can support up to two line printers, either HP 2631A serial printers or HP 2608A line printers or both. Up to four 1600-bpi magnetic tape drives can also be attached.

The HP 3000/33 supports all CRT terminals in Hewlett-Packard's 2620 and 2640 families, including the HP 2647A and HP 2648A Graphics Terminals with automatic plotting of columnar data. Also supported is the HP 2635A printing terminal. Each terminal operator independently has full access to all system resources. Data entry, data base updates and retrievals, interactive program development, data communications, and batch programs can all be supported simultaneously on the system.

Design Objectives

In addition to the main objective of delivering HP 3000 performance at a greatly reduced price, several other design objectives were set at the beginning of the Series 33 project. These included:

- Complete MPE (operating system) compatibility with Series II/III
- Complete user application software compatibility with Series II/III
- Incorporation of the new HP I/O interface based on ANSI/IEEE standard 488-1978, known as the HP-IB (Hewlett-Packard Interface Bus)
- Designing the system to be friendly and easy to use.

CPU Hardware

HP's complementary-metal-oxide-semiconductor silicon-on-sapphire (CMOS/SOS) process,¹ developed as a large-scale integrated circuit technology, was chosen for the CPU design. The benefits of using the CMOS/SOS process for the HP 3000 CPU included:

- Small CPU size. The equivalent functions in a Series III CPU occupying 4500 square centimetres are reduced to less than seven square centimetres on the Series 33 three-chip CPU set (see Fig. 3).
- High-speed circuits. The system clock period is 90 nanoseconds.
- Low power consumption. The three CPU chips with approximately 25,000 transistors consume only one watt.
- Lower cost, the combined result of small size, low power consumption, and good manufacturing yields.
- Very high component reliability.

The three CMOS/SOS chips used in the Series 33 CPU are the same chips that are used in the CPU of the HP 300, another new HP computer system.^{2,3} In the HP 3000 Series 33, one pin of each chip is wired to a different voltage than in the HP 300, and the microprograms executed by the CPU are different.

Operating System

MPE III, Hewlett-Packard's Multiprogramming Executive operating system for the HP 3000 product line, is a general-purpose, disc-based operating system that makes possible concurrent execution of many programs (transaction processing, timesharing, and batch) in a multilingual environment. MPE III virtual memory provides a total memory space that far exceeds the maximum main memory of one megabyte on the HP 3000/33. MPE provides these major capabilities on the HP 3000 Series 33:

- Multiprogramming: concurrent transaction processing, timesharing, and batch processing
- Virtual memory
- Stack architecture: separation of code and data, variable length segmentation, data stacks
- Concurrent multilingual capability: COBOL, RPG,

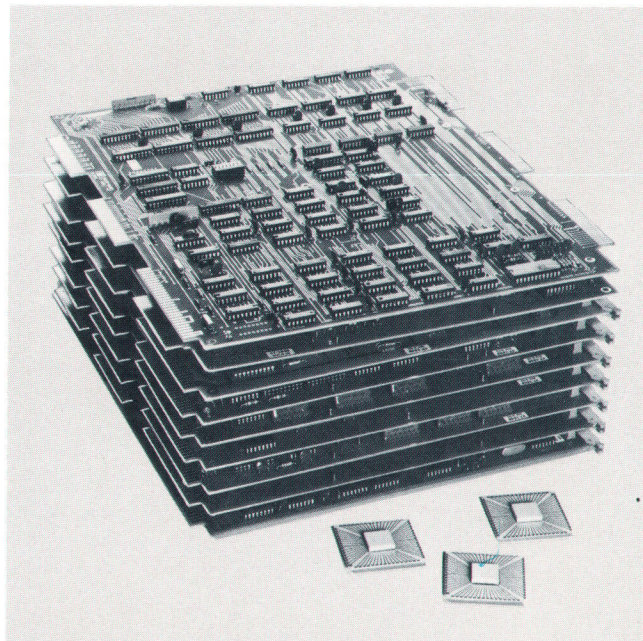

Fig. 3. Silicon-on-sapphire technology makes the Series 33 possible, reducing 4500 cm² of HP 3000 components on portions of nine circuit boards to the three SOS chips in the foreground.

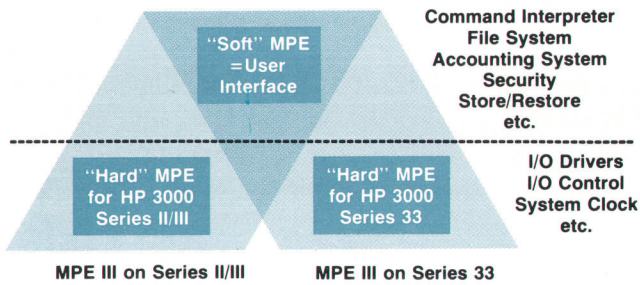

Fig. 4. Series 33 architecture differs from that of Series II and Series III. The MPE III operating system was divided into machine-dependent (hard) and machine-independent (soft) parts, and only hard MPE was modified, so all HP 3000 systems under MPE III have an identical user interface and compatible software.

BASIC, FORTRAN, and SPL

- A uniform, device-independent and language-independent file system with file backup and security
- System security and complete accounting of resources
- Dynamic resource control
- Friendly but powerful command language, including user-defined commands, conditional job control, on-line HELP facility, and meaningful error messages
- Device and file independence
- Input/output conveniences: spooling of input and output, private disc volumes, magnetic tape labels
- Complete and automatic terminal management, local and remote
- Automatic scheduling (under the control of the installation's management)
- System tailoring (under the control of the installation's management)

User Application Programs Existing HP 300 Series II/III Programs (Except APL)			
Utilities EDIT/3000 SORT/3000 FCOPY/3000 Compiler Library Scientific Library	Languages COBOL/3000 RPG/3000 BASIC/3000 FORTRAN/3000 SPL/3000	Data Entry VIEW/3000 DEL/3000	Data Management KSAM/3000 IMAGE/3000 QUERY/3000
MPE III Operating System			
Firmware			
HP 3000 Series 33 Hardware			

Fig. 5. User application programs written for the Series 33 can use all HP 3000 utilities, languages, data entry facilities, and data management software except APL.

- Power-fail/auto-restart.
- Because the Series 33's hardware, especially the CPU, is related more closely to the HP 300 than to other HP 3000 systems, changes had to be made to be able to run the Series 33 under MPE. MPE was divided into two sections, one that was hardware dependent, that is, unique to Series 33 or Series III, and one that was not hardware dependent, that is, identical for both Series 33 and Series III. We call these "hard" MPE and "soft" MPE, respectively (Fig. 4). The non-hardware-dependent section (soft MPE) is the user interface known as MPE III. This division enabled our designers to change only those sections that were affected by changing to the common HP 300 and HP 3000/33 hardware. The major sections changed were the input/output drivers

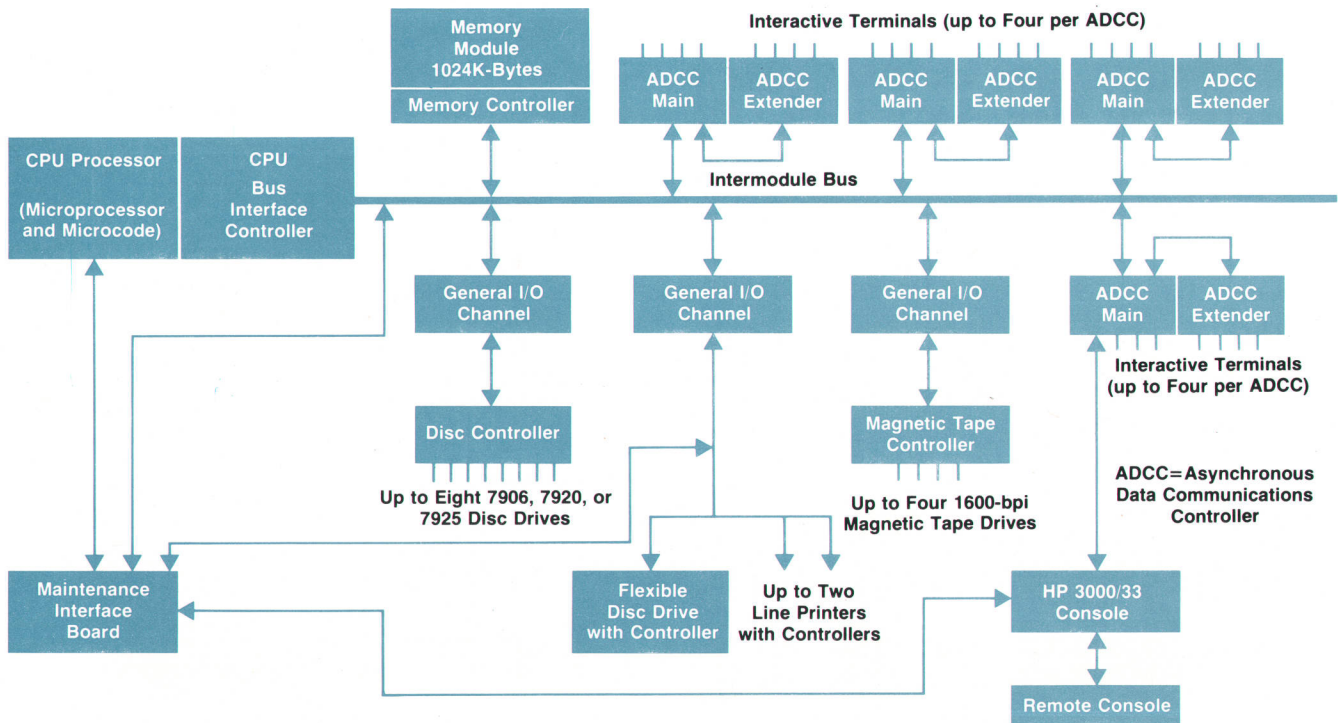

Fig. 6. HP 3000 Series 33 maximum configuration block diagram. The general I/O channels use HP-IB (ANSI/IEEE 488-1978) protocol.

for peripherals and the system clock. This amounted to about 15-20% of MPE.

The article on page 7 explains in greater detail how the changes in system microcode and hard MPE allowed the Series 33 to meet its design objective of MPE compatibility and complete user application software compatibility with HP 3000 Series II and III (see Fig. 5).

Architecture

Because it uses the HP 300 CPU chip set, the Series 33's architecture is markedly different from other HP 3000 systems. The HP 3000 Series 33 is designed around independent elements that are connected by a central bus structure (see Fig. 6). The elements of the system consist of a central processor that operates through a bus interface controller, memory arrays with a memory controller, general I/O channels, asynchronous data communications channels, and a bus system for communication between the I/O elements. Also, the system includes a system console, a system front panel, and a maintenance facility. Peripheral elements attach to the system through the general I/O channels. Interactive terminals attach to the system through the asynchronous data communications controllers.

When an I/O request is issued, the device driver in the CPU assembles the channel program, then issues a start I/O program (SIOP) instruction to one of two types of channels on the intermodule bus. These are the general I/O channel

(GIC) and the asynchronous data communications controller (ADCC). The GIC is the hardware I/O channel that provides the electrical interface between the computer system and peripheral devices connected to the Hewlett-Packard Interface Bus (HP-IB). The HP-IB is HP's implementation of ANSI/IEEE standard 488-1978, and is used on the Series 33 to connect peripheral devices. The HP-IB consists of eight data lines and eight control lines. The ADCC provides a bit-serial data interface between the computer system and terminals. The two channels operate in a similar manner, but the GIC has a DMA facility to permit high-speed transfer of large blocks of data, while the ADCC can transfer data only one character at a time.

This I/O structure is similar to the HP 300's. Its major benefit is that it is easy to add new HP peripherals designed with the standard I/O interface (HP-IB), so that customers have a wide choice of peripherals for future system growth.

Packaging and Service

The Series 33 is the first HP 3000 to be designed for the office environment. Along with a pleasant and functional desk package for the mainframe (see article, page 9) the designers have created a system that is friendly and easy to use. It is possible to configure the CPU, one megabyte of memory, I/O control for all permissible input/output peripherals, and terminal controllers for up to 24 terminals within a single 24-slot card cage. Fig. 7 illustrates the com-

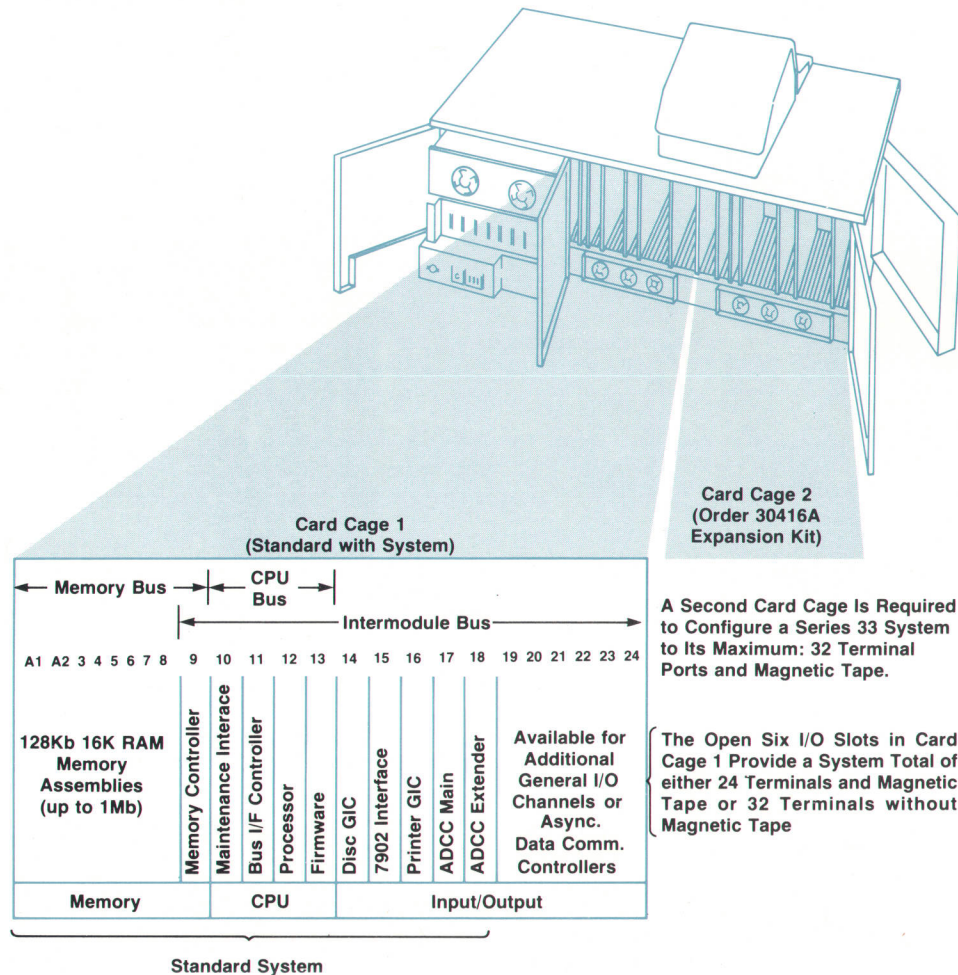

Fig. 7. Series 33 base system can be expanded within the same cabinet.

Adapting the Multiprogramming Executive to a New Hardware Environment

by Claude Robinson, Jr.

The HP 3000 Series 33 is first and foremost a member of the HP 3000 family. It is designed to be software compatible with the HP 3000 Series II and Series III and to run the same MPE (Multiprogramming Executive) operating system.

Adapting MPE to run on the new Series 33 was a nontrivial problem because of the Series 33's use of different hardware and a different I/O protocol from other HP 3000s, as explained in the accompanying article. The first task of getting MPE to run was to microprogram the new hardware with a subset of the existing HP 3000 instruction set. Since the Series 33 uses a different I/O protocol, the I/O instructions were redone. Along with new I/O instructions, some new instructions were coded to facilitate handling new features in the operating system and to handle the system clock on the Series 33.

To prepare for running MPE on the new hardware with the new I/O protocol, the MPE project team divided MPE into two portions, one hardware dependent and the other hardware independent. The hardware dependent portion, hard MPE, consists mostly of drivers, I/O system control modules, system clock handler, external and internal interrupt handlers, and some miscellaneous modules. The hardware independent portion, soft MPE, contains all the modules that nonprivileged users interface to.

MPE is a modular system divided into many segments. This new division meant rearranging segments so that they are either all hard MPE or all soft MPE. This task was complicated by the desire to maintain segmentation that would cause a minimum of absent-segment faults. Once the division was made, we were well on our way to getting MPE to run on the new hardware by changing only hard MPE. Since soft MPE was not changed, all user-mode and most privileged programs can be run on Series II, III, and 33 without changes, even at the object code level.

Because the system was intended as a low-price entry into the HP 3000 family, it was desirable to make the system functional without magnetic tape. The challenge was to do this in a manner that would not require retraining of current users of HP 3000s if they purchased a Series 33 to complement existing systems. We also wanted to accommodate the less-sophisticated user that we expect to encounter with this entry-level system.

Our solution was to design a serial disc interface. This capability is invisible to users except when a disc is declared as a serial disc. The serial disc interface allows the user to store files, back up the system, and do other serial, tape-like operations on the disc without additional effort on the user's part. HP 7905 cartridges on Series II and III, HP 7906 cartridges and flexible discs on Series 33, and HP 7920 and 7925 disc cartridges on Series II, III, and 33 may be used as serial devices.

The serial disc interface allowed us to make the flexible disc the backup device for Series 33 systems. It also gives great flexibility of files backup on the HP 3000: the user now has a choice of magnetic tape, serial disc, and private volumes for system backup.

New I/O protocol

The I/O bus used by the Series 33 (and the HP 300) is the HP-IB (ANSI/IEEE 488-1978). This standard, along with some system requirements on peripherals to be interfaced to the HP 300 and the HP 3000 Series 33, results in an I/O protocol that we refer to as the Amigo protocol (Amigo is the nickname used in the lab for the HP 300 system). The remainder of this article will address some of the differences in running MPE using the Amigo I/O protocol instead of the I/O protocol used on Series II and III.

The Amigo protocol requires more memory reserved for I/O

programs—on the average, about 100 words per device controller on the system. This means that, for initialization of I/O, more variables have to be set up. However, I/O programs can be (and are on Series 33) designed so that nearly all of these variables need to be set up only once after the system is up. This is done by initialization routines that are called by the system progenitor when the system first comes up.

The Amigo protocol requires more investigation by the driver on completion of I/O. This is in many cases an advantage, because it allows the designer of a driver to supply specialists and knowledgeable users with more information on I/O completion and to distinguish between various I/O failures, such as device failures, I/O channel failures, I/O programming errors, memory wraparounds, and DMA (direct memory access) aborts. This information can be determined and logged by the system. The overhead required for this benefit is minimal.

Here is an example of how this feature can help the specialists. When the 7925 disc drive was being interfaced to the Series 33, we decided to increase the size of the free space table on the disc. A problem was introduced that caused memory wraparounds on writes to the disc. Because of new features in the hardware and the Amigo protocol, the error was reported as soon as it occurred. In the past, this error would not have been noticed until much later (possibly days), long after the fact. It often takes weeks to determine where this type of problem originated. But with this new feature, we found and corrected the problem within hours.

Another difference of the Amigo protocol is that peripherals are not allowed to interrupt the CPU directly. Instead, peripherals are required to enable channel service request lines to indicate that they are ready for service. An interrupt to the CPU is caused only when the I/O program interpreter encounters an INTERRUPT instruction.

This is an advantage because the system designer has more control over when and how the CPU is interrupted. Also, the designer can supply more information along with the interrupt. The protocol requires reserving seven words per channel (called the channel program variable area, or CPVA) for interrupt information. The first four words of the CPVA are used with the INTERRUPT I/O instruction. The programmer may use any of the four words to put parameters in the CPVA to describe the cause of an interrupt. When DMA aborts, a known parameter is placed in CPVA0, and the memory address where the abort occurred is stored in CPVA4 and CPVA5.

The HP 3000 has automatic volume recognition for certain devices

Claude Robinson, Jr.



Chuck Robinson received his BS degree in mathematics from Morehouse College in Atlanta in 1970. With HP for nine years, he's worked in quality assurance, helped develop MPE C and the HP 3000 Series II, and served as project manager for HP 3000 Series 33 system software. He's currently section manager for MPE data access software. Outside of working hours, Chuck serves on the board of trustees of his church, coaches a youth soccer team, and enjoys tennis, golf, basketball, and woodworking. He's married, has two sons, and lives in San Jose, California.

when they are mounted. This requires running an I/O program to be able to see devices come on-line or taken off-line. The Amigo protocol allowed the system designer to have an I/O program in a WAIT state, requiring CPU or I/O program interpreter service only when the device in question enables the channel service request line (e.g., coming on-line).

Probably the greatest advantages of the new I/O protocol are a unified standard for all peripherals to be interfaced to the family of computers, and the new terminal controller, the asynchronous data communications controller or ADCC. The unified standard means that peripherals developed for one system in the new family can be easily interfaced on all. It also means fewer specialists are needed for

compact internal layout of the Series 33.

The Series 33 does not have the traditional computer system front-panel lights and switch registers. Total system control has been built into the system console. The CRT console, employing a specially microcoded microprocessor, is used for starting the system as well as receiving the traditional console messages. The user knows the status of the system from a status line on the console that displays either RUN or HALT and shows CPU utilization as a percentage from 0 to 100.

The system console also serves as the system maintenance console. Users are given a system diagnostic program that runs unattended in less than two minutes, displaying results on the console CRT screen. The diagnostic program checks out all hardware components involved in a system cold-load. Faults are isolated to the module level and concise, easy-to-understand messages are printed on the CRT.

Users can run the system self-test before calling Hewlett-Packard for hardware maintenance. If a service call is necessary, HP customer engineers and operating system specialists can use the console CRT display to inquire into the status of diagnostics initiated from the console system and even into the status of hardware registers for detailed troubleshooting.

Making this new maintenance console even more valuable is the ability to transmit the display and control functions to a remote HP 2645 terminal via a modem and telephone link. With this facility, the customer engineer on site can call the HP service office and have a specialist check out the system over the telephone using a remote system console/maintenance console. The customer engineer loads the remote maintenance code data cartridge into the console, then switches the modem (user-supplied) to the console using a switch built into the terminal junction panel to establish the telephone link. The specialist now has a duplicate display of the Series 33 system console/ maintenance

peripheral support.

The new terminal controller is probably the most significant advantage. Even with a CPU of slightly more than half the speed of the Series III, MPE on the Series 33 reads/writes a character from/to a terminal, on the average, in about the same time as the Series II/III. This is very important to an interactive transaction system such as the HP 3000.

Acknowledgments

Phil Ho developed the terminal I/O system for the Series 33. Rich Pearson and Dan Lundberg developed the peripheral access method.

nance console display, with the ability to send the customer engineer and/or system manager messages that are not transmitted to the computer. This remote maintenance console facility is a standard part of all Series 33 systems. It is described in more detail in the article on page 13.

References

1. D. Farrington, "CMOS/SOS," Hewlett-Packard Journal, April 1977.
2. G.R. Clark, "A Business Computer for the 1980s," Hewlett-Packard Journal, June 1979.
3. A.B. Bergh and K.C.Y. Mei, "Cost-Effective Hardware for a Compact Integrated Business Computer," Hewlett-Packard Journal, July 1979.

Richard C. Edwards

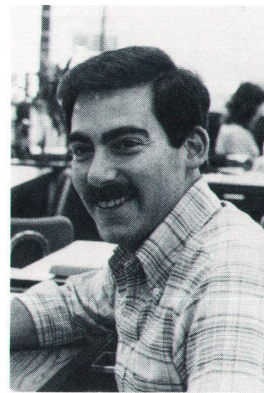

Rich Edwards received his BSE degree in electrical engineering from Princeton University in 1969 and his MBA degree from Stanford University in 1976. He's been with HP since 1976, serving as product marketing engineer for KSAM/3000, HP 3000 Series II Models 6 and 8, and HP 3000 software policy, and as product manager for the HP 3000 Series 33. He's now product manager for all HP 3000 systems. Rich served in the U.S. Navy from 1970 to 1974. As assistant director of the U.S. Naval Nuclear Power School, he taught mathematics, nuclear physics, and nuclear reactor operation. A member of IEEE, he's been selected as one of the "Outstanding Young Men of America" by the group of the same name. Born in Jacksonville, Florida, Rich is married to an attorney, has a son, and now lives in Oakland, California. He enjoys swimming, jogging, cooking, photography, skiing, and traveling.

SPECIFICATIONS HP 3000 Series 33 Computer System

HARDWARE SUPPLIED

- Central processing unit (CPU)
- 214 firmware instructions
- System clock
- 8 asynchronous terminal ports via two asynchronous data communications controllers (ADCCs)
- Modem support (for type 103/212/202S)
- General I/O channel for discs
- General I/O channel for line printers and flexible disc
- 256Kb fault control memory with memory controller
- System desk mainframe, one card cage, and power supplies
- System console/maintenance console
- 7906 19.6Mb disc with controller
- 1.2Mb flexible disc with controller (double-sided)

- 6 spare I/O slots and space for 1024Kb memory
- Room for 31 terminals plus system console
- Built-in isolation transformer

SOFTWARE SUPPLIED: HP 3000 Series Fundamental Operating Software, which includes:

- Multiprogramming Executive III operating system (MPE III)
- Text editor (EDIT)
- File-copying utility (FCOPY)
- Sort and merge package (SORT)
- IMAGE/3000
- QUERY/3000
- KSAM/3000
- HP VIEW/3000
- Facility to execute compiled programs without the source-language compiler on the system (except for programs written in APL 3000)

ENVIRONMENTAL

- TEMPERATURE (OPERATING): 50°-104°F (10°-40°C)
 - RECOMMENDED TEMPERATURE RANGE FOR MOST RELIABLE OPERATION: 68°-86°F (20°-30°C)
 - RELATIVE HUMIDITY: 30-80% non-condensing. 60% optimal. Maximum wet bulb temperature, 78°F (26°C).
 - LINE VOLTAGE: 200/210/220/230/240 V +4%, -10% single phase.
 - LINE FREQUENCY: 50 or 60 Hz ±0.5 Hz.
 - MAXIMUM RATE OF TEMPERATURE CHANGE: 18°F/hr (10°C/hr).
- PRICE IN U.S.A.:
HP 3000 Series 33 Standard System, \$58,500.
- MANUFACTURING DIVISION: GENERAL SYSTEMS DIVISION
19447 Pruneridge Avenue
Cupertino, California 95014 U.S.A.

A Friendly, Easy-to-Service Computer

by Yas Matsui and Manmohan Kohli

THE DESK-LIKE DESIGN of the HP 3000 Series 33 (see Fig. 1) puts a lot of computing power into a very small space, allowing it to fit easily into most business office environments. Visual compactness, low profile, low audio noise level and operator oriented design combine to achieve friendliness and space effectiveness.

The large desktop allows the operator to place the system console where convenient, and provides work space. Ample leg and knee space is provided under the desktop for comfortable seating, and all necessary controls are within reach of the operator.^{1,2}

A welded steel frame optimizes strength-to-weight ratio

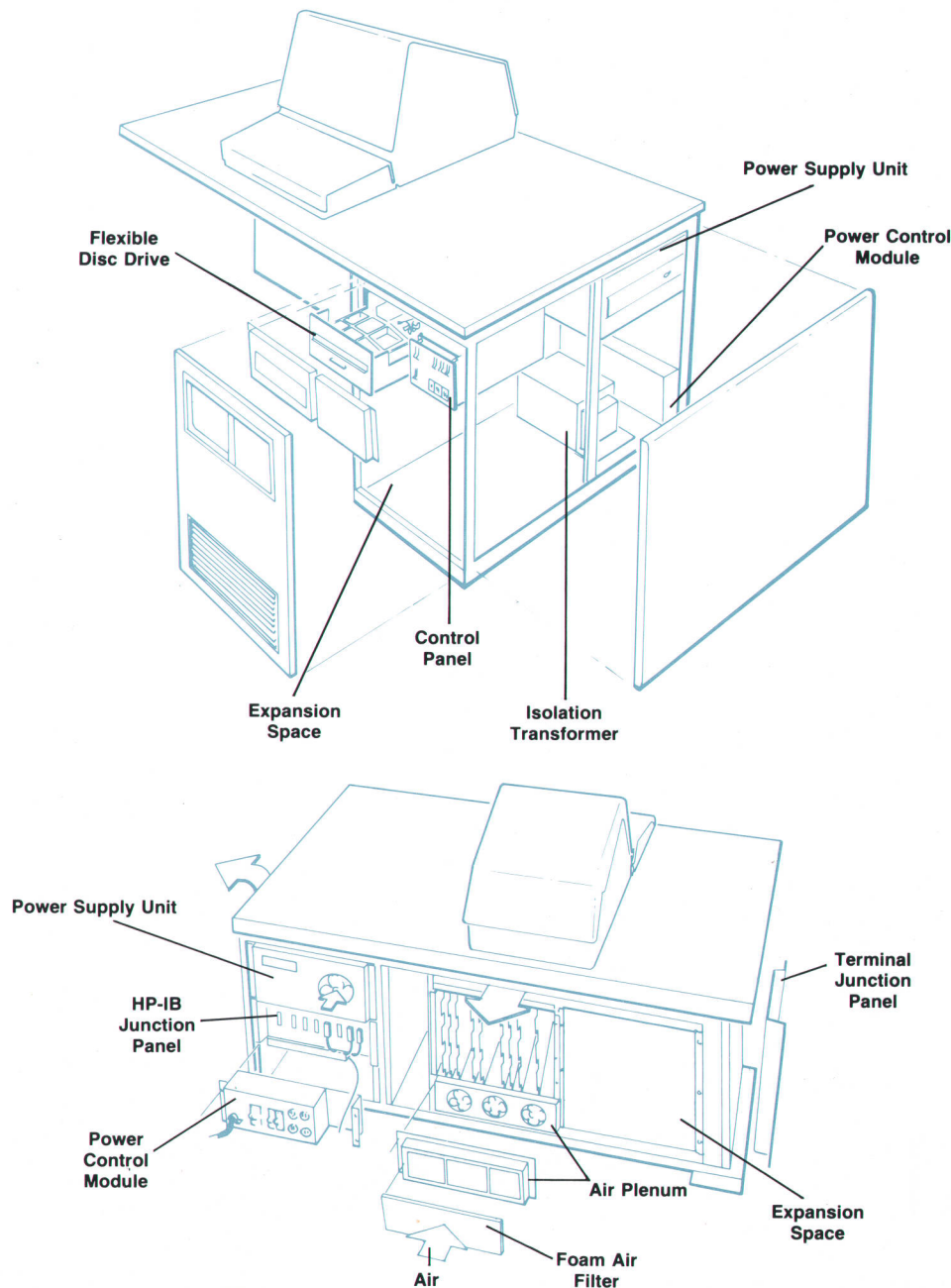

Fig. 1. HP 3000 cabinet design.

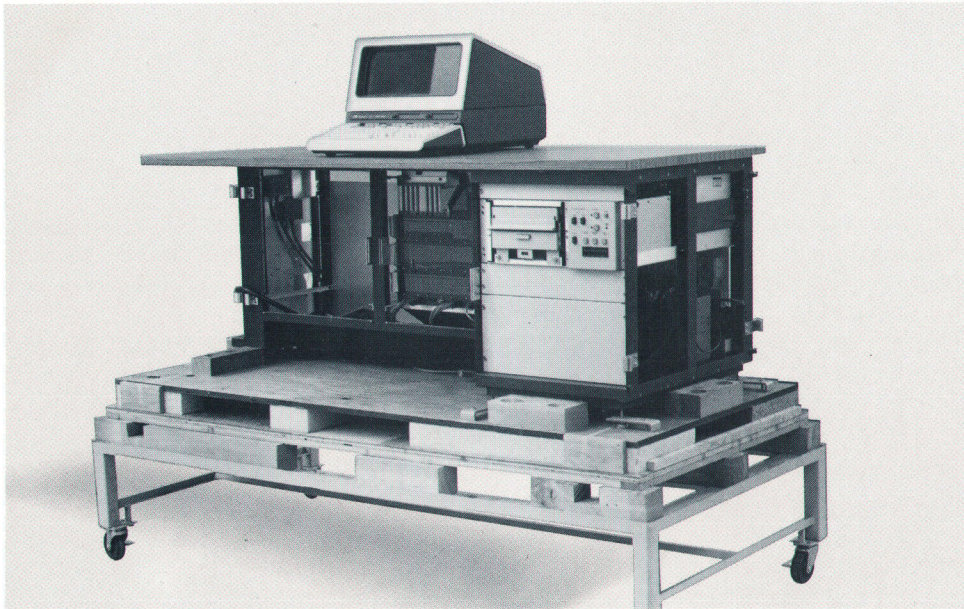

Fig. 2. Series 33 mainframe is mounted on a wooden pallet and placed on an elevated pedestal for ease of handling and assembly on the production floor. After final system assembly, the same pallet is used as the base for the shipping container.

and ensures structural integrity under various environmental load conditions (Fig. 2). This approach provides dimensional stability to the card cage, where 4250 individual contact points between printed circuit boards and the backplane must be kept free from undue stresses. The doors

and panels are made of steel sheet because it offers easy fabrication, low tooling costs, and excellent shielding for electromagnetic interference (EMI).

Two types of locks provide two levels of access security for the cabinet. The operator has access to the flexible disc unit and a backup control panel through the front door (Fig. 3) and to the terminal junction panel through the side door (Fig. 4). These doors use one type of lock assembly. All other doors use another type of lock assembly and are accessible only to service personnel.

The easily removable desktop is made of steel and laminated plastic veneer. It is reinforced with a spot-welded steel stiffener to prevent deflection due to large loads on the cantilevered portion. Plastic veneer was selected as the surface material for its scratch resistance, dimensional stability under severe environmental conditions, and ease of maintenance. The mainframe cabinet passes the HP class C

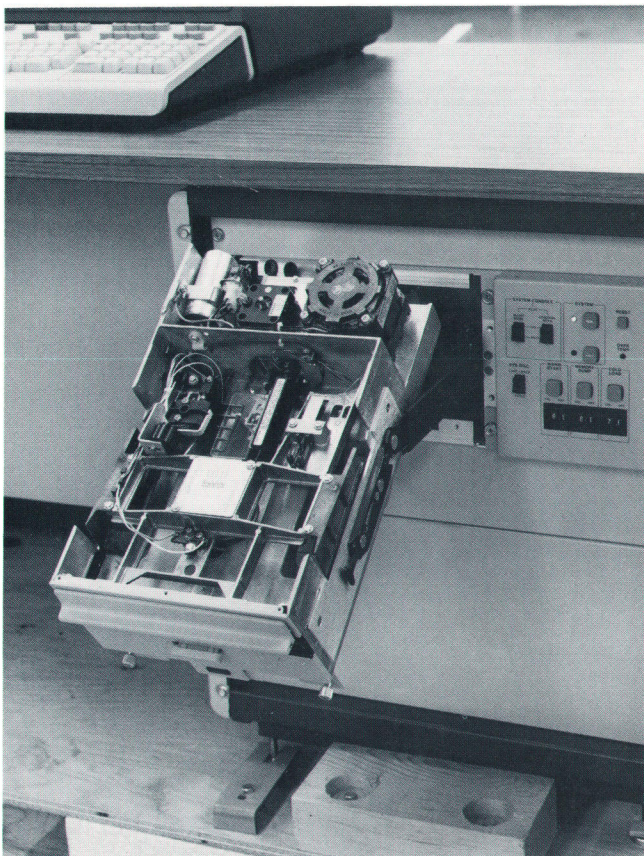

Fig. 3. Flexible disc is mounted on slides that extend and rotate to provide easy access to the top and bottom for service.

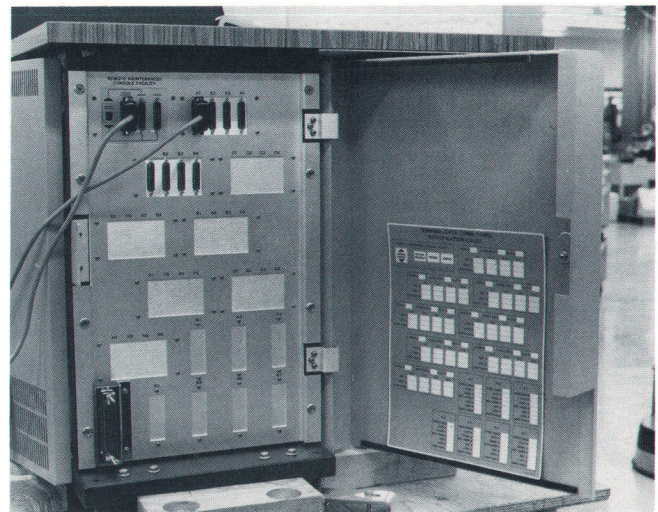

Fig. 4. Junction panels are accessible through the side door and are mounted with quick-disconnect fasteners for easy removal.

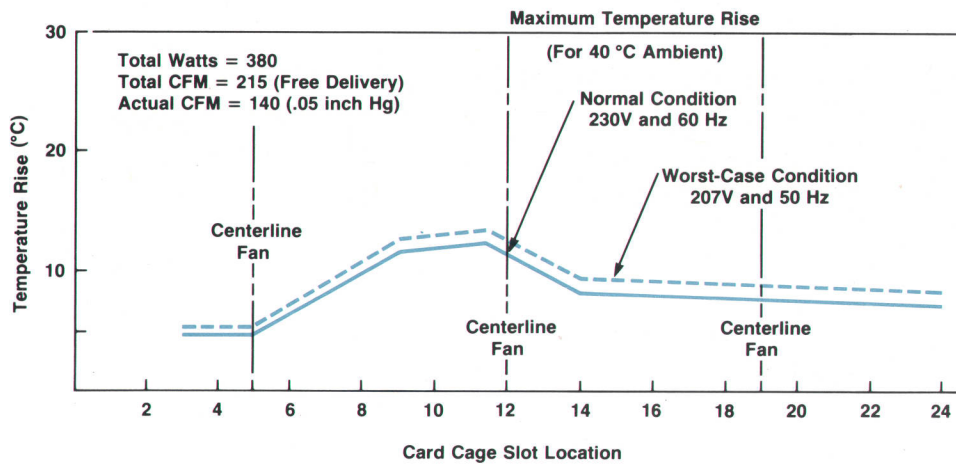

Fig. 5. Temperature profile at the card cage exhaust opening shows an average temperature rise of 10°C under normal operating conditions, leaving a 20°C margin for worst-case voltage, frequency, and altitude.

vibration test, an unpackaged drop test from three-inch height, a packaged drop test from 24-inch height, and a repetitive shock test to simulate transportation hazards.

The package consists of three modules: card cage module, power supply module, and desktop. They are bolted together and placed on a movable pedestal (Fig. 2) for ease of installation of subassemblies, making the mainframe fully accessible from all sides. After assembly, parts of the platform are used as a shipping container.

For a complex computer, the Series 33 is very serviceable. With seven access doors and two removable panels, access and removal of 90% of the subassemblies can be achieved within 10 minutes. Instrument slides are used for the heavy power supply unit and for a dirt and temperature sensitive flexible disc drive unit, enabling debugging and servicing without removal from the mainframe cabinet. Keyed connectors for all ac and dc power and dc signal cable harnesses ensure correct and quick system cabling.

Cooling

A concerted effort was made to maximize available internal space for cooling while keeping the audio noise generated by cooling fans within requirements for an office environment.³ Cooling was designed to meet the following primary objectives:

- Quiet enough for an office environment. Audio noise level not to exceed 60 dBA.
- Temperature rise to be kept within 10°C of ambient for system reliability.
- Air intake and exhaust to be kept away from operator.

To achieve these objectives, cooling for the system was separated into three areas: card cage cooling, flexible disc drive cooling, and power supply unit cooling. The card cage cooling was accomplished by using an air plenum with a built-in deflector to distribute the air flow evenly. The fans are mounted away from a foam air filter and the cabinet surface to minimize back-pressure buildup and radiated audio noise.

The peak velocity of air at a fan blade is directly proportional to the fan blade's diameter and rotational speed. Since peak velocity contributes to noise level, three smaller fans (4.50-in diameter, 75 ft³/min capacity) are employed rather than fewer higher-capacity fans.⁴ This results in lower fan noise and even distribution of air across the card

cage. In normal operating mode the average temperature rise has been measured to be 6°C while the noise level of the mainframe cabinet is held to 52.5 dBA. The temperature profile of the system is shown in Fig. 5 for normal operating conditions and for worst-case line voltage and frequency (207V at 50 Hz).

EMI and ESD

EMI shielding was accomplished by using commercially

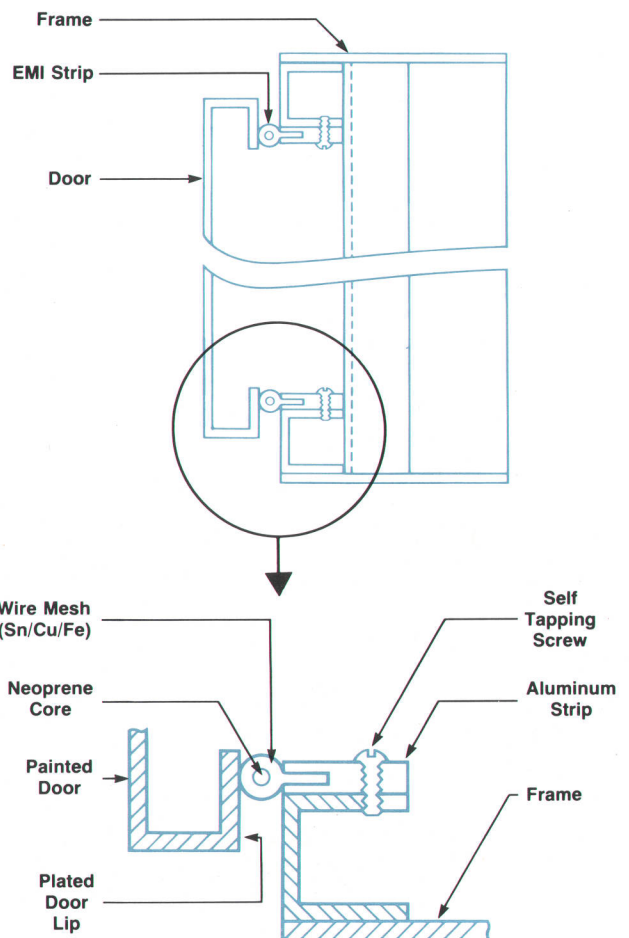

Fig. 6. EMI (electromagnetic interference) shielding detail.

available EMI gasket, a continuous strip of fine Fe-Cu-Sn alloy wire mesh wrapped around elastomer and mounted on an extruded aluminum strip.⁵ The aluminum strip is attached to the mainframe at front and rear door openings using self-tapping screws to create electrical bonding with the painted frame. The wire mesh gasket makes contact with the plated door lips when closed (Fig. 6) to provide EMI shielding at the frame and access doors. This scheme also provides electrostatic discharge (ESD) protection for the cabinet doors by a low-impedance path through the plated lip, EMI gasket, aluminum strip, and self-tapping screw to the cabinet frame. Additional ESD protection was achieved by providing good electrical bonding between the mainframe and all the subassemblies. Where there is no metal to metal contact available (painted-metal to non-painted metal or painted metal to painted metal contacts), stainless steel grounding buttons are press-fitted into painted metal surfaces to make low-impedance paths (Fig. 7). The final measurements indicate that the mainframe cabinet provides EMI shielding for radiated energy 15 dB below the level B requirement of VDE for the office environment, and the mainframe assembly is able to withstand a 20-kV discharge when tested with the Hish Model ESD-254, a widely used ESD tester.

Acknowledgments

The development of the mechanical parts of the HP 3000 Series 33 required significant contributions by many people at HP's General Systems Division. We would like to give special recognition to Gary Lepianka for his card cage and other mechanical package designs, George Canfield, who designed the power control module and the system cable harnesses, Steve Spelman, who designed molded plastic parts, Brock Dagg for doing the lion's share of the drafting, Vince Roland for hardware QA, Ron Morgan for

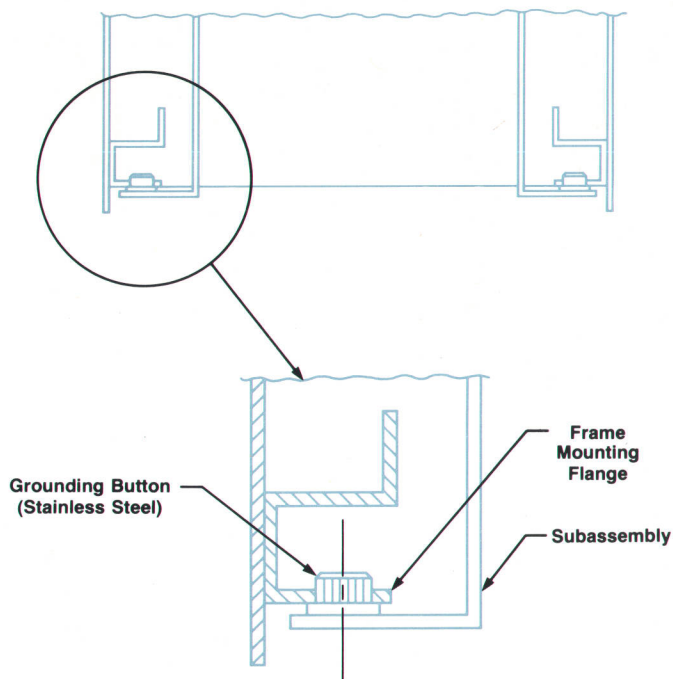

Fig. 7. ESD (electrostatic discharge) grounding detail.

product safety and for taking us through UL and VDE certifications, Jack Barbin, Steve DePaoli, and Dave Jones for providing us with production engineering support, Jerry Curran of HP's Santa Clara Division for providing product manufacturing support, and Lou DeWitt, Mike Borg, and Rich Edwards for constant marketing inputs. Special thanks to Tom Whitney and Matt Schmutz for their guidance and patience throughout the development of the product.

References

1. E.J. McCormick, "Human Factors Engineering," McGraw-Hill, 1964.
2. H. Dreyfuss, "Measurement of Man," Whitney Publications, 1960.
3. A.W. Scott, "Cooling of Electronic Equipment," John Wiley & Sons, 1974.
4. J.T. Broch, "Acoustic Noise Measurements," Bruel & Kjaer, 1971.
5. "EMI/RFI Shielding Handbook & Catalog," Metex Corp., 1976.

Manmohan Kohli

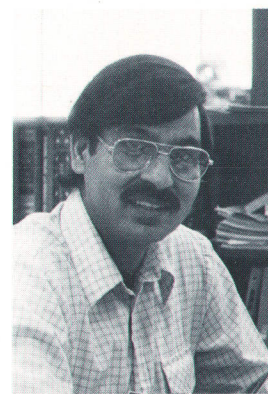

Manny Kohli designed the cabinets for the HP 3000 Series 33 Computer. A native of Punjab, India, he received his BSME degree in 1964 from Punjab University and his MSME degree in 1967 from the University of California at Berkeley. He's done mechanical design for impact printers and high-speed cameras, and stress analysis and galley design for commercial aircraft. With HP since 1974, he's designed thermal printers for the HP-91 and HP-97 Calculators and is now a project leader for computer cabinet design. Manny is married, has two children, and lives in San Jose, California. He spends his spare time gardening, working on his cars and house, and managing his investment property.

Yas Matsui

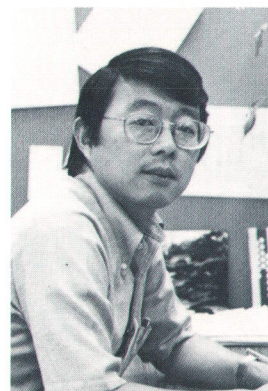

Yas Matsui is industrial design and product design manager for the HP 3000 product line. With HP since 1969, he's also done industrial design for signal generators, network analyzers, microwave systems, and passive components. He received his BS degree in industrial design from Carnegie-Mellon University in 1967, his MS in industrial design from the University of Illinois in 1969, and his MBA from Santa Clara University in 1976. Born in Tokyo, Yas is married, has two children, and lives high up in the Santa Cruz Mountains near Los Gatos, California, in a house of his own design. He enjoys skiing, backpacking, and furniture and jewelry design, and is currently designing solar heating and greenhouse systems for his home.

A Remote Computer Troubleshooting Facility

by David L. Nelson

SPECIAL MAINTENANCE TOOLS have been integrated into the HP 3000 Series 33 to aid in diagnosing and repairing the system when hardware or software failures occur. These tools allow the system engineer (SE) and the customer engineer (CE) to investigate the situation from their office. Hardware failures must ultimately be fixed by the CE on-site, but the SE can help the customer with software problems with almost the convenience of being on-site, and with the advantage of immediate response. The HP 3000 Series 33's remote console/maintenance facility has immediate benefits because it reduces the HP response time and eliminates unnecessary visits to the customer's site.

The remote console facility can also be used when the system engineer is at the site and wishes to consult on a problem with an expert, either in a field support office or at the factory, to help solve a particularly difficult problem.

The remote facility is not intended just for use by HP personnel. It is equally useful for any central office in a large corporation to assist operators of HP 3000s at other sites. Large corporations typically develop a significant amount of specialized software to fit their particular needs, and as a result must support those programs just as HP supports its operating system and subsystems. The remote console facility provides a convenient way for users of the software in a distributed system to demonstrate problems to the corpo-

rate personnel who support their applications and get immediate help in finding solutions to their problems.

The HP 3000 Computer System, including peripherals and software, is undoubtedly the most complex system that Hewlett-Packard produces. Consequently, it presents significant challenges in terms of system support and maintainability. The HP 3000 is typically used in interactive data base management activities, and customers often cannot carry out their business if the system is not operational. Thus system availability is very important. Since no hardware or software is perfect, it is necessary to have an effective means of maximizing availability of the system despite occasional hardware and software failures. Series 33's remote console/maintenance facility has been designed to meet this need.

Remote Console Implementation

To provide remote diagnostic capabilities it is necessary to have a smart device independent of the system CPU (central processing unit). This is because a significant amount of system hardware must be operational for the CPU to work, yet any hardware in the system might have failed. The system console contains a microprocessor that allows it to act as the independent smart device. To avoid transferring the diagnosis problem from the CPU to the console, the

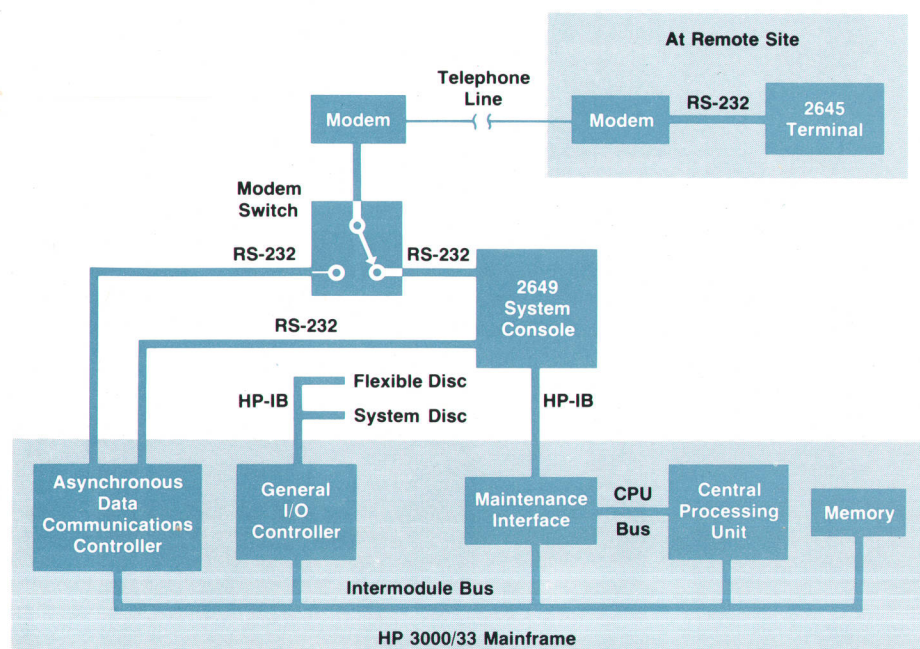

Fig. 1. HP 3000 Series 33 maintenance hardware includes the system console, a remote console, and the maintenance interface. The MI provides access to the CPU and the intermodule bus.

console has a self-test capability that is easily used by the customer. If the console fails, any other terminal can replace the console and the system will still be operational, although all remote diagnostic capabilities will be lost.

The system console is an HP 2649 Terminal that has been specially microcoded for this application. The firmware in the console is composed of the standard HP 2645A Terminal firmware plus custom firmware for the special console functions. Since no 2645A firmware was removed, the console can perform all 2645A functions in addition to its console functions. Essentially the console is an independent computer system containing the following items:

- Two RS-232 ports
- Dual cartridge tape drives
- CRT display
- Keyboard
- 8080 microprocessor
- 26K bytes of read-only memory
- 16K bytes of read-write memory
- HP-IB (ANSI/IEEE standard 488-1978) interface to special interface hardware within the HP 3000.

When a failure occurs within the HP 3000, the system console and the remote diagnostic capability can still be used. The only common failure within the system for which remote diagnosis is not very effective is a power supply failure. This causes the interface between the console and the system (called the maintenance interface, or MI) to stop operating, so the console can't get any response from the system whatsoever. For this case, power supply status LEDs are mounted behind a door on the system for examination by the customer.

Fig. 1 shows the maintenance hardware and the interconnect paths between the maintenance hardware and the rest of the system. The 2649 system console is the controller of all the maintenance hardware. It is connected to the modem via an RS-232 cable. All the information on the 2649 console screen can be displayed on the remote console, and console commands can be entered at the remote console.

The modem switch allows the modem to be used either for remote maintenance or for dial-in sessions. Thus the customer can use the modem conveniently for regular business. The modem switch also provides security for the local system, since the remote console facility is disabled when the modem is not connected to the system console.

Another RS-232 cable connects the 2649 console to the asynchronous data communications channel (ADCC). This allows the 2649 to be used as a system console by the operating system when the system is operating normally. An HP-IB cable connects the 2649 to the maintenance interface (MI). This connection allows the 2649 to access the CPU via the CPU bus and access the other boards of the system via the intermodule bus (IMB). Fig. 2 is a diagram of the maintenance interface.

Using the Remote Console Facility

To activate the remote console facility, the customer calls the HP system engineer and then loads the remote console/maintenance facility cartridge tape into the 2649 system console. The cartridge tape contains the code for controlling the modem. Next the user sets the modem switch to connect the 2649 to the modem. Both the user and the remote system engineer then set the data keys on their modems. The link is then established and the remote terminal becomes a system console. Both system consoles are effectively tied in parallel such that both users can enter commands to the HP 3000 or the 2649 system console. The information displayed at the remote console is identical to the information displayed at the local console. This allows the remote operator, in effect, to look over the local operator's shoulder to see exactly what the symptoms of the problem are. Also, the remote operator has the ability to demonstrate how to work around the problem if a work-around exists. Both operators can cold-load the system, dump memory, run diagnostics, and examine the internal state of the HP 3000. However, because of the low baud rate of the modem, all programs that reside on flexible disc or

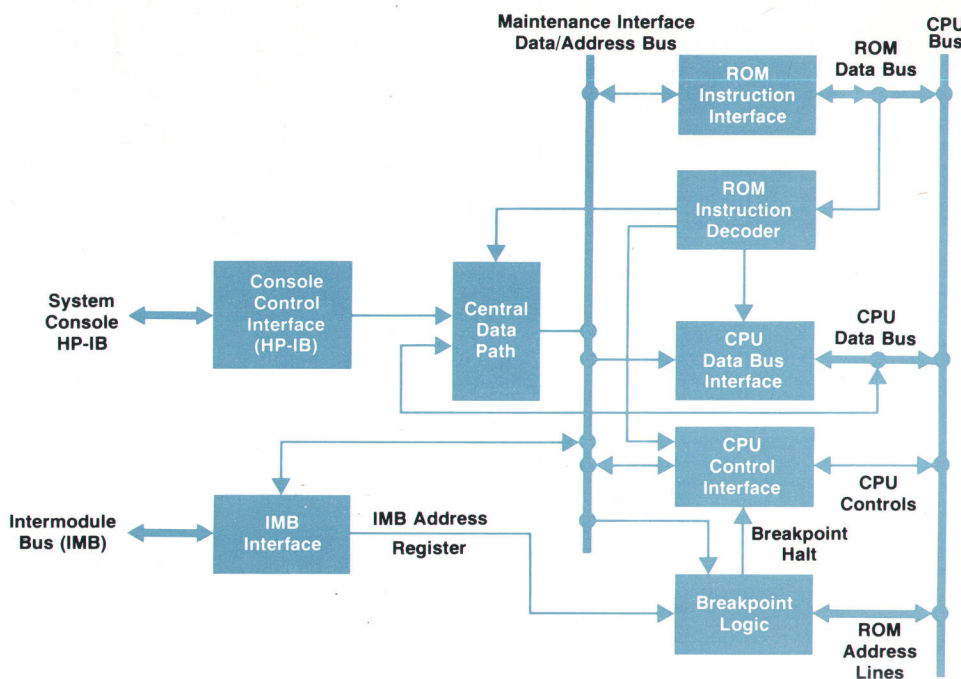

Fig. 2. Maintenance interface block diagram. The MI is connected to the system console by an HP-IB (ANSI/IEEE 488) cable.

Philosophy of HP 3000 Series 33 Diagnostics

by James H. Holl

One of the appealing features of the HP 3000 Series 33 is that it allows maintenance to be done with a minimum number of site visits from the customer engineer (CE). This saves the user both time and money. The system includes new self-test features that allow the user to start diagnosing problems before calling for help. If the user does require assistance, the system can be diagnosed remotely.

Tests the user can perform fall into two categories. If the operating system is running and one of the peripheral subsystems (flexible disc, line printer, or terminal) is suspected, the user can perform a self-test on the subsystem. If the user is willing to suspend job execution or if the system stops working, the user can be told over the phone how to run off-line diagnostics.

Peripheral self tests consist of steps that test data paths within the subsystem, verify read-only memory via a checksum test, test any random-access memory, test the microprocessor, and test the peripheral itself. Each peripheral subsystem contains a self-test key, button, or switch and a means of reporting the results of the self test (light-emitting diodes, paper, or CRT). The hard discs and magnetic tape do not have this capability. The user thus performs the same initial test that the customer engineer (CE) would perform. When an error is detected by a self-test program, the user can provide this information to the CE when the user requests service. The user may also run on-line programs that exercise the line printers and verify the data paths between the computer and the printers.

The user who has suspended job execution can run the Diagnostic and Utility system (DUS). The DUS is described in detail later in this article. Once the DUS is run, the CE knows what device is not working and what function within the device is failing. Because the CE will bring the proper service kits and tools, the percentage of successful first-time calls is increased and the mean time to repair is reduced.

If the user wishes to have the CE run the DUS, the user loads the REMOTE program into the 2649 system console from the console's cartridge tape unit and connects the console through the modem switch to a Bell 103-compatible modem. The CE can then connect a remote HP 2645 terminal through a matching modem to the customer's modem (using a phone line between modems). The CE obtains a duplicate copy of the system console on the remote terminal. The CE's keyboard and the user's keyboard are both active at this time, and all keyboard input appears on both screens. While the user watches on the system console, the CE runs the diagnostics from the remote site.

Both the REMOTE program and the system maintenance display can be installed without disturbing the system. The system maintenance display loads in the same way as the REMOTE program and uses part of the 2649 screen for its display.

When the user can not cold load the operating system, there is another set of options. First, self tests can be performed on the applicable peripheral subsystems as described earlier. This will not always isolate the problem. Second, the DUS can be used to help isolate the problem, but sometimes this system won't cold load either.

There is yet another set of tests. Two programs can be loaded into the 2649 system console. Together these programs execute inside the system console and test the system parts that are used to perform a cold-load operation. The first program is the diagnostic for the maintenance interface (MI) board. This board provides the console with the ability to monitor and control the central processing unit (CPU). The board is also used by the maintenance display mentioned earlier. The MI provides access to the intermodule bus (IMB) and the general I/O channel (GIC) to which the cold-load device is connected. This program is executed first to insure that the results of the

next program are valid.

The second program is the cold-load self test. This program tests all parts of the system that are needed to cold load except the actual cold-load device and the media containing the program to be loaded. The CPU, first bank of memory, cold-load GIC, cold-load device controller (the controller is identified and a loopback procedure is used to check the data path), and the system console's asynchronous data communication channel (ADCC) are tested. The CPU tests are actually part of the CPU microcode. The system console causes them to run and obtains their results.

By running these two programs, the user acquires specific information about the problem. By relaying this information to the HP CE, the user can again save time and money. These programs can also be run remotely from the CE's office if the user desires.

Diagnostic and Utility System

The DUS is a random-access file system that resides entirely on a single flexible disc. The DUS contains diagnostic programs for discs, magnetic tape, memory, the GIC channel, and the ADCC channel. It also includes the IOMAP utility and the SADUTIL utility. IOMAP shows the system configuration and has the ability to invoke a peripheral subsystem's self-test sequence and read back the self-test results. IOMAP also has the ability to perform a loopback test on a device controller. SADUTIL recovers disc files, condenses the data on a disc volume, and modifies the contents of a disc volume. Without precluding component repair, each diagnostic attempts to identify the field-replaceable assembly that is failing. Error messages are friendly, nonambiguous and contain both the stimulus and all symptom information. By running selected diagnostics or utilities, the user can provide more detailed information to the CE. The HP 3000 Series 33 DUS is similar to the DUS provided with the HP 300 Computer System.

The diagnostics that are part of the DUS are written either in AID (an interactive language) or in systems programming language (SPL-II). The diagnostics for the memory, the GIC, and the ADCC are written in SPL-II to provide maximum control during board repair (usually not done at the customer's site). The diagnostics for the peripherals are written in AID, are easily modified, and are self listing. A simulator for SLEUTH (an HP 3000 Series III troubleshooting language) has been written in AID and is provided as part of the DUS. SLEUTH is a powerful interactive language that can exercise any peripheral with

James H. Holl



Jim Holl received his BSEE degree from the University of California at Berkeley in 1966, then worked as a programmer for three years before joining HP in 1969. He's developed diagnostics for several disc drives and served as peripheral lab software manager and as diagnostic coordinator for the HP 300. Along the way, he picked up an MSEE degree from the University of Santa Clara in 1971. Currently he's project manager for HP 3000 serviceability. Jim is a member of IEEE, a long-distance runner, and a third-generation native Californian, born in Palo Alto and now living in Cupertino. He's married and has two sons.

high-level commands such as SEEK, READ and REW(ind). Peripherals of various types may be exercised concurrently. SLEUTH is used to troubleshoot both peripherals and the I/O system.

For the first time on a Hewlett-Packard system, there is built-in hardware to enable a utility program (IOMAP) to determine what channels are present and what Hewlett-Packard Interface Bus (HP-IB) devices are connected to the system. The system may contain as many as fifteen channels. Each channel responds to a roll call request by answering on the line corresponding to its channel number (set by a thumbwheel switch on each channel). Each channel contains an identification register that is read to determine the channel

type (GIC or ADCC). Each device connected to the GIC over the Hewlett-Packard Interface Bus responds to an identify request with a sixteen-bit code. This code is used by the utility to identify each peripheral subsystem.

Acknowledgments

The following individuals contributed to the design of the service package: Jim Chiochios, Jim Coffron, Dave De Lano, Curt Gowan, Tony Hunt, Carson Kan, Chuck Leis, Jim Lewis, Slava Mach, Dan Mathias, Dave Nelson, Wil Pomeroy, Peter Rosenblatt, Russ Scadina, and Fred White.

cartridge tape must be manipulated by the local operator. Bell 103-compatible (300 baud) modems were chosen as the primary modems because of their low cost, although the Bell 212 (1200 baud) modem also can be used.

Because the local 2649 system console has some specially defined keys while the remote terminal is a standard 2645 terminal, the remote operator must enter special escape sequences to cause a cold load, a warm start, or a memory dump of the local system.

Diagnosis

The remote modem driver is not the only code loaded into the console from cartridge tape. The maintenance interface diagnostic and the cold-load self test are used to test the basic hardware needed to perform a cold load of the system. Cold load means starting up the system by loading software from the flexible disc or the optional magnetic tape drive. Because the diagnostics that run within the HP 3000 must be cold loaded, the system console is the only means of

finding a failure that prevents the cold loading of diagnostics. The maintenance interface diagnostic and the cold-load self test are described in more detail on page 15.

A maintenance display program can also be loaded into the console from cartridge tape. The maintenance display for earlier HP 3000s was a hardware panel containing lights and switches and mounted inside a suitcase. The CE would carry the maintenance panel to the customer's site and plug it into the HP 3000. The maintenance display program for the Series 33 is stored on a cartridge tape and can be used remotely as well as on site. Because the display shows all the registers on the console and accepts verbal commands, it is much easier to use than the lights and switches of the old switch panel.

The maintenance display program allows the CE or SE to check the state of the CPU and memory. By checking the CPU and memory, the system engineer can determine where in the cold-load operation an error occurred. Although primarily used as a development tool in the factory, the maintenance display gives an experienced CE or SE a great deal of flexibility in diagnosing hardware problems. Fig. 3 shows the maintenance display that appears on the local and remote consoles. The hardware display shows all the CPU registers and flags. The software display shows the registers that are important when the CPU is running software, along with a memory window. The maintenance display allows the SE to change the contents of CPU registers and memory.

Acknowledgments

I am grateful to Dan Lee, Jim Coffron, Slava Mach, and Bob Saunders for their contributions to the console project.

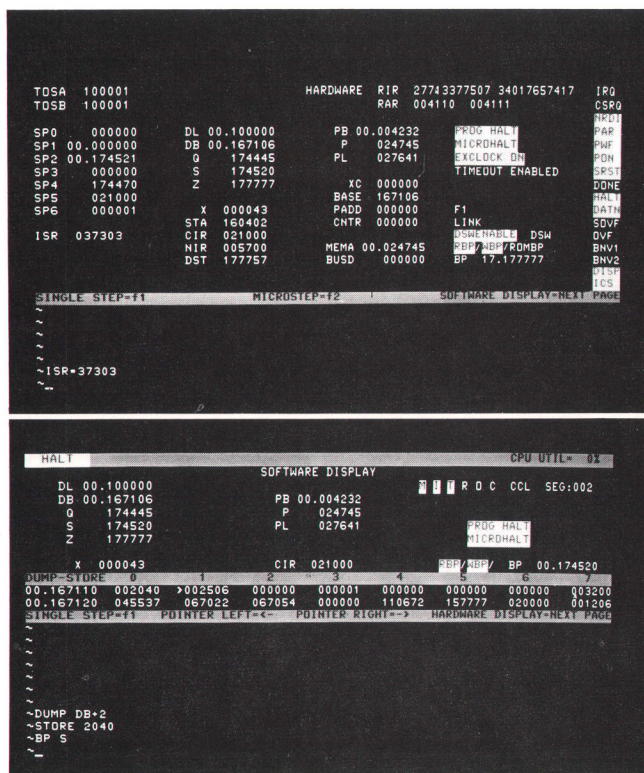
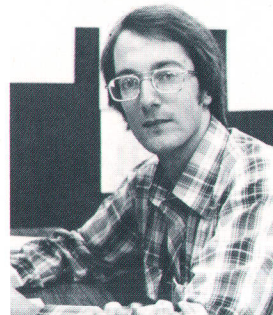

Fig. 3. Maintenance displays on local and remote consoles show CPU registers, flags, and memory information.

David L. Nelson

Dave Nelson designs development and service tools for HP 3000 systems. Raised in Spokane, Washington, he received his BSEE degree from Washington State University at Pullman in 1976 and joined HP the same year. He's a member of IEEE, and is currently completing work for a master's degree in computer science at Santa Clara University. Dave enjoys backpacking, hiking, raising houseplants, and reading, especially science fiction. He's single and lives in Santa Clara, California.



Controlling Electromagnetic Interference Generated by a Computer System

by Daniel T. Y. Wong

ELIMINATION OF EXCESSIVE electromagnetic interference (EMI) has long been a prime design consideration for electronic engineers. As electronic devices are being used in ever-widening range of applications, EMI control assumes even greater importance. For example, EMI suppression was a major factor in the design of the Hewlett-Packard System II instrument enclosure system,¹ which made its first appearance in 1973.

In the interest of maintaining a clean EMI environment as sources of EMI proliferate, many regulatory agencies around the world are imposing stricter and stricter rules governing EMI emissions from various types of equipment. At the present time, the most comprehensive set of regulations regarding EMI emission limits has been established by the Verband Deutscher Elektroniker (VDE), an independent association of electrical engineers in West Germany that prepares regulations and conducts tests for equipment safety, EMI emissions, and so on. Various countries have established their own regulations regarding EMI and the European Economic Community (EEC) is working toward a common set of regulations for its member countries. Since these will most likely be similar to the VDE regulations, it was deemed appropriate to design the HP 3000 Series 33 Computer and its peripherals to meet the VDE EMI requirements and to obtain an FTZ (West German Bureau of Telecommunications Technology) license as proof of performance. The pertinent VDE specifications^{2,3,4} are diagrammed in Fig. 1.

Designing for Quiescence

In designing equipment to meet EMI standards, two basic types of EMI emissions are considered: conducted and radiated. Conducted emissions consist of radio noise conducted through the ac power line. Radiated emissions consist of electromagnetic energy radiated from the equipment and connecting cables.

In the design of the HP 3000 Series 33, conducted emissions were minimized by filtering the ac line, shielding assemblies and cables, minimizing cable-to-cable and field-to-cable coupling, and special grounding techniques. To minimize cable-to-cable coupling, the cable bundles that distribute dc power from the power supplies in the right-hand equipment bay to the other bays are run along the bottom of the cabinet close to the steel members and away from the ac and data cables. Where feasible, the wires inside the cables are twisted to reduce differential-mode coupling.

A logic/signal ground point tightly coupled to the dc power supply return was established in a ground plane on

the six-layer main mother board which is solidly grounded to the card cage in the center bay. The ac line safety ground is connected to the framework where the ac line enters the system. The coupling between logic/signal and safety grounds is thus relatively loose to minimize coupling of common-mode noise from the logic/signal ground to the ac line.

The ac input is effectively filtered by a double-shielded isolation transformer that supplies all the ac power for the system including the two dc power supplies, a number of cooling fans, and the flexible disc drive motor (the isolation provided by the transformer also performs a safety function). The transformer attenuates common-mode noise coupled from the internal ac lines to the main power line by

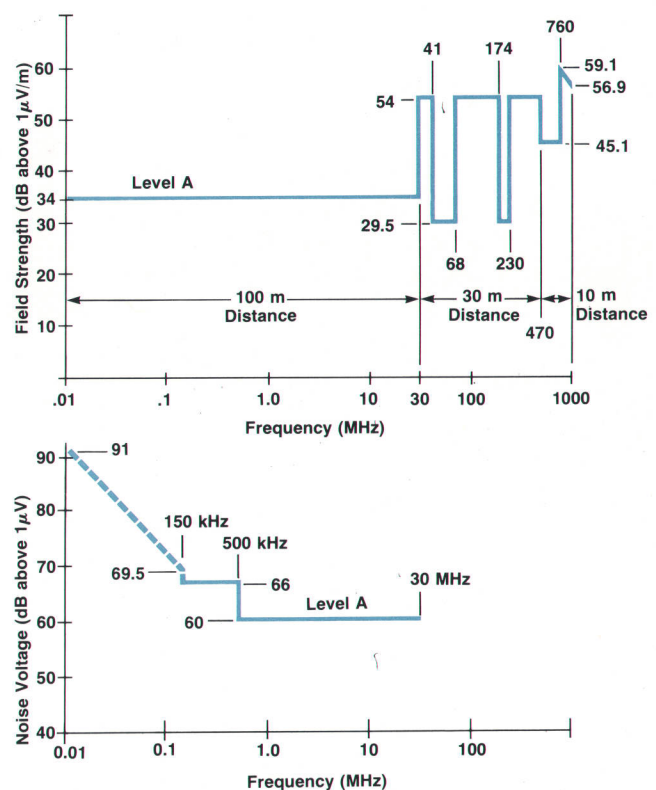

Fig. 1. Radiated and conducted emission limits specified by VDE 0871/6.78.

140 dB and differential noise by 70 dB. It is positioned at the ac input to make the primary ac leads within the system as short as possible, minimizing any direct coupling of noise to the ac line. The primary side of the transformer is protected by a circuit breaker but the system power on-off switching takes place on the secondary side so there is no need to run the unfiltered ac mains to the power switch at the front.

Shielding is effected by enclosing the sub-units, such as the power supplies and the card cage, with aluminum panels. Data is transmitted between units either on shielded cables or flat cables. The flat cables are as short as possible, routed close to the chassis or cabinet surface, and the wire assignments are ground-signal-ground-signal-etc. The connector shells of shielded cables are connected to the cable shields and the shells of the mating connectors are solidly grounded to the mounting panel. All this shielding prevents radiated interference from getting into the ac mains.

Radiated Emissions

Radiated emissions were controlled primarily by establishing an electrically "leakproof" cabinet. The system cabinet, made of steel not only for EMI control but for economic and structural reasons as well, is in two parts. One frame houses the power supplies, the isolation transformer, the control panel, and the flexible disc drive. The other frame houses the card cages. Electrical bonding between the two frames is assured by steel buttons on one that butt against plated mating surfaces on the other when the two are bolted together. The buttons are spaced about six inches (150 mm) apart, which is approximately one-tenth the wavelength of the highest frequency (200 MHz) that measurements showed were radiated by the system. Subsequent measurements confirmed that this spacing is effective in preventing the cabinetry from functioning as a radiator for system-generated interference. The card cages and the peripheral I/O junction panel at the left-hand end of the cabinet are also mounted to the frame against grounding buttons.

Electrical continuity around the cabinet doors is maintained by metallic mesh gaskets. The door surfaces that contact the gaskets are plated and then masked during painting to leave the metallic surface exposed. Electrical continuity is maintained not only between parts of the mainframe cabinet but also to the shields of the cables that interconnect the mainframe and the peripherals, thereby assuring continuity of the shielding throughout the entire system. As noted above, the cable shields are attached solidly to the connector shells, which are mounted to the junction panel of the mainframe. The logic ground return for each peripheral is handled separately on one of the cable conductors.

EMI Evaluations

During the design phase, radiated emissions from the various units that make up the computer system were evaluated initially with a spectrum analyzer (HP Model 8552B/8554B) connected to a broadband biconical antenna. Most of this work was done in a large shielded enclosure. Because of the possibility of standing waves within the

enclosure, results were considered simply as relative values for evaluating various design fixes. Once a problem frequency was identified, electric-field and magnetic-field probes were used with the spectrum analyzer to pinpoint the source of the radiation. An RF current probe was also used; clamped to an I/O cable, it helped determine the frequencies radiated by the cable.

When these tests indicated that an acceptable level of EMI performance had been achieved, quantitative measurements were made outdoors in an open field. A 52x60-metre elliptical area, oriented at right angles to nearby commercial radio transmitters, was cleared of all objects that could affect the electromagnetic fields. The equipment was placed at one focus of the ellipse and the measuring antenna was at the other. Tuned dipole antennas and tuned radio receivers of the VDE-recommended type were used to measure the electric field strength in the 30-to-1000-MHz range. The magnetic field strength was measured in the 10-kHz-to-30-MHz range using loop antennas and a tuned receiver. Analyses were then made on the nature of detected signals, the type of modulation, the polarity of the radiated signals, the orientation of the cables with respect to the equipment, and whether or not the radiations were a function of the type of data activity going on in the computer.

Measurements of Conducted EMI

Conducted emission measurements were initially performed in the shielded enclosure with the spectrum analyzer and a line impedance stabilization network (LISN), a device that inserts an RF transformer in series with any of the ac power line conductors for detecting the presence of EMI on the conductors. The LISN was mounted directly to the wall of the shielded enclosure for good RF grounding, and care was taken to assure a good impedance match between the RF transformer and the spectrum analyzer.

During these tests, the unit under test was operated as it

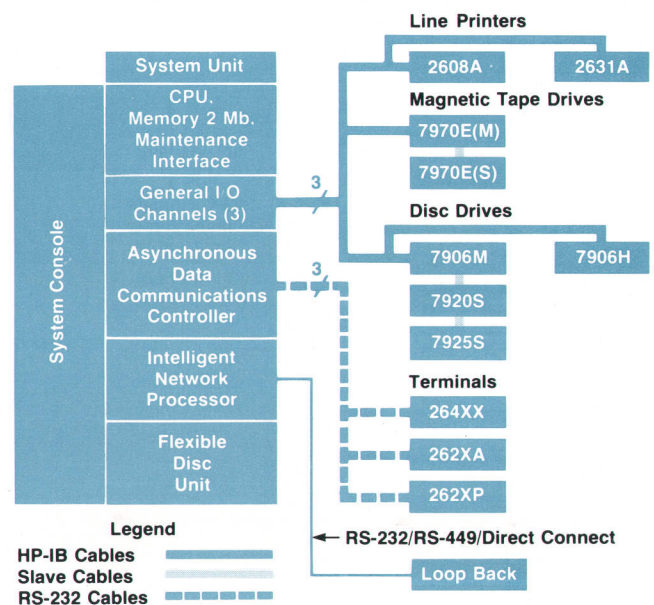

Fig. 2. HP 3000 Series 33 mainframe configuration and peripherals tested for VDE type-certification.

would be during normal operations. For example, for testing the flexible disc unit a looping program was written that caused data transfer in both directions between the disc and the CPU. Since the current levels encountered during write operations are different from those during read operations, all possible operations characteristic of normal activity were programmed so emission levels could be evaluated as a function of program activity.

The smallest operational assemblies were tested first and results were documented. From these results it was deduced what the total emissions would be. Then two or more assemblies were checked together, and finally an entire system was checked as a unit. Then, all practical combinations of the mainframe and various peripherals were checked. In cases where a system exceeded desired emission goals, peripherals and sub-units were individually powered off or electrically and physically removed to help trace the problem frequency. (The EMI emissions of the various peripherals had been controlled by the personnel of the relevant manufacturing divisions using techniques similar to those used for the mainframe.)

As a result of these tests, it was observed that conducted emissions that have frequencies below 1 MHz or so can be traced to the effectiveness of the line filtering. Emissions above 1 MHz, which were largely program dependent, are affected by grounding, shielding, and couplings between cables.

As with the radiated emission tests, once acceptable conducted EMI levels were achieved, quantitative measurements were made with tuned receivers of the type recommended by VDE.

Certification

In September 1978, VDE representatives measured the conducted and radiated EMI emissions of an HP 3000 Series 33 and peripherals, in the configuration shown in Fig. 2, using their measuring equipment according to prescribed procedures. As a result, the Series 33 was certified under VDE 0871/6.78 Level A specifications for ISM (industrial,

scientific, and medical equipment). Table I lists the units licensed by FTZ as a result of the VDE certification.

Acknowledgments

Many people contributed to the success of this effort. Without Elik Porat and Tak Watanabe's management help this work could not have been completed in such a timely fashion. Roy Eberline of Data Systems Division not only assisted in many measurements during the course of development but also provided critical and constructive comments in the analysis of the measurement data. Jim Bobroff, Vince Roland, Steve Upshinsky, and John Delaney provided much assistance when needed. Yas Matsui, Manny Kohli, and Gary Lepianka contributed to the system unit product design. Ron Morgan, Bob Lundin, and Rich Valencia handled the VDE submittal. Wayne Egan of Santa Clara Division assisted in making the shielded enclosure facility available. Peripheral designs were supported by Kent Anderson and Doug Mellor of Disc Memory Division on all disc drives, Phil Luque and Bob Deely of Boise Division on printers, Charlie Blackbird of Boise Division on tape drives, and Mike Cook and Benny Herbst of Data Terminals Division on terminals.

References

1. A.F. Inhelder, "A New Instrument Enclosure with Greater Convenience, Better Accessibility, and High Attenuation of RF Interference," Hewlett-Packard Journal, September 1975.
2. VDE 0871/6.78, "Radio Interference Suppression in High-Frequency Equipment for Industrial, Scientific, Medical (ISM) and Similar Purposes Specifications," VDE, Offenbach/Main, West Germany, June 1978.
3. VDE 0877 Part 1, "Measurement of Interference Voltage," VDE, Offenbach/Main, West Germany, 1959.
4. VDE 0877 Part 2, "Measurement of Interference Field Strengths," VDE, Offenbach/Main, West Germany, 1955.

Table I. Equipment licensed by FTZ.

System Unit	32413A
Line Printer	2608A 2631A
Data Terminals	2621A, B, P 2622A, B, P 2623A, B, P 2640B, F, K, N, R, S 2641A, B, F, K, N, R, S 2645A, B, F, K, N, R, S 2646A, B, F, K, N, R, S 2647A, B, F, K, N, R, S 2648A, B, F, K, N, R, S 2649A, B, C, D, F, K, N, R, S
Disc Drives	7906H, M, S 7920H, M, S 7925H, M, S
Mag Tape, Master	7970E
Mag Tape, Slave	7970E

Daniel T.Y. Wong

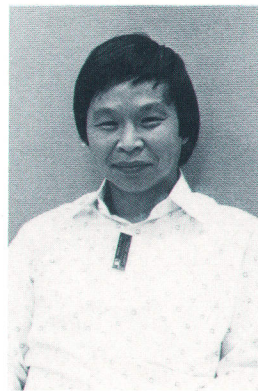

Danny Wong functioned as the catalyst for the HP 3000 Series 33 System EMI design and certification. He joined HP in June 1976, and was involved in several areas of Series 33 mainframe design in addition to EMI control. Before joining HP he was a research associate at the University of Missouri, where he spent four years leading a group of students working on a fast, large-scale (7,000 IC) hybrid computer for simulating electric power systems. The computer is used by the electric power industry for operator training today.

Danny is a member of IEEE and the IEEE Computer Society, and has contributed many technical papers in the field of hybrid computation of power systems. He is now doing memory systems design. He obtained his BS, MS, and PhD degrees from the University of Missouri at Columbia in 1971, 1972, and 1976 respectively, all in electrical engineering. He and his wife enjoy traveling and outdoor activities, and spend much of their spare time improving their home in San Jose, California.

Automated Pulmonary Function Measurements

Controlled by a "friendly" desktop computer, a completely integrated pulmonary lab automatically makes ventilation, distribution, and diffusion measurements, calculates results, compares them to predicted normals, and prints reports including labelled graphs.

by Maurice R. Blais and John L. Fanton

THREE BASIC TYPES of measurements are made in the pulmonary clinic: ventilation, distribution, and diffusion. Ventilation deals with the measurement of the body as an air pump, determining its ability to move volumes of air and the speed with which it moves the air. Distribution measurements provide an indication of where gas flows in the lungs and whether or not disease has closed some sections to air flow. Diffusion measurements test the lung's ability to exchange gas with the circulatory system.

The most widely performed measurement is ventilation. Historically, this has been performed using devices called spirometers that measure volume displacement and the amount of gas moved in a specific time. Usually this requires the patient to take a deep breath and then exhale as rapidly and completely as possible. Called the forced vital

capacity, this gives an indication of how much air can be moved by the lungs and how freely this air flows.

Distribution measurements quantify degrees of lung obstructions and also determine the residual volume, which is the amount of air that cannot be removed from the lungs by patient effort. The residual volume must be measured indirectly, such as with the nitrogen washout procedure to be described later.

Diffusion measurements identify the rate at which gas is exchanged with the blood stream. This is difficult to do with oxygen since it requires a sample of pulmonary capillary blood, so it is usually done by measuring the diminishment of a small quantity of carbon monoxide mixed with the inhaled air.

All these measurements vary widely according to the patient's age and physical size. Therefore, evaluating a



Fig. 1. Procedures for ventilation, distribution, and diffusion measurements in the pulmonary clinic are conducted automatically under computer control by the 47804-series Pulmonary Function Systems. The Model 9825A Desktop Computer is the basic component of all versions. Shown here is the Model 47804S, which has all the available options installed.

measurement requires comparison to a normal value established for people with similar physical characteristics in that particular age group. Normal values are established statistically by measuring a large population and correlating the measured values to such parameters as age, sex, weight, and geographical location (the lung characteristics of people living in Scandinavian countries, for example, differ from those of residents of the United States). Consequently, pulmonary function testing is a world of numbers and graphs.

Faster Measurements Automatically

The Hewlett-Packard Model 47804A Pulmonary Measurement System (Fig. 1) was designed to achieve a considerable reduction in the time required to analyze the data obtained in pulmonary testing. At the same time, it improves the quality of the data by minimizing testing errors and by obtaining higher accuracy in the measurements. Depending on the options chosen, it completely automates the measurements of ventilation, distribution, and diffusion and, after a brief training period, can be operated by pulmonary technicians who have not had previous experience with computers.

The system is designed around the Model 9825A Desktop Computer,¹ which controls the procedures by opening and closing appropriate valves, measuring flow rates and the concentrations of various gases, calculating results, and

Assuring Proper Pulmonary Test Procedures

The successful performance of any pulmonary maneuver requiring patient effort and cooperation depends upon the operator's training and his or her ability to encourage the patient. To assist the operator, the HP Model 47804A Pulmonary Measurement System checks the data and displays messages if the test does not meet certain criteria.

In the forced vital capacity test, for example, the system's desktop computer displays READY FOR TEST when the system is ready to accept data. Upon seeing a flow signal representing an expiratory flow rate greater than 0.12 liter/second, the computer blanks its display and starts taking a flow reading every 10 milliseconds, storing the results. If within the first 250 milliseconds the flow drops to below 0.03 liter/second or stops altogether, the data is assumed to be caused by an artifact such as motion of the transducer. All of the data is then rejected and the display again reads READY FOR TEST. Hence, the display may blink as the patient picks up the pneumotach, but this does not affect the test data.

If the flow rate drops to less than 0.03/s after one quarter second but before one-half second, this is taken as an indication of a cough or other false start. The display then momentarily presents:

FALSE START, REPEAT TEST.

The computer then resets the system and readies it for another test.

All patients should be able to exhale for at least one second so any test lasting less than that is similarly rejected with the message:

EXP < 1 SEC, REPEAT TEST.

After the first second, the flow signal changes much less rapidly so the flow signal is sampled every 50 milliseconds. At this point, the computer begins to display the exhaled volume. Patients with lung disease can exhale at very low flow rates for a very long time so an increasing volume display tells the operator that he should encourage the patient to continue exhaling. The computer then stops taking expiratory data if it sees an inspiratory flow rate greater than 0.15l/s or if it senses no flow for two seconds.

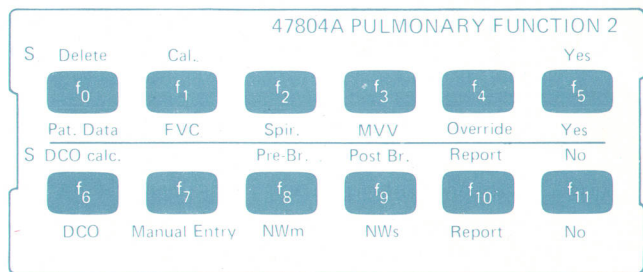

Fig. 2. An overlay labels the softkeys on the desktop computer, enabling any of the various pulmonary measurements to be initiated by pressing a single pushbutton.

printing the results. The twelve softkeys on the computer keyboard (Fig. 2) are programmed to initiate the various procedures.

A four-channel analog-to-digital converter (ADC) supplies the measurement data to the computer. Inputs to the ADC are from the various measurement devices, which include a pneumotach, that provides a signal proportional to air flow for the various measurements, a nitrogen analyzer for distribution measurements, and carbon-monoxide and helium analyzers for diffusion measurements. Any combination of these devices, along with some breathing hardware, may be supplied with the system or added later to provide the capabilities desired. All are installed in a convenient desk-height cabinet (Fig. 1).

The computer can print out results on its built-in 16-column strip printer, but an impact printer (Model 9871A) can be added to the system to give page-width reports and graphs (Fig. 3). Software supplied with the system on a cassette consists of over 70 programs and includes a customizing program that enables the user to meet his or her personal requirements by changing values included in the report, the headings on each report, the forms the graphs are in, and so on.

Operation of the system is simplified through the use of an automatic start routine at power on. During the start-up sequence, the system senses whether or not all necessary hardware is connected and operating and if not, it prompts the operator to connect the missing instruments and/or turn them on. It also senses what output devices are connected and automatically configures the software accordingly. For example, if the system is in its basic configuration, the software prints reports on the computer's strip printer but if the 9871A Printer is connected, the system automatically outputs page-width reports and uses the printer's plotting capabilities.

Since each measurement sequence is controlled and calculated by software, it is a simple matter to apply necessary corrections to the data in real time to enhance the overall accuracy of measurements. The power of the 9825A Desktop Computer also mitigates some common problems with automatic pulmonary measurement systems. For example, determination of the start of a forced vital capacity maneuver may be the most important factor in obtaining overall accuracy. The computer senses the initial change in air flow and tracks the rise in air flow rate to assure that the procedure is being followed correctly (see box). Many patients do not fully understand what they are supposed to do

Hewlett-Packard 47804A
Pulmonary Calculator System
Pulmonary Function Report

NAME: Smith, John R. ID #: 123-54-5820
SEX: MALE AGE: 27.0 YEARS
HEIGHT: 72.0 IN. 182.9 CM. WEIGHT: 176.0 LBS. 80.0 KGM.
TESTED BY: mrb DATE: 11/12/76
RACE: Cauc. SMOKER: YES 1.5 PACKS PER DAY
BSA(BOYD) 2.02 M²

FVC TESTS							
TRIAL	BRONC	FVC	FEV1	F25-75	PF	MEF50	IVC
1	PRE-	4.53	3.76	4.27	8.73	4.58	4.40
2	PRE-	4.42	3.87	4.34	8.97	4.49	4.35
3	PRE-	4.23	3.74	4.16	8.79	4.47	4.13
4	POST-	4.20	3.75	4.36	8.77	5.15	4.00
5	POST-	4.10	3.70	4.31	8.45	5.41	4.37

SELECT CRITERION: FVC+FEV1
PRE-BRONC
TRIAL # 1

	ACTUAL	PRED	%PRED	
FVC (L.)	4.53	5.65	80.3	NORMAL
FEV .5 (L.)	2.45	3.56	68.7	SLIGHTLY REDUCED
FEV.5/FVC (%)	53.97			
FEV 1 (L.)	3.76	4.58	82.2	NORMAL
FEV1/FVC (%)	82.99			
FEV 2 (L.)	4.42	5.27	83.8	NORMAL
FEV2/FVC (%)	97.44			
FEV 3 (L.)	4.53	5.44	83.3	NORMAL
FEV3/FVC (%)	100.00			
PEF.2-1.2 (L/S)	7.80	8.59	90.8	NORMAL
PEF25-75 (L/S)	4.27	5.53	77.2	SLIGHTLY REDUCED
PEF75-85 (L/S)	1.88	1.53	123.4	NORMAL
PF (L/S)	8.73	10.25	85.1	NORMAL
MEF 50% (L/S)	4.58	6.81	67.2	SLIGHTLY REDUCED
MEF 75% (L/S)	2.26	3.58	63.3	MODERATELY REDUCED
FVC TIME (SEC.)	2.90	5.00	58.0	
MET (SEC.)	0.53			
IVC (L.)	4.40	5.65	78.0	SLIGHTLY REDUCED
MIF 50% (L/S)	5.56			

Smith, John R.
123-54-5820
11/12/76
• PRE-BRONC. TRIAL # 1
* POST-BRONC. TRIAL # 4
X PREDICTED

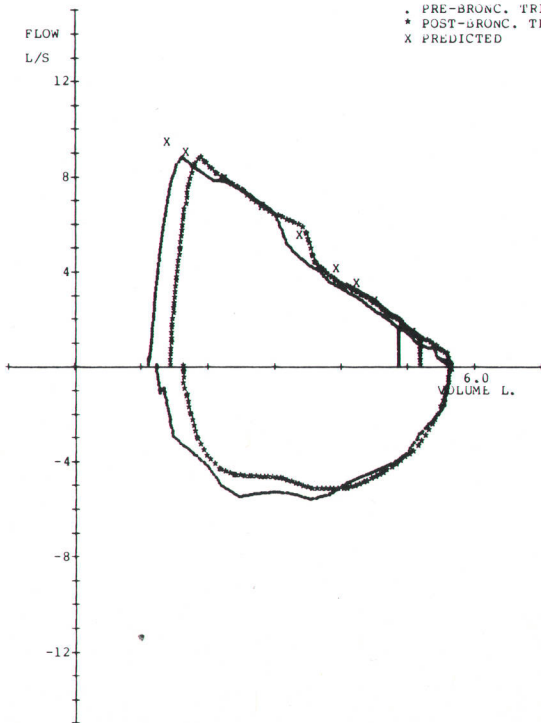

Fig. 3. Reports are generated automatically, listing tabular values for comparison to predicted normal values and plotting curves to give graphical interpretations.

and may perform the maneuver in a way that could lead to inaccurate determinations of volume.

One significant aspect of a software-controlled pulmonary measurement lab is that it allows new programs to be added or existing ones to be modified so new procedures can be implemented. Pulmonary medicine is a dynamic field with new diagnostic procedures being developed at an increasing rate. Problems with obsolescence are thus minimized.

An Accurate Pneumotach

A key element in this system, basic to all the measurements, is the pneumotach. Early spirometers consisted of a cylindrical enclosure with a counterbalanced plunger. The patient blew into the enclosure, displacing the plunger, and a recording pen connected to the plunger traced the air volume-vs-time record. The physician had to calculate rate of air flow from the slope of the trace. Not only was this procedure cumbersome to implement, but inaccuracies arose because of the cooling of the expired air and the condensation of the moisture.

The pneumotach designed for the 47804A System provides a much more accurate determination of flow rate (the computer integrates the flow rate to determine volume). It consists of a cylindrical enclosure in which a spirally wound sheet of corrugated metal is inserted, essentially creating a bundle of parallel tubes within the enclosure (see Fig. 4). As air flows through these tubes, the friction of the air against the tube walls causes a pressure differential between the input and output. A pressure transducer measures this pressure differential, thus giving an indication of flow rate.

At low flow rates, the flow through the pneumotach is smooth or laminar, and the pressure drop is proportional to the air flow. At higher flow rates, the flow becomes turbulent and the pressure drop is no longer linearly related to flow. However, precision manufacturing techniques achieve uniformity in the corrugations so that a uniform

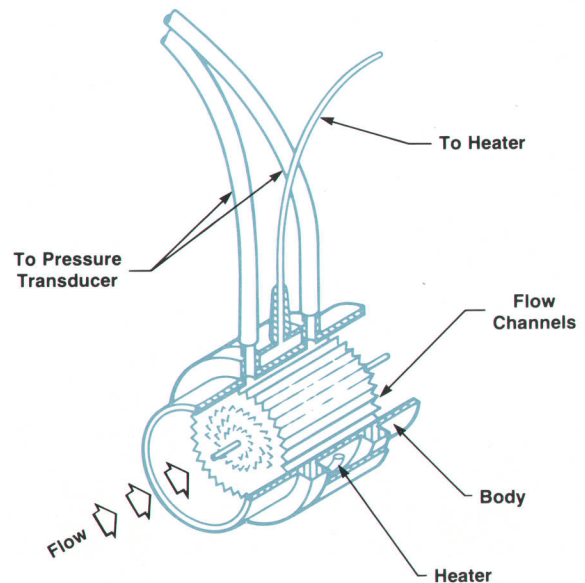

Fig. 4. Resistance to air flow in the pneumotach generates a pressure differential that is proportional to flow rate.

flow profile can be maintained, thereby assuring repeatable flow-to-pressure characteristics. Hence, the flow-to-pressure curve can be electronically linearized.

Peak flow rates in a forced vital capacity test may exceed 12 liters/s whereas the rates in single-breath nitrogen washout tests are limited to 0.5 liter/s, and much lower flow rates are encountered in research applications. A pneumotach that developed adequate pressure drop for applications involving low flow rates would present an unacceptably high resistance to the patient at high flow rates. Therefore, the pneumotach is built in five sizes with full-scale flow rates ranging from 0.26 to 13.0 liters/s.

Most respiratory parameters are reported in BTPS conditions (body temperature, ambient pressure, saturated with water vapor). This is the condition of the air in the lungs and in the mouth. To prevent condensation and maintain the gas under these conditions, the temperature of the pneumotach is maintained at 37°C. The heater that warms the pneumotach is electrically isolated from the metal case for patient safety, and it is encapsulated so the entire unit may be immersed in liquids for sterilization. The thermistor that senses the temperature, controlling the heater through a proportional controller, is buried in the metal case.

The accuracy of flow-rate measurements made with the pneumotach is enhanced by correction factors applied by the computer. For example, corrections for gas temperature and viscosity are made on every measurement during a nitrogen washout test, as explained in the following section.

Measuring the Inaccessible

The nitrogen washout test is used in the measurement of functional residual capacity (FRC), the volume of air remaining in the lungs at the end of a normal resting expiration. The FRC can be divided into two other volumes, the expiratory reserve volume (ERV), which is the volume of air a person can exhale beyond the resting level, and the residual volume (RV), the air that a person cannot force out of his lungs no matter how hard he tries. Because of the residual volume, the functional residual capacity cannot be measured by a simple patient maneuver, as are some other parameters, but is measured indirectly using the multiple-breath, nitrogen-washout technique.

Before a nitrogen washout is started, the gas in a patient's lungs is about 73% nitrogen, which is slightly less than atmospheric because the lungs are saturated with water vapor. During the test, the patient inhales pure oxygen so that each expiration contains a smaller amount of nitrogen than the preceding. The volume of nitrogen exhaled in each of the breaths is accumulated by the computer until the end of the test, typically when the expired nitrogen concentration is less than 1%, about three minutes after the start. Dividing this accumulated nitrogen volume by the initial nitrogen concentration yields the initial lung volume. If the patient was at the resting level when the test was begun, this volume is the FRC.

The amount of nitrogen exhaled in each breath is obtained by measuring the nitrogen concentration with the nitrogen analyzer, multiplying this by the flow rate as measured by the pneumotach, and integrating the product.

To obtain accurate results, the flow (pneumotach) and

nitrogen signals must be corrected for a number of factors. The pneumotach responds to the viscosity of the gas passing through it, and viscosity is a function of gas composition and temperature. The HP Model 47804A Pulmonary Measurement System contains a calibration program in which the pneumotach is calibrated using a large 1.5-liter syringe. For this calibration, the pneumotach heater is turned off so both the pneumotach and the air from the syringe are at room temperature. In actual use, the pneumotach is heated to body temperature and is placed close to the patient's mouth so the expired gas is measured under known conditions and the readings can be corrected for the differences in viscosity due to the higher temperature of the gas and the presence of water vapor and carbon

The Need for Pulmonary Function Measurements

Over twenty million people are affected every year by lung diseases, one of the major causes of occupational disability in the United States today.

The lung's basic function is to exchange gas with the blood—bringing in oxygen for the tissues and removing carbon dioxide, a byproduct of metabolism. The throat connects to the lungs through a bronchial tube that branches into two main bronchi which in turn branch again and again, approximately 25 times, finally ending in over 300 million small sacs of tissue called alveoli. The total surface exposed to the air in these alveoli is over 350 square meters, about the size of a doubles tennis court. The amount of blood in contact with this surface at any one time, however, is only one pint—obviously it is spread over this area in a very thin layer.

The overall performance of the lungs normally deteriorates with age. However, the average person is born with such a large reserve of lung tissue that the normal aging process does not deteriorate the lungs at a rate that ever reduces their functional capability below that necessary to sustain normal activity. Nevertheless, disease accelerates this deterioration and since there is no known way to reverse lung tissue damage, early detection of disease is imperative if major impairment is to be prevented.

Lung diseases can be classified in two general categories: obstructive and restrictive. Obstructive diseases are characterized by increased resistance to the flow of air, making it more difficult to move the air. Restrictive diseases impair the movement of the lungs, also making it more difficult to move the air.

The three most common obstructive diseases are asthma, chronic bronchitis, and emphysema. Asthma, usually an allergic disease that constricts the bronchial tubes, afflicts millions of people. It can usually be controlled by drug therapy. Chronic bronchitis has the same effect on the bronchial tubes, but unfortunately does not respond to drug therapy in the same manner. Emphysema is basically a disease of the alveoli and changes the elastic characteristics of the alveolar wall.

Restrictive diseases usually are characterized by an increase in fibrous material in the lungs. In many cases, these are caused by occupational exposure. Cotton workers, for example, have been known to develop lung disease from constantly inhaling cotton fibers.

At present, there is no definitive therapy for the major pulmonary diseases, but it is felt that if the diseases are detected at a very early stage, their course can be slowed by either a change in environment or drug therapy. Therefore, in respiratory medicine the early detection of pulmonary disease is the number one priority. Instruments that measure pulmonary function thus play a fundamental role in the pulmonary clinic.

dioxide. During a nitrogen washout a factor is applied to the inspired gas, which is at room temperature, to correct for both the thermal expansion and the viscosity change that occur as it passes through the heated pneumotach. The flow signal is also corrected during each measurement for the change in viscosity caused by the gradually decreasing level of nitrogen.

According to Poiseuille's law, the pressure developed across a pneumotach by laminar gas flow is directly proportional to the gas viscosity. The viscosity and temperature coefficient of viscosity for a variety of respiratory gases are listed here.

Gas	Viscosity (Micropoises) at 25°C	Temperature Coefficient (Micropoises/°C)
Air	183	.47
Nitrogen	177.3	.43
Oxygen	205	.52
Carbon Dioxide	148.35	.47
Helium	200.15	.43
Water Vapor	162	

The viscosity (η) of a mixture of gases is approximated by the equation:

$$\frac{1}{\sqrt{\eta}} = \frac{x_1}{\sqrt{\eta_1}} + \frac{x_2}{\sqrt{\eta_2}} + \frac{x_3}{\sqrt{\eta_3}} + \dots$$

where x_i is the fraction of gas having the viscosity η_i . From this and the values in the table, the viscosity of expired air at the start of a nitrogen washout test is 184.0 micropoises, assuming the air contains 73 percent nitrogen, 3.5 percent CO₂ and 6.2 percent H₂O. At the end of the test, when the nitrogen has dropped to 0.8 percent, the viscosity is 204.4. The computer calculates the viscosity for each exhalation during the test and applies the appropriate correction factor to the flow rate.

Acknowledgments

Jim Stratz did the packaging design, John Murphy designed the automated breathing valves, and Kaz Juvan designed the flow transducer. Toby Olson, who designed the A-to-D converter, contributed related software and Ray Stelling designed the diffusion system and software. Tom Morin contributed software and fulfilled the QA function.

John L. Fanton

John Fanton, who has BSEE and MSEE degrees from Cornell University, joined Hewlett-Packard's Waltham Division in 1968, initially working on the design of an ECG recorder for nurses' stations and then, as project leader, on a computerized catheterization laboratory system. Next, he became section manager for pulmonary measurements followed by a stint as product manager for pulmonary systems. He recently returned to the lab as section manager for medical data management systems. Outside of working hours, John enjoys skiing, photography, folk music, and the company of his wife and two daughters.

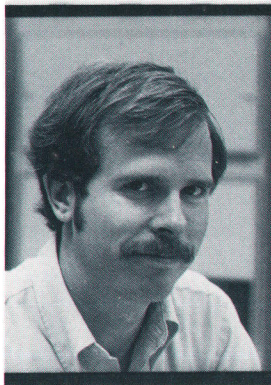

Reference

1. D.E. Morris, C.J. Christopher, G.W. Chance, and D.B. Barney, "Third-Generation Programmable Calculator Has Computer-Like Capabilities," Hewlett-Packard Journal, January 1976.

SYSTEM INFORMATION

HP Model 47804A/S Pulmonary Measurement System

The basic Model 47804A Pulmonary System includes an HP 9825A Desktop Computer with 24K bytes of memory, cartridge tape drive, appropriate ROMs, HP-IB interface card, pertinent manuals, and one HP Model 47301A Four-Channel Analog-to-Digital Converter. The options listed below may be added to obtain the desired measurement capabilities. The Model 47894S, a complete system for ventilation, distribution, and diffusion studies includes all options.

OPTION 007: HP 9871A Impact Printer/Plotter with bidirectional pin drive.

OPTION 019: HP 47304A Respiratory Flow Transducer with HP 21073B Pneumotach. MAXIMUM FLOW RATE: 13 liters/second.

OPTION 021: HP 47302A Nitrogen Analyzer including a nitrogen boom, power supply, vacuum pump, pertinent accessories, and an HP 47304A Respiratory Flow Transducer. RANGE: 0 to 80% N₂.

DISPLAY RESOLUTION: 0.01% from 0 to 9.99%; 1% from 10 to 80%.

CALIBRATION: Set with front-panel GAIN control, using N₂ or dry gas sample.

LINEARITY (with dry gasses): within 0.3% of full scale from 0 to 10%; within 0.5% of full scale or 1% of reading, whichever is greater, from 10 to 80%.

OPTION 022: Flow meter for single-breath nitrogen washout.

OPTION 023: HP 59307A Relay Box for automated oxygen switching.

HP 4704A Single-Breath Diffusion System for single-breath D_{CO}. Includes pneumotach, CO analyzer, He analyzer, controller, and a breathing boom with sample collector assembly and solenoid-actuated valves.

INSPIRED VOLUME

DISPLAY RESOLUTION: 0.01 liter.

ACCURACY: ±5% of reading ±30 cc.

BREATH-HOLDING TIME

DISPLAY RESOLUTION: 0.1 second.

ACCURACY: 0.1 second.

CO ANALYZER (Model 47312A):

SENSOR: Chemical cell.

DISPLAY RESOLUTION: 0.1% of full scale.

ACCURACY: 2.5% of full scale over 20-50% of full scale.

HE ANALYZER (Model 47313A):

SENSOR: Thermal conductivity cell.

DISPLAY RESOLUTION: 0.1% of full scale.

ACCURACY: 1% of full scale.

HP 47120A System Console.

CONSUMABLES PROVIDED: 100 disposable mouthpieces for flow measurements; four reusable mouthpieces for N₂ measurements; four reusable mouthpieces with single-flow screen, six water absorbers, and six CO₂ absorbers for diffusion measurements.

General

DIMENSIONS: Floor space, 1.72 × 1.32 m (45 × 33.6 in). Booms pivot 1.26 m (32 in) around mounting brackets on rear corners of console. Maximum height: 2.02 m (51.25 in). WEIGHT (shipping): Model 47804S, 245 kg (540 lb).

POWER: 115/230 V ac, ±10%, 48 to 66 Hz, 1380 VA max.

PRICES IN U.S.A.: Model 47804S, \$38,500; 47804A, \$10,700; Opt 007, \$3600; Opt 019, \$2550; Opt 021, \$7500; Opt 022, \$275; Opt 023, \$750; 47404A, \$11,000; 47120A, \$1400.

MANUFACTURING DIVISION: ANDOVER DIVISION

1776 Minuteman Road

Andover, Massachusetts 01810 U.S.A.

Maurice R. Blais

A native of Vermont, Moe Blais earned a BSEE at the University of Vermont in 1969, then joined the Vertek Company, a manufacturer of pulmonary measuring equipment in Burlington, Vermont, and automatically joined HP in 1972 when HP acquired the Vertek Company. He recently accepted a position as Director of Engineering at another firm where he continues to develop medical electronic equipment. In that spare time he has, Moe, who now lives in Andover, Massachusetts, enjoys tent-camping with his family (wife and two children, 8 and 6).



Triggered X-Y Oscilloscope Displays

Using the trigger circuits to turn on the CRT beam only during the time interval of interest provides timing information and also eliminates unimportant detail from Lissajous patterns traced on an oscilloscope.

by P. Guy Howard

ALTHOUGH THE OSCILLOSCOPE is highly regarded as a means of visualizing how dynamic phenomena vary as a function of time, also of significance is its ability to graphically portray how a quantity varies as a function of some quantity other than time.

A case in point is a plot of current versus voltage in a power transistor. Manufacturers of transistors define the safe operating area for their products as plots of collector current versus collector-to-emitter voltage with each plot bounded by the maximum permissible current, maximum voltage, maximum power, and second-breakdown limits for the device. In evaluating how a transistor performs under actual operating conditions, an X-Y plot made by an oscilloscope of the collector current versus voltage while the transistor is in operation graphically portrays how the transistor functions dynamically. This plot not only reveals the maximum current and voltage, but also indicates the maximum instantaneous power.

A question then arises: how do you determine what causes failures when steady-state operation is shown to be well inside the safe area?

It was to solve this problem with regard to a switching-regulated power supply that a new capability was developed for the variable-persistence/storage HP Model 1741A Oscilloscope (Fig. 1).¹ Known as the triggered A-vs-B mode of operation (option 002), this capability allows the oscilloscope's Z-axis unblanking circuits to remain operational while the instrument is making X-Y plots in the A-channel-versus-B-channel mode. In this mode, Model 1741A/opt 002 blanks the CRT beam until the B-channel or external trigger signal crosses the trigger threshold. The beam then turns on and remains on for a time determined by the sweep time controls (the sweep itself has no effect on the display other than to determine how long

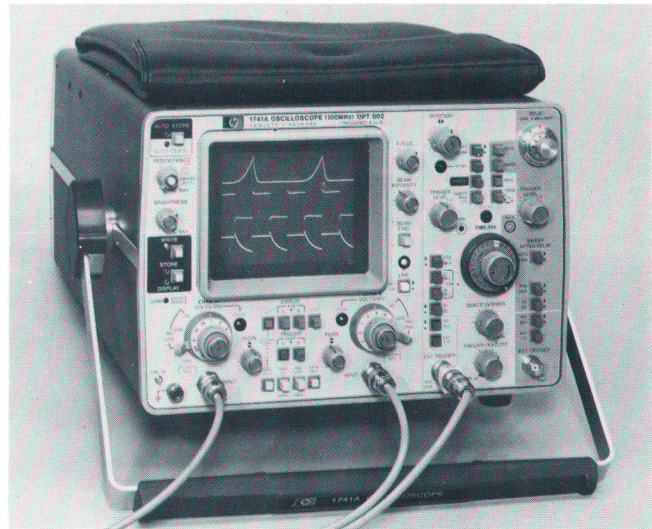

Fig. 1. Model 1741A is a portable, laboratory-grade, dual-trace 100-MHz oscilloscope that has variable-persistence and storage modes of operation with a writing rate of $>100 \text{ cm}/\mu\text{s}$. The most sensitive deflection factor is $5 \text{ mV}/\text{div}$, expandable to $1 \text{ mV}/\text{div}$ on both channels simultaneously (with a reduction in bandwidth to 30 MHz). An external waveform used for triggering the sweep may be displayed on a third trace to assist the operator in selecting the trigger point.

the CRT remains unblanked).

Windowing the Plot

Normally, the CRT beam is on continuously whenever an oscilloscope is in the A-vs-B mode, possibly displaying information outside the area of interest. With the new triggered A-vs-B option for the Model 1741A, irrelevant

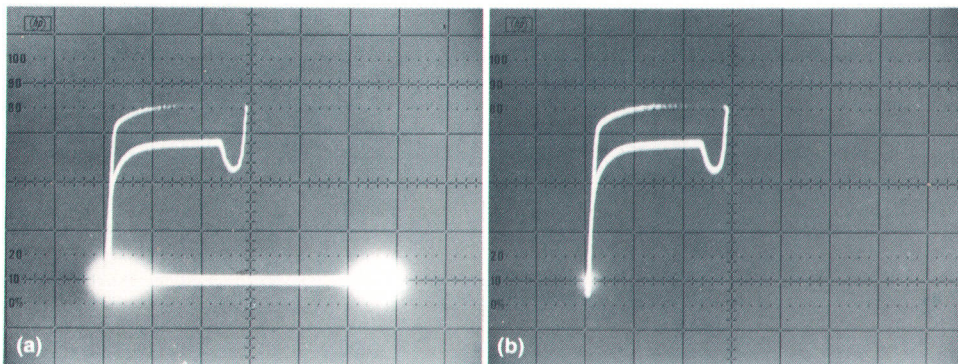

Fig. 2. Conventional A-vs-B plots bloom where the CRT spot remains stationary (a). The triggered A-vs-B mode can blank the static portions of the trace (b).

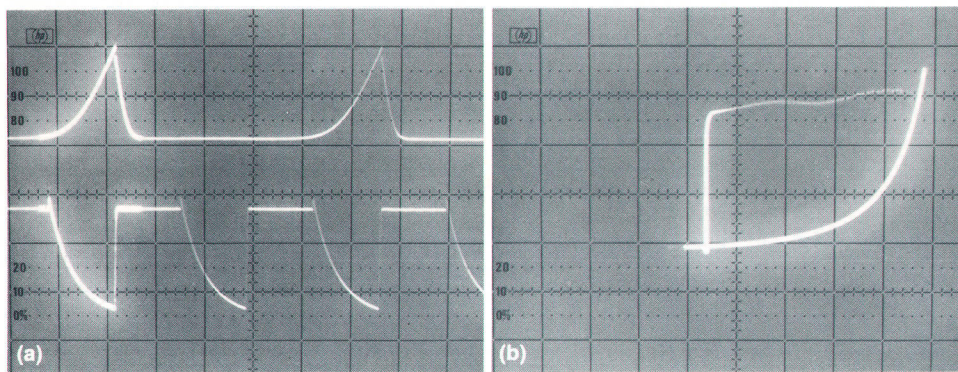

Fig. 3. Use of the delayed sweep intensity gate (brightened segments) while the oscilloscope is in the main intensified mode enables the operator to "window" the portion of the waveforms to be examined (a). Switching to the delayed sweep and A-vs-B mode causes an X-Y plot to be traced by the windowed portions while the remaining parts of the waveforms are blanked out (b).

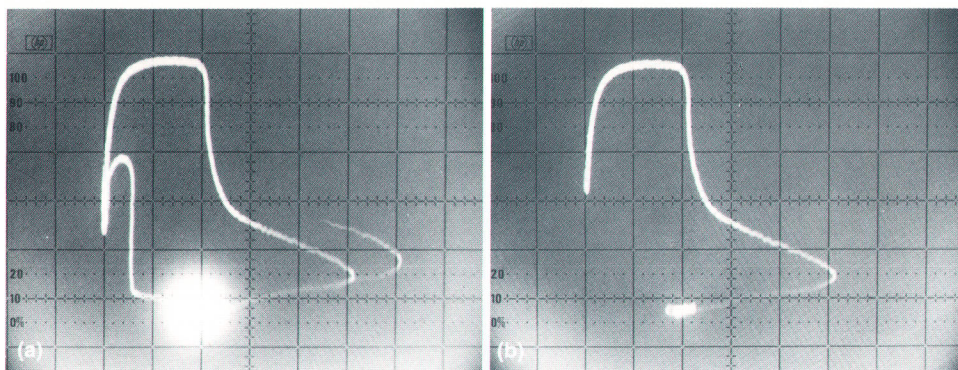

Fig. 4. The photo at left is a plot of collector current versus collector-to-emitter voltage in the switching transistor of a dc-to-dc inverter during the first 100 μ s of operation following turn on. In the photo at right, the delayed sweep is used in the A-vs-B mode to window a 2- μ s portion of the plot thereby showing that the high-power portion of the plot is of sufficiently short duration.

portions of the trace may be blanked (Fig. 2). Furthermore, the displayed portion's time relationship with respect to some reference event may be determined.

The photographs in Fig. 3 illustrate how time-related "windowing" is performed. First, the waveforms are presented on a conventional dual-trace voltage-versus-time display, with either Channel B or an external source supplying the sweep trigger. The delayed sweep, which appears in the main intensified sweep mode as a brightened segment on each trace, may then be positioned so as to span the portion of interest (Fig. 3a). Switching to the delayed-sweep mode eliminates all but the brightened segments for display and then switching to the triggered A-vs-B mode causes the selected portions of the waveforms to be displayed parametrically with the A-channel signal controlling the vertical axis and the B-channel signal controlling the horizontal axis (Fig. 3b). Just as a delayed sweep enables the user to window a specific area of interest when observing time-related events on an oscilloscope, the triggered A-vs-B mode makes windowing available for parametric displays. Furthermore, the parametric display is referenced to the same point in time as the voltage-versus-time display, and contains exactly the same information that was windowed in the voltage-versus-time display.

It is thus possible to window a single cycle of a current-versus-voltage plot so transistor behavior can be examined when a circuit is first turned on, when the output load is changed, and when the circuit is turned off (the storage capabilities of Model 1741A enable a single trace to be retained on display for up to 30 seconds). For example, Fig. 4a shows a conventional current-versus-voltage plot of a dc-to-dc inverter's switching transistor at turn-on. By use of the windowing technique, a 2- μ s portion of the trace is

selected for display (Fig. 4b). This shows that the maximum power swing occurs within the 2- μ s period and is therefore of short enough duration to be considered in a safe operating area.

The delayed sweep is also useful for determining the direction of time in A-vs-B plots. When the main sweep controls the Z-axis unblanking, the delayed sweep unblanking pulse appears as a brightened segment on the A-vs-B trace (Fig. 5). Increasing the delay time causes the

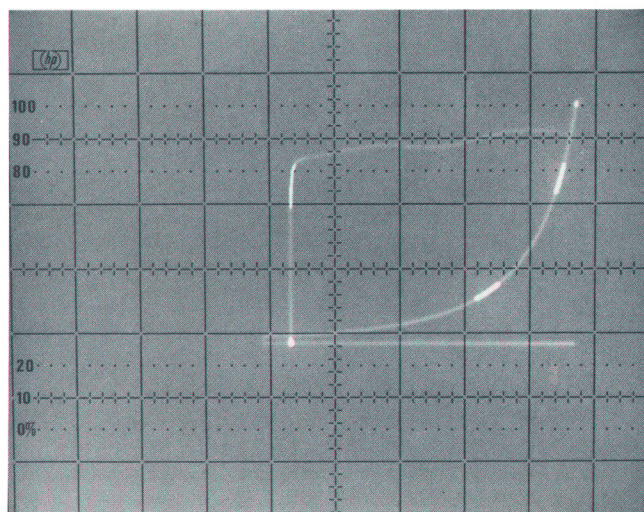

Fig. 5. Use of the delayed sweep intensity gate while making A-vs-B plots with the main sweep trigger enables the direction of time to be determined (see text), as illustrated by this triple-exposure photograph that shows the delayed sweep intensity gate in three different positions.

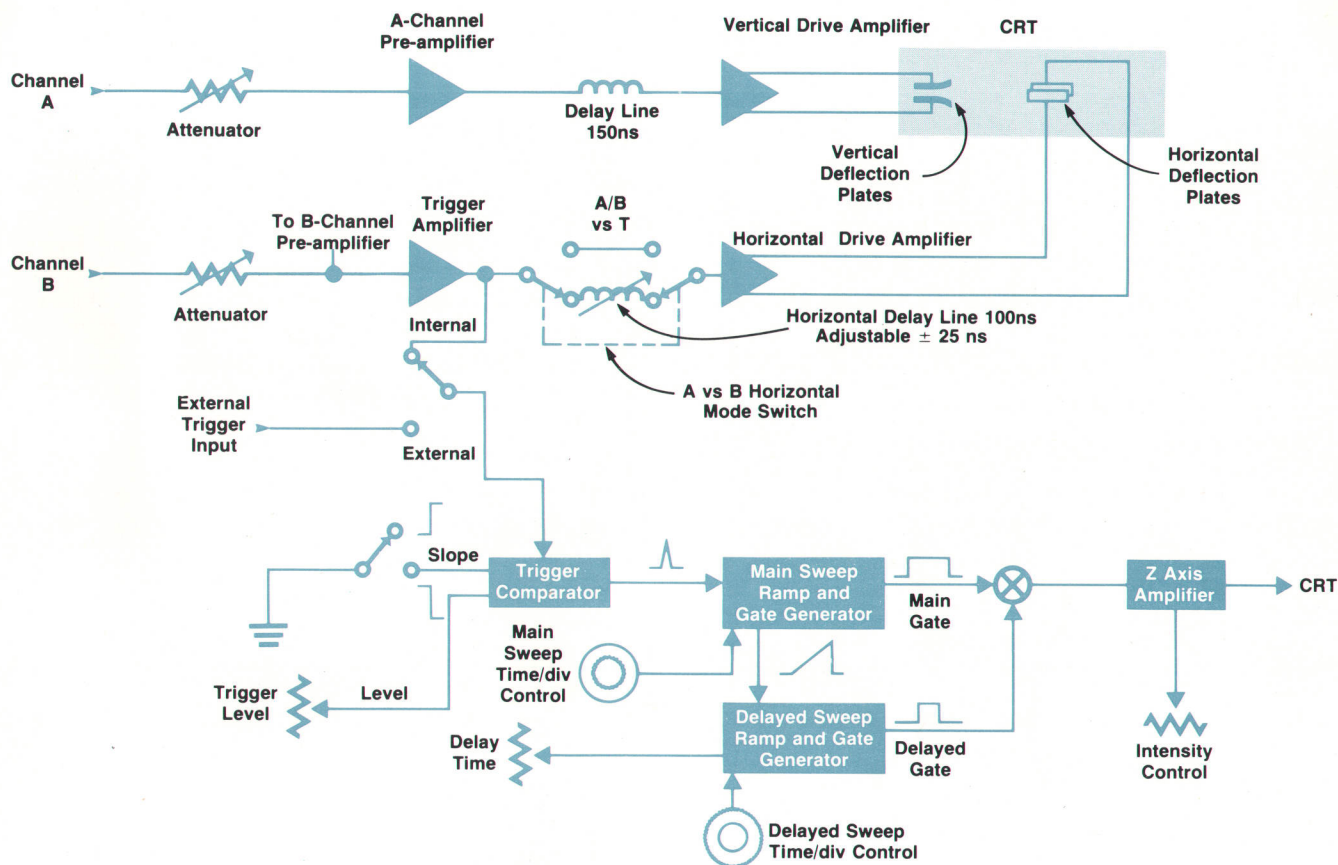

Fig. 6. Circuits pertinent to the triggered A-vs-B mode.

brightened segment to move to a later portion of the trace. Noting the direction of this movement indicates the direction of increasing time.

Implementation

The triggered A-vs-B option is added to the Model 1741A without compromising its voltage-vs-time capability in any

way. A block diagram of the circuits involved is shown in Fig. 6. As indicated, inputs to the B channel travel through the B-channel input attenuator to the sync pick-off point and then through the trigger and horizontal-drive amplifiers to the horizontal deflection plates. To match the time delay introduced by the delay line in the A channel, a delay line is switched into the B channel when the instru-

Capturing Randomly Occurring Oscilloscope Traces

One of the major advantages of a variable-persistence/storage oscilloscope is its ability to capture a randomly occurring transient event for display. The Model 1741A Oscilloscope has an AUTO STORE mode that enables the oscilloscope to wait in the single-sweep armed state—for several days if need be—until the random event triggers the sweep, capturing a single trace of the event. At the conclusion of the sweep, the 1741A switches to the STORE mode to retain the captured trace for subsequent viewing.

The maximum storage time of a captured trace normally is about 30 minutes but there are occasions—for example, monitoring a circuit over a weekend to determine whether circuit performance is affected by powerline transients at plant startup—when a longer storage time would be desirable. The effective storage time may now be extended indefinitely by a new AUTO CAMERA option (opt 003) for Model 1741A which captures a random event on photographic film. It works as follows:

1. A Model 179B Oscilloscope Camera is mounted on a 1741A equipped with opt 003 and the shutter control cable is connected

to the 1741A's AUTO CAMERA output on the rear panel.

2. The 1741A controls are adjusted appropriately for the signal to be viewed and the AUTO STORE mode is engaged.
3. When the triggering event occurs, the 1741A captures the trace and switches automatically to the STORE mode, as described previously.
4. Then, however, the 1741A switches to the DISPLAY mode and triggers the camera shutter to photograph the displayed trace.
5. Next, the 1741A switches to the ERASE mode, using the CRT flood guns to wipe out the trace. At the same time, it triggers the camera shutter a second time to photograph the CRT graticule while the flood guns are illuminating the phosphor.
6. Finally, the 1741A returns to the STORE mode and waits for subsequent action by the operator.

The exposed film, containing the trace superimposed upon the graticule, may be processed at a later, more convenient time, yielding a permanent record of the random event.

ment is in the A-vs-B mode. This enables the phase shift in the B channel to match that of the A channel within 1° up to the 5-MHz bandwidth capability of the horizontal deflection system.

The B-channel delay line consists of a 30-ns lumped-constant delay line in series with a commercial 0-to-70-ns variable delay line. The variable delay provides compensation for unequal delays in the transducers connected to the inputs. For example, current probes with their amplifiers usually have at least 10 ns more delay than passive voltage-divider probes. The variable delay control, accessible through a hole in the right side of the cabinet, allows a ±25-ns adjustment of the B channel delay with respect to the A channel delay.

Other changes to the basic oscilloscope include modifications to allow the unblanking gates to be operative in the A-vs-B mode. However, simply allowing the gates to be operative opened new problems. For example, if the vertical mode were set to ALT or CHOP when the instrument is in the A-vs-B mode, the B channel signal would be periodically switched to the vertical channel, superimposing a diagonal line on the A-vs-B plot. To prevent such illegitimate operating modes, additional control logic was added.

Acknowledgments

George Blinn modified the 1741A's mechanical design to accommodate the new options. Thanks are due Eldon Cornish for assuring that the modifications for triggered A-vs-B



P. Guy Howard

A native of Liverpool, England, Guy Howard first worked summers at HP's Colorado Springs Division between sessions at the University College of North Wales. On obtaining his BSc degree in electronics (1971), he worked two years in process control and medical instrumentation design at a British firm and then joined HP full time. Before entering college, Guy, who holds a British High National Certificate, worked as an apprentice telephone exchange designer and also did some development work on automatic utility meter readouts. At present, he is occu-

piated as a director of a consulting firm specializing in custom-made measurement systems. Outside of working hours, Guy does some cabinet work and also makes rifles that he shoots in competition.

operation would not affect the other modes of operation, and to Bob Beamer for smoothing a difficult transition to production.

Reference

1. V. Harrison, "An Easier to Use Variable-Persistence/Storage Oscilloscope with Brighter, Sharper Traces," Hewlett-Packard Journal, September 1976.

ABBREVIATED SPECIFICATIONS HP Model 1741A Oscilloscope

Cathode-Ray Tube

OPERATING MODES: Write, store, display, auto-store, auto-erase and conventional (rear-panel pushbutton).
PERSISTENCE: Approximately 100 ms to 1 minute. In conventional mode, same as P31 phosphor (40 μs).
STORAGE WRITING SPEED: ≥118 div/μs over center 7 × 4 div (with viewing hood).
STORAGE TIME:
DISPLAY MODE: ≥10s (at 22°C).
STORE MODE: ≥30s (at 22°C).
ERASE TIME: Approximately 300 ms.
GRATICULE: 8 × 10 div (1 div = 0.85 cm).

Vertical Amplifiers

BANDWIDTH: dc to 100 MHz.
RISE TIME: ≤3.5 ns, 10% to 90% of 6-div step.
DEFLECTION FACTORS: 5 mV/div to 20V/div.
MAGNIFICATION (×5): Increases sensitivity of 5 and 10 mV/div deflection factor settings of both channels to 1 mV/div and 2 mV/div. Bandwidth is dc to 30 MHz.
INPUT COUPLING: ac or dc (1MΩ) | 20pF, 501(dc), or ground (disconnects input connector and grounds amplifier input).

A vs B OPERATION

CHANNEL A (Y-AXIS): Same bandwidth as Channel A.
CHANNEL B (X-AXIS): dc to 5 MHz.
DEFLECTION FACTORS: 5 mV/div to 20V/div, both channels.
TRIGGER SOURCE: Selectable from channel A, channel B, both (composite), or powerline frequency.
TRIGGER VIEW: Displays trigger signal, internal or external. Triggering level is approximately center screen.

RANGE

MAIN: 50 ns/div to 2 s/div.
DELAYED: 50 ns/div to 20 ms/div.
MAGNIFIER: Expands all sweeps by a factor of 10 (extends fastest sweep to 5 ns/div).
CALIBRATED SWEEP DELAY: 0.5 to 10 × Main Time/Div settings (minimum delay is 150 ns).
TRIGGERING
MAIN SWEEP: From internal or external signal or automatic (displays baseline in absence of signal).
SINGLE: Sweeps once in response to internal or external trigger; armed for reoccurrence by pressing SINGLE or ERASE pushbutton.

Main and Delayed Time Bases

DELAYED SWEEP

AUTO: Sweep starts at end of delay.
TRIG: Sweep is armed and triggerable at end of delay.

General

POWER: 100, 120, 220, 240 Vac ±10%; 48 to 440 Hz, 100 VA max.
WEIGHT: 13.8 kg (30.5 lb).
DIMENSIONS: 197 mm H × 335 mm W × 521 mm D (7-3/4 × 13-13/16 × 20-1/2 in).
ACCESSORIES FURNISHED: Blue light filter, EMI filter and contrast screen for CRT, viewing hood, front-panel cover, storage pouch, two miniature 10:1 divider probes.
OPTIONS:
002: Triggered A vs B mode; phase shift, ≤1° dc to 5 MHz; internal triggering on channel B only.
003: Auto-camera.
005: TV sync separator.
PRICES IN U.S.A.: 1741A, \$4250; opt 002, \$150; opt 003, \$75; opt 005, \$215.
MANUFACTURING DIVISION: COLORADO SPRINGS DIVISION
1900 Garden of the Gods Road
Colorado Springs, Colorado 80907 U.S.A.

Hewlett-Packard Company, 1501 Page Mill Road, Palo Alto, California 94304

Bulk Rate
U.S. Postage
Paid
Hewlett-Packard
Company

HEWLETT-PACKARD JOURNAL

SEPTEMBER 1979 Volume 30 • Number 9

Technical Information from the Laboratories of
Hewlett-Packard Company

Hewlett-Packard Company, 1501 Page Mill Road
Palo Alto, California 94304 U.S.A.
Hewlett-Packard Central Mailing Department
Van Heuven Goedhartlaan 121
1180 AM Amstelveen The Netherlands
Yokogawa-Hewlett-Packard Ltd., Suginami-Ku
Tokyo 168 Japan

02000325036&&HARR&JA00
MR JULIAN A HARRIS
CHAYO ELECTRONICS LTD
COMMUNICATIONS DEPT
1575 NO 20TH AVE
PENSACOLA FL 32503

CHANGE OF ADDRESS: To change your address or delete your name from our mailing list please send us your old address label. Send changes to Hewlett-Packard Journal, 1501 Page Mill Road, Palo Alto, California 94304 U.S.A. Allow 60 days.