

The Oscilloscope — Determining Accuracy of Sweep Generator — 7

This is the seventh in a series of articles on the use of the oscilloscope in determining capabilities of the instrument and that of other servicing equipment.

Checking Sweep Linearity

The accuracy of the sweep generator must be known before it is used for alignment work. The generator should provide a reasonably linear sweep and constant amplitude over the swept band of frequencies. The test for this is quite simple and only requires a diode detector, an oscilloscope, and a marker source. A circuit diagram for this detector network is illustrated in figure 1.

The detector unit is inserted between the sweep generator output jack and the output cable normally connected to the receiver output. The detected signal is then fed to the vertical input terminals of the oscilloscope. The sweep generator, with blanking switch on, is adjusted to produce maximum width, or the sweep width normally used in alignment work.

The resultant wave form presented on the scope will be in the form of a base line which is the scope trace and a line below this trace produced by the detected sweep signal. Constant amplitude over the swept band is indicated when these two traces are parallel. A deviation from this condition will be indicated by the amount of tilt the lower or sweep signal contains in reference to the base line.

The user is not interested in portions of the swept signal beyond the frequency limits used in alignment. Markers at limit frequencies such as 41.25 and 47.25 mc are introduced so that any error within these areas can be determined.

Equipment Connections

In one type of sweep and marker system, it is only necessary to feed the detected signal into the marker generator at the terminal marked "receiver input" and the oscilloscope

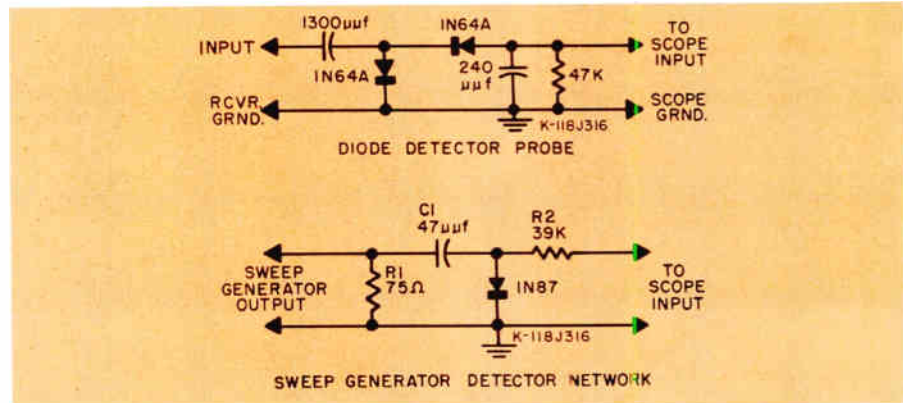

Fig. 1 Sweep Generator Detector Network

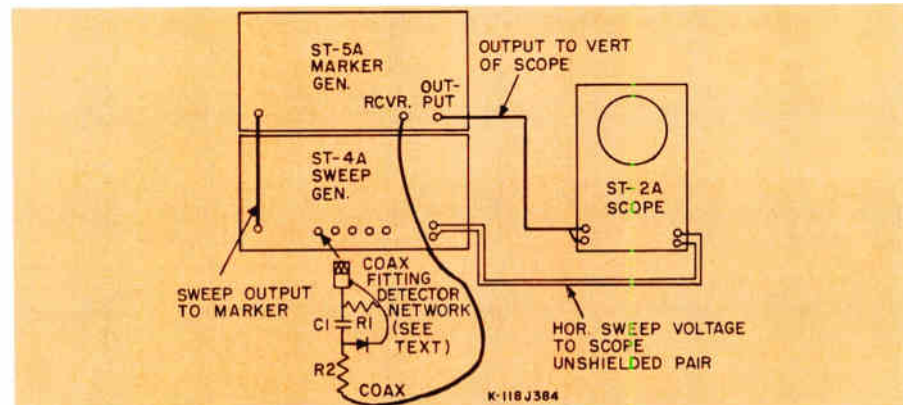

Fig. 2 Connection Diagram of Test Equipment — Sweep Test

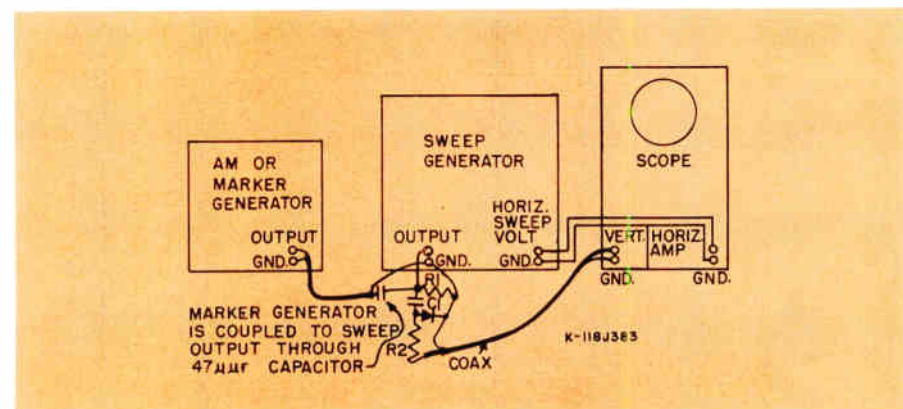

Fig. 3 Connection Diagram of Test Equipment — Sweep Test

(Continued on page 6)





BENCH NOTES

PREVENT MOBILE LOOSENING

When mounting or assembling components in chassis destined for installation in vehicles, dab a bit of shellac on the threads of nuts and screws and they'll stay put in the face of considerable vibration and prevent premature loosening and failure of mobile radio units, etc.

*H. Muller
Box 6
Daboro, Penna.*

REINFORCED STROBOSCOPE

The constant use of my cardboard stroboscope causes the center hole to wear and fray so much that it lobs around the turntable.

By glueing a plastic 45 rpm insert (spider) directly over the hole in the center the strobe will last longer. It can also be hung on a nail near the bench.

*Samuel Jacobs
Badger Radio
3 Badger Rd.
Hyde Park, Mass.*

MOTOROLA AUTO RADIO MODELS 216 & 345

Set operated normally until it was shut off. Set failed to operate when turned on again.

A noise generator was applied to V4 1st audio, V3 IF and V2 mixer transistors and provided satisfactory results. However, upon application of signal to V1, RF stage a barely discernable signal was heard.

A voltage measurement of V1 showed complete lack of voltage on base or emitter of transistor 2SA72.

Not having a direct replacement for the 2SA72 a * 2N384 was selected and installed and resulted in good set operation. A minor adjustment of C8A trimmer is required when this substitution is made.

*Leonard Chioma
2020 Natalen Road
Winter Park, Fla.*

*The General Electric Universal Replacement GE-9 could also be used.

LEAD HOLDER

A cardboard mailing tube makes an excellent device for storing test leads and line cords. Just coil leads around your hand, then push them into a mailing tube of suitable size.

*Chuck Cole
Cole Radio TV
676 Dorian Rd.
Westfield, N. J.*

TAPE SAVER

If a roll of tape of any kind lays around unused for a while, it loses its adhesiveness and dries out.

Preserve the tape's life by coating both sides of the roll with a thin layer of rubber cement which will keep the tape sticky indefinitely, since the seal remains as tape is taken off the roll.

*H. Josephs
Box 22
Gardenville, Penna. 18926*

COLOR CONVERGENCE

A relatively simple and effective way to test for precise convergence on color TV receivers is to use a magnifying mirror. These mirrors are readily available in department and variety stores at a nominal cost and should be about four to six inches in diameter.

After all convergence adjustments have been made using a dot or cross-hatch pattern, it is only necessary to hold the magnifying mirror a short distance from the viewing screen and check different areas as the dynamic convergence controls for these areas are carefully adjusted. This will produce very precise results and give an excellent converged picture.

*Carlton C. Mills TV
20 Gordon Place
Scarsdale, N. Y.*

SERVICE HINTS

To keep a soldering iron perfectly clean, just wipe it across a wet viscous sponge kept in a tray or a bottom half of a soap dish. The iron tip will be perfectly clean and tinned for use.

To save hours sometimes on AGC troubles, put a variable bias on the AGC line, either from a special supply or use your transistor radio power supply or auto radio supply. If the TV will work with a little negative voltage on the AGC line this pushes the trouble definitely to the AGC circuit and not gassy IF tubes or shorted filters.

*James A. Johnson
Johnson's TV Service
45 Island Dr.
Poland, Ohio*

SYNC TROUBLE

Regarding Zenith television sets chassis numbers 19R20, 19R21, 20M20, or similar chassis, I found one with very poor sync action. The sync clipper tube 6BE6, 6CS6, etc. has a 10 to 15 meg. resistor connected to pin #7. The voltage should read low about 2 to 4 volts neg. on pin #7. This was low yet near the voltage to be expected. A technician might think the 10 or 15 meg resistor connected to pin #7 was OK unless disconnected and checked. I disconnected it and found it open. A new 10 meg resistor restored the sync to normal.

*Henry A. Bratcher
Rt. 2
Dublin, Texas*

SAFETY SUGGESTION

To protect test equipment when servicing a transformerless TV set, use a Neon glow tester (cost about 50¢) to prevent a hot chassis.

Turn the set on and then hold one lead of tester in your hand and touch the chassis with the other lead. If the light glows you have a hot chassis.

Reverse the AC line plug in its socket and then the light will not glow indicating the chassis is not hot.

*Russell V. Book
6803 Navarre Rd., S. W.
Massillon, Ohio*

TRANSISTOR COLORCODE

This method saves me valuable time when I am working on transistor printed boards. After I locate the transistor terminals on the under side of the board I color code them with a very small dot of paint, (model paint dries fast), then when I turn the board around to work on the top side I do not have to look for the transistor terminals again. The code I use matches my checker. Base—yellow. Collector—red. Emitter—black.

*Frederick J. Seidel
Freddy's Electronic Service
R. D. 2, Box 136
Hamburg, Pa.*

PLASTIC SCRATCH REMOVAL

For removing scratches or dull spots from a plastic TV safety lens, I use Dupont No. 7 rubbing compound. This leaves a surface as clear as the original finish. You can rough down deep scratches with a pocket knife or a small file before using the compound. Make the refinished area large enough to eliminate distortion in the picture. This method can also be used for plastic radio cases.

*K. R. Giebler
Giebler TV-Radio Service
230 W. 9th
Hays, Kansas*

REMOVING PRINTED CIRCUIT COMPONENTS

Much advice has been written up including that which is given in courses on how to remove printed circuit components which have multiple lead connections such as I-F cans, controls, and printed components. Usually such advice amounts to using a soldering pot or a special constructed bent wire soldering tip on a soldering gun or iron.

This advice is good to some extent, but I would like to pass on a tip on doing the same job a whole lot quicker and better by using a slightly different approach. In this business efficiency is our constant aim and means more dollars to us. So in shops with two or more servicemen, I recommend that on removing printed circuit components from boards that two or more servicemen hold three or more soldering guns or irons to the component leads and remove the thing in a matter of a few seconds. Usually two of us here get together with soldering guns and the thing is out in a few seconds with no sweat. You must try this to believe it.

*Jerome Sit
Electronic Workshop
103 Hwy. 1, South
Greenville, Mississippi*

NOTE:

Those desiring to have letters published in this column should write the Editor Techni-Talk, Electronic Components Division, General Electric Company, Owensboro, Kentucky. For each such letter selected for publication you will receive \$10.00 worth of General Electric tubes. In the event of duplicate or similar items, selection will be made by the Editor and his decision will be final. The Company shall have the unlimited right without obligation to publish or otherwise use any idea or suggestion sent to this column.

Caution: The ideas and suggestions expressed in this column are those of the individual writers. These ideas and suggestions have not been tried by the General Electric Company and therefore are not endorsed, sponsored or recommended.

Multi Purpose
POCKET TOOL

\$1.98

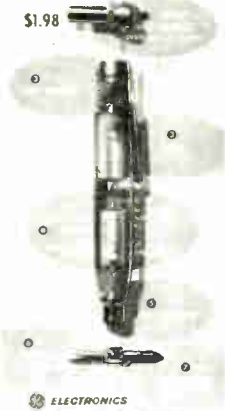

POCKET TOOL

Here is a practical and useful tool that will make servicing easier and faster. This new pocket tool will enable you to remove the back of any receiver regardless of the type of fastening without opening your tool or service case.

Lightweight pocket tool clips to a shirt pocket and contains Phillips and standard screw driver; 1/4", 5/16" and 3/8" hex sockets; high voltage tester and level.

Use screwdriver end as prod, neon bulb in handle indicates presence of high peak voltage at plate of horizontal output tube or high voltage rectifier.

Lay unit flat with G-E monogram down to use as a level when installing phonographs, air conditioners, etc.

ETR-3594 Cost \$1.98



PRINTED CIRCUIT BOARD CUTTING TOOL

This new G-E Service Aid is a real time saver when servicing printed circuit boards. This versatile tool makes Printed Circuit trouble shooting easy. Use tool to cut through — make test — then flow solder across cut.

Blade slides horizontally — adjusts to cut "paper thin." In this position tool cuts only the printed circuit and does not weaken board.

Handy for opening packages and numerous other daily tasks. Blade retracts — safe to carry in pocket or service case.

Uses standard single-edge blade.

ETR-3896 Cost \$0.25



Part Holder \$1.35

PART HOLDER

The General Electric Part Holder is designed to stand upright or attach to edge of service bench. Many times a "third hand" is needed to hold parts in position particularly while soldering. Other times something is needed to hold a piece of solder or some other item when both hands are being used. More than one G-E Part Holder can be used to hold different parts in a fixed position until solder "sets."

ETR-3851 Cost \$0.35

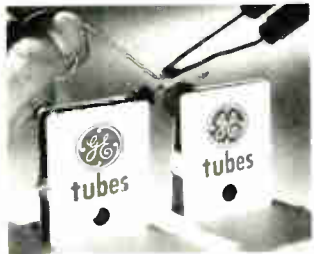

FIVE-IN-ONE COMBINATION TOOL

Here is a new lightweight tool that will save time either on the bench or on home service calls.

It is five tools in one with a pocket clip. Contains No. 1 Phillips screwdriver and standard screwdriver; 1/4", 5/16" and 3/8" hex sockets.

ETR-3910 Cost \$0.98



Adjustable Door Clock \$1.10

DOOR CLOCK SIGN

Let your customers know when you are OPEN, you are CLOSED, you will be BACK.

It can be used to hang on front door or in a visible location. Hands movable to time of return when leaving for lunch — for the day — for service calls — for emergencies. Sign turns around so OPEN is visible when you return.

ETR-3826 Cost \$0.50



PROMPT - EFFICIENT SERVICE

OPEN

ELECTRONICS
Best for any set!

GENERAL ELECTRIC

NEW G-E TUBE AND PARTS CABINET

Here is the answer to your tube and parts storage problem. Dress up your store with one or more for over-the-counter stock. Save time by having another at the bench to hold servicing supplies.

Six shelves provide over twelve feet of storage space. The pegboard hanger holes on each side give additional capacity for numerous items such as capacitors, semiconductors, tape, etc.

Cabinets can be mounted side by side or stacked one above the other.

Designed for shipping via parcel post. Can be assembled in a few minutes. All parts snap into place without use of nuts or bolts.

ETR-3803 Cost \$11.75





TOOL TOTER

A convenient, lightweight, portable unit designed for use wherever tools are needed and used. Invaluable when servicing car radios. The pegboard keeps screw drivers, pliers, nut drivers and wrenches clearly visible and easily removed or replaced. High-impact plastic trays hold screws, nuts, fuses, tape, capacitors and other small parts or tools.

ETR-2338 Cost \$1.49

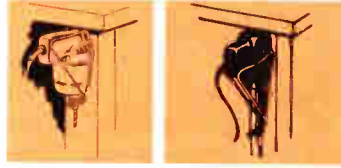

SOLDERING GUN OR ELECTRIC DRILL HOLDER

This G-E Soldering Gun or Electric Drill Holder prevents burns and damage to instruments, wires and service manuals. Holds an electric drill in a safe, ready-to-use position. It can be easily mounted to any surface with clamps and screws supplied with units.

ETR-2582 Cost \$0.75

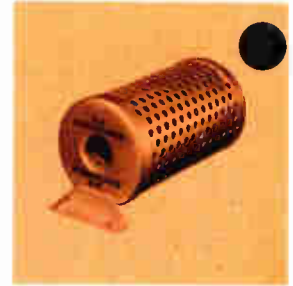

SOLDERING IRON HOLDER

Made to mount on bench edge or bench top. Will accommodate soldering irons up to 3/4" in diameter. Protects your hands, wires, diagrams, other tools from burns. Cadmium aluminum finish resists heat discoloration. Holes in both inside and outside cylinders provide maximum air circulation.

ETR-2790 Cost \$1.20

just heat solder...

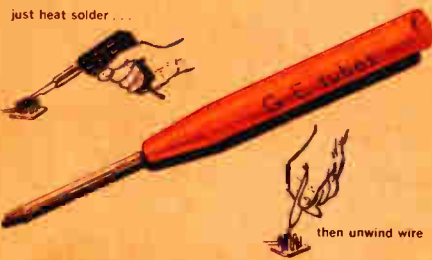

SOLDERING TOOL

Helps remove "wrap-around" soldered wires. (Heat solder first.) Convenient size (6" long) and shaped for general repair work. Orange-color handle makes it easy to locate on the bench or in service case. Single-ended tool, easier, to hold and use.

ETR-2377 Cost \$0.65



WIRE STRIPPER

Four cutting edges for most wire sizes. Select cutting edges slightly smaller than outside dimension of insulation. Press insulated wire fully into cutting channel. Rotate wire stripper completely around wire and pull.

ETR-2376 COST \$0.65

BENCH MIRROR

A mirror that saves you valuable time because it's designed specifically for the TV workbench. Adjusts quickly to any desired height.

ETR-1275 Cost \$3.50



TUBE PULLER

Never be without it on your workbench or in your service case. It protects you against burns, cuts and shocks — no matter how firmly the tubes may be wedged in their socket. Fits all regular glass types, all metal tubes, plus seven- and nine-pin miniatures, and compactrons.

ETR-1094 Cost \$0.35

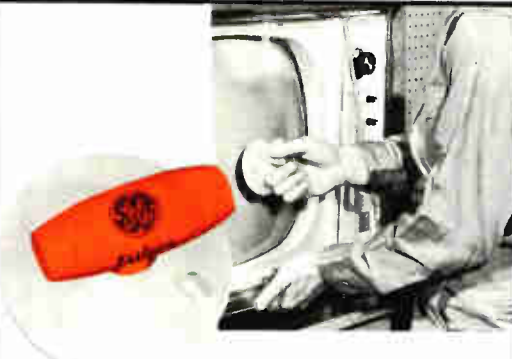

SAFETY GLASS PULLER

It's exactly what you need to remove safety glass quickly, easily — and safely! Prevents cracking, chipping and other damage while you remove the glass. The three-inch suction cup holds firmly, is easily removed from the glass by unique vacuum release tip. Won't leave marks on glass.

ETR-1592 Cost \$0.95



PICTURE TUBE PILLOW

This 1/2" thick foam-plastic cushion provides the surest possible protection against scratches on the tube face and edges. Order at least one for every technician in your shop. Never lay a picture tube on anything else.

ETR-1469 Cost \$0.75

SERVICE AIDS

specifically engineered and field-tested
for the TV/radio service dealer



SERVICE DROP CLOTH

A rugged, hard-wearing plastic sheet that does double duty: It protects furniture and floor coverings, even against hot solder. It serves as a protective cover for radio and TV cabinets when moving them to or from the home.

ETR-1021 Cost \$1.95

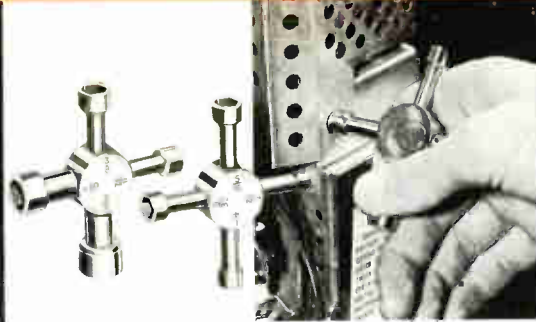

TWIN-X-WRENCH SET

The two wrenches in this set actually do the work of eight hex-head socket wrenches, save plenty of space and weight in your repair kit. They're designed especially for TV and radio service work, where you need to get maximum leverage, often in very close quarters.

ETR-752 Cost \$3.45



SERVICE CALL BOARD

In a single glance, this easy-to-use rolling chart tells you where your work stands — shows you your work schedule for days or weeks in advance — enables you to schedule work immediately. Marking pencil and complete instructions included.

ETR-2144 Cost \$1.49



FUSE AND HEATER CHECKER

Pocket-size — yet it will check virtually all tubes used in series-string TV sets and radios (AC, DC, and portable), including compactons, novars and picture tubes. Also tests pilot lamps and fuses. Rugged construction. Battery powered. Actual size — 4" x 2 3/4" x 1 3/4".

ETR-981 Cost \$2.95



COMPACTRON SOCKETS

Two 12-pin sockets for compactron devices in each package. New feature — a raised "key" ridge between pins 1 and 12 to help when inserting the compactron in hidden locations. The pins are numbered on the bottom of each socket.

ETR-2976 Cost \$0.39



CAPACITOR TAB ADJUSTER

Simplifies removal and installation of twist-prong electrolytic capacitors and also some types of variable controls. Hollow tip fits perfectly over mounting tabs. With a twist you break off old tab . . . lock in new.

ETR-2968 Cost \$1.00



REAR CONTROL EXTENSION

Permits quick, sure adjustment of TV controls without removing back of set. One end tapered to fit snugly over knurled control shafts. Pin in other end fits slotted shafts and, unlike screwdrivers, cannot slip off.

ETR-2089 Cost \$0.35

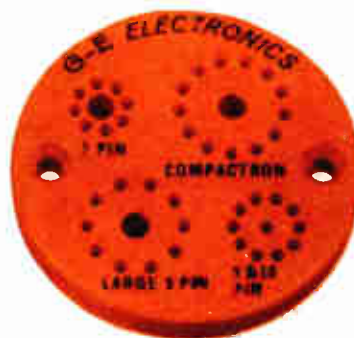

MULTI-TUBE PIN STRAIGHTENER

Straightens pins in a jiffy. Helps to eliminate tube damage caused by bent pins. New small size just right to slip into trouser or shirt pocket. Red-orange color makes it easy to find.

ETR-3200 Cost \$0.60

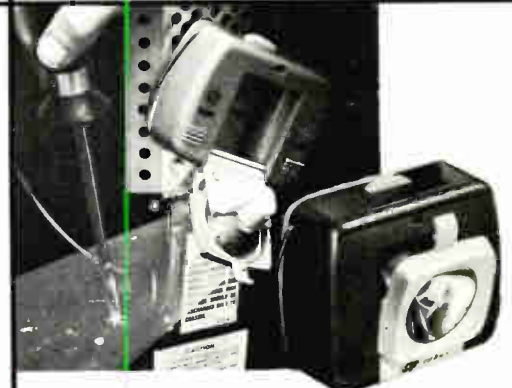

MAGNETIC SWING-BEAM SERVICE LIGHT

This TV Service Light has a magnet that holds it firmly to the chassis, leaving both hands free for work. The front of the lamp swings out to any desired angle, allowing you to aim the beam exactly where you need it.

ETR-1593 Cost \$2.25

What's new!

THE OSCILLOSCOPE

(Continued from page 1)

connected to the marker terminal identified as "output to scope."

A connection diagram is illustrated in figure 2. In those types where the marker signals are not mixed in this manner, the marker generator output can be coupled to the input to the detector unit through a 47 mmf capacitor as illustrated in figure 3. The results obtained from one type of sweep generator is illustrated in figure 4. For all intents and purposes, this sweep is flat in the area between 41.25 and 47.25 megacycles.

The results of tests performed on two additional sweep generators are illustrated in figures 5 and 6. The tilt observed in both cases is due to a variation of the amplitude along the swept band. For all practical purposes, this amount of error is con-

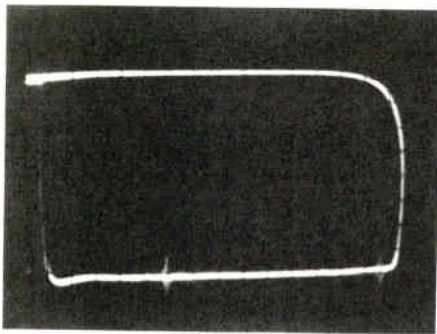

Fig. 4 Constant Amplitude Over Swept Band

sidered acceptable for field alignment use as this error is distributed throughout the entire band. A more serious condition would exist if an extreme variation in amplitude occurred within a narrow area of the swept band.

Inserting Markers

The linearity of the sweep can be checked by adding a series of markers using the same method suggested for inserting markers at limit frequencies. In this case, however, the frequency separation of the markers is equally displaced. Figure 7 illustrates the results observed using 1.5 megacycle markers. The spacing between markers are approximately equal indicating a very close approach to a linear condition.

Correcting Nonlinearity

Due to cost considerations, many sweep generators in the service category produce nonlinear sweep signals and variations in amplitude to varying degrees. In many instances, the error involved is not serious and the equipment is usable.

NEW GENERAL ELECTRIC TUBES AND COMPACTRONS LISTED BY RECEIVER

tubes



Here is a list of *NEW* General Electric receiving tubes and compactrons and the manufacturers using these types in their receivers. Be ready to service the new model re-

ceivers by having at least one of each type on hand. They are now available from your General Electric tube distributor.

TYPE	SET MANUFACTURER	FUNCTION
1BC2	GE TV	HV Rect.
6CG3*	Philco-Color	Damper
10BQ5	Philco TV	Audio Output
11BQ11*	GE TV	IF Amp.
13V10*	Magnavox-TV	Sound Det. & Output
15KY8A	RCA TV	Vert. Osc. — Output
17BZ3*	Philco & Westinghouse TV	Damper
21JY6*	Motorola TV	Hor. Output
21JZ6*	Philco & Westinghouse TV	Hor. Output
22JG6A	RCA TV	Hor. Output
38HK7*	Admiral TV	Hor. Output & Damper

*Compactron Type

Reference should be made to the instruction manual, pertinent to the particular generator if excessive tilt or nonlinearity exists, as some generators incorporate a control or means for correcting these conditions. If corrections are made, each

R-F and I-F channel should be checked as these adjustments may correct one channel and adversely affect one or more of the others.

If excessive nonlinearity or variations in amplitude exist in the output signal and cannot be corrected, the generator can be used if these errors are taken into consideration during alignment. It would, however, be advisable to have the generator repaired. Unless the user has had prior experience along these lines, the generator should be repaired by the equipment manufacturer or a specialist in this field.

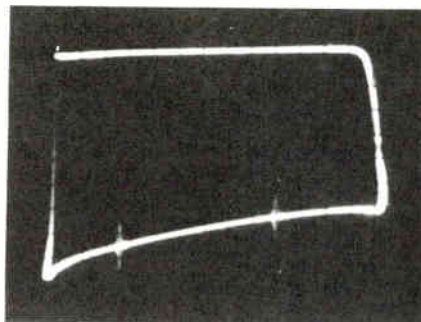

Fig. 5 Slight Variation of Amplitude — Acceptable

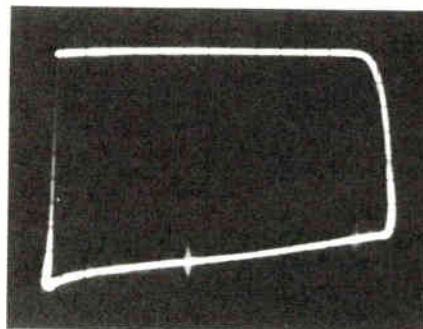

Fig. 6 Slight Variation of Amplitude — Acceptable

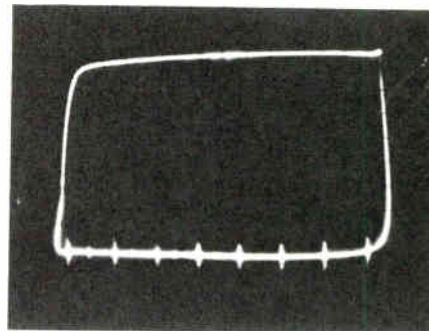

Fig. 7 Good Linearity Over Swept Band — Acceptable

Most marker generators include a crystal source for checking the accuracy of the marker frequencies. If the generator does not have this feature and the accuracy of the markers is suspected, the equipment should be recalibrated by an organization specializing in this type of work.

TELEVISION TROUBLESHOOTING THE "DB" CHASSIS

Horizontal Oscillator

The following procedure may be used by the service technician in checking the sine-wave horizontal oscillator of the DB Chassis while trouble shooting the horizontal-high voltage system. It may also be applied to other new G-E chassis incorporating the same type of horizontal circuitry.

The partial schematic diagram below shows the oscillator circuitry with circled numbers identifying areas referred to in the step-by-step procedure. In actual troubleshooting, the DB (or other chassis) main-chassis schematic diagram should be used, and common-sense troubleshooting practice followed; for

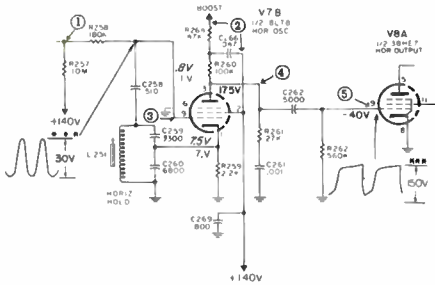

example, in the event of a failure in the horizontal or high-voltage area, a preliminary visual inspection and a check of circuit voltages may furnish immediate clues to the trouble source.

1. Connect a jumper between chassis ground and the junction of R257-R258. If high voltage becomes operative as shown by the raster, it can be assumed that the difficulty is in the phase detector or another stage on that side of the oscillator. In this case, normal troubleshooting practices should be applied beginning with the phase detector output and working back.

2. If the oscillator remains suspect after Step 1, check DC voltages at the 8LT8 screen (Pin 2) and the boost end of R264. Voltage at both points should be approximately 140 V without boost. If voltages are in this range, proceed to Step 3. (No voltage at the end of R264 indicates failure in the damper or flyback circuitry.)

3. Using an oscilloscope, check at the control grid (Pin 9) for a horizontal-frequency sine-wave indicating that the oscillator is functioning. If the waveform does not appear, or appears at considerably smaller amplitude than indicated on the schematic, troubleshoot the oscillator stage for possible tube or component failure. If the waveform appears normal, proceed to Step 4.

4. Connect the scope to the 8LT8 plate (Pin 3). If the scope does not show a trapezoidal waveform of approximately

100V amplitude, check for a short or open in the plate circuitry. Otherwise, go on to Step 5.

5. Connect the scope to the driver control grid (Pin 9 of the 38HE7). The display and approximate voltage reading should conform to that obtained at the plate of the 8LT8 in Step 4. If not, the coupling capacitor C262 may be at fault.

If the oscillator is operating and properly driving the horizontal output stage, a high-voltage failure indicates trouble — probably a tube or component failure — in the high voltage area itself.

CONSOLE PHONO

MODEL: ALL V.M.

SYMPTOM: Failure to center trip at end of record.

CAUSE: Bent trip pawl.

CORRECTION: Trip pawl tab may be checked and adjusted without removing changer from cabinet. Remove turntable and use a flat screw driver tip as a feeler probe through the turntable hub opening to test position of trip pawl. At rest position (trip pawl positioned furthest from outside circumference of main gear) the "gear tooth" of the pawl should have 1/32" clearing from the edge of gear assembly. If it does not, gently pry trip pawl outward to secure proper clearance.

Use Order Coupon Below

ORDER COUPON

General Electric Company
Department "B"
3800 N. Milwaukee Ave.
Chicago, Illinois 60641

Enclosed is money order or check payable to General Electric Company for:

Quantity		Price			Price
.....	ETR-752 Twin-X Wrench Set	\$ 3.45	ETR-2790 Soldering Iron Holder	1.20
.....	ETR-981 Fuse and Heater Checker	2.95	ETR-2968 Capacitor Tab Adjuster	1.00
.....	ETR-1021 Service Drop Cloth	1.95	ETR-2976 Compactron Sockets39
.....	ETR-1094 Tube Puller35	ETR-3200 Multi-tube Pin Straightener60
.....	ETR-1275 Bench Mirror	3.50	ETR-3594 Pocket Tool	1.98
.....	ETR-1469 Picture Tube Pillow75	ETR-3803 Tube and Parts Cabinet	11.75
.....	ETR-1592 Safety Glass Puller95	ETR-3826 Door Clock Sign50
.....	ETR-1593 Magnetic Swing-Beam Service Light	2.25	ETR-3851 Part Holder35
.....	ETR-2089 Rear Control Extension35	ETR-3896 Printed Circuit Board Cutter25
.....	ETR-2144 Service Call Board	1.49	ETR-3910 Five-in One Combination Tool98
.....	ETR-2338 Tool Toter	1.49	ETR-3960 Electronic Components Hobby Manual	1.50
.....	ETR-2376 Wire Stripper65	(Include applicable state and local tax) \$.....		
.....	ETR-2377 Soldering Tool65	TOTAL \$.....		
.....	ETR-2582 Soldering Gun or Electric Drill Holder75			

NAME

STREET ADDRESS

CITY, ZONE NO. AND STATE

(Please Print)



New G-E Electronic Components Hobby Manual, ETR-3960

The most comprehensive hobby manual produced by a major electronics manufacturer.

Every service technician, engineer, experimenter, hobbyist and student will find the new Electronic Components Hobby Manual, ETR-3960, educational, helpful and interesting. This 200-page digest includes 35 projects for car, entertainment, home, camp and workshop.

A few of the projects are:

A circuit to provide DC Meter Protection for VOM.

A Speed Reducer to provide easier and more accurate control for an electric drill.

A Night Light Control to turn light on at dusk and off at dawn.

A light that dims gradually at a pre-determined time — just right for the bachelor's den or the children's bedroom.

An Electronic Organ the size of a typewriter that gives off melodious tones when plugged into hi-fi or amplifier.

An Airport Receiver that eavesdrops on conversations between pilot and control tower.

A second Ignition System to improve gas mileage and assure quick winter starts.

Expanded in size and scope from last year's 50-page General Electric Silicon Controlled Rectifier Hobby Manual

which concentrated on simple circuitry using silicon controlled rectifiers, the new manual utilizes a wide range of components: transistors, vacuum tubes, reed switches, thyrectors, thermistors, capacitors and photoconductors, as well as silicon controlled rectifiers.

It also has 45 pages explaining in layman's language the fundamental operation of these components, including basic theories and terminology.

There's a step-by-step explanation for making the automatic lamp dimmer utilizing three transistors and several diodes. It will help the youngsters fall asleep in a gradually darkening room.

The eight-key organ employs a simple circuit with a unijunction transistor which permits manual raising or lowering of the octaves. The airport receiver uses two transistors, two penlight cells, some wires and a plastic box. And the electronic ignition system, as an alternative to the normal system, works off the existing coil and breaker points thanks to a silicon controlled rectifier.

There are 35 projects in all ranging from the gimmickry of a magic lamp that turns on and off with a magnetic wand to such handy items as a one-compactron, all band short wave re-

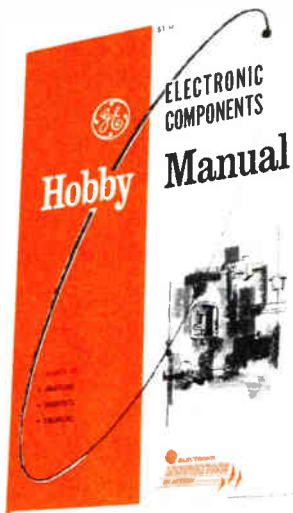

ceiver, a thermistor thermometer with remote control and alarm, and a battery saver employing one resistor and one silicon controlled rectifier.

Ask your distributor for a copy of ETR-3960. If he is out of stock or unable to supply you, use the handy order coupon on page 7. Only \$1.50.



Techni-talk



TECHNI-TALK DISTRIBUTION OFFICE

GENERAL ELECTRIC

SCHENECTADY, NEW YORK

Vol. 17 No. 2 Summer, 1965

In this issue: page

The Oscilloscope — Determining Accuracy of Sweep Generator — 7.... 1

Bench Notes 2

Complete Line of General Electric Service Aids 3

What's New 6

Service Notes 7

Form 3547 Requested

Techni-talk on AM, FM, TV Servicing, published quarterly by ELECTRONIC COMPONENTS DIVISION, GENERAL ELECTRIC COMPANY, OWENSBORO, KY. In Canada: Canadian General Electric Co., Ltd., 189 Dufferin St., Toronto 3, Ontario. R. G. Kempton, Editor. Copyright 1965 by General Electric Company.

This copy of **Techni-talk** comes to you through the courtesy of your General Electric tube distributor.



ELECTRONICS

NOTE: The disclosure of any information herein conveys no license under any General Electric patent and, in the absence of an express written agreement to the contrary, the General Electric Company assumes no liability for patent infringement (or any other liability) arising out of use of such information by others.