

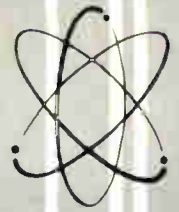

Techni-talk

COMPLETE ELECTRONIC SERVICING INFORMATION
radio • tv • hi-fi



Vol. 14, No. 4

Aug., 1962

Dealers Rush to Join G-E Tune-Up Program

THOUSANDS SIGN TO BOOST SALES

Service dealers across the nation are joining General Electric's sales-building "TV Tune-Up Spectacular" by the thousands.

Reports from all states indicate that the program may well be the broadest sales-promoting effort ever conducted in the industry. THE DEADLINE FOR SIGNING UP FOR THE TV GUIDE LISTING IS AUGUST 27, 1962.

The program will concentrate on boosting service dealer sales just prior to and during the World Series week — known as one of the highest TV-viewship periods of the year.

(Continued on Page 3)



GUY S. RALL, owner of T.V. Clinic, Houston, plans use of the "Food in Focus" book of recipes to build sales and service business.



SIGNING UP for the G-E Tune-Up Spectacular here is Robert "Tank" Zwerin, owner of Tank TV Service, Cincinnati, Ohio. At right is Paul Holub of Holub & Hogg, authorized G-E parts distributor in Cincinnati, and Art Efron, G-E district sales manager.



LOOKING for extra business through the Tune-Up program is Wallace "Wally" White, Woody's Service Shop, Hingham, Mass.



IN HOUSTON, Aubrey Galbreath, service manager of the House of Television, looks over the dealer kit for G-E Tune-Up Spectacular, with David Booth, G-E district sales manager (center), and Marrie K. Abramson, vice-president, sales manager, Sterling Electronics, Inc., Houston distributor.

PLANNING his Tune-Up campaign here is Gerald "Gerry" Delessandro, Del's Radio & TV, Quincy, Mass. He expects new business from the program — from both new and old customers.



FIRST FIVE DEALERS to sign up in Raleigh, N.C., through Southeastern Radio Supply Co. are shown here. Seated (l. to r.): David M. Crenshaw, Crenshaw Radio & TV Service, and W. E. Hicks, Southeastern. Standing (l. to r.): Garland Hoke, Southeastern; James L. Stough, Durham Music Co.; Dorsey Butler, Dorsey Radio-TV Service; C. H. Johnson, Taylor Radio & Electrical Co., and Cecil Stephens, service manager of Nelson's.

Dealers in Pennsylvania Adopt G-E Tune-Up Plan

A federation of television and radio service associations in Pennsylvania has adopted General Electric's 1962 tune-up spectacular to increase dealer prestige and boost sales for members.

The G-E promotion was adopted upon recommendation of a representative of service dealers in Philadelphia, who felt that promoting radio and television maintenance will promote the welfare of the service industry.

Officers of the association plan to visit cities through Pennsylvania, discussing with local groups the benefits of joining the G-E radio and TV maintenance promotion.



NEW BUSINESS is sought by Harvey Renne, Home Radio Co., Kansas City, Mo., with the "Food in Focus" booklet. Here he waits on Janice E. Park in his shop at 8201 Wornall Road.



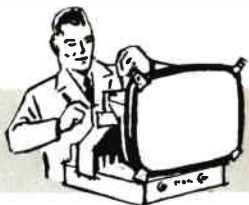

BENCH NOTES

SHOCK PROTECTION

When servicing AC-DC radios or TV sets, it is advisable to have an isolation transformer. In the absence of one, a person can take an ordinary two lead neon tester and determine whether or not a chassis is hot. Hold one lead in the hand and contact the free end to the chassis. If the neon glows dimly, unplug the chassis line cord, turn it over and plug it back in. The chassis will now be at ground potential.

Gerald Chambers
3415 - 25th
Lubbock, Texas

CURTAIN RAISER IN 10T1

Many homes today have two or more TV sets and in many cases the alternate sets are reconditioned sets, hauled down from the attic when the new set was purchased.

Another use for old and smaller sets is for "portable" operation when the family goes to their summer home or camp; taking along a small set for the few weeks they will be away.

On this basis many of the GE 10T1, 10T4, 10T5 and 10T6 series are finding their way into the service shops for repairs.

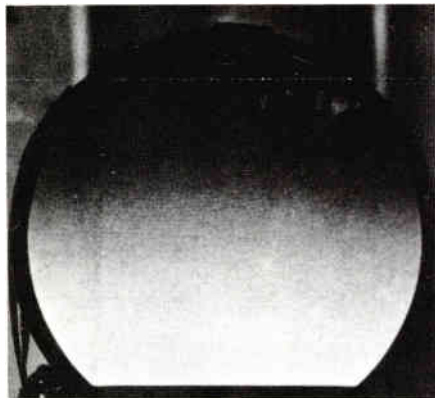

The photo shows the result of an open C-270 0.2 mfd at 200 WV in cathode circuit of picture tube.

The raster has a uniform shading from top to bottom. The bottom of the picture is overly bright while the top is dark. The shading is gradual and not abrupt like the bars caused by 60 cycle hum modulation.

L. Edwin Rybak
73 W. Garrison St.
Bethlehem, Pa.

CLEANING TUNER CONTACTS

I have found that brass polish, such as "copper brite," is very excellent for cleaning standard coil-type tuners. It can be used on any type tuner where contacts on a drum are exposed. It beats any contact cleaner on the market. Caution: do not allow it to get on coils in tuner. Use on externally exposed contacts only.

Armando T. Maciaci
Tex's TV Service
96 Highland Avenue
Newark 4, N.J.

CLEANER ATTACHMENT

An exceptionally useful shop device for extracting dust from cramped places in or around chassis and/or components, is a length of soft copper tubing fitted into a snug hole in a wood spool or dowel. The size of the spool should fit inside the nozzle end of a vacuum cleaner hose.

Being flexible, the tubing can be bent to fit into about any kind of location to pick up dust, stray bits of solder, etc.

Harry J. Miller
991-42nd St.
Sarasota, Florida

SCREWDRIVER IMPROVEMENT

Burring of Phillips-head screws can be reduced by simply filing down the tips of #1 and #2 screwdrivers about a 1/32nd of an inch so they seat better in the screw heads.

H. Josephs
P.O. Box 22
Gardenville, Pennsylvania

PHONO PLUG SAVER

I make a loop of fish-line by taking a piece about 7 or 8" long and doubling it back and tying it by a knot. I then slip it in the slots opposite each other on a phono plug. When I wish to remove the phono plug I merely slip a finger in the loop and give it a quick pull. This prevents loosening the shielding near the plug. I always use the loop of fish-line to avoid work of that nature that can't be charged for.

Lewis C. Ernst
503 E. Enn St.
Ann Arbor, Mich.

ARCING IN "U-2"

We have found the cause of damage to the printed board in the General Electric Television "U-2" chassis to be not component failure or board failure but the deterioration and electrical breakdown of the piece of sponge rubber which separates the board from the flyback transformer. We find that this allows L-251 to arc to the frame of the flyback transformer. Not all of these sets have this piece of rubber.

We remove this sponge rubber on all of the "U-2" sets that have to be serviced for any type of trouble.

Harold W. Arnold
Arnold Music Co.
221 Main Street
Sulphur Springs, Texas

Editor's Note: Make sure that clearance is adequate to prevent arcing after spacers are removed.

CEMENT HANGERS

A small cuphook makes an excellent stopper for tubes of cement, glues, etc.

By turning the hook into the open end of the tube until the flange is tight against it, you have a good seal, and the tube can be hung by its hook.

H. Muller
Box 6
Danboro, Pa.



"Hey, stupid! Don't let my rats out!"

WRENCH IMPROVEMENT

When trying to insert an Allen-head wrench in the hex opening of a hard-to-reach or hard-to-see Allen screw, it is much easier if bevel is ground along the edge of the Allen wrench.

E. Mayover
1601-14th St. W.
Bradenton, Fla.

MAGNIFYING GLASSES

I have found that the purchase of a pair of magnifying glasses at a medical supply firm has made my service work much easier. It brings everything much closer and easier to see. I have two pairs; one pair to wear when I go on house calls and the other pair in the shop. I suggest that you try it out and see for yourselves how much easier repair work can be by wearing a pair of these glasses.

Joe Sabol
S & S Radio
5541 W. Quincy St.
Chicago 44, Ill.

CONNECTION IDENTIFICATION

The following has saved me some time now and then when replacing circuit components or rewiring circuits where disconnects must be made at several junctions. It also comes in handy when a job may be interrupted for some time:

Solder loops of color-coded hook-up wire to small "gator" clips and use as reminders for component disconnect points at junctions, tube pins, etc. Hang 'em up with the loops when not in use.

Clarence D. Copeland
17515 N.W. 48th Court
Opa-Locka, Florida

Editor's note: Standard RETMA color code can be used to indicate connection to numbered terminals such as on tube sockets or transformers.

NOTE:

Those desiring to have letters published in this column should write the Editor Techni-Talk, Electronic Components Division, General Electric Company, Owensboro, Kentucky. For each such letter selected for publication you will receive \$10.00 worth of General Electric tubes. In the event of duplicate or similar items, selection will be made by the Editor and his decision will be final. The Company shall have the unlimited right without obligation to publish or otherwise use any idea or suggestion sent to this column.

Caution: The ideas and suggestions expressed in this column are those of the individual writers. These ideas and suggestions have not been tried by the General Electric Company and therefore are not endorsed, sponsored or recommended.

Servicing the G-E Sonic Remote Control V

Receiver and transmitter alignment was described in the Vol. 14 No. 3 issue. In this issue the servicing of the remote receiver and transmitter will be discussed.

Service of the sonic remote receiver is not to be considered difficult; however, certain precautions should be taken into account.

Shielding

The first amplifier is extremely high gain and therefore sensitive to mechanical and electrical pickup. When open servicing of the chassis is required, a metal clip-on shield should be placed over the top two inches of the chassis opening. Microphonics may be encountered in the first amplifier stage tube and if this is apparent, a simple switch of V701 with V703 should help the situation. This is possible because all the tubes used on the remote receiver are of the same type.

As was stated before, the pickup or transducer forms part of the capacity of the first amplifier tuned grid circuitry; therefore, it is desirable to have the pickup in place when servicing the receiver.

Stray pickup is not limited to R. F. type radiation. It is necessary therefore, to place a magnetic shield over L701 to prevent possible magnetic noise pickup when installed in the TV cabinet.

The first four amplifier sections of the Sonic Remote Receiver may be serviced much the same as any audio amplifier. Trouble shooting is not difficult using only a VTVM as an indicator. A VTVM is necessary to prevent loading the high gain stages.

Check Stepping Relay

The stepping relay has been designed to operate best in the upright position it assumes when the remote receiver is mounted in the cabinet.

Operating the receiver in any but the standing position may affect the relay operation. No adjustments to the relay should be necessary; however, certain items are pointed out here for operational explanation.

Care should be observed when handling the relay so as not to bend the arms. The relay may be checked for operation by placing one finger against the driving arm between the two rivets above the return travel adjusting screw and forcing the arm against the armature. The moveable arm should contact the ratchet wheel and move the contact to the center of the succeeding pad on the etched circuit board. The stop arm should then rest on the top of the ratchet to hold the ratchet from further travel. Allowing the arm to return to the rest position, the moveable arm should clear the ratchet wheel and be in place to pick up the next gear tooth.

The return screw should be set to allow the moveable arm to be just above the ratchet tooth. The tension spring set screw should not be adjusted unless the driving arm fails to fully return to the open stop position. Figure 1 illustrates these adjustments.

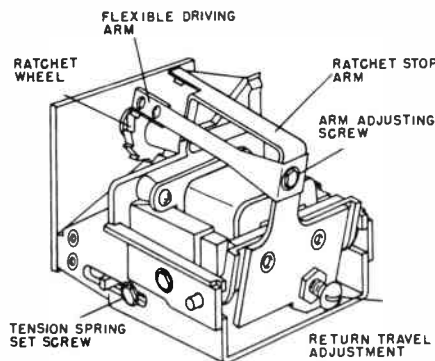

Fig. 1 Stepping Relay

Note that on the stop arm there is a tab which is bent to prevent the moveable arm from moving towards the ratchet wheel too far. This prevents the arm from sticking behind the ratchet wheel. On some relays this tab was not included and allowed some sticking condition when the unit was severely jarred or dropped.

Clip Prevents Jamming

If this condition occurs, it is necessary to open the remote receiver chassis and move the flexible arm away from the ratchet wheel to its natural position. This will clear the condition as long as the receiver is not transported. However, to permanently remove the possibility of a sticking relay, a WT3X48 detector mounting clip (shown in Fig. 2) may be installed and soldered to the actuator arm as shown. It is not necessary to remove the relay from the unit to make this modification.

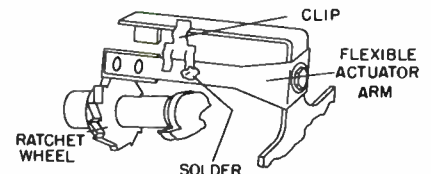

Fig. 2 Stepping Relay With WT3X48 Soldered in Place

Servicing the transmitter is relatively easy due to the simplicity of the circuit. Obviously the current drain (indicated on the schematics shown in the Vol. 13 No. 5 issue) will be significant. One unusual defect, which could be caused by dropping the transmitter, is an open connection to the transducer. When servicing this unit it is advisable to check all electrical connections. One extra note on service to be emphasized is that often low range is a direct indication of a weak battery.

Dealers Rush To Join G-E Tune-Up Program

(Continued from Page 1)

The program is using the major advertising and sales promotion channels in a tremendous sweep to gain business for service dealers employing General Electric tubes and other components. The advertising and publicity media employed include television, press, and direct mail in addition to store banners and other promotional pieces.

The plan offers service dealers these opportunities:

- Exclusive first use of a "Food in Focus" recipe book as a service business builder. Featuring favorite foods of famous stars, it is carefully designed to appeal to the housewife, the key buying influence in the radio and television service market.
- Listing of dealers names and ad-

resses in local editions of TV Guide magazine, providing consumers with ready reference to service facilities.

- Special five-minute network dealer shows (to be "presented by courtesy of your independent TV service dealer") featuring eight separate pre-World Series player interviews, on 155 stations, conducted by sports personality Joe Garagiola on the "Today" show.

- Special "Test Pattern" messages during the interview shows by sports announcer Mel Allen.

Name-listing forms and promotion kits may be obtained by service dealers from authorized General Electric tube distributors. Dealers may order either the promotional kit or the TV Guide listings, or both. Additional kit materials will be available in limited quantities to early participants who plan more widespread use of this program.



STAMPING the name of his shop, Tru Vue Television, on the stickers supplied on the Tune-Up Spectacular is Jack Pisciotta, alert service dealer of Raytown, Mo.

G-E SEPT TUNE-UP SPECTAC



Hugh Downs



Joe Garagiolo



Mel Allen



8 G-E WORLD SERIES FEATURES

ON THE NBC  **TODAY SHOW**

Full Lineup of 155 Local Stations
Covers 95% of U. S. Audience

Joe Garagiolo hosts sports personalities on this timely show. Mel Allen, with unique "Test Pattern Commercial," sells immediate need for your service to your customers through your local station. Starts Sept. 10.

These commercials direct viewers to your name, address and phone number in your local TV Guide.

SEE AD AT RIGHT ▶



FULL-PAGE AD PLUS YOUR NAME, ADDRESS, PHONE NUMBER IN SEPTEMBER 29 ISSUE OF YOUR LOCAL TV GUIDE

Your picture spoiling the new fall shows, sports, World Series?



NOW 13 WAYS TO A PATTERN-PERFECT TV PICTURE EASILY, ECONOMICALLY

If you're not getting the best picture your set can deliver, this sweet call one of the independent service dealers listed on the following pages. Right now, they are offering TV Tune-Up and Repair Specials. Start enjoying the new fall programs, sports and the World Series without irritation or distraction from faulty reception. A professional Tune-Up includes these 13 services—13 ways to a better TV picture:

- 1 Check horizontal circuit controls. Improper adjustment can cause "wax-out" and picture instability.
- 2 Adjust mechanical and electrical components for maximum brightness and sharpness focus.
- 3 Make necessary adjustments for proper picture size, proportion and contrast.
- 4 Calibrate range of fine tuning control to maximize near and picture "jumping."
- 5 Reset and check controls to assure best picture quality without overload.
- 6 Clean and inspect chassis and high voltage cage and leads. Dust and moisture can cause arcing or short circuits.
- 7 Inspect wiring for breaks. Insulation can become brittle and worn and cause short circuits.
- 8 Clean picture tube screen face and safety glass.
- 9 Check picture tube's dust shield and mesh for proper fit. They might need adjustment or replacement.
- 10 Inspect lighting screen and screen conductors for cracked insulation or breaks.
- 11 Check antenna for sag, corrosion, loose connections and positioning.
- 12 Test over-all performance of set to be sure circuits and tubes are functioning correctly.
- 13 Submit written recommendation for professional repair work, if needed.

FREE TV GUIDE RECEIPT BOOK
An exclusive collection of 27 laminating receipts, pre-printed main disks, metal inserts, desiccant bags are featured in TV Guide... plus professional tips for pattern-perfect TV picture. Get it from your independent TV service dealer while the supply lasts.



This week, check the picture quality of your set with this G-E test pattern. See it on the G-E World Series feature of the TODAY show on NBC: Sept. 28, Oct. 1, 2, 3, 4.
(Between 7:30 and 7:59 A.M., EDT)
The independent service dealers listed here are offering TV TUNE-UP and REPAIR SPECIALS and also have a supply of free TV GUIDE RECEIPT BOOKS.

STATE	CITY	NAME	ADDRESS	PHONE
ALABAMA	Anniston	W. J. Smith	1000 N. 1st St.	335-2344
ALABAMA	Birmingham	W. J. Smith	1000 N. 1st St.	335-2344
ALABAMA	Montgomery	W. J. Smith	1000 N. 1st St.	335-2344
ALABAMA	Mobile	W. J. Smith	1000 N. 1st St.	335-2344
ALABAMA	Tuscaloosa	W. J. Smith	1000 N. 1st St.	335-2344
ALABAMA	Prichard	W. J. Smith	1000 N. 1st St.	335-2344
ALABAMA	Dothan	W. J. Smith	1000 N. 1st St.	335-2344
ALABAMA	Enterprise	W. J. Smith	1000 N. 1st St.	335-2344
ALABAMA	Anniston	W. J. Smith	1000 N. 1st St.	335-2344
ALABAMA	Birmingham	W. J. Smith	1000 N. 1st St.	335-2344
ALABAMA	Montgomery	W. J. Smith	1000 N. 1st St.	335-2344
ALABAMA	Mobile	W. J. Smith	1000 N. 1st St.	335-2344
ALABAMA	Tuscaloosa	W. J. Smith	1000 N. 1st St.	335-2344
ALABAMA	Prichard	W. J. Smith	1000 N. 1st St.	335-2344
ALABAMA	Dothan	W. J. Smith	1000 N. 1st St.	335-2344
ALABAMA	Enterprise	W. J. Smith	1000 N. 1st St.	335-2344
ALABAMA	Anniston	W. J. Smith	1000 N. 1st St.	335-2344
ALABAMA	Birmingham	W. J. Smith	1000 N. 1st St.	335-2344
ALABAMA	Montgomery	W. J. Smith	1000 N. 1st St.	335-2344
ALABAMA	Mobile	W. J. Smith	1000 N. 1st St.	335-2344
ALABAMA	Tuscaloosa	W. J. Smith	1000 N. 1st St.	335-2344
ALABAMA	Prichard	W. J. Smith	1000 N. 1st St.	335-2344
ALABAMA	Dothan	W. J. Smith	1000 N. 1st St.	335-2344
ALABAMA	Enterprise	W. J. Smith	1000 N. 1st St.	335-2344
ALABAMA	Anniston	W. J. Smith	1000 N. 1st St.	335-2344
ALABAMA	Birmingham	W. J. Smith	1000 N. 1st St.	335-2344
ALABAMA	Montgomery	W. J. Smith	1000 N. 1st St.	335-2344
ALABAMA	Mobile	W. J. Smith	1000 N. 1st St.	335-2344
ALABAMA	Tuscaloosa	W. J. Smith	1000 N. 1st St.	335-2344
ALABAMA	Prichard	W. J. Smith	1000 N. 1st St.	335-2344
ALABAMA	Dothan	W. J. Smith	1000 N. 1st St.	335-2344
ALABAMA	Enterprise	W. J. Smith	1000 N. 1st St.	335-2344
ALABAMA	Anniston	W. J. Smith	1000 N. 1st St.	335-2344
ALABAMA	Birmingham	W. J. Smith	1000 N. 1st St.	335-2344
ALABAMA	Montgomery	W. J. Smith	1000 N. 1st St.	335-2344
ALABAMA	Mobile	W. J. Smith	1000 N. 1st St.	335-2344
ALABAMA	Tuscaloosa	W. J. Smith	1000 N. 1st St.	335-2344
ALABAMA	Prichard	W. J. Smith	1000 N. 1st St.	335-2344
ALABAMA	Dothan	W. J. Smith	1000 N. 1st St.	335-2344
ALABAMA	Enterprise	W. J. Smith	1000 N. 1st St.	335-2344
ALABAMA	Anniston	W. J. Smith	1000 N. 1st St.	335-2344
ALABAMA	Birmingham	W. J. Smith	1000 N. 1st St.	335-2344
ALABAMA	Montgomery	W. J. Smith	1000 N. 1st St.	335-2344
ALABAMA	Mobile	W. J. Smith	1000 N. 1st St.	335-2344
ALABAMA	Tuscaloosa	W. J. Smith	1000 N. 1st St.	335-2344
ALABAMA	Prichard	W. J. Smith	1000 N. 1st St.	335-2344
ALABAMA	Dothan	W. J. Smith	1000 N. 1st St.	335-2344
ALABAMA	Enterprise	W. J. Smith	1000 N. 1st St.	335-2344
ALABAMA	Anniston	W. J. Smith	1000 N. 1st St.	335-2344
ALABAMA	Birmingham	W. J. Smith	1000 N. 1st St.	335-2344
ALABAMA	Montgomery	W. J. Smith	1000 N. 1st St.	335-2344
ALABAMA	Mobile	W. J. Smith	1000 N. 1st St.	335-2344
ALABAMA	Tuscaloosa	W. J. Smith	1000 N. 1st St.	335-2344
ALABAMA	Prichard	W. J. Smith	1000 N. 1st St.	335-2344
ALABAMA	Dothan	W. J. Smith	1000 N. 1st St.	335-2344
ALABAMA	Enterprise	W. J. Smith	1000 N. 1st St.	335-2344
ALABAMA	Anniston	W. J. Smith	1000 N. 1st St.	335-2344
ALABAMA	Birmingham	W. J. Smith	1000 N. 1st St.	335-2344
ALABAMA	Montgomery	W. J. Smith	1000 N. 1st St.	335-2344
ALABAMA	Mobile	W. J. Smith	1000 N. 1st St.	335-2344
ALABAMA	Tuscaloosa	W. J. Smith	1000 N. 1st St.	335-2344
ALABAMA	Prichard	W. J. Smith	1000 N. 1st St.	335-2344
ALABAMA	Dothan	W. J. Smith	1000 N. 1st St.	335-2344
ALABAMA	Enterprise	W. J. Smith	1000 N. 1st St.	335-2344
ALABAMA	Anniston	W. J. Smith	1000 N. 1st St.	335-2344
ALABAMA	Birmingham	W. J. Smith	1000 N. 1st St.	335-2344
ALABAMA	Montgomery	W. J. Smith	1000 N. 1st St.	335-2344
ALABAMA	Mobile	W. J. Smith	1000 N. 1st St.	335-2344
ALABAMA	Tuscaloosa	W. J. Smith	1000 N. 1st St.	335-2344
ALABAMA	Prichard	W. J. Smith	1000 N. 1st St.	335-2344
ALABAMA	Dothan	W. J. Smith	1000 N. 1st St.	335-2344
ALABAMA	Enterprise	W. J. Smith	1000 N. 1st St.	335-2344
ALABAMA	Anniston	W. J. Smith	1000 N. 1st St.	335-2344
ALABAMA	Birmingham	W. J. Smith	1000 N. 1st St.	335-2344
ALABAMA	Montgomery	W. J. Smith	1000 N. 1st St.	335-2344
ALABAMA	Mobile	W. J. Smith	1000 N. 1st St.	335-2344
ALABAMA	Tuscaloosa	W. J. Smith	1000 N. 1st St.	335-2344
ALABAMA	Prichard	W. J. Smith	1000 N. 1st St.	335-2344
ALABAMA	Dothan	W. J. Smith	1000 N. 1st St.	335-2344
ALABAMA	Enterprise	W. J. Smith	1000 N. 1st St.	335-2344
ALABAMA	Anniston	W. J. Smith	1000 N. 1st St.	335-2344
ALABAMA	Birmingham	W. J. Smith	1000 N. 1st St.	335-2344
ALABAMA	Montgomery	W. J. Smith	1000 N. 1st St.	335-2344
ALABAMA	Mobile	W. J. Smith	1000 N. 1st St.	335-2344
ALABAMA	Tuscaloosa	W. J. Smith	1000 N. 1st St.	335-2344
ALABAMA	Prichard	W. J. Smith	1000 N. 1st St.	335-2344
ALABAMA	Dothan	W. J. Smith	1000 N. 1st St.	335-2344
ALABAMA	Enterprise	W. J. Smith	1000 N. 1st St.	335-2344
ALABAMA	Anniston	W. J. Smith	1000 N. 1st St.	335-2344
ALABAMA	Birmingham	W. J. Smith	1000 N. 1st St.	335-2344
ALABAMA	Montgomery	W. J. Smith	1000 N. 1st St.	335-2344
ALABAMA	Mobile	W. J. Smith	1000 N. 1st St.	335-2344
ALABAMA	Tuscaloosa	W. J. Smith	1000 N. 1st St.	335-2344
ALABAMA	Prichard	W. J. Smith	1000 N. 1st St.	335-2344
ALABAMA	Dothan	W. J. Smith	1000 N. 1st St.	335-2344
ALABAMA	Enterprise	W. J. Smith	1000 N. 1st St.	335-2344
ALABAMA	Anniston	W. J. Smith	1000 N. 1st St.	335-2344
ALABAMA	Birmingham	W. J. Smith	1000 N. 1st St.	335-2344
ALABAMA	Montgomery	W. J. Smith	1000 N. 1st St.	335-2344
ALABAMA	Mobile	W. J. Smith	1000 N. 1st St.	335-2344
ALABAMA	Tuscaloosa	W. J. Smith	1000 N. 1st St.	335-2344
ALABAMA	Prichard	W. J. Smith	1000 N. 1st St.	335-2344
ALABAMA	Dothan	W. J. Smith	1000 N. 1st St.	335-2344
ALABAMA	Enterprise	W. J. Smith	1000 N. 1st St.	335-2344
ALABAMA	Anniston	W. J. Smith	1000 N. 1st St.	335-2344
ALABAMA	Birmingham	W. J. Smith	1000 N. 1st St.	335-2344
ALABAMA	Montgomery	W. J. Smith	1000 N. 1st St.	335-2344
ALABAMA	Mobile	W. J. Smith	1000 N. 1st St.	335-2344
ALABAMA	Tuscaloosa	W. J. Smith	1000 N. 1st St.	335-2344
ALABAMA	Prichard	W. J. Smith	1000 N. 1st St.	335-2344
ALABAMA	Dothan	W. J. Smith	1000 N. 1st St.	335-2344
ALABAMA	Enterprise	W. J. Smith	1000 N. 1st St.	335-2344
ALABAMA	Anniston	W. J. Smith	1000 N. 1st St.	335-2344
ALABAMA	Birmingham	W. J. Smith	1000 N. 1st St.	335-2344
ALABAMA	Montgomery	W. J. Smith	1000 N. 1st St.	335-2344
ALABAMA	Mobile	W. J. Smith	1000 N. 1st St.	335-2344
ALABAMA	Tuscaloosa	W. J. Smith	1000 N. 1st St.	335-2344
ALABAMA	Prichard	W. J. Smith	1000 N. 1st St.	335-2344
ALABAMA	Dothan	W. J. Smith	1000 N. 1st St.	335-2344
ALABAMA	Enterprise	W. J. Smith	1000 N. 1st St.	335-2344
ALABAMA	Anniston	W. J. Smith	1000 N. 1st St.	335-2344
ALABAMA	Birmingham	W. J. Smith	1000 N. 1st St.	335-2344
ALABAMA	Montgomery	W. J. Smith	1000 N. 1st St.	335-2344
ALABAMA	Mobile	W. J. Smith	1000 N. 1st St.	335-2344
ALABAMA	Tuscaloosa	W. J. Smith	1000 N. 1st St.	335-2344
ALABAMA	Prichard	W. J. Smith	1000 N. 1st St.	335-2344
ALABAMA	Dothan	W. J. Smith	1000 N. 1st St.	335-2344
ALABAMA	Enterprise	W. J. Smith	1000 N. 1st St.	335-2344
ALABAMA	Anniston	W. J. Smith	1000 N. 1st St.	335-2344
ALABAMA	Birmingham	W. J. Smith	1000 N. 1st St.	335-2344
ALABAMA	Montgomery	W. J. Smith	1000 N. 1st St.	335-2344
ALABAMA	Mobile	W. J. Smith	1000 N. 1st St.	335-2344
ALABAMA	Tuscaloosa	W. J. Smith	1000 N. 1st St.	335-2344
ALABAMA	Prichard	W. J. Smith	1000 N. 1st St.	335-2344
ALABAMA	Dothan	W. J. Smith	1000 N. 1st St.	335-2344
ALABAMA	Enterprise	W. J. Smith	1000 N. 1st St.	335-2344
ALABAMA	Anniston	W. J. Smith	1000 N. 1st St.	335-2344
ALABAMA	Birmingham	W. J. Smith	1000 N. 1st St.	335-2344
ALABAMA	Montgomery	W. J. Smith	1000 N. 1st St.	335-2344
ALABAMA	Mobile	W. J. Smith	1000 N. 1st St.	335-2344
ALABAMA	Tuscaloosa	W. J. Smith	1000 N. 1st St.	335-2344
ALABAMA	Prichard	W. J. Smith	1000 N. 1st St.	335-2344
ALABAMA	Dothan	W. J. Smith	1000 N. 1st St.	335-2344
ALABAMA	Enterprise	W. J. Smith	1000 N. 1st St.	335-2344
ALABAMA	Anniston	W. J. Smith	1000 N. 1st St.	335-2344
ALABAMA	Birmingham	W. J. Smith	1000 N. 1st St.	335-2344
ALABAMA	Montgomery	W. J. Smith	1000 N. 1st St.	335-2344
ALABAMA	Mobile	W. J. Smith	1000 N. 1st St.	335-2344
ALABAMA	Tuscaloosa	W. J. Smith	1000 N. 1st St.	335-2344
ALABAMA	Prichard	W. J. Smith	1000 N. 1st St.	335-2344
ALABAMA	Dothan	W. J. Smith	1000 N. 1st St.	335-2344
ALABAMA	Enterprise	W. J. Smith	1000 N. 1st St.	335-2344
ALABAMA	Anniston	W. J. Smith	1000 N. 1st St.	335-2344
ALABAMA	Birmingham	W. J. Smith	1000 N. 1st St.	335-2344
ALABAMA	Montgomery	W. J. Smith	1000 N. 1st St.	335-2344
ALABAMA	Mobile	W. J. Smith	1000 N. 1st St.	335-2344
ALABAMA	Tuscaloosa	W. J. Smith	1000 N. 1st St.	335-2344
ALABAMA	Prichard	W. J. Smith	1000 N. 1st St.	335-2344
ALABAMA	Dothan	W. J. Smith	1000 N. 1st St.	335-2344
ALABAMA	Enterprise	W. J. Smith	1000 N. 1st St.	335-2344
ALABAMA	Anniston	W. J. Smith	1000 N. 1st St.	335-2344
ALABAMA	Birmingham	W. J. Smith	1000 N. 1st St.	335-2344
ALABAMA	Montgomery			

EMBER



3-part program* sells immediate need for your service before & during World Series

ULAR !!!



COMPLETE PROMOTION AND DISPLAY KIT

TV GUIDE RECIPE BOOK

First time available—this exclusive collection of recipes as featured in TV Guide, plus professional tips for TV viewing enjoyment. Unique new premium is yours exclusively; helps you build goodwill and the need for your services.

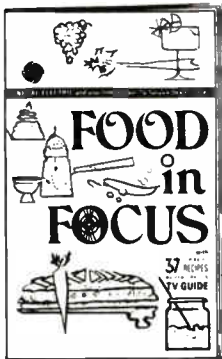

Window Banners



TV Commercial Banner



Tube Pin Straightener

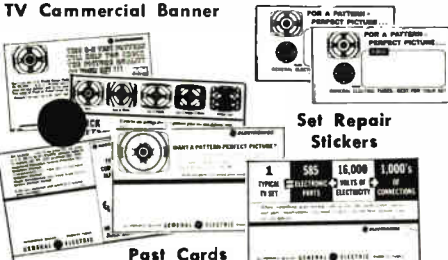

Set Repair Stickers



Ad Mats



G-E reporter, Roland Kempton, tells how September Tune-Up Spectacular

BUILDS BUSINESS FOR YOU 3 WAYS

1. Your customers prove to themselves the need for a tune-up and repair.
2. Through local television, local TV Guide and promotion materials.
3. In your city, your neighborhood, with your customers and prospects, you cash in on this TV TUNE-UP SPECTACULAR.

SEPTEMBER TUNE-UP SPECTACULAR is your campaign. It's easy to tie in. Proven effective. No red tape. Get full details from your G-E tube distributor, now. Names of participating dealers must be in by August 27. General Electric Company, Distributor Sales, Electronic Components Division, Room 1748, Owensboro, Ky.

Progress Is Our Most Important Product

GENERAL  ELECTRIC

What's new!

SAVE TIME AND MONEY WITH NEW GENERAL ELECTRIC "SG" PICTURE TUBES



ELECTRONICS

30

G-E SERVICE-DESIGNED "SG" PICTURE TUBES REPLACE 169 TYPES

STRAIGHT GUN DESIGN NEED NO ION TRAP

PICTURE TUBE NOW IN RECEIVER

12AP4	12AP5	12AP6	12AP7	12AP8	12AP9	12AP10	12AP11	12AP12	12AP13	12AP14	12AP15	12AP16	12AP17	12AP18	12AP19	12AP20	12AP21	12AP22	12AP23	12AP24	12AP25	12AP26	12AP27	12AP28	12AP29	12AP30	12AP31	12AP32	12AP33	12AP34	12AP35	12AP36	12AP37	12AP38	12AP39	12AP40	12AP41	12AP42	12AP43	12AP44	12AP45	12AP46	12AP47	12AP48	12AP49	12AP50	12AP51	12AP52	12AP53	12AP54	12AP55	12AP56	12AP57	12AP58	12AP59	12AP60	12AP61	12AP62	12AP63	12AP64	12AP65	12AP66	12AP67	12AP68	12AP69	12AP70	12AP71	12AP72	12AP73	12AP74	12AP75	12AP76	12AP77	12AP78	12AP79	12AP80	12AP81	12AP82	12AP83	12AP84	12AP85	12AP86	12AP87	12AP88	12AP89	12AP90	12AP91	12AP92	12AP93	12AP94	12AP95	12AP96	12AP97	12AP98	12AP99	12AP100	12AP101	12AP102	12AP103	12AP104	12AP105	12AP106	12AP107	12AP108	12AP109	12AP110	12AP111	12AP112	12AP113	12AP114	12AP115	12AP116	12AP117	12AP118	12AP119	12AP120	12AP121	12AP122	12AP123	12AP124	12AP125	12AP126	12AP127	12AP128	12AP129	12AP130	12AP131	12AP132	12AP133	12AP134	12AP135	12AP136	12AP137	12AP138	12AP139	12AP140	12AP141	12AP142	12AP143	12AP144	12AP145	12AP146	12AP147	12AP148	12AP149	12AP150	12AP151	12AP152	12AP153	12AP154	12AP155	12AP156	12AP157	12AP158	12AP159	12AP160	12AP161	12AP162	12AP163	12AP164	12AP165	12AP166	12AP167	12AP168	12AP169
-------	-------	-------	-------	-------	-------	--------	--------	--------	--------	--------	--------	--------	--------	--------	--------	--------	--------	--------	--------	--------	--------	--------	--------	--------	--------	--------	--------	--------	--------	--------	--------	--------	--------	--------	--------	--------	--------	--------	--------	--------	--------	--------	--------	--------	--------	--------	--------	--------	--------	--------	--------	--------	--------	--------	--------	--------	--------	--------	--------	--------	--------	--------	--------	--------	--------	--------	--------	--------	--------	--------	--------	--------	--------	--------	--------	--------	--------	--------	--------	--------	--------	--------	--------	--------	--------	--------	--------	--------	--------	--------	--------	--------	--------	--------	--------	---------	---------	---------	---------	---------	---------	---------	---------	---------	---------	---------	---------	---------	---------	---------	---------	---------	---------	---------	---------	---------	---------	---------	---------	---------	---------	---------	---------	---------	---------	---------	---------	---------	---------	---------	---------	---------	---------	---------	---------	---------	---------	---------	---------	---------	---------	---------	---------	---------	---------	---------	---------	---------	---------	---------	---------	---------	---------	---------	---------	---------	---------	---------	---------	---------	---------	---------	---------	---------	---------

PICTURE TUBE NOW IN RECEIVER

12AP4	12AP5	12AP6	12AP7	12AP8	12AP9	12AP10	12AP11	12AP12	12AP13	12AP14	12AP15	12AP16	12AP17	12AP18	12AP19	12AP20	12AP21	12AP22	12AP23	12AP24	12AP25	12AP26	12AP27	12AP28	12AP29	12AP30	12AP31	12AP32	12AP33	12AP34	12AP35	12AP36	12AP37	12AP38	12AP39	12AP40	12AP41	12AP42	12AP43	12AP44	12AP45	12AP46	12AP47	12AP48	12AP49	12AP50	12AP51	12AP52	12AP53	12AP54	12AP55	12AP56	12AP57	12AP58	12AP59	12AP60	12AP61	12AP62	12AP63	12AP64	12AP65	12AP66	12AP67	12AP68	12AP69	12AP70	12AP71	12AP72	12AP73	12AP74	12AP75	12AP76	12AP77	12AP78	12AP79	12AP80	12AP81	12AP82	12AP83	12AP84	12AP85	12AP86	12AP87	12AP88	12AP89	12AP90	12AP91	12AP92	12AP93	12AP94	12AP95	12AP96	12AP97	12AP98	12AP99	12AP100	12AP101	12AP102	12AP103	12AP104	12AP105	12AP106	12AP107	12AP108	12AP109	12AP110	12AP111	12AP112	12AP113	12AP114	12AP115	12AP116	12AP117	12AP118	12AP119	12AP120	12AP121	12AP122	12AP123	12AP124	12AP125	12AP126	12AP127	12AP128	12AP129	12AP130	12AP131	12AP132	12AP133	12AP134	12AP135	12AP136	12AP137	12AP138	12AP139	12AP140	12AP141	12AP142	12AP143	12AP144	12AP145	12AP146	12AP147	12AP148	12AP149	12AP150	12AP151	12AP152	12AP153	12AP154	12AP155	12AP156	12AP157	12AP158	12AP159	12AP160	12AP161	12AP162	12AP163	12AP164	12AP165	12AP166	12AP167	12AP168	12AP169
-------	-------	-------	-------	-------	-------	--------	--------	--------	--------	--------	--------	--------	--------	--------	--------	--------	--------	--------	--------	--------	--------	--------	--------	--------	--------	--------	--------	--------	--------	--------	--------	--------	--------	--------	--------	--------	--------	--------	--------	--------	--------	--------	--------	--------	--------	--------	--------	--------	--------	--------	--------	--------	--------	--------	--------	--------	--------	--------	--------	--------	--------	--------	--------	--------	--------	--------	--------	--------	--------	--------	--------	--------	--------	--------	--------	--------	--------	--------	--------	--------	--------	--------	--------	--------	--------	--------	--------	--------	--------	--------	--------	--------	--------	--------	--------	---------	---------	---------	---------	---------	---------	---------	---------	---------	---------	---------	---------	---------	---------	---------	---------	---------	---------	---------	---------	---------	---------	---------	---------	---------	---------	---------	---------	---------	---------	---------	---------	---------	---------	---------	---------	---------	---------	---------	---------	---------	---------	---------	---------	---------	---------	---------	---------	---------	---------	---------	---------	---------	---------	---------	---------	---------	---------	---------	---------	---------	---------	---------	---------	---------	---------	---------	---------	---------	---------

AUTHORIZED DISTRIBUTOR

Prepared by Our Most Important Product

GENERAL ELECTRIC

ETR-3292

G-E SERVICE DESIGNED AUTO RADIO TWIST-PRONG CAPACITOR KIT K-202



The new line of General Electric Service-Designed "SG" picture tubes offer many time and money saving features. Since only 30 "SG" tubes replace 169 types they provide prompt availability, faster customer service, simpler ordering and fewer emergency pick-ups.

"SG" types are easier to install because these tubes do not require an ion-trap magnet. The new high-

resolution gun combined with General Electric's aluminized high temperature phosphor screen produces the best picture any set can deliver.

The pocket size replacement guide shown above is available from your General Electric tube distributor. Ask for ETR-3292 and use it as a quick-reference guide whenever you need a picture tube.

Contains 10 capacitors including: 1-2 section, 8-3 section and 1-4 section twist-prong capacitors; 1 Service Light and 1 Capacitor Tab-Adjuster

- LIST PRICE:**
- 10 Capacitors.....\$33.30
 - Service Light 3.75
 - Tab Adjuster 1.65
-
- \$38.70

- SUGGESTED DEALER COST:**
- 10 Capacitors\$19.98
 - Service Light N/C
 - Tab Adjuster N/C
-
- \$19.98

Ask your G-E Tube distributor for a copy of the new Auto Radio Capacitor Replacement Guide ETR-3378. Lists G-E replacement for hundreds of auto radio capacitors.



ETR-3378 Auto Radio Capacitor Replacement Guide

NEW GENERAL ELECTRIC TUBES AND COMPACTRONS LISTED BY RECEIVER

tubes

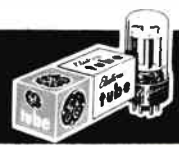

Here is a list of *NEW* General Electric receiving tubes and compactrons and the manufacturers using these types in their receivers. Be ready to service the new model receivers by having at least one of each type on hand. They are now available from your General Electric tube distributor.

Type	Set Manufacturer	Function
6AR11*	General Electric	IF Amplifier
6AS11*	General Electric	Video Ampl., Audio IF, AGC Keyer
6DQ4	Zenith	Damper Diode
6GX11*	General Electric	Audio Detector & Output
6J11*	Muntz	IF Amplifier
9A8/PCF80	Motorola	Audio IF & Vert. Osc., Hor. Osc. & Sync-Amp., AGC & Noise Inverter
12AX3*	General Electric	Damper Diode
12GE5*	General Electric	Horizontal Output
17AX3*	Muntz	Horizontal Output
17GE5*	General Electric	Damper Diode
27GB5/PL500	General Electric	Horizontal Output
27GB5/PL500	Motorola	Horizontal Output

* Compactron Type

TELEVISION

REMOVE SCRATCHES AND STATIC

USE NEW G-E ANTI-STATIC PLASTIC POLISH ETR-3390

Here is a polish that will effectively mask minor scratches and scuff marks on plastic picture tube face plates including the new General Electric "Lamilite" picture tube used in the "QX" line of receivers.

You know that plastic surfaces build up electro-static charges which attract airborne dust particles. Combine this with fingerprints, scratches, improper polishing — and even the most expensive surfaces become unattractive. To your customers, this is as annoying as a set that doesn't play.

Here's the answer to this problem. General Electric's new ANTI-STATIC PLASTIC POLISH restores sparkling life to all plastic-surface TV, radio and stereo sets.

Just rub it on . . . let dry . . . wipe off. It cleans as it polishes . . . neutralizes those dust-gathering electrostatic charges . . . even removes minor abrasions and scratches from the TV picture screen or plastic cabinet.

Regular use of G-E ANTI-STATIC PLASTIC POLISH keeps plastic surfaces attractively clean and glossy. And it's safe in the home for cleaning glass, ceramic tile, chrome, porcelain, and enameled surfaces.

Next time you're completing a service call, use some new anti-static polish. Show your customer how easy it is to use and how well it works.

When you're through, you've left a smooth, hard protective coating that



resists finger marks. And you have a happy customer.

This polish comes in an 8 ounce plastic squeeze bottle and has a list price of \$1.25. Dealer cost is \$.75. Ask your G-E tube distributor for ETR-3390. If your distributor is unable to supply you, use the coupon on page 7 and mail to our Chicago warehouse.

Here is an extra profit item that your customers will want as soon as they see it used. Carry one in your service case for cleaning and polishing safety glass and plastic cabinets and have a few extra available for your customers.

Use Order Coupon Below

ORDER COUPON

General Electric Company
Department "B"
3800 N. Milwaukee Ave.
Chicago 41, Illinois

Enclosed is money order or check payable to General Electric Company for:

Quantity	Price
..... ETR-1095 Three-ring binder with tabbed dividers and all Tele-Clues and Tele-Clue Schematics published to date	\$3.75 each.....
..... ETR-2000 Three-ring binder with tabbed dividers for Tele-Clues and Tele-Clue Schematics	\$2.00 each.....
..... ETR-2579 Complete set of Techni-talk back issues Vol. 1, No. 1 — Vol. 13, No. 5 (Includes all Tele-Clues and Tele-Clue Schematics)	\$3.50 each.....
..... ETR-3390 Anti-Static Plastic Polish	\$0.75 each.....
..... ETR-1592 TV Safety-Glass Puller	\$0.95 each.....
..... ETR-1593 Magnetic Swing-Beam Service Light	\$2.25 each.....

NAME.....

STREET ADDRESS.....

CITY, ZONE NO. AND STATE.....

(Please Print)

If you are receiving more than one copy of TECHNI-TALK, please cut out the order coupon with your address on the other side. Mark "Duplicate" and mail to Editor, TECHNI-TALK, General Electric Co., Owensboro, Ky.

RADIO

TROUBLESHOOTING MODEL P780

To assist in troubleshooting the distortion problem as well as to provide several other servicing aids, we have listed below the symptoms, causes, and remedies for the most common defects found in model P780:

Symptom: Distortion at normal listening level (speaker usually suspected).

Probable Cause: Defective TR7 or TR8.

Remedy: Distortion caused by one of the output transistors can be most accurately ascertained by checking the output with the use of an oscilloscope and a signal generator in the following manner:

1. Connect the scope across the voice coil.
2. Turn receiver volume to max with tuning gang closed.
3. Feed audio signal from signal generator through .05mf condenser to any terminal on the tone control (R23).
4. Adjust signal generator for desired output. If the following waveform appears

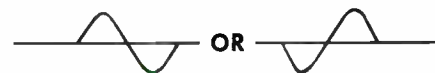

no distortion is present.

If one of the following similar waveforms

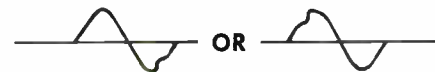

is shown, distortion is present and caused by one of the output transistors.

Now to ascertain which output transistor is defective, short the base to emitter of one transistor. Then, observe the scope. If the defective transistor was shorted, the following waveform would appear:

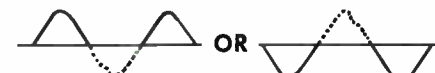

The dotted line is the defective transistor trace, since a clean undistorted line wave does not appear.

If the good transistor was shorted, the wave form would be as follows:

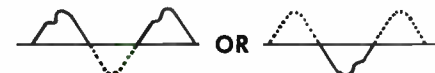

The distorted sine wave indicates that the other transistor (solid line) is defective.

Replace the defective transistor, then recheck the outputs on the scope.

SYMPTOM — Distortion at high volume setting with strong signal

CAUSE — Leaky TR4 or defective D1

REMEDY — Replace TR4 and retest; if distortion still occurs, replace D1.

SYMPTOM — Speaker buzz/rattle

CAUSE — Defective speaker case

REMEDY — Replace speaker.

SYMPTOM — Diol Cord Slippage

CAUSE — Loose diol cord

REMEDY — P780 "A" version; increase tension of spring on tuning drum.

NOTE: Be sure pulleys are not "frozen."

G-E SERVICE AIDS

TV SAFETY-GLASS PULLER ETR-1592

Here is a real time-saver when removing the safety glass from television receivers. The ETR-1592 TV Safety-Glass Puller is small enough (3" in diameter) to fit in any service case, easy to use and will not leave any marks on the glass. The stained wooden handle provides a secure hold.

One puller removes TV glass and holds while cleaning



Two pullers replace glass without finger prints

Since the safety glass is seldom removed more than once or twice a year it may stick either to the cabinet or the protective gaskets. The TV Safety-Glass Puller will facilitate glass removal without cracking, chipping the glass or marring the cabinet.

Ask your G-E tube distributor for a TV Safety-Glass Puller ETR-1592. If he is unable to supply you, use order coupon on page 7. The price is only ninety-five cents each.

MAGNETIC SWING-BEAM SERVICE LIGHT ETR-1593

Here is a new kind of service light that will save time and make your everyday service work easier. With this unit it is possible to illuminate even the most hidden area of a radio or TV chassis.

Features include a swing-out hanger bar, a built-in magnet and the "Swing Beam" which allows the light and reflector to swing in a full 180° arc.

Light swings 180°



Attaches magnetically or hangs handily.

The G-E "Swing-Beam" Service Light is an entirely different type of flash light. This light has been designed to hold its position whereas most other lights were designed to be held in position.

Ask your G-E tube distributor for a Magnetic Swing-Beam Service Light. If he is unable to supply you, use coupon on page 7. The price is only \$2.25

Kempton's Corner



Most service technicians use or have used carbon tetrachloride as a cleaning fluid. The fumes from carbon tet can be dangerous. There have been numerous cases of serious kidney damage caused by inhaling these fumes. Be sure that your shop is well ventilated whenever you use carbon tet for cleaning purposes.

ERRATA

Please make the following copy changes:

Vol. 14, No. 2

Page 1, first column at top of page, sixth line from top — change "40% off list" to "30% off list."

Page 1, first column under sub-title "Tuner Requirements" — change 10 MV to 10 μ V and 200 db to 20 db.

Page 3, first column, about one inch above center of page — change +100 KC to \pm 100 KC.

Vol. 14, No. 3

Page 7, sub-title near top of right hand column — change "Loose Tuning Knobs on Models P115, P165" to "Loose Tuning Knobs on Model P715."



Techni-talk

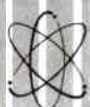

TECHNI-TALK DISTRIBUTION OFFICE

GENERAL ELECTRIC

SCHENECTADY, NEW YORK

BULK RATE
U. S. POSTAGE
PAID
Schenectady, N. Y.
Permit No. 148

Vol. 14, No. 4

AUGUST, 1962

RETURN REQUESTED

In this issue:

	Page
G-E Tune-Up Program.....	1
Bench Notes	2
Servicing G-E Remote Control System V	3
1962 Tune-Up Spectacular.....	4
What's New	6
TV and Radio Service Notes.....	7
Service Aids	8

Techni-talk on AM, FM, TV Servicing, published bi-monthly by ELECTRONIC COMPONENTS DIVISION, GENERAL ELECTRIC COMPANY, OWENSBORO, KY. In Canada: Canadian General Electric Co., Ltd., 189 Dufferin St., Toronto 3, Ontario. R. G. Kempton, Editor. Copyright 1962 by General Electric Company.

BOYDS RADIO SERVICE
1018 N MC CULLOUGH
SAN ANTONIO 12 TEXAS E221

PLEASE NOTE:

If there is any error in the address shown above, will you please clip it out, make any correction and return to me. Also if you are receiving two or more copies, please return the address panel to me and mark it "DUPLICATE."

R. G. Kempton, Editor

This copy of **Techni-talk** comes to you through the courtesy of your General Electric tube distributor.



ELECTRONICS

NOTE: The disclosure of any information herein conveys no license under any General Electric patent and, in the absence of an express written agreement to the contrary, the General Electric Company assumes no liability for patent infringement (or any other liability) arising out of use of such information by others.