

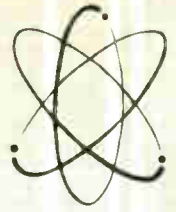

# Techni-talk

COMPLETE ELECTRONIC SERVICING INFORMATION  
radio • tv • hi-fi



VOL. 12 No. 1

FEB., 1960

## GE WIRELESS REMOTE CONTROL SYSTEM I

### Only Two Tubes and One Transistor Used

The "M-5" and "U-4" lines of General Electric TV Receivers are available with a remote control system. This system incorporates several design features not found in other systems. One feature is the use of only 2 tubes and 1 transistor in the complete system.

The three units shown in Fig. 1 represent the General Electric system. The power tuning assembly is at the left; the remote receiver (containing its own power supply) is in the center and the battery operated transmitter is at the right.

#### Operation of the System

The transmitter has four push buttons. Each selects a different function when depressed. The functions which may be remotely performed are: selection of television channels, increase volume, decrease volume, or turn the television receiver on or off.

When properly energized by depressing one of the four push buttons, the transmitter unit sends out an audio modulated r-f signal corresponding to the desired function.

The receiver antenna having picked up the energy from the transmitter, passes this information to the receiver unit where the r-f signal is amplified, demodulated and applied across the coil of a reed relay assembly. The reed relay assembly has four vibrating reeds each of which corresponds to one of the audio modulating frequencies used. When one of the reeds is made to vibrate, a corresponding sensitive relay is activated and thus causes the desired function to be performed.

#### Transmitter Circuit Analysis

Since each unit performs its own independent function each one will be analyzed separately. The transmitter will be examined first.

The remote transmitter is a self contained unit, and utilizes a single PNP triode transistor, in a common emitter configuration as shown in Fig. 2.

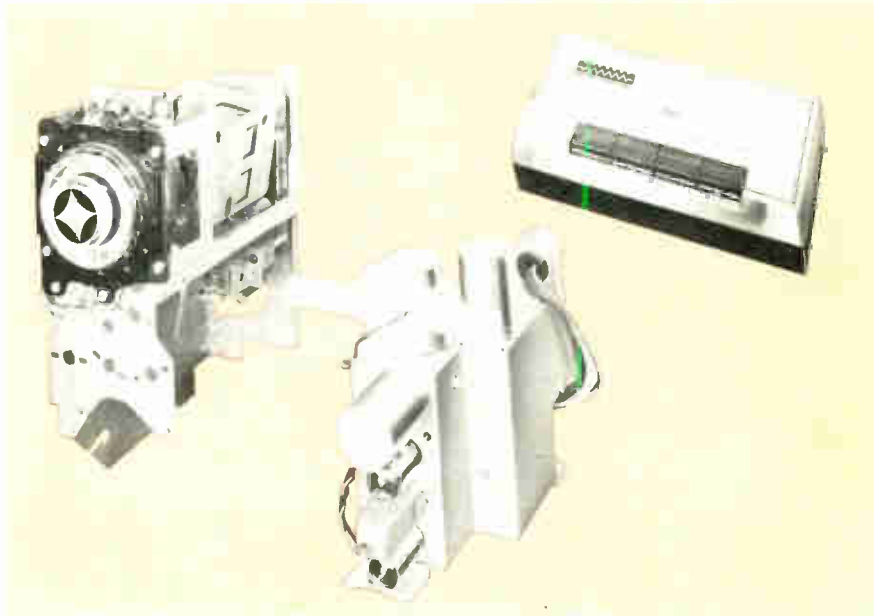

Fig. 1. The power tuning assembly, the remote receiver, and the transmitter used in the General Electric Remote Control System are shown from left to right.

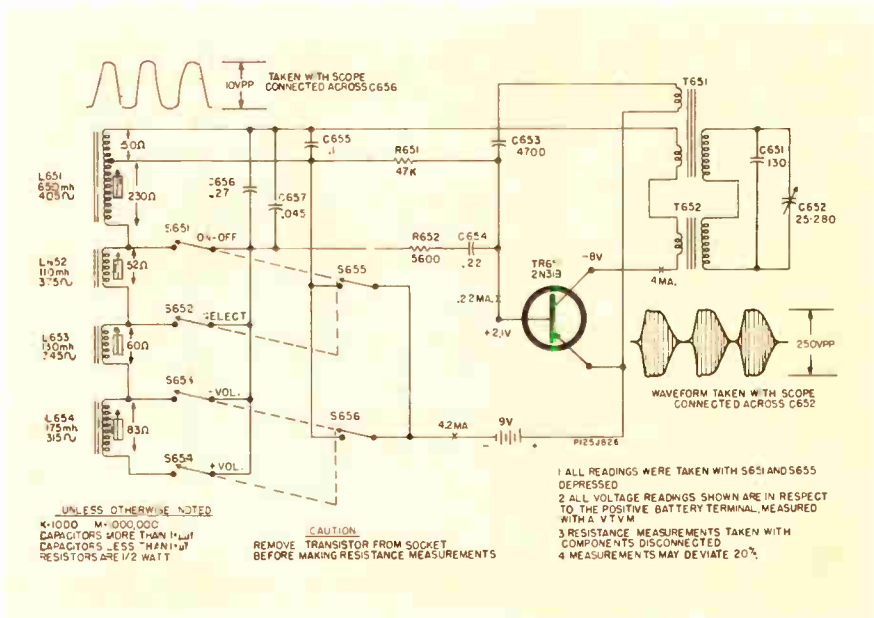

Fig. 2. Transmitter Schematic Diagram.

(Continued on page 3)



## **INCREASED ELECTRONICS BUSINESS FORECAST FOR 1960**

**By L. Berkley Davis**

General Manager, Electronic Components Division  
General Electric Co., Owensboro, Kentucky



Substantial increases in sales of semiconductors and sustained high production and use of receiving tubes, power tubes and cathode ray tubes will feature the electronic components industry in 1960.

Highlights of trends for the year:

1. Semiconductor sales will reach \$550 million, a 37 percent increase over 1959's \$400 million; included are estimated sales of 130 million transistors (53 percent over 1959) for a total of \$315 million.

2. Receiving tubes will remain as the mainstay of the industry, with 435 million new tubes placed in service in home entertainment equipment and industrial and military gear — about the same level of tube usage as in 1959.

3. Power tube sales will hit a new high of \$300 million, representing a continuation of the previously-predicted 10 percent annual growth trend — with the greatest increase in tubes for military end-purposes.

4. Television picture tube sales will total 13 million units (up 5 percent) selling for approximately \$260 million — with more than half of the tubes sold for replacement.

### **Semiconductors Up 37%**

By the end of the year the semiconductor industry will have sold about \$550 million worth of its goods. This is an increase of 37 percent over sales in 1959 when the industry achieved a volume of \$400 million.

The approximately 130 million transistors which will be sold by the industry in 1960 represents a 53 percent increase over 1959 sales of 85 million units. The industry dollar volume for transistors will increase from 1959 sales of \$225 million to a 1960 sales volume of \$315 million. 1960 transistor sales break down into a \$45 million consumer market, \$120 million industrial market and a \$150 million military market.

In the semiconductor rectifier area, industry sales will increase by about 18 percent, from \$78 million in 1959 to \$92 million in 1960. In terms of growth rate, sales of controlled rectifiers can be expected to essentially double as an increasing number of industrial and military

equipment manufacturers move the design of their products from the development to the production stage.

Tunnel diodes which were first introduced by General Electric in small sample quantities in the third quarter of 1959 will continue to be widely discussed and experimented with during 1960 but samples will be limited to small quantities pending the development of circuits. Within the next few years, however, the use of tunnel diodes in high frequency circuits will build up rapidly.

### **Receiving Tube Usage Still Strong**

Receiving tube production and usage will continue at about the same high level as in 1959, with emphasis on design of more specialized conventional types and development of unconventional devices such as micro-module units, ceramic tubes, and photoconductors.

In 1960, about 435 million new conventional receiving tubes will be placed in service in the United States in both original equipment and as renewals in television sets, radios, phonographs, industrial and military electronic equipment.

Of the 435 million tubes, however, approximately 20 million will be imported. Sales of the remaining 415 million domestic-made tubes will total about \$345 million.

Sales of commercial tube types made here will amount to about \$275 million, with over half in the renewal market. Of the commercial tubes that go into original equipment, the bulk will be used by television set manufacturers who will buy nearly 100 million for this purpose domestically.

Sales of high reliability tubes for aircraft, industrial and military equipment will be approximately \$70 million, with about 70 percent purchased by manufacturers of new equipment. Sales in 1960 of industrial and military tubes for replacement in vital electronic equipment will increase approximately 13 percent over 1959 to a total of \$9 million.

Receiving tube design efforts will concentrate in obtaining increased depth of knowledge of materials usage and processing.

### **Power Tubes Up 10%**

Power tube industry sales in 1960 will reach a new high of \$300 million, representing a continuation of the previously-predicted 10 percent annual growth trend.

The greatest increase will be in sales of tubes for military end-purposes. Electronics will continue to play an increasing role in defense against the intercontinental or space weapons of the era, and high-performance tubes are required for the establishment and maintenance of extensive detection, control and communications systems.

Military research and development expenditures in the power tube area will grow to accelerate progress toward highly sophisticated defense systems.

The demand for power tubes for industrial applications will hold steady in 1960 at 1959's healthy rate. User industries will not only continue to operate at a brisk pace, but will continue to expand capacity, thus maintaining good replacement and original equipment markets.

Sales of transmitting tubes will increase approximately 5 percent to supply the needs of an increasing number of sockets in communications and broadcast systems.

### **Cathode Ray Tubes Up 5%**

Nearly 13 million television picture tubes will be sold by the industry at approximately \$260 million during 1960, an increase of 5 percent over the number of tubes sold in 1959.

More than half of 1960's sales will be used for replacement and the remainder in new television sets. The large majority of picture tubes sold by the industry in the replacement market will continue to incorporate reused glass, a practice which when properly employed has resulted in substantial cost benefits to the consumer with the same quality as tubes using the new glass.

In the areas of industrial and military cathode ray tubes, there will be a rapidly expanding market for very high resolution recording tubes, and for tubes to be used with fully transistorized drive and sweep circuitry. As a result of proprietary developments, General Electric will be a major participant in these areas.



# G-E PROFIT RACK Accessory Items Available

## Simplifies Installation, Maintenance, Usage

All of the items shown in the photograph are available to make the G-E PROFIT RACK easier than ever to use.

### Tube Carton Index

The TUBE CARTON INDEX ETR-2151 shown at the left has all tubes listed in alpha-numerical order with the type of carton used for each tube type listed alongside. A full size drawing of each size carton (end view) appears at the top.

People not familiar with tube types have had difficulty locating tubes in the PROFIT RACK. Even those familiar with tubes have had trouble because some tube types classified as miniatures have overall dimensions which make it necessary to pack them in GT-regular cartons. The TUBE CARTON INDEX, therefore, indicates the carton used and not the tube size.

### Inventory Card

A new type inventory card ETR-2154 (top center) is now available as a substitute for the yellow sheets supplied with the PROFIT RACK. All cards will be identical and supplied in sets of twelve. Each of the four leading edges of these identical cards is adapted to one of the four carton separators. Every card has space to list each tube type and is inserted at the bottom outside edge of each box with the adaptable leading edge protruding. In this position the actual tube stock as well as the stock listed are visible.

Use of these cards enables you to maintain up-to-date inventory requirements without removal of tubes or separators, and simplifies reordering. Tube types are listed in the ruled space corresponding to each vertical row of tubes above and it is unnecessary to remove the card from the rack after it is once set up.

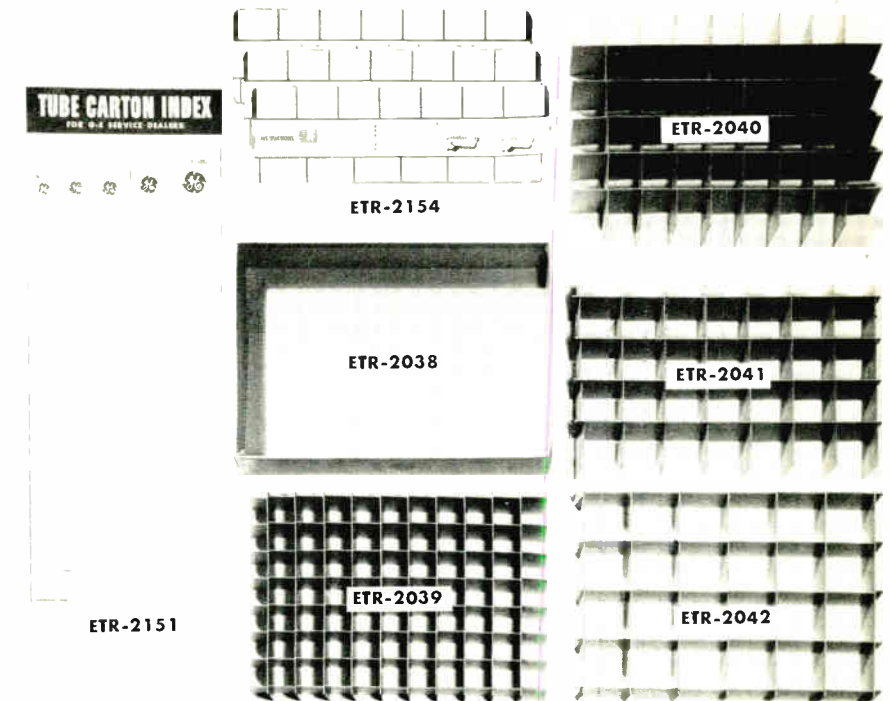

Each Inventory Card is ruled both horizontally and vertically so that one edge corresponds with one size carton separator.

Only one edge should be used on each card; the other three are left blank. Tube types are listed in the same order as they are positioned in each box section. The top tube is listed in the top space and whenever a space in the box is left empty to allow for new tube types, the corresponding line on the inventory card is also left blank.

A set of 12 cards is enough to equip one PROFIT RACK and will take care of any combination of boxes and separators.

### Boxes and Separators

Individual box sections ETR-2038

(at center) are also available. These boxes are all one size and can be used with any one of the separators shown bottom center, and on right side.

All of these items can be obtained from your General Electric tube distributor. Ask for the items you need by ETR numbers.

- ETR-2151 Tube Carton Index
- ETR-2154 Set of 12 Inventory Cards
- ETR-2038 Box Sections (one size)
- ETR-2039 Separators for 1" x 1" tube carton
- ETR-2040 Separators for 1 1/8" x 1 1/8" tube carton
- ETR-2041 Separators for 1 5/8" x 1 3/8" tube carton
- ETR-2042 Separators for 1 7/8" x 1 7/8" tube carton

## G-E WIRELESS REMOTE SYSTEM

(Continued from page 1)

When one of the four function buttons is depressed, the collector circuit of the transistor is connected to the negative side of the 9V battery. This places the transistor in

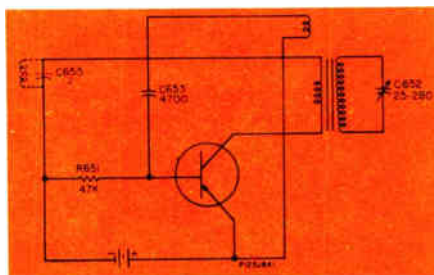

Fig. 3. Transmitter r-f Carrier Oscillator

operation and activates the r-f carrier frequency. At the same time, by virtue of the switching arrangement, the modulating audio frequency is activated.

Although only one transistor is used, the associated circuitry consists of two basic oscillators causing the transistor to operate in two modes. One of the two oscillators is operated at the r-f carrier frequency of the remote system, while the second oscillator is operated at audio frequency and modulates the r-f carrier frequency.

### R-F Carrier Oscillator

The portion of the circuitry which oscillates, or develops the transmitter r-f carrier frequency is shown by the schematic in Fig. 3.

This circuit configuration is a basic Meissner Oscillator and features a separate tuned circuit which is inductively coupled to the transistor elements. This circuit controls the frequency of oscillation by allowing only its resonant frequency to feed back to the transistor base, by use of the flywheel affect.

The tuned circuit consists of both secondary windings of T651 and T652 in conjunction with the two capacitors C651 and C652 (Fig. 2).

The determining factor in the amount of feedback is the close coupling between the various windings of T651 and T652, while the actual feedback voltage is applied to the transistor base by virtue of the

(Continued on page 9)

# GARROWAY'S BACK

...with a buy-the-best, buy-now message  
boosting G-E BLACK-DAYLITE Picture Tubes!

It's safe to count on the big lift popular Dave Garroway will give your business! And smart to plan ahead, in order to squeeze every penny of sales value out of the advertising dollars General Electric is spending. So... make sure that picture-tube and service prospects who see Dave Garroway know you install General Electric tubes!

Identification's easy, with the attractive new displays and other promotions General Electric has for you. They tie in your store or shop with Garroway; they will keep your phone busy with more jobs, tube installations, profits. See your G-E tube distributor! *Distributor Sales, Electronic Components Div., General Electric Co., Owensboro, Ky.*

Install the PROFIT PAIR

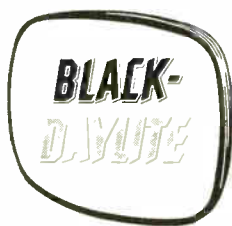

SERVICE-  
DESIGNED

that millions



**On TODAY**  
over NBC-TV starting April 20.  
Week after week 3,800,000  
television set owners from  
coast to coast will learn why  
picture quality starts with  
their serviceman who installs  
General Electric tubes!

*Progress Is Our Most Important Product*

**know by name!**

**GENERAL**  **ELECTRIC**



## Hum or Buzz in TV Receivers II

In the last issue the difference between hum and buzz was explained and some causes of both problems were discussed. In this issue additional sources of buzz plus hints on troubleshooting both hum and buzz will be described.

### Transmitter Modulation

Another source of buzz which is beyond the ability of the receiver to correct, is that due to transmission errors. If the video transmitter is permitted to modulate below about 8% in the white peaks practically any inter-carrier receiver will buzz. This condition is most frequently noted on commercials, which fortunately restricts the complaints.

To properly understand the problem of "intercarrier sync buzz" which is its full title, it is advisable to review some basic operating principles. It will be recalled that both the video and audio carriers are passed through the video detector. This detector also performs the added function of developing the 4.5 Mc. intercarrier audio signal. This comes about through the beat produced between the two carriers which are separated by 4.5 Mc. in frequency as transmitted.

Due to alignment and shaping of the i-f response curve, the video signal at the detector is from 6 to 8 times the amplitude of the audio signal. It should also be remembered that the video signal is amplitude modulated, with sync tips representing 100% modulation and deepest white being a minimum of 10%. The audio carrier is of course frequency modulated, so the resulting 4.5 Mc. audio signal is amplitude modulated by its video component and frequency modulated by its audio component. It is the f.m. component which is required to be recovered, but the a.m. must be removed, or buzz resulting mainly from the 60 cycle vertical sync pulse will result.

### Limiting

Receivers are designed to accomplish satisfactory limiting of this buzz component when amplitude relationships are correct, but cannot do so if the relationships are altered radically. Since the audio signal level is relatively low at the detector, it is the controlling factor in the amplitude of the 4.5 Mc. signal which will become lost very rapidly as the audio carrier is weakened. Under these conditions buzz results since there is insufficient limiting action remaining.

The other cause of buzz is overload at some point in the receiver which results in clipping the sync pulses. Removal of these by clipping action results in "holes" in the 4.5 Mc. audio signal due to interruption at the vertical sync pulse rate. This condition occurs most frequently in the video amplifier tube, and is often due to the tube being over driven as the result of an AGC problem or may be due to a sharp cut-off video amplifier tube.

### Trouble Shooting

When a buzz condition is determined to be due to the receiver, a logical procedure should be followed to avoid unnecessary waste of time. In the majority of late model receivers, the following sequence will usually isolate the problem.

1. Check adjustment of ratio detector transformer secondary. Using a VTVM across the ratio detector load, peak the ratio detector transformer primary, audio take-off transformer, and any other 4.5 Mc. transformers which the particular receiver may have.
2. Substitute video amplifier tube and all tubes in audio system.
3. Inspect the picture for any evidence of overload, such as horizontal pulling, vertical jitter or excessive contrast. The vertical blanking bar should be rolled down into the picture area, and with maximum brightness setting, it should be examined. The picture black level, blanking level, and sync pulse level should each appear darker than the previous one. If this condition cannot be met, the video amplifier tube should be changed for a known good one.
4. The AGC line should be clamped by means of a bias battery to check for improper AGC action.
5. All tubes under AGC control should be substituted, since a tube with gas or grid emission will nullify AGC voltage and permit overload.
6. Check aquadag grounding on picture tube since some receivers which use the picture tube capacity as a HV filter capacitor will buzz if the ground is poor. This can be checked by removing picture tube socket or by grounding the picture tube aquadag coating.

\* Detailed description given in Vol. 2, No. 1 issue of Techni-talk.

### Tough Soldering

If you have trouble soldering to galvanized iron, cast iron or steel components, remove the hair bristles from the tin-handled brush commonly used to apply the liquid flux, and replace the bristles with a bundle of fine copper wires clipped from a piece of electric cord.

Connect the positive side of a 2-volt source to the handle, the negative terminal of the battery to the work, then use this "copper" brush to apply the liquid acid flux.

This puts on a plating of copper, to which the solder has no trouble adhering fast and firmly.

S. Clark  
Box 2162  
East Bradenton, Florida

### Handy Tool

Those broken and discarded dentist hand tools make the best tools for working in printed circuits. They are also very handy as soldering aids. They are small but very dependable because they are made of very high quality steel. Any technician with the help of a small grinder can fix them in different shapes, angles and points, and if desired, he can insulate them with plastic tape or tubing or any of the liquid type high dielectric insulators on the market. The next time you see your dentist, ask him for some. He will probably give them to you free.

A/2C Araujo, Joaquin, A.  
AF 19593374  
Box 2011  
James Connally A.F.B., Texas

### Timesaver

A time saving idea we use on our Hickok 533A tube tester is to tape a small piece of paper on the tester showing the number of the last tube in the column. This is placed below the left hand column of tubes on the roll chart.

Mr. Larry Miller  
417 Wagner Ave.  
Washington, Illinois

Those desiring to have letters published in this column should write the Editor Techni-Talk, Electronic Components Division, General Electric Company, Owensboro, Kentucky. For each such letter selected for publication you will receive \$10.00 worth of General Electric tubes. In the event of duplicate or similar items, selection will be made by the Editor and his decision will be final. The Company shall have the unlimited right without obligation to publish or otherwise use any idea or suggestion sent to this column.

Caution: The ideas and suggestions expressed in this column are those of the individual writers. These ideas and suggestions have not been tried by the General Electric Company and therefore are not endorsed, sponsored or recommended.



Is your service bench equipped with a mirror? The G-E Bench Mirror is readily adjustable for easy viewing. This will save valuable servicing time and make bench work easier. Ask your distributor for ETR-1275.

# Tele-Clues

FILE THIS SHEET IN YOUR TELE-CLUE BINDER

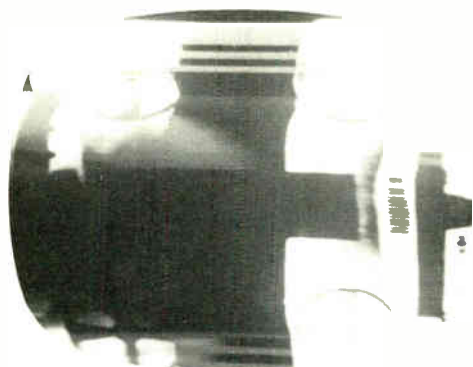

**Tele-Clue K-274**

**Receiver:** G-E "U-4" line (See "U-4" Tele-Clue Schematic).  
**Component:** C254, 5000 mmfd, 450 volt capacitor, temperature range 10" - 105" C - SHORTED.  
**Circuit:** Grid circuit of V8 Clipper tube.  
**Symptom:** Soft sync, horizontal side lock and possible audio buzz.

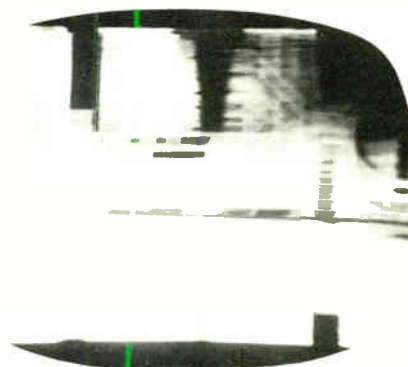

**Tele-Clue D-277**

**Receiver:** G-E "U-4" line.  
**Component:** C305, .1 mfd, 600 volt capacitor - OPEN.  
**Circuit:** Vertical linearity peaking capacitor in plate circuit of V9A vertical oscillator.  
**Symptom:** Vertical shrinkage and poor vertical sync.

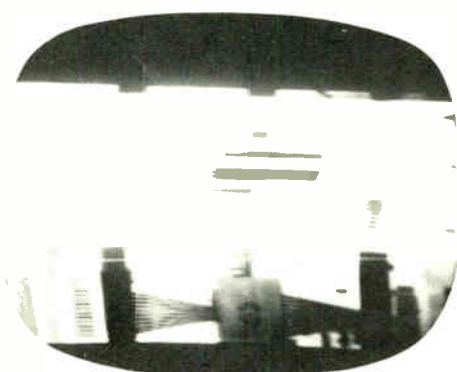

**Tele-Clue D-275**

**Receiver:** G-E "U-4" line.  
**Component:** C301, .015 mfd, 600 volt capacitor - LEAKY (1 meg).  
**Circuit:** Grid circuit of V9A vertical oscillator.  
**Symptom:** Top fold over, poor vertical sync.



**Tele-Clue D-278**

**Receiver:** G-E "U-4" line.  
**Component:** V9 tube, 3,000 ohm heater-cathode leakage.  
**Circuit:** Vertical oscillator and output.  
**Symptom:** Very poor vertical interlace. Vertical may lock-in too high or too low.

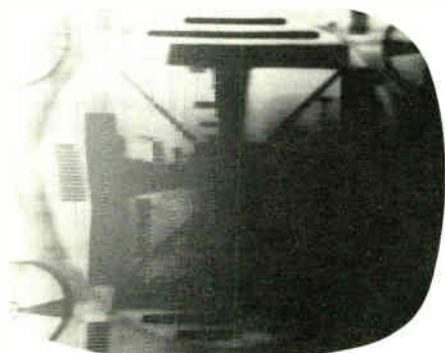

**Tele-Clue D-276**

**Receiver:** G-E "U-4" line.  
**Component:** C-307, .0082 mfd, 1600 volt capacitor - OPEN.  
**Circuit:** Vertical blanking charging capacitor in cathode circuit of picture tube.  
**Symptom:** Dim raster with shading on right.

This page of Tele-Clues has been punched for insertion in your Tele-Clue binder. These binders which contain two hundred and seventy-three Tele-Clues and an index sheet are available through your local G-E tube distributor. The letter which precedes each Tele-Clue number identifies the circuit in which the defect exists. Please enter the Tele-Clue number in the proper column on the index sheet according to the key letter.

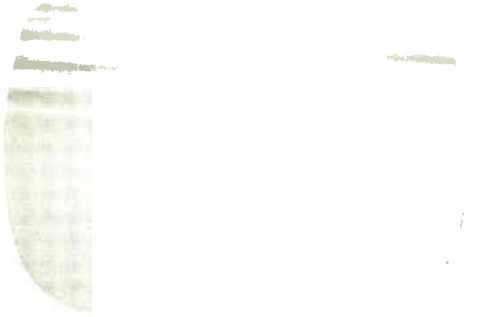

**Tele-Clue M-279**

**Receiver:** G-E "U-4" line.

**Component:** C250, 800 mmfd, 500 volt HiK capacitor — OPEN.

**Circuit:** Cathode bypass capacitor in V6B keyer.

**Symptom:** Partial blanking of screen and loss of sync which may appear to be corrected by change of AGC (R-254) control setting.



**Tele-Clue M-282**

**Receiver:** G-E "U-4" line.

**Component:** C251, 470 mmfd 1000 volt HiK capacitor — SHORTED.

**Circuit:** Keyer pulse coupling capacitor to plate of V6B.

**Symptom:** Blank raster due to overload.



**Tele-Clue M-280**

**Receiver:** G-E "U-4" line.

**Component:** C250, 800 mmfd 500 volt Hik capacitor — SHORTED.

**Circuit:** Cathode bypass capacitor in V6B keyer.

**Symptom:** Blank raster due to AGC overload which blocked out both video and audio.



**Tele-Clue M-283**

**Receiver:** G-E "U-4" line.

**Component:** R254, 40K potentiometer — OPEN ELEMENT.

**Circuit:** AGC control potentiometer in cathode circuit of V6B.

**Symptom:** Blank raster due to overload.



**Tele-Clue M-281**

**Receiver:** G-E "U-4" line.

**Component:** C251, 470 mmfd, 1000 volt HiK capacitor — OPEN.

**Circuit:** Keyer pulse coupling capacitor to plate of V6B.

**Symptom:** Blank raster due to overload which blocked both video and audio.



**Tele-Clue M-284**

**Receiver:** G-E "U-4" line.

**Component:** R250, 47K ohms, 1 watt resistor — INCREASED To 69K ohms.

**Circuit:** V6B keyer grid voltage divider.

**Symptom:** Blank raster due to overload. Buzz in audio.



## TELEVISION

### New G-E Anti-Static Cleaner and Polish



Most plastic surfaces gradually build up electrostatic charges which attract dust particles from the air. The new General Electric anti-static plastic cleaner and polish, Cat. No. WT90X21, has been developed for cleaning and polishing as well

as neutralizing those dust gathering charges.

Its polishing characteristics enable it to remove minor abrasions and scratches from plastic surfaces with a minimum of effort. After application it leaves a smooth, hard, protective

coating that resists fingerprints. It is ideal for cleaning plastic TV safety glass lens and cabinets. Easy to use — JUST RUB ON — LET DRY — WIPE OFF.

Its special formula makes it one of the safest solutions which can be used to clean and polish polystyrene plastic surfaces. In addition to its valuable uses with plastics, it will prove helpful in the home for cleaning glass, ceramic tile, porcelain and enameled surfaces.

Ask your G-E tube distributor for Cat. No. WT90X21. This polish comes in a 16 oz. can and has a list price of \$1.49.

Here is an extra profit item that your customers will want as soon as they see it used. Carry one in your case for cleaning and polishing safety glass and plastic cabinets and have a few extra available for sale to your customers.

## RADIO

### Model T120 — Dial Cord Breakage

This problem is caused in some early production sets by slight burrs on the protruding 90° angle bracket over which the dial cord rides near the dial drum.

This type of dial cord breakage can be eliminated in the following manner:

1. Remove cabinet back.
2. Remove the 12AT7 and 6AB4 from sockets.
3. With long-nose pliers, carefully grasp the top flat surface of the 90° angle bracket and twist firmly clockwise a small amount until the dial cord rides on the rounded area of the bracket.

### Phonographs — Loose Cartridge Holders

It has been found in some instances that low output or high cross-talk (on stereo records) may be the result of a loose cartridge holder.

When the above symptoms are diagnosed, first check for a loose cartridge holder in the following manner:

1. Carefully grasp cartridge holder and observe if it "slides" sideways under mounting screws.
2. If loose, tighten the mounting screws located on each side of the holder. Carefully tighten screws so as not to crack mounting bosses in tone arm.

### Techni-talk SUGGESTION AND INQUIRY COUPON

If you would like to receive additional information on some specific G-E Electronic Component, just clip out this coupon, write in the material desired, and send it to the Editor. Information, if available, will be sent to you by return mail.

Please check your name and address on the reverse side. Make any necessary corrections below.

Name.....

Street Address.....

City, Zone No. and State.....

If you expect to move within next two months, please print new address above.

If you are receiving duplicate copies, please check this box  and indicate mailing list number which appears at lower left corner of the address area on each copy you receive.

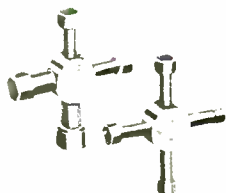

Is your service or tool case crowded? Perhaps you are using individual hex-head socket wrenches instead of the G-E Twin-X wrench set. This set actually replaces eight hex-head socket wrenches and thereby saves valuable space. Size is clearly marked on each wrench. Ask your distributor for ETR-752.

## G-E WIRELESS REMOTE SYSTEM

(Continued from page 3)

tickler winding on T651.

In operation, feedback is accomplished as follows. With application of voltage to the transistor collector, current flows in the primary windings of T651 and T652. This current causes an r-f current to flow in the tuned circuit, in turn, induces a voltage across the tickler winding on T651. The voltage developed across the tickler winding is then fed to the base of the transistor through blocking capacitor C653.

The feedback requirement to sustain oscillation is therefore satisfied.

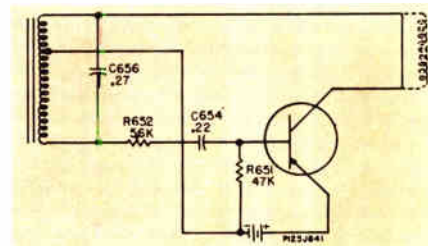

Fig. 4. Transmitter Audio Oscillator.

A simplified schematic of the audio modulating oscillator circuit is shown in Fig. 4.

On close examination of this configuration it can be readily seen that the circuitry involved is a conventional Hartley Oscillator. Although only one coil is shown in this simplified drawing, the actual circuitry of the audio oscillator portion of transmitter circuitry consists of four separate slug tuned coils. The four coils are connected in series so that in the final analysis one large coil is available with three taps. Each of the taps represent one of the audio frequencies, while the total inductance represents the fourth audio frequency. The frequency of the oscillator is therefore lowered from 405 to 315 c.p.s by depressing each of the four function switches and thereby progressively adding inductance.

The operation of the Hartley oscillator is straightforward and the circuitry is quite commonly used. The L/C tuned circuit, consisting of L651 through L654 and capacitors C656-C657, is used for both the input and output circuits. Voltage from the collector circuit is developed across the bottom portion of the inductance, inducing a voltage of sufficient magnitude and of the right phase into the base circuit so as to sustain oscillation. This feedback voltage is coupled to the base through C654, and amplitude is governed by R652.

Since there is but a single electron stream through the transistor the r-f carrier frequency is modulated at an audio rate by the audio oscillator portion of the transmitter circuitry.

(Continued in next issue)

# NEW G-E BUSINESS BUILDERS

**G-E PSM\* COURSE  
NOW AVAILABLE**

## POINT OF SALE MATERIAL

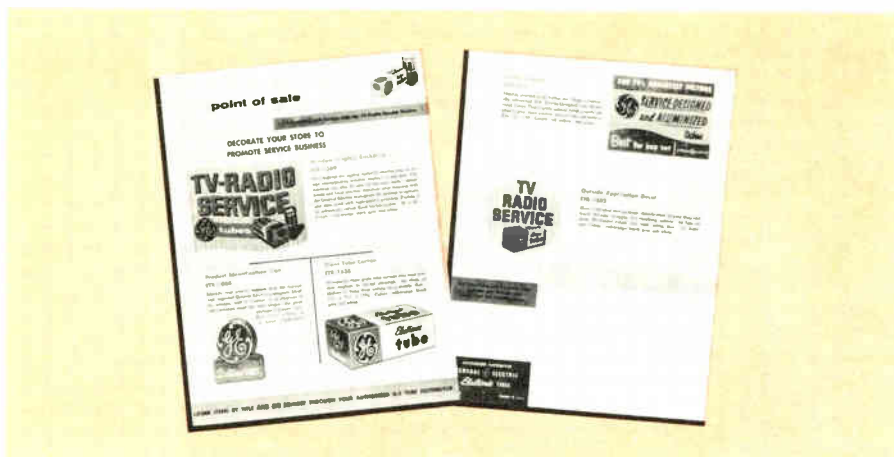

Are you using the General Electric POINT OF SALE material described in publication number ETR-1630? Use these items to decorate your store and promote service business.

The following POINT OF SALE store decorations are available from your G-E tube distributor:

Window Display Backdrop ETR-1569

Product Identification Sign

ETR-1088

Giant Tube Carton

ETR-1538

Product Decal

ETR-953

Outside Application Decal

ETR-1582

Ask your distributor for a copy of publication number ETR-1630. Make your selection; then ask for the ETR numbers you would like to have.

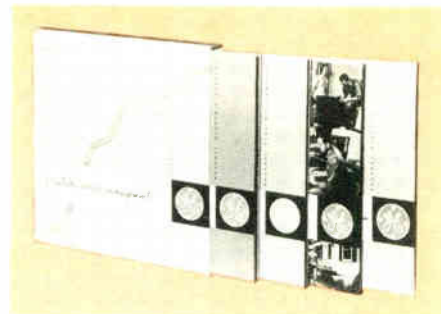

Are you using the new G-E Profitable Service Management Course to help you make more money and assure your success as a businessman? If not ask your distributor about the PSM\* Course.

Here is a course that will help you become more successful. The course includes two volumes of instruction plus an LP record "Sounds of Success." One volume is devoted to "Sound Business Practices" and the other to "Selling Electronic Service."

Don't delay! Ask your G-E tube distributor for complete information on General Electric's new business management and development program.

\*Profitable Service Management

**NOW available through your authorized G-E tube distributor**



# Techni-talk



ELECTRONIC COMPONENTS DIVISION

**GENERAL ELECTRIC**

OWENSBORO, KENTUCKY

BULK RATE

U.S. Postage  
PAID

Schenectady, N.Y.

Permit No. 148

VOL. 12 No. 1

FEB., 1960

### In this issue:

G-E Wireless Remote Control System I

Pages 1, 3 and 9

Increased Electronic Business

Forecast for 1960

Page 2

New G-E PROFIT RACK Accessory

Items

Page 3

Garroway's Back

Pages 4 and 5

Hum or Buzz in TV Receiver II

Page 6

New G-E Anti-Static

Cleaner and Polish

Page 9

Techni-talk on AM, FM, TV Servicing, published bi-monthly by Electronic Components Division, General Electric, Owensboro, Ky. In Canada: Canadian General Electric Co., Ltd., 189 Dufferin St., Toronto 3, Ontario. R. G. Kempton, Editor. Copyright 1960 by General Electric Company.

Mr. Thomas F. Poyd  
1111 N. Hill St.  
San Antonio 12, Texas  
E-222.1

Form 3547 Requested

1-25-60

This copy of **Techni-talk** comes to you through  
the courtesy of your General Electric tube distributor.

*NOTE: The disclosure of any information herein conveys no license under any General Electric patent and, in the absence of an express written agreement to the contrary, the General Electric Company assumes no liability for patent infringement (or any other liability) arising out of use of such information by others.*