

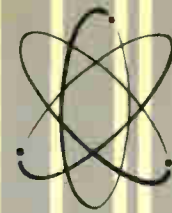

Techni-talk

COMPLETE ELECTRONIC SERVICING INFORMATION
radio • tv • hi-fi



VOL. 10 NO. 6

NOV.-DEC. 1958

NOISE CANCELLER CIRCUITS—II

In the previous issue, Noise Canceller Circuits used in "EE," "H," "J" and "O" receivers were described. In this issue, the circuits used in "G" and "K" receivers will be discussed.

Noise Canceller Circuit Used in "G" and "K" Receivers

A combination clipper and noise canceller circuit is used in the "G" and "K" receivers, as shown in Fig. 1. This is a rather unique device employing only one tube to perform both functions. Its operation is based upon the use of two successive electron stream control points within the tube. The first control point is used to shut off the tube when a strong negative polarity noise burst occurs. The second control point acts as the normal sync clipper. Thus the output of this stage consists only of sync information, except during noise burst periods, during which no signal, neither sync nor noise, will be found in its output circuit. At these times the inertia of the horizontal AFC system and the vertical sweep oscillator is relied upon to maintain synchronization. This stems from the psychology that the momentary short-time loss of sync is of little consequence and hence is far better than having sync plus large amounts of

noise passing through the sync system.

Let us first consider the sync clipper function of the circuit shown in Fig. 2. To simplify the discussion, we shall momentarily consider that the hi-mu (first) grid, pin No. 1, is merely tied to some small positive voltage and therefore simply allows the passage of the cathode electron stream. The second control grid, pin No. 7, is fed a composite signal consisting of video and positive polarity sync. (This signal is derived from the video amplifier plate circuit.) The pin No. 7 grid resistor is returned to cathode and hence, the grid and cathode form a diode which rectifies the applied signal and charges the grid capacitor negatively. This negative charge leaks off through the grid resistor to cathode, partially discharging the grid capacitor. This negative bias on the grid cuts off the tube, but because the charge is allowed to partially leak off, the most positive portion of the driving signal (i.e., the sync pulses) will cause the tube to conduct. Therefore, the plate circuit will contain negative polarity sync pulses which have been stripped free of video and blanking information. This general theory applies to most clippers now in use.

Incidentally, the extra time constant in the grid, consisting of C204 and R206 in

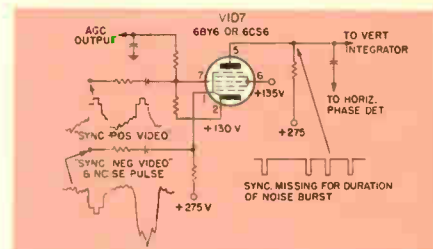

Fig. 2. Simplified clipper-canceller circuit.

Fig. 1 is used to permit rapid recovery from the effects of noise and rapid fading or flutter by enabling the grid to quickly change its operating bias. This "double time constant" circuit (C200-R202 and C204-R206) has been in common use for some time.

Now we shall consider the noise canceller function. One of the characteristics of the 6CS6 tube and certain other similar types is that the high mu grid (the one nearest the cathode) is capable of exhibiting great control over the tube electron flow when biased at or near zero volts with respect to cathode. However, when it is raised beyond a certain positive amount above the cathode, it possesses relatively little control and therefore merely acts as an accelerating grid.

Thus, when this grid is supplied with a low amplitude negative polarity sync plus video signal, as shown in Figs. 1 and 2, it will have little control of the beam since the grid is returned to some positive voltage selected by the area control. (We'll discuss this later, but let's assume that the

(Continued on page two)

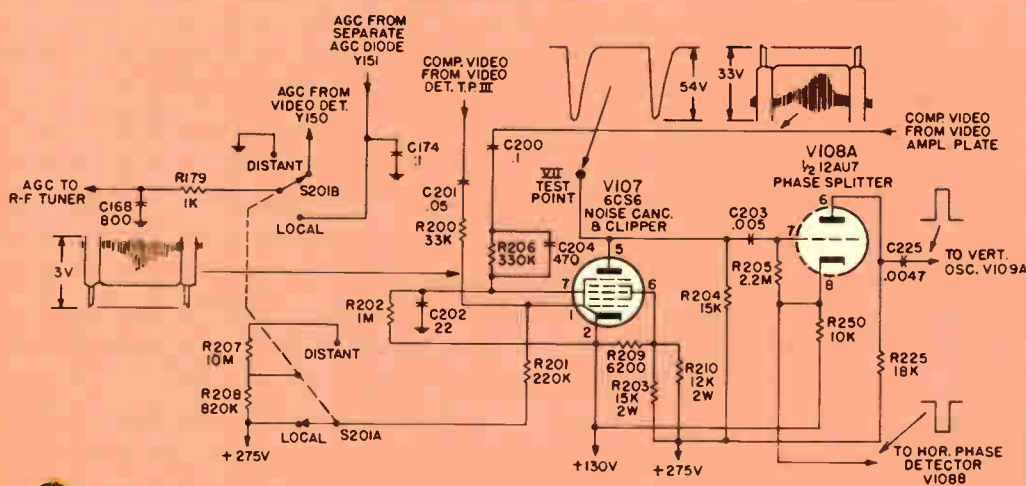

Fig. 1. Noise canceller, clipper and phase splitter used in "G" and "K" receiver.



Do you have trouble positioning a light "on the spot" when servicing receivers? If you do, the G-E Magnetic Swing-Beam Service Light will put the light where you need it and leave both hands free. Ask your distributor for ETR-1593.



SUCCESSFUL SERVICE MANAGEMENT

1959 BUSINESS OUTLOOK

A Good Year

by ANDREW E. KIMBALL—Manager—Marketing Research
Receiving Tube Department



As 1958 nears a close, attention of businessmen is turning to the outlook for business in 1959—and plans for the new year.

Total Economy

The recession which got started in September, 1957, reached its low point in the spring of 1958. Since that time, recovery in most industries has been substantial. A few industries have already pushed into new high ground and many others will soon do so. Most economists including those in General Electric, believe that the year 1959 will see a continuation of recovery and in general will be an excellent business year. Total industrial production, personal income, and retail sales will break previous records.

Despite expected general improvements, 1959 is not expected to be a "boom" year for all segments of the economy. Certain industries, including television, appliances and automobiles will increase substantially over 1958, but will not reach previous high sales rates.

Set Forecasts

Our forecasts of television set production anticipate an increase of 10% to nearly 6 million, compared with about 5.4 million in 1958. Improving economic conditions, coupled with rising replacement sales, will support this higher level. Saturation of sets has risen rapidly in recent years from 65% of households in 1955 to an estimated 84% currently. This

high level tends to restrain new owner sales below the "growth" years of 1950-1957. However, the solid base of replacement sales has risen from about 1.8 million in 1955 to a forecast 3.4 million in 1959—and multiple set sales continue at high rates.

In early 1959, the number of television sets in use will reach 50 million, compared with 47 million at the beginning of this year. To the service industry, this represents a tremendous potential market for replacement parts and repair—nearly a billion receiving tubes, 50 million picture tubes, and hundreds of millions of other components.

The general economic decline, especially in auto production, has caused a substantial drop in radio set production during 1958. Substantial improvement of 17% is foreseen as production jumps from 11.5 million sets in 1958 to 13.5 million in 1959. Over 150 million radio sets are now in use with over 800 million tube sockets.

The phonograph market, stimulated by great consumer interest in hi-fi and stereo,

will rise to new high levels in 1959.

Forecast of Replacement Tube Sales

The replacement market for tubes during 1958 has been adversely affected by the recession. Postponement of "marginal" repairs by many set owners has reduced receiving tube sales somewhat below the 180 million of 1957. However, this very delay in repairs should provide an extra boost in 1959. Improving consumer confidence and personal income will accelerate repair business. This factor, coupled with increases in sets in use, should result in all-time high renewal sales of 190 million receiving tubes and sales of 13 million picture tubes during 1959.

With this kind of growth, even the average service dealer should have a good year in 1959. Furthermore, the service dealer who uses real imagination, plans carefully, manages his business resources wisely, and displays a high degree of initiative, can have an outstandingly successful 1959.

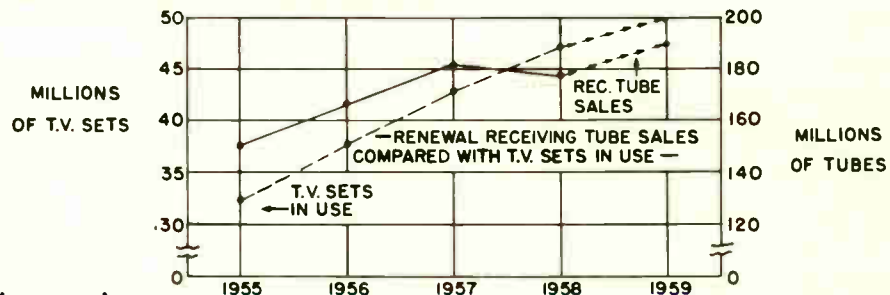

Noise Canceller Circuits (Con't)

grid is somewhat positive with respect to cathode.)

Now if a strong noise burst were to occur, the polarity of which must be negative because of the video detector diode polarity, the negative noise voltage would force the grid negative with respect to cathode and thus cut the tube off. Therefore, neither sync nor noise will be present in the output circuit of the stage.

Although this device is quite ingenious, it is not capable of satisfactorily operating over the entire range of signal strength that the receiver will be called upon to handle. Consequently, a means has been provided whereby we may alter the amount of positive bias on the high mu grid according to the incoming signal level. This is accomplished by one section of the area switch, S201A, shown in Fig. 1. In strong signal areas, we raise the positive grid bias to lessen its degree of control, since in these areas the amplitude of

the signal applied to this grid will be somewhat greater. If it were not compensated for, it would cause the cancelling action to take place on the negative polarity sync tips, thus causing a partial loss of sync. For progressively weaker signal areas, this positive "de-controlling" voltage is lessened in magnitude to maintain proper cancelling operation. In weak signal areas, the canceller feature therefore becomes most active. The other section of the ganged area switch controls the R-F tuner AGC voltage. In the "local" (strong signal) position, high AGC from the separate AGC diode, Y151, is fed to the R-F amplifier. In the middle position, the r-f amplifier is fed AGC voltage from the video detector, Y150, the same as the I-F system. The "distant" position removes AGC from the R-F amplifier and grounds the lead to chassis to permit its operating at maximum gain.

Perhaps a question will arise regarding

the b+ voltage distribution within the stage. It should be noted that in the previous discussion, we spoke of grid voltage *with respect to cathode*. Actually the *entire stage* is elevated b+ wise, above ground by 130 volts. This has nothing to do with the action of the stage, but merely allows it, together with certain other stages, to form a b+ voltage divider for the sake of b+ power economy.

(Continued in next issue)



Is your picture tube extension lead long enough and can it be used on 50-, 70-, 90-, and 110-degree tubes? If not, ask your distributor for the G-E Tri-plex Extension Lead, ETR-1527.



Our business and yours depends upon customer acceptance of our products. "King Customer" has asked for and is receiving slim cabinet television styling. Only by such innovations and improvements can the television industry remain strong. This article briefly describes how the General Electric Cathode Ray Tube Department met some of the problems of this new, shallow tube and also some of its interesting points from a servicing standpoint.

In changing from the 90-degree tubes to the lightweight 110-degree deflection tube, the obvious advantages of a reduction of more than 5 inches in length and 2 pounds in weight on the 21-inch tubes were realized. Proportionate gains were made in other sizes.

Neck Diameter

Approximately 40% more power would have been required for the 110-degree electron beam deflection over the 90-degree without other major tube design changes. The 110-degree tube, therefore, was designed with a smaller neck diameter permitting the deflection coils to be brought closer to the beam, thus eliminating most of this potential power loss. The change in neck diameter required major modification in manufacturing equipment and certain processes. Each important change was subjected first to engineering analysis and vigorous testing by Quality Control before it was released for production. Of course, one of the most important changes involved the complete redesign of the electron gun into a more compact unit without a sacrifice in performance.

As might be expected, the closer spacing in the neck magnified the problems of high-voltage operation. Increased attention to factory cleanliness over already excellent conditions became a necessity.

Basing

To minimize total tube length a new stiff lead stem and cover was introduced. This eliminated the use of corrosive flux and soldered base pin connections, while at the same time greatly reducing the chance for potential service problems due to opens, leakage along the base, and loose and tilted bases. Because of the fragile nature of the glass tip off a simple tip cover is used.

Handling

One important service note to remember is that, although the lead and base arrangement has many advantages over previous construction, reduced neck diameters, etc., make even greater care in tube handling, yoke adjusting, etc., mandatory. 110-degree tubes are now used exclusively in new set production by most manufacturers and probably foreshadow a trend to even wider deflection angles.

Basing and Stem Comparisons

Photo shows the basing details of the 110° tube left and conventional tube right. In both cases the base has been slipped down to show the basic differences in construction. Note that in the 110° tubes the stiff external leads are a continuation of the internal leads. The problems of loose bases, solder connections, etc., have been reduced or eliminated. The right-hand tube shows the conventional tube construction with its flexible external leads and the threaded base construction.



Gun Construction

In pressurized and air conditioned facilities in which incoming air is electrostatically filtered, trained operators assemble the electron gun, the heart of the picture tube. Lint-free clothing is worn by all operators and supervision in this operation. To meet its precision requirements the General Electric Company operates its own parts making plant.



Incoming Inspection

Sound designs and processes alone cannot assure high quality. Controls of incoming material is an important part of the General Electric story. Here an inspector examines a filament under an optical comparator, a device which can enlarge the image of a part many times to determine dimensions, surface, etc. The filament in the machine has an actual over-all length of less than .5 inches.



Aluminizing

A pioneer in the field of aluminized tubes, General Electric has retained this technical edge through the television years. 110° tubes are shown here on an automatic aluminizing machine. Note the operator checking aluminum thickness and "edge to center" distribution through use of a "Q" meter. By relating capacitance thus read to correlated aluminum thicknesses distribution can be gauged.



Life Testing

Design or processing changes are carefully evaluated before changes in production. The Quality Control Section's cycled life tests are continually under way to analyze the effect on tube life of new designs and processes under conditions which simulate ultimate set operation. Approximately 500 such life-test positions are used to life-test production and perform comparison tests of competitive tubes.

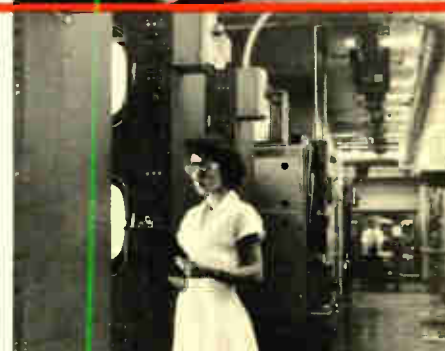



COACHES MIDGET-LEAGUE TEAM. For the past two years, Theodore W. Fickert, TV technician of Hatfield, Pa., has shown his 25-boy club how to play baseball. Active in community causes, he helped organize the Hatfield Junior Chamber of Commerce, and served as its secretary and state director; participates in the Heart Fund and other worthy drives; and is on the planning committee of St. Peter's Lutheran Evangelical Church.



A BRIGHTER, CLEANER CITY owes much to Bryce McNeely's work in connection with the Kelso, Wash., program for civic beautification. Bryce is on the mayor's committee for school and city improvement, is state JC vice president, and promotes young men's leadership training.



MAKES OTHERS' TROUBLES HIS OWN. One of the few TV technicians in an 85-mile area, T. E. "Buck" Adams of Channing, Tex., often aids in roadside emergencies, helps pen run-away cows, and has worked to improve local Baptist Church, parsonage.

CRIPPLED CHILDREN LEARN TO WALK through fund-raising efforts of Vernon E. Brooks, Norristown, Pa., who helped obtain \$100,000 to build a school for spastic paraplegics. Mr. Brooks (center) is a director of the Chamber of Commerce, and a prime mover in Red Cross, Community Chest, United Fund, and Salvation Army work. As national president of the American Business Club, he helped obtain more than 100 scholarships for the training of physical and speech therapists. He is chairman of the Muscular Dystrophy unit for the Tall Cedars of Lebanon.



All-American TV Technicians

HELPED TORNADO VICTIMS. When disaster struck the area around Menomonie, Wis., on June 4, Vernon Townsend quickly organized emergency radio facilities to speed relief to the sufferers. A leading member of the Radio Amateur Civil Emergency service, he is active in Dunn County civil defense work, and also maintains a radio entertainment service for the local city-county hospital.





TEACHES SCOUTS RADIO. Boys in Brockton, Mass., learn Morse Code and the elements of electronics at an early age, from instruction by TV technician Albert P. Kazukonis. Much of the equipment he supplies without charge. A devoted youth and community worker, Mr. Kazukonis is treasurer and a past president of the Electronic Technicians Guild of Massachusetts, Brockton Chapter.



DONATED LOUDSPEAKER SYSTEM. The 1958 Centennial parade and pageant at Bloomington, Minn., owed much of its success to the fine amplifier system installed without charge by Edwin B. Haines. Ed is widely known for the time, effort, and equipment he has supplied for the 2,000 boys in Bloomington's sports program. He is a leader and counselor in Boy Scout work, and gives assistance to the Lions and the Bloomington Civic League.

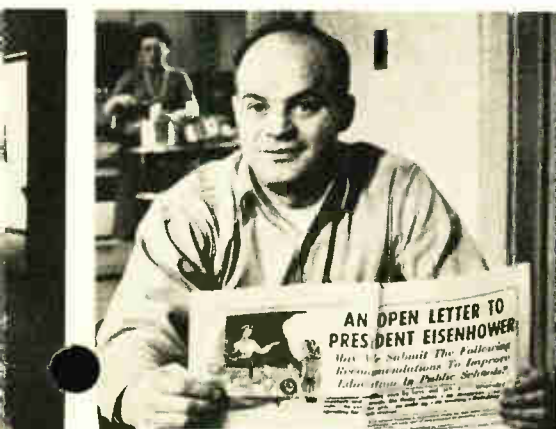

SPENDS TO PROMOTE EDUCATION. Out of his own pocket, A. George Catavolo, TV technician of Somerville, Mass., financed two full-page newspaper ads which presented to the President recommendations on public school education. Last year George contributed over 30 radios, plus his time, to teach boys electronics.

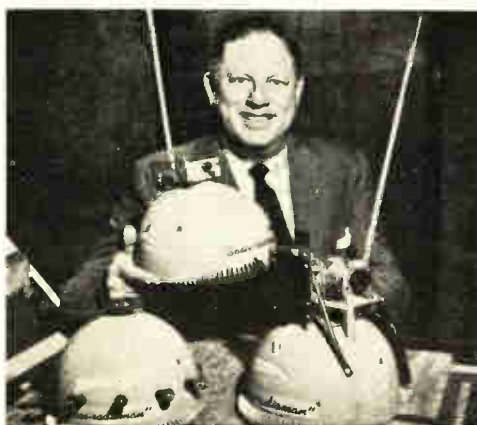

WORLD OF TOMORROW! This novel space radio-man hat, invented by Stanley Everett of Alhambra, Cal., helped publicize many worthy drives. Stanley is president of the Los Angeles Electric League; a director of the Alhambra Chamber of Commerce; past president of Kiwanis and district chairman of the United Fund drive.



COMMUNITY SERVICE is a watchword with Wayne E. Lemons of Buffalo, Mo. An active Rotarian, he works with Boy Scouts, promotes Little League baseball, and has instructed TV technicians in surrounding cities. He is West Central vice-president of the National Alliance of Television Electronic Service Associations.

Win General Electric Awards

PEOPLE the nation over nominated candidates for the 1958 All-American Awards, honoring TV service technicians. This broad response showed how important a place the television technician holds in our community life, and how widely esteemed are his efforts in aid of others.

The Award winners, shown here, were chosen by a panel of judges including John Sparkman, U. S. Senator and Chairman, Select Committee

on Small Business: Bennett Cerf, television panelist and head of Random House publishing firm; and Charles Shearer, 1957-58 president of the National Junior Chamber of Commerce.

With these Awards, General Electric pays tribute to the part played by the independent television technician in making this a better country for all. *General Electric Company, Receiving Tube Department, Owensboro, Kentucky.*

Progress Is Our Most Important Product

GENERAL  ELECTRIC



What's new!



Glass Housing for G-E Transistors

A new glass housing for transistors recently introduced by G.E.'s Semiconductor Products Dept. will make possible decreased production costs. It is believed to be the first such development to meet industry standards, and will lend itself more readily to high volume mechanization without sacrificing reliability. At least one line of glass packaged transistors is contemplated for introduction early in 1959, as a forerunner of other entertainment types for use in portables, car radios, and phonographs.



VAC-U-SEL* Double Diodes Simplify Your TV Needs

Now you can obtain the famous VAC-U-SEL* diode quality for replacement of horizontal phase detectors in TV repair through your G-E Semiconductor distributor. Two types are available which meet the requirements of any TV set in which a double diode selenium rectifier is now being used. Type 6GD1 is series connected and colored red; Type 6CG1 has a common cathode and is black. Leads are 1 3/8" long and can be easily clipped off or hand crimped for printed board installation. Both types list at \$1.65 each.

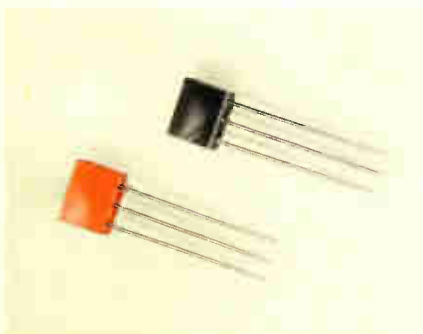

* Registered trade-mark of the General Electric Co.



General Electric "Stereo Classic" High Fidelity Tone Arm

A new compatible stereophonic and monaural high fidelity tone arm, the General Electric "Stereo Classic" Model TM-2G, is now available.

Every design feature of the new General Electric "Stereo Classic" Model TM-2G Tone Arm is directed toward optimum performance for true, fully rounded listening pleasure from stereophonic recordings. These design features also give the Model TM-2G outstanding monaural performance.

The dual signal impressions in stereo record microgrooves require the entire pickup system to operate with minimum record and stylus wear, low distortion, and maximum tracking precision.

To provide these characteristics for finest stereo reproduction, the Arm was designed specifically for use with G-E Stereophonic Cartridges, as an integrated, all-G-E pickup system. The Tone Arm also is highly compatible with G-E VR-II Four-Gram Cartridges, for highest quality monaural reproduction.

The Arm's primary feature for excellent stereo reproduction is its static balance. When adjusted, the arm maintains its lateral equilibrium at all times, even if the turntable is not perfectly level. It is highly resistant to shock, and its only lateral motion is that caused by the spiral progression of the record grooves.

Thus the stylus tip exerts even pressure against each of the two independently modulated walls of the V-shaped groove. Maintenance of static balance provides constant tracking pressure, constant stylus centering, and minimizes the necessity for critical turntable leveling.

The Arm also features an unusual two-step tracking force adjustment, for (1) Balancing the Arm to "zero" tracking force, and (2) Making a highly precise



tracking force adjustment between zero and six grams.

The Arm's lightweight aluminum construction minimizes vertical and lateral inertia, and its microball bearings provide minimum travel friction for reduced stylus and record groove wear.

Among the other features are a built-in arm rest, an easily removable cartridge head, a terminal board with four stereo cartridge lead terminals and one ground terminal, and trim, modern styling with brushed aluminum and chrome finish.



tubes

Service Designed Tubes

Numerous improvements have been made in General Electric "Service Designed Tubes." Many of these improvements were made in manufacturing techniques which extend to television some of the high reliability features originally developed for military tubes. Other improvements, such as the tapered pins shown below, make it easier for service technicians to insert and remove "Service Designed" tubes.



The new tapered pins will be found on the "Service Designed" 1J3 which also uses another "Service Designed" feature the SPIRAL SHIELD, that practically eliminates the possibility of shorts due to "electrostatic pull." For longer life and more dependable service, replace the 1B3-GT with a "Service Designed" 1J3 tube.



8YP4

Universal 110° Picture Tube

Use the General Electric 8YP4 for picture tube or circuit testing either "in the home" or "on the bench."

The 8YP4 is a rectangular eight-inch all-glass magnetic deflection picture tube designed for use in servicing television receivers. The tube features small size,



light weight, automatic self-focusing and requires no ion-trap magnet. This tube was designed for receivers with 110° deflection but may be substituted for tubes of other deflection angles.

HOW TO MAKE A TRANSISTOR TESTER

A rather simple circuit which can be used to effectively check both P-N-P and N-P-N transistors is shown in Fig. 1. This circuit can be used to construct an inexpensive transistor tester. Since the circuit contains such a few parts, construction details and layout have been intentionally omitted.

Parts Required

Symbol	Quantity	Description
BT-1	1	6-volt battery, Eveready No. 724 or equivalent
M-1	1	3-ma Full Scale Meter (under 1500 ohms)
R-1*	1	1500— $\frac{1}{2}$ -watt 10% Resistor
R-2 & 3	2	200 K $\frac{1}{2}$ -watt 5% Resistor
S-1**	1	Push-button type switch—DPST normally open. Switchcraft No. 1004 or equivalent
TB-1	1	Terminal strip with three terminals
X-1 & 2	2	Transistor sockets, Cinch Mfg. Co. No. 2H3 or equivalent

Instructions for Transistor Tester

Battery Check: Insert 560-ohm resistor between E and C (either socket). If meter does not read full scale, replace battery.

Operation:

Leakage—Insert transistor in appropriate socket. Meter reading indicates condition with respect to leakage.

* This resistance value depends upon the meter (M-1) used. The combined resistance of M-1 and R-1 should total about 1500 ohms.

** Two SPST push-button type switches can be used. The top switch in Fig. 1 would be used for testing P-N-P type transistors and the other for N-P-N types.

Gain —Depress Gain button and note increase in meter deflection. An increased deflection to the right equal to at least one division on the Gain scale compared to the deflection during leakage test indicates acceptable current gain.

Opens Shorts —A shorted transistor will be indicated by a full scale meter deflection in leakage test. An open transistor will be indicated by no meter deflection in both leakage and gain tests.

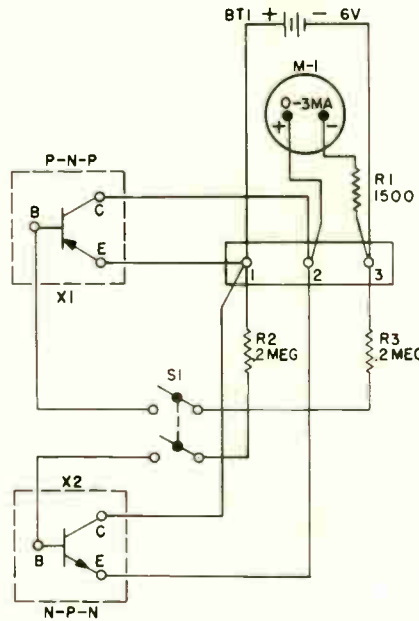

Fig. 1 Circuit diagram for transistor tester



BENCH NOTES

Those desiring to have letters published in this column should write the Editor, Techni-Talk, Electronic Components Division, General Electric Company, Schenectady 5, New York. For each such letter selected for publication you will receive \$10.00 worth of General Electric tubes. In the event of duplicate or similar items, selection will be made by the Editor and his decision will be final. The Company shall have the unlimited right without obligation to publish or otherwise use any idea or suggestion sent to this column.

Caution: The ideas and suggestions expressed in this column are those of the individual writers. These ideas and suggestions have not been tried by the General Electric Company and therefore are not endorsed, sponsored or recommended.

Tube Pusher

Here is a handy little time-saver that has helped me in TV servicing. After finding some tube shields difficult to remove and breaking a few tubes, especially in solid shields, I made up a number of these "tube pushers." Now I never break a tube trying to remove it from the shield.

Anyone can make these by using a piece of $\frac{1}{4}$ -inch plastic tubing, a lollipop stick and a piece of old pump hose or air hose. Usually the tube can be pushed out with a 3-inch piece of tubing, but occasionally some shields have a $\frac{1}{4}$ -inch opening which requires the plastic end.

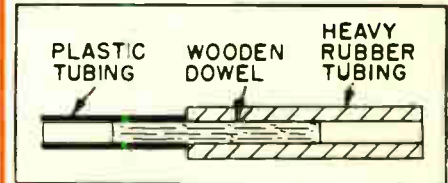

O. H. WILLIAMSON
Williamson Radio Service
631 W. Dallas Ave.
Cooper, Texas

Keep Soldering Iron Bright

To keep the tip of a soldering iron bright and fully tinned, heat with a blow torch and apply silver solder and flux (powdered borax) to the area to be tinned.

Since it will never reach the temperature at which the silver solder will melt, the iron will stay ever-clean and ready for use.

E. MAYOVER
1601 14th St., W. (U.S. 41)
Bradenton, Florida
Service Hint

Zenith Royal "R," 18R21 Chassis

I had quite a time locating a high-frequency whistle and a ripple effect in the picture which only occurred when the brightness control was turned to just below normal viewing level. I finally changed the high-voltage transformer and cleared up both troubles.

GLENN MORGAN
Vickers TV Service
Huntingdon, Tenn.

NEW BUSINESS BUILDERS

IDENTIFY YOUR STORE TO ATTRACT NEW BUSINESS



Dress up your store interior with a sign that tells the service message of your choice, such as: "TUBES TESTED FREE," "24 HOUR SERVICE," "TUNE-UP SPECIAL," etc. This flexible sign is complete with hanging hardware, easel back and a kit of letters and numbers. Illuminated with two 30-watt lamps. Size—37" x 14". Color—red-orange, black, grey and white.

SERVICE NOTES

TELEVISION

Power Tuning Repairs—U2 Receivers

There are two means of operating the power tuning units on these receivers, (1) by the push buttons, or (2) by the remote control unit. If the remote control unit operates the motor and the push buttons do not, then there is a discontinuity in the push-button circuit. This is probably caused by either poor contact between the brass cup washer (new #WT2X52, old #RMC075) and the individual contact springs or poor contact between the brass cup washer and the center shaft. In the former case, it is generally only necessary to tighten the center hex head screw located behind the channel indicator window to insure positive contact between the brass cup and the individual contact springs.

If this is not effective, then it is necessary to disassemble the push buttons and remove this brass cup and discard it. Reassemble the unit with two cups back to back. One cup will fit over the spring contacts same as before and the other cup will receive the plastic knob retainer. This will give twelve points of contact to the center shaft instead of the original six. With this assembly and the center hex nut tightened, a lasting and effective repair is made.

All power tuning sets produced since

the latter part of November, 1957, have power tuning units assembled in this manner.

Correction for Overload on Strong Signal—U2 Receivers

1. Check value of R175 and clip jumper across R185. Both resistors are in the AGC delay circuit for the tuner.
2. A very sharp cutoff 12BY7 video amplifier in a late version receiver together with a remote cutoff 6BQ7A or 6BS8 in the tuner will cause overload. To correct this condition new tubes should be tried in both circuits.

RADIO

Models 675 and P720 Current Readings

The following is a list of battery and collector current readings for the Models 675 and P720 transistor radios. These readings should be taken under no-signal conditions (quiescence) with volume control at maximum and gang condenser closed:

BATTERY	675	P720
CURRENT	5 MA.	10-12 MA.
X1	.5 MA.	8-1 MA.
X2	.5 MA.	8-1 MA.
X3	.5 MA.	8-1 MA.
X4	.5 MA.	8-1 MA.
X5	.3 MA.	2-3 MA.
X6		2-3 MA.

The above current figures do not ap-

Techni-talk

on AM, FM, TV Servicing

published bi-monthly by
ELECTRONIC COMPONENTS DIVISION

GENERAL ELECTRIC

SCHENECTADY 5, N. Y.

In Canada

CANADIAN GENERAL ELECTRIC CO., LTD.

189 Dufferin St., Toronto 3, Ontario

R. G. KEMPTON, Editor

COPYRIGHT 1958

BY GENERAL ELECTRIC COMPANY

pear in 675 and P720 service manuals; therefore, it is recommended that they be added in appropriate places.

Models P745 and P750—Circuit Changes

To improve the over-all performance of the P745 and P750 transistor radios, several resistor values have been changed during production. Please add these new values to your schematics.

P745A
R1 —27K, 33K, or 39K
R5 —27K to 39K
R17—1K to 12K
P750A
R1 —18K or 39K
R4 —330 ohms or 1K
R6 —27K to 68K
R20—100 ohms or 150 ohms



Fuse and Heater Checker

- Battery powered (use standard "C" size batteries).
- Tests continuity of 50°, 70°, 90°, and 110° picture tubes.
- Checks virtually all tubes used in series-string TV sets and radios (AC, DC and portable).
- Tests fuses and pilot lamps.
- Small enough to carry in service case or pocket.

ETR-981-A

NOW AVAILABLE THROUGH YOUR AUTHORIZED G-E TUBE DISTRIBUTOR

This copy of **Techni-talk** comes to you through the courtesy of your local General Electric tube distributor.

ELECTRONIC COMPONENTS DIVISION

GENERAL ELECTRIC

Schenectady 5, N. Y.

BULK RATE

U.S. Postage

PAID

Schenectady, N. Y.

Permit No. 148

Boyl's Radio Service
415 Fredericksburg Rl.
San Antonio 1, Texas
E-222

8-21-58