



Techni-talk

on AM, FM, TV Servicing

Copyright 1951 by General Electric Company

TWO 10-INCH CONVERSIONS

MAJOR SWEEP AND CABINET CHANGES

This is the fifth of a series of articles on converting ten and twelve inch TV receivers to use fourteen, sixteen or seventeen inch rectangular picture tubes. In this issue a General Electric ten inch Model 802 was converted to use a General Electric 14CP4 picture tube and a Capehart-Farnsworth ten inch model 260 was converted to use a General Electric 16KP4-A aluminized picture tube.

The following discussion is a description of the procedure followed which produced satisfactory results with respect to the particular model converted. If a conversion is attempted on a similar model of an earlier or later date or on a different model from the same manufacturer, then additional adjustments and steps may be necessary. The changes which were made have not been approved by the manufacturer and may therefore invalidate Underwriters' approval and the manufacturer's warranty.

GENERAL ELECTRIC MODEL 802

The General Electric Model 802 shown in Fig. 1 was originally a ten inch TV, AM, FM radio combination. This was converted to use a General Electric 14CP4 picture tube which was the largest size that could be used without major cabinet changes. The completed conversion is shown in Fig. 2. It is possible to convert this receiver to a sixteen or seventeen inch picture tube by mounting the tube in the center of the top section which now holds the chassis and picture tube. The phonograph section would then be eliminated and this area used for the chassis only. Due to the amount of cabinet work involved, plus the disadvantage of eliminating the phonograph, it was felt that the fourteen inch conversion would be the most practical. The conversion to a sixteen or seventeen inch picture tube may be described at a later date.

The following parts were required to convert this receiver to use a fourteen inch picture tube.

- 1—General Electric 14CP4 picture tube
- 1—General Electric RLD-024 deflection yoke
- 1—General Electric RTO-085 horizontal sweep transformer
- 1—General Electric RET-003 ion trap magnet
- 1—General Electric RKT-006 or 007 kit of parts required to use RTO-085 horizontal sweep transformer. Either of these kits contain the following parts:
 - 1—UCU-1544 470 mmfd mica capacitor
 - 1—UCU-2534 180 mmfd mica capacitor
 - 2—UCU-1052 1000 mmfd mica capacitor (not used)
 - 1—URD-073 10,000 ohm 1/2 watt carbon resistor
 - 2—URF-097 100,000 ohm 2 watt carbon resistor
 - 1—RLD-017 width control
- 1—.05 mfd 600 volt capacitor
- 1—.02 mfd 600 volt capacitor
- 1—.002 mfd 1600 volt capacitor
- 1—13 1/4" x 10" piece of safety glass
- 1—1427R fourteen inch light Royalite plastic mask measuring 15 1/2" x 12" (Manufactured by Precision Plastics, Inc. in Chicago

and represented by the Hy-Art Co., 136 Liberty St., New York City.

List prices of the foregoing parts, at date of publication, totaled \$72.35. However, allowance should be made for any local differences due to transportation costs, etc.

The complete receiver was brought to the shop because of the amount of time required to cut and finish the cabinet. The chassis was removed from the cabinet and the following changes made:

1. The large metal shield over the high voltage and sweep circuits was removed and the picture tube taken out.
2. The chassis was marked one and three-eighths inches down from the top and four inches in from each side. This area was then cut out with a drill and hacksaw leaving the two grounding strips as can be seen in Fig. 3. Three pieces of rubber were used to prevent the picture tube from resting on the metal edges.
3. The coil assembly in the original deflection yoke which was held in place by two small screws was removed from its metal case. The RLD-024 coil assembly was also removed from its case by drilling out the two rivets which held it in place. The RLD-024 coils were then inserted into the original shell and the two screws were used to hold it together.
4. This assembly should be handled carefully to prevent any change in the position of the coils or core material. This transfer made it possible to use the original focus coil and mounting bracket as seen in Fig. 4.
5. Two of the three porcelain stand-offs

which were fastened to the 1B3-GT tube socket were removed, and the third one was used to hold the socket in a position which would not interfere with the picture tube. The photograph in Fig. 3 was taken at this point in the conversion.

5. The original horizontal sweep transformer was removed and replaced with a General Electric RTO-085. The RTO-085 transformer was then connected as shown in Fig. 5.

6. The 1000 mmfd capacitor (C95) in the plate circuit of V21 was removed and replaced with the 470 mmfd capacitor (UCU-1544).

7. The original width control (L23) was removed and replaced with the new width control (RLD-017). This was wired as shown in Fig. 5. It was necessary to enlarge the original mounting hole to accommodate the new control. Some receivers may not have R-136 in the original circuit. If this is the case, it should be added.

8. A .002 mfd 1600 volt capacitor was connected between terminals 6 and 8 on the horizontal sweep transformer.

9. A 10,000 ohm resistor (URD-073) was connected across R-90.

10. The two 100,000 ohm 2 watt resistors (URF-097) were connected in parallel from the screen (pin 8) of V22 to chassis ground.

11. Removed C93 and replaced it with a 180 mmfd capacitor (UCU-2534).

12. Removed R126 in plate lead of the 1B3-GT tube.

13. Two angles, the dimensions of which are shown in Fig. 6, were used to raise the

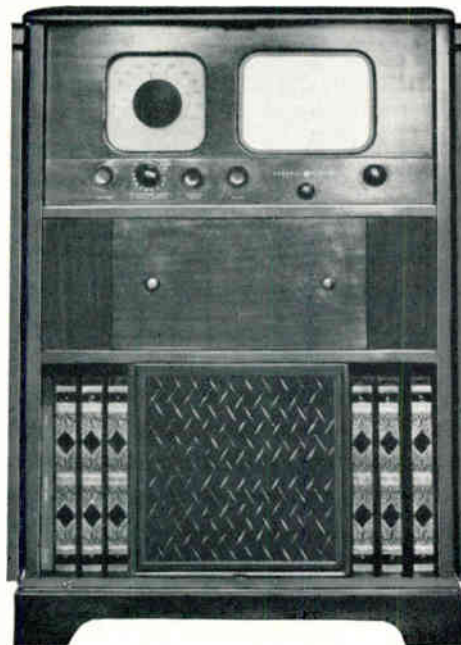

Fig. 1. General Electric ten inch TV combination Model 802 before conversion.

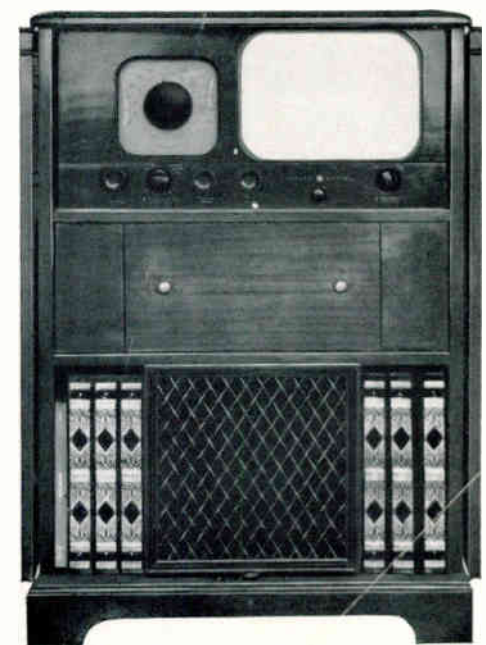

Fig. 2. The same receiver after being converted to use a General Electric 14CP4 picture tube.

TECHNI-TALK

on AM, FM, TV Servicing

Published by
TUBE DIVISIONS, ELECTRONICS DEPARTMENT

GENERAL ELECTRIC

SCHENECTADY 3, N. Y.
R. G. KEMPTON — Editor

yoke assembly and also to move it closer to the edge of the chassis. These were mounted to the chassis in new holes one inch in back of the original mounting holes. The mounted assembly can be seen in Fig. 4.

14. The five wires on the picture tube socket were extended by about three inches.

15. The vertical charging capacitor C92 which was connected between pins 5 and 8 on the 6V6GT vertical output tube was changed from .1 mfd to .07 mfd. A .05 mfd and a .02 mfd were connected in parallel to obtain this capacitance. This was the only change necessary in the vertical circuit to obtain sufficient height with good linearity.

16. The 14CP4 picture tube was placed in the chassis and held firmly in place with a piece of metal hanger strap. This is the type commonly used on antenna chimney mounts. Two three-inch pieces of one-inch wide sponge rubber were used between the top corners of the picture tube and the hanger strap to prevent slipping and to absorb shock.

17. The RET-003 ion trap magnet was placed on the neck of the picture tube and all electrical connections were made. The set was turned on and the ion trap and focus coil were correctly positioned. The necessary controls were then adjusted to obtain a linear test pattern.

CABINET CHANGES

The safety glass and mask were removed from the cabinet. A fourteen inch template was made using the largest dimension of the beveled mask edge for size. This was placed on the cabinet with the lower edge resting on the top of the raised portion of the panel and marked off with a scriber. This template should be carefully located so that it will be centered over the faceplate of the 14CP4 picture tube. This area was then carefully cut out with a fine point keyhole saw.

The edges of the mask area were sanded, stained and varnished to match the rest of the cabinet. The Royalite mask was then cut with a pair of scissors to the size of the safety glass. The safety glass and mask were fastened to the inside of the cabinet with four S clips, which can be obtained from most any glass company. The completed conversion is shown in Fig. 2.

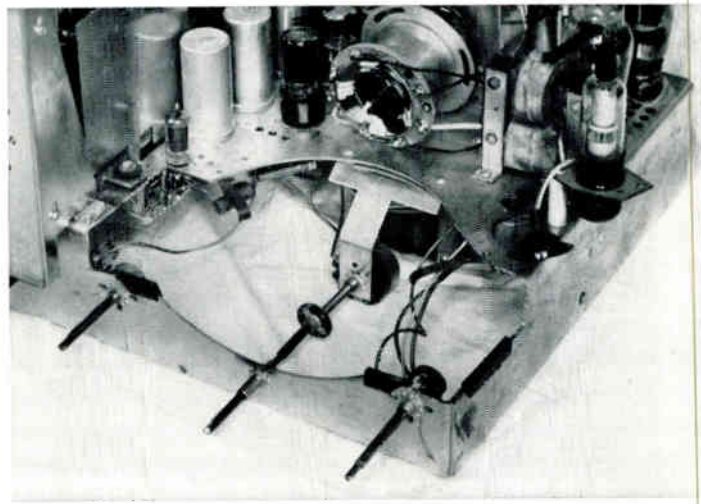

Fig. 3. Chassis of General Electric Model 802 shown after the chassis had been cut out to accommodate the 14CP4 picture tube. The original deflection yoke has been replaced with new 70° coils from a General Electric RLD-024 deflection yoke.

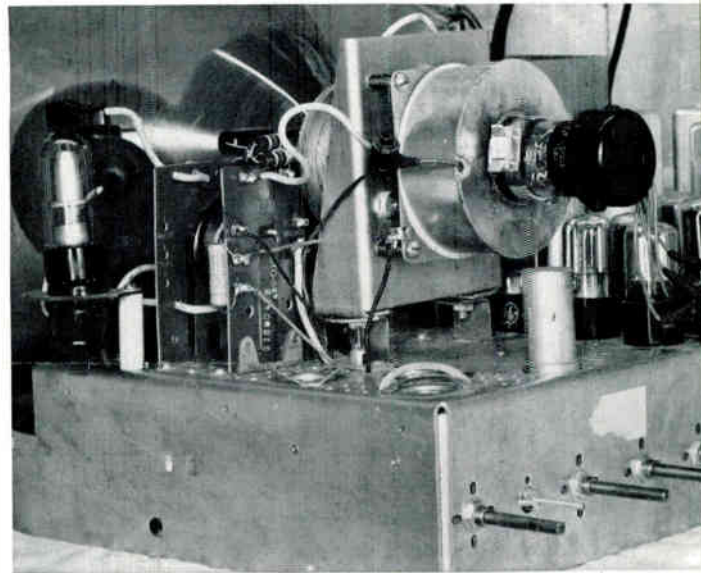

Fig. 4. Chassis of General Electric Model 802 shown after all the electrical and mechanical changes have been made.

CAPEHART-FARNSWORTH MODEL 651P

The next receiver converted was a ten-inch Capehart-Farnsworth Model 651P. The original model appears in Fig. 7. The owner of this receiver was an expert cabinetmaker who completely rebuilt the cabinet. It would probably be advisable to obtain a blank cabinet large enough to accommodate the completed conversion (which was 20 1/4" high) and make the

necessary holes in the front panel for the knobs and picture tube mask.

A considerable amount of time and parts were required to make this conversion and because of this, plus the cabinet problem, it cannot be considered an economical conversion. The original circuit, however, was so different from most receivers that it should at least be of some value for reference purposes. This chassis is the same as that used in Capehart-Farnsworth Model 661P, and the horizontal and vertical circuits are practically the same as Capehart-Farnsworth Model GV260.

The following parts were used in making this conversion:

(Continued on page 5)

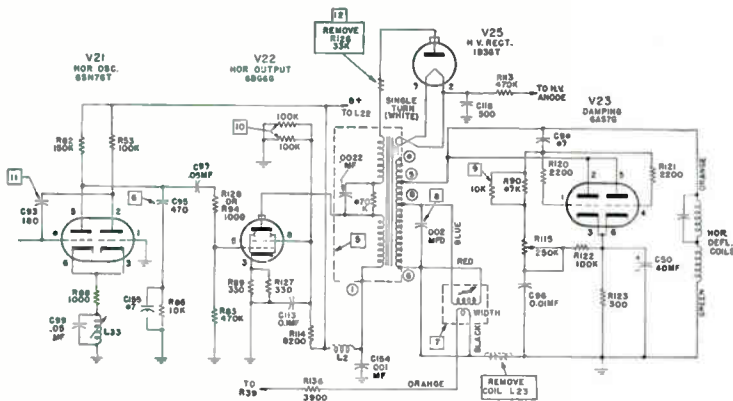

Fig. 5. General Electric Model 802 horizontal oscillator and sweep circuit showing the changes which are numbered and enclosed in squares. These numbers refer to the same numbers listed under circuit changes.

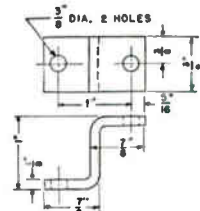
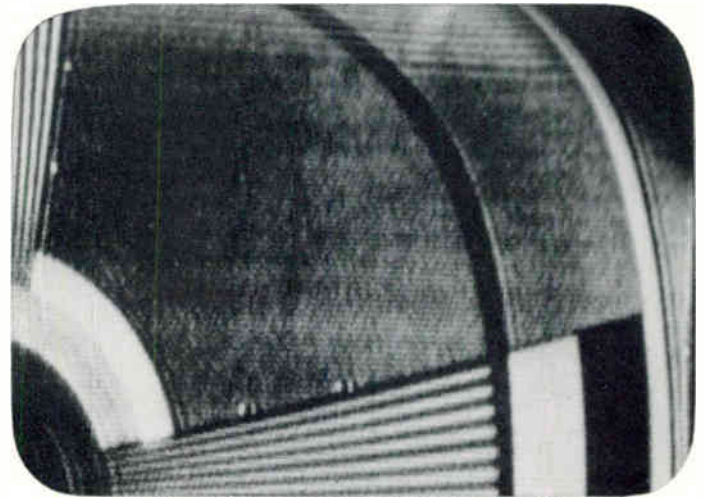

Fig. 6. Dimensions of the two angles which were used to hold the yoke and focus coil bracket assembly in place on the General Electric Model 802.

Tele-Clues

FILE THIS SHEET IN YOUR TELE-CLUE BINDER



Tele-Clue A81. The vertical foldover which can be seen at the right side both top and bottom was due to a defect in the vertical windings of the deflection yoke on a General Electric Model 802. Several vertical retrace lines were visible near the top and extended about one-inch down from the top. These could not be eliminated by adjusting the vertical hold, vertical linearity or height controls. Ordinarily a short in the vertical coils will result in a keystone effect similar to Tele-Clue No. A-21. This effect was not noticeable in this photograph, however a new yoke corrected the defect.

Tele-Clue A82. This is an enlarged view of the top right hand corner of Tele-Clue No. A81 which shows the foldover and vertical retrace lines which could not be eliminated.

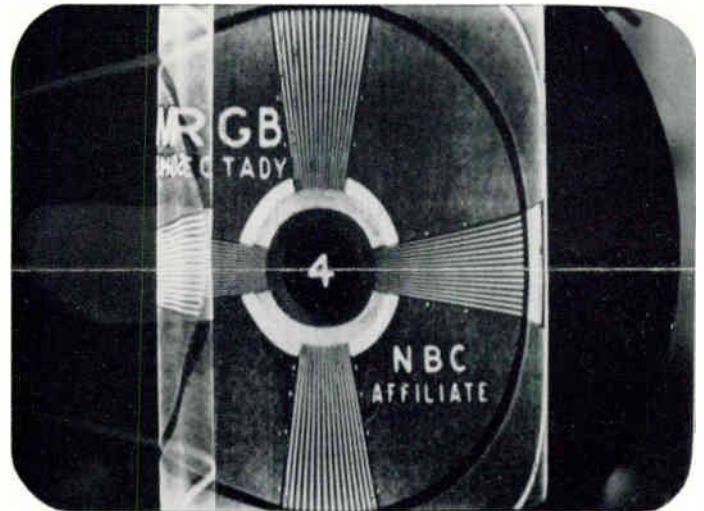
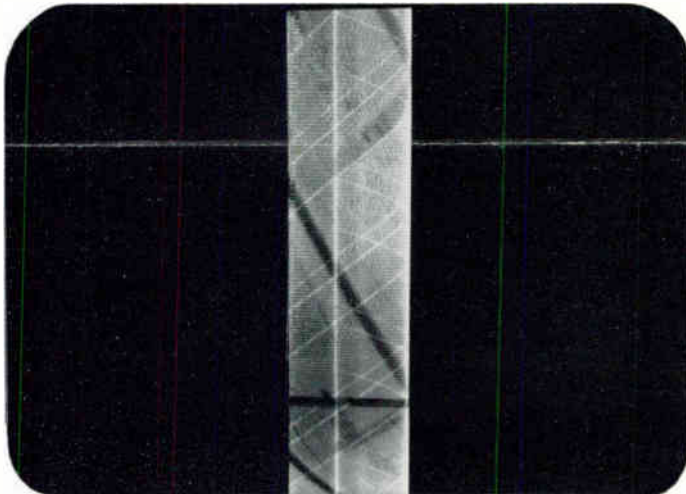

B 107

Tele-Clue No. A83. This illustrates another unusual defect in the deflection yoke. In this case the width is reduced and again without any noticeable keystone effect. This photograph was taken of a Westinghouse Model 619T12 chassis V2150-176. This same chassis is also used in Model 617T12. The horizontal output circuit for this receiver is shown in Fig. 1.

Tele-Clue No. E84. This shows the effect of removing the 6W4-GT damper tube in the circuit shown in Fig. 1. Ordinarily the removal of the damper tube results in a reduction of the high voltage to a point where little or no illumination of the screen is visible. In this circuit however, the high voltage was not noticeably reduced and there was a gradual change which took place during a two minute period after the damper tube was removed. After this period the test pattern appeared like Tele-Clue No. E85.

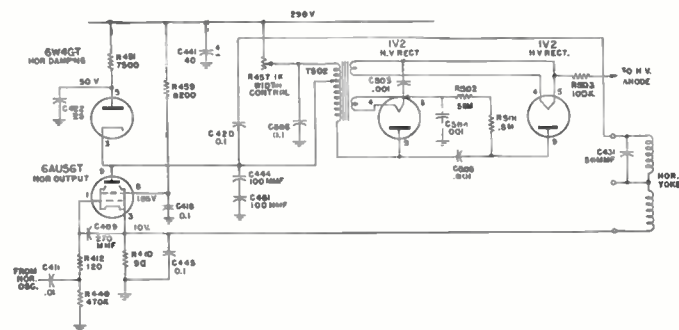
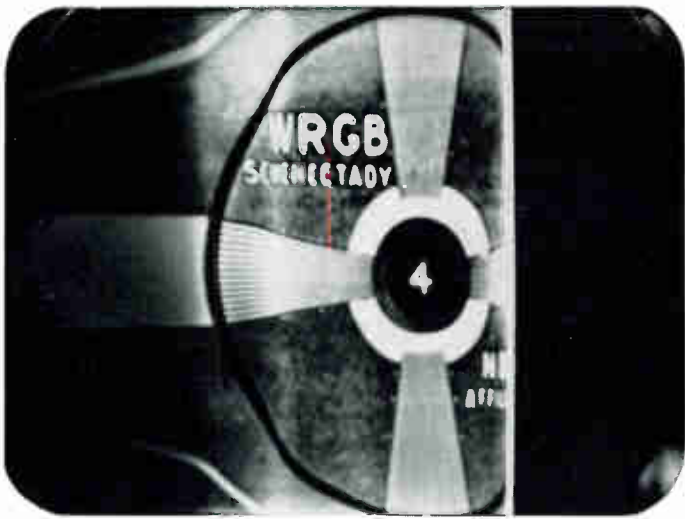

Fig. 1. Horizontal output circuit used in Westinghouse models H617-T12 and H619T12 chassis V2150-176.

THIS page of Tele-Clues has been punched for insertion in your Tele-Clue binder. These binders which contain eighty Tele-Clues and an index sheet are available through your local G-E or Ken-Rad tube distributor.

The letter which precedes each Tele-Clue number identifies the circuit in which the defect exists. Please enter the Tele-Clue number in the proper column on the index sheet according to the key letter which precedes each number.



Tele-Clue No. E85. This photograph was taken about two minutes after Tele-Clue No. E84. There was a gradual change to each side of the test pattern until it looked like the above photograph. The test pattern looked like this as long as the damper tube was out of the circuit.



Tele-Clue No. C86. This is a somewhat unusual defect which could take a considerable amount of time to run down. The picture was very dark and looked as if the contrast control was advanced too far. This control however, had no noticeable effect on the picture. The horizontal sync was critical and the vertical would jump a frame quite frequently. This condition was caused by a leaky capacitor C290 in Fig. 2. Because of this a positive voltage (50 V.) appeared on the picture tube grid. This circuit was used in the following General Electric TV receivers:

10T1	10C101	12T4
10T4	10C102	12C107
10T5	12K1	12C108
10T6	12T3	12C109

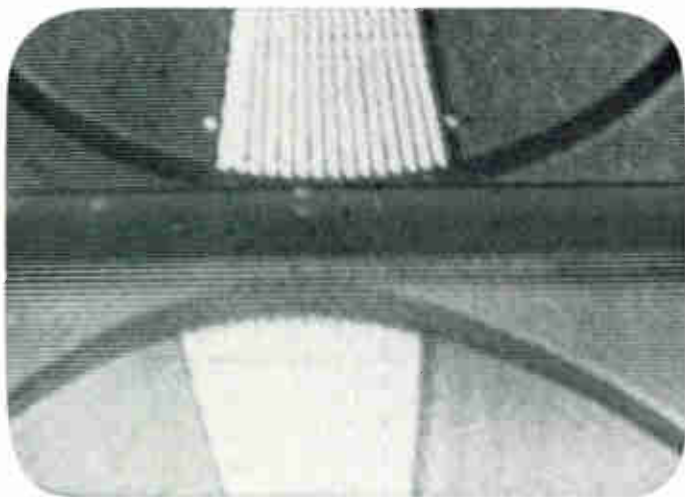

Tele-Clue No. C87. This is an enlarged view of the area between the frames shown in Tele-Clue No. C86. The vertical sync pulse has disappeared completely. This area should appear like that shown in Tele-Clue No. C88.

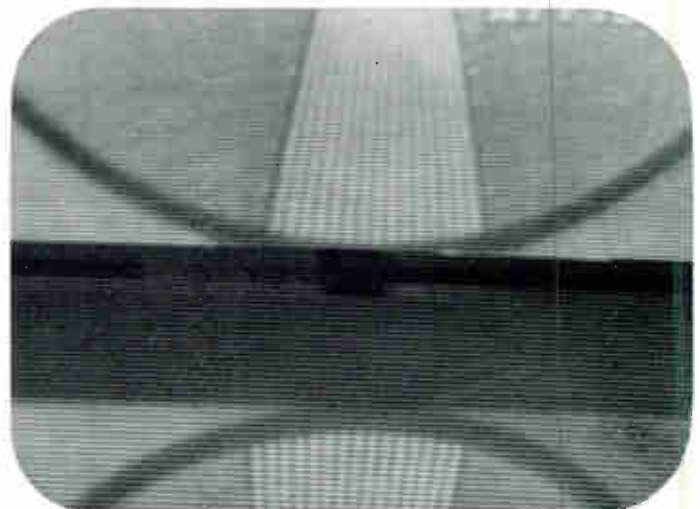

Tele-Clue No. C88. This photograph shows a normal vertical sync pulse as it should appear between frames. If this is compared with Tele-Clue No. C87 only three dots appear in the area where the vertical sync pulse should be. A discussion of the synchronizing pulses and their functions appeared in the Vol. 2 No. 1 issue of Techni-talk.

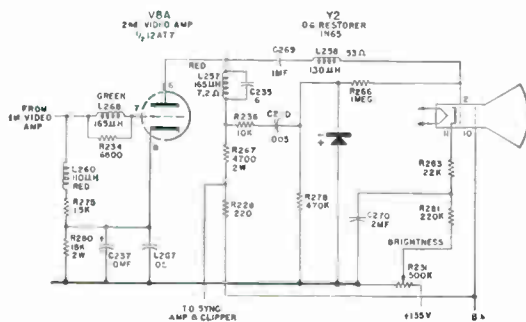

← **Fig. 2.** Video amplifier and d-c restorer circuit used in the General Electric receivers shown under Tele-Clue No. C86.

TELE-TIPS

40. A piece of scotch tape placed at the edges of the raster will provide an easily removed marker when making circuit changes to obtain more width or height.

41. The substitution of a 6V6-GT for a 6K6-GT in the vertical output circuit will usually provide additional height.

42. Noise in Dumont Input tuner can usually be eliminated by cleaning the contact surfaces with carbon tet.

43. Raster flashing in G-E Model 805 series U and W

version receivers caused by automobile ignition in weak signal areas can usually be eliminated by transferring the B- end of R276, which is the 2.2 megohm grid resistor for the 12AT7 second video amplifier (V8B), to pin 7 of the 6AL5 (V22) discriminator tube, and by connecting a 120 ohm one-half watt resistor between pin 8 of the 12AT7 (V8B) and B-.

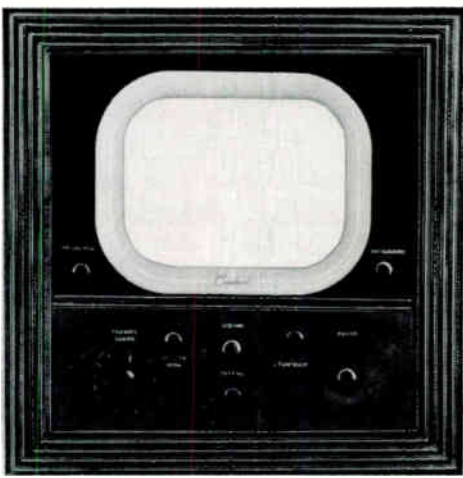

Fig. 7. Capehart-Farnsworth ten inch Model 651P before conversion.

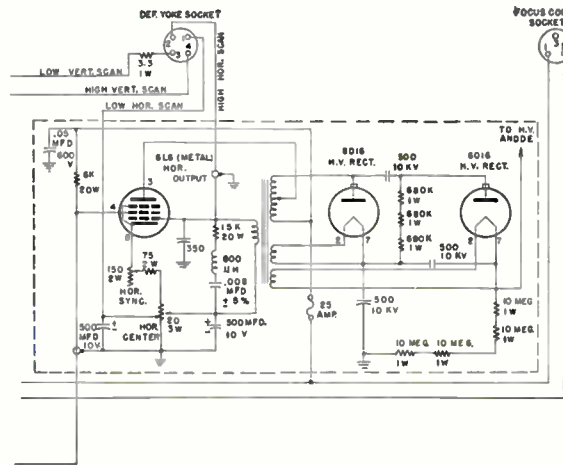

Fig. 8. Original horizontal sweep output circuit used in Capehart-Farnsworth Model 651P. The components within the broken line were replaced.

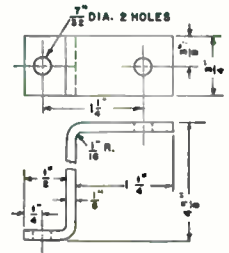

Fig. 9. Dimensions of the four angles which were used to hold the yoke and focus coil bracket assembly in place on the Capehart-Farnsworth Model 651P.

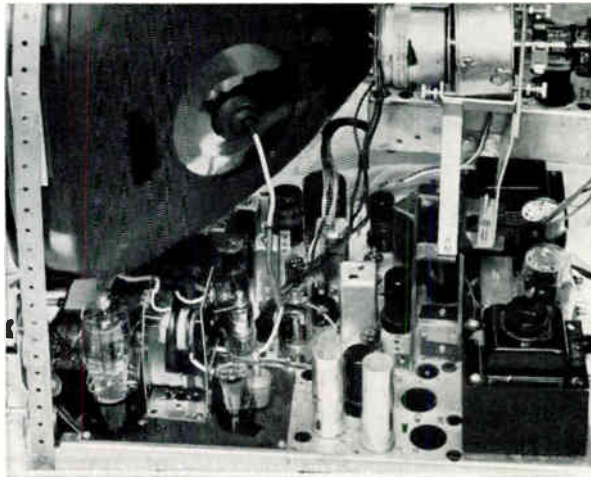

Fig. 10. Capehart-Farnsworth Model 651P showing the placement of the new horizontal components and the brackets supporting the deflection yoke and focus coil assembly.

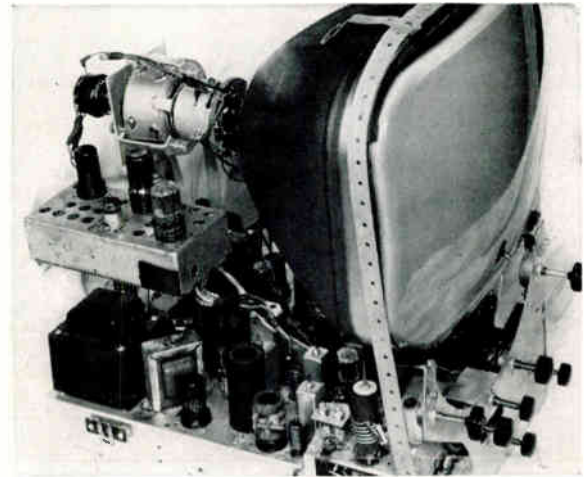

Fig. 11. This view shows the completed conversion of the Capehart-Farnsworth Model 651P with the sub-chassis mounted in its new location. The steel strap which is used to hold the picture tube in place and also to ground the anode coating is also visible.

(Continued from page 2)

- 1—General Electric 16KP4-A aluminized picture tube
- 1—General Electric RLD-025 deflection yoke
- 1—General Electric RTO-085 horizontal sweep transformer
- 1—General Electric RTO-064 vertical output transformer
- 1—General Electric RET-003 ion trap magnet
- 1—General Electric RLD-014 linearity control
- 1—Stancor P3061 6.3 volt 6 amp filament transformer
- 1—9 pin miniature socket
- 4—1½" right angles

- 4—angles as shown in Fig. 9
- 1—400 mmfd capacitor 600V
- 1—500 mmfd capacitor 20KV
- 2—.5 mfd 600V capacitor
- 1—.005 mfd 600V capacitor
- 2—.05 mfd 600V capacitor
- 1—.02 mfd 600V capacitor
- 1—1 megohm 1 watt resistor
- 1—330 ohm 1 watt resistor
- 2—330 ohm 2 watt resistor
- 2—30,000 ohm 2 watt resistor
- 1—1500 ohm 2 watt resistor
- 1—6CD6-G General Electric tube
- 1—6W4-GT General Electric tube

- 1—6BL7-GT General Electric tube
 - 1—1X2-A General Electric tube
- List prices of the foregoing parts, at date of publication, totaled \$120.35. However, allowance should be made for any local differences due to transportation costs, etc.

The following changes were made to the chassis:

- 1. The sub-chassis which was mounted above the high voltage section was removed. The plate which was used as an outside support was also removed.

(Continued on page 6)

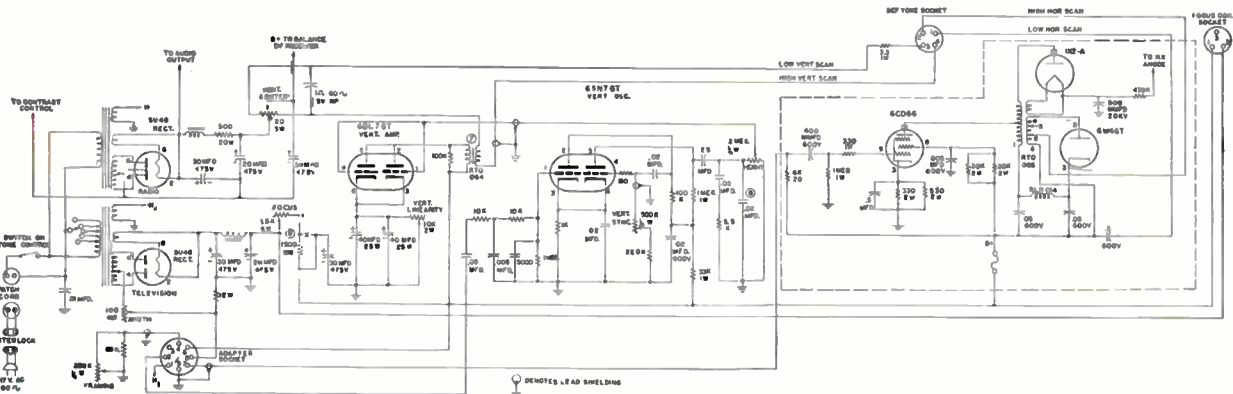

Fig. 12. Vertical and horizontal circuits showing the changes made to sweep a 16KP4-A picture tube. The portion enclosed in the broken line was completely changed. The other circuit changes numbered 7, 8 and 9 which are encircled refer to the same numbers listed under the circuit changes.

BENCH NOTES

Contributions to this column are solicited. For each question, short-cut or chronic-trouble note selected for publication, you will receive \$10.00 worth of electronic tubes. In the event of duplicate or similar items, selection will be made by the editor and his decision will be final. The Company shall have the right without obligation beyond the above to publish and use any suggestion submitted to this column. Send contributions to The Editor, Techni-talk, Tube Division, General Electric Company, Schenectady 5, New York.

DEMAGNETIZER

Screwdrivers, watches, drills and a number of metal things around the work bench become magnetized by working too close to permanent magnets. This may be annoying, especially when repairing tape and wire recorders and adjusting TV picture tubes. A simple remedy is to remove half of the laminations from an old filter choke and connect the choke to a 115 volt a-c line. The magnetized article is then passed over the field of the choke. Be sure to remove article from the field before shutting off the current.

Edw. G. Linden
300 No. Windsor Blvd.
Los Angeles, Calif.

SOLDERING AID

When you have to solder a wire that is hard to get at and you don't want to get solder all over it, just use a No. 2 pencil and cover the portion of wire not to be soldered with pencil lead.

Larry's Repair Service
5538 Vancouver
Detroit 4, Michigan

SYNC IMPROVEMENT

When the General Electric 810 is used in a fringe area, horizontal sync will be stabilized and a better picture will result if the 12AU7 video amplifier tube is replaced by a General Electric 12AT7 tube.

N. E. Hart
Hart Radio Shop
125½ W. Dixie Ave.
Elizabethtown, Ky.

TIMESAVER

If difficulty is experienced in putting a screw or nut into a hard-to-get-at place, try dipping the tool in soldering paste. This will hold it securely enough to get started.

Ever Ready Television Co.
2719 Mermaid Ave.
Brooklyn 24, N. Y.

(Continued from page 5)

TWO 10-INCH CONVERSIONS (Cont'd)

2. The horizontal sweep transformer, 6L6 and both 1B3-GT tubes, together with all of the component parts shown within the broken lines in Fig. 8, were removed. These included the bakelite panel containing several resistors and high-voltage capacitors as well as the horizontal sync and horizontal centering controls which were mounted on the rear apron of the chassis.

3. The RTO-085 horizontal sweep transformer, HV capacitor and 1X2-A socket were mounted as shown in Fig. 10.

4. The circuit shown within the broken lines in Fig. 12 was then used to wire the horizontal sweep circuit. The original 6L6 socket was used for the 6CD6-G tube, and the outside 1B3-GT socket for the 6W4-GT tube. The other 1B3-GT socket could not be used for the high-voltage rectifier as the increased voltage (14KV) caused an arc between the socket terminals and chassis. The RLD-014 linearity control was mounted in the hole previously used for the horizontal centering control.

5. A separate transformer P-3064 was used to supply the filament voltage for the 6CD6-G and 6W4-GT tubes. This was necessary because the additional current drain of 3.7 amperes would overload the power transformer.

6. The original deflection yoke was removed and replaced with a General Electric RLD-025 yoke. A General Electric RLD-024 with the focus coil bracket removed can also be used. The new yoke was slightly smaller than the original so three pieces of sponge rubber were used between the mounting strap and yoke.

7. The vertical output transformer was replaced with a General Electric RTO-064 transformer, and the 6SN7-GT vertical amplifier tube was replaced with a 6BL7-GT tube. This increased the height without foldover.

8. A .02 mfd capacitor was connected between the height control and ground as shown in Fig. 12. This corrected the vertical linearity which was stretched in the center and compressed at the top and bottom.

9. A 1500 ohm two watt resistor was inserted in the focus control circuit to extend the range of this control.

10. Four 1½" right angle brackets, which can be obtained at any hardware store, were used to support the front of the picture tube. Two one-inch square pieces of three-eighths inch thick sponge rubber were cemented to the top of each pair of angles to absorb shock. The mounting position of these angles can be seen in Fig. 11.

11. Four brackets, the dimensions of which are given in Fig. 9, were made and used to mount the deflection yoke and focus coil bracket four and five-eighths inches higher and one and one-quarter inches in back of the original position. These can be seen in Fig. 10.

12. The picture tube was mounted in position and held in place with a piece of steel strap which can be seen in both Fig. 10 and Fig. 11. Two five-inch pieces of this same metal strap were used to ground the graphite coating of the picture tube. One of these is visible in Fig. 11.

13. The sub-chassis was remounted on the opposite side of the chassis as can be seen in Figs. 10 and 11.

14. The picture tube socket wires were lengthened by about five inches.

15. A slight horizontal foldover was eliminated by using a piece of 75 ohm twin-lead eighteen inches long and connected as shown on page 4 of the Vol. 2, No. 6 issue of Techni-talk. The 47 mufd capacitor did not have to be removed. The twin-lead can be seen connected between the yoke and picture tube socket in Fig. 12.

After final adjustments were made with a test pattern on, the conversion was complete.

While these circuit modifications have been carefully tested, the General Electric Company can, of course, assume no responsibility for the application of these suggestions to the conversion of any particular receiver. General Electric offers this article as a suggestion of one possible way of making the conversion but it does not represent that this is the only way or the best way of accomplishing the conversion.

In the next issue conversion information on two more television receivers will be included.

DO YOU HAVE Tele-Clues?

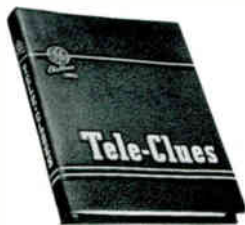

A must for every service dealer, this new bound edition gives you instant, at-your-fingertip reference to all Tele-Clues published. Kept up-to-date, too, through free insert sheets included in Techni-talk.

SEE YOUR G-E OR KEN-RAD
TUBE DISTRIBUTOR NOW!

Electronics Department
GENERAL ELECTRIC
Company
Schenectady 5, N. Y.

Sec. 34.66 P.L.&R.
U. S. POSTAGE
PAID
Schenectady, N. Y.
Permit No. 148

Mr. Wm. E. Malmsten
Malmsten Radio & Elec. Sales &
Service Company
3715 Glendale Terrace
Minneapolis 10, Minn.
2-17-50

POSTMASTER: If addressee has moved and new address is known, notify sender on Form 3547, postage for which is guaranteed. When Form 3547 is sent abandon this mailing. Return only if no correct address is available.