



RADIO TUBES

Techni-talk

on AM, FM, TV Servicing

Copyright 1949 by General Electric Company

THE HEAD-END—2

In the previous issue it was necessary due to space limitation, to split the head-end article in the midst of the trouble shooting procedure. The following, therefore, is a continuation of the previous article together with a discussion of the IF System.

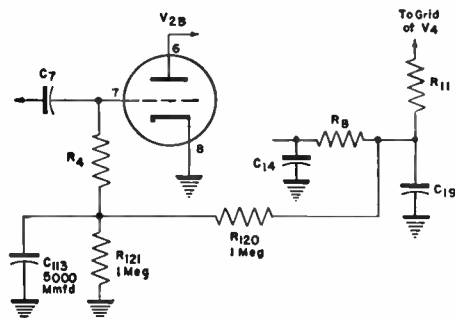

Fig. 1. Circuit modification to eliminate buzzing in G-E Models 810, 811 and 814 receivers

TROUBLE SHOOTING

An a.m. signal generator, or a sweep signal generator can be used as a signal tracer with the picture tube and the speaker supplying either the sight (dark horizontal bars) or sound (hum or 400 cycle note) indication. A 500 mmfd condenser should be used between the signal generator cable and the test points. The frequency used should be the one normally found at that point. For instance at the combination sound and video IF amplifier grid or plate and also at the mixer plate, the sound and video IF frequencies should be inserted. At the mixer grid insert the sound carrier, and video carrier. The oscillator frequency can also be inserted at this point as long as there is some other signal present for it to heterodyne with—this can be either a television broadcast signal or a second signal generator. At the r-f plate, r-f grid, and antenna terminals insert the sound carrier and video carrier frequencies. Either the fundamental frequency or if necessary the first or second harmonic may be used. The oscillator frequency can be determined if the IF frequencies are known, by adding either the sound IF frequency to the sound carrier or the picture IF frequency to the picture carrier. The picture carrier frequency can be found by adding 1.25 mc to the lowest channel frequency and the sound carrier by subtracting .25 mc from the highest frequency e.g., Channel 3 frequency 60-66 mc, Picture Carrier (60.0 mc + 1.25 mc = 61.25 mc), Sound Carrier (66.0 mc - .25 mc = 65.75 mc).

Another check which will indicate whether

or not the oscillator is functioning is a voltage check at the oscillator grid (if accessible) using a vacuum tube voltmeter. The voltage readings should range from about 1 to 12 volts depending upon the circuit design and channel. The above tests should help to locate the particular circuit within the head-end, which is not operating properly and it should then be reasonably easy to locate the defective part.

If noise should develop in the head-end assembly on G-E Models 810, 811 and 811 it can usually be cured by disconnecting and removing the head-end unit from the chassis and carefully cleaning the contacts with alcohol. Do not use carbon tetrachloride as it will act as a thinner if any gets onto the oscillator line tuning control which is made of polystyrene.

A piece of rubber band inserted between the oscillator wafer and the shaft will also materially help to eliminate noise and frequency shift caused by wobble or play in this section. The rubber band can be inserted by holding the ends of a piece of fine wire together (the type used on shipping tags works very well) and inserting the loop between the shaft and the wafer. A piece of rubber band is then inserted into the loop and pulled through resulting in a rubber cushion effect which is usually more satisfactory than the application of cement for this purpose. It is not advisable to tighten the nuts on this assembly as the increased pressure may cause one or more of the fiber sections to crack making the replacement of the entire assembly necessary.

In some cases, particularly in areas where an exceptionally strong signal is received from a high frequency station, a low frequency buzzing sound may appear with the audio signal. This may be due to the vertical sync pulses causing the converter grid to draw current which in turn, frequency modulates the oscillator voltage at the vertical pulse rate (60 cps.).

A circuit modification which has been used effectively on G-E Models 810, 811 and 814 to eliminate this buzzing is shown in Fig. 1 which applies bias developed in the a.v.c. circuit to the converter grid. If this type of change is necessary, care must again be exercised in order that the alignment is not affected. If any leads are moved they should be returned to their original position and the 5000 mmfd capacitor should be dressed as far away as possible from the oscillator trimmer.

Another method, which may or may not be practical depending upon the signal strength of the other stations, is the use of a resistance pad as shown on page 2 of the April-May issue. This will of course reduce the signal strength

on all channels which somewhat restricts its use.

Another method which will attenuate only the desired channel makes use of individual loading of the r-f amplifier plate coil by resistance. If this method is used, a resistor of 1000 ohms for Channels No. 2 through No. 6, or 100 ohms for Channels No. 7 through No. 13, is soldered directly across the r-f plate coil of the channel which is giving the buzz modulation. Lower resistance values in each case will give greater attenuation if needed. The r-f plate coil is connected between the selector switch rear wafer and the adjacent switch ground plate. This connection will not appreciably affect the alignment because of the damping effect of the resistor.

The above circuit modifications although suggested for G-E receivers may also be used in similar circuits of other receivers.

THE IF SYSTEM

We have so far followed the television signal through the head-end to the plate of the mixer tube. At this point we have two signals: one containing the audio information and the other the video information. In some receivers the audio signal is removed in the plate circuit of the mixer tube whereas others take advantage of the amplification afforded by one or more video IF stages before taking off this signal.

There are a number of different types of tuning systems employed in IF amplifiers as shown in Figures 2A, 2B and 2C. The circuit in Fig. 2A has both impedance coupling in the plate circuit of the 1st IF amplifier and transformer coupling, with both primary and secondary tuned, in the 2nd IF amplifier. Figures 2B and 2C are also single tuned impedance coupled amplifiers; Fig. 2B being center tapped, and Fig. 2C incorporating inductively coupled absorption type wave traps which will be discussed in detail later. There are other types of IF transformers which use condensers to tune either the primary or secondary or both; these are similar in diagrammatic appearance to the standard a.m. type IF transformer.

Some IF transformers are designed to pass a broad band of frequencies similar to Fig. 3A. In order to obtain this type of band pass it is necessary to overcouple the primary and secondary coils of each IF transformer and it may also be necessary to load one or both coils by connecting a carbon resistor across the windings as shown in the grid circuit of the 3rd IF in Fig. 2A.

The IF system may also be designed so that each coil tunes to a different frequency similar to Fig. 4. This is known as "stagger tuned" IF system and the over-all response is

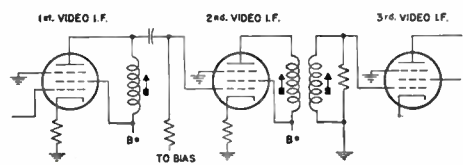

Fig. 2A

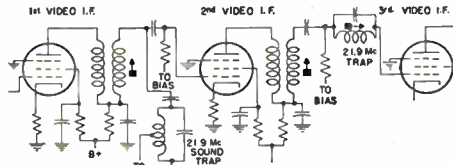

Fig. 2B

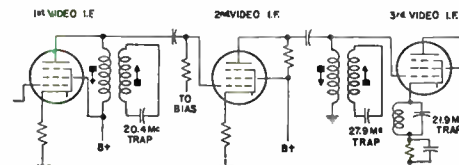

Fig. 2C

Typical IF circuits found in TV receivers



Fig. 3A. IF response curve without trap circuits

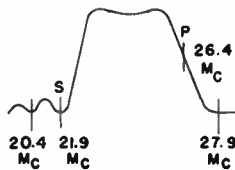

Fig. 3B. IF response curve showing the result of trap circuits

the product of each individual coil response shown as separate curves. This results in a curve similar to the one shown by the shaded area. The coils shown in Figures 2A and 2C are part of stagger tuned systems.

The bandwidth or pass band of the IF system will vary from about 2.0 mc up to a full 4.0 mc in different types of receivers. Generally, the more expensive type of receiver will have a wider pass band than the less expensive type. Receivers with seven inch tubes do not require fine detail since it would be impossible to see it at the usual viewing distance. This does not hold true in projection type receivers which have even smaller picture tubes. These tubes are capable of excellent detail due to the use of extremely high anode voltages. The result is a spot considerably smaller in size than is present in direct view receivers. In order to increase bandwidth it is necessary to sacrifice gain, therefore, more stages of amplification are required, and this is another reason why the lower priced receivers have a narrower band pass than the more expensive types.

TRAP CIRCUITS

TV receivers use a number of various types of trap circuits to absorb unwanted frequencies. The Video Carrier Set Trap for instance found in the top left hand corner of Page 2 in the June-July issue is used as a series resonant circuit and is adjusted so that the video carrier falls at the 50 per cent point on the video IF curve. The series type trap circuit shown in

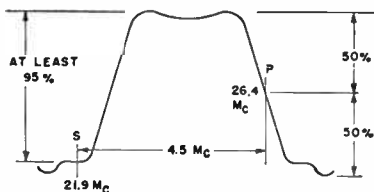

Fig. 5A. IF response curve of Intercarrier System

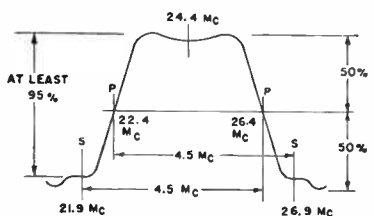

Fig. 5B. IF response curve of Intercarrier System with oscillator operating both above and below carrier frequencies

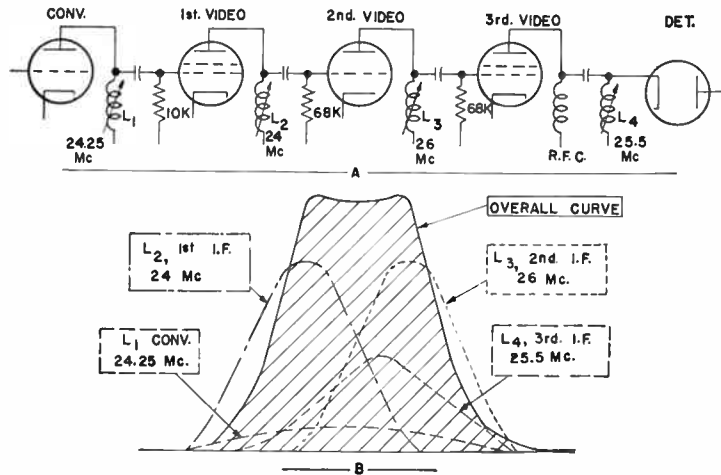

Fig. 4. IF response curve and circuit for a stagger tuned IF system

the secondary of the 1st video IF transformer of Fig. 2B is tuned to 21.9 mc and is used both to prevent the sound frequency from being passed through the video IF amplifiers and to take off the sound frequency which is fed to the sound IF amplifiers. The other series type trap in the grid circuit of the 3rd video IF also in Fig. 2B is used to absorb any 21.9 mc sound frequency which might still be present at this point.

The absorption type trap found in the 1st IF plate circuit of Fig. 2C is tuned to 20.1 mc to eliminate possible interference from the video carrier of the adjacent higher channel. If we assume that a receiver is tuned to Channel No. 3, the oscillator frequency of 87.65 mc (61.25 mc + 21.40 mc) will beat against the video carrier 67.25 mc of channel No. 4 producing a difference frequency of 20.4 mc which is close enough to the band pass of the video IF system so that it may produce picture interference. The trap in the grid circuit of the 3rd IF is tuned to 27.9 mc which is the difference frequency resulting from the oscillator beating against the sound carrier 59.75 mc of Channel No. 2 which is the adjacent lower channel (87.65 mc - 59.75 mc = 27.9 mc). This type of interference would only be present of course in areas where reception is possible from cities which have been assigned adjacent channels.

The parallel resonant type trap inserted in the cathode circuit of the 3rd IF tube in Fig. 2C is tuned to the sound carrier frequency of 21.9 and will reject any audio IF signal which is present at the grid of this tube. The purpose of this trap is the same as the aforementioned trap in the grid circuit of Fig. 2B.

The result on the IF response curve of these different types of trap circuits can be seen by comparing Fig. 3B with Fig. 3A. By rejecting these unwanted frequencies the skirts on both the low and high sides are considerably steepened. The result is a curve which more closely resembles an ideal. If one or more traps are incorrectly tuned to a frequency within the IF pass band, sharp dips will appear on the curve resulting in a considerable loss in picture quality.

INTERCARRIER SOUND SYSTEM

The Intercarrier Sound System is appearing in more and more of the new TV receivers. It is important, therefore, that the technician have an understanding of the principle differences which exist in receivers having this type of sound system. The head-end of the Intercarrier Type receiver is usually the same as the conventional type. In the output of the mixer we know that two signals are present as a result of the mixing action of the local oscillator with the video carrier and the sound carrier. These

two carriers are always 1.5 mc apart and must be maintained with ± 0.002 per cent of their standard frequency in order to conform to FCC standards. The full band of frequencies including the sound carrier are amplified by the IF system and the response curve at the input to the video detector is similar to Fig. 5A. The only apparent difference when Fig. 5A is compared with the conventional curve Fig. 3B is that the slope is less steep, and the sound IF frequency of 21.9 mc instead of being completely attenuated is located at about the center of a step in the slope. These differences are due to the elimination of the sound trap circuits.

One of the important requirements for the operation of this system is the shaping of the video IF amplifier passband so as to obtain the proper voltage ratio between the video IF carrier and the sound IF carrier at the input to the video detector. In this system the video detector acts as a mixer for the two carrier frequencies and the resultant beat frequency takes on the characteristics of the weaker of the two signals. Therefore, the input to the second detector must be properly dominated by the picture IF carrier as indicated in Fig. 5A. When the picture carrier is down 50% from maximum, the sound carrier must be attenuated approximately 95 per cent or more. This relationship must be maintained whenever this type of receiver is serviced or aligned.

The output of the video detector is fed into one or more video amplifiers and at some point a 1.5 mc trap is used to pick off the f.m. sound signal which is then fed to the sound section of the receiver. This trap also prevents the sound IF from interfering with the picture signal.

LOW SIDE OSCILLATOR

Some Intercarrier receivers obtain more stable oscillator operation by having the oscillator operate above the carrier frequencies on channels 2 thru 6 and below the carrier frequencies on channels 7 thru 13. In the following table only two low frequency and two high frequency channels are used to illustrate the frequencies found in receivers of this type.

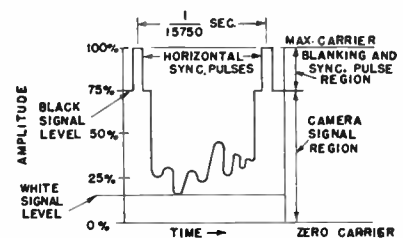

Fig. 6. Typical video signal with white signal at 15% level

Channel Number	Picture Carrier	Picture Carrier IF Frequency	Oscillator Frequency	Sound Carrier	Sound Carrier IF Frequency	Oscillator Frequency
5	77.25 mc	+26.40 mc	= 103.65 mc	81.75 mc	-21.90 mc	-103.65 mc
6	83.25 mc	+26.40 mc	= 109.65 mc	87.75 mc	-21.90 mc	-109.65 mc
7	175.25 mc	-22.40 mc	= 152.85 mc	179.75 mc	-26.90 mc	-152.85 mc
8	181.25 mc	-22.40 mc	= 158.85 mc	185.75 mc	-26.90 mc	-158.85 mc

Figure 5B represents a typical IF response curve resulting from these oscillator frequencies. The amplification is the same whether the sound carrier is on the high side of the curve at 26.9 mc or on the low side at 21.9 mc. This is also true of the picture carrier which will be 50% down the slope whether it falls on the high side of the curve at 26.4 mc or on the low side at 22.4 mc. The frequency which falls in the center of the curve in either case is 24.4 mc.

It is practical to use this type of oscillator operation only in receivers with the Intercarrier Sound System for two reasons: First, due to the broad skirts on the IF response curve and second, due to the method by which the sound frequency develops from the two carriers mixing in the video detector. This mixing results in a 4.5 mc beat frequency which is accepted by the sound IF system regardless of whether the oscillator operates above or below the carrier frequency. The conventional receiver, however, has a sound IF system which would only pass one of the sound carrier frequencies.

The fact that the sound is a result of the 4.5 mc beat frequency should eliminate a rather frequent complaint of viewers which is the necessity of readjusting the fine tuning control one or more times after the receiver is turned on. This is due to the oscillator frequency drifting during the warm-up period. This drifting which was sufficient to affect the sound in conventional type receivers due to the comparably narrow pass band

(± 100 kc)* of the sound system. The same amount of drift even though present in an Intercarrier Type receiver does not affect the sound because only the position of the carriers on the IF response curve will change and a variation of 100 or even 200 kc on such a wide band width would not be noticeable.

Hum modulation and microphonics which usually originated in the local oscillator are also eliminated in the Intercarrier System. This is a result of both carriers being affected simultaneously without changing the 4.5 mc difference frequency.

It is also possible to obtain slightly better reception in fringe areas by adjusting the fine tuning control until the picture carrier is at the top of the slope instead of the 50% point. When this is done on conventional receivers, the sound is lost due to the change in sound carrier frequency, and the only solution is realignment of the sound IF's including the take-off trap. The sound on Intercarrier receivers, however, is not affected to any great extent by this shift as the difference frequency remains at 4.5 mc. However, the picture quality is affected by this change, but in fringe areas this is usually preferred to no picture.

*200 kc. may not seem to be a very narrow pass band, however, the oscillator is operating at some frequency in the range of 80 mc up to around 200 mc depending upon the channel selector and a one tenth of one per cent drift at 100 mc will shift the sound frequency 100 kc which is from the center to the edge of the audio pass band resulting in either distortion or complete loss of the audio signal.

One of the principal complaints of users of Intercarrier type receivers is a 60-cycle audio buzz. This may be due to the contrast control being set too high which results in the vertical sync pulses which occur at a 60 cps rate, driving the video amplifier tubes to cut off. Buzzing may also be caused by the transmitter over-modulating the video carrier. The present FCC regulations state that the minimum amplitude of the video carrier may not exceed 15 per cent of the maximum sync pulse amplitude as illustrated in Fig. 6. The regulations, however, do not specify a minimum percentage. A TV station may therefore in order to increase its area of reception and to improve contrast, choose to over-modulate the carrier so that when a white image is transmitted, the carrier may reach zero per cent. When this happens the Intercarrier audio signal is momentarily interrupted due to the absence of one of the carriers necessary for mixing action. The only practical ways to check for transmitter over-modulation is by comparison with another Intercarrier receiver or by switching to another TV station whenever possible.

TROUBLE SHOOTING IN THE IF STRING

Trouble shooting in the IF amplifiers can be accomplished by injecting the frequencies normally present from a signal generator as described in the head-end trouble shooting procedure. Particular attention should be paid to proper alignment so that carriers are in their proper position on the curves and also that the sound tuned circuits are properly aligned at 4.5 mc. The troubles usually found in a.m. IF systems such as open coils, resistors changing value, shorted condensers and misalignment may also be found in TV receivers.

In the next issue the video detector, video amplifiers and a.g.c. circuits will be discussed.

KILL THAT RETRACE

A considerable number of requests have been received for information on the retrace elimination circuit.

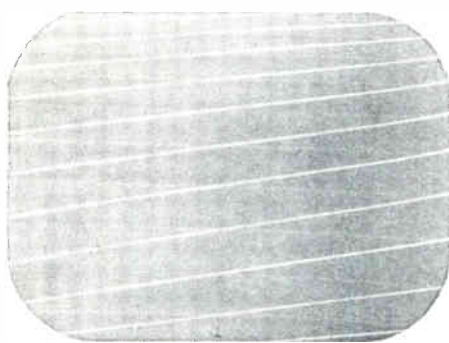

Fig. 1A. Scanning raster without retrace elimination circuit

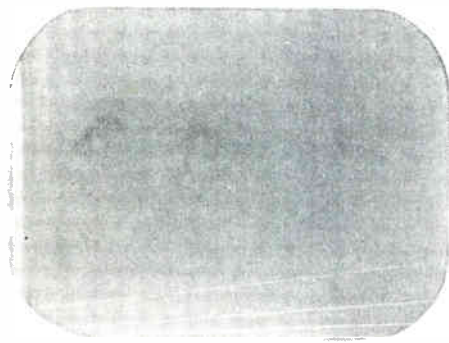

Fig. 1B. Scanning raster with retrace elimination circuit

tion circuit. Therefore, due to the importance and timeliness of this information, the "How to get the most out of your test equipment" article has been omitted in this issue. This series will be continued in the next issue with a discussion of the Vacuum Tube Voltmeter.

A change in cameras or program material at the transmitter will oftentimes result in the need for readjustment of the brightness or contrast control to remove retrace lines from the background of the picture. This may be objectionable to some viewers.

The retrace lines which appear on the scanning raster in Fig. 1A can be practically eliminated as shown in Fig. 1B by using a circuit which has been incorporated in recent model G-E receivers.

The basic circuit is shown in Fig. 2. Blanking pulses are picked off the vertical sweep output transformer and fed to the cathode of the picture tube biasing it to cutoff during the retrace period.

This circuit can be used on G-E receivers not already incorporating this change as well as receivers of other manufacture having vertical sweep output transformers.

The circuit shown in Fig. 3 has been successfully used on G-E Models 801, 802 and 803 to remove the retrace lines. The only difference between this circuit and the one appearing in Fig. 2 is that the point of injection is the grid instead of the cathode. If the blanking pulses are to be inserted into the cathode circuit they should be positive in polarity and if inserted into the grid circuit they should be negative in polarity. In either case the picture tube will be biased to cutoff. In order to obtain a pulse of the correct polarity the ground connection may have to be switched from the bottom of the vertical transformer to the top, in which case the blanking pulses would be taken from the opposite end.

The retrace elimination circuit will usually work on any receiver having a vertical sweep output transformer. In a few cases it may be necessary to experiment with condensers having a slightly different value in order to obtain maximum results. Due to the simplicity of the circuit however, it warrants consideration particularly in those cases where retrace lines are considered objectionable.

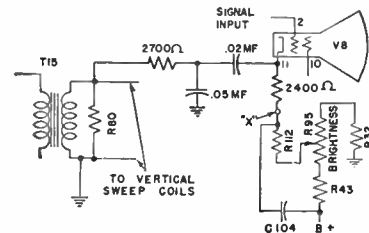

Fig. 2. Retrace circuit (heavy lines) used on G-E Model 810 type receivers which have the signal fed into the grid. "X" point was connected to cathode in original circuit

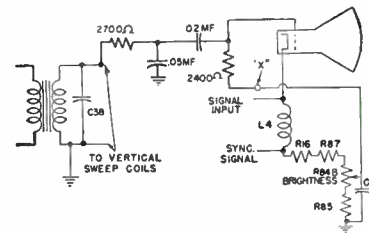

Fig. 3. Retrace circuit (heavy lines) used on G-E Model 801 type receivers which have the signal fed into the cathode. "X" point was connected to the grid in original circuit

BENCH NOTES

Contributions to this column are solicited. For each question, shortcut or chronic-trouble note selected for publication, you will receive \$10.00 worth of electronic tubes. In the event of duplicate or similar items, selection will be made by the editor and his decision will be final. Send contributions to The Editor, Techni-Talk, Tube Division, General Electric Company, Schenectady 5, New York.

BROKEN SLUG TUNING SCREWS

Frequently when adjusting tight plugs one side of the slotted screw breaks off. To repair simply screw on a one-fourth inch brass hex nut until flush with top of screw, then flow on solder to anchor in place. Adjustment can now be made with a standard one-fourth inch wrench or alignment tool.

We have found that adjustments can be made much more accurately and conveniently by this method since it eliminates most of the "play" and the nuisance of the screwdriver slipping out of the slot.

—William A. Pewitt, Jr.—Benton Radio & Recording Co., Kansas City, Mo.

OXIDATION ELIMINATION

To make a soldering iron tip last indefinitely I find that tinning with Silver Solder is very effective.

Silver Solder having a very high melting point resists the tendency of a soldering iron tip to Oxide.

A swipe of a rag is all that is needed to restore the tip to its original lustre.

—Joseph P. Burtis, St. Petersburg, Florida

EDITOR'S NOTE: This suggestion is considered very helpful to the busy service technician. It is felt, however, that some explanation regarding the actual tinning of the iron should be included. It will be necessary to heat the iron until it is red hot before either the flux or the silver solder will flow over the tip. The flame of the ordinary gas range can be used if the air valve is adjusted for maximum air intake. A gas-line blow torch can also be used if available. It was found

that silver solder coded B20 F5 flowed at the lowest temperature and was therefore easiest to use.

NEW SPEED FOR WEBSTER CHANGERS

Here's what might be termed a shortcut to playing the new 45 rpm recordings on the old Webster 56 and 156 record changers.

By removing the bushing on the motor shaft, the turntable will revolve at 45 rpm. Adding a 1½-inch spindle spacer as supplied by Webster for adapting their dual speed models, it is ready to handle these records with the addition of a G-E UPX-004 arm mounted on the changer chassis so that it will not interfere with the playing of 12-inch records automatically. This setup will then play 10- and 12-inch standard recordings automatically, and by removing the bushing, will play the new 45 rpm records, manually.

This could be a source of income for the serviceman, since the spindle spacer and extra arm can be obtained for less than ten dollars.

—William H. Olson, Arlington, California

EDITOR'S NOTE: In order to remove the motor shaft bushing it will also be necessary to supply the customer with a Bristol Key Wrench. This is the third smallest in G-E kit No. 5070.

PHONO NEEDLE INSERTION

Here is an idea that has helped me a lot in installing the newer type small phonograph needles. Just stick the needle into an eraser on the end of a pencil and insert it into the crystal cartridge. This saves time and sometimes the loss of a needle.

—Ken Simonson, Ventura, Calif.

SHOCK PROTECTION

When working on two or more A.C.-D.C. sets that are plugged into line, keep them well apart from each other on the work bench and don't put your hands on two set chassis at the same time as you may get a shock. The reason: one chassis may be at one side of line

potential, and the other chassis at opposite side of line potential. You will get a shock whether they are turned on or off. Don't take chances. Be safe by taking this precaution.

—Francis R. Pontonio, Chicago, Ill.

MORE TV QUERIES FROM THE PUBLIC (Con't)

Purchasers of TV sets have written to dealers regarding their troubles. The following excerpts were taken from some of their letters.

"Wednesday I could see the fighters' muscles ripple as they waltzed around the ring—last night I couldn't see their muscles ripple. Don't you think the set should be serviced?"

"My picture shakes as the train goes by—are you sure that it is not possible for the trains to finally shake the picture off the screen?"

"The service man said I would see ghosts on my picture. I have not seen any yet. Would you please send a service man to investigate why I can't see the ghosts?"

"My picture has moved over to the right so that part of it is behind the cabinet. Please send someone to push it around front where it should be."

"On one station I see snow and rain all the time. Where are they transmitting from?"

"I see four men fighting. There are two up front and two light men in back and a little over to the right. Please send someone to remove the two light men in the back."

ARE YOU PREPARED
FOR YOUR FUTURE?



Large second printing of TV
Service Course now on press
HAVE YOU SIGNED UP YET?

Printed in U.S.A.

Electronics Department
GENERAL ELECTRIC
Company
Schenectady 5, N. Y.

Sec. 34.66, P. L. & R.
U. S. POSTAGE
PAID
Schenectady, N. Y.
Permit No. 148

Boyd's Radio Service
411 Fredericksburg Rd.
San Antonio 1, Texas
E-223/J-75

6-13-49

POSTMASTER: If addressee has moved and new address is known, notify sender on Form 3547, postage for which is guaranteed. When Form 3547 is sent abandon this mailing. Return only if no correct address is available.