



# HAM NEWS

AMERICAN FACTORY  
APPLIANCE DEPARTMENT  
BOX 1721

TUBES

SEPTEMBER-OCTOBER, 1961

## TRANSMITTER PROTECTIVE CIRCUITRY

By Norman L. Morgan, W7KCS/9

*EVERY TRANSMITTER should have circuits designed into it to protect valuable components—and especially the transmitting tubes—against failure due to accidental overloads. Be safe—not sorry—with these low-cost circuits by W7KCS/9.*

Adequate protection of transmitting tubes is like taking out fire insurance for your home—it's pretty inexpensive compared with the cost of power components. Often power tube failures happen during initial testing when the builder is busily checking the transmitter operation and fails to notice damaging currents in expensive tubes.

Ideally the philosophy of protection should be that the tube can survive on only its own protective circuits, as shown in Fig. 1. With this idea as the objective in designing power supplies, only the usual precautions are needed to prevent excessive tube and component damage.

Electrical failures are caused by excessive element heating or element overvoltage. Excessive dissipation is generally a result of (1) loss of excitation, (2) failure of plate or bias supplies, or (3) excessive loading. Overvoltage is mainly a result of low voltage drop in series resistors when power is correctly applied to the tube.

Loss of excitation in unprotected circuits can cause damaging screen and plate currents. Protection is generally supplied by clamp tubes or fixed bias to cut off these currents. Although clamp tube operation is



NEAT STATION AT W7KCS/9, including the compact 250-watt CW and AM transmitter in which the protective circuits described in this article are installed. Transmitter covers 3.5 to 29.7 megacycles, and, except for commercial VFO and dial, is completely home made. Norm Morgan operates his transmitter mainly on the 21 and 28-megacycles bands. He is an Application Engineer with General Electric's Specialty Motor Department in Fort Wayne, Indiana. Norm has also authored several articles on electronic control circuits in trade magazines.

quite popular and is extensively used by many amateur designers, it must be realized that screen grid voltage variation is built in with these circuits. Clamp tubes usually operate with a dropping resistor which results in undesirable screen voltage changes so detrimental to good SSB operation of a linear amplifier.

On the other hand, the high reliability and positive protection of fixed bias to cut off currents allows the screen grid to be operated directly from a stiff power source to achieve the good voltage regulation necessary for class AB (triodes in class B) operation of the power amplifier.

Loss of plate voltage in tetrode or pentode tube essentially transfers plate current to the screen if it is separately powered, which generally results in excessive screen grid current and rapid failure.

Actual failure of the plate power supply is a rare phenomenon, but its effect is the same as when the high voltage power supply switch is accidentally switched off during operation. This is especially true during initial tune-up and neutralizing when the plate power supply may not be energized, although screen voltage may be accidentally applied along with power to exciter stages.

(continued on page 2)

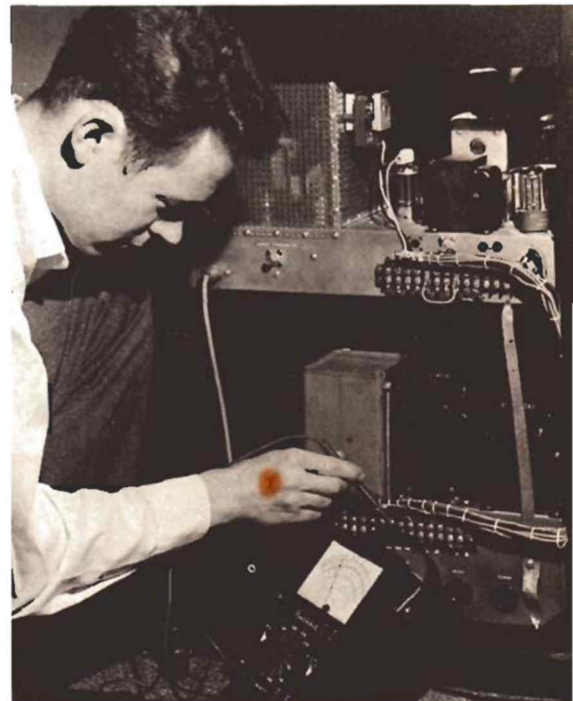

REAR VIEW of transmitter at W7KCS/9, with complete power supplies and modulator in lower unit, and RF exciter and power amplifier, and audio preamplifier in upper unit.

4A-4589 Chrysler

## IN THIS ISSUE

TRANSMITTER PROTECTIVE CIRCUITRY.....	page 1
INDUCTIVE TUNING FOR HIGH-C RF OSCILLATORS.....	page 4
SCANNING THE SPECTRUM.....	page 8
ANNOUNCING 10TH ANNUAL EDISON RADIO AMATEUR AWARD.....	page 8

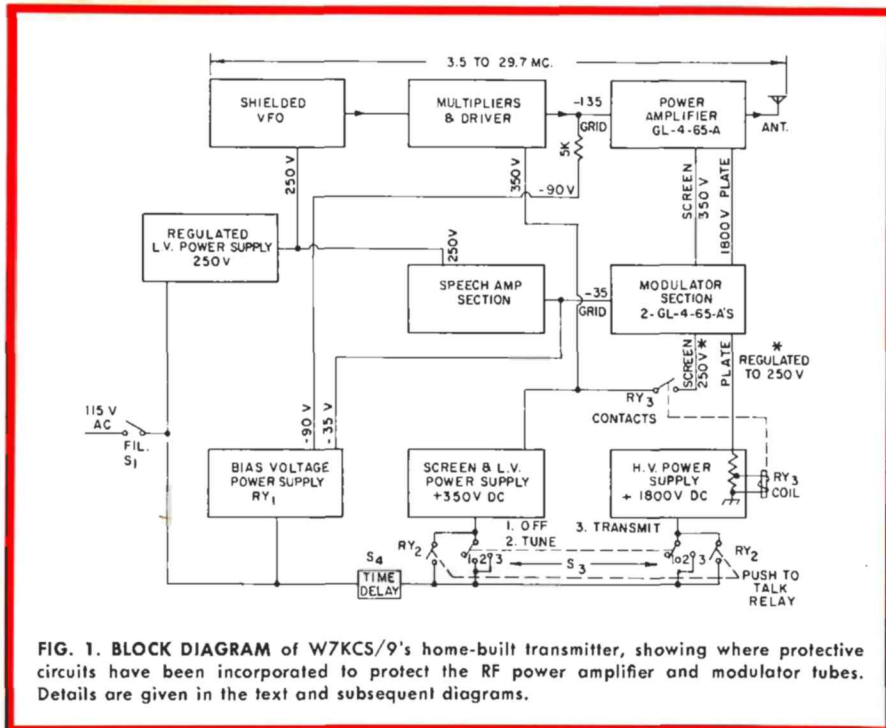

FIG. 1. BLOCK DIAGRAM of W7KCS/9's home-built transmitter, showing where protective circuits have been incorporated to protect the RF power amplifier and modulator tubes. Details are given in the text and subsequent diagrams.

**TRANSMITTER PROTECTIVE CIRCUITRY** (continued from page 1)

The two most used methods of preventing screen damage due to these circumstances are (1) screen dropping resistors or screen wattage limiting resistors, and (2) various current relays. The dropping resistor alone can cause screen grid failure through overvoltage resulting from low screen current.

The undesirable effects of poor screen grid voltage regulation through a dropping resistor can be partially offset by connecting a voltage regulator VR tube as shown in Figure 2. The wattage limiting resistor is chosen so that the screen grids cannot draw more than rated dissipation no matter what current they demand. The voltage regulating tubes maintain the 255 volt screen

voltage for all normal values of screen current.

Should the screen grid begin excessive current the limiting resistor drops the voltage, extinguishing the VR tubes and limiting the total dissipation of the screen grid to a safe level. Note that the screen grid should be operated somewhat less than maximum allowable wattage in order to leave some reserve for this action.

**SCREEN GRID OVER-CURRENT RELAYS** or plate voltage sensing screen relays allow the screen voltage to be supplied by a stiff power source. The screen grid current sensitive relay is probably the most positive method of preventing failure. It will disconnect screen voltage when the

screen grid current is excessive.

However, a less expensive method, the plate voltage sensing relay, protects the screen grid when plate voltage is not present and can be connected from the high voltage bleeder resistor to ground, as shown in Figure 2. The plate voltage will thus approach its full value before the screen power supply is connected to the tube screen grid. Unless there is plate voltage present, no screen voltage can be applied to the power amplifier or modulator tubes.

Failure of the negative control grid bias supply when it is used, is fortunately a rare occurrence. However, protection against this failure can be accomplished by installing relays in the plate and screen circuits which turn on these voltages only when bias voltage is present.

A push-to-talk switch can be connected in series with a voltage sensing relay which energizes the AC side of both the high voltage power supply and the screen power supplies. Notice in the schematic diagram of Fig. 2 that the voltage sensing relay is operated directly from the power amplifier grid bias source. Thus, plate and screen power cannot be applied unless grid bias is present. This relay in turn actuates the power relay which actually closes the primary AC circuits.

Since the coil current of the power relay is generally rather high it is advisable to use a small, low current relay in the push-to-talk circuit to actuate the power relay. Also, the power relay should be rated considerably higher than the normal primary current, since this current is largely inductive and may cause arcing and pitting of contacts on lower rated relays. Ideally, AC motor starting relays should be used to minimize these difficulties.

Damage to expensive power amplifier tubes can result from excessive plate loading, and can be pre-

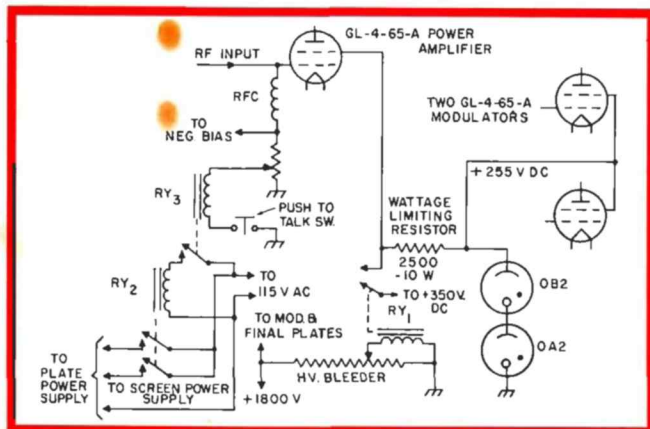

FIG. 2. SIMPLIFIED SCHEMATIC DIAGRAM of the basic protective circuits in the W7KCS/9 transmitter. High voltage plate supply cannot be turned on by RY<sub>2</sub> unless RY<sub>3</sub> is energized by the negative bias supply. Screen voltage is off until sufficient plate voltage energizes RY<sub>1</sub>.

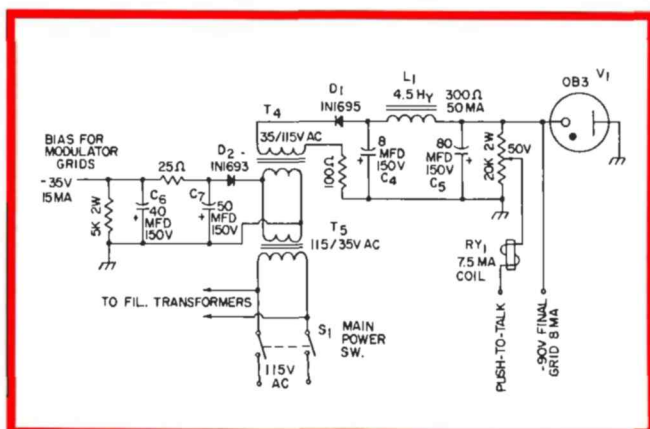
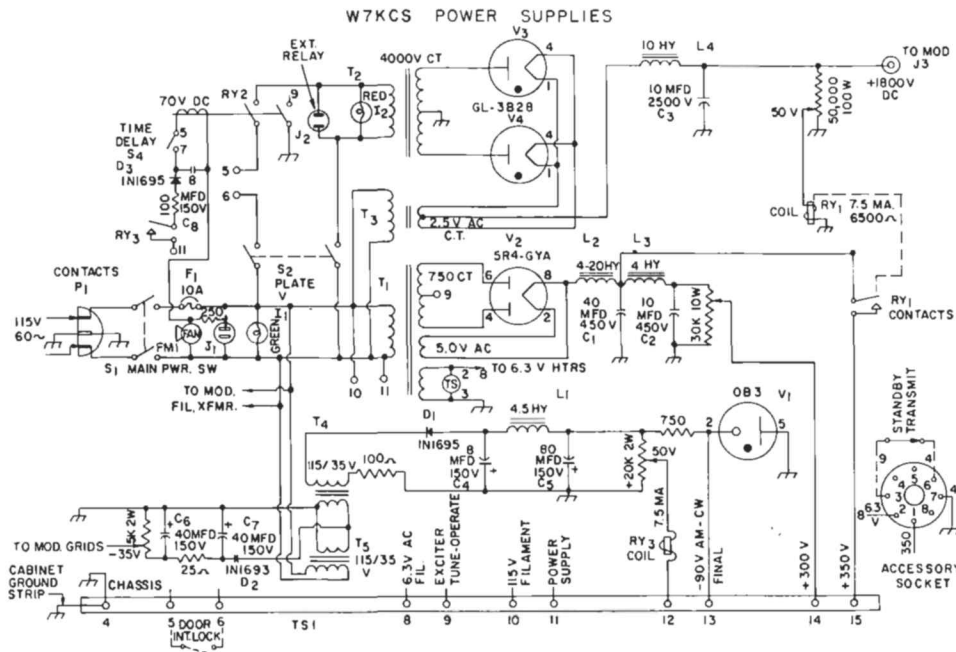

FIG. 3. SCHEMATIC DIAGRAM of the dual bias voltage supplies. Transformer T<sub>3</sub> and rectifier D<sub>2</sub> supply 35 volts negative bias for modulator grids. T<sub>5</sub> also supplies primary voltage for T<sub>4</sub>, a 90-volt regulated bias supply for RF power amplifier.



**FIG. 4. COMPLETE SCHEMATIC DIAGRAM** of protective circuits in the power supplies of the W7KCS/9 transmitter. Diagram includes the basic protective circuits shown in Fig. 3. Descriptions of components are given in TABLE I — PARTS LIST. Capacitances are in

microfarads (MFD); resistances are in ohms, with wattage ratings given for resistors over 1/2 watt. Relays RY1, RY2 and RY3 can have 5,000-ohm, 6-ma. coils; RY1 and RY3 have SPST contacts, RY2 has DPST contacts.

**TABLE I — PARTS LIST**

- C1.....40-mfd., 450-volt working tubular electrolytic (G.E. QT1-14).
- C2.....10-mfd., 450-volt working tubular electrolytic (G. E. QT1-6).
- C3.....10-mfd., 2500-volt working Pyranol metal cased capacitor.
- C4, C5—8-mfd, 150-volt working electrolytic (G. E. QT1-5).
- C6.....80-mfd., 150-volt working tubular electrolytic (G. E. QT1-20).
- C7.....40-mfd., 150-volt working electrolytic (G. E. QT1-13).
- D1, D3—400-peak volt, 100-ma. silicon rectifier (G. E. 1N1695).
- D2.....200-peak volt, 100-ma. silicon rectifier (G. E. 1N1693).
- F1.....10-ampere fuse and 3AG type fuse holder.
- FM1...115-volt; 60-cycle, shaded-pole motor (G. E. KSB-33).
- I1.....pilot lamp with 115-volt Canadabra socket, green jewel.
- I2.....same as I1 with red jewel.
- J1, J2...2-pin female chassis type power receptacle.
- J3.....high-voltage insulated connector.
- L1.....4.5-henry, 50-ma. filter choke.
- L2.....4 — 20-henry, 150-ma. swinging type choke.
- L3.....4-henry, 150-ma. filter choke.

- L4.....10-henry, 300-ma. high-voltage insulated filter choke.
- P1.....3-pin grounding type male power plug.
- S1, S2...DPST 10-ampere power toggle switch.
- S3.....3-position, 2-pole single section tap switch.
- S4.....115-v thermal switch; 60-second delay (Amperite 115NO60).
- T1.....power transformer, 750 volts, center tapped at 150 ma., 5-volt, 2-ampere, and 6.3-volt 6-ampere heated windings; 115-volt primary.
- T2.....high voltage transformer, 4000 volts, center tapped, at 300 ma., 115-volt primary.
- T3.....filament transformer, 2.5-volt, 10-ampere secondary, 10,000-volt insulation; 115-volt primary.
- T4, T5...35-volt, 100-ma. secondary, 115-volt primary.
- TS1...terminal strip, 15 terminals.
- V1.....G. E. type OB3 90-volt, octal-base voltage regulator tube.
- V2.....G. E. type 5R4-GYA full wave high-vacuum rectifier.
- V3, V4...GL-3B28, Xenon-filled high voltage rectifiers.

vented by plate over-current relays, other element relays, or by careful tune-up procedure. Normally, during initial tune-up a wary eye is kept on the plate currents so that excessive loading of these circuits is generally only a result of careless procedure. At first glance these schematic diagrams (Figs. 2 and 3) appear to contain several electro-mechanical elements; however, it is surprising how inexpensively voltage-sensitive relays can be obtained. The two voltage-sensitive relays used in the W7KCS transmitter were less than \$1.00 each.

Low-cost silicon diodes have greatly simplified the construction of grid bias supplies because they provide extremely low resistance in the forward direction. This is important

in bias supplies since the over-all equivalent resistance of the supply adds to the grid leak resistance to determine the total grid bias under excitation.

In the W7KCS transmitter it is necessary to provide two values of bias voltage; namely, minus 135 volts power amplifier, and minus 35 volts for the modulator. Ninety of the 135 volts are obtained across the OB3 90-volt regulator tube in the circuit of the dual bias supply, Fig. 3.

The AC side of the circuit is two 110/35 volt transformers connected primary to secondary and secondary to primary. With the low current drain on the bias supply it is possible to maintain a DC voltage nearly the same as the input AC RMS

voltage — or, the output voltage can be greater than the AC input voltage by using input filter capacitance. In addition, the high capacitance improves the normally poor regulation of half-wave rectifier supplies. Current limiting resistors are used (the 100 ohm resistor in the 90 volt supply) in order to reduce the transient currents during the first on-cycle of the rectifier. These small rectifiers cannot handle an extremely high current for an extended length of time; consequently, the impedance looking toward the source must sometimes be artificially made higher. In the low voltage (35 volts) supply the in-rush current was well within the approximately 20 ampere one cycle limit on these rectifiers.

(continued on page 7)

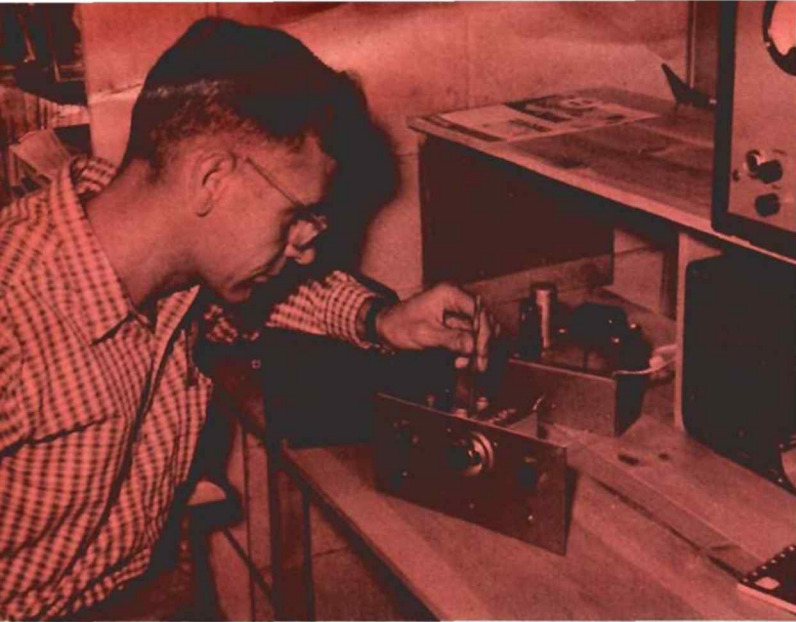

## INDUCTIVE TUNING FOR HIGH-C RF OSCILLATORS

By Jack Najork — K9ODE

**K9ODE TUNES UP HIS VFO EXCITER** after completing construction. Exciter is housed in perforated metal cabinet under Jack's left elbow. Corner of home-built transmitter appears on shelf above station receiver at right. Jack Najork was first licensed as W2HNN in 1934 and became K9ODE in 1958. He operates mostly on CW, with some voice operating on double sideband and 144 megacycles.

K9ODE is District Sales Manager in Chicago for General Electric's Communication Products Department, which manufactures and sells G. E.'s famous Progress Line two-way mobile radio. He formerly was located in Syracuse, N. Y., where he was an engineer on electronic test equipment, and later a field engineer for the radio and television receiver department. Jack has written a number of articles describing his home-built equipment for amateur radio and other electronics publications.

**THE ADVANTAGES** of inductive tuning in high stability oscillators (VFO's) have long been recognized by manufacturers of radio equipment. Unfortunately, the construction of a precision, high stability variable inductance is beyond the capabilities of the average radio amateur, and he has had to be content with capacitive tuning for his home built VFO. These VFO's are capable of excellent stability, but such stability is achieved only through meticulous attention to mechanical as well as electrical construction.

The pros and cons of the most popular types of capacitance-tuned oscillators — the Clapp and the high "C" Colpitts — have been exhaustively discussed in the amateur journals in recent years. The Clapp circuit is capable of excellent stability but mechanical problems of anchoring down the large, high "Q" inductance, together with variations in output over wide frequency changes remain bugaboos.

The high "C" Colpitts does away with the inductance mounting problem because the required coil is small and can be made mechanically sturdy. Large values of voltage divider capacities are required, however, and these, in turn, call for the use of extremely large values of tuning capacitances to cover the lower frequency bands. Such tuning capacitors are generally available only as replacement two or three section broadcast types, which are not designed for precision tuning. The flimsy construction and large mass of such units again lead to mechanical stability problems.

In addition, this large amount of capacity is extremely sensitive to humidity changes because the major portion of the dielectric is air. A gentle breath into the tuning capacitor of the high "C" VFO can cause a frequency shift of several hundred cycles. While the average ham doesn't make a practice of breathing into his VFO, changes in the humid-

ity content of the shack can cause short-term instability, particularly on "muggy" summer days.

The majority of high stability VFO's require some degree of temperature compensation and here again, the capacitively tuned oscillator is at a disadvantage because perfect compensation can be obtained at only one setting of the tuning capacitor. This problem is minimized in the inductively tuned circuit because the amount of capacity in the circuit remains fixed.

Most of the above mentioned problems are licked in this VFO exciter through use of an inductively tuned high "C" Colpitts oscillator tuned with a Mallory "Inductuner."

Amateurs with a background in television will recognize the Inductuner as the front-end tuning device used in many TV receivers manufactured ten years or so back. The tuner was manufactured in two, three and four section units and was used to provide continuous tuning of the TV and FM spectrum from 54 to 220 Mc. Each section of the tuner consists of a spirally wound, silver plated inductance firmly imbedded in low-loss plastic.

A silver plated slider driven by the tuning shaft rides along the inductance under tension. The excellent high frequency electrical and mechanical characteristics of this tuner make it ideal for use in a VFO and enable relatively simple construction of a tuned circuit which results in superb stability.

At first glance it would seem this VHF tuner could not possibly have enough inductive range to be useful at the lower frequencies at which VFO's generally operate. The high "C" Colpitts circuit, however, requires very little inductance, even in the two megacycle range. Each section of the Inductuner has a maximum inductance of approximately .8 microhenries and in the circuit shown one section of the tuner is used in conjunction with a fixed in-

ductance and fixed capacitors to cover the 1.75-2.0 Mc. range. By properly proportioning the fixed inductance and capacitors the desired range is made to occupy almost the complete six turn tuning spread of the Inductuner as shown in Fig. 1.

Some form of turn counting type dial is required for the Inductuner. The dial shown in the photographs is a Model 1320 series Microdial manufactured by Borg Corporation, Janesville, Wisconsin. This dial has provisions for ten turns broken down into 100 divisions per turn, and while it was designed for *Micropots*, it works fine in this application.

The two section Inductuner in the unit shown in the pictures was salvaged from an old TV booster. Most TV receivers employing this unit were equipped with the three section unit and some scrounging in the back rooms and basements of TV service shops should turn up this little gem. It may also be available on the surplus market. While only one section is used in this particular design there is no reason why two or more sections cannot be connected in series or parallel to provide more

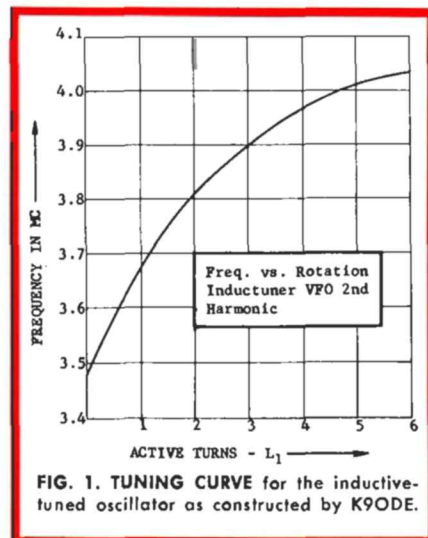
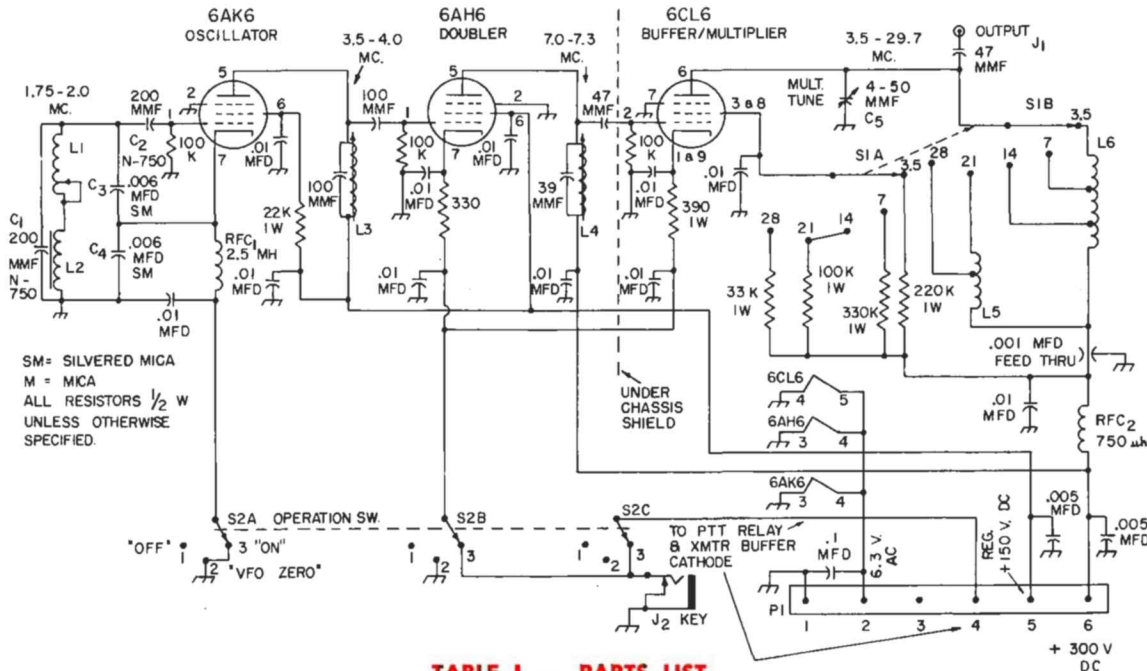

FIG. 1. TUNING CURVE for the inductive-tuned oscillator as constructed by K9ODE.



**FIG. 2. SCHEMATIC DIAGRAM** of the bandswitching exciter designed and built by K9ODE. The inductive-tuned oscillator circuit is shown at the left. Description of components is given in TABLE I — PARTS LIST, at the right. Capacitances are in micro-microfarads (MMF), or in microfarads (MFD), as marked. All bypass capacitors are disc ceramic or mica, 600 volts working. Resistances are in ohms, 1/2-watt rating, unless otherwise marked. **CAUTION:** Do not apply 150 volts to terminal 5 before 300 volts are applied to terminal 6.



**TABLE I — PARTS LIST**

- C<sub>1</sub>, C<sub>2</sub>.....200-mmf. ceramic temperature compensating capacitor, negative 750 parts per million (Centralab type TCN).
- C<sub>3</sub>, C<sub>4</sub>.....0.006-mfd. mica, made from three 0.002-mfd. mica capacitors connected in parallel; see text.
- C<sub>5</sub>.....4 — 50-mmf variable.
- J<sub>1</sub>.....chassis type coaxial cable jack.
- J<sub>2</sub>.....closed circuit type phone jack.
- J<sub>3</sub>.....6-pin male chassis-type power connector (Jones P-306-AB).
- L<sub>1</sub>.....One section of Mallory spiral type 6-turn VHF inductor.
- L<sub>2</sub>.....14 turns, No. 22 enameled wire on toroid form cut from Command Set transmitter plate coil tuning slug;<sup>1</sup> see Fig. 3.
- L<sub>3</sub>.....20-uh. slug-tuned coil (Miller No. 4407, or CTC X2060-5).
- L<sub>4</sub>.....12-uh. slug-tuned coil (Miller No. 4406, or CTC X2060-4).
- L<sub>5</sub>.....27-microhenry coil, 58 turns, No. 22 enameled wire 3/4 of an inch in diameter, closewound 1 1/8 inches long, tapped at 22 and 7 turns from bypassed end.
- L<sub>6</sub>.....0.8 microhenry coil, 11 turns, No. 18 enameled wire 1/2 inch in diameter, spacewound diameter of wire 1 inch long, tapped at 6 turns from bypassed end.
- RFC<sub>1</sub>.....2.5-millihenry 3-pi RF choke.
- RFC<sub>2</sub>.....750-microhenry 1-pi RF choke.
- S<sub>1</sub>.....Five-position, two-pole rotary tap switch with ceramic insulation (Centralab type 2002, or equivalent).
- S<sub>2</sub>.....Three-position, three-pole rotary tap switch (Mallory type 3243J, or equivalent).

<sup>1</sup>"Not Just a Novelty," by Davis A. Helton, QST, January, 1961, Pages 21 to 25.

or less tuning range or bandspread for different bands. For mobile applications and others where space is a problem it is possible to cut away all but the first section of the tuner.

**THE SCHEMATIC DIAGRAM** for the inductive-tuned VFO is shown in Fig. 2. The tube line-up consists of a 6AK6 pentode oscillator with the grid circuit tuning 1.75 — 2.0 megacycles, and plate circuit doubling to 3.5 — 4.0 megacycles. This drives a 6AH6 doubler on 7 megacycles which in turn drives the 6CL6 multiplier. Although drive to the 6CL6 is at 7 megacycles, enough 3.5 megacycle energy sneaks through to permit the 6CL6 to deliver plenty of output on this band. The 6CL6 operates straight through on 7 megacycles and multiplies as required to hit 14, 21, and 28 megacycles. To equalize output one section of the bandswitch is used to select 6CL6 screen resistors of appropriate values. If desired,

a potentiometer can be substituted in the screen to permit continuous output control.

Those accustomed to strings of multiplier tubes may raise eyebrows at the sight of a single 6CL6 tripling and quadrupling to provide output on 21 and 28 megacycles. The high transconductance of this tube makes it an extremely efficient multiplier, however, and the circuit, as shown, easily drives a 6L6 buffer on all bands. With voltages and constants shown in the schematic diagram, the 6CL6 operates well within its maximum plate dissipation rating and considerably more output can be obtained by reducing the value of the cathode resistance.

The control circuit switching arrangement permits the oscillator to run continuously. An S2 signal is heard from the oscillator on the 80 meter band and this can be cut off, if necessary, by throwing the control switch to "OFF."

The exciter is keyed in the doubler, multiplier and external buffer cathode circuits. If desired, the keying circuit can be adapted to a differential keying system. The current transmitter driven by this exciter consists of a 6L6 buffer driving four 6146's in DSB and when this mode of operation is used the push-to-talk relay also keys the exciter. For frequency spotting, the control switch activates the exciter stages only.

The fixed inductance used in conjunction with the Inductuner is a home-made toroid wound on a toroid form sliced from a Command transmitter tuning slug as described by WOPME.<sup>1</sup> Dimensions of the core are shown in Fig. 3. Although a conventional coil wound on a ceramic form can be used in place of the toroid, the toroid is strongly recommended because its smaller mass and electrical field contribute to both electrical and mechanical stability.

(continued on page 6)

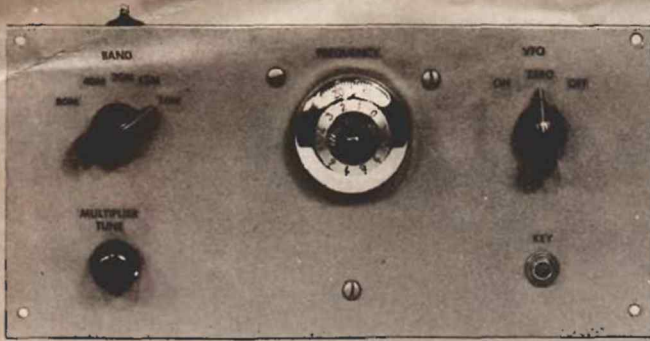

FRONT PANEL VIEW of K9ODE's inductive-tuned exciter. The counter type tuning dial is described in the text. The panel is  $9\frac{1}{8}$  inches wide, and 5 inches high, to fit a cabinet that Jack had on hand.

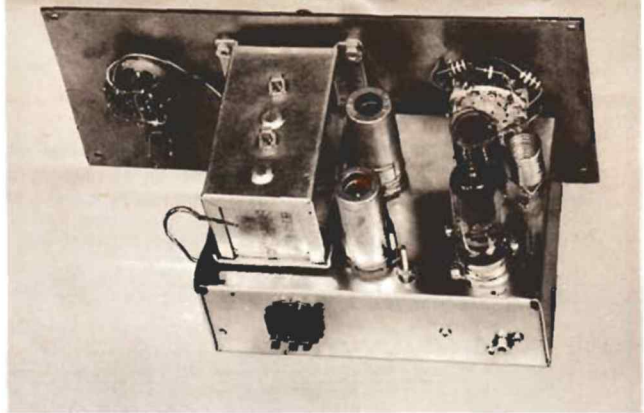

TOP VIEW of the exciter, showing the Inductuner with shields in place at the left. Coils  $L_5$  and  $L_6$  for the 6CL6 output stage are mounted on small pillar insulators fastened to the chassis.

### INDUCTIVE TUNING (continued from page 5)

**CONSTRUCTION** of the complete VFO-exciter was accomplished on a standard 4 x 6 x 2-inch deep aluminum chassis (Bud AC-431, or equivalent). The odd-size panel on K9ODE's model shown in the pictures was made to fit an available cabinet in which the unit was housed. Major parts were fastened in the locations shown in the chassis diagram, Fig. 4.

By following good construction practices the aluminum chassis will be found to be adequate for excellent mechanical stability inasmuch as the rugged Inductuner eliminates most of the common mechanical problems. All frequency components should be mounted on *one surface* of the chassis so that flexing of the chassis sides will not change their relative positions. As hammered home many times: anchor everything solidly!

All wiring and components in and around the oscillator circuit should be cemented or waxed to the chassis to prevent movement and vibration. The author used low melting point wax of the type used to impregnate coils. It is easy to flow around components and does a good job of holding things in place.

**TUNEUP** — With the components shown in TABLE I — PARTS LIST the VFO tuning range will be close to 1.75 — 2.0 megacycles. Some adjustment of inductance or capacity may be required. A considerable variation in toroid inductance can be made by simply spreading or compressing the turns on the form. To increase the tuning range, reduce the inductance by spreading the toroid turns. This will also move the range higher in frequency and it may be necessary to add fixed capacity across the inductances to bring the range down to the desired frequency. If the frequency spread is too great, increase the toroid inductance and decrease the fixed capacity across the inductances to bring the range back to the desired frequency.

The slug-tuned coils used in the oscillator plate and doubler plate circuits were made from a 4.5-megacycle interstage transformer found in the junk box. Standard commercial counterparts can be used, of course.

The 6CL6 plate circuit components are tailored to take into consideration the capacity introduced by 18"

of RG58U cable feeding the grid of a 6L6 stage in the transmitter. If a short, direct connection is used from the 6CL6 plate to the following grid, the inductances will have to be increased in value to resonate at the desired bands. If low impedance output is required, links can be wound over the plate coils and switched by an additional section of the band-switch.

**PERFORMANCE** — Many tests of the high "C" Colpitts oscillator show that short-term instability, or drift, is caused by two factors. The first is RF heating of the voltage divider capacitors which results in approximately 200 cycles positive (lower frequency) drift during the first ten minutes of operation.

The second cause is thermal heating of the tuned circuit caused by heat from the oscillator tube socket reaching these components via the connecting leads. This second effect can be minimized by using an oscillator circuit and tube which require a minimum of heater and plate power. In addition, components are located far enough away from the socket to prevent efficient thermal transfer. This thermal heating effect is most pronounced on the inductance in the tuned circuit and in this design the Inductuner plus the toroid are positioned so very little, if any, heat can be conducted to them from the oscillator tube socket.

Heating of the voltage divider

presents **HOW-TO-DO-IT IDEAS**  
from the 999 radio amateurs at  
**GENERAL ELECTRIC**

A bi-monthly publication of the RECEIVING TUBE DEPARTMENT  
Owensboro, Kentucky, U. S. A. • Editor — E. A. Neal, W4ITC

G-E HAM NEWS is available free from authorized G-E Tube distributors. Some distributors mail copies locally to their customers.

A low-cost direct-mail subscription plan is available to persons residing in the United States and its possessions (including APO and FPO numbers).

Subscription rates are:

One Year (6 issues).....	\$1.00
Two Years (12 issues).....	\$2.00
Three Years (18 issues).....	\$3.00
Five Years (30 issues).....	\$4.00

Enclose check or money order for U. S. currency for the proper amount above made payable to "General Electric Company."

Residents of Canada may subscribe to G-E HAM NEWS for \$1.00 per year from the Canadian General Electric Company, Ltd., Electronic Tube Market-

ing Section, 189 Dufferin Street, Toronto 3, Ontario, Canada. Enclose check or money order made payable to: "Canadian General Electric Company, Ltd."

Distribution of G-E HAM NEWS in more than 40 foreign countries is handled through the International General Electric Company. A listing of outlets is available from the G-E HAM NEWS office. Or, write to: Customer Inquiry Section, International General Electric Company, 150 East 42nd Street, 7th Floor, New York 17, New York, U. S. A.

**NOTE:** The disclosure of any information or arrangements herein conveys no license under any patents of General Electric Company or others. In the absence of an express written agreement to the contrary, the General Electric Company assumes no liability for patent infringement (or any other liability) arising from the use of such information by others.

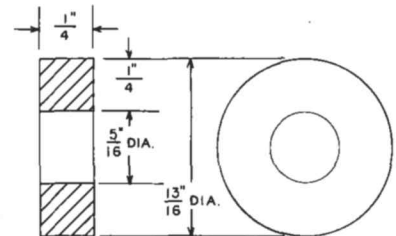

FIG. 3. DIMENSIONS of toroid coil core used for oscillator inductance  $L_2$ . Material is powdered iron.

capacitors from RF energy can be minimized by using the lowest possible voltages on the oscillator but despite this precaution, some heating and drift are inevitable. Various types and makes of mica and silver mica capacitors were tried and despite popular belief, some silver mica capacitors were no better than conventional micas in this application. A slight improvement was noted by paralleling several capacitors to provide the required 0.006 mfd. of capacitance. This VFO parallels three .002-mfd. capacitors for each of the voltage dividing capacitors.

The drift problem was licked in conventional fashion by the use of temperature-compensating capacitors in the oscillator grid-coupling and tuned circuit. These reduce the drift to less than 30 cycles at the fundamental frequency.

If you don't want to bother with temperature compensation you can still rate your VFO as manufacturers do by saying, "drift is negligible after ten minutes warmup." However, the true test for short-term VFO stability is the amount of drift measured from the moment plate power is applied, after two minutes of heater warmup. After all, the fellow at the other end doesn't wait ten minutes for your VFO to warm up before he starts to copy you!

Aside from the afore-mentioned drift considerations, the Inductuner VFO eliminates "pussyfooting" on the operating table. Even on 28 megacycles the VFO can be rapped sharply with no detectable change in beat-note — provided the oscillator components have anchored down. The Inductuner completely eliminates frequency variations usually found in the average home-built VFO where a push on the front panel shifts frequency.

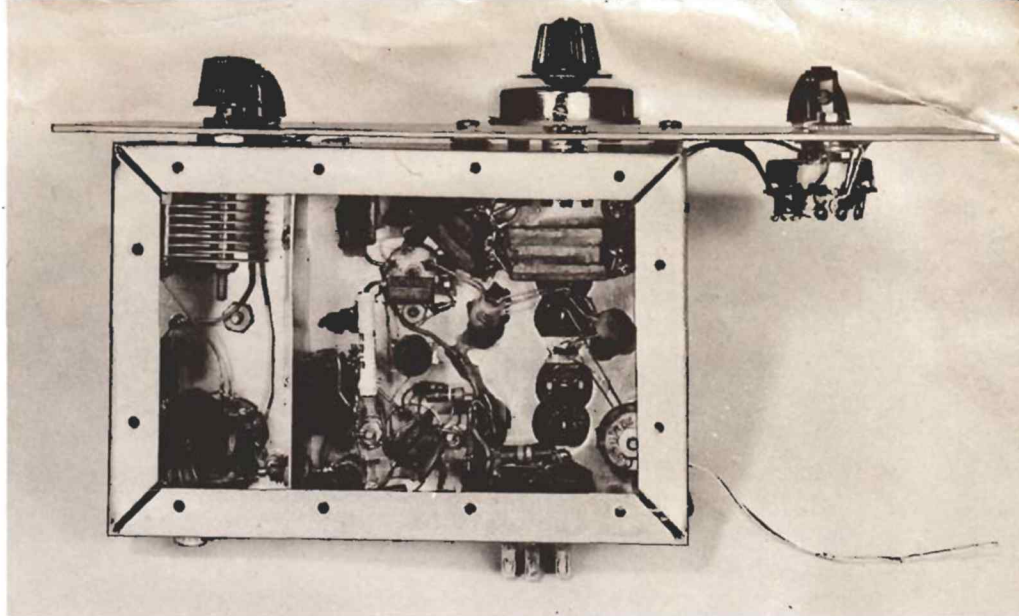

**BOTTOM VIEW** of the exciter, showing placement of smaller parts around the major components, locations of which are shown in Fig. 4 below. Note the two groups of three 0.002-mfd. mica capacitors in parallel for  $C_1$  and  $C_2$ . The toroidal coil,  $L_2$ , shown at the lower right corner, fastened to the chassis with insulating spacer washers and a brass machine screw. Bottom plate covers chassis for shielding.

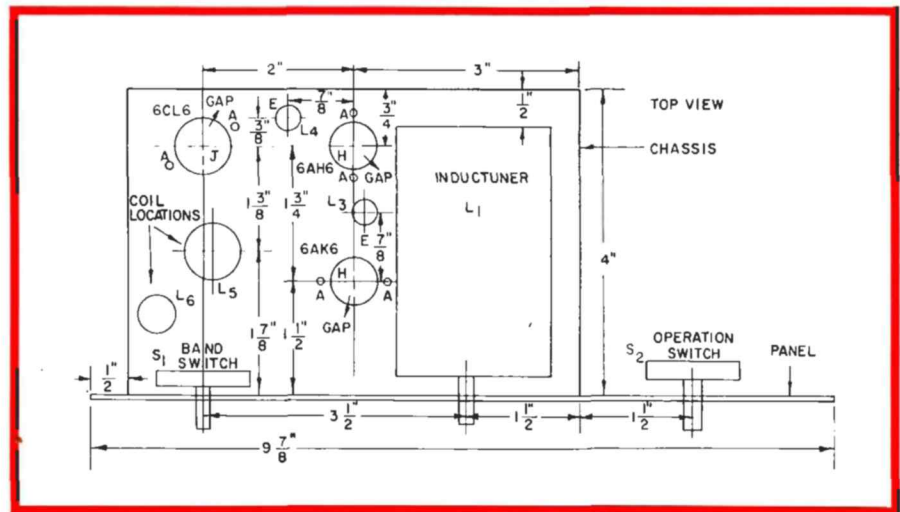

**FIG. 4. CHASSIS LAYOUT DIAGRAM** for the inductive-tuned VFO exciter. Locations for coils  $L_3$  and  $L_4$  are also shown. Holes marked "A" are No. 31 drill for No. 4 machine screws; those marked "E" are  $\frac{3}{8}$  of an inch in diameter for the mounting studs on  $L_3$  and  $L_4$ .

### TRANSMITTER PROTECTIVE CIRCUITRY (continued from page 3)

**THE COMPLETE POWER SUPPLY** for the transmitter at W7KCS is shown in the schematic diagram of Fig. 4. Note that all of the foregoing features have been included in this circuit. Power is fed into the power supply through a 3-prong AC line plug which provides for automatic grounding of the transmitter cabinet and chassis. A time-delay switch is included in the high voltage supply primary circuit to provide 60 seconds delay after the GL-3B28 filaments are energized, before the high voltage transformer can be energized.

Good construction practice should be followed in this unit, including adequate insulation in high voltage circuits, fastening small parts securely to prevent movement, etc. The

photographs of W7KCS's transmitter and power supplies on these pages show many of these construction details. Readers are also referred to the "Power Supply Construction" chapter of the ARRL *Radio Amateur's Handbook* for further suggestions.

Although W7KCS's protective circuits have been utilized in his AM transmitter, they are also excellent for the bias, screen grid and plate voltage power supplies for linear amplifiers. They can be easily added as subassemblies to existing power supplies.

It's smart to protect the lives of your transmitting tubes — not to mention your own life — by including these simple, but effective circuits in your transmitter.

**CONTROL CIRCUIT VOLTAGE** is measured by Norm Morgan checking the protective circuits in his transmitter. Note that all parts are firmly fastened to chassis.

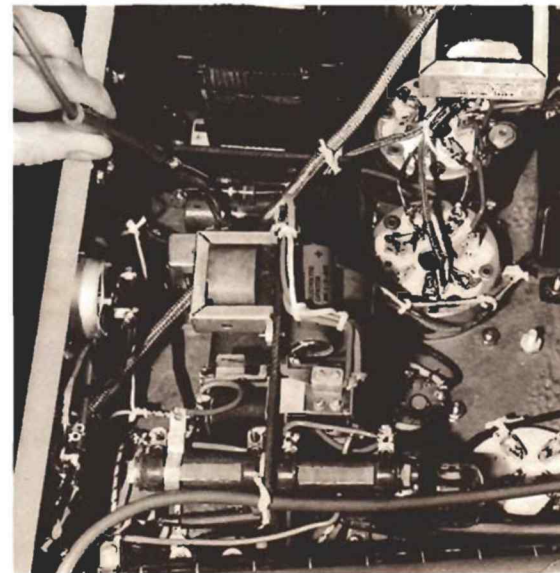

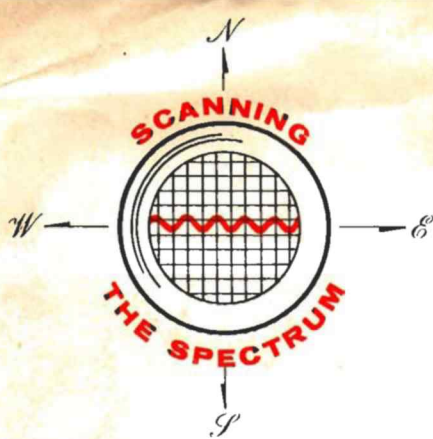

### MEET RADIO AMATEURS AMONG G-E TUBE DISTRIBUTORS



Picture courtesy of *Cleveland Plain Dealer*

**HARRY A. TUMMONDS, W8BAH**, owner of *Northern Ohio Laboratories* in Cleveland, Ohio, recently received the 1961 Public Service Award of the Ohio Council of Amateur Radio Clubs at the Dayton Hamvention. The award plaque reads, "Presented to Harry A. Tummonds, W8BAH, by the Ohio Council of Amateur Radio Clubs for Meritorious Journalistic Public Relations on Behalf of Amateur Radio, April 29, 1961."

Harry recently completed two years of writing a weekly newspaper column on amateur radio, "Ham Antenna," for the *Cleveland Plain Dealer*.

An enthusiastic amateur since 1920, Harry specializes in distributing amateur radio equipment, and sees that his customers regularly receive copies of *G-E HAM NEWS*.

### COMING NEXT TWO ISSUES



"The LWM-3 — A Bandswitching SSB Mobile Transceiver," by W. C. (Bill) Loudon, W8WFH, and A. F. (Al) Prescott, W8DLD, co-authors of the *G-E HAM NEWS* series on high-power mobile radio systems last year. This compact transceiver — 13 inches wide, 6 inches high, and 11 inches deep — attracted great attention at several amateur radio conventions during 1961. The LWM-3 (the letters stand for "Louden, William, Mobile — 3rd model") covers any eleven 200-kilocycle segments of the amateur bands between 3.5 and 29.7 megacycles. Bill's model, shown here, delivers about 5 watts PEP output, sufficient to drive his mobile linear amplifier described in the November-December, 1960 issue of *G-E HAM NEWS*.

In order to completely cover the LWM-3, the circuit and other electrical details will be run in the November-December, 1961 issue, with the mechanical and constructional details to follow in January-February, 1962.

### ANNOUNCING 10TH ANNUAL EDISON RADIO AMATEUR AWARD

NOMINATIONS for the 1961 Edison Radio Amateur Award are now open. This year marks the tenth anniversary of General Electric's annual Edison Award, established in 1952.

The Award is presented annually to a licensed radio amateur who, while

### ANNOUNCING G-E HAM NEWS 3RD BOUND VOLUME



COMPILATION of the 3rd Bound Volume of *G-E HAM NEWS* has been finished and the completed books are being shipped from our bindery starting in September. This 340-page book contains copies of all issues from January-February, 1956 (Vol. 11, No. 1), to November-December, 1960 (Vol. 15, No. 6), totalling 260 pages.

In addition, the 3rd Bound Volume contains an 80-page supplement with additional information, circuits and comments on many of the articles in the above issues; and a Cross Index of all articles published in *G-E HAM NEWS* from 1946 (Vol. 1) to the end of 1960 (Vol. 15).

The price to radio amateurs in the United States and possessions is \$3.00, postpaid. The 3rd Bound Volume should be ordered from the *G-E HAM NEWS* office, and remittance payable to "General Electric Company" enclosed with order.

In Canada, order the book from Canadian General Electric at the address shown on page 6 of this issue. Price of the book in Canada is \$3.50, postpaid.

Persons in other countries should order the *G-E HAM NEWS* 3rd Bound Volume from International General Electric at the address in New York City given on page 6. Price of the volume from IGE is \$3.50, postpaid.

pursuing his or her hobby within the limits of the United States, has performed an outstanding and meritorious public service in behalf of a group, the general public, or an individual.

Full details on the Award, and nominating candidates, are available from the *G-E HAM NEWS* office. Compile the public service record of your candidate now and mail it well before the deadline, January 2, 1962.



SEPTEMBER-  
OCTOBER  
1961  
VOL. 16, NO. 5

Available **FREE** from your G-E Tube Distributor