



HAM NEWS

NOVEMBER-DECEMBER, 1959

Also in this issue —

- Scanning the Spectrum.....page 2
- New Ceramic Receiving Tubes.....page 2
- Technical Information — 12FQ8....page 8

COPYRIGHT, 1959, General Electric Company

KILOWATT GROUNDED-GRID LINEAR AMPLIFIER

... see page 3



GL-813 pentodes have been popular with radio amateurs for years. And their smooth adaptability to grounded-grid linear amplifier circuits should continue their well-earned reputation for versatility.

—Lighthouse Larry

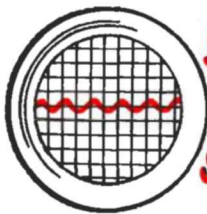

SCANNING the SPECTRUM

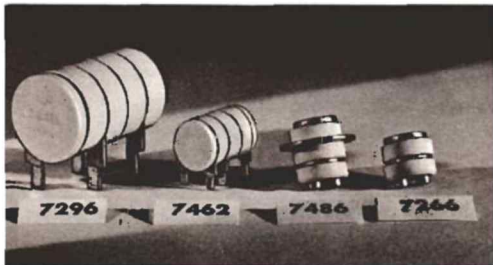

7077's CERAMIC SISTERS . . .

The four new G-E ceramic receiving tube types pictured above — plus the 7077 high- μ triode (see *G-E HAM NEWS*, January-February, 1959, page 8) form a team of ceramic tubes which are smaller in size, and unmatched in performance by any similar device that is on the market now or foreseeable in the near future.

While designed for the severe environment which military and commercial electronic equipment must frequently withstand, these tubes have many potential applications in amateur radio equipment.

Three of the tubes are high- μ triodes, and the other, the 7266, is a high frequency diode for detector, mixer or instrument probe circuits. The 7296 triode has a plate dissipation rating of 3.3 watts and a transconductance of 15,000 micromhos. The 7462 is a printed board version of the 7077 and can be soldered or welded directly into the circuit. The 7486 triode has a 1.0-watt plate dissipation and can deliver 0.3 watts output in a class C amplifier at 450 megacycles.

The 7077 was in the final transmitting stage of the Pioneer IV sun satellite which last March established a record for long-distance point-to-point communication of 406,000 miles.

NOTE: The disclosure of any information or arrangements herein conveys no license under any patents of General Electric Company or others. In the absence of an express written agreement to the contrary, the General Electric Company assumes no liability for patent infringement (or any other liability) arising from the use of such information by others.

COMING NEXT ISSUE . . .

A potpourri of short articles from radio amateurs at General Electric's Light Military Electronics Department in Utica, N. Y., will be featured in the January-February, 1960 issue. Subjects include an all-band balun, simplified coil design, feed-line test for transmitter parasitics, and improved carbon microphone circuitry. Ask for this issue right after New Year's at your General Electric tube distributor.

NEW G-E TRANSISTOR MANUAL . . .

General Electric tube distributors now have in stock the new fourth edition of the *G-E Transistor Manual*. This completely rewritten edition contains 227 pages of information on transistors and their use in electronic circuits.

Included in the twenty chapters is information on basic semiconductor theory, transistor construction techniques, biasing, switching characteristics, transistor radio servicing techniques, plus several chapters on circuit applications.

In addition, the book has a revised listing of all American JEDEC-registered transistor types with their basic specifications and interchangeability information.

Conclusion — it's a *must* for your amateur radio reference bookshelf.

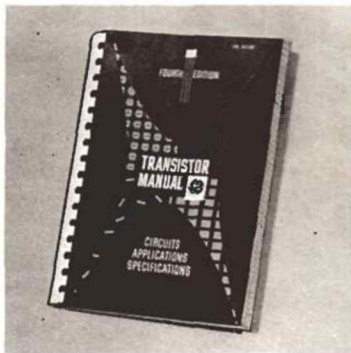

EDISON AWARD LAST CALL . . .

Nominations for the 1959 Edison Award close on January 4, 1960, so now is the time to write that letter giving full details of the public service performed by a United States radio amateur. Make sure that all worthy amateurs are nominated and thus eligible for the Edison Award's national recognition of the radio amateur who has performed the most outstanding public service during 1959.

Complete details were announced in the October and December issues of *CQ* and *QST*. Or, send a card to me for details.

KILOWATT GROUNDED-GRID LINEAR AMPLIFIER

Using only hand tools, an amateur can construct a high quality flexible linear amplifier in less time than it takes to round up the relatively few parts required.

The popularity of amateur transmitters in the 75- to 150-watt power class usually provides a ready-made exciter when the time comes to add a more powerful final amplifier to the amateur station. Because pentodes have a low driving power requirement, a power dissipating device must be employed when these tubes are driven from a 100-watt class rig.

A grounded-grid amplifier circuit provided a satisfactory solution; and, experience indicates that the GL-813 operates efficiently in grounded grid.¹ Also, this tube operates well as a high- μ triode, thus eliminating the need for a separate screen voltage supply.

To provide for a 1-kilowatt power capability as a linear amplifier, two GL-813 tubes are connected in parallel and operated in a grounded-grid circuit, with both the screen grids and beam forming plates at zero DC and r.f. potential. The tubes run in class B at an efficiency of 60 to 70 percent, depending upon the plate voltage.

THE CIRCUIT, shown in the schematic diagram, Fig. 1, is quite simple, since no

tuned grid circuit is required. The r.f. driving power is fed directly into the filaments of the two GL-813's. A dual r.f. choke (RFC₂) in the filament circuit isolates the filament transformer.

High voltage is applied to the GL-813 plates, connected in parallel, through RFC₁. Three blocking capacitors in parallel keep high voltage from reaching the pi-network tuning plate circuit. A ready-made tapped coil (L₁) and split-stator tuning capacitor on the input side of the pi-network provide nearly optimum L/C ratios on all amateur bands from 3.5 to 30 megacycles. One section of C₁ is in the circuit on 14, 21 and 28 megacycles, when S₂ is open. Both sections are in parallel on 3.5 and 7 megacycles, where greater maximum capacitance is required, S₂ being closed by a linkage from the switch on L₁.

A large variable capacitor (C₂) — 1500 mmf maximum — across the output side of the pi-network eliminates the need for several fixed capacitors, and a tap switch to add them to the circuit as needed. The output circuit will match impedances from 50- or 70-ohm unbalanced feedline and loads.

THE CONTROL GRIDS on the GL-813's, bypassed to the chassis at each tube socket, receive from 0 to 100 volts of negative bias from the built-in bias supply, depending

(continued on page 5)

¹As in the Barker & Williamson, Inc., models L-1000A, L-1001A and LPA-1.

LEFT REAR VIEW of the linear amplifier. A $\frac{1}{8}$ -inch thick sheet of aluminum 13 x 17 inches in size forms the main chassis and is fastened to the panel with chassis support brackets. The plate circuit connections are made with $\frac{1}{8}$ x $\frac{1}{2}$ -inch copper strip, while the GL-813 plate leads are No. 10 braided copper wire.

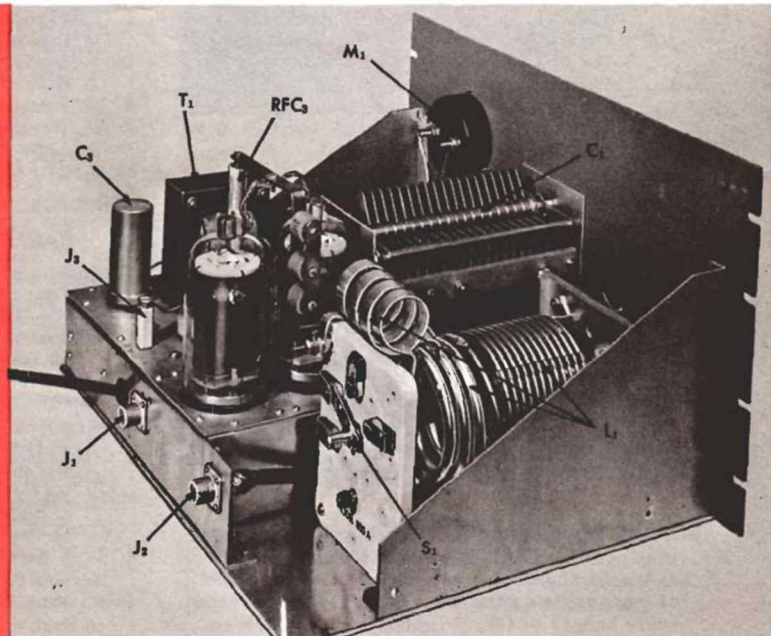

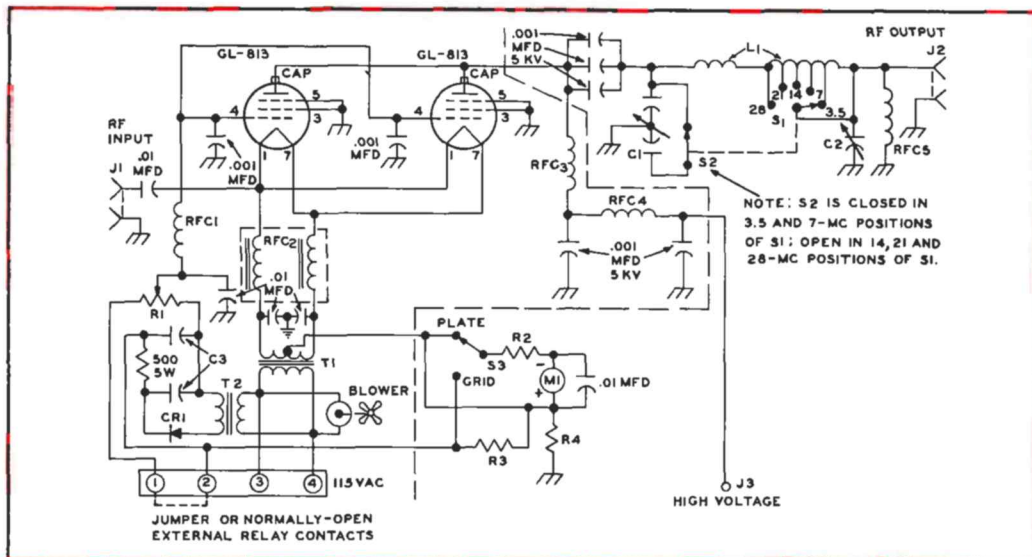

FIG. 1. SCHEMATIC DIAGRAM of the GL-813 grounded-grid linear amplifier. The five .001-mfd, 5KV fixed capacitors are of the cylindrical ceramic type with screw terminals (Centralab 8508-1000, or equivalent). All other bypass capacitances are disc ceramic, 500 volts working. Resistances are in ohms, with wattage ratings as specified. Resistances in the metering circuit are listed in TABLE I. No switch is shown in the 115-volt AC circuit, since it is controlled by external power switching circuits. All components to the left of the dashed line running down through the diagram are on the sub-chassis.

TABLE I — PARTS LIST

- C₁.....Split-Stator variable capacitor; front section, 28—160 mmf; rear section, 7-50 mmf; 0.125-inch air gap (Cardwell P-8060, or equivalent).
 C₂.....50—1500 mmf variable capacitor, 0.030-inch air gap (Cardwell P-8013, or equivalent).
 C₃.....2-section electrolytic capacitor, 40-mfd. 150 volts per section (Sprague TVL-2428).
 CR₁.....130-volt, 75 ma. selenium rectifier.
 J₁, J₂.....Chassis type coaxial cable connectors (Amphenol 83-1H hood on J₂).
 J₃.....1 1/2 inch high standoff insulator.
 L₁.....10 uh pi-network band switching inductor (B & W 851 for up to 600 watts; B & W 850A for over 600 watts).
 M₁.....DC milliammeter, 0-1 ma., full scale.
 R₁.....500-ohm, 2 watt potentiometer.
 R₂.....Series resistance for M₁; 1200 ohms, 1 watt.

- R₃.....12 ohms, 1 watt, for 100-ma grid reading.
 R₄.....2.4 ohms, 1 watt, for 500-ma plate reading.
 RFC₁.....0.5-mh, 300-ma r.f. choke (National R-300).
 RFC₂.....15-ampere dual choke (B & W No. FC-15).
 RFC₃.....200 uh, 500-ma r.f. choke (National R-175A, or B & W No. 800).
 RFC₄, RFC₅.....1 mh, 300-ma r.f. chokes (Nat. R-300).
 S₁.....5 position single section tap switch; part of L₁ pi-network coil.
 S₂.....Special 2-position, single section switch; see FIGS. 4 and 5 for details.
 S₃.....2 position, single section tap switch.
 T₁.....10-volt, 10-ampere filament transformer.
 T₂.....115-volt, 30-ma power transformer.
 V₁, V₂.....GL-813 power beam pentode tubes.

TABLE II
PARTS LIST, CATHODE COUPLER

- C₁.....12 — 325-mmf variable, 0.224-inch air gap (Hammarlund MC-325-M).
 C₂.....45—1260 mmf variable (3-section broadcast receiver variable, 15—420-mmf per section, all sections in parallel).
 L₁.....4.2 uh, 17 turns, No. 16 tinned wire, 1 1/4 inches in diameter, 2 1/8 inches long, spacewound 8 turns per inch, tapped 2 (21 MC, 4 (14 MC), and 10 (7 MC) turns from L₂ end of coil. (B & W No. 3018).
 L₂.....0.44 uh, 5 turns, No. 12 tinned wire, 1 inch in diameter, 1 inch long, spacewound 5 turns per inch, self-supporting.
 S₁.....1 pole, 5 position tap switch, ceramic insulation (Centralab No. 2500, or equivalent).
 Shield Box.....4 x 5 x 6-inch Minibox (Bud CU-3007), or 3 x 5 x 7-inch Minibox (Bud CU-3008).

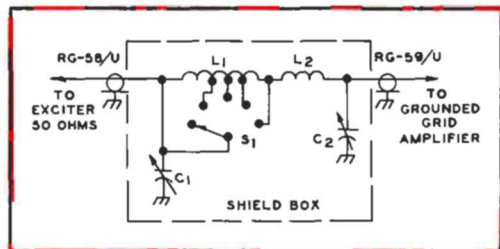

FIG. 2. SCHEMATIC DIAGRAM of an optional pi-network matching circuit. It will match the cathode circuit of the GL-813 amplifier to the 50-ohm output circuit of those exciters which otherwise might not be loaded heavy enough to fully drive the linear amplifier.

on the setting of R. When no connection is made between terminals 1 and 2 on the terminal strip, the tubes are biased to cut off plate current flow. Jumpering these terminals reduces the bias to the value selected by R. Leads should be run from these terminals to a switch, or relay contacts which close while transmitting.

Separate metering of current in the grid and plate circuits is accomplished by switching a single meter (M₁) across shunting resistors, R₂ and R₁, respectively.

Only plate current is read in the PLATE position of S₂, since the grid circuit is returned directly to the center tap on the filament transformer (T₁).

MOST EXCITERS will have a wide enough range in output impedance to match to the cathode circuit of the GL-813's (about 150 to 200 ohms, depending upon frequency). In case the exciter will only match into a 50- to 70-ohm load and will not drive the grounded grid amplifier hard enough, a pi-network matching circuit can be inserted between the exciter and amplifier.

The suggested circuit for this network is shown in Fig. 2. The parts values shown should have sufficient flexibility for most matching requirements. All components for the matching network were housed in a 4 x 5 x 6-inch Minibox (Bud CU-3007). Lengths of coaxial cable for the input and output were cut to the proper dimensions to run to the exciter and final amplifier.

CONSTRUCTION is quite simple, due to the utilization of standard, readily available components throughout the amplifier. The main chassis is a 13 x 17 x 1/8-inch thick sheet of aluminum fastened with its bottom surface 1/8 of an inch above the lower edge of a 10 1/2 x 19-inch aluminum relay rack panel. Only the pi-network components, meter and meter switch are on the main chassis, the remaining components being assembled on the 6 x 11 x 2 1/2-inch sub-chassis.

The photographs and drawings illustrate the placement of the major components (Figs. 3 and 4). Either a 3 1/2 or 2 1/2-inch meter may be used for M₁.

The front and back plates of C₁ and C₂ are fastened to 1/8-inch thick sheet aluminum brackets 7 inches high and 4 inches wide. The shaft on which the linkage for switch S₂ is supported also runs between these plates. The parts in this linkage, and assembly details, are shown in Fig. 5. A U-shaped clip, made from spring brass or phosphor bronze, completes the connection between copper angle brackets fastened to

(continued on page 6)

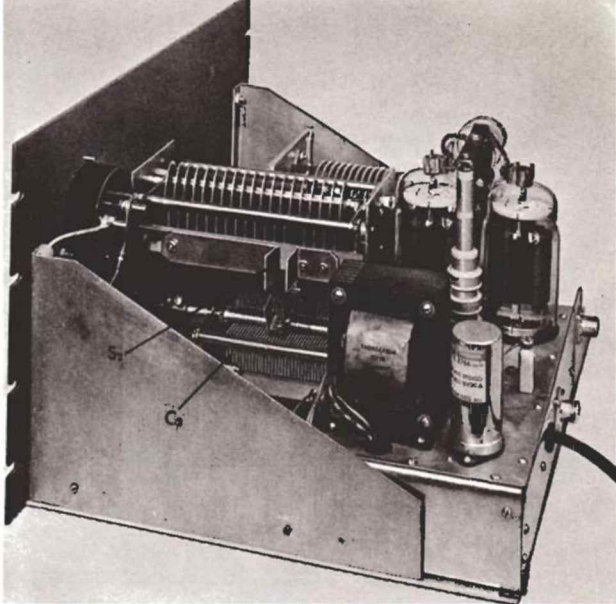

RIGHT REAR VIEW of the linear amplifier. Note how C₁ and C₂ are mounted on vertical brackets made from 1/8-inch thick sheet aluminum. The copper angle brackets and U-shaped angle bracket on C₁ is S₂ (See FIG. 5 for details). A 6 x 11 x 2 1/2-inch aluminum chassis houses most of the smaller components in the amplifier.

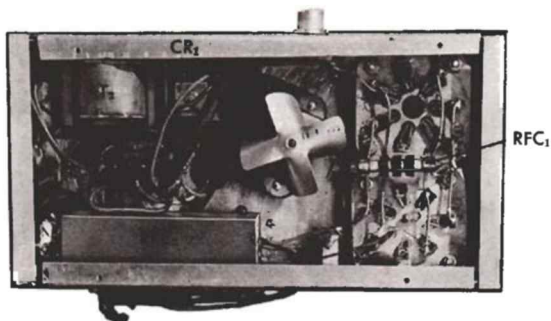
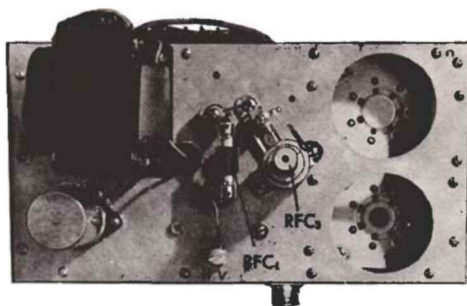

TOP AND BOTTOM VIEWS of the amplifier sub-chassis. The copper strip plate circuit connections have been removed from RFC₁ in the top view. Under-chassis wiring is insulated hookup wire, except for the filament leads, which are No. 12 tinned wire.

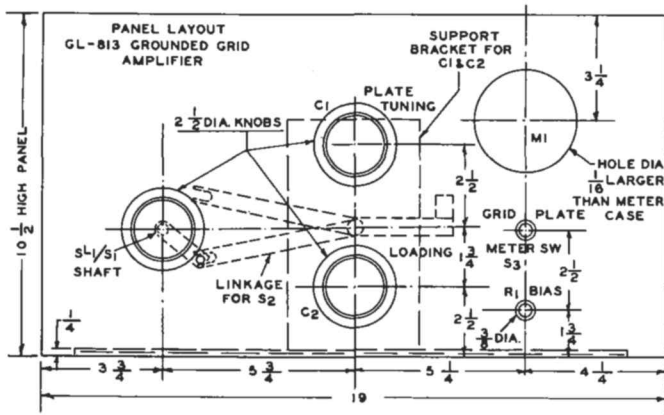

FIG. 4. PANEL LAYOUT DIAGRAM for the GL-813 linear amplifier. The linkage for S_2 pivots on the shaft located between C_1 and C_2 . Drill $3/8$ -inch diameter panel holes for this shaft, and the shafts on C_1 , C_2 , L_1 and the meter switch, S_3 . The aluminum chassis deck is positioned $1/8$ of an inch above the bottom edge of the panel.

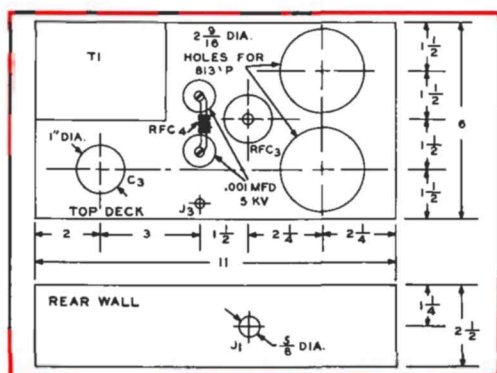

FIG. 3. LAYOUT DIAGRAM for the amplifier sub-chassis. Holes for the machine screws which secure the components in place are located from the holes on those components.

the two stator sections on C_1 , when L_1/S_1 is in the 3.5 and 7-megacycle positions. The arm on the L_1/C_1 shaft is adjusted so that it engages the forked arm, as shown in solid lines on the sketch, when S_1 is in the 7-megacycle position. Both arms should then move up so that the forked arm is in the position indicated by dotted lines when S_1 is in the 14-megacycle position.

Under-chassis wiring, except for the No. 12 tinned wire filament leads, is run with No. 18 insulated wire. The plate circuit connections were made with $1/16 \times 1/2$ -inch copper strip, as shown in the photos. A small 115-volt phonograph motor with a 3-inch diameter, 4-blade fan draws air up through holes in the aluminum base plate and out through the holes in the sub-chassis for the 813 tubes.

Once construction is finished, check the filament and bias voltage circuits before connecting the high voltage power supply to J_3 . A power supply with provision for reducing the output voltage to about one-

half or two-thirds of full voltage is recommended, especially if the full output is 2,000 volts or higher. Connect an antenna or dummy load to J_2 .

TUNEUP FOR SSB operation consists simply of applying full plate voltage and, with terminals 1 and 2 on the power strip shorted, setting R_1 for 40 milliamperes of plate current with S_3 in the PLATE position. Turn S_1 to the same band on which the driving exciter is operating and apply driving power to the amplifier by injecting carrier on the SSB exciter. Adjust the exciter loading for a full-scale reading on M_1 with S_2 in the GRID position.

Turn C_2 to maximum capacitance, S_3 to the PLATE position and adjust C_1 for minimum plate current. Turn on partial high voltage and decrease the capacitance of C_2 for a plate current reading of 200 milliamperes, readjusting C_1 for minimum plate current, as necessary. Apply full plate voltage and adjust C_2 for about 400 milliamperes plate current. The grid current should read 100 milliamperes.

Switch the exciter to deliver SSB output and adjust its operation for the audio gain for normal r.f. power output. With speech, the 813 linear amplifier should swing up to about 150 milliamperes plate current; while with a steady whistle the plate current should reach 400 milliamperes. The amplifier is now tuned up.

TUNEUP FOR CW operation is similar, except that the bias voltage is adjusted initially for almost zero plate current. The exciter is adjusted to deliver 100 milliamperes of grid current in the amplifier without plate voltage. After applying partial plate voltage, load the amplifier to about 180 milliamperes plate current. With full plate voltage, the plate current should be about 350 milliamperes.

FIG. 5. DETAIL DRAWING of the linkage which actuates S_2 from the shaft driving the bandswitch (S_1) on L_1 . Three $\frac{1}{8} \times \frac{1}{2}$ -inch brass strips, soldered to brass shaft couplings, are the linkage arms. U-shaped clip-on plastic arm closes circuit between copper angle brackets on C_1 in the 3.5 and 7-megacycle positions of L_1 .

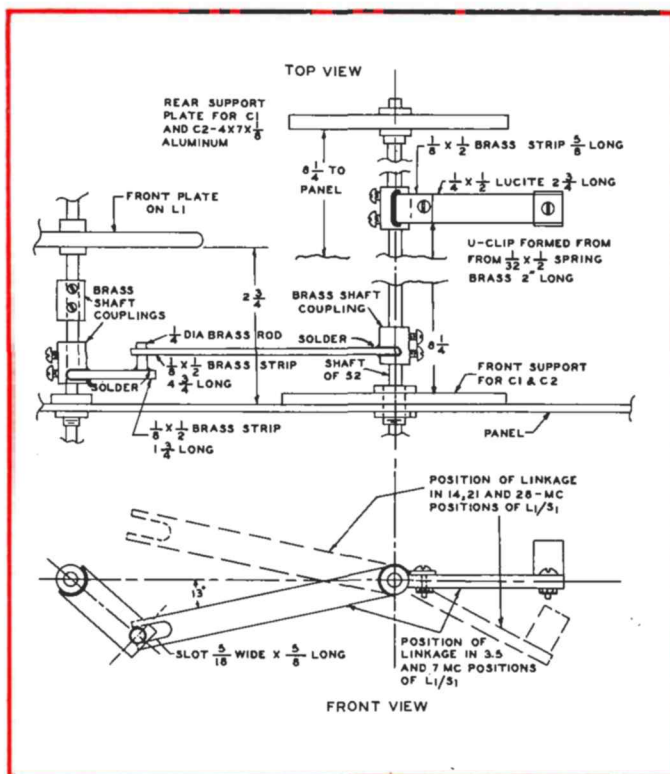

This amplifier also may be driven by a conventional amplitude modulated transmitter. The plate current is adjusted to 40 milliamperes at full plate voltage, the same as for SSB operation. Adjust the exciter for 90 to 100 milliamperes of amplifier grid current. Apply partial plate voltage and load the amplifier to about 150 milliamperes plate current. Next, apply full plate voltage and adjust for 300 milliamperes plate current.

Now, reduce the driving power from the exciter until the amplifier plate current reads 150 milliamperes. When the exciter is amplitude modulated 100 percent, the 813 amplifier plate current should rise not more than 5 percent, otherwise distortion of the output signal will result.

It's a good idea to check the operation of this amplifier with an oscilloscope during initial adjustment; and also periodically to ensure linearity of the output signal. The model amplifier constructed for this article has been operated on all bands for over a year at W2GPH without a failure for any reason. It is stable, easy to adjust and provides a really potent signal.

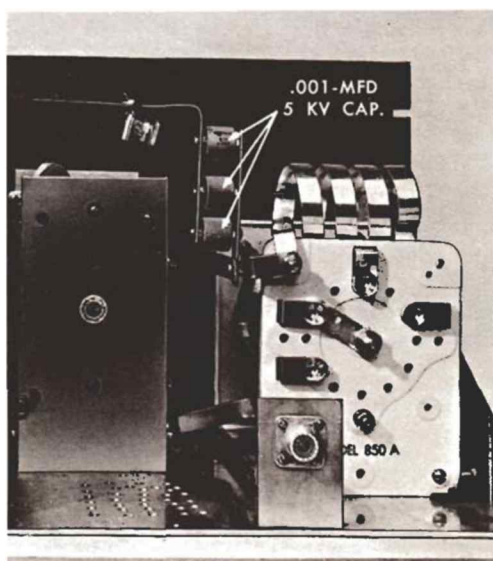

REAR VIEW of the amplifier plate circuit. Sub-chassis has been removed to show the holes in the aluminum plate through which cooling air is drawn into the chassis by the fan, and exhausted up through the chassis holes for the 6L8-813 tubes.

TECHNICAL INFORMATION — 12FQ8

Miniature twin double plate triode

Radio amateurs undoubtedly will doodle plenty of prospective circuits around this new and unique "signal-splitting" twin triode receiving tube with four plates — each brought out to separate base pins — instead of the usual two. The double plates make it possible to obtain two well-isolated output signals from each section.

The 12FQ8 can be used profitably to reduce the number of tubes in circuitry of instruments and other equipment where it is essential to economically reduce to a minimum the interaction between two outputs of one stage. Complete technical data and characteristics curves are available on request from the *G-E HAM NEWS* office.

ELECTRICAL DATA

Cathode — Coated Unipotential

Heater Voltage, AC or DC.....12.6 Volts

Heater Current0.15 Amperes

Maximum plate dissipation, each section.....0.5 Watts

AVERAGE CHARACTERISTICS, EACH SECTION

Plate Voltage250 Volts

Grid Voltage-1.5 Volts

Amplification Factor, Grid to Each Plate.....95

Plate Resistance, approximate, Each Plate.....76000 ohms

Transconductance, Grid to Each Plate.....1250 Micromhos

Plate Current, Each Plate.....1.5 ma

BASING DIAGRAM

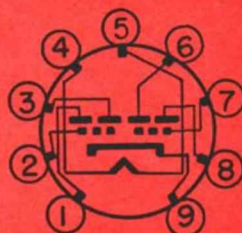

EIA 9KT

PHYSICAL DIMENSIONS

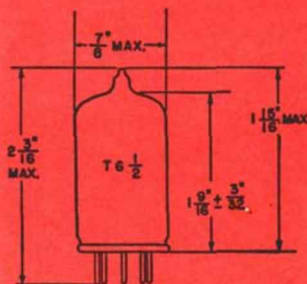

EIA 6-2



**HAM
NEWS**

NOVEMBER-DECEMBER, 1959

VOL. 14—NO. 6

BUILD-IT-YOURSELF IDEAS

from the 999 radio amateurs at

GENERAL  ELECTRIC

published bi-monthly by

RECEIVING TUBE DEPARTMENT

Owensboro, Ky.

Available **FREE** from your
G-E Tube Distributor

E. A. Neal, W4ITC — Editor

DES ROBERTS

14-60 N. VERNON STREET