



Electronic
TUBE

Ham News

Copyright 1952, by General Electric Company

JANUARY—FEBRUARY, 1952

VOL. 7—NO. 1



6-METER XMTR

Economical Fifteen-watt Phone-CW Transmitter
for Mobile or CD Use

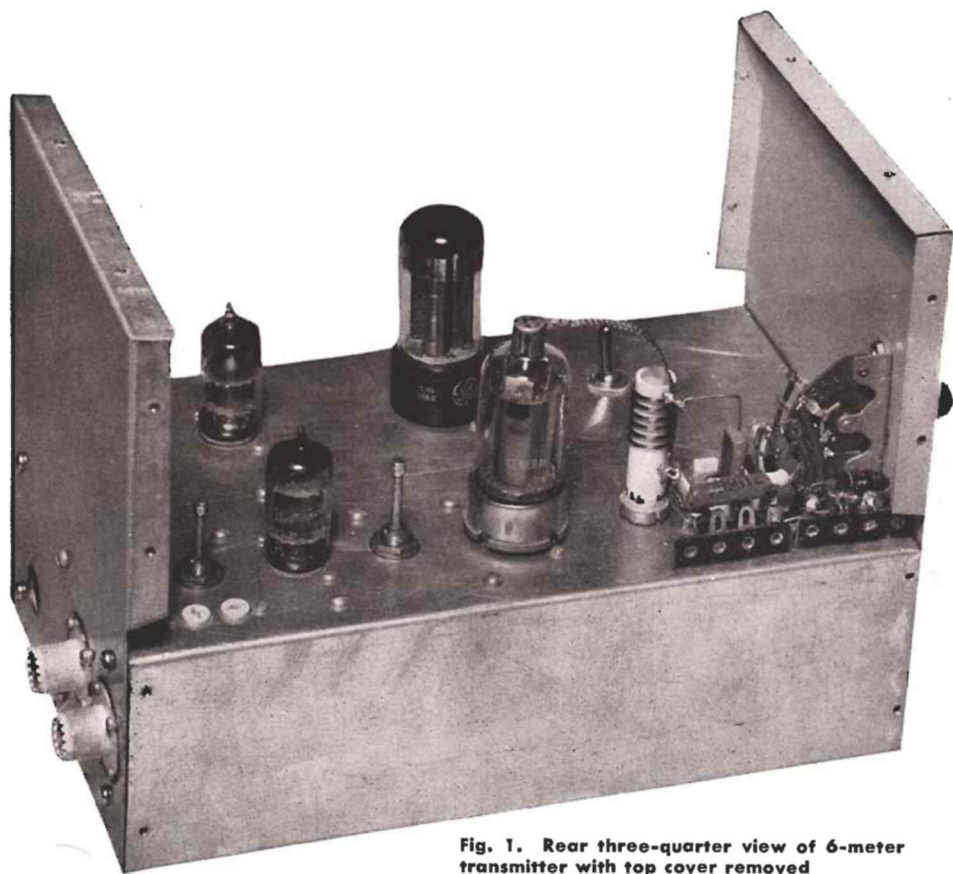

Fig. 1. Rear three-quarter view of 6-meter transmitter with top cover removed

Contents

6-Meter Transmitter.....	pages 1-10
Sweeping the Spectrum.....	page 11
Technical Information (GL-2826).....	page 12

6-METER XMTR

This transmitter has been designed specifically for civilian use, for either fixed-point or mobile operation. Schenectady County amateurs use this exact design for their fixed-point installations. Simplicity and reliability were the two major design points considered. The result is an economical four-tube transmitter, with two tubes in the r.f. section and two tubes in the modulator section.

Features of this six-meter transmitter include: regenerative crystal oscillator circuit capable of operating with any eight-megacycle crystal; input power of fifteen watts; send-receive operation without a relay; carbon microphone input to modulator; clamp-tube modulation; simple 'phone-c.w. change-over; and minimum current-drain requirements. If the design is followed faithfully, no one should have any difficulty in building or operating this transmitter.

DESIGN CONSIDERATIONS

In order to design a transmitter which could be duplicated in quantities of ten or more—as would be the case with any transmitter designed for civil-defense use—the transmitter had to be stripped of every non-essential part. This is true not only from the economic angle, but from the angle that the transmitters must be simple to build. Careful design work was required to reach this goal without sacrificing reliability, because reliability is even more essential than economy or simplicity. This requirement meant that commercial reliability had to be achieved with

amateur constructional practices.

A simple transmitter circuit has many advantages. In addition to being easy to construct, such a transmitter is easy to service—far from a minor point when it becomes necessary for a person unfamiliar with the transmitter to do the repair job. Simple circuitry also adds another big advantage, that of simplicity of operation. A civil-defense transmitter may be operated by many different amateurs, so that an absolute minimum of exposed controls is desirable.

Easy to build, easy to service, easy on the pocket-book—yet, capable of 24-hour continuous operation. This states the designer's problem succinctly.

CIRCUIT DETAILS

Refer to the circuit diagram, Fig. 2. A 12AU7 miniature tube serves as the oscillator-doubler, and a GL-2E26 acts as the final r.f. amplifier. In the audio section, a 12AT7 acts as a two-stage speech amplifier, and a 6AV5-GT is the clamp-tube modulator.

Several types of oscillator circuits were tried and discarded before it was decided to use the one shown. Most of the circuits tried operated rather well, but the circuit used is the only one which gave ample output with every eight-megacycle crystal tried. Finicky circuits have no place in civil-defense equipment, hence the reason for the search for a reliable circuit. The oscillator circuit shown is a standard regenerative triode oscillator. Experience with this circuit indicates that it is not necessary to use special over-

Electrical Circuit

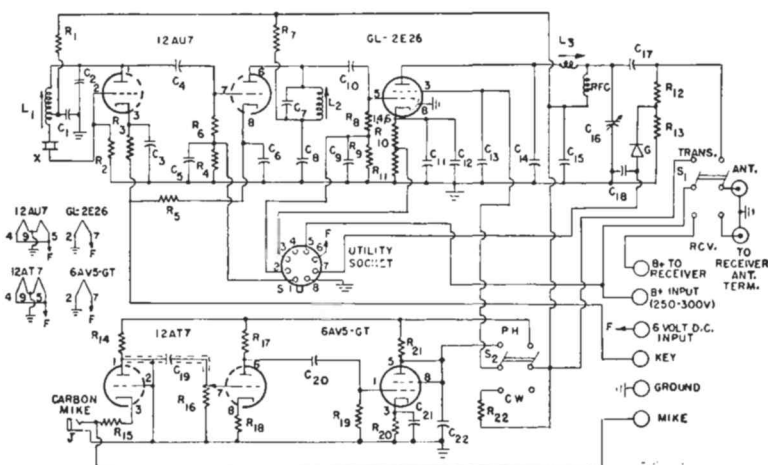

Fig. 2. Circuit diagram of 6-meter transmitter

tone crystals—*any* crystal in the range 8.333 to 9.000 megacycles should operate properly.

For an exhaustive discussion of this and other sorts of regenerative oscillator circuits, the reader is referred to the article Overtone Crystal Oscillator Circuits, by E. P. Tilton, in the April 1951 *QST*. A point emphasized by Mr. Tilton in that article is worth repeating here. The frequency of the overtone is not an exact multiple of the fundamental frequency. For example, a crystal with a fundamental frequency of 8.000 megacycles may oscillate on the third overtone at 24.020 megacycles. No information is available at this time on how much this variation may be; however, experience with the transmitter being described shows that the variation is not too great. Further, identical crystals seem to change frequency by the same amount. That is, three identical crystals (made by the same manufacturer) which have identical fundamental frequencies, will have overtone frequencies which are almost identical. A group of crystals for net operation will therefore be usable even on the overtone frequencies.

The oscillator shown in Fig. 2 operates on the third overtone. The resonant circuit, L_1 and C_2 , is therefore resonant at the third overtone, which is approximately 26 megacycles. Regeneration in the circuit is controlled by the position of the tap on coil L_1 . This same coil is slug-tuned, allowing the circuit to be tuned for proper operation. The second section of the 12AU7 serves as a doubler, with output directly on the six-

meter band.

The plate circuit of the doubler is tuned with a fixed capacitor and a slug-tuned coil. More than adequate output is obtained from the doubler to drive the GL-2E26. The doubler circuit is straightforward, and no regeneration is employed. Protective bias, supplied by R_5 , prevents damage to the tube in the event of oscillator failure.

The final amplifier is capacitively coupled to the doubler plate circuit. The plate circuit of the GL-2E26 consists of a pi network designed to work into a 50-ohm load. Operating bias for this tube is supplied by a combination of grid-leak and cathode bias. When excitation to the final fails, either due to accident or due to keying, the cathode bias holds the plate current to a safe value. This value of cathode resistor (R_{10} plus R_{11}) will hold the cathode current to a relatively constant value whether excitation is applied or not. Hence, the current variation due to keying is slight, and voltage regulation is not a problem. This is an important feature, especially when vibrator power supplies may be used.

The cathode of the GL-2E26 is bypassed for r.f. as well as for audio frequencies, in order that degeneration at these frequencies is held to a minimum. No trouble was experienced with instability of the final amplifier due to parasitics or other forms of oscillation. Special care was taken to shield the output circuit from all other tuned circuits to minimize feedback. Fig. 1 shows how the GL-2E26 tank circuit is

CIRCUIT CONSTANTS

(All resistors and capacitors = 20% tolerance unless specified otherwise)

$C_1, C_3, C_5, C_6,$	R_1	10,000 ohm, 2 watt
$C_8, C_9, C_{12},$	R_2, R_6, R_{13}	10,000 ohm, ½ watt
C_{12}, C_{13}	R_3, R_5	220 ohm, ½ watt
270 mmf mica or general purpose ceramic	R_4, R_9, R_{16}	1000 ohm, ½ watt
C_2	R_7	11,000 ohm, 4 watt (two 22,000 ohm, 2 watt resistors in parallel)
40 mmf silvered-mica or zero-temperature coefficient ceramic	R_8	22,000 ohm, 1 watt
C_4	R_{10}	500 ohm, 4 watt (two 1000 ohm, 2 watt, = 10% resistors in parallel)
25 mmf mica or general purpose ceramic	R_{11}	47 ohm, ½ watt
C_7	R_{12}	15,000 ohm, ½ watt
10 mmf silvered-mica or zero-temperature coefficient ceramic	R_{14}	22,000 ohm, 2 watt
C_{10}	R_{15}	100 ohm, ½ watt
100 mmf mica or general purpose ceramic	R_{16}	0.5 megohm potentiometer
C_{11}, C_{21}	R_{17}	0.1 megohm, 1 watt
50 mf 50 volt electrolytic	R_{19}	0.47 megohm, ½ watt
C_{14}	R_{20}	750 ohm, 2 watt, = 10% (OR, two 1500 ohm, 1 watt, = 10% resistors in parallel)
20 mmf mica or high-K ceramic	R_{21}	5,000 ohm, 10 watt
C_{16}	R_{22}	15,000 ohm, 20 watt (OR, two 30,000 ohm, 10 watt resistors in parallel)
65–320 mmf mica compression trimmer (EIMenco 303-M)	RFC	6-meter r.f. choke (Ohmite Z-50)
C_{17}	S	Octal socket
1000 mmf mica or general purpose ceramic	S	DPDT non-shorting lever switch (Centralab No. 1454)
C_{18}	S_2	DPDT toggle switch
5000 mmf mica, paper or high-K ceramic	X	8.333 to 9.000 megacycle crystal
C_{19}, C_{20}		
1000 mmf mica or high-K ceramic		
C_{22}		
500 mmf mica or high-K ceramic		
G		
Crystal diode (G-E 1N48)		
J		
Open-circuit phone jack		
L_1		
14 turns No. 18 enamel wire, space wound to cover one inch, on Millen No. 69046 coil form. Tap at 4½ turns from the crystal		
L_2		
6 turns No. 16 enamel wire, space wound to cover one inch, on Millen No. 69046 coil form.		
L_3		
6 turns No. 16 enamel wire, space wound to cover ½ inch, on Millen No. 69046 coil form.		

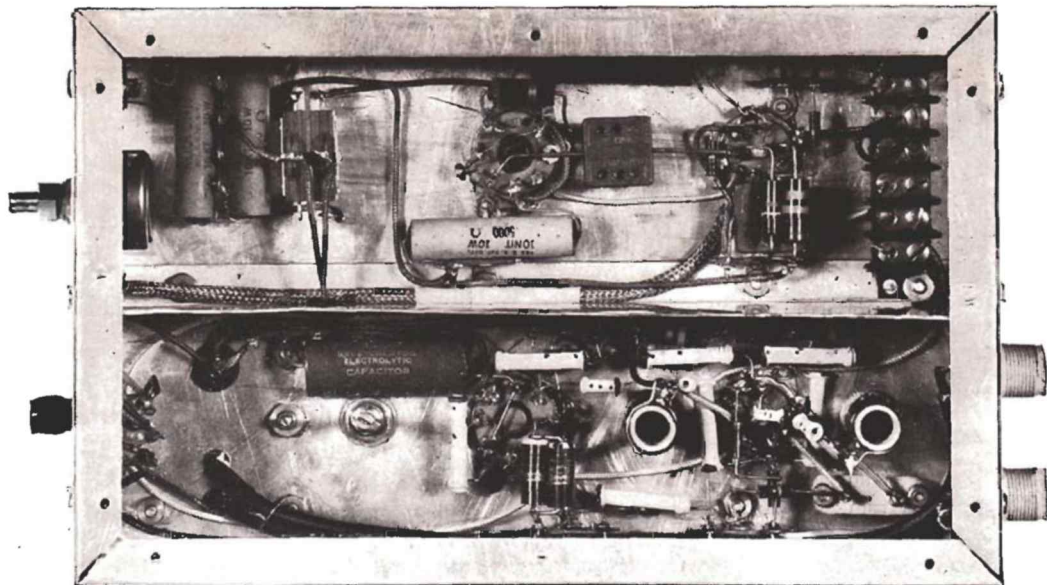

Fig. 3. Under-chassis view of 6-meter transmitter

mounted above the chassis.

The germanium diode, G, in the output circuit rectifies the r.f. signal and permits measurements to be made of the output voltage. It serves, therefore, as a tuning aid or as a monitoring point. This will be discussed in more detail later.

Provision for keying is incorporated into this transmitter. Again thinking of the civil-defense aspect, it is most desirable to be able to go to c.w. operation in case of an emergency, where a blown modulator tube could otherwise put the station off the air. The cathode circuits of both the oscillator and doubler section are keyed. No keying jack is used, but a terminal-board connection permits access to the keying lead. In normal operation the point marked "Key" is connected to ground.

Switch S₁ serves as the send-receive switch, and it handles the antenna switching as well as the high-voltage switching. In most transmitters of this sort a relay is used to do this job, but the relay cost can be eliminated and the current drain for the relay done away with if the proper type of switch is used. The switch specified is a lever-action "rotary" switch. The insulation on switches like this is adequate for r.f. insulation, and the contacts are capable of handling the r.f. current. Tests made with this transmitter have required more than 1000 operations of the switch, and there is no sign of contact deterioration at this time. In the "send" position the switch connects the antenna to the transmitter output circuit,

and also applies the plate voltage to all parts of the transmitter. In the "receive" position the antenna is connected to the receiver, and the plate voltage is routed through the terminal board to the receiver circuits.

The modulation system employed is of the clamp-tube variety. Obviously, this type of modulation will not produce as great a modulated signal as high-level plate modulation, but, the big advantage of clamp-tube modulation is that no transformers are required. This was too big an advantage to be overlooked in the design of an economical, simple, civilian-defense transmitter. Because clamp-tube modulation is essentially a low-level type of modulation, the carrier amplitude is approximately 25 to 30 percent of that obtainable from a high-level plate-and-screen modulation system.

A 6AV5-GT serves as the clamp tube. This is a high perveance tube, originally designed as a horizontal-deflection amplifier for television receivers. A high perveance tube means one which is capable of drawing a large current when relatively low plate and screen voltages are applied. The 6AV5-GT tube is an ideal tube for use as a clamp tube. With eleven watts of plate dissipation, it can handle sufficient power to do a good modulation job.

The clamp tube is driven by a two-stage R-C coupled preamplifier using a 12AT7 tube. Microphone current for the single-button carbon microphone is obtained from the cathode circuit of the first ampli-

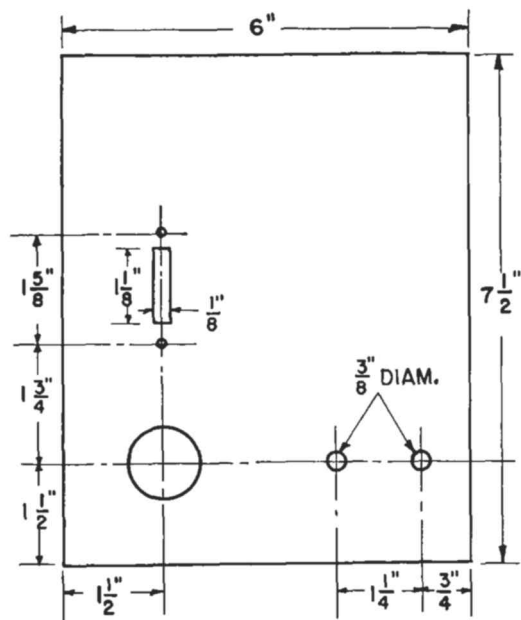

Fig. 4. Front-panel layout

fier stage. Approximately eight to ten mils is adequate for a carbon microphone, and this current is easily handled by the 12AT7 tube. A potentiometer in the grid of the second amplifier stage serves as an audio gain control.

Switch S_2 serves as the 'phone-c.w. switch. In the c.w. position the voltage is removed from the audio and modulator tubes, and the screen voltage to the GL-2E26 is fed through R_{22} . For c.w. operation the carrier output is approximately ten watts. The output for 'phone is about 5 watts.

The utility socket shown in the circuit diagram is used for three purposes. One, it serves as the connection point for the metering system; two, it serves as a pick-off point for auxiliary voltages; and three, it serves as an input point for emergency-power connections.

Insofar as the metering problem is concerned, it seemed pointless to provide the transmitter with a milliammeter—even one which could be switched from point to point in the circuit to read current values in all stages. From the economy standpoint, it is desirable to use a single meter and associated switching circuits to serve a large number of transmitters. The diagram of a test-meter suitable for use with this transmitter is shown in Fig. 10. More complete information on this metering system will be given in another paragraph. Of course, if a single transmitter is considered, it would be quite logical to include the meter and the switching arrangement in the cabinet with the transmitter.

Phone monitoring may be accomplished by connecting a pair of high-impedance headphones between pins 7 and 8 of the utility socket. It is thus quite easy to check the modulation of the transmitter, and, at the same time, assure yourself that you are "on-the-air."

The utility socket also provides a convenient source of voltage. For example, if you need auxiliary illumination, you may connect a 6-volt bulb in the circuit by making connections to pins 6 and 8. Similarly, voltage may be provided for an auxiliary receiver, or any other equipment requiring filament voltage and plate voltage. Fig. 9 indicates how these connections may be made.

Used in a reverse manner, filament and plate voltage may be brought in on the utility socket, if, for any reason, the terminal board connections become unusable. Using the utility socket normally for such purposes is not recommended, however, as then it would be impossible to meter the various circuits in the transmitter.

CONSTRUCTIONAL DETAILS

From the photographs it is evident that a home-made chassis and cabinet has been used in the construction of this transmitter. The principal reason for this is that no commercial cabinet and chassis combination satisfied the designer's requirements. Further, the designer felt that it would be useful for a number of amateur requirements. The bugaboo of availability

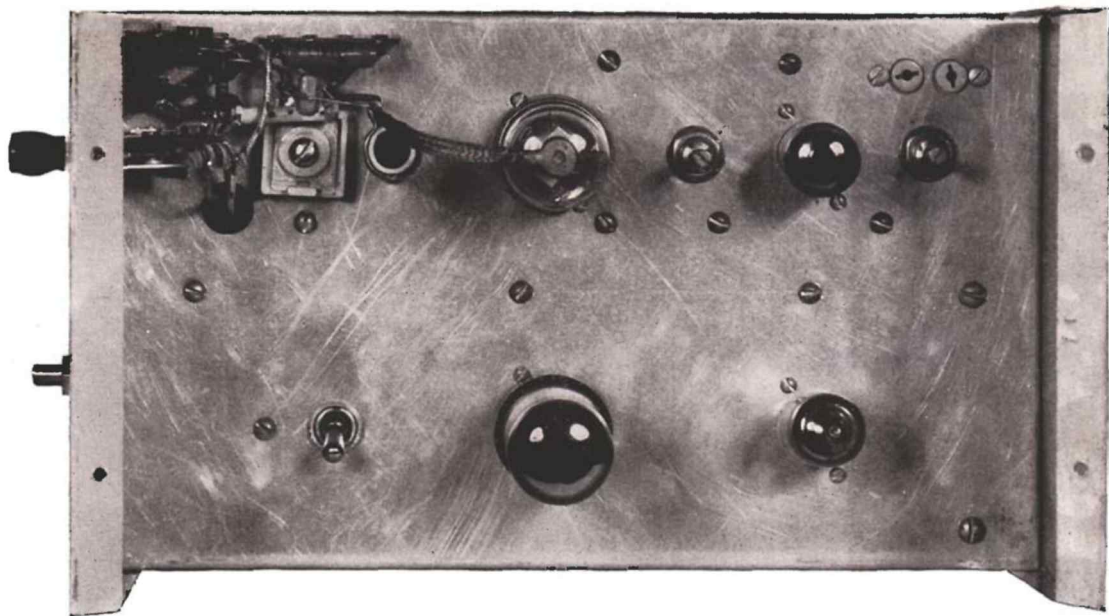

Fig. 5. Top view of 6-meter transmitter

need not be a problem, as this type of metalwork can be done by practically any sheet-metal shop. As a matter of fact, the chassis and cabinet design was deliberately held to the sort of work that could be done by a sheet-metal shop. As a further incentive toward use of a cabinet of this sort, the price is less than you would pay for an equivalent commercial product. The chassis and cabinet as shown should not cost more than \$3.00 from the average sheet-metal shop. You have to do the paint job, of course.

In quantity lots of 20 or more, larger sheet-metal concerns can supply the chassis and cabinet shown, *completely punched with all holes to your specifications*, for less than \$8.00.

The mechanical arrangement of the cabinet is very convenient when wiring the transmitter. The two ends (actually the front and back) are fastened to the chassis, as shown in Fig. 1. At this point it is very easy to mount all components, and then proceed with the wiring. The unit may be turned over when the under-chassis wiring is being done, and the front and rear panels act as "feet" to support the chassis. All parts are completely accessible when the top and bottom cover plates are removed.

Chassis size is ten by six by three inches. Material is 0.030 or 0.040 inch aluminum. Front and rear panel size is 6 inches wide and seven and a half inches high. Material is 20 gage iron. Bottom plate size is ten by

six inches, and the material is 20 gage iron. The top cover piece is in the form of an inverted "U," and of a size that completely covers the box. The material for the top cover is 22 gage iron. All pieces are held together with sheet-metal (self-tapping) screws.

Layout dimensions for the top of the chassis and the front panel are shown in Figs. 4 and 6. Parts mounting is not critical, although the r.f. section should be separated from the audio and modulator section by a shield, as shown in the bottom view of the transmitter, Fig. 3. In Fig. 6 only the major holes are shown. The diameters of the socket holes will be determined by the type of socket used.

Note that the 'phone-c.w. switch is mounted on the chassis, and not on the front panel. Being protected in this manner, there is less likelihood that the switch could be actuated accidentally, by someone unfamiliar with the transmitter. For a similar reason, note that the audio gain control has a locknut on the shaft. Once this control is set, there is very little reason for it to be changed. It is mounted on the front panel, however, so that changes can be made easily when desired.

All tuning controls are available from either the top or bottom of the rig, with holes arranged in the bottom plate or top cover so that screwdriver adjustments can be made easily. The microphone jack is placed on the front panel, but an auxiliary connection

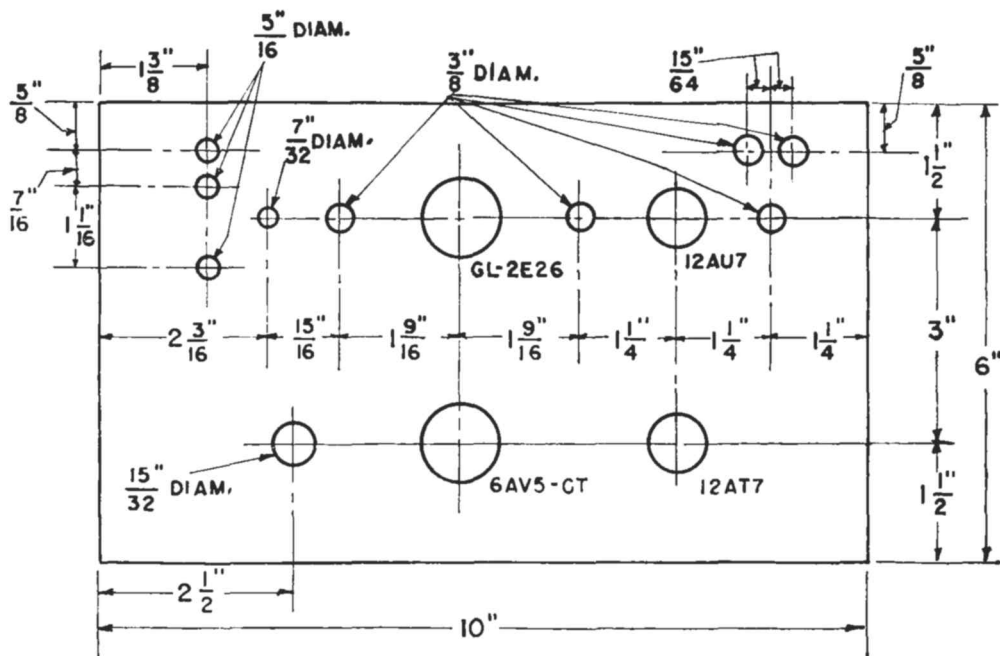

Fig. 6. Chassis layout

point has been arranged on the terminal board, so that the microphone cord may be brought in the rear of the cabinet, and thus not clutter the operating table directly in front of the rig. A hole is drilled in the rear of the transmitter cabinet so that all wires may be brought through and connections made to the terminal board. Fig. 3 shows how this terminal board is placed directly by the rear hole.

On the front panel will be found the microphone jack, the audio gain control, the utility socket, and the send-receive switch. The type of switch specified under Circuit Constants actually is a three-position switch, with a center "off" position. This "off" position is a convenience, as it permits the user to remove the plate voltage from both the receiver and transmitter, leaving on only the filament power.

Ventilation holes are provided on the top cover as shown in the photographs. Placed as shown, a chimney action takes place, and the cooling is very effective. After four hours of operation, in a test where the plate voltage was applied for about half the total time, the top of the cabinet became just perceptibly warm. No part of the transmitter became hot.

In wiring the modulator, use shielded wire between the plate of the 12AT7 and the gain control. It was not found necessary to shield the microphone lead from jack to terminal board, although shielded wire for this connection may be used. Referring to Fig. 3,

the terminal board connections are as follows, going from the connection nearest the center shield to the connection nearest the outside of the chassis: receiver B plus, 300-volt input, filament input, key lead, ground, and microphone connection.

COMPONENT PARTS

The parts listed under Circuit Constants are those which have actually been used in this transmitter. Some variation is allowable, obviously. The 270 mmf mica or general purpose ceramic condensers specified are all used for bypass purposes. Any value between 250 and 500 mmf would serve as well. In some cases a silvered-mica condenser has been specified, and this mainly for the sake of reliability. These or zero-temperature coefficient ceramics should work equally well. Condenser C_{14} is specified as a 1000-volt condenser. The actual voltage on this condenser should not exceed 600-700 volts, on modulation peaks.

The three coils (L_1 , L_2 and L_3) have been wound on Millen No. 69046 coil forms. These forms are tuned with an iron slug. Any type of iron-slug coil forms should work, although the winding information given will not be correct if coils of a different diameter are used. The Millen coil forms have a diameter of one-half inch.

Use the specified value of resistance for R_{20} . If this resistance is too low the 6AV5-GT will draw too much

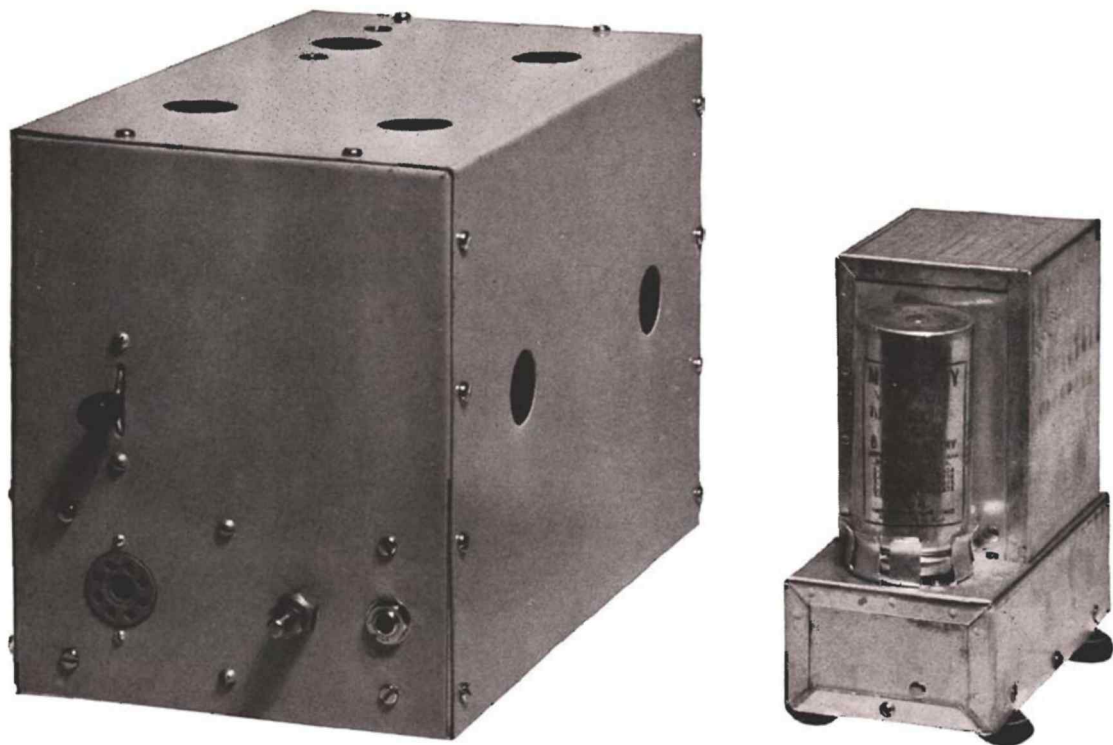

Fig. 7. Size comparison between 6-meter transmitter and its vibrator power supply

current, and if the resistance is too high, the GL-2E26 screen voltage will be too high.

METERING DETAILS

Fig. 10 gives the details of a suggested test meter. Basically, this consists of an 0 to 1 milliammeter and a two-pole, six-position switch, with three resistors to serve as voltage multipliers. This material may be mounted in almost any type of small metal box. No photograph is shown of a completed unit, because individual preference will determine the type of mechanical construction employed. The unit is provided with an octal plug on the end of a suitably long lead. When the octal plug is inserted in the utility socket on the transmitter, metering of all circuits in the transmitter is quickly accomplished.

In switch positions 1 and 2 the resistor R_1 causes the meter to act as a 0-10 volt voltmeter; in switch position 3, resistor R_2 makes the meter into a 0-5-volt voltmeter; in switch position 4, resistor R_3 forms a voltmeter with the range 0-1000 volts; in switch

position 5, the meter is used as a 0-1 milliammeter; in position 6 the meter is shorted (the recommended "off" position).

The following tabulation indicates the "current" and voltage which the meter reads when it is switched to the various positions:

Position 1: Full scale equals 10 mils doubler grid current.

Position 2: Full scale equals 10 mils final grid current.

Position 3: Full scale equals 100 mils final cathode current.

Position 4: Full scale equals 1000 volts plate voltage.

Position 5: Relative power output reading.

Position 6: Off.

For accurate scale readings, the resistors specified should be as accurate as possible. Strictly speaking, however, accuracy is not paramount, inasmuch as the metering system will undoubtedly be used mainly as a tune-up aid.

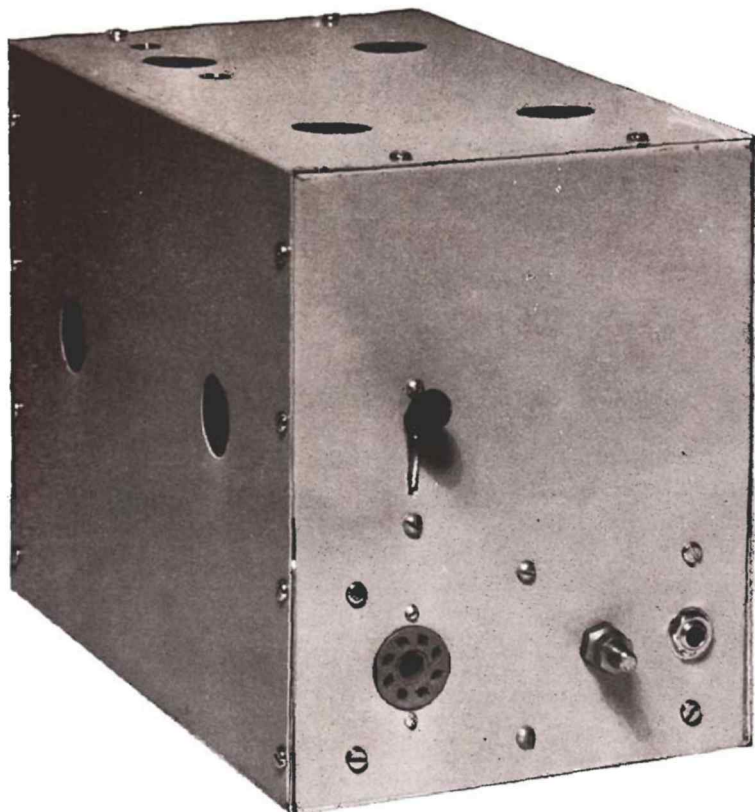

Fig. 8. Front-panel view of 6-meter transmitter

TUNE-UP PROCEDURE

Recommended procedure is as follows: Connect a 50-ohm dummy load to the output connector. Adjust the loading condenser (C_{16}) for minimum loading (maximum capacity). Insert crystal in crystal socket, and turn on filament and plate voltage, making sure that the send-receive switch is in transmit position. Adjust L_1 to resonance, as indicated by maximum grid current in the doubler stage. This current should be approximately 2 to 3 mils. After L_1 is adjusted for maximum doubler grid current, detune it slightly toward a higher frequency (turn slug so that it is coming out of coil slightly). This detuning is the same sort of thing that is done in tuning a conventional-type crystal oscillator, and is done to obtain maximum stability in the crystal stage.

If trouble is encountered with the crystal stage, the tap on the coil may be changed. As the tap is moved toward the plate of the tube the amount of regeneration is increased. If the tap is moved too far in this direction, the circuit will oscillate as a conven-

tional L-C type Hartley oscillator, and oscillations will be present whether or not a crystal is in the circuit. If the oscillator is working properly, there will be no output when the crystal is removed from the socket. Also, tuning the circuit with L_1 will produce only minor changes in frequency.

Next, the doubler plate circuit should be tuned with L_2 for maximum final grid current. This current will be approximately 1.5 to 2.5 mils. Incidentally, in all this tuning procedure make the adjustments rapidly, while plate voltage is on, in order that the tubes will not be damaged due to excessive off-resonant currents.

The plate circuit of the GL-2E26 should next be

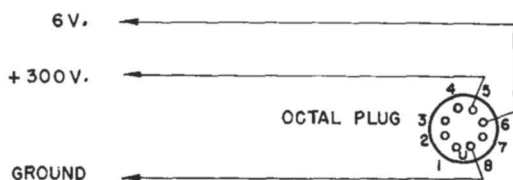

Fig. 9. Utility socket accessory connection

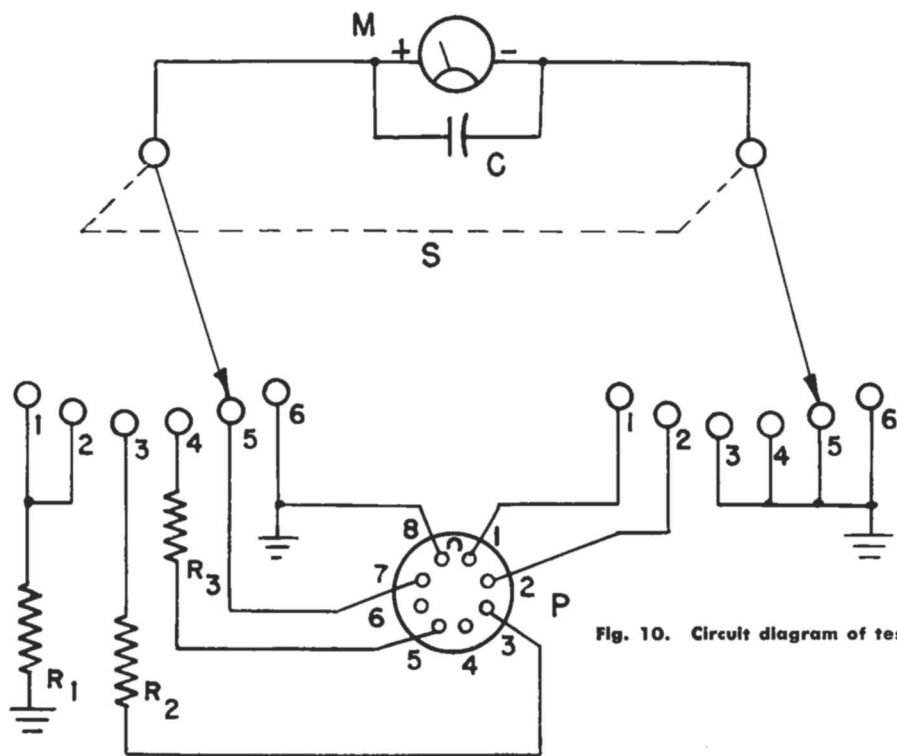

Fig. 10. Circuit diagram of test meter

CIRCUIT CONSTANTS

C.....270 mmf mica or high-K ceramic
M.....0 to 1 mil d.c. meter
P.....Octal plug
R₁.....10,000 ohm, ½ watt (see text)

R₂.....5000 ohm, ½ watt (see text)
R₃.....1 megohm, 1 watt (see text)
S.....Two-pole, six-position rotary switch

resonated at 50 megacycles with L₃ by observing the cathode current, and adjusting for minimum current. The minimum cathode current will run around 30 mils. Next, decrease the capacitance of C₁₆ to increase the loading, and retune L₃ for minimum current. Continue this process of decreasing C₁₆ and re-resonating L₃ until the cathode current is approximately 45 to 50 mils. At this point the transmitter should be properly tuned.

To check modulator performance, couple an absorption type loop and pilot lamp to L₃ and modulate the rig. An increase in lamp brilliancy should be obtained as the rig is modulated, indicating upward modulation. If you find that you have downward modulation, indicated by a decrease in lamp brilliancy as you speak, then check the grid drive to the final. If the current is over 2.5 mils, reduce it by slightly detuning L₂. This type of modulation requires heavy loading on the GL-2E26 plate circuit, and an optimum amount of grid drive. Following these adjustments,

the antenna may be connected and the transmitter output and modulation again checked.

Remember that this transmitter is designed to work into a 50-ohm load. This means that you should use an antenna whose impedance is approximately 50 ohms, or else couple into a tuning network with the same impedance. As a matter of fact, this transmitter can be coupled to a dipole antenna with a 70-ohm impedance, or into a standard quarter-wave automobile antenna with a 36-ohm impedance, and the mismatch will not be serious. Feed the dipole with 50- or 70-ohm line, and the quarter-wave antenna with 50-ohm coaxial cable.

CURRENT AND VOLTAGE REQUIREMENTS

Total filament current is 2.6 amperes, at 6 volts d-c or a-c. High voltage required is 250 or 300 volts. High voltage current drain is approximately 100 to 110 mils for 'phone operation, and 60 to 75 mils for c.w. operation.

SWEEPING *the* SPECTRUM



Some of you may be surprised at the emphasis which the G-E *Ham News* has been placing on civil-defense work. Many of you readers are grateful for the work already done, as shown by your letters, but I have the feeling that other amateur groups may wonder why so much space is being devoted to civil-defense equipment. Frankly, it is my opinion that civil-defense communications is the biggest challenge that has been put to the amateurs in many years.

There is no community in the United States that has too much communication equipment, or too elaborate a communication system. In fact, some communities have no system at all. Radio amateurs are communication specialists, by the very nature of their work, and it seems criminal to waste this talent. Unfortunately, there is a little of the "it can't happen here" philosophy in many amateur groups. It is not that these amateurs don't want to help, but they are not yet convinced that there is a good reason for taking a part in civil defense planning.

Probably nothing I can say here will convince the doubters of the seriousness of this problem. However, I would like to ask you to lend a sympathetic ear whenever you are approached by your local civil-defense authorities. These people look to you, the amateurs, as communication specialists. If you, individually, fail to measure up to these standards, then you hurt amateur radio as a whole. The challenge is there. It is up to each of us, as individuals, to meet this challenge by aiding in whatever way possible.



I'd like to ask you a question. Would you like to see a future issue of the G-E *Ham News* describe a six-meter receiver which is the companion unit to the six-meter transmitter described in this issue? This receiver is mounted in a cabinet identical in size and appearance to that shown for the transmitter. Actually, the receiver is a stripped-down version of the one that appeared in the September-October 1951 *Ham News*. It is a superhet with the same tube line-up, but several circuit changes have been made. You might call it a down-to-business, point-to-point communication receiver for six-meter civilian defense work.

If you would like to see this in a future *Ham News*, drop me a postcard. The address is Lighthouse Larry, Bldg. 267, General Electric Co., Schenectady 5, New York. I'd like to have your vote before February 15, if possible. Here's your chance to vote on what you want to see in *Ham News*. Whether you vote "yes" or "no," send in those postcards.



Finding some components hard to get these days? It's not unusual, because the military is taking an ever-increasing amount of material, and the manu-

facturers are finding it difficult to keep up with the demand. You, as an amateur, need not let this trouble you if you remember to use your priority. On October 4, 1951 the National Production Authority issued a new order designed to keep amateurs on the air. This order grants priority assistance to licensed amateur radio stations.

When you need materials, such as copper, aluminum, and other metals or raw materials, use the allotment symbol MRO on your order, and certify it by signing your name and station call letters on the order. For component parts, use the symbol DO-MRO in the same way. Amateurs are limited to an annual quota of \$100 in rated orders, unless they are members of one of the major military or emergency networks, in which case the annual quota is \$200. These organizations include: MARS, RACES, NTS (ARRL), Flood Emergency Network, National Emergency Net (ARC), CAP, USNR Communications Network, and ARRL Emergency Corps.

In order to preserve your quota, use the priority symbol only on those orders where a priority is required. The quota refers to orders bearing the priority symbol, and does not refer to your total purchases in any given year.



One question which has been asked quite often by the local ham gang concerns license renewals. The question is this: If I have applied to the F.C.C. for renewal of my license before the expiration date, but have not heard from them, is it legal for me to continue to operate after the expiration date of my license? In case you have this problem, the answer is yes. You may continue to operate past the expiration date of your license, if you applied for renewal before the license expired.



Dr. W. R. G. Baker, General Electric Vice-president, recently spoke before the National Electronics Conference on the subject "Electronics for Defense." One of his remarks was touched with the type of humor that a radio amateur might appreciate, so I'm going to repeat it. This remark was prefaced by statements having to do with the military's demands for equipment which could be considered as extremely rugged, completely standard, and as small as possible.

Dr. Baker went on to say, "What the military dreams of is such things as a gunfire computer rugged enough to be tossed out of an airplane at 5000 feet without a parachute, small enough to be carried in a vest pocket, and simple enough to be operated by someone who failed to graduate from the third grade, which can be disassembled and reassembled at midnight under three feet of water."

— *Lighthouse Larry*

BEAM POWER TUBE

DESCRIPTION

The GL-2E26 is a five-electrode beam power amplifier tube designed for use in FM transmitters, either in low-power driver stages, or in the output stage when only low power output is required. It is also useful in audio-frequency power and modulator service. The anode is capable of dissipating 13.5 watts, and cooling is accomplished by radiation. The cathode is the indirectly heated type. Maximum ratings apply up to 125 megacycles.

The 2E26 has high power sensitivity and high efficiency and can be operated at relatively low plate voltage to give large power output with small driving power.

The base of this tube has a short metal sleeve which shields the input to the tube so completely that no other external shielding is required. Separation of input and output circuits is accomplished by bringing the plate lead out of the bulb to a cap opposite the base.

GENERAL CHARACTERISTICS

Number of electrodes.....	5
Electrical	
Heater voltage, a-c or d-c.....	6.3 volts
Heater current.....	0.8 ampere
Transconductance, $I_b = 20$ ma.....	3500 micromhos
Grid-screen amplification factor.....	6.5
Interelectrode capacitances*	
Grid-plate.....	0.20 micromicrofarads
Input.....	13 micromicrofarads
Output.....	7 micromicrofarads
Mechanical	
Mounting position—any.....	
Net weight, approximate.....	1½ ounces

* With no external shielding and base sleeve connected to ground.



Ham News

Available FREE from

G-E Electronic Tube Distributors

Printed in U.S.A.

A Bi-monthly Publication

TUBE DEPARTMENT, ELECTRONICS DIVISION

GENERAL ELECTRIC

SCHENECTADY 5, N. Y.

(In Canada, Canadian General Electric Company, Ltd., Toronto, Ont.)

GEO. H. FLOYD, W3RYT — EDITOR

FROM: