



Electronic

TUBE

MARCH—APRIL, 1950

HAM NEWS

Copyright 1950, by General Electric Company

VOL. 5—NO. 2



Emergency-Portable Rig

Fifteen-watt 75-80 Meter Rig Designed for Emergency, Portable or Mobile Use

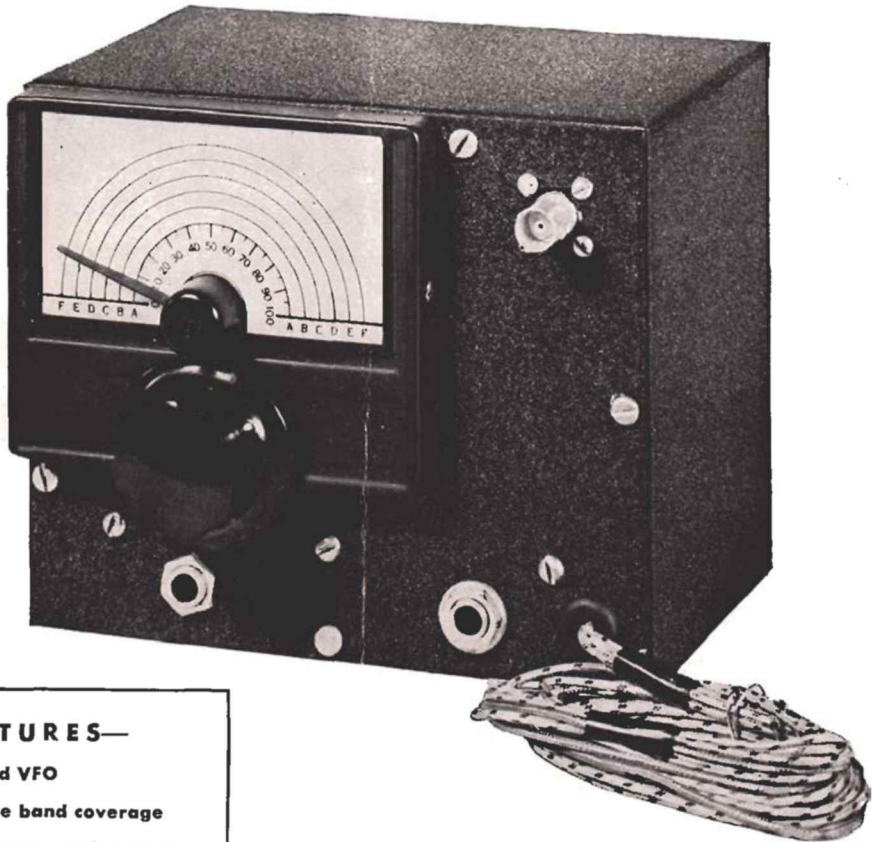

FEATURES—

- Self-contained VFO
- CW and phone band coverage
- Three tubes—one a voltage rectifier
- Lightweight and compact

Fig. 1. Front view of the Emergency-Portable Rig. Keying jack is on the left, plate current jack is on the right.

CONTENTS

Emergency-Portable Rig.....	pages 1-5
Designer's Corner (A Note on Capacitive Interstage Coupling).....	page 6
Sweeping the Spectrum.....	page 7
Technical Information (6AK6).....	page 8

ELECTRICAL CIRCUIT

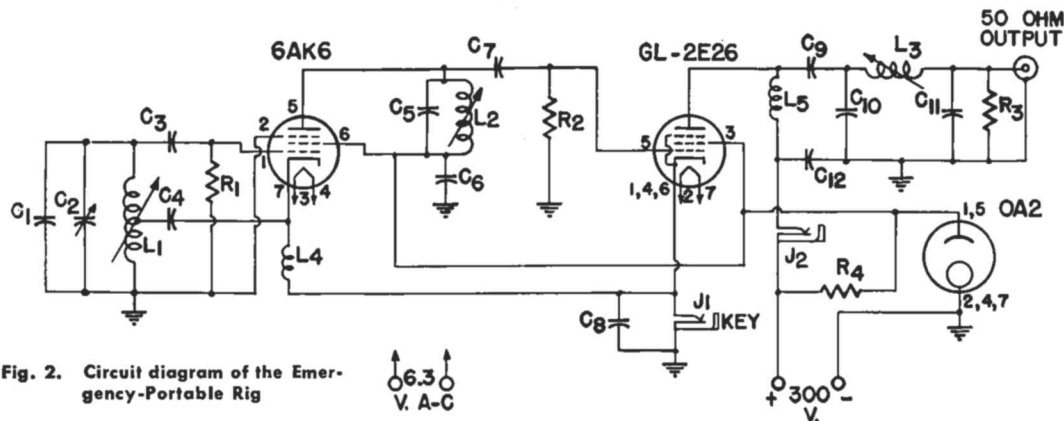

Fig. 2. Circuit diagram of the Emergency-Portable Rig

CIRCUIT CONSTANTS

C₁..... 400 mmf silver mica
 C₂..... 100 mmf variable (Hammarlund HF-100)
 C₃, C₅, C₁₀..... 100 mmf silver mica
 C₄, C₆, C₁₂..... 0.002 mf 500 volt
 C₇, C₁₁..... 100 mmf mica
 C₈..... 0.005 mf 500 volt
 C₉..... 0.001 mf mica
 J₁, J₂..... Closed circuit jack

L₁, L₂, L₃... 38 T No. 26 enamel wire on National XR-50 coil form (L₁ tapped 6 T from the bottom)
 L₄, L₅..... 2.5 millihenry r-f choke (Millen No. 34100)
 R₁..... 0.1 meg, 1/2 watt
 R₂..... 20,000 ohm, 1/2 watt
 R₂..... 5000 ohm, 1/2 watt
 R₂..... 5000 ohm, 5 watt

The Emergency-Portable Rig discussed in this issue is the first of several pieces of equipment, designed primarily for emergency use, which will be described in *Ham News*. A companion modulator will be described in an early issue, which, together with the E-P rig, can be powered by a 100 ma vibrator power supply.

GENERAL CONSIDERATIONS

Several features of any portable or emergency rig are almost mandatory. These are small size and low over-all drain. Other no less desirable features are a self-contained variable frequency oscillator and a final tube capable of as high an output power as is consistent with the primary power source.

It is also desirable that the transmitter be simple and use as few parts as possible, so that servicing is easy and the parts replacement problem simple.

Insofar as possible, all of the above points have been considered in the design of the Emergency-Portable Rig.

ELECTRICAL DETAILS

Refer to the circuit diagram, Fig. 2. The transmitter consists of a 6AK6 VFO and a GL-2E26 final. A voltage regulator tube is also included.

The oscillator operates on the 160 meter band. Some measure of isolation is achieved by doing this, and ample power output is obtained to drive the final, even though the oscillator is doubling.

The 6AK6 tube was chosen for the oscillator because of several desirable features. This tube has a separate suppressor which may be connected directly

to ground. If the suppressor grid were connected internally to the cathode, as is true with most miniature pentodes, extra coupling between the grid and plate circuits would exist which would materially affect the grid-plate isolation. This coupling is easily avoided by using a tube with a separate suppressor-grid.

Further, the 6AK6 is a well-shielded tube and will handle a fair amount of power—at least sufficient power output is obtainable to drive most low-power pentodes or beam-power tubes.

The choice of the tube for the final stage was a little more difficult to make. Many things had to be considered, such as cost, size, availability and performance. Perhaps the one thing that decided in favor of the GL-2E26 was the ease with which this tube can be made to operate properly.

Compared to receiving tubes, such as the 6V6, the GL-2E26 has a low grid to plate capacity. This means that the circuit need not be tricky in order to avoid undesirable touchiness. From this standpoint the GL-2E26 is well worth the small extra cost involved.

The plate circuit of the final may seem unduly cluttered until you realize that an antenna matching network has been included in the design. This is the usual sort of pi coupling arrangement which in this case has been designed for fifty ohm output.

Use of a coupler of this sort tends to eliminate spurious radiations and brings to a minimum the possibility of producing TVI.

The pi network shown is not tunable in the normal sense of the word. Coil L₃ is actually the plate tank

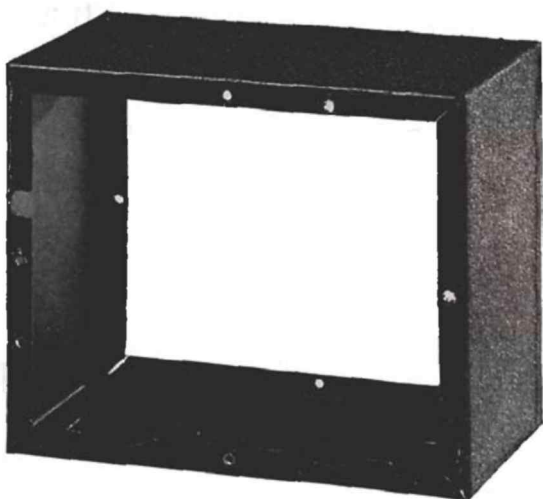
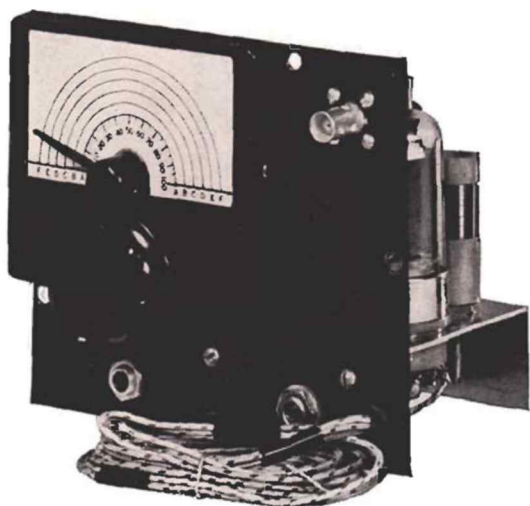

Fig. 3. Emergency-Portable Rig removed from its cabinet. The back of the cabinet has also been removed for the sake of clarity.

coil for the GL-2E26 stage. Tuning procedure will be explained later. As shown the output matches directly to 52 ohm coaxial cable which in turn must be matched to the antenna.

Other types of coupling, such as link coupling, could be employed. For example, to use link coupling merely eliminate C_{11} and R_3 and connect the right-hand end of coil L_3 to ground. The link is then placed around the ground end of the plate coil L_3 .

VOLTAGE REGULATION

A great deal of care was taken, design-wise, to ensure that the oscillator would give a clean keyed signal. There is no excuse for a chirpy signal, even from a rig designed primarily for emergency use. This dictated the use of a voltage regulator tube which provides 150 volts to the oscillator and the screen of the final. The additional current drain is still within our prescribed limits.

SLUG TUNING

Iron slug tuning coils are a perfect solution for interstage and final tuning elements in the E-P Rig. At the power levels encountered there is no loss problem and the tuning range achievable is more than adequate.

Variable condensers might allow slightly higher Q circuits to be obtained. However, the slight betterment of performance which might be obtained in this manner would not justify the extra cost and the extra space which would have to be made available.

In a transmitter of this sort rapid frequency changing from one end of the band to the other is not necessary, although it is possible, using slug tuning, to move a hundred kilocycles or so without retuning the coils.

For large changes in frequency it will be necessary to adjust L_2 and L_3 to resonance.

ECO VERSUS CLAPP

The excellence and popularity of the Clapp oscillator circuit might lead some people to ask why it was not employed in the Emergency-Portable Rig. This circuit was seriously considered, but several reasons caused it to be discarded in favor of the ECO circuit.

In order to take full advantage of the Clapp oscillator circuit it is necessary to use a high Q, high inductance coil in the grid circuit. For operation on 160 meters this sort of coil becomes unwieldy and large. To do the job properly would require a coil approximately two inches in diameter and two inches long—that is, a so-called fifty watt coil. This is obviously impractical in a four by five by six inch cabinet.

Other considerations make the ECO circuit ultimately practical. It is relatively tolerant of changes of the circuit components. It is a simple circuit with which most amateurs are familiar—no slight consideration if true emergency work has to be done.

These and other factors led to the choice of the electron-coupled oscillator circuit for use as the VFO.

CONSTRUCTIONAL DETAILS

The entire transmitter is housed in a four by five by six inch utility box. One of the removable sides serves as the front panel. It will be necessary to bend a chassis out of one-sixteenth inch aluminum or sheet metal. The top of the chassis measures $5\frac{1}{2}$ inches by 3 inches. One flange is bent down $1\frac{1}{4}$ inches and the other is bent down one-half inch.

The one-half inch flange mounts against the front panel at a height which allows the rear flange to extend down so that it is in line with the bottom edge of the front panel. (See Fig. 3.)

The Millen dial, No. 10039, mounts on the upper left portion of the front panel. The coaxial connector

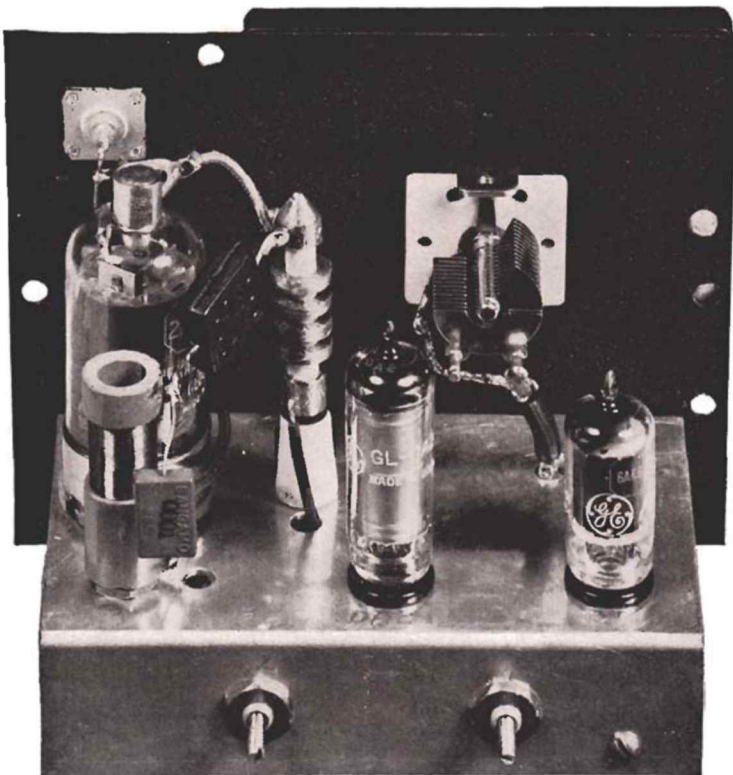

Fig. 4. Rear view of the Emergency-Portable Rig. Note the two slug-tuned coils mounted on the rear apron. Coil L_2 is on the left; coil L_1 is on the right.

for the 50 ohm output is at the upper right and the two jacks mount as pictured. A rubber grommet is placed in the lower right-hand corner of the front panel. The two filament leads and the two 300 volt leads are cabled and run through this grommet.

Figs. 4 and 5 give the details of parts mounting. The under-chassis view gives the impression that the parts are crowded together, but there is ample room in which to wire the rig.

Note that coils L_1 and L_2 are mounted under the chassis and coil L_3 is mounted in back of the GL-2E26 on top of the chassis. Components mounted above chassis, aside from the tubes, are C_2 , L_3 , L_3 , C_3 , C_{10} , C_{11} and R_3 .

As is evident from Fig. 3 it will be necessary to remove part of the flange on the box in order to clear parts mounted on the chassis. It is also necessary to drill two holes in the other removable side for tuning L_1 and L_2 and a hole must be drilled in the bottom of the box so that L_3 may be tuned.

One particular point of interest in the wiring can be seen clearly in Fig. 4. Coaxial cable (small size) is used to make the connection between the top of coil L_1 and the stator of C_2 . The coax is grounded at the point where it comes through the chassis. The inner conductor connects to the stator of C_2 .

If ordinary, unshielded wire were used for this

connection, mechanical shock would cause the wire to move and the result would be a minor variation in the stator to ground capacity of C_2 . Using coax permits thorough shielding and gives a minimum frequency change due to the connection being moved.

Component part placement is not critical. As a matter of fact, the mechanical layout shown in the photographs could probably be improved if the 6AK6 and the OA2 were interchanged in position, so that the 6AK6 was between the GL-2E26 and the OA2.

CRITICAL COMPONENTS

For best operation of the circuit C_1 , C_2 , C_3 , C_7 , C_{10} , and C_{11} should be as close as possible to the specified value. Silvered-mica condensers are recommended for C_1 , C_3 , C_3 , C_{10} and C_{11} . The remainder of the condensers are used for blocking or bypassing purposes and are not critical although the values specified should be used if possible. The ceramic high-capacity condensers will save space if employed as C_4 , C_6 , C_8 , C_9 , and C_{12} .

The thirty-eight turns of wire specified for coils L_1 , L_2 and L_3 should just fill the coil form with a one-layer winding. No pruning of coils should be necessary if the layout shown is followed.

Resistor R_4 should be of a value which will not

allow more than 30 mils through the OA2 tube when the keying jack is open.

VFO COVERAGE

A Hammarlund HF-100 condenser is recommended as the oscillator grid tuning condenser primarily because of its size. Any small 100 mmf condenser should serve as well.

The frequency variation possible with a 100 mmf condenser in use is not quite sufficient to cover the range from 3.5 to 4.0 megacycles.

For example, if C_2 is set at minimum capacity and L_1 adjusted so that the oscillator frequency is 4.0 megacycles, tuning C_2 to maximum capacity will bring the frequency down to 3535 kilocycles, approximately.

Conversely, if the oscillator frequency is set at 3.5 megacycles with C_2 at maximum capacity, the frequency will be 3910 kilocycles when C_2 is tuned to minimum capacity.

This slightly restricted tuning range can be used to advantage, however. If the bottom end of the range is set at approximately 3520 kilocycles, then the top of the range will be just inside the high-frequency end of the band. In this way you will be fairly certain to stay inside the band under all conditions. Remember,

there may be no frequency standard available in an emergency.

TUNE-UP ADJUSTMENTS

Remove the E-P Rig from its case and remove the GL-2E26 tube. Apply filament and plate voltage. Adjust L_1 until the 6AK6 is oscillating at the proper frequency. Tune L_2 to resonance by a pickup loop and a flashlight bulb, or a neon bulb. A meter plugged into the keying jack should read a current of approximately fifteen mils.

Replace the GL-2E26 in its socket. Short the 50 ohm output connector. (This effectively causes the final to be completely unloaded.) Apply plate voltage and tune L_3 to resonance by noting the dip in plate current.

The rig should now be tuned to the frequency of the ECO. Open the keying jack and measure the current flowing through the OA2. This should not exceed 30 mils. Adjust R_4 if it does. Close the key. The OA2 current should be five mils or greater. As a double check on this, make certain that the voltage on the GL-2E26 screen is 150 volts.

Remove the short from the 50 ohm output connector, place a matched 50 ohm feeder on the output jack, and you are on the air.

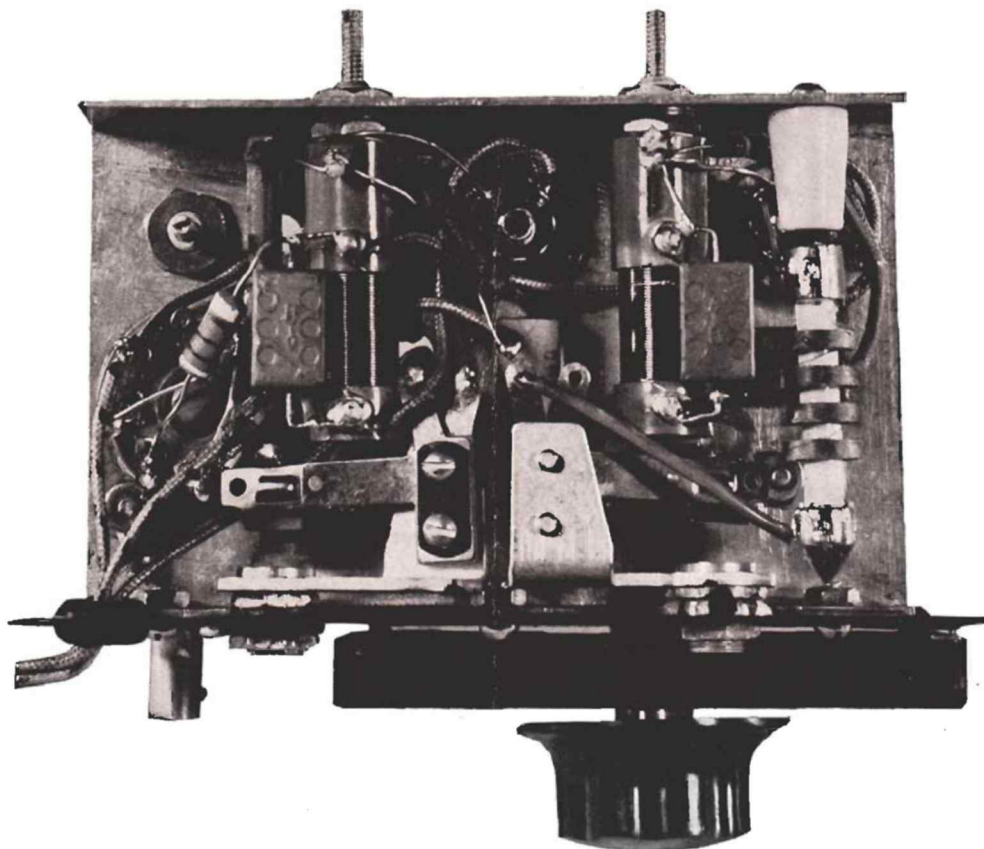

Fig. 5. Under-chassis view of the Emergency-Portable Rig

Designer's

CORNER

A Note on Capacitive Interstage Coupling

(The use of a capacitor to tie the grid of an amplifier to the preceding driving stage is one of the oldest techniques in transmitter design and construction. It's not very effective in getting the most out of the driver stage unless the grid of the PA happens to look like the optimum load for the driver. However, this is rarely serious, because the usual driver is capable of delivering many times the power required by the PA grids—especially if the PA is one of the high power gain beam power tubes. Certainly, capacitive coupling is a simple and compact way of driving the PA. But it is not foolproof. The following story of a series of incidents which occurred while testing the Emergency-Portable Rig described in this issue should illustrate this.—Editor's Note)

In the design of the Emergency-Portable Rig a consideration of available tubes quickly led to a choice of the 6AK6—2E26 combination shown. Capacitive coupling was the logical choice from the point of view of simplicity. Ample reserve driving power was available. A small ceramic capacitor, approximately 10 mmfd was chosen in order to prevent the low voltage—low impedance grid of the 2E26 from overloading the 6AK6. Although the 6AK6 was capable of handling the increased dissipation when overloaded, it did not look like a desirable thing to do. When power was applied, the grid current of the 2E26 stage was in the recommended range and so without further ado attention centered on the pi network coupling system. The dummy load resistor got encouragingly warm after the coil was tuned according to the procedure recommended in the article. A quick check on the 2E26 plate current showed normal current, and so we started to untangle the maze of clip leads. But we had failed to reckon with José.

José is our pet laboratory gremlin. We have learned to humor him, though he's become incredibly rude through 18 years of being kicked around the shack. He became quite profane until we agreed to measure the loaded plate current dip—although long experience with tetrodes and pentodes has taught us that one only gets a barely perceptible plate current dip when the system is properly loaded—for example 5%—10% dip. After connecting the clip leads once more, the pi network was tuned through resonance and the plate milliammeter observed. No dip! Perhaps

more from curiosity's sake than any other reason, the load resistor was shunted until a barely perceptible dip could be observed. This check indicated a load resistor of 25 ohms, not 50 ohms, for optimum performance. However, the load resistor had cooled off. The capacitor and coil values were checked by the instruments and found to be within very few per cent of correct values.

Our modest nature does not permit us to describe all the things that were tried in fruitless attempts to get the normal small loaded plate current dip to coincide with maximum power transfer. Suffice it to say that two packs of cigarettes and six cups of coffee later we cured the trouble by the simple expedient of increasing the coupling condenser between the plate of the 6AK6 and the grid of the 2E26 to the 100 mmfd value shown in the parts list.

Sober reflection indicates that such an effect might have been expected, and the explanation is not very involved. Since the 6AK6 was capable of delivering a good excess of power at a voltage far in excess of the requirements of the 2E26 grid it was readily possible to deliver sufficient energy through the high impedance of the small coupling condenser originally used to the 2E26 grid to establish normal bias and dc grid current. However, such a high impedance circuit is incapable of supplying the high peak current required by the 2E26 grid when it is driven to the recommended positive voltage. As a result, the driving waveform is not sinusoidal, the current pulses through the plate circuit of the 2E26 are distorted,* and the reaction of the dc plate current to tuning and load impedance changes is radically modified. Under these conditions tuning and loading according to the readings of the plate current milliammeter may lead to false indications of proper load match. By increasing the value of the coupling condenser and thus lowering the impedance of the grid coupling circuit, at the expense of driver efficiency, the proper conditions for driving the 2E26 grid were obtained, and all tuning and loading adjustments returned to normal.

Well, José has had his fun, and we suspect it's a fairly common old gremlin trick. So don't say we didn't warn you. And if we ever get our hands on that José . . . ? . . . ? . . . ?----W2FZW.

* P.S. If you think this distortion indicates that there are a lot of juicy TVI harmonics in the making, you're so right!

Sweeping the Spectrum

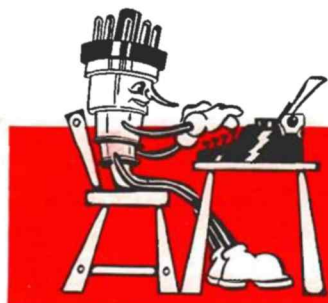

The Harmoniker (November-December, 1949 *Ham News*) certainly rang the bell with thousands of amateurs. Every mail delivery brings letters of thanks from amateurs who no longer get the shakes when the telephone rings.

Some amateurs, however, haven't built their Harmoniker yet, because they claim I specified mica condensers of such odd values. This can only mean that many of us are not familiar with the RMA preferred value system.

This system specifies the values for small resistors and condensers (among other things) in order to maintain an orderly progression of sizes. For example you now can buy small resistors and condensers of 10, 11, 12, 13, 15, 16, 18, 20, 22, 24, 27, 30, 33, 36, 39, 43, 47, 51, 56, 62, 68, 75, 82, 91 and 100 ohms or micro-micro-farads. Similarly, multiply these values by ten, or one hundred, etc. and you have other values obtainable.

The reasons for the selection of these values is mathematical and quite involved. The system is based on a given percentage difference between values which accounts for the large gap between the higher values and the smaller gaps between the lower values. Unfortunately there is not enough space available on this page to go into the details, except to say that the system seems to be very sound. Incidentally, not all values mentioned are obtainable in all ranges or styles.

All of you have seen a 47,000 ohm resistor specified in a circuit diagram. The reason is obvious if you check the list of numbers above. The values are not odd and unobtainable. Quite the reverse is true.

* * *

Of course, if you check the circuit constant data for the Harmoniker, you will see that some of the condensers specified are not in the RMA preferred value list. This is true, but as I explained on page four of the Harmoniker issue, the values specified were the correct values, and you were to get capacitors which came as close as possible to the specified values.

For example, the 80 meter 100 ohm Harmoniker requires 840 mmf condensers. Our list indicates that 820 mmf condensers are available. A quick check with a capacitance bridge (borrowed from a friendly serviceman) will show if the condensers are high—which brings them very close to the required 840 mmf—or if they are low. In the latter case you might want to parallel each condenser with an 18 or 20 or 22 mmf condenser.

I wish it had not been necessary to ask you to obtain condensers of a certain value for the Harmoniker. However, some designs turn out that way. They are so good that they must be published, but they require a little extra work on the part of the builder. Those of you who have been successful in eliminating TVI with the Harmoniker will agree, I am sure, that the extra effort was worth while.

* * *

The foregoing discussion brings up a point of editorial policy. I have always felt it desirable to present all the information possible on a circuit, especially insofar as component parts are concerned. For example, if a resonant circuit requires a padding condenser of, let us say, 117 mmf, I specify this value.

I might specify 100 mmf, figuring that if you find the circuit is not in tune you will have to adjust it in some manner, but this has not been done in *Ham News*, because too many people can be fooled. If this "rounding-off" process were to be done at several points in any one circuit the net result might be an unbelievable mess—electrically that is.

Obviously most values of resistors and condensers are not critical, even within the plus or minus twenty percent tolerance which you expect of inexpensive items. In these cases the nominal value is specified and almost any value will work.

Are you able to tell which are the critical values and which the non-critical values in a circuit? Would you like to see critical components listed a special way in the circuit components list?

Or, are you satisfied with the present system, where critical values are discussed in the text and the remainder listed with their nominal values given? I would appreciate your comments.

—Lighthouse Larry

TECHNICAL INFORMATION

6AK6

DESCRIPTION

Principal Application: The 6AK6 is a miniature power-amplifier pentode especially designed for use in the output stages of receivers where space and power consumption must be kept to a minimum.

The heater requires 6.3 volts at only 0.15 ampere. Except for its smaller size, the 6AK6 is similar to the 6G6-G.

Cathode..... Coated Unipotential
 Heater Voltage (A-C or D-C)..... 6.3 Volts
 Heater Current..... 0.15 Ampere

Envelope..... T-5 1/2 Glass
 Base..... E7-1 Miniature Glass-Button 7-Pin
 Mounting Position..... Any

MAXIMUM RATINGS

DESIGN-CENTER VALUES

Plate Voltage.....	300.....	Volts
Grid Number 2 (Screen) Voltage.....	250.....	Volts
Plate Dissipation.....	2.75.....	Watts
Grid Number 2 (Screen) Dissipation.....	0.75.....	Watt
D-C Heater-Cathode Voltage.....	100.....	Volts

PHYSICAL DIMENSIONS

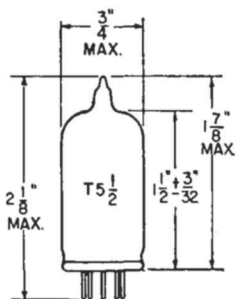

RMA 5-2

TERMINAL CONNECTIONS

- Pin 1—Grid Number 1
- Pin 2—Grid Number 3
- Pin 3—Heater
- Pin 4—Heater
- Pin 5—Plate
- Pin 6—Grid Number 2 (Screen)
- Pin 7—Cathode

BASING DIAGRAM



RMA 7BK
 BOTTOM VIEW



HAM NEWS

Available FREE from
 G-E Electronic Tube Distributors

Printed in U.S.A.

A Bi-monthly Publication

TUBE DIVISIONS, ELECTRONICS DEPARTMENT

GENERAL ELECTRIC

SCHENECTADY 5, N. Y.

(In Canada, Canadian General Electric Company, Ltd., Toronto, Ont.)

GEO. H. FLOYD, W2RYT—EDITOR

FROM: