



MEGABOOSTER

Frequency Tripler Gives 432 MC Output with 144 MC Input

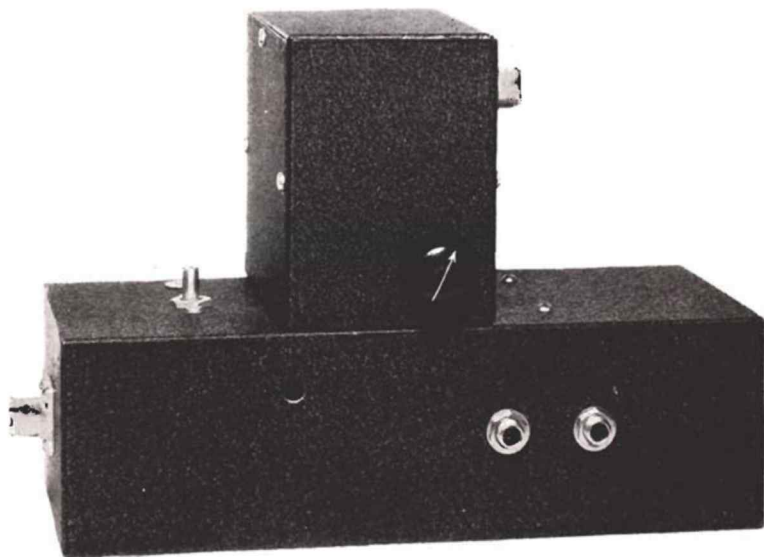

Fig. 1. Front View of Megabooster. The Tank Circuit is Shielded to Prevent Power Loss Due to Radiation

The Megabooster is a final amplifier designed for operation on the 420 to 450 megacycle band. No driving stages are incorporated, as the Megabooster may be driven by practically any 2 meter transmitter. The power output is sufficient for experimental work on the $\frac{3}{4}$ meter band. The Megabooster is easy to build and it may be modulated with any five to ten watt audio amplifier.

WHY CRYSTAL CONTROL

Because the $\frac{3}{4}$ meter band is so wide, it may seem unnecessary to use an MOPA or crystal controlled rig. However, definite advantages come from this

type of transmitter. From the transmission standpoint, several watts of output from a modulated oscillator will go as far as the same power from a crystal-controlled rig. The main advantage in using crystal control is to give the receiver at the other end a chance to do a better job. If a relatively narrow signal is transmitted, a 420 megacycle converter can be used with a regular receiver. This setup is much more sensitive than a regenerative or a super-regenerative receiver, which it would be necessary to use if a modulated oscillator were used. Of course, a special receiver, with a very broad i-f system could also be used.

CONTENTS

Megabooster (High-frequency Final Using 6L2C43 Lighthouse Triodes)	pages 1, 2, 3
Technical Tidbits (Caution—Screen Grid at Work; Wiring Techniques)	pages 4, 5
Tricks & Topics (Plug-in Variable Link; Noiseless Slip Rings; QSL Card Display; Eyelet Holder)	page 6
Questions & Answers (Standby Operation; Storing Spare Tubes; Frequency for Typical Data; VR Tube Jumpers)	page 7
Parasitics (Correction for Fig. 4 in the May-June 1948 Ham News)	page 4

ELECTRICAL CIRCUIT

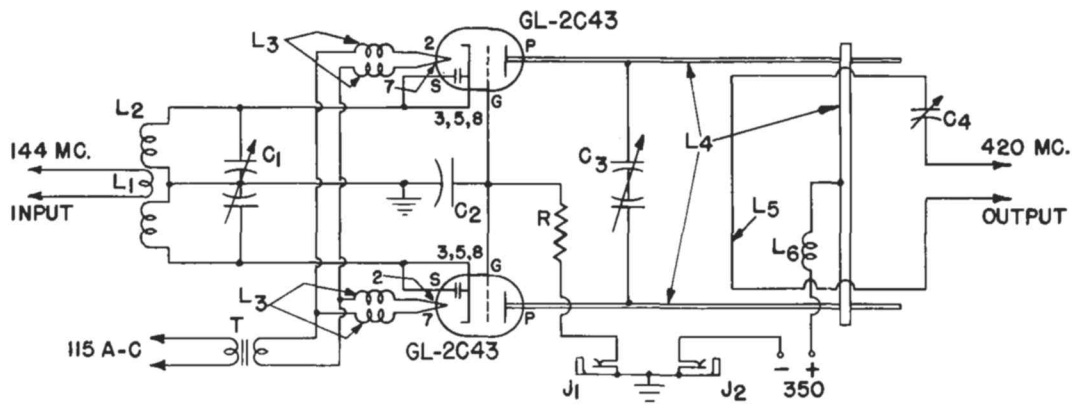

Fig. 2. Circuit Diagram of the Megabooster

CIRCUIT CONSTANTS AND PARTS LIST

- | | | | |
|------------|---|-------|--|
| C_1 | = 12 mmf/section butterfly condenser (Hammarlund BFC-12) | L_5 | = 1 T No. 10 wire; see photo |
| C_2 | = Made of varnished cambric (see text) | L_6 | = 20 T No. 26 wire; close wound on 100 ohm 1 watt resistor |
| C_3 | = Plate tuning condenser (see text) | R | = 2500 ohm 5 watt |
| C_4 | = Link tuning condenser (see text) | T | = 6.3 V 2 ampere transformer |
| J_1, J_2 | = Closed circuit-jack | 2 | ... GL-2C43 tubes |
| L_1 | = 2 T No. 14 wire; $\frac{1}{2}$ inch inside diameter | 1 | ... $5 \times 10 \times 3$ inch chassis |
| L_2 | = 4 T No. 10 wire; $\frac{1}{2}$ inch inside diameter (see photo) | 1 | ... $3 \times 5 \times 4$ inch cabinet |
| L_3 | = 30 T No. 18 wire; $\frac{1}{4}$ inch inside diameter; close wound | 2 | ... SO-239 Amphenol coaxial connectors |
| L_4 | = Plate lines (see sketch) | 2 | ... $\frac{1}{4}$ inch shaft bearing |
| | | 2 | ... Octal sockets |
| | | | Misc. brass and polystyrene as per sketches. |

CIRCUIT DETAILS

The circuit diagram of the Megabooster is shown in Fig. 2. A pair of General Electric GL-2C43 Lighthouse tubes is used in a grounded grid tripler circuit. Grid drive is applied to the cathodes of the two tubes. This circuit is similar to the usual grid input circuit except that the center-tap of coil L_2 is grounded instead of going to a bias supply.

The grids of the tubes are tied together and connected to ground through capacitor C_2 . The plate tank consists of a parallel line circuit, with a shorting bar for rough frequency adjustment and a tuning capacitor, C_3 , for fine frequency adjustment. Metering is accomplished by jacks J_1 and J_2 , grid current being read in J_1 and plate current being read in J_2 .

CONSTRUCTIONAL DETAILS

The main chassis ($5 \times 10 \times 3$ inches) as shown in Fig. 1 forms the base for the Megabooster, and the smaller $3 \times 5 \times 4$ inch chassis acts as a shield for the plate lines and the output link, L_6 . The tubes are mounted under the chassis, with just the plate lead extending through the chassis deck. Fig. 6 shows in detail how the tubes are mounted. Two three-quarter inch holes are cut in the chassis to match with the holes in the plate shown in Fig. 7E. A piece of varnished cambric 2×4 inches is placed between this plate and the chassis and forms capacitor C_2 . The grid ring on the GL-2C43 is flush against the plate and is kept from slipping by soldering a wire ring around the hole.

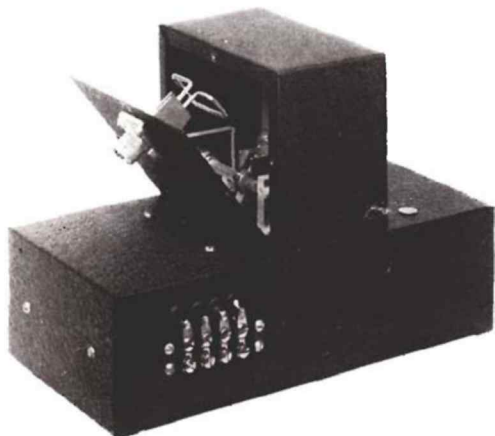

Fig. 3. Detail of Output Link of the Megabooster

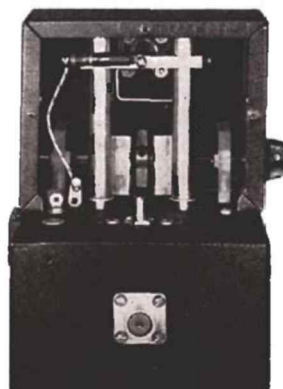

Fig. 4. End View of Megabooster Showing Plate Lines

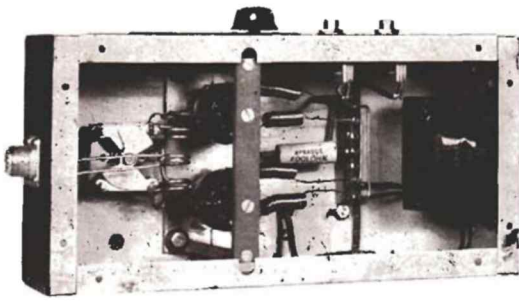

Fig. 5. Under-chassis View of the Megabooster

Referring to the underside view, Fig. 5, the input coaxial connector is on the left. The butterfly condenser, C_1 , is mounted against the top of the chassis. Coil L_2 is wired directly to this condenser. Each side of the coil is wired to a clamp which connects to the cathode shell of each GL-2C43. Pin 5 on each socket also connects to each side of the coil to provide a d-c path for the cathode. Link L_1 is supported by the coaxial connector. Next in line are the two tubes with their holder. This holder is made from bakelite or poly. The upright pieces are shown in Fig. 7C. The bar across the top of these pieces is made from a piece of $\frac{1}{4}$ inch bakelite, $\frac{1}{2}$ inch wide and 4 inches long. On the top of this piece are two pieces of $\frac{1}{2}$ inch poly rod, with a rubber grommet cemented to them. These pieces are adjusted on the 4 inch bar so that they fit into the recess in the bottom of the octal sockets and thus hold the tubes up against the grid plate.

The grid resistor (Fig. 5) fastens to the grid plate. The four filament chokes are connected as shown to a terminal strip. Two closed-circuit jacks and the filament transformer complete the underside wiring.

Fig. 4 shows in detail the above-chassis construction. The two plate lines (Fig. 7D) fasten on the plate caps of the GL-2C43 tubes. The shorting bar is made of $\frac{1}{4}$ inch brass, $2\frac{1}{2}$ inches long and $\frac{3}{4}$ inch wide. Two holes of a diameter to fit the plate lines snugly are drilled on $1\frac{3}{4}$ inch centers, and the bar is then drilled and tapped so that set screws can hold the bar to the plate lines. The fixed plates of C_3 (Fig. 7A) are fastened to the bottom of the plate lines with 2-56 machine screws. The slots permit the plates to be moved back and forth for adjustment of capacitance.

Two pieces of poly or bakelite form the bearings for the shaft of C_3 . These pieces are $1\frac{1}{2}$ inches square and drilled with a hole in the center of a diameter to suit the shaft bushings used. The pieces are also drilled and tapped for mounting to the chassis. The rotor of C_3 (Fig. 7B) is mounted on a $\frac{1}{4}$ inch shaft and placed between the two fixed plates.

Details of the output link are shown in Fig. 3. Condenser C_4 is formed of two pieces of flat brass. It will be necessary to experiment with the size of these

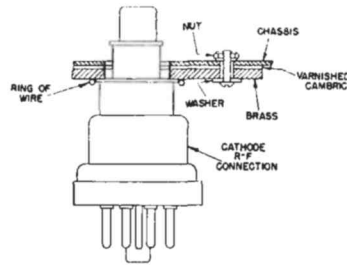

Fig. 6. Detail Showing Proper Mounting for GL-2C43 Tubes

plates in order to achieve maximum output. One side of the link solders directly to the coaxial output connector and the other side of the link supports one condenser plate. The other condenser plate solders to the ground lead of the connector.

In order to mount the $3 \times 5 \times 4$ inch chassis on top of the main chassis, it is necessary to cut one side of the box off with a hacksaw. A hole should also be drilled in the front to pass the shaft of C_3 .

OPERATING ADJUSTMENTS

An output of 5 to 7 watts or that obtained from an SCR-522 transmitter on 144 megacycles is adequate to drive the Megabooster. More driving power can be used as long as the coupling is arranged to provide the proper amount of power. Grid current to the two GL-2C43 tubes should run from 30 to 40 mils.

When the cathode circuit is properly driven, plate voltage can be applied. No neutralization is necessary because of the grounded-grid circuit. With the link side of the small chassis removed, resonance may be indicated by a neon lamp held close to the plate lines. The plate shorting bar is moved up and down until the neon lamp is at maximum brilliance. Condenser C_3 is used for fine adjustment.

With the link side of the small chassis replaced, it may be found necessary to re-resonate the final. This will depend in large part on the antenna used. This latter adjustment may be made with the other side of the chassis removed. It is also convenient to adjust the link condenser, C_4 , from this side.

Plate current should be approximately 50 mils at resonance. Under these conditions a measured power output of three watts was obtained on the unit pictured. It is very important to match the output link to the antenna in order to get maximum output. It may be necessary to spend more time determining the proper size for the link and for the plates of C_4 . They will depend on the link used and also the type of coaxial cable used as the antenna feeder.

It was found that the addition of the shielding chassis over the plate lines more than doubled the power output obtainable.

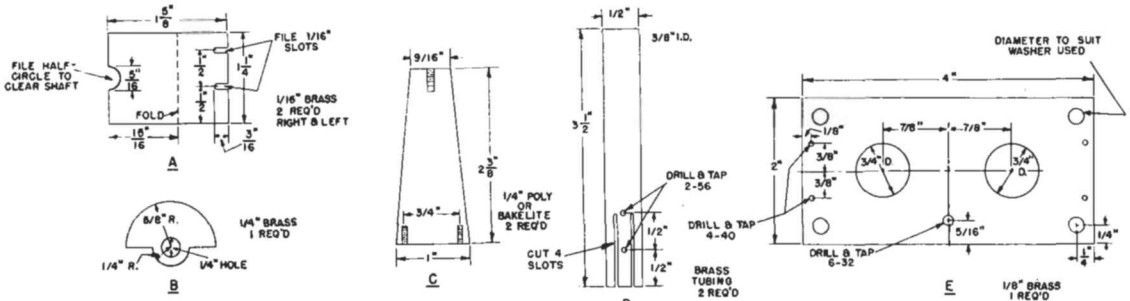

Fig. 7. Constructional Details of Parts Described in the Text

TECHNICAL TIDBITS

CAUTION—SCREEN GRID AT WORK

The screen grid is probably the most critical single element in modern high-gain tubes and yet it is undoubtedly the most abused element. The average ham looks upon the screen grid as an element which is supposed to be fixed in potential, and because the screen seems to go no place in particular in the circuit he completely neglects it. He feels that once he has connected the screen voltage lead that he is through with that part of the circuit until the rig wears out. (The latest census lists 1,269,321 cases of parasitics due to improperly bypassed and stabilized screen circuits. The adding machine broke down before the number of resultant key clicks was totalized.—Editor's note.)

If the screen is important, let us see why. The best way to do this is to compare triodes and screen-grid tubes. A comparison on this basis brings out the following points.

(a) In a triode there is a large capacitance between grid and plate. If this capacitance is not taken care of by neutralization, the resultant feedback voltage may cause oscillation. In a screen-grid tube, the screen, if suitably bypassed, acts as an electrostatic shield between grid and plate and therefore materially reduces the feedback.

(b) The plate voltage (and grid voltage) in a triode determines the amount of cathode current that flows. In a screen-grid tube the plate voltage has a negligible effect in determining the amount of cathode current because the screen acts as a shield between plate and cathode. It is the screen voltage (and grid voltage) which controls electron flow in a screen-grid tube, just as the plate voltage controls the electron flow in a triode. Obviously then, if the current flow is to be held constant, then the screen voltage must necessarily be held absolutely constant.

Thinking now of an actual circuit using a screen-grid tube, what do the above two points mean? Let us assume a screen-grid tube in the final of our rig. With the antenna tightly coupled to the final tank coil, we find that the plate current isn't high enough to suit us. The link is therefore coupled tighter and tighter in an endeavour to get more input. However, the plate current does not increase appreciably. At this point the average ham decides that his antenna won't load up properly. Actually all that happened was to be expected. In point "b" we stated that the current depended upon the screen voltage. Inasmuch as the screen voltage was not affected by increased loading, we found it difficult to change the plate current. All that was accomplished by the increased loading was a decrease in power output, because the plate voltage swing was decreased as the loading was increased and the plate dissipation went up.

Taking the other extreme of loading—too little load—we come to the exception in rule "b." That is, too little loading will bring on a condition where the plate voltage will affect the cathode current. Practically this means that if the final is lightly loaded,

the screen current will be high (even over rating), the plate current low, efficiency poor, and output low. This is true because a lightly loaded final (using screen-grid tubes) will have a large voltage swing, and the minimum voltage on the plate will occur when maximum current should flow. With a low enough plate voltage, the electrons in the tube will not be attracted to the plate as strongly as usual. These electrons will therefore tend to collect on the screen-grid. This large increase in screen current may harm the screen, as it is a flimsy element in comparison to the plate, and is not capable of dissipating too much energy.

Many amateurs have found from first-hand experience that this last point is true. When an ECO is lightly loaded so that this effect takes place, a slight change in loading will change the frequency quite a good deal, whereas the same ECO, when heavily loaded, will be less affected frequency-wise by a load change.

Adding up the information above gives us data by which we may formulate four rules for operating screen-grid tubes to make them do the fine job they were designed to do.

1. Carefully bypass and install the screen circuit so that it acts as a good shielding device. This means that the bypass condenser leads should be short and properly placed. Also, external shielding should be used on the tube if such is recommended.

2. Make certain that the screen voltage is accurately held to the design value. If the circuit is keyed this may require a separate, stable source of voltage. It is also important that an accurate voltmeter be used. The voltmeter part of volt-ohmmeters, especially home-made units, may easily be off 20–30% if the volt-ohmmeter is an old instrument.

3. Make all loading adjustments carefully for maximum power output and maximum circuit efficiency. Loading an amplifier or final too lightly or too heavily will cause poor circuit and tube efficiency. Maximum power output will be obtained when the loading is neither too light or too heavy.

4. Install a screen current monitoring position. A screen current meter, connected in the circuit at all times is to be preferred. This will help to avoid accidental damage to the screen due to overload. Also, a screen current meter is an invaluable aid in the tuning-up process, as this meter is much more sensitive as a tuning indicator than the plate current meter.

When a screen-grid circuit is unloaded, plate current will be very low and the screen-grid current will be high. As the loading is increased the screen current will drop off as the plate current rises. A point will be reached where further loading does not affect the screen current. This is the approximate point of proper loading. A further refinement would be to check power output as the loading was changed, and adjust the loading for maximum output.—Lighthouse Larry.

PARASITICS

Fig. 4, page 3 of the May-June 1948 Ham News is in error. The lead going from the top of R_6 to C_1 should be removed from C_1 and wired instead to the bottom of the secondary of T_2 . The C_4 lead from the

bottom of R_6 to the top of R_7 should be replaced with a direct connection. The lead going from R_4 to the bottom of R_6 should be rewired so that it connects R_4 to the top of R_6 .

TECHNICAL TIDBITS

WIRING TECHNIQUES

How many times have you built a piece of high-frequency ham gear, which had been described in glowing terms in your favorite radio publication, only to come to the conclusion that the author of the article probably never had it working either? You proceed to check and recheck the wiring, closely inspect the photographs to be certain that your layout is identical, measure the values of all components, and still it oscillates when it shouldn't, won't oscillate when it should, or just doesn't have the pep that the article led you to expect it to have.

Before you condemn the gadget and discard it, consider the one remaining factor in the construction, a factor which incidentally is not apparent from the circuit diagram and not always apparent from the photographs. That factor is the method of wiring, such as the placement of leads, the points of connection to the various components and the length of leads. Also to be considered is the type and characteristics of the components used. All of these points become increasingly important as higher frequencies are considered.

In a high-frequency circuit composed of resistance, capacitance and inductance, it is important that you use only resistance where such is called for, use capacitance only where a capacitor is specified, etc. This may sound obvious, but a resistor has long leads, and if these are not shortened, they add inductance in series with the resistor and the leads have a capacitance to ground. Minor details? Not at all. For example, a one inch length of No. 20 solid wire has an approximate inductance of .02 microhenries. This means that one inch of this wire will resonate at 146 megacycles when paralleled with 60 mmf. of capacity. We can control the lead lengths of various component parts, but we cannot control the components themselves, except to select the best.

The small size one-half and one watt composition resistors are generally suitable for high-frequency circuits. In the capacitor line, silvered-mica button capacitors, high-capacity ceramics and regular tubular ceramic capacitors are suitable for bypassing, coupling and padding applications.

Fig. 8 shows the circuit diagram of a typical mixer circuit using a 6AK5 miniature tube. This type of circuit embodies most of the principles of high-frequency wiring techniques. These same principles are of course applicable to radio-frequency amplifiers and oscillators. Fig. 9 is a photograph of this 6AK5 mixer circuit wired in two different ways. Circuit-wise the two methods are identical, but the layout on the left

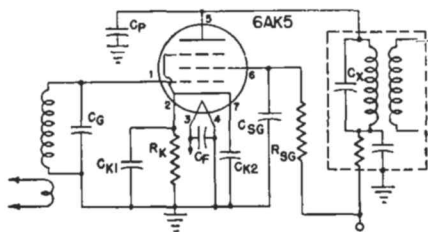

Fig. 8. Circuit Diagram of Mixer Circuit Described

uses high-frequency components and high-frequency wiring techniques, while the right-hand layout illustrates the more common type of wiring technique which should be avoided at high frequencies.

With reference to Fig. 9, the tuning condenser, C_r , is in the lower left section of both circuits with the grid coil directly above. The i-f transformer is mounted in the upper-right portion, with only the six leads extending below chassis. The similarity in layout stops at this point. In the right-hand unit mica condensers are employed for bypassing. These condensers all go to ground at a common point, and the length of leads involved becomes excessive. The left-hand unit uses silvered-mica button condensers which are mounted around the tube socket so that each condenser is opposite the socket pin to which it connects. One end of the button condenser bolts to the chassis and the other end has a lug which ties directly to the socket lug. There are no leads added to these condensers and hence a minimum lead length is obtained.

Another interesting point is the grid coil and condenser combination. In the right-hand unit the coil leads connect to the condenser and then two long leads of wire go from the condenser (C_r), one to pin No. 1 and the other to ground. These long leads have inductance which is in series with the condenser coil combination. Note how this series inductance is eliminated in the left-hand unit. The top coil lead goes directly to pin No. 1 and the condenser is connected to pin No. 1 through a piece of one-eighth inch wide copper strap. This strap has very little inductance. The lead from the grid to the coil has inductance but it forms a part of the coil inductance. The other two leads ground directly to the chassis, the

(Continued on page 8)

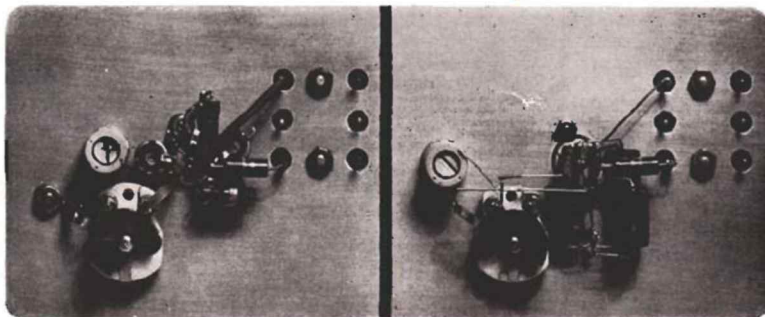

Fig. 9. Wiring Techniques—High-frequency Construction on the Left, Usual Construction on the Right

TRICKS AND TOPICS

How did you solve that last problem that almost had you stumped? Be it about tubes, antennas, circuits, etc., Lighthouse Larry would like to tell the rest of the hams about it. Send it in! For each "trick" published you win \$10 worth of G-E Electronic Tubes. No entries returned. Mark your letter "Entry for Tricks and Topics" and send to Lighthouse Larry, Tube Division, Bldg. 269, General Electric Company, Schenectady, New York, or in Canada to Canadian General Electric Company, Ltd., Toronto, Ontario.

PLUG-IN VARIABLE LINK

For medium and high power transmitters a variable link with plug-in coils is highly desirable to meet a wide variety of impedances, frequencies and loads. Also, for the suppression of harmonics, it is desirable to ground the center of the link.

With these thoughts in mind and with a view to simplicity of construction and availability of materials the plug-in variable link (Fig. 10A) was designed. Some dimensions such as the tank coil diameter, distance from center of tank coil to center of shaft, and width allowed in tank coil for link will be determined by each individual case. Other dimensions as used by the author are suggested.

A piece of mycalex $\frac{1}{4}$ in. thick and 2 in. long was used to mount the coil. Its width depends on the space available in the tank coil. Three holes are drilled and tapped for 6-32 machine screws. Screw in tightly three small sized banana plugs. Cut off the two outer screws flush with the top and allow the center one to stick up about $\frac{1}{8}$ in. A small hole just large enough for the wire is drilled near each of the outer plugs. A coil is made up of two, four or six turns so that the center tap can be soldered to the top of the screw of the center plug. The ends of the coil are brought through the two holes, bent over and soldered to the base of the plug. The coil will be self-supporting if No. 14 or larger wire is used. Mycalex was used because it is not affected by the heat of the soldering iron.

The arm is composed of another similar piece of mycalex and a piece of $\frac{1}{2}$ in. \times $\frac{5}{8}$ in. bakelite. The mycalex has three holes drilled in it at the same spacing as that of the coil support. The two outer holes are drilled with a $\frac{3}{8}$ in. drill and the center with a $\frac{5}{16}$ in. drill. In the two outer holes two banana jacks are inserted and the nut run down to within one turn of being tight. The lead wire is then soldered to both the nut and the jack. This allows the $\frac{1}{4}$ in. dia. jacks to fit loosely in the $\frac{3}{8}$ in. holes, to compensate for mechanical errors, and will give good contact without binding.

For the center jack a $\frac{5}{16}$ in. \times 1 in. copper or brass machine bolt was used. (Large size power wiring connectors have one in each of them.) It is drilled lengthwise to the inside diameter of the banana jack with the head being drilled out farther to accommodate the base of the plug. The piece of bakelite is then drilled lengthwise and tapped for the $\frac{5}{16}$ in. machine

screw. When this has been screwed down firmly, drill a hole through the side of the bakelite arm passing through the $\frac{5}{16}$ in. screw and tap for 6-32 screw. This provides the ground connection. Lastly drill the hole for the shaft at the desired distance from the center of the tank coil and provide one or two setscrews to hold it firmly in place.—W2FEN.

NOISELESS SLIP RINGS

Continuous rotation of beam antennas is highly desirable especially in cases where the antenna cannot be viewed from the shack to check "winding" feeders. Coaxial rotary joints are available but open wire or twin-lead types of feed lines usually require a difficult slip ring and brush assembly. With reference to Fig. 10B, the rings are $\frac{1}{2}$ in. wide bands sawed from large diameter aluminum tubing. They are supported around the mast by polystyrene spacers which also act as guides for the stationary contactors. These contactors consist of loops of braided copper shielding slightly larger than the rings. The loops are held taut by small springs and make contact over approximately 270° of the ring surface. This unusually large contact area permits absolutely noiseless reception and lossless power transmission during rotation. With rings $\frac{1}{8}$ in. thick spaced 1 in. between centers and standard $\frac{1}{2}$ in. braided shielding, no mismatch was apparent in a 300 ohm twin-lead feed system. Closer spacing would suit 75 ohm line and wider spacing should be used for open wire lines.—W4DWF.

QSL CARD DISPLAY

The usual method of mounting QSL cards on the wall results in a rather messy looking wall, with thumbtacks being used for each card. However, if the QSL cards are connected together (see Fig. 10C) with staples, strips of cards may be made up which will require only two thumbtacks for mounting.—W5BDG.

EYELET HOLDER

In dismantling war surplus equipment and making changes in existing equipment it is sometimes necessary to remove eyelets or rivets. The usual procedure is to use a hand drill so that the shoulder of the eyelet or rivet is removed. This stunt works nicely, except that the rivet always starts turning around with the drill so that no further drilling can be done. To prevent the rivet moving, the following trick is very useful.

A drill is placed in the vise, point up, and the underside of the eyelet or rivet placed on the drill. As the eyelet is drilled from the top, enough pressure is exerted so that the underside of the eyelet is forced into the drill which is fixed in the vise. This prevents the eyelet from turning. It may be necessary to experiment to get the right drill size, and in some rivets it may be necessary to drill a small pilot hole on the underside so that the fixed drill can bite into it.—VE3QC.

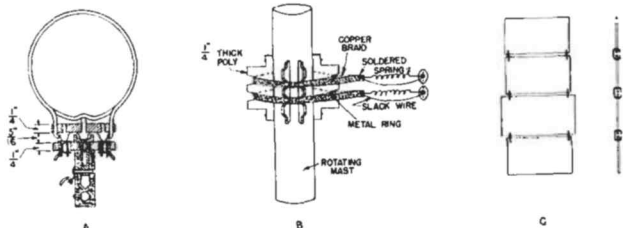

Fig. 10. W2FEN's Variable Link; W4DWF's Slip Rings; W5BDG's QSL Card Display

QUESTIONS AND ANSWERS

Do you have any questions about tubes or tube circuits that are of general interest? For each question published you will receive \$10 worth of G-E Electronic Tubes. Mark your letter "Entry for Questions and Answers" and send to Lighthouse Larry, Tube Division, Bldg. 269, General Electric Company, Schenectady, New York, or in Canada, to Canadian General Electric Company, Ltd., Toronto, Ontario.

STAND-BY OPERATION

Question: If a ham transmitter is not used for an hour or so, between contacts, is it better to leave the filament voltage on, or should it be reduced, or should the filament voltage be turned off entirely?—W6KSS

Answer: High power thoriated-tungsten filament transmitting tubes should be operated at eighty per cent of normal filament voltage during stand-by periods of less than two hours and shut down entirely for longer periods. For transmitting tubes of less than 250 watts plate dissipation the filament voltage may be removed for stand-by periods greater than fifteen minutes. There should be no reduction of filament voltage for periods of less than five minutes. However, the filament voltage may be reduced to eighty per cent during stand-by periods greater than five minutes, if so desired.

Transmitting tube filaments should not be kept on unnecessarily, because, in thoriated-tungsten filament tubes, the rate of deterioration of the filament goes on at about the same rate (when it is lit) with the plate voltage off as it does with the plate voltage on.

Oxide-coated filaments or cathode heaters should be operated at normal filament voltage during stand-by periods. If these periods exceed two hours the filament voltage may be shut off.—Lighthouse Larry.

STORING SPARE TUBES

Question: Do receiving and transmitting tubes deteriorate in storage? What precautions should be used to keep spare tubes in the best condition?—C. R. Nelin.

Answer: As a usual thing, high vacuum transmitting tubes do not deteriorate while being maintained as spares. However, to insure that tubes used as spares are good, it is usually good practice to put them in the equipment in which they are intended to be used and operate them for a few minutes. This test should normally be performed at three-month intervals and the conditions of operation should be within the tube manufacturer's ratings.

If the tube cannot be operated in the actual equipment for which it is intended, some benefit may be obtained by operating it statically using sufficient d-c grid bias to prevent excessive electrode currents or dissipations. In all such cases care should be exercised so that none of the ratings are exceeded.

Receiving tubes may be handled in a similar manner. It is still desirable to check them in the actual equipment every three months. In the event that such equipment is not available the receiving tubes may be checked in a regular tube tester.—Lighthouse Larry.

FREQUENCY FOR TYPICAL DATA

Question: When compiling information to be published as "typical operation" data for RF power amplifier tubes, are tests made at any specific standard operating frequency or is the published data an average of tests at various frequencies? Grid driving power, for example, as listed in technical information

sheets, could not be regarded as a constant for a wide range of frequencies. If there is a standard frequency, what is it?—W3LCK.

Answer: When the design work on a transmitting tube has been completed, the engineer usually knows the approximate frequency at which the tube is capable of operating under full ratings. Tests are then made on the tube at various frequencies near the approximate maximum frequency. From this data the engineer determines the exact frequency for operation at full ratings. This frequency is called the "frequency for maximum ratings." Let us assume for purposes of discussion that this frequency is 30 megacycles. This means that all of the typical operating conditions will apply for any frequency up to and including 30 megacycles. In addition, the engineer may put further ratings on the tube, for operation at frequencies above the frequency for maximum ratings. These higher frequency ratings are normally lower than the low frequency ratings, and usually these ratings are expressed as a percentage of the low frequency ratings. For example, if 30 megacycles is the frequency for maximum ratings, two other frequencies such as 60 and 100 megacycles may be selected. The maximum permissible percentage of maximum rated plate voltage and plate input for class C telegraphy service could be: 100% at 30 megacycles, 70% at 60 megacycles, and 50% at 100 megacycles. The tube data will usually give information of this sort, or, if lower ratings for higher frequencies are not recommended, then the data sheet will give the frequency for maximum ratings.—Lighthouse Larry.

V-R TUBE JUMPERS

Question: What is the purpose of the jumper lead (pins 3 and 7) in the VR tubes such as the GL-OA3/VR75 and the GL-OB3/VR90?—W6MVF.

Answer: Voltage regulator tubes are used in circuits when it is necessary to supply a constant voltage to a load. In many cases the load circuit would be damaged if this regulated voltage were suddenly to change to a higher voltage. This would occur if the V-R tube were removed from the socket, or if the unit were turned on when the V-R tube was not in its socket. To prevent this, a jumper wire is connected between pins 3 and 7 in the base of the GL-OA3/VR75, GL-OB3/VR90, GL-OC3/VR105 and the GL-OD3/VR150. This wire connects in no way with any other part of the tubes and is outside the tube envelope. The circuit is therefore wired so that this jumper is in series with the primary of the transformer which supplies d-c voltage to the V-R tube. Taking the V-R tube out of its socket turns off the voltage.

The two miniature tube voltage regulators, the OA2 and the OB2, are also made so that a jumper connection can be used. However, certain precautions are necessary. In the case of the OA2 and the OB2 the jumper connection is inside the tube. If 115 volts a-c were to be applied to these jumper connections, a gas glow might take place due to the a-c voltage. This glow would probably injure the tube, or at least prevent it from operating properly. Therefore the jumper is arranged in the tube so that it is connected to either the anode or the cathode. For example, in the OA2 and the OB2, pins 1 and 5 are anode connections. If the lead from the power supply is connected to pin 1 and the lead to the load is connected to pin 5, then the load will be removed if the tube is removed from its socket.—Lighthouse Larry.

TECHNICAL TIDBITS

(Continued from page 5)

condenser being connected through its lug to ground and the coil lead being soldered directly to the metal base of the Millen slug-tuned form.

Making all ground leads to one point has long been a favorite wiring trick, but in high-frequency work it is usually far better to ground to chassis at the closest point. Incidentally, make sure that the chassis is clean and bright before tightening the ground lug. In some cases, where grounds are made at random, it may be necessary to shift the grounding point slightly, although usually this will not be necessary.

A solid copper strap as shown will always give a lower inductance lead than a wire lead, and is even to be preferred over copper braid. Q meter tests made at 146 mc. on braid and solid copper of the same cross-section showed that the solid strap had a Q two and a half times as high as the Q of the copper braid. This great decrease in I^2R loss is a definite help at these frequencies.

Another good stunt is to place a portion of the IF transformer tuning capacity at the plate pin of the tube. In the right-hand unit the plate lead (pin No. 5) goes directly to the IF transformer. This long lead has inductance and is liable to cause a high-frequency parasitic, even though the IF transformer works at a

relatively low frequency. The left-hand unit shows a capacitor from pin No. 5 to ground. (The resistor-like component with the five color bands is this capacitor.) As long as this capacitor is in the order of 15 to 20 mmf. most high-frequency oscillation voltages will be short-circuited. In effect this capacitor (not shown in Fig. 8) is in parallel with C_x . It would be even better if the padding capacitor in the IF can were to be removed and wired in right at the socket.

The last point is the proper use of the two cathode connections on the 6AK5 tube. As shown in the circuit diagram, pins 2 and 7 are both bypassed to ground. This gives a lower impedance path to ground and is definitely desirable. If the ultimate in proper bypassing is to be used, then the double cathode leads would be used differently. The original idea in making two cathode leads available was to prevent a common coupling impedance. This is done by wiring the grid returns to one cathode connection, and the plate and screen returns to the other cathode connection. In this system, only one side of the cathode is bypassed to ground. Inasmuch as this latter system is not always a convenient method, the wiring as shown in the diagram may be used and will be perfectly satisfactory except for the most critical cases.—Lighthouse Larry.

Electronics Department

GENERAL  ELECTRIC

Schenectady, N. Y.

(In Canada, Canadian General Electric Company, Ltd.; Toronto, Ont.)