

# THE OSCILLOGRAPHER

VOL. 15, No. 1

JULY, 1954

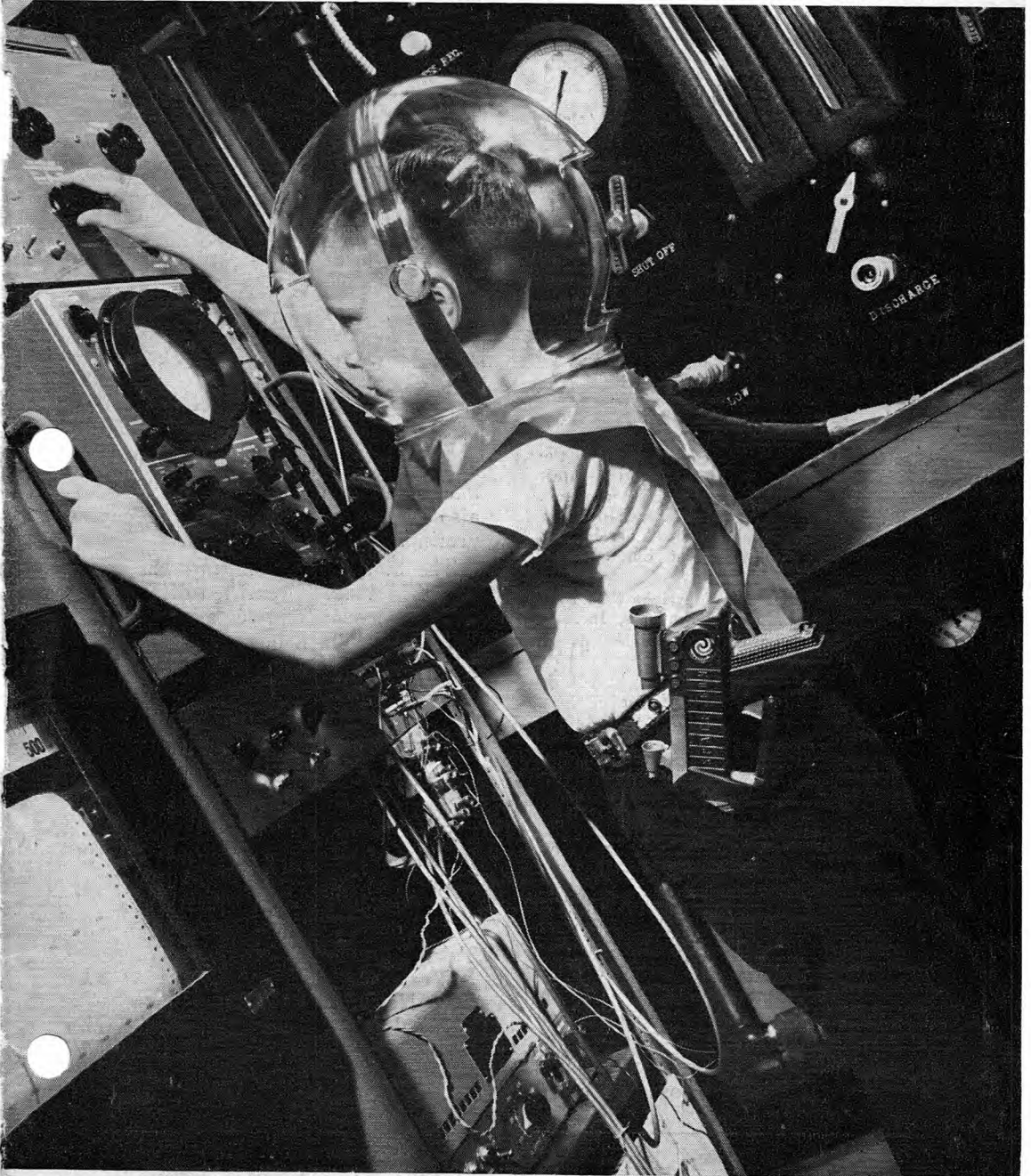

**ADVENTURES IN SPACE**

**SEE PAGE 2**

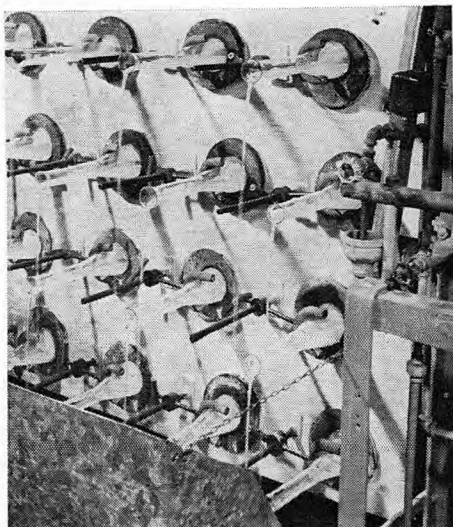

**Automatic table tilts for decanting portion of the gel-settling process. The screen material is uniformly held to the glass by the gel solution during decanting, avoiding uneven concentration of the screen in the direction of the tipping**

because it has been determined that the surface condition of the glass changes on drying and good adhesions and settling are no longer obtained.

The settling of the screen begins by first pouring a cushion of gelling solution into the tube which is held in the face downward position. The mixture of the phosphor, silicate, and water is then dispersed at high velocity into the cushion to assure an overall uniform mixture. The settling process, under gravity, then begins. What actually happens during settling is the surrounding of each phosphor salt particle by the gel and the settling of each little particle toward the faceplate. The gel also coats the glass and makes for better adhesion of the particles to the glass. The process assures uniformity of particle size and settling over the full screen area.

The screen settles for a half-hour or less, depending upon the phosphor and tube type, and the excess liquid is then decanted by automatically tipping the tube over slowly. The gel-settling process has the advantage in the decanting

operation of holding the screen material uniformly on the glass so as to avoid uneven concentration of the screen in the direction of the tube's tipping.

If a cascaded screen is being coated, such as the double-layer P7, the chemical that accounts for the long-persistence component of the screen is poured into the cushion first. About five minutes later, the material that is excited by the electron beam and gives rise to the shorter persistence component is dispersed into the same mixture. The second layer settles on top of the first and the cushion is then decanted as for a single layer screen.

Following decanting, the screen is dried with the tube face up in a fixture, inside of which a warm air jet is directed at the faceplate. The dried screen is inspected under white light and ultra-violet light, which simulates electron excitation to discover any flaws in the screen coating. Our chemists have even discovered that it is best to use ultra-violet lights of different wavelengths for best excitation of different screen types.

The adhesion of the screen is spot-checked both in the wet and dry stages by mechanically shocking the faceplate. The simulating of electron excitation is also spot checked with an even better method than ultra-violet light; that is, by putting the tube on a vacuum pump and exhausting it while exciting the screen with rf radiation from a probe placed inside the tube. It should be pointed out that none of the tubes that are spot checked are allowed to go through to finished stock. They are expendable at the expense of assuring better quality.

Now the screen is baked at about 750°F. The baking operation more thoroughly dehydrates the screen than the previous warm air jet, and is the first step in out-gassing the tube. The phosphor salt is now free to be bombarded by the electron beam. The baking also burns out organic materials that might otherwise contaminate the phosphor.

At a later stage in the processing of the tube, the screen is baked again dur-

ing the evacuating operation to get rid of gases in the screen that do not come out during the first baking operation.

All baking is done at a very precisely controlled temperature that has been determined to be optimum. Uneven temperatures would change the spectral characteristics of the screen from tube to tube.

The making of cathode-ray tubes is a fine art indeed. The next logical phases of the art to explain would be metallization and sealing — which will be described in detail in the next issue of the OSCILLOGRAPHER.

### Acknowledgment

Our thanks to Messrs. P. Gallagher, K. Hoagland, R. Koppelon — all of the Cathode-ray Tube Engineering Dept., and Mr. F. P. Rice — Cathode-ray Tube



Screen baking operation thoroughly dehydrates the screen and is the first step in out-gassing the tube. All baking is done at precisely controlled temperatures to prevent change in spectral characteristics from tube to tube

Division Manager, for their help in preparing this article for publication.

## Take Full Advantage of Your Oscillograph

By: William O'Meara

The Instrument Sales Department of Allen B. Du Mont Laboratories found that some owners of general-purpose cathode-ray oscillographs, especially in the industrial field, are not aware of the versatility of their instruments resulting from the use of the external provision for balanced input.

This feature is incorporated, for example, in the very commonly used Du Mont Types 322-A Dual-beam and 304-A Oscillographs. Balanced input in either of these two general-purpose oscillographs is accomplished simply by removing a ground lug on the front-panel input terminals. With the ground lug removed, it is possible to put a different signal on each grid of the first vertical amplifier stage. These grids are at a common ground; thus this first stage becomes a differential amplifier.

The most common use of balanced input is to remove an unwanted signal

from an oscillograph trace. Unwanted signal "pick-up", usually at power-line frequency, enters through the balanced input terminals but is rejected by the differential amplifier because the signal is common to both input grids (see figure 1). Applications which warrant the use of pre-amplifiers frequently require the balanced input feature of the oscillograph, since the pre-amplifiers output is usually balanced. Pre-amplifiers used in applications involving rejection of the common mode signals

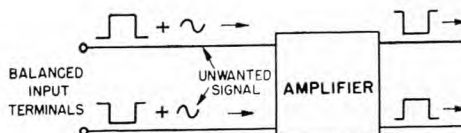
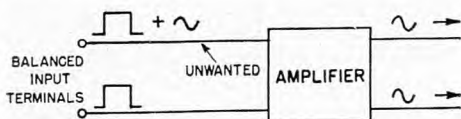

Figure 1. Unwanted signal "pick-up" at terminals of balanced input rejected by amplifier



**Figure 2. Balanced input permits examination of the difference between a signal of interest, and an unwanted signal which has been unavoidably mixed with one of the input signals**

usually have means of attenuating the signal that the oscillograph does not.

In a similar application without a pre-amplifier, the oscillograph with balanced input may be employed to examine the difference between a signal of interest and an unwanted signal which has been unavoidably "mixed" with the signal entering one of the input terminals. When these two signals are fed to the balanced input terminals, the oscillograph amplifiers will only amplify the difference between the instantaneous potentials on the balanced input terminals (see figure 2).

The above applications of balanced input are in common use. However, less well known is the use of balanced input as a null indicator. Null indications can be used for comparing phase or time relationships, or for supplying deflection timing markers.

The amplitude of two waveforms having the same phase relationship can be compared or made equal (a null) by

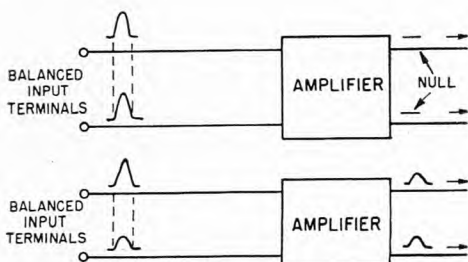

**Figure 3. Above: Input signals of equal amplitude and same phase will cancel (produce a null). Below: Input signals in phase but unequal in amplitude do not cancel. Amplitude of output signal is proportional to difference in amplitude of input signals**

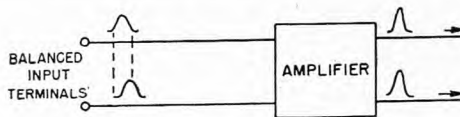
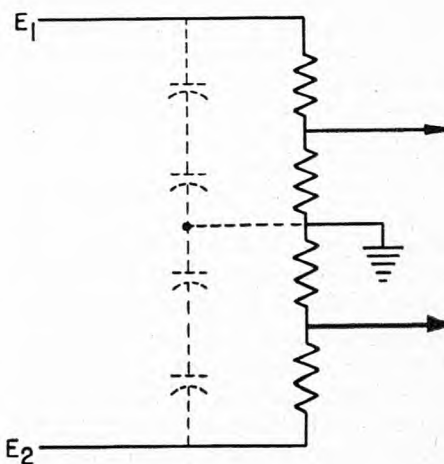

**Figure 4. Out of phase signals will add. Amplitude of output signal is proportional to the difference in phase of the input signals**

feeding each signal into one of the balanced input terminals. When the signals approach equal amplitude, the amplitude of the display on the cathode-ray tube approaches a null (see figure 3).

Similarly, the phase or time relationships between two waveforms of equal amplitude may be studied with balanced input. The indication or display will be minimum when both signals have identical time and amplitude characteristics (see figure 4). These null indications may also be obtained with constant but dissimilar amplitudes when checking for "zero" phase difference, and also with constant but dissimilar phase characteristics when comparing amplitudes.

Balanced input may also be used to



**Figure 5. Circuit of a typical balanced attenuator for use with the balanced input feature of an oscillograph. The dotted capacitors may be needed for trimmers at high frequencies**

supply deflection timing markers. The waveform under study is connected from one input terminal to ground, and the timing signal, in the form of a pulse, for instance, to the other input terminal and ground. The signal under study then appears with positive or negative spikes spaced in time according to the external timing generator. This deflection type of timing marker can also be used along with intensity modulation of the cathode-ray tube beam. For example, one set of markers might indicate limits of time in tens, while the

other type of timing marker could indicate time in units of one.

An external balanced attenuator can be used with the balanced input of an oscillograph to increase the range of the instrument. A typical balanced attenuator is shown in figure 5. Such an attenuator alleviates the necessity of keeping the oscillograph amplifiers at high gain.

For a more detailed discussion of balanced attenuators and differential amplifier action refer to Vol. 11, No. 3, page 15 of *THE OSCILLOGRAPHER*.

## TWO NEW SALES OFFICES ESTABLISHED

Customers demand for Du Mont industrial cathode-ray tubes and multiplier phototubes has required the establishment of two new sales offices for the Technical Sales Department of Allen B. Du Mont Laboratories, Inc. The new sales offices are physically located directly at the Du Mont plant that manufactures the products sold by that office. The purpose behind the establishment of these offices is to provide faster and more efficient customer service.

One office is located at Du Mont's cathode-ray tube plant at 750 Bloomfield Avenue, Clifton, New Jersey. It is headed by Daniel Echo.

The other office is at 2 Main Avenue, Passaic, New Jersey, where industrial cathode-ray tubes and multiplier phototubes are made. This office is headed by Robert H. Dolbear.

Danny Echo, who has been with Du Mont for the past three years, was formerly a tube development engineer at

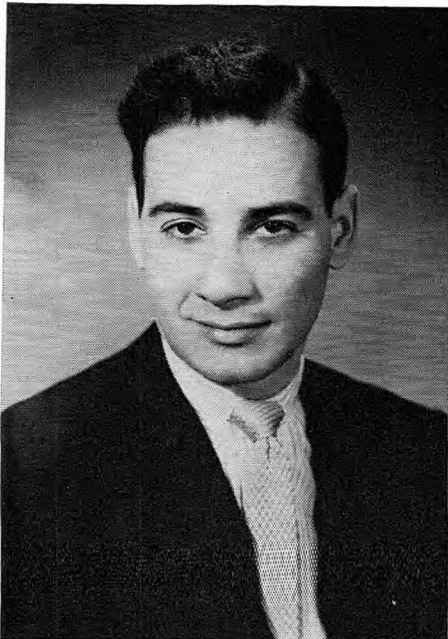

Daniel Echo



Robert H. Dolbear

National Union Radio Corporation. He served as a gunner in the Air Force during World War II. Dan earned a degree in electrical engineering from Tri-State College in Indiana. Since receiving his degree, he has taken special salesmanship and sales management courses at C. C. N. Y. and Rutgers. He is a member of Phi Kappa fraternity.

Bob Dolbear was formerly a field service engineer for the electronic division of the Curtiss-Wright Corporation,

working on electronic flight simulators. Prior to that he was service engineer for the Eclipse Pioneer Division of the Bendix Aviation Corporation, responsible for gyroscopic systems and associated instruments, and an engineer for Sperry Gyroscope where he did instructional work on electronic gun sights. During World War II, Bob was a pilot for the R.A.F., and later for the A.A.F. He holds an electrical engineering degree from Newark College of Engineering in New Jersey.

## Watching Corona

To meet government specifications for certain types of transformers, it is necessary to subject them to rigid tests for corona effect. Obtaining a reliable method for observing the voltage at which this corona effect begins was the problem of the New Jersey Electronics Corporation of Kenilworth, New Jersey. The solution was found in the Du Mont Type 304-A Cathode-ray Oscillograph.

The transformers under test for corona discharge are subjected to a voltage based on the transformer working voltages. These tests are accomplished by means of two circuits. Circuit 1 is utilized for the test of intrawinding insulation. Circuit 2 is used for the test of interwinding insulation, and insulation between winding and ground. Filament transformers are usually subjected to the circuit 2 test only, while plate transformers often get both tests.

The tests themselves consist of connecting the transformers in either or both circuits, and gradually raising the voltage, using a variable autotransformer, up to the limit specified for the test. If the corona discharge takes place, it will immediately become apparent on the oscillograph in the form of r-f oscillations superimposed on the basic sine-wave.

The test voltage applied varies according to the working voltage of the transformer. When the working voltage is to be above 700 volts, the specification formula for the acceptance voltage is:

$$V = 30\% (1.4 \times \text{working volts} + 1000)$$

Government specifications indicate that the oscillograph used for these tests should be sensitive enough to pro-

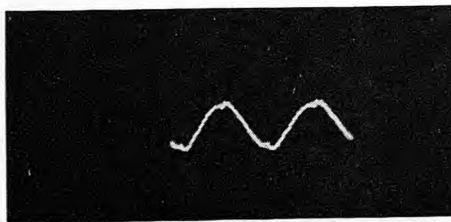

**Normal transformer test-voltage waveform. The noise apparent on the basic sine-wave is the result of unavoidable high-frequency signals emanating from industrial devices in that area.**

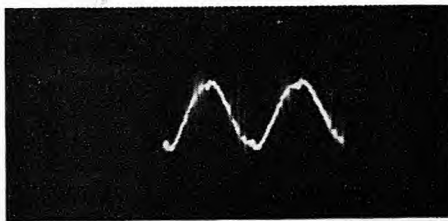

**An example of corona discharge. For the sake of obtaining this picture, the test-voltage was boosted far above the acceptance value.**

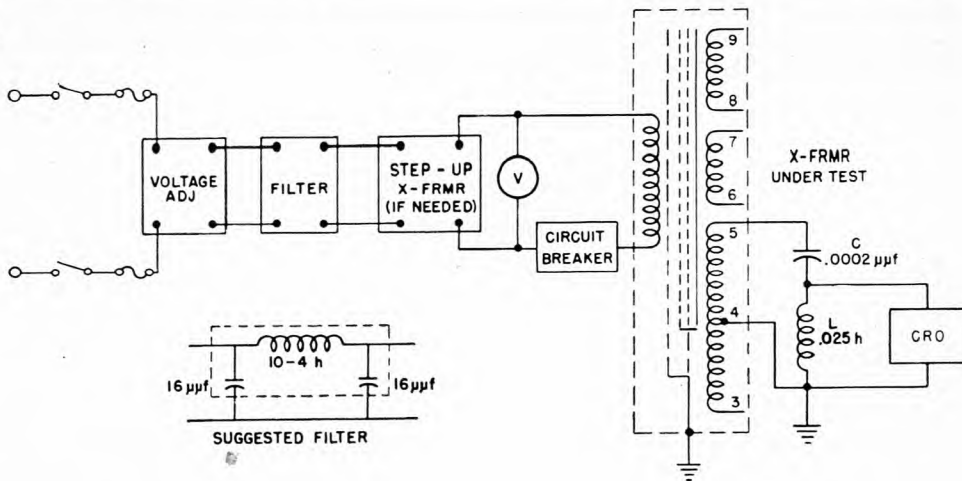

**Circuit 1.** This circuit is used primarily for corona-discharge tests of transformer intra-winding insulations.

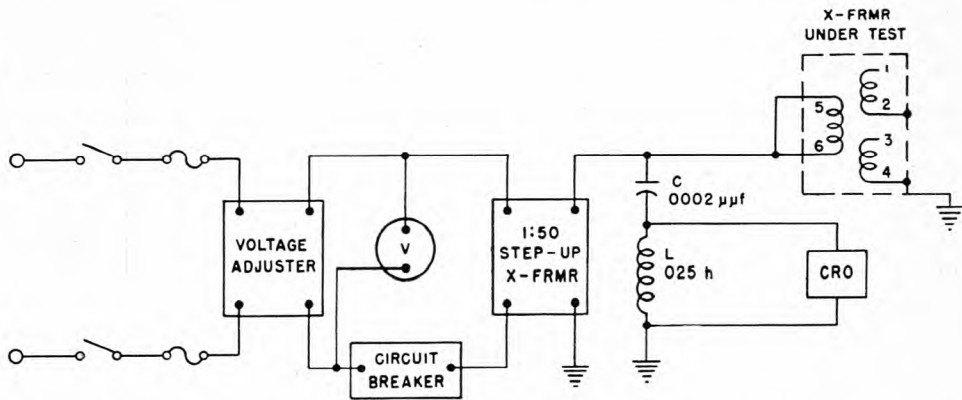

**Circuit 2.** This circuit is used for the corona-discharge test of transformer intrawinding insulations and insulations between winding and ground.

duce a signal one-inch in amplitude for a 0.1 volt peak-to-peak input. The Type 304-A is ideal for this application, having a sensitivity of .025 v p-p/inch and a wide frequency range.

An example of corona as displayed on the Type 304-A, and recorded with a Du Mont Type 297 Oscillograph-record Camera is shown. For the sake of obtaining this picture, the Engineers at New Jersey Electronics Corporation

boosted the voltage far above the acceptance value. The noise seen on the normal test-voltage waveform is the result of unavoidable high-frequency signals emanating from industrial devices in that area. Unfortunately, a shielded area was not available for taking the pictures.

Although these tests are not unique in the transformer manufacturing industry, it is an innovation in the oscillo-

graphic field. The New Jersey Electronics Corporation has tested many of their transformers in this manner, and

has reported that they and the government are completely satisfied with the results.

---

## “Who and Why”

(Continued from page 2)

tative for a complete line of electronic equipment and precision components.

The Sterling Company is a dual function organization. Besides the sales department, the company also has a service and engineering department. At the helm of the organization, under Sy, are six electrical engineers who deal in services to the customers as applications engineers. Their operating standard is this: to emphasize service before equipment, and to offer consultation on an engineering level, recommending necessary instrumentation to solve specific problems.

Sy is a member of the Institute of Radio Engineers, American Institute of

Electrical Engineers, Instrument Society of America of which Sy was past chairman, Detroit section, and the Engineering Society of Detroit.

---

### Eight Ball Corner

Honest, we are sincere in our efforts to make this magazine accurate, but while the last Oscillographer issue was on the press we discovered a mistake in the correction of a previous error. Of this we are sure, Walt Knoop graduated from Rensselaer Polytechnic Institute in Troy, N. Y., *not* from a different school in a neighboring town, or a misspelled school in the same town.

---

## SURVEY

So that we may compile our reader information more efficiently and bring our product and service information to the profession as expediently as possible, will you please fill out the survey form that has been folded into this *Oscillographer* and return it to us (no stamp is necessary). You will remain anonymous even though we're making our thanks public.



# "Who and Why"

## Du Mont Selling Agents

### Seymour Sterling

Du Mont is represented in Michigan and most of Ohio by the S. Sterling Company, a young progressive organization headed by Seymour "Sy" Sterling.

Appropriately, Sy is a young man himself, being born in 1923 just across the border in Toronto, Canada. After completing the usual elementary and high school education, Sy attended Lawrence Institute of Technology in Detroit, Michigan. He was graduated from there in 1946 with a Bachelor of



Seymour Sterling

## THE OSCILLOGRAPHER

A publication devoted exclusively to the cathode-ray oscillograph providing the latest information on developments in equipment, applications, and techniques. Permission for reprinting any material contained herein may be obtained by writing to the Editor at address below.

Published quarterly & Copyright 1954 by  
Allen B. Du Mont Laboratories, Inc.  
Instrument Division  
760 Bloomfield Ave.  
Clifton, N. J.

Neil Uptegrove — Editor  
Art Hoyt — Asst. Editor

PRINTED  
IN  
U.S.A.

Electrical Engineering degree. While attending school at Lawrence, Sy was also an instructor of electrical engineering.

The S. Sterling Company was conceived in 1946. It consisted of Sy, acting as one-man representative for Allen B. Du Mont Laboratories in Michigan. Since then the company has developed into manufacturers' represen-

(Continued on page 16)

### On the Cover

One of Captain Video's rookies, Johnny Bowar, adjusts the "stellar" instruments in his make believe spaceship in preparation for a quick landing. Johnny was caught in this pose (peering into the face of a Du Mont Type 304-H Cathode-ray Oscillograph) in the Minneapolis-Honeywell aeronautical engineering laboratory in Minneapolis, Minn. The occasion was an open house for sons of the lab employees recently.

## TABLE OF CONTENTS

	PAGE
"Who and Why" —	
Du Mont Selling Agents .....	2
How the Cathode-Ray Tube Is Made—A Step by Step Description .....	3
Take Full Advantage of Your Oscillograph .....	11
Two New Sales Offices Established .....	13
Watching Corona .....	14
Eight Ball Corner .....	16
Survey .....	16

# HOW THE CATHODE-RAY TUBE IS MADE

## A Step by Step Description

*By: Morton G. Scheraga*

**The cathode-ray tube is the heart of the oscillograph. Although simple in appearance, it is a highly-accurate device for displaying concise information. The manufacture of these tubes entails a series of meticulous, closely integrated steps; one of the reasons for the relatively few companies in the field.**

The cathode-ray tube does not appear to be a very complex device when thought of as an example of modern scientific development. However, as one delves into the design and manufacturing problems of these tubes, it becomes

apparent that great care and practiced techniques, learned only through years of experience, are required for producing these tubes in great numbers. These techniques and other phases of the manufacturing process will be described to

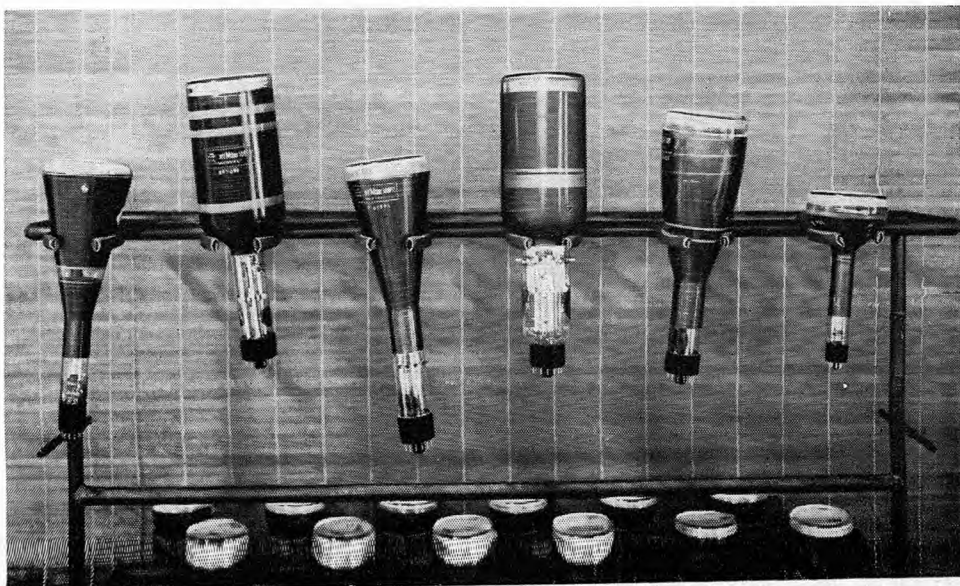

**A few of the myriad of industrial cathode-ray tube types manufactured. Types shown here, left to right, are: 5LP, 5XP, 5AMP, 5SP, 5ADP and 5AHP**

acquaint the reader with the problems involved in producing the modern cathode-ray tubes, and how these problems are solved.

The building of cathode-ray tubes can be divided into three main operations: (1) incoming material inspection, (2) manufacturing and processing, and (3) testing.

### Incoming Material Inspection

In order to enter the cathode-ray tube manufacturing and processing stages confidently, with the assurance that later testing will not reveal poor materials and result in large percentages of tube rejection, complete quality control on all materials used is a necessity. Before materials even reach our plant for subsequent inspection (either on a 100% basis or by samplings based upon previous statistical data and experience with various vendors), several steps have already taken place to assure quality. Samples of all chemical materials to be furnished by vendors are constantly ana-



**A portion of the Du Mont incoming parts inspection group. Thorough inspection of component parts minimizes rejection during subsequent tube testing**

lyzed by the Chemistry Laboratory to make certain that the fluorescent screens will have proper spectral response, uniform particle size, etc., or that the cathodes — one of the most critical parts of the tube — will have proper emitting characteristics. Chemical and physical analyses are made of the metal components in the gun structure to be sure that the vendor is furnishing the specified alloys. In our operation, only after a vendor's products have been thoroughly tested and approved by the Tube Engineering Department does he receive a certificate of approval.

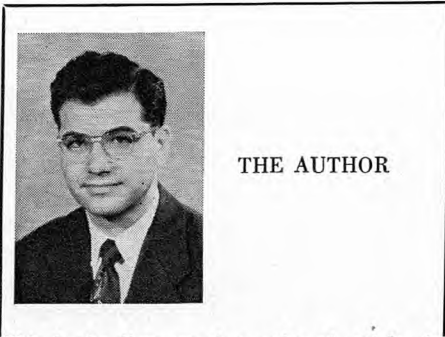

THE AUTHOR

*This is the first set of a series of articles by Morton G. Scheraga on the manufacture of cathode-ray tubes. Mr. Scheraga is Assistant Sales Manager of the Technical Sales Department of Allen B. Du Mont Laboratories, Inc. His duties place him in a position to obtain first hand information on all phases of the design and manufacture of cathode-ray tubes. These articles were written for a Du Mont internal publication, so naturally a Du Mont manufacturing process was used as a model; however, even though many of the processes discussed are unique to Du Mont, these articles contain many facts to interest and enlighten everyone interested in high-quality oscillography.*

### Manufacturing and Processing

The most important major assembly of the cathode-ray tube is the electron gun. In the manufacturing operation, specially designed jigs are employed to assure accurate spacing and angular alignment of the electrodes. In the assembly of the grid and cathode, for example, the spacing must be held within a tolerance of 0.0005 inches to maintain the grid cut-off specification of certain new tight tolerance tubes. Angular alignments during assembly are held to  $90^\circ \pm 15'$  to meet rigid specifications.

The other major assembly in the tube is the glass bulb. These bulbs are washed to more than surgical cleanli-

ness, for even extremely small traces of copper or other heavy metals that might get on the screen would cause discoloration. This condition is called screen poisoning, and is cause for rejecting the tube in test. After the bulb is washed and dried, it is inspected for flaws in the glass and then viewed under ultra-violet light, which simulates electron excitation of the glass to catch other flaws. Any flaws in the glass bulb, such as spots or scratches, could cause a light refraction resulting in uneven light output.

In the meantime the screen materials and reagents are carefully weighed out and are ready for coating the bulb. The coating process is carefully controlled because it is important to get a uniform coat on the screen; an uneven screen coating would result in uneven light output. This is accomplished in our plant, for example, by using a Du Mont developed and patented gel-setting process. This process will be described in detail later in the article. The coating is followed by the application of the conductive graphite coatings and accelerator bands to the sidewalls, as required by the particular tube design. If the screen is to be metallized (the process to be detailed in a subsequent article), a carefully controlled process is employed.

The bulb is again reinspected to be sure the coatings are applied properly and that no scratches or other damage has been done to the glass. The electron gun assembly is sealed into the blank, which is then inspected again for such things as alignment of the neck with the faceplate, and cracks in the glass that can develop after the heat-sealing operation. The tube is also inspected under polarized light to detect any strains that might have developed during sealing.

The tube is now exhausted, baked at high temperatures, the "getter" flashed to absorb any remaining gases, and the base added. Even the final stage of adding the base is a touchy process for certain types of tight-tolerance tubes.



**After coating, the screen of the tube bulb is excited by ultra-violet light to inspect for flaws in the screen or screen coating**

Before the tube can be tested, it is carefully aged. The exact aging time to assure maximum life of the tube has been arrived at empirically by our Engineering Department, and of course, is kept a trade secret. In our operation, a precisely controlled and timed automatic aging rack turns each tube on and off at the beginning and end of its cycle, thus assuring uniformity of every tube.

After activation on exhaust, the cathode must be stabilized by running the heater above normal voltages and applying higher than normal potentials to the other electrodes. This is necessary to stabilize emission from the cathode. Once a few electrons have been drawn, the process multiplies until uniform emission is achieved. Without this activation process the tube would have practically no light output at normal operating potentials.

With current now available from the cathode, the screen is then aged by applying a moving raster pattern to the full screen area. This brings out more

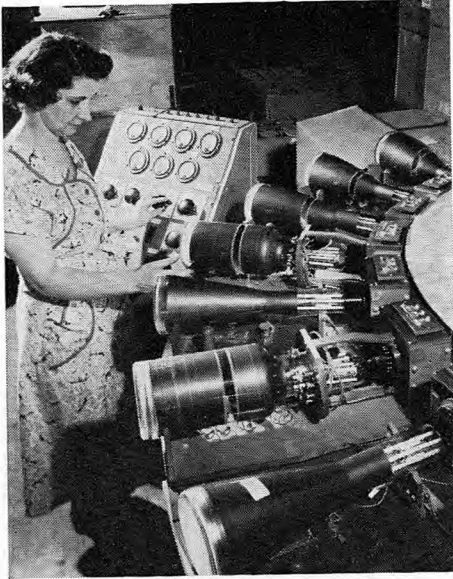

**Automatic aging rack applies various voltages to industrial cathode-ray tubes for stabilization. Precisely controlled and timed, the rack automatically turns each tube on and off at the beginning and end of its cycle, and ejects it upon completion**

gases which are absorbed by the getter.

### Testing

The testing of each tube involves checking all major parameters which

affect published specifications such as angular alignment, light output, focus, astigmatism, grid cutoff, etc. Many other tests are made, such as the use of raster patterns to check the screen coating for uniformity of screen thickness, light output, pinhole flaws, or the checks for grid emission and high voltage breakdown in the gun structure.

So ends the cycle of building industrial type cathode-ray tubes. This does not end the operation however. Concurrent with manufacturing, the quality control department constantly conducts tests in their laboratory. Here tubes picked at random from production are measured for specific performance as compared to "go-no go" measurements used in the Test Department. It can then be determined whether the performance is averaging around the design centers ("bogie" values) or falling near the limits. Quality Control can then advise whether jigs need readjusting to swing production back to the bogie values. If any other point in the process is going out of control, Quality Control can issue a warning to pull the process back into line.

Other tests conducted in the Quality Assurance Laboratory on a sampling basis involve pressure-testing of tubes to three atmospheres, water immersing



**Acceptance tests require 100% inspection of the industrial tubes by quality control for adherence to specification values. Results of those tests magnify any wavering manufacturing processes**



Tubes are given life tests of 500 hours, some for 1000 hours, and others to destruction. Shown giving the set-up a spot check is Mr. John Hinck, whose 22 years with Du Mont in the relatively new cathode-ray tube field is typical of the experience within the company

of the tubes in hot water at 122°F for 18 hours to check the cementing of the bases and contacts, and life-testing tubes for 500 hours, some for 1000 hours, and some to destruction. Tubes might also be pulled at random from stock to check packing and be sure that no deterioration has occurred while sitting on the storage shelf.

From this brief description it is easy to see that cathode-ray tube making is a fine art. What first looks like a relatively simple device involves complexities that account for the reasons that the manufacturing of cathode-ray tubes and the type of performance they give cannot easily be duplicated. With this overall view of the manufacturing process in mind, let us now analyze each operation in greater detail, and wherever possible elaborate on the design.

### The Heater Assembly

The heater element in a cathode-ray tube may seem very insignificant but when one considers that a burned out heater means the loss of even the most expensive tube, it can be appreciated why so much attention is paid to the design of the heater assembly. One method of mounting the heater (exclusive to Du Mont tubes) and the heater assembly is shown in figure 1.

In the assembly shown in figure 1, the heater "feet" are welded to stainless steel lugs that are riveted to a ceramic disc. The location of the rivets and the position of the lugs are carefully controlled so that the heater is accurately positioned on the disc. The advantages of this type of construction are several:

1. A firmly welded, vertically aligned assembly is achieved, which is inserted into the control grid cup and automatically positions the heater within the cathode.

2. Positive centering of the heater within the cathode prevents chafing of the delicate, coated tungsten wire and avoids heater-to-cathode shorts.

3. By welding the tungsten heater feet to the stainless steel lugs, rather than directly to the nickel stem leads, stronger welds are achieved and "hot spots" are avoided. The net result is fewer heater failures.

4. When the control grid is assembled, the distance between the top of the heater helix and the outer edge of the ceramic disc controls the depth to which the helix is seated inside the cathode. Optimum-depth seating is thus predetermined, insuring maximum heater efficiency.

5. By closing off the heater inside the grid cup with the ceramic disc, stray illumination from the incandescent heater is minimized. This is important in industrial applications of

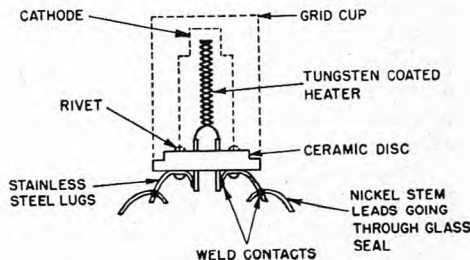
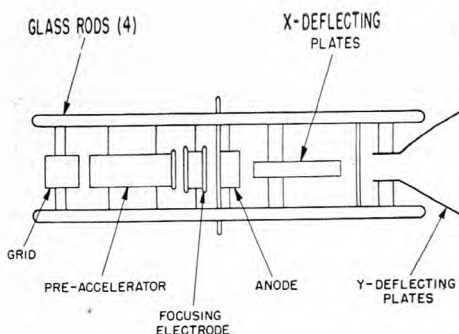

Figure 1. In Du Mont cathode-ray tubes, the heater "feet" are welded to stainless steel lugs that are riveted to a ceramic disc. The heater is accurately positioned on the disc by the location of the rivets and the position of the lugs



**Figure 2. Electron-gun assembly of a typical Du Mont cathode-ray tube. The problem is to align the electrodes shown into a rigid assembly, holding close tolerances on spacing, angular alignment and parallelism**

cathode-ray tubes where one often wishes to photograph the traces on the screen. If the camera shutter is open for any length of time, awaiting a single transient for example, the film would be fogged by the stray light from the heater. The method of assembling mentioned above greatly reduces this fogging effect.

## The Electron-Gun Assembly

Just as critical as the heater assembly is the overall assembly of all the electrodes in the electron gun and the method of doing it on a mass production basis. A typical gun assembly is shown in the sketch in figure 2.

The electron-gun assembly consists of the grid and cathode (the heater assembly is inserted later), the pre-accelerator, the focusing electrode, the anode, and the deflecting plates. The problem is to align these electrodes into a very rigid assembly, holding extremely close tolerances on spacing, angular alignment and parallelism.

When the decision to bring out a new line of tight-tolerance tubes was made, it was apparent that conventional methods of assembling electron guns would not be satisfactory in production. Too many of the operations were under the control of the operator and depended upon his skill to weld a contact while attempting to hold an alignment. Out of this relatively crude approach grew

the need for a completely mechanized method of assembly. In our process, all the electrodes shown in the above sketch are placed into a jig and locked into position. All spacing, parallelism, and angular alignment are thus carefully controlled, and uniformity of all guns readily obtained, economically and rapidly.

After the jig is locked, a glass rod is heated to a white heat, automatically timed by an electronic timing and control device, and brought in the semi-molten state to the jig and fastened to the supports protruding from the electrodes. The glass rod is held in position while it cools and solidifies. Here again, a timing device is used to control automatically the cooling cycle to make it independent of variables introduced by the operator. After the rod is cooled, the jig is indexed 90 degrees and a second rod brought over automatically. Four such rods are employed to hold the electrodes in our tubes. These rods are made of "Multi-form" glass, which



**Glass-rodging portion of the electron-gun assembly utilizes a concise mechanized jig to prevent variables introduced by an operator. Heating and cooling of the glass rods is automatically timed. The position of the gun in the jig is also automatic**

is manufactured in very precise sizes to allow tight dimensional-tolerance work. The result is an extremely rigid assembly capable of maintaining the alignment of the electrodes even under severe conditions of shock and vibration.

Following this assembly operation, the complete gun is inspected for alignment with "go-no go" gages. One can appreciate the tolerances held in the assembly by considering that the angular alignment of the X and Y deflecting plates is held to within  $0^\circ \pm 15'$  in order to meet specification of  $90^\circ \pm 1^\circ$  on perpendicularity. All spacing of electrodes is held to  $\pm 0.001$ -inch except the grid-cathode spacing, which must be held to within a half-thousandth in order to maintain the tight-tolerance grid-cutoff specification. Parallelism of the electrodes is held to within one-thousandth of an inch.

The inspected gun is then washed in a special bath to clean off any finger stains or other contaminants that might give rise to subsequent spurious charges, poor spot shape because of dirt in the apertures, or a poor vacuum.

All of this elaborate machinery and care means much in the final analysis. Listed below are some of the quality factors achieved:

1. Cathode-ray tubes with tighter tolerances and better performance at economical prices.
2. Greater uniformity in performance of tubes is achieved. A continuous maintenance program ascertains that no excessive wear of the jig parts will move the tolerances away from the bogie values. The jigs are even water-cooled to maintain constant temperature of the metal to eliminate uneven expansions and contractions as a possible source of error.
3. The four glass rod method of supporting the electrodes gives a very rigid structure. This permits top performance of the tubes, even under the most severe conditions of operations, for a long life span.
4. The holding of the electrodes in optimum, predetermined positions



**Final inspection of a Type 55P-A dual-gun with "go-no go" gages. The inspector checks for spacings, alignment of electrodes, and for specification qualifications in general**

means that better uniformity of focus, spot size and spot shape is achieved. It means better alignment of traces.

The heart of the oscillograph is the cathode-ray tube, and the heart of the cathode-ray tube is the electrode gun. It is therefore necessary that the electron gun is given a great deal of attention during manufacture.

### Coating the Screen

The majority of our screens are coated by a gel-settling process. Not all screens are coated by this process, however, because there are a few screen types and tube types that require specialized coating techniques. The gel-settling process was developed by Du Mont and is a patented technique, although it has been adopted in various forms by other manufacturers under license arrangements.

The screening operation really begins with the cleaning of the inside of the glass bulb. After the washing operation, the inside of the faceplate is acid treated to a degree that our chemists have determined to be optimum for adhesion of the particular chemicals used.

The glass is not dried prior to coating,