

DU MONT Instrument Journal



DU MONT

TECHNICAL PRODUCTS DIVISION



A PUBLICATION DEVOTED TO ELECTRONIC INSTRUMENTATION AND RELATED FIELDS, PROVIDING THE LATEST INFORMATION ON DEVELOPMENTS IN EQUIPMENT, APPLICATIONS AND TECHNIQUES. PERMISSION FOR REPRINTING ANY MATERIAL CONTAINED HEREIN MAY BE OBTAINED BY WRITING TO THE EDITOR AT THE ADDRESS BELOW.

PUBLISHED QUARTERLY & COPYRIGHT 1957 BY
ALLEN. B. DU MONT LABORATORIES, INC.
TECHNICAL PRODUCTS DIVISION
760 BLOOMFIELD AVE.
CLIFTON, N. J.

EDITOR - ARTHUR HOYT
ASST. EDITOR -
RICHARD SPARNON
CONSULTING EDITOR -
NEIL UPTEGROVE

On The Cover

The Du Mont Type 401 Cathode-ray Oscilloscope, the first instrument of the exclusive 400 Series to be introduced to the industry. Typical of the new design philosophy in Du Mont instruments, the 401 features exceptional visual and operational separations for greater efficiency, long life components and printed wiring circuitry, and many other notable "400 Series" characteristics intended to help the user. We invite you to read our feature article, beginning on page 3, on development of the newest trend in instrumentation.

Hot Corner

The center spread of this issue is an artist's conception of the Du Mont 400 Series. All of these instruments will be in operation in the Du Mont booths at the IRE Show. Be sure to visit the Du Mont display, Booth Nos. 3201, 3202, 3203, 3301, 3303, 3305.

Table of Contents

Page

Feature Article

"A New Era for Instrumentation"..... 3

A story on the reasoning behind the design development of the Du Mont 400 Series line of instruments.

Development

"An Improved Concept In Pulse Generation" 8

A technical explanation of the hard-tube circuitry used in the Type 404 Pulse Generator.

Components

"Printed Wiring Comes of Age" 17

Description of the manufacturing procedures for printed wiring circuits used in Du Mont instruments.

Regular Features

Dis'n Data 7

Who and Why 16

Editor's Page 19

A NEW ERA FOR INSTRUMENTATION

Through careful selection of styles for panel lettering, colors, knobs and control locations, the "Human Engineered" 400 Series became a group of instruments that, in spite of complex circuitry, is easy and convenient to operate and maintain. Operator strain and fatigue are materially reduced, and subsequently there is a substantial reduction in that most common form of inaccuracy — the human error.

The 400 Series constitutes the beginning of a new era of major advances for instrumentation. In addition to high quality circuitry, this series has achieved two important basic features — ease of operation and a more efficient, rugged interior. These and many more improvements prompted the company to offer such outstanding extras as a 5 year written guarantee on each instrument in the 400 Series line.

What Du Mont had set out to do

in the 400 Series, and did very successfully, was to add to instrumentation a previously missing factor. In addition to considering function and performance, the third ingredient was added — *the user*. Whether it should be called human engineering, functional design, or some other phrase is not important; the important fact is the recognition that the *user* is as important as the use, and as important as the *product* being used.

The application of this "user" con-



Type 401 Oscilloscope (left) and the Type 404 Pulse Generator (right), the first two instruments to incorporate the new look and features of the Du Mont 400 Series. The 400 Series of instruments (see center spread) are the result of an extensive study for functional design in instruments — with the user getting the greatest consideration.

cept is relatively new to electronic test equipment. There have been some aborted attempts in this direction, but studies indicate that from a professional designer's viewpoint, each fell short in some respect. Some made a mistake in color and contrast. Some made a mistake in style of legibility of lettering. Some made the mistake of sacrificing logic to expediency in location of controls. Some have concentrated all their efforts on front panels instead of treating the product as a whole. Du Mont was in a position to profit by the mistakes of others — by avoiding them.

The successful design of the 400 Series was not an overnight victory. The history of decisions and developments prior to the new line runs over 10 years. Some of the factual highlights in this history will bring out the difficulties involved.

BEGINNING OF A NEW DESIGN FOR KNOWN QUALITY

As far back as 1946 the thought to provide our oscilloscopes with a new look based on functional design principles was incubating. Emphasis at this time was primarily upon electronic design considerations. With this in mind Du Mont emphasized the electronic quality of the instrument rather than play up any mechanical programs such as we have today.

With the rapid advancement of the electronic industry in the past few years, and the more exacting requirements for instrumentation, it was necessary to make definite changes to provide the customer with a superior instrument. It was becoming increasingly apparent that advances could not be limited to the electronic circuitry. Emphasis was shifted to include the mechanical design features as well. The combination of the two has produced, through several years of evolution, the high quality bi-functional instrument the user expects.

FIRST CHANGES

In 1953 Du Mont took its first plunge into printed wiring. And an icy plunge it was. The early days were not easy; many problems had to be solved. At this time little information was available on printed wiring. Days and weeks of research and frustration ensued. Since 1953, printed wiring (thanks to the superb and constant support of the profession) has come along so rapidly in development that Du Mont can now guarantee proper functional operation without subconsciously holding their breath. As a matter of fact, a 5-year guarantee on all included printed wiring was introduced with the 400 Series.

CONTRACTING OF DESIGN CONSULTANT

By 1955 ideas on a new design were snowballing. At this point it was decided to retain the services of a professional industrial designer to assist in correlating the vast amount of accumulated data. After much consultation, one of the country's leading industrial designers, Henry Dreyfuss, was contracted. This took place in April 1955. From May to October 1955, design objectives were established, executed, accepted, and a selection was made for the introductory design.

An extensive management study followed which established schedules for cost (including engineering, tool-

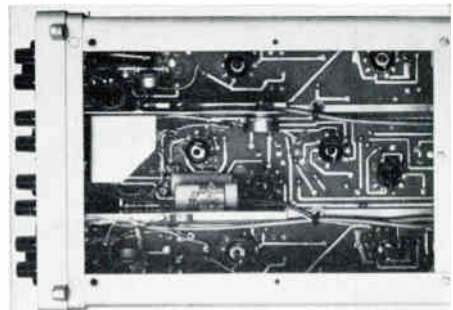

Underside view of the Type 401 shows printed wiring panel. Du Mont, first to use printed wiring in laboratory instruments, now guarantees all printed wiring in 400 Series instruments against any defects for 5 years.

ing, etc.), lead time for production, a sales program, date of introduction, advertising schedule, revisions of development and production schedules, and finally the choice of the name "400 Series" for this elite line of laboratory instruments.

On September 1, 1956, production started and the 400 Series line of instruments soon became available to industry.

COMPLETELY NEW EXTERIOR DESIGN

The introduction of the 400 Series is completed. Now the question arises, where or why is it different? To begin with, the front panels of the 400 Series scopes are now a rugged but attractive design. Fabricated from aluminum casting, front panels are physically and colorfully divided into two sections. The top section of the frames extend beyond the front of the instrument approximately one inch, both in front and rear, establishing a definite division between the *visual*, or indicator section, and the *operational* areas. The indicator area is of a satin-aluminum finish. The bottom section, or manual area, has a dark grey finish to afford the most efficient background for central nomenclature. The construction of the frames and the colors of the panels produce a mode of eye appeal and efficient workmanship.

The bezels now feature a complete change. The exterior is satin-aluminum to blend with the upper section of the front panel, while the interior has a black finish to minimize spectral glare, and to enhance adequate illumination during instrument operation. The front edge thickness is now 1/8-inch, as compared to 1/32-inch of the old model, to improve the use of comparatively heavy recording cameras. From this edge the bezel interior tapers in from five inches diameter to four inches diameter at the rear.

RE-DESIGN OF KNOBS

The selection ranges on all instruments are provided with clear lucite knobs with the graduations clearly

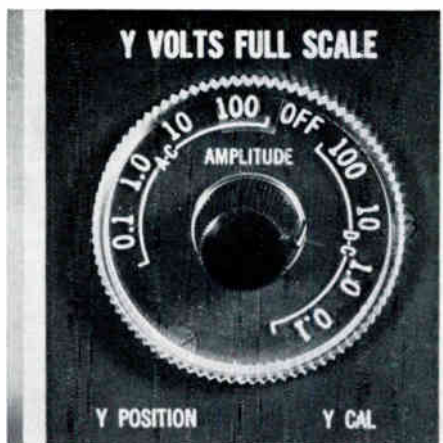

Selection ranges on all 400 Series instruments are provided with clear lucite knobs with graduations clearly and permanently etched on the knob. As is apparent, panel markings are large and very legible.

and permanently etched on the knob to eliminate excess front panel markings. One spot on the knob is colored black, with a red filled background, which is provided to highlight the reading being taken. All controls are channelized in blocks of function; i.e., X-amplifier, Y-amplifier, etc., are located in distinctly separated areas on the operation panel.

Control knobs, including push-push, rotary and bar type, and all binding posts have a smooth finish — except where serrations are required to facilitate rotation or tightening. The binding posts are now at the lower edge of the instruments so that all leads are kept clear of the controls.

To sum it up, the front panel now presents a more logical and clarified arrangement for all controls and the visual area. Through careful selection of type styles for panel lettering, of knob styles, panel colors, and control locations, the "Human Engineered" 400 Series comprises instruments that, in spite of complex circuitry, are easy and convenient to operate and maintain. Operator strain and fatigue are materially reduced, and subsequently there is a substantial reduction in human error.

STANDARD SIZE COVERS

The 400 Series is packaged in five standard sizes which are grouped into two designs. One design covers the three largest instruments and the second the two smallest. The overall dimensions for the three largest are 8 x 11, 3 $\frac{3}{4}$ x 15, and 12 x 15 inches. The smaller sizes are 4 x 7 and 6 x 8 inches. The large instruments have two dust covers which are removable from the side of the structural framework for easy access to every included component. The smaller units have "U" shaped, or can covers, and use a sliding-drawer type chassis. This construction is used only when the front and rear panel frames are not used.

The interior framework is extruded aluminum arranged into a rugged, efficient design. It is mounted longitudinally with the front and rear panel frames for structural strength. In the large instruments a center bar is provided for support and as a mounting area for a black leather handle (handles for the smaller instruments are safely mounted directly to the

cover). The side covers can be taken off easily by removing two screws which hold them to the frame, thus creating no problems in accessibility for servicing.

GOOD STYLING CAN NEVER BE UNDERESTIMATED

Unorganized elements seldom convey a feeling of good styling or good design. In attempting to break down, analyze and present the various elements that go into good styling and design, the importance of individual elements may seem small. Only when viewed as a whole, where each element contributes its subtle effect, does the full impact of good styling and good functional design become apparent.

The final result of the "400" design is an easier, more convenient and less fatiguing instrument that will satisfy the needs of the customer. With its dial readability, contrasting colors, logical grouping of controls and durable strength, the 400 Series has found the medium of high-dependability, easy functional operation and good styling.

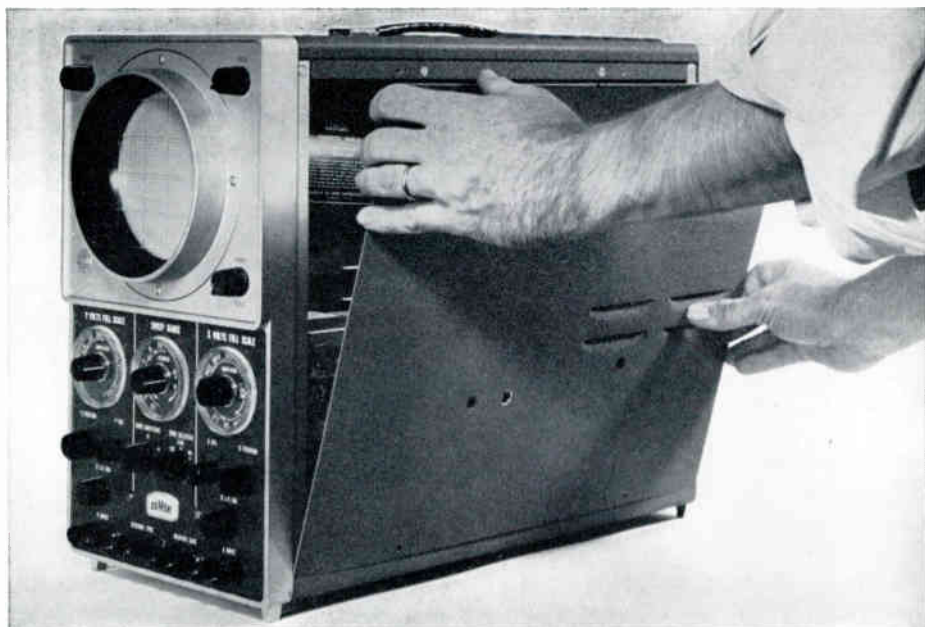

"Fall-away" side panels may be quickly removed to expedite tube changes or servicing operations. Solid aluminum castings, completely encircling the instruments, provide unprecedented mechanical strength.

DIS'N DATA

On frequent occasions, questions have been asked of Du Mont personnel and the staff of the INSTRUMENT JOURNAL concerning the applications and operations of Du Mont equipment.

If you, Mr. Reader, have any questions, basic or advanced, concerning oscilloscopes or related fields please send them along to 'DIS 'N DATA c/o the "Du Mont Instrument Journal" at the address shown on page 2.

Q. What is an attenuator circuit?

Ans. An attenuator circuit is a circuit in the oscilloscope to provide means for reducing the amplitude of incoming signals. The purpose of this circuit is to provide high impedance to impose minimum loading upon the signal and to supply sufficient attenuation so that the amplitude signal will not overload the first amplifier stage. The attenuator frequency must also be insensitive over the frequency range of the amplifier.

2. An internal time base generator connection to deflection plates.
3. An external signal fed to the deflection plates via the X amplifier.

Most often, the horizontal axis of the oscilloscope is used to display a voltage which is a linear function of time, while the vertical deflection is supplied by the test voltage with or without amplification. Thus, the unknown signal voltage is displayed as a function of time.

Q. What type of screen is best for use with photo-recording applications?

Ans. The screen that is recommended for the best results is the Du Mont Type P11. The P11 is a short persistence, blue fluorescent screen that is the most practical for short persistence general purpose viewing. Other types of screens have somewhat shorter persistence but the efficiency of the phosphor is lower. This application of shorter persistence is required only when the continuous-motion recording of signals containing frequency components above approximately 200 kc.

Q. What is meant by db?

Ans. Db is the abbreviation for decibel. A decibel is the ratio between two discreet quantities of electrical units based on a logarithmic scale. When used in relation to scopes, it is a means of defining the relative response at a particular frequency.

Q. How can I get linear time base for horizontal axis?

Ans. Generally there are three methods of moving the spot on the horizontal axis, and they are as follows:

Q. If the spot is kept stationary on the screen, will it damage the screen in any way?

Ans. It is a good practice to keep the spot constantly on the move. If the spot remains stationary over a period of time, the electron beam will eventually burn a hole in the fluorescent coating on the face of the tube. If a serious burn develops, the pattern will not be visible at that particular point, thus causing an inconvenience to the user.

1. A direct connection of signal to the deflection plates.

AN IMPROVED CONCEPT IN PULSE GENERATION

By: Max Schneiderman; Project Engineer

A new Pulse Generator was needed for a long time. A rugged, reliable source for high speed pulses, free of bumps and squiggles. It required a new concept in pulse generating circuitry which was not difficult to develop — once you knew how it was done.

Exact pulse trains had been difficult to obtain for too long. The generation of sharp-edged pulses at high repetition rates without guesswork had been a problem plaguing engineers almost since the introduction

of the hydrogen thyatron. The need for a versatile, reliable pulse generator that would minimize the undesirable characteristics of other generators was so great that Du Mont initiated an extensive research and de-



Figure 1. Type 404 Pulse Generator.

velopment program to produce such a unit. The result was a new concept in pulse generation — hard tube circuitry. Here is why it was used.

PROBLEMS OF OTHER METHODS

Primarily the deficiencies of existing equipment was in their use of thyratrons or mechanical switching systems for pulse generation. A brief discussion of these methods will help clarify the objectives Du Mont had in the development of the Type 404 Pulse Generator.

The spark discharge method provides rise times in the region of one milli-microsecond, and has comparatively simple requirements for power supply. This method has limitations that must be considered however. Among them is the fact that the spark gap cannot be reliably triggered by an external signal; it also has low and unstable repetition rates, and the spark gaps require constant maintenance.

The characteristics of mechanical-switch types of pulse generators are similar to those of the spark discharge method. The main disadvantage of this system — that of maintaining the switch points — is mushroomed by the resulting high cost of frequent relay replacements.

Thyratron pulse generators also have limitations that can be bothersome. Among their major limitations are their inherent jitter between initiating triggers and output pulses, and their inability to operate at repetition rates beyond about 15 kilocycles.

HARD TUBE CIRCUITRY IN PULSE GENERATION

The Du Mont Type 404 Pulse Generator was designed with hard-tube circuitry to overcome these deficiencies. It features (1) 100 kilocycle repetition rates, (2) pulse widths from 0.05 to 100 usec — continuously variable, (3) approximately 18 milli-usec rise times and (4) a 50 volt output into 50 ohms load with provision for accurate

control in one-half db increments, up to 60 db.

Figure 2 is a combined overall block and timing diagram. The internal rate generator (V101- A & B) is a free running multivibrator whose output is differentiated and clipped, resulting in the main internal trigger (T_0 , Fig. 2b). When the rate selector switch is in either of the external sync positions (+EXT/MAN, -EXT), this multivibrator is converted to a two stage trigger amplifier. Triggers from the internal rate generator are coupled into the Trigger Delay multivibrator (V104) which has a fixed delay duration of approximately 5 usec. The trailing edge of the gate waveform generated in this stage (T_1 , Fig. 2d) is used to trigger a blocking oscillator (V105 and T101) whose output constitutes the external trigger at the front panel (T_1 , Fig. 2e).

The main initiating trigger, (T_0 , Fig. 2c) an output of V103-A & B, simultaneously drives the Variable Trigger Position Multivibrator (V201). This circuit controls the pulse delay. The duration of the pulse delay is variable from 2 to 12

(Continued on page 12)



ABOUT
THE
AUTHOR

M. G. Schneiderman is a Project Engineer in the low-frequency instrument section of Du Mont's Technical Products Division. Max was the Project Engineer on the Type 404 Pulse Generator, and is the person who developed most of the included hard-tube circuitry — on which this story is based. He has been Project Engineer responsible for many other commercial and government types of instruments during his 15 years with Du Mont. Max has been scheduled to present a paper on this same subject at the Southwestern IRE, in Houston, Texas, in April, 1957.

the Series—



TYPE
403

Highest sensitivity oscilloscope commercially available. DC amplifier. 1 mv/full scale sensitivity.



TYPE
407

Transistorized low-noise pre-amplifier. Gain of 10. Battery operated. Self-contained. Size 4" x 3 1/2" x 4 7/8". Frequency response: 0.15 cps to 10 kc.



TYPE
401

High gain. DC-150KC. Identical X- and Y-amplifiers. Calibrated sweeps.

Sparkling new ideas materialize in the DuMont 400 Series. These 6 new instruments are *current* models, ready right now. See and operate these instruments at the New York I.R.E. Show. Or ask for a demonstration at your convenience. Write for complete details.

6 ready now

TYPE

404

Jitter-free, hard-tube
circuitry pulse generator.
Pulse repetition rates
up to 100,000 pps.

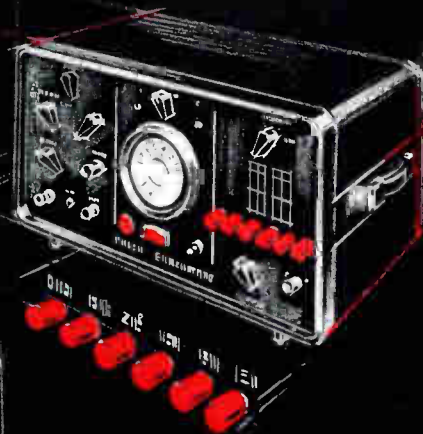

TYPE

410

High gain DC amplifier with
7 millimicrosecond rise time.
High duty cycle calibrated sweeps.
24 KV accelerating potential. Building
Block construction allows choice
of performance characteristics.

TYPE

405

AC-DC VTVM. Dual and
differential input. 0.1
volt full scale AC or DC.
121 megohm resistance on
DC. AC performance to UHF.
Storage compartment for probes.



WARRANTY

Every instrument in the DuMont 400 Series
carries a five-year guarantee.

DU MONT

Technical Products Division, Allen B. DuMont Laboratories, Inc., 760 Bloomfield Ave., Clifton, N. J., U.S.A.

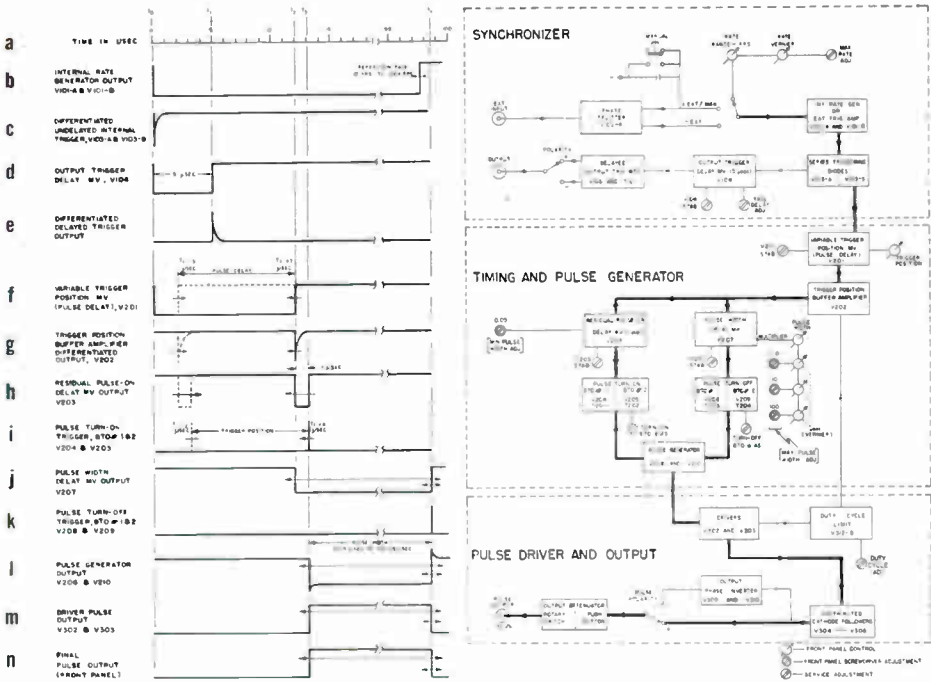

Figure 2. Combined overall block and timing diagram, showing the development of a pulse by hard tube circuitry.

(Continued from page 9)

usec. (T_1-3 to T_2 , Fig. 2f). The trailing edge of the delayed pulse is differentiated, then amplified by the Trigger Buffer (V202) whose function it is to generate T_2 (Fig. 2g), an isolated low-impedance trigger source, for subsequent stages. At time T_2 the Residual Pulse Delay multivibrator (V203) is initiated along with the Pulse Width multivibrator (V207). The residual pulse delay is inserted to enable the minimum width of the Pulse Width multivibrator to be set at 1.05 usec (T_2-T_3). This is much simpler than trying to build a multivibrator that must be varied over the required range with a 0.05 usec minimum.

The trailing edge of the residual multivibrator is T_3 , and is used to fire Pulse Turn-on BTO #1 (Blocking Tube Oscillator, V204 & T201) which in turn fires BTO #2 (V205 & T202). The purpose of the cascaded blocking oscillator stages is to

create a very sharp, narrow trigger (T_3 , Fig. 2i) to turn on the initial pulse generator (V206 & V210). Some time after the initial pulse generator is turned on, the output (T_4 , Fig. 2k) from a similar pair of cascaded blocking oscillators (V208 & T203, V209 & T204) is used to turn off the main pulse. The time of turn off is determined by the trailing edge of the pulse width delay multivibrator (T_1 , Fig. 2j), whose duration is controlled from the front panel pulse width controls.

At this point, the action of the timing and initial pulse generating phase is complete. The net result consists of a negative pulse with fast transitions and controllable duration, taken from the initial pulse generator. From this point on, the function of the remaining circuitry is to process the initial pulse by speeding up, clipping, and impedance transformation. The first step in this process takes place in the driver stage, which

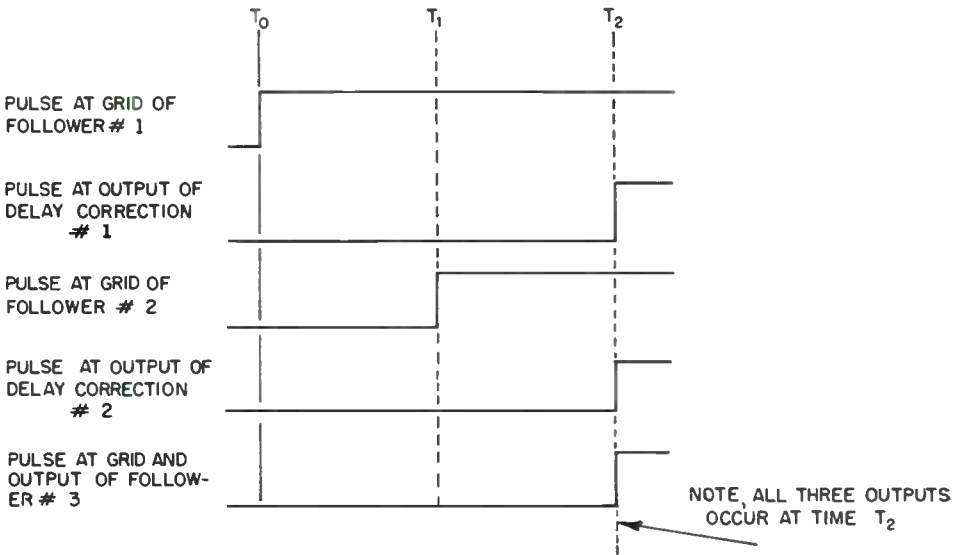
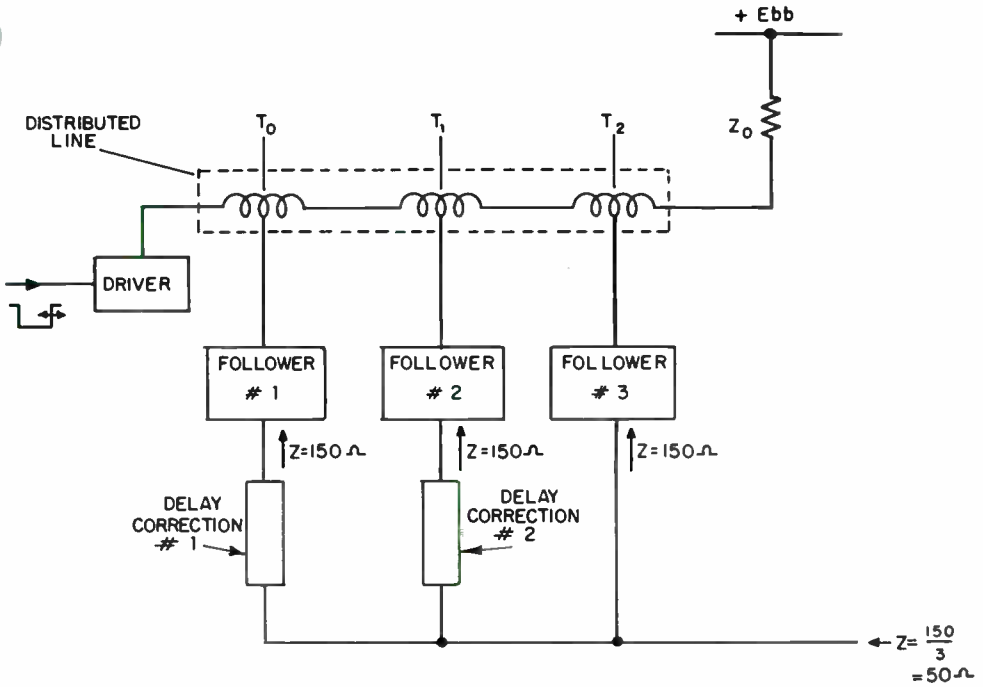

Figure 3. Simplified block and timing diagram showing the action of the output stage.

consists of a pair of power pentodes (V302 & V303) whose control grids are clamped to zero bias and whose screen grids are adjusted so that the

plates are drawing maximum allowable current. When the negative pulse from the initial pulse generator appears at the grids, plate current is

abruptly cut off resulting in a large positive pulse at the plate.

UNIQUE FEATURES OF THE TYPE 404

The unique feature of the Type 404 is the manner in which the pulse is treated from this point on. The driver plate load consists of the input end of a lumped constant transmission line terminated in its characteristic impedance of 300 ohms. The line serves a dual function of separating the input capacitance of the output stage from the driver plates, thereby preserving rise time and also making possible the use of three low cost tubes in parallel for the output stage.

Figure 3 is a simplified block and timing diagram showing the action of the output stage. Each of the grids of the three output follower tubes is connected to a different point on the line, in sequence and uniformly spaced, so that the signal at each grid arrives slightly later than that of its predecessor. Correction for this difference is made by lengths of coaxial cable. Since the first tube on the line sees the signal first, it has the largest delay correction in its cathode. The second tube has only half as much while the third tube has none. When the three outputs meet at a common output point, all three signals combine and are additive. The parameters of each cathode follower are adjusted for an average source impedance of 150 ohms so that the three cathodes in parallel result in the universally accepted 50 ohm source impedance.

Additional refinements for the preservation of pulse waveform are incorporated. The limit resistors in each cathode follower grid, for example, enable a clipping action — thereby serving to maintain a uniformly flat pulse top. Also, each screen is made to follow the cathode waveform by means of screen-to-cathode by-pass capacitors. By holding screen voltage constant with respect to input signal in this manner, Miller capacitance is held at a minimum — serving to

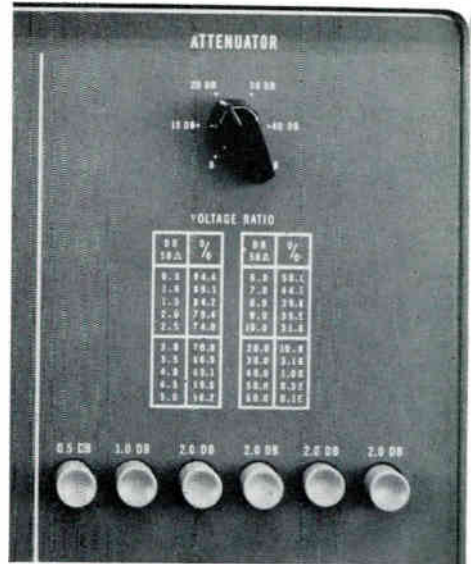

Figure 4. Attenuator section of Type 404 front panel. Six additional push-button actuated attenuators provide sufficient small increments to enable a total attenuation range of 59.5 db in 0.5 db steps.

further reduce any increases in rise time caused by capacitive loading.

Provision for negative output pulses is made via an inverter stage, consisting of a pair of high perveance dual triodes in parallel, driven from the cathode-follower output stage. Part of the inverter plate load consists of a group of ordinary 6.3 volt pilot light bulbs which act as non-linear plate loads. Their function is to provide an increase in plate load as average current increases at high repetition rates, thereby serving to maintain constant amplitude negative pulses. Since the inverter grids are driven hard into conduction, changes of bias would result due to charging of the input coupling capacitor. This is prevented by means of the inverter grid bias regulator whose function is to maintain a constant, low impedance bias source for the inverter tubes.

SAFETY FEATURES

Some circuits in the Type 404 operate with very high peak currents,

in the neighborhood of 2 amperes. As a result, it then becomes necessary to limit the duty cycle to a point where the average power dissipation does not exceed safe tube and component ratings. A positive safety feature therefore has been incorporated to prevent operation beyond safe limits. This consists of an integrator circuit which compares pulse width to repetition rate. When the duty cycle reaches 10%, a relay is actuated which disables the sync system, thereby momentarily terminating operation. The operator is made physically aware of the danger point by an audible click and a warning light flash on the front panel. As soon as the pulses stop the relay lets go, allowing operation to resume. If nothing is done to lower the duty cycle, such as reducing pulse width or repetition rate, this process will continue at a rate determined by the amount that the duty cycle is being exceeded. In this way, the average power dissipation is automatically reduced to a safe value.

ATTENUATION CIRCUITRY

The design of the output attenuator system was complicated by the fact that a 50-volt pulse into 50 ohms at 10% duty cycle resulted in an average power dissipation of 5 watts. This meant that individual attenuator increments greater than 2 db would require the use of large power resistors. In a system where all attenuator increments would be inserted individually, all resistors would have to be equally large. The resulting attenuator system would then be costly and space consuming. This problem was solved by putting a series of five 10 db attenuator increments on a rotary selector switch, arranged in a ladder configuration, so that only the first step required higher wattage resistors — all the others being standard half-watt values. Six additional push-button-actuated attenuators provide sufficient small increments to enable a total attenuation range of 59.5 db in 0.5 db steps. The major advantage of this system is that a true im-

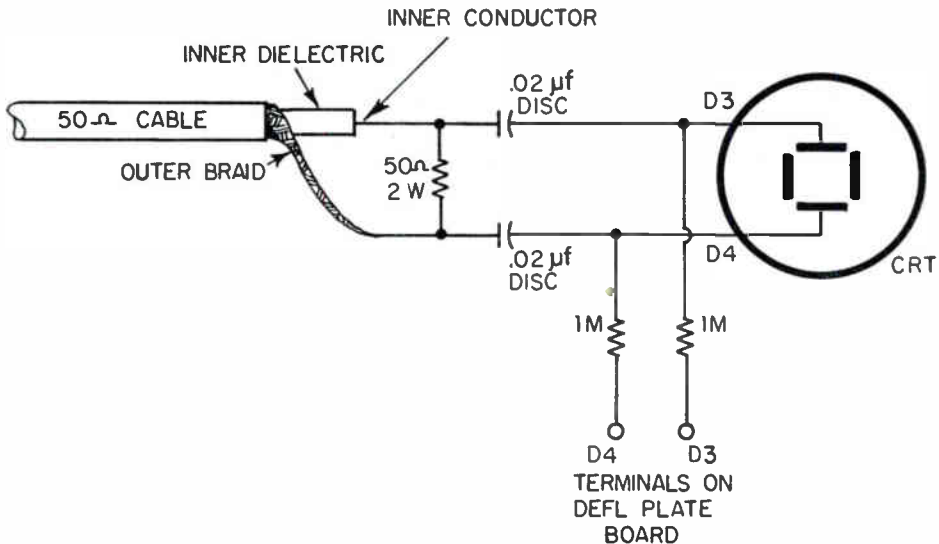

NOTE : DISTANCE BETWEEN END OF CABLE AND CRT HELD TO MINIMUM POSSIBLE

Figure 5. Diagram for proper termination when viewing pulses directly on high impedance deflection plates of cathode-ray tube.

pedance match exists under any possible combination of attenuator settings, thereby minimizing distortions of pulse waveform.

TERMINATION AND INTERCONNECTING CHARACTERISTICS

When dealing with fast, high quality pulses, the importance of impedance matching cannot be overemphasized. Interconnecting cables used with the Type 404 must be terminated with a pure 50 ohm resistance.

The method of termination and interconnection is also important. All junctions should be made up of coaxial plugs and connectors. Terminations should also be coaxial, even to the extent of using "T" connectors to provide plugged on terminations with a minimum of discontinuities. Failure to observe these precautions can result in severe distortions of pulse waveshape. When viewing pulses directly on high impedance deflection plates, the need for proper termination is accentuated. In most cases the use of deflection plate terminals provided by oscilloscope manufacturers is unsatisfactory because of the long leads from the terminal board to the deflecting plates. Figure 5 demonstrates the correct method for this type of viewing.

EXTENDING THE PULSE DELAY

The Type 404 does not normally exceed 8 usec of pulse delay. However, when the situation demands, it is possible to extend this range simply by adding a capacitor in shunt with a particular timing capacitor in the pulse delay multivibrator. Extended pulse delays up to hundreds of usec can be obtained in this manner, providing that the operator is aware of the 70% duty cycle limit on the pulse delay circuit. For instance, the maximum possible repetition rate when the pulse delay is 100 usec would be approximately 7.5 kc. Even at this longer delay, the jitter is less than that observed on many other makes of pulse generators.

Who and Why



JOHN A. GREEN

Among the more recent sales representative firms to join the Du Mont Technical Products selling team is the John A. Green Company. At the helm of the organization, oddly enough, is a gentleman named John A. Green, who works from his company headquarters in Dallas, Texas. The following is a short biographical sketch of John Green, and a short story on the development of the company he formed to sell in the states of Texas, Oklahoma, Louisiana and Arkansas.

The John A. Green Company began operation in Dallas, in 1950, with headquarters at 6815 Oriole Drive. At that time John and his wife were the only people active in the organization — representing seven organizations, including manufacturers of instruments and component parts.

This activity was expanded in the ensuing years, and is now a staff of three Sales Engineers, and four girls

(Continued on page 19)

PRINTED WIRING COMES OF AGE

Since its inception during World War II, printed wiring has steadily improved and now can be depended upon to perform efficiently over a long period of time. A program recently completed established a manufacturing process for producing exceptionally long life printed wiring boards.

An outstanding development that has helped the electronic industry in its coming of age is printed wiring. Printed wiring is basically an electrical circuit that is produced without the use of insulated wires, and provides a supporting medium in a form that is readily adaptable to component assembly.

This new system of wiring came into prominence during World War II, when the need for a much cleaner and compact circuit design arose. By permanently applying a metal, such as copper, and components to an insulated phenolic base or other insulated forms, it is now possible to achieve efficient uniform electronic performance, lower production costs and greater sales appeal.

With printed wiring, a virtually unlimited number of connections, according to the size of the circuit board, can be soldered at one time. The old method required that each lead be soldered individually. Components and wire leads are now featured as a solid electrical connection manufactured in one operation.

Because so many connections can be made at once, the number of people required to assemble a circuit is reduced. It not only reduces the need of extra help, it also cuts production time. All of this results in lower production cost.

Most technical people are only too

familiar with the old soldering method. It consisted of point-to-point assembly, where each lead (including component leads) was handled and soldered separately. Although this method of assembly was an effective one, everyone was subject to human error, and even a well trained solderer was no exception. Management had to guide help through a thorough breaking in period in order to achieve economically a properly soldered connection. This method also required a much more extensive inspection program prior to final assembly.

Printed wiring offers obvious sales appeal. With a cleaner and more compact circuit there is no longer evidence of bulky cable, and wire leads shooting out from cables in all directions. Look at the television receiver chassis eight to ten years ago, and notice how the mounting of the elements gives one the impression that somebody has picked up a handful of components and literally thrown them into the chassis. Printed wiring eliminates this and gives the user the advantage of a more easily serviceable instrument.

PRINTED WIRING NOW HIGHLY DEPENDABLE

Since its inception during World War II, printed wiring has steadily improved and now can be depended upon to perform efficiently over a

long period of time without the ever present thought of breakdown. Du Mont recently completed a program that established a manufacturing process for producing exceptionally long-life printed wiring boards. As a matter of fact, these boards — when combined with high quality components — are so dependable that Du Mont is able to *guarantee* the printed wiring circuits used in the 400 Series line of instruments for five years.

Printed wiring was introduced in Du Mont instruments in 1953. Since that time, an intensive research and development program has brought a steady stream of improvements. The greatest enigma, one that plagued manufacturers of printed circuitry since its inception, was the intermittance caused by an improperly soldered connection. This had to be ironed out, and was eventually done so by the procedure used today.

DU MONT PRINTED WIRING PROCEDURE

To begin with, an approved list of reliable vendors were chosen to sup-



The Type 3005 PANTODRILL, a semi-automatic drilling machine designed for rapid, economical and accurate drilling of large numbers of holes in printed wiring boards.

ply the various materials. This was important since the materials of some vendors were at a more advanced stage than that of others, thus offering higher quality materials. Once the vendors were chosen, they had to adhere to a group of rigid specifications dictated by the engineering department. In particular, the vendor who fabricated the boards had to be reliable even though his only concern was properly applying a solder plate to give the required pattern, and then etching away unwanted copper; all remaining operations are completed in the manufacturing department.

AUTOMATIC DRILLING OPERATION

The first operation in Du Mont's process is the drilling of the holes for inserting eyelets that mount the various components. To increase the production rate, the company developed the Type 3005 PANTODRILL. This is a semi-automatic drilling machine designed for rapid, economical and accurate drilling of large numbers of holes in the boards. Several boards may be drilled at one time in materials with thicknesses up to one inch. When the boards are stacked, the operator drops the work piece into two locating pins permanently fastened to a template, clamps them down and is ready to proceed. The template to be used for the entire production can be fabricated within a half hour.

EYELET SOLDERING PROCESS

When the drilling operation is completed the boards are "eyeleted" with the use of a semi-automatic hopper-fed eyeleting machine. Before the company receives the eyelets, they are pre-dipped in solder to aid in properly soldering connections between the eyelet and the printed circuit.

Sending the boards to various sections of the manufacturing department for the mounting of components is the next step. This procedure is

(Continued on page 20)

EDITOR'S PAGE

One of the new features we are introducing with our new "Instrument Journal" is a page on which to voice an opinion on subjects of slight controversial nature — known better as an editorial. We aren't foolish enough to expect our readers to accept our words of wisdom as gospel however; therefore, in subsequent issues of the "Instrument Journal" we will save space on this same page for you readers to talk back.

Your letters to the editor need not be answers to our editorials. We will enjoy hearing **any** comments you may have appropo to the electronic indus-

try. Naturally, we'd also like to see any compliments you may have, and only because we have to — complaints too. We guarantee this, and we'll swear on our tear stained copy of Roget's Thesaurus, that we'll print those that we feel are the best and most legitimate thoughts, while being the best combination to interest the industry in general. We'd like to print them all, but since we have 35,000 readers we're afraid we couldn't buy type small enough to stick to one page.

We sincerely hope you'll enjoy our editorial page in future issues. If you have any other features you'd like to see in "Instrument Journal", let us know. Send your communications directly to the Editor.

Who and Why

(Continued from page 16)

to handle the office operations in Dallas. They now have a Dallas Sales Office at 137 Parkhouse, which was established in 1955, and a Houston, Texas and Tulsa, Oklahoma office, both being established in 1953.

The Dallas Sales Office is not only the headquarters, it also includes the all important company showroom. The other two offices, though small, serve as places for the salesmen to operate from when in those vicinities, and as places of contact for customers. According to John, as the electronic business increases in the Southwest he hopes to put a full staff in the smaller offices too. As he says, only time will tell when this can be done.

John was born in Enid, Oklahoma on March 21, 1918. This in itself was not controlled by him, but he was there when his son Russell and daughter Mary were born in 1947 and 1951 respectively.

John graduated from Tulsa Central High School in 1936, then went to Tulsa University for two years. In 1938 he transferred to Purdue Uni-

versity where he earned his Bachelor of Science Degree in Electrical Engineering and Master of Science Degree in Engineering.

He has been very active in professional engineering activities and associations. John is a Senior Member of the IRE, and a licensed Professional Engineer in the states of Texas and Oklahoma. At one time or another in his career, John has been: Chairman and Secretary of the Cedar Rapids Section of IRE, Chairman and Secretary of the Iowa Section of AIEE, Regional Secretary of Region 5 of the IRE, Publicity Chairman for the 1951 Southwestern IRE conference, Secretary, Vice-Chairman and Chairman of the Dallas-Fort Worth IRE, Publicity Chairman for the Seventh Annual Southwestern IRE Conference and Electronics Show held in Dallas in 1955, Secretary of Region 6 IRE 1955-1956 and is now Industry Representative on the Southwestern IRE Conference Organization Board of Directors. Whew!

Du Mont is represented, and probably no one will dispute the fact, by an extremely capable engineer in the states of Texas, Oklahoma, Louisiana and Arkansas. It is our privilege to have them on our side.

PRINTED WIRING COMES OF AGE (Continued from page 18)

done in less time than previously because the old soldering operation is now eliminated.

BAKING AN IMPORTANT PROCEDURE

The boards are now placed in an oven for a period of one hour at a temperature of 250° F to extract any moisture in the laminated material that might be present. This process is important because it has been found that in a later operation, when the boards were dip-soldered, the intense heat could cause a blistering action which could possibly lead to a break in the circuit. The blister could occur anywhere on the board. If it occurs under a printed lead, the lead would be laying on a thin piece of skin and not be in direct contact with the board. This could create a situation where the wire can be easily torn away from the board, causing all sorts of problems. If it occurs at any other location on the board, there are no electrical problems involved, but it makes the board appear to be patched up and messy, not presenting a clean neat design.

DIP SOLDERING AND CLEANING

When the boards are removed from the oven they are carefully dipped in flux. They are then ready for dip-soldering. The solder used contains a mixture of 67% tin and 37% lead. Extensive tests have revealed that if the lead and tin content are steadily maintained, this mixture will allow the solder to flow faster at the lowest possible temperature. This is necessary, because when the boards are removed from the soldering pot there is a tendency for a certain amount of solder to remain on the boards.

The side opposite the one that the components are mounted on is the only side of the board that is dipped in solder. The heat penetrating through the eyelet is sufficient to

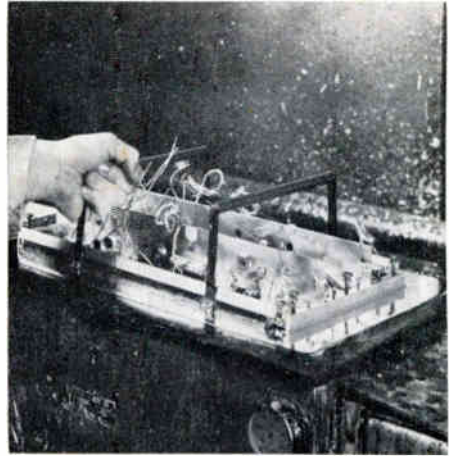

Dip soldering printed wiring boards. Boards are floated in a solder pot, with the aid of a special harness, to obtain uniformly soldered connections.

melt the plating on the eyelet; insuring a proper connection to the non-component side. When they are removed, the boards are put into two large pans to be cleaned. The cleaning solution contains a special formula, again prepared by an approved vendor, to clean the excess flux that remains on the surface from the dip-soldering operation. The boards are then checked for quality soldering connections, and when approved they are sent to the final assembly department to be mounted in the instrument. The printed circuit assembly is now complete.

IMPROVEMENTS STILL TO COME

The same extensive research program exists today — to further improve on the method of application of printed circuitry. Du Mont is going all out to make sure it will withstand any rigid requirements the user expects of it. The important contribution to date is that the company has tremendous faith in the program — as is evidenced by the five year guarantee.

DU MONT

TECHNICAL PRODUCTS DIVISION