



the GENERAL RADIO

# experimenter



VOLUME 39 NO 6

JUNE 1965

## A NEW LOW-NOISE PREAMPLIFIER

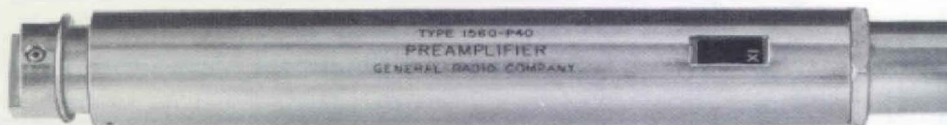

Figure 1.

Recent advances in the semiconductor field, notably in the development of low-noise, field-effect transistors, have made practical a preamplifier particularly suited for use in sound-level and vibration measurements, as well as for general use. Among other characteristics, such a preamplifier should be small and rugged, have a high input impedance, add little noise to the signal, be able to drive other devices through long cables, and consume little power.

The recently developed TYPE 1560-P40 Preamplifier, shown in Figure 1, meets the above requirements admirably. Its physical shape was designed to enhance its use in acoustical measurements, and its electrical properties suit it for many other uses as well. Voltage gain is either unity or 20 dB, as selected by a switch. The 20-dB gain position is particularly helpful in aug-

menting the gain of analyzers for work at low sound and electrical levels.

### DESCRIPTION

When one is making acoustical measurements at low levels, it is preferable to attach a microphone directly on the preamplifier. Since it is important that the structure disturb the acoustic field as little as possible, the preamplifier case is cylindrical and has approximately the same diameter as the microphone. Anechoic chamber tests prove that the preamplifier structure has a negligible effect on a measurement when used with a directly attached microphone, such as the GR TYPE 1560-P5 Microphone. On one end of the case is the input connector, which will accept the cartridge of the GR TYPE 1560-P5 Microphone and various adaptors. On the other end is a three-terminal audio connector that provides

*also in this issue:*

**OSCILLATOR-POWER-SUPPLY COMBINATIONS  
HETERODYNE DETECTORS  
COAXIAL MICROWAVE NEWS  
MULTIPLIER FOR ELECTRONIC VOLTMETER**



the GENERAL RADIO

# experimenter



© 1965—GENERAL RADIO COMPANY, WEST CONCORD, MASS., U.S.A.

*Published Monthly by the General Radio Company*

VOLUME 39

NO 6

JUNE 1965

## CONTENTS

Page

A New Low-Noise Preamplifier . . . . .	1
Oscillator-Power-Supply Combinations for Frequencies from 0.5 Mc/s to 2 Gc/s . . . . .	7
Heterodyne Detectors for the LF, MF, and HF Ranges . . . . .	10
Precision Connector for Coaxial Cable . . . . .	13
A 10:1 Multiplier for the Electronic Voltmeter . . . . .	16

## GENERAL RADIO COMPANY

**West Concord, Massachusetts\*, 01781**

Telephone (Concord) 369-4400; (Boston) 646-7400  
Area Code Number 617

- NEW ENGLAND:** 22 Baker Avenue, West Concord, Mass., 01781  
Telephone—617 646-0550
- METROPOLITAN  
NEW YORK:\*** Broad Avenue at Linden, Ridgefield, N. J., 07657  
Telephone—N. Y., 212 964-2722  
N. J., 201 943-3140
- SYRACUSE:** Pickard Building, East Molloy Road,  
Syracuse, N. Y., 13211  
Telephone—315 454-9323
- PHILADELPHIA:** Fort Washington Industrial Park,  
Fort Washington, Pennsylvania 19034  
Telephone—215 646-8030
- WASHINGTON\*  
and BALTIMORE:** 11420 Rockville Pike, Rockville, Md., 20852  
Telephone—301 946-1600
- ORLANDO:** 113 East Colonial Drive, Orlando, Florida, 32801  
Telephone—305 425-4671
- CHICAGO:\*** 6605 West North Avenue, Oak Park, Illinois, 60302  
Telephone—312 848-9400
- CLEVELAND:** 5579 Pearl Road, Cleveland, Ohio, 44129  
Telephone—216 886-0150
- DALLAS:** 2501-A West Mockingbird Lane, Dallas, Texas, 75235  
Telephone—214 Fleetwood 7-4031
- LOS ANGELES:\*** 1000 North Seward St., Los Angeles, Cal., 90038  
Telephone—213 469-6201
- SAN FRANCISCO:** 1186 Los Altos Ave., Los Altos, Cal., 94022  
Telephone—415 948-8233
- TORONTO:\*** 99 Floral Parkway, Toronto 15, Ontario, Canada  
Telephone—416 247-2171
- MONTREAL:** Office 395, 1255 Laird Blvd., Town of Mount Royal,  
Quebec, Canada  
Telephone—514 737-3673

\*Repair services are available at these offices.

GENERAL RADIO COMPANY (Overseas), 8008 Zurich, Switzerland

GENERAL RADIO COMPANY (U.K.) LIMITED, Bourne End,

Buckinghamshire, England

Representatives in Principal Overseas Countries

*The General Radio  
EXPERIMENTER  
is mailed without  
charge each month to  
engineers, scientists,  
technicians, and others  
interested in electronic  
techniques in measure-  
ment. When sending  
requests for subscrip-  
tions and address-  
change notices, please  
supply the following  
information: name,  
company address, type  
of business company is  
engaged in, and title or  
position of individual.*



the output and power connections. Power is supplied from an external source, either a rechargeable battery power supply or the instrument with which the preamplifier is being used. A recessed slide switch provides the choice of 1:1 or 10:1 gain.

A preamplifier for use after microphones and other high-impedance sources should have a very high input impedance. To minimize the effect of load impedance on the operating characteristics, it should also have a low output impedance. The TYPE 1560-P40 Preamplifier achieves an input impedance greater than 500 megohms shunted by 6 picofarads through the use of a field-effect transistor operating as a source follower in the first stage. Low output impedance, low distortion, and gain stability are achieved in the second and third stages by use of conventional transistors within a negative feedback loop. The preamplifier gain is changed by adjustment of the negative feedback. All three transistors are low-noise types, and the circuit was designed for minimum noise consistent with other requirements. The typical internal equivalent input noise voltage when the preamplifier is connected to a piezoelectric microphone is 2.0 microvolts for the C-weighted sound-level meter characteristic.<sup>1</sup> For a microphone with a sensitivity of -60 dB re 1

volt/ $\mu$ bar this noise corresponds to an equivalent sound level (C) = 20 dB. When an analyzer is used, the equivalent level will be even lower, as determined by the bandwidth. Typical frequency spectra of the equivalent  $e_n$  and  $i_n$  generators<sup>2</sup> are shown in Figure 2.

The frequency response is flat ( $\pm 1$  dB) from 5 to 500,000 c/s for output voltages up to 1 volt, peak-to-peak, across a high impedance load. Even more output, up to 5 volts, peak-to-peak, across a high impedance load, with less than 1% distortion, can be obtained if the frequency range is restricted to 5 to 20,000 c/s.

APPLICATIONS

The very high input impedance and low output impedance make the TYPE 1560-P40 Preamplifier an excellent amplifier and impedance converter for use with microphones, vibration pickups, or other high impedance sources. The low output impedance makes it possible to use long cables to connect the output of the preamplifier to the measuring instrument. Use of one mile of cable at unity gain or one-half mile at 10:1 gain is practical, with some re-

<sup>1</sup> S1.4-1961, American Standard Specification for General-Purpose Sound-Level Meters.  
<sup>2</sup> A. E. Sanderson and R. G. Fulks, "A Simplified Noise Theory and Its Application to the Design of Low-Noise Amplifiers," *NEREM 1960 Record*, General Radio Reprint No A-88.  
*I.R.E. Transactions on Audio*, Vol AU-9, No 4, July-August 1961, p 106.

Figure 2. Typical frequency spectra of internal noise.

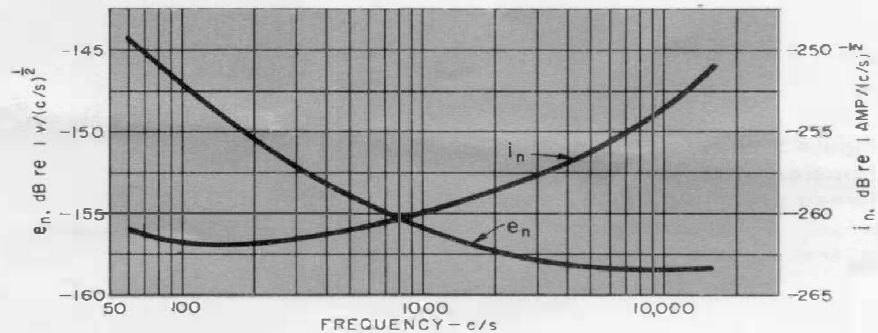



striction on signal level as shown in Figure 3.

**PREAMPLIFIER SETS**

The preamplifier is sold separately or as the main component of three different sets, each consisting of the preamplifier and a group of accessories suited for a particular type of use.

Adaptors supplied convert the preamplifier input connector to a 3-terminal, shielded, audio connector, to a GR-874 Connector, and to a connector that will receive the cartridge from a General Radio TYPE 1560-P3 Microphone. Cables supplied connect the preamplifier to the measuring instrument or to the power supply and transfer the output signal from the power supply to the measuring instrument.

**Type 1560-P96 Adaptor**—Preamplifier input to 3-terminal, shielded, audio connector.

**Type 1560-P97 Adaptor**—Preamplifier input to cartridge of TYPE 1560-P3 Microphone.

**Type 1560-P98 Adaptor**—Preamplifier input to GR874 Coaxial Connector.

**Type 1560-P72 25-ft Cable, Type 1560-P72C 4-ft Cable**—Preamplifier to power supply or other device supplying power. Also carries preamplifier output signal.

**Type 1560-P95 Adaptor Cable**—Preamplifier output signal from power supply through cable to a Type 274-M Double Plug.

**Type 1560-P99 Adaptor Cable**—Phone plug to 3-terminal, shielded, audio connector.

**Type 874-Q2 Adaptor**—GR874 Coaxial Connector to Type 274 Jacks (banana pin) on 3/4-inch spacing.

**The Type 1560-P40H Preamplifier and Power Supply Set**

This set includes a rechargeable battery power supply and a group of adaptors and is intended for applications where power for the preamplifier is not otherwise available and where only electrical signals are to be amplified or a suitable microphone is available for acoustical measurements. The set is made up of the following items:

- TYPE 1560-P40 Preamplifier
- TYPE 1560-4100 Power Supply
- TYPES 1560-P96 and -P98 Adaptors
- TYPES 1560-P95 and -P99 Adaptor Cables
- TYPE 1560-P72C Cable
- TYPE 874-Q2 Adaptor

**Shipping Weight:** 10 lb (4.6 kg).

The power supply consists of two standard nickel-cadmium batteries, a battery checking device, and a battery charger. The output signal from the preamplifier is available at a jack in the power-supply unit.

The TYPE 1560-P40H Preamplifier and Power Supply Set can provide added sensitivity at a very high input

**Figure 3. Maximum output as a function of length of cable between preamplifier and measuring instrument.**

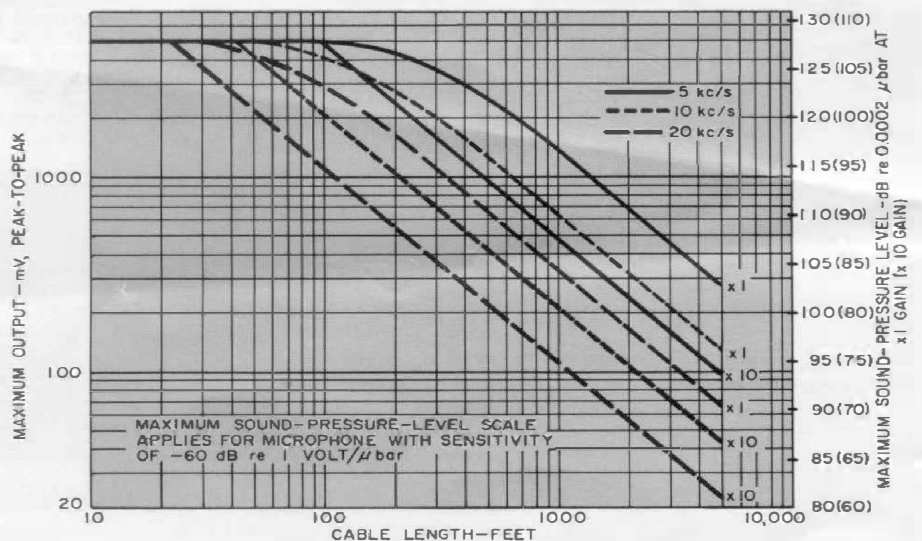



impedance to a wide variety of instruments, for example, the TYPES 1900-A Wave Analyzer, 1142-A Frequency Meter and Discriminator, 1150-series Digital Frequency Meters, 1206-B Unit Amplifier, 1232-A Tuned Amplifier and Null Detector, 1233-A Power Amplifier, 1521-B Graphic Level Recorder, and 1806-A Electronic Voltmeter. For the TYPES 1551 Sound-Level Meters and 1553 Vibration Meters this set makes possible the use of very long cables between the transducer and the meter without loss in signal or deterioration in signal-to-noise ratio.

To illustrate what can be achieved with the added sensitivity, the combination of this preamplifier set and the TYPE 1900-A Wave Analyzer yields an analysis system with as much sensitivity as 3 microvolts, full-scale, at an input impedance of greater than 500 megohms shunted by 6 picofarads. Because the preamplifier can usually be placed very close to the source of the signal being measured, full advantage can be taken of the very high input impedance.

**Type 1560-P40J Preamplifier and Adaptor Set, Type 1560-P40K Preamplifier and Microphone Set**

The TYPES 1560-P40J Preamplifier and Adaptor Set and 1560-P40K Preamplifier and Microphone Set do not include the power supply and are intended for use with measuring instruments that supply power to the preamplifier. Power is available from recent models\* of the TYPES 1564-A Sound and Vibration Analyzer and 1558 Octave-Band Noise Analyzer at the microphone connector. Thus the connection of the proper cable between the preamplifiers and those analyzers will not only provide the path for the signal but also will connect the dc power from the instrument to the preamplifier.

TYPE 1560-P40J Preamplifier and Adaptor Set consists of:

- TYPE 1560-P40 Preamplifier
- TYPES 1560-P96, -P97, and -P98 Adaptors
- TYPE 1560-P72C Cable

**Shipping Weight: 4 lb (1.9 kg).**

\* Earlier models of the TYPES 1564-A, 1558-A and 1558-AP can be readily adapted to supply this power.

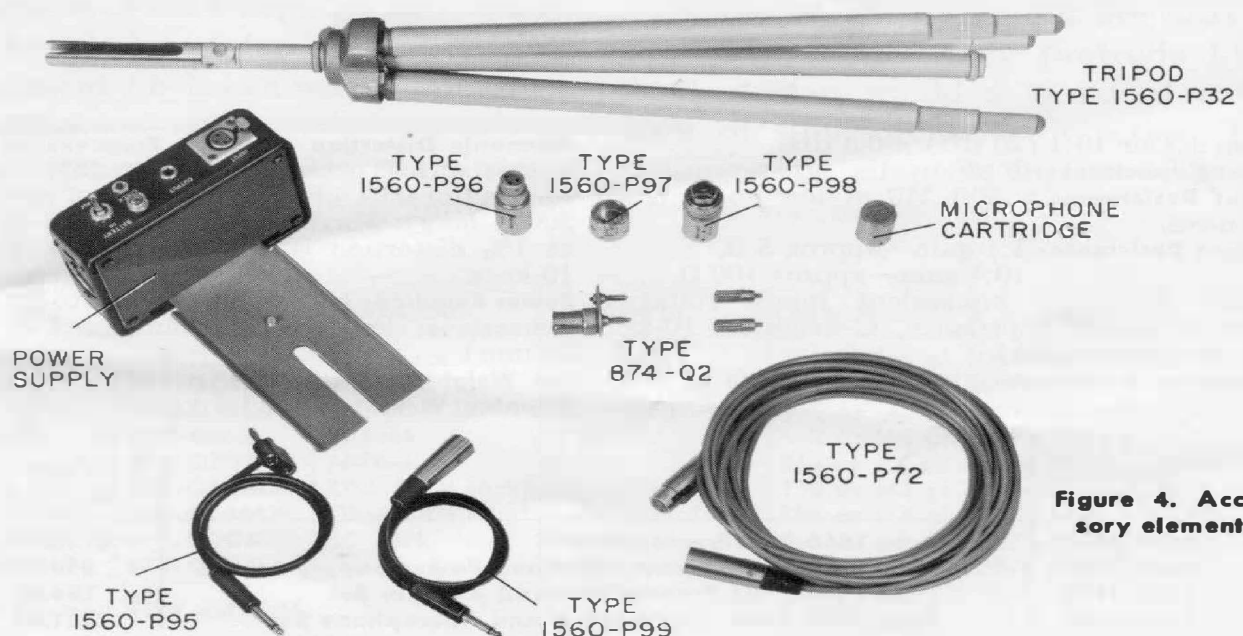

**Figure 4. Accessory elements.**



TYPE 1560-P40K Preamplifier and Microphone Set consists of:

- TYPE 1560-P40 Preamplifier
- TYPE 1560-2131 Microphone Cartridge
- TYPES 1560-P72 and -P72C Cables
- TYPE 1560-P32 Tripod

Shipping Weight: 14 lb (6.5 kg).

**Microphone Cartridge**

The microphone cartridge supplied with the TYPE 1560-P40K Set is from the new TYPE 1560-P5 Microphone. The cartridge fastens securely to the preamplifier so that there is no electrical noise that can result from relative motion of the two mated connectors.

Because of its low noise level the preamplifier is excellent for increasing the sensitivity of analyzers, level recorders, voltmeters, and amplifiers by 20 dB. The combination of the TYPE 1560-P40K Preamplifier and Microphone Set and a TYPE 1564-A, 1558-A, or 1558-AP Analyzer will permit measurements down to a sound-pressure level of 24 dB re 20  $\mu\text{N}/\text{m}^2$  (0.0002  $\mu\text{bar}$ ). In addition, the use of a cable between the preamplifier and the ana-

Figure 5. View of the Type 1560-P40K Preamplifier and Microphone Set with Type 1564-A Sound and Vibration Analyzer.



lyzer makes it possible for the observer to be far from the microphone, thus avoiding interference with the sound field.

— C. A. WOODWARD

**SPECIFICATIONS**

For Type 1560-P40 Preamplifier

**Gain:** 1:1 or 10:1 (20 dB)  $\pm 0.3$  dB.  
**Input Capacitance:** 6 pF.  
**Input Resistance:** > 500 M $\Omega$  at low audio frequencies.  
**Output Resistance:** 1:1 gain—approx 5  $\Omega$ .  
 10:1 gain—approx 100  $\Omega$ .  
**Noise:**  $\leq 2.5$   $\mu\text{V}$  equivalent input voltage (400-pF source impedance, C-weighted, 10-kc effective bandwidth).  
**Frequency Response:**  $\pm 1$  dB from 5 c/s to 500 kc/s.

**Harmonic Distortion at Audio Frequencies:** Open circuit, at 1 V, peak-to-peak: < 0.25%. Capacitor load of 0.01  $\mu\text{F}$  (equivalent to a cable over 200 ft long): Maximum output (peak-to-peak) at 1% distortion is 5 V for 1 kc/s, 2 V for 10 kc/s.  
**Power Required:** 15 V to 25 V, 1 mA to 2 mA, dc.  
**Dimensions:** length 6 $\frac{3}{8}$ , diameter 1 in (175, 26 mm).  
**Net Weight:** 9 oz (0.3 kg).  
**Shipping Weight:** 3 lb (1.4 kg).

Catalog Number	Description	Price in USA
1560-9640	Type 1560-P40 Preamplifier	\$140.00
1560-9500	Type 1560-P40H Preamplifier and Power Supply Set	310.00
1560-9510	Type 1560-P40J Preamplifier and Adaptor Set	184.00
1560-9520	Type 1560-P40K Preamplifier and Microphone Set	251.00



# OSCILLATOR-POWER-SUPPLY COMBINATIONS FOR FREQUENCIES FROM 0.5 Mc/s TO 2 Gc/s

General Radio high-frequency oscillators are compact, low-priced power sources, which provide continuous coverage from 500 kc/s to 2000 Mc/s with single-dial control and output in the order of several hundred milliwatts. Tuning ranges of a simple oscillator range from slightly over an octave at the highest frequencies to 100:1 at the lowest. In conjunction with one of the companion group of power supplies, any oscillator becomes a complete signal source with characteristics adapted to the customer's application. By appropriate choice of power supply, the oscillator can deliver (1) maximum power, (2) optimum frequency stability with minimum residual fm and a-m, (3) pulse- and square-wave-modulated output, (4) amplitude-regulated output for sweeping applications, or can be incorporated into a heterodyne detector system. Power supplies and oscillators are designed for semi-permanent attachment for bench use or relay-rack mounting.

Each possible operable combination has now been assigned an individual

type number to simplify selection and ordering.

Both bench- and rack-mount combinations are available. The rack-mounted combinations include panel extensions, necessary to convert the bench-mount instruments for rack mounting, and a coaxial cable, which permits the user to have the rf output available at either front panel or rear.

Combinations originally purchased for bench mounting can subsequently be converted for rack mounting by means of rack-adaptor kits, which are also available separately. Conversely, conversion from rack to bench is accomplished simply by removal of the panel extensions. Bench models have output at rear, except for TYPE 1361-A, which has its output jack on the front panel. The output connector is a locking GR874, to which adaptors to other types are easily attached. All adaptors lock securely in place and are neat in appearance since they protrude little further than would a standard panel jack of similar connector series. The locking-type adaptors in the table below are recommended.

<i>Adaptor to</i>	<i>Type Number</i>	<i>Contains GR874 and . . .</i>	<i>Connects GR874 to . . .</i>	<i>Net Weight</i>	<i>Catalog Number</i>	<i>Price in USA</i>
Type BNC	874-QBJL	BNC Jack	BNC Plug	1 1/2 oz (45 g)	0874-9701	\$5.75
Type C	874-QCJL	C Jack	C Plug	2 oz (60 g)	0874-9703	8.50
Microdot	874-QMDJL	Microdot Jack	Microdot Plug	1 1/2 oz (45 g)	0874-9721	11.00
Type N	874-QNJL	N Jack	N Plug	2 oz (60 g)	0874-9711	6.00
	874-QNPL	N Plug	N Jack	2 1/4 oz (70 g)	0874-9811	6.50
Type OSM/BRM	874-QMMJL	OSM/BRM Jack*	OSM/BRM Plug	1 1/2 oz (45 g)	0874-9723	12.00
	874-QMMPL	OSM/BRM Plug*	OSM/BRM Jack	1 1/2 oz (45 g)	0874-9823	12.00
Type SC	874-QSCJL	SC Jack	SC Plug (Sandia)	2 oz (60 g)	0874-9713	11.00
Type TNC	874-QTNJL	TNC Jack	TNC Plug	1 1/2 oz (45 g)	0874-9717	9.50

\* Mates also with NPM and STM.

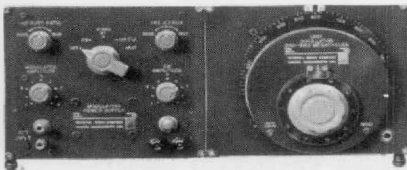

(Left) Type 1209-C4; Types 1209-CL4, 1215-C4, 1361-A4, 1211-C3, 1215-C3, 1209-CL3, 1209-C3 and 1361-A3 are similar in appearance.

(Right) Rack-mount version (Type 1209-C4R) of the combination shown above.

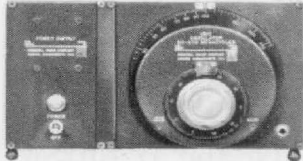
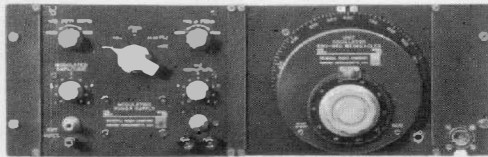

(Left) Type 1215-C9; similar in appearance are Types 1211-C9, 1211-C7, 1215-C7, 1208-C7, 1208-C9, 1209-CL7, 1209-CL9, 1209-C7, 1209-C9, 1361-A7, and 1361-A9.

(Right) Rack-mount version (Type 1215-C9R) of the combination shown above.

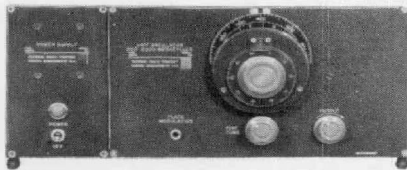
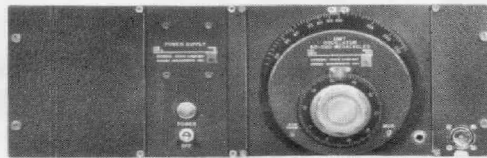

(Left) Type 1218-B9; Type 1218-B7 is similar.

(Right) Type 1218-B9R; Type 1218-B7R is similar.

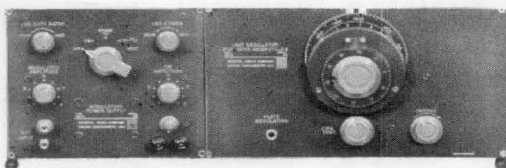
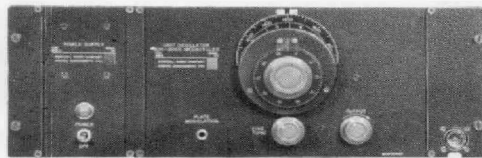

(Left) Type 1218-B4; Type 1218-B3 is similar.

(Right) Type 1218-B4R; Type 1218-B3R is similar.

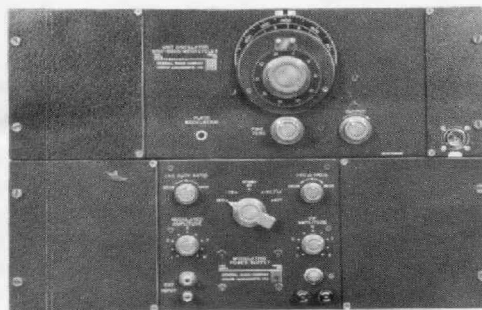

Frequency Range and (Oscillator Type)	Performance → (Power Supply Type)	
	Input Line Voltage	
500 kc/s-50 Mc/s (Type 1211-C)	Bench Mount	Catalog No. Type Price in USA
	Rack Mount	Catalog No. Type Price in USA
50-250 Mc/s (Type 1215-C)	Bench Mount	Catalog No. Type Price in USA
	Rack Mount	Catalog No. Type Price in USA
65-500 Mc/s (Type 1208-C)	Bench Mount	Catalog No. Type Price in USA
	Rack Mount	Catalog No. Type Price in USA
180-600 Mc/s (Type 1209-CL)	Bench Mount	Catalog No. Type Price in USA
	Rack Mount	Catalog No. Type Price in USA
250-960 Mc/s (Type 1209-C)	Bench Mount	Catalog No. Type Price in USA
	Rack Mount	Catalog No. Type Price in USA
450-1050 Mc/s (Type 1361-A)	Bench Mount	Catalog No. Type Price in USA
	Rack Mount	Catalog No. Type Price in USA
900-2000 Mc/s (Type 1218-B)	Bench Mount	Catalog No. Type Price in USA
	Rack Mount	Catalog No. Type Price in USA





<i>Maximum power; lowest cost</i> (1269-A)	<i>Ultimate cw stability; very low residual fm</i>		<i>Stable cw; 100% square-wave &amp; pulse modulation; internal 1-kc square-wave</i> (1264-A)	<i>Amplitude-leveled output behind 50-Ω source impedance; metered output level; 1-kc square-wave modulation, or cw</i> (1263-B)
	(1267-A)	(1267-AQ18)		
105 to 125 V or 195 to 250 V	105 to 125 V	195 to 250 V	105 to 125 V or 210 to 250 V	105 to 125 V or 210 to 250 V
1211-9439 1211-C9 \$415.00	1211-9437 1211-C7 \$510.00	1211-9438 1211-C7Q18 on request	Not Available	1211-9433 1211-C3 \$765.00
1211-9579 1211-C9R \$435.00	1211-9577 1211-C7R \$530.00	1211-9578 1211-C7RQ18 on request		1211-9573 1211-C3R \$786.00
1215-9439 1215-C9 \$300.00	1215-9437 1215-C7 \$395.00	1215-9438 1215-C7Q18 on request	1215-9434 1215-C4 \$525.00	1215-9433 1215-C3 \$650.00
1215-9579 1215-C9R \$320.00	1215-9577 1215-C7R \$415.00	1215-9578 1215-C7RQ18 on request	1215-9574 1215-C4R \$546.00	1215-9573 1215-C3R \$671.00
1208-9439 1208-C9 \$340.00	1208-9437 1208-C7 \$435.00	1208-9438 1208-C7Q18 on request	Not Available	Not Available
1208-9579 1208-C9R \$360.00	1208-9577 1208-C7R \$455.00	1208-9578 1208-C7RQ18 on request		
1209-9539 1209-CL9 \$375.00	1209-9537 1209-CL7 \$470.00	1209-9538 1209-CL7Q18 on request	1209-9534 1209-CL4 \$600.00	1209-9533 1209-CL3 \$725.00
1209-9589 1209-CL9R \$395.00	1209-9587 1209-CL7R \$490.00	1209-9588 1209-CL7RQ18 on request	1209-9584 1209-CL4R \$621.00	1209-9583 1209-CL3R \$746.00
1209-9439 1209-C9 \$375.00	1209-9437 1209-C7 \$470.00	1209-9438 1209-C7Q18 on request	1209-9434 1209-C4 \$600.00	1209-9433 1209-C3 \$725.00
1209-9579 1209-C9R \$395.00	1209-9577 1209-C7R \$490.00	1209-9578 1209-C7RQ18 on request	1209-9574 1209-C4R \$621.00	1209-9573 1209-C3R \$746.00
1361-9419 1361-A9 \$375.00	1361-9417 1361-A7 \$470.00	1361-9418 1361-A7Q18 on request	1361-9414 1361-A4 \$585.00	1361-9413 1361-A3 \$725.00
1361-9509 1361-A9R \$395.00	1361-9507 1361-A7R \$490.00	1361-9508 1361-A7RQ18 on request	1361-9504 1361-A4R \$606.00	1361-9503 1361-A3R \$746.00
1218-9429 1218-B9 \$540.00	1218-9427 1218-B7 \$635.00	1218-9428 1218-B7Q18 on request	1218-9424 1218-B4 \$750.00	1218-9423 1218-B3 \$890.00
1218-9549 1218-B9R \$561.00	1218-9547 1218-B7R \$656.00	1218-9548 1218-B7RQ18 on request	1218-9544 1218-B4R \$774.00	1218-9543 1218-B3R \$914.00



# HETERODYNE DETECTORS FOR THE LF, MF, AND HF RANGES

Of the kinds of detectors useful at radio frequencies, the so-called heterodyne type (actually superheterodyne) has the most to recommend it. Among its many advantages are (1) high sensitivity, (2) wide frequency range, (3) excellent selectivity, and (4) excellent effective shielding.

The GR TYPES DNT-1, -2, -3 and -4 Detectors have found widespread use at very-high and ultra-high frequencies. The new TYPES DNT-5, -6, and -7 now bring the heterodyne detector's definite advantages to the low-, me-

dium-, and high-frequency ranges. These detectors use the crystal mixers previously described.<sup>1</sup> The i-f amplifier for TYPES DNT-5 and DNT-6 is the TYPE 1232-A Tuned Amplifier and Null Detector; for the TYPE DNT-7, it is the TYPE 1212-A Unit Null Detector. Each detector combination is complete with local oscillator, mixer, i-f amplifier, and isolating attenuator pad, as shown.

<sup>1</sup>"Two New Mixers for the Detection of RF Signals," *General Radio Experimenter*, December 1963.

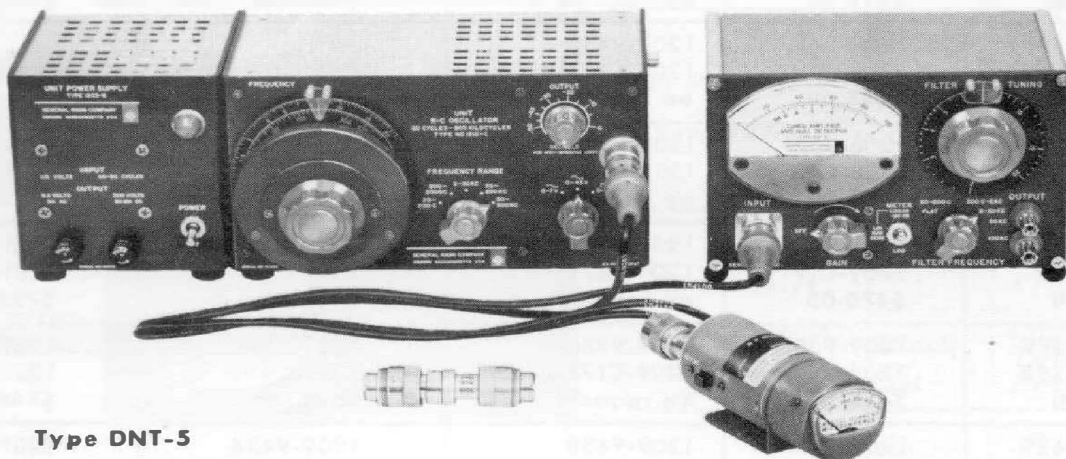

Type DNT-5

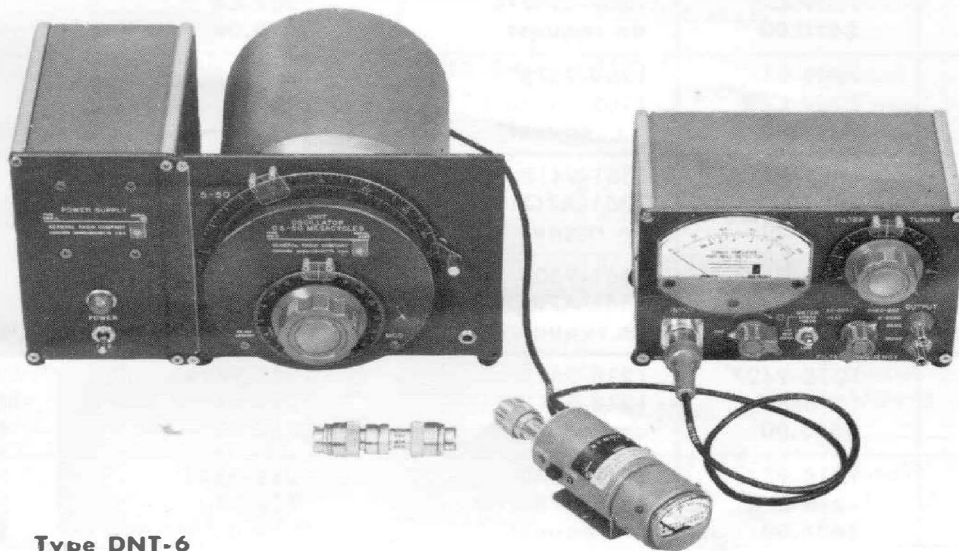

Type DNT-6



## TYPE DNT-5 AND TYPE DNT-6 HETERODYNE DETECTORS

The TYPE 1232-A Tuned Amplifier and Null Detector, which in these combinations is the i-f amplifier, covers, by itself, frequencies from 20 c/s to 20 kc/s and has spot frequencies at 50 kc/s and 100 kc/s. Thus, the TYPE DNT-5 gives nearly continuous coverage from 20 c/s to 500 kc/s. Present users of the TYPE 1232-A can extend the coverage to higher frequencies by buying only those components that

they do not already have (see list below).

In addition to the advantages of the heterodyne detector, as listed above, the TYPES DNT-5 and DNT-6 have a linear response and are suitable as indicators for measurements of attenuation, relative signal levels, leakage, and crosstalk by the substitution method with the aid of a calibrated attenuator. A complete list of components for each detector is shown below.

### TYPE DNT-5 HETERODYNE DETECTOR

70 TO 500 kc/s

- 1 TYPE 1232-A Tuned Amplifier and Null Detector
- 1 TYPE 1210-C Unit R-C Oscillator
- 1 TYPE 1203 Unit Power Supply
- 1 TYPE 1232-P1 RF Mixer
- 1 TYPE 874-G10L Fixed Attenuator

**Net Weight:** 17½ lb (8 kg).

**Shipping Weight:** 24 lb (11 kg).

Catalog Number	Description	Price in USA
1235-9605	Type DNT-5 Heterodyne Detector, for 105-to-125-volt supply	\$737.00
1235-9795	Type DNT-5Q18 Heterodyne Detector, for 195-to-250-volt supply	on request

### TYPE DNT-6 HETERODYNE DETECTOR

500 kc/s TO 10 Mc/s

- 1 TYPE 1232-A Tuned Amplifier and Null Detector
- 1 TYPE 1211-C Unit Oscillator
- 1 TYPE 1269-A Unit Power Supply
- 1 TYPE 1232-P1 RF Mixer
- 1 TYPE 874-G10L Fixed Attenuator

**Net Weight:** 24½ lb (11.5 kg).

**Shipping Weight:** 33 lb (15 kg).

Catalog Number	Description	Price in USA
1235-9606	Type DNT-6 Heterodyne Detector, for 105-to-125-, 195-to-235-, or 210-to-250-volt supply	\$912.00

**Sensitivity vs frequency for Type DNT-5 and Type DNT-6 Heterodyne Detector.**

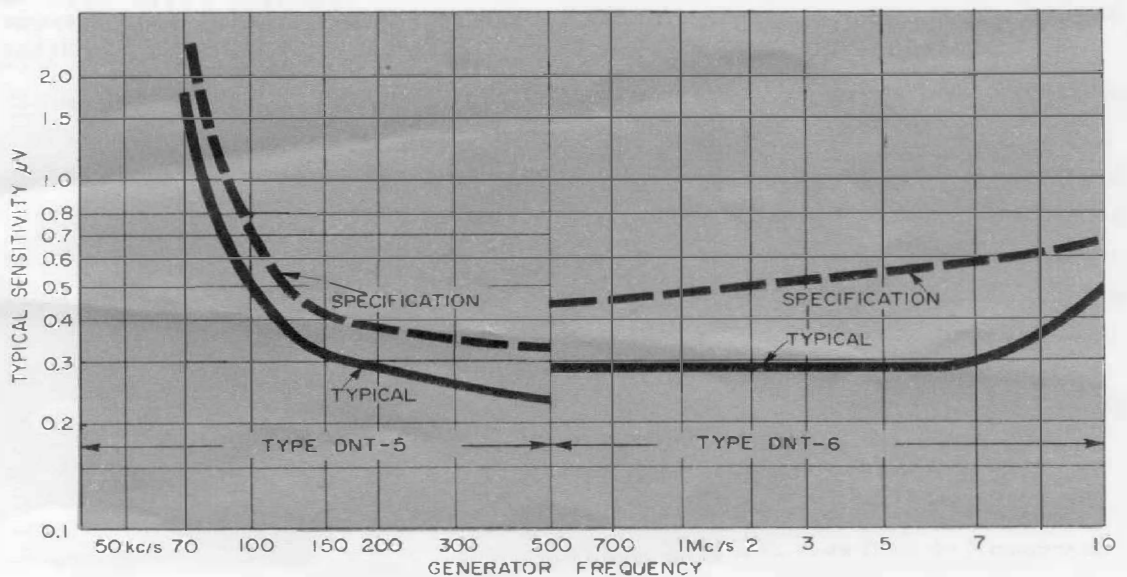



# TYPE DNT-7 HETERODYNE DETECTOR



Type DNT-7

The TYPE 1212-A Unit Null Detector, used as the i-f amplifier in this combination, is a broadband amplifier covering frequencies from about 20 c/s to about 3 Mc/s. In addition, it is a narrow-band tuned device when used with the TYPE 1212-P3 1-Mc Filter.

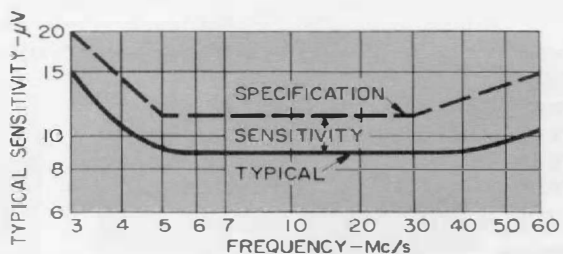

## TYPE DNT-7 HETERODYNE DETECTOR 3 TO 50 Mc/s

- 1 TYPE 1212-A Unit Null Detector
- 1 TYPE 1212-P3 RF Mixer
- 1 TYPE 1211-C Unit Oscillator
- 1 TYPE 1269-A Unit Power Supply
- 1 TYPE 1203 Unit Power Supply
- 1 TYPE 874-G10L Fixed Attenuator

Net Weight: 28½ lb (13 kg).  
Shipping Weight: 39 lb (18 kg).

## Type 900-C9 Cable Connector

Catalog Number	Description	Price in USA
1235-9607	Type DNT-7 Heterodyne Detector, for 105-to-125-volt line	\$802.00
1235-9797	Type DNT-7Q18 Heterodyne Detector, for 195-to-250-volt line	on request

Type DNT-5 Heterodyne Detector in use with the Type 916-AL RF Bridge.



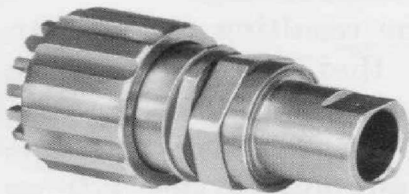

## PRECISION CONNECTOR FOR COAXIAL CABLE

A precision flexible-cable connector, the GR TYPE 900-C9, is the latest addition to the GR900 line.

Why is such a connector needed? Connector manufacturers argue that there is a limit to how good a cable connector need be because cables are generally poorer (some cable manufacturers indicate that cable vswr of 1.20 is considered good). Some cable manufacturers hold that the cables are good and the connectors have been generally poor (recent MIL connector vswr specifications are 1.200—1.30). Actually, both views are valid. Most flexible cables have random characteristic-impedance variations that produce significant reflections at microwaves; but nevertheless, very good pieces of cable can be selected. The connector reflections in this case may limit the performance. Hence the need for a good flexible-cable connector. The TYPE 900-C9 Precision Cable Connector meets this need.

### DESIGN CONSIDERATIONS

The principal performance goal in the design of the TYPE 900-C9 Cable

Connector was the achievement of low vswr and its maintenance by means of reliable techniques for assembly and for attachment to the cable. These were the same goals sought in the GR874 "A" series cable connectors<sup>1</sup> but which could not be fully realized there because of the general requirement for the crimped-ferrule method of attachment.

Crimping, which is used with many UG connectors, compresses the cable and produces a significant reflection at the joint. In the TYPE 900-C9 a new method of attachment is used, which eliminates this compression.

The assembly procedure is an important design consideration. The principal aims are precise axial location of the internal connector parts and a good solder joint without flow of cable dielectric. These aims have been achieved in the TYPE 900-C9 by the use of an assembly that is self-aligning, the use of a Teflon\* heat-barrier

<sup>1</sup> J. Zorzy, "New Coaxial Cable Connectors," *General Radio Experimenter*, August-September, 1962.

\* Registered trademark of E. I. du Pont de Nemours and Company.

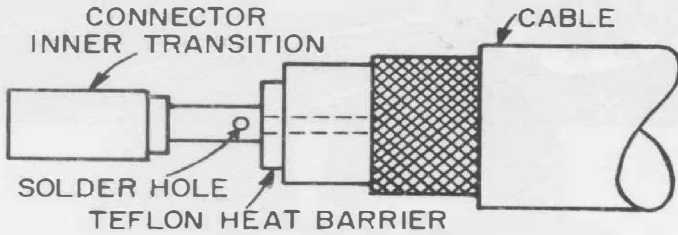

Figure 1. Inner-transition assembly showing Teflon disk.

disk<sup>2</sup>, and the use of low-temperature solder, which is furnished with each connector. The disk in position is shown in Figure 1.

Three important requirements affect the design of the mechanical attachment for the cable braid and jacket: (1) the electrical connection between the braid and the connector must not produce discontinuities; (2) the assembly must stand up under typical use by resisting twisting and/or pulling forces; and (3) the cable must not be compressed. These requirements are met by the attachment method shown in Figure 2. The braid is captured by a combination of butt and radial forces. The outer transition has a diamond-pattern knurl similar to that used on the GR874-series connectors. The radial forces come into play as the rubber gasket presses both the jacket and the braid against the knurled portion of the outer transition

<sup>2</sup> *Op. Cit.*

when the retainer body is threaded up tight. To obtain continuous and reliable electrical connection between the cable braid and the outer transition, the end of the transition is faired in, and the rubber gasket is extended into this region to press the braid against the faired-in edge.

The resulting joint is strong and resists the pull and torsion ordinarily encountered in use of a cable connector. In a pull test the connector assembly supported the 170-pound weight of the writer.

A low-vswr junction is achieved at the braid joint, and it does not deteriorate with use.

The inner and outer transitions are accurately positioned in the connector by means of the modified GR900 connector to which these are assembled. Axial relations are maintained automatically; nothing is left to skill or special tools. After assembly of the connector, the retention system described above is tightened, and the braid is automatically positioned as the connection is tightened.

The GR900 connector used is similar to the TYPE 900-BT except that the Teflon support, instead of being a press-fit into the body, is a sliding fit, which is necessary to facilitate the assembly of the cable connector.

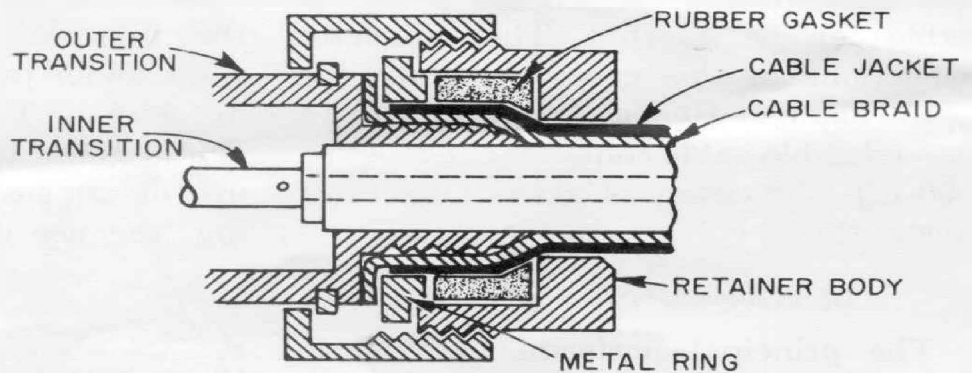
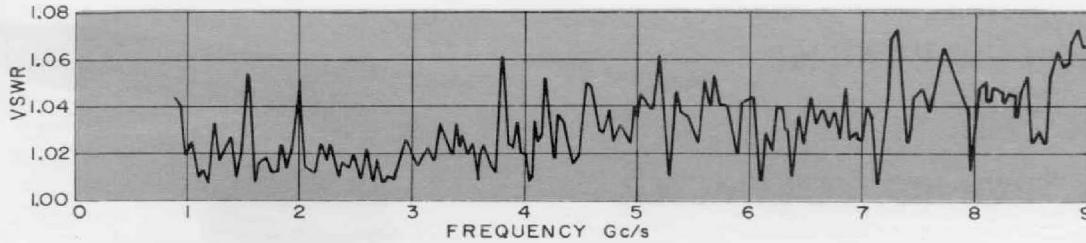

Figure 2. Braid and jacket-retention system shown before coupling ring is tightened.



**Figure 3. Typical VSWR of a single Type 900-C9 Connector on "infinite" length of RG-214/4 cable.**

**VSWR PERFORMANCE**

In order to assess the vswr characteristics of this connector, a good piece of RG-214/U cable was obtained. Its characteristic impedance was  $50 \pm 1\%$ , and it was free of any significant impedance nonuniformities. The vswr characteristics of the TYPE 900-C9 Connector mounted on this cable are shown in Figure 3. The cable was taken as infinite in length.

**APPLICATIONS**

The TYPE 900-C9 Cable Connector is recommended for any indoor flexible-cable application when an extremely low vswr connection is required or when a connection to other GR900 components is required. This connector also makes possible the accurate measurement of the vswr characteristics of cables at microwaves and vswr tests of cable connectors to new MIL specs, such as MIL-C-39012.

It is difficult to get a perfect 50-ohm termination for a cable. The so-called infinite cable termination is a poor one, because most cables have both random and periodic impedance variations. A relatively short piece of cable (in a short piece, the multitudes of small reflections cannot add up to cause a

large reflection), terminated in the TYPE 900-C9 and the TYPE 900-W50 Termination, is better.

The TYPE 900-C9 Precision Cable Connector was designed for use with the RG-214/U and for the RG-9 cables. It can be used with other popular cables of this size, for example, the RG-213/U or the RG-8 cables, but, because these cable diameters are smaller, the hole in the retainer body provides too much clearance. A turn or two of electrical tape, however, will build up the diameter to fit. The connector can be used with still other cables, but the mechanical clamping may not be effective because of deviations of over-all diameter or, with armored cable, lack of means for clamping the armor.

— JOHN ZORZY

**SPECIFICATIONS**

- Frequency Range:** Dc to 9 Gc/s.
- Characteristic Impedance:** 50  $\Omega$ .
- Leakage:** Better than 130 dB below signal.
- Insertion Loss:** Less than  $0.006 \sqrt{f_{Gc}}$  dB per pair.
- Maximum Voltage:** 1500 V peak.
- Dimensions:** Length of one connector,  $2\frac{1}{8}$  inches (54 mm); maximum diameter,  $1\frac{1}{16}$  inches (27 mm).
- Net Weight:**  $2\frac{1}{2}$  oz (75 g).

<i>Catalog Number</i>	<i>Description</i>	<i>Price in USA</i>
0900-9421	<b>Type 900-C9 Precision Coaxial Cable Connector</b>	<b>\$50.00</b>



# A 10:1 MULTIPLIER FOR THE ELECTRONIC VOLTMETER



The TYPE 1806-P2 10:1 Range Multiplier attaches to the probe of TYPE 1806-A Electronic Voltmeter and permits the probe to be used directly for the measurement of ac voltages up to 1500 volts.

In addition to its range-extension use, it can be used advantageously at all voltages at frequencies up to about

200 Mc/s. Transit-time effects at these frequencies increase the input conductance of the probe often to the point where the voltmeter may constitute too great a load on the source under measurement. This capacitive voltage divider produces an improvement of about one-hundred fold in this situation.

## SPECIFICATIONS

**Voltage Division Ratio:** 10:1  $\pm$  5%, as received. An adjustment is provided for matching the multiplier to the voltmeter within  $\pm$ 2%.

**Input Impedance:** Equivalent input resistance of the probe-multiplier combination is 100 times

that of the probe alone. Equivalent parallel capacitance is approximately 2 pF.

**Dimensions:** (dia)  $\frac{5}{8}$  by (length)  $1\frac{1}{4}$  in (16, 32 mm).

**Net Weight:**  $\frac{1}{2}$  oz (15 grams).

**Shipping Weight:** 3 oz (85 grams).

<i>Catalog Number</i>	<i>Description</i>	<i>Price in USA</i>
1806-9602	Type 1806-P2 10:1 Range Multiplier	\$20.00

PRINTED  
IN  
U.S.A.



GENERAL RADIO EXPERIMENTER  
GENERAL RADIO COMPANY  
WEST CONCORD • MASSACHUSETTS • USA

RETURN REQUESTED

