

THE GENERAL RADIO EXPERIMENTER



VOLUME 37 No. 8

AUGUST, 1963

A HIGHLY STABLE REFERENCE STANDARD CAPACITOR

The transfer of the high accuracy of measurements at the National Bureau of Standards to other laboratories requires standards of correspondingly high stability. For example, NBS now calibrates capacitance standards of 1000 pf at 1000 cps with an accuracy better than $\pm 0.002\%$ or ± 20 ppm (parts per million). But, whenever a capacitor calibrated at NBS is moved to another laboratory, the uncertainty of the calibration is increased by the possible changes in capacitance when the capacitor is transferred to and measured at the new location. Capacitance changes of the

order of 20 ppm can occur in most capacitors for several reasons.

SOURCES OF INSTABILITY

Mechanical Shock

Perhaps the most obvious source of change is mechanical displacement of the capacitor plates, resulting from vibration or shock in transport or in handling. Most capacitors must be handled with particular care to keep such changes below 20 ppm. Even with no handling at all, a capacitor sitting on a shelf can change in capacitance with time, because any strains left in

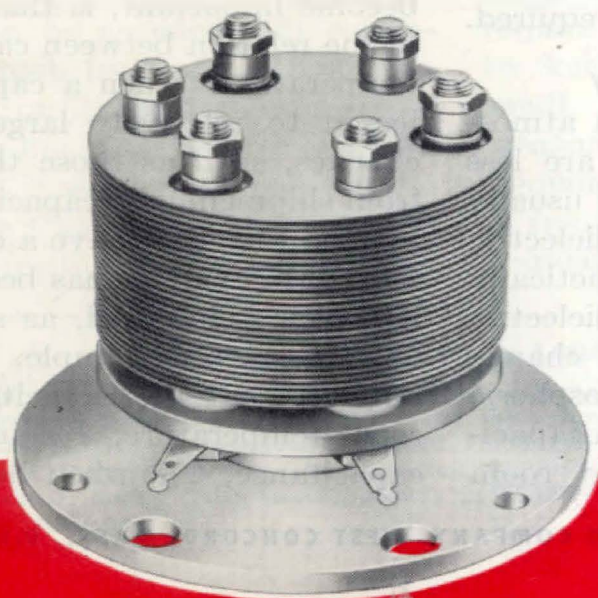

Figure 1. View of the 1000-pf capacitor removed from its cabinet and sealed container, showing the construction of the plate stack.



CONTENTS OF THIS ISSUE

	<i>Page</i>
A Highly Stable Reference Standard Capacitor	1
The New Look in High-Frequency Oscillators	9
The New Power Supplies	13
Flash-Delay Unit Simplifies Motion Analysis in High-Speed Machines	15
Measuring Surface Speeds	19
Montreal Sales-Engineering Office	20

the capacitor materials at the time of construction can change with age and thus change plate area or separation.

Temperature

Capacitance change also results from temperature change, not only because the dimensions are changed by mechanical expansion but also because the permittivity, particularly of solid dielectric materials, varies with temperature. Typical standard capacitors with air dielectric and plates of brass or aluminum have temperature coefficients of capacitance of the order of 16 to 22 ppm/°C, while the coefficient of a mica capacitor is of the order of 40 ppm/°C. Uncertainties of the order of 20 ppm can therefore result from temperature changes of only one degree. In order to apply corrections to reduce these uncertainties, accurate knowledge of both capacitor temperature and temperature coefficient is required.

Atmospheric Pressure and Humidity

Changes of capacitance with atmospheric pressure and humidity are less familiar because the effects are usually negligible. However, in an air-dielectric capacitor that is not hermetically sealed, the density of the air dielectric between capacitor plates will change with temperature and with atmospheric pressure. The resulting change in capacitance is about -2 ppm/°C at room

temperature and +18 ppm per inch of mercury pressure change. Since the atmospheric pressure and density decrease with altitude, if such an unsealed capacitor is moved from Washington near sea level to the mile-high altitude of Boulder, Colorado, the capacitance will decrease by the no-longer-inconsiderable order of 100 ppm. If water vapor is present in the air, the dielectric constant is increased, and the capacitance increase with atmospheric humidity is approximately 2 ppm per percent relative humidity. Water that condenses on capacitor plates or soaks into solid dielectrics causes capacitance changes that are usually larger and less predictable.

Hysteresis

Another deficiency, which appears in most capacitors when parts per million become important, is that of hysteresis in the relation between capacitance and temperature. When a capacitor is subjected to relatively large temperature changes, such as those that can result from shipment, the capacitance at room temperature may have a different value after the capacitor has been hot than it has after being cold, as shown in Figure 2. In this example, the capacitor may start at the capacitance, C_{RH} , at room temperature, T_R , increase to the capacitance, C_H , when heated, and re-

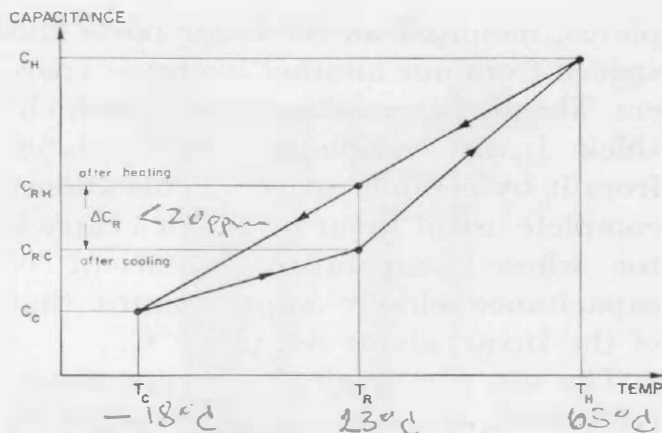

Figure 2. Capacitance vs temperature diagram showing hysteresis.

turn to C_{RH} when cooled to room temperature. This cycle can be retraced as long as the capacitor does not go much below room temperature. However, when the capacitor is cooled to the low temperature, T_C , and returned to room temperature, the capacitance at room temperature has a new value, C_{RC} , lower than the initial C_{RH} . Again, the cold cycle can be retraced from C_{RC} to C_C if the capacitor does not go far above room temperature. When the capacitor at C_{RC} is heated to T_H and then cooled to room temperature, the capacitance may return to the initial value, C_{RH} . Uncertainties of the order of 20 ppm can occur in capacitors that have such hysteresis unless: (1) large temperature variations can be avoided; (2) corrections can be made from a known characteristic curve; or (3) the capacitor can be run through a hot cycle before each calibration to put it at a known point in the cycle, such as C_{RH} . The source of such hysteresis is friction in the mechanical

structure, which restricts the motion resulting from the thermal stresses. In most mechanical structures the hysteresis cycle is not so simple or so retracable as assumed in this example.

Voltage and Frequency

Additional sources of capacitance change are variations in voltage and in frequency. Changes of capacitance no greater than a few ppm can be expected in standard air capacitors with voltages in the usual measurement range below, say, 100 volts. In silvered-mica capacitors, such as the TYPE 1409, changes from 10 to 200 ppm may occur for voltage changes from 1 to 100 volts. Such changes usually result from small isolated sections of the silver film that connect to the main body of film and add capacitance as the applied voltage increases. The magnitude of the change varies widely from capacitor to capacitor, depending upon the quality of the silver film. When foil electrodes are used instead of silvered mica, the changes with voltage decrease to the order of a few ppm.

In both air and mica capacitors the rate of change of capacitance with frequency is generally small enough to require no unusual frequency stability to keep the capacitance uncertainty small. Only when the frequency of measurement approaches the resonance frequency of the capacitor does accuracy of frequency become important, so that standard frequencies are required.

NBS Calibration of Type 1404 Capacitors

A report of calibration of the direct capacitance of these capacitors can be obtained from the National Bureau of Standards. After July 1, 1963, the accuracy of the report is ± 20 ppm. The fee (Item 201.105a in Test Fee Schedule) is \$35.00. For further information please write: Mr. Chester Peterson, Chief, Resistance and Reactance Section, Electricity Division, NBS, Washington 25, D.C.; or Frank D. Weaver, Acting Chief, Low-Frequency Calibration Services, Electronic Calibration Center, NBS, Boulder, Colorado.

Connections

The changes in capacitances produced by the connections to the capacitor can also be a source of error. These connection errors were described in some detail in the *Experimenter* a few years ago.¹ In capacitors with unshielded plug-and-jack connectors, a portion of the calibrated capacitance is associated with the terminals of both the capacitor and the bridge on which it is measured. Small changes in the geometry or in the environment of these terminals may produce capacitance changes as large as 0.1 pf. To eliminate uncertainties of this order, which are important in accurate calibrations of 1000 pf or less, the terminal geometry can, with care, be defined and controlled to the required precision. Or, more easily in most cases, the terminal capacitances and their uncertainties can be eliminated by the use of three-terminal capacitors and three-terminal measurements.

A NEW REFERENCE STANDARD

A new capacitor has been designed to obtain a standard in which capacitance changes remain small compared to 20 ppm without the use of unusual care in handling, in environmental control, or in measurement. This is the new TYPE 1404 Reference Standard Capacitor, a three-terminal, sealed, dry-nitrogen-dielectric capacitor with direct capacitance of 1000 pf or 100 pf. Stability in this capacitor has been obtained not by unusual design but by the use of a simple, solid, homogeneous structure of a single, low-temperature-coefficient material sealed in an invariant atmosphere.

Construction

The capacitor, as shown in Figure 1, is made up of a stack of round Invar

plates, mounted on six Invar posts and spaced from one another by Invar spacers. The posts are mounted on a 1/4-inch-thick Invar baseplate, and insulated from it by ceramic spacers. This almost complete use of Invar results in a capacitor whose temperature coefficient of capacitance closely approximates that of the Invar, about +2 ppm/°C.

The use of a single, low-temperature-coefficient metal makes the coefficient of the capacitor more reproducible and eliminates the differential drift that can occur when the capacitor uses two metals of higher but mutually compensating coefficients.

The capacitor is mounted inside a hermetically sealed heavy brass enclosure. All electrical connections are made through glass-to-metal seals. Before the exhaust tube is sealed, the enclosure is evacuated to remove water vapor and is filled with dry nitrogen at atmospheric pressure. This permanent, positive seal-

1. J. F. Hersh, "A Close Look at Connection Errors in Capacitance Measurements," *General Radio Experimenter*, 33, 7, July, 1959.



Figure 3. Panel view of the Reference Standard Capacitor.

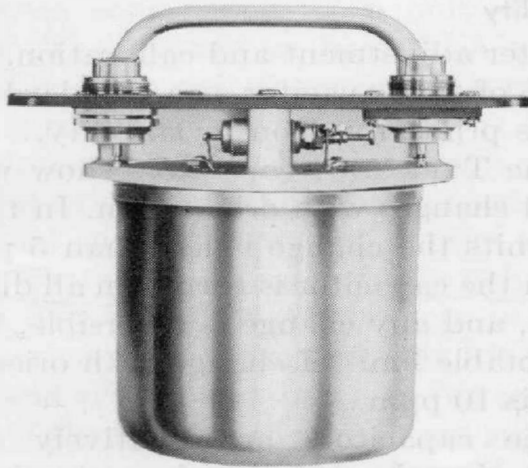

Figure 4. View of capacitor with cabinet removed, showing the sealed container and the three-terminal trimmer.

ing in an invariant atmosphere makes both capacitance and dissipation factor virtually independent of environmental changes in pressure, altitude, or humidity.

The sealed capacitor is mounted on a solid aluminum casting, which is fastened to the front panel of the cabinet, as shown in Figure 4. Webs in the casting provide shielding between the two leads from the capacitor, which are connected to two recessed locking TYPE 874 Coaxial Connectors on the panel. The left or H connector is completely insulated from the panel to eliminate ground-loop troubles when long leads are used and to facilitate the use of the capacitor as a dissipation-factor standard. The panel connectors can be converted to most other common types of coaxial connectors by the use of the appropriate TYPE 874 Adaptor, and the locking version of the adaptor can be used to make the connection semipermanent.

Also mounted in the web is a three-terminal trimmer capacitor used to adjust capacitance over very small ranges. The capacitance of this trimmer is such a small part of the total, about 0.01%, that its effect on over-all stability is negligible.

Stabilization and Test

After assembly and sealing, each capacitor is subjected to a number of hot and cold cycles of temperature to stabilize the structure and to determine the temperature coefficient and the magnitude of the hysteresis. The capacitor is heated to approximately 65 C or 150 F (T_H in Figure 2), then cooled to a room temperature, T_R , of 23 C or 73 F and measured to determine the capacitance C_{RH} after a hot cycle. Similarly, it is cooled to a temperature, T_C , of -18 C or 0 F, then measured at room temperature to determine the capacitance, C_{RC} , after a cold cycle. The hot cycle is then repeated to return the capacitor to the capacitance C_{RH} and to determine the retraceability of the cycle. The limits for acceptability are that the cycle retraces within ± 5 ppm and that the capacitance change at room temperature, ΔC_R , does not exceed 20 ppm for these hot and cold cycles. The capacitance change from hysteresis is typically less than 10 ppm. The change in capacitance at room temperature, $\Delta C_R = C_{RH} - C_{RC}$, is the measure of hysteresis.

The temperature coefficient is determined from measurements of capacitance made during this cycling while the capacitor is at a known temperature above or below room temperature. The coefficient is, typically, constant within ± 1 ppm/ $^{\circ}$ C over the temperature range of these cycles. The acceptable range of temperature coefficient is from +0 to +4 ppm/ $^{\circ}$ C. The typical coefficient is $+2 \pm 0.5$ ppm/ $^{\circ}$ C.

The temperature cycling is also a test for leaks in the hermetic seals. When leaks are present, the cycles do not retrace and the capacitance changes with time.



Adjustment and Calibration

After a capacitor has passed the tests for stability, temperature coefficient, and hysteresis, the capacitance is adjusted by means of the trimmer to make the measured capacitance very close to the nominal value of 1000 or 100 pf. The TYPE 1404 capacitor, unlike most previous standard capacitors, can be adjusted easily with an accuracy almost equal to the precision of measurement, which is better than ± 1 ppm. The measurement is made by comparison on a TYPE 1615-A Capacitance Bridge with one of a group of TYPE 1404 working standards that have been calibrated from a group of similar reference standards periodically measured by the National Bureau of Standards. The accuracy of the NBS calibration of these reference standards is ± 20 ppm.

Each capacitor is adjusted at a room temperature of 23 ± 1 C and a frequency of 1000 ± 10 cps to a capacitance 5 ppm above the nominal value with respect to the General Radio reference standards. The adjustment to a value above nominal (e.g. 1000.005 pf) is made because the standard is a little more convenient for use in bridge calibration when it is slightly greater instead of less than nominal (e.g. 999.995 pf). Although the precision of adjustment exceeds 1 ppm, the uncertainties of room temperature and capacitor temperature coefficient add to the adjustment error, so that the adjustment accuracy at the stated temperature is approximately ± 5 ppm.

The final adjustment of capacitance at room temperature is always made after the capacitor has last been through a hot cycle to 65 C, so that the capacitor is at the position similar to C_{RH} in the cycle of Figure 2.

Stability

After adjustment and calibration, the value of the capacitor as a standard depends primarily upon its stability.

The TYPE 1404 capacitors show very small changes with orientation. In typical units the change is less than 5 ppm when the capacitor is turned in all directions, and any change is reversible. The acceptable limit of change with orientation is 10 ppm.

The capacitors are relatively free from microphonics; therefore, the short-term stability is determined mainly by changes in temperature produced by environmental temperature changes. With the temperature coefficient of +2 ppm/°C, a high degree of stability can be obtained with only moderate temperature control. When higher stability is required, the capacitor can be operated in an air or oil bath with close temperature control, since the effects of connecting cables can be made negligible with three-terminal connections and measurements. When an oil bath is used, the panel with connectors and trimmer can be kept above the oil by the addition of longer spacers and shielded leads between panel and capacitor; only the sealed container of the capacitor is immersed. The modification can be made without change in the calibrated capacitance.

Any reference standard capacitor wears along with that title an implicit "Handle with Care" sign. Careful handling of the TYPE 1404 capacitors is always a wise precaution, but it is not always a necessity because the structure is not delicate. Sample capacitors have been put through impact shock tests of from 30 to 50 g with 11-millisecond durations, and the resulting capacitance changes have not exceeded 50 ppm and



have, in some cases, been only a few ppm. The capacitors have also withstood equally well those immeasurable, and apparently unavoidable, shock tests which occur in normal shipment.

Protection from both mechanical and thermal shock is provided by the shipping container of expandable polystyrene. The capacitor can be kept in this attractive plastic case, not only for storage and reshipment but also for reduction of thermal transients during laboratory measurements. The thermal time constant for changes in ambient temperature is increased from about 1 hour to 2.5 hours when the metal cabinet is covered by the plastic case and cables are connected through holes in the case.

The long-term stability (the capacitance change with time) of a well-coded capacitor is as important as it is particularly difficult to measure when the changes may be no more than a few ppm. Many months or years and many capacitors of the highest stability are required for stability measurement, and neither has been available in adequate quantity for this new capacitor. Present estimates of long-term drift must be based upon the intercomparison of a few capacitors for the period of a year or less and upon a few calibrations by NBS, but the available data indicate a drift rate well within 20 ppm per year. Data of more significance are now being accumulated by NBS and by the many standards laboratories which are already using the TYPE 1404 capacitors and sending them periodically to NBS for calibration.

High-Frequency Performance

Although intended primarily for low-frequency applications, the TYPE 1404 capacitors can be used at higher frequencies if certain considerations are

Figure 5. Equivalent circuit of Type 1404 Capacitors.
 $C_D = 1000$ pf for Type 1404-A
 $C_D = 100$ pf for Type 1404-B

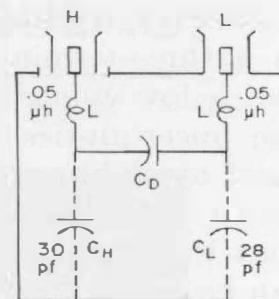

kept in mind. The direct or three-terminal capacitance at the terminals of the capacitor increases with frequency, primarily as the result of the resonance (in the equivalent circuit of Figure 5) between the series internal lead inductances, L , and the capacitance, C_D , shunted by the ground capacitances, C_H and C_L , in series. The effective capacitance is $C \cong C_o(1 + f^2/f_o^2)$, where C_o is the low-frequency capacitance and f_o is the resonance frequency. The resonance frequencies are approximately 16 Mc for the 1000-pf TYPE 1404-A and 47 Mc for the 100-pf TYPE 1404-B, and the corresponding measuring frequencies, f , for a capacitance increase of 50 ppm are 113 kc and 332 kc.

When leads are connected to the capacitor, however, the series inductance and shunt capacitance of the leads will cause a capacitance increase similar to and probably larger than that produced by the internal residuals. Correction can be made for the effects of internal and external residual impedances, but high accuracy is difficult to obtain with increasing frequency. Capacitors that can be connected to the bridge terminals without leads are recommended as standards for frequencies above, say, 10 kc.

Dissipation Factor and D Standard

The losses in the TYPE 1404 capacitors are extremely low because the only effective dielectric in the calibrated direct capacitance is dry nitrogen. All the ceramic insulation affects only the ca-



capacitances to ground, which are excluded in a three-terminal measurement. The loss is low enough to be comparable to the uncertainties in the calibration of most available standards of dissipation factor. The best estimate at present is that the dissipation factor at 1000 cps can be maintained below 10 ppm and is typically less than that.

Because the dissipation factor is very low and constant in this sealed capacitor, the capacitor can also be used as a standard of dissipation factor, for example, in bridge calibration. The desired magnitude of *D* can be obtained by the addition of loss in the form of a calibrated fixed or decade resistor in series or in parallel with the capacitor.*

Uses

The primary use of TYPE 1404 capacitors is as reference or working capaci-

* Detailed procedure for this use of the TYPE 1404 capacitors may be found in the Operating Instructions for the TYPE 1615-A Capacitance Bridge.

tance standards of the highest order for the calibration of other capacitors and bridges. The high stability should permit the accuracy of NBS calibrations to be transferred to other laboratories with uncertainties less than ± 20 ppm.

For many calibrations, such as that of the TYPE 1615-A Capacitance Bridge, either the 1000-pf TYPE 1404-A or the 100-pf TYPE 1404-B capacitor can be used with equal accuracy. There is no significant difference in quality between the two models, but the difference in capacitance is useful for some special purposes, such as the extension of the precision of the TYPE 1615-A bridge.

— JOHN F. HERSH

CREDITS

The design and development of the TYPE 1404 Reference Standard Capacitor was carried out by Dr. Hersh, with mechanical design support from G. A. Clemow, Design Engineer.

— EDITOR

SPECIFICATIONS

Calibration: A certificate of calibration is supplied with each capacitor giving the measured direct parallel capacitance at 1 kc and at 23 ± 1 C. The measured value is obtained by a comparison to a precision better than ± 1 ppm with working standards whose absolute values are known to an accuracy of ± 20 ppm, determined and maintained in terms of reference standards periodically measured by the National Bureau of Standards.

Adjustment Accuracy: The capacitance is adjusted before calibration with an accuracy of ± 5 ppm to a capacitance about 5 ppm above the nominal value relative to the capacitance unit maintained by the General Radio reference standards.

Stability: Long-term drift is less than 20 parts per million per year. Maximum change with orientation is 10 ppm, and is completely reversible.

Temperature Coefficient of Capacitance: 2 ± 2 ppm/ $^{\circ}$ C from -20 C to $+65$ C. A measured value with an accuracy of ± 1 ppm/ $^{\circ}$ C is given on the certificate.

Temperature Cycling: For temperature cycling over range from -20 C to $+65$ C, hysteresis (retraceable) is less than 20 ppm at 23 C.

Dissipation Factor: Less than 10^{-5} at 1 kc.

Residual Impedances: See equivalent circuit (Figure 5) for typical values of internal series inductances and terminal capacitances.

Maximum Voltage: 750 volts.

Terminals: Two coaxial, locking TYPE 874; easily convertible to other types of connectors by attachment of locking adaptors. Outer shell of one connector is ungrounded to permit capacitor to be used with external resistor as a dissipation-factor standard.

Accessories Supplied: Two TYPE 874-C58A Cable Connectors.

Cabinet: Sealed inner container mounted in outer lab-bench aluminum case. Easily adaptable to oil immersion of inner sealed container.

Dimensions: Width $6\frac{3}{4}$, height $6\frac{5}{8}$, depth 8 inches (175 by 170 by 205 mm), over-all, including handle.

Net Weight: $8\frac{1}{2}$ pounds (3.9 kg).

Shipping Weight: 12 pounds (5.5 kg).

Type		Code Number	Price
1404-A	Reference Standard Capacitor	1404-9701	\$225.00
1404-B	Reference Standard Capacitor	1404-9702	225.00

U. S. Patent No. 2,548,457.



THE NEW LOOK IN HIGH-FREQUENCY OSCILLATORS

The General Radio high-frequency oscillators have found widespread use as simple signal sources. They cover a very wide frequency range, and, with accessory equipment, which includes modulators, mechanical sweeps, attenuators, coaxial fittings, and a variety of power supplies, they can be assembled into more sophisticated systems to meet specific needs. Some of these possibilities are indicated in Figure 2.

To enhance further the adaptability and convenience of these oscillators, a redesign of panel arrangements has been carried out. The "new look" provides a simple uniform package which is readily attached to any one of an expanded line of companion power supplies or mounted in a standard relay rack. While the economical L-bracket construction that has become a virtual trademark of these

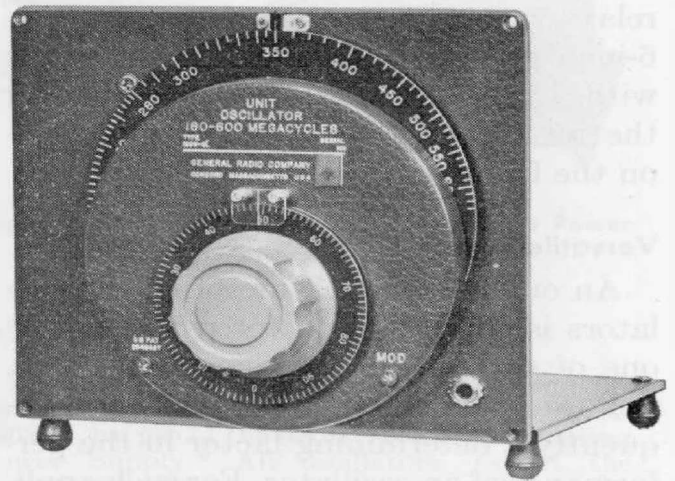

Figure 1. Panel view of the Type 1209-CL Unit Oscillator.

oscillators has been retained, the panels are now 7" high and 8" wide, the same size as the previously announced TYPE 1361-A UHF Oscillator (450 to 1050 Mc)¹ and the TYPE 1211-C Unit Oscillator (0.5 to 50 Mc)². Figure 1 shows the TYPE 1209-CL Unit Oscillator. The new models with their frequency ranges are tabulated on page 12.

¹ G. P. McCouch, "A New UHF Signal Source," *General Radio Experimenter*, 35, 3, March, 1961.

² E. Karplus, "The TYPE 1211-C, An Improved Unit Oscillator," *General Radio Experimenter* 36, 10, October, 1962.

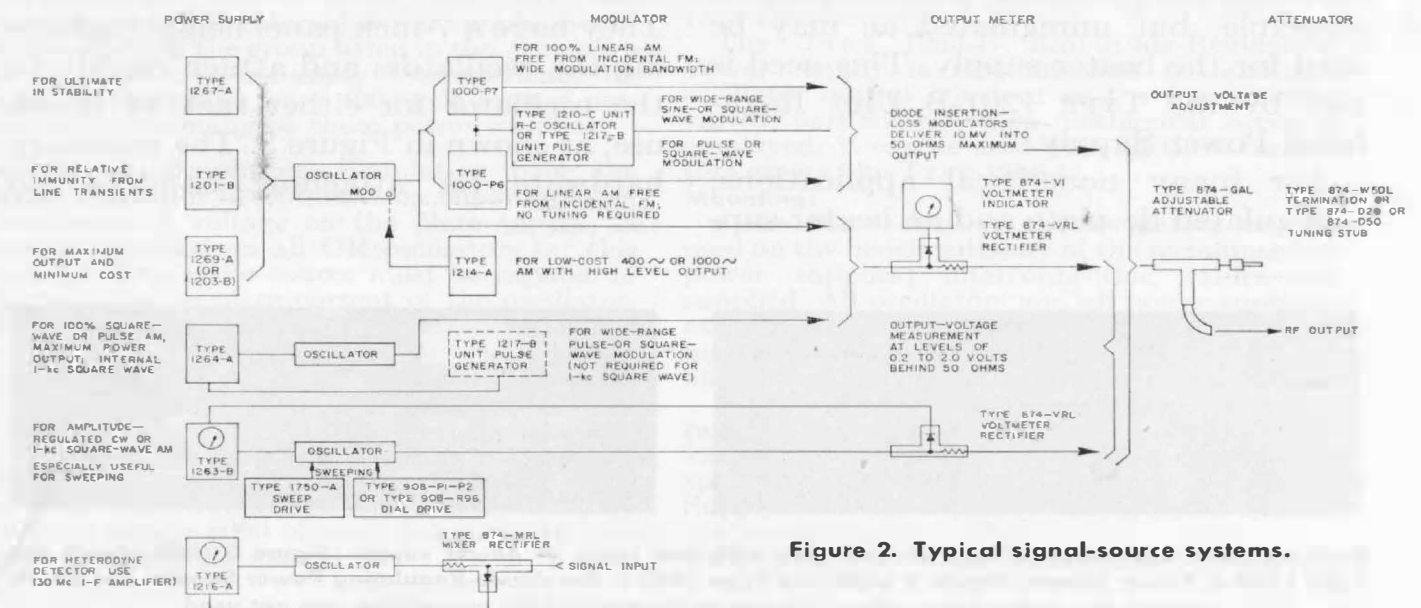

Figure 2. Typical signal-source systems.

Tapped holes near the four corners of the front panel permit rigid attachment to an associated power supply or, by means of low-cost adaptor plates, to a relay rack. The oscillators all have 6-inch precision dials and are equipped with TYPE 874 Locking Connectors for the RF output. The modulation jack is on the front panel.

Versatile Power Supplies

An outstanding feature of these oscillators is the provision for use with any one of several different power supplies.

Power-supply characteristics are frequently a determining factor in the performance of an oscillator. For such applications as parametric-amplifier pumps, oscillators must be stable against all power-line variations and free of modulation from power-supply ripple. For these extreme requirements, both plate and heater supplies should be regulated, well filtered dc, as in the TYPE 1267-A Regulated Power Supply.

Where relative freedom from line transients is required without ultimate reduction in long-term drifts and hum modulation, regulated plate supply is desirable, but unregulated ac may be used for the heater supply. This need is met by the TYPE 1201-B Unit Regulated Power Supply.

For many noncritical applications, unregulated dc plate and ac heater sup-

plies are entirely adequate and represent considerable economy. The TYPE 1269-A Power Supply is of this type.

Typical power-output curves for the several oscillators, when operated from these power supplies, are shown in the specifications.

Other applications require power supplies in which the plate-supply voltage is controllable to modulate or to regulate the oscillator output. The TYPE 1264-A Modulating Power Supply provides 100% amplitude modulation at high level by square waves or pulses as well as cw operation. The TYPE 1263-B Amplitude-Regulating Power Supply includes a feedback loop to maintain constant oscillator output as the oscillator frequency is varied. Constant output not only speeds and simplifies measurements where the oscillator is tuned manually, but is essential when making sweep measurements. The TYPE 1263-B Amplitude-Regulating Power Supply has an internal 1-kc oscillator for square-wave modulation.

The TYPES 1267-A and 1269-A power supplies† are new items, designed specifically for use with these oscillators. They have a 7-inch panel height, matching the oscillators and attach readily to the oscillator for either rack or bench use, as shown in Figure 3. The necessary hardware for attaching oscillator to

† See page 13.

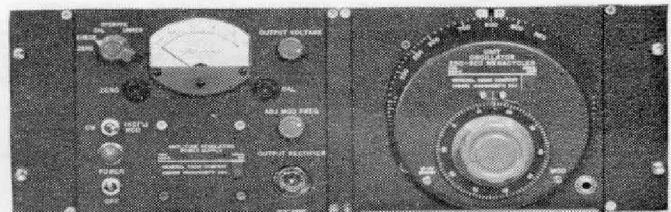
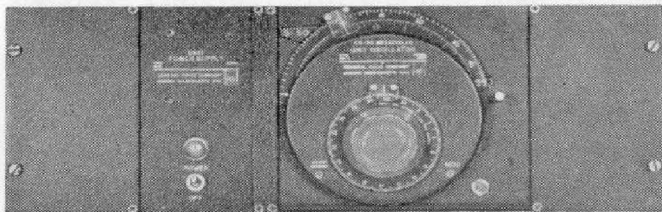

Rack-mount arrangements of a Unit Oscillator with two types of power supply. Figure 3 (left) shows the Type 1269-A Power Supply; Figure 4 (right) the Type 1263-B Amplitude-Regulating Power Supply. For bench mount, the rack-adaptor plates, shown at the ends of the assemblies, are not used.



power supply is furnished with the power supply. Rack adaptor panels are listed on page 13.

Figure 4 shows how the TYPES 1263-B and 1264-A power supplies attach to the oscillator for rack mount. The older Unit power supplies, TYPES 1203-B and 1201-B, are still available and connect to the oscillator through a plug-in cable, as shown in Figure 5.

— G. P. McCouch

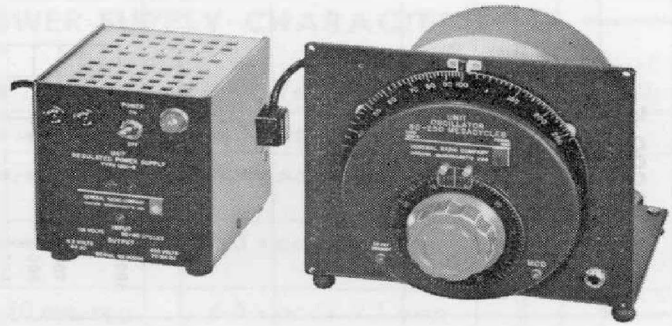

Figure 5. Oscillator with older type of Unit Power Supply, Type 1201-B.

SPECIFICATIONS

Frequency Control: TYPE 908 Gear-Drive Precision Dials are used on all models. Vernier drive ratio is 15:1.

Output Power: Output power is shown in tabulated specifications. With the TYPE 1263-B Amplitude-Regulating Power Supply, the maximum useful power output is 20 milliwatts. The available power is adequate for practically all laboratory measurements with bridges, slotted lines, admittance and transfer-function meters, tuned circuits, etc.

Output System: A short coaxial line brings the output from an adjustable coupling loop to a locking TYPE 874 Coaxial Connector. The output connector is located at the rear of the oscillator. Maximum power can be delivered to load impedances normally encountered in coaxial systems. Adaptors are available to convert the TYPE 874 Connector to any other common type. These adaptors lock securely in place, yet are easily removed.

Power Supply: The external power supply should be chosen from the group listed in the *Summary of Oscillator Power-Supply Characteristics* on page 13. Operation from 400-cycle lines is permissible with many of these power supplies.

Modulation: Amplitude modulation over the audio range can be obtained by superimposing a modulating voltage on the plate supply. A jack is provided on all GR oscillators for this purpose. The audio source must be capable of carrying the dc plate current of the oscillator. The inexpensive TYPE 1214 fixed-frequency oscillators are recommended as modulators, and are usually used in conjunction with the TYPE 1269-A, 1201-B, or 1267-A power supplies. For 30% a-m, incidental fm in this system is of the order of 0.01% at the lower part of the tuning range, and increases to about 0.05% at the high-frequency end. Approximately 40 volts across 8000 ohms is adequate to produce 30% modulation.

Square-wave or pulse modulation can be obtained on all oscillators, except the TYPE 1208-C, by use of the TYPE 1264-A Modulating Power Supply.* All oscillators, except the TYPE 1208-C, can be square-wave modulated at 1 kc by the TYPE 1263-B Amplitude-Regulating Power Supply.*

For video modulation up to 30% with 5-Mc bandwidth, the TYPE 1000-P6 Crystal-Diode Modulator* can be used at carrier frequencies from 20 to 1000 Mc. No tuning adjustments are required. This low-level absorption modulator introduces negligible incidental fm, but the output capability is limited to approximately 10 millivolts, peak, into 50 ohms.

Sweep Application: Mechanical sweep at speeds suitable for oscilloscopic display can be obtained by use of the TYPE 1750-A Sweep Drive.* The TYPE 1208-C is not recommended for this service because of the sliding contacts in its tuned circuit.

Slower mechanical sweep for use with xy recorders is possible with the TYPE 908-R96 Dial Drive.*

The TYPE 1263-B Amplitude-Regulating Power Supply is recommended to hold the oscillator output constant as the frequency is varied, particularly when mechanical sweep is employed. It can be used with all these oscillators except the TYPE 1208-C.

Mounting:

Bench Use — Any of the oscillators can be used on the bench with any of the recommended power supplies; interconnecting cables are supplied. All oscillators and all power supplies, except the TYPES 1201-B and 1203-B, are 7" high and can be attached to each other with the hardware supplied to form a rigid assembly.

Relay-Rack Use — Any oscillator can be relay-rack mounted together with a TYPE 1263-B, 1264-A, 1267-A, or 1269-A power supply in a space 7" high. When the TYPE 1201-B Power Supply is used, separate rack-adaptor panels are necessary.

* Consult the latest General Radio catalog for details.

(Continued on page 12)

SPECIFICATIONS (Continued)



Type Number	1215-C	1208-C	1209-CL	1209-C
Frequency	50 to 250 Mc	65 to 500 Mc	180 to 600 Mc	250 to 960 Mc
Tuned Circuit	Semi-Butterfly	Variable L and C	Butterfly	Butterfly
Calibration Accuracy	$\pm 1\%$	$\pm 2\%$	$\pm 1\%$	$\pm 1\%$
Warmup Frequency Drift (typical)	0.4%	0.5%	0.2%	0.2%
Output into 50 ohms with Type 1269-A or 1203-B supply	120 mw from 50 - 215 Mc 70 mw from 215 - 250 Mc	240 mw from 65 - 250 Mc 80 mw from 250 - 500 Mc	320 mw from 180 - 500 Mc 240 mw from 500 - 600 Mc	150 mw
Output into 50 ohms with Type 1267-A, 1201-B, or 1264-A supply	90 mw from 50 - 215 Mc 50 mw from 215 - 250 Mc	170 mw from 65 - 250 Mc 60 mw from 250 - 500 Mc	270 mw from 180 - 500 Mc 200 mw from 500 - 600 Mc	120 mw
<p>Typical and Guaranteed Output Power into 50 ohms</p> <p>Upper curves are typical Lower curves are guaranteed</p> <p>— with Type 1269-A (or 1203-B) Supply</p> <p>- - - with Type 1267-A, 1201-B, or 1264-A* Supply</p> <p>*Not for use with Type 1208-C.</p>				
Panel Dimensions	8 × 7 in. (180 × 205 mm)	8 × 7 in. (180 × 205 mm)	8 × 7 in. (180 × 205 mm)	8 × 7 in. (180 × 205 mm)
Depth Behind Panel	7½ in. (190 mm)	7⅝ in. (190 mm)	7⅝ in. (190 mm)	7⅝ in. (190 mm)
Net Weight	7¼ pounds (3.3 kg)	6 pounds (2.8 kg)	6 pounds (2.8 kg)	6 pounds (2.8 kg)
Shipping Weight	15 pounds (7 kg)	12 pounds (5.5 kg)	13 pounds (6 kg)	13 pounds (6 kg)
Code Number	1215-9703	1208-9703	1209-9933	1209-9703
Price	\$210.00	\$250.00	\$285.00	\$285.00



SUMMARY OF OSCILLATOR POWER-SUPPLY CHARACTERISTICS

Type	Applications	DC Plate Supply	Heater Supply	Panel Width
1267-A ¹	Ultimate stability for cw	300 v @ 70 ma, regulated	6.3 v dc @ 1 amp, reg	4"
1201-B ¹	Relative freedom from line transients	300 v @ 70 ma, regulated	6.3 v ac @ 4 amp	*
1269-A ¹ 1203-B ¹	Maximum output and minimum cost	380 v open circuit; 300 v @ 50 ma	6.3 v ac @ 3 amp	4" *
1264-A ^{1,2,3}	100% square wave and pulse a-m	200-300 v @ 50 ma, reg.	6.3 v ac @ 2.1 amp	8"
1263-B ²	Amplitude-regulated cw or 1-kc square-wave output	0-300 v @ 30 ma	6.3 v dc @ 0.5 amp	8"
1216-A ¹	Hetrodyne detector	300 v @ 30 ma	6.3 v ac @ 1 amp	*

¹Unit Instrument Cabinet.

²May be operated from 400-cycle supply.

³Not for use with TYPE 1208-C Unit Oscillator.

⁴Requires adaptor cable when used with TYPES 1215-C, 1209-CL, and 1209-C Unit Oscillators (see latest General Radio catalog).

Accessories for Relay-Rack Mount

The panel extensions listed below can be readily attached to any of the 7"-high oscillators, power supplies, or oscillator-power supply assemblies to permit mounting in a standard 19" relay rack.

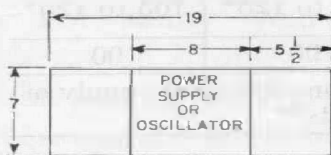

Adaptor Plate Set Type 480-P408 used to rock-mount a single 8"-wide power supply (Type 1263-B or 1264-A) or oscillator.

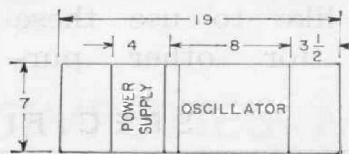

Adaptor Plate Set Type 480-P412 used to rack-mount an assembly of a 4"-wide power supply (Type 1267-A or 1269-A) and oscillator.

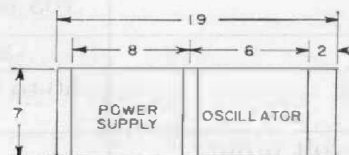

Adaptor Plate Set Type 480-P416 used to rack-mount an assembly of an 8"-wide power supply (Type 1263-B or 1264-A) and oscillator.

Type		Code Number	Price
480-P408	Adaptor Plate Set, for one 8"-wide instrument (7" high).	0480-9648	\$ 8.00
480-P412	Adaptor Plate Set, for assembly of one 8"- and one 4"-wide instrument (7" high).	0480-9642	7.00
480-P416	Adaptor Plate Set, for assembly of two 8"-wide instruments (7" high).	0480-9646	6.00
480-P4U1	Relay-Rack Adaptor Panel, for Type 1201-B or Type 1203-B Power Supply only (7" high).	0480-9984	11.00

THE NEW POWER SUPPLIES

To obtain the ultimate performance from our line of Unit Oscillators, the TYPE 1267-A Regulated Power Supply provides both regulated plate and heater voltages. Regulation is such that effects of line voltage on the oscillator performance are essentially eliminated. As a result, the residual fm of the oscillators

is approximately the same as that obtained with battery operation.

A vacuum-tube series regulator is used for the 300-volt, 70-ma, dc output and a transistor regulator for the 6.3-volt, 1-a, dc output. The vacuum-tube regulator shown in Figure 2 uses a differential-input amplifier to compare the

output voltage against a voltage-reference tube, a cascode amplifier for gain, a cathode follower for maximum bandwidth, and a series power tube for control. This combination results in an 80-db reduction of ripple voltage and a low output impedance over a wide frequency range.

The regulator circuit for the 6.3-volt dc output utilizes three high-gain transistor stages to provide a similar 80-db reduction of ripple voltage and input transients. Current limiting at one ampere and reduction of the small temperature effects of the transistor and Zener reference diode are added bonuses for those who would like to use these versatile supplies for other pur-



Figure 1. View of (left) Type 1267-A Regulated Power Supply and (right) Type 1269-A Power Supply.

poses than operating Unit Oscillators.

The TYPE 1269-A Power Supply is a simple unregulated supply adequate for many uses of the Unit Oscillators. It is similar in electrical characteristics to the TYPE 1203-B Unit Power Supply.

— M. C. HOLTJE

SPECIFICATIONS

Type	1203-B	1269-A	1201-B	1267-A
Input				
Volts	105 to 125*	105 to 125 or 210 to 250	105 to 125*	105 to 125*
Watts Full Load	50	50	90	90
Line Frequency (cps)	50 to 60; can also be operated from 400-cycle supply of 110 to 125 volts**			
Output (At 115- or 230-volt input)				
DC volts	300 @ 50 ma		300	
ma (max)	50		70	
regulation	No load voltage about 400		±0.25% (combined line & load)	
ripple, rms, at full load (120 cps)	80 mv		1 mv	
DC volts	—		—	
amp (max)	—		—	
regulation			±0.25% (combined line & load)	
ripple, rms, at full load (120 cps)			1 mv	
AC volts	6.3		6.3	
amp (max)	3		4	
Accessories Supplied	Mating plug for output connector, 3-wire line cord.			
Dimensions				
inches	5x5 3/4x6 1/4	4 1/4x7 5/8x9 1/4	5x5 3/4x6 1/4	4 1/4x7 5/8x9 1/4
mm	130x150x160	110x195x235	130x150x160	110x195x235
Net Weight				
pounds	5	5 3/4	6	7 3/4
kg	2.3	2.7	2.8	3.6
Shipping Weight				
pounds	6	7	7	9
kg	2.8	3.2	3.2	4.1

* Add Q18 to type number for 210 to 250 volts (see price table).

** Will operate any vhf or uhf unit oscillator from 400-cycle supply of 105-125 volts.



Figure 2. Elementary schematic of the Regulated Power Supply.

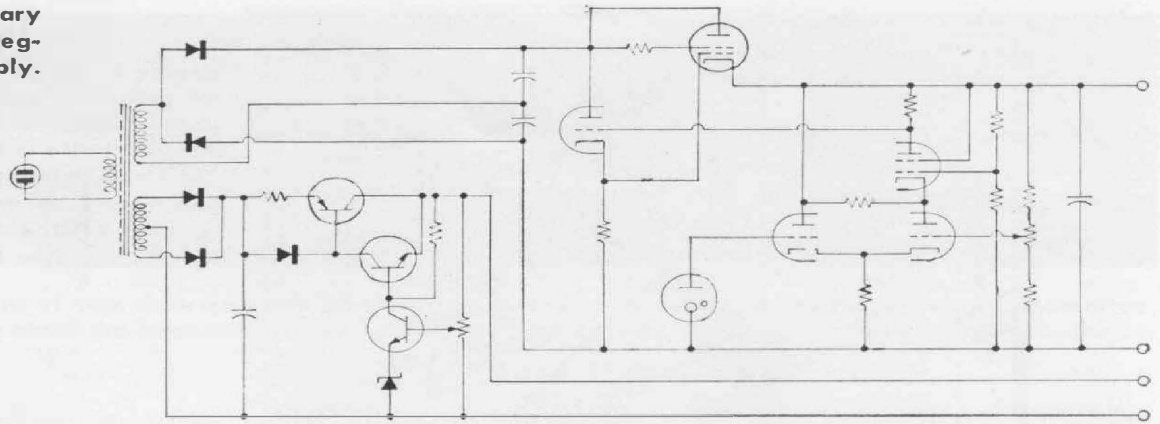

Type		Code Number	Price
1203-B	Unit Power Supply, 105 to 125 volts	1203-9702	\$ 55.00
1203-BQ18	Unit Power Supply, 210 to 250 volts	1203-9818	60.00
1201-B	Unit Regulated Power Supply, 105 to 125 volts	1201-9702	95.00
1201-BQ18	Unit Regulated Power Supply, 210 to 250 volts	1201-9818	105.00
1269-A	Power Supply	1269-9701	70.00
1267-A	Regulated Power Supply, 105 to 125 volts	1267-9701	170.00
1267-AQ18	Regulated Power Supply, 210 to 250 volts	1267-9911	180.00

FLASH-DELAY UNIT SIMPLIFIES MOTION ANALYSIS IN HIGH-SPEED MACHINES

For many years the STROBOTAC[®] electronic stroboscope has been a valuable tool in the development and maintenance of all kinds of rotating and recip-

rocating equipment. Two accessories greatly expand the usefulness of this stroboscope in the study of high-speed motion, the new TYPE 1531-P2 Flash Delay and the TYPE 1536-A Photoelectric Pickoff.¹

¹"Using a Photo-cell Where it Counts," *General Radio Experimenter*, 36, 10, October, 1962.

Figure 1. The Flash Delay and Photoelectric Pickoff in combination with the Strobotac[®] electronic stroboscope. The Flash Delay attaches conveniently to the Strobotac.

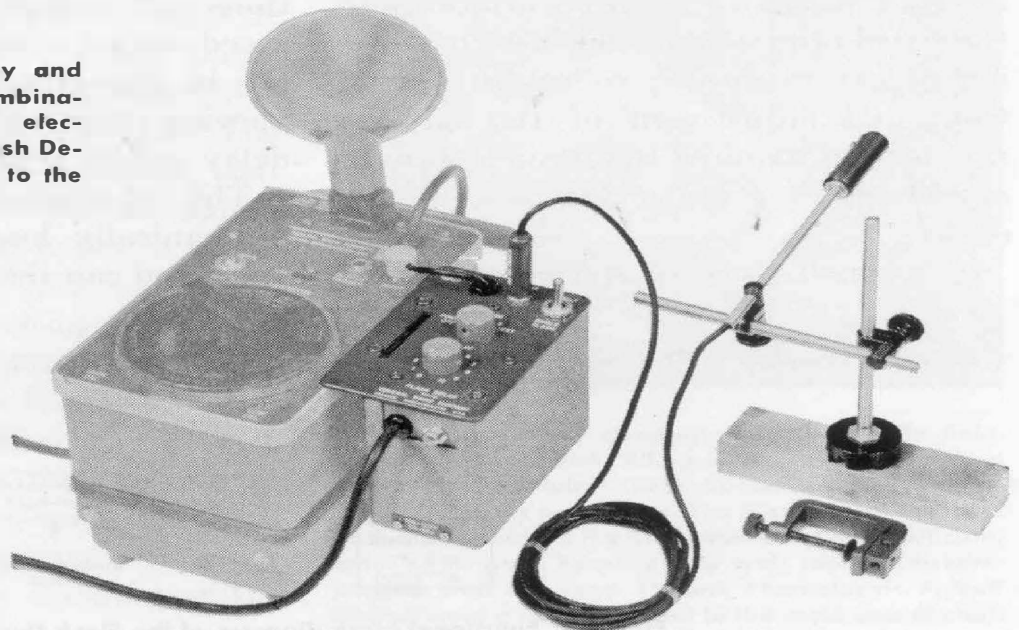

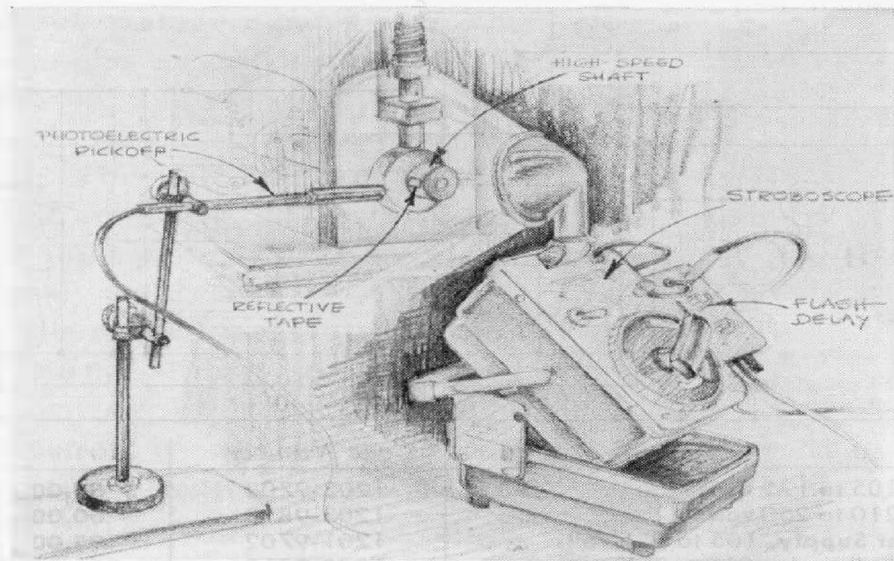

Figure 2. Sketch showing the use of reflective tape to produce a pulse signal in the Photoelectric Pickoff. Pulse is then delayed by the Flash Delay to fire the Strobotac at any desired point in the rotational cycle.

The combination of pickoff and flash delay provides a convenient means of synchronizing the STROBOTAC flash to rotating equipment, even when the speed of the equipment is irregular. The flash can be delayed with respect to the pickoff signal so that the moving object can be made to appear completely stationary at any point in its rotation cycle.

When a moving object is observed under stroboscopic light with the flashing rate determined by the stroboscope's internal oscillator, slight variations in the speed of rotation will cause the moving object to appear to rotate slowly. Continual adjustment of the flashing rate is then required to obtain a stationary image at a particular point in the cycle.

If a small piece of reflective tape is

placed on the rotating object, as shown in Figure 2, it is possible to obtain from the photoelectric pickoff a signal which is synchronous with the rotation, regardless of speed. By means of the flash delay, an adjustable time delay can be introduced between the pickoff and the stroboscope, so that the stroboscope can be made to flash at any desired position of the rotating object. By continually varying the time delay, the user can observe the object at all positions during a cycle of rotation. Small speed variations will not affect the image. If the speed varies widely, the reflective tape can be placed just ahead of the desired viewing point so that only a small time delay will be required.

The photoelectric pickoff does not mechanically load the rotating equipment and can therefore be used on very-

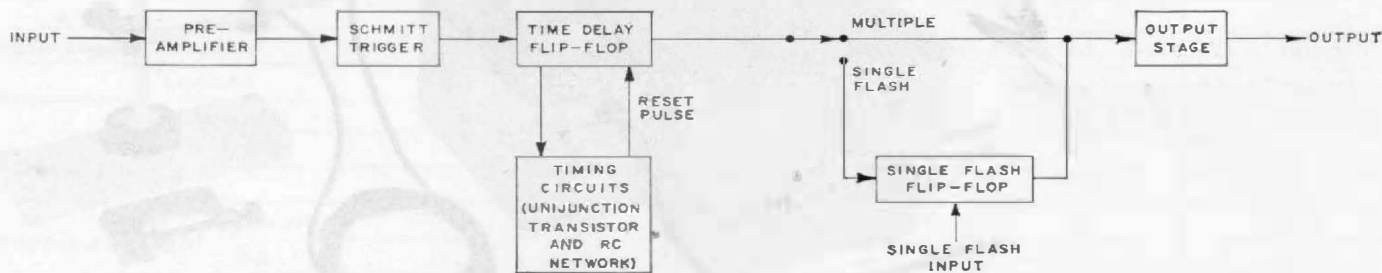

Figure 3. Functional block diagram of the Flash Delay.

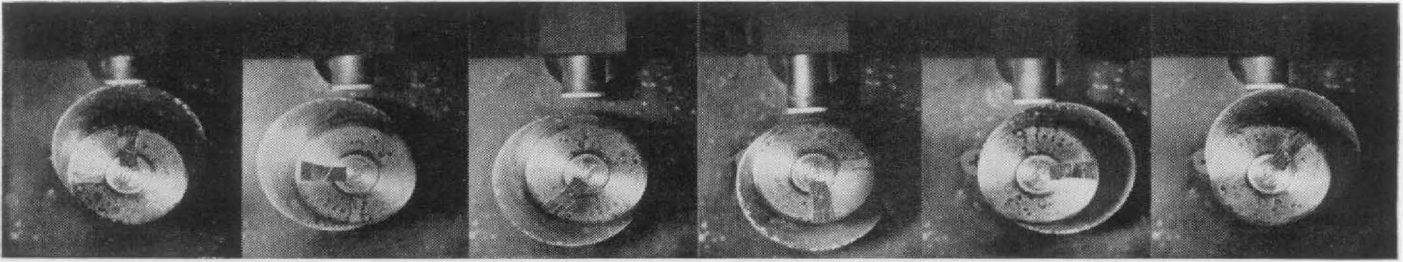

Figure 4. The action of cam followers can be easily examined with the Strobotac-Flash Delay combination. These photographs show the bounce of a cam follower at high speeds. The cam is rotating counterclockwise.

low-power devices such as relays, mechanical choppers, etc. The pickoff, with a time constant of approximately 200 μ sec, can be used with equipment rotating at speeds in the hundreds of thousands of rpm.

The TYPE 1531-P2 Flash Delay makes possible single-flash photographs of rotating equipment at any desired position in its cycle. The single flash of the STROBOTAC is synchronized both with the time the camera shutter is open and with the desired position of the rotating object.

Description

The TYPE 1531-P2 Flash Delay was designed primarily for use with the TYPE 1536-A Photoelectric Pickoff.¹ It can be triggered, however, by any transducer that will generate a positive electrical pulse of at least 0.3 volt. The block diagram of Figure 3 shows that the flash delay consists of a preamplifier, a Schmitt-circuit pulse shaper, a time-delay generator (consisting of a flip-flop, a unijunction transistor and RC network), and an output stage. Each trigger pulse from the Schmitt circuit starts a delay cycle. When the voltage across a capacitor in the RC circuit reaches approximately 9 volts (one-half the 18-volt charging voltage), the unijunction transistor fires, discharging the

capacitor, resetting the delay flip-flop, and sending a pulse to the output amplifier.

There are three delay ranges available. Range 1 allows an adjustment over 360 degrees for rotational speeds of 6000

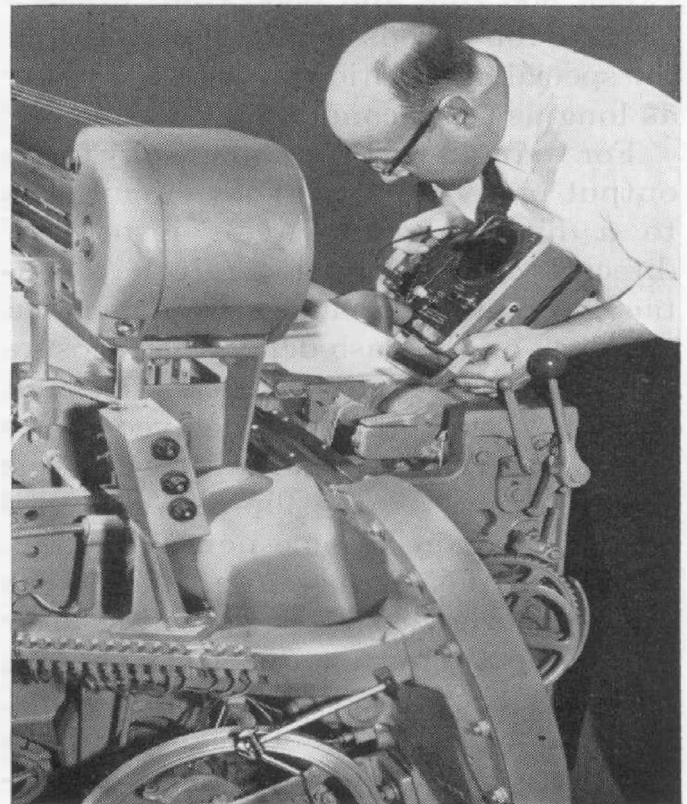

Figure 5. A typical application in the textile field: observing tape and filling-carrier behavior of a Draper DSL shuttleless loom. Speed of the filling carrier is 274 picks per minute. The Flash Delay makes it possible to observe the filling-carrier at any particular point on its path. Synchronism with loom is accomplished with the Type 1536-A Photoelectric Pickoff located near a rim connected to the main power shaft and shown at the bottom of the photograph.

¹ *Loc. cit.*

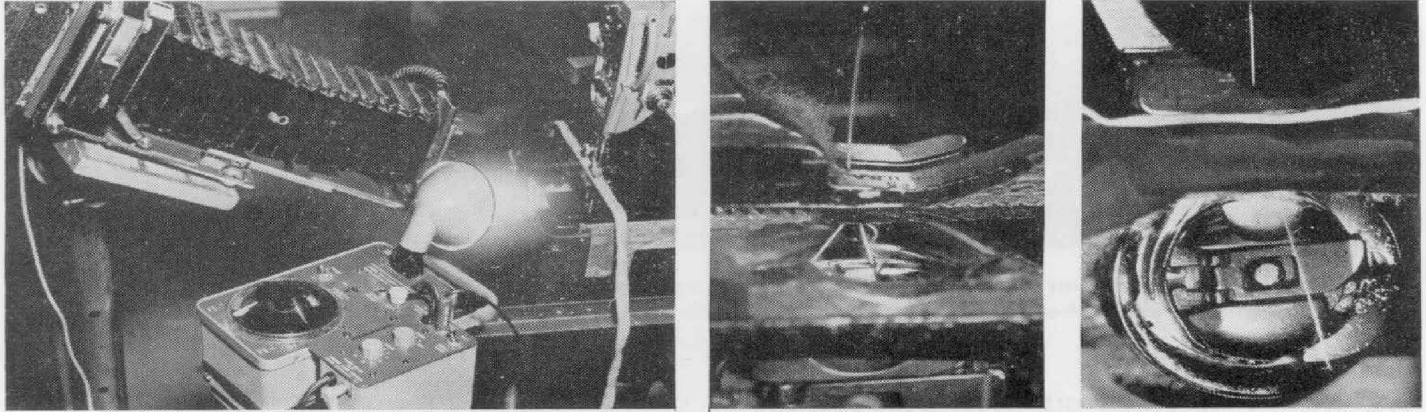

Figure 6. Study of thread behavior in high-speed sewing machine. Machine speed was 5000 stitches per minute; hook speed was 10,000 rpm. Photograph at left shows setup using Linhoff 4 x 5 with Polaroid film, Strobotac with attached Flash Delay, and sewing machine (the base of which is cut away to expose the parts underneath). Center and right photographs show the bobbin and hook action on thread at a specific phase selected by means of the Flash Delay. Photographs courtesy of The Singer Company.

rpm or higher; range 2 provides the 360-degree adjustment for speeds between 600 rpm and 6000 rpm; range 3 is used for speeds below 600 rpm and for special applications in which a delay as long as 0.8 second is required.

For single-flash photography, the output pulse from the delay circuit goes to a flip-flop gate circuit instead of directly to the output stage. If the x contacts of a camera shutter are connected to a jack on the flash delay, their closure will make the gate circuit conduct, and the next synchronized, delayed pulse will pass to the output stage. After this one pulse passes, the flip-flop gate will reset and again become nonconducting. The flash delay, therefore, allows the first synchronized pulse occurring after the camera shutter opens (x-contact closure) to trigger the stroboscope. Synchronism is thus obtained with both the shutter opening and the desired position of the rotating object. It is necessary to set the shutter speed so that the

shutter will be open for one complete rotation cycle.

The flash delay is housed in an aluminum case with bracket which clips directly to the STROBOTAC electronic stroboscope to make a convenient, compact assembly, as shown in Figure 1.

Applications

The TYPE 1531-A STROBOTAC[®] electronic stroboscope with the TYPE 1531-P2 Flash Delay and the TYPE 1536-A Photoelectric Pickoff has wide applications in the development, test, and maintenance of all kinds of moving machinery. The textile, automotive, machine-tool, and business-machine industries are only a few of the many that will find this combination an invaluable tool. The ability to obtain single-flash photographs at any desired position of a mechanism further enhances the value of these instruments. Figures 4 through 6 show a few of the applications of this versatile stroboscope assembly.

— M. J. FITZMORRIS

SPECIFICATIONS

Time-Delay Range: Approximately 100 microseconds to 0.8 second in three ranges.

Output Pulse: Better than 13 volts available for triggering the TYPE 1531-A Strobotac[®] electronic stroboscope.

Sensitivity: As little as 0.3-volt input will produce sufficient output to trigger the stroboscope.

Inputs: Phone jack for triggering; jack for camera synchronization.

Power Requirements: 105 to 125 (or 210 to 250)



SPECIFICATIONS (Cont)

volts, 50 to 60 cps. 5 watts with TYPE 1536-A connected.

Accessories Supplied: Trigger cable, phone-plug adaptor, and leather carrying case.

Accessories Available: TYPE 1536-A Photoelectric Pickoff.

Mounting: Aluminum case with bracket which clips directly onto the STROBOTAC electronic stroboscope.

Dimensions: 5 1/8 by 3 1/8 by 3 3/4 inches (135 by 86 by 96 mm).

Net Weight: 2 pounds (1 kg).

Shipping Weight: 5 pounds (2.3 kg).

Type		Code Number	Price
1531-P2	Flash Delay	1531-9602	\$160.00

MEASURING SURFACE SPEEDS

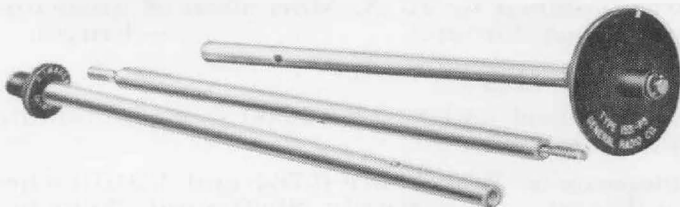

Figure 1. View of the Surface-Speed Wheel, showing the two speed discs and the sectional shaft.

The STROBOTAC® electronic stroboscope, widely used for the measurement and analysis of rotary, reciprocating, and other repetitive motions, can now be used for speed measurement of straight-line motion. The new TYPE 1531-P3 Surface-Speed Wheel accessory makes the STROBOTAC dial *direct reading in feet per minute* for measurements such as the following:

Lineal speeds of metal strip, textiles, paper, wire, plastic films, conveyed material, etc.

Surface speeds of processing rolls, machine-tool cutting or grinding operations, drums, belts, webs, pulleys, etc.

Belt slippage on drums and, especially, between belts on multiple-belt pulleys to avoid unequal load distribution and excessive wear.

Description

The new accessory consists of two wheels of different sizes mounted on opposite ends of a three-section, stainless-steel rod. The smaller wheel, with a di-

ameter of 0.764 inch, is better for slow surface speeds, while the larger wheel, with a diameter of 1.910 inch, is best suited for higher surface speeds. However, their useful ranges have a large amount of overlap, where the choice of which one to use can be based on accessibility. The range of surface speeds with the smaller wheel is 10-2500 feet per minute, and the range of the larger wheel is 50-12,500 feet per minute.

Operation

Operation is extremely simple. One of the wheels is simply allowed to ride on the surface whose speed is to be measured, and the wheel's image is "stopped" by means of the stroboscopic light beam, after which the surface speed in feet per minute is read directly from the dial of

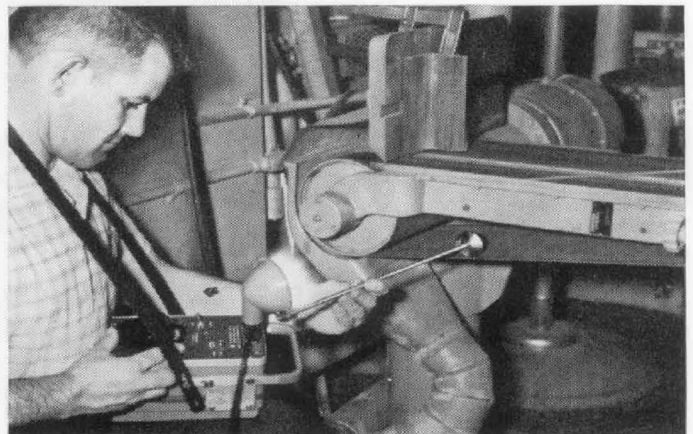

Figure 2. Measuring belt speed with the Surface-Speed Wheel.



the STROBOTAC. The fact that only the wheel has to be close to the surface whose speed is to be measured means that measurements can be made in "close quarters." The light from the STROBOTAC can penetrate well into the interior of machinery, and it is possible to build the wheel into such machinery if regular measurements must be made. For a built-in wheel, a "push-to-engage" lever is recommended in order to save wear on the wheel when a measurement is not actually being made.

The combination of the STROBOTAC electronic stroboscope with the surface-speed wheel provides an extremely sensitive indicator of small variations in linear speed and of differences in speed between two or more surfaces having the same nominal speed. A fraction of an rpm is prominently indicated when the speed of the wheel changes.

— W. R. THURSTON
CREDITS

The TYPE 1531-P3 Surface-Speed Wheel was designed by R. A. Mortenson of Mechanical Design Group. — EDITOR

SPECIFICATIONS

Accuracy: The basic accuracy of the STROBOTAC electronic stroboscope is 1% of reading; an additional 0.5% must be added to account for errors in the diameter of the wheel, giving an over-all accuracy of measurement of 1.5% of reading for surface speed over the entire range of measurement.

Speed Range: 10 to 2500 feet per minute with

small wheel and 50 to 12,500 feet per minute with large wheel.

Dimensions: Wheels are 0.764 and 1.910 inches in diameter, respectively. Shaft totals 20 inches in length.

Net Weight: 8 ounces (0.3 kg).

Shipping Weight: 2 pounds (1 kg).

Type		Code Number	Price
1531-P3	Surface-Speed Wheel	1531-9603	\$15.00

MONTREAL
SALES-
ENGINEERING
OFFICE

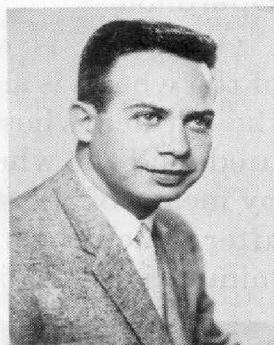

R. J. Provan

General Radio's new Montreal Sales-Engineering Office opened August 1, 1963, just six years after the opening of our first Canadian office in Toronto.

The new office is operating as a branch of our Toronto office to provide better

coverage and service for customers in Quebec and the Maritime Provinces. The Montreal office also covers Ottawa, although Government tenders should still be directed to the Toronto office.

R. J. Provan is in charge of the Montreal office, with Miss Beverley Gliddon as his secretary. Dick Provan, who has been at our Toronto office since its opening, is well known to Canadian engineers and scientists, having had ten years' experience selling General Radio products.

The Montreal office is located at Office 395, 1255 Laird Boulevard, Town of Mount Royal, Quebec, telephone 737-3673.

General Radio Company

WEST CONCORD, MASSACHUSETTS, U. S. A.

NEW YORK
FLORIDA

SYRACUSE
DALLAS

PHILADELPHIA
SAN FRANCISCO

WASHINGTON
LOS ANGELES

CHICAGO
CANADA

PRINTED
IN
U.S.A.