

# THE GENERAL RADIO EXPERIMENTER



VOLUME 36 No. 12

DECEMBER, 1962

## IN THIS ISSUE

**New**

500-Mc Frequency Converter  
Washington Service

Counter Errors





The General Radio EXPERIMENTER is mailed without charge each month to engineers, scientists, technicians, and others interested in electronic techniques in measurement. When sending requests for subscriptions and address-change notices, please supply the following information: name, company address, type of business company is engaged in, and title or position of individual.

©1962—GENERAL RADIO COMPANY, WEST CONCORD, MASS., U.S.A.

Published Monthly by the General Radio Company

VOLUME 36 • NUMBER 12

DECEMBER, 1962

CONTENTS

A New Converter for Frequency Measurements to 500 Mc.....	3
Digits Can Lie.....	7
Capitol Service.....	12

GENERAL RADIO COMPANY

West Concord, Massachusetts

Telephone: (Concord) EMerson 9-4400; (Boston) MIssion 6-7400  
Area Code Number: 617

- NEW YORK:\*** Broad Avenue at Linden, Ridgefield, New Jersey  
Telephone — N. Y., WOrth 4-2722  
N. J., WHitney 3-3140
- SYRACUSE:** Pickard Building, East Molloy Road,  
Syracuse 11, N. Y.  
Telephone — Glenview 4-9323
- CHICAGO:\*** 6605 West North Avenue, Oak Park, Illinois  
Telephone — Village 8-9400
- PHILADELPHIA:** 1150 York Road, Abington, Pennsylvania  
Telephone — Phila., HANcock 4-7419  
Abington, TURner 7-8486
- WASHINGTON:\*** Rockville Pike at Wall Lane, Rockville, Maryland  
Telephone — 946-1600
- FLORIDA:** 113 East Colonial Drive, Orlando, Florida  
Telephone — GArden 5-4671
- DALLAS:** 2501-A West Mockingbird Lane, Dallas, Texas  
Telephone — FLEetwood 7-4031
- LOS ANGELES:\*** 1000 North Seward St., Los Angeles 38, Calif.  
Telephone — HOLlywood 9-6201
- SAN FRANCISCO:** 1186 Los Altos Ave., Los Altos, Calif.  
Telephone — WHitecliff 8-8233
- CANADA:\*** 99 Floral Parkway, Toronto 15, Ontario  
Telephone — CHerry 6-2171

\*Repair services are available at these district offices.

GENERAL RADIO COMPANY (OVERSEAS), ZURICH, SWITZERLAND  
REPRESENTATIVES IN PRINCIPAL OVERSEAS COUNTRIES

COVER



Development Engineer H. T. McAleer measures the frequency stability of a Type 1215-B Unit Oscillator at 250 Mc with the Type 1130-A Digital Time and Frequency Meter and the Type 1133-A Frequency Converter.

# A NEW CONVERTER FOR FREQUENCY MEASUREMENTS TO 500 Mc

The introduction of our 10-Mc counter, the TYPE 1130-A Digital Time and Frequency Meter,<sup>1</sup> has stimulated requests that we produce a companion instrument to extend the frequency-measurement range. Several such instruments already exist, but we felt that we could contribute significant improvements in sensitivity, selectivity, and ease of use. Figure 1 shows the results of our efforts, the TYPE 1133-A Frequency Converter.

The converter heterodynes an unknown input frequency between 10 and 500 Mc against a 10-Mc multiple of a standard frequency, derived from the 5-Mc time-base oscillator of the counter, and applies the less-than-10-Mc difference frequency to the counter. The instrument can also amplify weak signals between 100 kc and 10 Mc to operate the counter.

Operation of the converter is simple and straightforward. The heterodyne reference frequency to be added to the counter reading is indicated directly by large in-line numerals. The range of

output amplitude acceptable for the counter is clearly indicated on the panel meter, and adjustment to this level is made by an output control. An input sensitivity control is also provided.

Among the unique features of the instrument are the use of linear mixers; a tuned amplifier, which can be used or not, as needed; signal lights to indicate proper control settings; and a novel dial readout to reduce reading errors.

## Principles of Operation

Figure 2 is an over-all block diagram. For input frequencies above 200 Mc a dual-conversion system is used; single conversion is used below 200 Mc. Input signals are first passed through an attenuator (controlled by the SENSITIVITY control) and through a 100-Mc-wide band-pass filter selected by the hundreds-reference-FREQUENCY control.

Input signals below 200 Mc are routed to the 2nd mixer, either directly or through the tuned amplifier. In the 2nd mixer, the input signal is heterodyned against the tens-reference frequency (from 10 to 190 Mc depending on the setting of the FREQUENCY controls), and the beat-frequency output of the mixer is passed to the video amplifier where it

<sup>1</sup>R. W. Frank, H. T. McAleer, "A Frequency Counter With a Memory and With Built-In Reliability," *General Radio Experimenter*, 35, 5, May 1961.

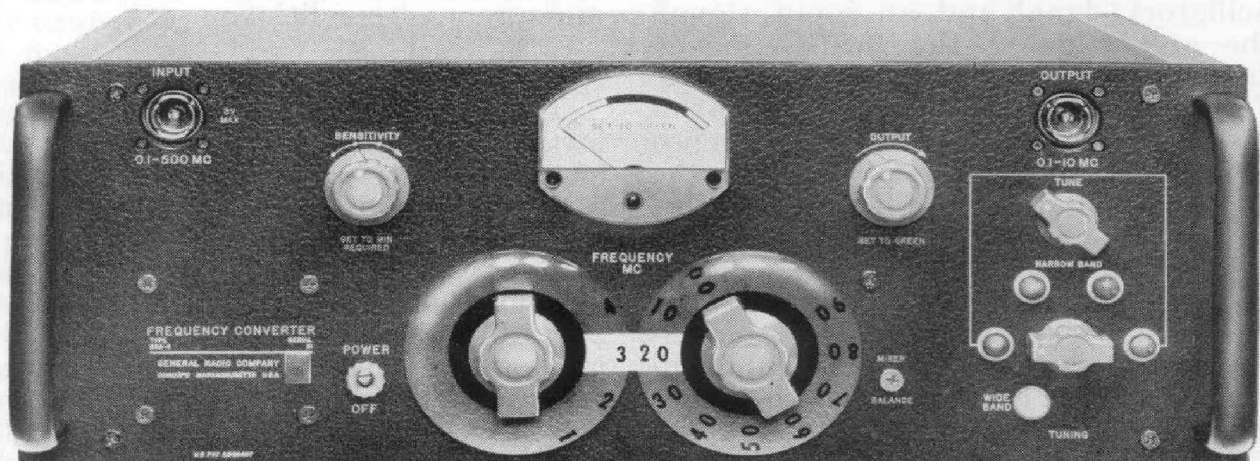

Figure 1. Panel view of the Type 1133-A Frequency Converter.



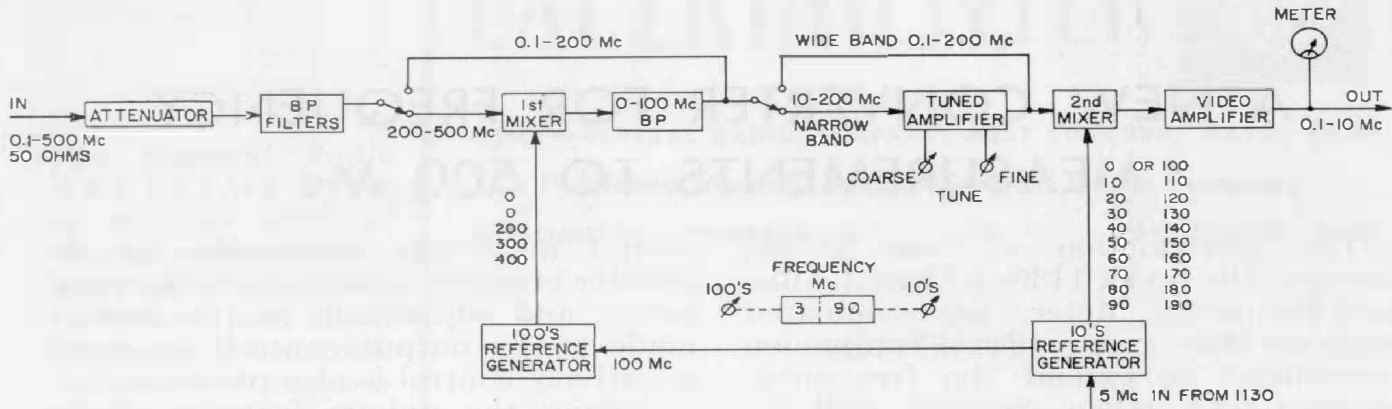

Figure 2. Over-all block diagram. A single conversion system is used below 200 Mc, a double conversion system from 200 to 500 Mc.

is amplified, metered, and applied to the output. The output control varies the gain of the video amplifier to set the output level.

Input signals above 200 Mc are heterodyned against the hundreds-reference frequency (200, 300 or 400 Mc) in the 1st mixer. The 0- to 100-Mc beat-frequency output of the 1st mixer is filtered and then processed exactly like an input signal below 200 Mc. If the signal applied to the 2nd mixer is below 10 Mc (input frequencies of 0-10, 200-210, 300-310, 400-410 Mc), the 2nd mixer is converted into an amplifier, and the gain of the video amplifier is increased. In such cases the tuned amplifier is not used (since it doesn't operate below 10 Mc).

### Linear Mixing

A mixer circuit usually operates with two signals applied, a reference (local-oscillator) signal and an input signal. The amplitude of the beat-frequency output depends more on the amplitude of the lower-level signal than on that of the higher-level signal. If the reference signal has the higher amplitude, the circuit will function as a linear mixer for the input signal. That is, the amplitude of the beat-frequency output will be proportional to the amplitude of the input signal, and, in particular, the signal-to-noise ratio of the input signal will be preserved in the output. If the input signal has the higher amplitude, however, the circuit will not operate as a linear mixer for that signal. The signal-

to-noise ratio of the reference will be preserved, but the signal-to-noise ratio of the input signal will be degraded.

In a heterodyne frequency converter either mixing method can be used. Several existing converters use the nonlinear method, since this eases greatly the requirements on the purity or "cleanliness" of the heterodyne-reference-frequency signals. For successful measurements, therefore, the input signal must be relatively clean; and, consequently, the measurement of low-level signals in the presence of noise may be impossible.

Since we feel that the burden of signal purity should be on the measuring instrument rather than on the unknown signal, clean, high-level reference signals and linear mixing are used throughout the TYPE 1133-A Frequency Converter. As a result, the instrument can be used under an unusually wide variety of measurement conditions.

### Tuned Amplifier

To increase the sensitivity of the instrument and to reduce further the effects of noise and extraneous signals, a tuned amplifier can be switched into the measuring system. With input frequencies from 10 to 500 Mc, the amplifier covers the range from 10 to 200 Mc. The amplifier is operated by two controls (see Figure 3). The TUNING control switches the amplifier (1) out of the system (WIDE BAND) to simplify operation when measuring pure, high-level signals, or (2) into the system

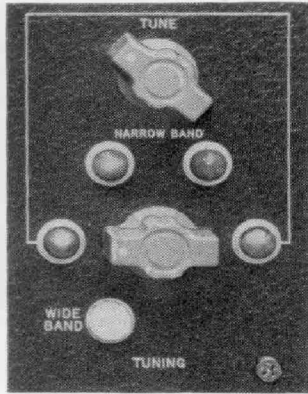

**Figure 3. Tuning controls. Signal lights indicate proper setting.**

(NARROW BAND) to enable measurement of noisy, low-level signals. It also selects one of the 4 coils necessary to cover the 20-to-1 tuning range. The TUNE control adjusts the tuning capacitor of the amplifier. The positions of the TUNING control corresponding to the different amplifier tuning coils are indicated by lights. With the TUNING control in the WIDE BAND position, the WIDE BAND indicator light will glow. With the TUNING control in any NARROW BAND position, one indicator light will glow, showing the position to which the control should be set. The indicator lights are controlled by the settings of the FREQUENCY controls. For example, with the FREQUENCY controls set to 330 Mc, the second NARROW BAND indicator light will glow, showing that the 20- to 40-Mc range of the tuned amplifier should be used. For certain positions of the FREQUENCY controls (00, 200, 300, 400) the WIDE BAND indicator light will remain on when the TUNING control is moved, indicating that the tuned amplifier cannot be used. For these positions, as mentioned above, the gain of the output amplifier is increased so that no loss in sensitivity occurs.

In addition to increasing the sensitivity of the instrument because of its gain, the tuned amplifier also provides selectivity to guard against noise and extraneous signals which may exist within the  $\pm 10$ -Mc conversion band. Figure 4 shows a typical plot of the bandwidth versus frequency of the tuned amplifier.

The sensitivity figures listed in the instrument specifications are broad, all-inclusive figures. Figure 5 shows a plot

of the sensitivity versus frequency of a typical instrument for both WIDE BAND and NARROW BAND operation. This plot was taken for a beat-frequency output of 10.1 Mc, where the sensitivity of the associated counter is poorest. Therefore, the plot is labeled "worst-case sensitivity." For operation at output beat frequencies lower than 10.1 Mc, the sensitivity is significantly better.

**Readout**

Figure 6 shows a close-up of the new type of dial readout used on the converter. The readout uses transparent plastic dials with characters silk-screened on the rear. A white area on the panel behind the dials effectively "illuminates" the desired characters, and a uniform in-line indication is presented.\* The readout has two main advantages:

- 1) The desired information always

\*This readout method was devised some time ago by General Radio engineer Warren R. Kundert and is currently being incorporated in several new instruments.

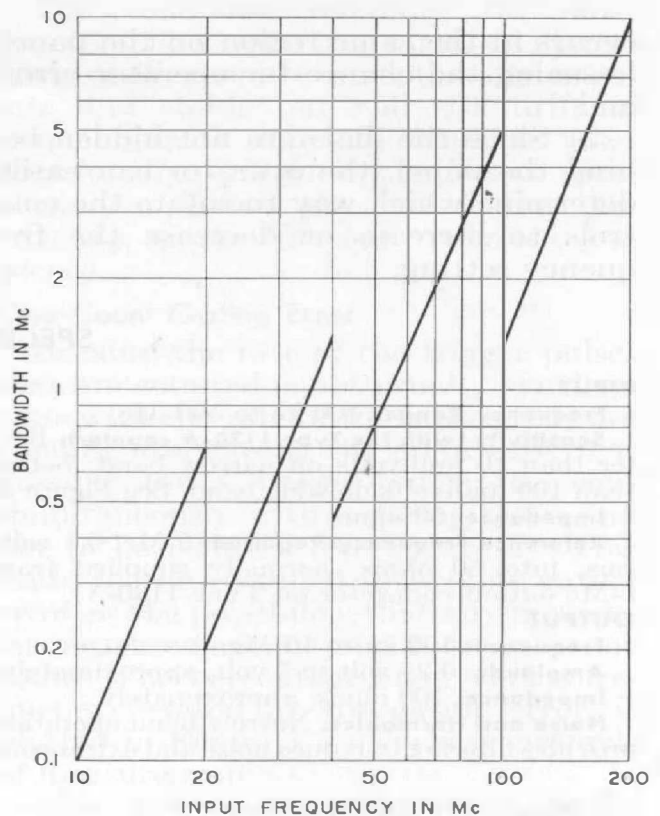

**Figure 4. Tuned-amplifier bandwidth versus frequency. For input frequencies above 200 Mc, amplifier operates from 10 to 100 Mc.**

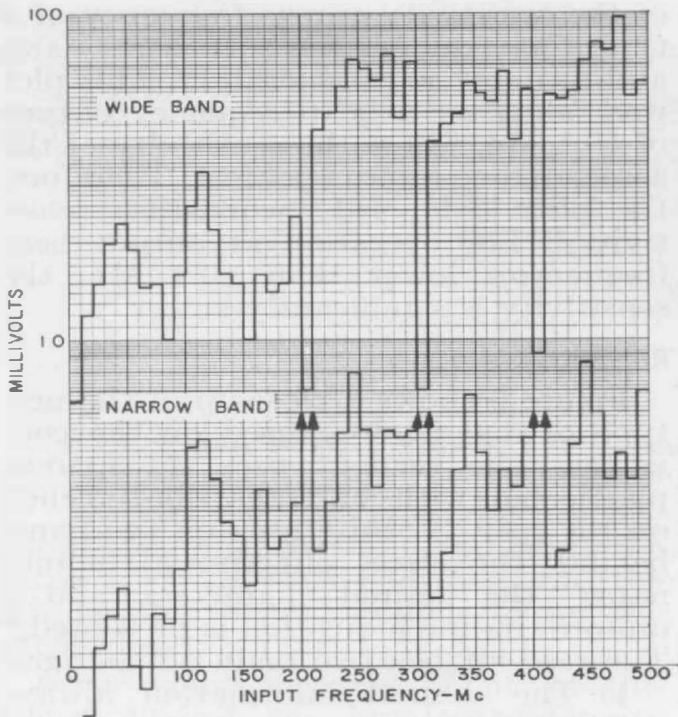

Figure 5. Typical over-all sensitivity of converter and counter for 10.1-Mc counter indication. This is worst case. Sensitivity is better for lower converter output frequencies.

occurs in the same region on the panel, lessening the chance for operator error, and

2) Since the dials are not hidden behind the panel, the operator can easily determine which way to rotate the controls to increase or decrease the frequency setting.

SPECIFICATIONS

INPUT

- Frequency Range:** 100 kc to 500 Mc.
- Sensitivity (with the Type 1130-A counter):** Better than 10 millivolts on narrow band; better than 100 millivolts on wide band. See Figure 5.
- Impedance:** 50 ohms.
- Reference Frequency Required:** 5 Mc, 0.1 volt, rms, into 50 ohms (normally supplied from 5-Mc output connector on Type 1130-A).

OUTPUT

- Frequency:** 100 kc to 10 Mc.
- Amplitude:** 0.25 volt to 1 volt, approximately.
- Impedance:** 100 ohms, approximately.
- Noise and Harmonics:** Narrow-band operation provides filtering to reduce noise and extraneous

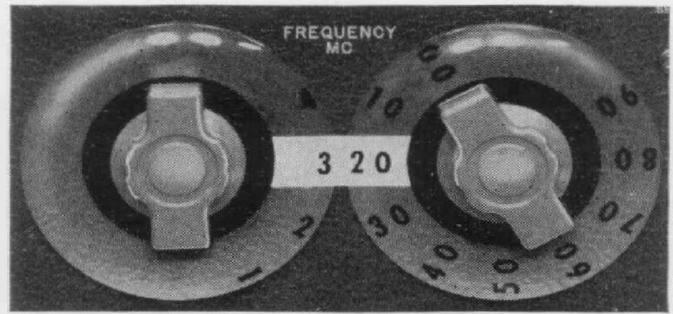

Figure 6. New in-line digital readout.

Over-all Versatility

In this all-in-one-package, wide-range converter, rugged construction and long-term reliability are combined with a number of important operating features — high sensitivity, the ability to make measurements in the presence of noise, positive identification of frequency, and simple controls — to produce an instrument of maximum usefulness in precise frequency measurement.

— H. T. McALEER

CREDITS

The design and development of the TYPE 1133-A Frequency Converter was carried out by W. F. Byers and H. T. McAleer, assisted by S. Samour. Progress from conception to completion was supported by G. Neagle, mechanical design; W. Montague, design drafting; R. H. Chipman, production engineering; and W. P. Buuck, test engineering.

— EDITOR

signals. Linear mixer preserves signal-to-noise ratio during conversion process.

GENERAL

- Power Input:** 105 to 125 (or 210 to 250) volts, 50 to 60 cps, 60 watts.
- Accessories Supplied:** Two coaxial patch cords for connection to counter, one coaxial cable connector, one 3-wire power cord, and spare fuses.
- Dimensions:** Bench model, width 19, height 7½, depth 17¾ inches (485 by 190 by 450 mm), over-all; rack model, panel, 19 by 7 inches (485 by 180 mm); depth behind panel, 14 inches (355 mm).
- Net Weight:** 34 pounds (15.5 kg).

Type	Description	Code Word	Price
1133-AM	Frequency Converter, Bench Model	NOVEL	\$1250.00
1133-AR	Frequency Converter, Rack Model	NEWEL	1250.00

U.S. Patent No. 2,548,457.



# DIGITS CAN LIE

## A Discussion of Error Sources in Counter Measurements

Since its introduction some 15 or so years ago, the counter, or digital time and frequency meter, has become a widely used electronic instrument, almost as ubiquitous as the vacuum-tube voltmeter or the oscilloscope. Wonderful as this instrument seems, however, it is still capable of producing wrong answers, even though its circuits may be functioning perfectly. Recognition and understanding of the sources of error will enable one to minimize their effects and to improve the usefulness and reliability of counter measurements.

When using a counter, one should keep in mind the distinction between precision and accuracy. Precision describes the degree of fineness, the least significant figures, of a measurement; accuracy indicates the possible extent of error. For example, it is quite possible (and fairly common) to measure a time interval with a counter to a precision of  $0.1 \mu\text{sec}$ , but with an accuracy of only  $\pm 1 \text{ msec}$ .

The simplified block diagram of Figure 1 shows the five basic circuit blocks of a digital time and frequency meter: input circuits, time base, main gate, program control, and decimal counting units. The input circuits generate trigger pulses from the input signal. For frequency measurement these trigger pulses are counted by the decimal counting units during a time interval derived from the time base; for time measurement the trigger pulses cause the main gate to start and stop the flow of

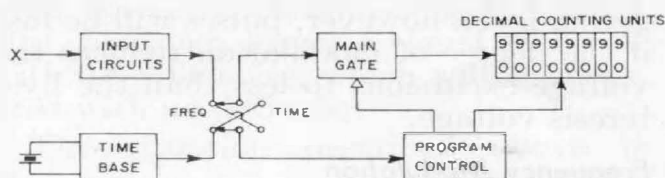

Figure 1. Simplified block diagram of a digital time and frequency meter.

time-base clock pulses into the decimal counting units.

The program control routes pulses to open and close the main gate, selects the proper pulses to be counted, controls the display, and handles the resetting operations.

Errors can, of course, occur if any of these circuit blocks malfunction, but we are concerned here with errors due to other causes. Such errors occur mainly in the time-base, gate, and input circuits. Some are inherent in the counting system; others depend upon the nature of the signal to be measured.

### INHERENT ERRORS

#### Time-Base Error

The time-base reference for most counters is a quartz-crystal oscillator. Such oscillators are exceptionally accurate and stable but will still drift in frequency with time and should be reset occasionally. *Satisfactory self-check operation of a counter does not indicate the accuracy of the time-base reference frequency.*

#### One-Count Gating Error

Because the rate of the trigger pulses that are counted is not usually synchronous with the rate of the pulses that are opening and closing the main gate, it is possible for a trigger pulse to occur simultaneously with a gating pulse and not to be counted (see Figure 2). This leads to the so-called one-count gating error — the possibility that any particular measurement may be in error by one count. The percentage error versus frequency, caused by the gating error, is plotted in Figure 3 for various methods of measurement.

This one-count gating error applies only to a single measurement. In a series of measurements of the same quantity (a typical use of a counter) *the answer is*



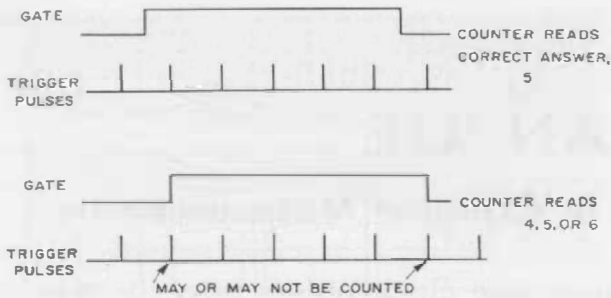

**Figure 2. One-count gating error. Pulses occurring simultaneously with the gate may or may not be counted.**

averaged, and the one-count error disappears. For example, if the true value of the last digit is between 4 and 5, say 4.5, the reading will jump back and forth between 4 and 5. By observing the relative rate of occurrence of the two digits, the operator can estimate a digit beyond the last one displayed. (Incidentally, it's easier to do this with the thermometer type of readout than with the more popular in-line readout.)

**ERRORS CAUSED BY NOISE**

There is an additional group of errors, which are caused by noise. Noise, in this instance, refers to anything that causes the input signal processed by the counter to be other than a perfect sine wave of infinite signal-to-noise ratio. Modulated signals, for example, may be considered to be noisy signals.

The effects of noise depend directly upon the operation of the input circuits, which function both as an amplitude

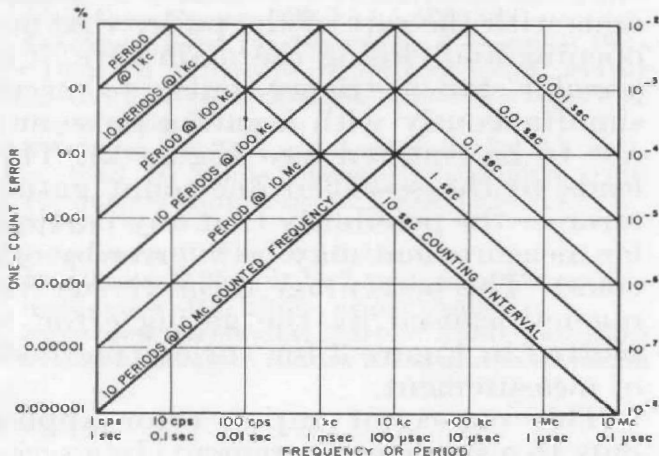

**Figure 3. Percentage error versus frequency caused by one-count gating error.**

limiter and a trigger pulse generator. In most counters, a Schmitt (or similar-type) circuit generates a trigger pulse when the input-signal voltage increases above a certain reference-voltage level and resets itself when the input voltage falls below another level, as illustrated in Figure 4. The voltage difference between the triggering and resetting levels is called the "hysteresis" voltage of the counter and determines the minimum input voltage necessary to operate the input circuits. A trigger-level control to adjust the absolute voltage of the trig-

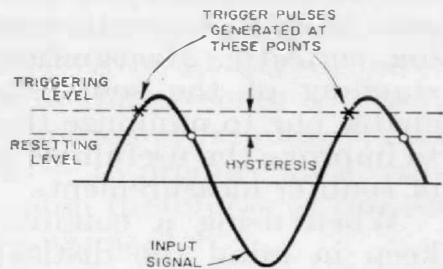

**Figure 4. Operation of input circuits.**

gering and resetting levels is very useful in combating the effects of noise and obtaining maximum input sensitivity.

**Frequency-Measurement Errors**

Errors in frequency measurement can be caused by modulation, either amplitude or frequency, or by the existence of spurious signals along with the desired signal.

**Amplitude Modulation**

If the input signal is amplitude-modulated, an error may occur if the triggering level is offset as shown in Figure 5. With the triggering and resetting levels adjusted symmetrically about 0 volts, however, the correct frequency will be measured as long as the minimum peak-to-peak excursion of the input signal is greater than the hysteresis voltage. Even with optimum adjustment of the triggering level, however, pulses will be lost if the degree of modulation reduces the voltage excursions to less than the hysteresis voltage.

**Frequency Modulation**

The counter is often used to measure various properties of a frequency-modu-



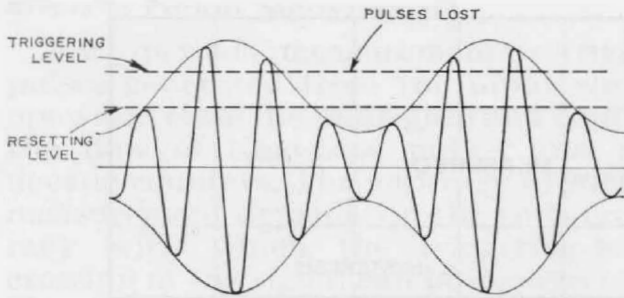

**Figure 5. Error caused by amplitude modulation.**

lated signal.<sup>1</sup> It can measure the average value of an input frequency during the chosen counting interval, provided that the frequency remains within the resolution capability of the instrument. If the frequency rises above the maximum counting rate of the instrument or falls below the minimum rate, pulses will be lost and the measurement will be in error.

If a heterodyne frequency converter for high-frequency measurements is used, care must be taken that frequency modulation does not drive the input frequency down through zero beat with the heterodyne reference frequency and "out the other side," or the counter reading will be incorrect.

### Noise

If the desired signal is accompanied by noise sufficient to cause extra transitions of the hysteresis region, as shown in Figure 6, extra counts will be registered. This error can often be combated by adjustment of the triggering level to the region of steepest signal slope or by attenuation of both signal and noise. Note that it is the absolute value of the noise voltage that is important, rather than the signal-to-noise ratio. In a counter with a 0.2-volt hysteresis region, for example, a 10-volt signal accompanied by 1 volt of noise will not be measured correctly. Attenuating the input 10:1, however, leaves a signal of 1 volt with 0.1-volt noise, which will be measured with no difficulty.

The situation described above is

slightly oversimplified; it is correct for signal and noise frequencies well below the maximum triggering rate. The hysteresis voltage of most counter input circuits is not constant for all input frequencies; it decreases at frequencies approaching the maximum triggering rate, even though the over-all sensitivity of the counter may decrease. A 10-Mc counter, for example, will be more sensitive to 10-Mc noise than to 1-Mc noise.

### Interfering Signals

Occasionally it is necessary to measure the frequency of a signal in the presence of another signal of nearly equal amplitude. Counters have been severely, and somewhat unjustly, criticized for being unable to make this type of measurement. The actual situation, however, is not as bad as may be believed.

A capture effect occurs in the input circuits of a counter, similar to that encountered in FM receivers. Figure 7 shows an experimental curve describing the effect on a counter measurement of two signals together. If the frequency of the interfering signal is much higher than that of the desired signal, the interference behaves like the type of noise described above. That is, if the peak-to-peak interference voltage is less than the hysteresis voltage of the counter, it will cause no difficulty. If the interference voltage is greater than the hysteresis voltage, however, it may cause errors — depending on the ratio of the frequencies of the two signals and their amplitudes. As the interfering frequency approaches the desired frequency, the counter can tolerate more interference amplitude before making an error.

Let us consider the case of an interfering frequency close to the desired frequency as the interference amplitude

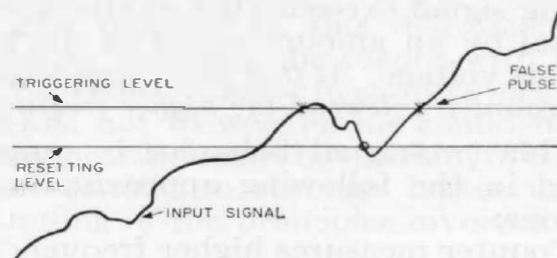

**Figure 6. Effects of additive noise.**

<sup>1</sup>I. Godier and P. S. Christensen, "New Method of Measuring FM Deviation Uses Electronic Counter," *Canadian Electronics Engineering*, July 1962, p. 38.

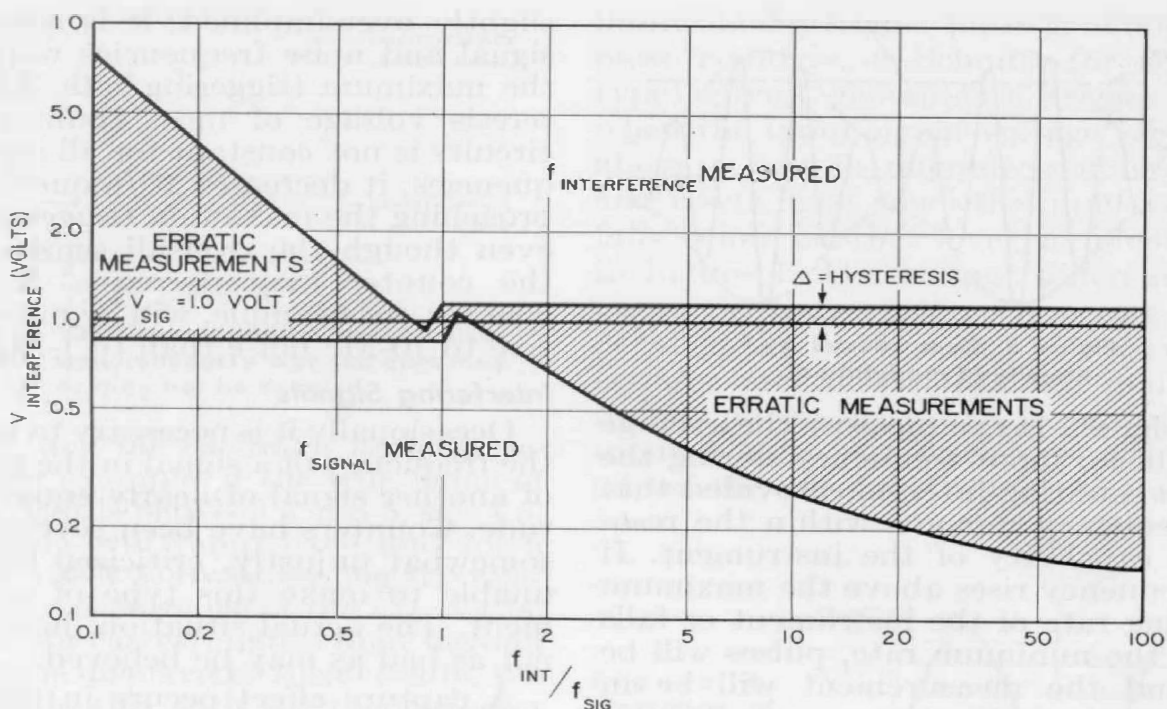

Figure 7. Capture behavior of a counter. Counter ignores an interfering signal with amplitude below the shaded area. If interference amplitude exceeds shaded area, counter will measure interfering signal only.

increases from zero. The composite voltage begins to wax and wane at a rate equal to the difference frequency and with an envelope amplitude equal to that of the interference. The voltage waveform looks like an amplitude-modulated wave, except that the phase of the "carrier" is also varying. The average frequency within the modulation envelope, *i.e.*, the average rate of positive zero crossings, is equal to that of the larger-amplitude, lower-frequency signal. The counter will continue to measure the lower frequency until the interference becomes great enough to compress the composite voltage amplitude within the hysteresis voltage limits. As the interference voltage increases still further, the counter will give erratic readings until the amplitude of the interfering signal exceeds that of the desired signal by an amount equal to the hysteresis voltage. *At that point and beyond, the counter will read the higher frequency.*

This two-signal behavior is summarized in the following approximate relations:

Counter measures higher frequency if  $V_h > V_l + \Delta$ ;

counter measures lower frequency if

$$V_h < \frac{f_l}{f_h} V_l + K\Delta,$$

where:

- $V_h$  = peak-to-peak amplitude of higher frequency signal,
- $V_l$  = peak-to-peak amplitude of lower frequency signal,
- $f_h$  = higher frequency,
- $f_l$  = lower frequency,
- $\Delta$  = hysteresis voltage of counter,
- $K$  = a factor varying between 1 and 2.

If neither condition is satisfied, the counter will give erroneous readings.

A counter, therefore, has a degree of inherent immunity to interference. If the interfering frequency is lower than the desired signal frequency, it will be completely ignored by the counter if its amplitude is less than the signal amplitude by at least the hysteresis voltage. As the interfering frequency exceeds the signal frequency, the counter can tolerate less and less interference amplitude but, in the limit, will still ignore interference amplitudes less than the hysteresis voltage.



### Errors in Period Measurement

For period measurements, trigger pulses generated from the input signal open and close the main gate and control the flow of time-base pulses into the decade counters. The accuracy of such a measurement depends on the time accuracy with which the triggering-level crossing of the signal can be determined. Errors in this determination may occur for several reasons: the triggering-level crossing of the signal may vary because of drift, hum pickup, noise, etc., or the triggering level itself may vary for similar reasons. Figure 8 illustrates the effect of uncertainty in either signal or triggering level. These uncertainties are additive and can be combined into a single "noise" voltage. For sine waves triggering at zero crossings, the following relationship applies:

$$\text{Max error in } \% = \pm \frac{1}{\pi} \frac{V_n}{V_s} \times 100$$

where  $V_n$  = peak noise voltage,  
 $V_s$  = peak signal voltage.

Stated in other terms, the fractional error caused by noise is about one-third the noise-to-signal ratio. For example, a noise voltage of 3% can produce an error of about 1%.

The effective noise includes both noise present in the signal and internal noise generated by the counter. The internally generated noise depends on the impedance of the signal source and the positions of the controls. For example, measuring the period of a clean signal of 1-volt rms amplitude from a 600-ohm

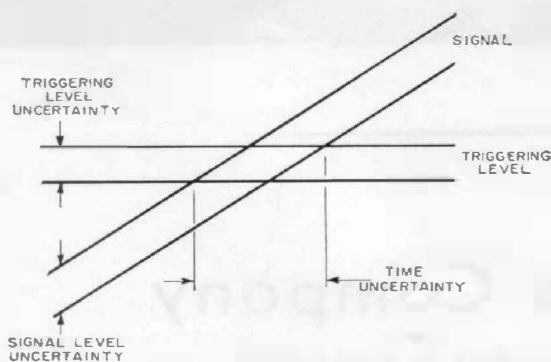

Figure 8. Effects of uncertainty in signal or triggering level.

source will yield an accuracy of about 0.05% on a General Radio TYPE 1130-A counter, indicating an effective internal noise of about 2 mv. A 10-periods measurement is at least 10 times as accurate since the time error is compared with a time interval 10 times as long.

The above remarks apply to noise of a random nature. If the noise is periodic, the measurement will display a cyclic variation, and it is possible to estimate the mean value of the measurement with greater accuracy than that indicated by the signal-to-noise ratio.

### Errors in Time-Interval Measurements

The sources of error described above apply also to time-interval measurements. Time errors caused by noise on the start and stop signals or triggering levels can be expressed as follows:

$$T = \pm \frac{V_n}{s}$$

where:  $T$  = error in seconds,  
 $V_n$  = peak noise voltage,  
 $s$  = slope of signal in volts/second.

As the slope of the signal increases, the time error caused by noise decreases, so that, for brief pulses or voltage steps with rise time comparable to one period of the counted frequency, the measurement error is reduced to  $\pm 1$  period of the counted frequency  $\pm$  the error of the time-base reference.

### Two Rules-of-Thumb for Counter Measurements

Two good rules-of-thumb to follow are:

1. A steady reading is usually correct; an erratic reading incorrect.
2. When in doubt, look at the input signal with an oscilloscope.

The purpose of this discussion has been to acquaint the reader with some of the causes of error in counter measurements, not to weaken his confidence in such measurements but, rather, to bolster that confidence through better understanding of the principles involved.

— H. T. McALEER





## CAPITOL SERVICE

The establishment of a service laboratory at our Washington, D. C., office brings to six the number of such operations in the U. S. and Canada. Donald W. Brown, formerly Service Supervisor at our New York Office, heads the new facility, located at Rockville Pike at Wall Lane, Rockville, Maryland (Telephone 946-1600). At New York, Raymond J. Jones becomes Service Supervisor.

All six service offices are fully staffed and equipped for the repair, reconditioning, and recalibration of General Radio instruments and for the certification of General Radio standards. All work performed by our service department is guaranteed for one year. Customers preferring to make their own repairs will

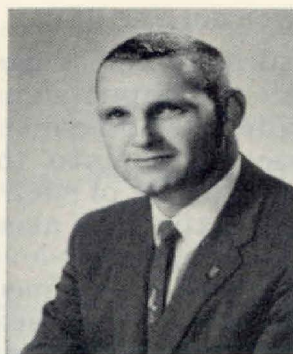

Donald Brown



Raymond Jones

find most replacement parts stocked at all six service centers.

Customers in need of service may choose whichever of the six offices is most convenient. For fastest, most economical service, we recommend the office located nearest to you. Whichever office you choose, you will find the expert, courteous assistance that has long been part of the GR tradition.

"Bridges and Techniques for Impedance Measurement" was the title of a seminar recently conducted by General Radio engineers at the plant of RCA Victor Company, Ltd., in Montreal. Morning lectures by Dr. John F. Hersh were followed by afternoon workshop sessions. Participating in the seminar were engineers from RCA Victor, Canadian Aviation Electronics, Northern Electric, and Canadian Marconi. The photo shows a workshop on coaxial-line measurements.



# General Radio Company

extends to all *Experimenter* readers its best wishes  
for a Happy and Prosperous 1963.