

THE *General Radio* EXPERIMENTER

VOLUME XXVI No. 8

JANUARY, 1952

Copyright, 1952, General Radio Company, Cambridge, Mass., U. S. A.



ELECTRICAL MEASUREMENTS AND THEIR INDUSTRIAL APPLICATIONS

VERSATILE RESISTANCE LIMIT BRIDGE DOUBLES AS LABORATORY STANDARD

Also

IN THIS ISSUE

	<i>Page</i>
POWER DISTRIBUTION	
PANEL.....	5
GRAPHIC RECORDER..	7
MISCELLANY.....	8

● **IN BOTH** the development and the manufacture of electronic equipment, it is frequently necessary to select resistors to close tolerances, to match pairs of resistors, and to make precise measurements of resistance in order to adjust circuit operating conditions. Most Wheatstone bridges, or resistance test sets, are not fast enough for production work, while the simple ohm-

meter, although rapid, has insufficient accuracy.

To meet the need for a satisfactory resistance-checking device in our own plant, our Development Engineering Department undertook the design of a resistance limit bridge sufficiently flexible in application to be used in manufacturing, in the model shop, and in the laboratory. The resulting instrument has proved so useful that it is now offered for

Figure 1. Panel view of the Type 1652-A Resistance Limit Bridge. Per cent deviation is indicated on the large meter, with its open, easily read scale.

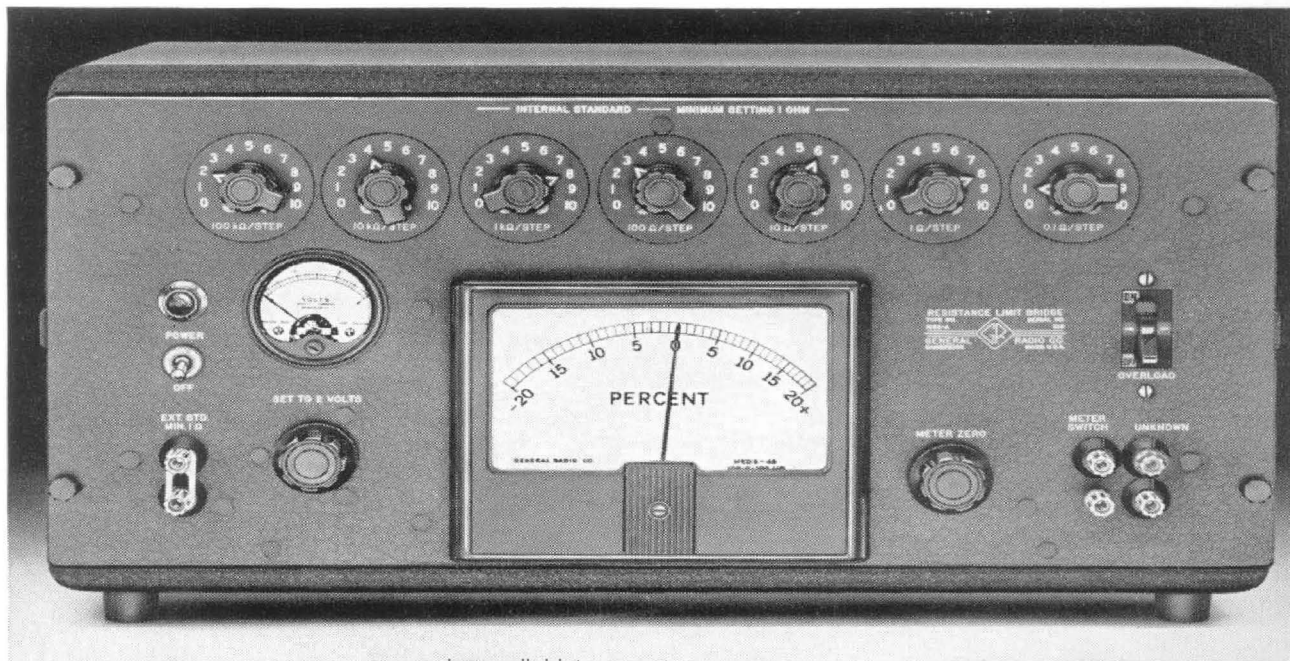

general sale as the TYPE 1652-A Resistance Limit Bridge.

The versatility of this instrument is best shown by the varied types of measurements for which it can be used. Specifically, it can:

- (1) Indicate percentage deviation of the unknown from an adjustable internal standard. Deviation is indicated on a large meter, with the scale from 0% to 5% colored gold and from 5% to 10% colored silver. Maximum deviation is $\pm 20\%$.
- (2) Indicate percentage deviation similarly from an external standard.
- (3) Be used to match one resistor to another, the percentage difference being indicated on the meter.
- (4) Be used as a conventional decade Wheatstone bridge for resistance measurements by the null method.
- (5) Be used with external equipment for automatic sorting by percentage limits.

In addition, the internal standard provides a seven-decade resistor that can be used in external circuits, subject to frequency and grounding limitations imposed by the internal circuit configuration.

The range of measurement is from one ohm to above one megohm, with an accuracy between 0.2% and 0.5%, depending on the type of measurement. The bridge is mounted in a metal cabinet and is available for either table or relay-rack mounting. The built-in resistance standard is composed of seven TYPE 510 Decade Resistors, adjustable from 1 ohm to 1,111,111, ohms in 0.1 ohm steps. External standards may be used from 1 ohm to 2 megohms. The internal power supply operates from the a-c power line.

CIRCUIT

The conventional equal-arm Wheatstone bridge circuit, shown in Figure 2, is used. The input voltage E is held constant, and the output voltage is indicated by a high-impedance vacuum-tube voltmeter, whose scale is calibrated in per cent deviation. When the unknown resistor, R_x , differs from the standard resistor, R_s , by P per cent, the bridge output voltage, V , will have the following relation to P : $V = \frac{E}{2} \left(\frac{P}{200 + P} \right)$. Since the input voltage, E , is held constant, the output voltage, V , is a function of

Figure 2. Elementary schematic circuit diagram of the limit bridge.

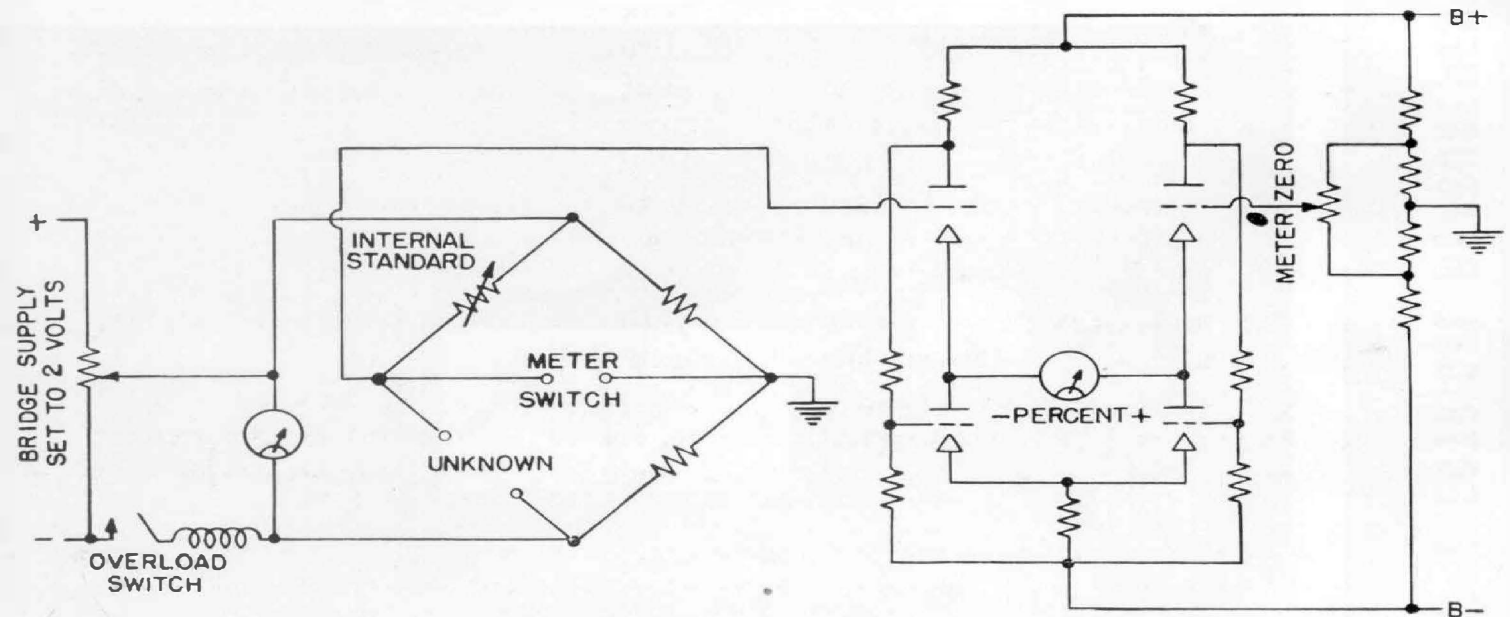



the percentage error of the unknown resistors. The fact that the percentage error, P , appears in the denominator of this expression accounts for the slight deviation from linearity of the meter scale. The d-c vacuum-tube voltmeter, shown at the right of Figure 2, uses a balanced circuit, similar to that in the TYPE 1800-A Vacuum-Tube Voltmeter, to minimize drift. The plate and cathode heater voltages are regulated by a saturable core transformer. As a result of these precautions, the drift due to line-voltage changes is completely negligible.

OPERATION

Limit Testing

For limit measurements, after the preliminary adjustments of internal standard value and meter zero, the meter indicates percentage error directly when the unknown is connected to the bridge. For such operations as acceptance tests on material coming into the plant, the speed and convenience of measurement can be greatly facilitated by the use of a test jig to accept the resistors being measured, and which provides an automatic means of shorting the meter when no resistor is connected. Such a jig is best devised by the user to suit his particular needs.

Matching Pairs

The procedure for matching pairs of resistors is the same as above, except that the internal standard is set to zero and one of the matched resistors is connected to the external standard binding posts. Resistors can also be compared to an acceptable sample by connecting the sample resistor to the external standard binding posts and setting the internal standard to zero.

Null Measurement

When the resistance limit bridge is used as a laboratory instrument to measure resistance, the unknown is connected, and the internal standard is adjusted until there is zero deflection on the meter. Sensitivity is constant for measurement up to several megohms without any additional booster voltage from external batteries.

HIGHER RESISTANCES

For resistors above a few megohms, the grid current drawn through the Wheatstone bridge by the vacuum-tube voltmeter will affect the normal operation of the bridge. However, it is still possible to measure resistors by the null method, using an external standard, providing a slightly different procedure is used. With the standard and unknown resistors connected to the bridge, the meter zero is set with the input voltage removed from the bridge (overload relay turned off). The input voltage to the bridge is then turned on and the external standard adjusted for a null. This procedure must be repeated a few times until the meter indication remains at zero as the voltage to the bridge is turned on and off.

ACCURACY

The basic accuracy of the resistance limit bridge in matching two resistors is $\pm 0.2\%$. When a resistor is being measured, the error of the standard must be added. The internal standard is accurate to $\pm 0.05\%$ (for values above 10 ohms) so that resistors may be measured to $\pm 0.25\%$. For resistors less than 10 ohms, the accuracy using the internal standard is $\pm 0.4\%$.

When the bridge is used as a limit bridge, for rapid inspection of resistors, finite accuracy of the meter reduces the

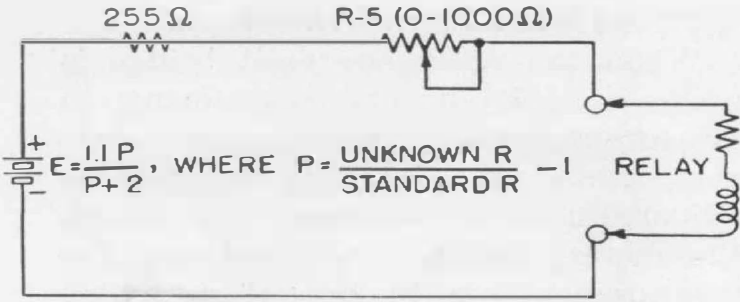

Figure 3. Equivalent circuit of the bridge voltmeter, showing method of connecting on external relay.

accuracy of the instrument to $\pm 0.5\%$. A control is available on the shelf of the instrument which allows adjustment of the meter sensitivity to remove the meter-calibration error at any one point on the scale. Thus if 5% resistors are always being measured, it is possible to increase the accuracy of the meter indication at the 5% limits with a corresponding decrease in accuracy at other points on the scale.

AUTOMATIC SORTING AND INSPECTION

A relay can be put in place of the meter on the resistance limit bridge for use in automatic equipment. The relay can then be used to control the operation of sorting machinery or rejection equipment. A suitable relay should have a sensitivity in the order of 100 microamperes and an internal resistance of a few hundred ohms. Figure 4 is an equivalent circuit of the bridge voltmeter, in which R-5 plus the relay resistance must be 850 ohms.

The TYPE 1652-A Resistance Limit Bridge is a versatile resistance measuring device, suitable, without additional equipment, for many types of measurement. For specialized applications where speed is essential, it provides a basic measuring circuit of high accuracy, to which automatic handling equipment can be connected.

— W. M. HAGUE, JR.

SPECIFICATIONS

Resistance Range: As a limit bridge, 1 ohm to 1,111,111 ohms with internal standard; for null measurement, 1 ohm to 1,111,111 ohms with internal standard; 1 ohm to 2 megohms with external standard.

Limit Range: Meter reads from -20% to $+20\%$, with the standard RTMA tolerance ranges of $\pm 5\%$ and $\pm 10\%$ clearly indicated by gold and silver coloring, respectively.

Accuracy: As a limit bridge, $\pm 0.5\%$ or better; for matching, $\pm 0.2\%$; for null measurement, with internal standard, $\pm 0.25\%$ above 10 ohms and $\pm 0.4\%$ between 1 ohm and 10 ohms; with an external standard, from 1 ohm to 2 megohms $\pm (0.2\% + \text{accuracy of standard})$.

Voltage Applied to Unknown: The voltage across the unknown resistor is exactly one volt when the meter indication is zero. As the meter indication varies from -20% to $+20\%$ the voltage across the unknown will vary from 0.89 volt to 1.10 volts.

Relay: When a relay is used in place of the meter, the relay resistance should be not more than 850 ohms and its sensitivity 100 microamperes or better. A current of 100 microamperes corresponds approximately to a limit of 20%, 50 microamperes to 10%, and 25 microamperes to 5%.

Power Supply: 105 to 125 volts or 210 to 250 volts, 60 cycles. The power input is approximately 30 watts.

Accessories Supplied: A line connector cord and spare fuses.

Vacuum Tubes: One Type 6X4 and two Type 6SU7-GTY's. All are supplied with the instrument.

Mounting: The bridge is supplied for either relay rack or cabinet mounting. Cabinet has black wrinkle finish.

Dimensions: Over-all, (width) 19 inches x (height) $8\frac{3}{4}$ inches x (depth) $10\frac{1}{2}$ inches.

Net Weight: 29 pounds.

Type		Code Word	Price
1652-AM	Resistance Limit Bridge (Cabinet Model)	BUXOM	\$365.00
1652-AR	Resistance Limit Bridge (Relay Rack Model)	BADGE	365.00



A PORTABLE POWER DISTRIBUTION PANEL FOR TELEVISION STUDIOS

For use in small or temporary television studios, or as an auxiliary switchboard in larger studios, engineers of the Canadian Marconi Company have designed and built the power distribution panel shown in Figure 1. Using Variac[®] autotransformers for circuits where voltage must be adjustable, this unit provides a convenient means of supplying power to both camera and lighting equipment from any available source of adequate capacity. An important feature of the panel is the simple, yet effective and safe, link system, which permits the panel to be operated from any one of the three common types of building power supply, as shown in the table below.

All circuits, including the Board Master, are controlled by circuit-breakers, serving as both switch and overcurrent protection, thereby eliminating fuses and their attendant nuisances and difficulties.

Pilot lights are provided to indicate visually the condition of the panel at all times; a "Lights Master" switch is provided to permit all lighting equipment to be turned off without affecting other apparatus being fed from the board; ammeters facilitate balancing the load, and indicate when the load limit of the panel is approached. A voltmeter is

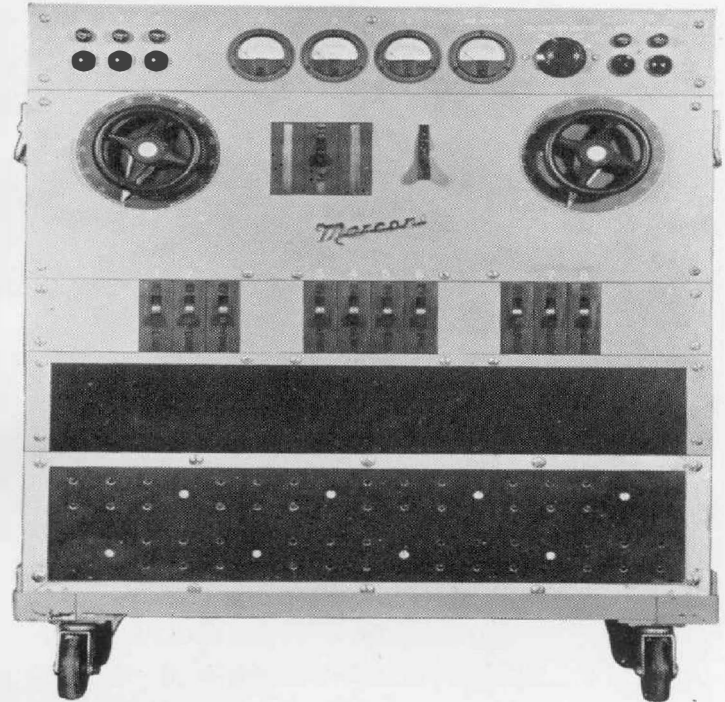

Figure 1. Panel view of the power distribution panel showing controls, pilot lights, circuit breakers, and lighting outlets. The older Type 100-Q Variacs were used on this model. Later models use the modern Type V-20M.

included to permit checking supply voltages under operating conditions.

The following output circuits are provided: Four Hubbell 20 amp. 2-wire Twist-Lock receptacles for camera equipment; four Duplex receptacles for auxiliary equipment; eight groups of three receptacles each, for standard 15 amp. Stage Connectors (Kliegl No. 955, or

TABLE I
Summary of Ratings

Supply Volts	Service Wires	Amps. per Leg or Ph.	Equipment Amps. (1)	Amps. for Lighting	Max. Total Output Amps. (2)
115	2	100	40	60	100
115-230	3	50	40	60	100
115 3 Ph.	4	50	50	100	150

Notes: (1) "Equipment Amps." shown is average for two-camera chain, together with a small amount of auxiliary equipment. Actual current drawn will depend on equipment used.

(2) "Max. Total Output Amps." is total of equipment and lighting currents at 115 volts, and is limited by maximum main breaker current. Therefore actual equipment used will govern amount of current available for lighting under some circumstances.

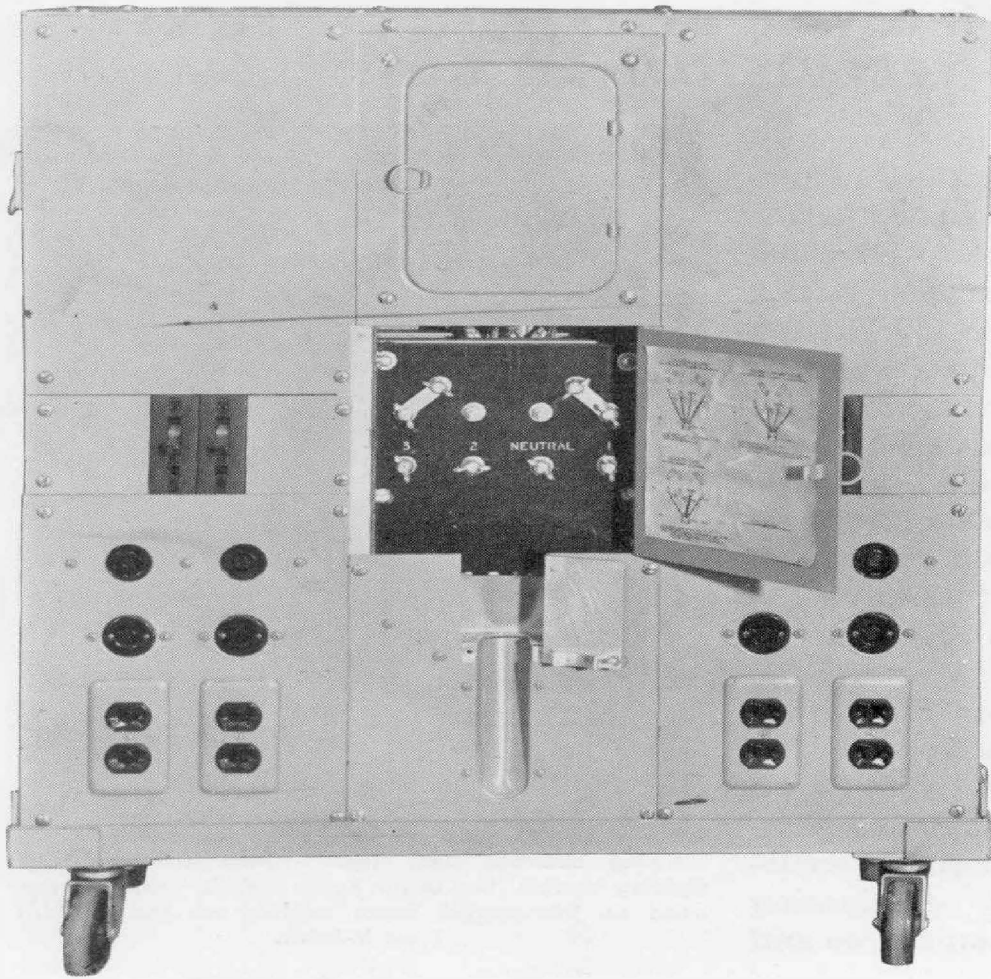

(Left) Figure 2. Rear view of the unit showing camera outlets, duplex outlets, and the panel for input connections, with links for adapting the circuit to different types of power supply.

(Below) Figure 3. Circuit diagram of the power distribution panel.

equivalent). Four of the eight latter groups are provided with dimmer control by means of the two Variacs on the front panel.

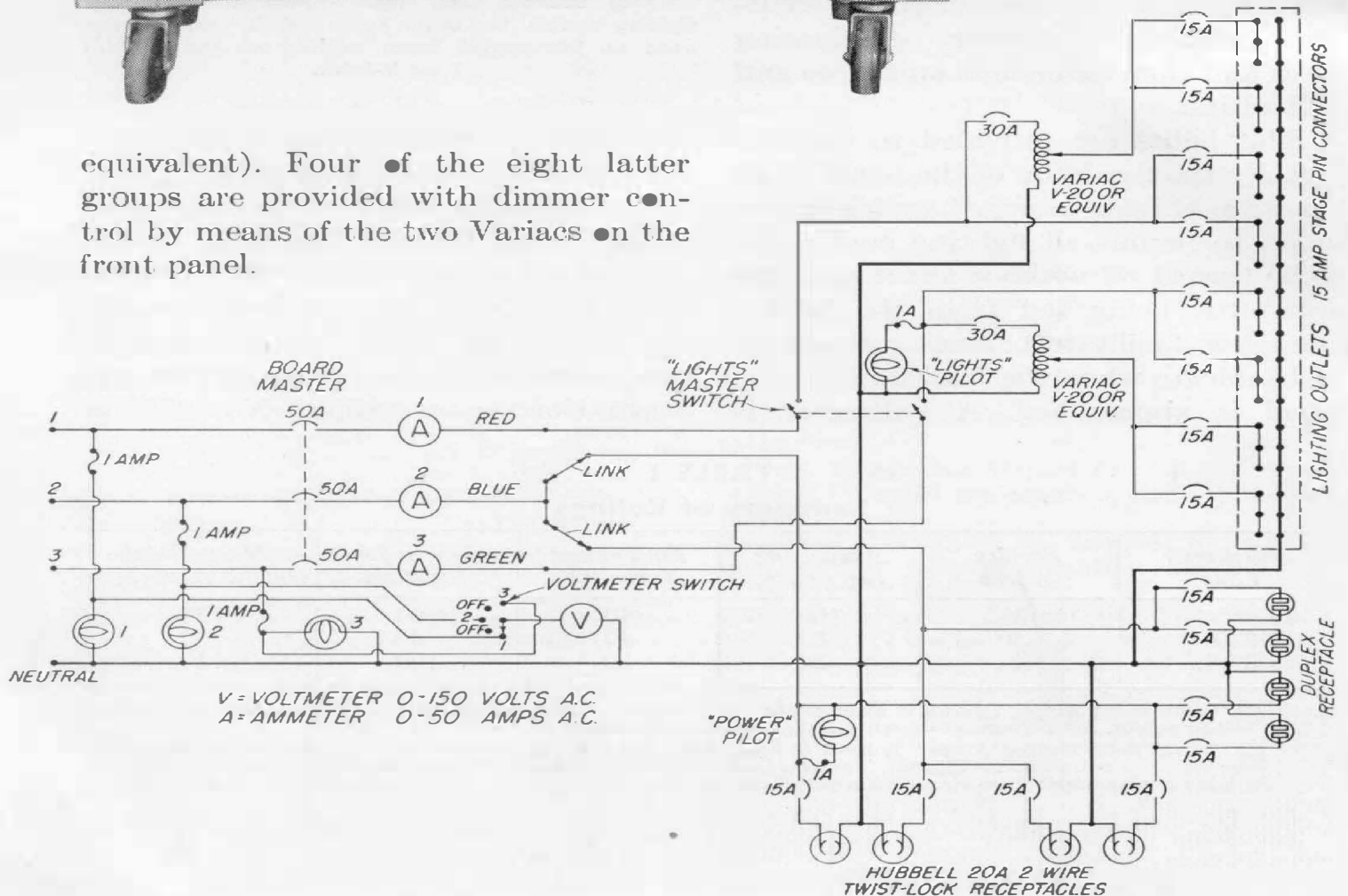



GRAPHIC RECORDER PLOTS LEVEL IN EITHER POLAR OR LINEAR COORDINATES

Sound Apparatus Company's Model PFR Polinear Recorder is an extremely adaptable instrument, particularly suited to the automatic plotting of the directional characteristics of microphones, loudspeakers, antennas, light sources, and other pattern-emitting or -receiving devices. This general-purpose pen-and-ink recorder plots a-c or d-c electrical voltage levels in either polar or rectangular coordinates on linear, square-root, or decibel scales.

Frequency response characteristics can be recorded automatically by coupling the recorder drive to the frequency-sweeping dial of an audio-frequency oscillator. For this purpose, the General Radio TYPE 1304-A Beat Frequency Oscillator is recommended. The beat-frequency oscillator is ideally suited for this type of measurement, since it gives a logarithmic frequency variation over three decades with a single sweep of the dial. In addition, it delivers 0.3 watt into 600 ohms with a total distortion of 0.25% or less.

Figure 1 is a close-up view of the Sound Apparatus Company's Polinear Recorder, and Figure 2 shows a complete setup for measuring frequency response characteristics in either polar or rectangular coordinates. Shown, left to

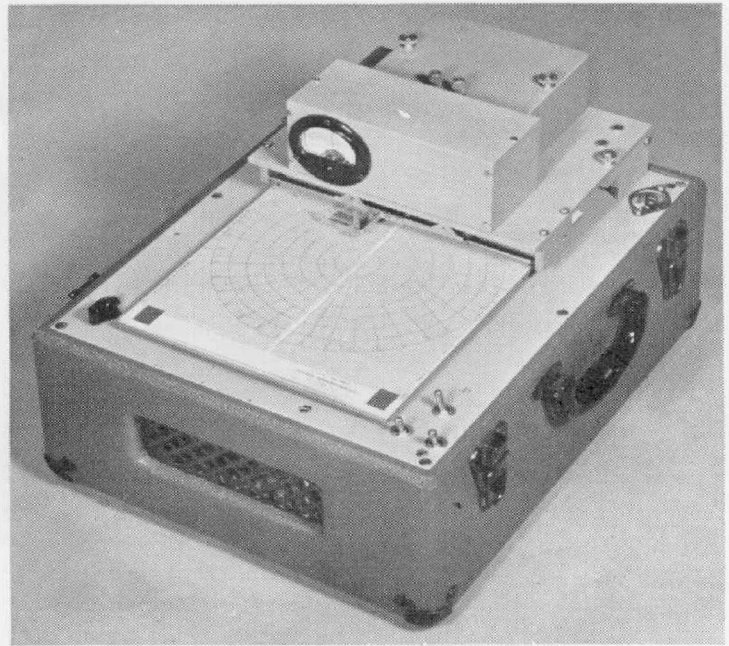
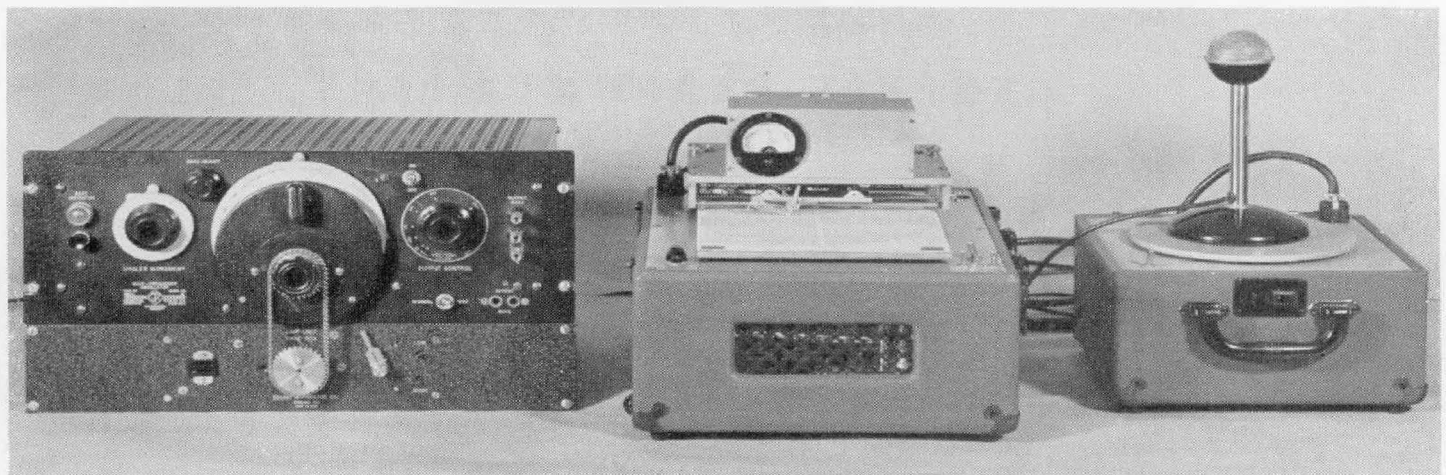

Figure 1. View of the Polinear Recorder.

right, are TYPE 1304-A Beat-Frequency Oscillator coupled with a Link Unit, the Polinear Recorder, and a Test Turntable for the polar recording of directional transmission characteristics. All three units are electrically connected by synchronous motors.

The Sound Apparatus Company manufactures the Link Unit and Test Turntable as well as the recorder. Included with the Link Unit is a sprocket for attachment to the frequency dial of the oscillator.

Figure 2. Complete assembly for measuring frequency response characteristics.





MISCELLANY

RECENT VISITORS to the General Radio plant and laboratories include:

From England:

LT. COL. REX COWLEY, Leland Instruments, Ltd., London.

From the Netherlands:

PROF. R. M. M. OBERMAN, Head, Laboratory of Automatic Telephone System, and PROF. G. H. BAST, Director, Netherlands Post, Telegraph, and Telephone Service, The Hague. Both Professor Oberman and Professor Bast are also associated with the Technical University at Delft.

From France:

P. BOURGEAS, Textile Engineer, St. Sauveur de Montagut, Ardeche; FRED. MOURARET, Moulinage et Retarderie de Chavanoz, Isere; and PIERRE DOUBLIER, M. La Croix, Lyon.

From Norway:

ROLF OLAUSSEN, Engineer, Bergen Fish Industries, Bergen.

From Italy:

DR. GUIDO CANDUSSI, Technical Director, Ente Radio Trieste, Trieste; and Bernado Caprotti, Manifattura B. Caprotti, Milan; and Giuseppe Fidecaro, Physicist, Istituto di Fisica, Citta Universitaria, Rome.

CREDIT — The general concept of the TYPE 1652-A D-C Limit Bridge was suggested by C. A. Tashjian, Foreman of the Variac Department, as a result of experience with a similar development at the Research Construction Company during World War II. Development and design were carried out by D. B. Sinclair and A. M. Eames, mechanical design by H. C. Littlejohn.

THE General Radio EXPERIMENTER is mailed without charge each month to engineers, scientists, technicians, and others interested in communication-frequency measurement and control problems. When sending requests for subscriptions and address-change notices, please supply the following information: name, company address, type of business company is engaged in, and title or position of individual.

GENERAL RADIO COMPANY

275 MASSACHUSETTS AVENUE

CAMBRIDGE 39

MASSACHUSETTS

TELEPHONE: TRowbridge 6-4400

BRANCH ENGINEERING OFFICES

NEW YORK 6, NEW YORK
90 WEST STREET
TEL.—WOrth 2-5837

LOS ANGELES 38, CALIFORNIA
1000 NORTH SEWARD STREET
TEL.—Hollywood 9-6201

CHICAGO 5, ILLINOIS
920 SOUTH MICHIGAN AVENUE
TEL.—WAbash 2-3820