

General Radio EXPERIMENTER

VOLUME XVI No. 12

MAY, 1942

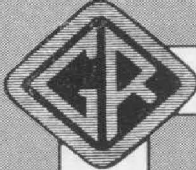

ELECTRICAL MEASUREMENTS AND THEIR INDUSTRIAL APPLICATIONS

THE TYPE 727-A VACUUM-TUBE VOLTMETER A PORTABLE BATTERY-OPERATED INSTRUMENT

Also
IN THIS ISSUE

	<i>Page</i>
DIELECTRIC STRENGTH TESTS WITH THE VARIAC.....	5
BROADCAST EQUIPMENT.....	6
HAVE YOU ANY IDLE INSTRUMENTS?...	7
SERVICE NOTES—ERRATA.....	8
MISCELLANY.....	8

● FOR A LONG TIME there has been need for a general purpose vacuum-tube voltmeter which was battery operated and truly portable. The TYPE 726-A instrument, introduced in 1937, has filled the need for an instrument of the laboratory type where line power is available, but is often inconvenient for field work on account of its size

and the required line connection. The new TYPE 727-A Vacuum-Tube Voltmeter is designed particularly for use in the field.

Both the new instrument and the older TYPE 726-A operate from the lowest audio frequencies up through the moderately high radio frequencies beyond 100 megacycles. Both are intended to cover as wide a voltage range as is reasonably practicable over such a wide frequency band. The different power supplies

FIGURE 1. View of the voltmeter with cover open.

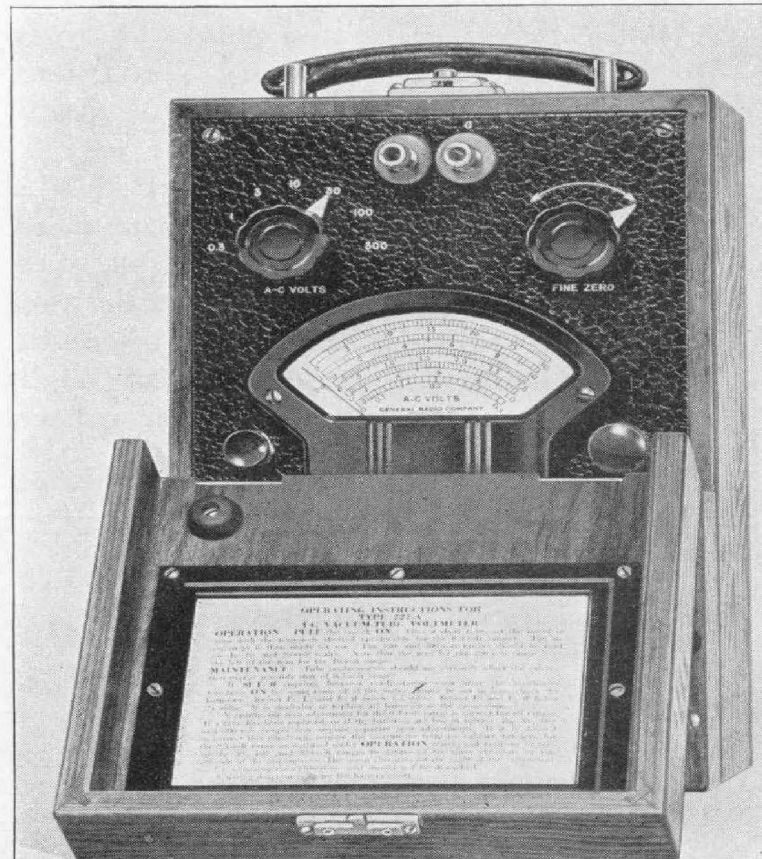

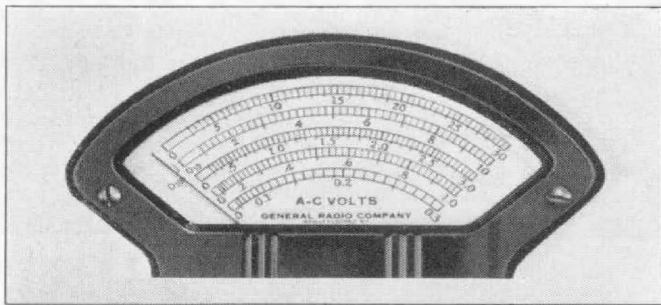

FIGURE 2. Close-up view of the meter scale.

and the size and weight considerations, however, result in somewhat different design compromises in the two cases.

In the new portable meter the stability of the battery power supply, in comparison with that of the regulated power-line supply of the older instrument, makes it possible to increase the sensitivity substantially without fluctuations or zero drift becoming bothersome. The most sensitive range gives full scale deflection on only 300 millivolts with 50 millivolts easily readable. On the TYPE 726-A Meter the most sensitive range is 1.5 volts full scale, and 0.1 volt is the lowest calibrated point. The new instrument is particularly convenient where readings of the order of a few tenths of a volt are to be made.

In the high-voltage direction the range of the new portable instrument extends to 300 volts without the use of an external multiplier, in place of the previous 150-volt limit. This two-to-one increase is obtained with a possible slight loss in accuracy on the higher ranges,

because a high-resistance voltage divider is employed in the d-c output circuit of the diode rectifier. Without this divider the voltage that can be measured is limited essentially by the B-supply voltage available, which must be made as low as possible in a battery-operated instrument to save weight. Since the expedient of a d-c voltage divider is made necessary in any event to reduce the battery requirements, it has been taken advantage of, within the limit set by the voltage rating of the rectifying diode, to increase the high-voltage limit of the instrument.

On the 0.3, 1, 3, and 10-volt ranges the sensitivity is largely determined by wire-wound resistances of relatively low value. The high-resistance voltage divider above referred to is used on the 30, 100, and 300-volt ranges only. The limits of accuracy of these upper three ranges are given as 5% of full scale instead of the 2% limit for the 1, 3, and 10-volt ranges, to allow for possible slow or seasonal drift in the divider ratio. Experience indicates that this allowance is conservative. In any event the maximum accuracy of 2% can be realized also on the high ranges if the setting of the internal calibration adjustments for these ranges can be checked occasionally.

In the new instrument the separate probe has been omitted to save space, and the rectifier circuit has been built into a compartment in the instrument, adjacent to the terminal posts. A con-

FIGURE 3. Schematic circuit diagram of the TYPE 727-A Vacuum-Tube Voltmeter.

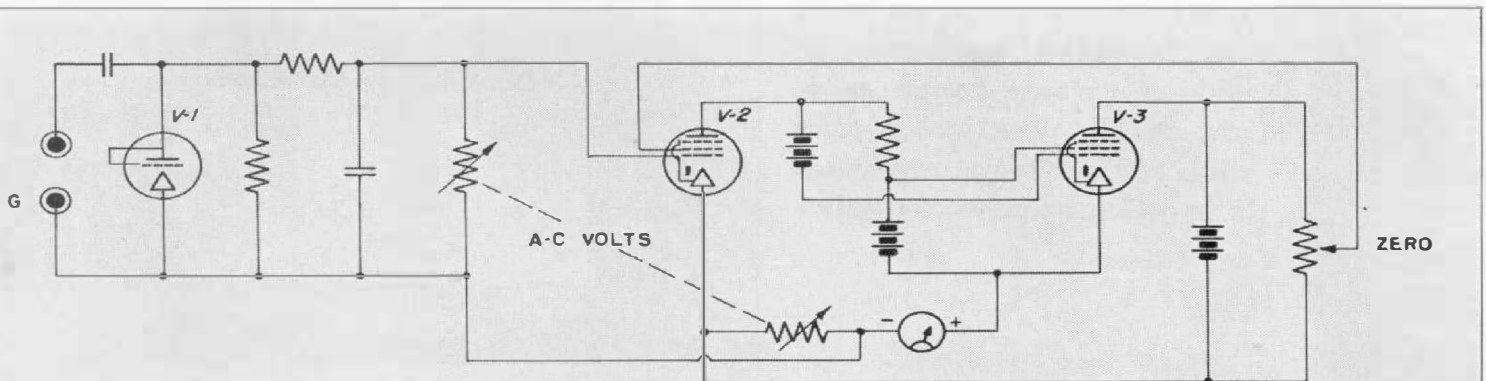

struction has been worked out which gives a resonant frequency for the input loop only slightly lower than for the separate probe arrangement. The probe type of construction raises the upper frequency limit slightly and has also proved convenient in permitting the measuring circuit to be located at the point where the voltage is to be determined. On the other hand, the very small size of the new instrument makes this construction unnecessary for many applications, and many experimental set-ups can be arranged to make the reference point of the circuit at the meter terminals.

The transit time error is slightly less in the new instrument than in the TYPE 726-A. Consequently the frequency correction varies less with voltage over the range covered by the instrument. A single correction factor for frequency, therefore, can be applied for all voltage readings at a given frequency. The frequency correction curve for the new instrument is shown in Figure 4 in comparison with that for the TYPE 726-A Voltmeter. Although the latter instrument can be used at somewhat higher frequencies, the correction is less convenient to apply if a wide range of voltages is to be covered.

One sacrifice in the new instrument is in regard to the input capacitance. This is 16 $\mu\mu\text{f}$, or more than double that obtained with the separate probe construction. Figure 5 shows the resistive and reactive components of the input impedance as functions of frequency. It will be seen that the parallel resistive component has dropped to approximately 100,000 ohms at 20 megacycles. In many applications the parallel capacitance component can be taken care of by slight retuning. The losses are negligible for most ordinary applications but can be taken into account if desired.

Several improvements of design con-

tribute materially to the convenience of operation of the instrument. Five scales are employed on the meter face for the seven voltage ranges, slight offsetting of the zero permitting the two highest voltage ranges to be read on the scales of the ranges below them. The five scales are printed alternately red and black, which materially reduces the eye-strain and effort involved in concentrating attention on any one scale.

Another improvement is that a circuit modification permits the zero of all four of the most sensitive ranges to be set by a single adjustment, thus obviating the use of any compensating arrangement which might get out of adjustment in time. The three highest

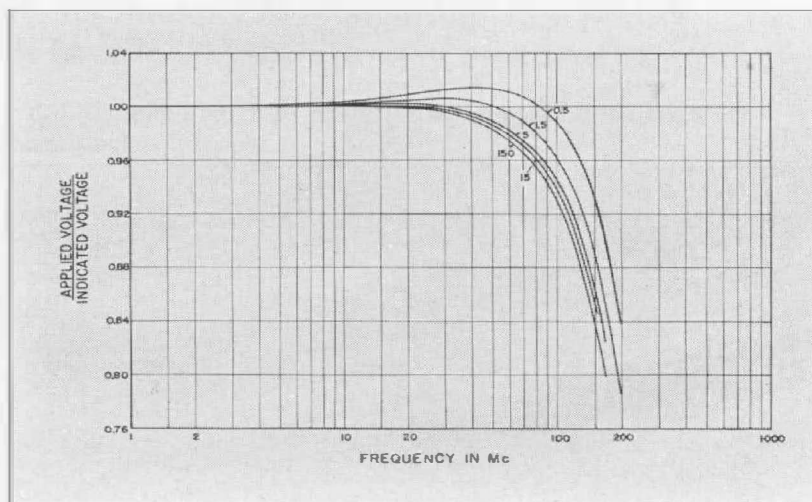
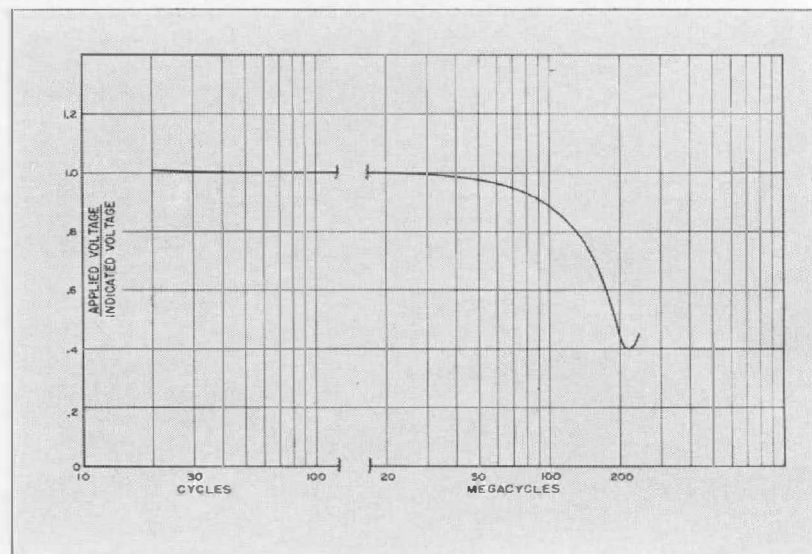

FIGURE 4a (above). Frequency characteristics of the older TYPE 726-A Vacuum-Tube Voltmeter.

FIGURE 4b (below). Frequency characteristics of the new TYPE 727-A Vacuum-Tube Voltmeter.



ranges of the instrument, however, still rely on the compensation method for zero alignment, but, since these ranges are the least sensitive, inconvenience seldom results.

The size and weight will be seen from the specifications to be very much reduced. The battery complement, giving a life of approximately 250 hours of intermittent operation, consists only of three 1.5-volt filament batteries and two 30-volt plate batteries. This results not

only in light weight, but in usually low replacement cost.

It is felt that, where size and weight considerations are important, as well as for those cases where battery operation is required, the new instrument will fill an important need in the vacuum-tube voltmeter field.

In appearance and general construction, the new voltmeter resembles the TYPE 729-A Megohmmeter previously described.* — W. N. TUTTLE

*W. N. Tuttle, "A Portable Megohmmeter," *Experimenter*, Vol. XV, No. 2, July, 1940.

SPECIFICATIONS

Range: 0.05 volt to 300 volts ac, in seven ranges (0.3, 1, 3, 10, 30, 100, 300 volts, full scale).

Accuracy: For sinusoidal voltages, $\pm 3\%$ of full scale on the 0.3-volt range;

$\pm 2\%$ of full scale on the 1, 3, and 10-volt ranges;

$\pm 5\%$ of full scale on the 30, 100, and 300-volt ranges (see text for a discussion of the accuracy of these ranges).

FIGURE 5. Input impedance of the TYPE 727-A Vacuum-Tube Voltmeter as a function of frequency.

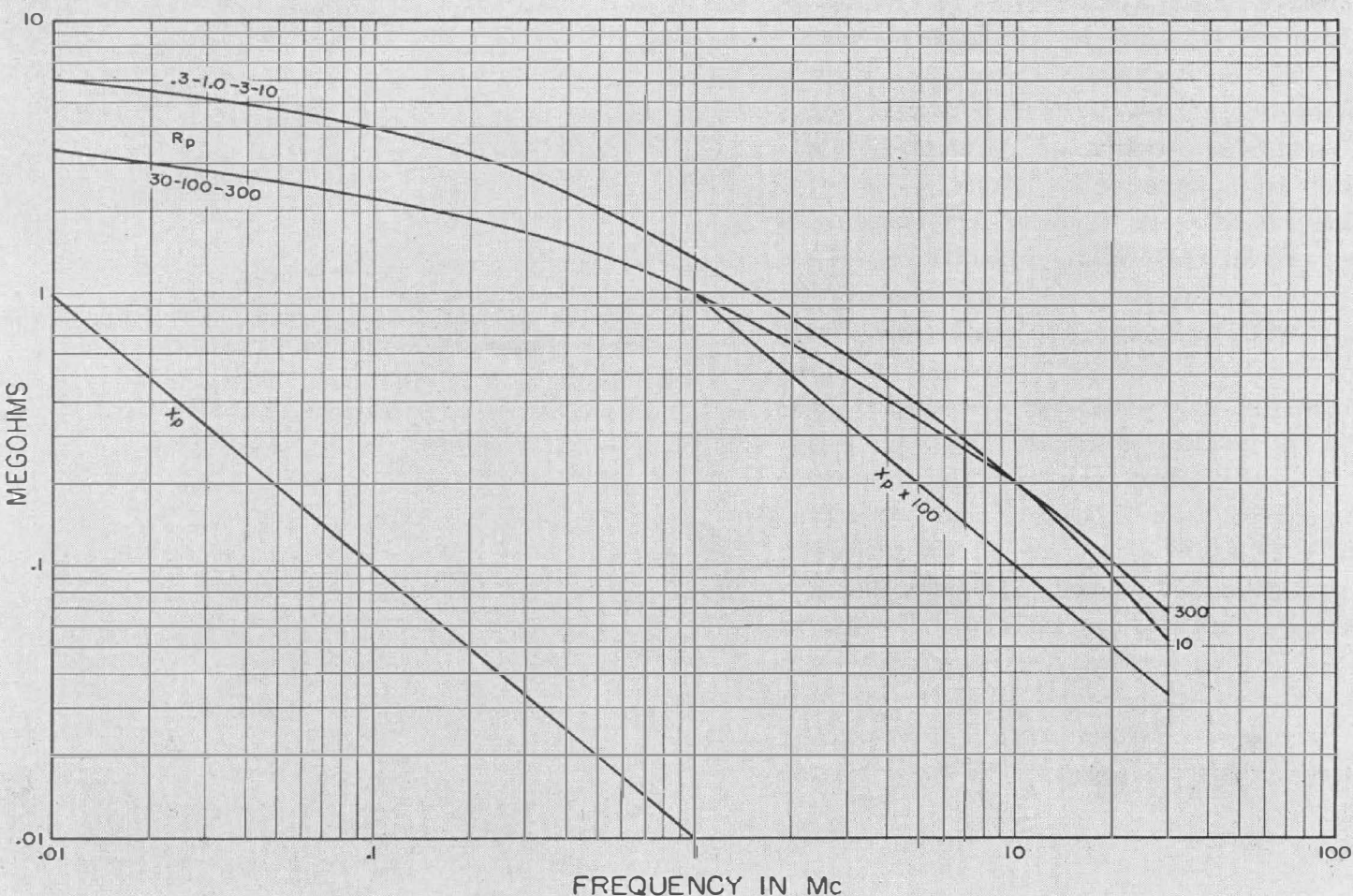

Waveform Error: The instrument is calibrated to read the r-m-s value of a sinusoidal voltage. On the higher voltage ranges, however, it is essentially a peak reading device, calibrated to read 0.707 of the peak value of the applied voltage, and on distorted waveforms the percentage deviation of the reading from the r-m-s value may be as large as the percentage of harmonics present. On the lowest ranges the instrument approximates a true square-law device.

Frequency Error: Less than 1% between 20 cycles and 30 Mc. At higher frequencies, the error is about +5% at 65 Mc and about +10% at 100 Mc.

Input Impedance: The input capacitance is approximately 16 μf . The parallel input resistance (at low frequencies) is about 5 megohms on the lower ranges and about 3 megohms on the 30, 100, and 300-volt ranges. The curves of Figure 5 give the variation of R_P and X_P with frequency.

Temperature and Humidity Effects: Over the normal range of room conditions (65° Fahrenheit to 95° Fahrenheit; 0 to 95% relative

humidity) the accuracy of indication is substantially independent of temperature and humidity conditions. Somewhat reduced accuracy may be expected, however, if the instrument is subjected to extremes of temperature.

Zero Adjustment: A zero adjustment is provided on the panel. The setting is the same for all ranges.

Vacuum Tubes: Two 1S5 tubes and one 957 tube are used and are supplied with the instrument.

Batteries: Two Burgess W20P1, one Burgess W5BP, and three Burgess 2F batteries are required, and are supplied with the instrument. Battery life is approximately 250 hours of intermittent operation.

Mounting: The instrument is supplied in a walnut case with cover and is mounted on an engraved black crackle-finish aluminum panel.

Dimensions: 11 x 6 $\frac{5}{8}$ x 5 $\frac{7}{8}$ inches, over-all (cover closed).

Net Weight: 10 $\frac{7}{8}$ pounds, including batteries.

Type	Code Word	Price
727-A Vacuum-Tube Voltmeter.	PIGMY	\$115.00

The TYPE 727-A Vacuum-Tube Voltmeter does not replace the TYPE 726-A. The two instruments are designed for

different fields of application and both will be available. — EDITOR

DIELECTRIC STRENGTH TESTS WITH THE VARIAC

● IN TESTING THE DIELECTRIC STRENGTH (or "break-down strength") of electrical insulating materials, it has been found that the apparent strength varies greatly with the rate at which the test voltage is applied to the specimen. If it is desired to establish significant commercial specifications, it is obviously necessary to specify the rate and method of increase; otherwise no common basis for acceptance or rejection of materials can be had. Accordingly, one of the A.S.T.M. Standard Tests* for electrical insulating materials at standard power frequencies calls for a *uniform* increase of voltage until break-down is reached. The actual rate of in-

crease will depend on the type of insulation under test; for rubber-insulated cables, for instance, 3 kv per second is specified.

Of the various available means of varying the test voltage, a Variac in the primary of the high-voltage transformer is probably the most satisfactory and convenient. With the Variac a constant rate of rotation of the control wheel gives a constant rate of rise of voltage; furthermore, the voltage at any point is independent of the load, so that variations in the charging and leakage currents drawn by the specimen do not affect the voltage-vs.-time characteristic. All of the other commonly accepted methods of voltage control lack one or both of these features, making it vir-

*"Tests for Dielectric Strength (D149-40T)," A.S.T.M. Standards on Electrical Insulating Materials, December, 1941.

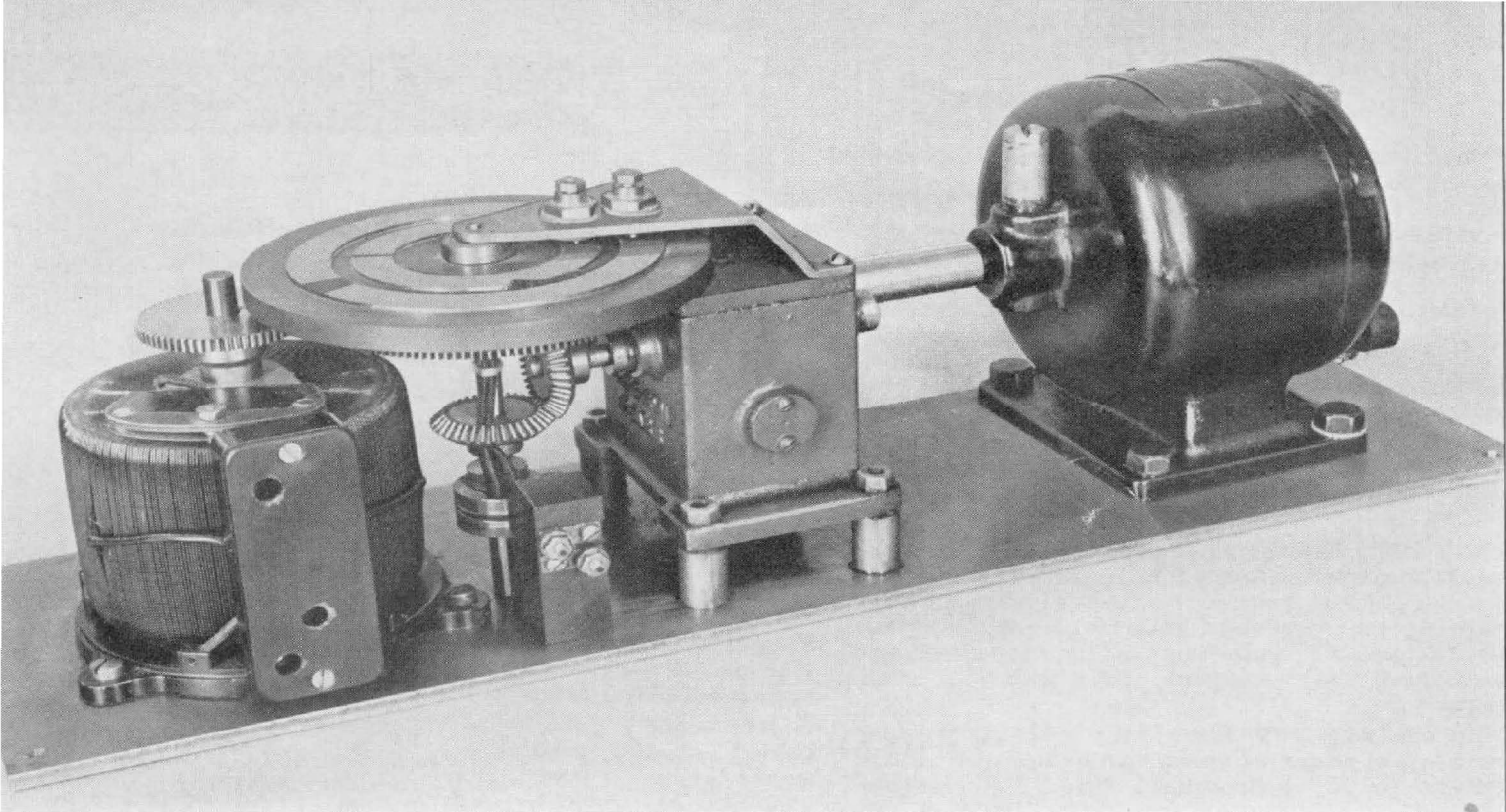

View of a motor-driven Variac with automatic limit attachment.

tually impossible to maintain the desired *uniform* increase of voltage. For these reasons the Variac has been widely used for voltage control in dielectric strength testing of all kinds.

Even with the Variac, however, a motor drive should be used; for tests have indicated that it is virtually impossible to rotate the Variac manually at a specified rate. The accompanying photograph, which is taken from the appendix to the specification mentioned above, shows a motor control arrangement incorporating automatic limit features.

A small direct-current motor (C) drives the TYPE 200-C Variac (A) through the reduction gears (B). The speed of the motor may be varied by

means of a resistor in the armature circuit. For any given testing transformer, this resistor may be calibrated in terms of rate of voltage rise, thus facilitating the adjustment to the desired value. The reversing switch for the motor is so arranged that in the reverse position the armature resistor is out of circuit, and the Variac is returned to zero setting at maximum speed.

The motor-operating circuit is automatically opened at either end of the range of Variac rotation by means of segments mounted on the insulating disc.

The General Radio Company is not in a position to supply motor-driven Variacs at the present time. This article is published only to acquaint readers with an interesting use of the Variac.

B R O A D C A S T E Q U I P M E N T

● WE ARE VERY SORRY to have to announce to our many customers in the broadcast engineering field that, owing to the increasingly rigid priority

restrictions on both the buying and selling of raw materials and completed instruments, we have been compelled to restrict the sale of monitoring and meas-

uring equipment to the broadcast industry very materially. This we do most reluctantly as we fully realize the importance of broadcasting to the war effort and to public morale, but the priority regulations are beyond our control.

Our policy on the sale of broadcast equipment is necessarily determined by these regulations. Instruments whose sole uses are in broadcasting will not be available after our present stock is exhausted, because the priority ratings available to most broadcasting stations are not sufficiently high to enable us to obtain materials for their manufacture. Broadcast instruments which are used also by the military services and for war production will still be manufactured, but they can be sold for broadcast use only in those instances where a high priority can be obtained.

Government policy about broadcast equipment is indicated by the following quotation from an FCC bulletin. It is by this policy, made after consideration of the over-all conditions, that we must all be governed.

“PRELIMINARY CURB ON BROADCAST ANTENNAS”

“At the request of the Defense Communications Board, pending the adoption of a specific policy by that Board

and the War Productions Board with respect to curtailing standard broadcast construction to meet materials requirements by the military, the Federal Communications Commission will make no further grants for the construction of new standard broadcast stations or authorize changes in existing standard broadcast transmitting facilities where all or a substantial part of the primary area in either category already receives good primary coverage from one or more other stations.

“In general the Federal Communications Commission’s Standards of Good Engineering Practice will be used as a guide in the determination of good primary service.

“National defense requires that there be adequate broadcast facilities, but this does not alter the fact that every economy in the use of critical materials for securing and maintaining these facilities must be practiced to the end that there will be the greatest possible saving in materials. Today’s announcement concerns standard broadcast facilities only. It is understood that the Defense Communications Board is proceeding with studies looking toward the conservation of materials in all other radio services and will submit recommendations at the earliest practicable date.”

HAVE YOU ANY IDLE INSTRUMENTS?

● WHILE PRACTICALLY ALL GENERAL RADIO INSTRUMENTS are urgently needed for war purposes, occasionally we are confronted with what might be termed a super-urgent need for a single instrument, the lack of which will delay the completion of a number of other projects. In these cases,

we make every effort to speed up our own production, but this is not always possible. At times we have even borrowed an instrument from one customer to help out another temporarily.

If you have any current-model General Radio instruments in good operating condition that are not being used, you

can help the war effort materially by letting us know about them. We can then refer prospective users directly to

you. Most urgently needed are such items as standard-signal generators, oscillators, bridges, wave analyzers, noise meters, and other general-purpose instruments.

SERVICE AND MAINTENANCE NOTES — ERRATA

● **THE INEVITABLE SPRINKLING OF ERRORS** in the first printing of our Service and Maintenance Notes has been discovered, and those which have thus far been brought to our attention are listed below.

Please check your copy and make corrections if necessary.

Type 620-A Heterodyne Frequency Meter and Calibrator

Paragraph 4.2 should read as follows:

If the plate current milliammeter reads about 6.5 and 2.5 with the switch in the HET and CAL positions, respec-

tively, both tubes are oscillating normally. Should this read higher, it would

Type 650-A Impedance Bridge

In the first mailing, pages 3 and 4 were missing. These will be sent on request.

Type 760-A Sound Analyzer

Paragraph 6.4, line 1; for R-28, read R-38.

Type 736-A Wave Analyzer

Paragraph 5.2, line 3; for V-7, read V-8.

Page 2, line 1; for 300, read 0.3.

MISCELLANY

● **A PAPER** entitled "Impedance Measurements from 1 to 100 Megacycles" was presented recently by R. F. Field at meetings of the Springfield (Mass.), Washington, and Detroit Sections of the Institute of Radio Engineers. In 1941, this paper was also presented at meetings of the Toronto, St. Paul, and Chicago Sections.

Another paper entitled "The Polarization Parameters of Several Solid Dielectrics and Their Changes with Temperature and Composition" was delivered by Mr. Field at the National Research Council Conference on Electrical Insulation at Williamsburg, Va., last October. This paper was also pre-

sented at two sectional meetings of the American Physical Society at Worcester, Mass., in March, 1942, and at Baltimore, Md., in May. A similar paper entitled "The Behavior of Dielectrics over Wide Ranges of Frequency and Temperature" was given by Mr. Field before the Boston Section of the I.R.E. on April 23, 1942.

We hope to publish these papers in forthcoming issues of the *Experimenter*.

● **WE STILL** have a supply of the cardboard Q-vs.-frequency templates mentioned in the article on iron-cored coils by McElroy and Field, which appeared in the March *Experimenter*. We shall be glad to send one to any reader who requests it.

GENERAL RADIO COMPANY

30 STATE STREET - CAMBRIDGE A, MASSACHUSETTS

BRANCH ENGINEERING OFFICES

90 WEST STREET, NEW YORK CITY

1000 NORTH SEWARD STREET, LOS ANGELES, CALIFORNIA