

General Radio EXPERIMENTER

VOLUME XVI No. 8

JANUARY, 1942



ELECTRICAL MEASUREMENTS AND THEIR INDUSTRIAL APPLICATIONS

AN A-C-OPERATED POWER SUPPLY FOR THE SOUND-LEVEL METER

<i>Also</i>	
IN THIS ISSUE	
	<i>Page</i>
IMPEDANCE BRIDGES ASSEMBLED FROM LABORATORY PARTS — PART VII	4
A 500,000-OHM RHEO- STAT POTENTIOM- ETER	7

● MANUFACTURERS OF SOUND-LEVEL METERS are generally divided on the subject of a-c operation versus battery operation. For portable use, battery operation is almost essential. For stationary operation or use only indoors, where power lines are available, a-c operation has some advantages, while for production work, where continuous operation is required, the a-c power supply has a distinct advantage in

that it eliminates the need for frequent replacement of batteries.

It is apparent that, for really universal application, a sound-level meter should be capable of operation either from the a-c power line or from batteries. However, since conventional tube types do not operate equally satisfactorily on both alternating current and small, portable dry cells, and because high-gain amplifiers represent a serious problem in regard to hum elimination when a-c operated, most sound-level meters have been designed for ei-

FIGURE 1. View of the power-supply unit installed in the battery compartment of the sound-level meter cabinet.

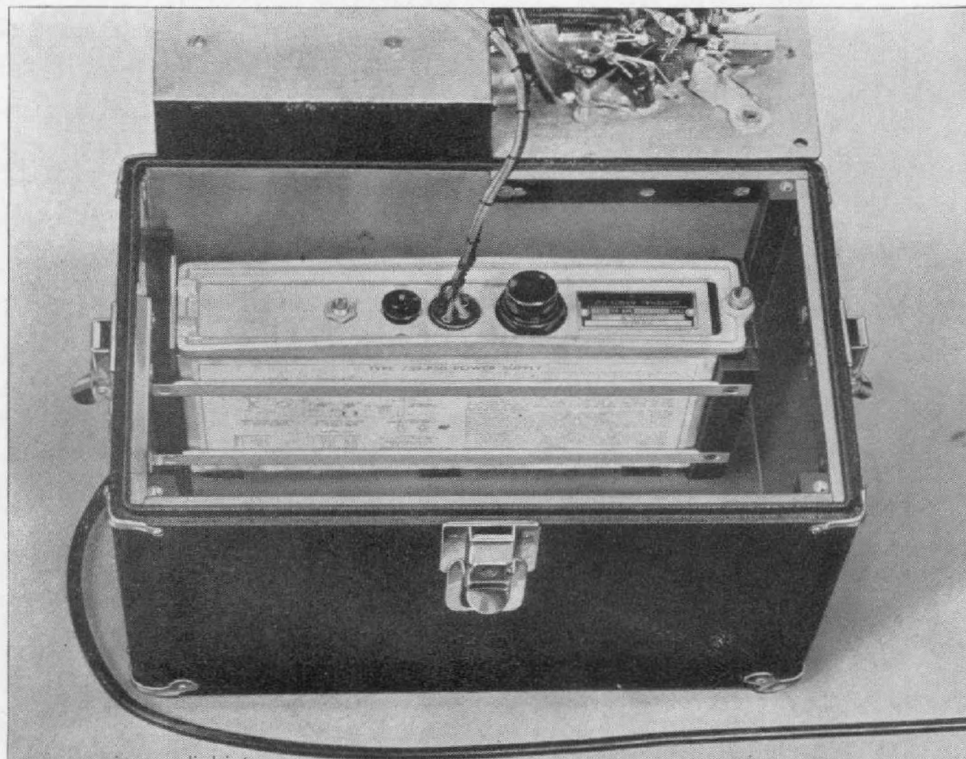

ther one or the other type of power supply, but not for universal operation. This seriously restricts the use of any such instrument. Many engineers and laboratories have need for only one sound-level meter and are somewhat at a loss, therefore, as to which type will best suit their requirements.

A logical answer to this problem is provided by the new TYPE 759-P50 Power Supply developed by the General Radio Company for use with its TYPES 759-A and 759-B Sound-Level Meters. In keeping with the company's policy of retarding obsolescence so far as possible, the power supply can be used with the earliest meters in the 759 series as well as the latest. It is small, light, and compact and fits directly in the battery compartment of the sound-level meter in place of the batteries.

The power supply includes an oxide rectifier and suitable filter circuits which supply either 3 or 1.5 volts for operation of the two filaments (depending, respectively, upon whether an A-type or B-type sound-level meter is used). The unit includes also a vacuum-tube rectifier and filter for supplying suitable plate voltage.

Hum level in the power supply has been kept so low that the TYPE 759-B Sound-Level Meter can be used over its entire sensitivity range with this new power supply. The TYPE 759-A Meter can be used down to 34 decibels, which is entirely adequate for most machinery problems such as are encountered in production testing.

In designing the new power supply, an interesting problem was encountered in the development of a suitable filter for the filament circuit. Because of the high gain of the sound-level meter amplifier and the fact that filament-type tubes,

originally intended only for battery operation, are used, it was found that small line-voltage fluctuations would momentarily shift the gain, causing fluctuation in the reading of the meter. While high-capacity electrolytic condensers satisfactorily eliminated all ripple frequencies from the filament voltage, some low-frequency variations were present, particularly with a poorly regulated or noisy power-supply line. The final solution was to use two flashlight cells in the last stage of the filter in place of a condenser. These function satisfactorily as a condenser, but also have the additional advantage that they maintain substantially constant voltage. When used with the TYPE 759-B Sound-Level Meter the cells are connected in parallel, and when used with the A-type they are connected in series. This transformation is accomplished by a simple plug which is inserted into a socket on the top of the power-supply unit.

When the instrument is operating, the cells are charging slightly, so that their life is practically equal to their normal shelf life. When the instrument is turned off, a small relay, built as part of one of the filter chokes, opens the circuit so that the cells will not run down. The cells are of the standard flashlight variety, readily replaceable, and cost only ten cents each. However, under normal line-voltage conditions, their life is six months, a year, or even longer.

The convenience of the power supply is its outstanding feature. At any time it is possible to interchange power supply and batteries immediately without any rewiring or circuit changes. This makes the same sound-level meter readily adaptable for production testing or field work and is a real source of economy in laboratories requiring only one meter.

No alterations to the sound-level

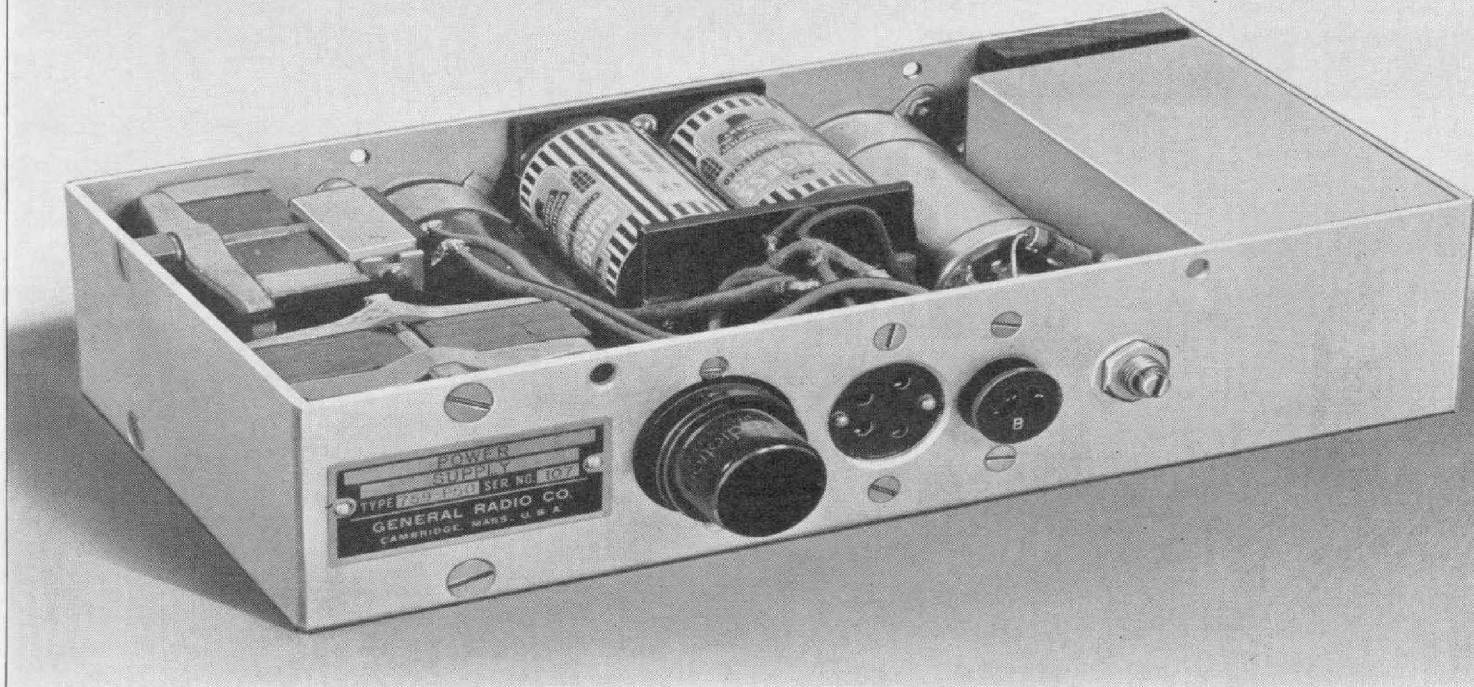

FIGURE 2. View of the power-supply unit showing the compact arrangement of parts.

meter are necessary when the power supply is installed in a TYPE 759-B Sound-Level Meter, and only minor changes are required for the TYPE 759-A.

Complete directions and a kit of parts

are supplied with each power unit so that these alterations can be easily made by the user. It is not necessary to return the instrument to the factory.

— H. H. SCOTT

SPECIFICATIONS

Output: 1.5-volt and 3-volt filament supplies; 90-volt plate supply.

Hum and Noise Level: Sufficiently low to assure satisfactory operation over the entire range of the TYPE 759-B Sound-Level Meter when the supply-line frequency is 60 cycles. On the TYPE 759-A Sound-Level Meter, satisfactory operation is obtained on all ranges except at the 60 db attenuator setting, provided the a-c line frequency is 60 cycles. Operation from line frequencies below 60 cycles is possible, but is not recommended.

Input: 105 to 125 volts, 40 to 60 cycles. The power input is less than 8 watts at 115 volts, 60 cycles.

Tube: One type 6H6 tube is supplied.

Terminals: An output socket fits the plug on the battery cable of the TYPE 759-B Sound-Level Meter.

Dimensions: (Length) 10 x (width) 2¼ x (depth) 5 inches, over-all.

Net Weight: 7 pounds, 6 ounces.

Type	Code Word	Price
759-P50	A-C Power Supply	NUTTY
		\$55.00

PRIORITIES

Because practically all of our manufacturing facilities are devoted to National Defense projects, a preference rating certificate or other approved priority rating will be necessary to secure delivery. At the present time a rating of A-10 or higher is required for delivery of all instruments and parts, but for certain items in especially heavy demand a rating of A-2 or higher may be necessary to insure reasonable delivery.

IMPEDANCE BRIDGES ASSEMBLED FROM LABORATORY PARTS

PART VII—MEASUREMENT OF DIRECT CAPACITANCE*

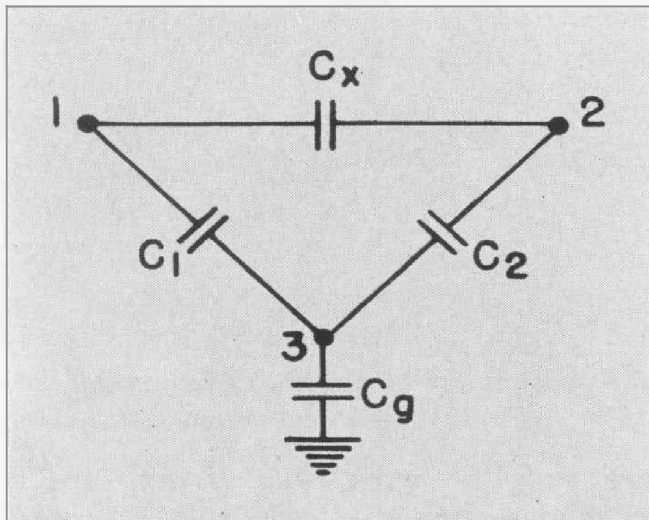

FIGURE 1. Representation of a capacitor which has, in addition to its direct capacitance (C_x), capacitance from each terminal to a third terminal. The third terminal can represent a shield, which itself has a capacitance to ground.

● **ANY CAPACITOR** which does not have one of its terminals grounded is effectively a three or four-terminal impedance. In addition to the desired capacitance between terminals, there exist stray capacitances from each terminal either to ground or to a shield, which has a capacitance to ground. The situation is illustrated in Figure 1. Since measuring circuits of the type under discussion are grounded at some point, consideration must be given to these capacitances when it is desired to measure the direct capacitance between terminals 1 and 2. In many practical cases, of course, the extraneous capacitances are negligible compared to the desired direct capacitance, and accurate measurements can be made simply by connecting terminals 1 and 2 to the measuring circuit. When C_1 , C_2 , and C_g are of the same order of magnitude as C_x , however, a direct

measurement can obviously not be made. If, however, the terminal impedances are large compared to the bridge arms, it is possible to connect the third terminal to the bridge in such a manner that the terminal impedances and the direct impedance are separated, and the latter can be measured subject only to the errors caused by the effect of the terminal impedances placed across the bridge arms. A few typical measurements of this sort are illustrated in Figure 2. Figure 2 (a) shows a three-terminal condenser connected to a capacitance bridge, the junction of whose capacitance arms is grounded. As shown, the third terminal is connected to the junction of the ratio arms, placing C_2 across the arm B , and placing C_1 in parallel with C_g across opposite corners of the bridge, where they do not influence the balance. The presence of C_2 across the arm B causes the dissipation factor reading of the bridge to be high by an amount $R_B \omega C_2$. The bridge reads correctly for C_x unless C_2 is sufficiently large to bring in the terms which are normally neglected in the simplified balance equations, or unless the losses and leakage in C_2 are sufficient to reduce appreciably the effective parallel resistance of the B arm.

In Figure 2(b) the third terminal is connected to the junction of the A and N arms. Here C_2 is effectively removed from circuit, while C_1 and C_g parallel the standard condenser, causing a direct

*Much of the material discussed in this installment has appeared in previous *Experimenter* articles and elsewhere, but is included here for the sake of completeness of the current series.

error in the capacitance balance, the magnitude of which depends on the ratio $\frac{C_1 + C_g}{C_N}$. The dielectric losses associated with C_1 and C_g increase the effective dissipation factor of the standard arm. Consequently the dissipation factor reading of the bridge is low, and may easily become negative.

If the third terminal is ground (C_g infinite in Figure 1), a direct measurement of C cannot be made with a bridge that is grounded at the junction of the capacitance arms, since the direct capacitance is paralleled with one of the terminal capacitances when it is connected to the bridge. By making three sets of measurements, however, with successive pairs of the three capacitances connected in parallel, data can be obtained from which the constants of the terminal capacitances as well as the direct capacitances can be computed.¹

With a bridge grounded at any point other than one side of the unknown, the direct measurement can be made even when the third terminal is itself grounded. This is illustrated by Figure 2(c), wherein the junction of the ratio arms is grounded. With this connection the capacitance C_2 is placed across arm B , introducing an error of $R_B\omega C_2$ in the dissipation factor balance. Figure 2(d) shows a fourth arrangement, wherein the bridge is grounded at the junction of dissimilar arms. With the third terminal connected between the ratio arms, C_2

parallels the B arm and the ground capacitance C_g parallels the A arm, while C_1 does not affect the measurement. Under these conditions the error in the dissipation factor caused by the presence of the extraneous capacitances is $(R_B\omega C_2 - R_A\omega C_g)$, while the capacitance balance is substantially correct.

As is the case with most impedance measurements, somewhat better accuracy can generally be obtained by the use of a substitution method, as indicated in Figure 3. If, as is customary, the disconnection is made at the high side of the N arm, an error equal to $A\omega C_1$ is introduced in the dissipation factor reading by the capacitance C_1 being placed across the A arm when the connection is made. If, on the other hand, the disconnection is made at the ground side, the capacitance C_1 is across the A arm for both balances, and the change in the capacitance shunting R_A is $\frac{C_X C_2}{C_X + C_2}$. Thus the error encountered in the dissipation factor measurement is different for the two methods of disconnection. The best method can be determined only by a consideration of the relative magnitudes of C_X , C_1 , and C_2 .

GUARD CIRCUITS

If direct measurements, independent of the terminal capacitance, are desired, the measuring circuits and procedure must necessarily be made more complex. This is commonly done by means of Wagner grounds, guard circuits, and

¹R. F. Field, "Direct Capacitance and Its Measurement," General Radio *Experimenter*, Vol. VIII, No. 6, November 1933.

FIGURE 2. Showing various methods of connecting the capacitance network of Figure 1 into a bridge, to obtain a measurement of C_X .

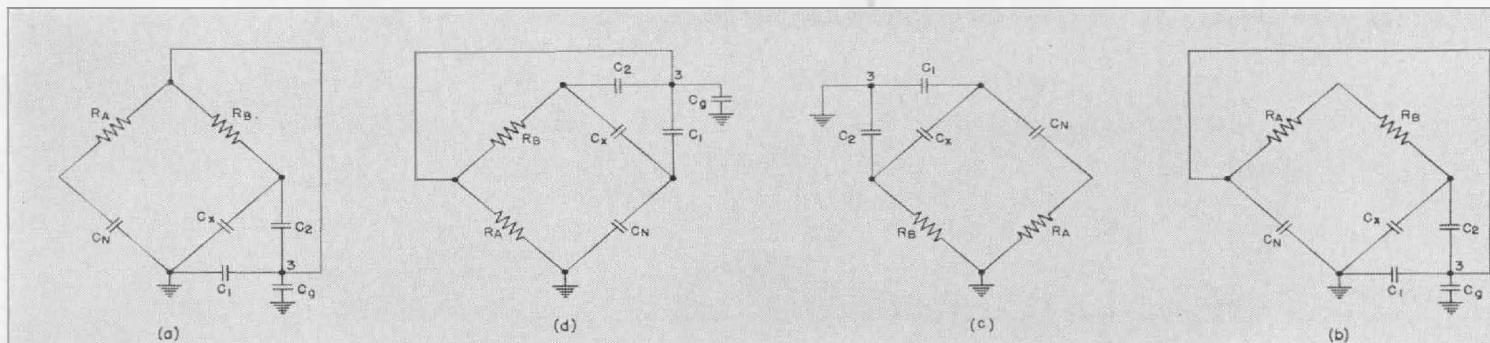

similar arrangements which provide an auxiliary circuit to which the third terminal can be connected. The terminal impedances then become a part of the auxiliary circuit and are balanced out. Although a number of different arrangements are possible, they all serve essentially the same purpose — namely, to bring the third terminal of the unknown impedance to the same potential as one corner of the bridge to which it is not normally connected.²

Figure 4 illustrates an impedance bridge with all four corners coupled to a common fifth point. In spite of the presence of the four additional impedances, a true balance of the main bridge circuit can be obtained, provided that a certain relationship is maintained between the impedances of the auxiliary network and those of the bridge. These relationships are:

$$\frac{Z_A}{Z_B} = \frac{Z_N}{Z_P} = \frac{Z_S}{Z_T} \quad (1)$$

or

$$\frac{Z_A}{Z_N} = \frac{Z_B}{Z_P} = \frac{Z_F}{Z_H} \quad (2)$$

For either type of balance, four equations of balance must be satisfied, since all impedances involved are complex.

By connecting the third terminal of the unknown to the fifth, or guard, terminal the two unwanted impedances are made part of the auxiliary circuit and can be balanced out.

An excellent method of making the auxiliary balance² is to connect the generator and detector to the bridge in the usual way, and to provide a switch to connect the guard terminal to one of the corners of the bridge. This places either Z_F and Z_H or Z_S and Z_T across a pair of bridge arms. Now, the relations of Equations 1 or 2 can be satisfied by first balancing the bridge alone, and then balancing the bridge and auxiliary circuit in parallel by adjusting the auxiliary circuit. Using this method, either of the two auxiliary circuits can be balanced without changing the generator and detector connections, and with relatively simple switching arrangements.

Let us consider the arrangement of Figure 2 (d). As redrawn in Figure 5 the

²R. F. Field, "A Guard Circuit for Capacitance Bridge Measurements," *General Radio Experimenter*, Vol. XIV, No. 10, March, 1940.

FIGURE 3. Connections for a substitution measurement of C_x .

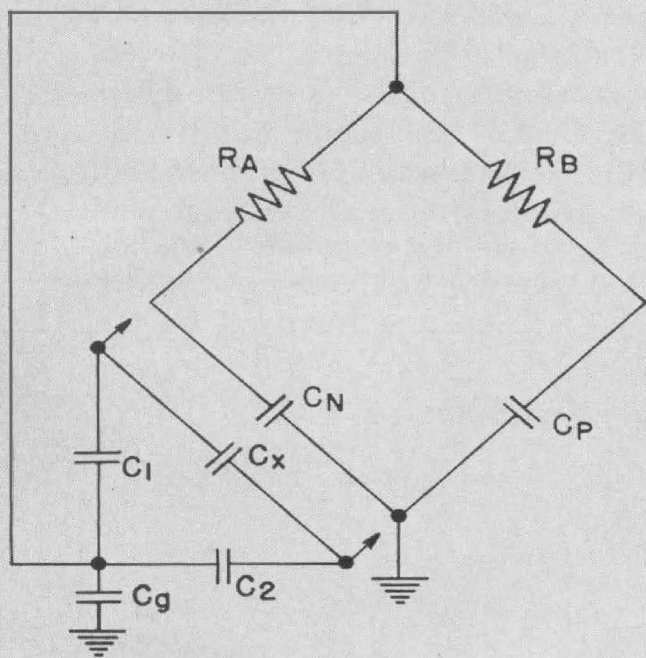
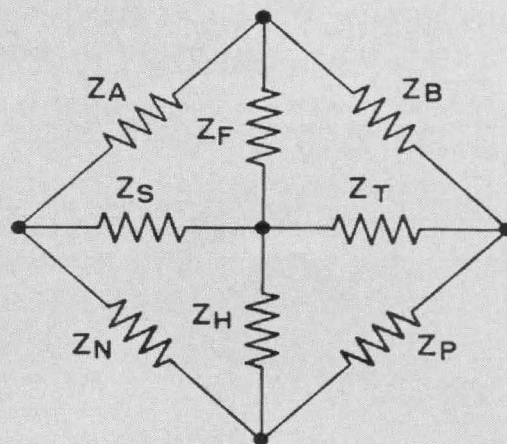

FIGURE 4. A five-terminal bridge network, showing an impedance between the fifth terminal and each corner of the bridge.



similarity to the generalized circuit of Figure 4 is apparent at once. Simply by providing an additional variable condenser across C_2 or C_g , it will be possible to balance partially the auxiliary circuit ($R_A-R_B-C_2-C_g$). As pointed out previously, both reactive and resistive balance of the auxiliary circuit must be provided for complete balance, to satisfy the expression $D_N + Q_A = D_P + Q_B = Q_F + Q_H$. It will frequently be adequate, however, to provide only for balancing the principal component of the auxiliary circuit³. Thus, in the simple case illustrated above, if C_2 and C_g are properly balanced, any unbalance of their resistive components will have only a negligible effect on the bridge balance, provided C_1 is small compared to C_N .

The guard circuit may also be used to eliminate stray impedances associated with the bridge terminals and arms, as well as those associated with the unknown, by making ground the fifth or guard terminal. The earliest and perhaps the best known of this type of circuit is the Wagner Ground, used to remove from circuit the stray capacitances to

³Balsbaugh, Howell, and Dotson, "Generalized Bridge Network for Dielectric Measurement," Trans. AIEE, 1940, pps. 950-956, has shown that, if the guard and coupling circuits are not in true balance, the error introduced in the equation of balance of the bridge is proportional to the product of the unbalances of these auxiliary circuits.

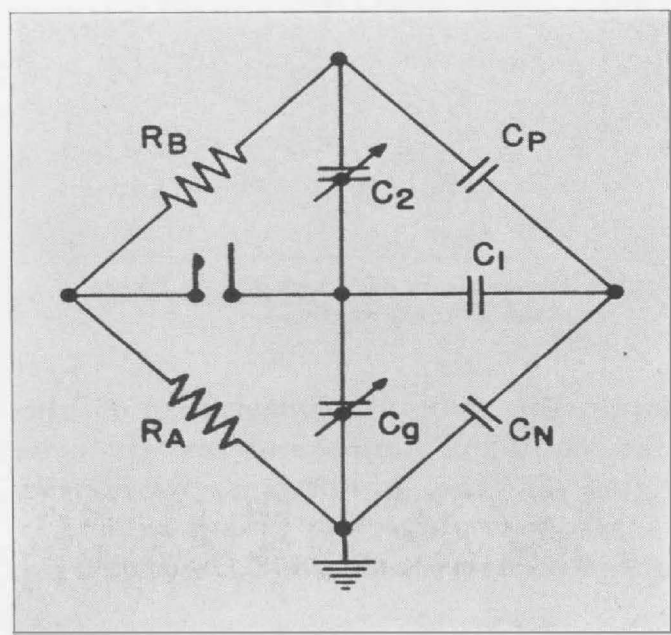

FIGURE 5. The arrangement of Figure 2 (d), redrawn to show its similarity to the generalized circuit of Figure 4.

ground of the generator terminals. As commonly used, balance is achieved by alternate adjustments of the bridge and the guard circuit, the detector being switched from one to the other. The detector may be left connected, however, and the balance made as suggested above, by adjusting the guard circuit with the bridge grounded at the junction of the ratio arms, and adjusting the bridge with this point ungrounded.

A 500,000-OHM RHEOSTAT POTENTIOMETER

● THE LATEST ADDITION TO OUR LINE of rheostat potentiometers is a large-size, high-resistance unit, TYPE 433-A, having a total resistance of 500,000 ohms.

This wire-wound variable resistor is similar in construction to other General Radio rheostat-potentiometers. Figure 1

FIGURE 1. View of TYPE 433-A Rheostat Potentiometer.

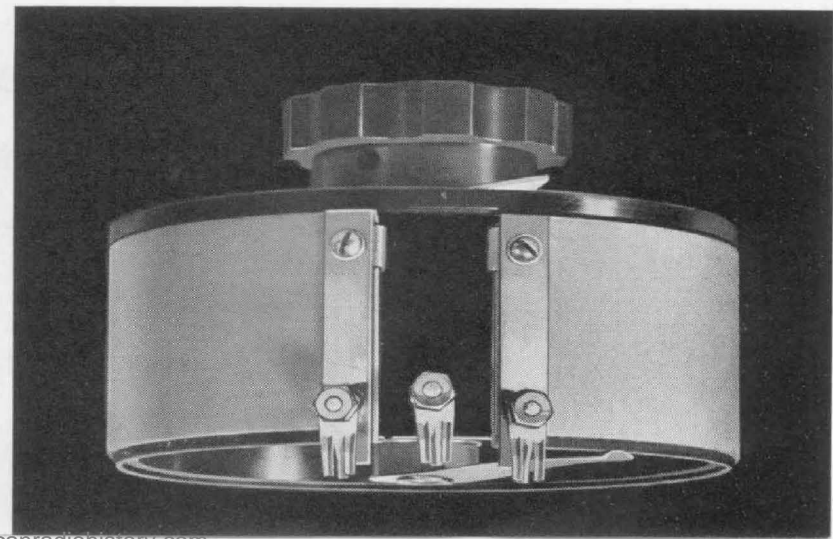

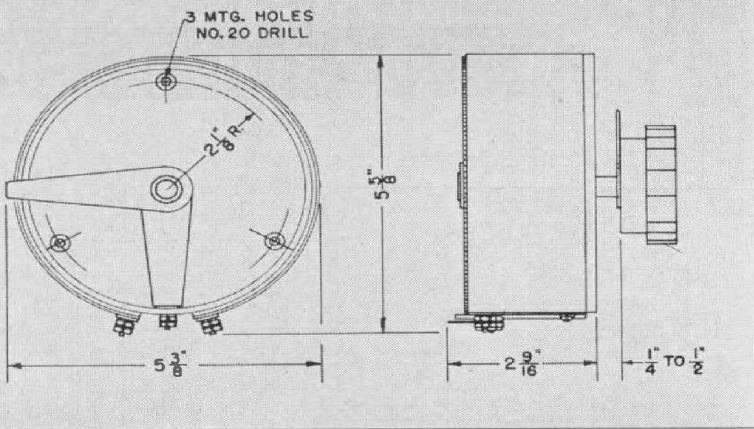

FIGURE 2. Dimensions of TYPE 433-A Rheostat Potentiometer.

shows the general appearance of the unit; complete dimensions are given in Figure 2. The winding is distributed linearly over an arc of 315 degrees and is protected from mechanical damage by a

linen bakelite cover strip. Continuous contact with the winding is maintained by a phosphor-bronze blade mounted on a $\frac{3}{8}$ -inch bakelite shaft. The control knob is a TYPE 637-Q. Connections to the ends of the winding and to the contact arm are brought out to screw terminals with 3-fingered tinned soldering lugs.

TYPE 433-A Rheostat Potentiometer is available from stock in the 500,000-ohm size only. The power dissipation for the whole winding is 25 watts, for a temperature rise of 50° to 60° Centigrade. This corresponds to a maximum current of 7 ma. The net weight of the unit is 1 pound, 2 ounces.

Type	Code Word	Price
433-A	IMBUE	\$13.50

MISCELLANY

● **THE CURRENT INSTALLMENT** of "Impedance Bridges Assembled from Laboratory Parts" concludes the series. Owing to the interest expressed in these articles, particularly by readers in engineering schools, we plan to reprint the entire series in a single booklet. Copies will be furnished free of charge to readers who request them and, if the demand warrants, they will be made available

in reasonable quantities to teachers for student use.

● **THE SERVICE AND MAINTENANCE NOTES**, originally scheduled for mailing in September, 1941, have been unavoidably delayed. Publication is nearly completed, however, and we hope to mail them during January to those who have requested them.

GENERAL RADIO COMPANY

30 STATE STREET - CAMBRIDGE A, MASSACHUSETTS

BRANCH ENGINEERING OFFICES

90 WEST STREET, NEW YORK CITY

1000 NORTH SEWARD STREET, LOS ANGELES, CALIFORNIA