

THE

General Radio EXPERIMENTER

VOLUME XIV NO. 8

JANUARY, 1940

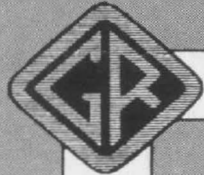

ELECTRICAL MEASUREMENTS AND THEIR INDUSTRIAL APPLICATIONS

Also

IN THIS ISSUE

ONE CYCLE PER SEC- OND FROM THE IN- VERSE FEEDBACK OSCILLATOR.....	<i>Page</i> 6
---	------------------

A BROADCAST FREQUENCY MONITOR FOR THE 20- CYCLE RULE

● ACCORDING TO RULE 3.59* of the Federal Communications Commission, on and after January 1, 1940, the frequency of each new broadcast station, and of each existing station where a new transmitter is installed, must be maintained within 20

cycles of the assigned frequency. After January 1, 1942, the frequencies of all standard broadcast stations must be held to this tolerance.

The FCC specifications for frequency monitors have necessarily changed as a result of the new tolerance specifications and, to meet these new specifications, the General Radio Company has designed a new visual-type frequency monitor. Although functionally the same as previous models, which have had a greater customer acceptance than any other make, this new monitor has a better

* Rules governing Standard Broadcast Stations.

FIGURE 1. Panel view of the broadcast frequency monitor.

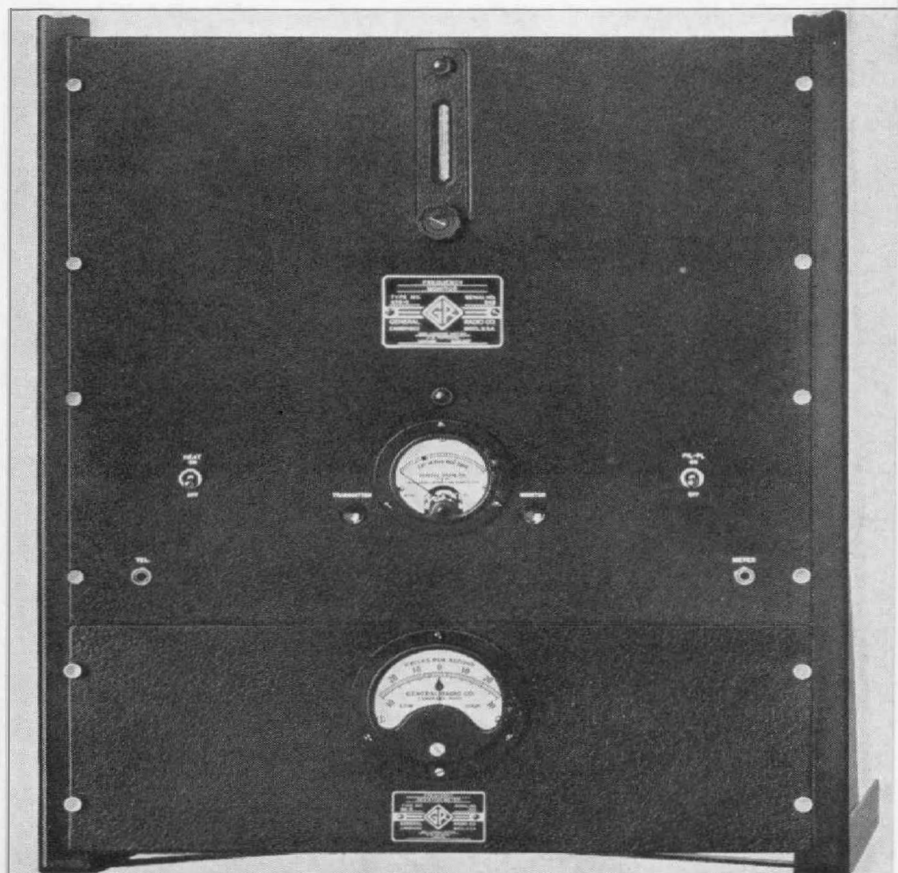

precision of reading, better accuracy, and better stability. In addition, it includes a number of improvements which contribute to increased ease of operation and decreased maintenance. It is designed for easy installation and simple, trouble-free operation. Provision has been made for stocking a number of standard panel finishes, and special finishes to match other equipment can also be obtained.

The complete visual-type frequency monitor consists of (1) TYPE 475-C Frequency Monitor, with a TYPE 376-L Quartz Plate and (2) TYPE 681-B Frequency Deviation Meter. The function of the frequency monitor unit is to produce an audio-frequency beat between a standard frequency oscillator and the transmitter. The frequency deviation meter indicates the deviation of the frequency of this beat from a standard 1000-cycle value. The process is shown functionally in Figure 2.

TYPE 475-B FREQUENCY MONITOR

The schematic circuit diagram of Figure 3 shows the several elements of the frequency monitor unit: a piezoelectric oscillator, a buffer amplifier, an amplifier for the transmitter voltage,

and a detector for producing the audio-frequency beat.

The circuit of the crystal oscillator has several interesting features which contribute to a high degree of frequency stability. The frequency depends on circuit and tube parameters to a far less degree than in most circuits. No tuning inductance is used, and the tuning condensers, C_1 and C_2 , have only a minor effect on the frequency, which depends almost completely upon the quartz crystal. For instance, a change of 25% in the capacitance of C_1 and C_2 produces a change of only 6 parts in one million in the oscillator frequency. Condensers C_1 and C_2 are locked at the factory and no panel tuning controls are necessary. This oscillator circuit was developed in the General Radio laboratories and is used in General Radio primary and secondary frequency standards for monitoring the frequencies of radio stations by the United States and foreign governments.

The quartz plate, TYPE 376-L, is cut to have a low temperature coefficient and is mounted in a dust-proof, air-gap-type holder. The temperature coefficient is less than 2 parts per million per degree Centigrade, as is shown by the plot of Figure 5.

The temperature of the plate is held to ± 0.1 degree Centigrade by a tem-

FIGURE 2. Functional block diagram of the monitoring system. The frequency of the monitoring crystal can be either above or below that of the transmitter, since reversing the leads of the indicating meter reverses the direction of the deviation indication.

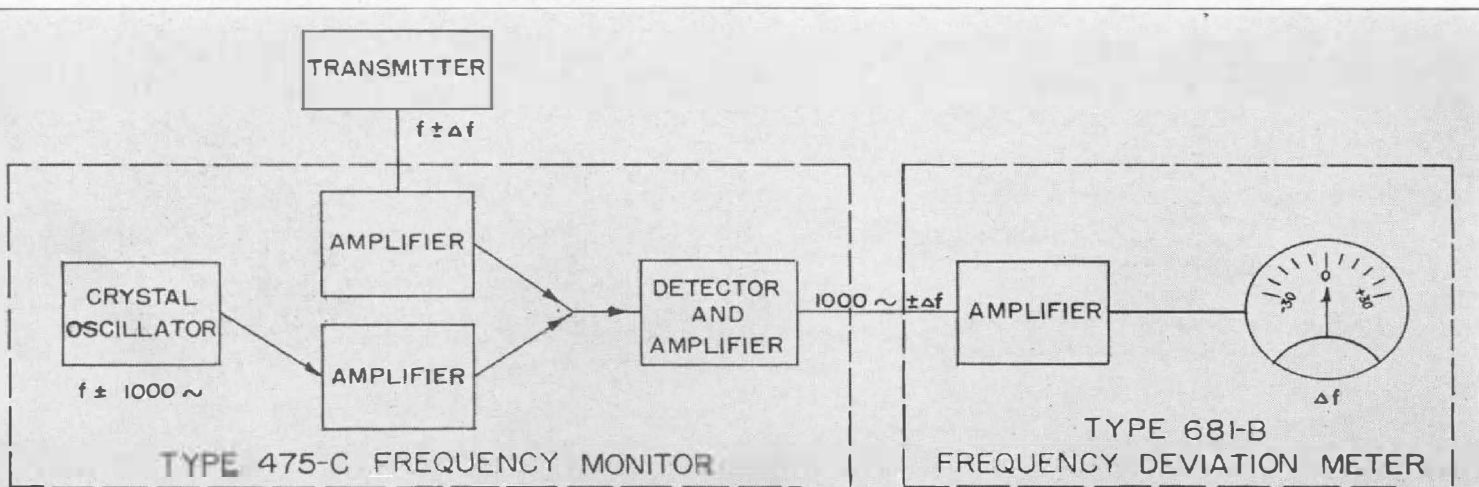

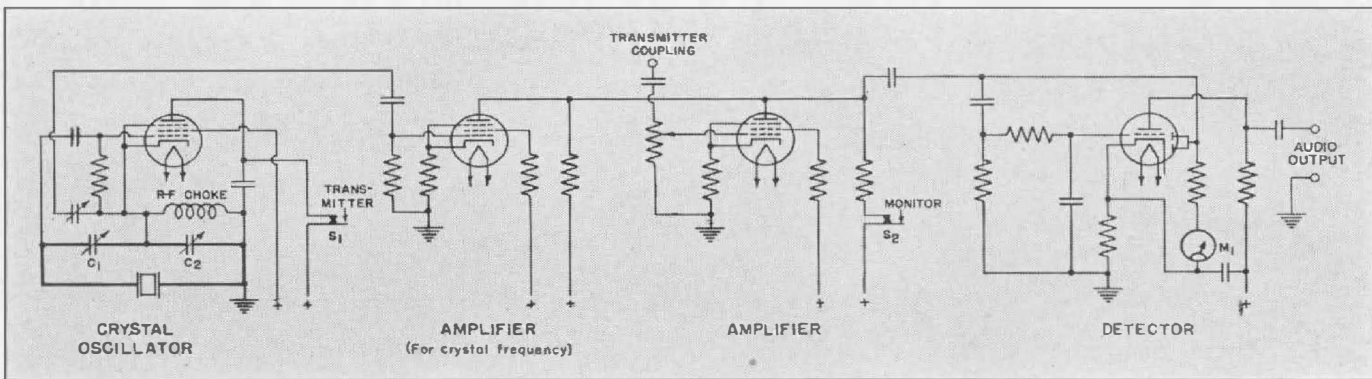

FIGURE 3. Schematic circuit diagram of the TYPE 475-C Frequency Monitor. The meter M_1 in the diode circuit indicates the levels of the signals from the crystal oscillator and the transmitter. Additional contacts (not shown in the diagram) on the push buttons short circuit the meter when neither button is depressed.

perature-control system, so that no appreciable variation in frequency with temperature can occur. Very little restraint on the vibration of the plate is introduced by the holder, so that the plate vibrates freely. The heat-control circuit is arranged so that the mercury thermostat breaks only a very small current, thus prolonging the life of the thermostat.

The crystal amplifier reduces the load which would otherwise be imposed on the oscillator and, by isolating the oscillator from the load, prevents the coupling to the transmitter from affecting the amplitude and frequency of the oscillator. The amplifier for the transmitter frequency prevents any voltage of the crystal frequency from getting into the transmitter circuits and producing modulation at 1000 cycles. Looser coupling to the transmitter can be used, and the monitoring voltage can be taken directly from the transmitter crystal control unit. For transmitters using low-level modulation, this is essential. A meter on the panel furnishes a positive indication of correct signal level from the transmitter and from the crystal oscillator. The level from the transmitter is read by pressing the button labeled TRANSMITTER. When the

reading falls within the red range on the scale, the level is correct. Similarly, pressing the MONITOR button gives an indication of crystal oscillator level. The same red range on the scale is used. Means for adjusting the input to both amplifiers are provided behind the panel. These insure correct coupling when the monitor is installed, prevent false readings due to overloading, and greatly facilitate maintenance, without unnecessarily complicating the operation.

TYPE 681-B FREQUENCY DEVIATION METER

Like the frequency monitor unit, the frequency deviation meter is func-

FIGURE 4. The signal-level indicator on the frequency monitor unit. When the input level is correct, the meter reading is within the red (shown black in the photograph) range on the scale.



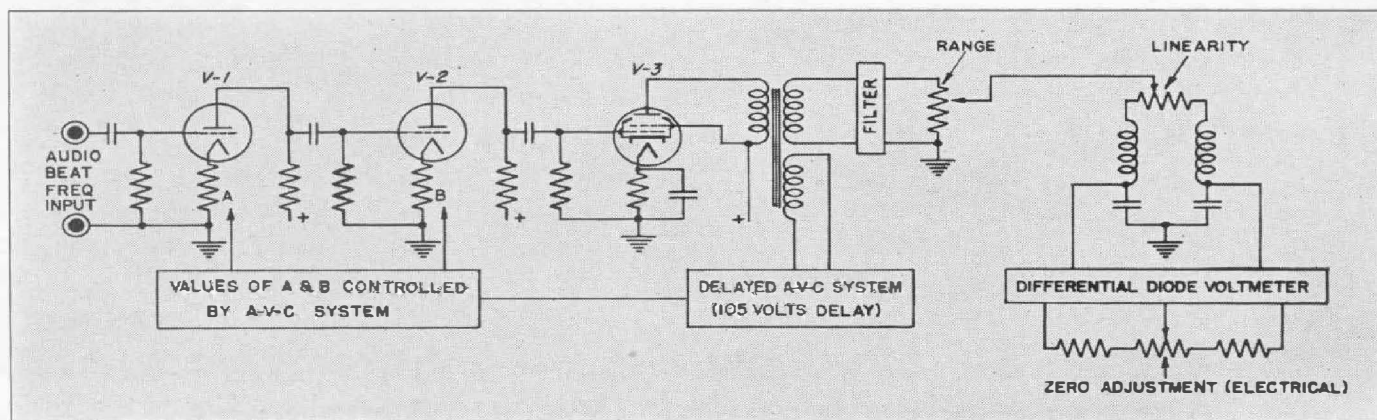

FIGURE 5. Schematic circuit diagram of the TYPE 681-B Frequency Deviation Meter. The automatic volume control eliminates the need for a manual input control.

tionally the same as previous models (see Figure 5), but has been completely redesigned in those details which produce greater accuracy and ease of operation.

Owing to the requirements of a narrower deviation range and increased precision of reading, errors of indication have necessarily been made very small. This has been achieved by making the response more nearly linear and the circuits more stable, and by reducing harmonics of the beat frequency. The linearity of the frequency meter has been improved by using a dual sharpness-of-resonance control (marked

LINEARITY in Figure 5) which operates on both tuned circuits simultaneously but in opposite senses. Better stability is obtained through improved construction of the tuned circuit inductors and capacitors. Lower distortion in the amplifier tube and the inclusion of a low-pass filter greatly reduce errors caused by waveform.

The A-V-C system replaces the manual level adjustment provided on older models. By using a large delay voltage, satisfactory operation is obtained over the same limits formerly attainable by manual adjustment. Constant input voltage to the frequency deviation meter is held over a beat-frequency amplitude range of 0.5 volt to 8 volts. This means that, after the monitor has been installed, such factors as changes in line voltage, changes in the adjustment of the transmitter, and aging of tubes and circuit elements will not affect the accuracy of the meter indication, and no corrective adjustments are required.

Only two controls are necessary, the mechanical and electrical zero settings. Both of these are screwdriver adjustments accessible from the panel. The electrical zero adjustment covers a range of ± 40 cycles. The indicating meter has a range of -30 to $+30$ cycles.

FIGURE 6. Frequency deviations are indicated on this meter, which can be read to better than one-half cycle.

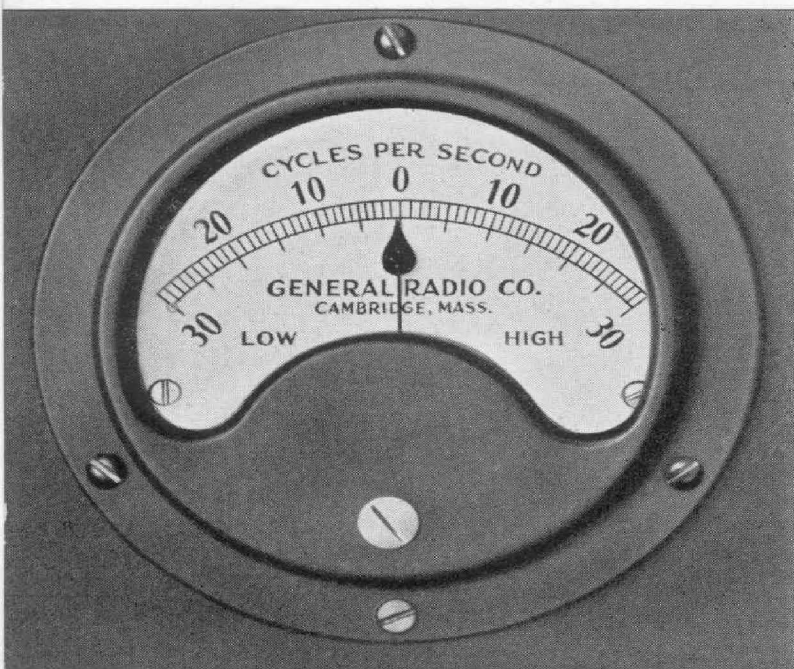

The meter scale is marked in steps of one cycle, and the accuracy is better than 0.5 cycle.

MECHANICAL DETAILS

The mechanical features of the new monitor are important. General interior construction is on nickel-plated brass shelves with dust cover. The dust cover is easily removable, and tubes are arranged for easy access from the rear. Each socket bears a metal tag with the tube type number. All interconnecting cables and a transmitter coupling cable are furnished. Removable dress panels are used on the instruments in order to simplify the furnishing of special finishes. In addition to the standard General Radio black-crackle finish, Western Electric gray, RCA gray or RCA flat black can be had at a price increase of \$10.00. For the same price, plain aluminum dress panels can be furnished the customer for finishing in any color desired, after which they can be returned to us for engraving and installation on the instruments.

INSTALLATION

This new frequency monitor is de-

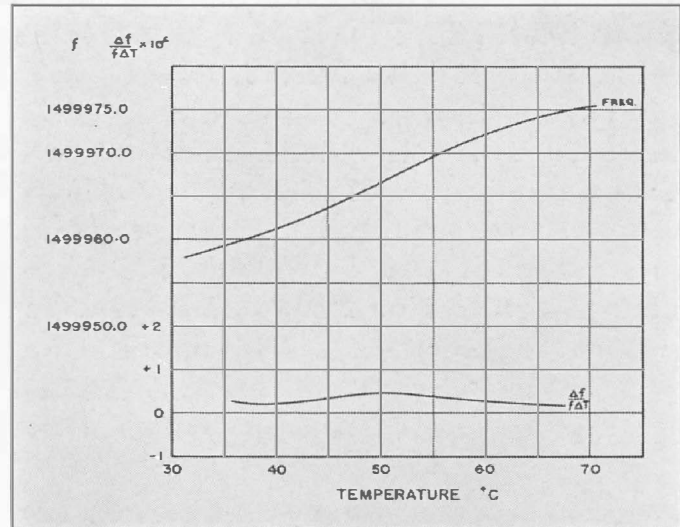
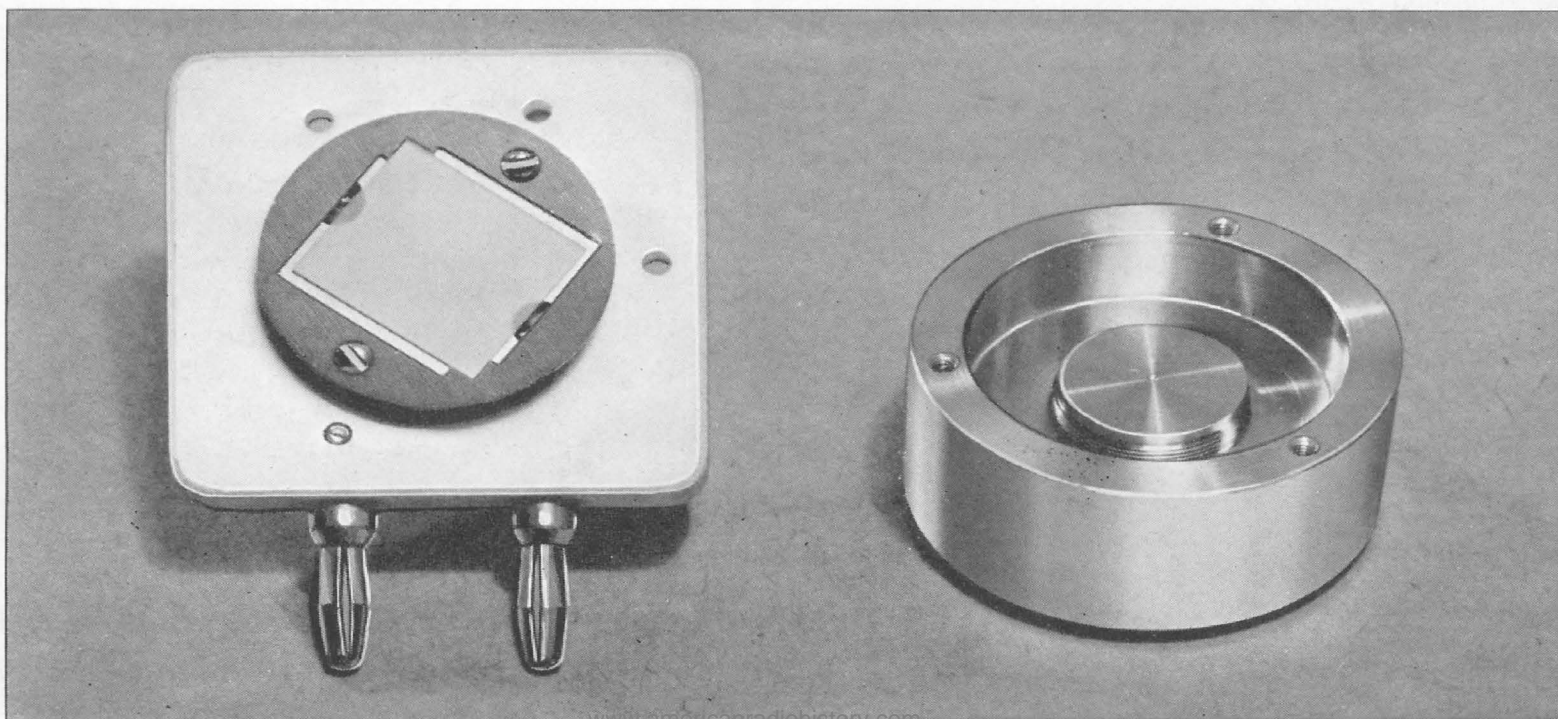

FIGURE 7. Plot of frequency vs. temperature and of temperature coefficient vs. temperature for a production crystal (TYPE 376-L).

signed to have no critical adjustments, and consequently nearly all panel controls have been eliminated. Adequate adjusting means to assure correct installation are behind the panel. The monitor can be installed without difficulty and, once installed, it needs practically no attention. Its accuracy and precision of reading are more than adequate.

FIGURE 8. This photograph shows the method of mounting the quartz plate so that it is held securely in position without restraining its vibration.



MODERNIZATION OF OLDER MONITORS

Between now and January, 1942, many users of the older models of frequency monitors will wish to have them modified to comply with the new rules. No models of the old TYPE 575 Frequency Monitors or TYPE 581 Deviation

Meters can be modernized. The TYPE 681 Deviation Meters also cannot be brought into compliance with the new rule. However, a program is now being worked out for modernizing the TYPE 475 Frequency Monitors, and a trade-in allowance arrangement will be made, if practicable, on old TYPE 681 Deviation Meters turned in for new ones. Details of these plans will be announced later.

— J. K. CLAPP

SPECIFICATIONS

Frequency Range: ± 30 cycles.

Accuracy: When received, ± 13 parts in one million; an adjustment is provided to bring the reading into agreement with monitoring station measurements.

Vacuum Tubes: The following tubes are required and are supplied with the instrument:

- 1 — 6J7G
- 2 — 6AC7
- 1 — 6R7G
- 1 — 5V4G
- 2 — 6F8G
- 1 — 6V6G
- 2 — 6H6G
- 1 — VR-105-30

Stability: ± 5 parts in one million.

Coupling to Transmitter: The monitor must be coupled to the transmitter at a point where the carrier is *unmodulated*. Only a small degree of capacitive coupling is required. A coupling wire is provided in the connecting cable supplied with the monitor.

Accessories Supplied: Connecting cables, pilot lights, and fuses (with spares).

Power Supply: 105- to 125-volt, 50- to 60-cycle, a-c line.

Power Input: 175 watts with heat on.

Mounting: Standard 19-inch relay-rack panels.

Dimensions: Panel, (length) 19 x (height) 22½ inches; behind panel, (length) 17¼ x (height) 22¼ x (depth) 11¾ inches.

Net Weight: 95 pounds.

<i>Description</i>	<i>Code Word</i>	<i>Price</i>
Visual-Type Frequency Monitor	DEVOR	\$560.00

- This instrument is manufactured and sold under the following U. S. Patents and license agreements:
1. Patents of the American Telephone and Telegraph Company, solely for utilization in research, investigation, measurement, testing, instruction and development work in pure and applied science.
 2. Patents and patent applications of Dr. G. W. Pierce pertaining to piezo-electric crystals and their associated circuits.
 3. Patent No. 1,944,315.
 4. Patent No. 1,967,184.
 5. Patent No. 2,012,497.

ONE CYCLE PER SECOND FROM THE INVERSE FEEDBACK OSCILLATOR

● IN THE RESEARCH LABORATORY there is frequently a need for a generator of frequencies well below the 15 or 20 cycles per second that is the usable low-frequency limit of most audio-frequency oscillators.

Good power output and good waveform at these very low frequencies can be obtained from the TYPE 608-A Oscillator* by using an external range-

extension unit. Extension of the operating range to low frequencies is made possible by the unique inverse-feedback circuit† used in this instrument.

The oscillator is normally operated by means of a series of push buttons, which provide oscillation at any one of

*H. H. Scott, "A Low-Distortion Oscillator," *General Radio Experimenter*, Volume XIII, No. 11, April, 1939.

†H. H. Scott, "A New Type of Selective Circuit and Some Applications," *Proceedings of the Institute of Radio Engineers*, Volume 26, No. 2, pp. 226-235, February, 1938.

27 frequencies throughout the audible range. The unit is also equipped with jacks, allowing operation of the circuit at various other frequencies, and this has proved to be a most advantageous feature since not only are other frequencies within the normal range available, but satisfactory operation can be attained at frequencies falling considerably outside of this normal range, provided some slight sacrifice in purity of waveform can be tolerated.

A good example of the usefulness of the oscillator at very low frequencies occurred recently in the General Radio laboratories, during work on the design of a vibration meter which will have a flat response down to 2 or 3 cycles per second. Such response is not difficult to secure in cases where only a moderate amount of amplification is required, but in this application the high degree of sensitivity required a high-gain multi-stage amplifier, and, obviously, some satisfactory means were required for making exact measurements of its gain-frequency characteristics.

An auxiliary unit containing the necessary high resistances for operation of the oscillator at lower frequencies was, therefore, constructed and arranged to plug into the standard TYPE 608-A Oscillator.

In several applications where customers have required special low-frequency oscillators, attachments have been built for the TYPE 608-A. One of these is shown in Figure 1. This particular model, TYPE 608-400, operates at 7, 8, 10, and 15 cycles and can be attached to any TYPE 608-A Oscillator with no changes in the unit excepting to cut a slot in the dust cover to allow passage of the cable.

The difficulties of accurate harmonic measurements at such low frequencies have made it impractical thus far to determine quantitatively the actual harmonic content of the oscillator waveform when operating at such low frequencies. There is no reason to believe, however, that it should be seriously worse than at higher frequencies, so long as the 5000-ohm output circuit is used, which does not involve the transformer. Certainly, for most laboratory uses at these frequencies the purity of waveform is entirely satisfactory. Figure 2 shows oscillograms of the output of the oscillator at several frequencies between one and 10 cycles per second.

Thus far the requirements of customers for equipment of this type have been so varied that no standard designs

FIGURE 1. Showing a range-extension unit connected to the TYPE 608-A Oscillator. A jack plate is provided in the oscillator, and the only necessary modification is the hole in the cover to admit the plug.

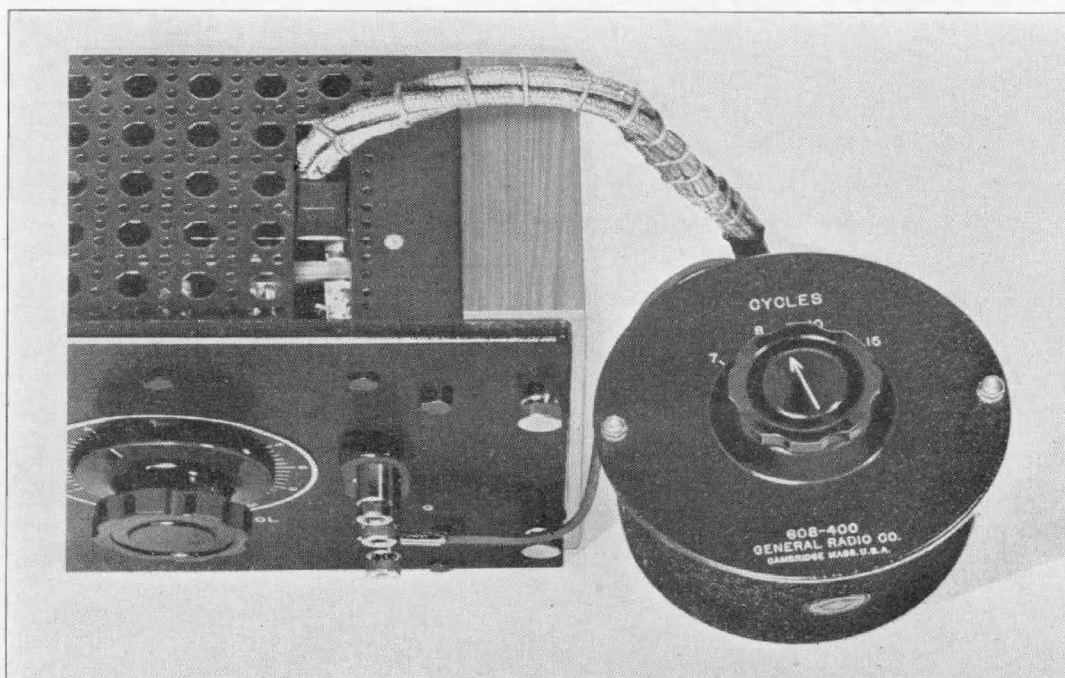

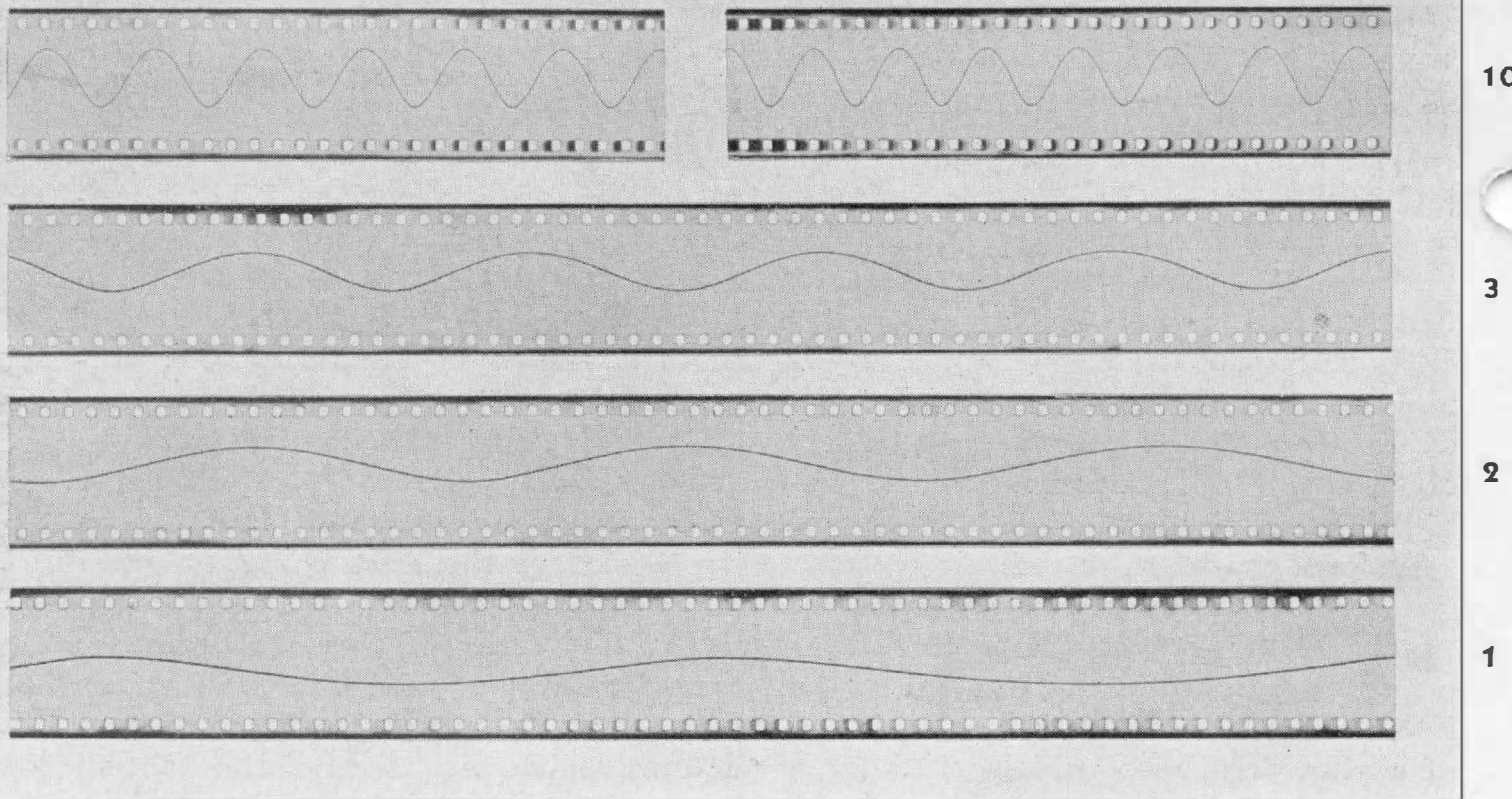

FIGURE 2. Oscillograms of the output voltage of TYPE 608-A Oscillator at low frequencies. Reading from top to bottom the frequencies are 10, 3, 2, and 1 cycle per second. These waveforms were photographed with a TYPE 651-A Camera.

are being carried in stock. Special range-extension units of this type can, however, be built to order to customers' specifications. The cost is dependent upon the number of frequencies required and the value of the frequencies. The

price of the unit increases as the frequency decreases, due to the higher values of the precision resistances required. Correspondence regarding your particular requirements is invited.

— H. H. SCOTT

MISCELLANY

● **THE NEW Broadcast Frequency Monitor** described in this issue was designed by J. K. Clapp, H. H. Hollis, and P. K. McElroy.

● **AN EXHIBIT** of General Radio apparatus will be held at the Stevens Hotel, Chicago, from February 12 to 17, 1940. This is to be a working display of equipment as it is used in typical appli-

cations and will include many new instruments. *Experimenter* readers are cordially invited to attend.

● **AT THE DECEMBER 15** meeting of the Boston Section of the Institute of Radio Engineers, Dr. W. N. Tuttle and Dr. D. B. Sinclair of the General Radio Company presented a symposium on Twin-T Null Circuits.

GENERAL RADIO COMPANY

30 STATE STREET · CAMBRIDGE A, MASSACHUSETTS
 BRANCH ENGINEERING OFFICES
 90 WEST STREET, NEW YORK CITY
 1000 NORTH SEWARD STREET, LOS ANGELES, CALIFORNIA