

The **AEROVOX**

CONDENSER and RESISTOR MANUAL and **CATALOGUE 1929-1930**

**A Helpful Manual on the
Proper Use of Condensers and
Resistors in Radio Receivers
and Power Supply Units with
Detailed Specifications of
AEROVOX
Condensers and Resistors**

AEROVOX WIRELESS CORPORATION

Cable Address
Radiwac, New York

70-82 WASHINGTON ST.
BROOKLYN, N. Y.

Code:
Bentley's

Sales Offices

94 Portland St.
Boston, Mass.

821 Dayton Savings and Trust Bldg.
Dayton, O.

11 S. Desplaines St.
Chicago, Ill.

324 N. San Pedro St.
Los Angeles, Cal.

1602 Arcade Bldg.
St. Louis, Mo.

3815 Clairmont Ave.
Birmingham, Ala.

607 Kerr Bldg.
Detroit, Mich.

1427 L. C. Smith Bldg.
Seattle, Wash.

1913 Pacific Ave.
Dallas, Tex.

208 W. King St.
Toronto, Ont., Canada

430—4th St., N. E.
Washington, D. C.

The
AEROVOX

**CONDENSER and
RESISTOR MANUAL**
and CATALOGUE 1929-1930

A Helpful Manual on the
Proper Use of Condensers and
Resistors in Radio Receivers and
Power Supply Units with Detailed
Specifications of AEROVOX
Condensers and Resistors



Published in the Interests of Better Radio by

AEROVOX WIRELESS CORPORATION

70-82 WASHINGTON ST.

Cable Address
Radiwac, New York

BROOKLYN, N. Y.

Code:
Bentley's

AEROVOX PRODUCTS ARE "BUILT BETTER"



GENERAL FEATURES AND INSULATION SPECIFICATIONS OF ALL AEROVOX PAPER DIELECTRIC CONDENSERS

Capacity Tolerance

On manufacturer's order, Aerovox paper condensers can be made to any standard tolerance in accordance with specifications.

Special Capacities

Smaller, larger or intermediate sizes, as well as combinations of various units into blocks or special units can be made to manufacturers' specifications in standard or special cans or containers.

Impregnation

All Aerovox paper condensers are impregnated scientifically by means of a special process improved by the Aerovox organization. The special impregnating compound used in Aerovox condensers has a high melting point of 195 degrees Fahrenheit, which protects the condenser against the heat developed in modern amplifier and power supply units.

The average melting point of the paraffins still used in many condensers is approximately 130 degrees Fahrenheit.

How To Use Insul. Spec. Chart

All capacities of any given voltage series have the same insulation specifications. Run down the first column at the left of the chart till the desired D.C. voltage rating is found. All characteristics of the series of condensers listed on the line above will be found to the right of the D.C. voltage rating. Two different types of insulation are used in the 400 and 1000 volt classes, as indicated.

Winding Characteristics

All standard Aerovox paper condensers listed in this catalog are non-inductively wound. Inductively wound condensers can be furnished to manufacturers in any capacity or voltage rating, on special order.

Safety Factor

All Aerovox paper condensers are scientifically designed, built and rated to operate safely at their rated working voltages. The safety factor is in excess of that required to withstand both R. M. A. and N. E. M. A. retest requirements of twice the rated voltages for 15 seconds after which the condenser is to be immediately discharged through a resistance of 50 ohms or more.

Standard Packages

All Aerovox paper condensers listed in this catalog are packed one in a box. A standard package contains ten boxes.

Insulation Resistance

The insulation resistance of all Aerovox condensers is in excess of R. M. A. and N. E. M. A. standard requirements.

Dielectric Material

All dielectric material used in Aerovox paper condensers of all capacities and working voltages is pure, 100 per cent linen paper, free from acid, alkali, bleaching material and impurities.

Dependability

Aerovox condensers are being used in large quantities by receiver manufacturers who realize the importance of sending out receivers which they can be sure will not be returned for service and repairs due to condenser breakdowns. They have been selected by the largest and best known manufacturers only after exhaustive, competitive tests have proved conclusively the ability of Aerovox condensers to perform safely and efficiently under all conditions of operation.

A Word About Voltage Ratings

All Aerovox Paper Dielectric Condensers are conservatively rated for safety. Because of the comparative lack of standardization of some condenser manufacturers on voltage ratings, condensers should be compared on the basis of their insulation specifications for any given capacity and price. Aerovox makes no secret of the insulation specifications of its condensers.

INSULATION SPECIFICATIONS Of Aerovox Paper Dielectric Condensers						
Maximum D. C. Working Voltage	Maximum A. C. Working Voltage	D. C. Retest Voltage (15 sec.)	Total Number of Papers	No. of Papers Between Plates	Thickness of Each Paper in Inches	Total Thickness of Insul. Bet. Plates
200-Volt Series—Types 200-S, 202, 207, 250, 260, 261, 270						
200	125	400	4	2	.0005	.001
300-Volt Series—Types 300-S, 302, 307, 350, 360, 361						
300	175	600	6	3	.0004	.0012
400-Volt Series—Types 400-S, 402, 407, 450, 460, 461						
400	250	800	6	3	.0005	.0015
400-Volt Series—Type 470						
400	250	800	4	2	.001	.002
500-Volt Series—Type 502						
500	300	1000	8	4	.0004	.0016
600-Volt Series—Types 602, 650, 670						
600	350	1200	8	4	.0005	.002
800-Volt Series—Type 802						
800	440	1600	10	5	.0005	.0025
1000-Volt Series—Types 1002, 1003, 1051						
1000	600	2000	12	6	.0005	.003
1000-Volt Series—Type 1070						
1000	600	2000	6	3	.001	.003
1500-Volt Series—Type 1503						
1500	800	3000	12	3	.0005 .001	.0045
2000-Volt Series—Type 2003						
2000	1100	4000	12	6	.001	.006
2500-Volt Series—Type 2503						
2500	1300	5000	14	7	.001	.007
For detailed specifications and prices of the items listed above consult the detailed descriptions of those units in the other pages of this catalog.						

APPROVED AND USED BY THE BEST-KNOWN SET MANUFACTURERS



STOCK CAPACITIES AND COMPARATIVE PRICES OF ALL AEROVOX PAPER DIELECTRIC CONDENSERS

Cap. Mfds.	D. C. Work. Volt.	Type No.	List Price	Cap. Mfds.	D. C. Work. Volt.	Type No.	List Price	Cap. Mfds.	D. C. Work. Volt.	Type No.	List Price
.01 Mfd.											
.01	200	270	\$.45								
.01	400	470	.50								
.01	600	670	.55								
.01	1000	1070	.60								
.015 Mfd.											
.015	200	270	.45								
.015	400	470	.50								
.015	600	670	.60								
.015	1000	1070	.65								
.02 Mfd.											
.02	200	270	.50								
.02	400	470	.55								
.02	600	670	.65								
.02	1000	1070	.70								
.03 Mfd.—200v. D.C.											
.03	200	270	.50								
.05 Mfd.—200v. D.C.											
.05	200	270	.55								
.05	200	200-S	.60								
.05	200	207	.65								
.05	200	260	.65								
.05	200	250	.70								
.05 Mfd.—300v. D.C.											
.05	300	300-S	.65								
.05	300	307	.70								
.05	300	360	.70								
.05	300	350	.75								
.05 Mfd.—400v. D.C.											
.05	400	470	.60								
.05	400	400-S	.70								
.05	400	407	.75								
.05	400	460	.75								
.05	400	450	.80								
.05 Mfd.—600v. D.C.											
.05	600	670	.70								
.05	600	650	.90								
.05 Mfd.—1000v. D.C.											
.05	1000	1051	1.00								
.1 Mfd.—200v. D.C.											
.1	200	270	.60								
.1	200	200-S	.65								
.1	200	207	.70								
.1	200	260	.70								
.1	200	250	.75								
.1 Mfd.—300v. D.C.											
.1	300	300-S	.70								
.1	300	307	.75								
.1	300	360	.75								
.1	300	350	.80								
.1 Mfd.—400v. D.C.											
.1	400	470	.65								
.1	400	400-S	.75								
.1	400	407	.80								
.1	400	460	.80								
.1	400	450	.85								
.1 Mfd.—600v. D.C.											
.1	600	670	\$.75								
.1	600	650	1.00								
.1 Mfd.—1000v. D.C.											
.1	1000	1051	1.25								
.25 Mfd.—200v. D.C.											
.25	200	200-S	.70								
.25	200	207	.75								
.25	200	260	.75								
.25	200	250	.85								
.25 Mfd.—300v. D.C.											
.25	300	300-S	.80								
.25	300	307	.85								
.25	300	360	.85								
.25	300	350	.95								
.25 Mfd.—400v. D.C.											
.25	400	400-S	.85								
.25	400	407	.90								
.25	400	461	1.00								
.25	400	450	1.00								
.5 Mfd.—200v. D.C.											
.5	200	200-S	.80								
.5	200	207	.85								
.5	200	260	.85								
.5	200	250	.95								
.5 Mfd.—300v. D.C.											
.5	300	300-S	1.00								
.5	300	307	1.10								
.5	300	361	1.10								
.5	300	350	1.25								
.5 Mfd.—400v. D.C.											
.5	400	400-S	1.15								
.5	400	407	1.25								
.5	400	461	1.25								
.5	400	450	1.40								
1 Mfd.—200v. D.C.											
1	200	200-S	.90								
1	200	207	1.00								
1	200	261	1.00								
1	200	202	1.25								
1	200	250	1.25								
1 Mfd.—300v. D.C.											
1	300	300-S	1.50								
1	300	302	1.60								
1	300	307	1.60								
1	300	361	1.60								
1 Mfd.—400v. D.C.											
1	400	400-S	1.75								
1	400	402	1.85								
1	400	407	1.85								
1 Mfd.—500v. D.C.											
1	500	502	2.30								
1 Mfd.—600v. D.C.											
1	600	602	2.75								
1 Mfd.—800v. D.C.											
1	800	802	\$3.50								
1 Mfd.—1000v. D.C.											
1	1000	1002	4.25								
1	1000	1003	5.00								
1 Mfd.—1500v. D.C.											
1	1500	1503	10.00								
1 Mfd.—2000v. D.C.											
1	2000	2003	13.50								
1 Mfd.—2500v. D.C.											
1	2500	2503	18.50								
2 Mfd.—200v. D.C.											
2	200	200-S	1.75								
2	200	207	1.90								
2	200	202	2.00								
2 Mfd.—300v. D.C.											
2	300	300-S	2.25								
2	300	307	2.40								
2	300	302	2.50								
2 Mfd.—400v. D.C.											
2	400	400-S	2.65								
2	400	407	2.80								
2	400	402	2.90								
2 Mfd.—500v. D.C.											
2	500	502	3.50								
2 Mfd.—600v. D.C.											
2	600	602	4.00								
2 Mfd.—800v. D.C.											
2	800	802	5.25								
2 Mfd.—1000v. D.C.											
2	1000	1002	7.50								
2	1000	1003	9.00								
4 Mfd.—200v. D.C.											
4	200	200-S	3.00								
4	200	202	3.25								
4	200	207	3.25								
4 Mfd.—300v. D.C.											
4	300	302	4.00								
4 Mfd.—400v. D.C.											
4	400	402	4.50								
4 Mfd.—500v. D.C.											
4	500	502	5.75								
4 Mfd.—600v. D.C.											
4	600	602	7.25								
4 Mfd.—800v. D.C.											
4	800	802	9.75								
4 Mfd.—1000v. D.C.											
4	1000	1002	14.00								

THERE IS AN AEROVOX RESISTOR FOR EVERY REQUIREMENT

NON-INDUCTIVE CONDENSERS IN BAKELITE CASES



Types
250, 350, 450, 650 and 1051

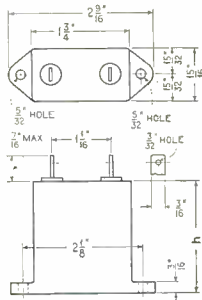

Height dimension "h" is 1 3/16" for the "Y" case types and 1 3/4" for the "Z" case types.

MOUNTED in an attractive bakelite case, these condensers are the latest development in paper wound condensers for radio and audio frequency bypassing, resistance or impedance coupled amplification, parallel feed amplifiers, coupling condensers in photo-electric cell amplifiers, or for any purpose where a compact, high insulation resistance, non-inductive condenser is required. The bakelite case prevents leakage between terminals and eliminates all possibilities of grounding the terminals through the case.

WORKING VOLTAGES

Type No.	Working Voltages	
	D. C.	A. C.
250	200	125
350	300	175
450	400	250
650	600	350
1051	1000	600

For Insulation Specifications of all Aerovox Paper Condensers, see page 3.

STOCK CAPACITIES

Cap. Mfds.	List Price	Code Word	Case Symbol
TYPE 250			
.05	\$.70	THIGH	Y
.1	.75	THINE	Y
.25	.85	THING	Y
.5	.95	THINK	Y
1.0	1.25	THIRD	Z
TYPE 350			
.05	\$.75	TOPER	Y
.1	.80	TRAIL	Y
.25	.95	TRIAL	Y
.5	1.25	TULLE	Z
TYPE 450			
.05	\$.80	TOTAL	Y
.1	.85	THONG	Y
.25	1.00	THORN	Y
.5	1.40	TUTOR	Z
TYPE 650			
.05	\$.90	TOUCH	Y
.1	1.00	THROB	Y
TYPE 1051			
.05	\$1.00	TOUGH	Y
.1	1.25	THROW	Z

Special Capacities: Larger or intermediate sizes, as well as combinations of various sizes into blocks or special units may be had on special order for manufacturers only. Packed one in a box. Standard Package—10 boxes.

COMPACT CONDENSERS IN FIBRE TUBE CASES

STOCK CAPACITIES

Cap. Mfds.	List Price	Code Word	Tube Symbol
TYPE 270			
.01	\$.45	TABID	U1
.015	.45	TANSY	U1
.02	.50	TAUBE	U1
.03	.50	TAWNY	U1
.05	.55	THRUM	U2
.1	.60	THUMB	U4
TYPE 470			
.01	\$.50	THUMP	U1
.015	.50	THYME	U1
.02	.55	TIDAL	U2
.05	.60	TIGHT	U5
.1	.65	TIMID	U7
TYPE 670			
.01	\$.55	TACIT	U1
.015	.60	TASTY	U2
.02	.65	TAUNT	U3
.05	.70	TOTEM	U6
.1	.75	TRAWL	U8
TYPE 1070			
.01	\$.60	TINGE	U1
.015	.65	TIPSY	U5
.02	.70	TIRED	U6

Special Capacities: Larger or intermediate sizes, as well as combinations of various sizes into blocks or special units may be had on special order for manufacturers only. Packed one in a box. Standard Package—10 boxes.

TYPES 270, 470, 670 and 1070 compact condensers are non-inductively wound, thoroughly impregnated and sealed in round fibre tubes. The terminals provide a convenient means for mounting the condenser on subpanels or directly to binding post terminals.

They are suitable for use in circuits where small capacities of from .01 to .1 mfd. are required.

For Comparative Prices of all Aerovox Paper Condensers, see page 4.

For General Characteristics of all Aerovox Paper Condensers, see page 3.

WORKING VOLTAGES

Type No.	Working Voltages	
	D. C.	A. C.
270	200	125
470	400	250
670	600	350
1070	1000	600

For Insulation Specifications of all Aerovox Paper Condensers, see page 3.



Types
270, 470, 670 and 1070

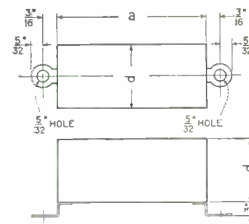

TUBE DIMENSIONS

Tube Symbol	Length of Tube	Diameter of Tube
	a	d
U1	1 3/8"	7/16"
U2	1 3/8"	3/4"
U3	1 3/8"	9/16"
U4	1 3/8"	5/8"
U5	1 3/8"	1 1/16"
U6	1 3/8"	3/4"
U7	1 3/8"	1 1/8"
U8	1 1/8"	1 1/8"



GENERAL PURPOSE NON-INDUCTIVE CONDENSERS



Types 207, 307 and 407

Types 200-S, 300-S and 400-S

WORKING VOLTAGES			
Type No.	Working Voltages		
	D. C.	A. C.	
207	200	125	
307	300	175	
407	400	250	

For Insulation Specifications see page 3.

STOCK CAPACITIES			
Cap. Mfds.	List Price	Code Word	Can Symbol
TYPE 207			
.05	\$.65	TOPSY	AA
.1	.70	TITLE	AA
.25	.75	TOADY	AA
.5	.85	TOAST	AA
1.0	1.00	TOKEN	A
2.0	1.90	TONGS	B
4.0	3.25	UNMAN	BD
TYPE 307			
.05	\$.70	TONIC	A
.1	.75	TOXIN	A
.25	.85	TRESS	A
.5	1.10	TRYST	A
1.0	1.60	TWEAK	B
2.0	2.40	ULTRA	BC
TYPE 407			
.05	\$.75	TOQUE	A
.1	.80	TRAIT	A
.25	.90	TRITE	A
.5	1.25	TUMOR	B
1.0	1.85	TWINE	BB
2.0	2.80	UNIFY	BD

Special capacities and working voltages or combinations with or without mounting lugs can be supplied on special order to manufacturers only. Packed one in a box. Standard Package—10 Boxes.

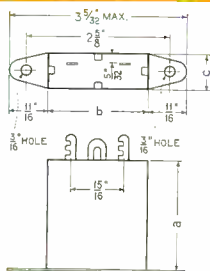

Can Dimensions
Types 207, 307 and 407

ALL of these condensers are non-inductively wound and the elements are of the same high grade as all other Aerovox paper condensers. They are designed for use in all radio and audio frequency bypass circuits, for resistance and impedance coupled amplification, for power amplifier output circuits and for all other purposes where capacities of from .05 to 4 mfd. in working voltages of 200, 300 and 400 volts D.C. are required.

For General Characteristics of all Aerovox Paper Condensers, see page 3.

For Comparative Prices of all Aerovox Paper Condensers of similar capacities and working voltages, see page 4.

The 300 and 400-volt units are ideal for bypassing the 90, 135 and 180-volt taps of voltage divider circuits, where the voltages are usually much higher than the nominal voltages at the taps, before the heater tubes warm up and plate current is drawn.

The only difference between the two series of units is in the case mountings. The body dimensions of both types, for equal capacities and working voltages are the same.

CAN DIMENSIONS

Can Symbol	Height a	Width b	Depth c
AA	1 3/8"	1 1/8"	5/8"
A	2 1/8"	1 1/8"	5/8"
B	2 1/8"	1 1/8"	1 7/8"
BB	2 1/8"	1 1/8"	1 5/8"
BC	2 1/8"	1 1/8"	2"
BD	2 1/8"	1 1/8"	2 1/2"

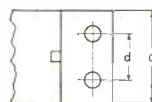

Types BC and BD cans are provided with two mounting holes on each end instead of one, as shown in the sketch to the left. Dimension "d" is 1" for BC and 1 1/2" for BD can.

WORKING VOLTAGES			
Type No.	Working Voltages		
	D. C.	A. C.	
200-S	200	125	
300-S	300	175	
400-S	400	250	

For Insulation Specifications see page 3.

STOCK CAPACITIES			
Cap. Mfds.	List Price	Code Word	Can Symbol
TYPE 200-S			
.05	\$.60	ICING	A
.1	.65	IDEAL	A
.25	.70	IDIOM	A
.5	.80	IMAGE	A
1.0	.90	IMPEL	A
2.0	1.75	IMPLY	B
4.0	3.00	UNITY	BD
TYPE 300-S			
.05	\$.65	TOMIN	A
.1	.70	TOWEL	A
.25	.80	TREND	A
.5	1.00	TRUTH	A
1.0	1.50	TWANG	B
2.0	2.25	ULCER	BC
TYPE 400-S			
.05	\$.70	TOPIC	A
.1	.75	TRAIN	A
.25	.85	TRIBE	A
.5	1.15	TUMID	B
1.0	1.75	TWILL	BB
2.0	2.65	UNCLE	BD

Special capacities and working voltages or combinations with or without mounting lugs can be supplied on special order to manufacturers only. Packed one in a box. Standard Package—10 Boxes.

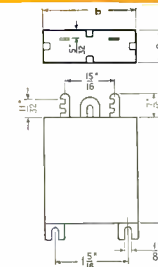

Can Dimensions
Types 200-S, 300-S and 400-S

AEROVOX CONDENSERS ARE COMPACT FOR EASY ASSEMBLY



STAMPED METAL CASE CONDENSERS



Types 260, 360 and 460



Types 261, 361 and 461

WHILE these units were particularly designed for manufacturers' use the demand for them among experimenters and professional setbuilders has been so great that it has been decided to make them available for general use.

This series of condensers is available in working voltages of 200 volts D.C., 300 volts D.C. and 400 volts D.C. and in capacities of from .05 to 2 mfd.

They are ideal for all bypassing requirements in R. F. and A. F. circuits where single capacities are required at various points and are also available in combinations of capacities in the units listed on page 12.

The sections are hermetically sealed in the stamped metal containers and terminals are brought out through insulating strips, centered in large holes in the case, to prevent leakage and short-circuits to the can.

In the X-type cans, terminals can be brought out either

at the side as shown in the illustration or at the top. Mounting may be effected by any of the four mounting holes shown. On special order,

any combination of the four holes shown can be furnished and the mounting lugs trimmed to any desired size.

It is also possible to furnish these units with one terminal of the unit grounded to the case.

Condensers in the Type XX and XY cans can be furnished in a variety of combinations. The single mounting lug at one end is slotted along its length to avoid trouble in lining up for mounting. The two mounting lugs at the other end can be set for any center-to-center distance within the limits of the can or the cans can be furnished with a single mounting lug at each end.

Terminals can be brought out at either end or can be arranged so that some terminals are brought out on one end and some on the other end. One terminal of single sections units or more than one terminal in the case of combinations of units can be grounded to the case.

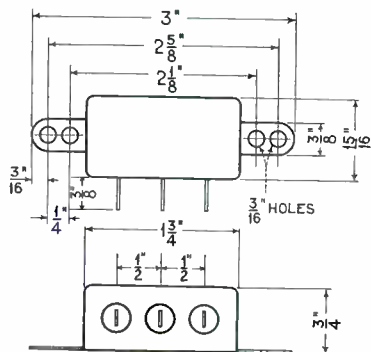

Dimensions of X-type Cans used in Types 260, 360 and 460 Condensers.

For Comparative Prices of all AeroVox Paper Condensers, see page 4.

WORKING VOLTAGES

Type No.	Working Voltages	
	D. C.	A. C.
260 & 261	200	125
360 & 361	300	175
460 & 461	400	250

For insulation specifications, of all AeroVox Paper Condensers, see page 3.

STOCK CAPACITIES

Cap. Mfds.	List Price	Code Word	Can Symbol
TYPE 260			
.05	\$.65	TOKAY	X
.1	.70	TOUSE	X
.25	.75	TREAT	X
.5	.85	TROUT	X

TYPE 261			
1.0	\$1.00	TWAIN	XX

TYPE 360			
.05	\$.70	TOPAZ	X
.1	.75	TRACE	X
.25	.85	TRIAD	X

TYPE 361			
.5	\$1.10	TUBER	XX
1.0	1.60	TWEED	XY

TYPE 460			
.05	\$.75	TORCH	X
.1	.80	TRASH	X

TYPE 461			
.25	\$1.00	TROLL	XX
.5	1.25	TUNNY	XX

SPECIAL CAPACITIES: Larger or intermediate sizes, as well as combinations of various sizes into blocks or special units may be had on special order for manufacturers only.

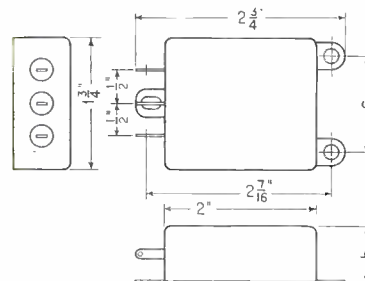

Dimensions of XX-type and XY-type Cans used in Types 261, 361, 461, 461-21, 461-31 and 461-225 Condensers. Dimension "h" is 3/4" for XX cans and 1" for XY cans.



SOCKET POWER, FILTER AND HIGH VOLTAGE CONDENSERS



Type 202

THE Types 1003, 1503 and 2503 high voltage condensers are designed to fill the requirements of heavy duty power supply units which are used to furnish power to heavy duty amplifiers and transmitters.

They are provided with high grade porcelain terminals, designed to eliminate leakage and breakdown at high voltages. The cases are all of uniform height and width for convenience in mounting. When mounted side by side, they make a compact and pleasing appearance. The cases are similar to those used in the 1002 series, except that porcelain terminals at the tops are provided in place of the terminal strip with wire leads.

They are available for operation at working voltages of 1000, 1500, 2000 and 2500 volts D.C.

For Comparative Prices of all Aerovox Paper Dielectric Condensers, see page 4.
For General Characteristics of all Aerovox Paper Dielectric Condensers, see page 3.



Types 1003, 1503, 2003 and 2503

WORKING VOLTAGES

Type No.	Working Voltages	
	D. C.	A. C.
202	200	125
302	300	175
402	400	250
502	500	300
602	600	350
802	800	440
1002	1000	600
1003	1000	600
1503	1500	800
2003	2000	1100
2503	2500	1300

For Insulation Specifications, see page 3.

STOCK CAPACITIES

Cap. Mfds.	List Price	Code Word	Can Symbol
TYPE 202			
1	\$1.25	OMENS	E
2	2.00	OLIVE	F
4	3.25	ONION	G
TYPE 302			
1	\$1.60	MELEE	E
2	2.50	MERGE	F
4	4.00	MERIT	GG
TYPE 402			
1	\$1.85	PEWIT	F
2	2.90	PHASE	G
4	4.50	PHIAL	HH
TYPE 502			
1	\$2.30	UHLAN	F
2	3.50	UNION	G
4	5.75	UPSET	HH
TYPE 602			
1	\$2.75	QUIRK	G
2	4.00	QUIET	HH
4	7.25	QUOTE	KK
TYPE 802			
1	\$3.50	RIGHT	GG
2	5.25	RIGID	II
4	9.75	RIGOR	LL
TYPE 1002			
1	\$4.25	RAVEL	HH
2	7.50	RAVEN	KK
4	14.00	READY	N
TYPE 1003			
1	\$5.00	RANGE	HH
2	9.00	RAPID	KK
TYPE 1503			
1	\$10.00	RIVET	LL
TYPE 2003			
1	\$13.50	ROAST	O
TYPE 2503			
1	\$18.50	ROBIN	P

Special capacities: Larger or intermediate sizes, as well as combinations of various sizes into blocks or special units may be had on special order for manufacturers only. Packed one in a box. Standard package—10 boxes.



Type 402

THIS series of non-inductive condensers (Types 202, 302, 402, 502, 602, 802 and 1002) is available in seven groups to meet the requirements of all types of modern socket power units or power packs. Each unit is equipped with long, heavy, flexible, rubber covered wire leads, convenient for easy wiring. The use of leads instead of terminals prevents leakage between terminals and simplifies connections.

The cases are of uniform height and provided with convenient mounting feet. Any number of units can be mounted side by side, making a pleasing and compact assembly. They are conservatively rated and have a high safety factor for safe operation at their rated voltages.

For detailed Can Dimensions of all Aerovox Paper Dielectric Condensers listed on this page, refer to the corresponding Can Symbol Code Letters on page 13.



Type 1002

FILTER AND BYPASS CONDENSER BLOCKS

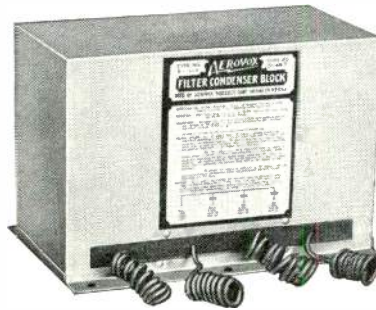

TO meet the demands of all types of filter circuits for use with different types of rectifiers and amplifiers, the Aerovox Wireless Corporation has introduced a Universal Series of Filter Condenser and Bypass Blocks in the type of can shown above.

The filter condenser blocks in this series consist of 2-2-2 and 2-4-4 mfd. units in four voltage series. Bypass condenser blocks to match these units are available in four different combinations of capacities and working voltages.

For detailed specification of these units, see pages 10 and 11.

IN some instances a receiver manufacturer may desire to have a condenser unit or block mounted in a can similar to other units in the receiver to preserve uniformity of appearance in the chassis. The Aerovox Wireless Corporation is in a position to build such units in cans furnished by the receiver manufacturer, or to furnish complete units, including cans designed to match the other units of the chassis. To all appearances the unit becomes a part of the receiver manufacturer's own output.

The Aerovox Wireless Corporation is serving as the main source of supply for the leading set manufacturers.

THE Aerovox Wireless Corporation is tooled to make any size can and to assemble any condenser combinations in accordance with specifications. In drawing up specifications, manufacturers might keep in mind that R.M.A. and N.E.M.A. recommend a standard height of five inches and standard widths of two inches or four inches, with depth dependent on capacities and working voltages.

A sample of one of these units is shown above. These can be made with or without mounting lugs or flanges and with terminals or flexible wire leads, arranged as desired for ease in assembly.

FILTER BLOCKS Code Words and Prices

Type No.	Total Cap. Mfd.	List Price	Code Word
Universal Units			
A-400	6	\$ 6.75	SALAD
B-400	10	10.00	SALVO
A-600	6	9.50	SAUCY
B-600	10	13.75	SCALD
A-800	6	12.50	SCALP
B-800	10	19.00	SCALY
A-1000	6	17.00	SCAMP
B-1000	10	25.00	SCANT

Bypass Units

B-1	2	\$2.40	SCATH
B-2	3	4.20	SCOBS
B-3	6	6.45	SCREW
B-4	9	9.00	SEEDY

Miscellaneous

BH-320	14	\$10.00	SAPPY
BH-420	14	13.00	SATIN
AC-29	12	18.00	SCARE

Packed one in a box.
Standard Package—5 boxes.
For detailed specifications of filter
and bypass condenser blocks
see pages 10 and 11.

CONSULTING SERVICE

A special study has been made by Aerovox engineers of the peculiarities of various types of filter circuits and receiver requirements to determine the minimum and maximum capacity and insulation requirements necessary in filter blocks to attain efficient operation. Radio engineers and receiver manufacturers may avail themselves of this service without charge or obligation.

ECONOMY FACTORS

Large economies can often be effected in condenser manufacture by proper selection of the dimensions of the units or blocks. The importance of early consultation between receiver engineers and Aerovox engineers while the receiver is in its formative stages is evident. By making proper space allowance for the most economical condenser assembly, costs can be reduced and assembly facilitated.

SPECIAL FILTER BLOCKS MADE TO ORDER AT SHORT NOTICE

UNIVERSAL FILTER CONDENSER BLOCKS

THIS series of Universal Filter Condenser Blocks was designed to fill all requirements of modern power supply units.

The only difference between the "A" series, listed in the left column, and the "B" series,

listed in the right column, for any given voltage requirement is that a 2-2-2 mfd. combination type of filter is used in the "A" series while a 2-4-4 mfd. combination type of filter is used in the "B" series.

Type A-400

List Price—\$6.75
Code Word—SALAD

Cap. Mfd.	Color Leads	Working D. C.	Volt. A. C.
0	Black	—	—
2	Red	400	250
2	Green	300	175
2	Green	300	175

Can Symbol—II



Types A-400 and B-400

These two units are for use in power supply circuits employing a 280 type full-wave rectifier tube and designed to supply "B" and "C" voltages to receivers employing one or two 171-A type tubes in the power stage. They can be used with any power transformer designed to supply a secondary voltage of not more than 300 volts AC per anode to the rectifier.

Type B-400

List Price—\$10.00
Code Word—SALVO

Cap. Mfd.	Color Leads	Working D. C.	Volt. A. C.
0	Black	—	—
2	Red	400	250
4	Green	300	175
4	Green	300	175

Can Symbol—LL

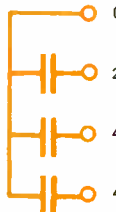

Type A-600

List Price—\$9.50
Code Word—SAUCY

Cap. Mfd.	Color Leads	Working D. C.	Volt. A. C.
0	Black	—	—
2	Yellow	600	350
2	Gray	500	300
2	Red	400	250

Can Symbol—KK



Types A-600 and B-600

These two units are for use in power supply circuits employing either one or two 280 type full wave rectifiers or two type 281 rectifiers connected to give full wave rectification, to supply "B" and "C" voltages to receivers employing one or two 245 or two 171A type tubes in the power stage. They can be used with any power transformer designed to supply a secondary voltage of not more than 400 volts AC per anode to the rectifier.

Type B-600

List Price—\$13.75
Code Word—SCALD

Cap. Mfd.	Color Leads	Working D. C.	Volt. A. C.
0	Black	—	—
2	Yellow	600	350
4	Gray	500	300
4	Red	400	250

Can Symbol—M

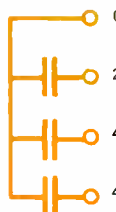

Type A-800

List Price—\$12.50
Code Word—SCALP

Cap. Mfd.	Color Leads	Working D. C.	Volt. A. C.
0	Black	—	—
2	Brown	800	440
2	Yellow	600	350
2	Yellow	600	350

Can Symol—M

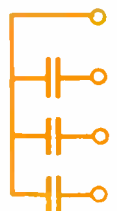

Types A-800 and B-800

These two units are for use in power supply circuits employing either one 281 type rectifier for half-wave rectification or two 281 tubes for full wave rectification, to supply "B" and "C" voltages to receivers employing one or two 210 type tubes in the power stage. They can be used with any power transformer designed to supply a secondary voltage of not more than 600 volts AC per anode to the rectifier.

Type B-800

List Price—\$19.00
Code Word—SCALY

Cap. Mfd.	Color Leads	Working D. C.	Volt. A. C.
0	Black	—	—
2	Brown	800	440
4	Yellow	600	350
4	Yellow	600	350

Can Symbol—O

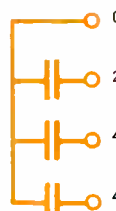

Type A-1000

List Price—\$17.00
Code Word—SCAMP

Cap. Mfd.	Color Leads	Working D. C.	Volt. A. C.
0	Black	—	—
2	White	1000	600
2	Brown	800	440
2	Brown	800	440

Can Symbol—O

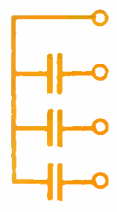

Types A-1000 and B-1000

These two units are for use in power supply units employing one or two 281 rectifiers for half or full-wave rectification, to supply "B" and "C" voltages to receivers employing one or two 250 type tubes in the power stage. They can be used with any power transformer designed to supply a secondary voltage of not more than 750 volts AC per anode to the rectifier.

Type B-1000

List Price—\$25.00
Code Word—SCANT

Cap. Mfd.	Color Leads	Working D. C.	Volt. A. C.
0	Black	—	—
2	White	1000	600
4	Brown	800	440
4	Brown	800	440

Can Symbol—Q



For bypass condenser blocks suitable for use in connection with the voltage divider taps of power supply units, see page 11.

For can dimensions see page 13.

For can dimensions see page 13.

UNIVERSAL BYPASS CONDENSER BLOCKS

Type B-1

List Price—\$2.40

Code Word—SCATH

Cap. Mfd.	Color Leads	Working D. C.	Volt. A. C.
0	Black	—	—
1	Green	300	175
1	Blue	200	125



Can Symbol—FF

The Type B-1 unit can be used where a 90 to 135-volt tap and a 45-volt tap must be bypassed. It is also ideal for use in bypassing two grid bias resistors, across one of which the voltage drop may be comparatively high such as the 51 volts required for 245 type power tubes and the 84 volts required for 250 type power tubes.

Type B-3

List Price—\$6.45

Code Word—SCREW

Cap. Mfd.	Color Leads	Working D. C.	Volt. A. C.
0	Black	—	—
1	Red	400	250
4	Green	300	175
1	Orange	300	175



Can Symbol—JJ

The Type B-3 unit is similar to the B-2 unit except that a 4-mfd. section has been substituted for one of the 1-mfd. sections. The use of the 4-mfd. section across the 90-volt tap improves filtering and reduces hum, usually due to coupling, to a minimum. This unit can also be used as a filter unit for the use recommended in connection with B-2 with better filtering action provided by the 4-mfd. section.

To complete the condenser requirements of the average power supply unit, bypass condensers are required at the various taps of the voltage divider.

This line of Universal Bypass Condenser Blocks Types B-1, B-2, B-3 and B-4 has been designed to match the Universal Filter Condenser Blocks listed on page 10.

The dimensions of the cans in height and depth are such that the Bypass Blocks can be arranged alongside the Universal Filter Blocks making a neat, compact and economical assembly.

The splitting up of the filter and bypass units also permits mounting the condenser units in odd spaces, on the chassis, which are too small to permit the mounting of a single complete assembly.

It will be noted that condensers of 300 D.C. working voltage rating and in some cases 400 D.C. working voltage ratings have been used in place of lower voltage condensers in most sections. The use of such higher rating condensers is necessary in receivers using the heater type tubes and the 245 and 250 type tubes which have a decided time lag before plate current is drawn.

This time lag of the tubes results in temporary excessive voltages at the 90, 135 and 180-volt taps and requires the use of higher voltage rating condensers. In practically all of the modern receivers, a 300-volt D.C. working voltage condenser should be used at the 90 to 135-volt taps and a 400-volt condenser at the 180-volt tap. The increasing popularity of grid bias detectors, with higher plate voltages in the detector stage sometimes makes the use of a 300-volt condenser advisable in the detector stage.

For comparative prices of all Filter and Bypass Blocks see page 9.

All Bypass Blocks packed one in a box. Standard package 5 boxes.

Type B-2

List Price—\$4.20
Code Word—SCOBS

Cap. Mfd.	Color Leads	Working D. C.	Volt. A. C.
0	Black	—	—
1	Red	400	250
1	Green	300	175
1	Green	300	175

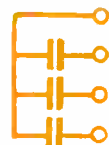

Can Symbol—HH

The Type B-2 unit is designed for bypass service in connection with voltage dividers which furnish one 180-volt tap and two lower voltage taps. It may also be used as a filter block in connection with a 280-type rectifier circuit, where cost is a very important factor and some hum due to somewhat imperfect filtering is not objectionable.

Type B-4

List Price—\$9.00
Code Word—SEEDY

Cap. Mfd.	Color Leads	Working D. C.	Volt. A. C.
0	Black	—	—
1	Red	400	250
4	Green	300	175
1	Orange	300	175
1	Orange	300	175
1	Blue	200	125
1	Blue	200	125



Can Symbol—KK

The Type B-4 unit is similar to the Type B-3 unit except that three additional 1-mfd. sections have been added to take care of an extra tap at the divider and to provide two low voltage sections for bypassing grid bias resistors.

This unit can also be used as an inexpensive filter and bypass block for a 280 type rectifier, using the 1-4-1 sections as the filter unit and the others as bypass units.

FILTER BLOCKS FOR RAYTHEON CIRCUITS

Type BH-320

List Price—\$10.00

Code Word—SAPPY

Cap. Mfd.	Color Leads	Working D. C.	Volt. A. C.
0	Black	—	—
2	Brown	400	250
2	Orange	300	175
8	Red	200	125
1	Blue	200	125
1	Blue	200	125



Can Symbol—L

TYPES BH-320 and BH-420 Filter Blocks listed in this section are designed for Raytheon rectifier tube circuits.

The Type BH-320 is designed for use in filter circuits designed to furnish only "B" supply and in which the maximum terminal output voltage of 180 volts is obtained by applying a maximum of 250 volts A.C. to each anode of the rectifier. The Type BH-420 is designed for use in filter circuits to furnish both the maximum of 180 volts for the "B" supply and 40 volts for the grid bias or a total of 220 volts, obtained by applying a maximum of 325 volts to each anode of the rectifier.

Type BH-420

List Price—\$13.00

Code Word—SATIN

Cap. Mfd.	Color Leads	Working D. C.	Volt. A. C.
0	Black	—	—
2	Brown	400	250
2	Brown	400	250
8	Red	300	175
1	Blue	200	125
1	Blue	200	125



Can Symbol—M

THERE IS AN AEROVOX UNIT FOR EVERY BYPASS NEED



BUFFER AND BYPASS CONDENSER BLOCKS

Type 461-21

List Price—\$1.25
Code Word—SCRUB

Cap. Mfd.	Sect. No.	Working D. C.	Volt. A. C.
0	0	—	—
.1	1	400	250
.1	2	400	250

Can Symbol—XX

Type 461-31

List Price—\$1.75
Code Word—SCULL

Cap. Mfd.	Sect. No.	Working D. C.	Volt. A. C.
0	0	—	—
.1	1	400	250
.1	2	400	250
.1	3	400	250

Can Symbol—XX

Type 461-225

List Price—\$1.65
Code Word—SCURF

Cap. Mfd.	Sect. No.	Working D. C.	Volt. A. C.
0	0	—	—
.25	1	400	250
.25	2	400	250

Can Symbol—XX

All units packed one in a box.
Standard Package—10 boxes.

For dimensions of XX cans
see page 7.



THE type of can shown above is the type used in the Types 461-21, 461-31 and 461-225 Buffer and Bypass Condensers.

For more detailed information regarding single and combination capacities in this can and in the smaller can shown

TYPES 646, 1046 and 1546 Buffer Condensers are ideal for use across the sections of the secondary windings of power transformers designed for use with gaseous type rectifiers.

These units consist of two non-inductively wound .1 mfd. sections, connected in series and provided with a centertap as shown in the diagrams. The centertap is connected to the centertap of the secondary winding while the other terminals are connected to the ends of the winding.

They are made in different types with condensers of various working voltages to take care of the voltages encountered in different types of rectifier circuits.

The A.C. voltages applied to the anodes of the rectifiers with which these buffer condenser blocks are used should not exceed the A.C. working voltages of the units.



Type 646, 1046 and 1546



Type 646

List Price—\$1.60
Code Word—SAGAS

Cap. Mfd.	Color Leads	Working D. C.	Volt. A. C.
.1	Red	600	350
0	Black	—	—
.1	Red	600	350

Can Symbol—E

Type 1046

List Price—\$2.25
Code Word—SALVE

Cap. Mfd.	Color Leads	Working D. C.	Volt. A. C.
.1	Red	1000	600
0	Black	—	—
.1	Red	1000	600

Can Symbol—F

Type 1546

List Price—\$2.75
Code Word—SAVOY

Cap. Mfd.	Color Leads	Working D. C.	Volt. A. C.
.1	Red	1500	800
0	Black	—	—
.1	Red	1500	800

Can Symbol—H

All units packed one in a box.
Standard Package—10 boxes.

For dimensions of E, F and H cans
see page 13.



to its right see page 7, where detailed dimensions of cans, methods of mounting and special features of this type of assembly are given.

These units can be made in any combination and with various arrangements of terminals and mounting feet.

BUFFER and Bypass Units can be furnished in special cans with any desired arrangement of terminals and mountings to manufacturers only. A sample of a special type of mounting is shown above. We shall be glad to quote on special requirements.

DIMENSIONS OF CANS FOR FILTER CONDENSERS AND FILTER CONDENSER BLOCKS

2-Hole Mounting Cans

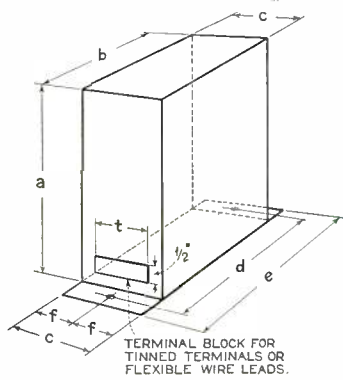

Can Symbol	a	b	c	d	e	f	t
E	5"	2"	5/8"	25/8"	3 5/2"	1 5/8"	3/8"
F	5"	2"	1 1/8"	25/8"	3 5/2"	1 7/2"	1 1/8"
G	5"	2"	1 7/8"	25/8"	3 5/2"	1 1/2"	7/8"
FF	5"	4"	3/4"	45/8"	5 5/2"	3/8"	3/8"
GG	5"	4"	1"	45/8"	5 5/2"	1/2"	5/8"
HH	5"	4"	1 1/4"	45/8"	5 5/2"	5/8"	3/4"
II	5"	4"	1 1/2"	45/8"	5 5/2"	3/4"	7/8"

4-Hole Mounting Cans

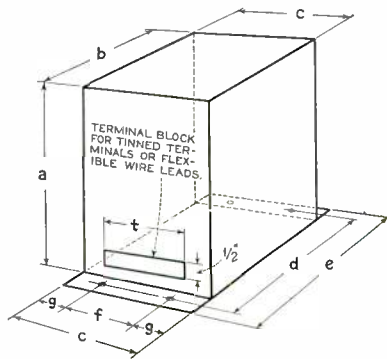

Can Symbol	a	b	c	d	e	f	g	t
H	5"	2"	1 1/8"	25/8"	3 5/2"	1 1/8"	1/2"	1 1/8"
I	5"	2"	2 5/8"	25/8"	3 5/2"	1 5/8"	1/2"	1 3/4"
J	5"	2"	3 7/8"	25/8"	3 5/2"	2 1/8"	1/2"	2 1/8"
JJ	5"	4"	1 3/4"	45/8"	5 5/2"	3/4"	1/2"	1"
KK	5"	4"	2"	45/8"	5 5/2"	1"	1/2"	1 1/4"
LL	5"	4"	2 1/2"	45/8"	5 5/2"	1 1/2"	1/2"	1 5/8"
M	5"	4"	3"	45/8"	5 5/2"	2"	1/2"	2 1/4"
MM	5"	4"	3 1/2"	45/8"	5 5/2"	2 1/2"	1/2"	2 1/2"

6-Hole Mounting Cans

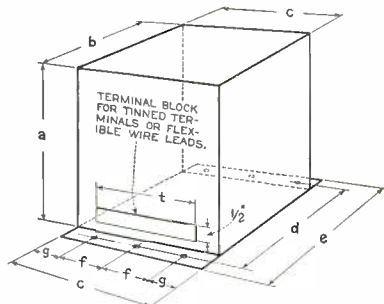

Can Symbol	a	b	c	d	e	f	g	t
K	5"	2"	4"	25/8"	3 5/2"	1 1/2"	1/2"	3 1/8"
L	5"	2"	5"	25/8"	3 5/2"	2"	1/2"	4"
N	5"	4"	4"	45/8"	5 5/2"	1 1/2"	1/2"	3"
O	5"	4"	5"	45/8"	5 5/2"	2"	1/2"	4"
P	5"	4"	6 3/8"	45/8"	5 5/2"	2 1/8"	1/2"	5 1/4"
Q	5"	4"	7 5/8"	45/8"	5 5/2"	3 1/8"	1/2"	6 1/2"

Overall dimensions of cans are plus or minus 1/16"

The Aerovox Wireless Corporation is tooled to make up cans of any type, size or mounting at short notice.

CAN SIZES ARE IN ACCORD WITH STANDARDIZED PRACTICE

BAKELITE MOULDED MICA CONDENSERS



Type 1450



Type 1460



Type 1475

THESE condensers are moulded in genuine bakelite. The capacity of the condenser element is predetermined by a patented process. The bakelite seals and protects the condenser against extreme temperature, moisture or chemical action. The dielectric is of the finest grade India Ruby Mica, the plates are tin-

foil, and the condenser element is thoroughly impregnated. They are compact in size with special lugs which allow for screw, eyelet or soldering assembly. The soldering tabs of Types 1450 and 1475 condensers have split elongated slots for easy connection to solid or stranded wire. The type 1460 condenser is

made to the same exacting standards as the larger Type 1450 and 1475 units. An outstanding feature of the Type 1460 condenser is the mounting consisting of two insulated holes which permit mounting on metal subpanels. This unit may also be mounted by means of the soldering lugs, on insulated panels.

STOCK CAPACITIES Type 1450

Cap. Mfd.	List Price	Code Word
.00004	\$.30	SERGE
.00005	.30	SERVE
.00007	.30	SETON
.000075	.30	SKULK
.0001	.30	SEPOY
.00015	.30	SEPIA
.0002	.30	SENNA
.00025	.30	SEDE
.00037	.30	SEDAN
.0005	.30	SECCO
.001	.35	SCULK
.0015	.35	SKULL
.002	.40	SENSE
.0025	.40	SHOOT
.003	.45	SHORE
.004	.45	SHORT
.005	.50	SHOTE
.006	.50	SHOUT
.0075	.70	SHOVE
.01	.75	SHOWY
.015	1.00	SHREW
.02	1.25	SHRED

CAPACITY TOLERANCE

Stock capacities of Aerovox Mica Condensers, both of the moulded and canvas bakelite type, are accurate to within 10 per cent of marked ratings. They can be made to closer tolerances on special order.

RETEST VOLTAGES

Types 1350, 1375 and 1460 mica condensers will stand a retest voltage of 600 volts D.C. Types 1450 and 1475 mica condensers will stand a retest voltage of 1000 volts D.C.

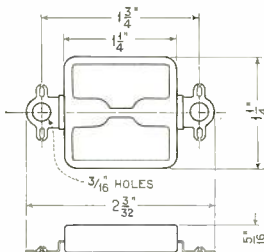

Comparative Prices Of All Types of Aerovox Mica Condensers

Cap. Mfd.	Type 1350	Type 1450	Type 1460
.00004	\$.22	\$.30	\$.20
.00005	.22	.30	.20
.00007	.22	.30	.20
.000075	—	.30	.20
.0001	.22	.30	.20
.00015	.22	.30	.20
.0002	.22	.30	.20
.00025	.22	.30	.20
.00037	.22	.30	.25
.0005	.22	.30	.25
.001	.27	.35	.25
.0015	—	.35	.25
.002	.32	.40	.35
.0025	.32	.40	.35
.003	.37	.45	.40
.004	.40	.45	.40
.005	.45	.50	.40
.006	.45	.50	.40
.0075	.60	.70	.40
.01	.65	.75	.40
.015	.80	1.00	.40
.02	1.00	1.25	.40

Cap. Mfd.	Type 1375	Type 1475
.0001	\$.30	\$.40
.00015	.30	.40
.00025	.30	.40
.0005	.30	.40

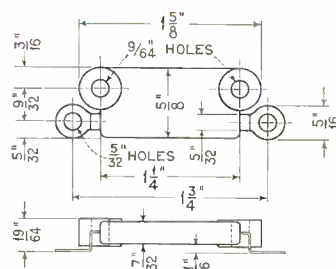

These dimension drawings will be found valuable in designing receivers. The one on the left is of the Type 1450 condenser, the one above is of the Type 1460 and the one on the right is of the Type 1475 condenser.

STOCK CAPACITIES Type 1460

Cap. Mfd.	List Price	Code Word
.00004	\$.20	TEENS
.00005	.20	TEETH
.00007	.20	TEMP
.000075	.20	URBAN
.0001	.20	TENET
.00015	.20	TEPID
.0002	.20	TERSE
.00025	.20	TESTY
.00037	.25	THAN
.0005	.25	THANK
.001	.25	THEIR
.0015	.25	USAGE
.002	.35	THEME
.0025	.35	THERE
.003	.40	THICK

TYPE 1475

.0001	.40	SHRUB
.00015	.40	SHRUG
.00025	.40	SHUCK
.0005	.40	SHUNT

SPECIAL CAPACITIES

The capacities listed in this section are stock capacities. Intermediate capacities may be obtained to order at the price of next higher stock capacity.

DIELECTRIC MATERIAL

Only the finest grade of India Ruby Mica is used as dielectric material in all types of Aerovox Mica Condensers.

STANDARD PACKAGES

All mica condensers listed in this section are packed 10 in a box and 10 boxes to a package.

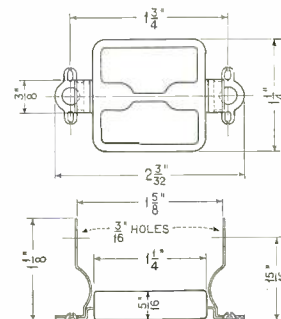



CANVAS BAKELITE MICA CONDENSERS



Type 1350

THESE condensers are used extensively. They are standard in size, compact, highly efficient and of attractive design. The dielectric is the finest grade of India Ruby Mica, the external insulation is canvas Bakelite, and the

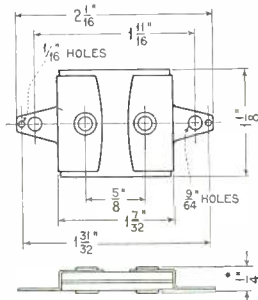

*Thickness varies somewhat with different capacities.
Dimensions of Type 1350 mica condensers.

STOCK CAPACITIES

Type 1350

Cap. Mfds.	List Price	Code Word
.00005	\$.22	CAMEL
.0001	.22	CABLE
.00015	.22	CARET
.00025	.22	CARGO
.0005	.22	CAROL
.001	.27	CASTE
.002	.32	CATCH
.0025	.32	CATER
.003	.37	CAVIL
.004	.40	CEASE
.005	.45	CEDAR
.006	.45	CHAFE
.0075	.60	CAROM
.01	.65	CHANT
.015	.80	CANTO
.02	1.00	CARVE

Type 1375

.0001	\$.30	CHART
.00015	.30	CHEST
.00025	.30	CHASM
.0005	.30	CHEER

Complete details of comparative prices of stock capacities of all types of mica condensers and special characteristics of all mica condensers will be found on the opposite page.



Type 1375

soldering lug and end plate are made in one piece, tinned for easy soldering and efficient contact. They may be mounted either through the hollow rivets which hold the end-pieces or through holes for the purpose provided in the terminals.

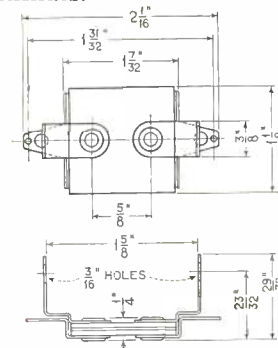

Dimensions of Type 1375 mica condensers.

FREE

The AEROVOX

Research Worker



The Aerovox Research Worker is a monthly house organ of the Aerovox Wireless Corporation. It is published to bring to the Radio Experimenter and Engineer authoritative, first hand information on condensers and resistances for radio work.

Vol. 1
No. 7

THE Aerovox Research Worker is a free publication issued monthly by the Aerovox Wireless Corporation, to keep radio experimenters, engineers and manufacturers abreast of the latest developments in radio.

Special attention is given each month to design problems in connection with radio receivers and power supply units, with special attention on the proper use of resistors and condensers.

During the past year such subjects as the "Measurement of the A.C. Component of Composite Voltages"; the "Construction of a Peak Voltmeter"; "Latest Developments in 'A' Condensers"; "Notes on the Design of

Filters"; "Principles of Voltage Divider Design"; "How to Test Condenser Capacities"; "Trouble Shooting in A.C. Receivers"; the "Selection of Resistors for Power Supply Work" and other such subjects have been treated in detail.

A request to be placed on the mailing list for the Research Worker will bring you this interesting monthly without charge or obligation. Address your request to:

THE AEROVOX RESEARCH WORKER,
Aerovox Wireless Corporation,
60-64 Washington Street
Brooklyn, N. Y.

AEROVOX MICA CONDENSERS ARE PERMANENT UNDER ALL CONDITIONS

"A POWER" CONDENSERS

THIS condenser was developed to meet the demand for an efficient, low voltage, high capacity unit suitable for use in the filter circuit of an "A" battery eliminator for operation from either A.C. or D.C. lines.

A filter composed of three Type 6A-2000 units and two choke coils (.1 to .5 Henry, capable of carrying 2 amperes) as shown in Fig. 1, will effectively filter the output of a standard dry rectifier and provide an excellent "A" battery eliminator. "T" is a step-down transformer to produce a voltage of about 12 volts across the terminals of the rectifier. This is sufficient to produce a voltage of 5 to 6 volts across the output (A+ and A-) terminals of the unit.

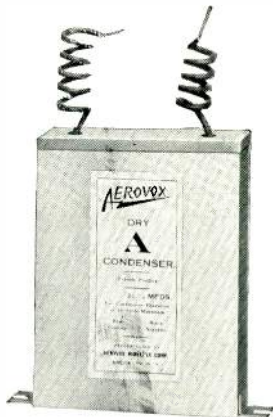

Types 6A-1500,
6A-2000 and 6A-4000.

filter circuit shown in Fig. 1, in place of the transformer and rectifier shown.

For 110-volt D.C. lines, a similar filter circuit can be connected across the lines, using a suitable resistance bank to reduce the 110 volts of the line to the required voltage input to the filter, as shown in Fig. 2.

These high capacity units are ideal for eliminating the hum in A.C. dynamic speakers which are designed as separate units to work directly from the A.C. lines. In such speakers, a transformer and rectifier unit is used to provide the energizing current for the field winding. The use of an "A" condenser as shown in Fig. 3 will effectively remove all hum from the speaker.

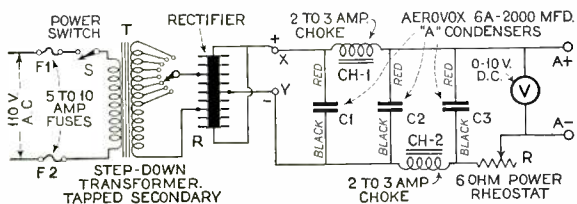

Fig. 1

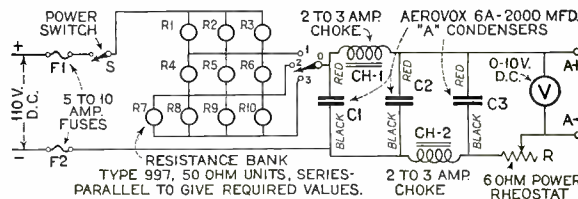

Fig. 2

A rheostat "R" may be used for exact adjustment of the output.

If a Tungar tube, Balkite or dry rectifier type of charger is available, it is possible to obtain a very efficient "A" eliminator by connecting the output of the charger to terminals "X" and "Y" of the

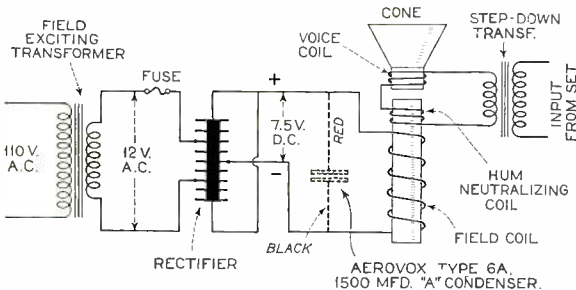

Fig. 3

The low voltage types of high capacity condensers cannot be used across the high voltage field windings of dynamic speakers which operate from power amplifier circuits. In such cases the use of the high voltage types of high capacity condensers listed at the bottom of this page can be employed to advantage.

IMPORTANT

"A Power" Condensers **MUST** be mounted and used in an upright position.

Type No.	Cap. Mfds.	Max. D.C. Working Voltage	Rec. D.C. Working Voltage	List Price	Code Word	Dimensions	
						Standard	Special
6A-1500	1500	12	6 to 8	\$3.50	CONCH	1 3/4" x 4" x 5 1/2"	2" x 2" x 7"
6A-2000	2000	12	6 to 8	4.00	CONGE	1 3/4" x 4" x 5 1/2"	2" x 2" x 7"
6A-4000	4000	12	6 to 8	7.50	CONOY	2 1/2" x 4" x 5 1/2"	

Type 6A-4000 unit consists of two 6A-2000 units in a single can.
Packed one in a box. Standard Package—10 boxes.

IMPORTANT

The Maximum D.C. working voltage of 12 volts **MUST NOT** be exceeded.

HIGH CAPACITY—100-VOLT CONDENSERS

THESE high voltage, high capacity units are the latest developments in high voltage, high capacity units. They were perfected to meet the in-

sistent demand for high capacity units to effectively filter out hum due to insufficient filtering provided by low capacity units. They are ideally

suited for eliminating hum in high voltage speakers whose field windings are energized from a source not exceeding 100 volts D.C.

IMPORTANT

These high voltage, high capacity units **MUST** be mounted and used in an upright position.

No. Type	Mfds. Cap.	Max. D.C. Working Voltage	Rec. D.C. Working Voltage	Price List	Word Code	Dimensions
100A-75	75	100	90 to 100	4.00	CACHE	1 3/4" x 4" x 5 1/2"
100A-100	100	100	90 to 100	5.75	CADDY	1 3/4" x 4" x 5 1/2"

Packed one in a box. Standard Package—10 boxes.

IMPORTANT

The maximum D.C. working voltage of 100 volts **must not** be exceeded.

INTERFERENCE FILTERS



Types IN-24 and IN-44

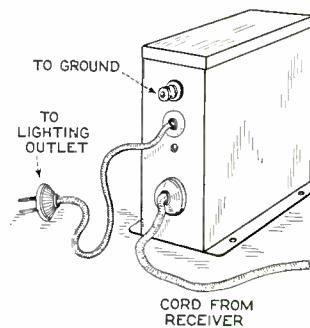

Type No.	List Price	Code Word	For Use on		Can Symbol
			D. C.	A. C.	
IN-24	\$6.50	INDUE	200	110	I
IN-44	7.50	INERT	400	220	J

Packed one in a box. Standard Package—10 boxes.
For dimensions of cans see page 13.

ELIMINATION OF "MAN-MADE" STATIC

RADIO listeners all over the country are finding welcome relief from the innumerable line noises caused by motors, elevators, refrigerators, oil burners, bells and other electrical appliances by using Aerovox Interference Filters. These units are also effective in preventing disturbances from electrical appliances from being applied to the electric lines to cause annoyance to neighboring receivers.

Because of the inherent nature of radio interference and the uncontrollable factors met with occasionally, no single piece of apparatus can be guaranteed to eliminate all types of interference under all conditions, but the use of the standard Aerovox Interference Filters, even in such extreme cases, will usually reduce the annoyance to an unobjectionable minimum.

The average type of noisy interference which causes trouble can usually be classified under two main headings: first, that caused by interference which comes over the antenna and ground system and which it is impossible to eliminate except by finding the source of interference and eliminating the interference at the source by suitable filter-

ing, and second, the type of disturbances which come over the lighting lines to which the receiver is connected. Interference over the lighting lines may be the result of the connection of spark or surge producing apparatus to the line, or to pickup of the line which may act as an antenna or as a secondary circuit in which varying voltages in other nearby circuits are induced in the lighting lines.

Interference which comes to the receiver over the lighting lines can be eliminated in the majority of cases by the use of an Aerovox Interference Filter, between the line and the receiver, connecting the ground terminal of the interference filter to ground, as shown in the sketch on this page.

To use the Interference Filter with an electrical device such as a motor, electric refrigerator, vacuum cleaner or other electrical device which creates radio interference, plug the cord of the electrical device into the receptacle of the Interference Filter and plug the cord of the Interference Filter into the wall outlet or lamp socket. The binding post of the Interference Filter should be connected to a good ground.

Two types of units are available to suit practically all installations. The IN-24 unit is for use on 110-volt A.C. lines and on D.C. lines up to 200 volts. The IN-44 is for use on 220-volt A.C. lines and on D.C. lines up to 400 volts.

Since the Aerovox Interference Filters are pure capacity filters, there is no danger of burnouts, no matter how much current is drawn by the devices with which they are connected.

These units are sold on a money back guarantee. If for any reason they do not prove satisfactory in eliminating the greater part of the interference, the purchase price will be refunded on return of the unit in an undamaged condition to the dealer.

It is suggested that these units be disconnected from the line when not in use. The energy consumed by the connection of one of these units across a line is negligible being of the order of one to two cents of current per month even when connected continuously across the line. However, keeping the unit connected across the line continuously constitutes a strain on the dielectric of the condenser which reduces the useful life of the unit.



PYROHM HEAVY DUTY VITREOUS ENAMEL RESISTORS

AEROVOX Pyrohm Resistances are made of the best grade of resistance wire, wound on a refractory tube and coated with a porcelain enamel which is fired on and thoroughly covers and protects the wire against moisture, oxidation and mechanical injury.

The wire, tube and enamel have the same coefficient of



expansion which permits the unit to be used under heavy loads, without displacement of

or injury to the wire.

In the process of manufacture, the unit is subjected to high heat, and for this reason will stand overheating in service without injury.

Heat is radiated rapidly from the glassy porcelain surface. The resistance value is permanent and will not change with use.

IMPORTANT DATA ON RESISTOR RATINGS

The standard method of arriving at the maximum rating of resistors of the Pyrohm vitreous enamel type, is the input in watts required to produce a temperature rise of 250 degrees Centigrade (482 degrees Fahrenheit) at the hottest point of the resistor, when the resistor is surrounded by at least one foot of free air, the surrounding air being at a temperature not exceeding 40 degrees Centigrade (104 degrees Fahrenheit).

This is a standard of the N. E. M. A. and the R. M. A.

The maximum rating in watts and the maximum current capacity of Pyrohm Resistors listed in this section is based on the above standard, although these resistors will carry heavier loads safely, with corresponding increase in temperature.

The maximum loads which may be applied safely to these resistors, as well as to any similar resistor, as long as the maximum rating is not exceeded, is governed by the use to which the resistor is put and

by the heat tolerances of apparatus placed in close proximity to the resistor.

When used in poorly ventilated places, or close to other pieces of apparatus, such as condensers, which might be damaged by excessive heat, it is necessary to reduce the rating of the resistor. It is impossible to tell just to what extent poor ventilation or close proximity of other apparatus will increase the temperature of the resistor with any given current flowing through it. However, in the following tables of Pyrohm Resistor characteristics, three different ratings are given for each resistor and will serve as a guide in using the resistors.

The "Maximum" watt rating or "Maximum" current capacity rating is based on the input which will cause a temperature rise at the unit of 250 degrees Centigrade (482 degrees F.) when suspended in at least one foot of free air. The "Normal" watt rating or "Normal" current capacity rating is based on the input which will cause a temperature rise of 175

degrees Centigrade (347 degrees F.) under the same conditions of ventilation. The "Cool" watt rating or "Cool" current capacity rating is based on the input which will cause a temperature rise of 100 degrees Centigrade (212 degrees F.) under the same conditions of ventilation.

A safe rule to follow in using any resistor of this type is to use it at the "Cool" rating. This rating is 50 per cent of the maximum current rating and 25 per cent of the maximum watt rating. Where there is no danger of damage to other parts, or where ventilation is good, it is permissible to use them at the higher, "Normal," and even "Maximum" ratings.

The surges met with in circuits containing considerable capacity or inductance or both capacity and inductance at the time when the circuits are opened or closed should always be analyzed carefully and the peak conditions taken into consideration in determining the watt ratings of the resistors to be used in any given application.

EDISON BASE PYROHM RESISTORS

THE Types 997 and 998 Edison Base Pyrohm Resistors are ideal for use wherever high-grade resistors of high current carrying capacity are required. The use of the Edison Base mounting permits easy insertion into or removal from a circuit for quick changes of resistances to compensate for varying conditions of line voltage or load.

The Edison Base may be screwed into any lamp socket, screw type socket or series tap.

The various stock values are suitable for use in cutting



Types 997 and 999

down excessive line voltages for operating a receiver at its rated voltage, as regulating resistances in battery chargers, as elements of resistance banks in D.C. battery eliminators, as units in testing load banks for laboratory and experimental work, as primary circuit resistors or for any other purpose where a resistor with this type

of mounting is required to effect quick changes of resistance values. Resistance values and current carrying capacities other than those listed may be obtained by series and parallel connections of the units. Special values of resistance and current carrying capacity can be furnished on special order to manufacturers.

The approximate overall size of the Type 997 resistor is 5 $\frac{1}{4}$ " long and $\frac{7}{8}$ " diameter. The overall size of the Type 999 unit is 8 $\frac{1}{2}$ " long and 1 $\frac{1}{4}$ " diameter.



UNIVERSAL ADJUSTABLE PYROHM RESISTORS

TYPE UR-1

List Price—\$1.25
Code Word—SEINE
Total Resistance—175 ohms
Wound on a Type 994 Tube
Possible Resistance Values
25, 50, 75, 100, 125, 150 and
175 ohms.

Section Taps	Resist. Ohms	Current Cap. in ma.		
		Max.	Normal	Cool
1 to 2	25	408	286	204
2 to 3	50	408	286	204
3 to 4	100	408	286	204

TYPE UR-2

List Price—\$2.00
Code Word—SEIZE
Total Resistance—3,000 ohms
Wound on a Type 996 Tube
Possible Resistance Values
200, 400, 600, 800, 1,000, 1,200,
1,400, 1,600, 1,800, 2,000, 2,200,
2,400, 2,600, 2,800 and 3,000 ohms.

Section Taps	Resist. Ohms	Current Cap. in ma.		
		Max.	Normal	Cool
1 to 2	200	249	174	124
2 to 3	400	180	126	90
3 to 4	800	150	105	75
4 to 5	1,600	127	89	63

TYPE UR-3

List Price—\$2.50
Code Word—SERUM
Total Resistance—22,400 ohms
Wound on a Type 996 Tube
Possible Resistance Values
3,200, 6,400, 9,600, 12,800, 16,000,
19,200 and 22,400 ohms.

Section Taps	Resist. Ohms	Current Cap. in ma.		
		Max.	Normal	Cool
1 to 2	3,200	105	73	52
2 to 3	6,400	75	52	37
3 to 4	12,800	63	44	31

TYPE UR-4

List Price—\$2.00
Code Word—SETTO
Total Resistance—25,600
Wound on a Type 996 Tube
This resistance value of 25,600 ohms
follows the last section of Resistor
UR-3 in geometrical progression.

Section Taps	Resist. Ohms	Current Cap. in ma.		
		Max.	Normal	Cool
1 to 2	25,600	63	44	31

By using a complete set of the above units consisting of Types UR-1, UR-2, UR-3 and UR-4, it is possible to obtain any resistance value from 25 to 51,175 ohms in steps of 25 ohms. This means that it is possible to obtain any resistance value to within 12.5 ohms above or below the exact value required.



THESE Universal Adjustable Pyrohm Resistors were designed to meet the requirements of experimenters, laboratory workers and professional set builders for adjustable units. They eliminate the necessity of keeping on hand a very large stock of individual resistors and give much more accurate and permanent results than "variable" resistors.

Any required resistance value is obtained simply by connecting the sections of one or more of these units in series. In addition other resistance values can be obtained by connecting the various sections of the resistors in parallel or in series parallel.

The Types UR-10, UR-13 and UR-14 are ideal for use as grid bias resistors, or for use as voltage divider sections where close adjustment of comparatively small resistance values up to 2,250 ohms are required.

The Type UR-14 is especially designed for use as a grid bias resistor for two 245 tubes. Connecting the 50 and 100 ohm sections in parallel gives an additional value of 33 ohms which can be added to the 700 ohm section to give a value of 733 ohms.

The Type UR-2, UR-11, UR-12 and UR-13 units are especially suited for use as voltage divider sections.

It is possible to build up an economical voltage divider of the proper resistance and current carrying capacity values for best results, by mounting and connecting together as many of the units as are required to obtain the desired values.

All units listed on this page are packed one in a box. Standard Package—10 boxes. Special units to meet special requirements for adjustable resistors can be furnished on special order to manufacturers.

TYPE UR-10

List Price—\$1.50
Code Word—SHADE
Total Resistance—750 ohms
Wound on a Type 994 Tube
Possible Resistance Values
50, 100, 150, 200, 250, 300, 350,
400, 450, 500, 550, 600, 650, 700
and 750 ohms.

Section Taps	Resist. Ohms	Current Cap. in ma.		
		Max.	Normal	Cool
1 to 2	50	249	174	124
2 to 3	100	249	174	124
3 to 4	200	127	89	63
4 to 5	400	127	89	63

TYPE UR-11

List Price—\$1.50
Code Word—SHADY
Total Resistance—3,750 ohms
Wound on a Type 994 Tube
Possible Resistance Values
250, 500, 750, 1,000, 1,250, 1,500,
1,750, 2,000, 2,250, 2,500, 2,750,
3,000, 3,250, 3,500 and 3,750 ohms.

Section Taps	Resist. Ohms	Current Cap. in ma.		
		Max.	Normal	Cool
1 to 2	250	127	89	63
2 to 3	500	127	89	63
3 to 4	1,000	127	89	63
4 to 5	2,000	90	63	45

TYPE UR-12

List Price—\$2.25
Code Word—SHAFT
Total Resistance—15,000 ohms
Wound on a Type 996 Tube
Possible Resistance Values
1,000, 2,000, 3,000, 4,000, 5,000,
6,000, 7,000, 8,000, 9,000, 10,000,
11,000, 12,000, 13,000, 14,000 and
15,000 ohms.

Section Taps	Resist. Ohms	Current Cap. in ma.		
		Max.	Normal	Cool
1 to 2	1,000	90	63	45
2 to 3	2,000	90	63	45
3 to 4	4,000	90	63	45
4 to 5	8,000	90	63	45

TYPE UR-13

List Price—\$1.50
Code Word—SKIMP
Total Resistance—2,250
Wound on a Type 994 Tube
Possible Resistance Values
150, 300, 450, 600, 750, 900, 1,050,
1,200, 1,350, 1,500, 1,650, 1,800,
1,950, 2,100 and 2,250 ohms.

Section Taps	Resist. Ohms	Current Cap. in ma.		
		Max.	Normal	Cool
1 to 2	150	249	174	124
2 to 3	300	127	89	63
3 to 4	600	90	63	45
4 to 5	1200	90	63	45

TYPE UR-14

List Price—\$1.25
Code Word—SKIRT
Total Resistance—850 ohms
Wound on a Type 994 Tube
Possible Resistance Values
33, 50, 100, 150, 700, 733, 750,
800 and 850 ohms by series, parallel
and series parallel connections of
sections.

Section Taps	Resist. Ohms	Current Cap. in ma.		
		Max.	Normal	Cool
1 to 2	100	294	206	147
2 to 3	50	481	337	240
3 to 4	700	127	89	64

UNIVERSAL RESISTORS ARE ADAPTABLE TO ANY REQUIREMENT



CHARACTERISTICS AND PRICES OF PYROHM RESISTORS

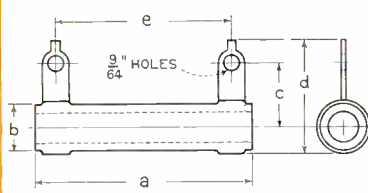

**Dimensions of
Types 991, 992, 993, 994, 996-4,
996-5, 996 and 998 Pyrohm
Resistors.**

Dimensions given in the above tables are approximate. Any resistance value within the limits given can be furnished to manufacturers.

The maximum resistance limit given for each type is the highest resistance which it is possible to furnish in that type, without taps, using resistance wire not smaller than .002" in diameter. Higher resistance values can be obtained by using finer wire. While we do not

Type No.	Rating in watts			Limits in ohms		Dia. of Tube	Finished Dimensions				
	Max.	Normal	Cool	Min.	Max.		a	b	c	d	e
991	7.0	3.5	1.75	.1	1,000	7/16"	1"	1/2"	9/16"	1 1/8"	5/8"
992	15.0	7.5	3.75	.5	5,000	7/16"	2"	1/2"	9/16"	1 1/8"	1 5/8"
993	24.0	12.0	6.0	1.0	8,000	7/16"	3"	1/2"	9/16"	1 1/8"	2 3/8"
994	32.0	16.0	8.0	1.5	12,000	7/16"	4"	1/2"	9/16"	1 1/8"	3 5/8"
996-4	60.0	30.0	15.0	2.0	17,500	3/4"	4"	1 1/8"	3/4"	1 1/2"	3 5/8"
996-5	75.0	37.5	18.75	2.5	25,000	3/4"	5"	1 1/8"	3/4"	1 1/2"	4 5/8"
996	100.0	50.0	25.0	3.0	35,000	3/4"	6 1/2"	1 1/8"	3/4"	1 1/2"	6 1/8"
998	200.0	100.0	50.0	6.0	60,000	1 1/8"	8 1/2"	1 1/8"	1"	1 1/8"	8 1/8"
997	60.0	30.0	15.0	2.0	20,000	3/4"	Edison Base, Overall 5 1/4" x 7/8" dia.				
999	150.0	75.0	37.5	5.0	60,000	1 1/8"	Edison Base, Overall 8 1/2" x 1 1/4" dia.				

recommend the use of wire finer than .002", we can fill manufacturers' specifications requiring the use of wire as fine as .00175", where space considerations make this necessary.

The use of taps on these units will reduce the available winding space for the resistance element and consequently the maximum total resistance it is possible to furnish in each type. Type 991 cannot be furnished with taps. On Types

992, 993 and 994, deduct 2,200 ohms from the maximum limit for each tap. On Types 996-4, 996-5 and 996, deduct 3,400 ohms from the maximum limit for each tap. On Type 998 deduct 4,500 ohms from the maximum limit for each tap. The maximum limit, less deductions for taps gives the maximum total resistance which can be obtained on a given type of tube using wire not finer than .002".

Max. Rating—7 Watts

TYPE 991

Tube Size—1" x 7/16"

FOR MANUFACTURERS ONLY

Resist. Ohms	List Price	Code Word	Current Cap. in ma.			Resist. Ohms	List Price	Code Word	Current Cap. in ma.		
			Max.	Normal	Cool				Max.	Normal	Cool
10	\$.65*	ACME	837	591	418	200	\$.65*	ABBOT	187	132	93
20	.65*	ACUTE	591	418	295	250	.75*	ABHOR	167	118	83
25	.65*	ABAFI	529	374	264	300	.75*	ABIDE	152	108	76
50	.65*	ABASE	374	264	187	400	.75*	ABODE	132	93	66
75	.65*	ABASH	305	216	152	500	.75*	ABUSE	118	83	59
100	.65*	ABATE	264	187	132	750	.75*	ABYSS	96	68	48
150	.65*	ABBEY	216	152	108	1,000	.75*	ACRID	83	59	41

Max. Rating—15 Watts

TYPE 992

Tube Size—2" x 7/16"

Resist. Ohms	List Price	Code Word	Current Cap. in ma.			Resist. Ohms	List Price	Code Word	Current Cap. in ma.		
			Max.	Normal	Cool				Max.	Normal	Cool
3	\$.75*	ADULT	2,236	1,581	1,118	1,100	\$.80	ANKER	116	82	58
4	.75*	AEGIS	1,936	1,369	968	1,200	.80	AGILE	112	78	56
5	.75*	AGAVE	1,732	1,225	866	1,250	.80	AORTA	109	77	54
50	.75*	AMEND	548	387	274	1,500	.80	AGONY	100	70	50
75	.75*	ACTOR	447	316	223	1,750	.80	AISLE	92	65	46
100	.75	ADAGE	387	274	193	1,800	.80	APPLY	91	64	45
150	.75	ADAPT	316	223	158	2,000	.80	ALARM	86	61	43
200	.75	ADDER	274	193	137	2,250	.90	ALDER	81	57	40
250	.80	ADDLE	245	173	122	2,400	.90	ALERT	78	56	39
300	.80*	ADEPT	223	158	111	2,500	.90	ALIAS	77	54	38
350	.80	ADIEU	207	146	103	2,750	.90	ARGIL	73	52	36
400	.80	ADOBE	193	137	96	3,000	.90	ALIBI	71	50	35
500	.80	ADOPT	173	122	86	3,250	.90	ARIES	70	50	35
650	.80	ANISE	152	107	74	3,500	.90	ALIEN	65	46	27
700	.80	AFFIX	146	103	73	3,750	.90	ARRET	63	45	31
750	.80	AFOUL	141	100	70	4,000	.90	ALIGN	61	43	30
800	.80	AGAPE	137	96	68	4,500	.90	ALIKE	57	40	28
1,000	.80	AGENT	122	86	61	5,000	1.00	ALLAY	54	38	27

Max. Rating—24 Watts

TYPE 993

Tube Size—3" x 7/16"

FOR MANUFACTURERS ONLY

Resist. Ohms	List Price	Code Word	Current Cap. in ma.			Resist. Ohms	List Price	Code Word	Current Cap. in ma.		
			Max.	Normal	Cool				Max.	Normal	Cool
100	\$.90*	ASSET	490	346	245	3,000	\$.95*	ANNUL	89	63	44
600	.90*	AMASS	200	141	100	3,500	.95*	ANODE	82	58	41
1,000	.90*	AMITY	155	110	78	4,500	1.00*	ANTIC	78	55	39
2,000	.90*	AMUCK	110	78	55	5,000	1.00*	ANVIL	69	49	34
2,500	.95*	ANNEX	98	69	49	8,000	1.25*	APART	55	39	27

Max. Rating—32 Watts

TYPE 994

Tube Size—4" x 7/16"

Resist. Ohms	List Price	Code Word	Current Cap. in ma.			Resist. Ohms	List Price	Code Word	Current Cap. in ma.		
			Max.	Normal	Cool				Max.	Normal	Cool
10	\$.90*	ARGUE	1,789	1,264	894	2,000	\$.95	ATOLL	126	89	63
20	.95*	ARGUS	1,264	894	632	2,500	1.00	ATTAR	112	79	56
100	.95*	AROMA	566	400	283	3,000	1.00	ATTIC	103	73	51
250	.95*	ARROW	357	253	179	4,000	1.00	AUGHT	89	63	49
500	.95*	ARRAS	253	179	126	5,000	1.00	AVERT	79	56	39
700	.95*	ARRAY	214	151	107	6,000	1.10	AWAIT	73	51	36
750	.95*	ARSON	207	146	103	8,000	1.10	AWARD	63	49	31
1,000	.95	ASSAY	179	126	89	10,000	1.25	AWARE	56	39	28
1,500	.95	ASTER	146	103	73	12,000	1.25	AXIOM	51	36	25

SPECIAL PYROHM RESISTORS CAN BE SUPPLIED ON SHORT NOTICE



CHARACTERISTICS AND PRICES OF PYROHM RESISTORS

Max. Rating—60 Watts			TYPE 996-4			Tube Size—4" x 3/4"					
Resist. Ohms	List Price	Code Word	Current Cap. in ma.			Resist. Ohms	List Price	Code Word	Current Cap. in ma.		
			Max.	Normal	Cool				Max.	Normal	Cool
100	\$1.25*	BACON	775	548	387	2,000	\$1.25*	BATHE	173	122	86
500	1.25*	BARON	346	245	173	2,500	1.25*	BAYOU	155	109	77
700	1.25*	BASIL	293	207	146	4,500	1.25*	BAIRN	115	81	57
1,000	1.25*	BASTE	245	173	122	10,000	1.50*	BELCH	77	55	38
1,500	1.25*	BATCH	200	141	100	17,500	1.75*	BERRY	58	41	29

Max. Rating—75 Watts			TYPE 996-5			Tube Size—5" x 3/4"					
Resist. Ohms	List Price	Code Word	Current Cap. in ma.			Resist. Ohms	List Price	Code Word	Current Cap. in ma.		
			Max.	Normal	Cool				Max.	Normal	Cool
100	\$1.40*	BAIZE	866	616	433	2,000	\$1.40*	BEAST	193	137	96
500	1.40*	BANNS	387	274	193	5,000	1.40*	BEDEW	122	86	61
1,000	1.40*	BASAL	274	193	137	10,000	1.65*	BEDIM	86	61	43
1,500	1.40*	BEAMY	224	158	112	25,000	1.90*	BEDYE	54	38	27

Max. Rating—100 Watts			TYPE 996			Tube Size—6 1/2" x 3/4"					
Resist. Ohms	List Price	Code Word	Current Cap. in ma.			Resist. Ohms	List Price	Code Word	Current Cap. in ma.		
			Max.	Normal	Cool				Max.	Normal	Cool
50	\$1.50	BEGUM	1,414	1,000	707	3,500	\$1.50	BLARE	169	119	84
100	1.50*	BELIE	1,000	707	500	4,000	1.50	BLAST	158	111	79
150	1.50	BELOW	812	574	406	5,000	1.50	BLAZE	141	100	70
250	1.50	BENET	632	447	316	6,000	1.75*	BLEAK	129	91	64
500	1.50	BILGE	447	316	223	7,500	1.75*	BLEAR	115	81	57
750	1.50	BILLY	365	258	182	8,000	1.75	BLEED	111	79	55
1,000	1.50	BIPED	316	223	158	10,000	1.75	BLEND	100	70	50
1,200	1.50*	BERYL	289	204	144	12,000	1.75	BLESS	91	64	45
1,500	1.50	BISON	258	182	129	15,000	1.75	BLIND	81	57	40
2,000	1.50	BLADE	223	158	111	25,000	2.00	BLOCK	63	44	31
2,500	1.50	BLAME	200	141	100	30,000	2.00	BLOOM	57	40	28
3,000	1.50	BLANK	182	129	91	35,000	2.50	BLUFF	53	37	26

Max. Rating—200 Watts			TYPE 998			Tube Size—8 1/2" x 1 1/8"					
Resist. Ohms	List Price	Code Word	Current Cap. in ma.			Resist. Ohms	List Price	Code Word	Current Cap. in ma.		
			Max.	Normal	Cool				Max.	Normal	Cool
10		BIFED	4,472	3,162	2,236	2,500		BOLUS	283	200	141
50	Price	BIGHT	2,000	1,414	1,000	5,000	Price	BOOSE	200	141	100
100	on	BLAND	1,414	1,000	707	10,000	on	BOOZE	141	100	71
250	Appli-	BLOAT	894	632	447	25,000	Appli-	BOSKY	89	63	44
500	cation	BLOOD	632	447	316	50,000	cation	BOURN	63	44	31
1,000		BOGUS	447	316	223	60,000		BRAID	57	40	28

EDISON BASE PYROHM RESISTORS

Max. Rating—60 Watts			TYPE 997			Overall Size—5 1/4" x 7/8"					
Resist. Ohms	List Price	Code Word	Current Cap. in ma.			Resist. Ohms	List Price	Code Word	Current Cap. in ma.		
			Max.	Normal	Cool				Max.	Normal	Cool
3	\$1.50*	BORAX	4,472	3,162	2,236	60	\$1.50*	BRUNT	1,000	707	500
4	1.50*	BOSSY	3,873	2,739	1,936	75	1.50*	BRUSH	894	632	447
5	1.50*	BOTCH	3,464	2,449	1,732	90	1.50*	BRUSK	812	574	406
6	1.50*	BOUGH	3,162	2,236	1,581	110	1.50*	BRUTE	737	521	368
7	1.50*	BOUND	2,927	2,069	1,463	220	1.50*	BUDDY	521	368	260
10	1.50*	BOWER	2,449	1,732	1,224	250	1.50*	BRUIN	490	346	245
15	1.50*	BOXER	2,000	1,414	1,000	330	1.50*	BUDGE	426	301	213
20	1.50*	BRACE	1,732	1,224	866	350	1.50*	BRAZE	413	292	206
25	1.50*	BRAIN	1,549	1,095	774	440	1.50*	BUFFO	368	260	184
30	1.50*	BRAKE	1,414	1,000	707	600	1.50*	BUGLE	316	223	158
50	1.50*	BRASS	1,095	774	547	1,000	1.50*	BREAK	245	173	122

Max. Rating—150 Watts			TYPE 999			Overall Size—8 1/2" x 1 1/4"					
Resist. Ohms	List Price	Code Word	Current Cap. in ma.			Resist. Ohms	List Price	Code Word	Current Cap. in ma.		
			Max.	Normal	Cool				Max.	Normal	Cool
62	\$2.75*	BUILD	1,560	1,102	780	110	\$2.75*	BURGH	1,167	825	583
75	2.75*	BULKY	1,414	1,000	707	220	2.75*	BURIN	825	583	412
90	2.75*	BUNCH	1,290	913	645	330	2.75*	BURLY	693	490	346

* Asterisk used with prices of items listed indicates units made regularly for manufacturers and usually available from stock.
Items not marked with asterisk are stock sizes.

All units packed one in a box. Standard Package—10 boxes. For manufacturers only, Pyrohm resistors can be furnished in any resistance values, within the limits specified on previous page, on special order.

AEROVOX PYROHM RESISTANCE VALUES STAY CONSTANT IN SERVICE

PYROHM VOLTAGE DIVIDER RESISTORS

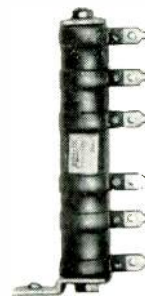
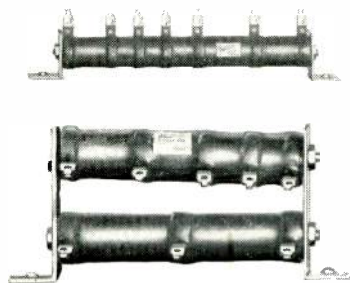

AEROVOX Tapped Pyrohm Voltage Divider Resistors are made to meet the requirements of practically all the

popular receiver and power pack circuits, and give the user a substantial saving in price, labor and space.

by using individual Pyrohm Resistors or Universal Pyrohm Resistors in the various sections to get the exact values.

TYPE CC

List Price—\$5.50
Code Word—SKATE
Total Resistance—41,000 ohms

Section Taps	Resist. Ohms	Current Cap. in ma.		
		Max.	Normal	Cool
Resistor No. 1				
1 to 2	6,000	63	44	31
2 to 3	2,700	63	44	31
3 to 4	2,300	63	44	31
4 to 5	2,000	63	44	31
5 to 6	8,000	63	44	31
Resistor No. 2				
7 to 8	5,000	75	52	37
8 to 9	7,000	75	52	37
9 to 10	8,000	75	52	37

This voltage divider is designed for use in power supply units for operation with receivers and amplifiers employing one or two 210 or 250 tubes in the power stage. It consists of two Type 996 Tapped Pyrohm Resistors, with a Type VV-2 double vertical mounting. It can be had with Type HH-2 horizontal mounting on request.

In use, Tap No. 6 of Resistor No. 1 is connected with Tap No. 7 of Resistor No. 2, thus connecting the two units in series. Tap No. 1 is connected to "B—" and Tap No. 10 is connected to "B+ Max."

The taps to use for various voltages depends on the tubes used in the receiver and amplifier. The proper taps to use can be found by calculation or by trial.

When the resistance values required by special circuits cannot be obtained with these units, the special voltage dividers required can be provided

TYPE 996-171

List Price—\$2.10
Code Word—SIGHT
Total Resistance—13,000 ohms

Section Taps	Resist. Ohms	Current Cap. in ma.		
		Max.	Normal	Cool
1 to 2	2,000	70	49	35
2 to 3	3,000	70	49	35
3 to 4	3,000	70	49	35
4 to 5	3,000	70	49	35
5 to 6	2,000	70	49	35

This voltage divider is designed for use in power supply units for operation with receivers and amplifiers employing one or two 171-A power tubes in the power stage. It consists of a Type 996-5 Tapped Pyrohm Resistor. No mounting is furnished with this resistor but Type VV-1 vertical mounting or Type HH-1 horizontal mounting are available as separate units.

In use, Tap No. 1 is connected to "B—", Tap No. 6 to "B+ Max."

The taps to use for various voltages depends on the tubes used in the receiver. The proper taps may be found by calculation or by trial.

TYPE 996-245

List Price—\$4.75
Code Word—SKEIN
Total Resistance—11,325 ohms

Section Taps	Resist. Ohms	Current Cap. in ma.		
		Max.	Normal	Cool
Resistor No. 1				
1 to 2	2,000	150	105	75
2 to 3	1,350	150	105	75
3 to 4	200	249	174	124
4 to 5	775	150	105	75
Resistor No. 2				
6 to 7	1,000	90	63	45
7 to 8	800	150	105	75
8 to 9	700	150	105	75
9 to 10	3,000	90	63	45
10 to 11	750	150	105	75
11 to 12	750	150	105	75

This voltage divider is designed for use in power supply units for operation with receivers and amplifiers employing one or two 245 power tubes in the power stage. It consists of two Type 996 Tapped Pyrohm Resistors, with a Type VV-2 vertical double mounting. It can be had with Type HH-2 horizontal mounting on request.

In use, Tap No. 1 is connected to "B—" and Tap No. 12 to "B+ Max." Tap No. 5 of Resistor No. 1 is connected with Tap No. 6 of Resistor No. 2 to connect the two units in series.

The taps to use for various voltages depends on the tubes used in the receiver and amplifier. The proper taps may be found by calculation or by trial.

INFORMATION REQUIRED WITH SPECIAL ORDERS

Resistance of unit or sections in case of tapped resistors.

Total watt dissipation in case of single units or watts dissipation in each section in the case of tapped units. Voltage drop across each section or current in each section may be furnished in place of watt dissipation.

Accuracy required. Units are regularly made to a tolerance of 10 per cent, but can be made to closer tolerances on special order.

A circuit diagram, showing the application of the resistor, with constants of the circuit elements especially as regards voltages and currents is desirable, although not absolutely essential.

A drawing or plan showing the location of the resistor in reference to other parts is desirable.

Unless otherwise specified, our standard tubes and terminals will be furnished. Special tubes and terminals can be furnished to manufacturer's specifications.

PYROHM RESISTOR MOUNTINGS

THE Pyrohm Resistor Mountings listed on this page are designed to simplify the assembly of resistors into receivers and power supply units. They are available in four distinct types, for mounting a single resistor in a horizontal or a vertical position and also for mounting two resistors

as a single unit in a horizontal or a vertical position.

Each type is available in two sizes, one for mounting small-size Pyrohm resistors such as the Types 991, 992, 993 and 994 resistors and the other for mounting the larger sizes such as the 996-4, 996-5, 996 and 998 resistors.

VERTICAL MOUNTINGS		
Type No.	List Price	Code Word
V-1	\$.15	SCORN
V-2	.25	SCOUR
VV-1	.25	SCRAP
VV-2	.35	SCRIP
Packed one in a box. Standard Package—10 boxes.		

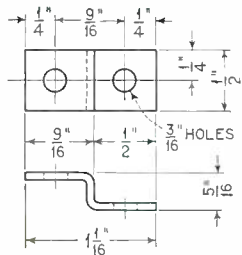

Dimensions of
Type V-1 Single Mounting



Types V-1 and VV-1 Types V-2 and VV-2

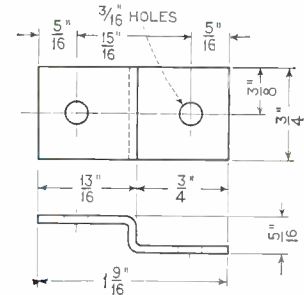

Dimensions of
Type VV-1 Double Mounting

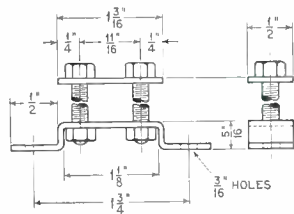

Dimensions of
Type V-2 Double Mounting

Type No.	For Mounting Pyrohm Resistors
H-1	One 991, 992, 993 or 994
H-2	Two 991, 992, 993 or 994
V-1	One 991, 992, 993 or 994
V-2	Two 991, 992, 993 or 994
HH-1	One 996, 996-4, 996-5 or 998
HH-2	Two 996, 996-4, 996-5 or 998
VV-1	One 996, 996-4, 996-5 or 998
VV-2	Two 996, 996-4, 996-5 or 998
All units are furnished complete with threaded rods, nuts and washers	

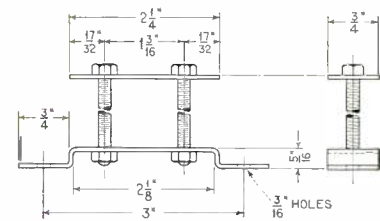

Dimensions of
Type VV-2 Double Mounting

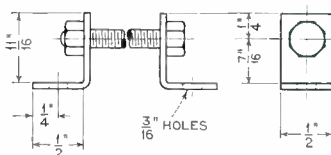

Dimensions of
Type H-1 Single Mounting



Types H-1 and HH-1

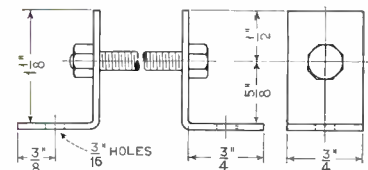

Dimensions of
Type HH-1 Single Mounting

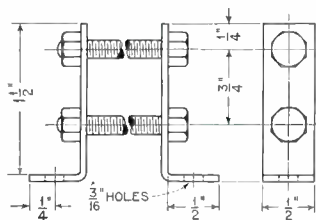

Dimensions of
Type H-2 Double Mounting



Types H-2 and HH-2

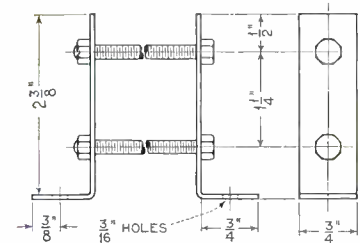

Dimensions of
Type HH-2 Double Mounting

HORIZONTAL MOUNTINGS		
Type No.	List Price	Code Word
H-1	\$.15	SCOPE
H-2	.25	SCORE
HH-1	.35	SCOUT
HH-2	.35	SCOWL

GRID LEAKS AND RESISTORS



Type 1090



Type 1093



Type 1092

Resist. Ohms	Type 1090		Type 1092		Type 1093	
	List Price	Code Word	Price List	Word Code	List Price	Code Word
10,000	\$.20	FAUGH	\$.25	NORTH	\$.35	POISE
25,000	.20	FIRST	.25	NERVE	.35	POKER
50,000	.20	FIRTH	.25	NEVER	.35	POLAR
75,000	.20	FLAKE	.25	NICHE	.35	POLKA
100,000	.20	FLAIL	.25	NIECE	.35	PORCH
150,000	.20	FLANK	.25	NINNY	.35	POUND
200,000	.20	FINIS	.25	NINTH	.35	POWER
240,000	.20	FAULT	.25	NOISE	.35	PRANK

Packed 10 in a box. Standard Package—10 boxes.

Resist. Meg.	Type 1090		Type 1092		Type 1093	
	List Price	Code Word	List Price	Code Word	List Price	Code Word
.25	\$.20	FACET	\$.25	NABOB	\$.35	PILOT
.5	.20	FAGOT	.25	NADIR	.35	PIOUS
.75	.20	FARCE	.25	NITRE	.35	PITCH
1.0	.20	FAINT	.25	NAIAD	.35	PITHY
1.5	.20	FANCY	.25	NAIVE	.35	PIVOT
2.0	.20	FAVOR	.25	NAPPY	.35	PLAID
2.5	.20	FEAST	.25	NASAL	.35	PLANE
3.0	.20	FEMUR	.25	NASTY	.35	PLANK
4.0	.20	FENCE	.25	NATAL	.35	PLANT
5.0	.20	FENNY	.25	NATTY	.35	PLATE
6.0	.20	FERRY	.25	NAVAL	.35	PLEAD
7.0	.20	FETCH	.25	NEEDY	.35	PLUCK
8.0	.20	FIBRE	.25	NAVVY	.35	PLUME
9.0	.20	FIELD	.25	NEGRO	.35	PLUSH
10.0	.20	FILLY	.25	NEIGH	.35	POACH

Packed 10 in a box. Standard Package—10 boxes.

THE Type 1092 and 1093 Metalohm grid leaks and resistors are built around a resistance element which consists of a metallic deposit on a glass rod, sealed in a glass tube. The properties of the deposit used permits a substantial coating which will carry, without change in resistance the current required in resistance and impedance coupled amplifiers. The Type 1090 units are for use where price is an important factor. All are permanent, accurate and noiseless.

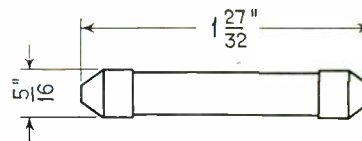

Body dimensions of Types 1090, 1092 and 1093 resistors.

GRID LEAK AND RESISTOR MOUNTINGS

TYPE 1049 single mounting and Type 1050 double mountings will take any standard grid leak or resistor and make good contact. The base is genuine moulded Bakelite



Type 1049

and the clips are made of phosphor bronze. The terminal lugs are tinned copper for ease and permanence in soldering.

Type No.	Mounting	List Price	Code Word
1049	Single	\$.25	TABBY
1050	Double	.40	TABLE

Packed one in a box. Standard Package—10 boxes.

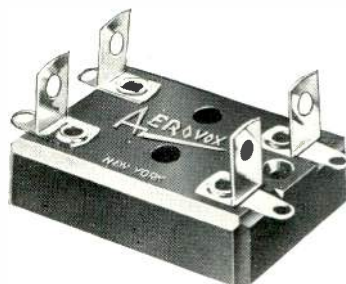
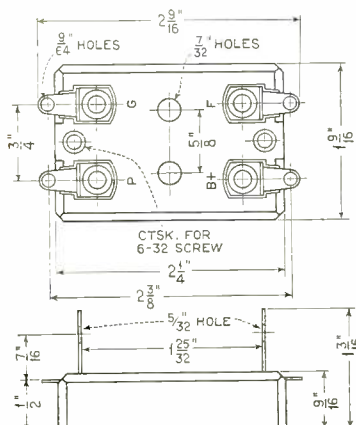

Type 1050

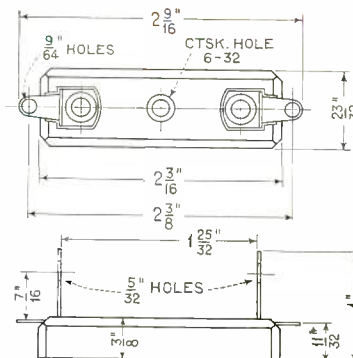

WIRE WOUND RESISTORS

GRID SUPPRESSORS



Type 981

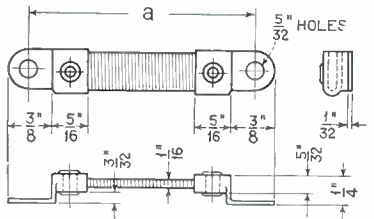

Dimension "a" varies with resistance and current carrying capacity of element.

STOCK SIZES			
Resist. Ohms	List Price	Max. Current Ma.	Code Word
100	\$0.20	120	PROVE
250	.20	120	PRUDE
500	.20	85	PULSE
750	.20	85	PUNCH
1000	.20	70	PUNIC
1250	.35	70	PUPIL
1500	.35	70	PUPPY
2000	.35	70	PUISM

Packed one in an envelope.
Standard Package—100.

THE Type 981 resistor units are wire wound on flat fibre strips. The extremely low inductance and distributed capacity of these units make them ideally suited for use as grid suppressors.

Terminal connections are firmly made by fastening the terminal lug to the strip with eyelets. They are provided with lugs which serve the double purpose of terminals and mountings.

CENTER-TAPPED RESISTORS

THE Type 986 resistor units are specially designed for use in A.C. filament circuits. They are available in a wide variety of sizes to suit all conditions of operation with different types of tubes. All terminals are solidly anchored, the units are center-tapped and the terminal lugs are designed to simplify mounting and connections.

SPECIAL VALUES
Resistance values other than those listed may be obtained on special order by manufacturers.

ACCURACY
Type 981 and 986 resistor units are accurate to within 10% but may be obtained to closer tolerance on special order.



Type 986

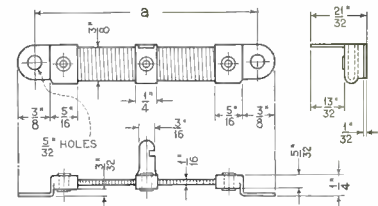

Dimension "a" varies with resistance and current carrying capacity of element.

STOCK SIZES			
Resist. Ohms	List Price	Max. Current Ma.	Code Word
10	\$0.25	447	RAZOR
20	.25	321	REACH
30	.25	231	REALM
40	.25	231	REBUS
50	.25	196	RECUR
60	.25	196	REDAN
100	.25	101	REFER
200	.25	70	REGAL

Packed one in an envelope.
Standard Package—100.

LAVITE NON-INDUCTIVE RESISTORS



Type 1098

AEROVOX Lavite Resistors should be used wherever non-inductive resistors capable of carrying comparatively heavy currents are required. The resistance element consists of a heavy special deposit on a large corrugated insulating rod. The properties of the deposit used permits the application of a substantial coating capable of carrying comparatively high currents without change in resistance.

These units are particularly suited for use in resistance and impedance coupled amplifiers and are the ideal resistors for

STOCK SIZES			
List Price	All Values		\$1.00
Resist.	Max. Current Ma.	Recom. Current Ma.	Code Word
1,000	54.8	38.3	ELDER
2,000	38.7	27.1	ELITE
5,000	24.5	17.1	ELOPE
10,000	17.3	12.1	EAGER
15,000	14.1	9.8	EARLY
20,000	12.2	8.5	EASEL
25,000	10.9	7.6	ELUDE
30,000	10.0	7.0	EBONY
50,000	7.7	5.4	EMERY
75,000	6.3	4.4	ECLAT
100,000	5.5	3.8	EDIFY
200,000	3.8	2.5	EDICT
250,000	3.5	2.4	EDUCE
500,000	2.4	1.7	EJECT

Packed one in a box.
Standard Package—10 boxes.

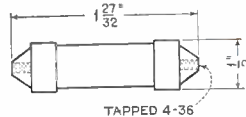

television amplifiers.

The maximum rating of these resistors is three watts. The maximum and recommended currents which they will carry without undue heating in poorly ventilated places is given in the table.

Lavite resistors are standard in size to fit any grid leak mounting. The ends of the resistors are tapped to take a 4/36 screw, for use where it is easier or more economical to use screws for connection into the assembly.

Special values can be supplied on order to manufacturers.

The Fundamental Principles of Power Supply Unit Design

By the Engineering Department, Aerovox Wireless Corp.

Most of the success or failure of A.C. operated receivers can be traced to the power unit. If the receiver functions properly giving hum-free and distortionless reproduction it may be taken for granted that the rectifier, filter and voltage divider systems of the power unit have been correctly designed. A well-designed power supply unit will provide the proper filament, plate and grid bias voltages and good regulation to keep the output voltages fairly constant in spite of ordinary fluctuations in the line voltage or the load.

The design of a successful power unit should be begun by considering the requirements of the receiver. Unless these requirements are filled, good operation cannot be expected.

To give a concrete example we shall consider a receiver and amplifier employing two R. F. stages consisting of two C-324 screen grid tubes requiring a plate voltage of 180 volts, a control grid bias voltage of minus 1.5 volts and a screen grid voltage of 75 volts. The detector stage employs a C-327 with 45 volts for the plate. A CX-326 tube at 90 volts plate voltage and 6 volts negative grid bias is used for the first audio stage and two CX-350 tubes in push pull with 400 volts on the plates and 70 volts grid bias are employed in the power stage.

The above combination is not the best arrangement for practical purposes. The lineup of tubes has been selected so as to take in a wide variety of tubes and operating conditions for the purpose of illustration. The same principles will hold true in designing a power pack for other tube combinations.

Consultation of tube charts will show that the current drawn by the C-324 tubes with the plate voltage, grid bias and screen grid voltage conditions given will be 4 milliamperes each or a total of 8 milliamperes. The detector tube will draw 2 milliamperes, the CX-326 amplifier tube will draw 3.5 milliamperes and the two CX-350 tubes will each draw 55 milliamperes. In addition to the 400-volt, 180-volt, 90-volt and 45-volt taps required for the plates of the tubes, a 75-volt tap must be provided for the screen grids of the C-324 tubes. The current drawn at this tap will be very small, of the order of .6 milliampere for both tubes.

The required voltages and the

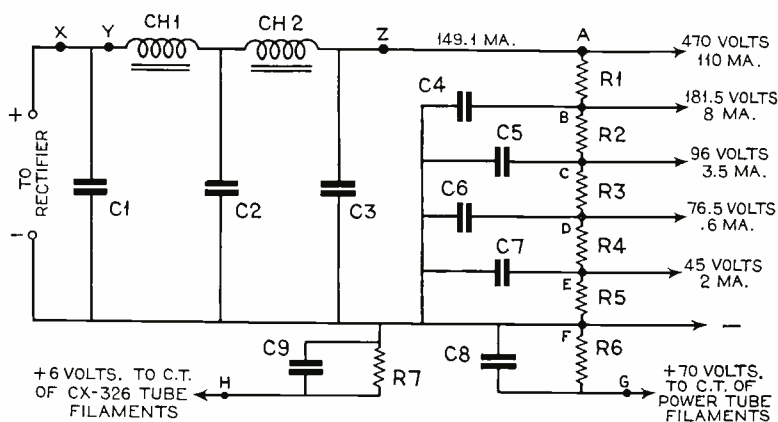

Fig. 1.

current drawn at each tap can therefore be tabulated as follows:

Two CX-350 tubes at 400 volts	110.0 ma.
Two C-324 tubes at 180 volts	8.0 ma.
One CX-326 tube at 90 volts	3.5 ma.
Screen grids at 75 volts6 ma.
One C-327 tube at 45 volts	2.0 ma.
Total current drawn by receiver	124.1 ma.

The grid bias voltages which must be deducted from the plate voltage taps of the power unit will be 70 volts for the power tubes and 6 volts for the CX-326 tube. The 1.5 volt control grid bias required for the C-324 tubes will be obtained by the use of 375-ohm resistors, suitably bypassed by .01 to .1 mfd. condensers, connected between the "—" lead and the cathodes of the tubes, a separate resistor and condenser unit being connected in for each tube.

This means that the voltage at the 400-volt tap, as measured between the filament and the tap, must be 470 volts as measured between the "—" lead and the "400-volt" tap. Similarly the voltage measured between the "—" tap and the "90-volt" tap should be 96 volts to allow for the drop of 6 volts between the "—" lead and the filament of the CX-326 tube. Also the voltage measured between the "—" lead and the "180-volt" tap should be 181.5 and that at the "75-volt" tap should be 76.5 to allow for the 1.5-volt drop between the "—" lead and the cathodes of the tubes.

The actual voltages which should obtain at the various taps, as measured between the "—" lead

and those taps are shown in Fig. 1. It will be noted that the voltages at the ends of the grid bias resistors, where they connect to the filaments of their respective tubes are positive but since the grid returns in the various stages are connected to the "—" leads, the grid potentials of the tubes will be negative with respect to their filament or cathode potentials.

To obtain good regulation at the various taps, it is necessary to allow for a comparatively high "bleeder" or "waste" current through the voltage divider. This "bleeder" current will serve as a reservoir which is drawn upon when more than the usual current is drawn at the taps because of strong signals or the comparatively high current required for the reproduction of bass notes.

In a heavy duty amplifier, this bleeder current should not be less than 25 milliamperes. This 25 milliamperes, added to the 124.1 milliamperes required by the receiver and amplifier gives a total drain of 149.1 milliamperes. The power unit will therefore be called upon to supply a current of 149.1 milliamperes at a voltage of 470 volts in order to meet the requirements of the receiver and amplifier.

Designing the Voltage Divider

With these facts we can proceed to the design of the voltage divider shown in Fig. 1.

The output voltage as measured between the "—" lead and the 470-volt lead of the power unit must be 470 volts when the full load of 149.1 milliamperes is being drawn from the unit. All of the external circuits, through the tubes and the circuit through the



voltage divider resistances are connected across the terminals of the power unit.

Since the plate circuits of the power tubes are connected between point "A", the high voltage end of the power unit, and point "G", the end of the grid bias resistor "R6" which connects to the filament of the power tubes, and since point "G" is 70 volts positive with respect to the "-" lead (point "F"), the difference in potential between points "A" and "G" will be the required 400 volts necessary between the filaments and plates of the power tubes. The current drawn by the two power tubes is 110 milliamperes. The available current of 149.1 milliamperes divides at point "A", 110 milliamperes going to the external circuit consisting of the plate circuits of the power tubes and the balance or 39.1 milliamperes going through resistor "R1". The voltage drop which this resistor must cause, with a current of 39.1 milliamperes, in order to reduce 470 volts to the 181.5 volts required for the plates of the C-324 tubes is 288.5 volts (470—181.5). Dividing the voltage drop required (288.5), by the current through the resistor, .0391 amperes (39.1 milliamperes) gives an answer of approximately 7,380 ohms for "R1".

At "B" the current divides again, eight milliamperes of the 39.1 milliamperes available at that point going into the external circuit consisting of the plate circuits of the C-324 tubes, while the remainder or 31.1 milliamperes continues on through resistor "R2". The resistance of "R2" to cause a drop of 85.5 volts from the 181.5-volt tap to the 96-volt tap, is naturally 85.5 divided by .0311 ampere (31.1 ma.) or approximately 2,750 ohms.

At point "C", the 96-volt tap, the current divides again, 3.5 milliamperes going into the external circuit consisting of the plate circuit of the CX-326 tube and the balance or 27.6 milliamperes going through resistor "R3". Here we find in the same manner as before that the resistance required to produce the necessary voltage drop of 19.5 volts between the 96-volt tap and the 76.5-volt tap with a current of 27.6 milliamperes is approximately 708 ohms.

At "D" the current divides again, .6 milliamperes going into the external circuit consisting of the screen grid circuit while the remainder, or 27 milliamperes goes on through resistor "R4". The drop required between the 76.5-volt tap and the 45-volt tap is 31.5 volts and this drop, with a current of 27 milliamperes is obtained with a resistor of approximately 1,166 ohms.

At "E" the current divides again, two milliamperes going to

the external circuit consisting of the detector plate circuit while the balance, or 25 milliamperes of "bleeder" current flows on through "R5". The drop of 45 volts at this current is obtained with a resistor of approximately 1,800 ohms.

Since the current of 110 milliamperes in the plate circuits of the two power tubes flows through the grid bias resistor, "R6", the value of resistance required in this unit to produce a voltage drop of 70 volts is 70 divided by .11 ampere (110 milliamperes) or approximately 636 ohms.

Similarly with a current of 3.5 milliamperes through resistor "R7", the resistance necessary to produce the required 6-volt drop is approximately 1,715 ohms.

So far we have considered only the actual resistance values of the units which must be used to obtain the proper voltages and necessary regulation at the various taps. Later, we shall take up the selection of the proper resistors as regards watts dissipation or current carrying capacity.

The Selection of Bypassing Condensers

Before leaving the subject of the voltage divider, it is necessary to stress the importance of proper bypassing at each voltage tap to avoid coupling between the various circuits and to prevent hum, motorboating, and distortion.

The selection of bypass condensers of the proper capacity depends on the circuits in which they are used, the frequencies which they are to bypass and the resistance around which they must furnish a "path of least resistance" for the frequencies which they are called upon to bypass.

To be truly effective, the capacity of a condenser used to bypass current of a given frequency should be such as to offer an absolute minimum of reactance to current of that frequency. In bypassing a band of frequencies such as is met with in the radio frequency or audio frequency circuits of a radio receiver, the condenser must be of such capacity as to offer considerably less reactance in ohms to the passage of current of the lowest frequency in the band than is offered by the resistance of the apparatus across which it is intended to bypass the current.

In a voltage divider system such as is shown in Fig. 1, condenser "C5" is called upon to bypass the A.C. (audio frequency) component of the current in the plate circuit of the first audio amplifier tube. If a bypass condenser is not used as shown at this point, the audio frequency current has two paths by means of which it can reach

the filament or cathode of the tube in order to complete the plate to cathode circuit of the tube. One path is through resistances "R2", "R1", condenser "C3" and the grid bias resistor and condenser combination, "R7" and "C9" to the cathode. The other path is through resistances "R3", "R4", "R5" and the grid bias resistor and condenser combination "R7" and "C9" to the cathode.

Unless the reactance of the condenser "C5", connected between the 96-volt tap and the "-" lead is considerably lower than the impedance offered by the two paths which lead to the "-" lead, a large part of the current in the plate circuit of the first audio tube will pass through the circuits of the voltage divider and produce coupling with the other circuits which is certain to result in feedback, distortion, hum and generally poor reproduction. When bypass condensers are used at the other taps, the importance of using a high capacity at the particular tap mentioned becomes even more important, since such condensers reduce the impedance between the taps to which they are connected and the "-" lead. With no condensers at "C6" and "C7" for instance the impedance in that path for current from the 96-volt tap is the resistance of "R3", "R4" and "R5". The use of condensers at "C6" and "C7", shunting those resistances reduces the total impedance of the circuit between the 96-volt tap and the "-" lead making it necessary to use a larger capacity condenser at "C5".

In general bypass condensers at voltage taps for radio frequency circuits should not be less than from .01 to .25 mfd., while those for audio frequency circuits should not be less than 1 mfd. and preferably 2 and 4 mfd.

The capacities used across grid biasing resistors should always be comparatively large, if good reproduction, free from distortion is to be obtained. The reactance of a 1-mfd. condenser at 100 cycles, for instance, is 1,575 ohms. The use of such a condenser to bypass a resistor of 636 ohms, such as "R6" of Fig. 1, is of course, not good practice. Even a 2-mfd. condenser which has a reactance of 787 ohms at 100 cycles would not be sufficient. To obtain tolerable bypassing this condenser should have a capacity of at least 4 mfd.

In the case of condenser "C9" which is shunted across a grid bias resistor of 1,715 ohms, "R7", a condenser having a capacity of 1 mfd., having a reactance of 1,575 ohms is hardly adequate. A 2-mfd. condenser, having a reactance of approximately 780 ohms would be better suited.

The resistances bypassed by condensers "C5" and "C7" are

much higher of course, and in those cases the 1-mfd. condensers will be found suitable, although higher capacities up to 4 mfd. will give much better results.

Condensers "C4" and "C6" are used for radio frequency circuits and capacities of .1 to .25 mfd. are sufficient.

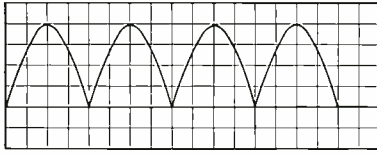

Fig. 2.

Designing the Filter Circuit

The next step is to design a good filter circuit.

The conventional type of filter circuit, as shown in Fig. 1, consists of two choke coils "CH1" and "CH2" and three filter condensers, "C1", "C2" and "C3".

The choke coils should have an inductance of from 15 to 30 Henries and should be capable of passing safely the maximum current drawn by the receiver, amplifier and voltage divider, in this case 149.1 milliamperes. The resistance of these chokes should be as low as possible so as to provide good regulation, avoid unnecessary waste through excessive voltage drop and also to avoid excessive heat. A good general value for heavy duty units of this type is about 200 ohms per choke or a total resistance of 400 ohms for the filter.

The importance of using chokes of low resistance can be seen clearly by taking a concrete example, and considering the effect on the difference in voltage between the voltage input to the filter and the voltage output of the filter under different load conditions.

If chokes "CH1" and "CH2" have a total resistance of 400 ohms, the voltage drop across the chokes will be 20 volts with a current of 50 milliamperes and 60 volts with a current of 150 milliamperes, a difference of 40 volts under the two load conditions mentioned of 50 and 150 milliamperes. If chokes "CH1" and "CH2" have a total resistance of 1,000 ohms, the voltage drop across the chokes will be 50 volts at 50 milliamperes and 150 volts at 150 milliamperes, a difference of 100 volts under the two load conditions, which shows clearly the much poorer regulation of high resistance chokes.

The greater voltage drop through the chokes will therefore necessitate the use of a higher voltage transformer and the application of higher voltages to con-

densers at "C1" and "C2" than are necessary when chokes of lower resistance are employed.

With a current of 149.1 milliamperes, the drop produced by 400 ohms is 400 times .1491 amperes or 59.64 volts. This means that the rectifier system must provide an output voltage (input voltage to the filter) of 529.64 volts to produce a voltage of 470 volts across the terminals of the voltage divider, allowing for the 59.64-volt drop through the chokes.

Selecting the Filter Capacities

The values of capacities to select for the filter condensers "C1", "C2" and "C3" is largely a compromise between efficient safe operation and cost.

The function of the first filter condenser, "C1" of the filter is to increase the available output voltage of the rectifier. An eliminator without any condenser at "C1" has the best regulation, but since the omission of this condenser results in a very low output voltage, thus necessitating exceptionally high A.C. input voltages to the rectifier

some voltage available for the load. In this regard it acts in much the same way as the air chamber in a force pump.

This state of affairs is shown diagrammatically by Figs. 2 and 3. Fig. 2 shows the output of a full wave rectifier, a rectified sine wave (assuming the rectifier to

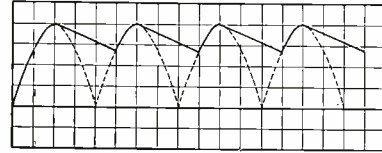

Fig. 3.

introduce no distortion). If no condenser were connected across this output, the voltage across the load would have practically the same waveform. If, however, a condenser is connected across the output of the rectifier, it will charge up in phase with the rectifier voltage until it has attained a charge equal to the maximum rectifier voltage. The rectifier voltage then decreases sinusoidally. The condenser voltage however, decreases at an entirely different rate, determined solely by its capacity and the magnitude of the load resistance. The condenser voltage falls at this rate until it meets the increasing rectifier voltage, by which it is charged up again to its maximum value. The cycle then repeats itself, as shown in Fig. 3 by the heavy line curve.

The maximum available output voltage can be increased either by increasing the capacity of the condenser or by decreasing the load (increasing the load resistance). Since the load is fixed by the characteristics of the receiver and amplifier, the only means left is to increase the capacity of the condenser.

With small values of capacity, the available voltage is raised less and less for equal increments of capacity, until a point of diminishing returns is reached, where the cost of the additional capacity is not met by the slight increase in voltage gained thereby.

This "compromise" capacity is in the neighborhood of two to three microfarads under average conditions and explains why a condenser of two microfarads is usually recommended at position "C1".

Curves showing the actual available voltages for various values of capacity at "C1", and for various load currents, in a typical case, are shown in Fig. 4. It is easily seen that the increase in voltage due to changing "C1" from 0 to 1 mfd. is greater than the increase due to changing "C1" from 1 mfd. to 2 mfd. It is also seen how much more the voltage is increased at low loads by the

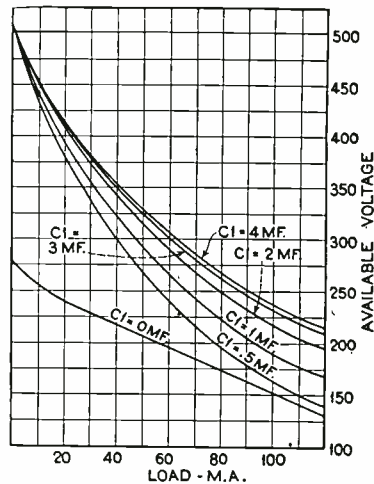

Fig. 4.

to obtain the required output voltage, a condenser is almost universally used at "C1".

The ability of "C1" to control the available output voltage is due to the fact that the condenser is charged by a source whose resistance is much lower than that of the load into which the con-

$$\Delta E_1 = \frac{1}{R_f C_1}$$

ΔE_1 = VOLTAGE FLUCTUATION AT TERMINALS OF "C1"
R = LOAD RESISTANCE IN OHMS
f = FREQUENCY OF RECTIFIED WAVE
C₁ = CAPACITY OF FILTER CONDENSER IN FARADS

Fig. 5.

denser discharges. Since the rates of charge and discharge are functions of the charging and discharging resistances, the condenser is charged up faster than it is discharged, and hence always has



use of a condenser of any capacity over the value which obtains with no condenser at "C1".

It is also seen that above 2 mfd. the gain is small compared with the additional expense of higher capacity.

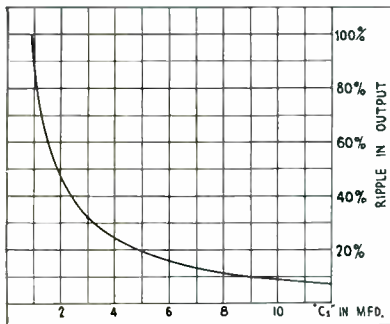

Fig. 6.

Filtering to Eliminate Hum

The next point to consider in the design of the filter is the effect of various capacities in eliminating hum in the output.

A simple mathematical calculation shows that the filtering action of "C1" may be represented by the formula shown in Fig. 5. In the case of a full wave rectifier, the frequency "f" is twice that of the power supply line, whereas in a half wave rectifier, it is equal to the frequency of the supply line.

This formula tells us several interesting facts. The first one is that the voltage fluctuation is related to the capacity of "C1" by a function of the type $XY = K$, an hyperbola. This signifies simply that if we increase the capacity of "C1" uniformly, the voltage fluctuation will be reduced far more by the first few increments of capacity than by succeeding increments. To make this statement more concrete, let us assume an eliminator which supplies 50 milliamperes at 220 volts, and see how the capacity of "C1" affects the hum. Substituting in the formula shown in Fig. 5 and plotting the results, we obtain the curve of Fig. 6.

A voltage fluctuation of $\frac{1}{4}$ to $\frac{1}{2}$ of one percent is just about tolerable in the output. The futility of attempting to remove any appreciable portion of the hum by means of "C1" is readily apparent from the curve of Fig. 6, which shows that even a capacity of 12 mfd. will only reduce the hum to somewhat less than 10 percent.

It is easily seen therefore that the only purpose of condenser "C1" is to increase the available voltage and any attempt to use high capacity at that point to reduce hum is a waste of money.

The formula shown in Fig. 5 indicates that the filtering action of "C1" is inversely proportional

to the current drain. In other words the higher the current drain (low resistance in the load) the higher will be the fluctuation or hum, and conversely, the lower the current drain (high resistance in the load) the smaller will be the fluctuation or hum.

This explains the reason why higher capacity in the filter is necessary to offset higher current drain, in order to keep the voltage fluctuation or hum down.

Another fact that this formula brings out is that the filtering action varies inversely with the frequency. The higher the frequency fed to the filter, the lower the hum. In other words a filter will remove only half as much hum from a half wave rectifier which delivers 60 cycle current to the filter than it will from a full wave rectifier which delivers 120 cycle current to the filter.

Furthermore the succeeding sections of the filter act in the same way as regards frequency, so that finally a given two-section filter will remove only one-quarter as much hum from a half wave rectifier as from a full wave rectifier.

This of course explains the much greater freedom from hum of an eliminator using a full wave rectifier over that of an eliminator using a half wave rectifier.

Selecting the Capacities for Minimum Hum

We can now proceed to the capacities required at "C2" and "C3". Mathematical and experimental data, too lengthy to be discussed here indicates that for best filtering action, and for best results in tone quality as a result of using sufficient capacity at "C3", the capacity at "C2" and "C3" should be equal. If two equal capacities are not available, then it is best to use the higher capacity of the two at "C3" rather than at "C2" unless the high voltage tap for the power tubes is taken at the juncture of the two choke coils, in which case it is desirable to obtain fairly good filtering at condenser "C2" so as to keep the ripple down to a minimum in the supply of the power tubes.

The curves in Fig. 7 represent the results of a vacuum tube voltmeter study of the conventional two choke and three condenser type of filter circuit shown in Fig. 1 for current drains of up to 150 milliamperes, using a full wave rectifier. These curves show the relative efficiency of a 2-2-2 mfd. filter, a 2-4-4 mfd. filter and a 2-6-6 mfd. filter under different conditions of load.

It indicates clearly the fact that at higher loads the filtering with any given capacity combination decreases sharply and that higher capacities are required in the second and third condensers, "C2" and "C3" to keep the hum around the .5 percent which is about the

maximum tolerable limit for hum-free operation.

It can be seen that for loads of less than 90 milliamperes, with the particular transformer, rectifier and chokes used in this case, a 2-2-2 filter is perfectly satisfactory if a very slight hum is not objectionable. For very quiet, hum-free operation, however, this type of condenser combination should not be used at more than about 40 to 60 milliamperes.

The 2-4-4 filter will produce passably hum-free operation with loads of almost up to 150 milliamperes, but is really hum-free at loads of not more than 100 to 120 milliamperes.

For loads of over 125 milliamperes and up to 170 milliamperes it is advisable to use higher capacity filters such as 2-6-6 or even 2-8-8 combinations.

In the particular receiver, amplifier and power supply unit we have been considering therefore, in which the current drain is 150 milliamperes, a 2-4-4 filter may be used, although better results will be obtained by using a higher capacity filter such as 2-6-6, 4-6-6, 2-8-8 or 4-8-8.

While the standard units made by the Aerovox Wireless Corporation are 2-2-2 and 2-4-4 mfd. combinations it is a simple matter to connect additional individual capacities in parallel with any of the condenser blocks to increase the capacities of the units. It is also possible to connect a 2-2-2 unit in parallel with a 2-4-4 unit to make a 4-6-6 unit or to connect two 2-4-4 units together to make a 4-8-8 combination.

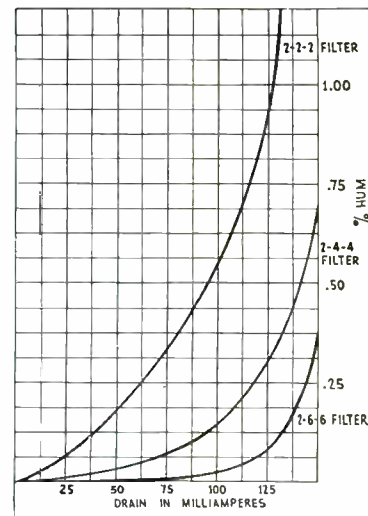

Fig. 7.

Determining the Working Voltage of the Filter Condensers

Since the voltage across condenser "C1" is a pulsating direct current, whose value varies from a maximum equal to the crest or peak value of the charging voltage to a minimum determined by the



capacity of "C1" and the magnitude of the load resistance, the reading of a D.C. voltmeter cannot be used to determine the working voltage of the condenser at "C1", because the D.C. voltmeter reading would be approximately the mean of the maximum and minimum values. The proper instrument to use in reading the maximum voltage applied to the condenser is a peak voltmeter.

Some of the interesting results obtained by the use of the peak voltmeter are shown in the curves of Fig. 8, which give the relation between peak voltage and D.C. voltmeter readings for a representative CX-380 rectifier and filter circuit for loads of from practically zero or "no load" to 120 milliamperes.

Curve "C" shows the D.C. component of the voltage across condenser "C1" as compared with the peak voltage for the same load, as represented by curve "B". The difference in magnitude is striking and the fallacy of determining the working voltage of "C1" by a D.C. test is apparent.

It will be seen that the peak voltage is not constant, but decreases slowly with increased load. This is due to two causes: voltage drop due to internal resistance of the rectifier, and regulation of the transformer. Curve "A" shows the dropping of the peak voltage at the output of the rectifier, due to these two causes. If the rectifier had no internal resistance, and the transformer had perfect regulation, the peak voltage would be constant at all loads and equal in value to the peak voltage of the transformer secondary.

The curves of Fig. 8 show that the D.C. voltage reading under no load is practically the same as the peak voltage under similar

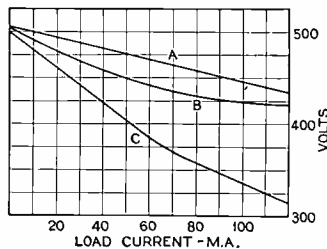

Fig. 8.

conditions. However as comparatively heavy loads are imposed, the D.C. voltage drops sharply while the peak voltage drops slowly. In this particular case, it is seen that to fully protect condenser "C1" against the maximum peak voltage under the no load conditions of operation using an A.C. voltage of about 350 volts per anode on the rectifier would require a condenser rated at 500 volts D.C. working voltage at "C1". If the power unit is operated continuously with a load of 100 milliamperes or more however,

curve "B" shows that the peak voltage will not exceed 425 volts.

For protection against absolute no-load conditions therefore, the first condenser in a filter circuit should be rated at 1.4 times the A.C. voltage applied to the anode of the rectifier, but if the power unit is operated under fairly heavy load conditions at all times, the rating of the first filter condenser can safely be 10 to 15 percent less than that value.

In actual practice, a power unit which has a voltage divider connected across the output of the filter is never operated under no load conditions, since the voltage divider resistance and the resistance of the filter chokes across the output of the rectifier constitute a load. The lower this total resistance is, the greater the load which will be imposed under so-called "no-load" conditions when the amplifier and receiver tubes are not in circuit or before the tubes heat up, and the greater the effect of this normal load resistance in keeping down the peak voltages across the condensers of the filter. This is another factor in favor of using a comparatively low resistance voltage divider drawing a fairly high bleeder current and the use of low resistance chokes.

In general practice therefore it is customary to use a filter block in which the first filter condenser is lower by as much as 10 percent than 1.4 times the A.C. voltage applied to the rectifier. This lower rating can be used with perfect safety and in the AeroVox line of Universal Filter Blocks this factor has been taken into consideration in making available a line of filter blocks which are perfectly safe for the uses for which they are recommended without unduly increasing the cost by recommending an outlandishly high safety factor, which serves no useful purpose.

The jagged waveform of the rectifier is strongly attenuated by the combined action of condenser "C1" and choke coil "CH1" so that the voltage across "C2" has but a small ripple in it. A peak voltmeter shows that the maximum voltage across "C2", under load conditions, is only a few volts higher than the steady or D.C. voltage. The difference is so small that the working voltage of this condenser may safely be determined by a D.C. test only or may be calculated from the D.C. voltage across "C1" by making due allowance for the voltage drop through choke "CH1". At least 10 percent should be added to this value to allow for ripple.

The ripple at the terminals of "C3" is so small that it may be neglected altogether and the D.C. voltage there may be taken as the peak voltage for any given load condition.

Determining the Characteristics of Rectifier and Transformer

To get back to our example, where we left off before discussing the characteristics of the condensers used in the filter, we found that we must provide a source of current capable of feeding the input of the filter with 529.64 volts at a current drain of 149.1 milliamperes or approximately 530 volts at 150 milliamperes.

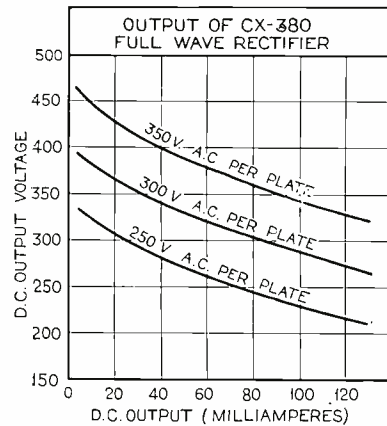

Fig. 9.

A glance at the output curves of a CX-380 rectifier given in Fig. 9 shows that it is impossible to obtain this output from that type of rectifier since the maximum output which it is possible to obtain from that tube, at the maximum permissible input of 350 volts per anode, is approximately 125 milliamperes at 325 volts D.C.

The output curves of a single CX-381 rectifier, shown in Fig. 10, show that this type of rectifier would also be unsuitable, since with the maximum input voltage of 700 volts A.C., the output does not exceed 85 milliamperes.

The output curves of the full wave rectifier consisting of two CX-381 tubes shown in Fig. 11 however, show that it is possible to obtain an output of up to 700 volts D.C. at a current drain of 150 milliamperes and this type of rectifier is therefore suitable.

Since all that is necessary is 530 volts at 150 milliamperes, and since the curves show that with 600 volts per plate, the D.C. voltage output is approximately 575 volts at 150 milliamperes, it is necessary either to use a lower voltage transformer or to use the standard 600 volt A.C. windings and reduce the 575 volts D.C. output voltage to the required 530 volts D.C. by the use of a resistor at point "X", in Fig. 1 which locates the resistor between the output of the rectifier and the first filter condenser.

This is the best position for a voltage reducing resistor, since at that position it protects the first

filter condenser "C1" and the other condensers of the filter against the unnecessarily high output voltage of the rectifier. The same end, as far as reducing the voltage at the terminals of the voltage divider is concerned, could be served by inserting the resistor at points "Y" or "Z" but it is best to use it at point "X".

The reason for this is too lengthy to be discussed here, but experimenters who are interested are referred to an article on the subject entitled "Overlooked Factors Which Cause Grief in the Design of Power Supply Units",

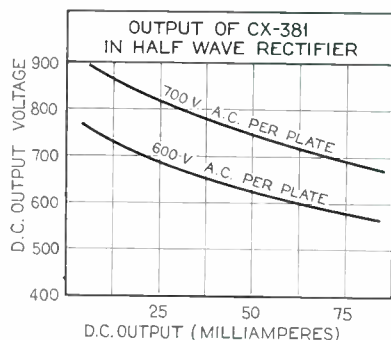

Fig. 10.

which appeared in the April 1929 issue of the Aerovox Research Worker. A copy of this issue may be had on request to the Aerovox Wireless Corporation.

Since the voltage drop required to reduce 575 volts to 530 volts is 45 volts and the current flow through the resistor under load conditions is 150 milliamperes, the value of resistance required will be 300 ohms.

Under absolute no load conditions, that is with tubes and voltage divider resistance out of the circuit, the peak voltage which would be applied to all three condensers in the filter would be close to 600 (the A.C. voltage applied to the rectifier) times 1.4 or approximately 840 volts. This means that 1,000 volt condensers would have to be used in all three sections. This is due to the fact that at practically no load, the peak voltage and the D.C. voltages at the various sections are practically the same, and there is practically no drop through the resistances of the chokes.

However, the resistance of the voltage divider, amounting to 13,804 ohms, the resistance of the chokes amounting to 400 ohms, and the 300-ohm resistance of the voltage reducer at "X" would always be connected across the output of the rectifier and would constitute a load of approximately 14,500 ohms. With such a load, the current drain imposed on a CX-381 full wave rectifier with 600 volts A.C. per plate can be calculated from the curves given in Fig. 11, by finding what combination of voltage output and

current represents a load of 14,500 ohms. The answer is found to be a current 50 milliamperes and a voltage of 700 volts D.C.

Since at comparatively low current drains the D.C. voltage approaches the peak voltage the use of an 800-volt condenser at "C1" would probably be sufficient to withstand the highest peak voltage, even without a voltage reducer at "X" in Fig. 1, although it would be safer to use a 1000-volt section rather than operate that close to the working voltage of the condenser.

Since the peak voltages across "C2" and "C3" would be only slightly higher than the D.C. voltages across them, because of the attenuation introduced by the choke coils and condensers, and the small drop through choke coils "CH1" and "CH2", 800-volt D.C. working voltage condensers would be ample at "C2" and "C3".

The use of a 1,000-volt section for "C1" and 800-volt D.C. working voltage condensers at "C2" and "C3" would therefore be ample to protect the unit for the condition existing when all the load except that furnished by the voltage divider and choke resistance, is removed, provided of course that the comparatively low resistance voltage divider is used, thus limiting the "no-load" condition.

Under normal operation of course, the peak voltage across "C1" is considerably reduced after the manner shown in Fig. 8.

Since the D.C. voltage at the input of the filter is only 530 volts with a current of 150 milliamperes being drained, and since there is a drop of 30 volts through choke "CH1", the maximum D.C. voltage across condenser "C2" will be 500 volts and adding 10 percent to that for ripple will only bring it up to 550 volts so that a 600-volt working voltage condenser is sufficient at this point. Another 30-volt drop takes place through choke "CH2" and since the voltage across "C3" has practically no ripple, a 600-volt condenser is more than sufficient at that point. The use of an 800-volt D.C. working voltage unit at "C1" and 600-volt D.C. working voltage units at "C2" and "C3" is sufficient, therefore under full load conditions but trouble may be encountered under "no load" conditions.

To meet all requirements for power pack design the Aerovox Wireless Corporation has provided a complete line of Universal Filter Blocks.

The A-400 filter block consisting of a 2-2-2 mfd. combination with working voltages of 400-300-300 respectively and the B-400 filter block consisting of a 2-4-4 mfd. combination, also with working voltages of 400-300-300 should be used with rectifier combinations in which the A.C. volt-

age applied to each plate of the rectifier does not exceed 300 volts for full protection under load conditions and with rectifier combinations in which the A.C. voltage does not exceed 280 volts for protection under so-called "no-load" conditions with receiver and amplifier disconnected but with a voltage divider of not more than about 15,000 ohms across the output.

The A-600 filter block consisting of a 2-2-2 mfd. combination with D.C. working voltages of 600-500-400 respectively and the B-600 filter block consisting of a 2-4-4 mfd. combination, also with working voltages of 600-500-400 should be used with rectifier combinations in which the A.C. voltage applied to each plate of the rectifier does not exceed 400 volts for full protection under load conditions and with rectifier combinations in which the A.C. voltage applied to each plate of the rectifier does not exceed 350 volts for protection under the so-called "no load" conditions mentioned above, using a voltage divider of not more than 15,000 ohms.

The A-800 filter block consisting of a 2-2-2 mfd. combination with D.C. working voltages of 800-600-600 respectively and the B-800 filter block consisting of a 2-4-4 mfd. combination, also with working voltages of 800-600-600 should be used with rectifier combinations in which the A.C. voltage applied to each plate of the rectifier does not exceed 600 volts for full protection under load conditions and with rectifier combinations in which the A.C. voltage

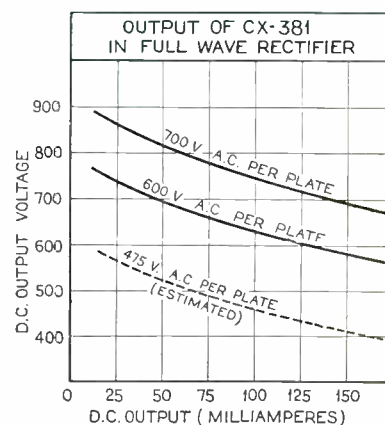

Fig. 11.

applied to each plate of the rectifier does not exceed 550 volts for protection under the so-called "no load" conditions already mentioned, using a voltage divider of not more than 15,000 to 20,000 ohms.

The A-1000 filter block consisting of a 2-2-2 mfd. combination with D.C. working voltages of 1000-800-800 respectively and the B-1000 filter block consisting of a 2-4-4 mfd. combination also with working voltages of 1000-800-800



should be used with rectifier combinations in which the A.C. voltage applied to each plate of the rectifier does not exceed 750 volts for full protection under load conditions and with rectifier combinations in which the A.C. voltage applied to each plate of the rectifier does not exceed 650 volts for protection under the so-called "no load" conditions already mentioned, using a voltage divider of not more than 15,000 to 20,000 ohms.

Bypass Condenser Ratings

It is very important to make sure that the voltage ratings of the bypass condensers used across the taps of the voltage divider are sufficiently high to meet the conditions in service. A complete line of bypass condensers and bypass condenser blocks to suit all requirements are listed in the pages of this catalog. Because of the varying conditions met with in power supply units, due to the increasing use of tubes which have an appreciable time lag before drawing current, it is desirable to use bypass condensers of higher voltage ratings than the usual 200-volt units in bypassing 90, 135 and 180-volt taps. Most 90- and 135-volt taps now require 300-volt D.C. working voltage condensers for bypassing, while 180-volt terminals should be bypassed with 400-volt D.C. working voltage condensers to guard them against high voltage surges when used in high power amplifiers where the total voltages across the entire voltage divider exceeds 300 volts.

Choosing the Proper Resistors

After the proper resistances to use in the various sections of the voltage divider have been decided upon, the next step is to decide upon the proper current carrying capacity or watt ratings for the resistors.

For cool operation, the maximum current carrying capacity of the resistor used should be at least twice the highest current which will flow through the resistor under any condition of operation.

Under normal operating conditions, the current flowing through the various voltage divider and grid bias resistors of the case under discussion and shown in Fig. 1 are as follows:

R1	—	39.1 ma.	—	7,380 ohms
R2	—	31.1 ma.	—	2,750 ohms
R3	—	27.6 ma.	—	708 ohms
R4	—	27.0 ma.	—	1,166 ohms
R5	—	25.0 ma.	—	1,800 ohms
R6	—	110.0 ma.	—	636 ohms
R7	—	3.5 ma.	—	1,715 ohms

Under so-called "no load" conditions however, with only the voltage divider connected across the output, we have seen that the current drain through the voltage divider may rise to a value as high

as 50 milliamperes. On this basis, the maximum current rating of each section of the voltage divider should be twice this current or 100 milliamperes, although under ordinary operating conditions the use of a resistor having a maximum current of twice the normal current carried by each section is sufficient.

If the resistors are carefully placed so as to get fair ventilation and also so that there will be no danger of heat from the resistor damaging other parts, the resistors may be selected on the basis of a maximum rating of 1.4 times their normal current or twice their watt dissipation.

The watts dissipation of a resistor under operating conditions can be found by squaring the current in amperes and multiplying the answer by the resistance of the resistor.

The proper resistor to use in each position can be found by consulting the current carrying capacity tables for the various types of Pyrohm resistors listed in this catalog. If the exact value required is not obtainable in a standard fixed resistor, approximately the correct value will do or very close to the required value can be obtained by using the Universal Adjustable Resistors listed in this catalog, by means of which any desired resistance value can be obtained. Care should be taken of course to make sure that the resistors selected are capable of carrying the desired current.

In selecting the resistor, choose a type of the proper resistance whose "Cool" current capacity rating is equal to or more than the maximum current which the resistor will be called upon to carry. In this particular case, all of the voltage divider resistors, "R1", "R2", "R3", "R4" and "R5" must be capable of carrying 50 milliamperes, to prevent excessive heat even under "no load" conditions. Resistor "R6" must carry 110 milliamperes without undue heating while resistor "R7" need only be capable of carrying 3.5 milliamperes.

The voltage divider can be made up by using the following Pyrohm fixed resistors.

A 7,500-ohm, Type 996 Pyrohm which is rated at 57 milliamperes for cool operation is close enough to the required resistor of 7,380 ohms at "R1".

A 2,500-ohm, Type 994 Pyrohm which is rated at 56 milliamperes is close enough to the required resistor of 2,750 ohms at "R2". Note that the use of a lower value at "R2" compensates for the higher value at "R1" so that the total resistance of "R1" plus "R2" is kept very close to the required value.

A 700-ohm, Type 992 Pyrohm which is rated at 73 milliamperes is ideal for resistor "R3".

A 1,100-ohm, Type 992 Pyrohm, rated at 58 milliamperes will do nicely at "R4".

A 1,800-ohm, Type 992 Pyrohm, rated at 45 milliamperes will be more than sufficient for use at "R5", since this resistor will easily take care of the normal operating condition of 25 milliamperes and will not heat up excessively, even under "no-load" conditions.

Two 1,250-ohm, Type 992 Pyrohm resistors rated at 54 milliamperes each (cool operation), connected in parallel will provide a resistor of half the resistance of either section and twice the current carrying capacity or 625 ohms with a "cool" current rating of 108 milliamperes which is very close to the 636 ohms with a current capacity of 110 milliamperes required for "R6".

A Type 992, 1,750-ohm resistor, rated at 46 milliamperes is more than sufficient and is close to the required resistance value for use at "R7".

If a 300-ohm resistance is required at "X" to reduce the D.C. output of the rectifier, this resistor will have to be capable of passing 150 milliamperes without undue heating. This 300-ohm resistance can be obtained by connecting two 150-ohm, Type 992 resistors in series. These units can pass 158 milliamperes without undue heating.

If the fixed units mentioned above cannot be obtained it is possible to use Aerovox Universal Adjustable Resistors to obtain the proper values. The UR-12 for instance can be used to obtain a value of 7,000 ohms for "R1". The UR-11 can be used to obtain a value of 2,750 ohms for "R2". The UR-14 can be used to obtain a value of 700 ohms for "R3". The UR-2 or UR-13 can be used to obtain a value of 1,200 ohms for "R4". The UR-13 can be used to obtain a value of 1,800 ohms for "R5". A value of 625 ohms, close enough to the 636 ohms required at "R6" can be obtained by connecting two 1,250 ohm sections in parallel. These 1,250 ohm sections can be obtained by using Resistors UR-11. Each UR-11 resistor connected to give a value of 1,250 ohms has a "Cool" carrying capacity of 63 milliamperes and two units connected in parallel would provide a "Cool" carrying capacity of 126 milliamperes, more than enough for the 110 milliamperes which must be carried by "R6". A value of 1,750 ohms, close enough to the 1,715 ohms required for "R7" can be obtained by using resistor UR-11.

By using any of the standard Aerovox Filter Condenser Block and Bypass Condenser Block units and either fixed or Universal Adjustable Pyrohm resistors it is possible to meet the requirements of any power supply unit for condensers and resistors.



Fully Equipped to Render Service



THIS booklet was prepared to give complete, detailed information on Aerovox products.

The electrical specifications, details of construction, and general data on both condensers and resistors are given in such form that all who have use for these products can determine very easily the units which are best suited for their requirements.

To insure the uniformity and high quality of Aerovox products, a completely equipped laboratory, manned by competent engineers, tests the raw material and carefully follows the manufacturing processes.

To rush tools and dies required to manufacture units for special needs a modern tool and machine shop is maintained.

A staff of trained men stands ready at all times to assist in the selection of standard parts, or in the design of parts for special uses.

Aerovox prompt service is directly due to the complete manufacture of each product in its entirety from the raw materials within one plant. Because of this complete supervision and control, Aerovox products are

"Built Better"

AEROVOX PRODUCTS ARE FOR SALE BY

If you do not know where to buy Aerovox products in your locality, the Aerovox Sales office nearest to you (see front cover) will be glad to tell you where to buy them, or you may write direct to the Aerovox Wireless Corporation, 70 Washington St., Brooklyn, N. Y., for information regarding your nearest dealer.

