

AEROVOX-ACME SCREEN ROOM FILTERS

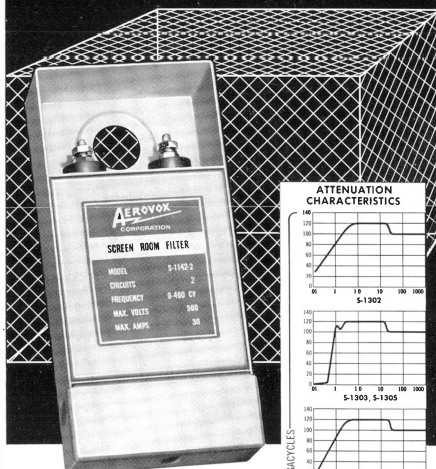

Choose from a wide range of attenuation patterns from 14kc to 10,000 mc.

Aerovox offers a complete selection of high attenuation screen room filters in single, double and triple section units to comply with the rigid specifications of advanced type screen room designs. Each filter is hermetically sealed and terminals at both ends are shielded. Easy mounting arrangements plus high attenuation performance assures you of the finest equipment specifically designed for screen room use.

Write for technical details to . . .

AEROVOX CORPORATION
NEW BEDFORD • MASSACHUSETTS

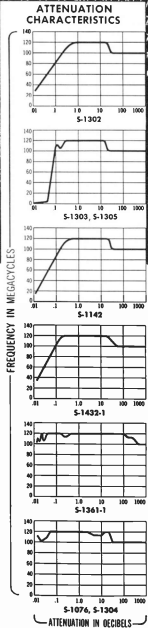

AEROVOX RESEARCH WORKER

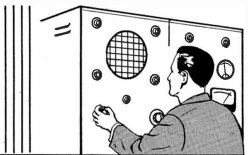

Radio Editors of magazines and newspapers will be given permission to reprint in whole or in part, with proper credit to the Aerovox Corporation, the contents of this issue of the Aerovox Research Worker, upon written request.

The Aerovox Research Worker is edited and published by the Aerovox Corporation to bring to the Radio Experimenter and Engineer, authoritative, first hand information on capacitors and resistors for electrical and electronic application.

VOL. 28, NOS. 5-6

MAY-JUNE, 1958

Subscription By Application Only

Audio Frequency Measuring Requirements

Part II

By the Engineering Department, Aerovox Corporation

FREQUENCY MEASUREMENT AND COMPARISON

AUDIO frequency measurement involves the comparison of the unknown frequency with an accurately-known frequency derived from a standard instrument such as described in the foregoing paragraphs. Or the frequency may be determined with an instrument which previously has been calibrated against some audio frequency standard. The several common methods of measurement are discussed below.

Direct Comparison. Two audio frequencies may be compared directly by either visual or aural means. The zero-beat method is employed. In the aural scheme, headphones are used to detect zero beat by ear. In the visual method, the zero beat indicator may be either an ac-vision, magic-eye indicator, or oscilloscope.

Figure 5 shows a simple circuit for direct frequency comparison. Best results are obtained when the voltage amplitudes of both the standard and unknown signals are equal. Rheostats R_1 and R_2 are provided for individual adjustment of these signal levels. The direct-comparison method is satisfactory only when one of the frequencies can be varied and brought to zero beat with the other. When the two frequencies are close in value, an audible beat note will be set up. This is evidenced by a throbbing sound in the headphones or by a fluttering of the deflection of the visual indicator. At zero beat,

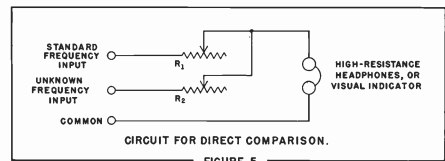

CIRCUIT FOR DIRECT COMPARISON.

FIGURE 5

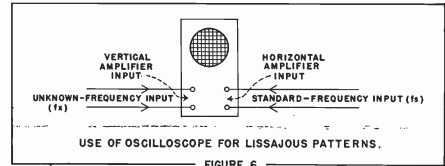

USE OF OSCILLOSCOPE FOR LISSAJOUS PATTERNS.

FIGURE 6

the headphone signal disappears, or the visual indicator shows zero deflection. At zero beat, the unknown and standard frequencies are equal. The direct-comparison method permits measurement of frequency differences of less than 1 cycle per second. The ultimate accuracy depends upon the accuracy of the standard frequency used in the comparison. A shortcoming of this method is its requirement that fundamentals only of the two signals be used.

Oscilloscope Method. Frequency comparisons by means of an oscilloscope, using Lissajous figures, is superior to the simple method just described. A decided advantage is that the fundamental-frequency relationship is not required. An integral relationship must exist between the standard and unknown frequencies but one may be a harmonic or subharmonic of the other.

Figure 6 shows how an unknown frequency (f_x) and standard frequency (f_s) may be applied to an oscil-

AEROVOX - - The Finest In Electronic Components

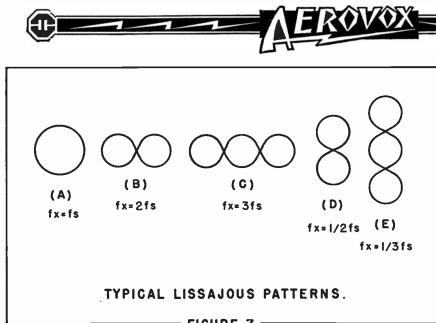

FIGURE 7

oscope having its internal sweep oscillator switched off. The unknown is applied to the vertical amplifier input; the standard to the horizontal amplifier input. When the frequencies have an integral relationship, either even or odd, the pattern will be stationary on the screen. Figure 7 shows typical patterns. When the fundamental of the standard frequency and unknown frequency are equal, a circle or ellipse (Figure 7A) is obtained. When the unknown is a harmonic of the standard (as in B and C), a series of connected, horizontally-aligned loops is obtained. The unknown frequency then is determined by multiplying the standard frequency by the number of loops. When, instead, the unknown is lower than the standard frequency, a series of connected, vertically-aligned loops (such as C and D) is obtained. The unknown frequency then is determined by dividing the standard frequency by the number of loops.

This method is limited only by the number of loops which can be counted on a screen of given size. It may be employed with ease, with a 5-inch screen, for frequency ratios up to 10:1 and with some difficulty at higher ratios.

Since for convenience a calibrated, variable-frequency audio oscillator or signal generator often is used as an adjustable secondary frequency standard for checking frequencies by the oscilloscope method, it is important to note the accuracy and stability to be expected of this type of oscillator. In laboratory-type instruments, frequency stability when the standard frequency can be varied. The reason for this is that the circle will rotate and make counting difficult unless f_s is an exact multiple of f_x . Frequency ratios of 50 to 1, or higher, may be detected on a 5-inch screen.

Service-type instruments offer comparable low distortion but their frequency accuracy is of the order of $\pm 3\%$ to $\pm 5\%$. The Editors have found no figures describing frequency drift of this class of instrument. The accuracy and ease of use of the oscilloscope method using loops (Figures 6 and 7) suffer when the number of loops on a 5-inch screen extends ten. For higher frequency ratios, wheel patterns may be used with better results.

Figure 8(A) shows the setup for wheel patterns. Here, the standard audio frequency is applied to an adjustable phase-shifting network, RC. The horizontal and vertical signal voltages are taken from this network. The coupling transformer, T, may be any available interstage audio transformer having a turns ratio of not less than 1 to 1. The internal sweep oscillator of the oscilloscope is switched off.

For a given standard frequency (f_s), rheostat R is adjusted for a 90-degree phase shift between the horizontal and vertical signals. This will give a circular trace on the screen. The signal of unknown frequency (f_x) then is applied between ground and the intensity modulation (Z-axis) input of the oscilloscope. This latter signal will modulate the circular trace, breaking it into a number of bright spots, or segments, as shown in Figure 8(B). The unknown frequency is determined by counting the number of segments or the spaces between them and multiplying the standard frequency by this number.

This method is most practical when the standard frequency can be varied. The reason for this is that the circle will rotate and make counting difficult unless f_s is an exact multiple of f_x . Frequency ratios of 50 to 1, or higher, may be detected on a 5-inch screen.

The accuracy of this method, like that of the loop method, depends upon the precision of the standard frequency. Accuracy of $\pm 1\%$ may be obtained with a good-grade variable-frequency audio oscillator as the standard frequency source.

Bridge Method. The Wien bridge has a different null point for each supply frequency. This frequency dependence makes it possible to use the bridge as a simple audio frequency meter in the range 20 cycles to 20 Kc. The dial attached to the ganged variable arms of the bridge may be graduated directly in cycles per second. A direct-reading frequency meter is obtained. It becomes necessary only to balance the bridge and read the frequency from the dial. In this audio-frequency application, the Wien bridge becomes comparable to the absorption wavemeter used in a somewhat similar manner at radio frequencies.

Figure 9 shows the circuit of the Wien bridge-type audio frequency meter. In this circuit the control is the 2-gang potentiometer, R_1 , R_2 . While, for simplicity, headphones are shown as the null detector (and may be used), the meter may be an oscilloscope or a c-vtm.

Capacitors C_1 and C_2 are made equal, and R_3 and R_4 are equal at all settings. When this condition obtains, the unknown frequency f_x is $1/(6.28C_1R_4)$; where f_x is in cps, C_1 in farads, and R_4 in ohms. A direct-reading frequency dial is attached to R_1 , R_2 . The potentiometer R_2 has a very low resistance value with respect to R_4 and R_3 (usually not more than 1000 ohms). It serves as an auxiliary resistance balance which deepens the null but does not shift the calibration of the R_1 , R_2 dial.

In practical instruments, the maximum resistances of R_3 and R_4 usually are 10,000 ohms each. Capacitors C_1 and C_2 are switched in value simultaneously to change the frequency range. In commercial bridge-type frequency meters, the basic range is 20-200 cps. By switching C_1 and C_2 , additional ranges of 200-2,000, and 2,000-20,000 cps are obtained.

The accuracy of the bridge-type frequency meter depends upon the closeness of tracking between R_1 and R_2 , precision of the frequency source from which the R_1 , R_2 dial initially is calibrated, stability of capacitors C_1 and C_2 , sensitivity of the null detector, absence of harmonics in the signal of unknown frequency, and to some extent upon the signal-voltage amplitude. Frequency accuracy of 0.5% is obtainable in these instruments.

Use of Wave Analyzer. Just as the bridge-type of meter is comparable to the absorption r-f wavemeter, the

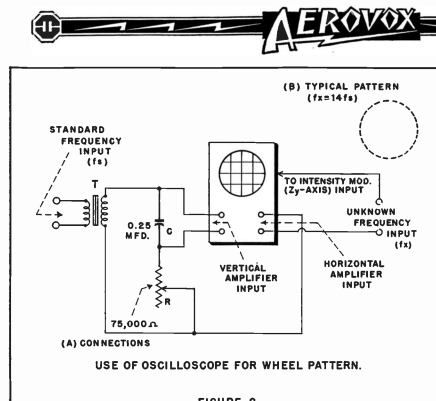

FIGURE 8

wave analyzer is comparable to the superheterodyne receiver. The wave analyzer is a highly-selective, heterodyne-type instrument which is continuously tunable throughout the range 20-16,000 cps or 50-50,000 cps, depending upon model and manufacture. Its band width may be only 50 cycles.

When the wave analyzer is intended primarily for harmonic distortion measurements, it is convenient also for the secondary purpose of audio frequency measurements. In a manner similar to the tuning of a radio receiver, the wave analyzer frequen-

cy dial is adjusted for maximum deflection of the built-in vtvm, with the signal of unknown frequency applied to the input terminals of the analyzer. At this point, the unknown frequency is read directly from the tuning dial.

Typical frequency accuracy of a commercial wave analyzer is $\pm 2\%$ plus 1 cycle.

Meter Method. Direct-reading audio frequency meters find application where rapid measurements are required. They are especially useful when the extent of frequency fluctuations must be observed. The

direct-reading electronic audio frequency meter has high input impedance and covers the range 20-100,000 cps in several switched ranges. The unknown-frequency signal is applied to a pair of input terminals and the frequency is read directly from an indicating meter. Deflection of the meter is independent of signal amplitude and waveform over a wide range. Accuracy of frequency indication is $\pm 2\%$ of full scale. There is no drift if the signal itself is steady.

The instrument may be recalibrated occasionally, when needed, by checking a single point on the meter scale (in each range) against an accurate audio frequency standard.

Use of Stroboscope. The vibration frequency of bells, contactors, certain types of belts, and similar mechanical devices may be determined with the aid of a carefully-calibrated stroboscope. When the flashing rate of the stroboscope illuminating the vibrating or reciprocating device is adjusted to equal the frequency of vibration, the device appears to be motionless. At this point, the vibration frequency may be read from the "tuning" dial of the stroboscope or from a calibration chart.

A signal voltage of unknown frequency may be applied to an audio amplifier provided with a loudspeaker, and the light flashes from a stroboscope directed upon the vibrating cone of the speaker. When the flash rate is adjusted equal to the speaker vibration frequency (which is the frequency of the unknown signal), the cone and voice coil appear motionless.

The direct-reading dial of a typical commercial stroboscope is graduated in rpm (that is, flashes per minute) between 600 and 14,400. This corresponds to audio frequencies between 10 and 240 cps. Accuracy is $\pm 1\%$. However, most stroboscopes are calibrated periodically by their owners by reference to the a-c power line, and the accuracy with which the line frequency is maintained in the locality of use will be an important factor in determining the accuracy of the instrument.

Electronic Counter. Electronic counters, such as decimal scaler and events per-unit-time meter, are used extensively for audio and supersonic frequency measurement. These instruments literally count the cycles in the unknown signal. The frequency is indicated by neon lamps arranged in several decades. In the second type of meter, the count may be made over a selected time interval, such as 0.1, 1, or 10 seconds. The time base is derived from a temperature-controlled 100-kc crystal oscillator and associated timing circuitry.

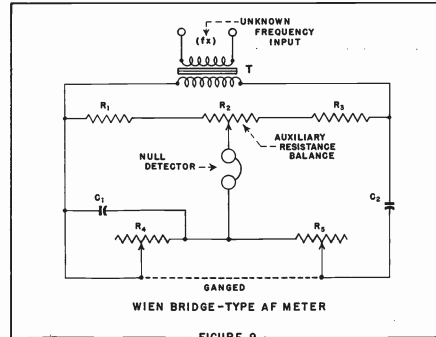

FIGURE 9