

Radio Editors of magazines and newspapers will be given permission to reprint in whole or in part, with proper credit to the Aerovox Corporation, the contents of this issue of the Aerovox Research Worker, upon written request.

The AEROVOX Research Worker

The Aerovox Research Worker is edited and published by the Aerovox Corporation to bring to the Radio Experimenter and Engineer, authoritative, first hand information on capacitors and resistors for electrical and electronic application.

VOL. 25, NO. 6

JUNE, 1955

Subscription By Application Only

Constant-Current Supplies

By the Engineering Department, Aerovox Corporation

IN most familiar vacuum-tube circuits, as well as straight electrical circuits, voltage is the independent variable. E-I tests of these circuits involve setting the voltage to predetermined levels and observing corresponding current values. Constant-voltage supplies, also known as voltage-regulated supplies, therefore are desirable for operation of these circuits.

Modern electronics is becoming increasingly concerned with current-operated devices. Some of these are: semiconductor components, such as crystal diodes, rectifiers, transistors, thermistors, and non-linear resistors; saturable reactors; and non-linear capacitors. In many applications of these devices, satisfactory operation is obtained only by using *constant-current* power supplies. One case in particular (that of the point-contact transistor) is very important — the component can run itself to destruction when operated incorrectly from a constant-voltage supply! Constant current in larger amounts is desirable in electroplating, solenoid operation, and instrument calibration.

Testing of the E-I characteristics of current-operated components involves setting the current to predetermined levels and observing the resulting voltage drop across the component. This, of course, is the exact opposite of the technique used in checking voltage-actuated devices.

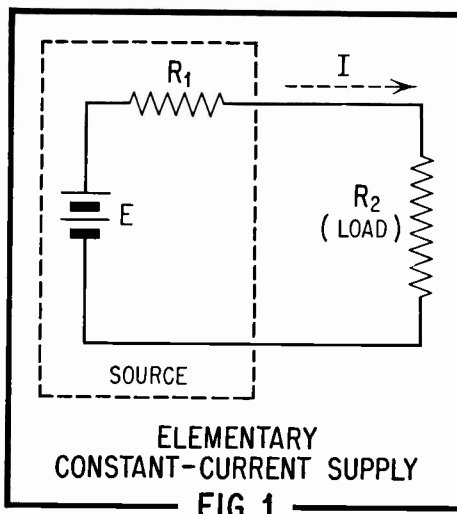

The continual development of new circuits and applications for current-actuated devices, especially in the semiconductor field, an analysis of this type of power supply, is of interest for operation.

Voltage and Current Supplies — Basic Differences

A power supply must have an effective low internal resistance in order to maintain a constant voltage at its output terminals under varying load conditions. This type of supply, the operation of which is characterized by stabilized voltage over a wide range of output-current variation, now is well known.

A constant-current supply, on the other hand, is generally characterized by its appreciable internal resistance. Its terminal voltage is not constant, for the obvious reason that the voltage must adjust itself continuously, in order to maintain a stabilized current flow with variations of external loads.

Series-Resistance-Type of C. C. Supply

From the foregoing descriptions and comparisons, it may be deduced that an elementary constant-current supply might consist simply of a voltage source connected in series with a limiting resistance. And this is true. However, both the voltage and the resistance must be large in most cases. The following discussion will show why this is necessary.

Figure 1 shows an elementary constant-current system. Here; E is a voltage source, R_1 a series resistance associated with this source (internal or external), and R_2 , a load resistance. The components E and R_1 have been enclosed within the dashed-line box to segregate them as the constant-current source, generator, or supply, although it is understood that R_1 can be connected simply to voltage generator E as an external component.

The same magnitude of current, I , flows through both R_1 and R_2 , since this is a simple series circuit. Now; to return to the requirement that the

AEROVOX - The Sign Of The Complete Capacitor Line

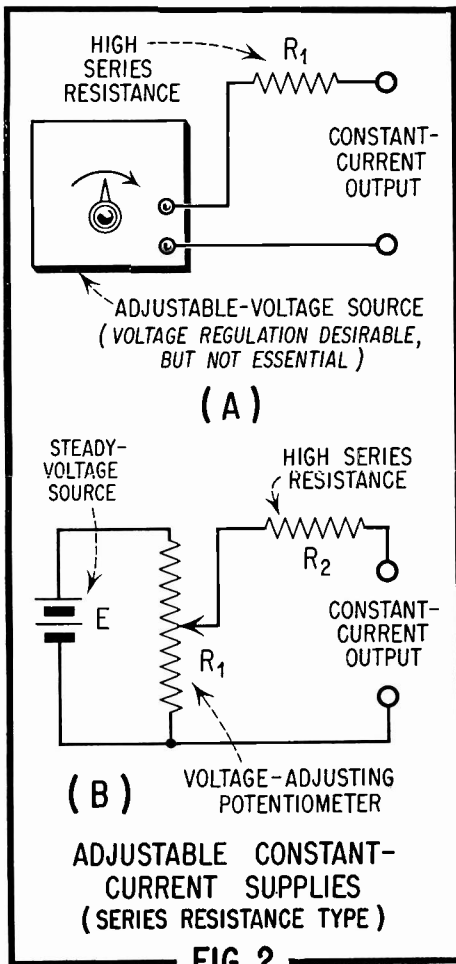

series resistor be high-valued, Ohm's Law shows that a large value of R_1 (with respect to the load resistance, R_2) will have more influence in determining the value of I than will

the value of R_2 . Hence, the load resistance can undergo considerable fluctuation without materially changing the value of I , when the ratio of R_1/R_2 is sufficiently high.

An example will clarify this point. When R_1 is 10 times R_2 , for instance, a 10-percent change in R_2 causes less than 1% change in the circuit current. And a 100-percent change in R_2 causes only an 8½% change in I . If R_1 is 100 times R_2 , doubling the value of R_2 produces only a 1% change in current.

Thus; the larger R_1 is made, with respect to R_2 , the more constant the current will be maintained during large fluctuations of R_2 . However, increasing R_1 to more favorable values means that voltage E must be increased proportionately, to produce the desired current value. The required supply voltage $E = I (R_1 + R_L)$; where E is in volts, I in amperes, and R_1 and R_L in ohms. Here, R_L is the resistance of the current-actuated load device and is identical with R_2 in Figure 1. A good rule of the thumb often followed in laboratories is to make R_1 at least 100 times R_2 whenever practicable. It would, of course, be attractive to have R_1 1000 times R_2 , but too high a limiting resistance entails use of a voltage so high as to be unwieldy.

It is important to note that a certain percentage change in supply voltage E can cause the same current change that would be produced by the same total change in circuit resistance. A quite large voltage change must occur for a significant current change when R_1/R_2 is high. Nevertheless, in applications demanding the utmost in stability, volt-

age E should be supplied by a voltage-regulated source.

While a d. c. voltage source is shown, for simplicity, in Figure 1, this circuit is not limited to direct-current applications. An a. c. voltage source also may be employed if an a. c. constant-current system is desired.

Figure 2 shows two arrangements for adjusting the constant-current output. Both are series-resistance-type units and secure their adjustable feature through control of the supply voltage. Figure 2(A) shows the simple addition of a high series resistance to an adjustable-output a. c. or d. c. supply. In Figure 2(B); the power source itself is not adjustable, so a voltage-setting potentiometer, R_1 , has been added externally. While a battery is shown for simplicity, E can also be an a. c. source, such as the secondary of a power transformer. It also can be a power-line-operated d. c. power supply.

To Determine Required Voltage

$$(1) E = I (R + mR)$$

Where E is the required voltage,
 I , the desired current,
 R , the resistance of the load device,
 m , the desired ratio of series resistance to load resistance.

$$mR = \text{Value of the series resistance.}$$

To Determine Maximum Series Resistance for Use with a Given Voltage

$$(2) R_S = (E/I) - R_L$$

Where E is the available voltage,
 I , the desired current,
 R_L , the resistance of the load device,
 R_S , the maximum permissible series resistance.

To Determine Current Regulation

$$(3) \% \text{ Reg.} = 100 \Delta I / (I_1)$$

Where ΔI is the difference between the initial current value (I_1) and a final current value (I_2) resulting from a change in load resistance from an initial value (R_{L1}) to a final value (R_{L2})

$$I_1 = E / (R_S + R_{L1})$$

$$I_2 = E / (R_S + R_{L2})$$

Where R_S is the series limiting resistance, and R_L the load resistance.

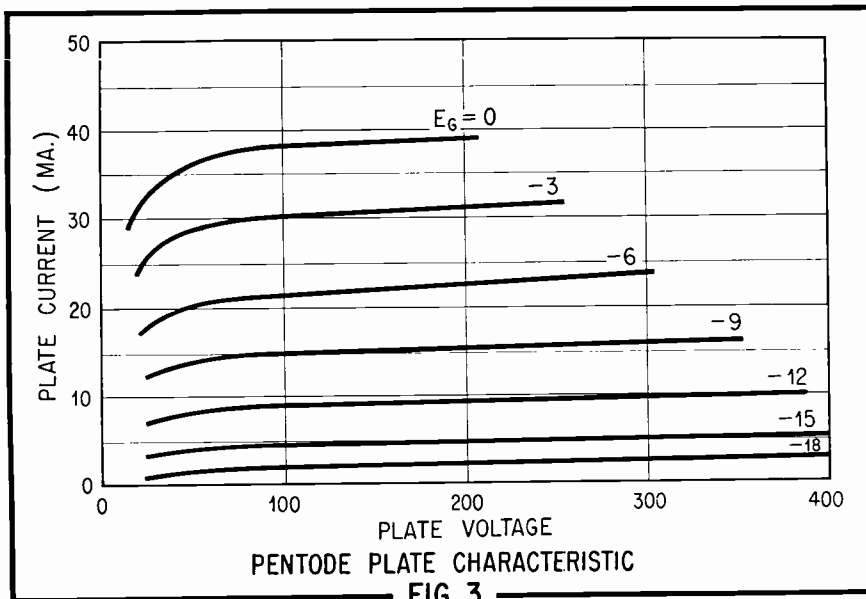

The equations on page 2 will be helpful in determining parameters required for constant-current supplies of the series-resistance type. In each case, E is in volts, I in amperes, and R in ohms.

Pentode Current Regulator

The constant plate current characteristic of a pentode tube suggests utilization of this characteristic to establish constant current in an external device. Adjustment of the d. c. control grid bias to various levels allows the selection of corresponding constant output-current values. In this way, the pentode tube can be used as a constant-current adaptor in conjunction with a d. c. voltage supply.

Figure 3 shows a typical family of E_p-I_p curves for a pentode. This family is plotted for seven values of control grid bias and are the characteristics of Type 6AK6 pentode operated at a screen potential of 180 v. Note that each curve is nearly flat over a substantial portion of the plate voltage range and that the current level is reasonably constant. A current-operated device connected into the pentode plate circuit would utilize this constant current. The resistance of the device might vary over rather wide limits, the lower limit of constant current being governed by the position of the lower bend in the curves.

Figure 4 is the basic circuit of a pentode-type current regulator. Plate and screen voltages are obtained from the d. c. source, E_2 . Control grid bias, adjusted by means of potentiometer R, is obtained from d. c. source E_1 . Some advantage will be obtained by voltage-regulating each of these voltage supplies. The current-actuated load device is connected to the CONSTANT-CURRENT OUTPUT terminals. Settings of potentiometer R allow selection of desired

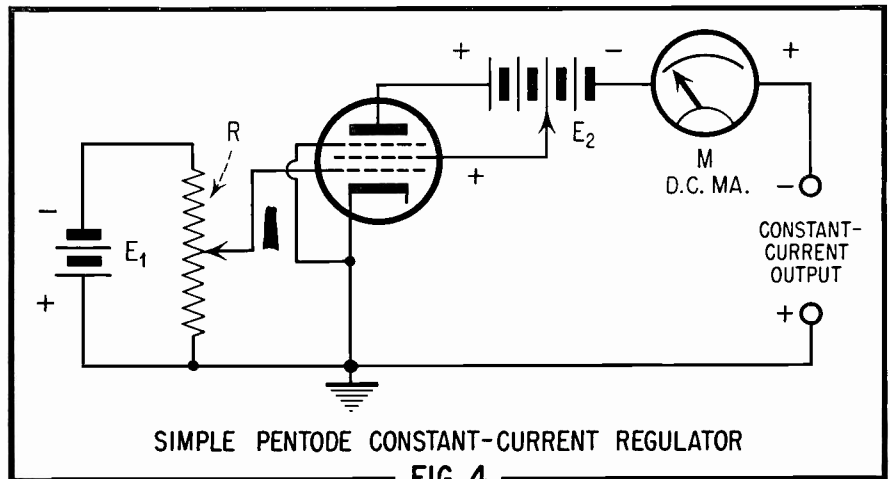

output-current values, monitored by d. c. milliammeter M.

Many modifications of this basic arrangement are possible. A variety of pentode-type tubes is available, and tubes may be connected in parallel for higher current output. Ingenious practical arrangements are possible for supplying grid, screen and plate voltages from a common d. c. supply through a voltage divider system. While batteries are shown for simplicity in Figure 4, power-line-operated voltage supplies are entirely feasible in this application.

Transistor-Type Current Regulator

Since the collector E-I curves of a junction transistor closely resemble the plate curves of a pentode tube, the transistor may be used as a regulator at low current levels in a manner similar to application of the tube. Typical maximum operating levels are: currents up to 10 ma. and power dissipations up to 150 milliwatts, depending upon the type and manufacture of transistor.

Figure 5 shows the circuit of a simple, miniature constant-current

d. c. supply employing a Type CK722 PNP junction transistor and suitable for output currents up to 4.5 ma. The polarities shown are correct for the PNP type of junction transistor. If an NPN type is used, both battery polarities and the meter polarity must be reversed. The emitter bias is derived from the 1½-volt cell, E_1 , and is set by means of potentiometer R. The collector is biased by the 10½-volt battery, E_2 . The constant collector current (the level of which is determined by the setting of R) flows through milliammeter M and the external, current-actuated load device.

This small-sized unit allows any selected output current level between 0.5 and 4.5 milliamperes to be maintained with excellent regulation in output loads between 15 and 1500 ohms.

Unlike the tube-type supply, the transistorized regulator can suffer from the pronounced temperature sensitivity of the transistor. However, in applications in which it is feasible and practicable to stabilize the ambient temperature, this scheme offers many attractions for stabilizing low current levels.

Special Precautions

When the external load is removed from any of the current regulator circuits shown in this article, the full supply voltage (or very nearly this value) appears at the output terminals.

The operator must keep this fact in mind, since the high terminal voltage is a probable source of damage to any high-resistance voltage-actuated device which might be connected to the constant-current terminals. It is also a source of electric shock, an important thing to remember when high supply voltages are employed.

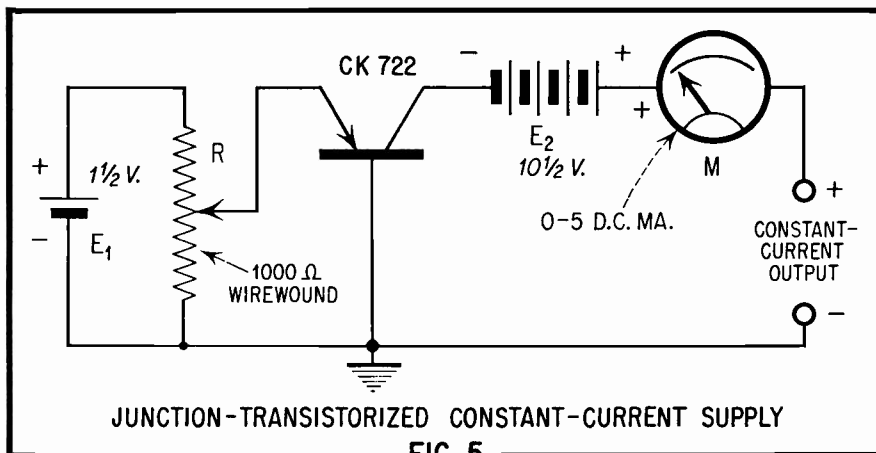

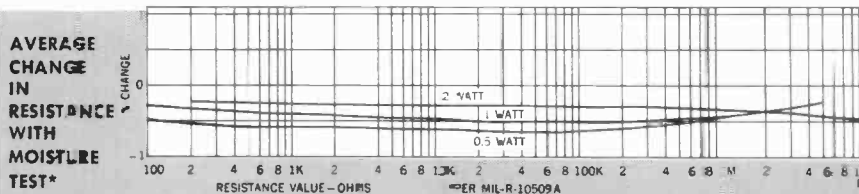

For *Lasting* precision...

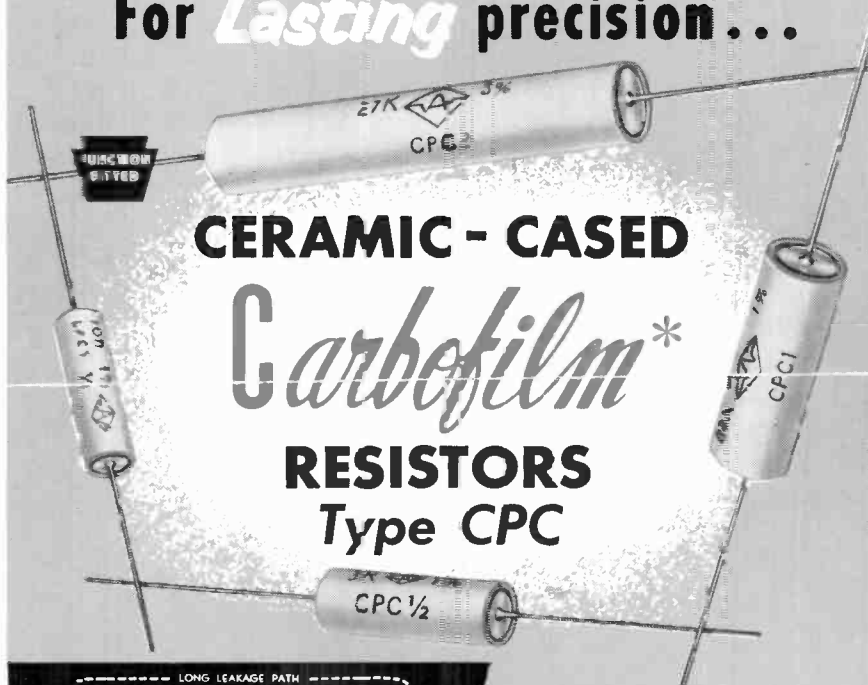

CERAMIC-CASED

*Carbofilm**

RESISTORS
Type CPC

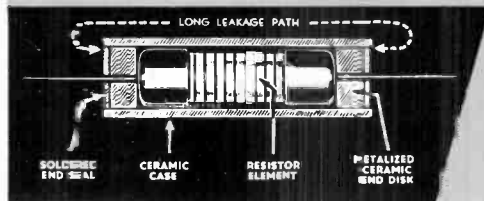

Carbofilm means precision resistors. And Ceramic-Cased (Type CPC) means *lasting* precision, plus additional advantages over metal-cased (Type CPH) units such as:

1. Ceramic case eliminates need for insulating sleeves, making these units more readily adaptable where space is at a premium.
2. Resistor can be mounted on terminal board, with body in contact with eyelets or rivet lugs, without shorting.
3. Capacitance effect between resistor and outward casing is eliminated.
4. Leakage path considerably increased over metal-cased unit.

Plus superlative characteristics — temperature vs. load; average change in resistance with temperature cycling; low temperature exposure; short-time overload; moisture test; solder dip test load life test; etc. Available in three types: Coated, Metal-Cased, Ceramic Cased. 1/2, 1 and 2 watt ratings. Standard tolerances of plus/minus 1, 2 and 5%.

GET THE FACTS! Description, performance curves and specifications (Form No. NPQ-101) sent on request. Consult us about your precision resistance needs.

*Trade mark

HI-Q[®]
DIVISION

AEROVOX CORPORATION

CLEAN, N. Y.

In Canada: AEROVOX CANADA, LTD., Hamilton, Ont.
Export: Ad. Aurovax, 870 Broadway, New York, N. Y. • Cable: Aurovax, N. Y.

AEROVOX CORPORATION, NEW BEDFORD, MASS. • ACME ELECTRONICS, INC., MONROVIA, CALIF.
CINEMA ENGINEERING CO., BURBANK, CALIF. • HENRY L. CROWLEY & CO., WEST ORANGE, N. J.