

Radio Editors of magazines and newspapers will be given permission to reprint in whole or in part, with proper credit to the Aerovox Corporation, the contents of this issue of the Aerovox Research Worker, upon written request.

*The* **AEROVOX**  
**Research Worker**



The Aerovox Research Worker is edited and published by the Aerovox Corporation to bring to the Radio Experimenter and Engineer, authoritative, first hand information on capacitors and resistors for electrical and electronic application.

VOL. 21, NOS. 6, 7, 8

JUNE, JULY, AUGUST, 1951

Subscription By Application Only

## Metallized-Paper Capacitors

*By the Engineering Department, Aerovox Corporation*

### TABLE OF CONTENTS

Early History (Chapter I) .....	Page 2
Manufacturing Process (Chapter II) .....	Page 3
Characteristics of Metallized-Paper Capacitors (Chapter III) .....	Page 4
P 83Z "Microminiatures" .....	Page 9
Applications (Chapter IV) .....	Page 11

### Foreword

*As a timely contribution to the literature on capacitor art, Aerovox presents the following information in handy reference form.*

*For the most part the material herein contained is based on papers and discussions presented at recent symposiums on metallized-paper capacitors. As a leading pioneer of this development in this country, Aerovox has accumulated a vast fund of practical "know-how" from the engineering, application and production angles. Such background is gladly shared with those who would take advantage of the characteristics inherent in metallized-paper capacitors.*

*We are especially indebted to Louis Kahn, Director of Research of Aerovox Corporation, for much of the following information based on his papers delivered at recent symposiums.*

---

# AEROVOX PRODUCTS ARE BUILT BETTER

---

# METALLIZED-PAPER *Capacitors*

## CHAPTER I

### EARLY HISTORY

#### METALLIZED PAPER CAPACITORS

The history of metallized paper capacitors has been traced as far back as 1900 when Mansbridge of England was granted a British patent for "capacitors made with paper coated on one or both sides with metal in a finely divided condition."

Mansbridge conceived the first practical approach to the problem in England during the middle 1920's when he developed a paper upon which was imposed a thin layer of tin. The tin coating was first applied as "sludge", then dried, and calendered. This type of capacitor was then known as the Mansbridge capacitor and was manufactured both here and in England for several years. However, the characteristics of this type of capacitor, (manufactured by the Mansbridge method), did not give satisfactory results, and therefore was discontinued. The biggest handicap experienced was the non-uniformity of the metal film on the paper and weakening of the paper during the rolling process. As a result of this characteristic, single paper capacitors could not be used. One additional fault was that electrical resistance of the Mansbridge coating was high, because of the granular structure and the material itself. This meant that the electrode resistance would be high, thus producing correspondingly high ohmic losses. Figure 1 is a photograph of a 2 mfd. capacitor made by the American Automatic Electric Sales Company of Chicago, Illinois. The volume of this unit is 6 cubic inches compared to 3.06 cubic inches for a 400 volt bathtub type capacitor or 1.31 cubic inches for a 200 volt capacitor of present day design.

The Mansbridge patent then, will be remembered as being the patent of a pioneer whose experiments were accorded some commercial success. He would appear to have been the exponent, if not the originator, of the notion of "self-healing", and he further demonstrated how metallized paper could be "broken down" to remove electrical defects.

Although the use of Mansbridge paper capacitors was dropped, the basic principles employed were sound and the idea of metallizing paper was not discarded. The main requirements for a successful metallized paper unit are a thin metallic coating of uniform thickness and high conductivity which can be applied without damage to the paper or the dielectric spacer. Many methods and suggestions were suggested and devised for achieving this, but most of them proved unsuccessful (i.e. metal spraying and the application of powdered metals). It should be pointed out here that we are referring only to paper capacitors and not to electrolytic capacitors.

The development of an evaporation technique of plating metals to any surface under high vacuum offered the first practical solution of metallizing paper for capacitor use.

Metallized paper capacitors were developed in England and Germany almost simultaneously during 1930-40. The English concern, A. H. Hunt, employed aluminum while in Germany, Robert Bosch used zinc. The Bosch process differed from Hunt's in that the paper was lacquered on one side before the application of the metal film. By a very ingenious method, the Bosch people produced margins on the paper by preventing the deposition of the metal on certain areas. These areas to be free of metal were coated with an aromatic kerosene. When these areas passed over the metallizing nozzles, the vapour pressure of the evaporating hydro-carbon prevented deposition of any metal on that surface.



$C = 2.215 \mu f$  50V 60 CPS  
 $PF = 1.625 \%$   
 $IR = 100$  MEGOHMS AT  $\frac{3}{4}$  VOLTS  
40 MEGS AT 200V

Figure 1

At the end of the war, the Bosch patents for the manufacture of metallized paper capacitors was made available to all manufacturers as a result of the Alien Property Custodian Act. At that time, a considerable amount of publicity was released by the U. S. Government stating that metallized paper capacitors were smaller, cheaper and featured desirable characteristics over the regular foil type of capacitor. As a result, a considerable amount of public interest was created for the production of such units.

# METALLIZED-PAPER *Capacitors*

## CHAPTER II

### A. Manufacturing Process

Capacitor tissue of correct thickness is first lacquered with a cellulose acetate lacquer whose thickness is kept between  $\frac{1}{2}$  and 1 micron (20 to  $40 \times 10^{-6}$ ). This coating must be extremely uniform. The use of the lacquer coating increases the insulation resistance materially and also increases the sparking voltage limits.

After lacquering, the paper is thoroughly dried using elevated temperatures and high vacuum to remove all volatile compounds in addition to the water. The jumbo rolls of paper (about 42" wide) are then placed in the metallizing chamber which is evacuated to a pressure of less than 1 micron of mercury. This is done before the heaters for vaporizing the aluminum are started. Simultaneously, the paper is started and brought to the proper speed for the thickness of metal coating required.

The speed of paper past the aluminum source is determined by the resistance of the aluminum film between the two insulated rollers. After metallizing, the paper is then run over another series of rollers and a voltage applied across the paper. All shorted portions or weak spots are cleared by isolating the defective points.

The next step in the preparation of the paper is slitting and marginating. This is done in one machine. Marginating involves the removal of the metal in narrow bands or widths by use of a spark discharge. These bands are twice the width of the margins required and the slitting is then done down the center of the demetallized area.

The rolls of metallized paper are then paired into right and left hand rolls and are used in pairs for winding capacitor sections. Sections are wound on conventional type winding machines with the paper registration on both sides, one margin on each side.

After winding and forming into the desired shape, the ends are metal sprayed with copper, (when necessary) masking a portion of each end to permit good drying and impregnation. The sections may be impregnated separately or assembled in their containers prior to impregnation, depending upon the design of the unit. In all other respects the assembly of metallized paper capacitors is the same as that of conventional capacitors.

After the impregnation and final assembly, the capacitors must be cleared. Unlike standard foil-paper capacitors, a large percentage of metallized paper capacitors come off the assembly

line shorted. The resistance of the short may vary from less than 1 ohm to greater than 10,000 ohms. After clearing, the capacitors are given final measurements exactly as the conventional units.

As pointed out earlier, two metals have been used for the manufacture of commercial metallized paper capacitors. Each metal has certain individual characteristics making its use desirable.

Zinc, having a lower evaporation temperature, permits the use of less complicated equipment than that required for aluminum film. As a result, the speed at which the paper may run through the metallizing equipment is higher. Among its disadvantages are these; the fact that zinc being a more highly chemically active metal than aluminum, must consequently be handled with greater care, particularly after the paper has been metallized. In addition, to reduce the resistance of the film to the required values as well as to offset the effects of oxidation, it becomes necessary to deposit a thicker film on the paper.

Aluminum, although it requires a much higher temperature for evaporation, has certain advantages. The most important of these being that aluminum is extremely stable after the formation of a thin oxide film, and the finished metallized paper can be stored without fear of deterioration over long periods of time under normal storage conditions. Aluminum, possessing greater strength than zinc, permits the development of stronger lead connections on the ends of the capacitor.

### B. Impregnants

The impregnants that may be used with metallized paper capacitors are extremely limited because of the thinness of the metal film, and the effects of any contaminating or corrosive materials on these thin films. The impregnants must be extremely pure and stable. No chlorinated materials which decompose under temperature or electric arc can be used as impregnants.

This limits the usable impregnants to Mineral Waxes, Oils, Silicones and Aerolene. More will be said about impregnants in the chapter dealing with characteristics.

Single paper capacitors are normally impregnated in a microcrystalline wax. Multi-layer capacitors (rated 400 and 600 VDC) may be impregnated in Mineral Oil or Wax. Capacitors impregnated in Mineral Oil have temperature characteristics similar to those of conventional paper capacitors.

# METALLIZED-PAPER *Capacitors*

## CHAPTER III

### A. Characteristics of Metallized Paper Capacitors

Metallized paper capacitors have characteristics which in a great many ways differ from those of regular paper capacitors. In fact, the characteristics of metallized paper capacitors should be considered in most cases without any reference to the characteristics of paper-foil type capacitors. We suggest this to avoid the carry-over of any conceptions based on the performance of paper-foil types as against those of the metallized paper variety. The basic difference in the characteristics of the two capacitors is attributed entirely to the fact that the metal electrodes in the metallized paper capacitors are extremely thin, normally being of the order of  $\frac{1}{2}$  a millionth of an inch thick. By virtue of this extremely thin metal layer, these capacitors are self-healing. This phenomenon of self-healing depends primarily on the ability of the capacitor to isolate from the active portion of the capacitor, faults or other imperfections within the dielectric layer, thus eliminating the short circuit which would normally be responsible for the failure of a paper-foil capacitor. (See Figure 2). This self-healing characteristic is used to advantage in metallized paper capacitors especially in the low voltage ratings by allowing a reduction of the total thickness of the dielectric and decreasing the number of multiple layers of dielectric required by paper-foil type of capacitors.

In the paper-foil type of capacitors, multi-layer insulation is of the most importance even in extremely low voltage (five volts) applications because all paper has a certain number of conducting paths. These conducting paths may be due to the inclusion of metallic particles in the paper, pin holes, thin spots, or the possibility of conducting spots caused by other materials of low resistivity. When multi-layer insulation is used, the possibility of having these conducting paths line up is extremely small

and therefore, a minimum of two sheets of paper is generally used.

When metallized paper is used, these conducting paths are isolated in the manufacture of metallized paper. Any conducting paths that may occur as a result of dielectric failure in the use of the capacitor are isolated or cleared by the energy in the system. This condition presupposes that there is sufficient energy in the system at a potential high enough to allow it to flow through to the point of failure and to isolate this point of failure by melting and possibly vaporizing the metal surrounding it and thus "heal" the capacitor. The exact amount of energy and the minimum voltage required to clear the shorts is still not definitely known.

Computations of the energy required to heat and melt the aluminum film in a spot  $\frac{1}{32}$ " diameter have been made and found to be  $9.9 \times 10^{-13}$  watt-seconds for aluminum. The energy for zinc is  $6.5 \times 10^{-11}$  watt-seconds.

These calculations are based on a metal thickness of 50 milli-microns. The assumption is also made that the time to clear the fault is so short that very little heat is lost by conduction to the surrounding materials.

Measurements of the energy required to clear faults have not been very satisfactory. Indications are, that the energy required depends mostly on the resistance of the fault. The majority of faults which occur will have a resistance of less than 1 ohm and the remainder will be under 100 ohms. Percentage-wise the following was found in a one-hundred lot of 200V, 1 mfd. and a one-hundred lot of 200V, 2 mfd. capacitors after impregnation. Please note that these figures are based on capacitors measured after impregnation, but prior to a standard clearing procedure.

Faults under 1 ohm—16.5%

Faults between 1 ohm and 100 ohms—6.5%

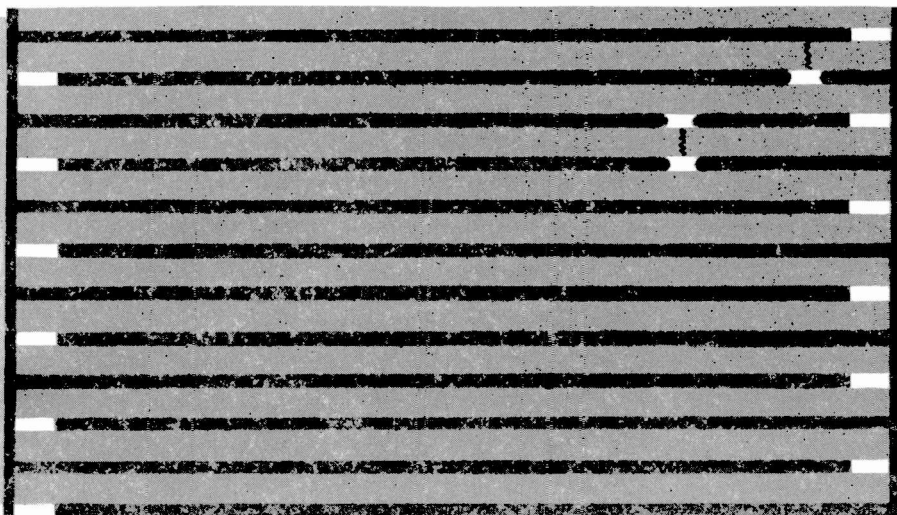

Figure 2

Faults under 1 ohm will clear with a current of about 10 m.a. However, an appreciable length of time may be required for clearing. When the clearing current is limited to 100 m.a., the fault is cleared in less than 10 micro-second. The voltage required for clearing is determined by the resistance of the fault. Therefore, most faults will be cleared at 3 volts or less.

**AEROVOX**

*Individually Tested*

**PRODUCTS**

# METALLIZED-PAPER *Capacitors*

## B. Basic Characteristics

In considering metallized paper, the following characteristics are important:

1. **Capacitance**
  - a. Temperature effect
  - b. Life effect
2. **Voltage**
  - a. Rated voltage
  - b. Operating voltage
  - c. Test voltage
  - d. Sparking voltage
  - e. Breakdown voltage
3. **Insulation Resistance**
  - a. Temperature effect
  - b. Life effect
4. **Power Factor — E. S. R.**
  - a. Temperature effect
  - b. Frequency effect
  - c. Life
5. **Noise**
6. **Life**

In our formal educational processes, if we may be permitted to use ourselves as examples, we were led to believe (intentionally or unintentionally) that circuit elements were fixed and invariable even as the gram and meter. Yet, when we come face to face with these elements in a circuit, we find them far from being fixed values. Temperature, frequency, position, and many other factors must be considered in analyzing components.

Capacitance of metallized paper capacitors are a function of temperature as shown by the following curves.

Figure 3 shows the effect of temperature and frequency on the capacitance and power factor of 200 volts and 400 volt 0.5 mfd. (single and multiple papers) metallized capacitors impregnated in Hyvol K, Mineral Wax. These are typical curves and some deviations may be expected. However, this deviation will normally not exceed 1%. These curves will also hold true for other ratings.

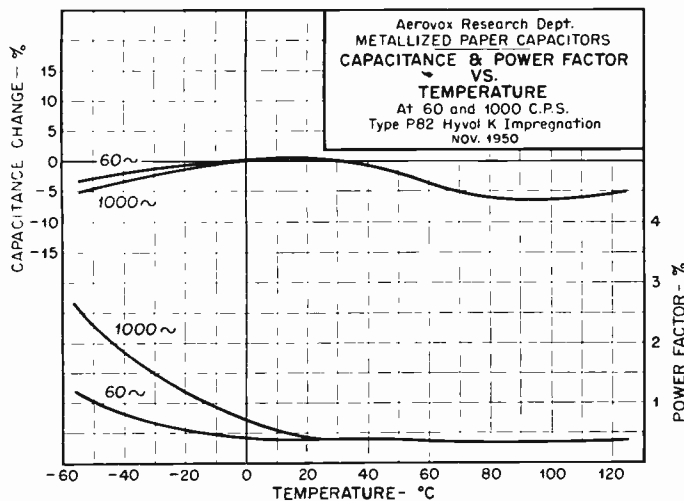

Figure 3

Particular notice should be made of the effect of frequency on capacitance and power factor at low temperatures. The dip in the capacitance curve at 60°C to 80°C is caused by the melting of the impregnant whose melting point is approximately 75°C. It is also of interest that the power factor is flat through the melting point, although some change might be expected to occur. Since measurements were taken at 10°C intervals, peaks that might have occurred may have been missed.

Figure 4 is a similar curve for a Mineral Oil impregnated capacitor.

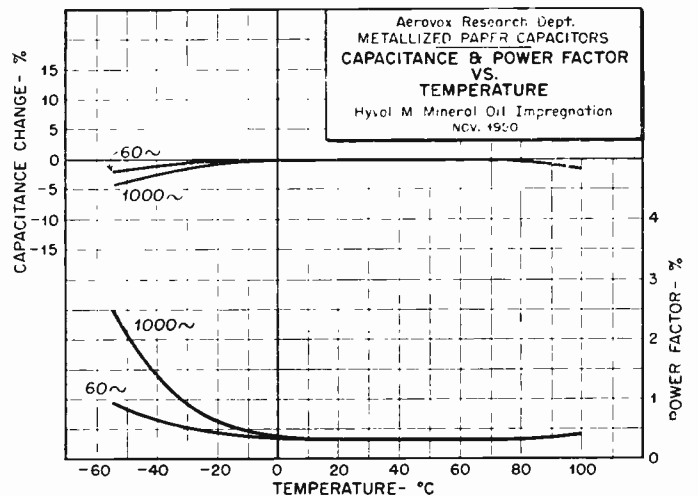

Figure 4

Measurements of capacitance at higher frequencies have not been made, primarily because capacitors of higher capacitance values are used essentially as by-pass capacitors. In such cases, the impedance at frequencies below the resonant frequency of the unit is of importance between the points of connection. This impedance is determined by the lead length and diameter as well as the capacitance of the section. Above the resonant frequency the reactance component of the impedance is, of course inductive, and this may be a factor in some applications.

Measurements were made by shorting the capacitors by as short a lead as possible and the use of a grid dip oscillator, as well as by the measurement of the minimum impedance using the circuit shown in Figure 5.

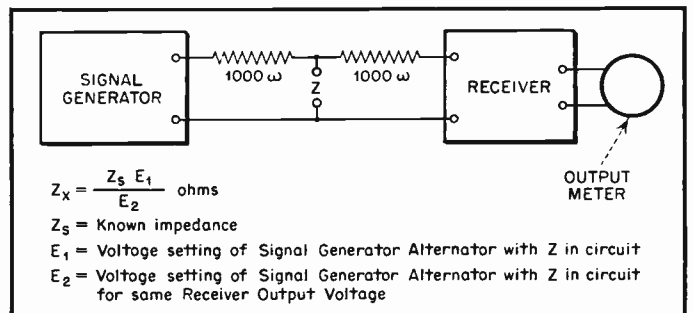

Figure 5

# METALLIZED-PAPER *Capacitors*

Figure 6 shows some of these resonant frequencies. The upper curve shows the self resonant frequency of metallized paper capacitors of various capacitance values. The curve just below, is the curve for conventional tubular capacitors. All measurements were made using as short a lead length as possible. Since a shorter lead length is feasible with metallized paper capacitors, it accounts for the higher resonant frequency.

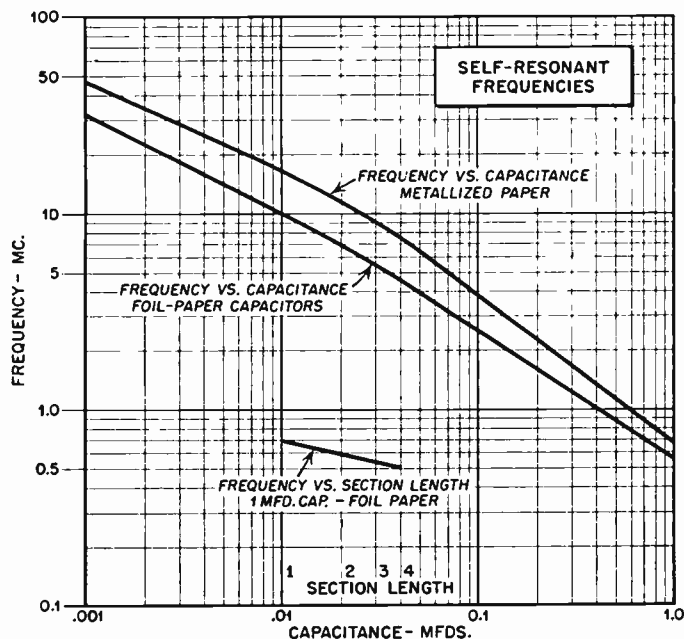

Figure 6

The lower curve shows the effect of section length on the resonant frequency of a conventional paper capacitor. This is demonstrated to give some idea of the effect of section length on the resonant frequency. As a further check on the effect of section length, the resonant frequencies of parallel plate capacitors were determined and found to be the same as the tubulars. This is not entirely surprising as the total length of current travel in a P 83Z is approximately  $\frac{1}{4}$ " which is the same as in a disc capacitor of  $\frac{1}{8}$ " diameter with the connections made to the center of the electrodes.

As in the electrolytic capacitor, a new concept of voltage rating must be adopted. The first principal that must be decided is, "What is a voltage failure?" There is no doubt about voltage (dielectric strength) failure on a conventional foil capacitor, but on self-healing units other criteria must be used.

Therefore, several voltage levels have been adopted and these are defined below.

**Voltage Rating**—The voltage rating of metallized paper capacitors is determined by the sparking voltage limit, rather than by life, as in the paper-foil type of capacitor. The reason for this is quite obvious. As long as the metallized paper capacitor will heal, there is no danger of voltage failure or a short circuit. The limiting or the determining characteristic of the life of a metallized paper capacitor will be by the number of

sparks or pulses, minimum insulation resistance, or the maximum power factor of the capacitor that the circuit will tolerate. Therefore, the sparking voltage becomes the determining factor.

There are four voltage levels to be considered in the characteristics of a metallized paper capacitor. These are in order as follows:

a. **Rated Voltage** — Capacitors operated at or below rated voltage and within the temperature range of the impregnant will seldom, if ever, short circuit. As a result, insulation resistance will not decrease with operation if the capacitor case is hermetically sealed. In fact, capacitors operated under such conditions will generally show an increase in insulation resistance with time. Random short circuits rarely occur, but when they do occur, the capacitor will heal with very little change (if any) in the characteristics of the capacitor, providing the applications are correct. If the capacitor is not hermetically sealed, the characteristics will depend on the efficacy of the seal, and so forth, rather than the section design itself. The operating voltage is the rated value for temperatures of 50°C, or below. For operation at temperatures above 50°C, the operating voltage will be less than the rated voltage by a derating factor. This derating curve will be discussed in more detail later.

AC operation of metallized paper capacitors is entirely possible and satisfactory, provided the proper ratings are observed. The maximum 60 cps. voltage for units rated at 200VDC is 70 volts RMS and 250 volts RMS for units rated at 400VDC. At these ratings life tests of 4,000 hours at 65°C have not shown any change in capacitance, power factor or insulation resistance. Although insulation resistance as such, is of no meaning as far as performance of metallized paper capacitors on AC is concerned, it is an excellent indicator of the possible number or amount of sparking.

b. **Test Voltage** — Figure 7. The test voltage of the capacitor is generally a voltage 50% higher than the rated voltage. The test voltage then, is the voltage that capacitors are tested to make certain that there aren't any faults that cannot be cleared, or that the number of faults that do occur are relatively small, insuring that the faults or partial failures which might otherwise occur at rated voltage, will be extremely small. The 50% increase of the rated voltage used as a test voltage also insures that the capacitor will not cause voltage fluctuation or voltage surges below the maximum test voltage values.

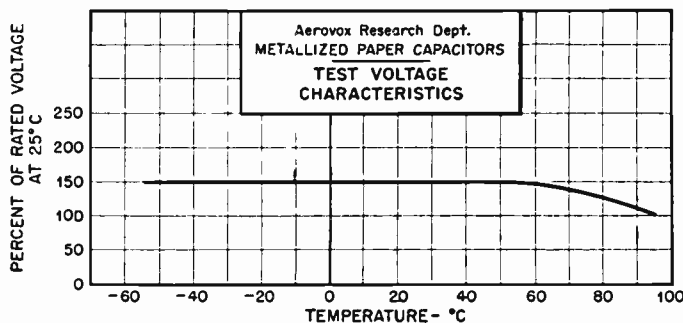

Figure 7

# METALLIZED-PAPER *Capacitors*

This voltage also is based on a 50°C rating and will decrease in accordance with the operating voltage decrease with temperature.

c. **Sparking Voltage** — Figure 8. This is a voltage level at which sparking of an intermittent nature, generally of the order of one or two or possibly more sparks will occur per hour. At

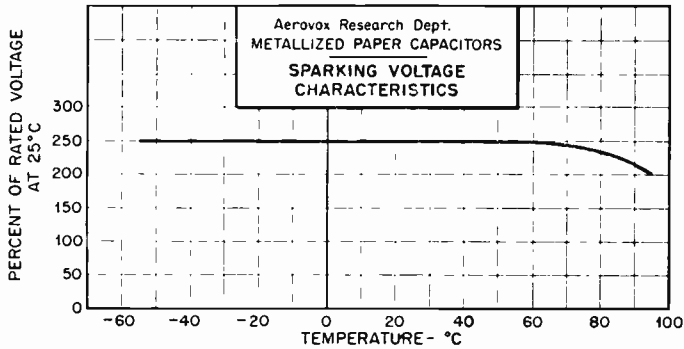

Figure 8

this level, the short circuits will clear themselves. Since the dielectric is stressed very highly, new faults may occur in time and the clearing will continue. Under this type of operation, the insulation resistance of the capacitor is rapidly lowered making it an unsafe operating condition. In certain types of circuits where the limiting resistance is extremely low, and where the circuit has considerable power capabilities, these shorts may cause a complete failure or very low resistance if allowed to continue for extended periods of time. However, in some types of applications, surge voltages reaching into the sparking voltage range may be used safely, provided the system is immune to the electrical noises or pulses set up by the sparking.

The amount of sparking is reduced very sharply as the voltage stress on the dielectric is reduced and also as the capacitance is reduced. Preliminary tests show that for capacitors having a nominal rating of 200 volts and 1 mfd., there is no sparking at 100 volts, 85°C, for periods up to 100 hours.

d. **Breakdown Voltage** — Figure 9. As the voltage across a

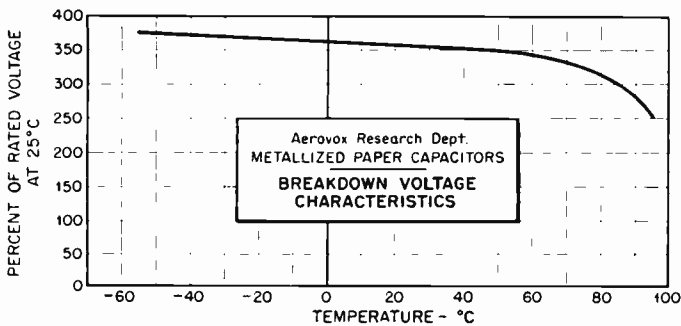

Figure 9

metallized paper capacitor is increased, a value of voltage will be reached at which continuous sparking will occur. The capacitor, is to all intents, short circuited. Under this condition carbonization of the impregnant and of the paper will occur, and the capacitor operation is not of satisfactory nature. If the breakdown voltage is maintained for an extremely short time, the capacitor may still be operated, and will perform from then on as well as any capacitor that has not been subjected to this test.

**Derating** — Figure 10. Metallized paper capacitors must be operated at voltages lower than their rated voltage if the ambient exceeds 50°C. The derating curve for metallized paper capacitors is somewhat steeper and the allowable operating voltage drops off more rapidly than the conventional type of capacitor. The reason for this of course, is the higher dielectric stress at which these capacitors operate, and the fact that with the thinner dielectric there is a greater tendency for dielectric breakdown at the higher temperatures.

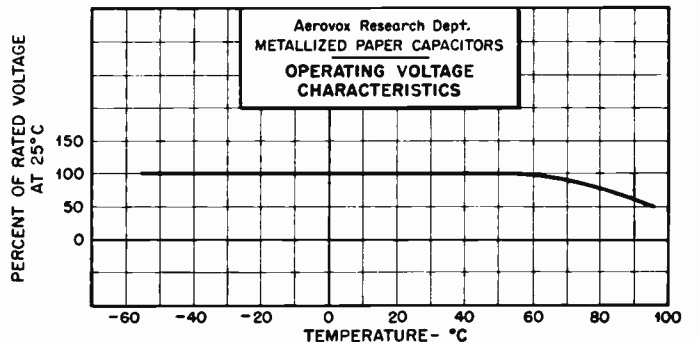

Figure 10

**Power Factor at Low Frequencies** — The power factor of metallized paper capacitors at low frequencies (that is at frequencies below 100,000 cycles per second) is similar to that of mineral wax or mineral oil impregnated capacitors. At the present time the maximum allowable power factor for a mineral oil or a mineral wax impregnated metallized paper capacitor is 1% at either 60 cycles or at 1,000 cycles, depending upon the voltage rating and the capacitance of the unit.

**Power Factor at Radio Frequencies** — Generally speaking, slightly lower power factors may be obtained with metallized paper capacitors as against conventional foil capacitors at the higher frequencies. The difference in the R.F. impedance is negligible except at the resonant frequency of the capacitor, which will be close to the resonant frequency of any type of capacitor having the same capacitance value. The reason for the minute difference in R.F. impedance (except at the resonant frequency) is



# METALLIZED-PAPER *Capacitors*

that the major component of the impedance is capacitor reactance below the resonant frequency and lead reactance above the resonant frequency. This is independent of the type of construction, except for a hidden foil construction in which the tabs are not placed at the center of the winding and within a half of a turn of each other.

The series resistance as found by minimum impedance measurements at resonance will vary from approximately 0.05 ohms in the vicinity of 0.8 MC for a 1 mfd. capacitor to 0.35 ohms at 10 MC for a 0.02 mfd. unit. These values are affected somewhat by the ratio of diameter to length of the section.

**Insulation Resistance** -- Figure 11. The insulation resistance of a metallized paper capacitor is generally lower than that of a paper foil capacitor, particularly for capacitors with single paper dielectric. With the use of a single paper dielectric, a larger number of conducting paths are present. When these conducting paths are cleared by the application of current and voltage to the capacitor, a certain amount of the impregnating material in the vicinity of the conducting path become over-heated, deteriorating and lowering the insulation resistance. The effect of a

single cleared spot can generally be neglected, but when a multiplicity of these spots occur, the insulation resistance will show a marked decrease. It is impossible to predict how many such spots will occur in a given construction. The number depends on many factors, one of which is the paper. The treatment of the paper during the metallizing and the handling of the paper after metallizing, the impregnation cycle, and the handling of the capacitors, as well as test voltages and temperatures are all factors. As a result, the minimum insulation resistance values that can be guaranteed are of the order of 500 megohm microfarads or lower, depending upon the capacitor size and voltage rating. While it is true that the majority of capacitors will have insulation resistance values considerably higher than the minimum values guaranteed, a sufficient number of low value units occur in production making it necessary to limit the guaranteed values.

One very important characteristic of metallized paper capacitor capacitance values is that insulation resistance at high temperatures generally is within specified high temperature limits, regardless of the insulation resistance of the capacitor at room (25°C) temperatures.

The reason for this is as follows: Very low insulation resistance of metallized paper capacitors is usually due to a partial conducting path acting like a resistor in parallel with the capacitor. The resistance of this path is relatively constant compared to the change of insulation resistance of the capacitor dielectric with temperature. As the temperature of the capacitor is increased, the total resistance will decrease and at high temperatures the effective insulation resistance will be the parallel resistance of the partially conducting circuit, which has not changed materially and the section insulation resistance which may have dropped to as low as 1/50 of its original value (depending on the temperature). Thus, an 8 microfarad unit may have an insulation resistance of only 20 megohms at room temperature, yet, will have a resistance of 5 megohms at 85°C. The minimum required insulation resistance for this capacitor at 85°C is .5 megohms.

This characteristic is of the utmost importance, since the limiting value of insulation resistance as far as circuit operation is concerned is determined by the insulation resistance at the high operating temperature, regardless of the insulation resistance at room temperature. Unless the capacitor insulation resistance is correct for the high temperature operation, the low temperature insulation resistance is meaningless.

**Noise** -- There has been considerable thought given to the noise characteristics of metallized paper capacitors. Noise is of importance, of course, in any audio system but it is also of importance in any pulse operated systems in which intelligence is trans-

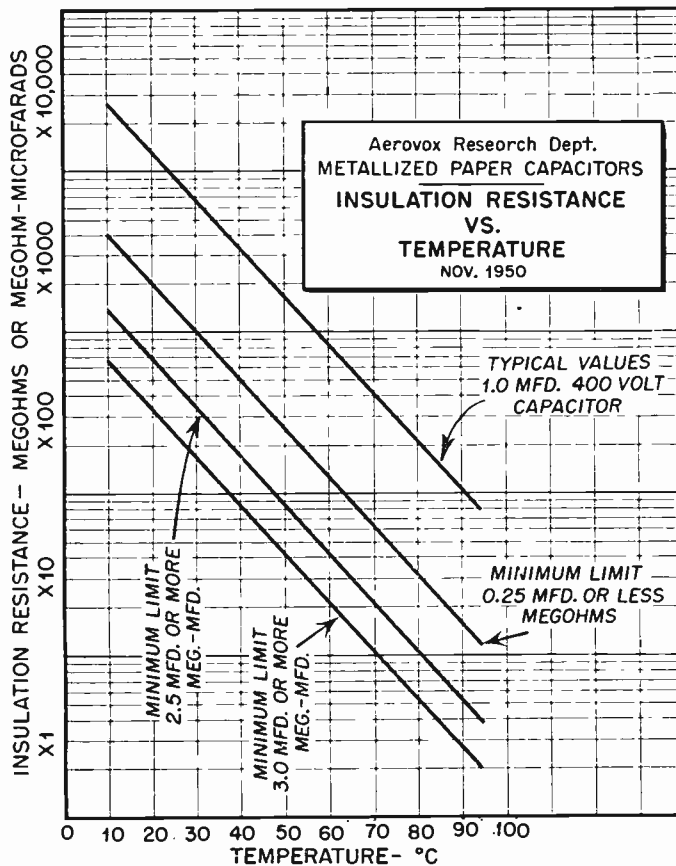

Figure 11

**AEROVOX**

*Individually Tested*

**PRODUCTS**



# METALLIZED-PAPER *Capacitors*

mitted by means of one or more pulses. Breakdowns or sparking is an exaggerated form of noise, but other possibilities exist which may cause noise or pulses that may not be of sufficient magnitude to operate pulse counters or to be indicated on a meter.

To measure this noise level, a Ferris Model 32-B Radio Field Strength Meter was used in a circuit shown in Figure 12. Measurement of a large number of 200 volt metallized capacitors at 90VDC and 110VAC did not show any noise voltages.

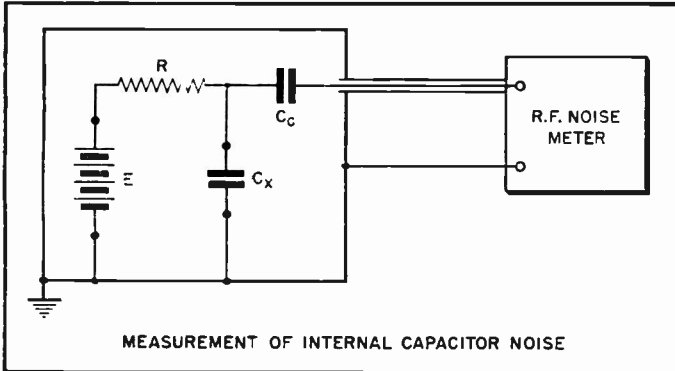

Figure 12

With the development of unitized assemblies, potting of components has come back. The effect of potting as well as temperature cycling of metallized capacitors was considered as a possible cause for shorting or very low insulation resistance of these capacitors.

Cycling tests in which the capacitors were heated from—55°C to +85°C daily over a period of 20 days were conducted without any signs of failure. All measurements were made at 1½ volts in order to detect any faults before measuring the insulation resistance at the rated voltage.

Capacitors were also potted at temperatures up to 350°F (177°C) without any effect on the electrical characteristics other than an increase of insulation resistance.

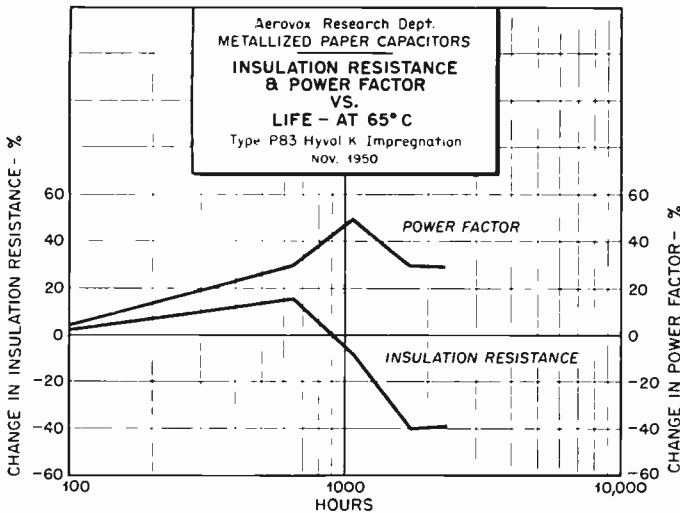

Figure 13

**Life** — The life of a metallized paper, as pointed out previously, is measured by a change of characteristics, rather than by its inability to function as a capacitor. This conception of life is also applicable to conventional foil type capacitors as in the case of insulation resistance for certain applications.

Accelerated life tests are not possible because of the voltage characteristics of the capacitor. Therefore, life tests require considerably longer times and design tests. They may run as long as 10,000 hours (15 months) Figure 13.

## P 83Z MICRO MINIATURES

With the availability of metallized paper and the demetalizing technique, a new type of capacitor winding became possible. This development is of great importance as it permits the manufacture of "Micro-Miniature" capacitors as shown in Figures 14, 15. At the present time, these capacitors are made in the following sizes and ratings.

Molded Case— $\frac{3}{8}$ " dia. x $\frac{7}{8}$ " long	0.01 mfd. 200v
Molded Case— $\frac{1}{4}$ " dia. x $\frac{9}{8}$ " long	0.04 mfd. 200v
	0.01 mfd. 400v
	0.0068 mfd. 600v

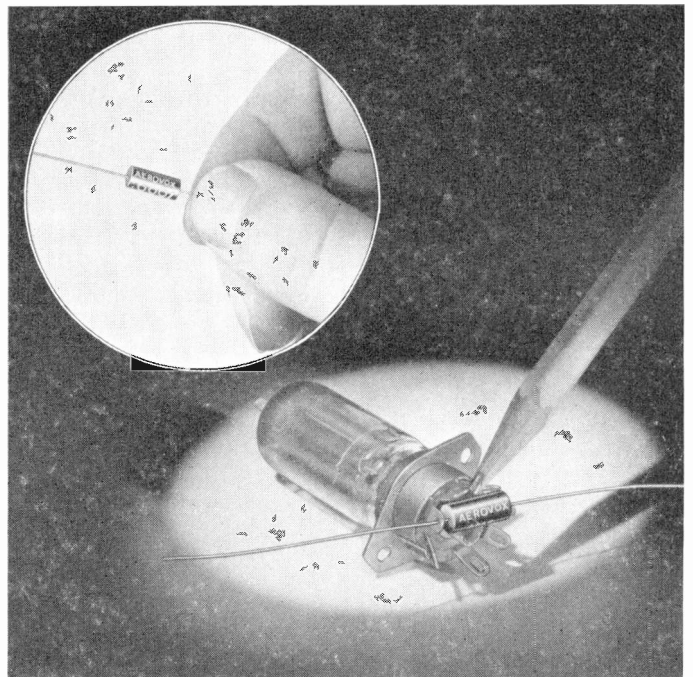

Insert Figure 14

Figure 15

The paper used for the "Micro-Miniature" capacitor is the same paper used for all metallized paper capacitors. However, only one sheet of paper is used and both electrodes are on one side of this paper. Figure 16 shows a part of a web of paper with the inter-spaced patterns.

**AEROVOX**

*Individually Tested*

**PRODUCTS**

# METALLIZED-PAPER *Capacitors*

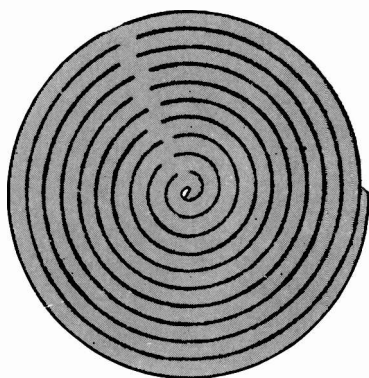

Figure 16

As the paper is wound, it will be noted that the "teeth" of the pattern are of sufficient length to form one complete turn. Figure 17 shows the paper with the metallized pattern with teeth of increasing size and the rolled paper. Thus, the capacitor is a series of concentric cylinders with the metal band on the outside edges connecting together alternate concentric cylinders. After winding, the ends are sprayed with copper, tinned, and the sections are then ready for assembly, impregnation and any other processing necessary.

For higher voltage ratings which use an interleaved or multiple dielectric, the space between the adjacent teeth is increased so that a complete turn of demetallized paper is made before the next metallized surface starts. In this way, one, two or three layers of paper between electrodes can be used.

The use of this single paper permits the handling of very narrow widths on simple machines resulting in sections that are only 1/4" long and 1/8" diameter. Figure 18 shows the two states in the manufacture of a P 83 capacitor.

Electrically, these miniature capacitors have characteristics similar to that of their larger counterparts. Figure 19 shows the capacitance, power factor temperature curves for a mineral wax impregnated unit. The power factor curve at the high temperature end is somewhat higher than that of the larger metallized paper capacitors. There is no immediate explanation for this characteristic.

Physically, these capacitors have an interesting feature which is of importance in the use of the unit. The strength of the bond between the terminals and end of the section is extremely good and is even greater than the tensile strength of #26 wire. This eliminates a production problem . . . the open circuits found when conventional small diameter capacitors are assembled into a chassis.

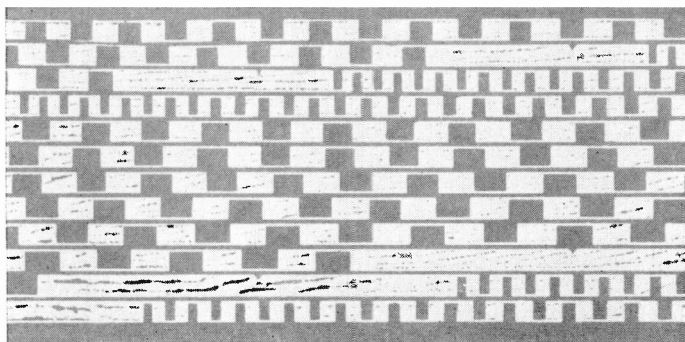

Figure 17

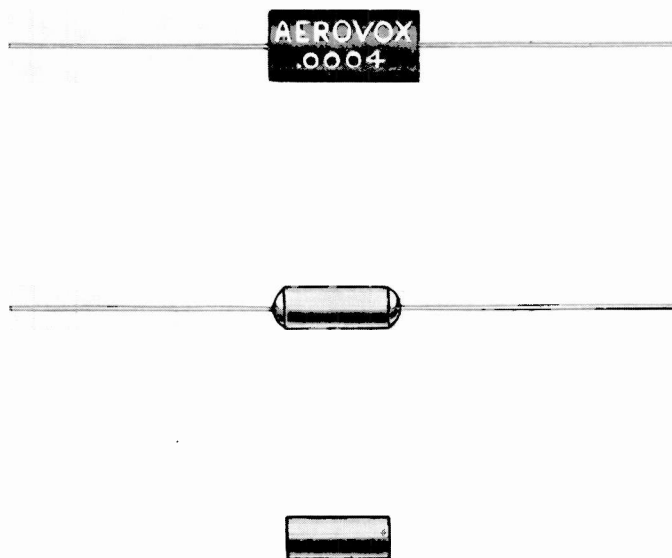

Figure 18  
This photo is four times actual size

These small sections are available in a high temperature wax case or in a metal can with a vitreous ceramic seal. The metal cased units are hermetically sealed in the full sense of the word, while the wax molded units will meet present RMA (REC 118) humidity test of 120 hours at 40°C and 95% relative humidity.

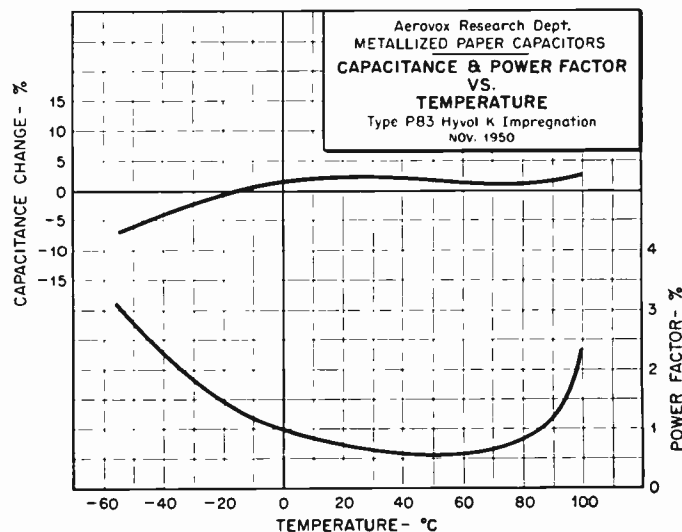

Figure 19

**AEROVOX**

*Individually Tested*

**PRODUCTS**

# METALLIZED-PAPER *Capacitors*

## CHAPTER IV

### APPLICATIONS

The application of metallized paper capacitors requires a careful review of the characteristics of metallized paper capacitors and the operating conditions to which these capacitors will be subjected. In addition to the normal criteria used for the selection of a capacitor in any circuit, the following points must be considered:

1. The spread of the insulation resistance of metallized paper capacitors will be greater at any temperature than that of regular paper-foil capacitors, although at high temperatures the insulation resistance of metallized paper units approaches the insulation resistance of foil type capacitors.

2. The capacitors are subject to occasional sparking depending on the operating voltage. At voltages of 75% or less of voltage rating, no sparking is expected.

3. A minimum value of voltage and current is required to clear faults when they occur.

4. The maximum series resistance between the power supply and the capacitor is of importance, so that sufficient current may be passed through the fault in order that it clears.

5. Maximum surge currents or maximum RMS values of current which the capacitor must carry.

Since metallized capacitors are relatively new, there is still a great deal of information concerning the characteristics of these capacitors which is not known, particularly with respect to unusual operating conditions. It is important, therefore, to analyze carefully each circuit requirement.

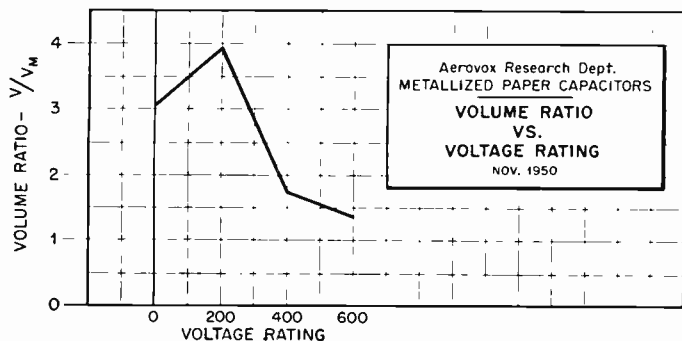

Figure 20

The maximum saving in volume of a metallized paper capacitor will occur in capacitors rated at 200 volts. At the present time, for the same type of construction, the metallized paper capacitor will have a volume of approximately one-fourth the size of a conventional type of capacitor, while at 600 volts, the ratio of size is approximately four to five. Above 600 volts there is little advantage in size, and the only advantage that the metallized paper capacitor has over the regular paper capacitor is pri-

marily its self-healing characteristic. This advantage is partial however, since at the higher voltages it becomes more difficult to clear faults and the conditions under which such-clearing will take place are limited.

Considering all the characteristics of metallized paper capacitors, the ideal applications at the present time, for these units are in a power circuit for use as by-pass capacitors and filters. In addition, metallized paper capacitors can be used to advantage in any circuit where the maximum voltage is less than 75 per cent of the rated operating voltage for the maximum ambient temperature, regardless of series resistance. The probability of dielectric fault in such applications is extremely remote.

Any faults that may occur caused by momentary over-voltage or mechanical injury can be cleared by a minimum voltage of 4½ volts or a minimum current of 10 M.A.

There are many other applications for metallized paper capacitors, both in communication equipment and in instrument work where its small size and light weight coupled with the other characteristics of the unit eminently fit into such requirements. Since the use of such capacitors is in its infancy, many metallized paper capacitor applications will occur which fall outside of the general applications discussed above. It is highly desirable that under such conditions, there be the closest cooperation between the design engineer and the capacitor engineer in order that the advantages of this particular capacitor be realized to the utmost.

### BIBLIOGRAPHY

- |                                       | Patent Number  |
|---------------------------------------|--|
| G. F. Mansbridge                      | British Patent 19,451; 1900  |
| William Dean                          | U. S. Patent 965,922; 1910   |
| R. A. Grouse et al.                   | U. S. Patent 2,399,789   |
| R. A. Grouse                          | U. S. Patent 2,388,139   |
| R. A. Grouse                          | U. S. Patent 2,435,441   |
| Alfred Ortlieb                        | U. S. Patent 2,216,558   |
| G. F. Mansbridge                      | "The Manufacture of Electrical Condensers"; Jour IEE Vol. 41, p. 535; 1908                   |
| H. G. Wehe                            | "Metallizing Paper for Capacitors" Bell Labs Record Vol. 27, p. 317, Sept. 1949              |
| D. A. McLean                          | "Metallized Paper for Capacitors" Proc. IRE Vol. 38 No. 9, 1010, Sept. 1950                  |
| D. A. McLean, L. Egerton              | Paper Dielectrics containing chlorinated impregnants,  |
| G. T. Holman, M. Brotherton           | Deterioration in DC Field Ind. & Eng. Chem. Vol. 34 p. 101; Jan. 1942                        |
| J. R. Weeks                           | "Metallized Paper Capacitors" Proc. IRE Vol. 38 No. 9 p. 1015; Sept. 1949.                   |
| J. I. Cornell                         | "Metallized Paper Capacitors" "The Solar System" Vol. IV; Nov.-Dec. 1946.                    |
| Philip Godley and Jayson C. Balsbaugh | "Metallized Paper Capacitors" Electronics. Vol. 20 No. 4, p. 112, April 1947.                |
| Fred E. Henderson                     | "Metallized Paper Fixed Capacitor Units" by Robert Bosch Co.; U. S. Dept. of Commerce Report |

**AEROVOX**

*Individually Tested*

**PRODUCTS**

**LOOK! "300 VDC TEST, 1. MFD."—It's another of those Aerovox "Space Misers"—typical of the perfected**

**AEROLITE\***

*Metallized-paper*

**CAPACITORS**

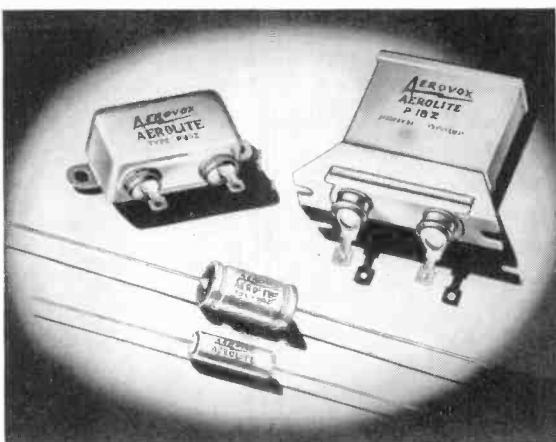

● Minimum weight, slashed bulk. Improved reliability. That's the why-and-whereof of AEROLITES\* Aerovox's new, improved metallized-paper capacitors. Now available in the same variety of types as corresponding paper-and-foil sections—cardboard tubulars, hermetically-sealed tubulars, and the usual oil-filled metal-cased units.

AEROLITES\* are self-healing when subjected to voltage overloads. Yet such units provide a generous margin between rated voltage and overload test. Likewise, satisfactory insulation resistance. AEROLITES\* meet JAN vibration, temperature, immersion cycling and life-test requirements.

● Aerovox Application Engineering assures performance satisfaction with AEROLITE\* metallized-paper capacitors. For literature and answers to your particular application problems, write on your letterhead to AEROVOX CORPORATION, DEPT. A-150, NEW BEDFORD, MASSACHUSETTS.



**HERMETICALLY-SEALED AEROLITES\* MEAN...**

...marked reduction in bulk and weight.

...operating temperatures of  $-55^{\circ}\text{C}$  to  $+55^{\circ}\text{C}$  without derating. Operation at ambient temperatures up to  $95^{\circ}\text{C}$  with voltage derating.

...power factor same as conventional mineral-oil-impregnated ca-

pacitors.

...extended electrode type construction for minimum r-f impedance.

...immersion proof.

...time-and-service-proven Aerovox terminals and cases.

...backed by Aerovox engineering experience and "know-how."

\*Trade-mark



THE HOME OF CAPACITOR CRAFTSMANSHIP

**AEROVOX CORPORATION, NEW BEDFORD, MASS., U. S. A.**

Export: 41 East 42nd Street, New York 17, N. Y. • Cable: AEROCAP, N. Y. • In Canada: AEROVOX CANADA LTD., Hamilton, Ont.

SALES OFFICES IN ALL PRINCIPAL CITIES