

Radio Editors of magazines and newspapers are hereby given permission to reprint in whole or in part, with proper credit to the Aerovox Corporation, the contents of this issue of the Aerovox Research Worker.

The AEROVOX Research Worker

The Aerovox Research Worker is a monthly house organ of the Aerovox Corporation. It is published to bring to the Radio Experimenter and Engineer authoritative, first hand information on condensers and resistances for radio work.

VOL. 10, NO. 5

MAY, 1938

50c per year in U.S.A.
60c per year in Canada

Practical Methods of Testing Condensers

PART 5

By the Engineering Department, Aerovox Corporation

BRIDGES

ONE of the simplest and most popular bridge circuits is the slide-wire bridge. In its simplest form the circuit is like the one in Figure 1. If it is assumed that both condensers are perfect, the relation between the bridge arms is

$$\frac{C_1}{C_2} = \frac{R_3}{R_4}$$

This relation holds also when both condensers have the same power factor. However, there is a slight inaccuracy when we assume that the above relation holds in the case of two condensers with different power factors. As long as the power factors are only a few percent, this error is

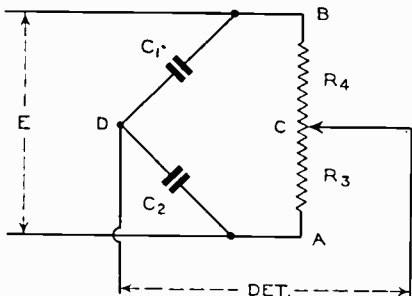

Fig. 1

negligible for all but the most precise type of measurement.

Slide-wire bridges are used for quickly checking capacity in the ser-

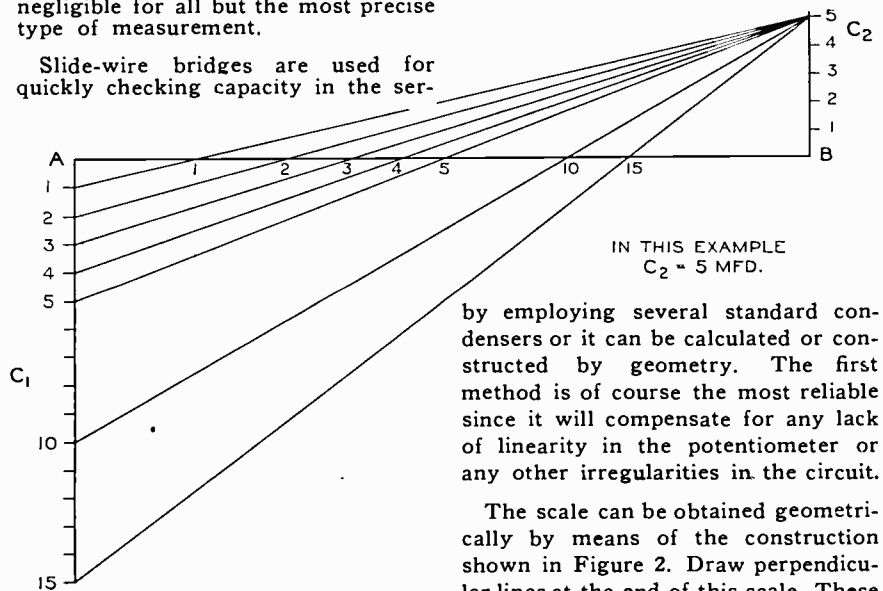

Fig. 2

vice shop and in the laboratory. In such cases the slide-wire is usually a linear potentiometer with a dial directly calibrated in microfarads for any one value of the standard condenser. Other ranges are obtained by replacing the standard condenser by another one, 10 or 100 times as large.

The calibration of the dial is made

by employing several standard condensers or it can be calculated or constructed by geometry. The first method is of course the most reliable since it will compensate for any lack of linearity in the potentiometer or any other irregularities in the circuit.

The scale can be obtained geometrically by means of the construction shown in Figure 2. Draw perpendicular lines at the end of this scale. These lines are to be marked with divisions representing microfarads using the same unit of length per microfarad in both cases. Note that the line representing the unknown is drawn at the end B of the scale AB while the unknown condenser is actually connected to the side A of the potentiometer (Figure 1). From the various divisions on the scale of the unknown condenser, C., draw lines converging to

AEROVOX PRODUCTS ARE BUILT BETTER



the division on scale C_2 marking the value of the standard. The intersections of this line with AB are to be marked with the same capacity as their intersection with scale C_1 . In order to obtain intersections with AB up to the ends it may be necessary to change the unit of length per microfarad along the C_1 and C_2 scales.

It will be noted that the scale becomes more and more crowded at the ends and therefore it is recommended that one do not go beyond the point where C_1 equals ten times C_2 or one-tenth C_2 . If it is desired to spread the useful part of the scale over the complete range of the potentiometer without any waste at the ends, it can be done by the use of two fixed resistors as in Figure 3. In order to minimize trouble from stray capacitances the resistance value of the potentiometer should be low—not more than 5000 ohms.

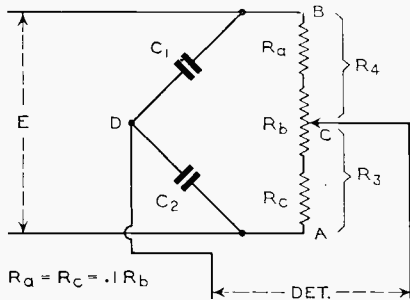

Fig. 3

If the point C of the potentiometer is grounded, the detector can be grounded at one side which permits a direct connection to the grid circuit of an amplifier tube without employing a transformer. In this case the power source should be coupled to the bridge by a shielded transformer as explained in Part 4 (April).

POWER FACTOR MEASUREMENT

The same bridge can also be used to measure power factor as well as capacity if a variable non-inductive re-

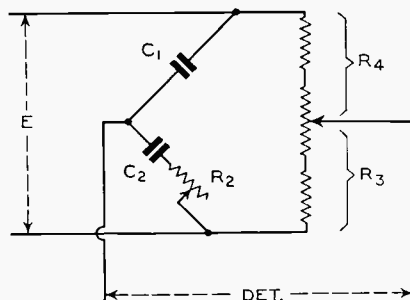

Fig. 4

sistance is placed in series with the condenser having the lowest losses—

generally the standard. While in the circuit of Figure 1 and 3 the "balance" was represented by the minimum reading of the detector, it was never possible to obtain zero signal at the detector because of the power factor difference, the bridge was never perfectly balanced. In the circuit of Figure 4 however, a perfect balance can be obtained by adjusting R_2 and the potentiometer.

When the bridge is balanced the following relations hold:

$$\frac{C_1}{C_2} = \frac{R_3}{R_4}$$

$$\text{POWER FACTOR} = \frac{100 R_2}{\sqrt{R_2^2 + \left(\frac{1}{\omega C_2}\right)^2}} \text{ PERCENT}$$

The last equation can be simplified introducing a negligible error if the power factor is less than 20 percent

$$\text{POWER FACTOR} = 100 R_2 \omega C_2 \text{ PERCENT}$$

The resistance R_2 can thus be calibrated directly in percent power factor for any one value of the standard. Changing the standard requires a new calibration and gives an entirely different power factor range.

C AND PF BY SINGLE ADJUSTMENT

It was explained above that with the bridge circuit of Figures 1 and 3 zero reading at the detector is never attained when the power factors of the two condensers are unequal. It is interesting to note that the residual signal, after adjusting for minimum signal, is a measure of the power factor of the unknown condenser. Thus the bridge can be used to find both capacity and power factor with but one single adjustment.

for minimum detector signal; here it is assumed that the detector is a vacuum-tube voltmeter, drawing no current and the standard condenser is assumed to have zero power factor.

E represents the voltage of the power source. E_1 and E_2 are the voltage drops across R_1 and R_3 respectively. They are in phase with E and their sum equals E . The vector I_c represents the current through both of the condensers which is equal if the detector does not draw any current. The vector E_z represents the voltage drop across the unknown condenser C_1 . Its angle with the current vector is less than 90 degrees. This vector E_z can be considered the vector sum of two other vectors, one being the voltage drop across a pure capacitance, the other the voltage drop across a resistance (equivalent series resistance). These two vectors are shown and labelled E_{c1} and E_{r1} . The vector E_{r1} represents the voltage drop across C_2 and this vector is perpendicular to the vector I_c and parallel with the vector E_{c1} .

Now the power factor in percent is $100 \cos \phi$ and the angle ϕ is found several times in the Figure 5. It will be seen that

$$\phi = 90^\circ - (\alpha + \beta)$$

Now the cosine of ϕ can be expressed in terms of the vectors by applying well known trigonometric and geometric principles. The expression obtained is

$$\cos \phi = \frac{E_{r1}}{E_z} = \frac{E_{r1}}{E_z} \frac{E_z}{E_{c2}}$$

A somewhat similar expression can be found for the co-tangent of ϕ which is nearly equal to $\cos \phi$ for values below .1.

$$\cot \phi = \frac{E_{c1}}{E_{r1}} = \frac{e E}{E_1 E_2 - e^2}$$

In practice it is best to calculate the power factor for different values of C_1 and e , keeping C_2 and E_z constant. A chart can then be made for ready reference eliminating calculations after the measurement. It will be found that the curves are nearly straight and can be represented by straight lines with very little error.

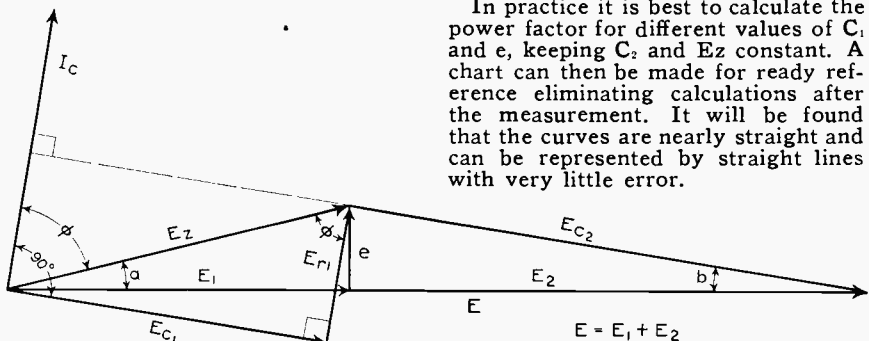

Fig. 5

The meter reading of the balance indicator does not show power factor directly, for the power factor also depends on the ratio C_1/C_2 and on the magnitude of the input signal. The situation is best explained by the vector diagram of Figure 5 which refers to the bridge circuit of Figure 1. The vector diagram shows the condition

Such a system has been in use at the Aerovox laboratory, the complete circuit being shown in Figure 6. In order to adjust the value of E_z to the standard 110 volts a variac is employed. A transformer is also required because the detector is grounded. The detector consists of a high resistance voltage divider feeding

a vacuum-tube voltmeter which is calibrated in volts. After adjusting E_z to 110 volts with the switch at 1, the switch is set at 2 and adjustment for minimum reading is made. The value of C_1 is then read from the scale of the potentiometer. The power factor

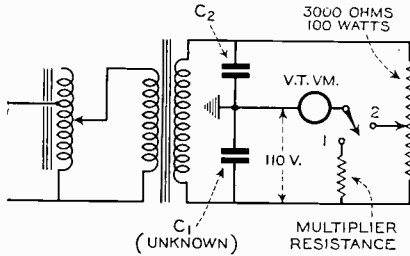

Fig. 6

is found from the values of e and C_1 by means of a chart calculated beforehand from the equations previously given.

THE SCHERING BRIDGE

Up to recently, the Schering bridge was used for high voltage cable tests only. It has been found that this bridge circuit lends itself very well for capacity measurements and precise equivalent series resistance measurements. Capacities of 1000 mfd. and of .1 mmfd. have been measured with it. It is easy to shield and lends itself nicely to the measurement of electrolytic condensers with a.c. super-imposed on d.c.

The circuit of the Schering bridge is shown in Figure 7. Here C_1, R_1 represents the unknown condenser with its equivalent series resistance. When balance is obtained C_1 and R_1 can be found from the following equations

$$C_1 = \frac{C_2}{R_4} R_3$$

$$R_1 = \frac{R_4}{C_2} C_3$$

To get independent adjustment for the two balance conditions it is best to vary R_3 for the capacity balance and C_3 for the power factor balance. Different ranges are then provided by changing the ratio C_2/R_4 . One such change of this ratio will change both the capacity range and the equivalent series resistance range of the bridge. They are shifted in different directions which is exactly what is required since the same power factor range is covered again.

Any stray capacity across the standard C_2 can be compensated for by choosing the standard condenser correspondingly smaller. Any stray capacity across C_1 can be measured and taken into account. R_2 and R_1 are usually small (below 5000 ohms) so that stray capacity across them is not very important. However, in extreme-

ly precise measurements, R_3 is made equal to R_1 and the stray capacities across the two are then made equal so that they cancel each other. The only limitation is in the condenser C_3 . This condenser should have a very low power factor because the losses in the condenser can be represented as a parallel resistor which is in parallel with R_3 and causes errors in the capacity reading. Therefore an air condenser is recommended wherever possible. Otherwise a mica decade is used. The ranges covered and the size of R_3 will determine whether this limitation is serious or not.

A bridge of this type with two ranges: 0 — 15 mfd. and 0 — 150 mfd. had the following bridge constants. The standard condenser was a 1 mfd. mica condenser; R_3 was a 15,000 ohm variable resistance while C_3 consisted of a condenser decade of .2 mfd. maximum capacity in parallel with a 1000 mmfd. variable condenser. R_4 was 1000 ohms for the lower range and 100 ohms for the higher range. The equivalent series resistance ranges obtained were 0 — 210 ohms and 0 — 21 ohms.

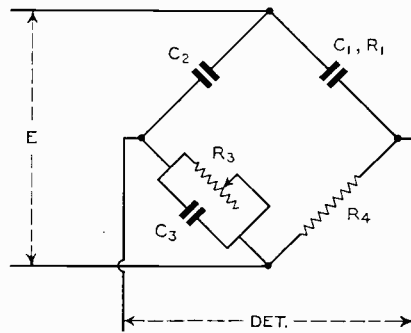

Fig. 7

In many applications of the Schering bridge the sensitivity may be relatively low due to the low impedance of R_3 and R_1 , as compared to the reactance of C_1 and C_2 . The remedy is to use a rather large a.c. signal up to several hundred volts for small capacities.

The power supply for the bridge discussed above contained a variable polarizing voltage and a 120 cycle source. It is illustrated in Figure 8. The variable polarizing voltage is supplied by a grid controlled rectifier, a 2A3. The plate of this tube is always connected to the highest transformer voltage but the grid receives only a part of the a.c. voltage determined by the setting of the 1 megohm potentiometer. This arrangement permits a 4 to 1 variation in the output voltage at a drain of approximately 30 ma. After careful filtering of the ripple which was 60 cycles, the 120 cycle a.c. signal is introduced. This frequency is best obtained from a full wave rectifier at a point ahead of the filter. In this case the secondary must be tuned

to 120 cycles to eliminate the numerous harmonics which are present.

The reader should be warned here that the capacity and power factor as measured on the bridge depends on the polarizing voltage, the a.c. voltage and the wave shape. Consequently, the

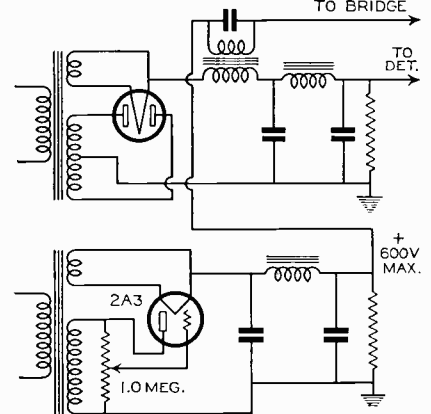

Fig. 8

same electrolytic condenser may show different results on different bridges because one or more of these quantities are different. The capacity measurements will vary but little. However, the power factor measurements may differ greatly. This is not to be blamed on either one of the bridges; all measurements may be correct. A better way of comparing the accuracy of two bridges is to use a paper condenser with a variable non-inductive series resistance. The readings of the capacity and equivalent series resistance should then be the same.

When the Schering bridge is used for the measurement of very small capacities, such as the inter-electrode capacity of a tube, a slight modification is necessary. Instead of C_2 , three condensers are used; a .002 mfd. variable air condenser in parallel with a .01 mfd. fixed condenser and this combination in series with a .001 mfd. condenser. In this combination a change of 1 mmfd. in the variable results in a change of about .01 mmfd. in the total so that very precise adjustments can be made. C_1 consists of a similar combination of condensers and the unknown is shunted across them. R_2 and R_1 are fixed, both at 5000 ohms and C_3 is a variable air condenser. Still another small variable air condenser is connected across R_4 to balance out the stray capacity across R_3 . The bridge is first balanced without connecting the unknown condenser. Then the unknown is connected across C_1 and the variable condenser is readjusted until balance is again obtained. The difference in the two values of C_1 gives the value of C_x . This system of substitution is the most accurate way of employing a bridge for capacity measurements.



AEROVOX

Transmitting Condensers

● Popularity justifies real mass production, and that in turn makes the present amateur net costs possible for the HYVOL line of high-voltage transmitting condensers. Leading off with the "09" series, illustrated and described at left, there are also available the following other types . . .

Features . . .

Selected paper sections impregnated with Hyvol, the new super-dielectric oil.

● Section hermetically sealed in sturdy welded-steel aluminum-finished can, filled with Hyvol.

● Container positively leakage and seepage-proof. Fitted with adjustable mounting bracket, used as shown.

● High-tension pillar terminals. Fitted with locknuts and soldering lugs.

● Truly heavy-duty long-life units, offered at following Amateur Net Costs . . .

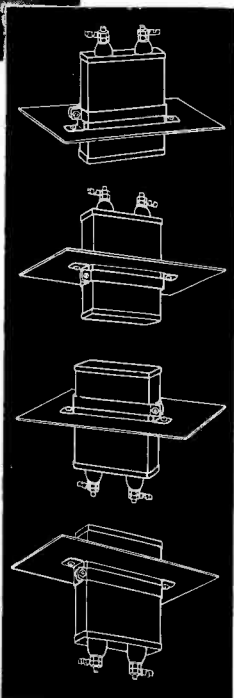

ROUND-CAN INVERTED MOUNTING

● Designed for inverted screw mounting with can grounded. May be insulated from metal chassis with insulating washer. In aluminum can similar to electrolytic condenser. Used extensively in filter circuits of power supplies, high-fidelity amplifiers, television circuits, transceivers, etc. This "10" series available in 600 to 1500 v. D.C.W., .5 to 4 mfd. Very economical.



ROUND-CAN MOUNTING

● Highly popular "05" series. Similar specifications to rectangular-can oil-filled job, but in round aluminum can with adjustable ring mounting. 600 to 3000 v. D.C.W. 1, 2 and 4 mfd. Costs slightly less than rectangular-can job.



WAX-FILLED RECTANGULAR UNITS

● A real money-saving job for medium-duty applications. Similar in appearance and dimensions to "09" series, but has section sealed in high-melting-point wax instead of oil filling. Note typical low prices of these popular 2 mfd. capacities in the "11" series, wax-filled units:—

| | | | | |
|------|---|---------|---|------|
| 1011 | — | 1000 v. | — | 1.50 |
| 2011 | — | 2000 v. | — | 2.45 |
| 3011 | — | 3000 v. | — | 4.95 |



| Type 609-600v. D.C.W. | | | Type 2009-2000v. D.C.W. | | |
|-------------------------|-----------------------|-------------|-------------------------|-----------------------|-------------|
| Cap. Mfds. | Size-In. L x W x D. | Amateur Net | Cap. Mfds. | Size-In. L x W x D. | Amateur Net |
| 1 | 2 1/4 x 1 1/2 x 1 1/8 | \$1.65 | 1 | 3 3/4 x 2 1/2 x 1 1/4 | \$2.70 |
| 2 | 2 1/4 x 1 1/2 x 1 1/8 | 2.10 | 2 | 3 3/4 x 2 1/2 x 1 1/4 | 3.30 |
| 4 | 3 3/4 x 2 1/2 x 1 1/8 | 2.70 | 4 | 3 3/4 x 2 1/2 x 1 1/4 | 5.40 |
| Type 1009-1000v. D.C.W. | | | Type 2509-2500v. D.C.W. | | |
| 1 | 2 1/4 x 1 1/2 x 1 1/8 | \$1.80 | 1 | 3 1/4 x 3 3/4 x 1 1/4 | \$4.80 |
| 2 | 2 1/4 x 1 1/2 x 1 1/8 | 2.40 | 2 | 4 1/4 x 3 3/4 x 1 1/4 | 7.80 |
| 4 | 3 3/4 x 2 1/2 x 1 1/8 | 3.00 | | | |
| Type 1509-1500v. D.C.W. | | | Type 3009-3000v. D.C.W. | | |
| 1 | 2 1/4 x 1 1/2 x 1 1/8 | \$2.10 | 1 | 4 1/4 x 3 3/4 x 2 1/4 | \$7.20 |
| 2 | 2 1/4 x 1 1/2 x 1 1/8 | 3.00 | 2 | 4 1/4 x 3 3/4 x 3 3/8 | 9.00 |
| 4 | 3 3/4 x 2 1/2 x 1 1/8 | 4.20 | | | |

Have You Our Catalog?

Latest AEROVOX catalog devotes considerable space to these high-voltage and other condensers for transmitting uses. Ask your jobber for copy, or write us direct.



AEROVOX CORPORATION

70 WASHINGTON STREET, BROOKLYN, N. Y.



Sales Offices in All Principal Cities