

COMMUNICATIONS

INCLUDING "RADIO ENGINEERING" AND "TELEVISION ENGINEERING"

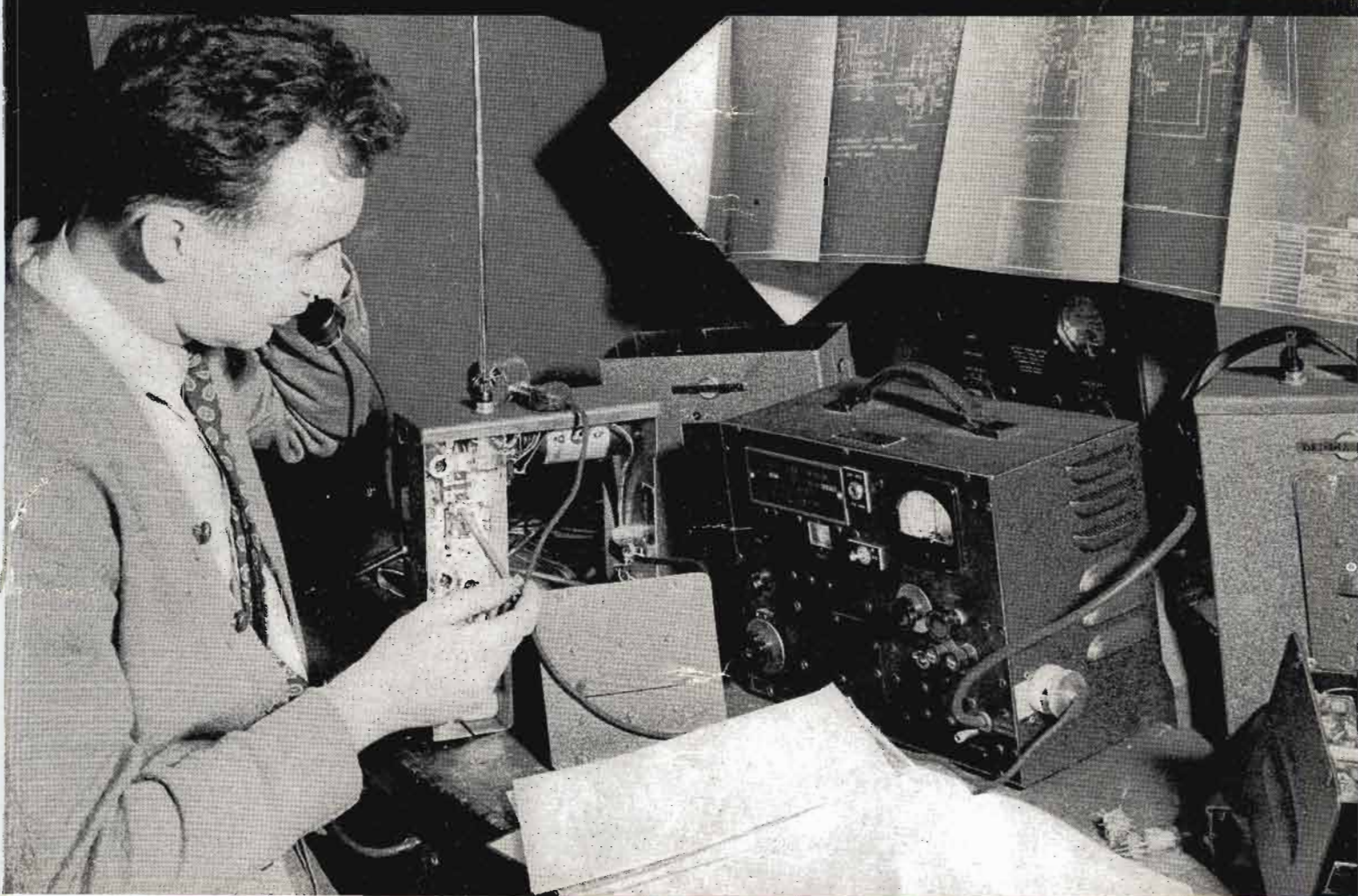

APRIL

★ AUDIO PROBLEMS IN A-M BROADCASTING

★ EMERGENCY COMMUNICATIONS EQUIPMENT

★ COMMERCIAL AIRLINE GROUND-AIR COMMUNICATIONS SYSTEM

1947

The Complete **E-V** Line Assures the Right Microphone for Every Need

● Only ELECTRO-VOICE provides such a complete line of microphones. With outstanding developments in Unidirectional, Differential†, Bi-directional, and Non-directional types . . . in Dynamic, Crystal, Carbon and Velocity models . . . you can more easily obtain the microphones best suited to your needs.

● Proved in critical service, E-V Microphones are widely used today by leading manufacturers and sound engineers in all kinds of applications. They are produced from finest materials under E-V quality control. Consult our engineers.

THE CARDYNE—True cardioid unidirectional dynamic microphone, with exclusive E-V *Mechanophase** principle, *Acoustalloy* diaphragm, smooth, wide range response, and high output.

THE CARDAX—The only high level cardioid crystal microphone with Dual Frequency response for high fidelity voice and music, or rising characteristic for extra crispness of speech.

†Patent No. 2,350,010 *Electro-Voice Patents Pending

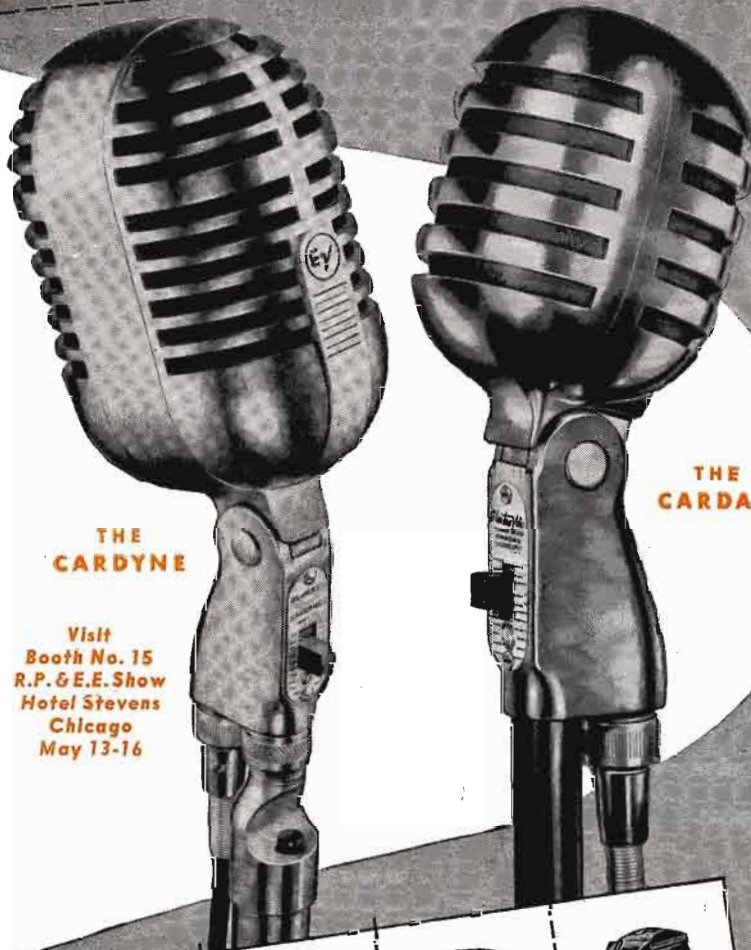

THE CARDYNE

THE CARDAX

Visit
Booth No. 15
R.P. & E.E. Show
Hotel Stevens
Chicago
May 13-16



Send for Catalog No. 101

This illustrated catalog gives complete data and information on E-V Microphones. Includes helpful selection guide. Write for it today.

 V-3, V-2, V-1 Velocity	 640 Dynamic	 630 Dynamic	 605 Dynamic 905 Crystal	 610 Dynamic 910 Crystal	 600-D Dynamic 210-S Carbon 602 Differential	 205-S Differential
				 606 Differential	 Comet Crystal Comet-D Dynamic	

A portion of the Complete E-V Line is shown here

NO FINER
CHOICE THAN

Electro-Voice

ELECTRO-VOICE, INC., BUCHANAN, MICHIGAN

Export Division: 13 East 40th Street, New York 16, N. Y., U. S. A. Cables: Arlab

Crystal Microphones
licensed under Brush patents

5-5-47 1A 32

Both are

FERRANTI

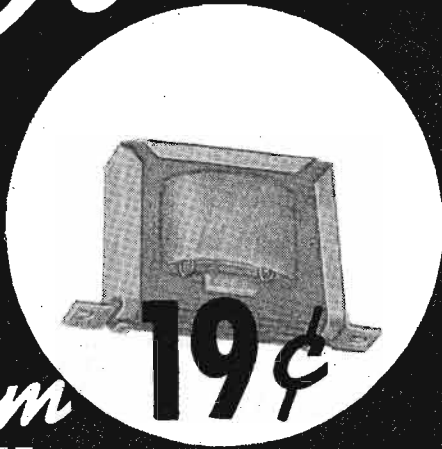

19¢

from THE

LOWEST PRICED TRANSFORMER

to



\$19.00

THE HIGHEST PRICED TRANSFORMER

Both backed by

FERRANTI

HIGH QUALITY
PROMPT SERVICE
RAPID DELIVERY

and

COMPLETE ENGINEERING SERVICE

Order any Quantity - no matter how small or large



FERRANTI ELECTRIC, INCORPORATED

NEW YORK 20

RCA

NEW YORK

BUILDING

TRANSFORMERS • CHOKES • FILTERS • WIRING AND ASSEMBLIES

COMMUNICATIONS

Including Television Engineering, Radio Engineering, Communication & Broadcast Engineering, The Broadcast Engineer. Registered U. S. Patent Office.

LEWIS WINNER

Editor

F. WALEN

Assistant Editor

Bryan S. Davis, President

Paul S. Weil, Vice Pres.-Gen. Mgr.

F. Walen, Secretary

A. Goebel, Circulation Manager

Chicago Representative:

Lawrence Wehrheim
5510 W. Lemoyne Ave., Chicago 51, Ill.
Telephone MERRimac 7919

Cleveland Representative:

James C. Munn
2656 E. 126th St., Cleveland 20, Ohio
Telephone CEdar 7783

Pacific Coast Representative:

Brand & Brand
1052 W. Sixth St., Los Angeles 14, Calif.
Telephone Michigan 1732
1085 Monodnock Bldg., San Francisco 5, Calif.
Telephone Douglas 4475

Wellington, New Zealand: Te Aro Book Depot.
Melbourne, Australia: McGill's Agency.

Entered as second-class matter Oct. 1, 1937 at the Post Office at New York, N. Y., under the Act of March 3, 1879. Subscription price: \$2.00 per year in the United States of America and Canada; 25 cents per copy. \$3.00 per year in foreign countries; 35 cents per copy.

COVER ILLUSTRATION

C. Miller Sanford, assistant project engineer of Bendix Radio, adjusting a v-h-f railroad radio pack set designed to provide track-side communications in end-to-end operation.

SOUND ENGINEERING

- Audio Problems in A-M Broadcasting.....H. L. Blatterman 18
Analysis of Some Current Fidelity Problems and Solutions Found at KFI Through Use of Reverberation Channel, Automatic Equalizing Amplifier, and Intermodulation Analyzer.
- Magnetic Playback-Recorder Using Paper Discs.....John H. James 32
Unit Uses Magnetically Coated High-Coercivity Paper Discs That Can Be Folded.
- Lateral RecordingW. H. Robinson 38
Measuring Setups, Frequency Run Recordings, Styli, Cutting Angles, etc.

AERONAUTICAL COMMUNICATIONS

- Ground-Air Communications Unit.....S. A. Meacham 22
Commercial Airline Model Covers 125 to 525-kc, 2 to 20-mc, 100 to 160-mc.

RAILROAD RADIO ANTENNAS

- Vertically Polarized Nondirectional Broadband Antenna....J. P. Shanklin 28
Fixed Station Antenna for 152 to 160-mc Service.

F-M BROADCASTING

- Putting a New F-M Station on the Air.....George W. Yazell 30
Selecting Site, Preparing for Temporary and Permanent Operation and Arranging for Dealer-Station Program Schedules.
- Loop Antennas for F-M Broadcasting.....N. Marchand 34
Requirements and Applications of Loop Antennas and Modified Types, Circular and Square, For F-M.

POLICE COMMUNICATIONS

- Five-State One-Frequency Link For Emergency Communications
Fred E. Ebel 36
Single Frequency, 37.9-mc, Used by Ohio, Western Pa., New York, Virginia and West Virginia, Provides Coordinated Law-Enforcement Operation.

TELEVISION

- Variable Inductance Tuning for TV Receivers.....Myron F. Melvin 48
Application Data For the 44 to 216-mc Bands.

MONTHLY FEATURES

- News and ViewsLewis Winner 17
- Veteran Wireless Operators' Association News..... 42
- The Industry Offers 44
- News Briefs of the Month..... 46
- Advertising Index 64

Entire contents Copyright 1947, Bryan Davis Publishing Co., Inc.



Published monthly by Bryan Davis Publishing Co., Inc.
52 Vanderbilt Avenue, New York 17, N. Y. Telephone MURray Hill 4-0170



DE MORNAY • BUDD STANDARD TEST EQUIPMENT

For Precision Measurements in the Microwave Field

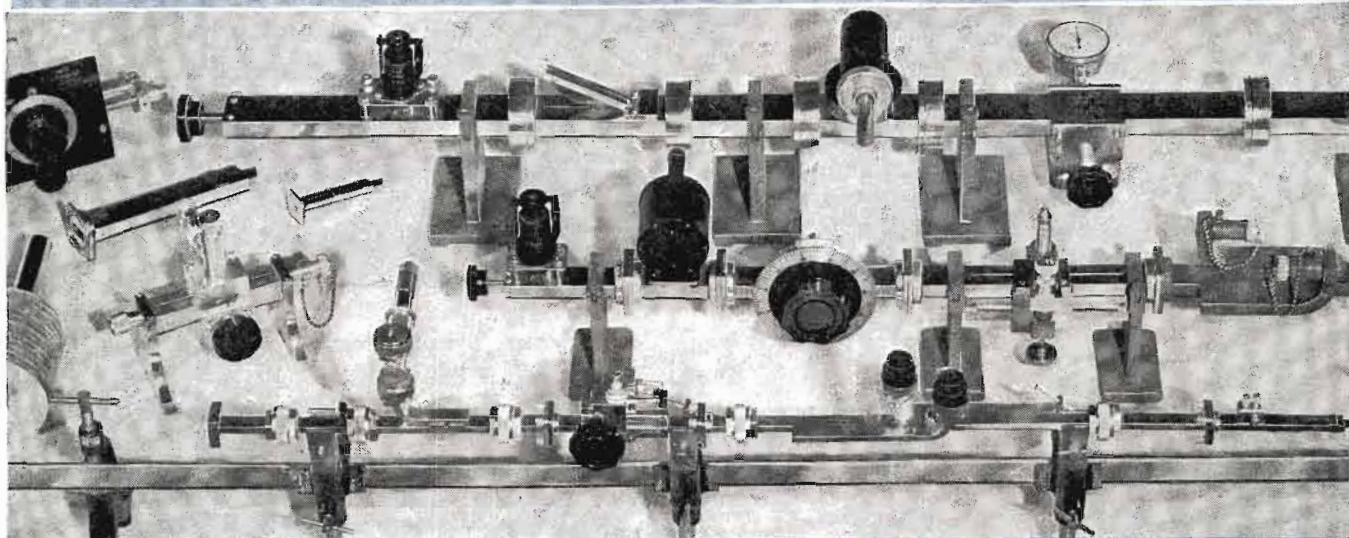

The complete line of De Mornay-Budd standard test equipment covers the frequency range from 4,000 mcs. to 27,000 mcs. It provides all R. F. waveguide units necessary for delicate, precision test work requiring extremely high accuracy in attenuation measurements, impedance measurements, impedance matching, calibration of directional couplers, VSWR frequency measurements, etc.

To eliminate guesswork, each item of this De Mornay-Budd test equipment is individually

tested and, where necessary, calibrated, and each piece is tagged with its electrical characteristics. All test equipment is supplied with inner and outer surfaces gold plated unless otherwise specified.

NOTE: Write for complete catalog of De Mornay-Budd Standard Components and Standard Bench Test Equipment. Be sure to have a copy in your reference files. Write for it today.

The three test set-ups illustrated above include:

Tube Mount
Flap Attenuator
Frequency Meter
Calibrated Attenuator
Tee
Stub Tuner

Tunable Dummy Load
Standing Wave Detector
Type "N" Standing Wave Detector
Directional Coupler
High Power Dummy Load
Cut-Off Attenuator

Stands, etc.

DE MORNAY
BUDD



EQUIPMENT
FOR
97% OF ALL
RADAR SETS

DE MORNAY • BUDD INC., 475 GRAND CONCOURSE, NEW YORK 51, NEW YORK. CABLE ADDRESS "DEMBUD," N. Y.

Listen...IT'S A Jensen SPEAKER!

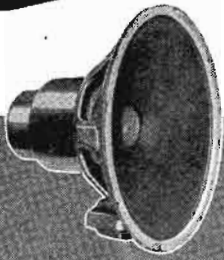

Model HNP-51
(15-inch)

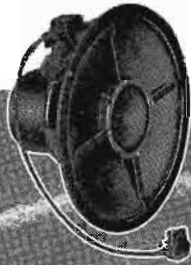

Model JAP-60
(15-inch)



Model JHP-52
(15-inch)

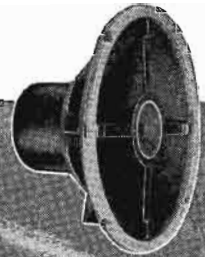

Model JCP-40
(12-inch)

JENSEN BASS REFLEX REPRODUCERS with COAXIAL SPEAKERS

TYPE "RD"

REPRODUCER NO.	STOCK NO.	CABINET NO.	SPEAKER NO.	IMPEDANCE, OHMS
RD-122	ST-159	D-121	JCP-40	6-8
RD-151	ST-160	D-151	HNP-51	500-600
RD-152	ST-161	D-151	JAP-60	500-600
RD-153	ST-162	D-151	JHP-52	500-600

TYPE "RA"

RA-124	ST-134	A-121	JCP-40	6-8
RA-151	ST-136	A-151	HNP-51	500-600
RA-153	ST-138	A-151	JAP-60	500-600
RA-154	ST-139	A-151	JHP-52	500-600

JENSEN BASS REFLEX CABINETS

TYPE "D"

MODEL NO.	STOCK NO.	SPEAKER SIZE	DIMENSIONS		
			HEIGHT	WIDTH	DEPTH
D-121	ST-156	12"	27 7/8"	31 3/8"	13 3/8"
D-151	ST-157	15"	27 7/8"	31 3/8"	13 3/8"

TYPE "A" (Finished)

A-81	ST-123	8"	24"	18"	9 1/4"
A-121	ST-124	12"	27"	24 3/4"	13 1/2"
A-151	ST-125	15"	32 3/8"	27 3/8"	13 1/2"

TYPE "A" (Unfinished)

A-82	ST-145	8"	24"	18"	9 1/4"
A-122	ST-146	12"	27"	24 3/4"	13 1/2"
A-152	ST-147	15"	32 3/8"	27 3/8"	13 1/2"

*Designers and Manufacturers
of Fine Acoustic Equipment*

JENSEN MANUFACTURING COMPANY

6603 SOUTH LARAMIE AVE., CHICAGO 38, U. S. A.

IN CANADA: Copper Wire Products Ltd., 11 King St. W., Toronto, Ont.

*Trade Mark Registered



Jensen

SPEAKERS
WITH **ALNICO 5**

PROFESSIONAL PERFORMANCE—that keeps the original sound alive!

*Always
on the nose*

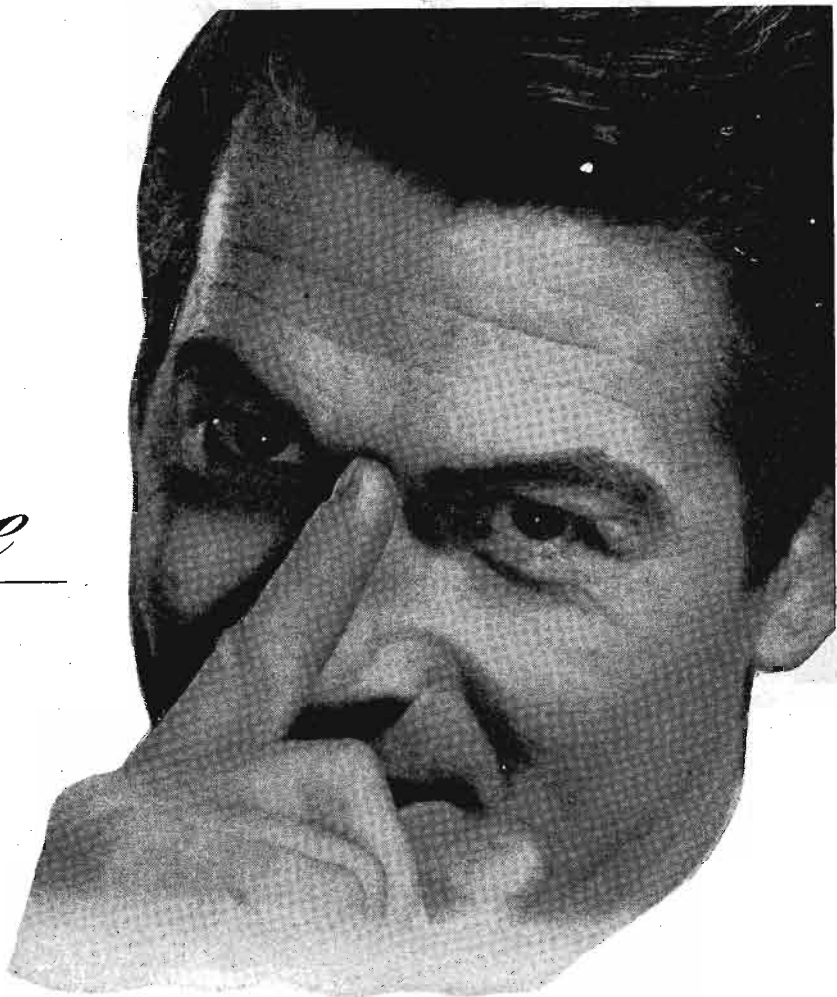

—with split-second timing at 33.3 rpm

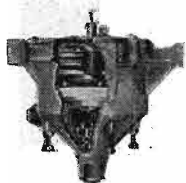

The way to a listener's pocketbook is through his ears. Give him the last full note of every record . . . a natural unhurried ending to every story on the program — and you'll keep him in a receptive mood for your spot commercials.

But cut his entertainment short; or mar its quality with speedups or slowdowns to compensate for faulty drive timing — and you'll never get his pocketbook open.

Professional recording and playback require precision timing. In maintaining broadcasting schedules, where seconds count, you're offered the positive Fairchild direct-from-the-center turntable drive, shown above. Rim or belt driven tables cannot duplicate Fairchild's split-second timing. The 33.3 rpm speed is obtained through a gear-and-worm reduction of its 1,800 rpm synchronous motor speed. The 78 rpm speed is obtained through a precision friction-ball-race stepup.

Fairchild's precision timing is available on Transcription Turntables, Studio Recorders and Portable Recorders designed in close collaboration with AM and FM broadcast and recording engineers to meet and exceed very exacting professional requirements for lateral recording on acetate or wax masters at 33.3 and 78 rpm. For complete information — including prompt delivery — address: 88-06 Van Wyck Boulevard, Jamaica 1, New York.

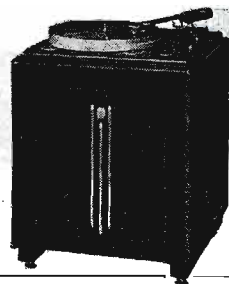

Transcription Turntables

Studio Recorders

Magnetic Cutterheads

Portable Recorders

Lateral Dynamic Pickups

Unitized Amplifier Systems



CAMERA

AND INSTRUMENT CORPORATION

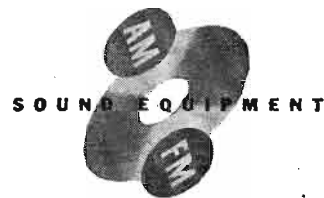

Why

this team is out

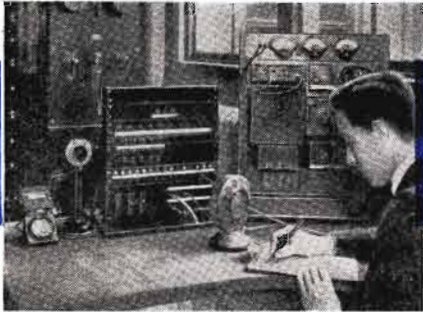

1922. One of the earliest audio systems, shown here at WWJ, Detroit, used a Western Electric 8-type amplifier, with keys, jacks and plugs provided for line selection and output switching.



1926. The first coordinated speech input system was this Western Electric 7A, with all controls in a wooden console mounted on a desk. First to use rectified a-c for plate supply.

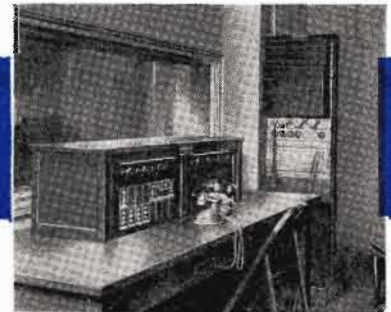

1929. Studio control equipment installed in the first New York studio of the Columbia Broadcasting System. This was one of the first custom-built audio systems.



1939. This custom-built audio console for WOR was the first commercial type meeting all requirements for FM use. It provided circuits and equipment to meet specific operating conditions. The tailored metal desks mounted amplifiers, control and switching equipment and turntable units—all within easy reach of the operator.

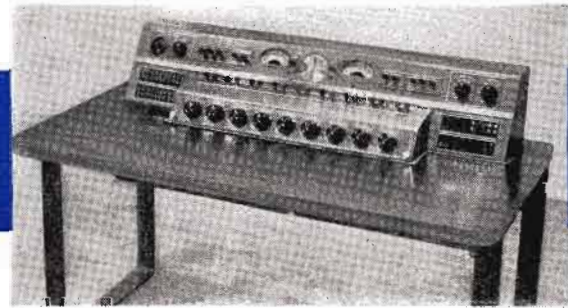

1946. The 25B console is an improved, enlarged version of the 25A, introduced in 1942. For either FM or AM use, the 25B provides two channels and controls two FM or AM programs simultaneously. This new equipment is compact, rugged and modern in appearance. Ease of control, instant accessibility, plug-in cable connections and a frequency response of ± 1 db, 50 to 15,000 cycles are some outstanding features.

— QUALITY COUNTS —



front in Broadcast Audio Systems

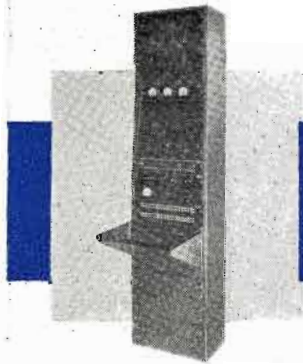

1931. This smartly styled 9A audio equipment was the first all a-c system. All controls in a single panel; frequency response stepped up to 10,000 cycles.

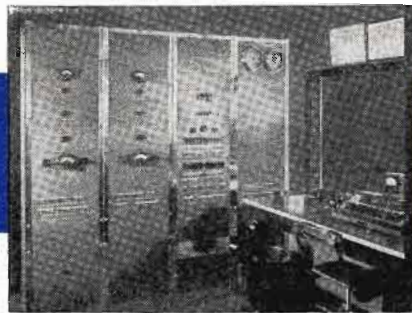

1933. The factory-assembled 700 series was the earliest to use recessed panel construction, interchangeable for rack or cabinet mounting. For multiple channel operation, several panels were combined.

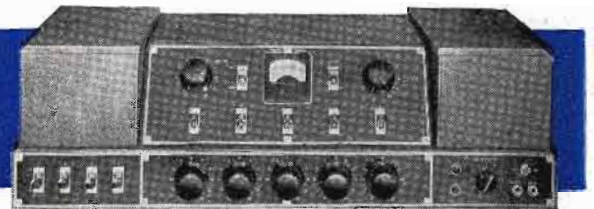

1936. The all a-c, console type, self-contained 23A studio control equipment introduced a brand new style for standardized studio units. First studio system to use stabilized feedback. The current 23C, with frequency response to 15,000 cycles, is widely used in AM and FM broadcasting.

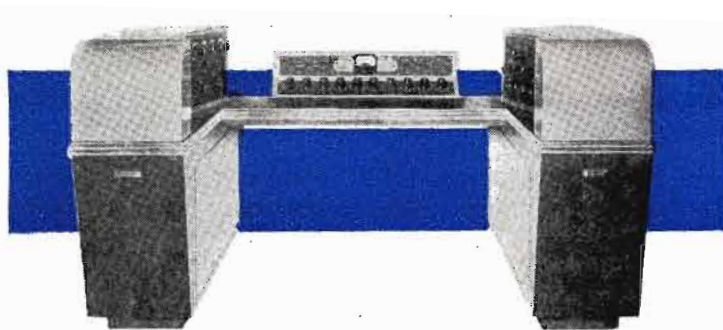

1947. Typical of the custom-made broadcast audio systems being produced by the Bell Laboratories-Western Electric team is this up-to-the-minute custom console designed for KHJ, Hollywood. Custom-built equipment such as this is engineered to meet completely requirements of any station and provides the most flexible, versatile method of program control.

Ever since the Laboratories' scientists designed and Western Electric produced the first high power commercial broadcast transmitter and provided the audio facilities to go with it, this same team has pioneered in broadcast audio systems. Years of experience in the production of telephone amplifiers and switching equipment have given Bell Laboratories and Western Electric a head start in the broadcast audio facilities field—and constant research has kept them ahead.

When you need speech input equipment—for studio or portable use, standard console or tailor-made, AM or FM or both—look to Western Electric.



BELL TELEPHONE LABORATORIES

World's largest organization devoted exclusively to research and development in all phases of electrical communications.

Western Electric

Manufacturing unit of the Bell System and the nation's largest producer of communications equipment.

4-750A

ANOTHER EIMAC TETRODE



Designed for

**Industrial
Heating**

**Communications
Airline
Police
Emergency
Broadcast**

**Medical
Diathermy**

Experimental r-f

Here's a new Eimac tetrode—the power step-up you have been asking to have added to the Eimac line.

Capable of 2-kw power output at 4000 plate volts, with less than 15 watts of grid drive, the 4-750A opens a new field of possibilities to designers of electronic equipment. A pair of these tetrodes, driven by low cost, low-power tubes, will supply more than 4-kw output.

A potential workhorse for communications and industrial use, the 4-750A has the ability to deliver its maximum power over a wide range of frequencies. Inherent characteristics include the familiar attributes of Eimac tetrodes—stability, economy, and dependability.

Complete technical data and performance characteristics will soon be available. Write now for your copy.

**EITEL-McCULLOUGH, INC., 1405 San Mateo Avenue
San Bruno, California**

EIMAC 4-750A POWER TETRODE	
Electrical Characteristics	
Filament: Thoriated tungsten	
Voltage	7.5 volt
Current	20 amp
Direct Interelectrode capacitances (av.)	
Grid-plate	.24 μf
Input	26.85 μf
Output	7.78 μf
Maximum Ratings	
D-C Plate Voltage	4000 max. volts
D-C Plate Current	700 max. ma.
Plate Dissipation	750 max. watts

Follow the Leaders to

Eimac
REG. U. S. PAT. OFF.
TUBES

EXPORT AGENTS: FRAZAR AND HANSEN, 301 CLAY STREET
SAN FRANCISCO 11, CALIFORNIA, U. S. A.

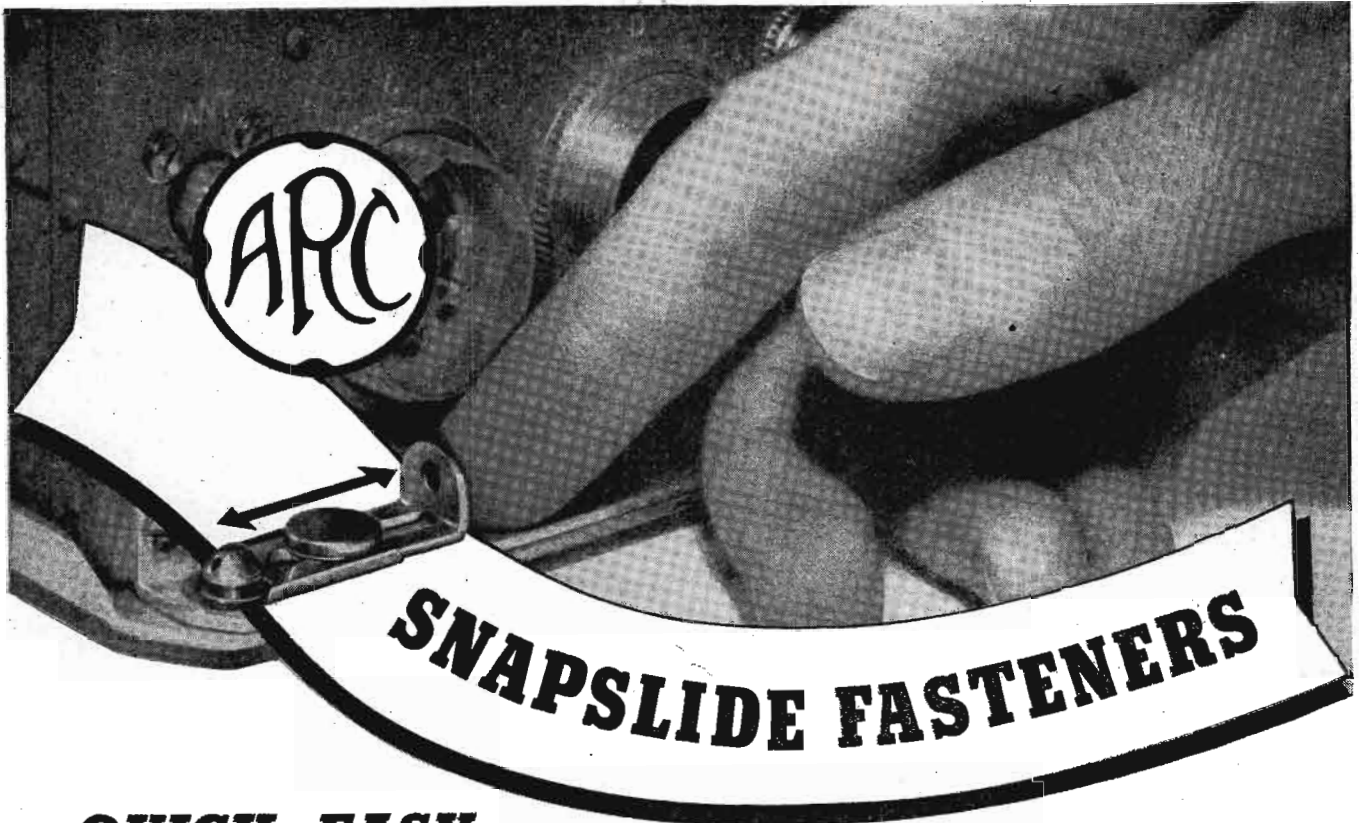

**QUICK, EASY,
ENTIRELY VISIBLE,
NO TOOLS NEEDED**

These Snapslide Fasteners were originated by A. R. C. to provide positive means of attachment and yet to allow instant disengagement. Note how the two spring jaws of the Snapslide lock around the Stud and insure complete security. Both large and small Snapslide Fasteners are available, with Buttons and Studs for various applications and different thicknesses of material.

VARIETY OF USES

Large Snapslides, approximately $\frac{7}{16}$ " wide by 1" long, are suitable for attaching radio sets or such units as dynamotors, converters, etc. to shock absorbers or directly to mounting plates.

Small Snapslides, approximately $\frac{1}{4}$ " wide by $1\frac{1}{32}$ " long, are used to hold down tube covers, fuse covers, and similar light-weight parts.

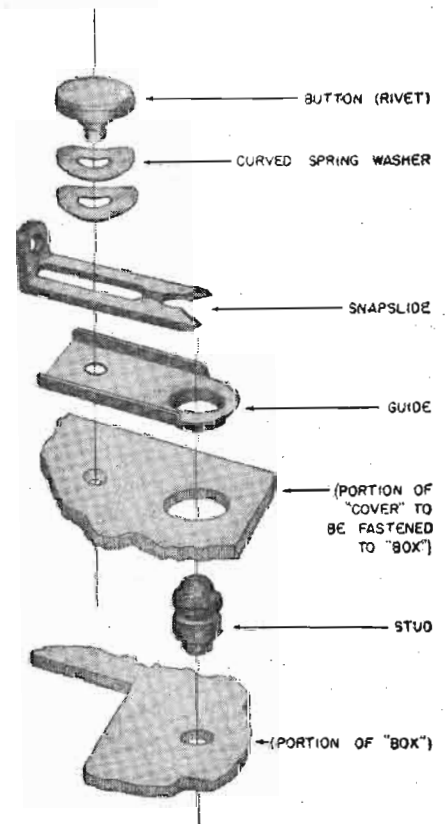

AIRCRAFT RADIO CORPORATION 

Boonton, N. J.

Designers and Manufacturers of Radio and Electronic Equipment Since 1928

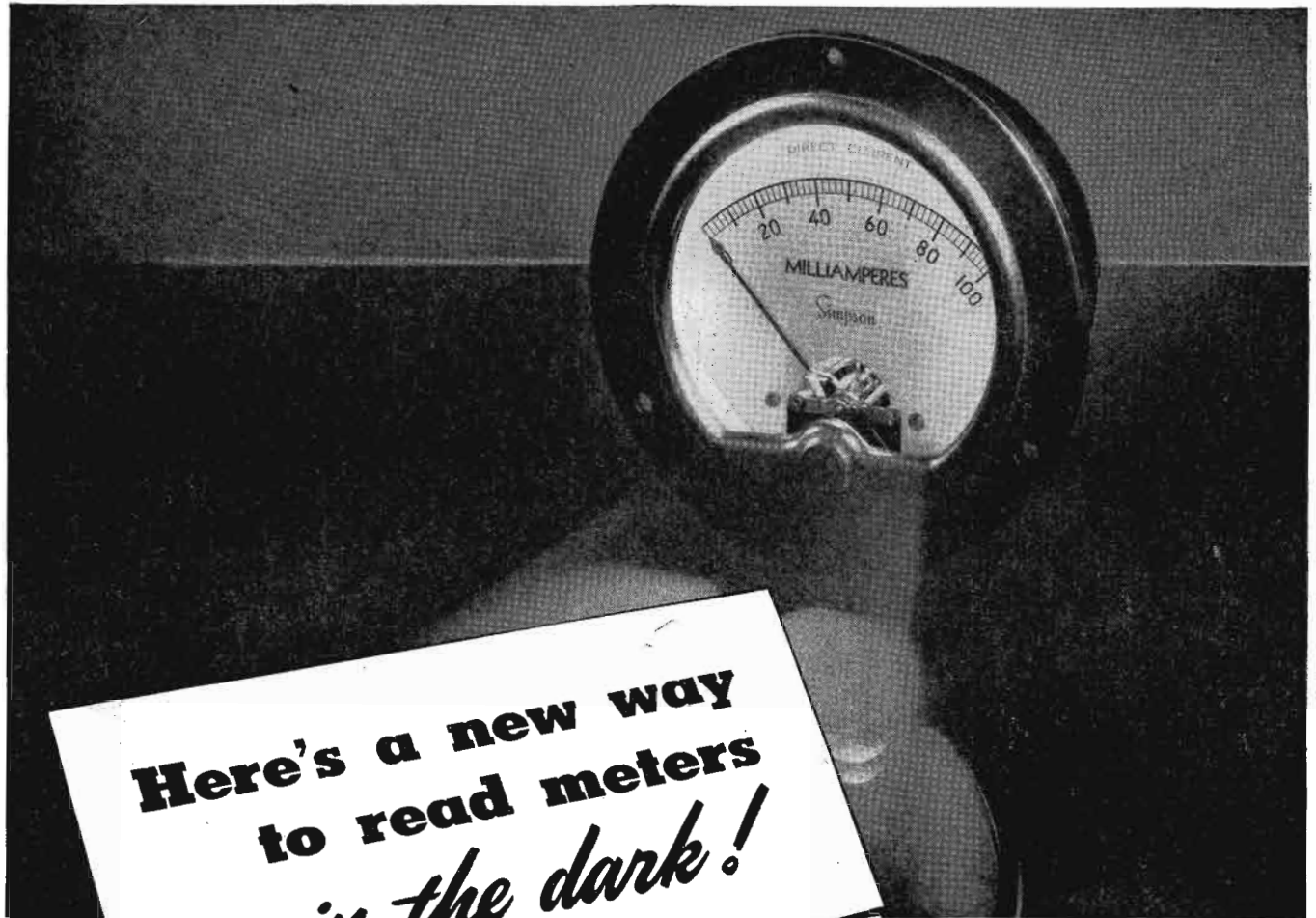

**Here's a new way
to read meters
... in the dark!**

How often have you wished for a meter you could see *clearly*—the whole scale of it, wherever you were using it—in the dark, under low lights, or even in the kind of glare that causes reflections on the glass—a really illuminated meter? Well, here it is—the result of a new Simpson patented method of illumination.

On these new Simpson Illuminated Meters (voltmeters, ammeters, milliammeters, and microammeters), every fraction of the dial face is flooded with light—there isn't a spot of shadow. And this isn't a dull glimmer of light. It's a full and even radiance.

An ingeniously shaped Lucite cone carries the light from a recessed bulb in the back of the instrument through the front edge that surrounds the entire dial. This makes possible the use of the standard Simpson metal dial. Unlike translucent dials, it cannot fade or discolor so that reading becomes difficult. It cannot warp or buckle, causing the pointer to stick, or distorting readings. The bulb recess is neoprene sealed.

Behind the refinement of this superior illumination lies the basic reason for preferring Simpson instruments—their in-built accuracy. That high quality which is the indispensable component of every Simpson instrument makes sure that the accuracy will *stay* there, year after year.

Simpson

INSTRUMENTS THAT STAY ACCURATE

SIMPSON ELECTRIC COMPANY
5200-5218 W. Kinzie Street, Chicago 44, Illinois
In Canada, Bach-Simpson, Ltd., London, Ont.



OPEN FACE



SHROUD STYLE

2" Round Case. Flange diameter, 2-3/4"; depth overall, 2-5/16"; body diameter, 2-11/64"; scale length, 1-7/8".

3" Round Case. Flange diameter, 3-1/2"; depth overall, 2-1/4"; body diameter, 2-3/4"; scale length, 2-9/16".



3" Rectangular Case. Width, 3"; height, 3-1/8". Mounts in round hole. Body diameter, 2-3/4".

2" Rectangular Case. 2-3/8" square. Mounts in round hole. Body diameter, 2-3/16".

5-5-47

no matter how

we tell it



IT'S NEWS

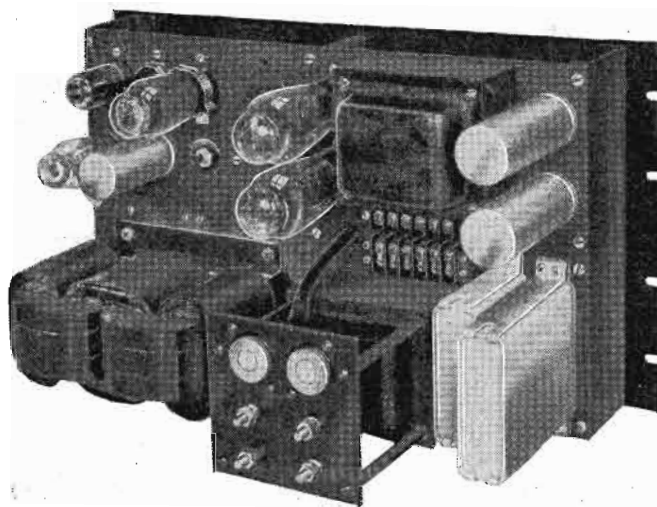

The **STABILINE** *Electronic* Voltage Regulator

Instantaneous in action with a maximum waveform distortion of 3 percent — this new completely-electronic voltage regulator maintains a stable output . . . within $\pm .1$ volt of nominal for line variations from 95 to 135 volts; within $\pm .15$ volt of nominal for any load current change or load power factor change from lagging .5 to leading .9.

Rated—Input: 95-135 volts, 1 phase, 60 cycles. Output: settable between 110-120 volts, 1 KVA. Let us supply you with complete technical and performance data.

WRITE-PHONE-WIRE -OR MAIL THIS COUPON TODAY

STABILINE *Electronic*
VOLTAGE
REGULATOR

THE Superior Electric

COMPANY
83 LAUREL STREET
BRISTOL, CONNECTICUT

The SUPERIOR ELECTRIC Company
BRISTOL, CONNECTICUT

OC

Gentlemen:
Please forward complete engineering and performance data on the new STABILINE electronic voltage regulator.

Company.....

Address.....

City.....State.....

Name.....Position.....

*Come and See One of the
World's Largest Displays of
Radio-Electric Components*

**PARTS SHOW
VISITORS
WELCOME!**

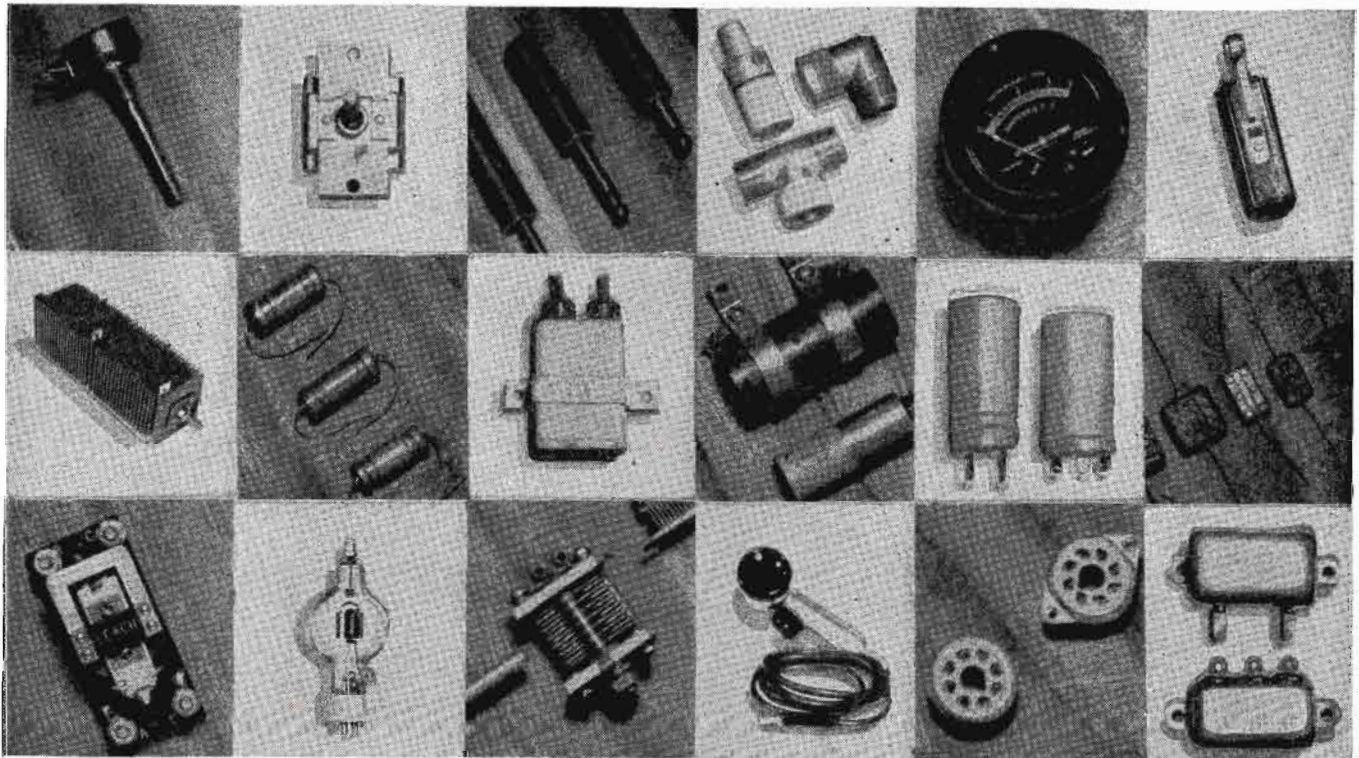

A National Service

For those who are unable to visit Chicago, Wells maintains a complete catalog service covering every item in our huge inventory. Catalogs or descriptive lists are now available in the following categories: Relays, Volume Controls, Micro Switches, Phone Jacks and Plugs, Transmitting Tubes, Condensers, Transformers, Resistors, Jones Strips, Wafer Switches, Radio Amateur Equipment, Dry Disc Rectifiers, Wire, and Coax Connectors. Send for your copies today.

Wells Moves to Convenient New Location

Thousands of types of radio-electric parts and equipment have been assembled in one tremendous display area located within easy walking distance of Chicago's Loop. Manufacturers, distributors and radio amateurs are cordially invited to see this extraordinary selection of the best of Government contract termination components. Everything is priced at a fraction of the original cost and is backed by the substantial Wells guarantee.

**WELLS
SALES, INC.**

Distributors: Write for the Wells Jobber Manual

320 N. LA SALLE ST. DEPT. M-4, CHICAGO 10, ILL.

★ ANSONIA ★ Ankoseal

Flexible in Use...

Flexible in Application...

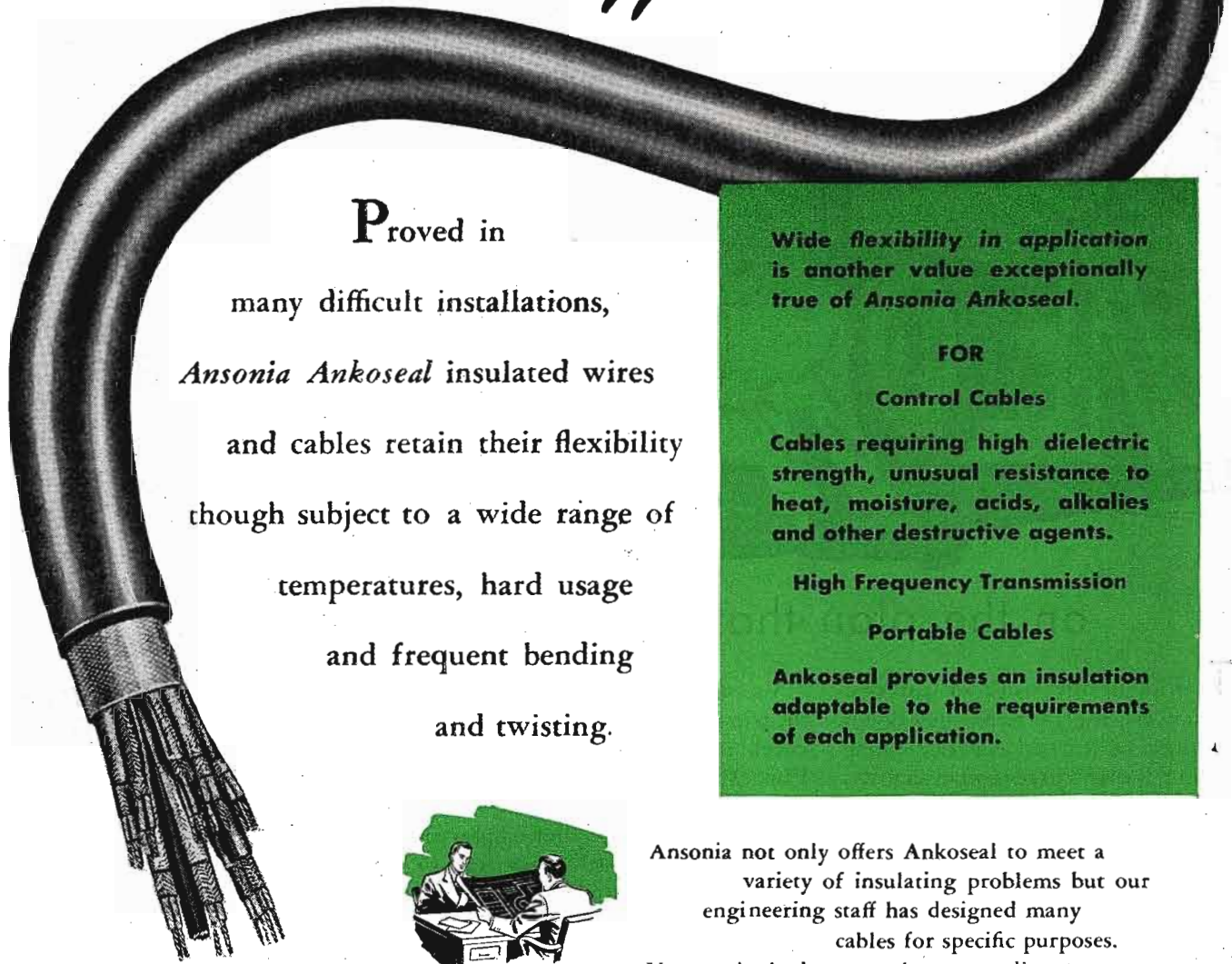

Proved in

many difficult installations,

Ansonia Ankoseal insulated wires

and cables retain their flexibility

though subject to a wide range of

temperatures, hard usage

and frequent bending

and twisting.

Wide flexibility in application is another value exceptionally true of *Ansonia Ankoseal*.

FOR

Control Cables

Cables requiring high dielectric strength, unusual resistance to heat, moisture, acids, alkalis and other destructive agents.

High Frequency Transmission

Portable Cables

Ankoseal provides an insulation adaptable to the requirements of each application.



Ansonia not only offers *Ankoseal* to meet a variety of insulating problems but our engineering staff has designed many cables for specific purposes.

You are invited to consult us regarding your wire or cable problems.

THE ANSONIA ELECTRICAL DIVISION

ANSONIA, CONNECTICUT *of*

NOMA ELECTRIC CORPORATION, NEW YORK, N. Y.

Time for a

Spring Check-up...

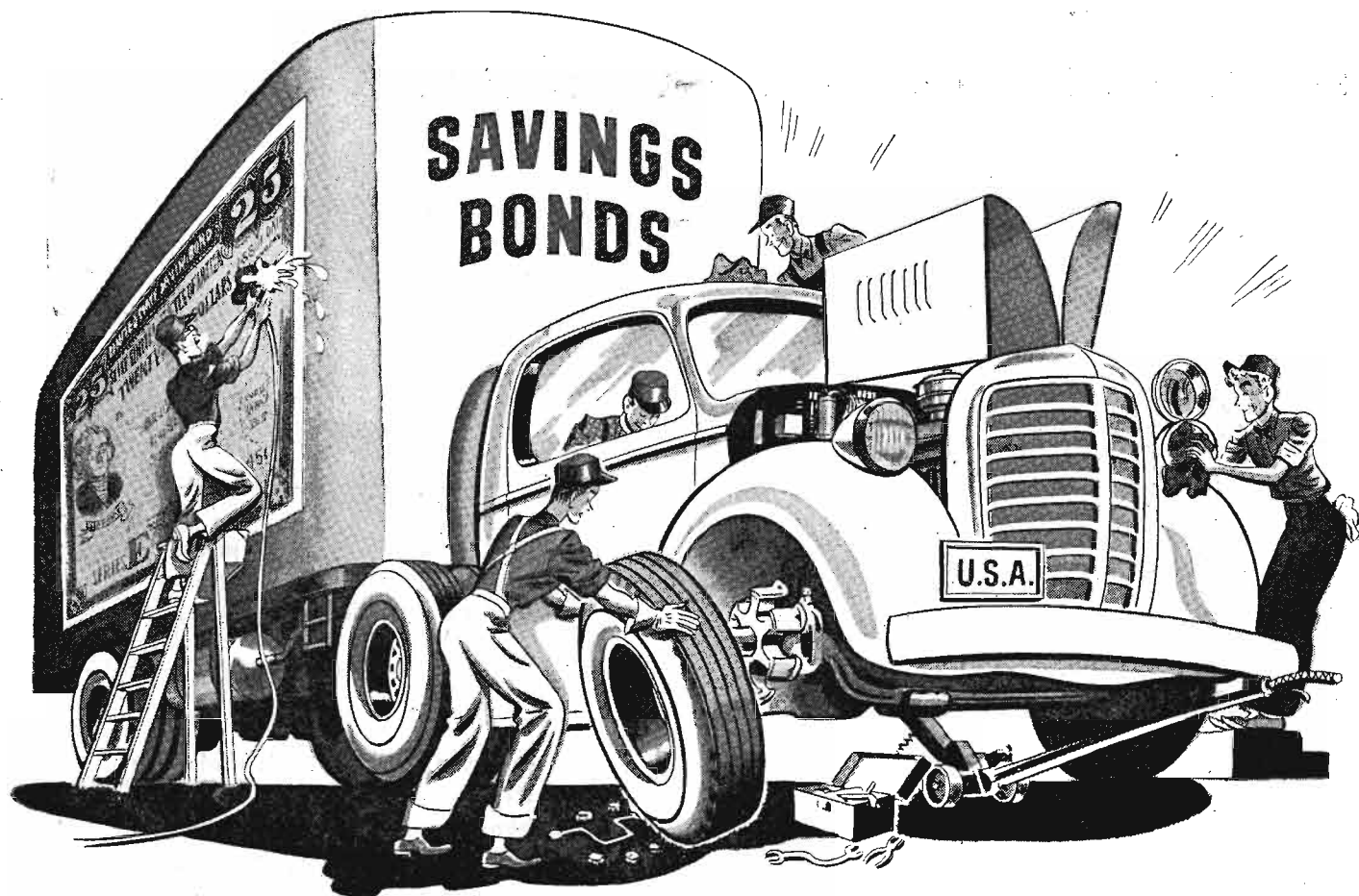

on the plan that delivers Peace of Mind

THANKS to the work of patriotic volunteers, the U. S. Savings Bonds program has carried America a long way up the road to economic security.

During 1946, in spite of all the problems and uncertainties the nation faced, sales of Savings Bonds exceeded redemptions by \$1,389,216,000. The success of this great sales operation has helped stem the tide of inflation, has reduced public debt holdings of the banking system, and has given millions of citizens a stake in their country and a profitable investment in their own futures.

Yes, we've come a long way—but the trip isn't over! Now is the time to check up on your Payroll Savings Plan. Make sure that all your new employees are familiar with its advantages. Remind *all* your employees that there's no easier, surer way to build their own futures—and America's—than by buying Bonds regularly through the Payroll Savings Plan. Every \$3 invested pays \$4 at maturity!

For any help you need in conducting the Payroll Plan, call on your State Director of the Treasury Department's Savings-Bonds Division.

New Savings Bonds Plan won't affect the P.S.P.

SOON the Treasury Department and the banks of America will make it possible for farmers, doctors, and other self-employed people to participate in "automatic" Bond buying by special arrangement with their banks. This extension of the Savings Bonds program is not a partial payment plan and is intended *only* for people who are not in a position to take advantage of the Payroll Savings Plan.

The Treasury Department acknowledges with appreciation the publication of this message by

COMMUNICATIONS



This is an official U.S. Treasury advertisement prepared under the auspices of the Treasury Department and The Advertising Council.

Simultaneous **CHANNEL OPERATION** WITH *WILCOX 99A Transmitter*

SIMULTANEOUS TRANSMISSION

Simultaneous Transmission on several frequencies brings new flexibility and operational ease. Three operators can use the transmitter at one time, thus increasing by 3 times the volume of traffic normally handled.

EASY MAINTENANCE

Every major component is instantly removable by means of plugs and receptacles, providing complete accessibility and easy maintenance.

COMPACT CONSTRUCTION

Housed in a single steel cabinet, the rectifier, modulator, remote control equipment, and 4 transmitting channels combine to make the most compact multi-frequency transmitter in the 400-watt field.

Write for Free Catalog...

TOMORROW'S TRANSMITTER TODAY

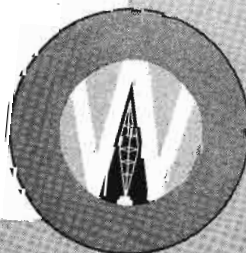
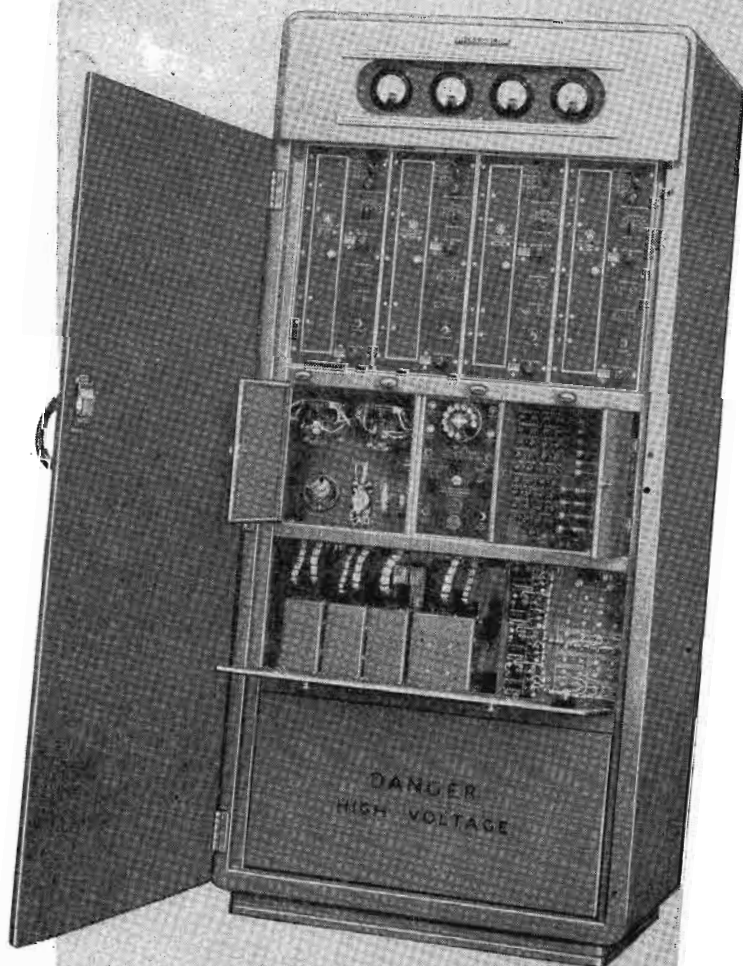

WILCOX ELECTRIC
COMPANY, INC.
Kansas City 1, Missouri

NOW you can get Sylvania quality in transmitting tubes too!

SYLVANIA INTRODUCES THE TYPE 3D24

BEAM POWER TETRODE WITH ELECTRONIC GRAPHITE ANODE

First of Sylvania's new line of transmitting tubes, the 3D24 is a four-electrode amplifier and oscillator with 45 watt anode dissipation. An outstanding development is the electronic graphite anode, which allows high plate dissipation for small area and maintains constant inter-element relationship and uniform anode characteristics.

The 3D24 may be used at full input up to 125 Mc — maximum permissible frequency will be announced later upon completion of tests.

OTHER FEATURES INCLUDE:

1. **Lock-In base.** Short leads, no soldered joints.
2. **Top cap** providing for short path, greater cooling by radiation and convection, resulting in a cooler seal.
3. **Thoriated tungsten filament,** giving high power output per watt of filament power.
4. **Vertical bar grids.** #1 grid supplied with two leads for better high frequency performance. #2 grid provided with heat-reflecting shield for greater dissipation, low grid-plate capacity.
5. **Low interelectrode capacity.** No neutralizing needed with proper circuit arrangement.
6. **Hard glass envelope.** Permits high power for small size.

The 3D24, a product of the Electronics Division of Sylvania, has interesting potentialities in amateur, police, mobile and marine radio.

MECHANICAL SPECIFICATIONS

Type of cooling Air—radiation and convection
 Mounting position Vertical, base down or up
 Length overall 4.3 inches max.
 Seated height 3.769 inches
 Diameter 1½ inches
 Net weight 1.3 ounces

ELECTRICAL CHARACTERISTICS

Filament Voltage 6.3 volts
 Filament Current 3.0 amperes
 Amplification Factor 50
 Direct Interelectrode Capacitances
 Grid-Plate 0.2 μf max.
 Input 6.5 μf
 Output 2.4 μf

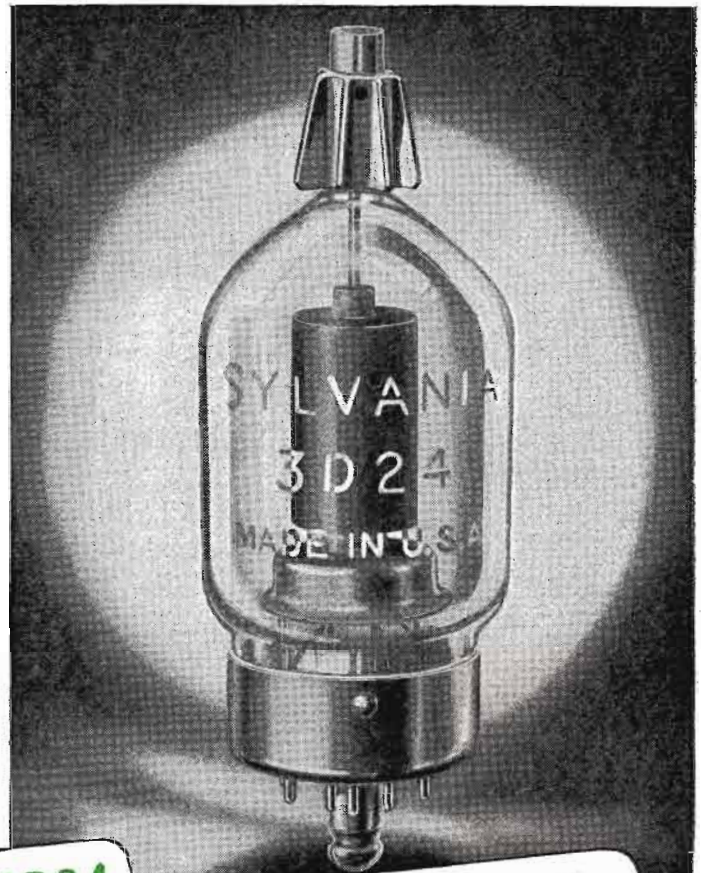

3D24		
TYPICAL OPERATING CONDITIONS		
R. F. Power Amplifier and Oscillator—Class C Telegraphy		
Characteristic	C. C. S.	C. C. S.
D. C. Plate Voltage	1500 volts	2000 volts
D. C. Control Grid Voltage	-300 volts	-300 volts
D. C. Screen Grid Voltage	375 volts	375 volts
D. C. Plate Current	90 ma	90 ma
D. C. Control Grid Current	10 ma	10 ma
D. C. Screen Grid Current	22 ma	20 ma
Peak R. F. Grid Input Voltage	400 volts approx.	400 volts approx.
Full Driving Power	4.0 watts approx.	4.0 watts approx.
Plate Power Output	105 watts	140 watts

Direct inquiries to Radio Tube Division, Emporium, Pa.

SYLVANIA ELECTRIC

MAKERS OF ELECTRONIC DEVICES; RADIO TUBES; CATHODE RAY TUBES; FLUORESCENT LAMPS, FIXTURES, WIRING DEVICES; ELECTRIC LIGHT BULBS

COMMUNICATIONS

LEWIS WINNER, Editor

APRIL, 1947

THE FCC "NO" TO COLOR TV:

Many sturdy factors contributed to the FCC negative tv color-standards decision. The solidarity of industry opposition developed in the RMA report, of course, was an important swaying item. But the engineering testimony offered by such experts as Dr. G. H. Brown on antennas was particularly significant and made a deep impression with the Commission.

In his antenna comment, Dr. Brown stated . . . "Since a small dipole at 490 mc will produce a voltage on the transmission line 17 db lower than the voltage produced on the transmission line by a half-wave dipole at 67.25 mc, it would be necessary to use a receiving antenna with a power gain of 50 at 490 mc to achieve equal voltages on the transmission line at the two frequencies. . . . A power gain of 50 at 490 mc calls for a receiver antenna with an aperture at least 5 feet wide and 5 feet high. . . . The effective aperture or capture area of a half-wave dipole at 67.25 mc is approximately 25 square feet. Hence, to obtain the same voltage on a transmission line at 490 mc, we must use the same area for the directive antenna, and if we go to 900 mc we must again use an antenna with an aperture of at least 5 feet on the side. . . . I am of the opinion that a receiving antenna with an effective area of 25 square feet will not be looked on with favor by the purchaser of a television receiver." These statements struck hard at the u-h-f defense.

Compatibility was also of acute interest to the FCC. Some of the Commissioners saw in that factor the "yes" or "no" decision. And when the RMA disclosed that their engineering department believed the simultaneous system was superior because of compatibility, as well as freedom from flicker, freedom from color fringing, freedom from color breakup, greater freedom from

limitations on color reproduction and capable of providing the public with more television service at a lower price, the petition received its most staggering blow.

And while this decision sets aside the u-h-f tv standards issue, development activity will continue and effective progress will, undoubtedly, be recorded in the future. In the meanwhile, monochrome research has been placed on an accelerated schedule, with many significant developments already past the experimental stages and on the production program.

PLANS TO SKIP PHONE OPERATOR EXAMS:

There may be no more oral or written exams for those seeking Restricted Radiotelephone Operator Permits, if an FCC proposal is adopted. In the change the applicant would only have to certify that he can receive and transmit spoken messages in English; can keep a rough written log in English or in another language that can be readily translated into English, and is familiar with the provisions of the treaties, laws, rules and regulations of operation.

Simple enough!

U. S. LOOKING FOR HELP:

The latest scientific personnel bulletin issued by the Navy lists about 300 vacancies in the Office of Naval Research for radio engineers, electronic engineers, mathematicians and technical editors. The positions are open at various Naval Stations throughout the country, and there are also a few posts open in the Aleutians and Guam.

The bulletins are in file at libraries and several service offices. And we'll be very happy to show our bulletin to anyone who visits with us.

800 KC BETWEEN F-M CHANNELS:

Recent reports of interference between B-channel stations (metropolitan-rural) in such cities as Syracuse have resulted in a proposal to double the present frequency separation from 400 to 800 kc. The proximity of the channels appears also to have placed the stations too close on the dial for satisfactory tuning.

In the changes proposed by the FCC, class A and B stations would be interspersed to provide a normal minimum separation of four channels or 800 kc between class B stations in a city or immediate area. At the present time, there are 34 stations in 13 cities operating on channels 400 kc from other stations.

In the original standards, the Commission endeavored to provide from one and one-half to two times as many class B channels per city as a-m stations, with a limit of 20 class B channels for major cities like New York. Using all alternate channels, these cities required 40 of the 60 class B channels, with the remaining 20 channels used for stations in adjacent major cities.

The proposed change which, by the way, will be given a hearing on May 8th and 9th in Washington, will, according to the FCC, require readjustment only of transmitters now operating and slight alterations in transmitters being built.

WHAT IS A SCIENTIST?:

We found quite an answer recently in an industry house organ. We learned that . . . "A thorough-going scientist is suspicious of his generalizations, his theory and laws. . . . To a scientist a theory is something to be tested. . . . He seeks not to defend his beliefs but to improve them. . . . He is, above everything else, an expert in *changing his mind*." The answer, by the way, was written by Wendell Johnson.—L. W.

(Right)
Arrangement of the tubing used in the KFI reverberation system.

(Below)
Reverberation panel with reverberation time and gain controls, and microphone gain control for 25', 50', 75' and 100'.

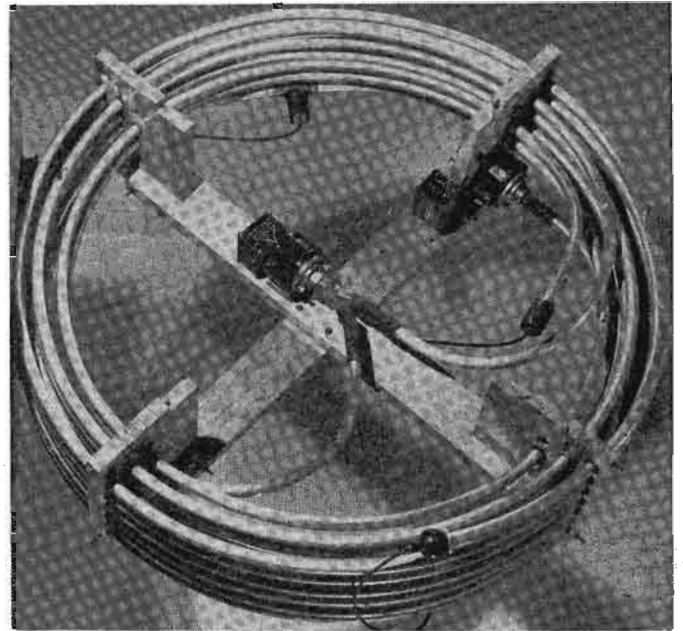
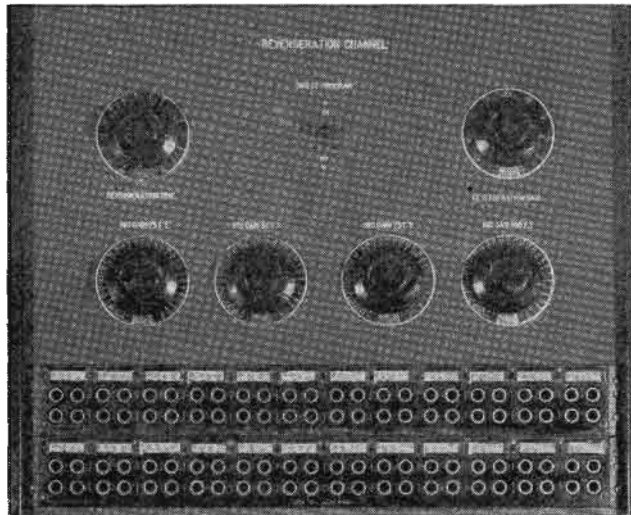

AUDIO PROBLEMS In A-M Broadcasting

ALTHOUGH SIGNIFICANT progress has been achieved in many phases of a-m broadcasting, there still are several factors which have been neglected and unfortunately dismissed by many as unworthy of further effort. This is particularly true of the fidelity problem.

On the abstract idea of fidelity, most engineers have pretty generally accepted as their goal the transferring of music and speech, without a change, from one location to another. This is a comparatively simple process, but still difficult to attain at moderate cost. And today, we are being forced to the conclusion that in a competitive system, even this may not be enough.

The Reverberation Factor

Music and speech, in addition to having fidelity, should be easy to listen to. The human ear seems to be so constructed that, given an adequate frequency response, it is easier to convey intelligence to the brain if there is a small amount of reverberation present either in speech or music. This probably is due to the vibratory character of sound. A reenforcing of the original vibration by a reverberation acting on the ear mechanism, and pro-

An Analysis of Some of the Current Fidelity Problems and Solutions Found at KFI through the Use of a Controlled Reverberation Channel, Automatic Equalizing Amplifier for Transcriptions, and Intermodulation Analyzer.

by **H. L. BLATTERMAN**

Co-Chief Engineer
KFI, Los Angeles

longing the impulses, gives the brain a longer time to absorb the intelligence. Practically everyone who has had the opportunity to listen to music with and without an optimum amount of reverberation has agreed that it was more pleasant to hear; they could actually hear more with less volume on the loudspeaker, and with less effort. In addition, the music and speech had a more pleasing character.

Music is a fine art. Much of its appeal is emotional and depends on small gradations of volume and subtle tonal effects which are produced by harmonics or overtones. The magnitudes of these values are extremely small in

some cases, and they are easily lost unless extreme care is taken in pickup and transmission. The fidelity of the electrical part of the system is comparatively easy to attain with currently available equipment, which provides extended frequency response from microphone to loudspeaker. However, no unanimity of opinion has been achieved when fidelity observations were limited to frequency response. The recurring arguments over so-called high fidelity and its acceptance by the public have neglected the reverberation factor, which is possibly a more important ingredient to the pleasure of the listener than an extended-

Figure 1
Reverberation channel used at KFI.

frequency response. Extended frequency response is of course desirable. However other factors such as freedom from distortion and optimum reverberation over the entire frequency range must be present before accurate evaluations of listener response to this question can be made.

It is pretty hard to evaluate the elusive reverberatory effects unless a direct comparison is available. When dealing with listener response to any sound system, it is difficult to reduce the findings to a formula unless all the variables involving that response are under control. It is only recently that any significant advances have been made in acoustic control over an extended-frequency range, and the science has certainly not been reduced to a formula.

Listener response to reverberation has been forcefully and sometimes unpleasantly brought to our attention by circumstances. When the transcontinental network was first set up from New York to the coast, there was a noticeable difference in quality between the voices of our announcers and those in New York. The frequency characteristics of our equipment were better than the network, but yet, on a comparison basis, the network announcers' voices sounded rich and full toned, while the voices of our announcers were thin and washed out. Local announcements followed networks with practically no time interval, providing the listener with a direct comparison. This difference was also noted on music which was sometimes even more pronounced. It seems that there was some overall delay effect in the electrical system of the transcontinental network which sounded the same as reverberation and actually enhanced the program. As far as the listener was concerned, this was more important than the frequency response. The magnitudes of the frequency responses involved were 100 to 4,900 cycles for the networks and 50 to 8,000 cycles for the studios.

Reverberation Control

Theoretically, of course, the proper place for control of acoustics is in the theater or studio where the performance is given. In this way the per-

Figure 2
Automatic equalizing playback amplifier, featuring a two-stage preamplifier with equalizing feedback.

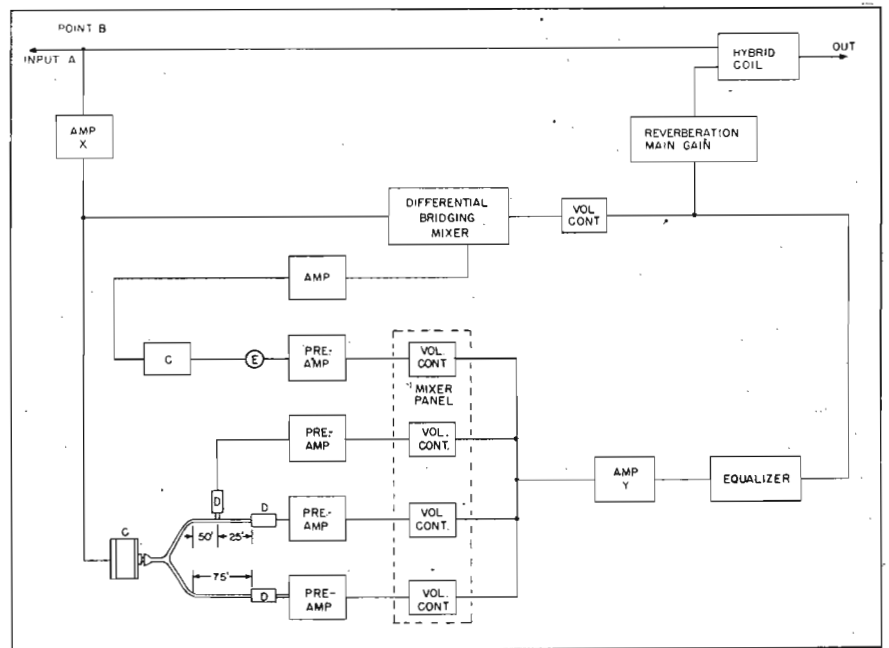

forming artists, either vocal or instrumental, are helped by the reverberation of their own voice or instruments. It is easier for them to control the pitch of their voice or instrument when a considerable amount of reverberation is present. Some artists have gone to the trouble of having concealed microphones installed in the footlights and small loudspeakers placed in the wings of the theater in order to hear themselves sing or play; a simulated single reflection offering appreciable help.

Convex reflecting surfaces have been of immeasurable help in improving studio acoustics, providing an effective control of part of the frequency spectrum. However, standing waves on the bass frequencies which tend to be a

function of the size of the room, rather than the shape of the walls, are still a problem.

The application of an electrical device for reverberation control has been found to be quite effective, such a system providing for: (1) addition of reverberation; (2) control of reverberation in minute degrees; (3) control of reverberation in different points in the frequency spectrum.

Most networks and large broadcast stations use an electrical system that provides some of the foregoing features. For instance, the use of a small live room connected to the electrical part of the system through pipes, microphones and loudspeakers is generally used. In general, this is susceptible to resonant peaks which are hard

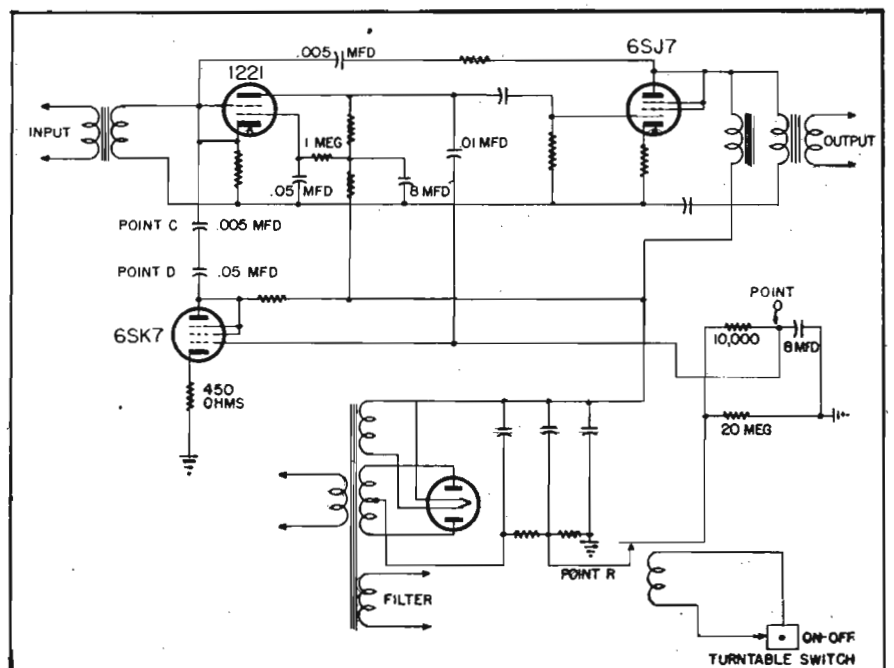

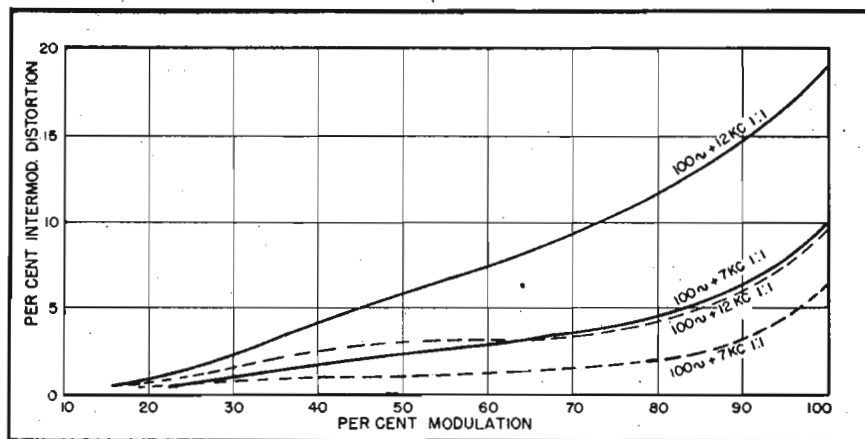
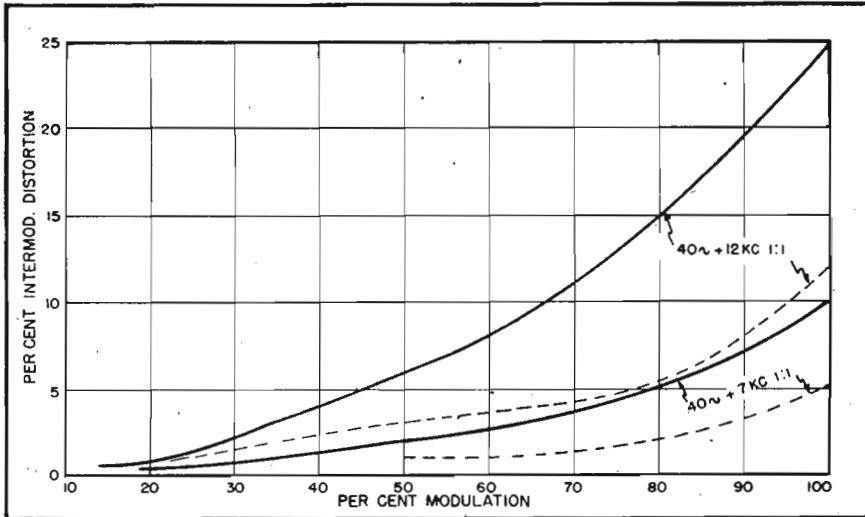
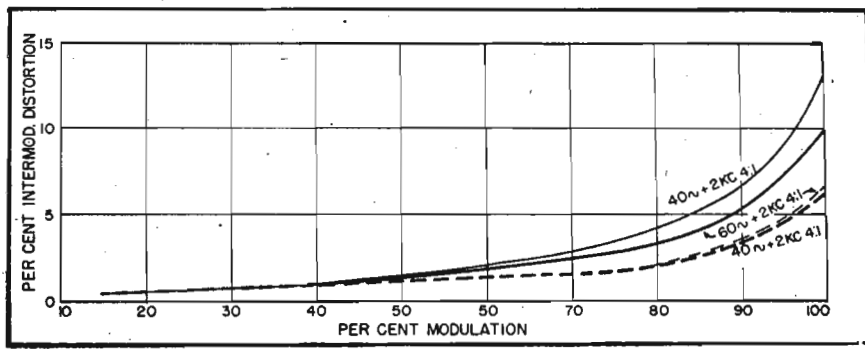

Figure 3

Sample of intermodulation curves of 50-kw transmitter showing reduction in intermodulation distortion effected through use of intermodulation analyzer. The solid line shows the result before tuning of final grid circuit and the dashed line shows the after result.

to control. A further development of this procedure has been underway at the RCA Laboratories at Princeton, New Jersey, under the direction of Dr. H. F. Olson.

As a result of observations of this system a project¹ to develop a similar device was initiated in 1946. The developed system consisted essentially of four sections of coiled pipe through which sound was transmitted, delayed,

fed back and allowed to travel and decay, then mixed with the original sound in order to produce synthetic reverberation.

As this unit was developed and used on actual programs, it was found that the frequency response of the speaker, pipe and microphone unit had to be perfectly flat. A difference of a few db at any one frequency produced a tendency to oscillate and destroy its

usefulness. After the frequency response had been made flat, it had to be made controllable both as to the amount of reverberation used, and as to the time period of said reverberation.

Reverberation System Operation

In Figure 1 appears a block diagram of the reverberation channel developed at KFI. Input *A* is bridged at *B* by an amplifier *X*, whose output is connected to *C*, a modified loudspeaker unit.² The speaker is connected by a special acoustic device and *Y* connector to 25', 50' and 75' sections of 1" coiled aluminum pipe. The signal passes through these sections of pipe and is delayed according to the length of pipe, then equalized and fed through hybrid coil to output.

A branch circuit is taken from the output of amplifier *X* and fed through a differential bridge mixer to the speaker, *C*, connected to the 100' pipe. The output of this is mixed through conventional methods with the outputs of the 25', 50', 75' sections. The volume from each of these acoustic paths can thus be balanced accurately. In order to get true reverberatory effects, it is necessary to return a portion of the output of amplifier *Y* and send it through the 100' section of pipe, again and again.

This procedure simulates the reverberation effects of any given studio. In addition, the time period of reverberation is controllable with the mixing panel and the amount of reverberation main gain. It was found that extreme care was necessary in equalizing electrical circuits and in coupling speakers and microphones to pipes.

The results, however, seem to justify the somewhat elaborate circuits. We are in the process of learning how to use the device, and in general, we are guided by the effects wanted by our staff musical director and production men. It is remarkable how a small amount of reverberation used in the right spots enhances the music of an orchestra or vocalist.

We intend to incorporate a control so that reverberation can be peaked at certain frequencies. This will allow the operator to compensate for de-

¹Development by Wayne Johnson, KFI Research and Development Department, which is under the direction of George Curran.

²W.E. 555.

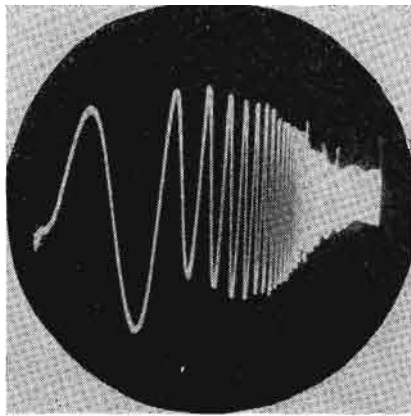

Figures 4a (left) and b (right)
 At a appears an actual photograph of a normal frequency response at inside diameter of 8" of a 136-line transcription, with no equalizing amplifier in circuit. In b appears an actual photograph of the frequency response of the same type record with, however, the equalizing amplifier in the circuit.

equal to the rate at which the high frequencies build up as the playback needle moves away from the inside diameter of the recording.

Circuit Operation

The capacitor-resistor combination is placed in a circuit which controls a frequency conscious feedback loop in the pre-amplifier. In actual practice, this changes the playback frequency characteristic of the amplifier from deemphasis to essentially flat at the beginning of the playback. The needle velocity is low at this diameter, so that needle scratch is essentially the same on both inside and outside diameter of the record.

It will be found by test that most of the high frequencies are lost in the first five minutes of playback and the loss changes logarithmically as the needle travels away from center. Fortunately this is the way a capacitor-resistor combination discharges, and therefore, makes a perfect compensating device.

The circuit, providing an automatic equalizing amplifier, consists of a conventional two-stage preamplifier with equalizing feedback.

When the amplifier is placed in operation and turntable switch turned off, relay *R* is closed, allowing capaci-

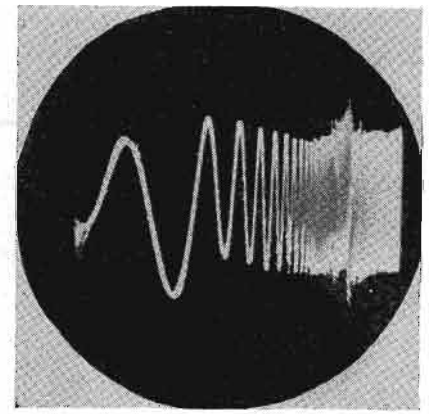

iciencies in reverberation which occur in the studio itself.

Delayed Transcription Fidelity Problems

Another fidelity problem has appeared in the delayed transcriptions used to rebroadcast coastal shows, which cannot be presented at originating time at either coast because of the time differentials. For instance, the half-hour Jack Benny show, which originates at 4:00 P.M. on the west coast, is recorded and rebroadcast locally at 9:30 P.M. P.S.T. Thus advertising agency, performers and at-home listeners form a critical and highly articulate audience for our transcription efforts.

The fidelity problem involved the inevitable loss of high frequencies which occurs at the inside start of every transcription. It was particularly noticeable on a half-hour show when switching instantaneously from the outside of one record to the inside of another. Various methods of equalizing the recordings were tried and discarded. Super-imposing diameter equalization on top of the standard NAB preemphasis curve proved impractical because the high frequency peaks overloaded badly and caused a high degree of intermodulation distortion. The actual readings taken on measuring equipment ran as high as 60% intermodulation.

The obvious alternative was to incorporate diameter equalization in the playback instead of the recording. It was also impractical to use any mechanical switch operated by a delicately balanced playback mechanism. Switches are step-by-step affairs and tend to get noisy, especially in low-level circuits, and are thus quite objectionable.

We found that the problem could be solved electrically with a capacitor-resistor combination, by charging it and allowing it to leak off at a rate

tor *C* to charge with voltage from tap on *B* power supply. The voltage at point *O* is applied to the grid of the 6SK7, biasing the tube to cutoff and nullifying the effects of capacitors *B*, *C* and *D* on the frequency characteristic of the first stage. Capacitors *B*, *C* and *D* form a feedback path which is adjusted frequency-wise by capacitor *C* to the deemphasis curve, but only when the 6SK7 tube is not biased to cutoff.

When the relay *R* is operated (by starting switch on the turntable) the charging voltage is lifted from point *O* and capacitor immediately begins discharging through 10,000-ohm and 20-megohm resistors. This slowly changes the bias on 6SK7, thus closing feedback path formed by capacitors *C*, *D* and *B*, and slowly drops the high-frequency characteristic of the amplifier down to the deemphasis playback curve. By the time this has taken place, the playback has moved to a position on the record which calls for

(Continued on page 50)

Figure 5
 Equalizing amplifier setup with a-f signal generator and intermodulation analyzer test equipment.

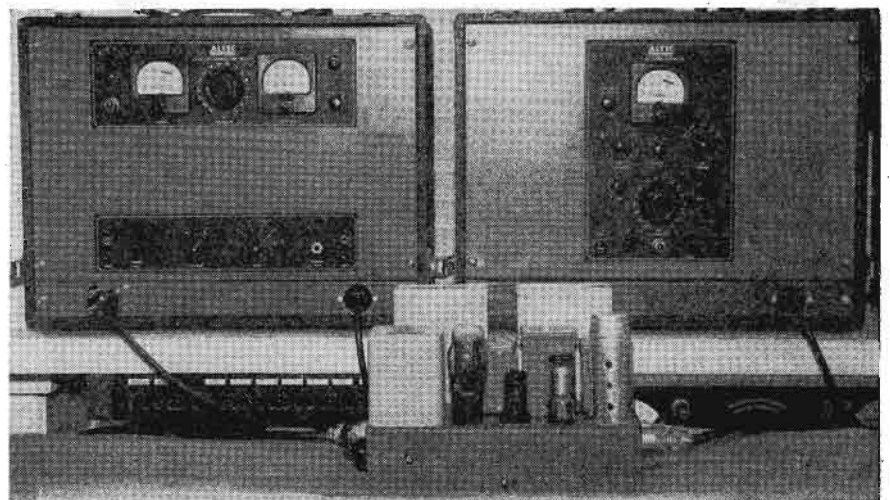

Ground - Air

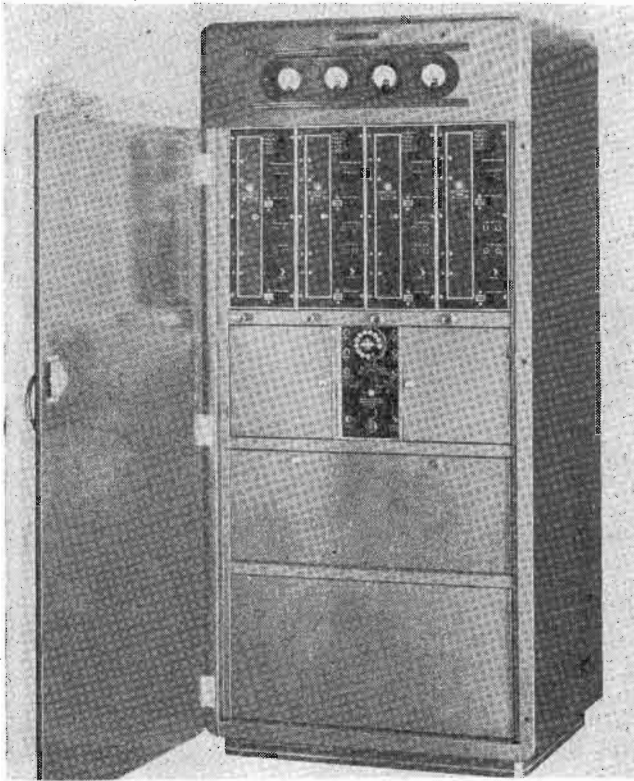

Figure 1
Front view of the air-ground transmitter with four r-f channel units mounted in position. Cabinet is 72" high, 32" wide and 26" deep.

AIRLINE COMMUNICATIONS SYSTEMS, which began to function on a reasonably advanced scale between 1925 and 1930, provided for, principally, the application of airborne radio equipment to post the pilot on weather, field conditions, etc. The pilot likewise conveyed similar information to the ground, including position reports, if required.

The transmitters on the aircraft were of the c-w type and were of relatively low power, 25 watts or less. The ground stations were similar to

the aircraft installations but of slightly increased power. Considering the state of the radio and the aircraft art, this equipment served its purpose very well. Many of the airlines covered long-distances by a series of short hops. These short hops with small flying equipment made low powers satisfactory. The development of larger aircraft permitted longer distances between stops and provided space for more powerful radio equipment on the airplane. The longer distances between stops, and the need for increased reliability in com-

munications due to the dependence of operations on this factor, demanded greater power in ground-station communications installations.

The trend towards greater distances and higher power equipment continued until about 1938 when powers of 5-kw. were in use on the ground and 100 watts in the air. The flights were between large centers where the traffic density was high. The small waystations, where traffic density was low, were bypassed.

Shortly after 1938, the airlines began to think seriously of the traffic possibilities of the smaller hitherto bypassed cities and began to plan accordingly. In analyzing the communications aspects of the small city program, we found that new types of ground-communications equipment would be required.

For instance, equipment could emit less power. For the most part, the smaller stations were situated between the large stations with an obvious decrease in radio transmission distances. The power of one-fifth to one-sixth the larger stations was determined to be most desirable from an operation, cost, and size of equipment standpoint. Placing the larger equipment at 2,500 to 3,000 watts output, the smaller intermediate-power transmitter could then be approximately 400 to 500 watts.

With night and day frequencies, and quadrature traffic distribution in use, it was felt that the equipment should have more than one channel and preferably four channels, with at least two of these channels operating simultaneously on radiotelephone.

To accommodate the widely separated frequency bands assigned to aeronautical services, 200-400 kc, 2-12 mc, and 108-132 mc, it became quite apparent that three distinct types of r-f transmitting channels would have to be provided, operating at fixed frequencies within these ranges. The use of a common power supply and modulator for all r-f channels was considered feasible.

(Provision for the four transmitting channels in three frequency ranges, provided a solution for the problems which confronted the industry in changing the bulk of radio communications from the 2-12 range to 108-132 mc.

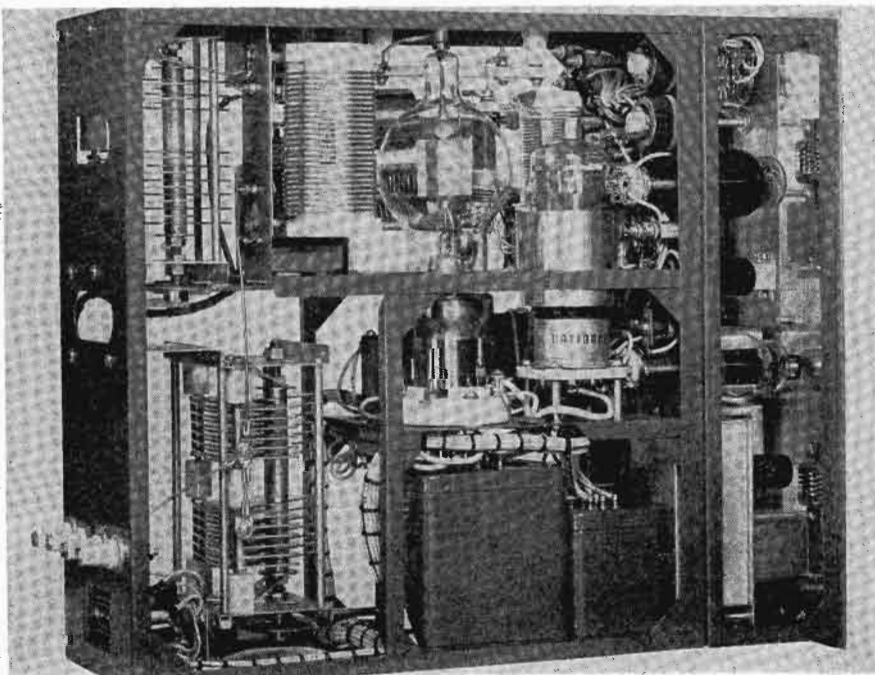

Figure 2

The 2-20-mc r-f unit removed from its cabinet.

COMMUNICATIONS UNIT

Medium-Powered Transmitter, Developed for Commercial Airline Service, Features Three Types of R-F Channels: 125 to 525 kc, 2 to 20 mc, and 100 to 160 mc. System Also Applicable to Police, Navigation and Other Point-to-Point Services.

by S. A. MEACHAM

Wilcox Electric Co., Inc.

This change, it was realized, would occupy a period of years, during which communications would necessarily be carried on in *both* the foregoing frequency ranges, a feature practical only with a transmitter having separate r-f channels designed for these frequencies.)

In many foreign applications, and even in certain domestic operations, the inclusion of an r-f channel covering the 200-400 kc band could provide for the use of the transmitter as a non-directional radio beacon as an aid to navigation. Actually, the frequency range of the channel was extended from 125 to 525 kc.

As a result of these analyses and tests with several models, a medium-powered ground-station transmitter¹ was developed.

Three types of r-f channels have been provided; 125 to 525 kc, 2 to 20 mc, and 100 to 160 mc. The cabinet has been designed to accommodate four of these r-f channels, in any combination that may be desired.

The medium frequency unit is complete from the crystal oscillator through to the final amplifier and antenna coupling circuits. All power supplies, with the exception of the filament transformers, are external to the

¹99A.

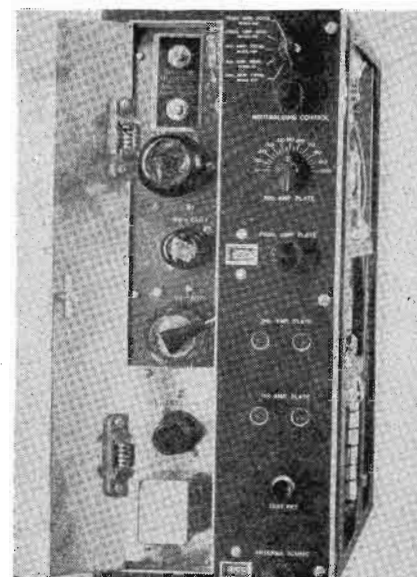

Figure 3
The 2-20-mc r-f unit. At the left of the cabinet are the bias isolator circuit and keying tubes.

r-f units. All coils to cover the required frequency range, with the exception of the final amplifier plate coil, and the driver-amplifier plate coil, are self-contained and require only band switching to select the desired frequency range.

A high velocity air stream from two blowers in the base of the cabinet is directed by internal ducts to each of the four r-f channels, as well as to the rectifier and modulator components. Air air-operated switch, connected in the transmitter overall interlock circuit, is situated in each of the two air streams. In the event of the failure of either blower, the transmitter is automatically disabled, protect-

Figure 4
Internal view of the 100-160-mc r-f unit.

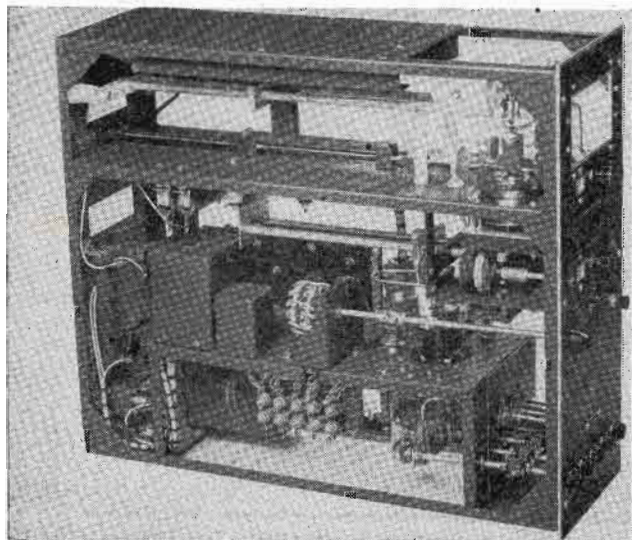
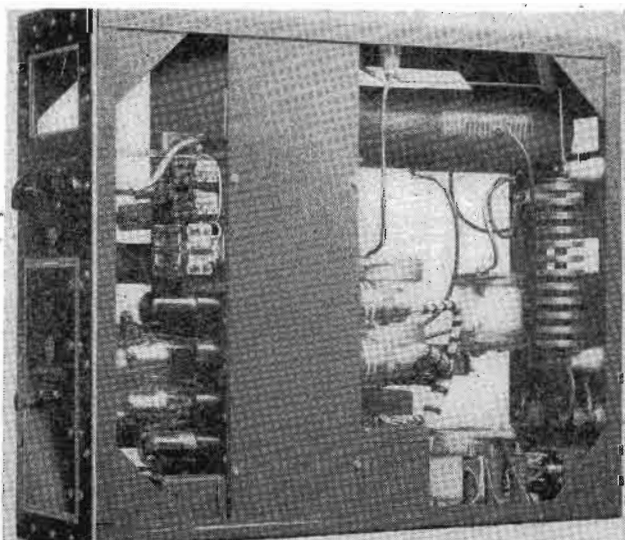
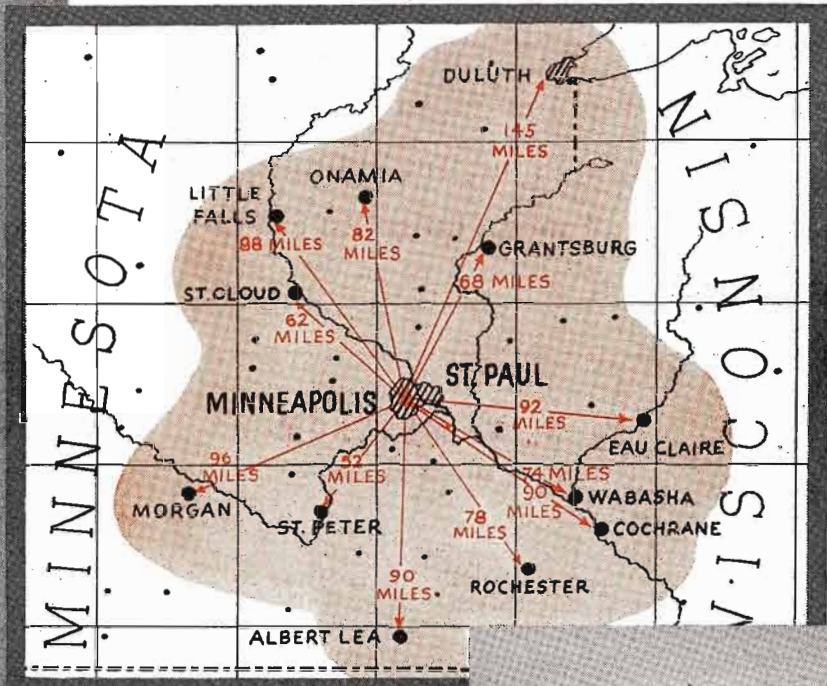
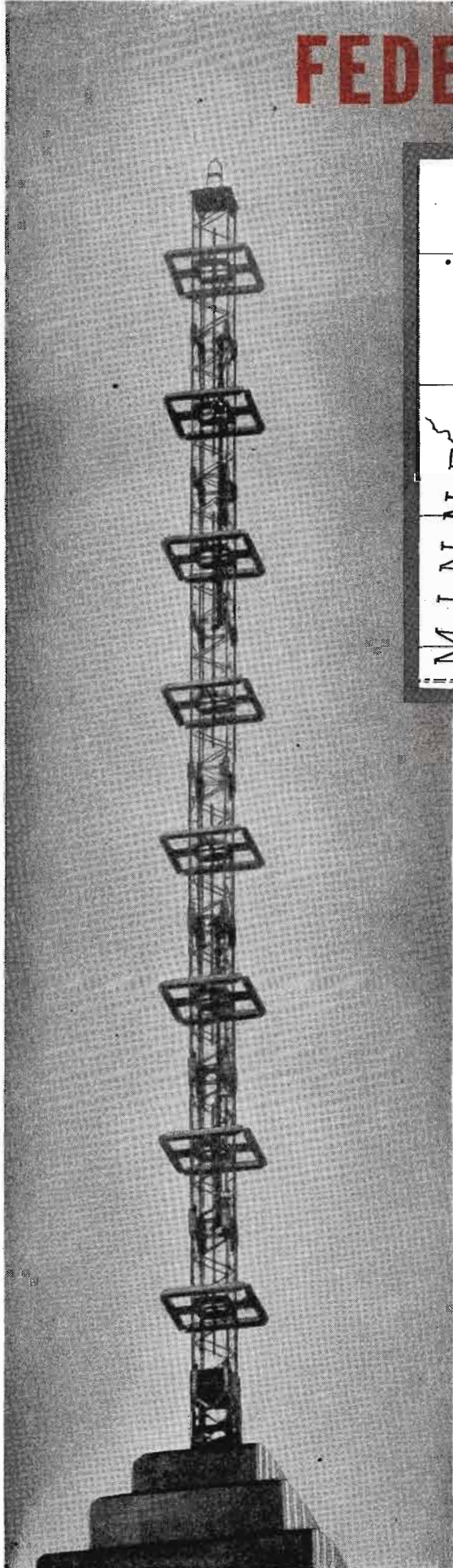

Figure 5
A view of the 125- to 525-kc r-f channel unit with the rear panel removed.



FEDERAL'S 8-ELEMENT



▲ A survey of surrounding cities indicates a radiation pattern approximately as shown by the shaded area above. Listeners almost 150 miles away reported excellent volume and clarity of reception. The remarkable coverage is due to the power gain of Federal's Square-Loop Antenna. The clarity and tone quality is made possible by the exceptional fidelity and mean carrier stability of Federal's "Frequematic"* Modulator — an exclusive feature of every Federal FM transmitter.

*Trade Mark



Federal's 8-Element Square-Loop Antenna dominates the Minneapolis skyline from the top of the Foshay Tower — highest building in the Northwest. Ruggedly constructed to withstand heavy winds and icing loads, this 80-foot antenna has already proved its dependability in temperatures down to 22 degrees below zero! ▲

Federal Telephone

In Canada:—Federal Electric Manufacturing Company, Ltd., Montreal.
Export Distributors:—International Standard Electric Corp. 67 Broad St., N.Y.C.

SQUARE-LOOP **FM** ANTENNA MAKES WORLD DEBUT!

WTCN-FM, Minneapolis, goes on the air with most efficient FM Antenna installed anywhere . . . boosts 3kw transmitter to 25kw . . . with coverage of 30,000 square miles

FEDERAL's 8-Element Square-Loop Antenna made radio history with the opening of the Twin Cities FM station, WTCN — the first super-directive antenna of its type and power gain to be installed anywhere. It gives the 3kw Federal transmitter an effective radiated power of 25kw — providing excellent reception over an area of approximately 30,000 square miles. This makes WTCN the world's *most efficient* FM station—and, with an FCC permit for an output of 400kw, it will eventually be one of the country's *most powerful* stations, too. With

Federal's high-gain antenna, this maximum rating of 400kw can be achieved with the installation of only a 50kw transmitter!

WTCN is among the FM stations with permits for the most powerful ratings in the country. Others are KWK, St. Louis, with 369kw — and WTMJ, Milwaukee, with 349kw. These three stations have *all selected FM by Federal!* And Federal can equip your new FM station, too — from microphone to antenna. Write today for complete information. Dept. B310.



Station WTCN was officially opened by a gala inaugural program featuring the Minneapolis Symphony Orchestra, Dimitri Mitropoulos conducting. With FM by Federal, listeners at home were enabled to hear this famous orchestra with the same brilliance and tonal color as the studio audience. Insert shows Mr. Mitropoulos and Governor Luther W. Youngdahl of Minnesota, at opening of ceremonies.



"Wonderful! Magnificent! A terrific step of progress." This was the comment of the famed conductor, Dimitri Mitropoulos, when he heard his own orchestra over an FM receiver, during an on-the-air rehearsal.

and Radio Corporation

Newark 1, New Jersey



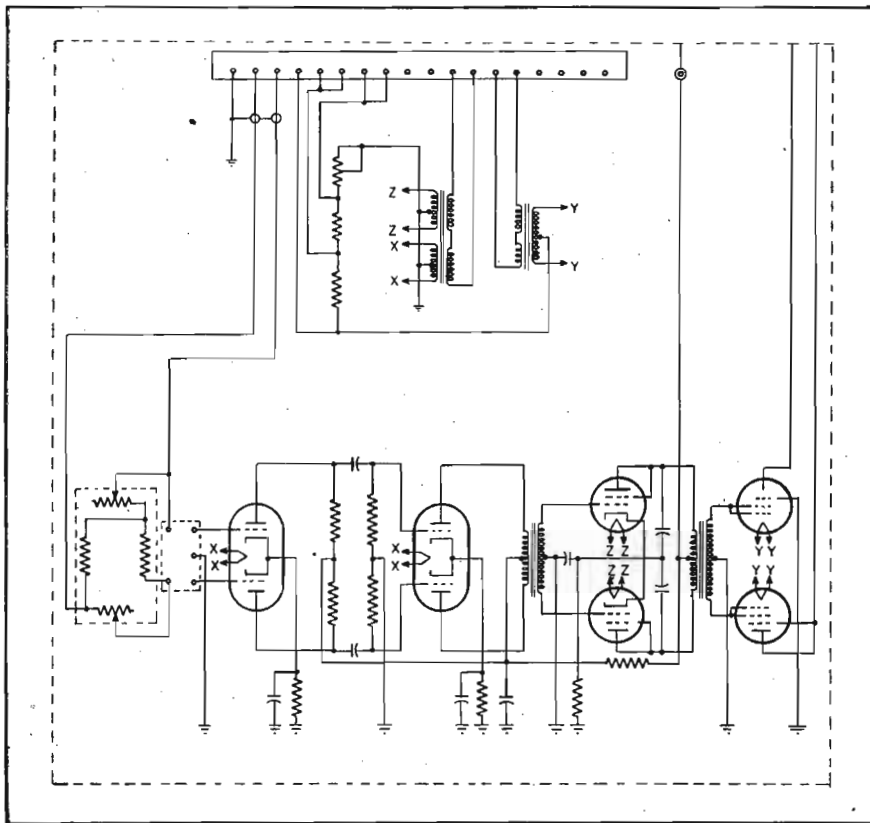

Modulator unit, one of four, used in the commercial airline transmitter.

ing the component parts from excessive heating.

Medium H-F Channel Features

Since a detailed description of each of the three types of r-f channels would be too lengthy, the medium h-f range channel (2 to 20 mc) has been selected as a representative unit for discussion.

The unit features a crystal-controlled shielded oscillator permitting continuous operation of the oscillator circuit. Greater stability and a less active oscillator circuit is accomplished in this manner, thus offering a considerably reduced strain on the quartz plate.

The oscillator is followed by a first amplifier buffer, a second amplifier doubler, and third amplifier or doubler and the final amplifier.

With a rated power output of 400 watts, the actual power output is usually closer to 500 watts under normal load and line voltage conditions. The amplifier-doubler stages afford a means of deriving the output frequency with sufficient power to drive the final amplifier. Adequate drive of the final amplifier at all frequencies is necessary to provide high efficiency in the final amplifier and to provide equal

At left, below, list of parts for the v-h-f unit. At right, below, list of parts for the medium frequency unit.

output at any point in the operating band.

The circuit of the radio frequency unit is straightforward with no radical features. Compactness has been obtained by considering each part carefully before placing it in the design. A bias isolation circuit has been provided for the final amplifier. Bias isolators in power this low are usually not employed. However, by the use of this feature, the size of the bias supply is greatly reduced. The isolator provides grid bias for the tube at all times during a static condition of the final amplifier. When the final amplifier is being driven, the bias supply no longer furnishes bias voltage. The isolator tube employed becomes a grid leak, thus providing a self-bias during dynamic or driven conditions. A protective relay system is employed which removes all damaging voltages from the circuits of the transmitter when the bias voltage supply fails.

An underload-overload relay system is also employed. The overload relay which operates from the final amplifier plate current is adjusted by means of a parallel shunting resistance. The relay is adjusted to operate at a predetermined point just above the normal operating final amplifier total current. An increase in current of the final amplifier will cause the relay to operate. Upon operation the relay contacts open the primary contactor of the high voltage transformers. This overload circuit cycles as long as the overload exists. On exceedingly heavy overloads the cycling continues several times until the fuse of the overloaded circuit blows out. The underload circuit is adjusted to operate at a current point slightly below normal operating current for the final amplifier. The contacts of the relay controlled in this circuit are used to switch the filaments of the modulator to an operating condition. By means of this circuit, the modulator is turned on only if the

(Continued on page 52)

C1 .002 MFD 500 V.	R1 47,000 OHMS 1 W.	L1 OSC. PLATE INDUCTOR
C2 .002 MFD 500 V.	R2 112.8 OHMS 1 W.	L2 1ST AMP. GRID HARMONIC TANK IND.
C3 .002 MFD 500 V.	R3 47,000 OHMS 1 W.	L3 1ST AMP. PLATE INDUCTOR
C4 50 MFD VARIABLE	R4 112.8 OHMS 1 W.	L4 2ND AMP. PLATE INDUCTOR
C5 .002 MFD 500 V.	R5 4.3 OHMS 1 W.	L5 3RD AMP. GRID INDUCTOR
C6 500 MFD 500 V.	R6 47,000 OHMS 1 W.	L6 3RD AMP. GRID CHOKE
C7 500 MFD 500 V.	R7 112.8 OHMS 1 W.	L7 3RD AMP. PLATE INDUCTOR
C8 500 MFD 500 V.	R8 4.3 OHMS 1 W.	L8 FINAL AMP. GRID INDUCTOR
C9 500 MFD 500 V.	R9 2,000 OHMS 1 W.	L9 FINAL AMP. GRID CHOKE
C10 25-30 MFD VARIABLE	R10 112.8 OHMS 1 W.	L10 FINAL AMP. PLATE INDUCTOR
C11 500 MFD 500 V.	R11 4.3 OHMS 1 W.	L11 FINAL AMP. PLATE INDUCTOR
C12 500 MFD 500 V.	R12 5,000 OHMS 20 W.	L12 ANTENNA COUPLING LINK
C13 500 MFD 500 V.	R13 5,000 OHMS 20 W.	
C14 500 MFD 500 V.	R14 100,000 OHMS POT.	
C15 25-30 MFD VARIABLE	R15 3,000 OHMS 1 W.	
C16 500 MFD 500 V.	R16 500,000 OHMS 1 W.	
C17 500 MFD 500 V.	R17 800 OHMS 10 W.	
C18 500 MFD 500 V.	R18 2,500 OHMS 10 W.	
C19 35-30 MFD VARIABLE	R19 3,000 OHMS 10 W.	
C20 SPECIAL VARIABLE	R20 1,000 OHMS 10 W.	
C21 500 MFD 500 V.	R21 10,000 OHMS 10 W.	
C22 500 MFD 500 V.	R22 100,000 OHMS 1 W.	
C23 10 MFD 300 V.	R23 4.3 OHMS 1 W.	
C24 15 MFD 300 V.	R24 25 OHMS 25 W. POT.	
C25 15 MFD 300 V.	R25 25 OHMS 25 W. POT.	
C26 15 MFD 300 V.	R26 5,000 OHMS 50 W.	
C27 510 MFD 500 V.	R27 4.3 OHMS 1 W.	
C28 510 MFD 500 V.	R28 10,000 OHMS 20 W.	
C29 510 MFD 500 V.	R29 10,000 OHMS 20 W.	
C30 500 MFD 500 V.	R30 4,000 OHMS 500 W.	
C31 500 MFD 500 V.	R31 5.0 OHMS 1 W.	
C32 .002 MFD 500 V.	R32 250,000 OHMS 1 W.	
	R33 100,000 OHMS 1 W.	
	R34 47,000 OHMS 1 W.	
	R35 510 OHMS 1 W.	
	R36 10,000 OHMS 20 W.	
	R37 20,000 OHMS 20 W.	
	R38 50,000 OHMS 1 W.	
	R39 25,000 OHMS 1 W.	
	R40 15,000 OHMS 20 W.	
		V1 OSC.
		V2 1ST AMPLIFIER 6A45
		V3 2ND AMPLIFIER 6A45
		V4 3RD AMPLIFIER 8B9-B
		V5 FINAL AMPLIFIER 4-152A
		V6 KEYING RELAY 6-123A
		V7 ELECTRONIC KEYS 6S7GT
		V8 BIAS ISOLATOR 6Y60T
		S1 CRYSTAL SELECTION RELAY
		S2 KEYS SELECTION SWITCH
		S3 BIAS PROTECTION RELAY
		S4 KEYING RELAY
		S5 CHANNEL CONTROL RELAY
		S6 OVERLOAD RELAY
		S7 UNDERLOAD RELAY
		S8 TEST KEY

C1 .01 MFD 300V.	R1 100,000 OHM 1 W.	K CRYSTAL
C2 .01 MFD 300V.	R2 24,000 OHM 1 W.	L1 OSC. FL. R-P CHOKE
C3 .002 MFD 500V.	R3 240,000 OHM 1 W.	L2 1ST AMP. FL. TANK INDUCTOR
C4 .01 MFD 300V.	R4 60,000 OHM 1 W.	L3 2ND AMP. FL. TANK INDUCTOR
C5 .002 MFD 500V.	R5 51,000 OHM 1 W.	L4 3RD AMP. FL. R-P CHOKE
C6 .01 MFD 300V.	R6 470 OHM 1 W.	L5 3RD AMP. FL. TANK INDUCTOR
C7 .01 MFD 300V.	R7 50,000 OHM 1 W.	L6 FINAL AMP. GRID R-P CHOKE
C8 .002 MFD 1,000V.	R8 51 OHM 1 W.	L7 FINAL AMP. FL. R-P CHOKE
C9 75 MFD 300V.	R9 4.3 OHM 1 W.	L8 FINAL AMP. FL. TANK INDUCTOR
C10 75 MFD 300V.	R10 50 OHM 1 W.	L9 ANTENNA LOADING INDUCTOR
C11 .002 MFD 1,000V.	R11 10,000 OHM 1 W.	L10 ELECTRONIC KEYS
C12 .01 MFD 300V.	R12 100,000 OHM 1 W.	L11 3RD AMP. FL. R-P CHOKE
C13 .002 MFD 1,000V.	R13 100,000 OHM 1 W.	L12 3RD AMP. FL. TANK INDUCTOR
C14 75 MFD 300V.	R14 240,000 OHM 1 W.	L13 3RD AMP. FL. TANK INDUCTOR
C15 75 MFD 300V.	R15 240,000 OHM 1 W.	L14 3RD AMP. FL. TANK INDUCTOR
C16 .002 MFD 1,000V.	R16 15,000 OHM 1 W.	L15 3RD AMP. FL. TANK INDUCTOR
C17 .01 MFD 300V.	R17 1,000 OHM 2 W.	L16 3RD AMP. FL. TANK INDUCTOR
C18 .01 MFD 300V.	R18 100,000 OHM 1 W.	L17 3RD AMP. FL. TANK INDUCTOR
C19 .01 MFD 300V.	R19 500 OHM 10 W.	L18 3RD AMP. FL. TANK INDUCTOR
C20 .002 MFD 500V.	R20 510 OHM 1 W.	L19 3RD AMP. FL. TANK INDUCTOR
C21 .002 MFD 500V.	R21 2,000 OHM 10 W.	L20 3RD AMP. FL. TANK INDUCTOR
C22 .002 MFD 500V.	R22 1,750 OHM 10 W.	L21 3RD AMP. FL. TANK INDUCTOR
C23 .002 MFD 500V.	R23 4.3 OHM 1 W.	L22 3RD AMP. FL. TANK INDUCTOR
C24 .001 MFD 2,500V.	R24 25 OHM 25 W.	L23 3RD AMP. FL. TANK INDUCTOR
C25 .001 MFD 2,500V.	R25 25 OHM 25 W.	L24 3RD AMP. FL. TANK INDUCTOR
C26 .001 MFD 2,500V.	R26 25 OHM 25 W.	L25 3RD AMP. FL. TANK INDUCTOR
C27 .001 MFD 2,500V.	R27 25 OHM 25 W.	L26 3RD AMP. FL. TANK INDUCTOR
C28 2.9-12 MFD 9,000V.	R28 112.8 OHM 20 W.	L27 3RD AMP. FL. TANK INDUCTOR
C29 .001 MFD 2,500V.	R29 10,000 OHM 20 W.	L28 3RD AMP. FL. TANK INDUCTOR
C30 .001 MFD 2,500V.	R30 10,000 OHM 20 W.	L29 3RD AMP. FL. TANK INDUCTOR
C31 .002 MFD 12,500V.	R31 5,000 OHM 20 W.	L30 3RD AMP. FL. TANK INDUCTOR
C32 150 MFD 4,750V.	R32 5,000 OHM 20 W.	L31 3RD AMP. FL. TANK INDUCTOR
C33 .002 MFD 2,500V.	R33 4.3 OHM 1 W.	L32 3RD AMP. FL. TANK INDUCTOR
C34 360 MFD 2,250V.	R34 2,500 OHM 20 W.	L33 3RD AMP. FL. TANK INDUCTOR
C35 .002 MFD 2,500V.	R35 2,500 OHM 20 W.	L34 3RD AMP. FL. TANK INDUCTOR
C36 .002 MFD 2,500V.	R36 2,500 OHM 20 W.	L35 3RD AMP. FL. TANK INDUCTOR
C37 8 MFD 450V.	R37 500 OHM 1 W.	L36 3RD AMP. FL. TANK INDUCTOR
C38 .01 MFD 300V.	R38 51 OHM 1 W.	L37 3RD AMP. FL. TANK INDUCTOR
C39 .01 MFD 300V.	R39 51 OHM 1 W.	L38 3RD AMP. FL. TANK INDUCTOR
C40 .002 MFD 500V.	R40 51 OHM 1 W.	L39 3RD AMP. FL. TANK INDUCTOR
C41 .002 MFD 2,500V.	R41 51 OHM 1 W.	L40 3RD AMP. FL. TANK INDUCTOR

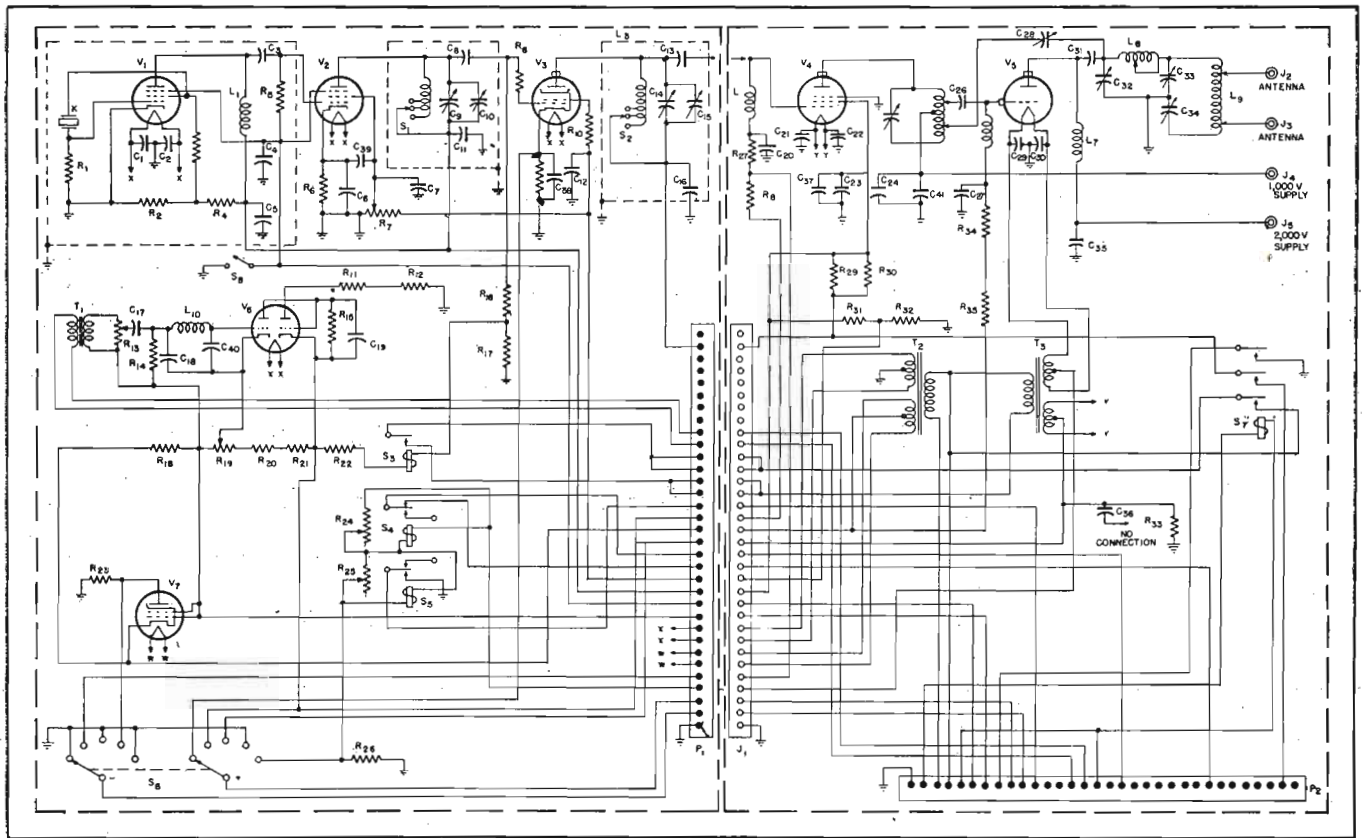

The medium frequency unit of the airline transmitter.

Circuit of the v-h-f unit of the ground-air transmitter.

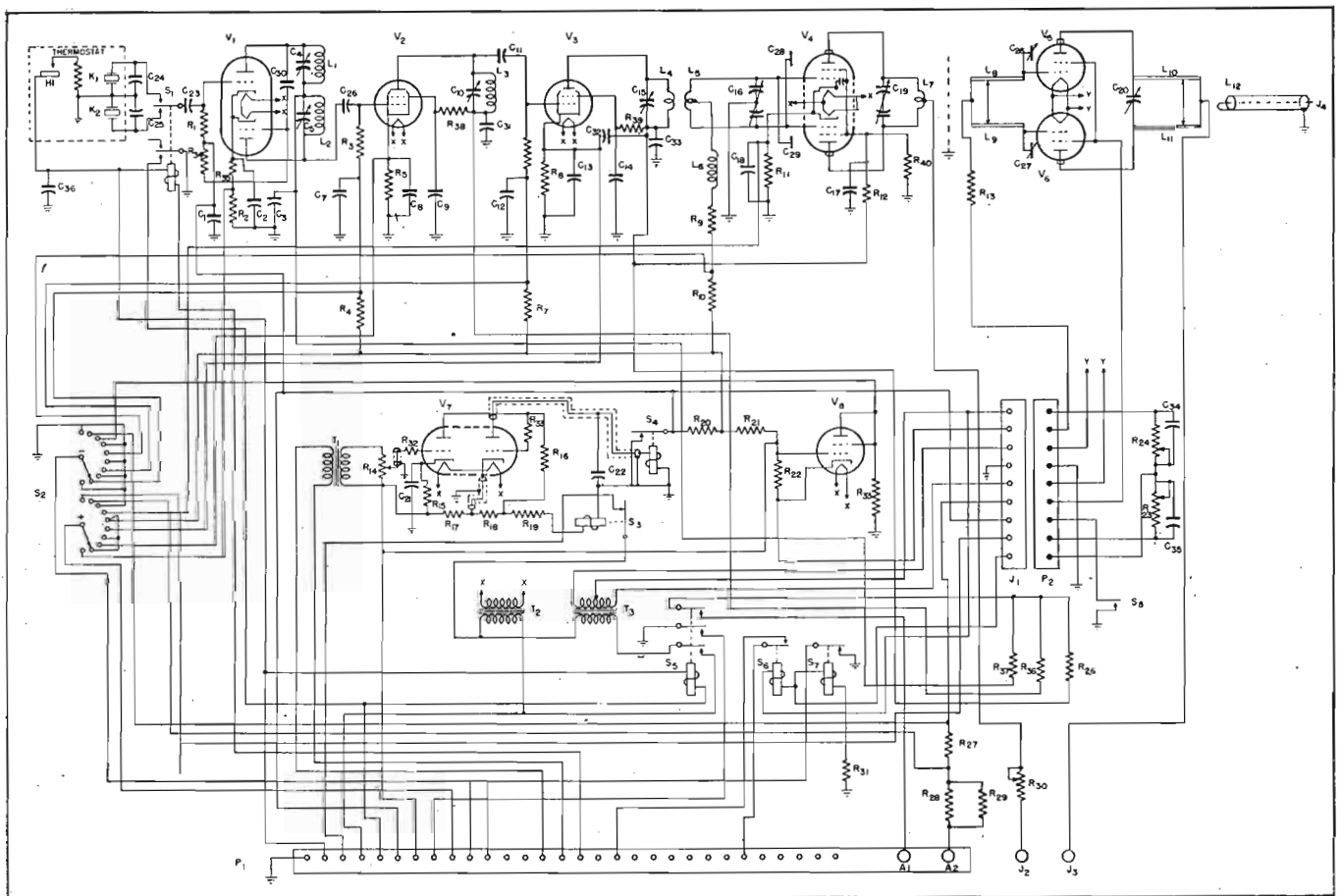

Vertically Polarized Nondirectional BROADBAND RADIATOR

Fixed Station Antenna Designed for Railroad and Other Services Operating in the 152-162 mc Band.

by J. P. SHANKLIN

Project Engineer
Bendix Radio, Division of Bendix Aviation Corp.

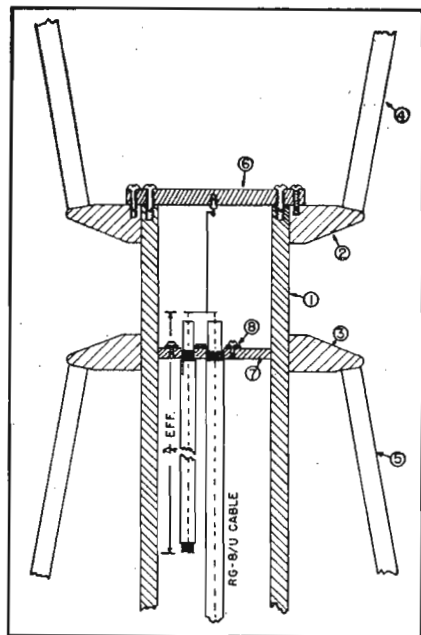
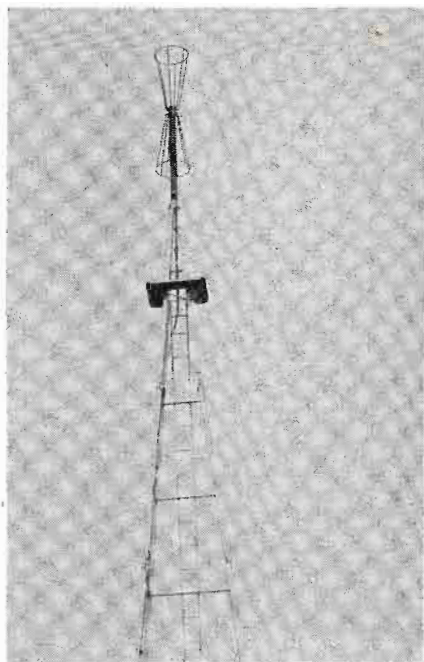

THE NEED for compact-type antennas for v-h-f fixed station operation has prompted the development of several interesting and effective types for a variety of applications. In Figure 1 appears one such type,¹ a vertically polarized antenna composed of two truncated conical structures, mounted coaxially with their smaller end to-

gether and fed at this point, each cone being $\lambda/2$ long at 157 mc.

The antenna would at first appear to be equivalent to stacked cophased $\lambda/2$ dipoles and so radiate a similar vertical pattern. However, due to the end loading caused by the rings in the ends of the cones and also the large cross sectional area of the cones, the current distribution is such that the pattern is sharpened and becomes very similar to the theoretical pattern of stacked cophased $5/8\lambda$ antennas. This last is the highest gain pattern possible from two radiating elements mounted colinearly.

In Figure 2 appears an experimentally obtained vertical radiation pattern.

(Continued on page 51)

¹MS-110A Biconical Antenna.

Figure 1 (left, top)
Fixed station antenna installation atop office building of the Frisco Lines R.R. at Springfield, Missouri.

Figure 3 (left)
Method of feeding the biconical antenna. At 1, phenolic supporting tube; 2 and 3, clamps on to which are welded rods 4 and 5; 6, metal end plate electrically connected to upper cone by screws; and 7, internal metal disc connected electrically to clamp 3. The outer braid of the coaxial feed cable is clamped to 7 by plate 8 and screws.

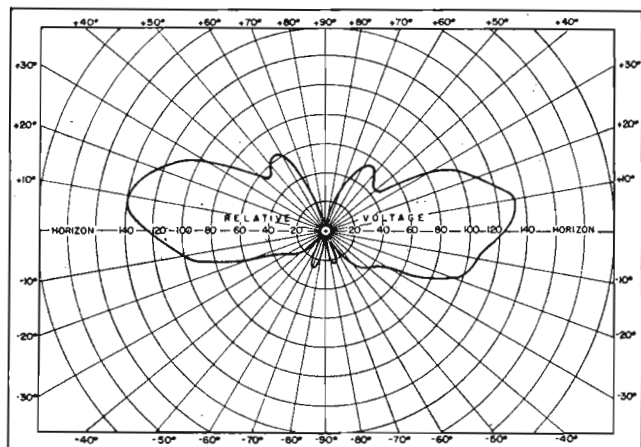
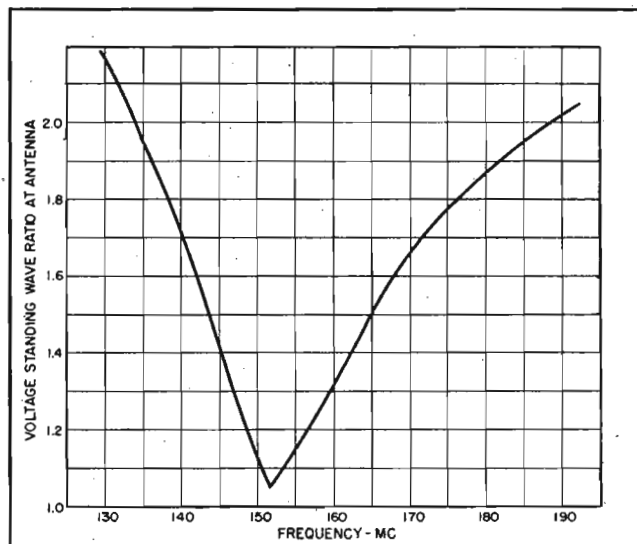

Figure 2 (above)
Experimentally obtained vertical radiation pattern of antenna.

Figure 4
A s-w-r versus frequency plot for the biconical antenna.



NEW VHF NAVIGATION

SYSTEM PROVED*

*** First Demonstrations at Indianapolis
Successful in Fog and Snow Storm**

On January 4-5, and again from January 20-23, a new VHF airborne receiving and indicating system, giving ADF type presentation, was successfully demonstrated in conjunction with the CAA's Omnidirectional Range at Indianapolis. The radio and instrumentation equipment was designed and built to specifications of Aeronautical Radio Inc. by the Collins Radio Company.

In full cooperation with commercial aviation in its untiring efforts to establish improved air navigation facilities, the Collins 51R system was speeded to completion by intensive engineering effort, and is the *first* of its type to be demonstrated. ARINC's Radio Equipment Committee and commercial airline engineers witnessed the earlier demonstration in the Collins flight research plane, a Beechcraft 18S. Fog and low-hanging clouds precluded any but instrument flying and provided ideal conditions for proving the effectiveness of the system.

The second demonstration was at the request of the Air Transport Association's Air Navigation Traffic Control Research Group for ATA members. The equipment was installed in ATA's experimental plane, a DC-3.

The Collins 51R Navigation System includes

a 280 channel receiver covering 108 mc to 136 mc in 100 kc steps and provides facilities for the following:

- a. Localizers, tone type (90/150 cycles), including flag alarm.
- b. Localizer, phase type, including flag alarm.
- c. Omnidirectional ranges, indicating on cross pointer meter, course chosen by manual course selector. Includes operation of ambiguity indicator and flag alarm.
- d. Omnidirectional ranges which, when automatically combined with magnetic heading information, provide automatic direction finding type of presentation in the cockpit.

The receiver utilizes the exclusive Collins Drift Cancelled Oscillator (DCO) circuit which provides extremely high stability and rejection of spurious signals. Two or more receivers can be operated with a single antenna.

These successful demonstrations are historic because they mark the first major step in the development of a complete, fully integrated system which will permit guided and controlled flight in any direction, on any track, to any point within the coverage of the basic radio facilities.

IN RADIO COMMUNICATIONS, IT'S . . .



COLLINS RADIO COMPANY, Cedar Rapids, Iowa

11 W. 42nd Street, New York 18, N. Y.

458 South Spring Street, Los Angeles 13, Calif.

PUTTING A NEW F-M STATION On The Air

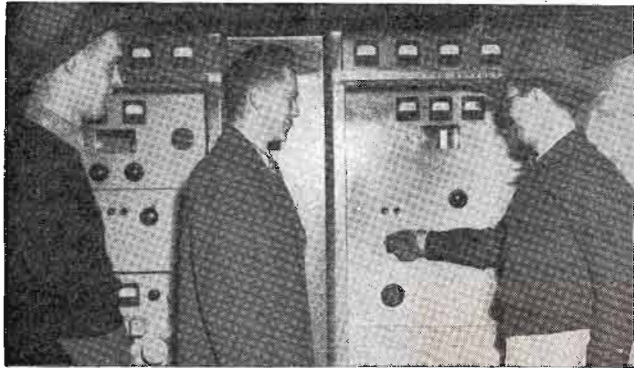

Figure 1
George W. Yazell at the controls of the WCFC f-m transmitter. At extreme left, Wally Warren, station engineer; center, Sid Doherty, announcer.

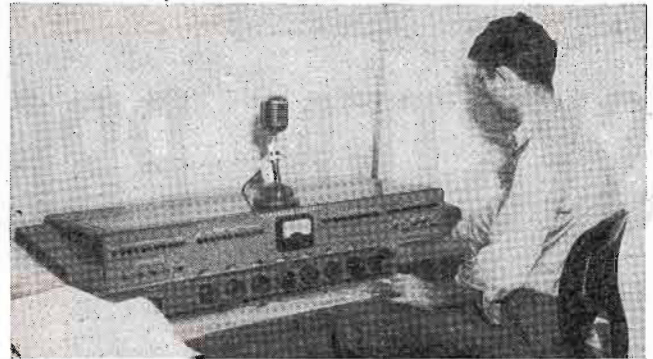

Figure 2
Lacking studio and office equipment the f-m console was tested while mounted on the packing case in which it was shipped.

WHEN THE DECISION WAS MADE to install an f-m station in our rural area, a step-by-step installation approach calendar was prepared. The first item on the program was, of course, site selection for the transmitter.

After weeks of tramping and searching, it was decided to locate the entire plant on a 2,500' peak in a residential section, overlooking and about a half mile from the business section. Factors contributing to its selection were its accessibility, availability of utilities, possibility of nearby quarters for the staff, and proximity to the center of the area we desired to serve. One of its finest assets was an abandoned

reservoir situated at the peak, constructed of doubly reinforced concrete and measuring 60' square and 17' deep.

The grounds were cleared and a tank prepared as a foundation for the building. This was a stroke of luck as our preparations qualified us for a permit to complete construction under the building restrictions imposed shortly thereafter.

Next Step—The Building

A combination studio-transmitter building was planned to fit the existing foundation, with all necessary working space on the first floor. The entire

basement, with the exception of space required for the air conditioning system, was left for future expansion. Everything looked rosy until we found that the FHA's blessing and money in the bank were not adequate to cope with building material shortages.

And so we found ourselves with our building only half completed when the 250-watt exciter unit¹ and studio equipment² arrived. These units, incidentally, were the second set off the assembly lines. We felt we could learn quite a bit about the transmitter's operation if we could set it up temporarily, a move which would also add impetus to our promotion campaign. So we asked the FCC if we could put the 250-watt signal on the air under a *Special Temporary Authorization*. Permission

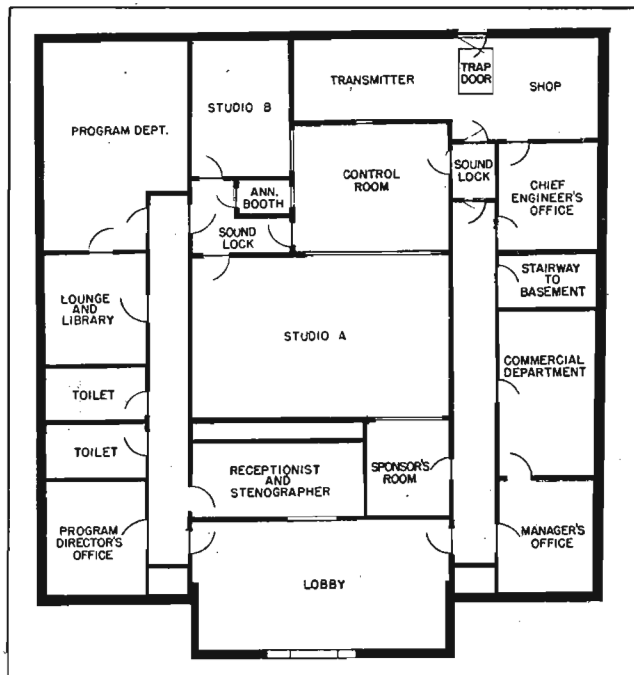

Figure 3
Floor plan of WCFC.

Figure 4
Mr. Yazell applying the finishing touches to the temporary 101.1-mc antenna, a composite turnstile. Temporary studios of WCFC are in building at rear.



Selecting the Site, Developing Makeshift Remedies for Factory-Delay Problems, Preparing for Temporary and Permanent Operation, and Organizing a Dealer-Station Program to Promote F-M.

by **GEORGE W. YAZELL**

Chief Engineer
WCFC, Beckley, West Virginia

was obtained and a small four-room apartment across the street from our permanent location was leased for the operation.

Incidentally, we are comparatively isolated from the large electronic supply centers, and thus many makeshift arrangements had to be used to establish our service as soon as possible.

Antenna Problem

Our antenna plans provided for the use of a two-bay *donut*³ antenna mounted temporarily on a 50' pole, but we were disappointed to learn that this unit would not be available for several months. We therefore decided to use a temporary setup featuring a single-bay turnstile antenna arrangement for our 101.1 mc frequency. The engineering staff designed and constructed the antenna and mounted on it a 40' pole made up of two lengths of 1½" galvanized pipe threaded together and guyed with sash cord. The antenna gave excellent service in all weather, with satisfactory reception reported by listeners as far as 37 air-line miles away; this in spite of its power gain of .5. Incidentally the entire antenna cost was in the neighborhood of \$25.00.

Polarization

A vertically polarized antenna having nondirectional characteristics would have been simpler to build and would have been approved by the FCC, but since horizontal polarization was to be used eventually and manufacturers are producing horizontal antennas for home installation it was felt the turnstile was preferable.

RG-8/U cable (51.5 ohms) was found to serve nicely for this amount

of power. The r-f loss is high enough to cause it to run slightly warm when handling 250 watts at 100 mc. This affords an easy check on proper impedance matching, since standing waves produce noticeable warm spots.

Copper Pipe Dipole Elements

Three-quarter-inch copper pipe was chosen for the dipole elements since it was large enough to make the antenna reasonably broad in frequency response and consequently the length of the dipole elements was not too critical.

Program Service

Program service was initiated August 15, 1946, and continued on a seven-hour-a-day basis until February 7, 1947. The project proved more than successful since it gave the engineering staff an opportunity to become familiar with the operation of the equipment, remedy a few defects that came to light in the early models, and at the same time continue with the preparation of the permanent location.

In addition, public enthusiasm for f-m was heightened and dealers had an opportunity to demonstrate their f-m models.

New Tower

During the period of temporary operation a 242' tower was erected and the commercial two-bay antenna mounted. The building construction progressed in spite of adverse weather and when the 1-kw amplifier arrived in February all was in readiness to

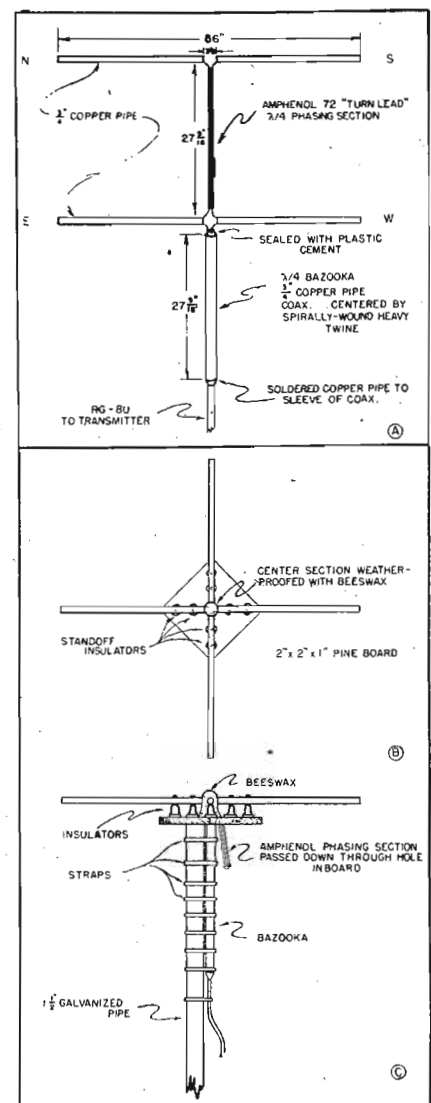

Figure 5

The composite single-bay turnstile antenna. At *a* appears the schematic of the complete antenna; at *b*, the top view; and at *c* the side view.

move the transmitter to its permanent location, even though the studios and offices were not complete. After a short silence necessitated by moving the exciter unit to the new building, we returned to the air February 28th, with an effective radiated power of 1,500 watts.

Coverage

While we have not had an opportunity to accurately determine the extent of our coverage, we have been pleased to receive reports of reception up to 83 miles away, which considerably exceeds the calculated coverage for this power.

Our station, one of the first f-m broadcasters to take the air in West Virginia, was also one of the first to operate in the Southeast.

1, 2, 3General Electric.

MAGNETIC PLAYBACK-RECORDER

Using Paper Discs



Figure 1
Paper disc recording-playback unit. Note grooved plastic disc.

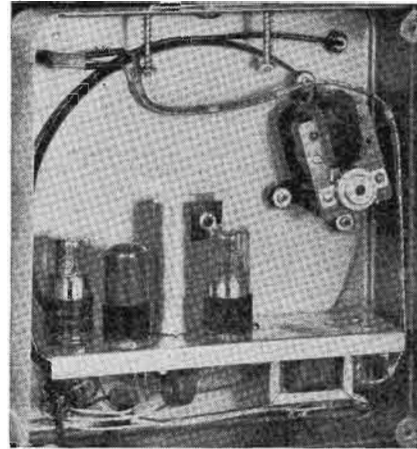

Figure 2
Interior view of the magnetic recorder-playback container.

by JOHN H. JAMES

The Brush Development Co.

IN DEVELOPING MAGNETICALLY-COATED paper materials for recording and playback, and studying the applications of various sizes and shapes of papers, it was found that disc-shaped coated stock displayed many possibilities. Possessing magnetizing and demagnetizing properties, the paper was

Unit Uses Magnetically-Coated Paper Discs That Can Be Folded, Discs Having High Coercivity to Provide Low-Speed Recording.

found to be creasable without influencing recording or playback properties.

As a result of this analysis, a paper-

¹Mail-A-Voice.

disc unit project was initiated, and the device¹ shown in Figure 1 developed.

An interesting feature of the unit is the guide groove. Since it was not
(Continued on page 55)

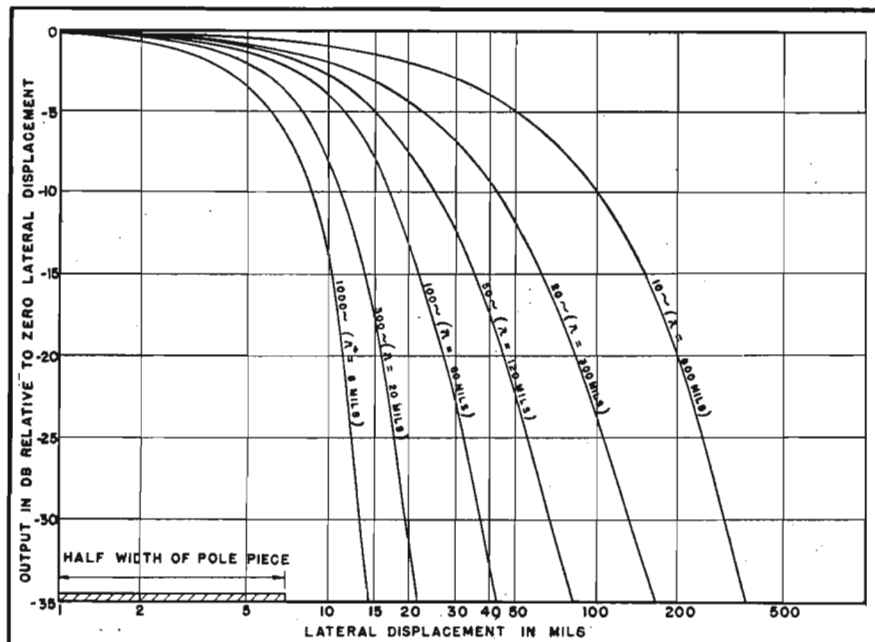
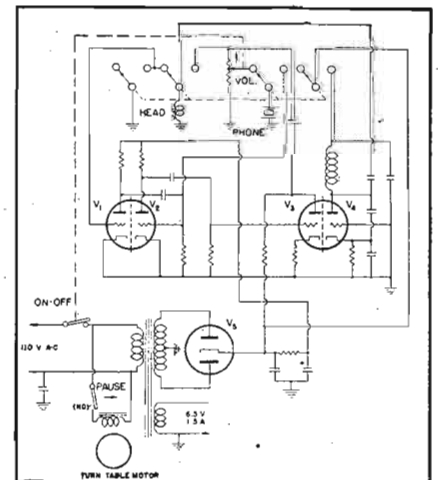

Figure 3
Family of curves showing playback level at different displacements and frequencies for a tape speed of 6 inches per second.

Figure 4
Circuit of the paper disc playback-recorder.





GUARDIAN Stepping relays

FOR SELECTION AND CONTROL OF MULTIPLE CIRCUITS

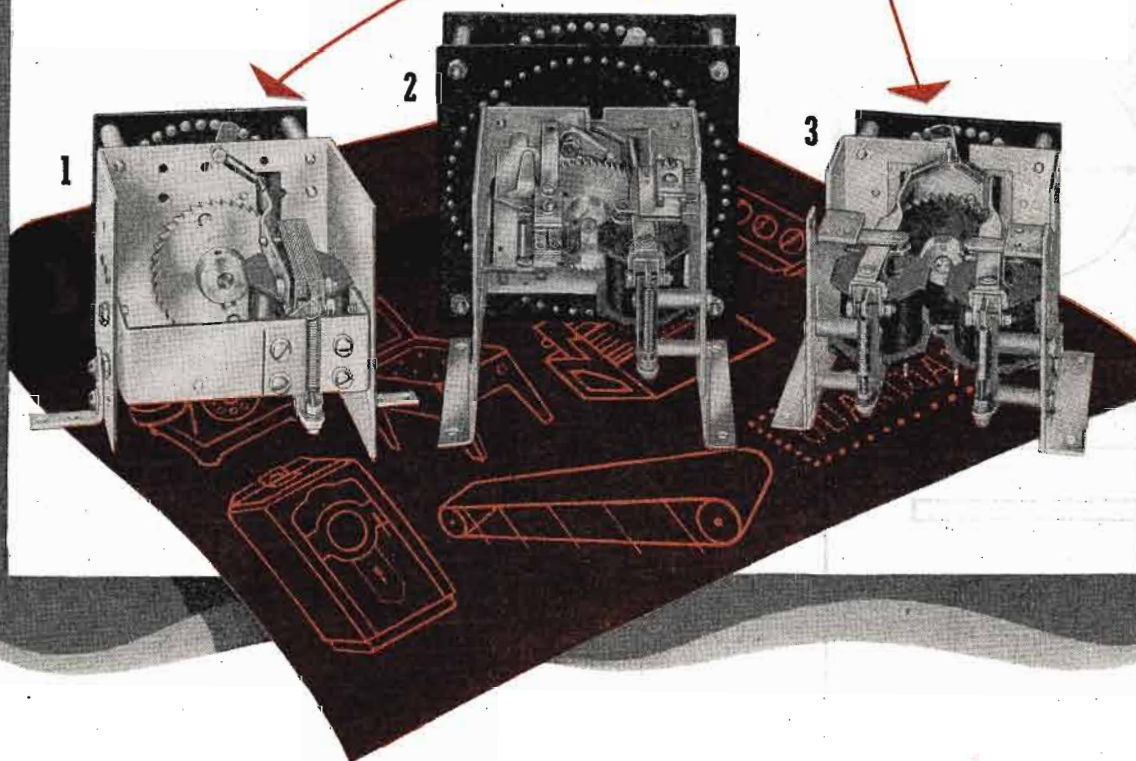

This trio of standard Guardian Stepping Relays: (1) continuous rotation, (2) electrical reset, (3) add and subtract—will start you off with a minimum of design and keep your product operating indefinitely. The Guardian Steppers shown are adaptable to numerous applications: automatic circuit selection; automatic sequence selection of circuits; automatic sequence cross-connection of circuits. They are used in automatic business machines, production totalizers, conveyor controls, animated displays, telephony, remote tuning, with a host of additional uses you will soon discover. On each, the contact finger rotates counter-clockwise. All three Steppers follow 10 pulses per second within the rated voltage range of the relay. Special construction prohibits skipping or improper indexing of the ratchet. Available in separate units or in combination with relays, contact switches, solenoids; completely assembled and wired to terminals; mounted on special bases or in enclosures. "Special" modifications are obtainable in production quantities. Write for Bulletin SR.



Series 100 Snap-Action Relay



Guardian Featherrib Switch

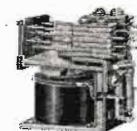

Series 500 Midget Relay



Series 1-A Solenoid

GUARDIAN



ELECTRIC

1610-D W. WALNUT STREET

CHICAGO 12, ILLINOIS

A COMPLETE LINE OF RELAYS SERVING AMERICAN INDUSTRY

Loop Antennas For F-M BROADCASTING

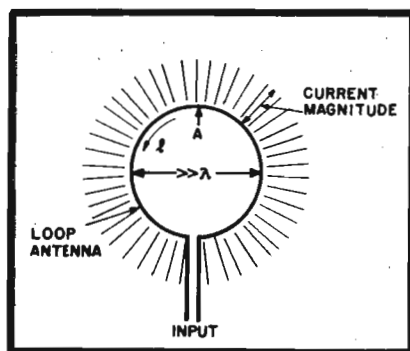

Figure 1

The current distribution around a loop antenna whose diameter is very small with respect to the wavelength, λ , at which it is being used.

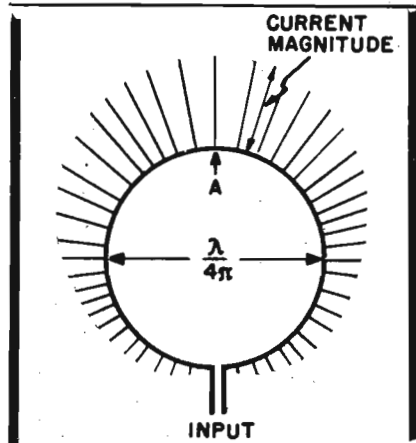

Figure 2

The current distribution around a loop antenna whose circumference is equal to a half wavelength at the frequency being used.

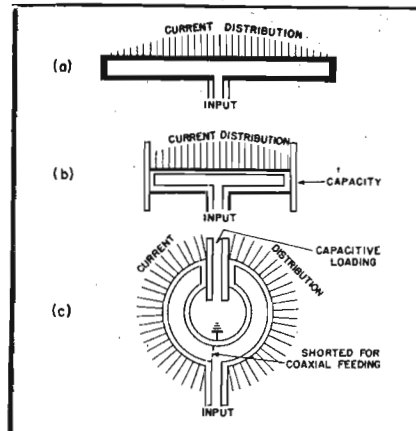

Figure 3

The evolution of the f-m circular antenna from an ordinary folded dipole. At (a), folded dipole; (b), folded dipole with end capacity added; (c), elements of (b) bent into a circle.

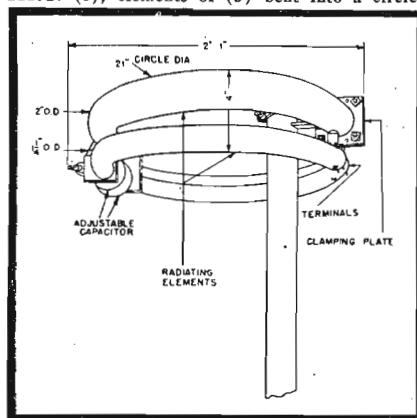

Figure 4

Constructional details of the f-m circular transmitting antenna employing a capacity-loaded folded dipole.

(Courtesy G.E.)

THE F-M BROADCAST radiating system usually consists of an array of individual antennas providing horizontally polarized radiation.

It is preferable to install the radiating system on the tallest point in the center of the area to be covered. For maximum efficiency, therefore, the horizontal radiation pattern of each antenna must be omnidirectional. When installation in the center of the area to be covered is not possible, then the horizontal radiation pattern should provide a uniform field strength over the desired region. Each antenna must direct its radiated energy in the horizontal direction; the higher this directivity, the fewer the antennas that have to be stacked to obtain the desired horizontal gain.

Each antenna should be noncritical, easy to feed, simple to adjust and preferably capable of adjustment at the factory before shipment so that no adjustments need be made upon installation. The antenna should not be affected by changes in the weather; but, if it is affected by the elements, such as ice, then precautionary devices, such as deicers, should be provided. Other required antenna features include lightness and sturdiness to allow mounting on a tall mast; the taller the mast, the higher the horizontal gain.

Many antennas have been designed to meet the foregoing requirements, with the basic designs of most employing variations of the horizontal loop antenna or variations of the turnstile antenna.¹

The Loop Antenna

The horizontal loop antenna, or magnetic dipole as it is sometimes called, has the proper omnidirectional horizontal radiation pattern. It also has some vertical directivity and can be easily stacked in an array. But, an ordinary loop antenna, when used in the 100-megacycle band, has too low a

radiation resistance for practical use. The ordinary loop antenna, as used in the lower frequency bands, consists of a number of turns of wire around a loop whose dimensions are very small with respect to a wavelength. Actually, the total length of wire—from one terminal, around the several turns and back to the other terminal—is usually negligible with respect to a wavelength. For 100-megacycles, even if only one turn should be used, the loop dimensions would have to be so small that its radiation resistance would be exiguous; it would be extremely difficult to feed and adjust.

The problem of loop design is mainly one of current distribution in the radiating elements. In Figure 1 is shown a loop antenna whose diameter is very small with respect to the wavelength, λ , at which it is being used. The magnitude of the current around the loop is indicated by the height of the shading around the circumference of the loop. A close approximation of the current distribution can be obtained by assuming that the distribution is the same as that of a lossless transmission line. Hence the loop, for purposes of determining the current distribution, can be assumed to be a lossless transmission line fed at the input and shorted at the point A , equidistant from the balanced input terminals. The distribution will follow the equation

$$I_l = I_{\max} \cos \frac{2\pi l}{\lambda} \quad (1)$$

where l is the distance, measured in the same units as the wavelength, from the point A along the circumference to the point at which the current magnitude I_l is desired. I_{\max} is the current magnitude at the point A , its maximum value. Inasmuch as this distribution follows a cosine curve, for small values of l the current will be constant; this is illustrated in Figure 1 where the diameter of the loop is very much smaller than a wavelength. The radiation pattern for this type of loop is

¹R. F. Holtz, *Super-Turnstile Antenna*, Sixth Annual Conference of Broadcast Engineers, Columbus, Ohio; COMMUNICATIONS, April, 1946.

A Discussion of F-M Antenna Requirements and the Fundamental Application of the Loop Antenna and Its Modifications, the Circular and Square Types, for F-M.

by **N. MARCHAND***

Consulting Engineer
Lowenherz Development Company

omnidirectional in the plane of the loop.

When the diameter is increased, to obtain a higher radiation resistance, the current no longer remains constant around the circumference and the radiation pattern begins to distort. For a

diameter of $\frac{\lambda}{4\pi}$, about 10" at 100 meg-

acycles, the current actually falls to practically zero at the input, as shown in Figure 2. The pattern will no longer be omnidirectional.²

The F-M Circular Transmitting Antenna³

In Figure 3 is shown the evolution of the f-m circular antenna from an ordinary folded dipole. In (a) is illustrated an ordinary folded dipole. The current distribution is maximum in the center of the dipole and falls to zero at either end as shown. The dipole can be shortened and the current made more uniform along the length by capacity loading on the ends of the

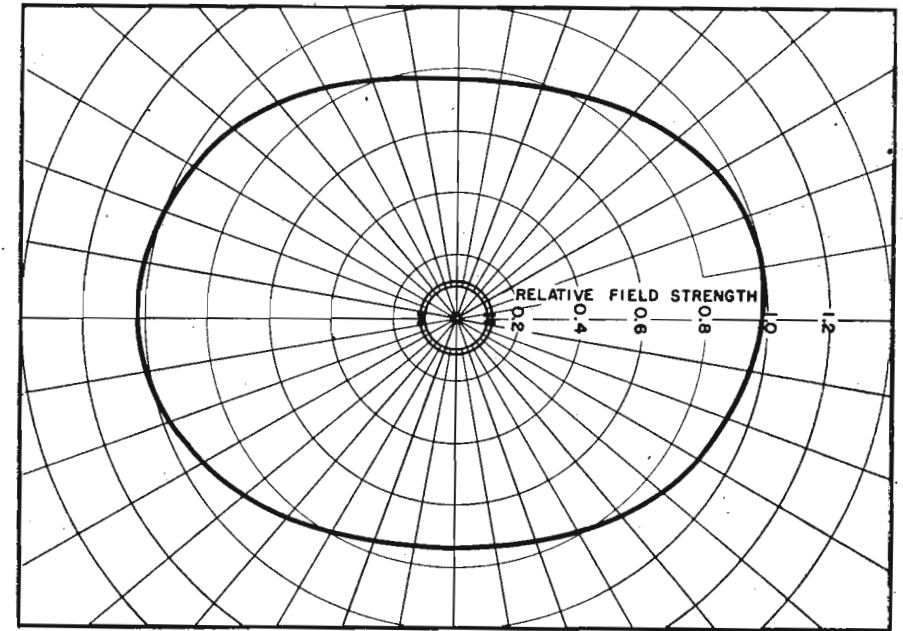

Figure 5
Experimental horizontal radiation pattern of the circular f-m antenna illustrated in Figure 4.

dipole. The effect is similar to the effect of a hat on a vertical broadcast antenna. The capacity takes the place of a portion of the antenna, replacing the low-current end segments. The elements of the shortened, folded dipole are then bent into a circle. The two capacity elements now approach one another forming an air capacitor where provision is made for adjust-

ment of the capacity value. The current is not exactly uniform but it is symmetrical enough to give a substantially omnidirectional pattern.

In Figure 4 appears the constructional details of the final antenna. Its overall diameter is 25" and it employs 2" and 1 1/4" o-d pipes for the antenna proper.

Normally this type of antenna would be fed with a balanced line or, if a coaxial line is used, some type of con-

(Continued on page 62)

²J. B. Sherman, *Circular Loop Antennas at Ultra-High Frequencies*, Proc. IRE; Sept. 1944.

³M. W. Scheldorf, *F-M Circular Antenna*, General Electric Review; March 1943.

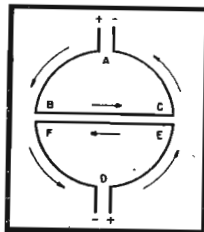

Figures 6 (above) and 7 (below)

Figure 6: Basic operating principle of the u-h-f loop antenna showing how two small loops are effectively placed back to back to create a larger loop. Figure 7: The two-element u-h-f loop modified to permit coaxial line feed. The coaxial line is fed through the mast that supports the loop proper.

(Courtesy FTR)

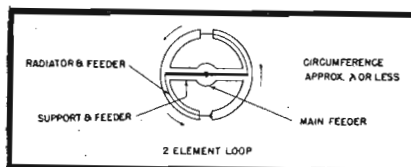
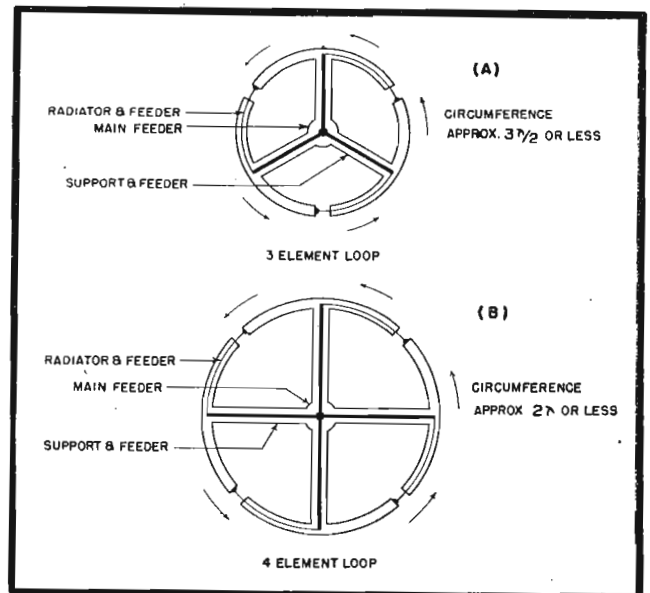

Figure 8
Three and four-element u-h-f coaxial-fed loops. Each added element allows the circumference of the loop to be increased a half wavelength.
(Courtesy FTR)



FIVE-STATE ONE-FREQUENCY LINK For Emergency Communications

Use of Single Frequency, 37,900-kc, By Ohio, Western Pennsylvania, New York, Virginia and West Virginia, Provides Coordinated Law-Enforcement Operation Between States, Counties, Car-To-Station and Car-To-Car.

by FRED E. EBEL

"FORGET FREQUENCY ALLOCATION problems. Put all your central stations and mobile units on one frequency!" That was the advice offered five years ago to the Ohio *city police* and *county sheriffs*. They not only adopted the idea, but today the network plan, using 37,900 kc as the frequency, has spread to the neighboring states of New York, Western Pennsylvania, Virginia, and West Virginia.

As for the boggy of interference, operating experience has demonstrated very little annoyance. True, in congested areas where several stations overlap there is some difficulty in this respect, but even here brevity in dispatching has alleviated the condition.

Far offsetting this factor are the tremendous gains in overall efficiency. Law enforcement officials have reported a greater number of apprehensions brought about by better coordination between departments. Flexibility is the keynote of the system. Not only is it possible to communicate county-to-county and car-to-station, but all patrol cars can also contact each other.

The ability to enlist the aid of cars in surrounding areas is particularly important during times of emergency. The recent flood in the Elmira, New York, section demonstrated dramatically the real worth of one-frequency operation. Here flood waters wiped out telephone communication for 36 hours, and the only medium of communication available to city police was 2-way radiotelephone. Yet, because surrounding municipalities and counties could hear the fate of their neighbor, sheriffs *four counties away* were able to lend patrol cars to the stricken area.

This vitally-needed assistance enabled authorities to delegate several cars for investigation purposes. A

rumor, for example, that a dam was on the verge of breaking was quickly squelched when a dispatched radio car called back that the dam was not only intact but showed no danger of breaking. Had this rumor not been quieted it is quite possible that panic with its tragic consequences could have developed.

But because the communications systems were operating on one frequency there was complete coordination with the result of greatly lessening the destructive effects of a natural disaster.

Car Theft Reduction

One-frequency operation has also proved its effectiveness in diminishing the number of car thefts. Police of Mansfield, Ohio, for example, have been able to set up efficient blockade systems even after the stolen-car chase has led them beyond the reliable range of the main station. During such emergencies, assistance requests are made car-to-car without the time-consuming procedure of relaying for aid through the central station.

With car efficiency increased approximately 100%, the law breaker, in trying to escape from the 37,900-kc network, finds himself involved in a sort of "chain reaction" where one communication system sets off another.

Plan Originator

The one-frequency plan was conceived by Eugene S. Goebel¹ five years

¹Acting Director of Sales, Communications and Electronics Division, Motorola Radio.
²Motorola.

ago. Now throughout New York State, Virginia, and Ohio, alone, there are thirty-nine 2-way radiotelephone central stations² with over 400 mobile units.

Over 100 miles of the rich Shenandoah Valley with its numerous gaps and grottoes are radio covered by five central stations located at Staunton, Harrisonburg, Winchester, Waynesboro, and Martinsburg. Other Virginia installations are spotted at Bristol, Petersburg, and Portsmouth.

Romney, W. Virginia, the state police station, monitors 37,900 kc. The Ohio State highway patrol stations also provide a complete tie-in with other systems by monitoring 37,900 kc at Wilmington, Findlay, Massillon, Cambridge, and Columbus. Ohio's municipal police and sheriff's systems reciprocate by monitoring the highway patrol's frequency of 1,730 kc.

Dispatcher Familiarity

Much of the efficiency of the 37,900-kc network can be credited to what might be termed *dispatcher familiarity*. It is only human nature to cooperate more fully with a known voice than with an utterly strange one.

The one-frequency *party-line* system displays another interesting facet—that of preparing communities miles away of a spreading crime wave. If a series of drug-store robberies, for instance, plagues one community, it is the immediate concern of all adjacent communities to set up *traps* at their own drug stores, just in case the hoodlums labor under the delusion that distance lends freedom and virgin territory.

Yes, *one-frequency* operation has proved to be an efficient communications tool for law enforcement.

KFI
640 K.C.
50,000 WATTS
N.E.C. AFFILIATE



141 N. VERMONT AVE.
LOS ANGELES 4
CALIFORNIA
PAID 1947 9121

Paul C. Anthony, Inc.

January 6, 1947

Mr. John Hilliard
Altec Lansing Corporation
1161 North Vine Street
Los Angeles, California

Dear Mr. Hilliard:

The purpose of this letter is to tell you about the performance of the type TI-401 Signal Generator and the type TI-402 Intermodulation Analyzer which we recently purchased from you.

We have found the equipment extremely useful for the following operations: 1. Reducing intermodulation distortion in our 50 KW transmitter; 2. Reducing distortion in our speech input equipment; 3. Routine checking of speech input equipment; 4. Indispensable in building special equipment for broadcast purposes such as echo devices, filters, etc.; 5. Indispensable in our Recording Department for checking cutter head performance, playback heads, equalizing amplifiers, compression devices, etc.

We consider it one of our most valuable tools.

Very truly yours,

H. L. Blatterman
H. L. Blatterman
Chief Engineer

MEMBER NATIONAL ASSOCIATION OF BROADCASTERS



A BUSY ENGINEER took time out to write and tell us, point for point, about the tremendous success his station has had with the Intermodulation Analyzer. Its use is not limited to broadcasting stations. Scores of organizations are enjoying similar benefits. Find out how it can be of help to you. Write us for technical data on the TI 401 Signal Generator and TI 402 Intermodulation Analyzer.

ALTEC
LANSING CORPORATION

1161 N. VINE ST., HOLLYWOOD 38, CAL.
250 W. 57th ST., NEW YORK 19, N. Y.

"KEEP ADVANCING WITH ALTEC LANSING"

'Indispensable'
writes a
Broadcasting Engineer
about the

ALTEC LANSING

Intermodulation
Equipment

LATERAL Recording

MANY RECORDING setups do not have the facilities to measure the cutter head at the necessary frequencies. An arbitrary choice can be made, which will be quite satisfactory, if the resistance is made nearly equal to the amplifier output impedance.

Several typical setups are shown in Figure 5.

Several methods can be applied to determine when the cutter has the desired characteristics. One, which is tedious, involves the use of a calibrated microscope to measure the amplitudes cut at the different frequencies. In another method a frequency run is played back through a calibrated playback system. A much simpler method is the so-called *Christmas-tree* pattern. This pattern can be seen if a recording of bands of frequencies is made by the head starting at one end of the frequency band to be used, usually fifty cycles, and recording bands at 50-70-100-200-300-500 - 800 - 1000 - 2000 - 3000 - 4000 - 5000-6000-7000-8000-9000 and 10,000 cycles.

Recording a Frequency Run

In making the aforementioned frequency runs, each amplifier compo-

by **W. H. ROBINSON**

Technical Advisor
Kasper-Gordon, Inc.

nent in the setup is put through a test run, and then a composite frequency run of the entire amplifier setup from the input of the system to the output is taken. For the latter run, however, the head should be disconnected, and the output of the amplifier terminated with a resistance load of the proper value. The overall amplifier system should then be adjusted to give linear frequency response over the range in which it is desired to have the cutter work. Care should be taken to insure that the output is as free from distortion as possible. Normally, the output stage should be capable of supplying at least ten or twelve undistorted watts. However, it is much better to use an output stage capable of supplying up to fifty watts of undistorted power.

After the system has been adjusted to the proper frequency response, the

cutter head may be connected to the amplifier with its corrective network, and an actual recording can be made of the frequency versus velocity characteristics of the entire system. In making the test, an audio oscillator is fed into the input terminals of the amplifier system. The level is adjusted to that suitable for the head in use. If a *v-i* is used across the output, the level should be adjusted so that the maximum level fed to the head and the corrective network is not greater than that specified by the manufacturer. A simple cut should then be made at the turnover frequency and inspected to see if the level is too high or too low in the groove; this can be ascertained with a microscope. If the groove is not fully modulated, the level can be adjusted in 2 db steps; a check being made with the microscope each time until the correct level is ascertained. It would be wise to reduce the actual top indication used below this value for the complex type of cut, as the meter will not indicate instantaneous peaks. A *v-i* may be used at the input of the system for setting the level, but great care must be taken to insure that the level fed to the head is not too great, otherwise damage to the cutter head will ensue.

Recording at 78 RPM

In the next step another series of frequencies are recorded at 78 rpm, each frequency recorded for ten seconds with approximately five seconds blank groove left between frequencies. If the head travels toward the inside

Figure 4

Ideal recording curve of frequency versus velocity of the stylus point using a 500-cycle turnover point. The stylus velocity is constant above this 500-cycle turnover point while the recorded modulation in the groove has an amplitude which decreases with frequency above this point. Below the turnover point the velocity decreases with frequency and amplitude of the modulation in the groove remains constant.

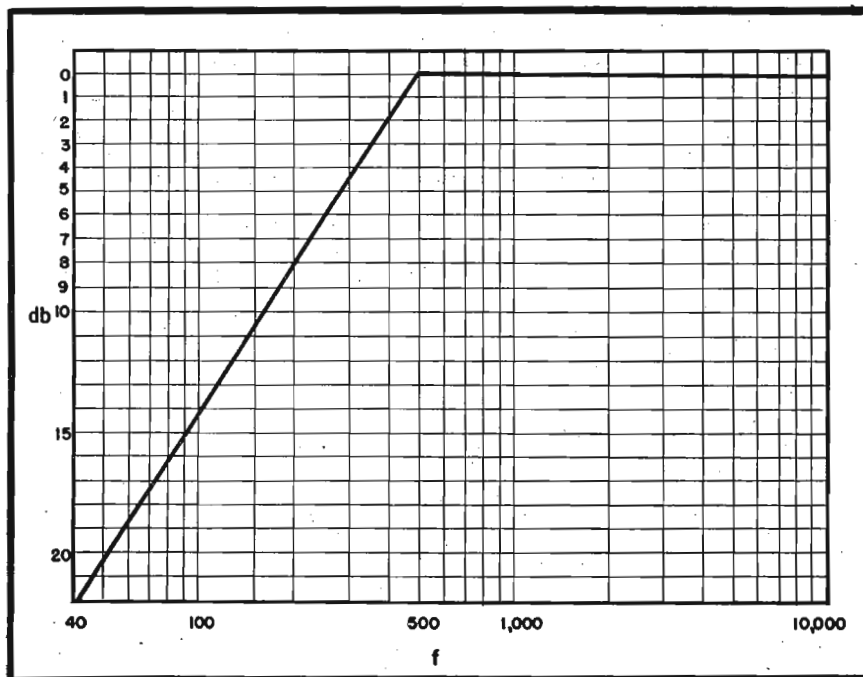
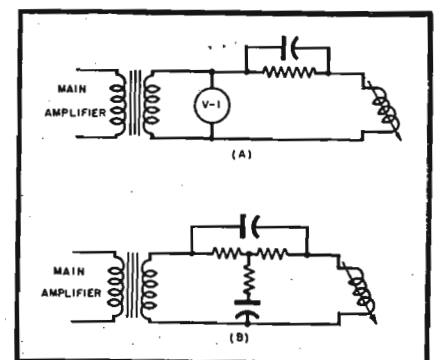
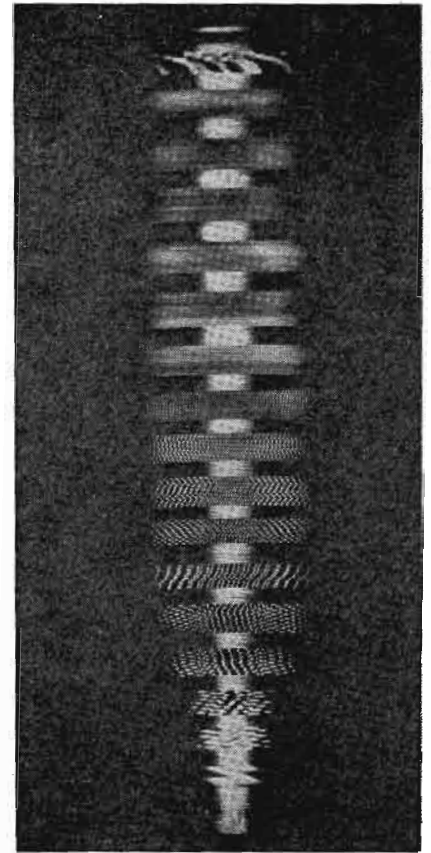
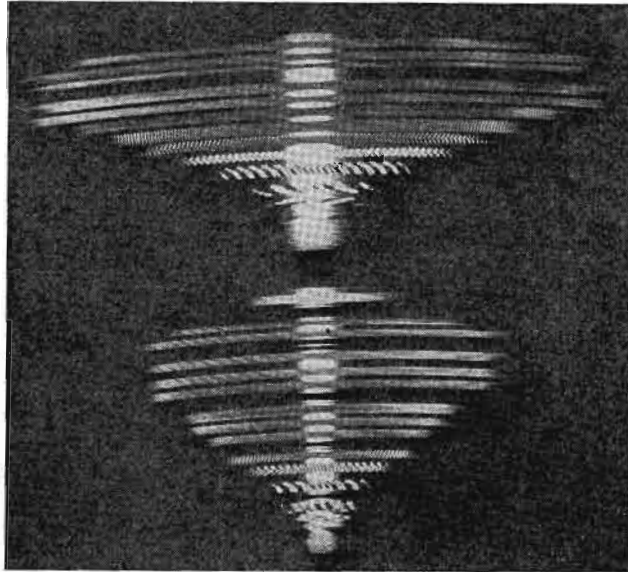

Figure 5

Two variations of equalizers or networks which are used to correct the load offered to the amplifier by the cutting head. In (B) we have a method for correction of a constant load and at the same time correcting for some of the deficiencies in frequency response of the cutter.



Second Installment¹ Covers Measuring Setups, Frequency Run Recordings, Styli, Cutting Angles, Discs, Scratch Filters and Preemphasis.



Figures 6a (above) and 6b (right)

of the disc, the frequencies should be recorded in the following order starting at the outside of a 12" disc: 500 - 10,000 - 9,000 - 8,000 - 7,000 - 6,000 - 5,000 - 4,000 - 3,000 - 2,000 - 1,500 - 1,000 - 800 - 500 - 300 - 200 - 100 - 70 - 50 cycles.

After the runs have been made, the disc is taken from the table and placed beneath a strong light so that a distinct pattern can be seen; Figure 6. This pattern actually shows the velocity of the stylus point. Therefore, for frequencies above 500 cycles, it should have straight sides as the velocity is constant. Below this frequency, assuming of course that 500 cycles is the turnover frequency, the sides should slant inward in the manner of a triangle.

Recording Frequency Runs at 78 RPM

The actual response of the head shows up much truer when recorded

Figure 6a illustrates two response patterns, each from a different head. They are far from those desired as the upper frequencies are decidedly peaked, resulting in shrill response. In Figure 6b appear a near ideal response pattern of cutting assembly and associated equipment as found by methods discussed in paper. The frequencies starting at the small tapered end of the pattern are: 50-70-100-200-300-500-1,000-1,500-2,000-3,000-4,000-5,000-6,000-7,000-8,000-9,000 and 10,000 cycles. The turnover frequency of this system is 500 cycles. The pattern traces the stylus velocity and as can be seen is very nearly constant for the frequencies above 500 cycles where the stylus velocity is supposed to be constant.

at 78 rpm than at 33 1/3 rpm, unless a large disc is used for the runs. Analyzing this rather odd situation, we find that when a record is being cut, the stylus cuts a longer length of groove at the outside edge of the disc in a given length of time, than it does as it approaches the inside of the disc; Fig. 7.

The actual ratio of groove length between the outside of the disc and a

groove cut 3" from the center of the disc is 2.625 approximately. This means that for every inch of groove cut at the outside edge of the disc, the stylus cuts a groove only 1/2.625 of an inch at a point 3" from the center. With the disc passing beneath the stylus at 33 1/3 rpm approximately 2.3 as much information, music, etc., must be cut in a given length of groove than if it were travelling at 78 rpm (78/33 equals approximately 2.3). At the higher frequencies to be recorded a great many excursions of the stylus must take place in a comparatively short length of groove. The stylus must trace the modulation in the groove without distorting it. Now as the groove length becomes shorter and shorter, the inside diameter of the disc is approached. The modulation

Figure 6

Proper arrangement of light source and disc to evaluate frequency response pattern of a recording system with the so-called 'christmas tree' pattern.

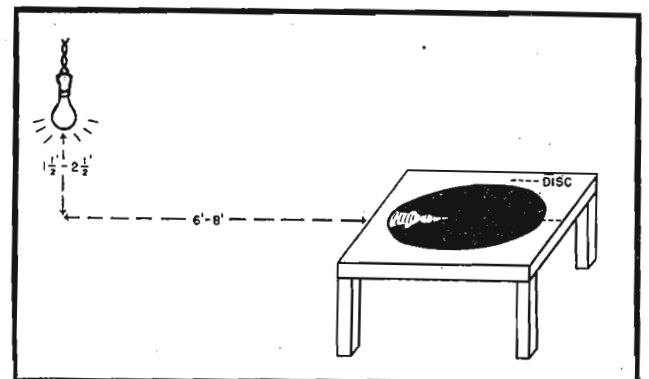

¹First installment appeared in the February issue of COMMUNICATIONS.

traces are crowded closer and closer together until a point is finally reached where they are, in fact, so crowded that at ordinary levels the stylus is not able to trace the higher modulation frequencies, so that the playback is able to reproduce them. To overcome this, the higher frequencies must be progressively increased in level as the stylus approaches the center of the disc, thus keeping the response of the recording nearly normal to an inside diameter of seven inches. It is actually a practical impossibility to keep the response exactly normal, especially at the extreme upper frequency limits, but it is possible in this manner to keep the response normal as far as the average ear is concerned. The reproducer needle provides another interesting effect. Its diameter is great enough at the higher frequencies at the inside of the disc so that the actual radius of curvatures of the modulation in the groove is less than the radius of curvature of the reproducer needle point. The reproducer needle has difficulty in following these frequencies under these conditions, further contributing to decreasing frequency response as the inside of the disc is approached.

The equalizer that overcomes this is called the *diameter equalizer*. One of the best-known cutting assemblies has the equalizer mechanically connected to the travelling head so that the equalizing is accomplished automatically. In many setups, the equalizing is done manually. Starting at approximately six minutes in on the recording, for a fifteen-minute recording, the equalizer is adjusted approximately 2 db per minute of cutting. It will be found necessary to reduce the low frequencies slightly below 150 cycles also; this is taken care of in the equalizer design.

As a precaution, the level for recording the frequency run should be approximately 6 db below normal program level. As another precaution it is necessary to see that the head is not fed a continuous voltage for any length of time from the audio oscillator; otherwise there will be a tendency for the head to heat up, resulting in head damage. With complex waves, such as we have when recording a program, the peaks do not occur continually and the head is not working as hard as it is under the above mentioned conditions.

If the cutter travels from the inside to the outside of the disc, the frequency run can be started about four minutes from the outer edge of a 12" disc, and the order of recording of the various frequencies is reversed. The resulting pattern should be the same

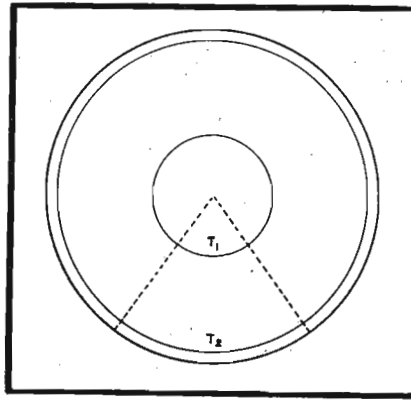

Figure 7

A graphical analysis of stylus travel; for any given length of time the distance travelled by the disc beneath the stylus is considerably shorter near the inner portion of the disc than it is at the outside edge. In the figure T_1 equals T_2 and refers to the time it takes for the disc to travel the distance between the dotted lines intersecting the two grooves. This variation in the length of groove cut in a given time as the cutting stylus approaches the center of the disc results in the modulation being compressed more and more as the center of the disc is approached. This combined with the fact that the disc travels $1/2.3$ as fast at $33\ 1/3$ rpm as at 78 causes the difficulty in recording and reproducing the higher frequencies when cutting at the slower speed.

as the one previously shown. In many cases, the pattern shows marked deviation from the proper pattern, and should be corrected. If a peak shows up it will usually be between the turn-over frequency and the highest frequency to be recorded. This can be corrected by equalizing the amplifier, or correcting the cutter head filter to bring the response at the point back to normal. It is not within the scope of this article to discuss equalizers or corrective filters. However, many heads as they age develop a peak in the range between 500 and 10,000 cycles, due to various reasons such as mishandling, aging of the damping material in the head, dirt collecting on the armature, etc. The proper procedure is, of course, to send the head back to the manufacturer for adjustment. If this is not feasible, the corrections mentioned previously may be applied. It is always better to have a cutter head that operates properly than to try to get around the faults by corrective measures. The cutter head is a delicate instrument and should be treated with the utmost respect if the best results are to be obtained from it.

Styli

There are several types of styli in use today; stellite, steel, and the stylus with an aluminum shank and a sapphire cutting point. The last mentioned is the best from the standpoint of a quiet groove, frequency response, and length of life. The all steel stylus be-

comes noisy after about fifteen minutes of use and cannot be resharpened, while the sapphire will last about six to ten hours of recording time and can then be resharpened at a fraction of the cost of a new sapphire. The initial cost of the sapphire is approximately six to eight times the cost of the steel stylus, but in the long run is much more economical than the steel stylus. The stellite stylus ranks next to the sapphire.

The styli used today in the instantaneous recording systems have a flat on the shank which faces the front so that it can be held firmly in place by the set screw. It is impossible to get the stylus in the chuck improperly if any care is used at all.

The stylus should be inserted all the way into the chuck. The practice of some technicians of drawing the stylus part way out of the chuck to get the proper cutting angle is not a good one. As we have already discovered, it requires considerable care to achieve high quality records and it doesn't take a very high degree of carelessness to cause considerable loss of high-frequency response in the recording process. Unless the stylus is inserted as far as possible into the chuck, it is possible for it to dampen the vibrations at the higher frequencies. Another *must* is that the set screw must be tightened firmly to ensure that the stylus is held firmly in the chuck. Any play or looseness of the stylus will cause considerable loss at the higher frequencies and at the same time create undue distortion. The angle of the stylus point with respect to the surface of the disc being cut is also important. A wrong cutting angle can cause unnecessary noise in the cut and can even, in extreme cases, be the cause of ruining the point of the stylus.

Cutting Angles

It is a simple matter to adjust the cutting angle of the stylus properly. Most cutting assemblies have some provision for adjusting this angle. The correct procedure is to place a disc on the cutting table and then set the assembly on the table in position for cutting. The cutting head is then moved to a position near the outside edge of the disc, the cutting head gently lowered so that the stylus point rests on the surface of the disc (the table is of course stationary). Now with the eye level with the top of the table on the side opposite that on which the stylus rests, we sight across

(Continued on page 58)

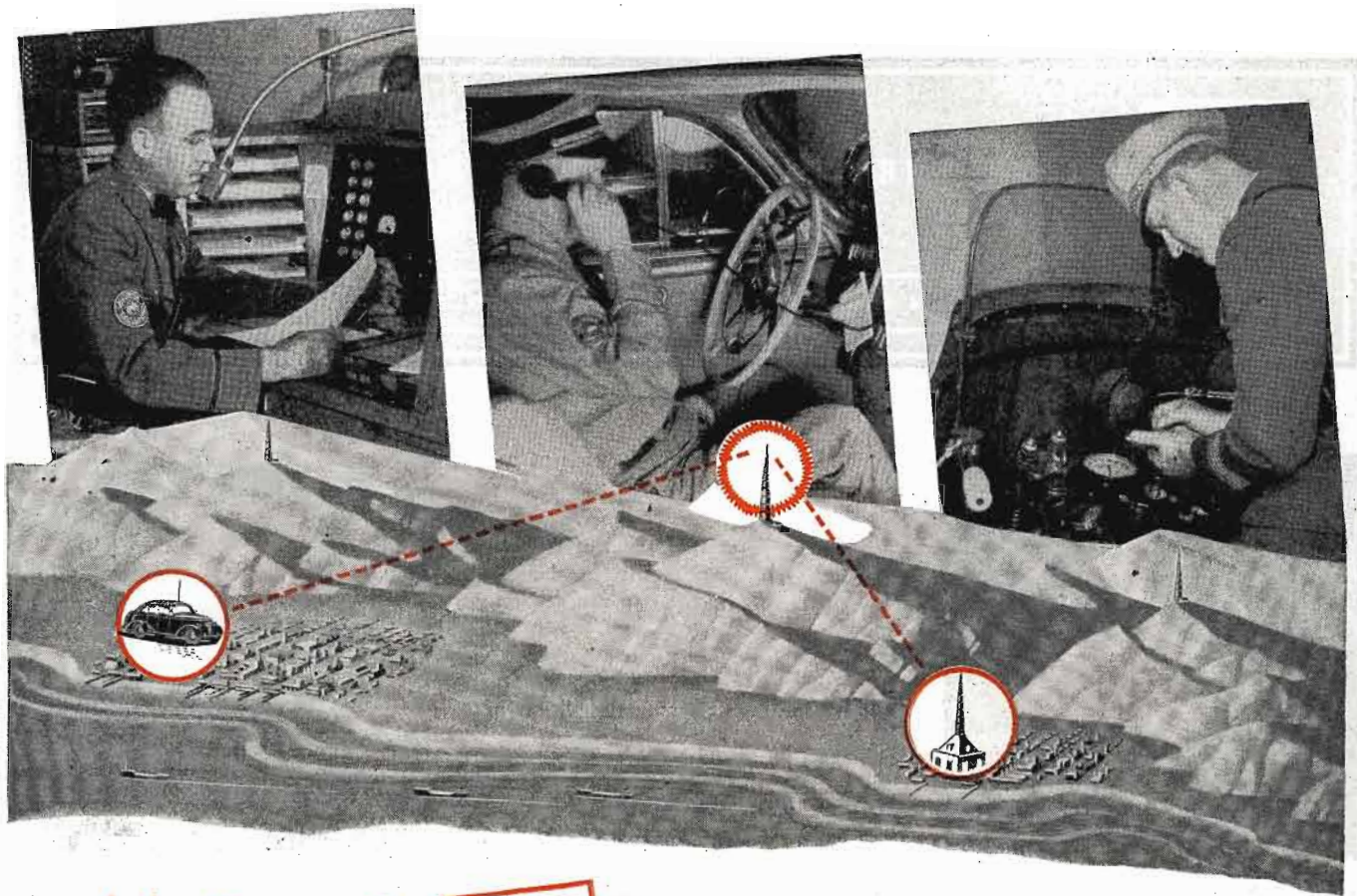

Motorola **F-M** Radio Makes MOLEHILLS out of MOUNTAINS!



When tremendous natural barriers like the lofty Sierra Nevadas presented seemingly insoluble problems in California's state-wide radiotelephone coverage . . . Motorola 2-Way F-M Radiotelephone units came through with all the answers.

Cloud-ringed giants like Mt. Whitney, Mt. Shasta, and Mt. Lassen were, as effective obstacles to transmission and reception, leveled to the ground. As a result, California's Highway Patrol radiotelephone

communications rank among the country's most efficient, with 485 two-way unit patrol cars and 377 one-way unit motorcycles patrolling 58 counties.

In 36 states and over 2,500 communities throughout the United States, Canal Zone, and Hawaiian Islands, police F-M 2- and 3-way radiotelephone installations have proved the remarkable skill and experience displayed by Motorola engineers. Your state, county, city or community can take advantage of this experience. For Full Details, Write Today.

GALVIN

MFG. CORPORATION • CHICAGO 51

COMMUNICATIONS AND ELECTRONICS DIVISION

F-M & A-M HOME RADIO • AUTO RADIO • AUTOMATIC PHONOGRAPHS • TELEVISION • F-M POLICE RADIO • RADAR • MILITARY RADIO



VETERAN WIRELESS OPERATORS ASSOCIATION NEWS

W. J. McGONIGLE, President

RCA BUILDING, 30 Rockefeller Plaza, New York, N. Y.

GEORGE H. CLARK, Secretary



George E. Sterling, who has been named FCC chief engineer

WE WERE QUITE PROUD to hear that our good friend George E. Sterling, VWOA oldtimer, has been appointed chief engineer of the FCC. Formerly assistant chief engineer in charge of the FCC Field and Research Branch and wartime head of the Radio Intelligence Division, GES succeeds VWOA member George P. Adair who has resigned to open up a consulting engineering office in Washington.

GES is quite an old timer, having been in radio since 1908 when he began pounding brass as a ham at his home at Peaks Island Portland, Maine. In 1923 he entered government service as a radio inspector in the Bureau of Navigation of the Dept. of Commerce. He became an inspector in charge of the third radio district of the Federal Radio Commission in 1935. And in 1937 he was appointed assistant chief of the FCC Engineering Department Field Division in Washington, D. C.

The war years saw him quite active on many fronts of the government communications operations. In 1940 he was named chief of the National Defense Operations Section of the Field Division and in 1942 he became chief of the Radio Intelligence Division, as well as assistant chief engineer. In 1945, he was named head of

the Field and Research Branch of the FCC.

In 1946, GES served as a delegate of the Provisional International Civil Aviation Organization at the demonstrations of radio aids to air navigation in London.

Thousands of amateurs and engineers have read GES' book "The Radio Manual," the fourth edition of which is now being prepared.

Good luck GES!

WALTER EVANS, another VWOA oldtimer, who is vice president of Westinghouse Electric and vice president and general manager of the Westinghouse radio stations, has received the Army Certificate of Appreciation for his wartime radio activities.

Under WE's direction, Westinghouse manufactured over \$400,000,000 worth of electronic equipment for the Army and Navy, which included proximity fuzes, airborne search radar, land based aircraft warning radar, etc.

WE began his operating days in 1921 with KYW, Chicago. He became successively chief engineer and general manager, and in 1932 was placed in complete charge of all Westinghouse broadcast stations. He was named vice president of Westinghouse in 1942.

C. C. RICHELIEU, who became a commercial operator in 1928 serving aboard numerous ships, is now district manager for the Simplex Recording Company in Milwaukee, Wis. . . . W. Q. Ranft, chief engineer of WFBR in Baltimore, Md., recently took charge of the WBBR f-m station. . . . Fred McDermott, a pioneer radioman in the United States Navy, recently returned to his assignment with A. T. & T. Glad to have you back Fred. . . . E. N. Pickerill, former chief aboard the Leviathan, a veteran member of VWOA, started in radio in 1905 with the American De Forest Company. He then went with United Wireless, Marconi Wireless Telegraph Company,



Walter Evans, Westinghouse vice president, who recently received a Certificate of Appreciation from the U. S. Army.

RCA and RMCA, and is now with RCAC at Broad Street. ENP is one of the oldest active pioneers on the VWOA rolls. . . . Happy to learn that Gilson V. Willets, chairman of the San Francisco chapter and charter member of VWOA and his wife, who were both very ill, are now on the road to recovery. . . . Veteran member Edward G. Raser, secretary of the Delaware Valley Radio Association and director of the Atlantic division of the ARRL is on the prowl for old-time radio equipment. . . . Life member H. A. Steinberg who continues his numerous jaunts about the country in behalf of his radio accounts, invariably puts in a good word for VWOA. . . . A. H. Waite, who saved Admiral Byrd's life back in 1934 was aboard the U. S. S. Mount Olympus as civilian radio engineer for the Byrd Antarctic Expedition. . . . Joe Graham of Woburn, Mass., is stationed at the FCC monitoring station at Millis, Mass. . . . Max Ortelet, a real oldtimer, is at the Tropical Telegraph land station WBF at Hingham, Mass. . . . Received a note from Monte Cohen from Longmeadow, Mass., and Charles E. Maps of the Westchester Telephone Company. . . . Edward Oberle is conducting a radio-engineering consulting practice in Jacksonville, Fla.

READY NOW



Hams around the world have been National's collaborators in creating the NC-173—ready now after five years of intensive research. Here are some of the advantages this 13-tube superheterodyne receiver offers:

- The NC-173's newly designed adjustable threshold double diode noise limiter—working on *both phone and CW*—has an extremely high limiting efficiency because of the short recovery time.
- Voltage regulated circuits give the NC-173 high stability and less drift for changes in powerline voltage. The pitch of code characters barely changes—even over extended listening periods.
- The S-meter circuit allows signal strength recordings to be taken on either *phone or code*.
- Works equally well on coaxial feed-line, single-wire, directional or balanced antenna.
- AC powered. Will also operate on battery for portable or emergency use—110/120 or 220/240 volts, 50/60 cycle. Frequency range .54 to 31 and 48 to 56 MC. (Includes calibrated band spread on 5, 10, 11, 20, 40 and 80 meters).
- Ask your dealer to let you see and hear the new moderate-priced NC-173.

IN ANSWER TO HAMS' DEMANDS

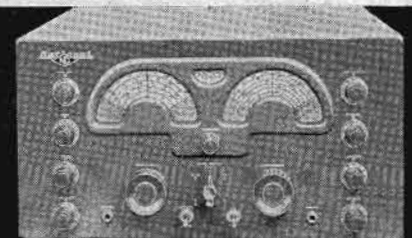
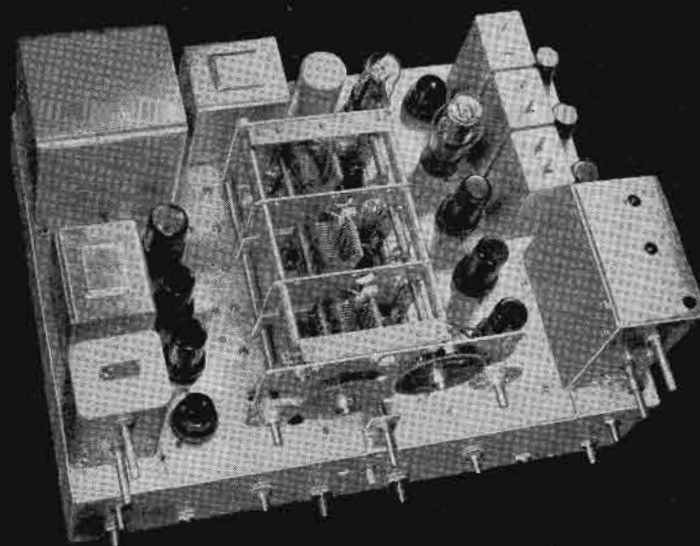

THE NATIONAL NC-173

NATIONAL
COMPANY, INCORPORATED
MALDEN, MASS.

THE MOST DISTINCTIVE NAME IN RADIO COMMUNICATIONS

The Industry Offers

FAIRCHILD LATERAL PICKUP ARM

A lateral pickup arm, 542-M1, combined with dynamic cartridge and equalizer, has been developed by the Fairchild Camera and Instrument Corporation, Jamaica, N. Y.

Arm is balanced to reduce skating over the record.

Mounting base of pickup, which is available with either a 3-mil or a 2.2-mil stylus tip, is adaptable to varying heights of turntable platters by a setscrew adjustment. The extra length from pivot point to stylus tip is said to reduce distortion resulting from tangential tracking error.

Frequency response said to be ± 2 db in 30 to 10,000-cycle range.

Stylus pressure, 25 grams; center of base to stylus tip, $12\frac{1}{2}$ "; overall length, $14\frac{1}{2}$ "; diameter of base, 3"; and height of base, $3\frac{1}{4}$ ".

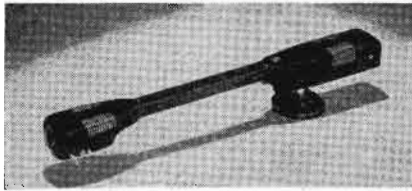

DU MONT TELEVISION SYSTEM

A television station setup using a translucent rear projection screen, special prism and 16-mm projector operating at 30 frames per second instead of the conventional 24 frames, and standard field image orthicon cameras, has been developed by the Allen B. Du Mont Laboratories, Inc.

In operation, the 16-mm projector is mounted together with the prism in the rear of the translucent screen which can either be mounted in a portable frame or built into the main studio wall separating the projection room from the main studio. The image orthicon camera which is used to televise both live and film programs is moved directly in front of the translucent screen and focused on the projected image.

HYTRON INSTANT-HEATING V-H-F BEAM PENTODE

An instant-heating filamentary-type 15-watt transmitting beam pentode, type 5516, has been developed by the Hytron Radio and Electronics Corp., 76 Lafayette Street, Salem, Massachusetts. Designed for v-h-f mobile equipment, the tube can be used as a class C frequency multiplier or as a class C amplifier requiring no neutralization in properly designed circuits operating up to 165 mc. Filament is rated at 6.0 volts.

Tube has a zirconium-coated plate, gold-plated control grid, and carbonized screen grid. Three separate base-pin connections to the filament center tap provide for low cathode lead inductance.



HEWLETT-PACKARD U-H-F SIGNAL GENERATOR

A wide band u-h-f signal generator, 616A, for the 1,800- to 4,000-mc bands, featuring direct reading frequency and voltage scales, c-w, i-m pulsed or delayed pulse output, has been announced by Hewlett-Packard, Palo Alto, Calif.

The generator utilizes a resonant-cavity, reflex-klystron oscillator. R-f output may be directly set and directly read, either in microvolts or db, on output dial. Accuracy of frequency calibration is said to be within $\pm 1\%$; stability of the order of 0.005% per degree C in ambient temperature.

R-f output ranges from 0.1 volt to 0.1 microvolt, or 7 dbm to 127 dbm.

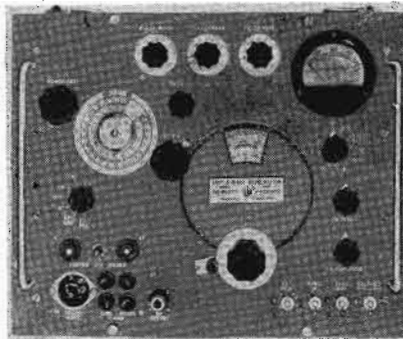

G.E. AIRCRAFT TRANSMITTER-RECEIVER

A $9\frac{1}{2}$ " long two-way transmitter-receiver, type AS-1C, has been designed by the transmitter division of G. E.

Designed as a companion unit to the AS-1B radio for the private plane, the new unit provides two-way tower and radio range station communication as well as broadcast reception.

Operates directly from a twelve-volt power system. Features of receiver (200-420 kc and 500-1,500 kc) include AVC, directional loop antenna arrangement, and a voice filter.

The transmitter has a 12-watt carrier output and operates at 3,105 kc, crystal controlled.

DE MORNAY-BUDD MARINE RADAR

Marine radar equipment for ocean freight and passenger vessels, featuring a range of from 100 yards to 32 miles has been announced by DeMornay-Budd, Inc., 475 Grand Concourse, New York 51, N. Y.

Has a peak pulse power output of 18 kilowatts. Units have a 12" screen and display U. S. geodetic charts on a companion screen; microfilm copies of charts are made on 70-mm color film to present a true image of charts, including correct color of the various indicators such as buoys and channels.



SUPERIOR ELECTRIC BINDING POSTS

A multi-purpose binding post (type DF30) providing five ways of connecting leads has been announced by The Superior Electric Company, 44 Church Street, Bristol, Connecticut. Five connections are—permanent clamping of wire up to size 12 through center hole; looping of wire around the center shaft and clamping; plug-in connection of a standard $\frac{3}{4}$ " center banana plug; clip-lead connection by removing the hexagonal shaped phenolic head; and spade lug connection. Binding post can be used on panels up to $\frac{1}{4}$ " thick. Metallic components are recessed. Current-carrying capacity is 30 amperes.

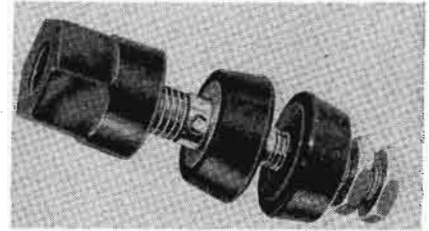

SYLVANIA BEAM POWER TETRODE

A v-h-f beam-power tetrode type 3D24, for use up to 125 mc, has been announced by the electronics division, Sylvania Electric Products, Inc., 500 Fifth Avenue, New York 18, N. Y.

Tube has a carburized thoriated tungsten filament rated at 6.3 volts, 3 amperes. Number one grid is of the vertical bar type with two support leads; number two grid is connected to an internal heat-reflecting shield to provide a low grid-to-plate capacity characteristic.

No metallic getter flash is deposited on the bulb.

Typical operating conditions are: Plate voltage, d-c, 1,500; control grid voltage, d-c, -300; screen grid voltage, d-c, 375; plate current, d-c, 90 ma; control grid current, d-c, 10 ma; screen grid current, d-c, 22 ma; peak r-f grid input voltage, 400; full driving power, 4 watts; and plate power output, 105 watts.

LANGEVIN PLUG-IN AMPLIFIERS

Plug-in type pre-amplifiers ($10'' \times 2'' \times 5''$), type 116-A, and monitor amplifiers ($10'' \times 3\frac{1}{4}'' \times 5\frac{1}{2}''$), type 117-A, have been developed by The Langevin Co., Inc., 37 W. 65th St., New York 23.

The 116-A has a gain of 40 db with provision for adjusting to 34 db. Output power is said to be +18 dbm (0.63) with less than .5% rms total harmonic distortion over the range 50 to 15,000 cycles, and less than 1% total distortion over the range 30 to 15,000 cycles; output noise equivalent to an input signal of -124 dbm over a band width of 20,000 cycles.

Input source impedance, 30/150/250/600 ohms; output load impedance, 150 or 600 ohms.

Uses two 1620 tubes.

The 117-A has a gain of 50 db. Output power is said to be +30 dbm with less than .5% rms total harmonic distortion over the range 50-

(Continued on page 59)

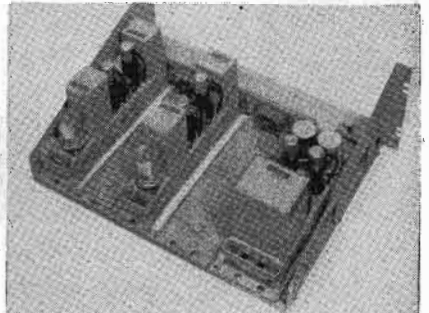

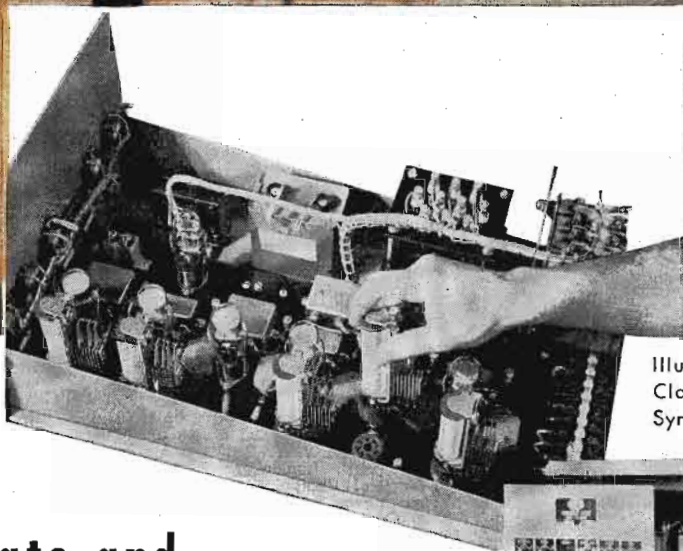
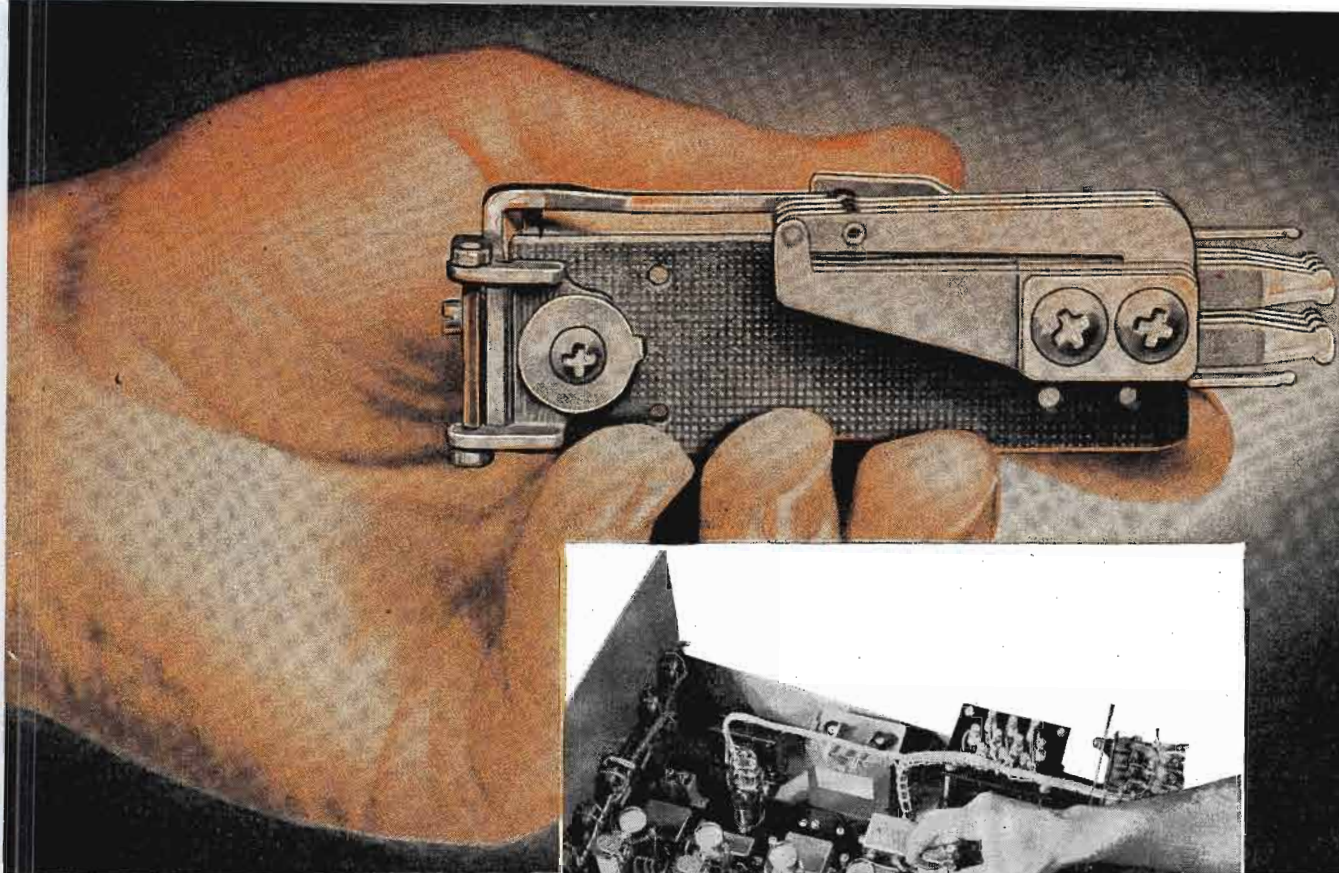

Illustration shows use of Clare Relays in Raytheon Synchronous Control Cabinet

CLARE RELAYS

Help Provide Accurate and Dependable Operation for **RAYTHEON** Electronic Welding Control

● Resistance welding is speeded up by this new Raytheon Electronic Synchronous Control. Spot, seam or pulsation timing are also provided from the same cabinet.

Clare Relays were chosen by Raytheon Manufacturing Company of Waltham, Mass., for this new modern unit because of their accurate, efficient and dependable operation. Clare compact, clean-cut design met Raytheon demands that all components contribute to the ease and convenience of use, the flexibility of application and streamlined appearance.

Four Clare Type "C" d.c. Relays and one Clare Type "A" a.c. Relay, shown

in this drawer type sequence timer, are supplied by Clare with coil windings, contacts and all special adjustments to meet exact Raytheon requirements.

This use of standard Clare Relays with modifications to meet the job at hand is what we mean by Clare "custom-building." It is available to you for your unusual relay requirements. Expert Clare sales engineers are located in principal cities. Let us know your problem. Address: C. P. Clare & Co., 4719 West Sunnyside Avenue, Chicago 30, Illinois. In Canada: Canadian Line Materials Ltd., Toronto 13. Cable Address: CLARELAY.



CLARE RELAYS

"Custom-Built" Multiple Contact Relays for Electrical and Industrial Use

News Briefs

INDUSTRY ACTIVITIES

On May 17, the newly created North Atlantic Region of the IRE, composed of the Connecticut Valley Section and the Boston Section, will sponsor an all-day radio engineering meeting at the Hotel Continental in Cambridge, Massachusetts.

Scheduled for the meeting are six technical papers:

Low Drag Aircraft Antennas for 2 to 18 mc; John V. N. Granger, Student, Harvard University.

The Commercial Design of Geiger-Mueller Counter Tubes; Herbert Metten, Sylvania Electric Products, Inc.

Recent Developments in Frequency Stabilization of Microwave Oscillators; William G. Tuller, M. I. T.

A V-H-F Bridge for Impedance Measurements at Frequencies Between 20 and 140 mc; R. A. Soderman, General Radio Company.

Design Problems of F-M Receivers; Aldo Miccioli Associate of Dale Pollack.

Wartime Developments in Wave-Guide Theory; Julian S. Schwinger, Professor, Research Laboratory of Physics, Harvard University.

Research and engineering facilities of the Farnsworth Television and Radio Corporation have been moved to enlarged quarters at the Fort Wayne plant.

The Sangamo Company, Limited, Leaside, Ontario, Canadian affiliate of the Sangamo Electric Company, Springfield, Illinois, will produce mica and paper capacitors, including plastic molded paper tubulars.

Aircraft Radio Corporation, Boonton, N. J., has delivered ten v-h-f omni-directional range receiving systems (type 15) to the CAA.

Systems are being installed in the CAA's fleet of regional inspection aircraft.

Under its 1947 program the CAA plans to activate 288 v-h-f radio range stations. Of these, 218 will be of the omni-directional type. Remainder of stations will be the two-course visual-aerial type, similar to the over-the-mountains airway type that has been in operation for some time between Denver and Las Vegas.

Measuring instruments manufactured by the Boonton Radio Corporation, Boonton, N. J., will be distributed outside of the United States by the RCA International Division.

The Marine Division of Mackay Radio and Telegraph Company will supply and install commercial radar (Mariners' Pathfinder type made by Raytheon) on the tankers of the Union Oil Company of Calif.

The equipment operates on 10 centimeters. Mackay Radio is authorized sales and service organization within the United States for the Raytheon radar unit.

KKLA, Los Angeles f-m broadcast station, has installed a 10-kw Collins f-m transmitter.

KKLA will transmit on 93.7 mc with an effective radiated power of 48 kw, and expects to apply for a 60-kw assignment.

KAKC-FM, Tulsa, Okla., recently went on the air with a Collins 250-watt f-m unit. Station is authorized to use 3,000 watts f-m at 94.9 mc. The 3-kw f-m amplifier will be added later.

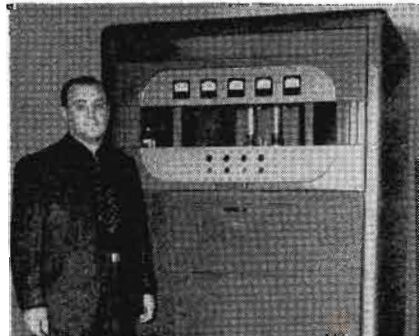

C. Harvey Haas, chief engineer of KKLA, and the f-m exciter unit.

The E. F. Johnson Company, Waseca, Minnesota, has purchased the Gothard line of indicator lights from the Gothard Manufacturing Company, Springfield, Illinois.

The Gothard line is now being manufactured at the Johnson plant in Waseca.

Collins Radio recently consigned one of its transmitters to the FCC in Washington to be used in conjunction with 30-kc channel separation tests.

Transmitter will eventually be used for broadcasting by WOOK, United Broadcasting Company, Silver Springs, Maryland.

Wells Sales have moved to 320 N. LaSalle Street, Chicago.

A plan to provide colleges throughout the country with low-cost low-powered f-m broadcast transmitters and use educational f-m channels has been proposed to the FCC and the U. S. Office of Education by G. E.

The station plan calls for use of transmitters with a power output of 2½ watts; this would be the modulator section of large G. E. f-m units.

The diminutive transmitter would provide a five- or six-mile range and is enough to cover most college campuses, fraternity or sorority houses and surrounding student homes.

G. E. points out that these transmitters can be enlarged to a full-size educational f-m station up to 50 kw, and eventually become part of statewide networks.

Bolinco Electronics Corporation, Manila, R. P. I., have established offices at 50 Broadway, New York 4, N. Y.

James B. Lindenberg is vice president in charge of Philippine operations. His staff is said to consist of three American electrical and radio engineers and 50 Filipino technicians and sales personnel.

The home offices of the company are in the China Bank Building, Manila.

Sola Electric Co., 2525 Clybourn Avenue, Chicago 14, Ill., has opened a New York City office at 50 Church Street, New York 17, N. Y.

The Broadcast Equipment Division of Raytheon presently located in Chicago, will be moved to the main plant at Waltham, Mass.

* * *

PERSONALS

Leonard Cramer, executive vice president of Allen B. Du Mont Labs. has been named general manager of WABD, Du Mont's video station.

Donald MacGregor, formerly executive vice president of Webster-Chicago Corporation, has been elected vice president in charge of production of the Zenith Radio Corp.

Austin C. Lescarboursa, well-known editor and industrial advertising consultant of Croton-on-Hudson, N. Y., has been awarded the French order of "Officier de l'Instruction Publique." The citation carries the Paris date of January 15th, 1947, and is in recognition of technical services rendered for many years past.

D. A. Myer has become technical field director of Westinghouse Radio Stations, Inc. George E. Hagerty succeeds Myer as engineering manager.

Royal V. Howard, vice president of Associated Broadcasters, San Francisco, has been named NAB director of engineering.

Arthur J. Sanial has resigned as chief engineer of the Atlas Sound Corp. and is now devoting his full time to consulting engineering in loud-speaker and sound-system design, measurement, etc., at 168-14 32d Avenue, Flushing, N. Y.

E. F. Lazar has been appointed director of the Sperry Gyroscope federal department to handle all contractual relations with military departments of the government. George Tate, formerly director of district sales and service, is the new director of export sales. A. R. Weckel, formerly aeronautical sales manager, has been appointed director of commercial sales.

Richard W. Hubbell has resigned from the executive staff of Crosley Broadcasting to open a television, radio and motion picture consultant office, Richard W. Hubbell and Associates.

Temporary headquarters are in Cincinnati at 140 West Ninth Street. Permanent headquarters will be in New York at 2101 International Building, 630 Fifth Avenue.

A Hollywood office, 3201 Tareco Drive, will also be opened with H. Russell McCune in charge.

E. N. Wendell, vice president in charge of sales, Federal Telephone and Radio Corporation, was recently elected a fellow of the IRE.

William G. Ellis has been named manager of industrial electronics sales of the RCA engineering products department.

William F. Barnes is now manager of the RCA tube mounts and accessories sales section.

Kenneth B. Shaffer, formerly renewal sales field representative for the RCA tube department in Cincinnati, has been transferred to the Harrison, N. J., headquarters where he will supervise the sale of parts to tube and parts distributors.

Dr. Wilbur Reed LePage, formerly senior research engineer of Stromberg-Carlson, has been appointed associate professor of electrical engineering in the College of Applied Science, Syracuse, New York.

Professor Igor M. Plusc, formerly mathematician and physicist for the Colonial Radio Corporation of Buffalo, New York, has been appointed assistant professor of electrical engineering in the College of Applied Science, Syracuse University, Syracuse, New York.

Clyde H. Schryver, Merchandise Mart, Kansas City, Missouri, has been named sales representative for Eimac tubes in Missouri, Kansas, Nebraska (east of the 100th meridian), and Iowa, except Cedar Rapids.

Pierre F. Marshall has been named advertising manager for The Magnavox Company.

Dr. Vladimir Kosma Zworykin is now vice president and technical consultant of the RCA Laboratories Division, RCA.

Dr. Zworykin has been director of the Electronic Research Laboratory of the RCA Laboratories Division, Princeton, N. J.

Edward R. McCarthy has been appointed general sales manager of Sorensen & Company, Inc.



Edward McCarthy (left), Helen S. Sorensen, president of Sorensen & Co., and chief engineer Leo Helterline at their booth during the recent IRE meeting in N. Y.

A. B. Bronwell, Northwestern University, has been elected president of the National Electronics Conference, Inc. This corporation is sponsored jointly by Illinois Institute of Technology, Northwestern University, AIEE, IRE and the University of Illinois, with the Chicago Technical Societies Council a cooperating organization.

W. O. Swinyard, Hazeltine Electronics, Inc., is now chairman of the board of directors.

Others elected include W. L. Everitt, University of Illinois, executive vice president; and G. H. Fett, University of Illinois, vice president in charge of programs.

Plans are now being made for the 1947 National Electronics Conference, which will be held on November 3, 4 and 5 at the Edgewater Beach Hotel, Chicago.

John N. Leedom has been appointed assistant sales manager of the Sprague Products Co., North Adams, Mass.



Clyde E. Dickey is now general sales director of Federal Telephone and Radio Corporation, Clifton, N. J.

Mr. Dickey, who has been with I. T. & T. for more than 19 years, will be in direct charge of the sales of commercial radio, rectifiers, Megatherm, wire transmission, rectifier stacks, wire and cable, tubes, transformers and crystals.



Merrill A. Trainer is now manager of RCA television equipment sales. Mr. Trainer will supervise the sale of television transmitters, studio equipment, antennas, television microwave relay equipment, etc.



LITERATURE

O'Neil-Irwin Manufacturing Co., Lake City, Minn., have released a 40-page Di-Acro catalog, No. 46-11, covering die-less duplicating applications.

Chemical Publishing Co., Inc., 26 Court Street, Brooklyn 2, N. Y., has issued a catalog covering books on chemistry, technology, physics, general science, mathematics, engineering, technical dictionaries, etc.

The E. F. Johnson Co., Waseca, Minn., have published data sheets covering their f-m isolator, phase sampling loops, filters, phase sampling transformers, tower lighting filters, supports for open-wire transmission lines, pressurized capacitors, neutralizing capacitors and high-current, high-voltage, fixed and variable inductors.

(Continued on page 63)

5-5-47

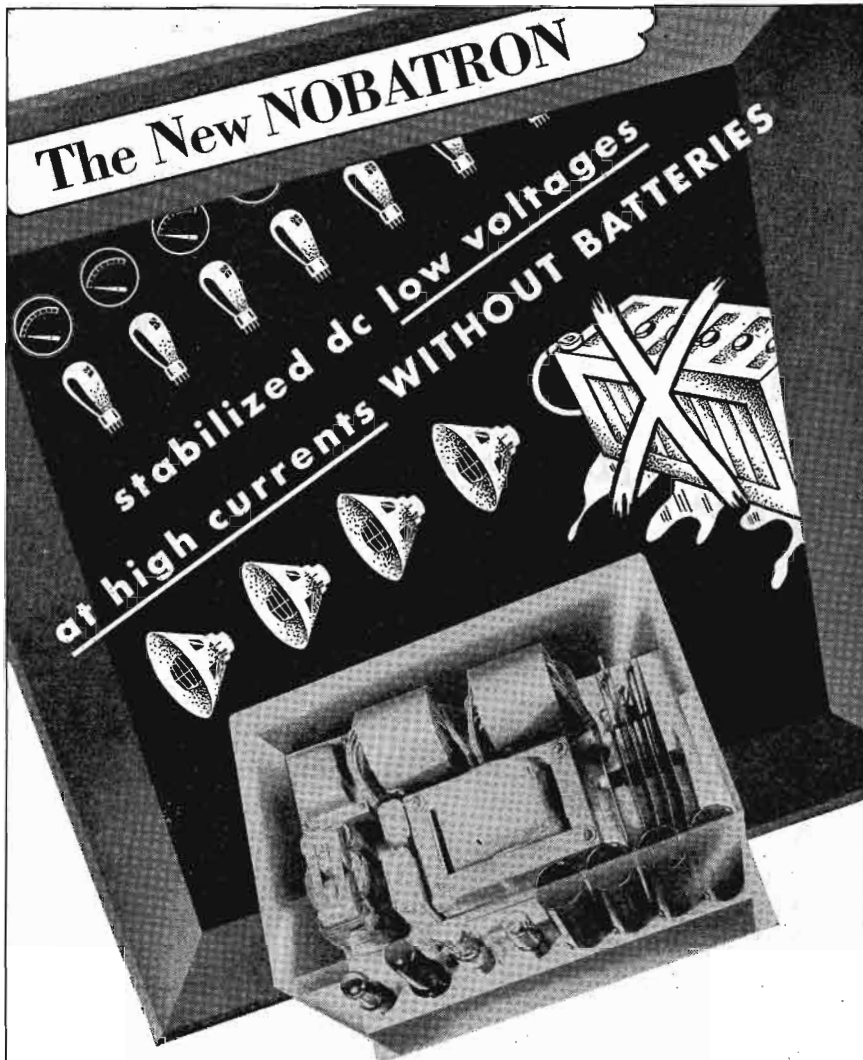

• The Sorensen NOBATRON provides a new source of DC voltages regulated at currents previously available only with batteries.

• Six standard NOBATRON models operate on a 95-125 volt AC source of 50 to 60 cycles and provide currents of 5, 10, and 15 amperes at output voltages of 6, 12, or 28.

• Ideally suited for critical applications where constant DC voltages and high currents are required, the NOBATRON maintains a regulation accuracy of 1/2 of 1%, RMS of 1% and has a recovery time of 1/5 of a second.

• Investigate the many advantages of Sorensen regulators applied to your unit. Write today for your copy of the new complete Sorensen catalog, S-C. It is filled with schematic drawings, performance curves, photos, and contains in detail, "Principles of Operations."

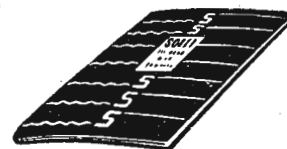

SORENSEN & COMPANY, INC.
STAMFORD, CONNECTICUT

A LINE OF STANDARD REGULATORS FOR LOAD RANGES UP TO 30 KVA.
SPECIAL UNITS DESIGNED TO FIT YOUR UNUSUAL APPLICATIONS.

Designed for



Application



10035

**The No. 10035
Illuminated Panel Dial**

A truly "Designed for Application" control. Compact mechanical design, sturdy construction, easy to mount. Totally enclosed mechanism eliminates back of panel interference. Provisions for mounting and marking auxiliary controls, such as switches, potentiometers, etc. Finish, flat black art metal. Size 8 1/4 x 6 1/2. Ratio 12 to 1. Hinged escutcheon permits direct calibration without necessity for removal of scale, thereby maintaining accurate calibration. Two 4 and 5 line scales furnished with each dial.

**JAMES MILLEN
MFG. CO., INC.**

MAIN OFFICE AND FACTORY
**MALDEN
MASSACHUSETTS**



**Variable Inductance
Tuning For TV Receivers**

by **MYRON F. MELVIN**

Field Engineer
P. R. Mallory and Co., Inc.

**Application Data for the 44
to 216-mc Bands.**

WITH THE ADVENT OF V-H-F wide-range tuning for television receivers, it has become necessary to employ other than the standard variable-capacitor method of control. In studying the problem, engineers have found that variable inductance tuning offers a solution, particularly as a basis for tuning the r-f mixer and oscillator stages.

Using the inductance-tuning procedure and applying a three-inductance type unit, shown in Figure 1, many circuits can be utilized. For tv wide-pass band work, it has been found that grounded-grid amplifiers work well with the variable inductance units. Reflections can be eliminated by matching the transmission line impedance in the cathode circuit. However, in order not to exceed the recommended bias value of the tube, it is sometimes impractical to provide an absolute match to the line; but the amount of mismatch

Figure 1
The Inductuner.

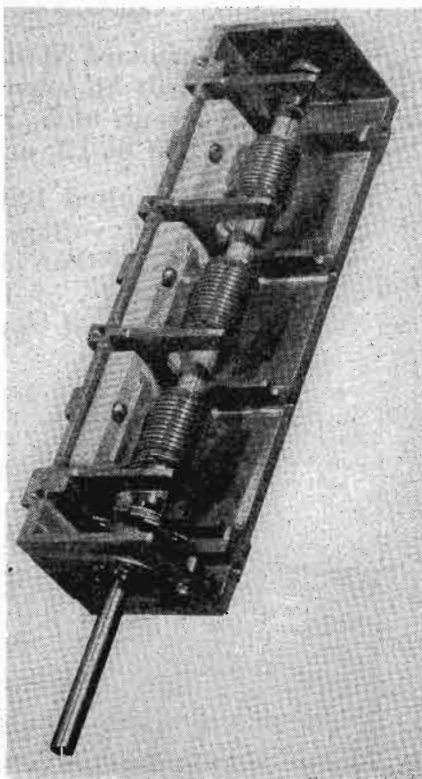

Crystals for the Critical

"STABILIZED"

H4 COMMUNICATIONS CRYSTAL

Can be supplied in a frequency range of 1800 kc to 20 mc. Pin spacing is 3/4" and pin diameter is 1/8". Quartz plates are pressure mounted between stainless steel electrodes. Unit will stand maximum vibration. Our "Stabilizing" process prevents frequency shifts due to age.

Send for Illustrated Catalog

**The JAMES KNIGHTS CO.
SANDWICH, ILLINOIS**

QUICK

DELIVERY
ON
PRECISION
WOUND

TRU-OHM RESISTORS

- SILVER-SOLDERED TERMINALS
- GENUINE HIGH-TEMPERATURE VITREOUS ENAMEL COVERING
- ACCURATE & DEPENDABLE
- FULLY TRADE & WAR TESTED

The TRU-OHM Resistor, is a superior product of fine engineering skill and manufactured with war-tested experience. A wide variety of types is available for immediate or quick delivery. Write us your requirements or send for free catalog.

MODEL ENGINEERING & MFG., INC.
RESISTOR DIVISION, HUNTINGTON, INDIANA

is not sufficient to be discernible on the picture.

A practical means of utilizing the tuner is to allow one of the three variable inductances to serve as the oscillator, variable element. The remaining two inductances may be used as the elements of a band pass circuit; the width of this can be designed for the specific application. The bandwidth can be quite broad by overcoupling the end inductors and overcoupling capacitively. An essentially constant bandwidth may be maintained over the tuning range by opposite coupling of the end inductors. Reducing the coupling, the desired selectivity can be obtained for communications-type services.

Sample Performance Data

In a variable-inductance application using a grounded-grid amplifier with one-half of a 6J6 miniature dual triode, 6AK5 converter and 6J6 oscillator with grids and plates strapped together, gain was found to be about 10, measured at the grid of the first i-f stage with the test signal fed between the cathode and ground of the grounded-grid amplifier. This value was found to be quite constant over the band of 50 to approximately 170 mc, increasing slightly at the higher frequencies. Bandwidth, in this particular application, varied from 5.25 mc at a setting of 50 mc to 6 mc at 220 mc, with a maximum of 7 mc at the 150-mc setting.

Tuning-Unit Features

The tuning unit shown in Figure 1 consists of three coils mounted on a single insulated shaft. A contactor nib rides axially on a grooved, flat plate and maintains a constant contact between the coil and the plate. As the contactor slides, more or less of the coil is shorted out, effectively changing the inductance. The unused, or shorted, portion of the coil is such that its distributed capacitance resonates it above the desired frequency and prevents absorption with its resulting loss in Q .

The inductance can be varied from a value of 1 microhenry to .02 microhenry in ten turns of the shaft, or $3,600^\circ$ of rotation. To limit the upper tuning range and to give the desired tracking and Q , an end inductor is used. The end inductor consists of a couple of turns of wire, self-supporting spacewound, in series with the variable element. This series inductance, with the distributed capacitance plus

¹Inductuner; licensed under Paul Ware patents.

(Continued on page 63)

FOR POSITIVE CONNECTIONS

connect with

Cannon Plug



Turner "211" Mike with steel shell "XL" plug. Special adapters are required to re-convert these mike receptacles to "XL".

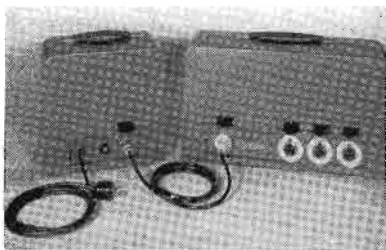

Raytheon's 3-channel Remote Amplifier and power unit uses two types of Cannon Plugs: "X" and "P". Three receptacles on amplifier at right are P3-13.

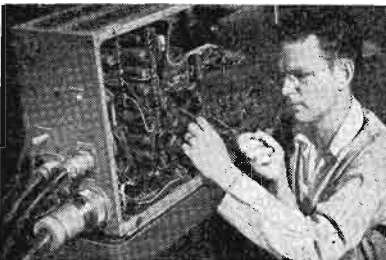

Rear end of RCA modern television monitor and control unit. Four types of Cannon Plugs are used in this unit: "TQ", "P", "R" and "PMR".

—Don Lee Television photo.

The connectors shown above are summarized with list prices in new C146A Condensed Catalog. Write to Dept. D-121 for a copy. Types "P", "X" and "XL" are also available direct from more than 125 leading electrical jobbers.

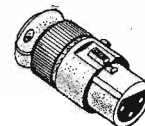

Type XL-3-11SC
(\$2.80 List)

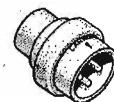

Type XL-3-50N
(\$1.30 List)

One of three types of adapters made by Cannon Electric for converting microphones over to Cannon "XL" connectors when original plug installation is of another manufacture. The steel shell plugs not only have an integral cable clamp (5/16" Dia.) but are practically unbreakable.

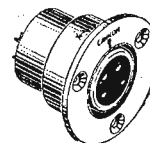

Type X-4-13
(\$3.25 List)

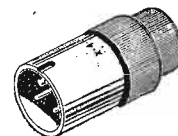

Type X-3-12
(\$1.25 List)

The "X" series of light plugs are made in zinc with bright nickel finish and have three available insert arrangements: 1 to 4 contacts for No. 14 and No. 16 wires. Friction-hold coupling. Cable entry 9/32" with gland nut and bushing.

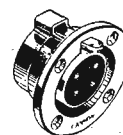

Type P4-13
(\$4.55 List)

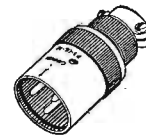

Type P3-CG-12
(\$2.50 List)

The Type "P" Series has been standard on many types of quality electrical equipment for many years. It includes a wide variety of shell styles in both plugs and receptacles and six different insert arrangements from which to select two to six 30-amp. or eight 15-amp. contacts. Two cable entries 9/32" and 25/32".



CANNON ELECTRIC
DEVELOPMENT COMPANY

3209 Humboldt Street, Los Angeles 31, California
Canada & British Empire—Cannon Electric Co., Ltd., Toronto, Ontario • World Export
Agents (excepting British Empire) Frazar & Hansen, 301 Clay St., San Francisco 11, Calif.



CONSTANT-IMPEDANCE Controls

★ The Clarostat Series CIB Attenuator (shown) was developed to meet the need for a constant-impedance attenuator capable of handling considerable power with low insertion loss. Provides linear attenuation with ample power-handling capacity.

Recommended as output level control for power amplifiers, or as input attenuator for individual loudspeakers in P-A system.

Dissipates 10 watts at any setting. Linear up to 30 db. in 10 steps, beginning with absolute zero and progressing in 3 db. steps up to 24, and then 30, followed by infinity.

Available in several ohmage to meet all requirements. Fibre-glass resistance elements. Single-hole mounting. Only 2 3/4" long by 2" diameter.

★ DATA on request . . .

Write for Bulletin 111 on Series CIB Attenuator. If interested in L-pads and T-pads, ask for Bulletin 102, as well.



CLAROSTAT MFG. CO., Inc. • 285-7 N. 6th St., Brooklyn, N. Y.

Audio Problems

(Continued from page 21)

full effect of the deemphasis curve, a requirement which remains stable until the conclusion of the record.

Since installing these equalizing amplifiers in our playback machines, we have had no complaints which could be traced to changing frequency response of our transcriptions. The inside diameter intermodulation distortion has been reduced to an average of 4%.

Other Transcription Problems

There are other problems in the recording and playback of transcriptions which will shortly be pointed up by their extensive use on f-m. Incidentally we have yet to see a transcription that will comply with the FCC requirements for f-m programs; for instance, noise level of -60 db below program level, frequency response of 30-15,000 cycles and a maximum of 3 1/2% rms harmonic distortion. In addition, we have also noted that intermodulation due to turntable rumble, pickup unbalance, etc., is quite high on the average transcription playback table. Combined noise level of recording table, playback table and record material is generally closer to -45 db below program level rather than -60 db.

Under laboratory conditions we have been able to closely approach the extended frequency range of 30 to 15,000 cycles demanded by f-m, but not with any commercial-type equipment.

Fidelity and the Intermodulation Analyzer

During our development work we have found that the intermodulation analyzer³ and a-f signal generator⁴ are invaluable in making many major fidelity checks. For instance, distortion measurements have been facilitated to such an extent that full potentialities of amplifiers, microphones and loudspeakers could be utilized after a few minutes' test with this equipment.

In our recording department it has been possible to make comparative checks on recording heads by the simple process of recording the two reference frequencies on a given record through each head under test, and playing back and measuring the amount of intermodulation distortion present. Playbacks can be checked by a single recording played and measured by each playback under test. Of course, no one test can determine the

HOPP Plastic RADIO DIALS

DIAL WINDOWS, NAME PLATES, GAUGES, CALCULATORS, SCALES, CHARTS, ETC.

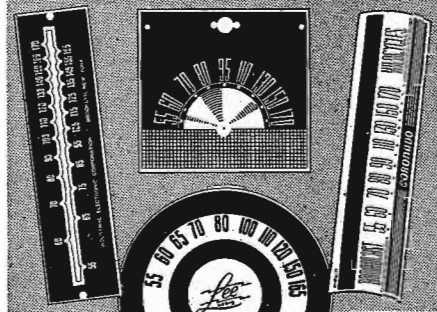

PLASTIC RADIO DIALS have endless possibilities in design, size, shape and color combination. Attractive and durable, our radio dials, windows and scales are preferred by many leading Radio manufacturers.

Not only for dials, but for numerous other electronic and electrical applications, Laminated Plastics are preferable.

Consult with our artists and engineers regarding applications for your particular purpose. Or . . . send us your blue prints or samples for quotation.

THE HOPP PRESS, INC.
460 W. 34th STREET, NEW YORK 1, N. Y.
ESTABLISHED 1893

WANTED SALES ENGINEERS

Long established, well-known manufacturer of Electrical Controls, desires to increase strength of sales organization.

Only well established, financially sound sales engineers or firms of highest calibre with electrical engineering background, experienced in electrical circuits will be considered.

State qualifications, sales staff, territory covered, lines representing and other pertinent information.

Box 447, COMMUNICATIONS, 52 Vanderbilt Ave., New York 17, N. Y.

goodness of any playback. We have found that some playbacks have excellent frequency characteristics but also a high percentage of intermodulation. By proper centering of armature in the magnetic gap, it has been found possible to reduce this figure to a reasonable level. Compression amplifiers have been checked with this method, and as a result we have been extremely careful in the use of some of them. With some amplifiers, a small adjustment allowed us to use increased com-

(Continued on page 51)

Broadband Radiator

(Continued from page 28)

tern of the antenna. The gain over a dipole calculated from this pattern is 3 db above a short dipole.

The center conductor of a 52-ohm coaxial feed cable goes to center of δ in Figure 3 through a rather long wire which acts as a tuning inductance. This inductance in combination with the capacity across the feed point of the various metal parts and the antenna's self impedance result in 52 ohms feed impedance to match the feed cable. A shorted stub of cable (AN-RG-8/U) is also connected in shunt with the feed point. This stub is effectively $\lambda/4$ long and so appears as a very high impedance at the frequency of operation. It performs no tuning function but acts as a static drain to ground for the upper cone.

In Figure 4 appears a s-w-r curve, which illustrates the match of the antenna to the feed line. As a standing wave ratio less than 2:1 is considered a good match for this type of service it can be seen that this antenna provides an effective match in the 152 to 162-mc range. The antenna is capable of satisfactory operation over a much wider frequency range. Due to shift of the radiation pattern, the gain is slightly less at these extreme frequencies.

Ordinary accumulations of ice and snow have no measurable effect on the performance of the antenna as its broadband characteristics make it insensitive to dimensional changes.

Audio Problems

(Continued from page 50)

pression without increase in distortion.

Routine maintenance tests are greatly facilitated by the use of this type equipment. Noise and distortion measurements can be made with a minimum expenditure of time.

Another interesting use of this equipment has been in checking and reducing distortion in the 50-kw transmitter. In a series of checks we were able to effect a reduction of intermodulation distortion, in some cases approximately 13%; Figure 3. This was achieved by a small readjustment of the grid circuit of the final amplifier.

*Altec Lansing TI-402.

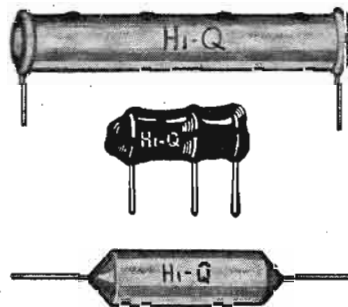
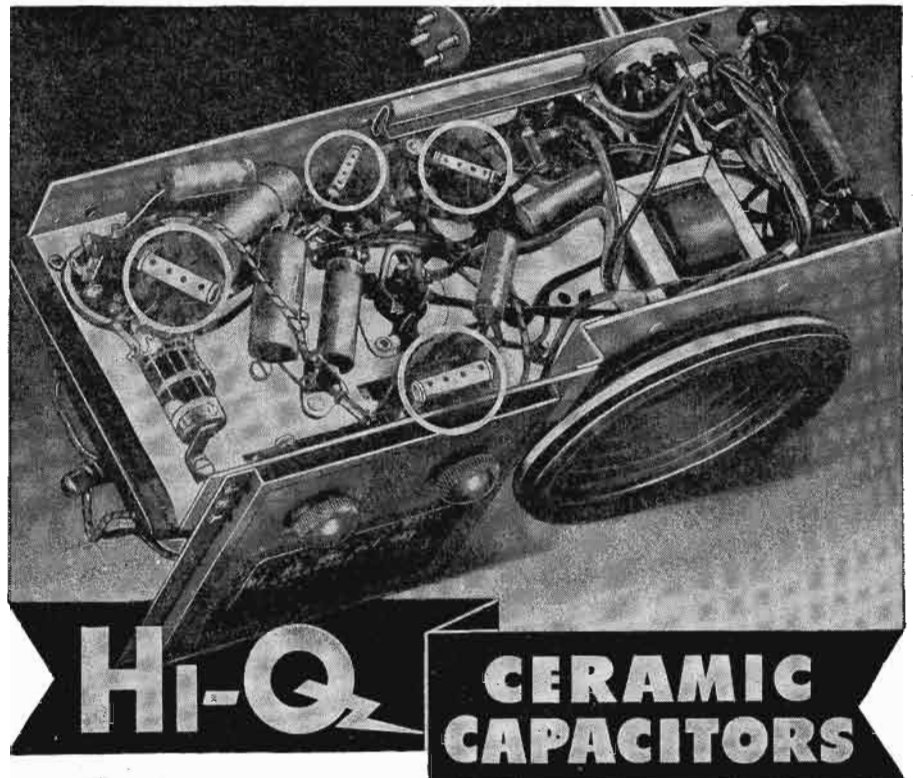

*Altec Lansing TI-401.



General purpose capacitors adequately meet the requirements of small AC-DC sets. Their reliable performance and long life make them especially desirable in applications where other types of more expensive units must be replaced. In addition HI-Q general purpose capacitors avoid aging and comparable reduced performance.

We shall be glad to submit samples for your examination.

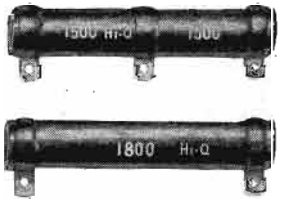
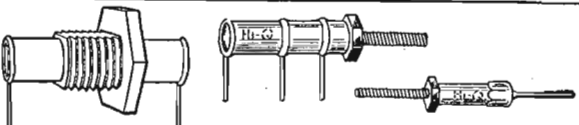
OTHER HI-Q COMPONENTS

WIRE WOUND RESISTORS		
FEED-THRU & STAND-OFF CAPACITORS		
CHOKE COILS		

HI-Q
ELECTRICAL REACTANCE CORPORATION
FRANKLINVILLE, N. Y.

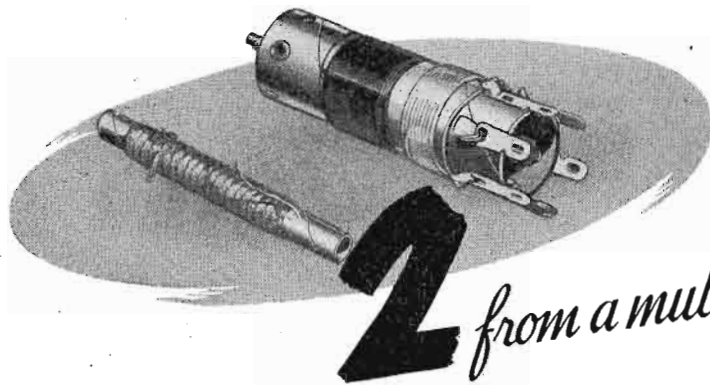

for experienced cooperation
"call Cleveland"

2 from a multitude

of applications of

COSMALITE*

a spirally laminated paper base Phenolic Tube

#96 Cosmalite . . . for coil forms in all standard broadcast receiving sets.

SLF Cosmalite for permeability tuners.

Advantages include lower costs and quicker deliveries.

Ask also about our spirally wound kraft and fish paper Coil Forms and Condenser Tubes.

*Trade mark registered.



The **CLEVELAND CONTAINER Co.**
6201 BARBERTON AVENUE CLEVELAND 2, OHIO

PRODUCTION PLANTS also at Plymouth, Wisc., Ogdensburg, N. Y., Chicago, Ill., Detroit, Mich., Jamesburg, N. J.
PLASTICS DIVISIONS at Plymouth, Wisc., Ogdensburg, N. Y. • ABRASIVE DIVISION at Cleveland, Ohio
New York Sales Office—1186 Broadway, Room 223
IN CANADA—The Cleveland Container Canada Ltd., Prescott, Ontario



VACUUM TUBE VOLTMETER

MODEL 62



SPECIFICATIONS:

RANGE: Push button selection of five ranges—1, 3, 10, 30 and 100 volts a.c. or d.c.

ACCURACY: 2% of full scale. Useable from 50 cycles to 150 megacycles.

INDICATION: Linear for d.c. and calibrated to indicate r.m.s. values of a sine-wave or 71% of the peak value of a complex wave on a.c.

POWER SUPPLY: 115 volts, 40-60 cycles—no batteries.

DIMENSIONS: 4¾" wide, 6" high, and 8½" deep.

WEIGHT: Approximately six pounds. *Immediate Delivery*

- MANUFACTURERS OF**
- Standard Signal Generators
 - Pulse Generators
 - FM Signal Generators
 - Square Wave Generators
 - Vacuum Tube Voltmeters
 - UHF Radio Noise & Field Strength Meters
 - Capacity Bridges
 - Megohm Meters
 - Phase Sequence Indicators
 - Television and FM Test Equipment

MEASUREMENTS CORPORATION
BOONTON NEW JERSEY

Ground-Air System

(Continued from page 26)

final amplifier is operating properly to provide a load to the modulator.

All of the manual controls for circuit tuning and meter selection are provided at the front panel. The transmitter may be completely tuned and adjusted for circuit operation from the front of the r-f chassis. Lower power stages are adjusted by means of screw-driver adjustments. The third amplifier tank capacitor is adjusted by means of a knob attached directly to the capacitor shaft extension. A pi-network circuit adjustment for the final amplifier is indicated by two counter type indicators, one for the tuning and the second for the loading capacitor. These counters provide accurate indication of the capacitor positions. A neutralizing capacitor is also adjusted from the front panel.

Lights are provided to indicate the r-f channel and the modulator selected. A caution light is also provided to indicate when the high voltage is applied.

Modulator Circuit

The modulator circuit is fundamentally a simple audio amplifier incorporating some unique tube applications. The circuit consists of four push-pull stages, the first two being resistance coupled and the last two transformer coupled. Input from the line is controlled by means of a potentiometer which operates into a filter unit.

The low-pass filter of the modulator may be eliminated for operational requirements demanding higher fidelity. The filter unit has been designed to limit the a-f input to the modulator to frequencies below 300 cycles, in an effort to reduce adjacent channel interference caused by audio sidebands. The cut-off point is designed to attenuate 3500 cycles approximately 65 db below the response at one thousand cycles. A low-distortion modulator following the filter produces a modulated carrier that conforms to the FCC regulations for higher power equipment. In the v-h-f spectrum where broadband modulation is permissible and even desired in certain applications, the input filter may be removed. Tone control circuits or other similar circuits may then be employed.

The first and second stages of the modulator are push-pull resistance coupled 6SN7, the plate circuit of the second stage operating into a transformer which drives a pair of 807s. The push-pull 807s are triode connect-

ed and serve as drivers for the modulator tubes. The modulator tubes are two 813s, also connected as triodes.

To provide a low distortion modulator, it is necessary to provide a driver stage that has adequate power capabilities as well as excellent regulation. The regulation factor is more difficult to obtain than the power. The foregoing assumes that the grids of the modulator are driven to current conditions or approximately to current conditions. Under these conditions, the grid impedance shifts considerably and severe distortion may occur if adequate regulation of the driving circuit is not provided. The ideal method of obtaining good regulation is to provide a very low resistance and low impedance circuit. The 807s, while offering a large reserve of power, also provide a very low-impedance tube when connected as a triode, by placing the screen and plate together. The curves on this tube, connected as a triode, indicate an impedance of approximately 800 ohms. The screen and plate dissipation are found to be well below rating.

The successful operation of the 807 as a triode gave the lead toward operating the 813 as a triode. Connecting the plate and screen together was not practical because of the high plate voltages and normally low screen voltages required of this tube. The screen was therefore connected to the grid, the suppressor grid being grounded. After complete measurements were made on the tube, it was found that the bias voltage supply could be replaced with a cathode or heater return bias resistor. This resistor developed the required voltage without an increase in the distortion level of the amplifier. The elimination of the bias supply reduced the space requirements of the unit.

Complete distortion measurements on the modulator unit when operating into the r-f vacuum tube load have shown the distortion to be below 5%. This figure represents the total harmonic distortion when measured by means of a wave analyzer. The arithmetical sum of all harmonics to the sixteenth was included. A check with a noise and distortion meter indicated a distortion of approximately 2.5%; the noise and distortion meter is a device that measures the algebraic sum of the harmonics and thus will, in general, record approximately one-half that noted by the wave analyzer.

All air required for the transmitter is drawn in through the rear of the cabinet through ducts and filters. Each blower provides approximately 600

(Continued on page 54)

NEW DI-FAN RECEIVING ANTENNA



...covers ALL
television and
FM frequencies

THE Andrew Co., pioneer specialist in the manufacture of a complete line of antenna equipment, continues its forward pace with the introduction of this new DI-FAN receiving antenna.

The DI-FAN antenna provides excellent reception on *all* television and FM channels. It thus supersedes ordinary dipole antennas or dipole-reflector arrays which work well over only one or two television channels.

In addition, the following advanced features will recommend the DI-FAN to dealers and receiver manufacturers who want the best possible antenna for use with their FM and TV receivers:

- Impedance of DI-FAN matched to impedance of transmission line, preventing ghost images.
- Designed for use with 300 ohm transmission lines, conforming to RMA standards for FM and TV receivers.
- DI-FAN has a graceful, attractive shape—looks well on any building.
- Light in weight but strong and durable. High strength aluminum alloy elements. Supporting members of heavily plated steel.
- All insulators are high grade glazed steatite.
- Mounting supports available for either chimney or roof installations.

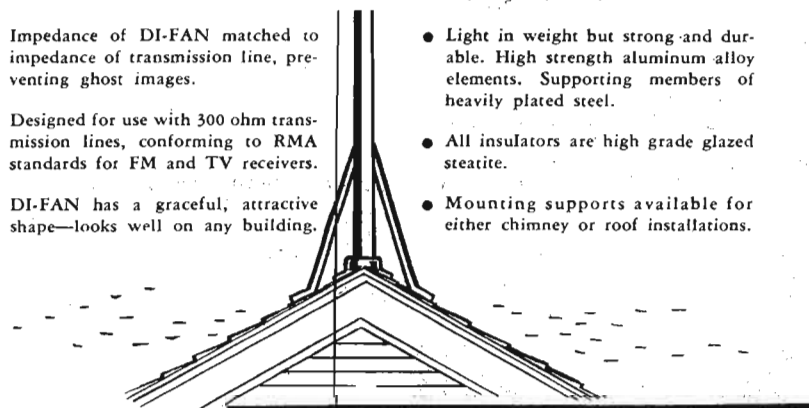

**ANDREW
CO.**

363 E. 75th St.
Chicago 19, Ill.

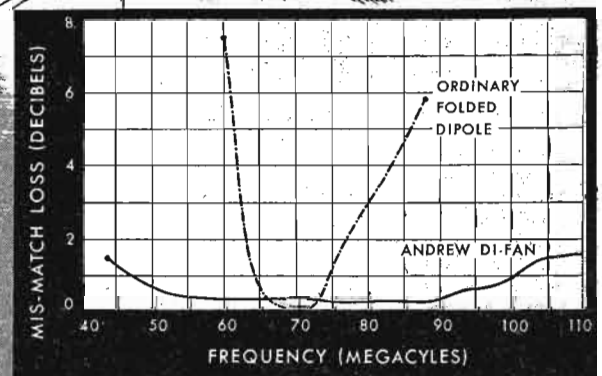

This graph illustrates the superiority of the Andrew DI-FAN over an ordinary folded dipole.



THERMOSTATIC METAL TYPE DELAY RELAYS

PROVIDE DELAYS RANGING
FROM 1 TO 120 SECONDS

FEATURES:—Compensated for ambient temperature changes from —40° to 110° F... Hermetically sealed; not affected by altitude, moisture or other climate changes... Explosion-proof... Octal radio base... Compact, light, rugged, inexpensive... Circuits available: SPST Normally Open; SPST Normally Closed.

PROBLEM? Send for "Special Problem Sheet" and Bulletin.

AMPERITE REGULATORS

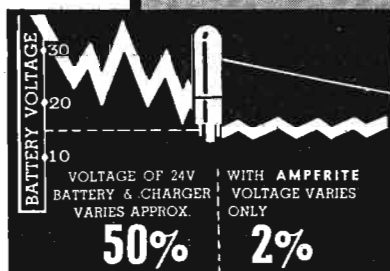

Amperite REGULATORS are the simplest, lightest, cheapest, and most compact method of obtaining current or voltage regulation... For currents of .060 to 8.0 Amps... Hermetically sealed; not affected by altitude, ambient temperature, humidity.

Write for 4-page Illustrated Bulletin.

AMPERITE CO., 561 Broadway, New York 12, N. Y.

In Canada: Atlas Radio Corp., Ltd., 560 King St., W. Toronto

PREMAX

Antennas for Mobile Units

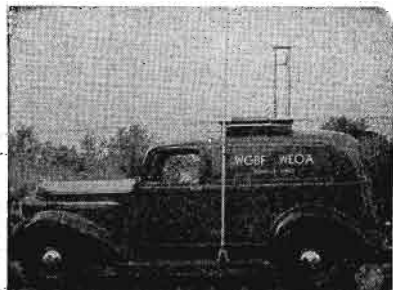

Collapsible Tubular Metal Antennas in varying heights from 6' to 35'—the type that will withstand weather conditions, corrosion and severe shock. Tested and proven in war—now standard equipment in fire, police and other municipal and federal services.

Ask your Radio Jobber for the new Premax Antenna Catalog.

Premax Products

Division Chisholm-Ryder Co., Inc.

4710 Highland Avenue, Niagara Falls, N. Y.

JONES SHIELDED TYPE PLUGS and SOCKETS



P-101-1/4"



S-101

Low loss Plugs and Sockets suitable for high frequency circuits. Ideal for antenna connections, photo-cell work, microphone connections, etc. Supplied in 1 and 2 contact types. The single contact type can be furnished with 1/4", .290", 5/16", 3/8", or 1/2" ferrule for cable entrance.

Knurled nut securely fastens units together.

All metal parts are of

brass suitably plated to meet Navy specifications. No. 101 Series Plugs have ceramic insulation and Sockets have XXX Bakelite. For complete listing and information write today for your copy of catalog No. 14.

HOWARD B. JONES DIVISION
CINCH MFG. CORP.
2460 W. GEORGE ST. CHICAGO 18

Ground-Air System

(Continued from page 53)

cubic feet per minute air flow which is distributed to various points within the cabinet.

The meters for the transmitter are mounted across the top of the cabinet. The line voltage and audio level input is recorded by one meter, the particular function being selected by means of the selector switch on the control panel. All currents in the transmitter are recorded by means of a meter switch on the front of the given r-f unit. The r-f unit being measured is selected by means of a switch on the control panel.

The antenna terminals of the transmitter are contained in a well in the top of the cabinet. This well provides a screen air outlet for forced air cooling of the transmitter as well as protective recess for the antenna terminals.

For remote installations, the transmitter may be located several miles from the operator's position. Complete control, including channel selection, type of operation, and starting and stopping the unit is possible from the operator's position. Two telephone lines may be employed, allowing two operators to transmit, simultaneously, on two frequencies. These may be either telephone or c-w transmissions. Another possible combination allows one operator to operate any one of the four r-f units as either telephone or c-w transmitters. Other combinations possible allow complete elimination of the telephone lines by use of v-h-f radio links.

A fourth type r-f head for the 152-162 mc f-m band is in development; this will also fit the standard space provided. All electrical connections will be identical with the other three units.

With the f-m channel the transmitter will be suitable as a fixed station for multi-channel communication with mobile units such as taxicabs. The f-m channel could also serve as a means of communication with emergency vehicles, with three high-frequencied channels used for operations on a nationwide police c-w network.

NOBLE RECEIVES IRE FELLOWSHIP



D. E. Noble (center), vice president in charge of the communications and electronics division of Motorola, receiving IRE fellowship diploma from Dr. W. R. G. Baker, president of IRE, while FCC chairman Charles R. Denny looks on.

Paper-Disc Recorder

(Continued from page 32)

possible to provide guide grooves in the paper blanks, it was decided to use a spirally-grooved plastic tracking disc. As finally developed, the disc is $5\frac{1}{8}$ " in diameter, with a hole to fit an indexing pin.

A guide stylus, on the tone arm which holds the recording-reproducing head, was placed in the spiral groove to guide the tone arm so that the magnetic head would always trace out the same path on the exposed portion of the recording blank.

For slight variations in tracking from one instrument to another a *tuner* knob was placed on the tone arm. The guide stylus was mounted eccentrically on the shaft which terminates in this knob. Thus rotating the *tuner* knob moves the arm relative to the grooved *tracking* disc, and permits the magnetic head to be centered directly over the sound track.

The unit provides for the making of recordings from the inside out, because of the much greater certainty with which the starting point can be determined at the inside edge. To operate, the tone arm is lifted slightly off the recording blank and moved in to the center as far as it will go. Releasing then automatically places the arm in the innermost portion of the sound track.

The turntable (9") was designed to rotate at 20 rpm. This provided a lineal speed of the medium beneath the recording head of 5.7 inches per second at the inner edge of the exposed portion, increasing to 9.4 inches per second at the outer edge. Such low speeds for a magnetic recording medium were unheard of only a few years ago. Poulsen's original magnetic recorder, built about 1900, used piano wire as the recording medium which had to be run at a speed of 10 feet per second to get acceptable voice quality.

Another factor that required close study, during the design of this unit, was the coercivity of the material used in recording blanks. Coercivity, a measure of the force with which it resists demagnetization, also indicates the extent to which variations in magnetism can be crowded together on the medium without influencing each other, or in other words, the *fineness of resolution* of the medium. The higher the coercivity of a magnetic recording medium, the greater is the quantity of recording that can be crowded into a given space.

To permit the discs to run at low speeds, high coercivity material was therefore chosen. This same property

(Continued on page 56)

Announcing...THE NEW TURNER MODEL 20X HAND MICROPHONE

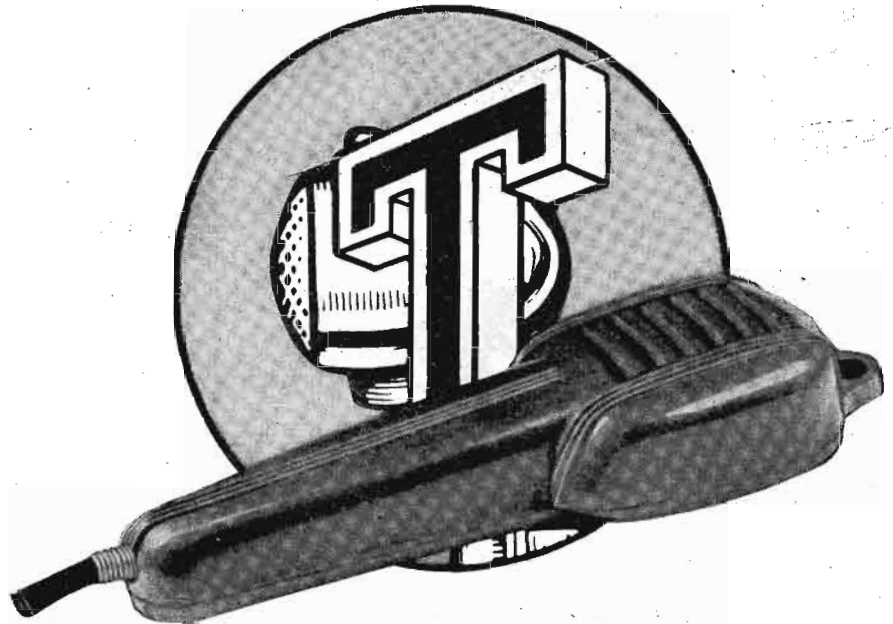

a little mike
with a **BIG** future

We're mighty proud of this new addition to the line of Microphones by Turner. Small in size yet *big in performance* it inherits those qualities of sound engineering and careful workmanship that have made the name Turner a symbol for precision and dependability.

The New *Model 20X* is designed to appeal to owners of home recorders and amateur communications equipment. It has innumerable applications in offices and factories and for paging and call system work. Sound pressure tests reveal remarkable performance characteristics for a low priced unit. Its circuit features a Metalseal crystal which withstands humidity conditions not tolerated by the ordinary crystal. Response to voice and music is smooth and flat within ± 5 db from 40-7000 c. p. s. Level is 54db below 1 volt/dyne/sq. cm. Finished in lustrous brown baked enamel, the *Model 20X* is light in weight and natural to hold. It may be hung on a hook. Furnished complete with 7 ft. attached shielded cable.

WRITE FOR BULLETIN

THE TURNER COMPANY

907 17th Street N. E. • Cedar Rapids, Iowa

Microphones  BY TURNER



"THE PASSWORD TO SOUND PERFORMANCE"

LICENSED UNDER U. S. PATENTS OF THE AMERICAN TELEPHONE AND TELEGRAPH COMPANY, AND WESTERN ELECTRIC COMPANY, INCORPORATED. CRYSTALS LICENSED UNDER PATENTS OF THE BRUSH DEVELOPMENT COMPANY.

PRECISION CRYSTALS



The
REEVES-HOFFMAN
factory is equipped to manufacture a very large variety of quartz crystal units, both standard and custom. If you need quartz crystal units for use in the fields of communications, electronic control, ultrasonics, diathermy, instruments, or other special applications, REEVES-HOFFMAN can design and manufacture to fill your needs. Estimates and quotations promptly submitted.

REEVES-HOFFMAN
Crystal Units Catalog RHC-1 lists standard crystal units complete with specifications. It also gives valuable information on how to order crystal units.



REEVES-HOFFMAN
CORPORATION

SALES OFFICE: 215 EAST 91 STREET, NEW YORK 28, N. Y.
PLANT: 321 CHERRY STREET, CARLISLE, PA.

(Continued from page 55)

also makes it possible to record forty sound tracks side by side in an inch-wide strip of the medium without cross-talk. The width of the sound track is .014"; in other words, the sound tracks are separated from each other by only .011".

The figure of forty sound tracks per inch was arrived at on the basis of cross-talk studies which were made on powder-coated media. A single sound track was recorded on coated tape, and the playback level measured when the reproducing head was directly over the sound track, and when it was displaced laterally by successively larger amounts. The family of curves in Figure 3 shows the playback level at different displacements and frequencies for a tape speed of 6" per second. From these curves it will be noted that for a 100-cycle signal the output of the reproducing head will be 13-db higher when the head is directly over the sound track, than when it is displaced 0.02" to either side of the sound track.

These curves also reveal the relationship of cross-talk to frequency; the lower the recorded frequency, the more the reproducing head must be displaced laterally to secure a given reduction in level. The paper-disc playback-recorder was designed exclusively for the speech range, and so the very low frequencies can be dispensed with entirely. This results in no loss in intelligibility, and permits the sound tracks to be spaced much closer together than would be possible if music were being recorded. The frequency response of the unit is, as a matter of fact, about the same as that of a telephone. With the magnetic head properly centered over the sound track, no cross-talk can be detected.

Somewhat closer spacing of the sound tracks would be permissible if cross-talk was the only criterion. Satisfactory operation has been obtained with a spacing of sixty sound tracks to the inch. For such close spacing, however, indexing the record becomes critical when it is removed and subsequently replaced. By using a spacing of forty tracks to the inch the indexing of the record becomes substantially foolproof, and variations of the dimensions of the record with age and climatic conditions become of negligible importance.

Dual-Purpose Crystal Phone

A single crystal phone was included in the unit to serve as recording microphone and playback earphone. Its voltage output as a microphone is high, and it was found necessary to use only one amplifier stage, V_2 , between it and

CHICAGO



ALL TUNING FACTORS EASY AND SIMPLY ADJUSTABLE

Meet us in Person at Booth 42 to see the new improved Shur Interceptor & Antenna Mount

THE 300 OHM SPACED LINE
And -- Two NEW Antennas: --
The DELUXE INTERCEPTOR
The SHUR "Jiffy" ANTENNA

SHUR-ANTENNA-MOUNT, INC.

EASTERN DIVISION SEA CLIFF, NEW YORK

Peerless POWER PACKS

TUBES! TUBES! TUBES!

Transmitting and Receiving Types
ALL NEW! ALL GUARANTEED!

<p>27¢ 991 1629</p> <p>49¢ 6C4 2C22</p> <p>59¢ 954 955 956</p> <p>69¢ 866A 1613 1625 VR90 VR105 VR150 9006</p> <p>79¢ 5R4GY</p> <p>89¢ 2X2A 6AK5</p>	<p>89¢ 6AL5 VR75 2050 2051</p> <p>98¢ 6AG7 6X4 6Y6 1616 9001 9003 9005</p> <p>\$1.09 2C34 211</p> <p>\$1.19 6AG5 24G(3C24)</p>	<p>\$1.49 802 809 836</p> <p>\$1.59 6AK6 801A</p> <p>\$2.19 2AP1 826 872A</p> <p>\$2.59 810</p> <p>\$2.89 3BP1 3B24 446A 829A 829B 860</p> <p>\$14.95 RK65 575A</p>	<p>\$3.39 812 837</p> <p>\$3.75 805</p> <p>\$3.95 832A</p> <p>\$4.95 5BP1 5CP1</p> <p>\$5.95 813 8020 8025 1603</p> <p>\$8.95 803</p> <p>\$11.75 304TH</p> <p>\$150.00 880 880 207</p>	<p>\$17.95 250TL 953B</p> <p>\$24.95 723A/B 724A/B</p> <p>\$29.95 450TH</p> <p>\$45.00 725A 725A-B</p> <p>\$75.00 730A</p> <p>\$105.00 869B 728/BY, DY-FY-GY</p> <p>\$120.00 827R 892R</p>
--	--	---	--	--

All prices F.O.B. Jamaica, New York. Include postage.
Write Dept. CM1.

PEERLESS RADIO DISTRIBUTORS, INC.
92-32 MERRICK RD., JAMAICA 3, N. Y.
Branch: 71 MURRAY STREET, NEW YORK 7, N. Y.

output tube, V_3 , which supplies recording current to magnetic head; Figure 4. A supersonic bias current, used in recording, is generated by an oscillator tube, V_4 , and fed to the magnetic head in parallel with the signal current from V_3 .

Mixed bias and signal currents flowing through the coil of the magnetic head produce a varying magnetic field across the gap in the pole pieces. This gap rests directly on the surface of the moving recording blank and the varying magnetic field locally magnetizes the coating of the blank to a degree proportional to the instantaneous strength of the signal current.

In the playback process the magnetic head retraces the same path over the blank, and magnetic variations along this path generate a voltage in the coil, corresponding to the original signal. Amplified by V_1 and V_2 , this voltage is supplied to the grid of the output amplifier, V_3 , which drives the crystal phone to supply an audible signal.

To achieve the minimum possible noise level, it is essential that no remanent magnetization exist in the polepieces of the recording head. In practice, this is a somewhat difficult condition to achieve. Although the polepieces are specially heat-treated to yield the magnetically softest possible material, minute strains set up in the assembly process tend to counteract the effect of the heat treatment, and render the polepieces slightly susceptible to stray magnetic fields.

To overcome this difficulty the head was placed in a circuit which provided automatic demagnetization every time a switch was thrown to a play position. This was accomplished by the inclusion of a capacitor in the circuit.

In operation the capacitor is charged up during the operation of the instrument. When the switch is thrown from *record* to *play* capacitor discharges through oscillator tube, generating a damped sine-wave which is applied to the coils of the magnetic head. This decaying a-c field effectively demagnetizes the polepieces each time it is applied to them, removing any slight remanent magnetism which might exist. Thus every time the switch is thrown the magnetic head is neutralized. This procedure also provided an improvement in the signal-to-noise ratio.

To provide maximum use of the disc, a *pause* switch was included in the unit; this can be used to interrupt a recording momentarily while the operator decides on the next word or phrase. As long as this switch is held in the *pause* position, the turntable will

(Continued on page 58)

Astatic Crew ARRIVES FOR THE CHICAGO SHOW!

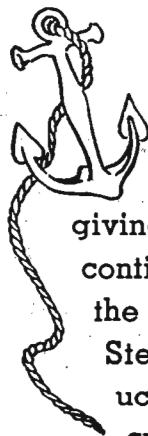

Just in case you're not at the dock when this craft pulls in, we're giving you a preview of Astatic's first contingent of conventioners arriving for the Annual Electronic Parts Show at The Stevens. They're taking sample products along, of course...newest Astatic creations in Crystal and Dynamic Microphones, Phonograph Pickups and Cartridges. It's going to be fun showing this fine line of Astatic products, but it's going to be equally exciting to meet all the old gang again as well as newcomers in the field. Happy days ahead ...in May...at the show! See you there!

HOTEL
STEVENS
MAY
13 to 17

THE
Astatic
CORPORATION
CORNEAULT, OHIO

IN CANADA: CANADIAN ASTATIC LTD. TORONTO, ONTARIO
Astatic Crystal Devices Manufactured
under Brush Development Co. patents.

3 WAYS TO BE AHEAD in Buying Test Equipment

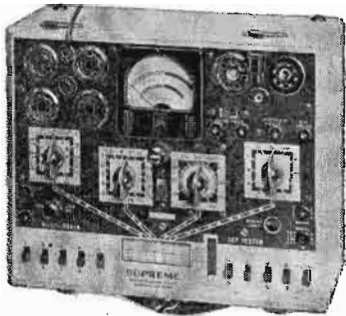

Model 599-A Tube and Set Tester

SPECIFICATIONS
 DC Volts — 5 ranges 0/6/15/150/600/1500 volts, 1000 ohms per volt.
 AC Volts — 3 ranges 0/15/150/600 volts..
 DC Current — 3 ranges 0/6/60/600 milliamps.
 Output Volts — 0/15/150/600 volts.
 Ohmmeter — 4 ranges 0/200/20,000 ohms and 0/2/20 megohms.

Condenser Checker—Ohmmeter provides fast method of checking leakage of both paper and electrolytic condensers.

Battery Tester — Tests most commonly used dry portable batteries of 1.5/4.5/6.0/45/90 volts. English reading "Replace-Good" scale.



WRITE FOR
NEW
CATALOG

SUPREME INSTRUMENTS CORP., Greenwood, Miss., U.S.A.

Export Department: {THE AMERICAN STEEL EXPORT CO. Inc.,
347 Madison Ave., New York 17, N. Y., U.S.A.

- 1 BUY ACCURACY
- 2 BUY DEPENDABILITY
- 3 BUY SUPREME-ACY

Ask your nearest SUPREME jobber for a demonstration of Model 599-A Tube and Set Tester (above), Model 561-AF & RF Oscillator, Model 546-A Oscilloscope, Model 592 Speed Tester. Ask to see the complete line of SUPREME equipment.

SUPREME

Tube Testing — Circuit incorporates proven and modernized emission circuit. Checks for short, leakage, and noise tests between elements.
 Power Supply—100-133 volts—50/60 cycles. Special voltages and frequencies on request.

Lateral Recording

(Continued from page 40)

the surface of the disc and adjust the angle of the head until the cutting edge of the stylus makes a straight line with its reflection in the disc. In this position, the stylus is vertical with the disc surface. With some stylus points and discs, it may be necessary to set the angle of the cutting edge with the disc at slightly less than 90°. While the angle, which gives the quietest groove, must never under any conditions exceed 90°, it may vary with discs and styli from 90° to a minimum of 85°.

The depth of the groove is an important element in the cutting of a good record. Too deep a cut will cause echo due to heavy modulation level, causing the walls of adjacent grooves to be distorted by modulation in the preceding or following grooves. Too light a cut or too shallow a groove will result in the inability of some playbacks to track properly.

[To be continued]

Paper-Disc Recorder

(Continued from page 57)

not revolve, and no recording time is wasted.

In common with all magnetic recordings, the disc blanks can be played back many times without appreciable loss of volume or quality. Heat, cold, and wide variations of humidity have no effect on them, and they can be stored indefinitely for long periods.

A blank on which a recording has been made can be erased at any time by rotating it beneath a special bar magnet.

TV STUDIO RECEIVER

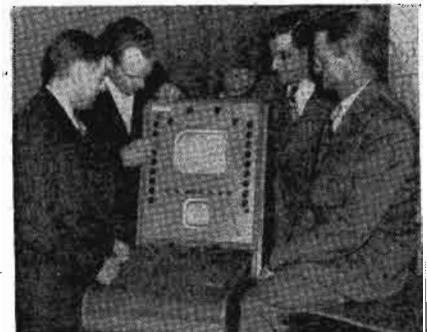

Television studio-type receiver, recently designed by General Electric, being demonstrated by Philip G. Caldwell, G. E. tv equipment sales manager, during a tv broadcasting conference at the Syracuse plant of G. E. Left to right, G. E. field men, W. C. Jaeger, Boston; S. W. Pozgay, Chicago; and M. F. Chapin, Minneapolis.

Here's Your NEW
ALLIED CATALOG

FREE

Everything in
Radio &
Electronic
Supplies



Send for it Now

Complete, Expert Service
for Radio Engineers

Write for your FREE copy of the new ALLIED Catalog—the accepted Buying Guide for Radio and Electronic supplies. Get everything you need in your research and development work from a single dependable source with more than 20 years of radio supply experience. Largest stocks of parts, tubes, test instruments, public address equipment . . . send for your copy today!

ALLIED RADIO CORP., Dept. 31-D-7
833 W. Jackson Blvd., Chicago 7, Illinois

SEND FREE 1947 ALLIED CATALOG.

Name.....

Address.....

ALLIED RADIO

BOOKS FOR THE ENGINEER

UNDERSTANDING MICROWAVES

(Chapter Heads)

The Ultra High Frequency Concept Stationary Charge and its Field • Magnetostatics • Alternating Current and Lumped Constants • Transmission Lines Poynting's Vector and Maxwell's Equations • Waveguides • Resonant Cavities • Antennas • Microwave Oscillators • Radar and Communication • Section Two is devoted to descriptions of Microwave Terms, Ideas and Theorems. Index.

400 PAGES

PRICE \$6.00

A-C CALCULATION CHARTS

Student engineers will find this book invaluable. Simplifies and speeds work. Covers all AC calculations from 10 cycles to 1000 megacycles.

160 PAGES

PRICE \$7.50

JOHN F. RIDER, Publisher, Inc.

404 FOURTH AVENUE, NEW YORK 16, N. Y.
EXPORT DIV. ROCKE-INTERNATIONAL ELEC. CORP.
13 E. 40TH STREET, NEW YORK CITY. CABLE ARLAB

The Industry Offers

(Continued from page 44)

15,000 cycles and less than 1% total distortion over the range 30-15,000 cycles; as a monitor amplifier, +39 dbm (8 watts) with less than 1% total rms harmonic distortion over the range 50-10,000 cycles. Output noise equivalent to an input signal of -120 dbm over a bandwidth of 20,000 cycles.

Input source impedance and output load impedance same as 116-A.

Uses two 1620 and two 6V6GT.

WIRERECORDER UNITS

First of five wire recording models, model B, has been announced by The Wirecorder Corporation, Detroit, Mich.

Recorder is said to be interchangeable with most sound-on-disc and sound-on-film recording equipment and usable with any suitable amplifying system already in operation.

Features of recorder include a capstan drive, magnetic clutches to keep wire tension constant during recording, cam-operated recording head to wind the wire in even layers on takeup spool, and safety switches to stop the motor when a spool is almost entirely unwound.

Wirecorder Corp. is represented by R. C. Powell and Co., New York City.

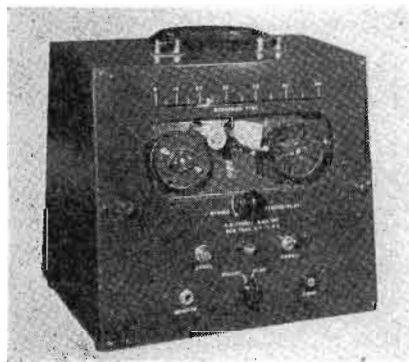

KEITHLEY SIGNAL DIVIDER

A signal divider (model 101) to provide low level input signals used in testing high gain amplifiers has been designed by Keithley Instruments, 1508 Crawford Road, Cleveland 6, Ohio. Signal divider attenuates in decade steps, and is used in conjunction with the output control of the signal source.

The circuit is a resistance potentiometer with one side grounded.

In operation, the input is connected to a source of test signal, and the output to the circuit under test. Terminals are provided for connecting a monitoring voltmeter in parallel with the input. Test voltages are obtained by setting the test oscillator output to a value between one and ten volts, which is a multiple of 10 greater than the desired voltage, and then setting divider to reduce the oscillator voltage by the correct multiple of 10.

Signal divider also said to feature a comparatively wide frequency range and an input impedance of 11,000 ohms.

Output voltages available from ten microvolts with 0.1 volt input, to 100 volts with 100 volts input. Frequency range is 0 to 200,000 cps.

JFD TEST LEADS

A line of test leads and test lead accessories has been produced by the JFD Manufacturing Co., 4117 Fort Hamilton Parkway, Brooklyn 19, New York. Test leads use fiber and cast phenolic prod handles, and are made of No. 18 soft-drawn copper. End fittings (phone tip, phono needle point, spade lugs, alligator clip, banana plug, and elbow angle tips) are of chromium-plated brass.

GUARDIAN ELECTRIC MIDGET RELAY

A relay comprised of two basic parts, a coil assembly and a contact assembly (series 600), with basic part interchangeable, has been announced by Guardian Electric Mfg. Co., Dept. 600, 1623 West Walnut Street, Chicago 12, Illinois. Contact assembly can be used with any of the series 600 or 605 coils whether the

(Continued on page 60)

**NEW
TECH-LAB
DEVELOPMENT**

For **RAPID
MEASUREMENT
OF
AUDIO FREQUENCY
GAIN or LOSS**

TYPE 1A TRANSMISSION MEASURING SET

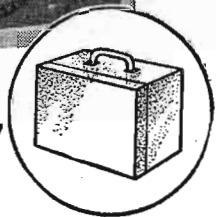

Completely Self-Contained

PORTABLE • AC OPERATED

With this instrument it is possible to quickly and accurately analyze and service equipment in different locations without fuss in time consuming demounting and transportation of apparatus. It will thus pay for itself in a short time and no modern radio station can afford to be without it. It can also be used to good advantage in factory checking and inspection of audio equipment.

The set combines in a modern efficient manner an accurate vacuum tube voltmeter, an audio oscillator with four fixed frequencies and a precision attenuator all mounted in a handy cabinet easily carried by the operator.

SPECIFICATIONS

- GAIN: Up to 80 db.
- LOSS: 60 db. maximum.
- VACUUM TUBE VOLTMETER:
Range—40 to +40 db.
(1 mv. ref. level)
- AUDIO OSCILLATOR:
Freq. Range; 100 to
10,000.
- PRECISION ATTENUATOR:
Flat to 20 KC; 93 db.
in .1 db. steps.
- DIMENSIONS:
10 1/4" x 16 1/4" x 8 3/4"
- WEIGHT: 30 lbs.
- INPUT: 115 Volts.
60 cycles, 70 watts.

TECH
LABORATORIES, INC.

Manufacturers of Precision Electrical Resistance Instruments
337 CENTRAL AVE. • JERSEY CITY 7, N. J.



Still the Leader

WINCHARGER TOWERS

The surging, booming post-war rush of radio broadcast construction finds Wincharger again supplying the industry with the bulk of its towers. And for the same reasons. Wincharger's guyed tower, with its uniform sections and resulting mass production economy, continues to be the industry's recognized dollar-and-cents value. The convenience of Wincharger's "packaged-buying" and Wincharger's reliable maintenance and service, continue to be powerful attractions.

FM broadcasters are following in the footsteps of the AM industry in likewise choosing Wincharger Antenna Tower Supports.

All Wincharger towers come completely equipped and ready for installation. This includes necessary lighting such as a 300 MM beacon, flasher, obstruction lights, wire, conduit, fuse box. No extras to buy—easy to erect. No wonder Wincharger Towers continue to be the industry's favorite.

FM ANTENNAS

The new, ultra-high-frequencies are an old story to the engineers who developed Wincharger's FM Folded Dipole Antenna. Pre-war FM experts, they set to work during the war to create some of the Armed Forces' finest radar equipment. And now again the Wincharger FM Folded Dipole Antennas lead, without a doubt, the finest engineering in the industry.

WINCHARGER Corporation SIOUX CITY 6, IOWA, U.S.A.

Input impedance (volts a-c): 12 megohms shunted by 6 mmfd; (volts d-c) 15 megohms. Tubes used include two 6X5GT (rectifiers); one 6SJ7 (cathode follower); one 6SN7GT (vacuum-tube voltmeter); one OD 3/VR 150 (voltage regulator), and one 9006.

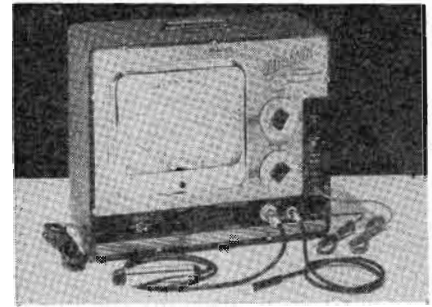

SPRAGUE MINIATURE CAPACITORS

Miniature capacitors in round and flat types, types 63P and 64P, have been announced by the Sprague Electric Company, North Adams, Mass. Standard units available include capacities ranging from .00025 to 1 mfd; typical capacitor rated .005 mfd at 150 volts is 3/16" long x 3/16" diameter.

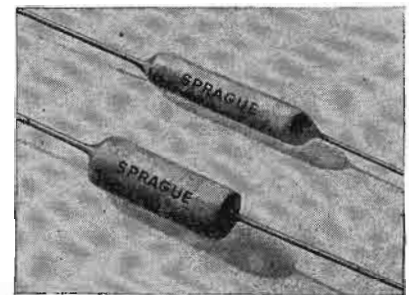

The Industry Offers

(Continued from page 59)

operating voltage is 3, 6, 12, 18, 24, 32, 50, 115, 230 a-c or 3, 6, 12, 18, 24, 32, 50, 110 d-c. Maximum contact current capacity is 8 amperes and power consumption is 6 va.

Relay can be furnished with many contact switch combinations up to and including four-pole, double-throw.

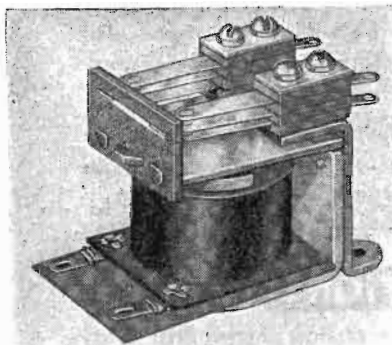

GENERAL COMMUNICATION U-H-F SIGNAL GENERATOR

An u-h-f signal generator, designed to furnish an r-f signal for calibration and alignment of u-h-f receivers, and for general laboratory work within the range of 1,200 to 4,000 mc (model P142), has been developed by the General Communication Co., Boston, Mass. Provides unmodulated, pulse modulated, or f-m signal.

A bolometer with indicating meter is provided so that the r-f output level of the unit may be checked continuously. As this monitoring level varies in amplitude, a calibration curve is provided to compensate for this variation. The monitoring level is also frequency

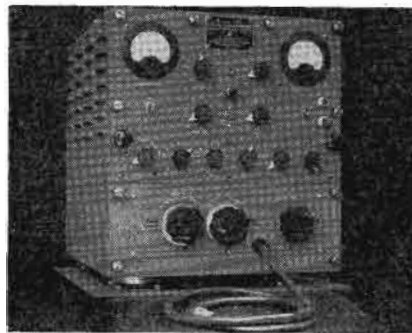

selective and another calibration curve is provided to compensate for this frequency error.

Oscillator is a velocity-variation reflex type using an adjustable cavity. One control is used for setting cavity length and another is provided for accurately setting the repeller voltage in order to peak the oscillator tube to the desired mode.

Absorption type wavemeter is used in conjunction with a crystal detector and level indicating microammeter.

HICKOK VOLT-OHM-CAPACITY-MILLIAMMETER

An electronic volt-ohm-capacity-milliammeter, model 209, with a low capacity, high-frequency probe has been developed by the Hickok Electrical Instrument Co., 10529 Dupont Avenue, Cleveland 8, Ohio.

Unit measures d-c voltages across avc discriminator and limiter circuits (d-c circuit rejects all a-c voltages). Polarity reversing switch permits use on d-c without changing lead connections.

Ranges: volts (a-c or d-c and ma), d-c, 0-3, 12, 30, 120, 300, 1,200; capacity, 1-10,000 mmfd in 2 ranges, and 1-1,000 mfd in 5 ranges; inductance, 50 mh-100 henries (using conversion chart); resistance, 1/10 to 10,000 megohms in 8 ranges.

BURNELL SCRATCH FILTER

A scratch filter featuring a flat response within the bass band and sharp attenuation above cutoff frequencies has been developed by Burnell & Co., 45 Warburton Ave., Yonkers 2, New York.

Three cutoff frequencies are provided via a single-circuit switch.

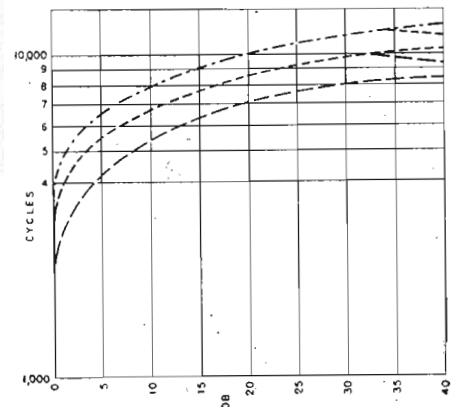

RCA GERMANIUM CRYSTAL PROBE

A miniature germanium crystal rectifying probe, which adapts the voltohmmyst and chalynt for tv, f-m and other v-h-f circuit testing has been developed by the test and measuring section of the RCA engineering products department.

The probe (type MI-8263) employs the crystal to rectify applied a-c voltages which are then measured by the d-c circuit of the meter; meter reading is proportional to the positive peak of the applied a-c voltage.

WHEELER LAB R-F INDUCTANCE METER

A direct-reading inductance meter for measuring inductance at the radio frequencies of nor-

mal operation has been developed by the Wheeler Laboratories, Inc., Great Neck, New York. In five decades it covers continuously the ranges of $1\mu\text{h}$ to 100 mh; values of inductance are read directly from the linear scale of a standard variable capacitor with the decimal point being determined by a proper multiplier.

Instrument can also be used for direct measurement of small capacitance (up to 1,000 mmfd) and for indirect measurement of larger capacitance.

Inductance range: Decade 1, 0 to 10 μh , 1,600 to 1,100 kc; 2, 0 to 100 μh , 500 to 350 kc; 3, 0 to 1 mh, 160 to 110 kc; 4, 0 to 10 mh, 50 to 35 kc; and 5, 0 to 100 mh, 16 to 11 kc.

* * *

TRIPLETT VOLT-OHM-MILLIAMMETER

A high-impedance volt-ohm-milliammeter, model 2450, has been announced by the Triplett Electrical Instrument Co., Bluffton, Ohio.

Instrument uses two voltage regulator tubes.

Ranges are: D-c volts, 0-2.5-10-50-250-500-1,000; a-c volts, 0-2.5-10-50-250-500-1,000; d-c milliamps, 0-0.1-1.0-10-50-250-1,000; ohms, 0-1,000 (midscale 10)-10,000-100,000; megohms, 0-1-10-100-1,000; and capacity in mfd, 0-.05-.5-5-50-500.

* * *

SIMPSON ILLUMINATED METERS

Illuminated meters in 2" and 3" sizes, and in rectangular and round cases, have been developed by the Simpson Electric Company, Chicago, Illinois.

A patented method of illumination is used with a lucite cone carrying the light from a recessed bulb in the back of the instrument through the front edge of the cone which entirely surrounds the dial face. This makes possible the use of a standard metal dial.

* * *

RCA BATTERIES

Four new types of batteries have been announced by RCA.

Batteries range from a baby flashlight cell and a penlight cell to a lantern battery; $1\frac{1}{2}$ -volt-baby flashlight cell (type No. VSO33), 1" in diameter by $1\frac{7}{8}$ " long; penlight cell (type No. VSO34), also $1\frac{1}{2}$ volts, $9/16$ " by $1\frac{15}{16}$ "; $1\frac{1}{2}$ -volt ignition cell (type VSO61S), $2\frac{5}{8}$ " by $6\frac{9}{16}$ "; and 6-volt lantern battery (type VSO40), $2\frac{5}{8}$ " x $2\frac{5}{8}$ " x 4".

STANDARD SIGNAL GENERATOR

**MODEL
65-B
RANGE
75 KC
to
30 MC**

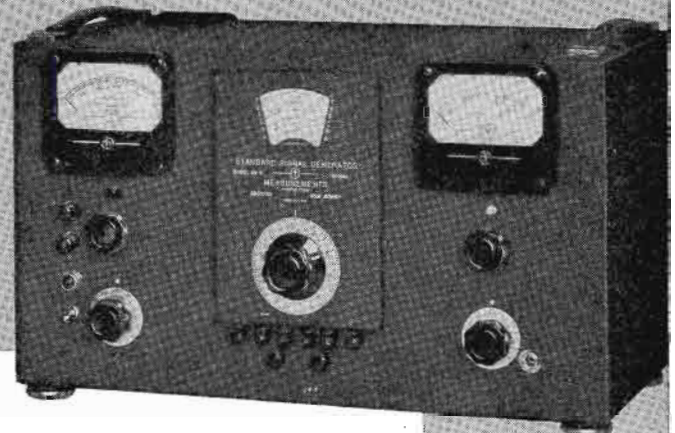

Individually Calibrated Scale

OUTPUT: Continuously variable, .1 microvolt to 2.2 volts.

OUTPUT IMPEDANCE: 5 ohms to .2 volt, rising to 15 ohms at 2.2 volts.

MODULATION: From zero to 100%. 400 cycles, 1000 cycles and provision for external modulation. Built-in, low distortion modulating amplifier.

POWER SUPPLY: 117 volts, 60 cycles, AC.

DIMENSIONS: 11" high, 20" long, $10\frac{1}{4}$ " deep, overall.

WEIGHT: Approximately 50 lbs.

Catalog on request

MANUFACTURERS OF
Standard Signal Generators
Pulse Generators
FM Signal Generators
Square Wave Generators
Vacuum Tube Voltmeters
UHF Radio Noise & Field
Strength Meters
Capacity Bridges
Megohm Meters
Phase Sequence Indicators
Television and FM Test
Equipment

MEASUREMENTS CORPORATION
BOONTON NEW JERSEY

ELECTRICAL AND MECHANICAL ENGINEERING POSITIONS OPEN

FOR ELECTRICAL AND MECHANICAL ENGINEERS EXPERIENCED IN DESIGN OF HOME, TELEVISION AND AUTO RADIO RECEIVERS.

COLLEGE EDUCATION DESIRABLE BUT NOT NECESSARY IF SUFFICIENTLY EXPERIENCED. MINIMUM EXPERIENCE OF THREE YEARS REQUIRED IN ANY CASE. NONE OTHERS NEED APPLY.

Write Details of Education, Experience and Salary Required

QUALIFIED INDIVIDUALS WILL BE GRANTED APPOINTMENTS FOR INTERVIEWS IN BUFFALO AT OUR EXPENSE

COLONIAL RADIO CORPORATION
ENGINEERING DIVISION

1280 MAIN ST.

BUFFALO 9, N. Y.

F-M LOOP ANTENNAS

(Continued from page 35)

version transformer would have to be employed. Measurements made on the circular antenna, comparing the results obtained by feeding it directly with a coaxial line, grounding one of the terminals, and feeding it with a conversion transformer indicated that there is no practical need for including the transformer in the circuit.⁹ Hence, one terminal of the input leads is grounded, dotted in Figure 3c, when a coaxial feed line is employed. With one terminal grounded, horizontal pattern measurements showed no evidence of redistribution of the currents in the important radiating elements.

In studying the final antenna we find that the double current path serves two purposes. First, it permits a transformation of the radiation resistance to a

terminal resistance value in the general order of the nominal characteristic impedance of the coaxial transmission lines used to feed the antenna. Second, it permits direct mounting of the radiating system at a point of ground potential so that the disturbing capacity effects, which normally accompany insulated mountings, are eliminated and protection against lightning is secured. The adjustable capacitor permits tuning of the electrical circuit to resonance at the factory to the desired frequency of operation. An experimen-

⁹A. G. Sheldorf, *Circular Antennas*, Sixth Annual Conference of Broadcast Engineers, Columbus, Ohio; COMMUNICATIONS, April, 1946.

¹⁰A. Alford and A. G. Kandoian, *UHF Loop Antennas*, AIEE Transactions Supplement, p. 843; vol. 59, 1940.

Figure 10

The measured horizontal radiation pattern of the loop shown in Figure 9. (Courtesy FTR)

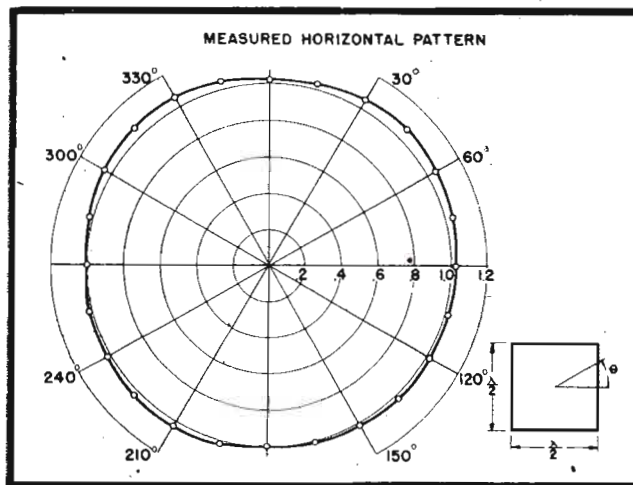

tal horizontal pattern is illustrated in Figure 5.

The Square Loop F-M Antenna

The square loop f-m antenna is based on the u-h-f loop antenna developed for blind landing systems.¹⁰ The basic operating principle is illustrated in Figure 6. Two small loops, small enough so that the current is quite uniform, are fed in the phase indicated on the figure by the plus and minus signs. Both plus terminals and both minus terminals are in the same phase. The loops are semi-circular and placed back to back as shown. The current in the leg *BC* will cancel the current in the leg *FE*. Hence points *B* and *F* and points *C* and *E* can be solidly connected.

This type of loop antenna can be fed by a coaxial line in the manner of a shielded loop wherein the shield is the antenna and the coaxial line runs up through the shield. This is illustrated in Figure 7. It is called a two-

Figure 9

Constructional details of the square f-m loop, a modification of the loop shown in Figure 8(b). (Courtesy FTR)

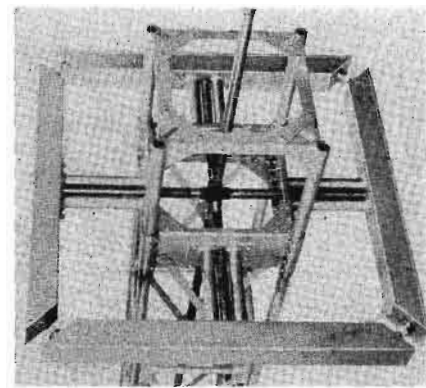

... For Dependable Commercial Service

Designed for the rigors of commercial service in all types of radio communication . . . broadcast, mobile, aircraft, police. Precision made for utmost in stability, dependability, trouble-free operation. Calibrated within .005 per cent of specified frequency . . . range 1.5 to 10.5 MC Temp. coefficient less than 2 cycles per mega cycle per degree centigrade. Weighs less than 3/4 ounce. Gasket sealed against contamination and moisture. Meets FCC requirements for all above services. See your jobber—Petersen Radio Company, Inc., 2800 W. Broadway, Council Bluffs, Iowa. (Telephone 2760.)



PR Precision CRYSTALS

Electronic Research & Mfg. Corp.

A Service to INDUSTRY
Development and Construction of
Electronic Equipment for Any Application

1420 E. 25th St., Cleveland 14, O. - Ph.: SU. 1958

WHEN YOU CHANGE YOUR ADDRESS

Be sure to notify the Subscription Department of COMMUNICATIONS, 52 Vanderbilt Avenue, New York 17, N. Y., giving the old as well as the new address, and do this at least four weeks in advance. The Post Office Department does not forward magazines unless you pay additional postage, and we cannot duplicate copies mailed to the old address. We ask your cooperation.

element loop and its circumference cannot exceed one wavelength. To increase the size of the loop, more elements are added. Figure 8 shows the schematic diagrams of the three- and four-element loops. The circumference can be increased a half wavelength for each added element.

In the final design a four-element loop was chosen and, since the electrical characteristics of a loop do not vary as the shape is varied within reasonable limits, a square construction was employed. This is illustrated in Figure 9. The lines coupling the main feeder to the radiating elements are used as the matching device to match the antenna to the characteristic impedance of the feed line.

It was found that the same sized mechanical structure could be used for any frequency in the f-m band. The measured radiation pattern of the final antenna is shown in Figure 10.

[To be continued]

Variable Inductance Tuning

(Continued from page 49)

the lead inductance, determines the upper frequency to be selected. As can be seen, the spacewound fixed inductance will have a higher Q than the portion of the last turn of the tuner. This causes the Q to rise as the upper frequency limit is approached.

Special alloys of wire, trolley guides, and end rings, in conjunction with the nib contactor aid in reducing the tuner noise to a level below that of the tube noise.

The problem of reset error, or reset-ability, is a serious one in high-frequency circuits. Therefore the tuner has been designed for a maximum reset error of .025% or 100 kc at 200 mc, making it possible to use the unit in conjunction with a motor drive or mechanical pushbutton arrangement.

News Briefs

(Continued from page 47)

Sylvania Electric Products, Inc., Emporium, Pa., has released a 378-page technical manual containing basic application data for 545 types of receiving tubes used by circuit designers, radio set repairmen and industrial electronic engineers.

Data supplied includes characteristic curves for types in common use; resistance-coupled amplifier data; interchangeable tube charts; connections for standard RMA internal and external shields; typical receiver and amplifier circuits; dictionary of tube, circuit and f-m terms; and instruction on the use of characteristic curves.

Priced at eighty-five cents, manuals are available from Sylvania distributors or from Sylvania Electric, Emporium, Pa.

Andrew Co., 363 East 75 Street, Chicago, Ill., has released folders and magazine reprints covering folded unipole and quadrupole antennas.

5-5-47

SPECIALIZED Skill in METAL

PANELS • CHASSIS • RACKS
with Beautiful Chrome Trim

CABINETS

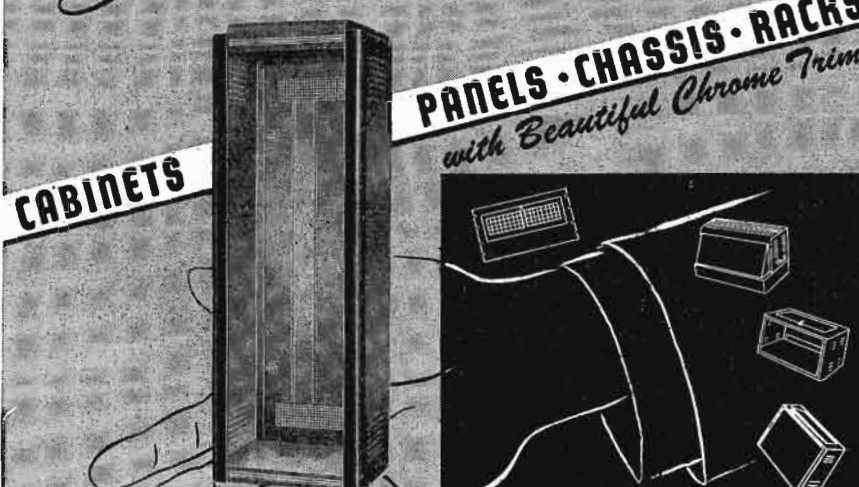

PAR-METAL
PRODUCTS CORPORATION
32-62 - 49th STREET
LONG ISLAND CITY 3, NEW YORK
Export Dept.: Radio International Corp.
13 East 40 Street, New York 16

The time-tested Par-Metal line presents superior features of styling, design, and construction. True to policy, Par-Metal continues to specialize in Electronic Housings exclusively... and is therefore able to offer leadership in value. Compare! Write for Catalogue.

new

CONCORD
Radio
Catalog

RADIO PARTS • RADIO SETS
RECORD CHANGERS • PLAYERS
HAM GEAR • AMPLIFIERS • TESTERS



It's here—the new 1947 Concord Catalog—a vast, complete selection of everything in Radio and Electronics. See these value-packed pages showing thousands of items available for IMMEDIATE SHIPMENT—hundreds of them now available for the first time—featuring new, latest 1947 prices. See new LOWER prices on finest-quality RADIO SETS, PHONO-RADIOS, RECORD CHANGERS, RECORD PLAYERS, PORTABLES, AMPLIFIERS, COMPLETE SOUND SYSTEMS, TESTERS. See latest listings of well-known, standard, dependable lines of radio parts and equipment—tubes, condensers, transformers, relays—available for IMMEDIATE SHIPMENT from huge stocks in CHICAGO and ATLANTA. Mail coupon NOW!

CONCORD RADIO
CORPORATION
ATLANTA, GA.

free

Mail COUPON TODAY!

Concord Radio Corporation, Dept. S-47
901 W. Jackson Blvd., Chicago 7, Ill.
Yes, rush FREE COPY of the comprehensive new Concord Radio Catalog.

Name.....
Address.....
City..... State.....

CONCORD
RADIO CORPORATION
LAFAYETTE RADIO CORPORATION
CHICAGO 7, ILL. ATLANTA 3, GA.
901 W. Jackson Blvd. 265 Peachtree St.

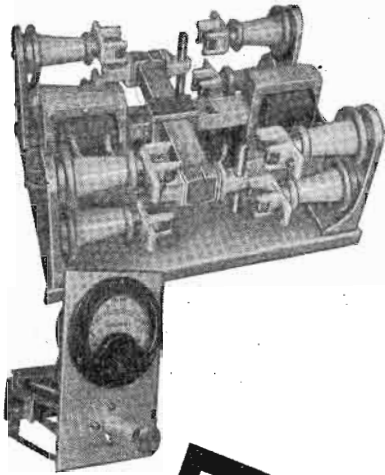

R. F. CONTACTORS
and
M. B. B. SWITCHES

JOHNSON R. F. Contactors were designed for switching high voltage, high current, R. F. circuits. Contacts are sectionalized to provide large contact area, and through wiping action, are self cleaning. No holding current is required to operate, and either DPDT or SPDT types are available.

Optional auxiliary switches operate low current control circuits; pilot lights, high current control circuits, or provide sequence operation of contactors.

Electrical Rating	Type JR	Type JS
Solenoid Voltage	230/115V	230/115V
Contacts - Continuous		
Max. R. F. current	50 amps.	30 amps.
Voltage Breakdown	20,000V. peak	14,000V. peak
Dimensions		
Width	9½"	6"
Length	12"	9"
Height	5"	4¼"

With *Make - Before - Break Switches meters may be inserted and removed from antenna or similar high voltage circuits without opening the circuit. They're designed with excellent R. F. insulation for high voltage breakdown and current carrying capacity.

Data Sheets and Prices Available on Request to Dept. ED.

FOR BROADCAST STATIONS
COMPLETE DIRECTIONAL ANTENNA SYSTEMS ★ HIGH VOLTAGE COMPONENTS ★ CO-AXIAL TRANSMISSION LINE ★ F-M ISO-COUPLER ★ OPEN WIRE TRANSMISSION LINE SUPPORTS.

JOHNSON
a famous name in Radio



E. F. Johnson Co. Waseca, Minn.

ADVERTISERS IN THIS ISSUE

COMMUNICATIONS—APRIL, 1947

AIRCRAFT RADIO CORPORATION Agency: Burke Dowling Adams	9	JENSEN MFG. CO. Agency: Burton Browne, Advertising	4
ALLIED RADIO CORP. Agency: George Brodsky, Advertising	58	E. F. JOHNSON CO. Agency: David, Inc.	64
ALTEC-LANSING CORPORATION Agency: Reiss Advertising	37	HOWARD W. JONES DIV. CINCH MFG. CO. Agency: Merrill Symonds, Advertising	54
AMPERITE CO. Agency: H. J. Gold Co.	54	THE JAMES KNIGHTS CO. Agency: Rudolph Bartz, Advertising	48
ANDREW CO. Agency: Burton Browne, Advertising	53	MEASUREMENTS CORPORATION Agency: Frederick Smith	52, 61
THE ANSONIA ELECTRICAL DIV. NOMA ELECTRIC CORP. Agency: Albert Frank-Guenther, Law, Inc.	13	JAMES MILLEN MFG. CO., INC.	48
THE ASTATIC CORPORATION Agency: Wearstler Advertising, Inc.	57	MODEL ENGINEERING & MFG., INC. Agency: The Signet Corporation	48
BELL TELEPHONE LABORATORIES Agency: Newell Emmett Co.	6, 7	NATIONAL CO., INC. Agency: John A. Cairns & Co., Inc.	43
CANNON ELECTRIC DEVELOPMENT CO. Agency: Dana Jones Co.	49	PAR-METAL PRODUCTS CORP. Agency: H. J. Gold Co.	63
C. P. CLARE AND CO. Agency: Hamilton Adv. Agency, Inc.	45	PEERLESS RADIO DISTRIBUTORS, INC. Agency: Seymour Ullman	56
CLAROSTAT MFG. CO., INC. Agency: Austin C. Lescarboursa & Staff	50	PETERSEN RADIO CO., INC. Agency: Bozell & Jacobs	62
THE CLEVELAND CONTAINER CO. Agency: The Nesbitt Service Co.	52	PREMAX PRODUCTS DIV. CHISHOLM-RYDER CO., INC. Agency: Norton Adv. Service	54
COLLINS RADIO CO. Agency: McCann-Erickson, Inc.	29	REEVES-HOFFMAN CORP.	56
COLONIAL RADIO CORP.	61	JOHN F. RIDER PUBLISHER, INC. Agency: Lansford F. King, Advertising	58
CONCORD RADIO CORP. Agency: E. H. Brown Advt. Agency	63	SHUR ANTENNA MOUNT, INC. Agency: H. J. Gold Company	56
DeMORNAY-BUDD, INC. Agency: Federal Advertising Agency	3	SIMPSON ELECTRIC CO. Agency: Kreicker & Melbrot, Inc.	10
EITEL-McCULLOUGH, INC. Agency: L. C. Cole, Advertising	8	SORENSEN & CO., INC. Agency: Henry A. Stephens, Inc.	47
ELECTRICAL REACTANCE CORP. Agency: Scheel Adv. Agency	51	THE SUPERIOR ELECTRIC CO. Agency: Hugh H. Graham & Associates	11
ELECTRONIC RESEARCH & MFG. CORP.	62	SUPREME INSTRUMENTS CORP. Agency: O'Callaghan Adv. Agency, Inc.	58
ELECTRO-VOICE, INC. Agency: Henry H. Teplitz, Advertising	Inside Front Cover	SYLVANIA ELECTRIC PRODUCTS, INC. Agency: Newell-Emmett Co.	16
FAIRCHILD CAMERA & INSTRUMENT CORP. Agency: G. M. Basford Co.	5	TECH LABORATORIES, INC. Agency: Lewis Adv. Agency	59
FEDERAL TELEPHONE & RADIO CORP. Agency: Rickard & Co.	24, 25	THE TURNER CO. Agency: The W. D. Lyon Co.	55
FERRANTI ELECTRIC, INC.	1	WELLS SALES, INC. Agency: Turner Advtg. Agency	12
FRANKLIN AIRLOOP CORP. Agency: Sam J. Gallay	Back Cover	WESTERN ELECTRIC CO. Agency: Newell-Emmett Co.	6, 7
GALVIN MFG. CORP. Agency: Gourfain-Cobb Adv. Agency	41	WILCOX ELECTRIC CO., INC. Agency: Arthur G. Rippey & Co.	15
GENERAL RADIO CO.	Inside Back Cover	WINCHARGER CORP. Agency: Critchfield & Co.	60
GUARDIAN ELECTRIC CO. Agency: Kennedy & Co.	53		
THE HOPP PRESS, INC. Agency: Gallard Adv. Agency	50		



WAVEMETERS

0.5-150 Mc

55-400 Mc

IN STOCK!



TYPE 566-A — 0.5 to 150 Mc

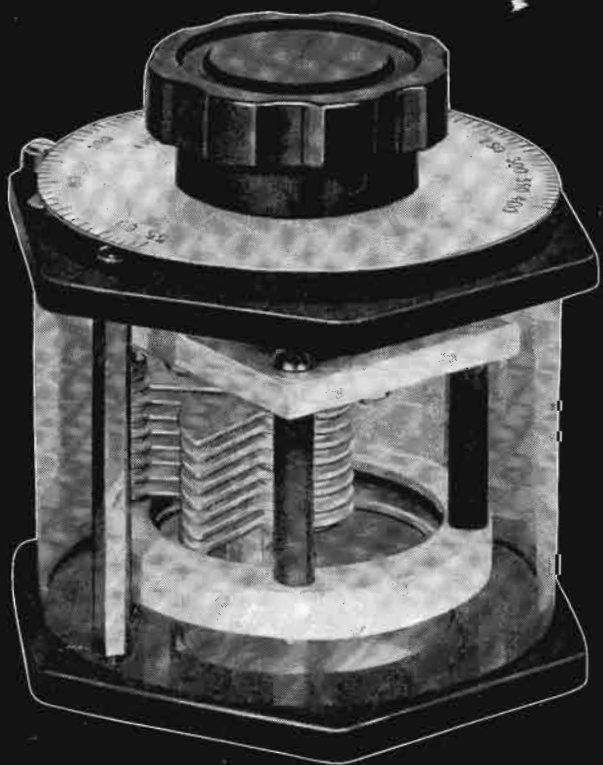

TYPE 758-A — 55 to 400 Mc

● To meet an insistent demand, we have concentrated some of our production facilities on these two popular wavemeters and have managed to accumulate a moderate stock of each.

Both are of the well-known absorption type with accuracies sufficient for a wide variety of routine frequency checks on the ranges of coils, oscillators, receivers, transmitters, etc.

The Type 566-A Wavemeter consists of a variable air condenser, five plug-in coils and an incandescent lamp for resonance indication. The Type 758-A Wavemeter covers its entire frequency range with a single-turn loop the inductance of which is varied simultaneously with the capacitance. An incandescent lamp is used for resonance indication. For low power uses (less than about 2 watts), resonance indication is obtained by the reaction of the wavemeters on the plate or grid currents of the oscillator.

These wavemeters are compact, rugged, inexpensive and direct reading in terms of our primary standard of frequency.

TYPE 566-A WAVEMETER

FREQUENCY RANGE: 0.5 to 150 Mc

COILS: Five plug-in type, all supplied. When not in use coils can be plugged into a rack on side of the instrument case

DIAL CALIBRATION: Direct reading in frequency

ACCURACY: $\pm 2\%$, 0.5 to 16 Mc; $\pm 3\%$, 16 Mc to 150 Mc

RESONANCE INDICATOR: Incandescent lamp

ACCESSORIES SUPPLIED: Two spare indicator lamps

DIMENSIONS: $4\frac{3}{4} \times 5\frac{7}{8} \times 5\frac{3}{4}$ inches, over-all

WEIGHT: 3 pounds

PRICE: Type 566-A WAVEMETER — \$60.00

TYPE 758-A WAVEMETER

FREQUENCY RANGE: 55 to 400 Mc

COILS: A single turn loop; inductance and capacitance are varied simultaneously

DIAL CALIBRATION: Direct reading in frequency

ACCURACY: $\pm 2\%$

RESONANCE INDICATOR: Incandescent lamp

TEMPERATURE AND HUMIDITY: Over ranges normally encountered, accuracy is independent of both

DIMENSIONS: $5 \times 5 \times 4\frac{3}{4}$ inches, over-all

WEIGHT: 1 pound, 12 ounces

PRICE: Type 758-A WAVEMETER — \$35.00

**ORDER NOW — DELIVERY
PROBABLY FROM STOCK**

GENERAL RADIO COMPANY

Cambridge 39,
Massachusetts

90 West St., New York 6

920 S. Michigan Ave., Chicago 5

950 N. Highland Ave., Los Angeles 38

1 MILLION



INSTALLED IN RADIO RECEIVERS IN LESS THAN A YEAR

***AIRLOOPS** . . . back panel and loop antenna in one unit

It was less than a year ago that large scale production of **AIRLOOPS** began to feed radio set assembly lines and in this short time more than a million receivers, fitted with **AIRLOOPS**, went into service throughout the world.

The enthusiastic acclaim and acceptance of the **AIRLOOP** is well earned. It has dem-

onstrated that its many superior features improve set performance and lower the cost of radio assembly and manufacture. Time and use have proved the **AIRLOOP** the most significant post war development in radio components . . . no set builder can afford to overlook the values **AIRLOOPS** contribute to set performance .

FRANKLIN



. flat sheets of copper die-stamped into perfect super sensitive loops . . . are air dielectric throughout . . . are lower in cost . . . are back panel and loop in one unit . . . have high uniform "Q" over entire band . . . have low distributed capacity . . . have 27% greater effective loop area . . . have electrical and mechanical stability . . . increase set sensitivity . . . eliminate individual loop adjustment . . . eliminate haywire.

FRANKLIN AIRLOOP CORPORATION
43 - 20 34th ST. LONG ISLAND CITY 1, N. Y.