

COMMUNICATIONS

\$1.00

INCLUDING "RADIO ENGINEERING" AND "TELEVISION ENGINEERING"



- ★ DIRECTIVE ANTENNAS FOR V-H-F
- ★ LONG RANGE RADIOTELETYPE SYSTEM
- ★ I R E WINTER MEETING REPORT

- ★ AERONAUTICAL COMMUNICATIONS
- ★ INTERFERENCE IN F-M
- ★ MICROPHONE DESIGN IN ELECTRIC MEGAPHONES

★ INTERMODULATION TESTS FOR BEAM POWER AND TRIODE OUTPUT ANALYSIS

FEBRUARY

1940

ANNOUNCING



The New 205 TS

HAR-CAM VISUAL ALIGNMENT SIGNAL GENERATOR

This new HAR-CAM unit provides the most efficient and effective method of aligning the IF circuit of receivers both FM and AM. By

use of an oscilloscope, the performance of the IF circuit is shown visually, and rapid, accurate alignment is easily accomplished.

SPECIFICATIONS

1. Frequency range 100kc to 20mc with direct reading dial calibrated in megacycles.
2. Linear frequency sweep deviation adjustable from zero to 900kc peak to peak.
3. Vernier frequency control of 100kc allows zero beat calibration of main tuning dial or for vernier frequency deviations about main dial frequency setting.
4. Stable rf gain control independent of frequency.
5. Five-step attenuator of rf output

giving over-all voltage range of 1 microvolt to 1 volt when used in conjunction with the gain control.

6. Output impedance, 1 ohm to 2500 ohms.
7. Phone jack for aural monitoring of zero beat calibration of main tuning dial.
8. Panel jack to feed linear sweep voltage to x-axis amplifier of oscilloscope, thus synchronizing the frequency linear sweep of the generator with the spot trace on the scope screen.
9. Voltage regulated supply for internal oscillators.

10. Careful oscillator design to minimize drift.

11. Stable and proven circuit principles used throughout to insure complete reliability.

12. Size, 7" wide, 9½" high, 10½" deep. Weight, 18 pounds.

For complete information on the HAR-CAM Visual Alignment Signal Generator, write for Bulletin H-40.

HARVEY RADIO LABORATORIES, INC.

442 CONCORD AVENUE ; CAMBRIDGE 38, MASSACHUSETTS



FERRANTI FOR

Quality

FERRANTI ELECTRIC, INC.

Transformers · Instruments
ELECTRONIC EQUIPMENT

FERRANTI

TELEPHONE CIRCLE 7-0912-3
CABLE ADDRESS FERRATRAM

30 ROCKEFELLER PLAZA
NEW YORK 20 · N. Y.

February 1, 1946

Mr. Chief Engineer

Dear Sir:

During the war Ferranti Electric greatly expanded its facilities particularly in the field of WIRING AND ASSEMBLY WORK AND SHEET METAL AND BAKELITE FABRICATION.

We are now in an excellent position to give you ATTRACTIVE PRICES AND DELIVERIES in any or all of the following fields:

- (A) AUDIO AND POWER -- transformers, chokes, filters, rectifiers, power supplies, inductors, etc., etc.
- (B) WIRING AND ASSEMBLY -- mechanical and electronic assemblies, sub-assemblies and component parts.
- (C) SHEET METAL AND BAKELITE FABRICATION -- from sheets, rods or tubes. Cut, drilled, punched, formed or engraved.

Your inquiries will receive our prompt and careful attention. The Ferranti Engineering Department is always available for consultation. Send us your drawings or copies of your specifications. We have a definite SERVICE to render YOU.

Very truly yours,

FERRANTI ELECTRIC, INC.

W. R. Spittel

Vice-President

WRSpittel/em

FERRANTI
FOR

Service

LEWIS WINNER, Editor
 WALEN, Assistant Editor

We See...

OWNERSHIP AND APPLICATION RIGHTS OF COMMUNICATIONS developments originated during the war, involving hundreds of industry and government patents, have prompted a lively debate between Washington and commercial interests. Radar and the numerous allied h-f, v-h-f and s-h-f transmitter and receiver developments are the cause of most of the vigorous discussions, with the military declaring that a cooperative patent pool is necessary for proper use of all wartime patents and industry citing that such a plan is unnecessary.

To support their contention, industry points to the present accelerated activity in the art with scores of radar type facilities in operation, or ready for operation soon throughout the country. They say that the use of sub-licensing arrangements, made years ago, permits over a hundred major companies to participate in a satisfactory cross-control arrangement, and this licensing privilege can be extended.

A report recently issued by a joint Army-Navy Committee declares, however, that the greatest percentage of wartime communications patents are Government owned and thus must be allocated in some fashion if the art is to progress. Another confusing issue is, they say, that many of the patents are interrelated in ownership. Thus, it is impossible to prescribe procedure for legal patent use. A statement prepared by former FCC chairman Paul Porter for a Senate Military-Commerce Sub-Committee, considering bills for federal aid to science, said . . . "no company on earth can safely proceed to manufacture radar with any confidence that it will be immune from suits of infringement."

During a recent interview, Sir Robert Watson-Watt of radar fame declared that U. S. industry controlled but 15% of radar and affiliated patents. In Great Britain the program was completely nationalized, he said, and thus a patent pool will eventually be adopted for the country.

Many industry officials have declared that a government-industry patent system to license manufacturers would not equalize use privileges, a generally assumed fact, but instead introduce complex priority problems. It would be difficult, they say, to judge the extent of patent or development participation, since while in some instances activities were related, in many other instances inventions were the results of individual efforts.

The Washington contention that wholly-owned government patents and related industry-government patents cover most of the major aspects of the wartime communications program and thus some assignment format must be adopted, does not appear to be accepted by industry. Government feels that a pool is necessary to provide the necessary legal rights of use. Industry does not subscribe to this belief. Industry points out that there are sufficient basic patents, industry controlled.

Several bills prescribing methods for administration of government-owned and related wartime inventions are expected to be reported to Congress during the next few weeks. The resultant decisions are eagerly awaited.—L. W.

COMMUNICATIONS

Including Television Engineering, Radio Engineering, Communication & Broadcast Engineering, The Broadcast Engineer. Registered U. S. Patent Office.
 Member of Audit Bureau of Circulations.

FEBRUARY, 1946

VOLUME 26

NUMBER 2

COVER ILLUSTRATION

C 47 transport of the Gypsy Airline (Gypsy Task Force) over the AACCS direction-finder station at Batista Field, Cuba.
 (Courtesy AAF, AACCS)

AMPLIFIER ANALYSES

Intermodulation Tests (For Comparison of Beam Power and Triode Tubes Used to Drive Loudspeakers) John K. Hilliard 15

V-H-F ANTENNA DESIGN

A V-H-F Directive Antenna (Used to Beam Signals Over a 10-Mile Path Between Stations in Rome, Italy) Dr. Ascanio Niuatta 18

ENGINEERING CONFERENCE REVIEW

A Report on the 1946 IRE Winter Technical Meeting (Highlights on Papers by Gordon; Wallman; Alford; Smith; Sceley; Larsen and Merrill; Goldmark; Schlesinger; Serrell; Young; Frankel, Glauber and Wallenstein; Reeves; Lyman; Schade; Svedlund; Epstein and Pensak; Rose, Weimer and Law; Ruzé; Van Atta, Kock; Sinclair, Vaughn and Jordan; Weber; Torrey; Miller; and Delinger and Smith) Lewis Winner 22

SOUND ENGINEERING

Microphone Design in Electric Megaphones (Designs That Permit High Pressures Without Feedback) Arthur J. Sanial 30
 Electroacoustic Laboratory at Harvard University 50

MOBILE COMMUNICATIONS

Mobile 2- to 18-mc Radioteletype for Long Range Operation
 Harry R. Landau 36

F-M BROADCASTING

Interference in F-M (Second in a Series on F-M Transmitter Design and Operation) N. Marchand 38
 250-Watt F-M Transmitter for 88 to 108 mc
 Morton B. Kahn and S. L. Sack 44

H-F DEVELOPMENT

High Frequency Direction Finders 50

COMMUNICATIONS RECEIVER DEVELOPMENT

CAA Alaskan Diversity Receiving System (Part II) Jaek Ivers 56

MONTHLY FEATURES

Editorial (We See) 2
 Veteran Wireless Operators' Association News 48
 News Briefs of the Month 52
 The Industry Offers 72
 Advertising Index 80

Published Monthly by the Bryan Davis Publishing Co., Inc.

BRYAN S. DAVIS, President

F. WALEN, Secretary

PAUL S. WEIL, Vice Pres.-Gen. Mgr.

A. GOEBEL, Circulation Mgr.

Advertising and Editorial offices, 52 Vanderbilt Ave., New York 17, N. Y. Telephone, MUrray Hill 4-0170. Cleveland 6, Ohio: James C. Munn, 10515 Wilbur Ave.; Telephone, SWEEtbriar 0052. Pacific Coast Representative: Brand & Brand, 1052 W. Sixth St., Los Angeles 14, Calif.; Telephone, Michigan 1732. Wellington, New Zealand: Te Aro Book Depot. Melbourne, Australia: McGill's Agency. Entire Contents Copyright 1946, Bryan Davis Publishing Co., Inc. Entered as second-class matter Oct. 1, 1937, at the Post Office at New York, N. Y., under the act of March 3, 1879. Yearly subscription rate: \$2.00 in the United States and Canada; \$3.00 in foreign countries. Single copies, twenty-five cents in United States and Canada; thirty-five cents in foreign countries.

SYLVANIA NEWS

CIRCUIT ENGINEERING EDITION

FEB. Published by SYLVANIA ELECTRIC PRODUCTS INC., Emporium, Pa. 1946

TINY T-3 TUBE ASSURED A BIG SUCCESS IN RADIO

New Wonder Tube Developed by Sylvania for Midget Portables

The development by Sylvania Electric of the tiny T-3 radio tube is an important factor in making possible light weight, "vest pocket" radio sets.

Ever since the announcement of Sylvania's development of a peanut-sized electronic tube for the famous "war secret" proximity fuze, manufacturers and circuit engineers have been busy making plans for producing super-small radio sets and walkie-talkies that would capture the public's imagination. Now that the Sylvania T-3 (commercial version of the proximity fuze tube) has been perfected, these revolutionary radio ideas are becoming more and more practical.

Future designs of this versatile tube will permit a wide variety of applications, ranging from sets no larger than a package of cigarettes up to deluxe farm receivers. The tiny tube features extremely small size with feather-weight. It has a life of hundreds of hours, is rugged and exceptionally adaptable to operation at high frequencies.

For further, interesting information, or for the answers to any of your questions concerning this remarkable tube, write to SYLVANIA ELECTRIC PRODUCTS INC., Emporium, Pennsylvania.

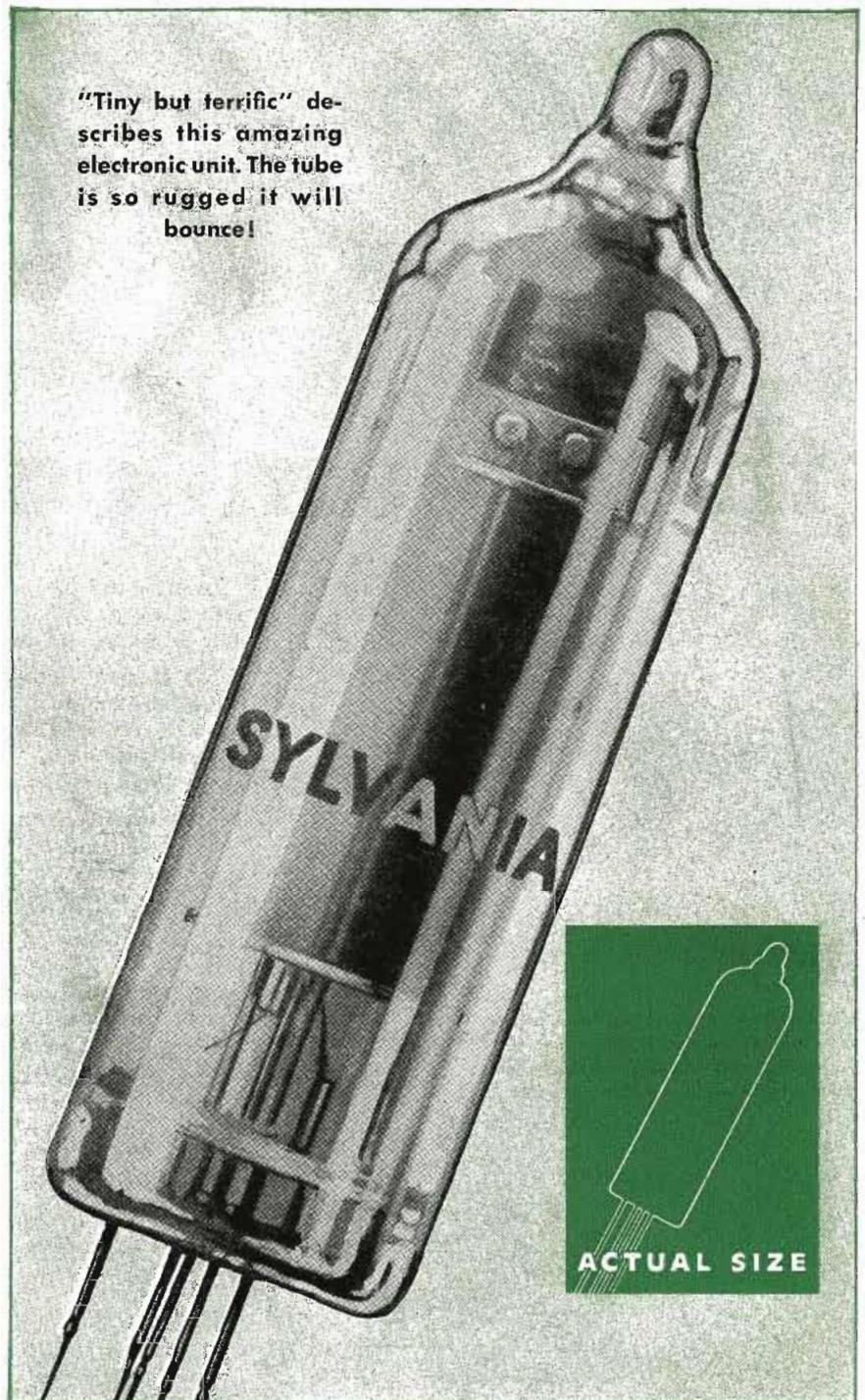

SYLVANIA ELECTRIC

Emporium, Pa.

MAKERS OF RADIO TUBES; CATHODE RAY TUBES; ELECTRONIC DEVICES; FLUORESCENT LAMPS, FIXTURES, WIRING DEVICES; ELECTRIC LIGHT BULBS

COMMUNICATIONS FOR FEBRUARY 1946 • 3

Why

this team could do

There are three reasons why the team of Bell Telephone Laboratories and Western Electric was able to handle big war jobs fast and well.

(1) It had the men—an integrated organization of scientists, engineers and shop workers, long trained to work together in designing and producing complex electronic equipment.

(2) It had unequalled physical facilities.

(3) Perhaps most important of all, it had a long-established and thoroughly tested method of attack on new problems.

What is this method of attack?

In simple terms, it is this. Observe some phenomenon for which no explanation is known—wonder about its relationship to known phenomena—measure everything you can—fit the data together—and find in the answer how to make new and better equipment.

In the realm of *pure research*, Bell Laboratories have carried on continuing studies in all branches of science, with particular emphasis on physics, chemistry and mathematics. Often they have set out to gain new knowledge

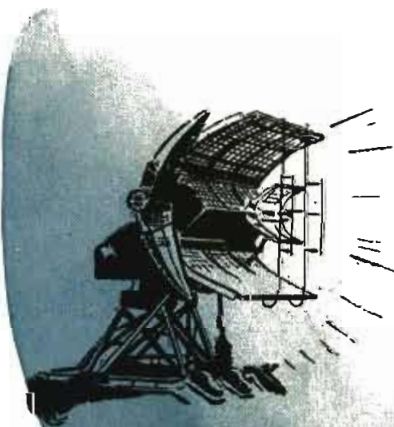

Bell Laboratories and Western Electric teamed up to supply more than 56,000 radars of 64 types—approximately 50% of the nation's radar production on a dollar volume basis.



Bell Laboratories designed and Western Electric produced more than 1600 electronic gun directors and gun data computers which greatly increased the accuracy of anti-aircraft and coast defense guns.



More than 1,000,000 airborne radio receivers and transmitters were furnished by Western Electric to help coordinate attack and defense in the air.



Bell Laboratories designed and Western Electric furnished more than 139,000 multi-channel FM receivers and 74,000 multi-channel FM transmitters for use by the Armored Forces and Artillery.



Bell Laboratories and Western Electric furnished revolutionary carrier telephone terminal equipment in great quantities—all "packaged" for quick installation in the field.

war jobs like these

with no immediate prospect of an application in the communications field. Time after time, their discoveries have eventually brought about fundamental scientific advances.

Applying new discoveries

As new discoveries have reached the stage of application, Western Electric manufacturing engineers have always worked closely with Bell Laboratories men to assure a final design suited to quantity production of highest quality equipment.

During the war, the capabilities of this unique research-production team expanded rapidly. New techniques were explored—new methods were developed—new ideas were born, rich with possibilities for the future.

What this means to YOU

Today Bell Laboratories and Western Electric are once more applying their facilities and their philosophy to the development and production of electronic and communications equipment for a world at peace. Depend on this team for continued leadership in equipment for mobile radiotelephone service.

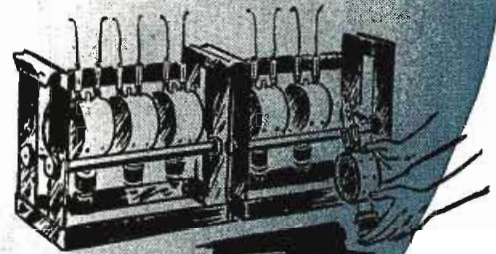

Bell Laboratories and Western Electric played outstanding roles in the design and production of magnetrons and other essential vacuum tubes for use in radar and communications.



BELL TELEPHONE LABORATORIES

World's largest organization devoted exclusively to research and development in all phases of electrical communication.

Western Electric

Manufacturing unit of the Bell System and nation's largest producer of communications and electronic equipment.

MARION "HERMETICS" ARE HERE TO STAY *because...*



...they're dustproof and moisture-proof — foreign matter which oxidizes pivots and attacks bearings and thus shortens the life of an instrument cannot enter.

...sustained performance over a longer period of time is assured and rejects of complete equipment due to instrument failure are minimized, if not eliminated.

...the magnetic and electrostatic shielding obviates the need for special calibration for different types of panels or separate shielding of instruments in order to prevent RF leakage through the case.

...interchangeable colored flanges, in both round and square shapes, are available at no extra charge; finer in performance, Marion "hermetics" are also smarter in appearance.

...they are 100% guaranteed for six months — after that, regardless of condition and provided the seal has not been broken, we will replace any 2½" or 3½" instrument from 200 microamperes upward for \$1.50; any 2½" and 3½" type with sensitivity greater than 200 microamperes for \$2.50.

Marion Glass-to-Metal Truly Hermetically Sealed 2½" and 3½" Electrical Indicating Instruments

Note: Marion "hermetics" cost no more than most standard unsealed instruments—and they are positively interchangeable. Write for the new Marion Catalog.



MARION ELECTRICAL INSTRUMENT CO.

MANCHESTER, NEW HAMPSHIRE

EXPORT DIVISION • 456 BROADWAY • NEW YORK 13, N. Y., U. S. A. • CABLES: MORHANEX

IN CANADA, THE ASTRAL ELECTRIC COMPANY, SCARBORO BLUFFS, ONTARIO
• COMMUNICATIONS FOR FEBRUARY 1946

A rugged performer with a big voice and keen ear!



Collins AN/ARC-2 Autotune transmitter-receiver

Remote
Control
Box



The AN/ARC-2 Autotune transmitter-receiver was designed and is built by Collins for two place and larger military aircraft. It is an example of the experience, design ingenuity and manufacturing skill also available, in the Collins organization, to commercial users of communication equipment.

Transmitter, receiver and dynamotor are all contained in the same case. The weight and space requirement of the AN/ARC-2 is considerably less than that of the equipment it replaces. Any one of eight pre-tuned channels is immediately and automatically available by means of the Collins Autotune, operated either at the main panel or by remote control. The transmitter and receiver operate on the same frequency and are tuned simultaneously by a single set of controls.

This equipment, including its Autotune mechanism, functions reliably at all temperatures from -58° to $+140^{\circ}$ F, all altitudes from sea level to 40,000 feet, and all conditions of humidity up to saturation.

The Collins organization specializes in fulfilling exacting requirements. We will welcome an opportunity to make recommendations regarding your needs in the field of radio communication equipment. Collins Radio Company, Cedar Rapids, Iowa;
11 West 42nd Street, New York 18, N. Y.

IN RADIO COMMUNICATIONS, IT'S . . .

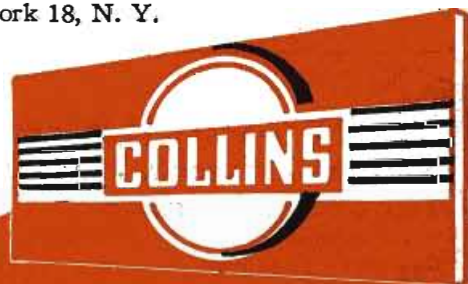



LABORATORY INSTRUMENTS FOR SPEED AND ACCURACY

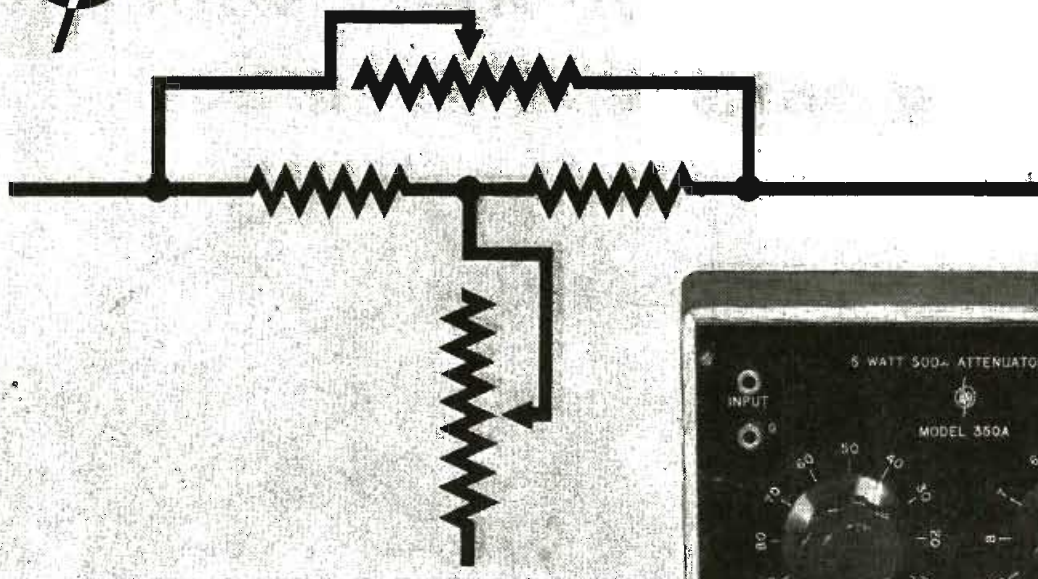

THE -hp- MODEL 350A BRIDGED-T ATTENUATOR

A Small Instrument With a Lot of Uses

The schematic diagram above shows the basic bridged-T circuit, two of which make up the -hp- 350A attenuator set. One is a 100 db attenuator, calibrated in 10 db steps, and one is a 10 db attenuator, calibrated in 1 db steps. Response is substantially flat at frequencies as high as 100 k.c. See figure 3. Accuracy is assured because the resistors are adjusted to plus or minus 1/2%.

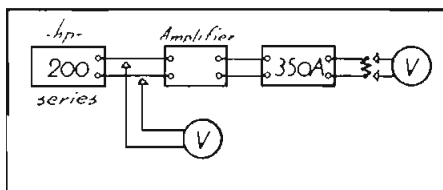

FIG. 1

In conjunction with an -hp- Audio Oscillator and two voltmeters, this -hp- Model 350A Attenuator may be used to make exact measurements of power gain . . . See figure 1.

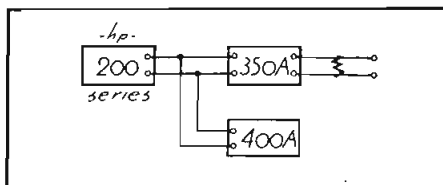

FIG. 2

The 350A may also be used to augment an -hp- audio oscillator and a vacuum tube voltmeter (-hp- 400A) to form a signal generator. See figure 2.

FOR MEASUREMENT CONTROL

The 350A is built with a large power handling capacity—5 watts continuous duty. It is particularly adapted to work in the supersonic field, and for other measurement work above the range of the conventional AF attenuator. It may also be used down to zero frequency.

The 350A like all -hp- instruments is held to a minimum size for convenience in use; actual dimensions are 5" by 8" by 4 1/2". Input and output binding posts are available on the front panel; the unit is completely shielded from moderate fields.

Write today for more information on this and other -hp- instruments.

1163

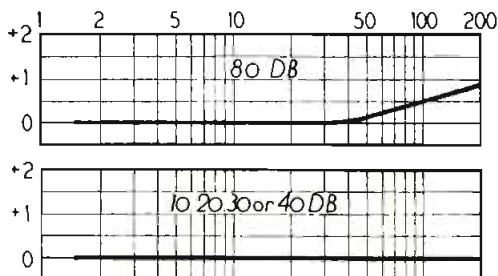

FIG. 3

HEWLETT-PACKARD COMPANY

BOX 1163E • STATION A • PALO ALTO, CALIFORNIA

Audio Frequency Oscillators Signal Generators Vacuum Tube Voltmeters
Noise and Distortion Analyzers Wave Analyzers Frequency Meters

Square Wave Generators Frequency Standards Attenuators Electronic Tachometers

OTHER -hp- INSTRUMENTS



RESISTANCE-TUNED AUDIO OSCILLATORS

Require no zero setting! Several models available in 200 series, covering frequencies from 2 cps. to 200 kc.

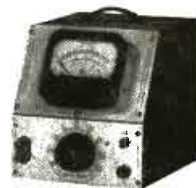

VACUUM TUBE VOLTMETERS

For speed and accuracy in making voltage measurements from 1 cycle to 1 megacycle. The 400A covers 9 ranges (.03 to 300 volts) with full scale sensitivity.



AUDIO SIGNAL GENERATOR

The Model 205 AG consists of an -hp- resistance-tuned audio oscillator, combined with input and output meters, attenuator, and impedance matching system—all in one compact instrument.

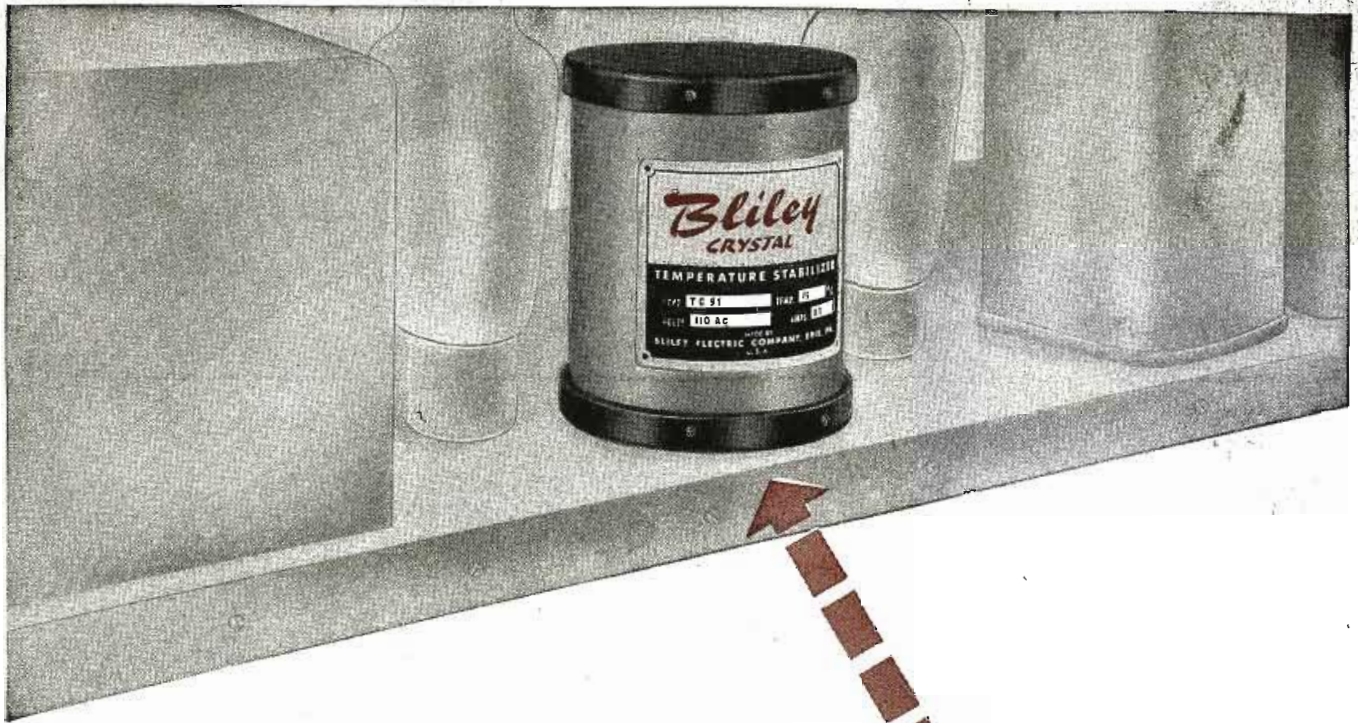

It's a mark of quality in any equipment when the frequency source is a **BLILEY CRYSTAL**

Anyone familiar with radio frequency applications knows that the name Bliley on a crystal means original engineering for a specific job. True—Bliley builds crystals by the million—but Bliley craftsmanship was never gained through mass production.

Fifteen years of interpreting the needs of communications engineers, personalized attention to their individual problems, has provided the engineering background and experience that has

made possible consistent quality production.

In the current line of Bliley Crystals all that proved good in wartime models has been retained, with important refinements for peacetime applications. New types have been added—more are on the way.

Make it a habit to consult Bliley engineers on all of your frequency control problems. You will benefit from this mark of quality in your equipment.

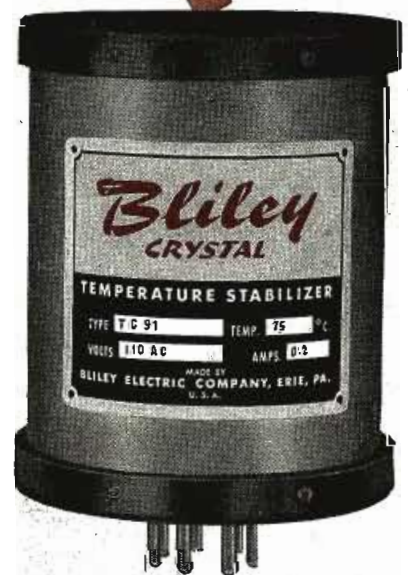

TYPE TC91—This new Temperature Stabilizer is just one of many products described in a new Bliley bulletin. Write for your copy.

Ask for bulletin **CM-27**

Bliley CRYSTALS

BLILEY ELECTRIC COMPANY • UNION STATION BUILDING, ERIE, PENNSYLVANIA

COMMUNICATIONS FOR FEBRUARY 1946 • 9



FOR
HEARING AIDS
VEST POCKET RADIOS
AIR BORNE DEVICES

UTC SUB-OUNCER SERIES

UTC Sub-Ouncer units are 9/16" x 5/8" x 7/8" and weigh only 1/3 ounce. Through unique construction, however, these miniature units have performance and dependability characteristics far superior to any other comparable items. The coil is uniform layer wound of Formex wire . . . On a molded nylon bobbin . . . insulation is of cellulose acetate . . . leads mechanically anchored (no tape) . . . core material Hipermalloy . . . entire unit triple (waterproof) sealed. The frequency response of these standard items is ± 3 DB from 200 to 5,000 cycles.

Type	Application	Level	Pri. Imp.	D.C. in Pri.	Sec. Imp.	List Price
SO-1	Input	+ 4 V.U.	200 50	0	250,000 62,500	\$5.00
SO-2	Interstage/3:1	+ 4 V.U.	10,000	0	90,000	5.00
SO-3	Plate to Line	+ 23 V.U.	10,000 25,000	3/1.5 mil.	200 500	5.00
SO-4	Output	+ 20 V.U.	30,000	1.0 mil.	50	5.00
SO-5	Reactor 50 HY at 1 mil. D.C. 3000 ohms D.C. Res.					4.50

UTC OUNCER SERIES

The standard of the industry for seven years. The overall dimensions are 7/8" diameter by 1-3/16" height including lugs. Mounting is effected by two screws, opposite the terminal board side, spaced 11/16". Weight approximately one ounce. Units not carrying D.C. have high fidelity characteristics being uniform from 40 to 15,000 cycles. Items with D.C. in pri. are for voice frequencies from 150 to 8000 cycles.

Type	Application	Pri. Imp.	Sec. Imp.	List Price
0-1	Mike pickup or line to 1 grid	50, 200, 500	50,000	\$11.60
0-4	Single plate to 1 grid	8,000 to 15,000	60,000	\$ 9.25
0-5	Single plate to 1 grid, D.C. in Pri.	8,000 to 15,000	60,000	\$ 9.25
0-6	Single plate to 2 grids	8,000 to 15,000	95,000	\$10.45
0-8	Single plate to line	8,000 to 15,000	50, 200, 500	\$11.60
0-9	Single plate to line, D.C. in Pri.	8,000 to 15,000	50, 200, 500	\$11.60
0-12	Mixing and matching	50, 200	50, 200, 500	\$10.45
0-13	Reactor, 200 Hys-no D.C., 50 Hys-2MA D.C., 6,000 ohms			\$ 8.10



Manufacturers: Our experience in building hundreds of thousands of uncers and sub-uncers is yours for the asking. Special types, and mountings are readily available. U.T.C. engineers can help you save weight and space in the design of miniature equipment.



United Transformer Corp.

150 VARICK STREET

NEW YORK 13, N. Y.

EXPORT DIVISION: 13 EAST 40th STREET, NEW YORK 16, N. Y.,

CABLES: "ARLAB"

*This Magnet is
the heart of the
Blind Landing
Indicator!*

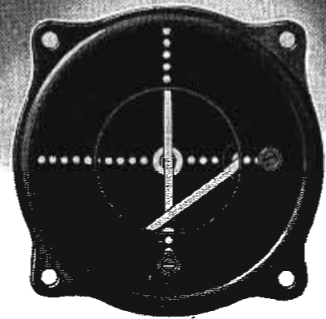
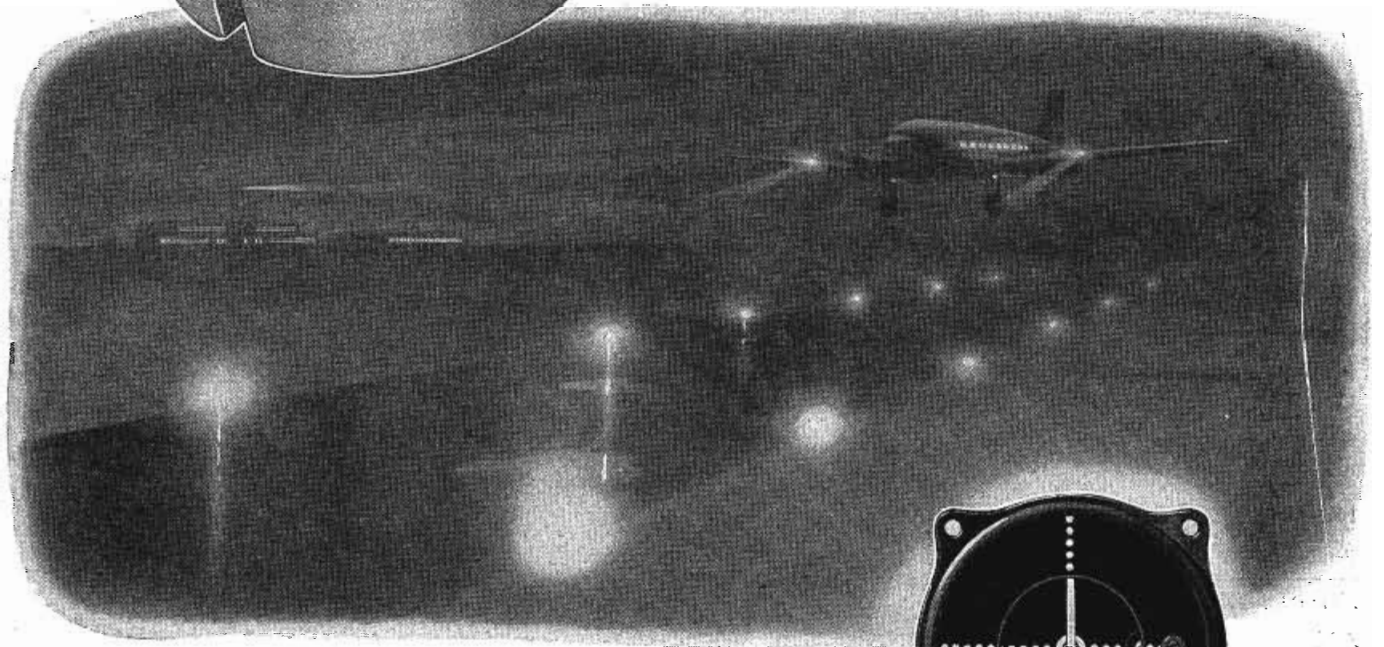
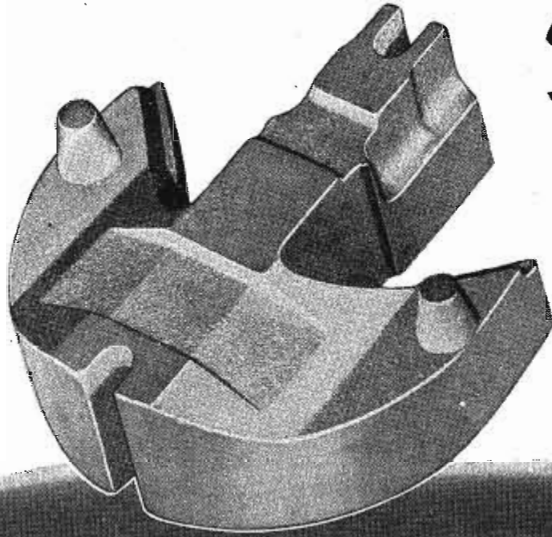

Approaching the field in darkness, fog or storm, the pilot tunes in the radio-activated blind landing indicator. Any drift to right or left of runway is indicated by fluctuation of needle to right or left of vertical dotted line. Fluctuation of other needle above or below horizontal dotted line indicates that rate of descent should be corrected. When both needles cover dotted lines, proper glide path is being maintained.

Perfecting the blind landing indicator involved a difficult problem in magnetics.

Thomas & Skinner, specialists for 44 years in designing and manufacturing all sizes and shapes of permanent magnets, provides an unusual magnet containing *two* magnetic cir-

cuits and having maximum flux and stability.

For solution of *any* of your problems in magnetics, consult Thomas & Skinner engineers. Write us today.

THOMAS & SKINNER STEEL PRODUCTS CO.
1113 East 23rd Street Indianapolis 5, Indiana

**Thomas &
Skinner**

Permanent Magnets



COMMUNICATIONS will cost

**you only \$1.00
for the next 12 issues**

To the Publisher of
COMMUNICATIONS
52 Vanderbilt Ave., New York 17, N. Y.

Please enter annual subscriptions (12 issues) for each of the undersigned for which payment is enclosed at the rate of \$1.00 each. (This rate applies only on 4 or more subscriptions when classifications are given.)

Name

Address

City-State

Occupation

Employed by

Nature of Business

(State if Manufacturer, Broadcast Station, etc.)

Product

Name

Address

City-State

Occupation

Employed by

Nature of Business

(State if Manufacturer, Broadcast Station, etc.)

Product

Name

Address

City-State

Occupation

Employed by

Nature of Business

(State if Manufacturer, Broadcast Station, etc.)

Product

● A subscription to COMMUNICATIONS will provide timely and authoritative articles of decided importance to every engineer and executive in radio, broadcasting, television, facsimile, sound recording and projection, aeronautical, police, railroad, marine and emergency communications.

Leading design, manufacturing and operations engineers keep posted on all new developments in this fast-moving industry by reading COMMUNICATIONS every month. It has helped them. It can help you.

You and your associates can obtain a year's subscription to COMMUNICATIONS (12 issues) for only \$1.00 each by using the Group Subscription Plan. Here's how:

A regular yearly subscription to COMMUNICATIONS costs \$2.00—but, when four or more men sign up at one time, each one is entitled to the half-price rate. (Foreign subscribers only pay \$2.00 each.)

It is easy to get three or more of your associates to subscribe with you. Thousands of leading engineers and executives have subscribed year after year on that basis. Use the convenient form on this page. Fill in the names, tear out and mail today with your check or money-order. Renewals and extensions are acceptable also.

COMMUNICATIONS • 52 Vanderbilt Ave., New York 17, N. Y.



Announcing
THE NEW
SPERRY Microline*

As a reading glass aids visual search, so MICROLINE test and measurement equipment provides means for making all measurements at microwave frequencies.

Sperry announces a comprehensive line of microwave test and measurement equipment for labora-

tory and field use. The new line... the MICROLINE... is the outgrowth of years of research and experience in modern microwave techniques beginning with the development of the Klystron.

Write our Special Electronics Department for further information.

- Available now:**
- WAVEMETERS • WATTMETERS
 - BARRETTOR ELEMENTS AND MOUNTS
 - DIRECTIONAL COUPLERS
 - KLYSTRON SIGNAL SOURCES
 - STANDING WAVE DETECTORS
 - ATTENUATORS
 - IMPEDANCE MATCHING EQUIPMENT
 - WAVEGUIDE AND COAXIAL COMPONENTS

*TRADE MARK

SPERRY GYROSCOPE COMPANY, INC. GREAT NECK, N. Y.



Division of the Sperry Corporation

★
 LOS ANGELES • SAN FRANCISCO • SEATTLE • NEW ORLEANS
 CLEVELAND • BROOKLYN • HONOLULU

GYROSCOPICS • ELECTRONICS • RADAR • AUTOMATIC COMPUTATION • SERVO-MECHANISMS

✓✓
**ONLY HAMMARLUND RECEIVERS
 HAVE THIS FEATURE...**

UNITED STATES PATENT OFFICE 2,222,043

2,222,043
SELECTIVE WAVE TRANSMISSION
 Donald K. Gram, Forest Hills, N. Y., assignor to
 The Hammarlund Manufacturing Company, In-
 corporated, New York, N. Y., a corporation of
 New York

Application June 28, 1939, Serial No. 281,612
 8 Claims. (Cl. 178-44)

This invention pertains to electrical apparatus
 and circuits of the type known as filters and
 more especially to such apparatus and circuits
 of the type referred to as band-pass filters.
 One object of my in-

corporated in such receiver to such a degree as
 may be found necessary, and to make such re-
 duction quickly and to a predetermined degree.
 Another purpose is "greater" to attenuate

Series 400
 "Super-Pro"



The variable crystal filter
 used in the "HQ-129-X"
 and the "Super-Pro" is an
 exclusive Hammarlund
 patent. It provides wide
 band crystal selectivity for
 use in crowded amateur
 phone bands and single
 signal-code reception.

Write For Technical Details



HAMMARLUND

THE HAMMARLUND MFG. CO., INC., 460 W. 34TH ST., NEW YORK 1, N. Y.
 MANUFACTURERS OF PRECISION COMMUNICATIONS EQUIPMENT

COMMUNICATIONS

LEWIS WINNER, Editor

* * FEBRUARY, 1946 * *

A Study of The Outputs Of 10, 15, 40 and 50- Watt Amplifiers with Beam Power and Triode Tubes Using Intermodulation Tests and Checking With Actual Listening Tests

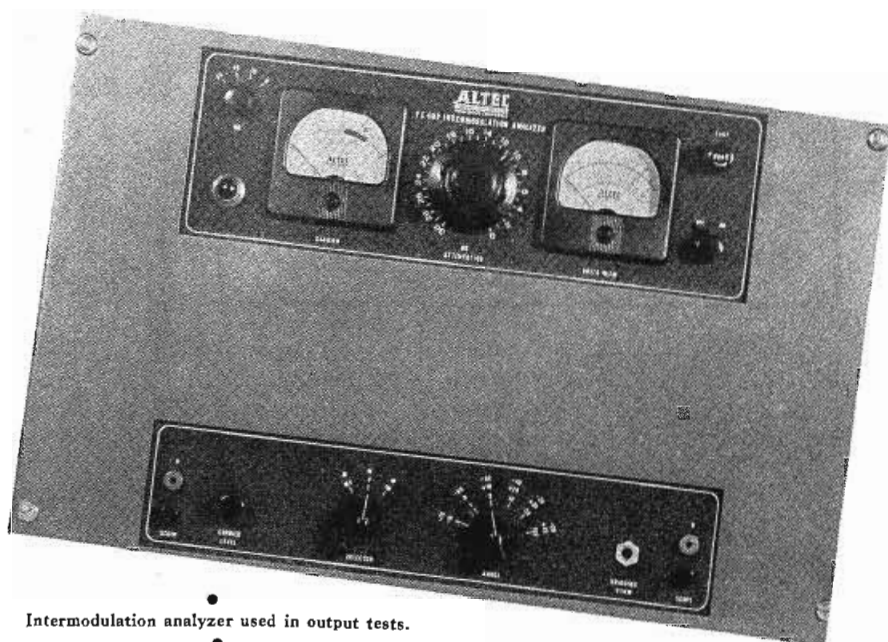

Intermodulation analyzer used in output tests.

INTERMODULATION TESTS FOR COMPARISON OF BEAM AND TRIODE TUBES USED TO DRIVE LOUDSPEAKERS

by JOHN K. HILLIARD

Chief Engineer
Altes Lansing Corporation

SINCE the introduction of the beam power tube several years ago, it has been used in many applications because of its high efficiency, high power sensitivity and its high maximum power output. These outstanding characteristics not present in former tubes, however, caused several important limitations, the most important of all being its apparent high distortion when working into a loudspeaker, since the tubes have a very high internal output impedance. To overcome this objection negative feedback was introduced. This reduced the impedance down to a point where it became the equivalent of a constant-voltage generator.

Even under these conditions, comparisons with low-impedance triode

tubes led to a widespread belief that the beam tube could not compete in quality reproduction with the triode.

The skepticism about the use of the beam power tube was apparently justified in a great many cases and as a result, tests were conducted to determine if the two types of tubes could give comparable results.

The desire to use the beam power tube instead of the triode arose because of the advantages of high efficiency, high sensitivity, and an indirect heater cathode offering less hum than the high power filamentary triode.

Since the intermodulation method¹

of testing amplifiers appears to have the best correlation with actual listening tests, it was used for testing the two types of tubes.

Early work on this comparison indicated that the output transformer seemed to be the limiting factor. This resulted from the fact that with the use of feedback from the secondary winding, a large phase shift took place at both the very low and high frequencies, causing motor-boating or supersonic high frequency singing. This instability was minimized in

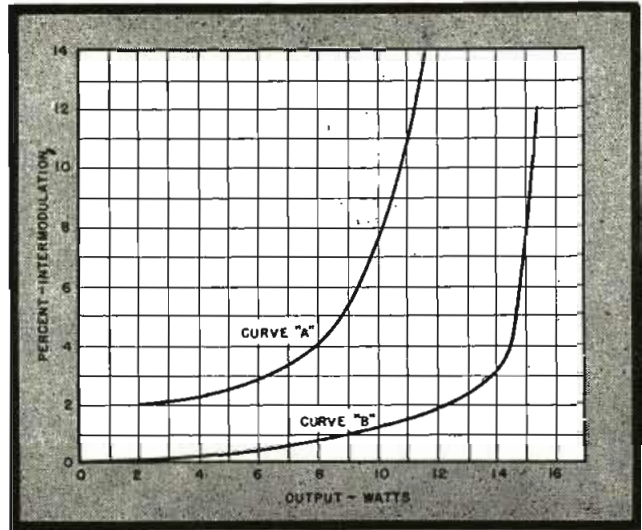
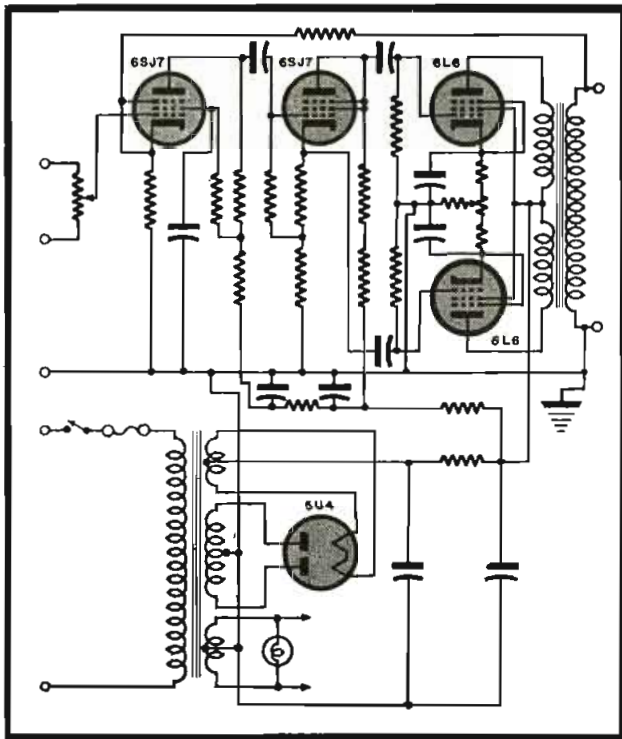

Figures 1 (above) and 2 (left)
 Figure 1. Measured intermodulation results of a 2A3 10-watt triode amplifier, curve A (Figure 3, below), and a 6L6 15-watt beam-power amplifier, curve B (Figure 2, left).

those cases by reducing the feedback in various ways. However, a comparatively large amount of feedback is required so that the output impedance will be low. Another practice which caused severe distortion was the fallacy of using negative feedback to correct the overall frequency characteristics, and other circuit deficiencies such as excessive shunt capacity and small coupling capacitors.

The result of this practice was that little or no feedback was available at the very low and very high frequencies and accordingly the output impedance

varied over a large ratio throughout the frequency band being transmitted.

To overcome these objections an amplifier which had the required frequency and power capacity without feedback was constructed for the tests.

This was accomplished by designing an output transformer with a very high self impedance, accurate balance between windings, a high coefficient of coupling to reduce leakage, and a very low distributed capacity. Another necessary requirement was that the carrying capacity of the transformer be such that its maximum output

power should be maintained uniformly within 1 db from 40 to 10,000 cycles. Care was taken to determine that sufficient driver power to the grid of the tubes was available. With these conditions fulfilled intermodulation tests were made. These tests indicated that the distortion could be reduced to an insignificant degree up to a point very near the theoretical overload point.

A comparison test was then set up and a critical listening group was invited to determine the difference, if any, between the beam and triode type amplifiers.

High quality direct wire monitor facilities from networks, best available studio film and disc records and special sound effects were used as the source of program material.

In one set of tests we used a 15-watt 6L6 push-pull amplifier (Figure 2) in comparison with a 2A3 10-watt triode amplifier (Figure 3). The measured intermodulation products are shown in (Figure 1). The intermodulation test signals consisted of 60 and 1000 cycles. The 1000-cycle signal was transmitted 12 db below the 60-cycle signal.

The second test utilized a 40-watt amplifier (Figure 5) using a pair of

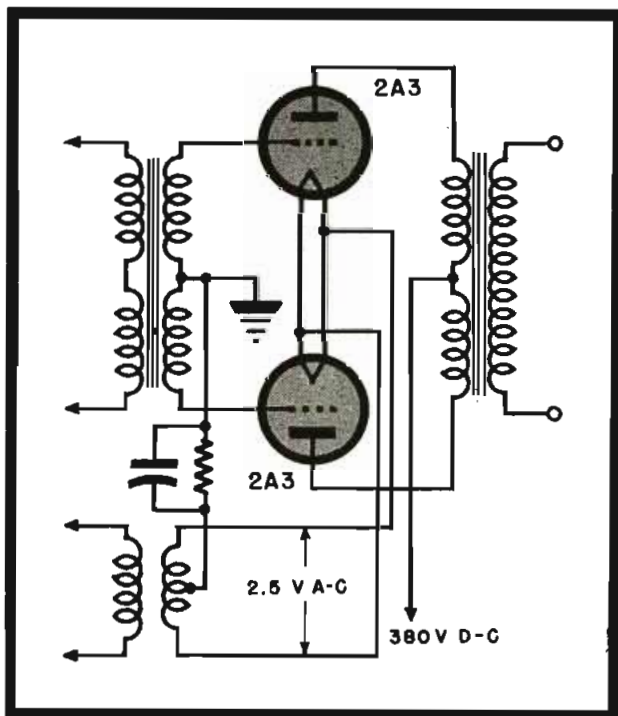

Figures 3 (below, left) and 4 (below)
 Figure 3. The 10-watt 2A3 amplifier used in intermodulation tests. Figure 4 shows intermodulation products of a 40-watt amplifier (curve B) with 807s and a 50-watt unit (curve A) with 845s.

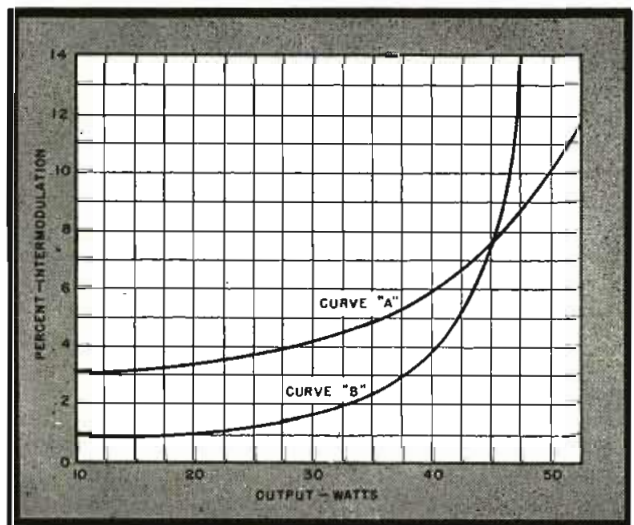

807s in comparison with a 50-watt unit using a pair of 845s (Figure 7). Their respective intermodulation products are shown in Figure 4.

Figure 6 illustrates the power and frequency characteristics of the 40-watt 807 type amplifier. The power curve was obtained by observation of the maximum power that could be generated before departure from a sine wave form, observed on an oscilloscope.

The frequency characteristic is plotted 3 db below rated power and also applies for a level 60 db below the rated power output.

The feedback and output transformers were designed so that the measured output impedance was identical for both the beam power and triode amplifiers. These amplifiers were compared on a two-way loudspeaker system² designed for high-quality, high-power reproduction.

All of the listening group stated that the beam power tube amplifiers were at least equal to the triodes and some observers favored the beam power tubes slightly over the triode type amplifiers.

The reason for favoring the beam power tubes may have been because the output hum was approximately 15 db lower for the same net gain and because the intermodulation curves indicated the lower intermodulation products in the average power range.

It is well to bear in mind the fact that equalization in the feedback circuit to modify the frequency characteristic of an amplifier, changes the output impedance. This changing impedance with frequency can be a very undesirable condition when the amplifier is driving a loudspeaker since the

(Continued on page 54)

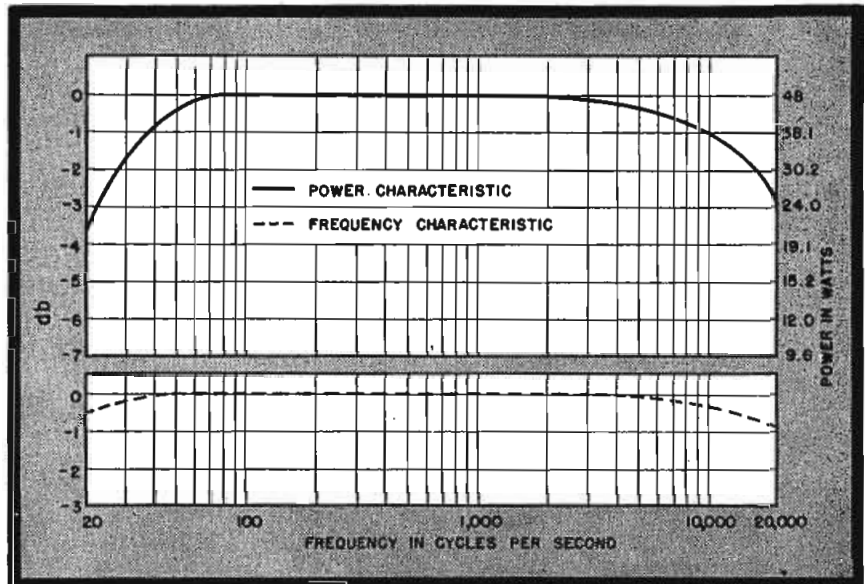
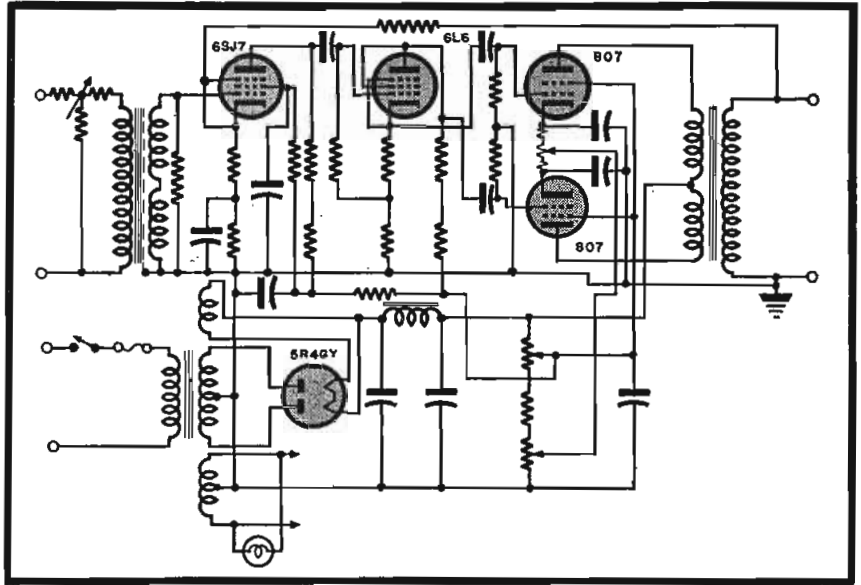

Figures 5, 6 and 7 (top to bottom) Figure 5 illustrates the 40-watt beampower amplifier used in tests. See curve B of Figure 4 for intermodulation results. In Figure 7 we have the 845-triode amplifier. Curve A in Figure 4 shows the intermodulation product for this 50-watt unit. Figure 6 shows the power and frequency characteristics of the 40-watt beampower unit. The power curve was obtained by observation of the maximum power that could be generated before departure from a sine wave form as viewed on an oscillograph. Frequency characteristic is plotted 3 db below rated power and also applies for a level 60 db below rated power output.

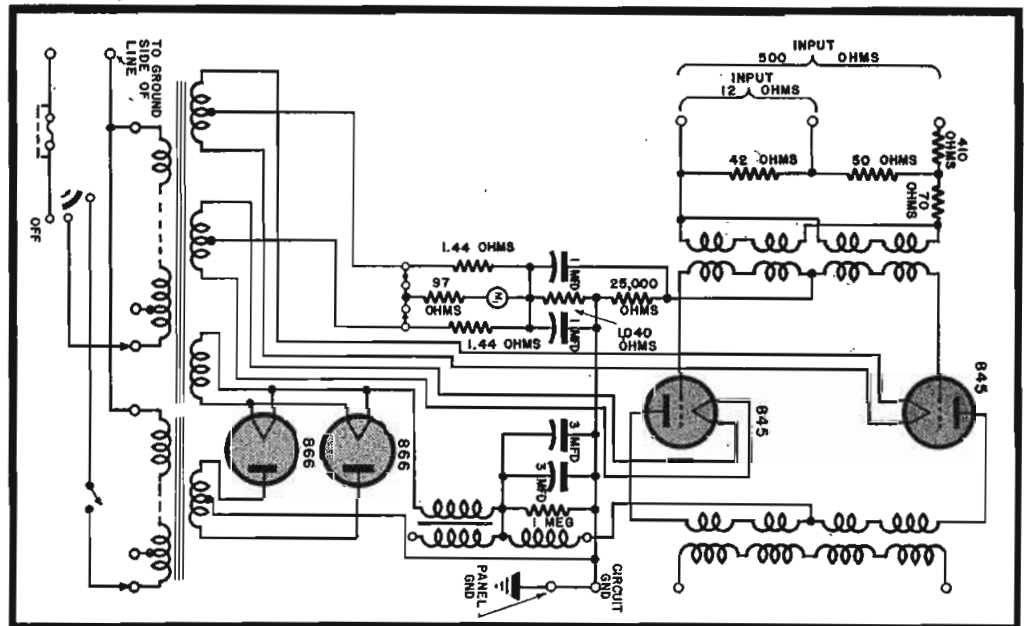

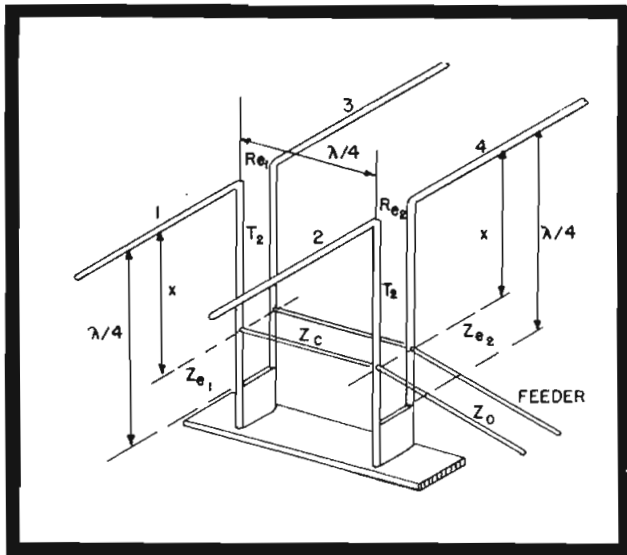
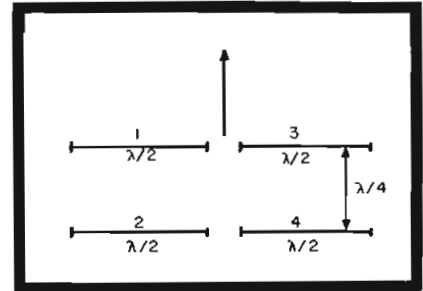

Figure 1 (below)
Antenna system developed by Dr. Niutta. Antenna consists of two groups of horizontal parallel half-wave conventional dipoles (1-3, 2-4), located far off the ground. Current feeding the 1-3 radiator group lags by $\pi/2$ the current feeding the 2-4 reflector group.

Figure 2 (left)
Connection of four dipoles of system to obtain the correct feed conditions.



A V - H - F D I R E C T I V E

IN v-h-f unidirectional antenna systems, it is quite important that the system feature simplicity of assembly and adjustment, to minimize test and operational procedure. This is particularly true where a consistent receiving schedule must be maintained. To provide this type of service, several types of antennas have been conceived. One such type, recently developed, that appears to have many interesting features, is shown in Figure 1.

Antenna Construction

The antenna consists of two groups of horizontal parallel half-wave conventional dipoles (1-3, 2-4), located far off the ground. Current feeding the 1-3 radiator group lags by $\pi/2$ the current feeding the 2-4 reflector group. These currents have equal amplitudes. The distance between the two groups of dipoles is a quarter-wavelength. The system is thus unidirectional and the maximum radiation is in the 2-4 to 1-3 direction.

To obtain the desired feeding conditions for this antenna system, the four dipoles are connected as shown in Figure 2.

Matching Transformer

Each pair of dipoles is connected at the opened end of a quarter-wave matching transformer (T_1 , T_2). The impedance along this transformer varies from maximum (equal to the input impedance R_o of the two di-

Unidirectional Compact Antenna Used to Beam Signals Over a 10-Mile Path From Malnome Receiving Station in Rome to Central Office; Frequency About 100 MC

by DR. ASCANIO NIUTTA

Research Engineer, Malnome Receiving Station
Italcable Company, Rome, Italy

poles) at the upper end, to zero at the short-circuited lower end. A quarter-wave line having a characteristic impedance, Z_c , parallel to the plane containing the four dipoles, is connected at the x section to the two transformers. The distance x is chosen so that the characteristic impedance, Z_c , of this line satisfies the equation, $Z_c = \sqrt{Z_{e1} Z_{e2}}$, where Z_{e1} and Z_{e2} are the resulting impedances at the section x of the T_1 - T_2 quarter-wave matching transformers. The system is assumed free of losses and Z_{e1} and Z_{e2} are assumed to be real. When the power having the appropriate radio frequency is supplied for instance to the reflector side at the x section, then the desired $\pi/2$ delay between the current in the 1-3 and 2-4 dipoles is obtained. Moreover in each group of dipoles the voltage and the current are

in phase. When the feeder is connected at section x on the reflector side, the input impedance of the system in this section is $Z_{e1}/2$ and thus, the characteristic impedance Z_o of the feeder must be matched to this value.

The lower ends of the T_1 and T_2 quarter-wave transformers can be mechanically connected and grounded.

Mechanical Features

The connection line between T_1 and T_2 mechanically improves the system. Because this antenna is principally used for u-h-f and v-h-f, it can be built in a very solid form with only metallic parts and without insulators which usually introduce undesirable losses.

Naturally, instead of two pairs of simple dipoles, the antenna can consist of whatever radiating and reflect-

Figure 3 (below)
Another form of v-h-f unidirectional antenna design using the principle analyzed by Dr. Niutta.

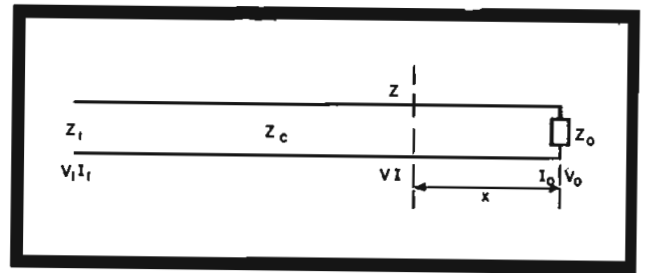
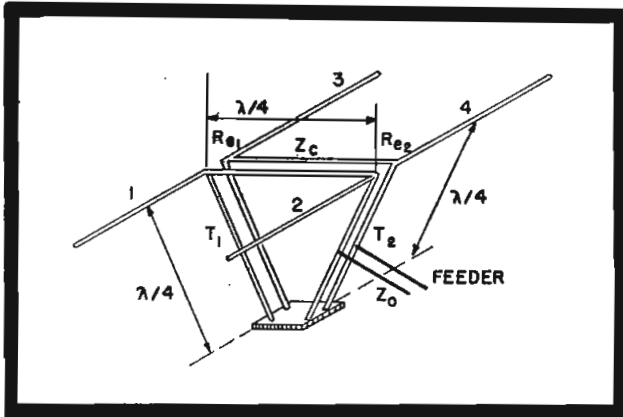

Figure 4 (above)

A loss-free and non-radiating line ($\alpha = 0$). See expression (1) in text. V_0 , I_0 and Z_0 are the complex numbers representative of voltage, current and impedance at the end of the line; V , I and Z are the same values in whatever section of the line x is from the end; Z_c is the characteristic impedance of the line and $\beta = 2\pi/\lambda$, the phase constant. The phase of the current at the end of the line is assumed as a reference.

A N T E N N A S Y S T E M

ing system satisfies the assumptions made.

Another form of this antenna is shown, as an example, in Figure 3.

Theory of Design

The general equation for a loss-free and non-radiating line ($\alpha = 0$) such as is shown in Figure 4, can be written as

$$V = I_0 (Z_0 \cos \beta x + j Z_c \sin \beta x)$$

$$Z_c I = I_0 (Z_c \cos \beta x + j Z_0 \sin \beta x) \quad (1)$$

$$Z = Z_c \frac{Z_0 \cos \beta x + j Z_c \sin \beta x}{Z_c \cos \beta x + j Z_0 \sin \beta x}$$

$$= Z_c \frac{Z_0 + j Z_c \tan \beta x}{Z_c + j Z_0 \tan \beta x} \quad (2)$$

where: V_0 , I_0 , Z_0 are the complex numbers representative of voltage, current and impedance at the end of the line, and V , I and Z are the same values in whatever section of the line x is from the end; Z_c is the characteristic impedance of the line; and $\beta = 2\pi/\lambda$, the phase constant.

The phase of the current at the end of the line is assumed as a reference. In the present case the line which connects the two transformers T_1 , T_2 is a quarter-wave long; then $\beta = \pi/2$.

The terminal impedance is assumed to be real; thus I_0 and V_0 are in phase, (2). Placing $\beta = \pi/2$ in equation (2) gives the impedance Z_1 at the input of the line

$$Z_1 = Z_c^2 / Z_0 \quad (3)$$

The impedance matching is obtained when (3) is met. Because Z_c and Z_0

are assumed real, Z_1 also shall be real. This condition means that voltage and current are in phase at the input of the line also.

The phase shift between the current at the end, and the current at the input of the line is given, from equation (1) by

$$V_1 = I_0 (Z_0 \cos \pi/2 + j \sqrt{Z_1 Z_0} \sin \pi/2) \\ = j V_0 \sqrt{Z_1 / Z_0}$$

$$I_1 = \frac{1}{\sqrt{Z_1 Z_0}} (\sqrt{Z_1 Z_0} \cos \pi/2 \\ + j Z_0 \sin \pi/2) = j I_0 \sqrt{Z_1 / Z_0}$$

It is evident that the current at the end of the line lags by $\pi/2$ the current at the input. Then, when the line is employed to connect the dipoles, according to the assumptions made, the radiating system should be correctly fed and radiate unidirectionally.

Pattern Shapes

In practice, because of the different radiation resistance of the two groups of dipoles, which are fed by the same power, the antinode currents are different. This fact will affect the directional pattern shape, which will present a lobe in the rear side also.

Moreover, the T_1 and T_2 matching transformers introduce inevitably a reactive (inductive) component into the input impedance. This component is, however, a very small and practically negligible reactance, when the characteristic impedance of the T_1 and T_2 quarter-wave lines is low. This reactive component could be, however,

balanced by an opposite (capacitive) reactance obtained, for instance, by making the T_1 - T_2 transformers a little longer than a quarter wavelength.

Example . . . 150-Mc Antenna Design

(a)—Equivalent radiation resistances and reactances:

Referring to Figure 1 the equivalent radiation resistances and reactances of the four dipoles are

$$R'_1 = R'_3 = R_{11} + R_{21} + R_{31} + R_{41} \\ R'_2 = R'_4 = R_{22} + R_{12} + R_{32} + R_{42} \\ X'_1 = X'_3 = X_{11} + X_{12} + X_{21} + X_{41} \\ X'_2 = X'_4 = X_{22} + X_{12} + X_{32} + X_{42}$$

where the right sides are the values of the ohmic and reactive components of mutual impedances of the dipoles; the subscripts have the known conventional significance. These values are:

$$R'_1 = 140.41 \text{ ohms}; X'_1 = 114.11 \text{ ohms} \\ R'_2 = 83.71 \text{ ohms}; X'_2 = 11.29 \text{ ohms}$$

(b)—Balancing radiation reactances:

Radiation reactances are inductive and thus it is necessary to balance them by decreasing the length of the dipoles a little. The equation which permits us to calculate this decrease is

$$\Delta u' \% = \frac{\xi}{\omega l} 100$$

where: ξ is the distributed reactance, equivalent to the lumped reactance, l is the distributed self inductance, and

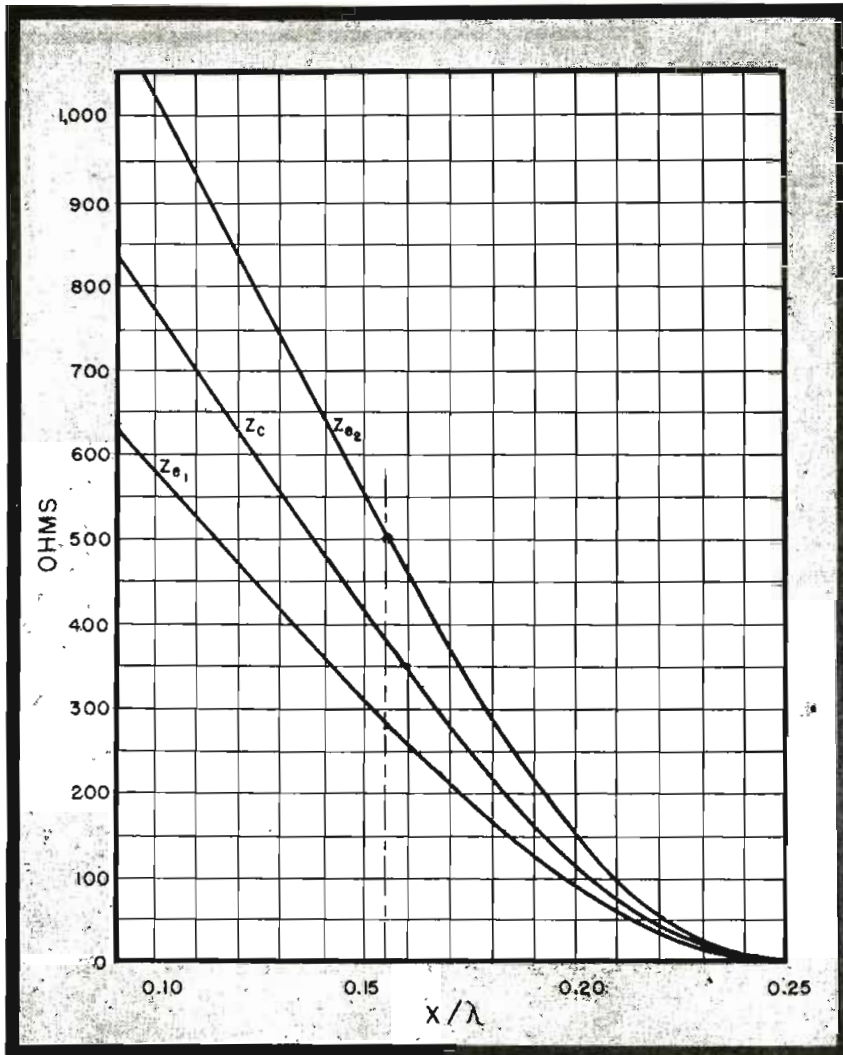

Figure 5

Plot of characteristic impedance of link line. If we assume that the characteristic impedance of the feeder, $Z_0 = 250$ ohms, we find from this plot that $Z_{e2} = 500$ ohms, $Z_c = 370$ ohms, and $x = .155 \lambda = 31$ cm.

side the resistance is $R_{e2} = 2 \times 776 = 1552$ ohms.

(d)—Determining the characteristic impedance of the link line

The impedance, Z_e , along the T_1 and T_2 quarter-wave transformers varies from R_e to 0 according to the equation

$$Z_e = \frac{R_e}{1 + \tan 2\pi x/\lambda}$$

As indicated previously, to calculate the characteristic resistance, Z_c should equal $\sqrt{Z_{e1} Z_{e2}}$. To simplify application, it is convenient to plot the diagrams of Z_{e1} , Z_{e2} , and Z_c versus x . By means of these diagrams, shown in Figure 5, Z_c can be found quickly.

Characteristic Impedance

The characteristic impedance, Z_0 , of the feeder being given, the equation $Z_{e2} = 2Z_0$ must be filled. We then find first the value of x on the curve of Z_{e2} and, on the same abscissa, Z_c can be found.

Example

As an example, let us assume $Z_0 = 250$ ohms. From Figure 5 we find that $Z_{e2} = 500$ ohms, $Z_c = 370$ ohms, and $x = 0.155 \lambda = 31$ cm.

$\omega = 2\pi f$, where f is the frequency. The reactance ξ is given by the approximate equation

$$\xi = 4X/\lambda$$

where: λ is the wavelength in meters and X the calculated radiation reactance.

The self inductance l is

$$l = 2[\ln(2u/\rho) - 1] \times 10^{-7} \text{ H/m}$$

where: u is the length of the wire and ρ its radius.

If $u = 1000$ mm and $\rho = 5$ mm, we have, for the radiator, $\xi_1 = 2 \times 114.11 = 228.22$ ohms/m; $l_1 = 2 (1n 2000/5 - 1) \times 10^{-7} = 10^{-6}$ H/m; and $\omega = 2\pi f = 6.28 \times 15 \times 10^7 = 94 \times 10^7$.

$$\frac{228.22 \times 100}{2 \times 94 \times 10} = 12.1\%$$

Then $\Delta u'_1\% = 12.1\%$.

Because of the smaller propagation velocity along the dipole, with reference to that in the free space, the dipole length must be reduced again by about 2%.

Dipole Lengths

The total reduction of length is then $\Delta u''_1\% = 14\%$, and the length of 1-3

dipoles becomes $u'_1 = 100 \times 0.86 = 86$ cm.

For the reflector we have: $\xi_2 = 22.58$ ohms/m; $l_2 = l_1 = 10^{-6}$ H/m; $\Delta u'_2\% = 1.2\%$. The total reduction is then $\Delta u''_2\% = 3.2\%$; and the length of the 2-4 dipoles is $u'_2 = 100 \times 0.968 = 96.8$ cm.

(c)—Input resistance:

Let us call R_0 the characteristic impedance of the dipole. Then the input impedance at the voltage antinode is $R_1 = R_0^2/R'_1$, where R_0 is found from $R_0 = 60 (1n u'/\rho - 1)$, u' and ρ being known.

Radiator Reflector Resistance

We have, for the radiator: $R_0 = 60 (1n 860/5 - 1) = 248$ ohms; $R_1 = 248^2/140.41 = 437$ ohms; and for the reflector, $R_0 = 255.6$ ohms and $R_2 = 776$ ohms. Therefore the input resistance of the system, looking from the radiator side, is $R_{e1} = 2 \times 437 = 874$ ohms. Looking from the reflector

Specify Federal RADIO HOOK-UP WIRE

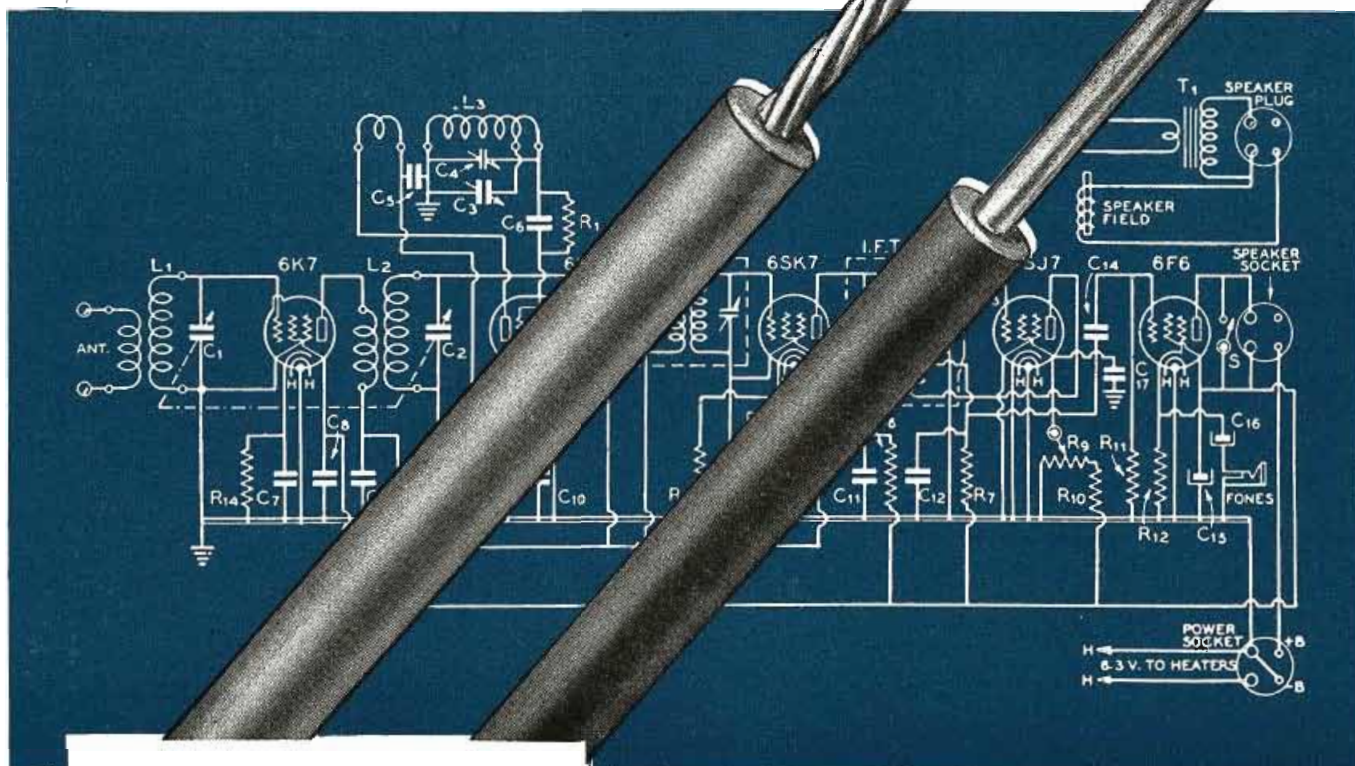

LONG LIFE
FLAME RESISTANT
LOW MOISTURE
ABSORPTION
RESISTS OXIDATION
HIGH DIELECTRIC
STRENGTH
WIDE COLOR RANGE

THERMOPLASTIC INSULATION FOR SUPERIOR QUALITY AND SERVICE

Federal's light-weight, pliable, thermoplastic insulated hook-up wire . . . fitted to your job . . . means better assembly with wire possessing superior dielectric strength and exceptional mechanical stamina.

Resistant to flame, moisture and oxidation . . . this tough but flexible thin-walled thermoplastic insulation covers all Federal's hook-up wire and combats aging, water absorption, abrasion, oils and greases.

Available in solid or stranded types . . . for high or low voltage needs in radio, electronics, appliances, communications, and allied fields . . . these labor-saving light-weight hook-up wires come in 14 brilliant colors and range in size from 24 to 14.

Whether your needs be large or small, get complete details . . . write to Federal now.

Federal Telephone and Radio Corporation

Export Distributor:
International Standard Electric Corporation



Newark 1, N. J.

A REPORT ON THE 1946 IRE

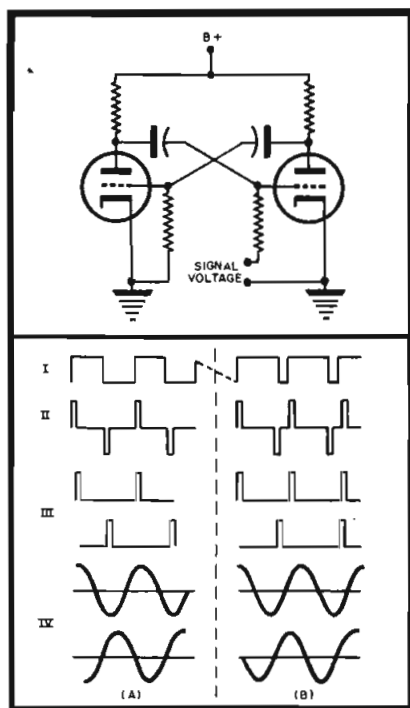

Figures 1 and 2

In Figure 1 appears a method of changing the width of a multivibrator pulse by means of the signal voltage, described by James F. Gordon. Figure 2 illustrates the transition from variation in pulse width to a phase-modulated wave.

ANGULAR VELOCITY MODULATION EMPLOYING PULSE TECHNIQUES

JAMES F. GORDON
Bendix Radio

IN obtaining phase deviation with crystal-control systems a small primary phase deviation usually results. A system that affords large deviations was described by Mr. Gordon. In this method a multivibrator is tripped by a crystal oscillator. Thus the leading edge of the square pulse generated by the multivibrator always occurs at a definite frequency, that of the oscillator.

The width of the pulse is determined by the audio or other signal voltages, Figure 1; the signal voltage is impressed on the grid of a multivibrator tube. In Figure 2 is shown the conversion of the width variation of the pulses into phase deviation. In the illustration the first half of each line is identified as *A* and the second half, *B*. From *A* to *B* the signal voltage is varied so that the width of the pulse is varied. We note that frequency is constant so that the separation between the leading edges remain constant. The pulses are differentiated so that two sets of narrow pulses are obtained, one set being determined by the leading edge and the other set (the negative pulses) determined by the trailing edge. When these pulses are separated and used to generate r-f waves then the wave generated by the trailing pulse will shift in phase as the width of the pulse is varied.

The system described used a 400-kc

CIRCUIT DEVELOPMENTS

multivibrator. A phase deviation of 200° was obtained directly.

STAGGER-TUNED WIDE-BAND AMPLIFIERS

H. WALLMAN
Radiation Laboratory, M.I.T.

WITH increasing use of the 10 to 200-mc bands, the design of wide band amplifiers with substantial gains has presented many problems. Some of these problems and their solutions were analyzed by Mr. Wallman. His discussions covered amplifier design of 4 to 20 mc with center frequencies between 10 and 200 mc and gains between 80 to 100 db. A figure of merit was determined by the gain bandwidth factor which was equal to $g_m/2\pi C$ where g_m is the transconductance of the tube and C the total capacity tuning a single-tuned parallel-resonant circuit load. He stated that the curve to be obtained for the overall characteristic of the wide-band amplifier was

$$\frac{1}{\sqrt{1 + X^{2n}}}$$

When n is 1, then the result is a single tuned circuit; 2, a double tuned or two single-tuned staggered stages and so on. For n stages or staggered tuned circuits it is possible to duplicate the above equation. It was pointed out that the flat top response curve is not too necessary and a response curve with dips in it may be used.

Mr. Wallman stated, but did not prove, that the final equation of the characteristic can be factored directly into a number of linear factors yielding the characteristics of the staggered circuits directly. In alignment all that is necessary is peak tuning of the several resonant circuits.

FREQUENCY MODULATION

ANTENNA FOR F-M STATION WGFM

ANDREW ALFORD

A NEW type of slot antenna for use in f-m was described by Mr. Alford. Normally slot antennas have consisted of a slot in a sheet of metal of resonant length (about $\lambda/2$) which when excited by a voltage across the slot at its center caused currents to flow in the sheet of metal. These currents did the radiating; Figure 3. In Figure 3a we have an ordinary balanced transmission line indicating, in a dotted manner, usual distributed capacitance. The standing wave pattern is shown for a shorted line. In *b* appears the lengthening of the standing wave pattern as the line is loaded with inductance, while *c* shows how this inductance is applied. It is in the form of a slotted tube with each edge of the slot being one of the lines. V_1 represents a pattern obtained with a normally small tube, while V_2 shows that the standing wave becomes almost exponential in shape as

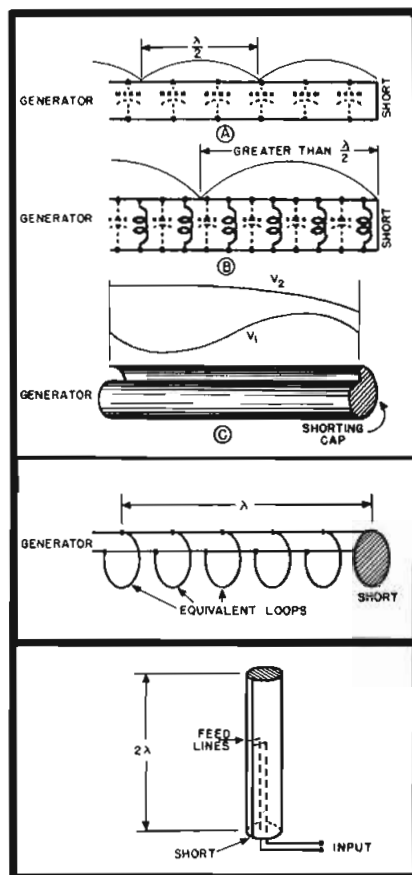

Figures 3, 4 and 5

Standing wave patterns discussed by Andrew Alford in his slot-antenna paper; *A*, curves of voltage along a standard dual line; *B*, line loaded with inductance; *C*, line loaded by means of a circular sheet connecting both lines. (V_1 represents pattern obtained with small tube, V_2 shows how the standing wave becomes almost exponential as the tube is increased in diameter). Figure 4 shows an equivalent circuit of the slotted tube, indicating that it is similar to a stack of loop antennas. In Figure 5 we have a slot antenna two wavelengths long fed in the center and slotted at both ends. Current throughout the length is in phase.

the tube is decreased in diameter. At that point where the minimum is about one wavelength from the short it is equivalent to a stack of loop antennas. This is shown in Figure 4 where all of the loops have in-phase current of practically the same magnitude. Thus it can be used similar to a stacked loop array for radiation.

Figure 5 shows how this was done for the Alford method. The slotted tube is mounted vertically and shorted at both ends. Its length is two wavelengths, so that when it is fed at the center the current is constant throughout. It has a minimum power gain of 2.55. When two such antennas are stacked their power gain is about 4.88. The cylinder has a neutral line opposite from the slot on which it may be mounted.

Poles up to 14" in diameter have been built and found to have very little effect. The driving point impedance, when corrected, is 175 ohms for a 11" cylinder, 0.14 wavelengths in diameter. Impedance

WINTER TECHNICAL MEETING

is 100 ohms for two stacked antennas of the same type.

THEORY OF IMPULSE NOISE IN F-M RECEIVERS

DAVID B. SMITH
Philco Corporation

In usual f-m circuits thermal noise is not noticeable except when the signals are very weak. However, impulse noises, sounding like clicks and pops, are quite prominent. The results of a study of these noises were discussed by Mr. Smith. In the analysis a simplified receiver was cited. It used a linear bandpass filter, an ideal f-m detector including de-emphasis and a linear low-pass audio amplifier.

The analysis presented involved a study of the nature of the transient signal produced at the detector as a result of impulse noise excitation. The noise can be considered as a constant signal which rises and decays. Depending on where it occurs in the phase of the transmitted signal, it may only vary the phase a small amount yielding a click effect or it may cause the phase to slip one complete revolution causing a pop or loud noise in the receiver. It is just a matter of chance which will occur.

It was pointed out that the amplitude of the click is largely, and that of the pop completely independent of the amplitude of the noise signal. The chances of the noise producing a pop instead of a click increase linearly with the degree of instantaneous modulation and with mistuning.

DISCRIMINATORS FOR F-M RECEIVERS

S. W. SEELEY
RCA Laboratories

In an analysis of several types of discriminators, Mr. Seeley offered data on their sensitivity, linearity and tuning characteristics. In the balanced phase-shift type of discriminator, for instance, he pointed out that the discriminator sensitivity is the rate of change of the difference of the magnitudes being detected by each of the two diodes involved. The primary tuning has no effect on the

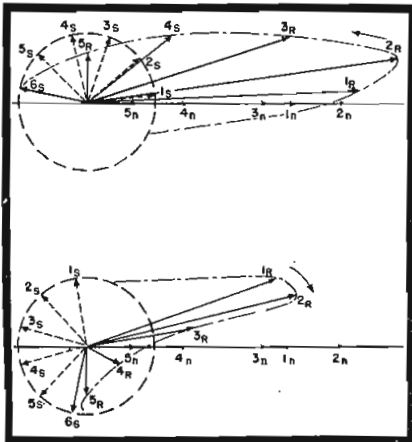

Highlights of Papers Presented By
Gordon; Wallman; Alford; Smith; Seeley;
Larsen and Merrill; Goldmark; Schlesinger;
Serrell; Young; Frankel, Glauber and
Wallenstein; Reeves; Lyman; Schade;
Swedlund; Epstein and Pensak; Rose,
Weimer and Law; Ruze; Van Atta; Kock;
Sinclair; Vaughan and Jordan; Weber;
Torrey; Miller; Dellinger and Smith

by LEWIS WINNER

Editor

characteristic but varies the amplitude of the output signal as it is tuned.

The characteristics curve of a discriminator is not very linear and only a very small portion of it can be used. However, if the curve for the variation in signal with frequency which will yield a linear output is plotted, as shown in Figure 8, we note that it follows very closely the center portion of a double-tuned circuit curve. The primary impedance can be made to follow this curve and result in a very linear discriminator characteristic.

In a ratio detector it is found that by moving the tap down on the primary circuit, linearity can also be obtained.

use 9 appears the complete circuit including a trap circuit made up of C_t , L_s and C_s . The trap circuit attenuates by forming a series resonant path to ground. The design is first carried out as though no trap circuit were involved and the trap is designed later. A graph of the values of Q_1 , Q_2 and C_m is plotted against $\frac{\Delta f}{f_0}$ for

for the ratio of $C_2/C_1 = 2$. Thus once the value of bandwidth Δf is known it becomes a simple manner to find the parameters of the circuits from these curves.

In designing the trap circuit three points have to be considered: Degree of

RECEIVER DESIGN

CAPACITANCE COUPLED I-F AMPLIFIERS

M. J. LARSEN and Dr. L. L. MERRILL
Stromberg Carlson Company

A SIMPLIFIED method of approach to the design problem of capacitance-coupled amplifiers was offered by Mr. Larsen, who presented the paper. In Fig-

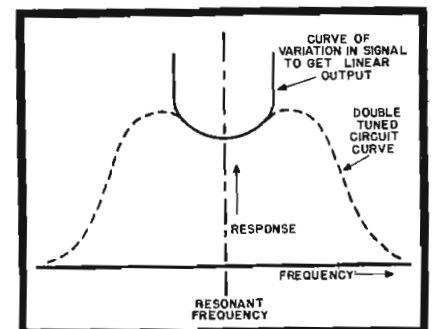

Figures 6 and 7 (Smith paper)

Figure 6 (top) shows several successive positions of a signal in the absence of noise, 1_s to 6_s . A noise transient may be regarded as a fixed vector which grows out of the hub, past the circle to some maximum value and then recedes. Possible set of positions for noise vector are shown by 1_n to 6_n . What happens when two signals pass through phase opposition is shown in Figure 7. The phase of the resultant is pulled back as the noise grows.

Figure 8 (Seeley paper)

The superposition of a curve necessary to secure linear response in a discriminator and the response curve of a double-tuned circuit showing their similarity.

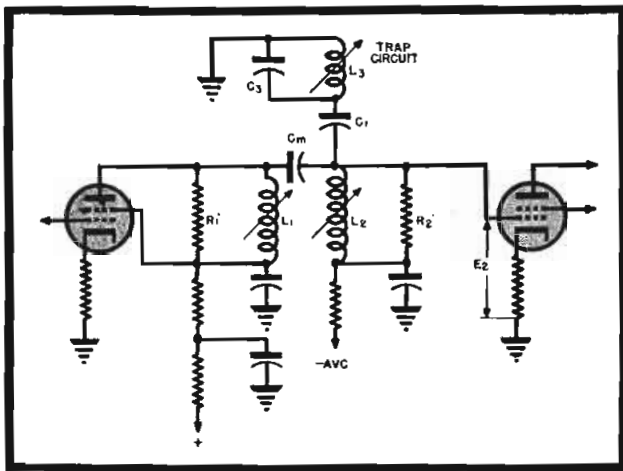

Figure 9 (Larsen-Merrill paper)

Schematic of an amplifier including a trap circuit. The trap circuit attenuates by forming a series-resonant path to ground. The circuit design is first completed as though no trap circuit were involved and the trap is designed later.

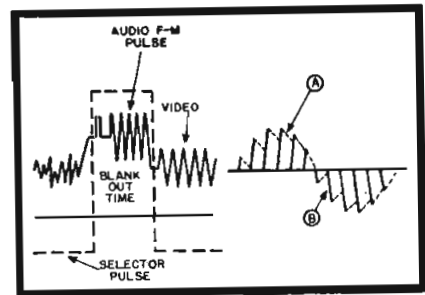

Figure 10 (Schlesinger paper)

Sound signal detection which involves selecting the f-m bursts from the video signal, detecting those bursts and then integrating the result to obtain the audio signal. A indicates audio signal after integration; B, pulses obtained from detection of audio f-m bursts before integration.

attenuation, effect on the response curve, and shape of the trap response. The trapping circuit should not be too sharp because any oscillator drift will throw it off to one side.

after each frame with a field repetition rate of 120 per second; 525-line double interlace is used yielding a scanning frequency of 31,500.

TELEVISION ENGINEERING

TELEVISION IN THE U-H-F

Dr. PETER C. GOLDMARK
CBS

HIGHLIGHTS of the 1-kw 490-mc television transmitter, W2XCS, and advantages of operation in the u-h-f bands, were discussed by Dr. Goldmark.

He said that the immediate advantages of the u-h-f bands (480-920 mc) were:

(1)—With the proper antenna design it is possible to obtain more efficient radiation. This is because the wavelength is shorter and antenna arrays can be built much more efficiently. A beam width in the horizontal plane of 6° was obtained with the CBS installation.

(2)—Because of the high frequency, it is possible to use a parabolic receiver antenna and obtain such good directivity that no reflections at all are visible in the receiver. In fact, it is possible to obtain perfect pictures from reflecting objects with no interference from the direct signal. The parabola used at the receiver is 6' wide and 10" deep.

Discussing the transmitter, Dr. Goldmark said that sight and sound were being transmitted on the same carrier by means of f-m pulses of energy during the blank-out time. Incidentally the present transmitter covers the 480 to 496-mc band. It was found that a single receiver antenna can be used over the whole band between 400 and 920 megacycles.

The present color television system employed is the sequential additive type employing red, green, and blue which are the primary colors. The color is changed

SIGHT AND SOUND ON ONE CARRIER

KURT SCHLESINGER
CBS

CONTINUING the analysis of the CBS transmitter, Mr. Schlesinger said that the highest frequency that can be transmitted on such a system, since it has to take place during the blank-out time of the video signal, is one-half the repetition rate of the bursts of energy. In this case, since the line frequency is 31,500 cycles, the highest frequency would be slightly over 15,000 cycles which will yield the necessary fidelity. Color television with its higher scanning rate thus yields higher fidelity.

A number of methods of inserting the sound on the blank-out pedestal are possible. One method is to vary the amplitude of a pulse but this requires some method of obtaining the base amplitude. Pulse-width variation and pulse-time variation would both yield good results. CBS employs bursts of f-m energy on the blank-out pedestal. A subcarrier of 7.8 mc with a ±600-kc deviation is used. These subcarrier bursts of energy start at the end of each line-synchronizing pulse. Coherent phases in these bursts are necessary to avoid interaction beat notes between them. These are combined with the video signal and the total signal is amplitude modulated on the carrier signal.

Discussing the receiver, Mr. Schlesinger said that it is necessary to separate the two signals. This is done as shown in Figure 10. An electronic switch operated by a selector pulse (shown dotted) admits only the f-m signal into the audio channel. This same pulse is also used to blank out the retrace of the picture tube. Once the f-m energy has been selected it

passes through an ordinary discriminator which yields vertical pulses, the height of which is proportional to the frequency of the burst of energy. Before applying the signal to the audio system it is integrated by a simple RC network to obtain the final form of the audio signal. Any small serrations are not detrimental since the frequency of those variations are very high.

It was claimed that putting both signals on a common carrier resulted in ease of tuning, absence of drift and some resultant simplification of complete circuits.

U-H-F TELEVISION TRANSMITTERS AND ANTENNAS

ROBERT SERRELL
CBS

ADDITIONAL data on the CBS transmitter were presented by Mr. Serrell. He said that the 6C22, formerly the L600N, is being employed extensively in the transmitter. It is used in the modulator and multiplier stages as well as in the final power amplifier. (An analysis of this tube and its circuits appears in the digests of the Young, and Frankel, Glauber and Wallenstein papers.) A grounded grid unit is featured.

The present antennas have a power gain of about 4 or 5. Two antennas are employed, each covering 180° of azimuth. The new antennas that are now being constructed will have a power gain of about 20 in the horizontal plane.

The receiver antenna is broad enough to cover the whole u-h-f television band. It has a beam 23° wide at the 6 db attenuation points. The antenna consists of a cone antenna inside a vertical sheet bent into a parabola in the horizontal plane. It has an aperture of .2½ meters with a focal length of 18". The coefficient of reflection on the transmission line to the antenna is less than 10% over the whole u-h-f band. It is said to have approxi-

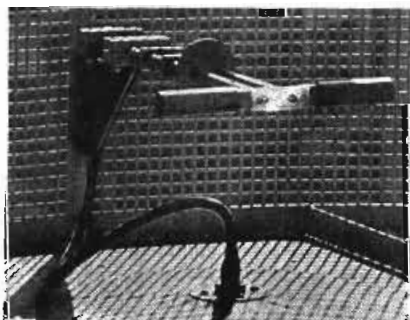

At left 10" horizontal bar of receiving antenna used by CBS at 485 Madison Avenue, N. Y. City, to pick up signals from the Chrysler building, in their color-television tests. Note parabolic reflector in background. At right, CBS film pick-up equipment. In the foreground is the arc lamp with its control mechanism, while directly behind the film reel is the cylindrical unit that houses dissector tube.



mately the same intercept area as a half-wave dipole at 100 mc.

THE CBS TRANSMITTER

NORMAN YOUNG
Federal Telecommunications Labs.

MR. YOUNG pointed out that the transmitter built for CBS has a 490-mc carrier with a modulation characteristic linear from d-c to 10 mc.

One of the most interesting features is that the d-c is transmitted through the video amplifier to the modulator. This is accomplished by using bucking power supplies between stages.

The r-f portion of the transmitter consists of a conventional chain of amplifiers and frequency multipliers following a crystal oscillator. The oscillator stage uses a 6V6GT in a tri-tet circuit, with a crystal frequency of 6.805 mc. The oscillator stage is arranged to double the crystal frequency in the plate circuit, so the output of this stage is approximately 3 watts at 13.611 mc.

The following stage uses a 815 in a push-pull frequency tripler circuit. This tube, which is a dual beam tetrode, delivers approximately ten watts at 40.833 mc. The following stage is another 815 in a tripler circuit, delivering approximately ten watts at 122.5 mc.

This stage is followed by an amplifier using a 4-125 power tetrode, operating without neutralization, but with the reactance of the screen lead series resonated to bring the screen to ground potential more effectively. The stage delivers approximately 120 watts at 122.5 mc.

The remaining stages of the r-f chain make use of the 6C22. This tube, which is a triode of high mutual conductance and low plate resistance, uses the ring-seal technique to reduce the inductance of the leads to the electrodes, and to make the tube suitable for operation at u-h-f. The anode is a solid block of copper fitted with a water jacket for cooling. With a water flow of one gallon per minute the tube may be used for plate dissipations up to 1 kw. In applications where no grid dissipation is encountered, as is common in video-frequency amplifiers, somewhat greater dissipation is permissible, and with a water flow of two gallons per minute, a dissipation of two kw is reasonable.

The fifth r-f stage consists of a 6C22 in a coaxial circuit operating as a frequency doubler. With an input of 120 watts at 122.5 mc, this stage delivers 250 watts output at 245 mc. In this stage the cathode of the tube is bypassed to ground, and the grid circuit is excited with driving energy. The anode circuit of this stage is a quarter-wave line shorted at the end farthest from the tube. Tuning is by a movable piston.

The sixth r-f stage also uses a 6C22 in a frequency doubler circuit, but in this case it is no longer possible to ground the cathode, because of the cathode lead inductance. In this case the grid is grounded, and the drive energy fed into the cathode circuit. With 250 watts of drive, this stage delivers 300 watts output at the final carrier frequency of 490 mc.

The seventh stage is a neutralized amplifier, using a 6C22 in a grounded-grid circuit. With 300 watts of drive it delivers approximately 700 watts output at 490 mc.

The modulator system consists of a five-stage video frequency amplifier hav-

ing uniform response from d-c to 10 mc.

The first stage of the modulator system uses a 6AG7. Normal input for the stage is approximately 2 volts peak-to-peak.

The following stage uses a 807 tube, giving a gain of 2.8 and an output of 40 volts.

The third stage uses three 807s in parallel. This is necessitated by the relatively large input capacity of the following stage. The stage gain is 4.5 and the normal output 180 volts.

The fourth stage uses a 6C22 as a conventional triode amplifier. Although the tube interelectrode capacitances are not large, the Miller effect increases the apparent input capacity of the stage to a considerable degree. With a suitable driver stage no other detrimental effects are found. The gain of this stage is 3.5 and its output is 700 volts.

The fifth stage is a cathode-follower using two 6C22s. The principal purpose of this stage is to supply a driving signal from a source of sufficiently low impedance so that the effects of the changing load imposed by the output stage grid circuit will be negligible. At 490 mc the mutual conductance of each tube is approximately 10,000 micromhos so that the source impedance of this stage may be considered as 50 ohms. In addition, the high current capabilities of this stage and the negative feedback present in the cathode follower link is said to provide a flat frequency response in spite of the shunt capacitance of the r-f amplifier load. The stage gain is 0.8 and the output voltage is 550 volts.

MEDIUM POWER TRIODE FOR 600 MC

**S. FRANKEL, J. J. GLAUBER,
J. P. WALLENSTEIN**
Federal Telecommunications Labs.

PULSE techniques used in radar requiring tubes with peak-emission currents at high voltages prompted the development of the tube described in this and the CBS papers, the 6C22.

In an analysis of the operating conditions for oscillator and amplifier (Tables 1-2, page 26) we learned that most of the recent studies on this tube have been made at 600 mc with c-w operation. At this frequency it has been studied as an oscillator and as a neutralized amplifier in a grid separation circuit. It has also been operated successfully as a doubler from 300 to 600 mc, and as a tripler from 200 to 600 mc.

In all cases, the circuits used were of the coaxial type to assure uniform cur-

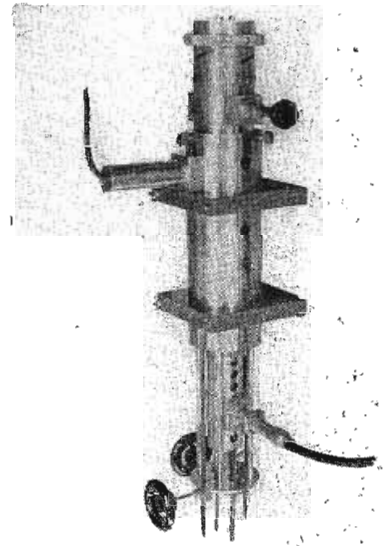

Figure 11 (above)
Coaxial amplifier for 500 mc, using the 6C22 tube described by Frankel, Glauber and Wallenstein.



Figure 12 (above)
The 6C22 triode power-amplifier tube for operation up to 600 mc. It was developed for use in the CBS color television transmitter.

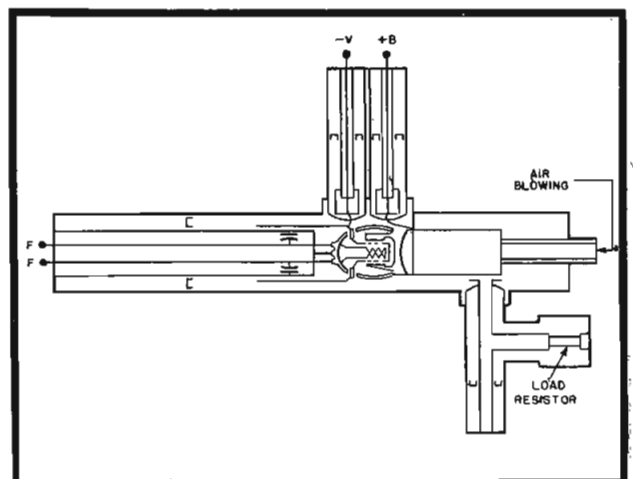

Figure 13
Circuit of test oscillator using an air-cooled version of the 6C22, the L600NR. Plate and grid-bias voltage are brought in through quarter-wave chokes. Cathode circuit is piston tuned, while the plate is adjusted for half-wavelength open-line operation.

rent distribution and thereby reduce losses to a minimum.

A circuit of a test oscillator using an air-cooled version of the 6C22, known as the L600NR, is shown in Figure 13. Anode voltage and grid bias voltage were brought in through quarter-wave chokes. The cathode circuit was piston-tuned, while the anode adjusted for half wavelength open line operation. The r-f output was coupled to the load by means of a capacitive pick-up and matching section.

Air-cooling was brought to the anode through a dielectric pipe which extends into the inner region of the anode line cylinder. In the case of the 6C22 which is liquid cooled, two dielectric pipes of small diameter are used.

When operated as a neutralized inverted amplifier, the amplifier can be driven either from a doubler or a tripler or from another amplifier using the same type of tube to deliver approximately 500 watts at 600 mc.

A laboratory crystal-controlled 500-watt 600-mc transmitter described used an 807 crystal oscillator and tripler (12½ mc); a 807 doubler (25 mc); a 807 doubler (50 mc); a HK-54 doubler (100 mc); and a 6C22 doubler (200 mc).

Life tests conducted for 600 hours as a c-w oscillator at 535 mc with 725 watts input, indicated a 35% efficiency with a negligible decrease in filament emission.

TELEVISION STUDIO EQUIPMENT

JAMES J. REEVES
CBS

THE film pickup unit (Figure 16) used in the CBS color system was described by Mr. Reeves. He said that it consists of a standard arc light source with a condenser lens in front of it. A water cell is located immediately after the condenser lens to cool the light beam. It is followed by a color disc which is synchronized properly with the film movement selector disc and scanning generator to obtain a correctly balanced picture. The film moves continuously and

Frequency	600 mc
D-C anode voltage.....	1200 v
D-C anode current.....	0.6 ampere
D-C grid current.....	0.050 ampere
Power output	250 watts
Anode dissipation	170 watts
Efficiency	35%

Table 1 (L600NR tube)
Experimental data for an oscillator tube setup.

Frequency	600 mc
D-C anode voltage.....	1600 v
D-C anode current.....	0.65 ampere
Anode power input.....	1040 watts
Power output	500 watts
Driving power	190 watts
Power gain	2.6

Table 2 (L600NR tube)
Typical operation data for an experimental neutralized inverted amplifier

a selector disc with slots in it is used to choose one of five lenses that project the picture on the orthicon camera tube.

Another interesting piece of equipment described was a monitoring device which allowed push-button choice of fifteen signals that could be viewed on a cathode-ray monitoring tube. The horizontal sweep is adjusted to give two traces, one above the other, so that two parts of the same signal can be compared.

U-H-F TELEVISION RECEIVERS

HAROLD T. LYMAN
CBS

TWO types of u-h-f receivers for the 400 to 920-mc bands were described by Mr. Lyman. One was a direct-viewing model with a 10" picture. Another was a projection type offering a 15¼" x 21" picture. In both models, the color disc is completely enclosed to minimize the sound. A 15" focal length lens is used in the direct viewing model to enlarge the picture. The unit for separating the



Figure 14
Direct-viewing color television receiver developed by CBS. Uses a 10" tube with view magnified to approximately the size of a 12" tube.

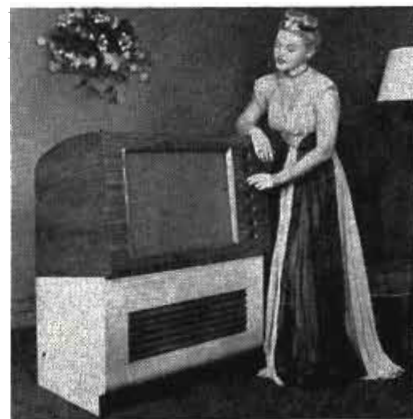
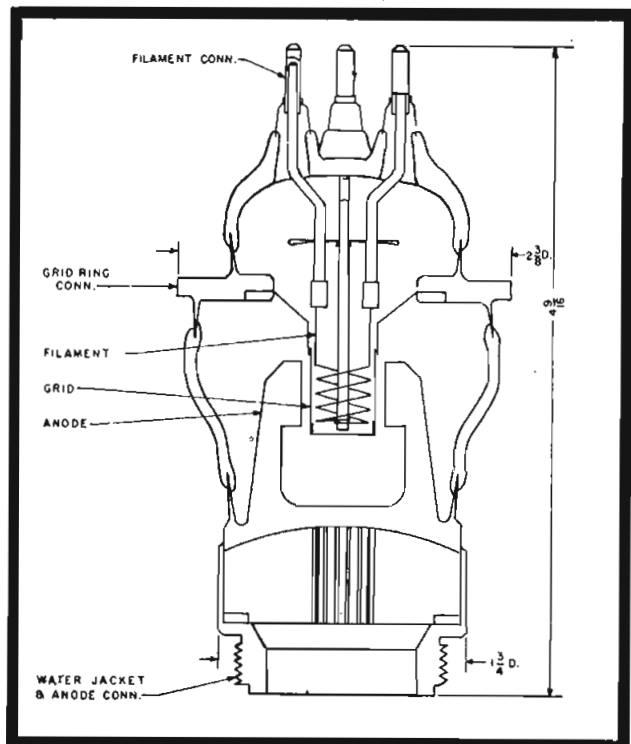
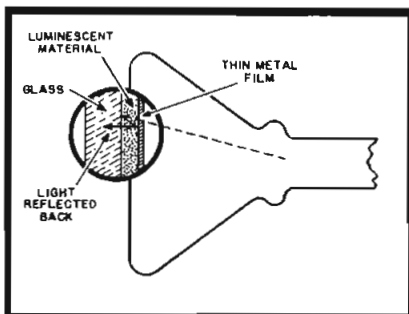
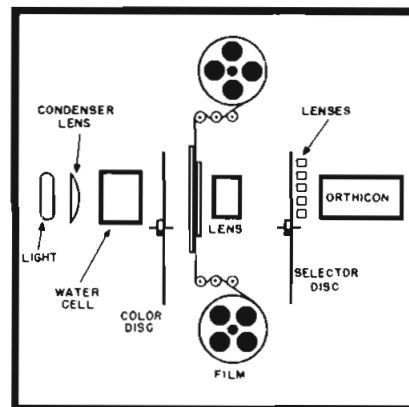

Figure 14a
Projection viewing color television receiver also built by CBS for their color television sets. Image of about 22" width is provided.



Figures 15 (left), 16 (right top) and 17 (right bottom)

Figure 15. Cross-sectional view of the 6C22.
Figure 16. CBS film-pickup unit system used in color picture transmission. Figure 17. Cathode-ray picture tube discussed by Epstein. Enlarged section shows screen with a thin metal film located in back of the luminescent material.



NEW EIMAC EXTERNAL ANODE TRIODE 3X2500A3

Rugged mechanical construction Outstanding electrical efficiency

In the new 3X2500A3, Eimac engineers have developed a highly efficient external anode triode which, in Class C service, delivers up to 5 KW output at a plate voltage of only 3,500 volts. The mechanical design is radically simple, incorporating a "clean construction" which gives short, low inductance heavy current connections that become an integral part of the external circuits at the higher frequencies.

The external anode, conservatively rated at 2500 watts dissipation, has enclosed fins so as to facilitate the required forced air cooling.

Non-emitting vertical bar grid does not cause anode shadows ordinarily created by heavy supports in the grid structure.

Thoriated tungsten filament. Note unusually large filament area, and close spacing.

Filament alignment is maintained throughout life of the tube by special Eimac tensioning method.

New glass-to-metal seals do not have the RF resistance common to iron alloy seals, nor the mechanical weaknesses of the feather-edged types.

Grid ring terminal mounts a cone grid support which acts as a shield between plate and filament.

A coaxial filament stem structure forms the base of the tube. This makes possible proper connections to the filament lines.

Grid and filament terminal arrangements make it possible to install or remove the 3X2500A3 without the aid of tools.

The new mechanical and electrical features of the Eimac 3X2500A3 external anode triode make it valuable for use on the VHF as well as low frequencies. More complete data and information yours for the asking.

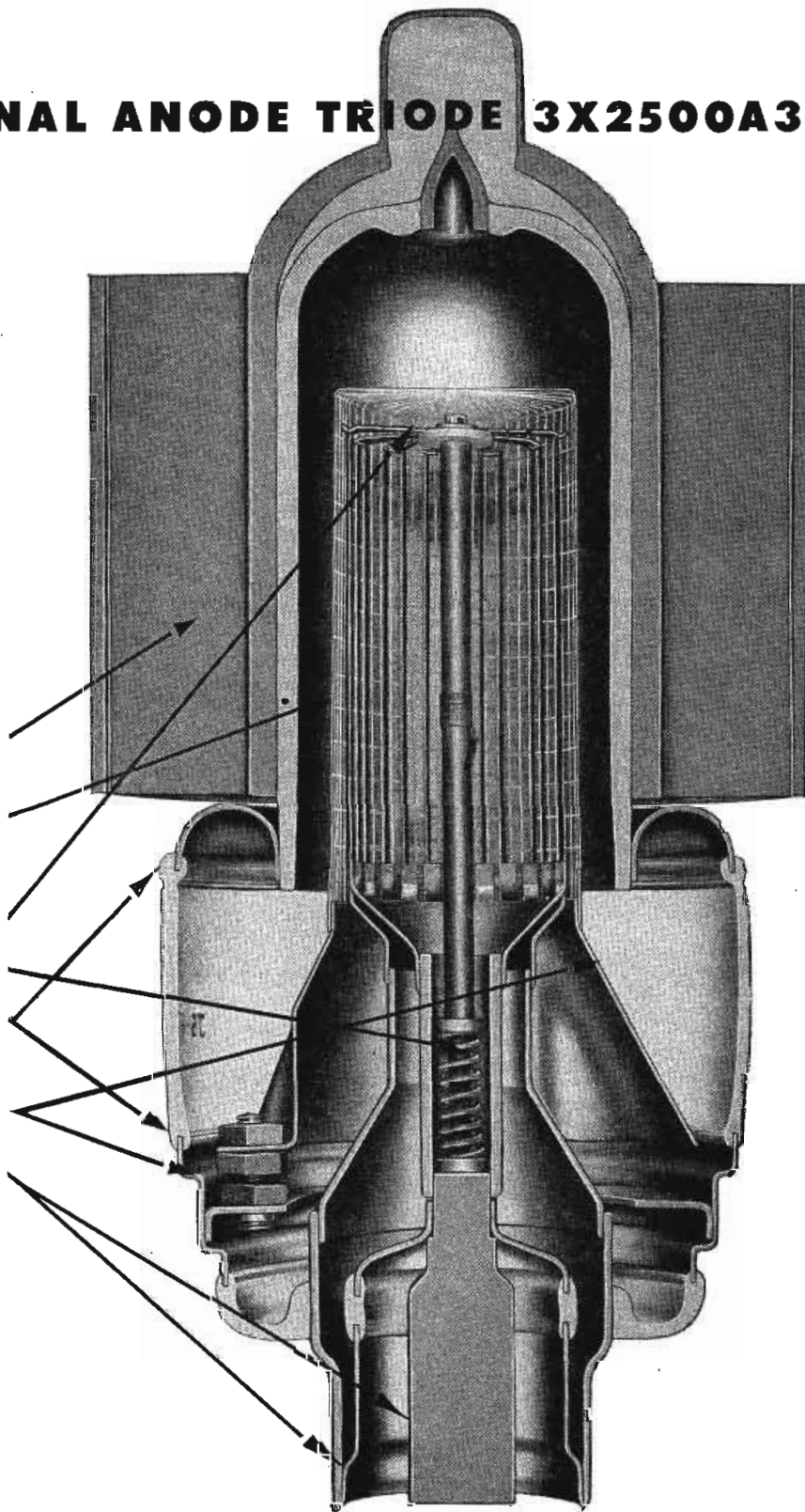

FOLLOW THE LEADERS TO



EITEL-McCULLOUGH, INC., 1123F San Mateo Ave., San Bruno, Calif.

Plants located at: San Bruno, Calif. and Salt Lake City, Utah
Export Agents: Frazar and Hansen, 301 Clay St., San Francisco 11, Calif., U. S. A.

TYPE 3X2500A3 — MEDIUM MU TRIODE ELECTRICAL CHARACTERISTICS

Filament: Thoriated Tungsten	
Voltage	7.5 volts
Current	48 amperes
Amplification Factor (Average) 20	
Direct Interelectrode Capacitances (Average)	
Grid Plate	20 <i>unfd.</i>
Grid Filament	48 <i>unfd.</i>
Plate Filament	1.2 <i>unfd.</i>
Transconductance ($i_b=830$ ma., $E_b=3000$ v.) 20,000 μ mhas	

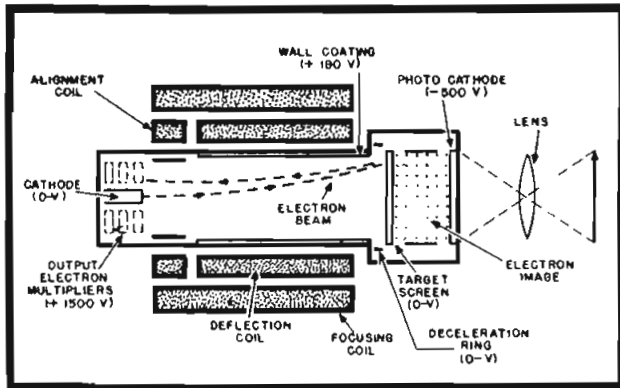

Figure 18 (Rose, Weimer and Law paper) Schematic of the image orthicon. Voltages on electrodes are shown in parentheses.

sound was said to be simple and easy to adjust.

ELECTROOPTICAL CHARACTERISTICS OF TELEVISION SYSTEMS

O. H. SCHADE
RCA Victor

AN interesting study of the electrical and optical relationships in a television system was offered by Mr. Schade. Discussing a typical television system, he pointed out that the contrast in the received image has to increase as the resolution increases in order to be perceptible by the eye; 10% is the eye sensitivity at 400 lines and goes to zero at about 700 lines. If a television system has 450 lines the information cut off by the present-day components is a little less than 10%, showing that the present-day channels result in about the best picture possible. An increase in the number of lines would not be beneficial, he said. To benefit from an increase in the number of lines a better combination of camera tube and picture tube, than is available today, is necessary.

It was stated that slightly above 400 lines the visibility of the noise does not increase with increase in the number of lines. It is possible to tolerate three times the peak noise, than flat channel noise. A 200:1 signal-to-noise ratio produces an excellent picture.

The present-day image orthicon is 100 times as sensitive as the iconoscope.

For color television, he said that two to three times as much light is required. If filters are used 30 to 45 times as much light is needed on the object.

A KINESCOPE FOR HOME PROJECTION-TYPE TELEVISION RECEIVERS

L. E. SWEDLUND
RCA Victor

BRIGHTENERS, voltage supplies and tube face surfaces were discussed by Mr. Swedlund.

The high voltage source appears to have been solved by an r-f power supply. However, for the high light output necessary the amount of current that can be focused and the amount of energy that can be ab-

sorbed is limited. About 30 kv is used for the projection tube in a home receiver.

The face of the direct light type of tube has to be optically flat. At the present time it is ground, but it is hoped that a method of producing it cheaper will soon be developed. For greater light output a front focusing tube was used but that has been replaced by the use of a direct light tube with a metal film. (See digest of Epstein and Pensak paper.)

Because of the high voltages employed special care in insulation has to be taken. The electrodes have to be carefully treated by rounding and polishing to avoid arc over. The glass in the neck under the yoke must take the full stress and has to be carefully made. The neck is also coated with a conducting film at ground potential. The glass has to be treated with a moisture impervious material to prevent the forming of a moisture film. A button stem is used with two pins omitted on each side of the high voltage pin.

It was found that a 24" picture was produced most economically by a 5" tube with electrostatic focusing.

IMPROVED C-R TUBES WITH METAL BACKED LUMINESCENT SCREENS

D. W. EPSTEIN and L. PENSAK
RCA Labs.

IN present-day kinescopes only about 25% of the light is available for direct viewing. The rest of the light is reflected back and scattered, some illuminating the dark areas of the picture and thereby decreasing the contrast. A method of overcoming this defect was described, Figure 17, page 26. A thin metal film is deposited behind the luminescent material. This film is thin enough to allow the energy to penetrate but thick enough to reflect back any light that might fall on it. In this way it prevents the scattering of the light through the back. The requirements for this material are . . . must be smooth and mirrorlike, must not absorb much energy from the electron beam, must be strong enough to withstand focusing, and must reflect the light that impinges upon it.

At the present aluminum is applied by means of evaporation in a vacuum. A one-micron thick film only absorbs 23% of the energy. To obtain a smooth and mirrorlike finish the aluminum is evaporated over a layer of organic material. Conductivity of the film is necessary to

avoid a secondary emission problem. With a conducting film, the film charges up to the voltage of the beam yielding a 1:1 secondary emission characteristic.

The advantages of aluminizing, besides increasing the contrast and saving light energy are . . . stoppage of ion spots, protection of the fluorescent material, and better stability of the pattern which is obtained.

THE IMAGE ORTHICON

ALBERT ROSE, P. K. WEIMER
and H. B. LAW
RCA Labs.

SOME of the necessary requisites for a good camera tube are resolution, reasonable size, reasonable output, freedom from spurious signals, and the ability to reproduce scenes under adverse lighting conditions. Mr. Rose pointed out that the image orthicon camera tube has demonstrated that it meets these requirements.

A cross-sectional view of the tube is shown in Figure 18. A photocathode is used to obtain an electron image which is focused on a two-sided target screen. This target screen is a thin sheet of glass 0.010" thick wherein the charges from both sides of the glass neutralize in the time of scanning but do not diffuse laterally. The output is picked up by a standard orthicon beam, but instead of returning to the cathode the beam is attracted to an electron multiplier which produces the output current. A multiplier gain of 300 to 500 is found to exhaust the multiplier output. Very high sensitivity is obtained and a large range of brightness is obtainable. An illustration by slides showed that the tube sensitivity was greater than that of 35-mm super XX film in a camera with an equivalent lens.

A N T E N N A S

DESIGN CONSIDERATIONS IN BROADSIDE ARRAYS

JOHN RUZE
Camp Evans Signal Corps Lab.

THIS paper discussed methods of feeding broadside arrays between the frequencies of 100 and 1,000 megacycles. It was stated that the beam width of an array depends on the size of an array and decreases as the aperture is increased. However, the spurious radiation is about 25% which is not good for radar purposes. One method of eliminating this is to taper the current reducing sometimes to 1/10 the current in the end antennas as compared with the currents in the center antennas.

Two methods of feeding antenna arrays shown in Figure 19 (page 62), illustrate the difference between centerfeeding and branch feeding. For horizontal dipoles the mutual effect can be neglected but where the mutual effect has to be taken into account the antennas are all fed directly from a junction point and the lengths of the connecting lines are made an odd number of quarter wavelengths long. The power is divided by making the characteristic impedance of the connecting lines vary in the same proportion.

Lobing the arrays was first accomplished by mounting two arrays at an angle to one another and switching between them. One antenna array with a

(Continued on page 62)

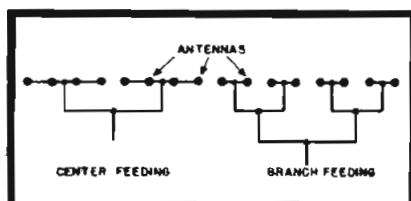

Figure 19 (Ruze paper) Variation in connections for center feeding and branch feeding of an antenna array.

look first to AMPHENOL...

**When You Select
Electronic Components**

In one great line, Amphenol offers almost endless variety of Connectors, Cables, Sockets and many other essential parts for electric circuits, radio, communications and electronic controls for industry. All are engineered to the highest performance standards. Amphenol components are produced and tested to give the most efficient, dependable service under all conditions. Detailed technical information is ready and will be sent to you on request. *Ask for Condensed Catalog No. 72.*

AMERICAN PHENOLIC CORPORATION
Chicago 50, Illinois • In Canada • Amphenol Limited • Toronto



U. H. F. Cables and Connectors • Conduit • Fittings
Connectors (A-N, U. H. F., British) • Cable Assemblies • Radio Parts • Antennas • Plastics for Industry

MICROPHONE DESIGN

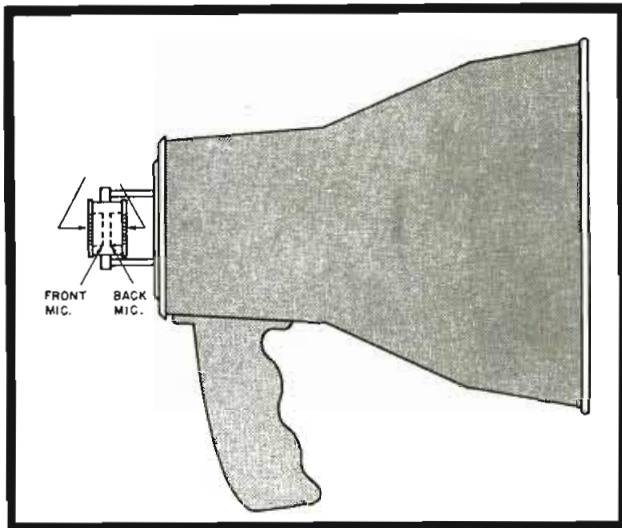
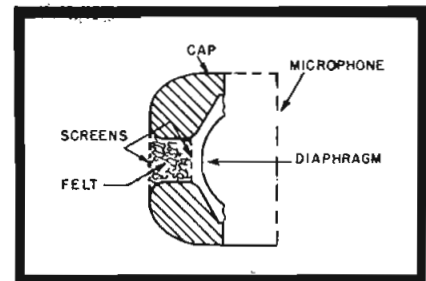

Figure 1 (below)
A microphone for an electric megaphone with a special cap, packed with acoustic felt, for close-talking use.

Figure 2 (left)
Arrangement of double-phasing microphone assembly in an electric megaphone. Two separate microphones are used with each diaphragm facing either end of the housing.



PREVIOUSLY,¹ it was shown that 111 bars was the highest pressure that could be attained by taking maximum advantage of horn design. To get higher pressures than this with the same input it is necessary to further reduce acoustic feedback. It is logical to turn to the microphone to see if it can be made to discriminate to some degree against sounds other than those originating from the talker's mouth. In earlier discussions we noted that the necessity of placing the microphone at its most convenient position at the rear of the horn fortunately provides one of the most important factors for feedback reduction. However, considerable experimental work has been done in an effort to make the microphone itself more insensitive to sound coming back from the horn. This is a difficult approach, for we find that there is no differentiating factor to distinguish between the original speech signal and that reproduced by the loudspeaker, as far as the feedback effect on an ordinary microphone is concerned.

One method which had been used to reduce feedback at this point used a microphone designed for very close talking purposes. This effect alone did not give sufficient f-b reduction except in relatively low-power megaphones. It is however one of the most important factors, since a successful electric megaphone must be designed for close talking and used in that manner.

There are certain types of microphones which exhibit an output characteristic that seems to rise faster than linearly proportionate with input pressure variation, up to a point. They

thus appear to become very sensitive to higher input pressures applied relatively close. A system using this design of microphone gains slightly in f-b margin under *close-talking* conditions, but the non-linearity tends to produce marked amplitude distortion.

Another method which has been found to give some additional discrimination against f-b involves a microphone with a cap having a small opening partially packed with acoustic felt; Figure 1. This opening apparently results in an impedance mismatch to the atmosphere; that is, the loss to the relatively low-pressure speech-frequency sound waves from the loudspeaker prevents acoustic feedback from starting at the level it would without this loss. However, the loss to the sounds from a talker's mouth, close to the opening, is small, due to a better impedance match or more efficient *coupling*. There are several drawbacks to this method, one of the chief ones being that it is difficult to achieve this improvement over a substantial frequency band.

Methods of closing off the talker's mouth completely by a rubber cap or other means, which supposedly provides an airtight seal, are not recommended. In practice, there is no assurance that the user is certain to seal his mouth completely by the cap. Then, it is unwieldy and cumbersome to use. And in addition, the cavity formed may produce bad resonances. Theoretically it may be possible to reduce the latter by using acoustic vents in the sealing cap which maintain a

¹Acoustic Feedback Reduction by Increased Directivity in Megaphones, COMMUNICATIONS; September, 1945.

high transmission loss at other than the cavity-resonance frequencies, but this seems not only problematical, but apt to be complicated and costly.

A special type of microphone assembly which gave some increase in the f-b margin necessary for a higher power megaphone was developed recently.² This assembly (Figure 2) consists of two separate microphones mounted in a housing, with each diaphragm facing, respectively, either end of the housing, both of which are open and covered with a grille. In this microphone, the talker speaks in the usual manner close to one of the diaphragms which is facing away from the loudspeaker horn. The output circuits of the two microphones are connected in opposite phase. For most effective cancellation of unwanted sound fed back from the loudspeaker, the interfering sound must impinge on each diaphragm simultaneously with the same pressure and in the same phase. Any difference in time or space phase, or difference in instantaneous sound pressure reduces the degree of cancellation. Ideally, the two microphones should be identical in every respect, for if one has a response peak at the same frequency that the other has a dip, for instance, the resultant cancellation effect is reduced correspondingly at this frequency. It is, of course, almost impossible to procure a pair of microphones that are identical, unless specially built, adjusted, and calibrated under laboratory conditions. Quite satisfactory results can be obtained, however, by selecting two microphones of the same type, which test measurements show give the best cancellation.

One method of making such tests is

IN ELECTRIC MEGAPHONES

A Discussion of Electric Megaphone Microphone Designs That Permit Extremely High Sound Pressure Outputs Without Feedback

by **ARTHUR J. SANIAL***

Chief Engineer
Atlas Sound Corporation

to measure the pick-up of each microphone separately (with the microphone housing assembly in place at the rear of the megaphone), the loudspeaker portion of the megaphone, driven by an a-f oscillator, being the source of sound for this test. It is quite necessary that a coupled beat-frequency oscillator curve-tracer setup (Figure 3) be used, so as to obtain a continuous curve which includes all peaks and dips. These curves will provide a measure of the output voltages generated in each of the microphones by the sound radiated to the rear by the loudspeaker, but will give no indication of relative phase of these voltages. The microphones must then be connected electrically together in opposite phase, and a frequency response curve of the combined outputs made in the same manner as before. By analyzing the two sets of curves, it is possible to get a fairly good picture of the magnitude of the inequalities in amplitude response between the two microphones, as they are placed. The curves will also indicate how much the finite dimensions of the microphones, their separation distance, and the proximity of the horn housing, prevents a sound wave of a given frequency from arriving at the two diaphragms at exactly the same phase.

It is evident, that as the frequency

increases from zero, the relative phase of those portions of the sound wave from the horn, which impinge on the two microphone diaphragms simultaneously, departs from exact in-phase relationship until a frequency is reached at which the cancellation effect becomes ineffective. This frequency depends chiefly on the separation distance of the diaphragms, and the angle at which the sound waves

**Electroacoustic Consulting Engineer.*

Figure 4
Relation between X , the distance between two instantaneous values of an assumed sound wave from the horn, which are acting on the front and back microphone diaphragms simultaneously; d , the separation distance between diaphragms on the microphone axis; and θ , the angle between the axis and the direction of wave motion.

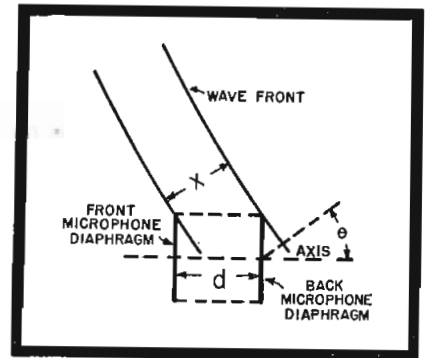

from the horn arrive (i.e., the angle between the normal to the wave front and the axis of the microphones). This is shown in Figure 4, where

x = the shortest difference in path length between two instantaneous values of sound pressure in the wave, which are acting on the front and rear diaphragms respectively, and

d = separation distance of microphone diaphragms.

²Developed by writer and Nunzio Tralli, St. John's University.

Figure 3
Setup for measuring pickup over frequency range of either microphone or with both connected, with switch to reverse phase as required, using coupled beat-frequency audio-oscillator curve tracer for continuous amplitude-frequency response curve, and megaphone's loudspeaker as a sound source.

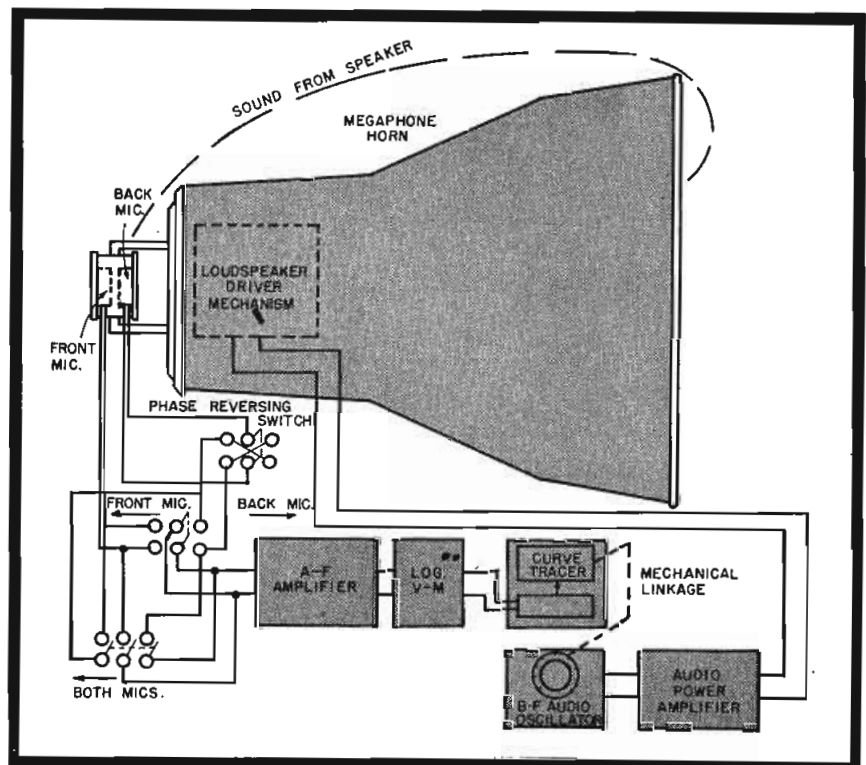

Then $x = d \cos \theta$

It can be seen by inspection that when x is effectively one-half wavelength, the diaphragms are 180° out of phase, the voltages adding in the electrical output circuit due to the reversed phase connection, their sum being double that of one of the microphones alone, assuming equal pickup sensitivity, etc. Effective cancellation of the sound fed back becomes zero when the output of the two microphones is equal to that of one alone so that no increase in the f-b margin will result under this condition. (The assumption is made throughout that the over-all transmission gain of the system is adjusted to compensate for the impedance of two microphones versus that of one.) As the f-b margin will actually decrease when the combined output is greater than that of one, it is important to know the relationship of the variables involved.

Let us consider a sine wave voltage generated by each microphone, these voltages being equal in maximum and effective values but displaced in phase; that is, let

microphone 1 voltage $e_1 = E_1 \sin wt$

microphone 2 voltage $e_2 = E_2 \sin(wt - \theta_2)$

Where: $\theta_2 =$ difference in phase between the two voltages (or between the sound pressures acting on the respective microphone diaphragms)

and $E_1 = E_2$

Now the phase shift is related to the separation distance as follows:

From the foregoing, $x = d \cos \theta$, and the phase shift, $\theta_2 = 2\pi (d \cos \theta) / \lambda$

Figure 5
Vector diagram showing subtraction of two voltage vectors E_1 and E_2 displaced θ_2 radians, and resulting vector E_0 displaced θ_0 radians from E_1 .

As the microphone outputs are connected out of phase, the resultant voltage generated by the combination is the difference of e_1 and e_2 . This may be expressed as

$$E_0 \sin(wt - \theta_0) = E_1 \sin wt - E_2 \sin(wt + \theta_2)$$

As $E_1 = E_2$, the vector of E_0 will be equally displaced in phase angle from the vectors of E_1 and $-E_2$; Figure 5. The phase displacement of E_1 and $-E_2$ is $(2\pi - \theta_2 + \pi)$ so that

$$\theta_0 = (\pi - \theta_2) / 2$$

From the foregoing, and since the resultant voltage is maximum when

$$(wt - \theta_0) = \pi / 2$$

then

$$E_0 = E_1 [\sin(\pi - \theta_2 / 2) - \sin(\pi + \theta_2 / 2)]$$

Since $\sin(\pi - A) = \sin A$, and $\sin(\pi + A) = -\sin A$

$$E_0 = 2E_1 \sin(\theta_2 / 2)$$

Relating this to the separation distance,

$$E_0 = 2E_1 \sin[(\pi d \cos \theta) / \lambda]$$

The most unfavorable condition

Figure 6

Curve showing variation of E_0/E_1 with values of ratio of separation distance to wavelength, d/λ , for equal values of E_1 and E_2 and $\theta = 0$ from relation $E_0 = 2E_1 \sin \left[\frac{\pi d \cos \theta}{\lambda} \right]$

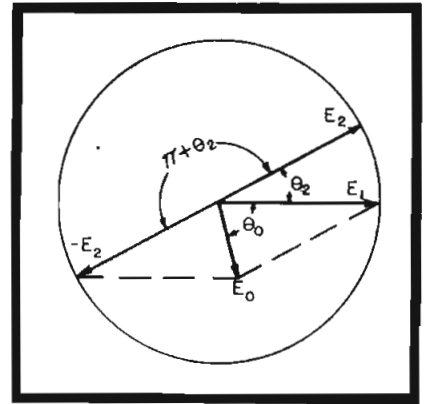
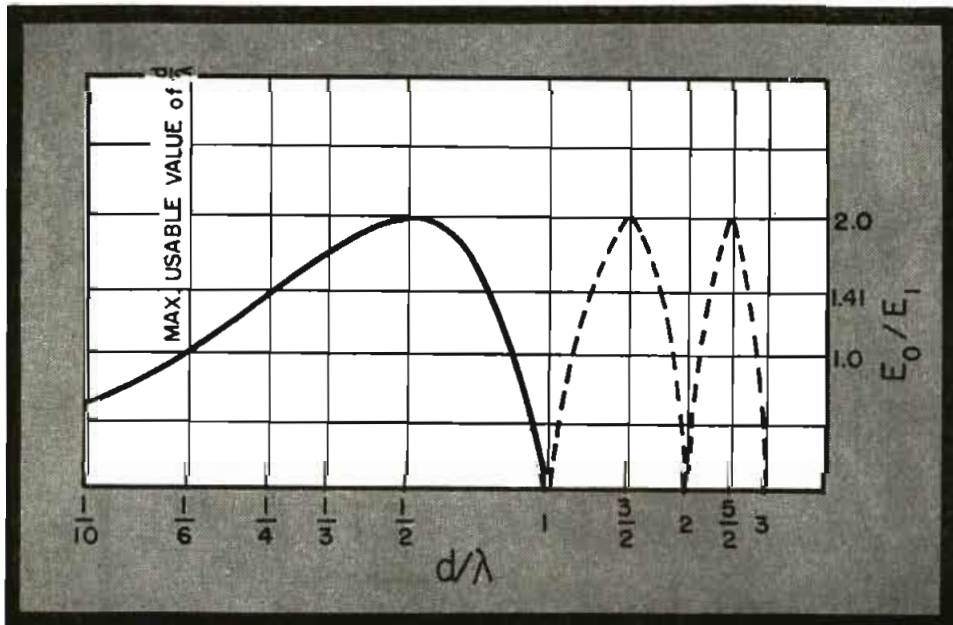

exists when the sound from the horn arrives parallel to the axis, or when θ is zero. In this case,

$$E_0 = 2E_1 \sin(\pi d / \lambda)$$

For the limiting condition (zero cancellation effectively), $E_0 = E_1$ under the conditions outlined above,

$$\sin(\pi d / \lambda) = 1/2$$

Thus

$$d = \lambda / 6$$

It is evident that a useful gain in f-b margin is obtained from a double microphone of this kind only when

$$d < \lambda / 6$$

For the sound wave arriving at any other angle θ (considering the first and fourth quadrants as being of interest),

$$d < \lambda / 6 \cdot \cos \theta$$

It is interesting to note that the cancellation effect goes to zero, and then becomes negative in a useful sense, and although it increases again at higher frequencies, it is no longer useful. The relationship $E_0/E_1 = 2 \sin(\pi d / \lambda)$ is plotted in Figure 6 as a function of d when $\theta = 0$, and shows how the change in phasing of the two microphones with frequency causes a fluctuation of the ratio between 0 and 2. The shaded area is the useful region. (Some experimental work has been done to extend the range of f-b cancellation between $\lambda/6$ and $\lambda/2$ by *tricking up* the circuit of the back microphone.)

Cancellation Effect

This means that the cancellation effect of the double microphone in reducing pickup of the loudspeaker sound, ceases for all practical purposes when the frequency is such that the separation distance is equal to or greater than one-sixth of the wavelength, with the sound arriving perpendicular to the diaphragms. Thus, for f-b reduction up to 1,500 cycles, d

must be less than 1.5". If the back wave arrives at 45° to the axis, *d* may be greater, as

$$d = \lambda/6 \cdot \cos \pi/4$$

or $d = 2 + \text{inches}$

The above analysis is perhaps fairly accurate for microphones of small diameter. Indications are that as the diameter increases, a correction factor for *d* is necessary. In the present work, this factor has not been determined, but its effect would be included in curves taken as described. Microphones much over an inch, approximately, in diameter have not given the most satisfactory results experimentally.

With these relationships in mind, and with the information provided by the response curves described, it is possible to make an analysis of the functioning of a given double microphone, and from this devise means to reduce or equalize some of the departures from ideal. For instance, amplitude versus frequency response may be modified by redesign of the diaphragm and its coupling networks (acoustic). In some cases, the microphone cap parameters have considerable influence. Thus the area and configuration can be changed so as to reduce or increase response within certain limits, where necessary in the frequency spectrum. If the response curve of the two microphones connected together out-of-phase show insufficient cancellation effect, say at 1,500 cycles, as revealed by comparing it with the response curve of one microphone alone, and further comparison of the individual response curves of each of the microphones alone do not exhibit undue dissimilarity in sensitivity in this region, then these units are either too large in diameter, or the diaphragms are separated too far. It will then be necessary to reduce these dimensions.

A change in location of the microphone housing with respect to the rear of the horn, or an actual change in the shape or size of the latter can sometimes be made to effect an improvement in the cancellation. The object in this case is to influence the returning sound from the horn so that the wave front travels at a greater angle to the microphone axis.

One double-microphone assembly, made according to these principles for experimental work, when used in place of a single similar microphone on a certain electric megaphone, provided an additional increase of 2 db f-b margin in the 1,500-cycle region, with less above and more at lower frequencies. In the previous paper on electric megaphones,¹ it was shown that a megaphone with a horn of special design

Figure 7
Single microphone response required, with assumed rear pressure of piston speaker at microphone position, to maintain 22-db feedback margin between 500 and 2000 cycles and resulting loss in warble band.

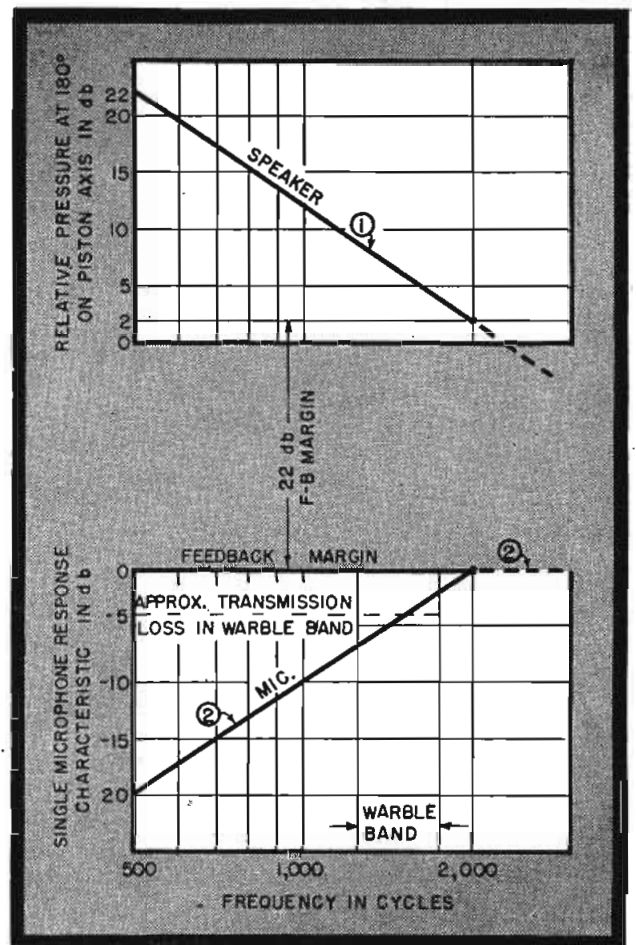
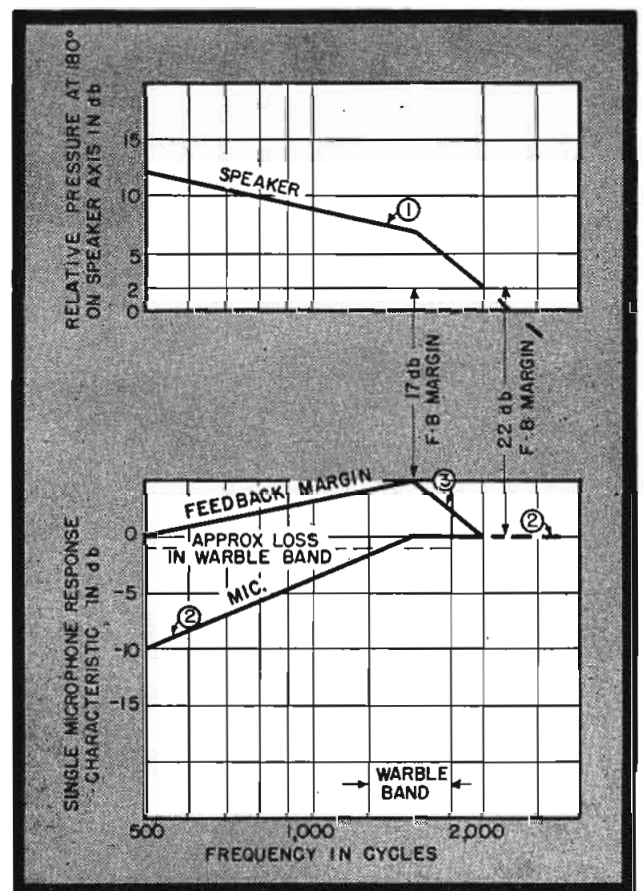

Figure 8
Response of single microphone (2) required to maintain a minimum of 17-db feedback margin (3) in the warble band, using a horn loud-speaker with average response as in (1), and resulting loss.



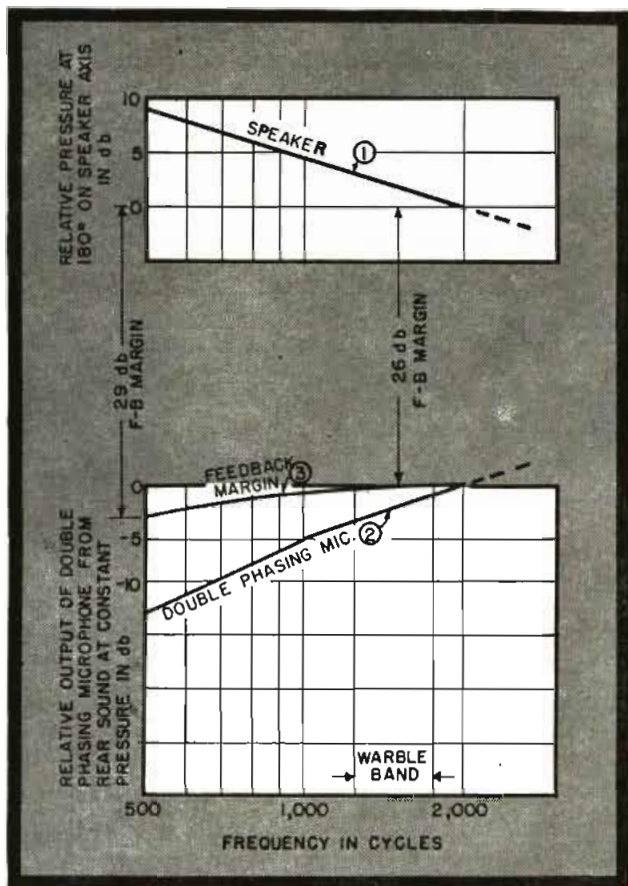

Figure 9
Feedback margin (3) over range resulting from use of special directional horn with low rear radiation (1) and double-phasing microphone assembly discriminating against rear pickup (2).

could be made to produce in the 1,500-cycle region 111 bars of sound pressure at 4' on the axis of the horn, with the standard test sound pressure at the microphone diaphragm. Now if this type of megaphone horn is combined with a double microphone, as described, effecting an increase of 2 db in the f-b margin in the warble band, an increase of output sound pressure can be obtained before feedback; that is,

$$20 \log_{10} (P_m/111) = 2$$

$$P_m = 140 \text{ bars (approximately)}$$

In other words, with the same input pressure, the amplifier gain may be increased 2 db before feedback occurs, providing of course that the power stage can handle the increased power requirement. The f-b margin above 1,500 cycles is maintained by virtue of the reduction in sound fed back from the horn with increasing frequency, as previously explained.

To clarify the manner in which the combination of microphone and loudspeaker in an electric megaphone act together to determine the resulting f-b margin over the frequency range, let us review and correlate the factors brought out in this and previous papers. The loudspeaker was first considered, for purposes of illustration, as a piston of 1' diameter, developing sound pressures at 180° off the forward axis which increased 20 db from 2,000

to 500 cycles; curve 1, Figure 7. To maintain uniform f-b loss over the required frequency range in this case, the curve of microphone sensitivity to sound returning from the loudspeaker must be adjusted so as to have the inverse slope, curve 2. Inasmuch as the warble frequency band of 1,250-1,750 cycles has been chosen for standard testing (as it was considered to be most adequate as a gage of loudness on voice), the minimum reduction in sensitivity in this band was desirable. As the f-b margin of 22 db at 2,000 cycles, due to the loss of sound energy at the rear of the horn, must be maintained over the range, the microphone sensitivity was therefore attenuated correspondingly from this frequency down to 500 cycles, this attenuation being zero at 2,000 cycles and 20 db at 500 cycles, as shown in curve 2. Assuming that the amplifier and speaker transmission response is flat, this microphone equalization gives a loss averaging 4 to 5 db in the warble band.

Let us take, as an example, a more practical type of loudspeaker, instead of assuming that the speaker has the characteristics of the equivalent piston. Actual horn loudspeakers show a great variation in the amount of sound fed back at 180°, compared to what would be expected of an equivalent piston, depending on their design and size. It is also necessary to have minimum transmission loss in the

warble band, i.e., the 1,500-cycle region. In Figure 8, curve 1 represents the average, from 500 to 2,000 cycles, of the sound field at the rear of a megaphone loudspeaker, when it is driven to give constant output pressure on its axis. Assuming this f-b sound is 22 db down from axial pressure at 2,000 cycles, as we did previously, it will be about 17 db down in the warble band, and 12 db down at 500 cycles. Considering 17 db as the minimum permissible margin against feedback, we can then use a microphone (single) response without attenuation from 2,000 to 1,500 cycles, but falling off below this frequency as shown in curve 2. The resulting f-b margin is never less than 17 db over this range as shown by curve 3. By adjusting for the smallest required f-b margin in the region of the test warble band in this manner, a better transmission response, using a single microphone, is obtained as compared to simply introducing 20-db loss (10 db per octave) gradient from 2,000 to 500 cycles, and better efficiency is realized in the warble range. This combination is similar to that used in one of the early electric megaphones, which could produce 40 bars at 4' on the axis before feedback started, with the standard test pressure at the microphone. (In the figure, it will be noted that the curves are averages over the range, so as to show the effects more clearly than if all peaks and dips were included. Allowances must be made in practice for peaks in the overall response, as they reduce the f-b margin, this effect depending upon where the peaks occur and their magnitude. It will also be noted that the range above 2,000 cycles is not considered, since the directive type horns used for this purpose radiate comparatively little energy at 180° at higher frequencies.)

Now considering the operation of an electric megaphone made up of a combination of phasing microphones, and a horn as described previously (which was shown to feed back 7 db less sound in the 1,500-cycle region than the equivalent piston) we can illustrate in a general way how the f-b margin varies over the significant frequency range. Figure 9 shows averages of curves taken on such an electric megaphone. Curve 1 is the sound pressure developed by the loudspeaker at the position occupied by the microphone of the megaphone normally, the measuring microphone being a laboratory standard with a uniform, flat response. Curve 2 is the output of a double-phasing microphone combination, in position at the rear of the megaphone, when driven by sound produced by the loudspeaker, the curve being cor-

(Continued on page 60)

THE NEW RCA SINGLE-RIBBON MICROPHONE



... quickly adjustable to any pickup pattern you want

THIS Multi-Purpose, Polydirectional Microphone (Type 77-D) will help you add even greater balance, clarity, naturalness, and selectivity to your studio pickups.

By means of a continuously variable screw adjustment, located at the back of the microphone, an infinite number of pickup response patterns can be obtained—unidirectional, all variations of bidirectional, and nondirectional. Undesired sound reflections can be quickly eliminated merely by switching to a more suitable pattern.

A three-position VOICE-MUSIC switch on the bottom of the microphone is available for changing the low-frequency response, thus per-

mitting the selection of the best operating characteristic.

A unique single-ribbon unit combines the performance of the velocity-operated and the pressure-operated units used in previous designs.

Other outstanding features: excellent frequency response, uniform directivity at all frequencies, shielded output transformer, shock mounting, spring-type cord guard, lightweight, small size, and an attractively styled umber-gray and chrome housing.

A bulletin completely describing this outstanding microphone is yours for the asking. Write: Radio Corporation of America, Dept. 24-B, Broadcast Equipment Section, Camden, N. J.

UNIDIRECTIONAL



Uniform response from operating side. At rear, sounds are attenuated 14 to 20 db for an approximate 10:1 ratio of desired-to-undesired pickup.

BIDIRECTIONAL



Pattern similar to conventional RCA 44-BX bidirectional microphone, except rear response is three db down compared with the response from the front.

NONDIRECTIONAL

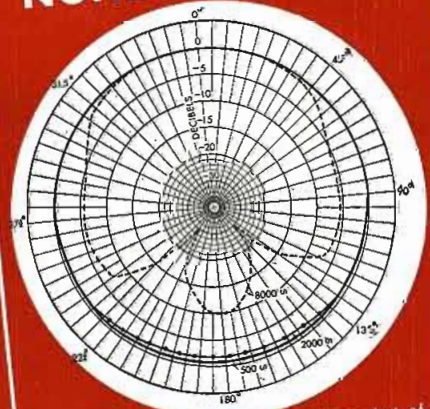

The nondirectional pattern is similar to that of other pressure microphones. Many other patterns possible by varying screw adjustment.



BROADCAST EQUIPMENT

RADIO CORPORATION of AMERICA

ENGINEERING PRODUCTS DIVISION, CAMDEN, N. J.

M O B I L E

Designed During Closing Months of War, System Is Now Used in Railroad Car and Airplane of President Truman

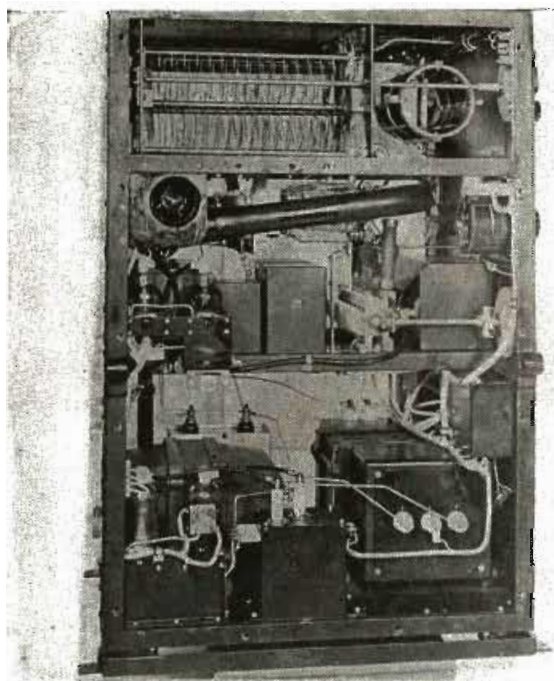
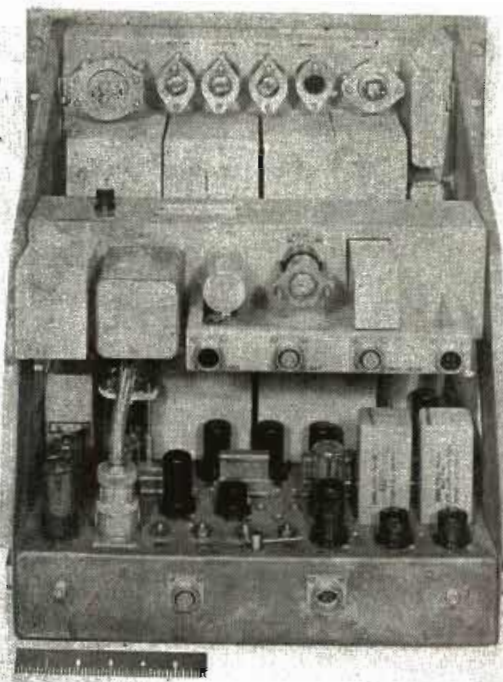
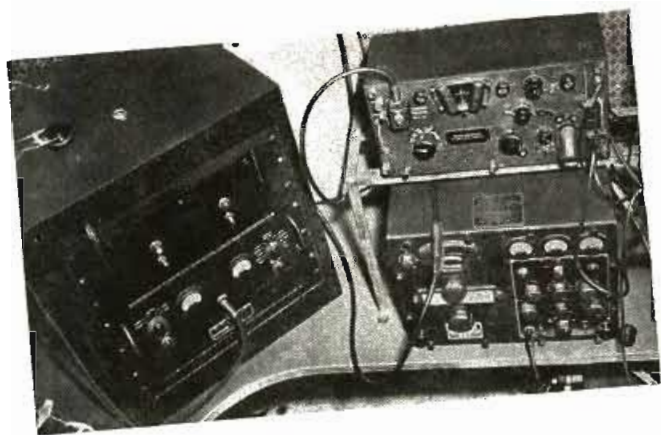

Figures 1 (top), 2 (center) and 3 (bottom)

Figure 1. A section of the Presidential car unit with a frequency-shift converter and two receiving units used in the diversity arrangement of the radioteletype system. Figure 2 shows the dual diversity system. Figure 3. Amplifier used with system. A frequency shift exciter is also used in the system. This unit contains a master oscillator continuously tunable from 2 to 6 mc, and with adequate driving power to permit multiplication in the low stages of the transmitter to the output frequency of 18 mc. Frequency shift keying is provided electronically by d-c signals which are transmitted from the teletype shelter over field wire.

A LONG-RANGE, mobile, radio-teletypewriter station, light enough to be installed in a railroad car or transport plane and sufficiently powerful to transmit and receive messages across the continent, was developed during the closing months of the war.

This system, AN/MRC-2, installed in President Truman's communications coach, enables the Chief Executive, while traveling by rail, to maintain national and international contact. An experimental test, conducted in the Sacred Cow, the Presidential plane, has already demonstrated that similar communication may be maintained during aircraft travel.

For use in tactical ground operations, the system is transported in four standard 2½-ton Army cargo trucks, and the equipment is set up in three shelters, which for protective purposes and greater efficiency are usually separated by considerable distances. One shelter, normally located near a message center, contains teletype printers, a tape transmitter, and a tape reperforator. The transmitter section, some distance from the control unit, consists of the radio transmitter and associated equipment. The third shelter contains the receiver.

Before this system was developed, the Army had to depend for its radio-teletype communication service on equipment primarily designed or adapted for fixed-plant installation. Because of the cumbersome size and weight of these units, and the time required for their installation, they could not be set up until military operations in the area had been stabilized.

The new equipment was designed around SCR-399, a 300-watt unit. The

2 TO 18-MC RADIOTELETYPE FOR LONG-RANGE OPERATION

by **HARRY L. LANDAU**

Office of the Chief Signal Officer
War Department

power of the SCR-399 was raised to 2 kilowatts and other adaptations were made. To provide the wide frequency range necessary to insure reliable communications, night and day, over great distances, the radio set was required to operate over the 2 to 18-mc range.

The equipment had to be fitted to standard Army vehicles and arranged for remote control, and all components had to be lightened in weight. As an illustration of how well the engineers succeeded in scaling down weights, the commercial teletype machine previously used weighed more than 300 pounds; the teletypewriter and scrambler designed for the AN/MRC-2 have a combined weight of 70 pounds.

Operating over a distance of 1,100 air miles, between the Coles Signal Laboratory, Red Bank, N. J., and Royal Palm State Park, Florida, most-

ly across salt water, satisfactory two-way teletype communication has been maintained with this system.

Installing the equipment in a railway coach entailed serious technical problems. While the normal antenna

height for fixed-teletypewriter operation is 35' to 50', the antennas on the train could not be more than 6' above the car roof, and it was impossible to mount the transmitting and receiving antennas farther apart than 6'. A novel arrangement overcame these difficulties, and the attendant possibility of interference induced between the two antennas. Folded doublet transmitting antennas were placed lengthwise atop the car, and a single-wire receiving antenna was attached to narrow ledges along the sides near the roof. The roof

(Continued on page 54)

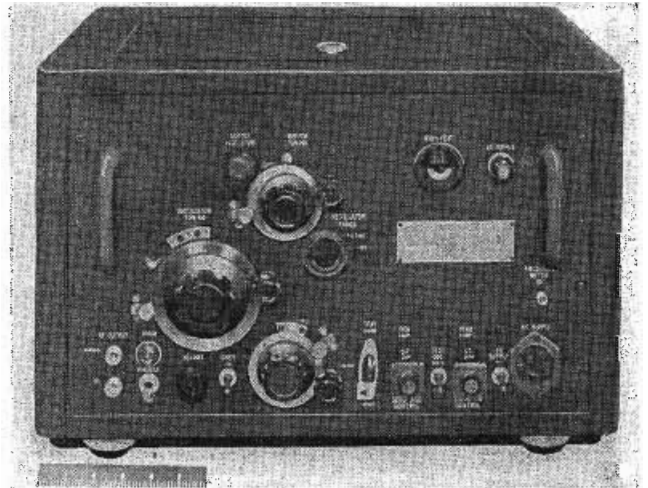
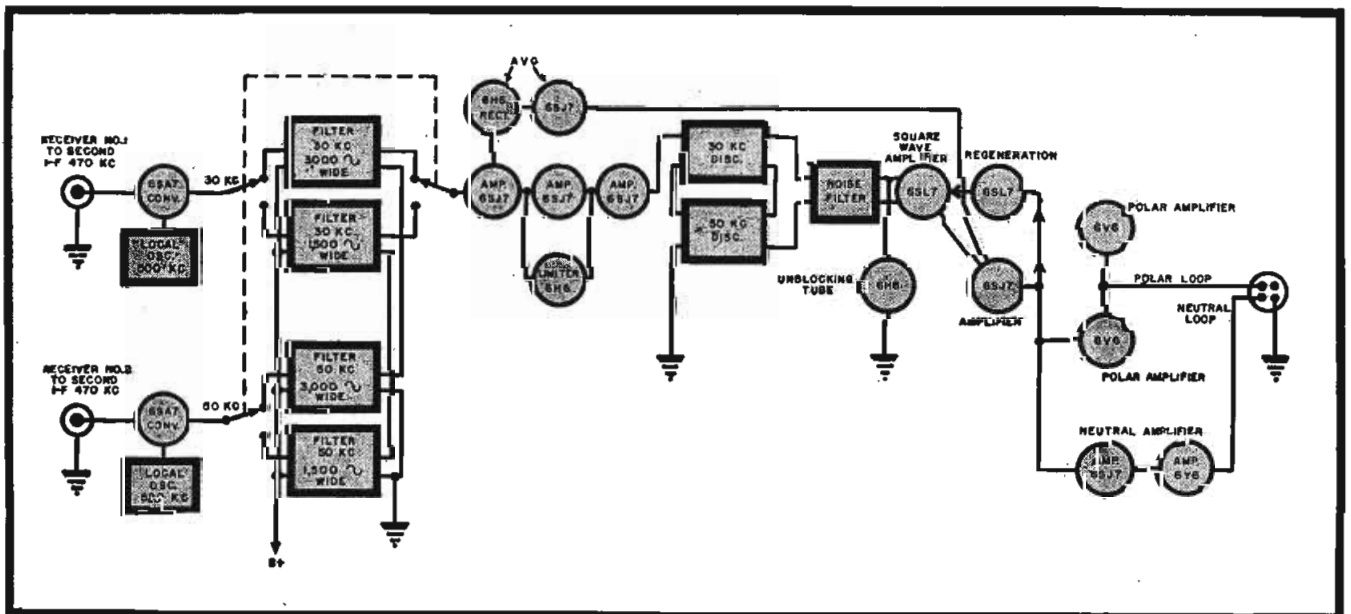

Figure 4
Frequency shift exciter
of radioteletype system.

Figure 5
The dual-diversity converter. This is linked to the i-f outputs of two receivers which permit dual space-diversity reception. The unit provides limiting over a wide range, instantaneous diversity action and conversion of signals to polarized or neutral d-c pulses.



INTERFERENCE IN

by N. MARCHAND*

Chief Engineer

Lowenherz Development Company

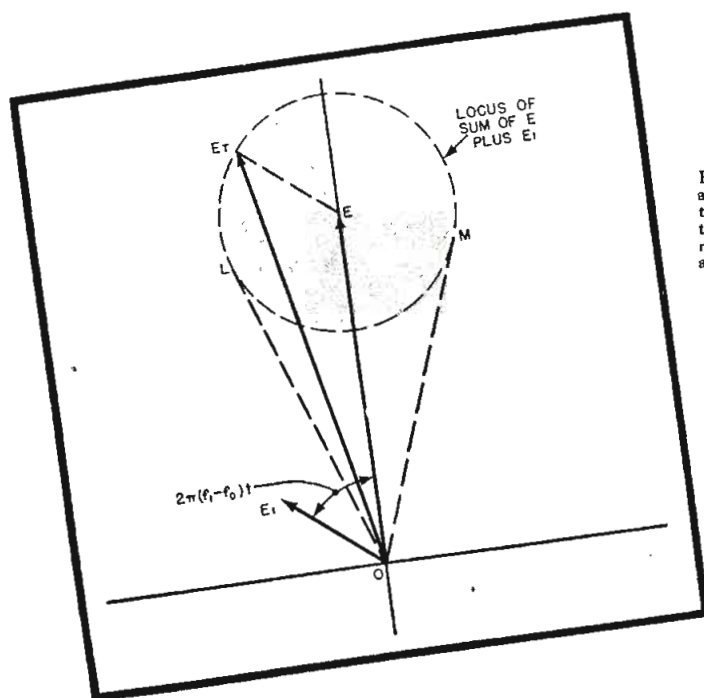

Figure 1
Phasor diagram of adjacent carrier interference. Here the received carrier, E , is stationary. E_1 is the interfering carrier.

perhaps the most important is *random noise*. This consists of the random band of frequencies which is generated at the input to any receiver, being determined by the impedance across the input terminals. This type of noise is what determines the signal-to-noise ratio of the receiver.

Very often interference and distortion can be caused by poor design as well as pickup from outside sources. This is particularly true in f-m where careful design is required in order to obtain the best results at the receiver.

Adjacent Carrier Interference

The simplest type of interference is that which is caused by another carrier displaced in frequency from the carrier being received. It will be assumed, since it is usually the case in practice, that the adjacent carrier is small in comparison to the carrier being received. In Figure 1 is shown a phasor diagram which has the received carrier, E , stationary. The interfering carrier E_1 , since it is at a different frequency will rotate in the phasor diagram at a rate equal to the difference frequency. In other words, at progressive instants of time E will remain stationary while E_1 will assume different positions on a circle

THE term *interference* is used to signify the introduction of any voltage or extraneous signal that will interfere with the fidelity of the received signal. Interference may be caused by other frequency-modulated signals on the same or adjacent channels. This is not common at f-m broadcast frequencies and is usually caused by some defect in the receiver or a chance set of conditions of propagation wherein the field strengths of the received signals are varying. Amplitude-modulation stations and unmodulated carriers can cause the same type of interference.

Other Noise Sources

Insufficient shielding of the receiver results in direct pickup into the circuits. This is usually very difficult to trace and eliminate. Another source of interference, *impulse noise*, is similar to interference by an adjacent modulated carrier with which it is sometimes confused. The source of this noise can be a low-frequency spark or similar discharge. The wave radiated then consists of a low-frequency fundamental very rich in harmonics. If we consider the characteristics to be similar to a square wave, such as is actually found in impulse

noise, then all of the harmonics will be in phase. The pass band of an f-m receiver will then pass the harmonics which are in that band. Actually then impulse noise interference will consist of a spectrum of closely spaced radio-frequency signals which can be considered practically equal in amplitude over the bandwidth of an f-m receiver. This is true because it is a small band of very high harmonics. The last source of interference and

In last month's paper the side bands and bandwidth for amplitude modulation, frequency modulation and phase modulation were derived and compared. In this installment the comparison is continued for interference conditions. Common channel interference is derived for both amplitude and frequency modulation. The results are then applied to the derivation of signal-to-random noise and signal-to-noise ratio improvements.

*Instructor in Graduate Electrical Engineering courses, Columbia University.

FREQUENCY MODULATION

The Second of a Series of Papers Covering the Operation and Design of F-M Transmitters. The Papers Will Include a Discussion of the Design of F-M Modulators, Frequency Control Methods, Antenna Designs, and An Analysis of Auxiliary Transmitter Equipment

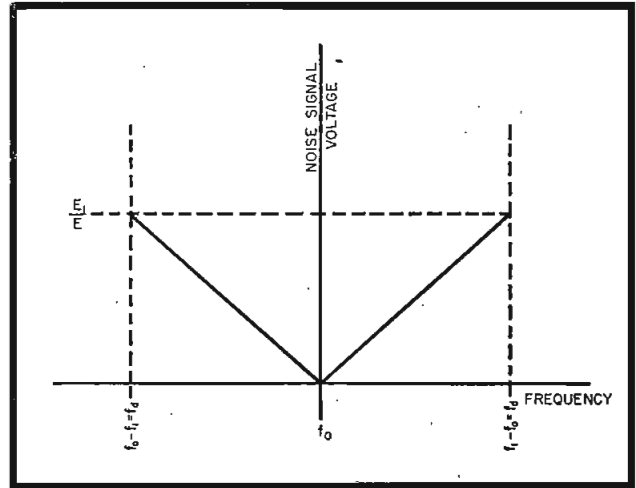

Figure 2
Noise voltage generated by an adjacent signal of frequency f_1 , magnitude E_1 , on a carrier of frequency f_0 and magnitude E . Receiver frequency deviation, f_d .

about O . Suppose we let f_0 be the frequency of the carrier E and f_1 be the frequency of the interfering carrier E_1 . If f_1 is larger than f_0 , E_1 will rotate counterclockwise and if f_1 is smaller than f_0 , E_1 will rotate clockwise. Let the carrier voltage e be expressed by

$$e = E \sin 2\pi f_0 t \quad (1)$$

where e is the instantaneous voltage and E is the peak voltage designated as $O-E$ in Figure 1. The interfering carrier voltage e_1 is expressed by

$$e_1 = E_1 \sin 2\pi f_1 t \quad (2)$$

where e_1 is the instantaneous voltage and E_1 the peak voltage, E_1 being very much less than E . When these two

voltages are added they will result in a voltage which has both amplitude modulation and frequency modulation. As shown in the figure, when E_1 is in phase with E the resultant voltage will be in phase with E and its amplitude will be $E + E_1$. When E_1 makes an angle of approximately 90° with E the maximum phase shift of the resultant E_r will take place. The maximum phase shift as shown will be between OL and OM . To obtain the frequency modulation present in this phase shift it is first necessary to obtain the expression for the phase shift and differentiate it to obtain the frequency shift.

Expanding 2 to obtain the interfering voltage as components of E

$$\begin{aligned} E_1 \sin 2\pi f_1 t &= E_1 \sin (2\pi f_0 t) \cos [2\pi (f_1 - f_0) t] \\ &+ E_1 \cos (2\pi f_0 t) \sin [2\pi (f_1 - f_0) t] \end{aligned} \quad (3)$$

Adding (1), the equation for the original carrier to the expansion as given in (3),

$$\begin{aligned} E_r = [E + E_1 \cos 2\pi (f_1 - f_0) t] \sin 2\pi f_0 t \\ + [E_1 \sin 2\pi (f_1 - f_0) t] \cos 2\pi f_0 t \end{aligned} \quad (4)$$

Equation (4) has to be converted to a magnitude and an angle with respect to the fundamental frequency. The magnitude is obtained by taking the square root of the sum of the squares of the sine and cosine magnitudes, while the angle is the arc tangent of one divided by the other.

$$\begin{aligned} E_r = \sqrt{E^2 + E E_1 \cos 2\pi (f_1 - f_0) t + E_1^2} \\ \cdot \sin \{2\pi f_0 t \\ + \tan^{-1} \left[\frac{E_1 \sin 2\pi (f_1 - f_0) t}{E + E_1 \cos 2\pi (f_1 - f_0) t} \right] \} \end{aligned} \quad (5)$$

Thus E_r has two types of modulation incorporated into it. From (5) it can be seen that the amplitude and the phase angle both vary with t .

Amplitude Modulation

Considering first the amplitude alone and factoring out E

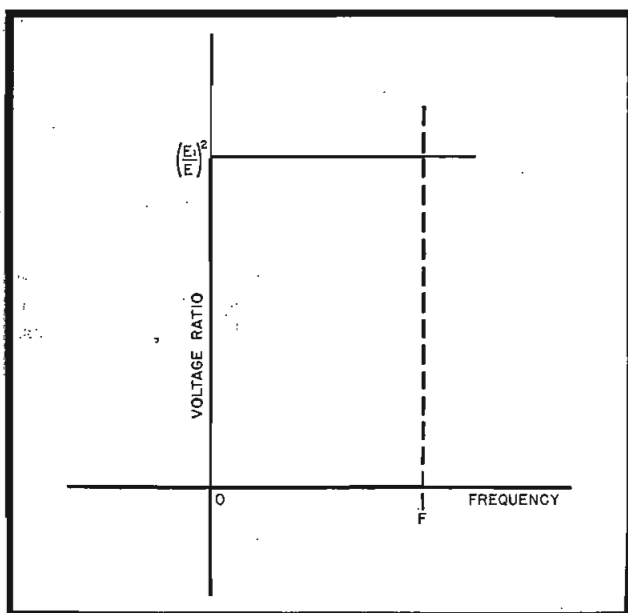

Figure 3
Curve of random noise voltage ratio squared for an amplitude-modulation system.

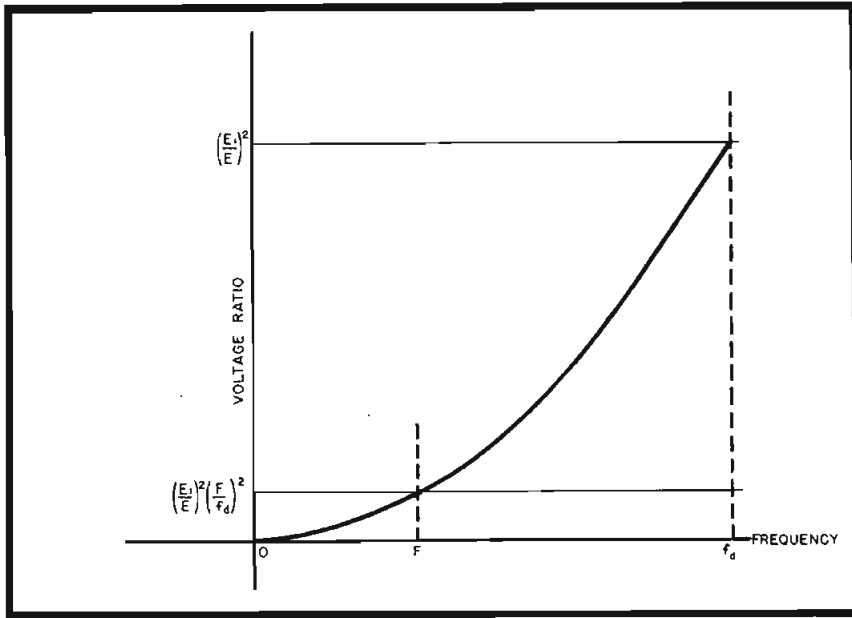

Figure 4

Curve of random noise voltage ratio squared for a frequency-modulation system. In f-m the noise voltage varies with the generated frequency. All that has to be taken into account, in this problem, is the area under the curve from O to F.

$$|E_r| = E \sqrt{1 + 2 \frac{E_1}{E} \cos 2\pi (f_1 - f_0) t + \frac{E_1^2}{E^2}} \quad (6)$$

A term consisting of E_1 divided by E is obtained. If E_1 is assumed very much smaller than E the last term under the radical may be neglected since it consists of the ratio squared. Using the first two terms of the expansion

$$(1 + x)^n = 1 + nx + \dots \quad (7)$$

Equation (6) becomes

$$|E_r| = E \left[1 + \frac{E_1}{E} \cos 2\pi (f_1 - f_0) t \right] \quad (8)$$

Equation (8) is the standard equation for an amplitude-modulated wave where the modulation factor is E_1/E and the frequency of modulation is $|f_1 - f_0|$. This is the signal that would be received in an a-m receiver. It means that an interfering peak voltage of E_1 would be received.

F-M Reception

In an f-m receiver the amplitude variation would be removed by some type of limiting action or by the use of a detector which is not susceptible to the amplitude variation. In this

case the only part of (5) which has to be considered is the angle, θ , where

$$\theta = 2\pi f_0 t + \tan^{-1} \left[\frac{E_1 \sin 2\pi (f_1 - f_0) t}{E + E_1 \cos 2\pi (f_1 - f_0) t} \right] \quad (9)$$

Again since E_1 is very much smaller than E the second term in the denominator may be neglected. For the same reason, since the resultant angle will be small the arc tangent may be assumed to be equal to the angle itself. (9) then becomes

$$\theta = 2\pi f_0 t + \frac{E_1}{E} \sin 2\pi (f_1 - f_0) t \quad (10)$$

To obtain the signal that would be received it is necessary to differentiate (10) and divide by 2π in order to obtain the variation in frequency with t :

$$\frac{1}{2\pi} \frac{d\theta}{dt} = f_0 + \frac{E_1}{E} (f_1 - f_0) \cos 2\pi (f_1 - f_0) t \quad (11)$$

where the peak variation from the carrier frequency f_0 is $E_1/E \cdot (f_1 - f_0)$. If the receiver detector has a frequency deviation of f_d for which the output is unity (100% modulation), the output signal will be E_{π} , where

$$E_{\pi} = \frac{E_1 (f_1 - f_0)}{E f_d} \cos 2\pi (f_1 - f_0) t \quad (12)$$

Comparing equation (12) to equation (8) for amplitude modulation it can be seen that the interference is cut down by a ratio of the difference frequency to the frequency deviation which is being used in the system. This means that no beat note will be received if the two carriers are on the same frequency, and the interfering voltage will increase as the difference frequency is increased. If the audio band pass is adjusted for a maximum of 15 kc without deemphasis the maximum interference will be obtained when the difference frequency is 15 kc. Above that the interference would be cut off in the audio amplifiers. For a 75-kc deviation this means that even at that point the interference would be cut down by a ratio of 5. In modern receivers, using deemphasis, which cuts down the gain at the higher audio frequencies, this ratio is vastly increased.

Random Noise Calculations

Random noise consists of a band of frequencies at random phase covering the pass band of the receiver. It has been shown that the resultant noise output is proportional to the square of the voltage components over the spectrum of the noise frequencies. All frequencies generated at the detector above 15 kc will be neglected since they are inaudible. The output noise is then proportional to the area under a curve of noise voltage squared, versus frequency of output signal. Equation (8) shows that the noise voltage generated in an a-m receiver is independent of frequency so that the curve for an audio system

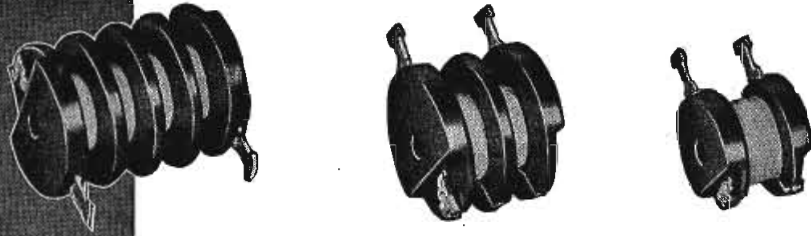

3 NEW BOBBIN TYPE RESISTORS

MAXIMUM RESISTANCE VALUES

Type RX3	Type RX4	Type RX5
100,000 ohms <i>(wound with 1.5 mil. dia. ceramic-insulated wire)</i>	300,000 ohms	500,000 ohms
25,000 ohms	75,000 ohms	125,000 ohms <i>(wound with 2.5 mil. dia. ceramic-insulated wire)</i>

MAX. POWER RATING AT 80° C. AMBIENT

1 watt	2 watts	3 watts
--------	---------	---------

MAX. TEMPERATURE—Ambient plus rise: 150° C.

RESISTANCE TOLERANCE:

$\pm 1/2\%$ to $\pm 5\%$, as specified. Where close tolerances are necessary, power ratings should be reduced in order to maintain stability. For example, one-third power rating is consistent with 1% tolerance.

TEMPERATURE COEFFICIENT—

Standard temperature coefficient is that of nickel-chromium wire, .017%. Lower coefficients can be provided with special alloy wires, restricting the resistance range in some cases.

STABILITY—Resistors can be current- and temperature-aged after

winding to provide instrument resistor stability. When operated at ratings consistent with tolerance, stability is $\pm 0.1\%$ or 1/10 of tolerance, whichever is larger.

CONSTRUCTION—Resistors are wound with ceramic-insulated Sprague Koolohm resistance wire on molded, high-temperature plastic forms. The lug terminals are tinned copper inserts molded in the plastic form.

HUMIDITY RESISTANCE—Resistors are impregnated to provide protection against tropical humidity conditions.

SPRAGUE KOOLOHM

Trademark Reg. U. S. Pat. Off.

WIRE-WOUND RESISTORS

FIRST with Grade 1, Class 1 Resistors; FIRST with resistors wound with ceramic-insulated wire; FIRST with glass-to-metal sealed resistors; FIRST with glazed ceramic coatings and new style end seals; FIRST with Megomax high-resistance, high-voltage resistors.

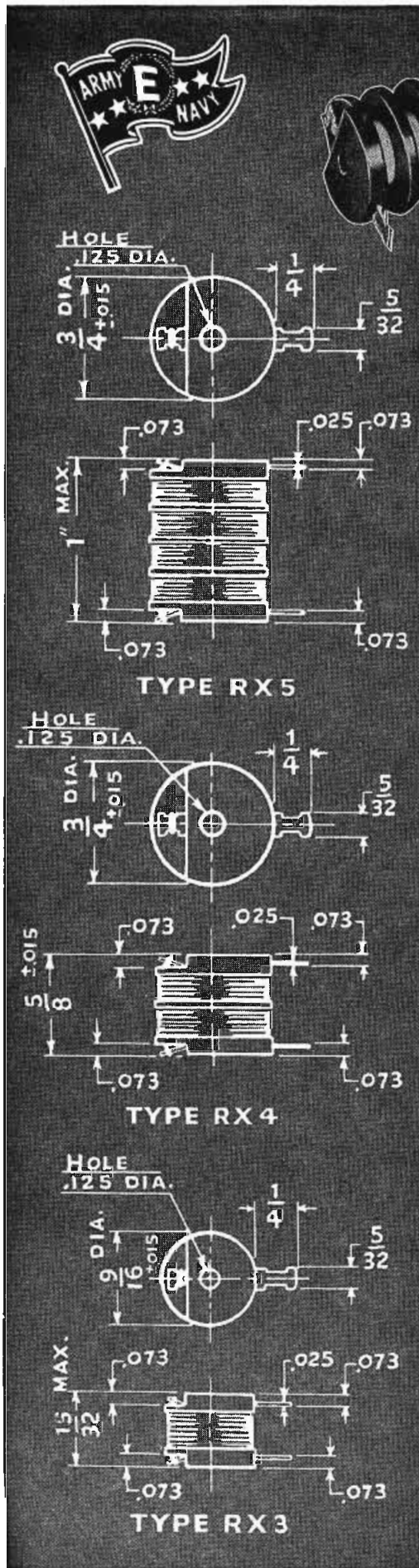

SPRAGUE ELECTRIC COMPANY, Resistor Division, NORTH ADAMS, MASS.

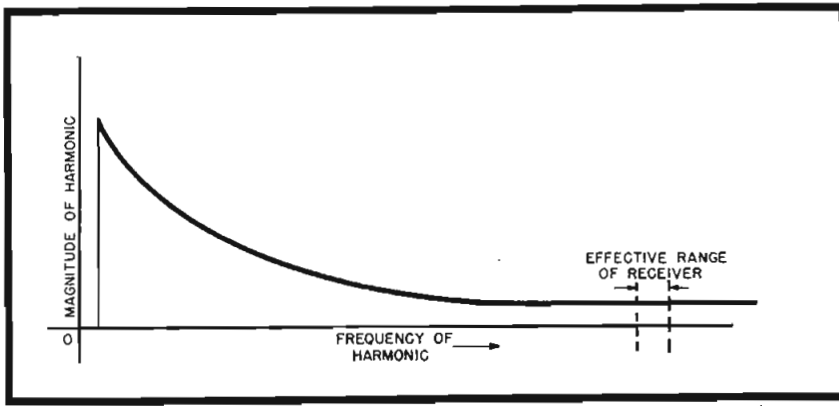

with a maximum frequency of F will be a horizontal line as shown in Figure 3. The area under the curve is

$$W_{A-M} = (E_1/E)^2 F \quad (13)$$

where W_{A-M} is proportional to the output noise power for amplitude modulation. For f-m, as shown in equation (12), the noise voltage varies with the generated frequency. A curve of random noise voltage squared is shown in Figure 4. All that has to be taken into account is the area under the curve from O to F .

$$W_{F-M} = \int_0^F \left(\frac{E_1}{E}\right)^2 \cdot \left(\frac{f}{f_d}\right)^2 df \quad (14)$$

where W_{F-M} is proportional to the output noise power for frequency modulation. Integrating (14)

$$W_{F-M} = \left(\frac{E_1}{E}\right)^2 \cdot \frac{F^3}{3f_d^2} \quad (15)$$

The ratio of the noise power in a-m to the noise power in f-m is

$$\frac{W_{A-M}}{W_{F-M}} = \frac{1}{3} \left(\frac{f_d}{F}\right)^2 \quad (16)$$

The rms noise voltages are proportional to the square root of the ratio of the noise powers so that (16) becomes

$$\frac{N_{A-M}}{N_{F-M}} = \sqrt{\frac{W_{A-M}}{W_{F-M}}} = \sqrt{3} \frac{f_d}{F} \quad (17)$$

Figure 5
The magnitude of variation of the harmonics of a low-frequency impulse noise showing that the received signals are practically of equal magnitude.

where N is the symbol for rms noise voltage. Since (17) is calculated for 100% modulation in both cases it is also the expression for the comparison of signal to noise ratios. Thus since the ratio of signals is *one*, dividing the signal ratio by the noise ratio given by (17) and keeping the f-m signal-to-noise ratio in the numerator

$$\frac{\text{F-M signal-to-noise ratio}}{\text{A-M signal-to-noise ratio}} = \sqrt{3} \frac{f_d}{F} \quad (18)$$

Thus the improvement in signal-to-noise ratio is equal to $\sqrt{3}$ times the result of dividing the frequency deviation by the maximum frequency of the audio system. If the deviation is 75 kc and the maximum audio frequency is 15 kc the improvement is over eight times the ratio for a-m.

Noise Reduction Methods

In Figure 4 we notice how the curve climbs rapidly as the frequency is increased. To cut down on this large increase, accentuation of the high frequencies is employed at the transmitter and deemphasis is used at the receiver. This means that the response of the receiver at the higher frequencies where the greatest amount of noise is present is cut down so that the noise in turn is decreased. This

helps to improve the signal-to-noise ratio even more for f-m.

Impulse Noise

The calculation of the improvement in signal-to-noise ratio for impulse noise is very similar to that employed in random noise except that the noise voltages are added directly. This is true since the impulse voltages over the spectrum will add instead of combining in random fashion as in the previous calculation. This means that the noise voltages can be integrated over the audio band directly so that

$$\frac{\text{Impulse noise voltage in A-M}}{\text{Impulse noise voltage in F-M}} = \frac{\frac{E_1}{E} \cdot F}{\int_0^F \frac{E_1}{E} \cdot \frac{f}{f_d} df} \quad (14)$$

Integrating (14) and simplifying

$$\frac{\text{Impulse noise voltage in A-M}}{\text{Impulse noise voltage in F-M}} = \frac{2f_d}{F} \quad (15)$$

Equation (15) can be converted to signal-to-noise ratios as was done in the case of random noise, so that

$$\frac{\text{Signal-to-impulse noise ratio for F-M}}{\text{Signal-to-impulse noise ratio for A-M}} = 2 \frac{f_d}{F} \quad (16)$$

Equation (16) shows that for impulse noise the improvement is slightly greater. Again the deemphasis in the receiver will help to increase the improvement in signal-to-impulse noise ratio.

References

- Stuart Ballantine, *Fluctuation Noise in Radio Receiver*, Proc IRE; August 1930.
- O. E. Keal, *Interference in Relation to Amplitude, Phase and Frequency Modulation*, The Wireless Engineer; January 1941.
- S. Goldman, *F. M. Noise and Interference*, Electronics; August 1941.
- Hans Roder, *Noise in Frequency Modulation*, Electronics; May 1937.
- M. G. Crosby, *Frequency Modulation Noise Characteristics*, Proc IRE; April 1937.

Federal's **vast**
TUBE-MAKING
EXPERIENCE

focussed on

FM

**NEW HIGH-PERFORMANCE TUBES
FOR FM TRANSMITTERS**

Federal's notable achievements over the years in the development of high-power tubes to operate efficiently in the upper portions of the radio spectrum . . . now is reflected in the design and production of *new* power tubes for FM application.

Employed in the power amplifier stages of FM transmitters . . . these air-cooled, high efficiency vacuum tubes assure long life, dependable performance and stable operation.

In focusing its vast tube-making experience on FM . . . Federal adheres to all the eminent standards it established and has maintained during more than three decades of contribution to the art.

For the finest in FM tubes . . . specify Federal . . . because "Federal always has made better tubes."

Federal Telephone and Radio Corporation

Export Distributor
International Standard Electric Corporation



Newark 1, N. J.

250 - W A T T F - M

— by **MORTON B. KAHN** and **S. L. SACK** —

President

Chief Engineer

Transmitter Equipment Manufacturing Co., Inc.

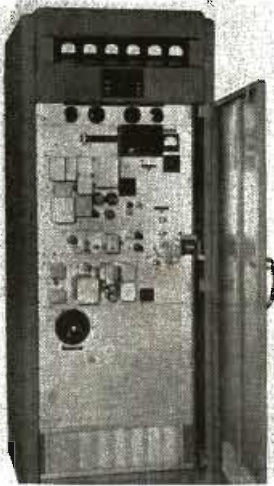

Figure 1
Exciter unit of 250-watt f-m transmitter.

IN the old f-m band of 42-50 mc, it was possible to use successfully design methods employed in standard band a-m broadcast transmitters. The tube types that were available permitted the use of lumped circuit constants. It was only when considerable powers were required that it became necessary to use linear circuit elements in the tank circuits. The moving of the f-m band to the 88 to 108-mc region has however necessitated the use of new techniques of design and construction to obtain efficient operation of all stages of the transmitter. The development of u-h-f miniature tubes during the war solved the problem of the tube types to be used for the oscillator and multiplier stages to raise the primary oscillator frequency to the desired carrier frequency. The use of these tubes permitted extremely compact design and the low inter-electrode capacities of these tubes reduced the severity of the shielding problems to a minimum.

Circuit Features

The primary oscillator of the exciter unit of this 250-watt u-h-f transmitter operates

within the 11 to 13.5-mc range. A multiplication of eight times is used to raise the oscillator frequency to the desired carrier frequency. The use of balanced modulators and a push-pull oscillator provides twice the f-m swing of the oscillator frequency that would normally be obtained with a single modulator. This permits the use of a multiplication factor of only eight to raise the oscillator frequency to the carrier frequency. It has the further advantage of eliminating distortion due to second order products.

Cathode currents of the 6AK5 modulator tubes in the exciter are balanced, and controls are provided for adjusting the value of the quadrature voltage fed back to each grid. The quadrature voltages fed to the grids of the modulator tubes are in phase. Thus if we connect the grids together and apply a modulating voltage of the same phase, the reactive currents, flowing through the push-pull oscillator tank coil as a result of the modulator plate currents, will be effectively zero. This affords a means of adjusting the cathode currents of the modulator and the values of the quadrature voltages fed to each grid so that no f-m modulation of the oscillator frequency occurs, with a modulating voltage being applied to the grids of the modulators. The balancing of the modulators can then be carried on at various input levels of modulating voltage, insuring operation of the modulator tubes on the same portion

of their G_m characteristic, which will result in symmetrical shift of the oscillator frequency around its center value. With modulating voltages of opposite phase being applied to the grids of each modulator tube, the reactive currents now flowing through the oscillator tank coil will be of the same sign and opposite phase so that the total net effect on the oscillator frequency will be effectively doubled.

The 6AK5 miniature pentode tubes were purposely selected as modulators due to their low inter-electrode capacities and comparatively low input and output capacities and because of the fact that they have relatively high transconductance. To insure stable modulator operation and to prevent relaxation types of oscillation that can develop in the modulators, it was necessary to shield the grid and plate circuits of each modulator tube carefully and to place each modulator in a separate can. The audio modulating voltage fed to the grids of the modulator tubes is carried through a 500-ohm line, across which is placed a series resistance inductance network having a high frequency pre-emphasis characteristic. The slope of the pre-emphasis curve may be adjusted by variation of the resistance arm of the network so that it will lie between the limits specified by the FCC. The audio voltage after pre-emphasis is fed through a 500-ohm pad to the grids of the modulator tubes. No correcting voltage, developed as a result of drift in the primary oscillator as compared to the standard crystal oscillator, is fed back to the grids of the modulator tubes for center frequency correction of the oscillator. Because of this, the modulators are always operating within the

Figure 2
Circuit of final amplifier.

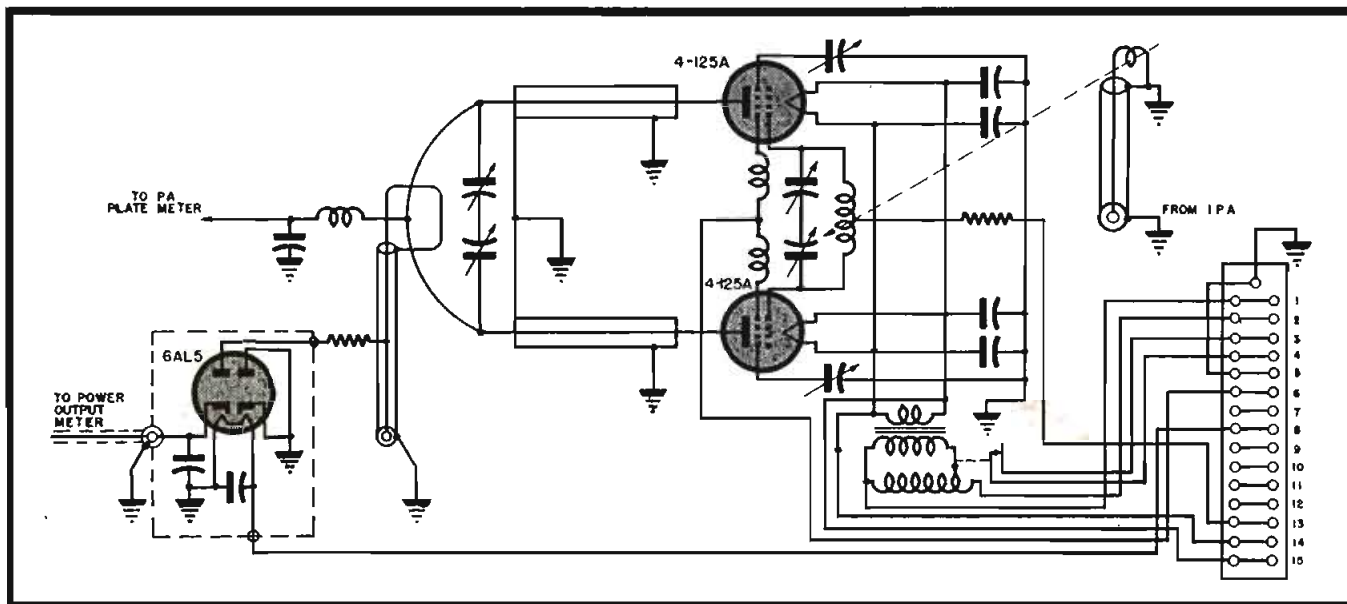

Designed for



Application



**THE 90800
"50 WATT"**

Transmitter-Exciter

Again in production is the No. 90800 transmitter-exciter unit. Based on an original Handbook design, this flexible unit is ideal for either low power amateur band transmitter use or as an exciter for higher power PA stages. Priced at only \$37.50; less tubes, but with coils for one band operation. Unless otherwise requested, coils furnished are for 10 meter output with 40 meter crystal. Tubes used are 807 and 6L6.

**JAMES MILLEN
MFG. CO., INC.**

MAIN OFFICE AND FACTORY
**MALDEN
MASSACHUSETTS**



V-H-F F-M TRANSMITTER

(Continued from page 45)

the region of 22-27 mc. To obtain considerable amounts of second harmonic voltages from the 807 plate tank circuit, it is necessary to use a large value of grid resistance in the 807 grid circuit, which in turn necessitates the development of considerable amounts of driving power from the 6J6 first doubler. To reduce the effects of the input capacity of the third doubler, the tank circuit of the 807 is link coupled to the grid of the third doubler. This circuit arrangement still permits the use of lumped constants in the 807 plate tank, in spite of the fact that the tank circuit operates in the frequency range of 44-54 mc. The 807 second doubler is capable of developing considerably more power than is required to drive the grid of the third doubler stage. A potentiometer is placed in the screen circuit of this tube so that the driving power delivered to the grid of the third doubler can be adjusted for optimum conditions. To insure stable operation of the 807 as a doubler in the region of 50 mc, it was necessary to isolate perfectly the grid and plate circuits and this was accomplished by placing each circuit in separate shields. The tank circuit of the 807 doubler is link coupled to the grid of the third doubler.

At the time this transmitter was designed, the only tubes that were available and capable of supplying 250 watts of output power in the frequency range of 88-108 mc were the Eimac tetrodes, type 4-125A. During this period, the data available indicated that the driving power required at the grids of the 4-125A's at 108 mc was approximately 9 watts. Since it is desirable from an operational standpoint and because of space considerations, it was decided to use the third doubler as the driver for the 4-125A's. To assure the development of sufficient power from this stage capable of supplying any transmission losses existing between its output tank circuit and the grid circuit of the 4-125A's, a 3D23 tetrode power amplifier was selected as the third doubler and driver for the final amplifier. To further assure the development of fairly large amounts of reserve driving power, a concentric line element was chosen as the tank circuit for the 3D23. Due to the relatively high power gain of this tube and to the fairly high frequencies involved, the problem of designing a stable doubler assumed proportions that do not exist at lower frequencies. To obtain stable operation, it is essential that no external coupling exist between the grid and plate circuits. To prevent this possibility, a concentric transmission line is used as the tank element with the outer conductor at both d-c and r-f ground potential. This method of construction effectively prevents any radiation from the tank circuit. Since, constructionally, it was necessary to have the 3D23 tank circuit on the front of the panel, this method of construction removes the possibility of accidental shock due to contact with this tank circuit. A 50-ohm concentric line connected to the 50-ohm point on the 3D23 tank and terminating in a small coupling loop couples the grid circuit of the final amplifier to the tank circuit of the driver.

In the final amplifier lumped constants are used in the grid circuits. In spite of the fact that the frequency of operation is relatively high, it was felt that with

**JONES 2400 SERIES
PLUGS and SOCKETS**



P-2406-CCT



S-2406-SB

A new series of Plugs and Sockets designed for highest electrical and mechanical efficiency. Improved Socket Contacts provide 4 individual flexing surfaces which make positive contact over practically their entire length.

The Contacts on both Plugs and Sockets are mounted in recessed pockets greatly increasing leakage distance, increasing voltage rating. Molded BM 120

Bakelite insulation. Plug and Socket contacts are silver plated. The finished appearance of this series will add considerably to your equipment.

The 2400 Series are interchangeable with all units of the corresponding No. 400 Series.

Send today for general catalog No. 14 listing and illustrating our complete line of Plugs, Sockets and Terminal Strips.

HOWARD B. JONES COMPANY
2460 W. GEORGE ST. CHICAGO 18

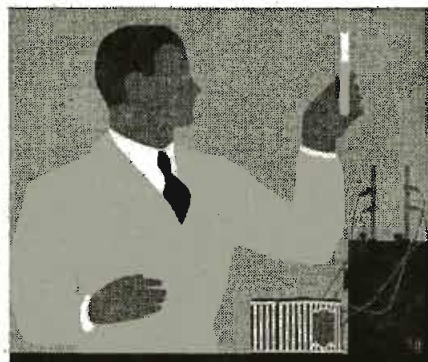

proper design of the circuit elements it was still possible to use lumped constants since the tubes are being used in push-pull and place only half their input capacity across the grid coil. The use of a coil and capacitor in the grid circuit simplified the construction problems considerably and, in spite of the fact that the grid losses might be relatively high, it was felt that sufficient amounts of reserve driving power were available to overcome all circuit losses and completely drive the 4-125A's to full output. Events justified this assumption. As a matter of fact, it is relatively easy to overdrive these tubes and it became necessary to insert a potentiometer in the screen of the 3D23 to control the drive to the final amplifier grids. To obtain high efficiencies out of the plate circuit of the final amplifier, concentric line elements are employed. The same reasons that dictated the use of concentric lines with the outer conductor grounded in the driver stage applies as well to the final amplifier. In spite of all precautions taken to prevent external coupling between plate and grid circuits, and in spite of the fact that special sockets were constructed which constituted the bypass capacitors for the screens and filaments of these tubes, it became necessary to neutralize the screen lead inductance of the 4-125A's. It was not possible to cross-neutralize in the conventional manner because the neutralizing leads themselves offered considerable inductance at these frequencies. It was necessary therefore to neutralize these tubes by placing variable capacitors from the screen pins to ground and series resonating the screen lead inductance effectively bringing the entire screen structure to r-f ground potential. Tuning of the lines is accomplished by placing a small capacitor at a point of low impedance across the lines. It is possible to use a capacitor with fairly close spacing because no d-c potential exists across it and because the capacitor is placed at a point of low r-f potential. The output power from the final amplifier tank circuit is taken off by means of an adjustable coupling link terminating in a 50-ohm line, which is connected to the output connector at the top of the cabinet. A relative measure of the output power of the final amplifier tank circuit is obtained by the use of a diode rectifier connected at the junction of the 50-ohm concentric line and the output connector. The type 6AL5 diode is used as a rectifier which in turn supplies d-c to the output indicator. If the line is properly terminated, it is possible to use the indicator as a direct measure of output power since it was so designed to have an expanded scale over a narrow range of output power.

One of the major problems encountered in the use of direct frequency modulation of the primary oscillator is the attaining of consistent, stable, center frequency control of that oscillator. The methods employed in this transmitter depart somewhat from the conventional methods normally used, in order to overcome the difficulties that exist with conventional methods. The primary object in any center frequency stabilization control system is to make the reference crystal the sole frequency determining element. It was therefore necessary to devise methods that would make all other circuit elements of the system non-critical. It is a

(Continued on page 53)

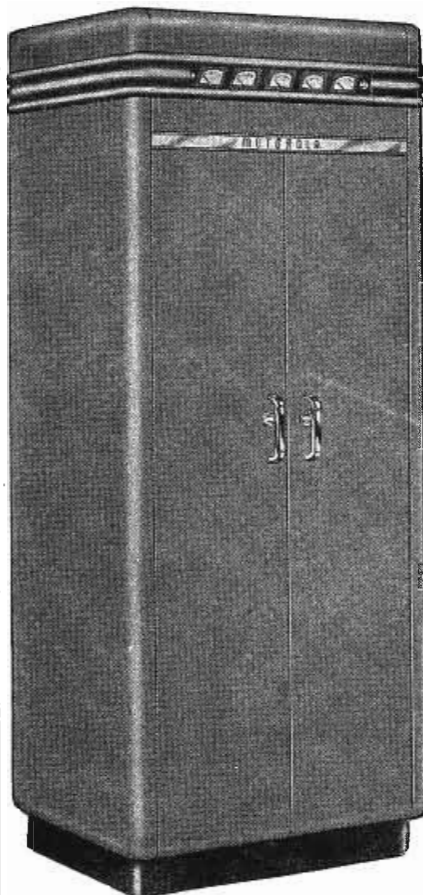

Illustrated is Motorola's newest contribution to this field—the Model FSTRU-250-BR 250-watt Central Station Transmitter-Receiver Unit, designed for the newly-established 152-162 mc. band.

Motorola
uses
ANDREW
COAXIAL CABLE

That all Motorola Police and Public Utility equipment uses ANDREW Coaxial Cable is indicative of Motorola's confidence in ANDREW engineering and manufacturing skill. The ANDREW Company is a pioneer in the manufacture of coaxial cable and accessories.

POLICE USE *Motorola*

Eighty percent of all FM Police radio equipment in use today is Motorola. This includes a roster of 35 state police systems and many thousands of city and county systems throughout the United States.

ANDREW CO.

363 EAST 75th STREET
CHICAGO 19, ILLINOIS

WRITE FOR
ANDREW CATALOGUE
TODAY



VETERAN WIRELESS OPERATORS ASSOCIATION NEWS

W. J. McGONIGLE, President

RCA BUILDING, 30 Rockefeller Plaza, New York, N. Y.

GEORGE H. CLARK, Secretary

21st Annual Dinner-Cruise

A MARCONI Memorial Service Award Plaque was presented to the Institute of Radio Engineers at the annual dinner-cruise in New York City. The plaque was awarded to the engineers, in significance of their conspicuous contributions to the successful prosecution of World War II.

Other awards included a Memorial Medal of Service to Major General Harry C. Ingles, Chief Signal Officer of the Army in recognition of his pioneering achievements in radio and successful leadership of the Signal Corps during World War II . . . Marconi Memorial Medal of Service to Rear Admiral Joseph R. Redman, former Director of Naval Communications, in recognition of his contributions to radio in Navy circles . . . Marconi Memorial Medal of Service to Major General H. M. McClelland, Air Communications Officer of the Army Air Forces, for the splendid part he played in setting up a world wide AAF communications system . . . Marconi Memorial Medal of Service to Commodore E. M. Webster, Chief Communications Officer of the United States Coast Guard, for his early pioneering and progressive contributions to the success of Coast Guard operations through radio communications during World War II . . . Marconi Memorial Commemorative Medal to Sgt. Irving Strobing, Army radio operator, who sent the last message from Corregidor . . . Marconi Memorial Medal of Valor to Sgt. Forrest Vosler, Congressional Medal of Honor winner for his heroic services aboard a B-17 Flying Fortress over the English Channel . . . Scroll of Appreciation to E. J. Girard of the Federal Telephone and Radio Corporation, for his outstanding contributions to the simplification and coordination of marine radio installations during the Liberty and Victory ship construction campaign . . . Scroll of Appreciation to A. J. Costigan in recognition of his outstanding contributions to the success of international radio conferences during the past quarter century . . . Scroll of Appreciation to Robert V.



E. J. Girard, assistant vice president of FTR, who received a VWOA Scroll of Appreciation at the annual dinner-cruise in N. Y. City.

Howley, president of Tropical Radio Telegraph Company, in recognition of his conspicuous achievements in the field of Pan-American Telecommunications.

Guests of Honor

Among the guests of honor were: General David Sarnoff, VWOA first life member and president of the Radio Corporation of America, who presented the Marconi awards to General Ingles and General McClelland during the NBC broadcast. . . . George P. Adair, FCC chief engineer . . . Major General Frank E. Stoner, Assistant Chief Signal Officer of the Army, who accepted the Marconi award for Gen. McClelland . . . Admiral Joseph F. Farley, Commandant of the United States Coast Guard . . . J. R. Poppele, vice president of WOR and TBA president . . . Major General Ingles, Chief Signal Officer of the Army . . . George H. Clark, who received an ovation for his magnificent contributions to radio for his grand work for VWOA, George will retire now after years of outstanding service . . . Col. Thompson H. Mitchell, executive vice president of RCA Communications . . . George W. Bailey, president of the American Radio Relay League . . . Dr. F. B. Llewellyn, IRE presi-

dent . . . Wm. C. Simon, VWOA treasurer and executive secretary . . . Captain C. W. Horn, U.S.N.R., pioneer in wireless and more recently active in the office of the Director of Naval Communications . . . Haraden Pratt, vice president and chief engineer of Mackay Radio and Telegraph Company and life member of VWOA . . . Captain Pierré H. Boucheron, life member of VWOA and director of public relations of Farnsworth . . . John V. L. Hogan . . . Arthur H. Lynch . . . Pete Podell . . . and E. H. Rietzke.

Door Prizes

D OOR prize exhibits donated included a National Company 240 C receiver presented through the courtesy of William A. Ready, president of the National Company; and a Hallicrafters communications receiver presented through the courtesy of life member 'Bill' Halligan, president of Hallicrafters.

Personals

I T is a genuine pleasure to welcome 25-year veteran wirelessman Robert Parker Herzig, Radioman First Class, U. S. Navy, who has served aboard the George Washington, Manoa, and Pelican the Yacht Invader. He has also seen service at Red Salmon, Alaska. A commendable record. . . . Chief Radioman Clarence R. Spicer of the Navy during World War I. He was then a member of the communications staffs of the USS Yorktown and Oklahoma, Navy Radio San Francisco, Navy Radio Dutch Harbor, Alaska and Guam, Naval Air Service at Pensacola, Florida, and at the Farallone Islands D/F station . . . We were delighted to receive acknowledgment of the receipt of honorary membership certificate from Admiral Luke McNamee, president of Mackay Radio. We are proud to include him among our illustrious honorary members.

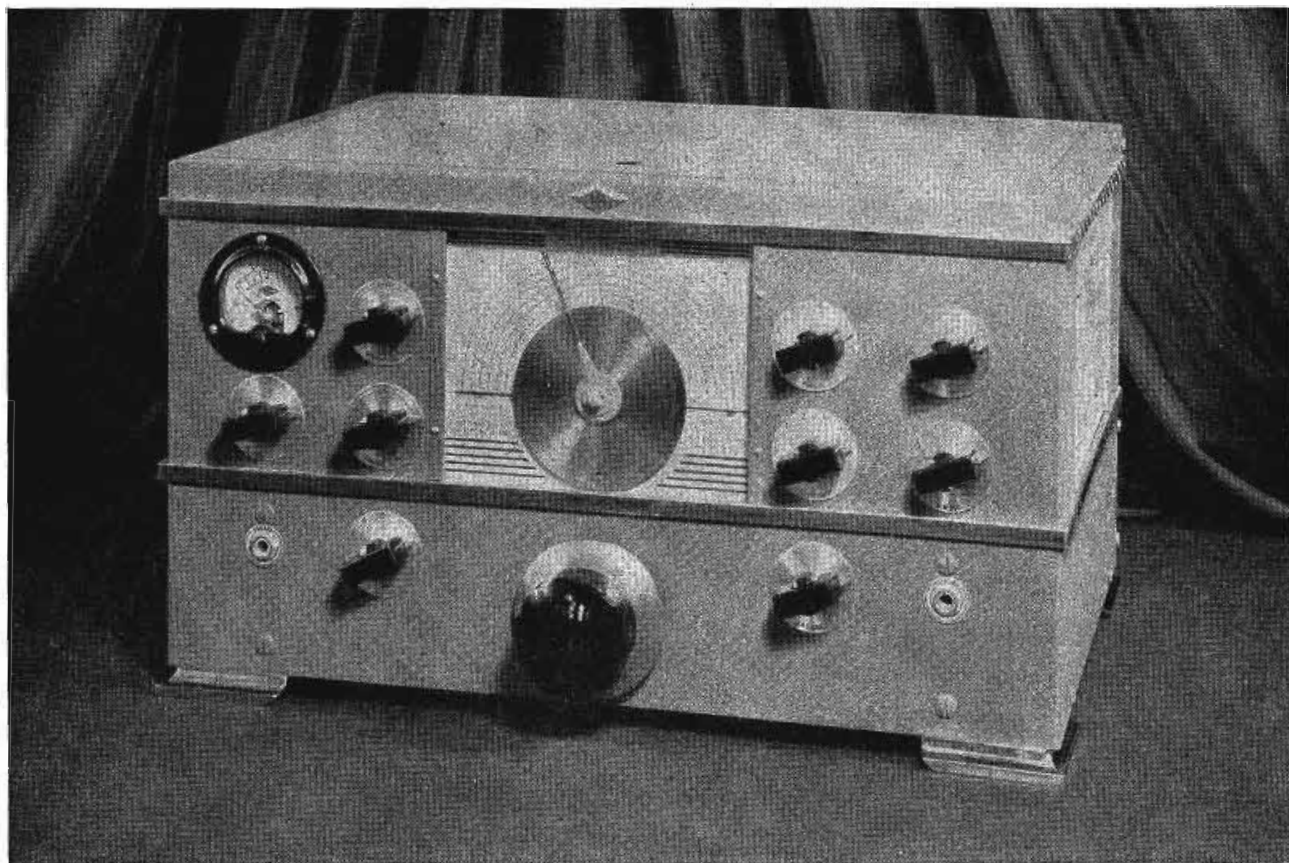

THE NC-2-40C

This superb new receiver reflects National's intensive receiver research during the war period. Many of the NC-2-40C's basic design features stem from the NC-200, but to them have been added circuit and construction details that set it apart as a performer. Stability and sensitivity are outstanding. A wide range crystal filter gives optimum selectivity under all conditions. The series-valve noise limiter, the AVC, beat oscillator, tone control and S-meter are among the many auxiliary circuits that contribute toward the all-around excellence of the NC-2-40C. See it at your dealer's.



NATIONAL COMPANY, INC.

MALDEN, MASSACHUSETTS, U.S.A.

MALDEN
MELROSE
★★★★

ELECTROACOUSTIC LABORATORY AT HARVARD UNIVERSITY

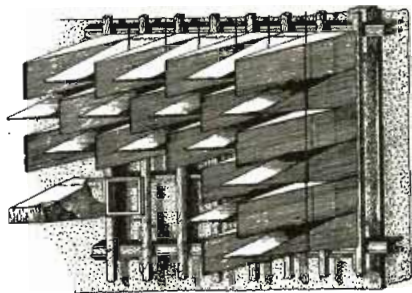

Wedge-shaped fibrous-glass structures that lined the wall of a sound room built in the Cruft Building of Harvard University during the war for NDRC research. There were 20,000 of these wedges in the room, known as the *anechoic chamber* (without echo).

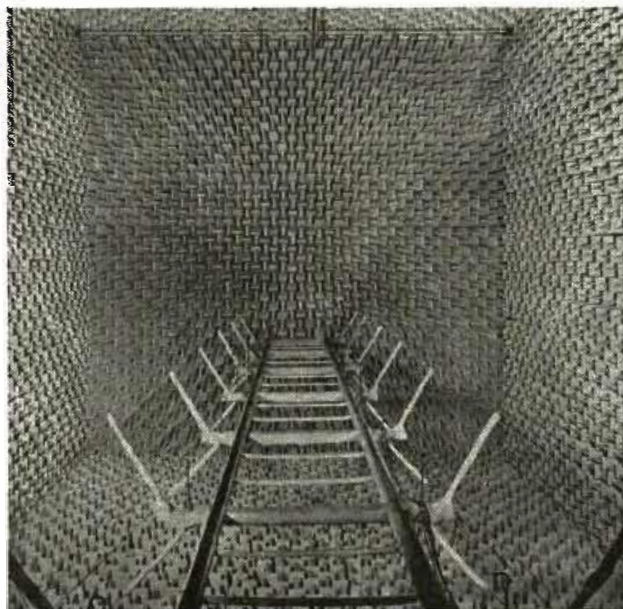

Above, a view of the echo-free chamber that was built to simulate atmospheric conditions existing at 1,000' to 3,000' above earth. The walls are almost perfectly absorbing; less than 1/1,000 of the sound that strikes a wall is reflected. The room was developed under the supervision of Dr. Leo L. Beranek, as head of the electroacoustic laboratory. H. P. Sleeper, Jr., was co-inventor of the room. The room has been used to study loudspeakers, microphones, and headphones. It is equally good at frequencies between 70 and 20,000 cps. Density of the fibrous glass material and the dimensions must be critically determined once the lowest frequency at which 99% or better absorption is decided upon.

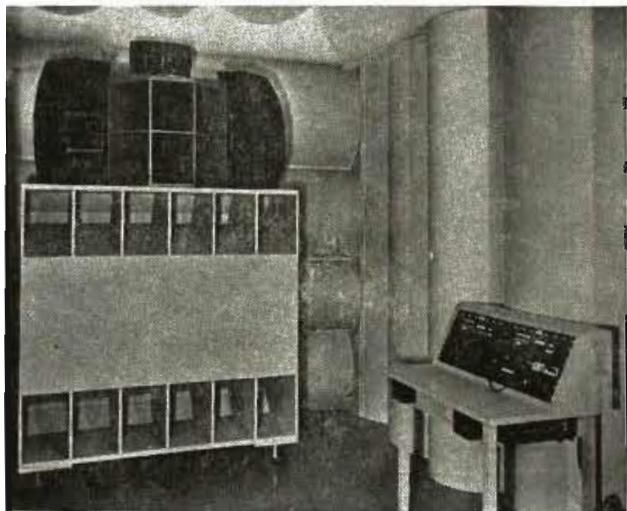

Room at left shows a diffuse room where noises heard during plane flight were reproduced to test microphones, amplifiers and headsets. Battery of loudspeakers produced sounds which were reflected at random from the cylinders.

HIGH-FREQUENCY DIRECTION FINDERS

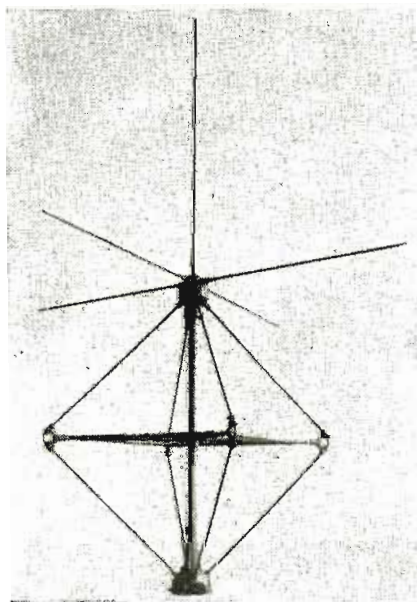

Typical land antenna used in FTR 1.5 to 30-mc direction finder developed during the war for submarine search. Has 5 collapsible masts, four of which form a square about 25' on a side; two diagonally opposite pair provide two directional antennas. Center mast provides a means of determining sense to avoid 180° ambiguity.

Control equipment of a semi-portable FTR h-f direction finder. Uses a horizontal U-line transmission line system. Overall d-f frequency range is 2 to 10 mc. Receiver has a 1.5 to 30 mc 4-band range.

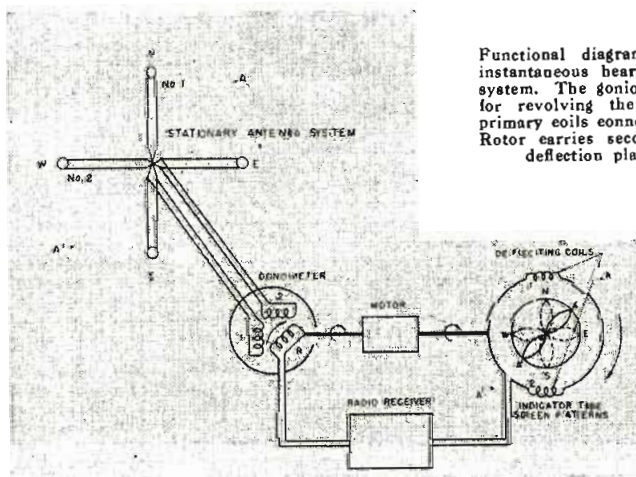
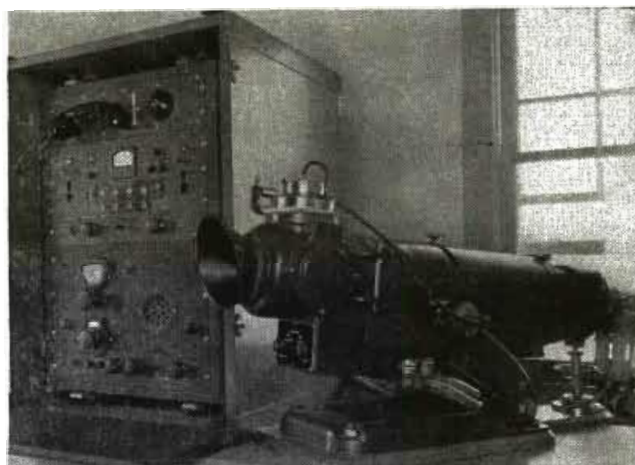

Functional diagram of goniometer circuit and instantaneous bearing indicator used in h-f d-f system. The goniometer eliminates the necessity for revolving the antenna. Stator holds four primary coils connected to two pairs of antennas. Rotor carries secondary coils connected to the deflection plates of a c-r oscillograph.

Special c-r oscillograph operates in conjunction with mirrors and provides a 360° scale on the periphery. Received signal shows up as a twin-leaf pattern. Extremities point toward bearing of transmission and its diametric opposite.

THREE DESIGNS

to Meet Your Installation Requirements

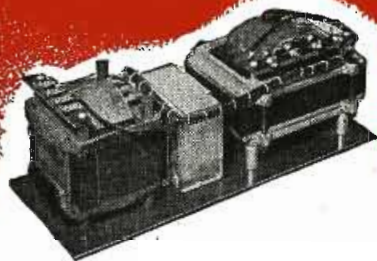
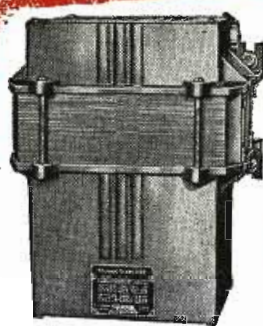

Raytheon Voltage Stabilizers

**CONTROL FLUCTUATING
POWER SUPPLY TO $\pm 1/2\%$**

One of these three Raytheon Voltage Stabilizer models can do a great job in improving *accuracy* and *reliability* of your electrical equipment...if varying line voltage causes uneven performance.

Smooth out your input troubles. Eliminate power fluctuation. The cost is low. The improvement is often great. And one of these three models will meet your need.

Write today for the complete story—and determine how your own equipment can benefit. Send for our illustrated Bulletin DL 48-537.

**Get these principal
operating advantages:**

- Control of output voltage to within $\pm 1/2\%$ of 115 or 230 V.
- Stabilization at any load within rated capacities.
- Quick response. Stabilizes varying input voltage within 1/20 second.
- Entirely automatic. No adjustments. No moving parts. No maintenance.



JUST PUBLISHED!

The Most Indispensable Reference in Radio-Electronics!

Electronic Engineering Master Index

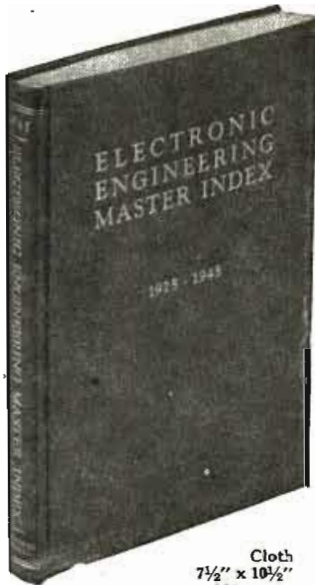

A master compilation of over 15,000 titles, articles and texts selected for their value to the research engineer, this INDEX covers the years 1925-1945 and enables you to survey twenty years of research literature on any subject in a matter of minutes!

Vitally Needed in Every Laboratory and Library
COMPLETE IN ONE VOLUME

PART I
January 1925 to
December 1934

PART II
January 1935 to
June 1945



PARTIAL LIST OF PERIODICALS INDEXED:

Bell Laboratories Record	Jour. of Applied Physics
Bell System Technical Journal	Journal of I.E.E.
Communications	General Electric Review
Electrical Communication	Physical Review
Electronics	Proceedings I.R.E.
Electrical Engineering	Transactions of A.I.E.E.
Electronic Industries	Radio News
	R.C.A. Review
	Wireless Engineer

Cloth
7 1/2" x 10 1/2"
320 pages

A \$500 Reference Library in One Volume for \$17.50

Descriptive circular on request.

ELECTRONICS RESEARCH PUBLISHING COMPANY

2 West 46th Street

New York 17, N. Y.

NEWS BRIEFS

PROGRAM FOR THE SIXTH ANNUAL BROADCAST ENGINEERING CONFERENCE

[Sponsored by the Dept. of E. E. of Ohio State University and the University of Illinois with the cooperation of NAB and IRE]

Campbell Hall Auditorium
Ohio State University
Columbus, Ohio

March 18 to 23, 1946

MONDAY, MARCH 18

9:00 A.M. Contributions of War Developments to Broadcasting; A. B. Chamberlain, chief engineer, CBS

11:00 A.M. Symposium on Broadcast Maintenance Problems; A. J. Ebel, chief engineer, University of Illinois Radio Service, Chairman

2:30 P.M. Design of Broadcast Studios With Irregular Boundary Surfaces

TUESDAY, MARCH 19

9:00 A.M. Antenna Patterns and the Antenna Analyzer; George H. Brown, research engineer, RCA

11:00 A.M. Symposium on Recording Techniques; Lynn Smeby, Associate Director, Operational Research Staff, Office of the Chief Signal Officer, U. S. War Department

2:30 P.M. General Acoustical Problems in Broadcasting; E. J. Content, WOR

WEDNESDAY, MARCH 20

9:00 A.M. Symposium of V-H-F Antenna and Coupling Circuits; E. C. Jordan, Dept. of Electrical Engineering, University of Illinois, Chairman

11:00 A.M. Symposium on Television Station Operation; Robert E. Shelby, NBC, Chairman

2:30 P.M. Radio Relays for F-M and Television

THURSDAY, MARCH 21

9:00 A.M. Stratovision; Ralph Harmon, Westinghouse Electric Corporation and representatives from Glenn L. Martin Aircraft Co.

11:00 A.M. Round Table and Question Box; A. D. Ring, Chairman; John Willoughby, assistant chief engineer, Federal Communications Commission, in charge of broadcasting; also representative chief engineers from broadcasting stations

2:30 P.M. Interconnecting Facilities for F-M and Television Broadcasting; H. I. Romnes and W. E. Bloecker, American Telephone and Telegraph Company

6:30 P.M. Banquet, Fort Hayes Hotel

FRIDAY, MARCH 22

9:00 A.M. High Powered Tubes for V-H-F Operation; W. W. Salisbury, Collins Radio Company

11:00 A.M. Symposium on F-M Operating Problems; Phillip B. Laeser, Milwaukee Journal Company, Chairman

2:30 P.M. Symposium on F-M Monitors; R. C. Higgy, director, WOSU, Ohio State University, Chairman; D. B. Sinclair, General Radio Company; Frank Gunther, Radio Engineering Laboratories; H. R. Summerhayes, Jr., General Electric Company

SATURDAY, MARCH 23

9:00 A.M. Symposium on F-M Modulation Methods; W. L. Everitt, Head, Department of Electrical Engineering, University of Illinois, Chairman

11:00 A.M. Symposium on Field Experiences in V-H-F Propagation; Raymond M. Willette, Chairman

(Continued on page 67)

Toroids..

by

DX

Doughnut Coils for electronic and telephone purposes. High Permeability Cores are hydrogen annealed and heat treated by a special process developed by DX engineers. Send us your "specs" today—ample production facilities for immediate delivery.

DX RADIO PRODUCTS CO.
GENERAL OFFICES 1200 N. CLAREMONT AVE., CHICAGO 22, ILL., U.S.A.

DX COILS
"the heart of a good receiver"

V-H-F F-M TRANSMITTER

(Continued from page 47)

well-known fact that when two carriers differ in frequency by a relatively small amount, one carrier can be considered as phase modulating the other carrier. The amount of phase modulation of either carrier is determined by the relative amplitudes of the two carriers and the value of the beat difference between them. Advantage was taken of this fact. The output of the primary oscillator and the standard crystal oscillator are fed to two mixer stages. The a-m audio component is obtained from one mixer stage while the other mixer stage is fed through limiters, then to a discriminator from which the f-m audio is recovered. The a-m and f-m audio is then fed to a phase detector. The phase of the f-m audio in relation to the a-m audio is dependent upon the sign of the beat difference between the standard crystal oscillator carrier used as a reference and the primary oscillator carrier. The level of the d-c output voltage from the phase detector is a direct function of the beat difference between the two carriers and the sign of that voltage is a function of the sign of the beat between the carriers. The output voltage from the phase detector is then passed through a d-c amplifier, which in turn controls the grids of a pair of thyratron tubes. The output circuit of the thyratrons provides the a-c voltage of the proper phase to operate a two-phase motor which in turn is mechanically coupled to the primary oscillator tuning capacitor. The d-c output voltage from the phase detector is used as a measure of the beat difference between the two carriers. Thus, placing a zero center d-c voltmeter having a high internal resistance across the output of the phase detector provides a direct indication of the primary oscillator frequency in cycles, with respect to the standard crystal oscillator frequency, and indicates as well the sign of that difference.

Frequency stability of the transmitter is ± 1500 cycles or better of assigned center frequency. Audio input for 100% modulation is +16 vu (+5 db at a reference level of 12.5 mw across 500 ohms). Audio input, average program level is +10 vu (-1 db). Audio frequency response is ± 1 db 30-16,000 cycles (after de-emphasis). Pre-emphasis of the higher frequencies is obtained through a series inductance-resistance circuit having a time constant of 75 micro-seconds and a frequency characteristic within $1 \pm$ db of the normal curve for that circuit.

COMPONENT CHECK BOOTH

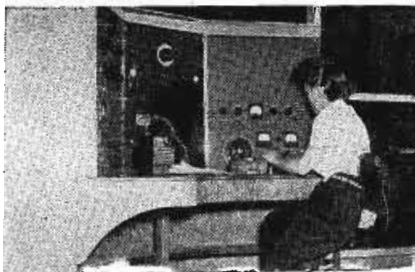

One of four component inspection booths at Aireon Mfg. Corp. in Kansas City, Kan. Booths are designed to provide a specific set of voltages and meters for a particular group of components. Console with its allied equipment was designed and built by Kenneth Orton, chief inspector, and Ray O'Neal, technical inspector.

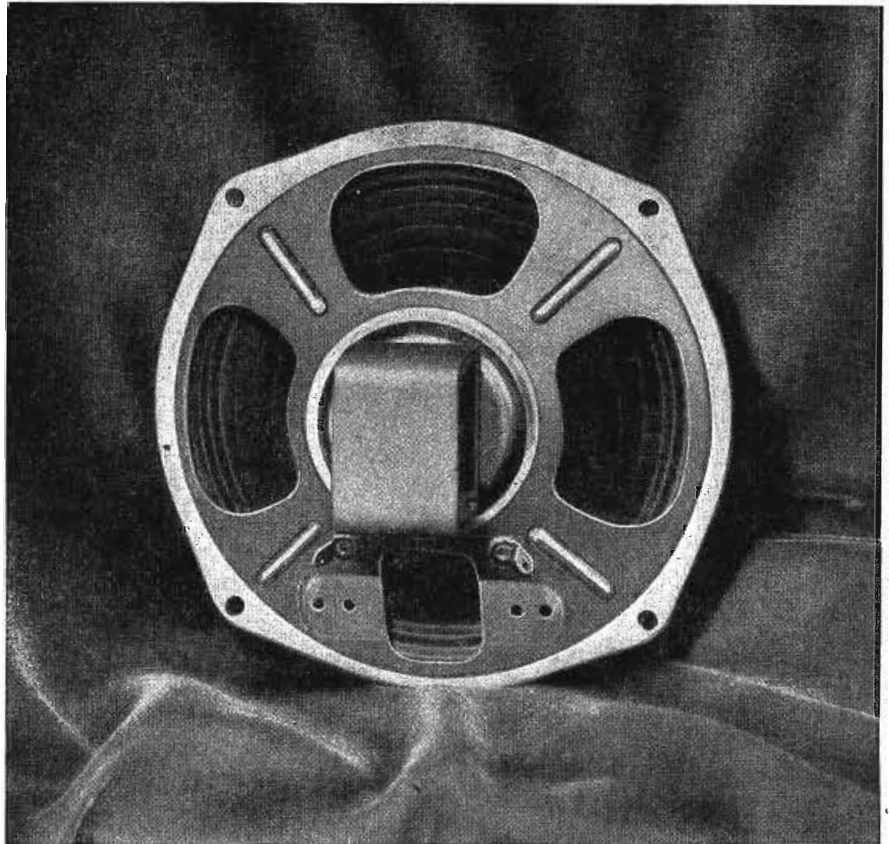

Maximum Performance with Minimum Magnet Weight!

Permoflux, with less than a 1½ ounce Alnico Five magnet weight, now achieves performance in permanent magnet dynamic speakers up to 6" obtainable only before by using a much *heavier* Alnico Five magnet.

Like other Permoflux developments that have so notably demonstrated their superiority, this new speaker design is destined to become an engineering standard wherever lightness of weight and efficient acoustical performance are important considerations.

We invite you to consider the advantages of this outstanding new Permoflux speaker development as applied to your own products.

BUY MORE VICTORY BONDS!

TRADE MARK
PERM-FLUX
PERMOFLUX CORPORATION
4900 WEST GRAND AVE., CHICAGO 39, ILL.



PIONEER MANUFACTURERS OF PERMANENT MAGNET DYNAMIC TRANSDUCERS

STANDS UP IN HARD SERVICE



IT'S
ENGINEERED WITH
HI-Q
COMPONENTS

Every engineer knows that failure starts with the little parts. That's why more and more development engineers place their dependence on Hi-Q Ceramic Capacitors, Wire Wound Resistors and Choke Coils. They know through their own actual tests, that Hi-Q Components stand up under every condition of temperature, humidity, vibration and shock. Test these sturdy components in your own applications. Send your specifications for samples and complete data.



CERAMIC CAPACITORS

Made of titanium dioxide (for temperature compensating types). Tested for physical dimension, temperature coefficients, power factor and dielectric strength.



WIRE WOUND RESISTORS

Immediately available in standard ratings or precision built to any tolerance or value.



CHOKE COILS

Sturdy Construction. Insulated or bare types. Quantity production available at once.

**ELECTRICAL REACTANCE
CORPORATION**
FRANKLINVILLE, N. Y.

INTERMODULATION TESTS

(Continued from page 17)

damping of the speaker depends to a degree upon the load impedance of the amplifier.

It has been common practice in the past to adjust the amplifier output impedance to a value which is much lower than the normal rated impedance of the loudspeaker. In the case of triode operation the amplifier internal output impedance has been approximately one-third the impedance of the speaker. In the case of beam power tubes it has been the practice to make the output impedance so low that it may be considered the equivalent of a constant voltage generator.

With the current introduction of high quality loudspeakers, which have higher efficiency due to improvements in magnetic circuits and voice coil construction, these conditions no longer prevail. These new loudspeakers have sufficient internal damping. Thus for optimum operation the impedance of the amplifier should be equal to the impedance of the loudspeaker. This new requirement modifies the amount of feedback that can be used since the feedback voltage determines the internal output impedance of the amplifier.

It is, therefore, necessary in future design to use only sufficient feedback to reduce the amplifier impedance to match the loudspeaker impedance where high quality performance is to be obtained.

Test Results

As a result of these tests we learned that:

- (1) Beam power tubes can deliver the same audio power as triodes with the same or less distortion.
- (2) A high overall power efficiency can be obtained using relatively low plate voltages and inexpensive tubes.
- (3) The circuit of the beam power tubes need not be complicated.
- (4) The signal-to-noise ratio is improved, since indirect heater cathodes are used on the beam tubes.
- (5) Intermodulation method of testing compares favorably with the listening tests.
- (6) Excellent output transformers are required.

¹J. K. Hilliard, *Distortion Tests by the Intermodulation Method*, I.R.E.; December, 1941.
²Motion Picture Sound Engineering, pp. 97-115. D. Van Nostrand Company, Inc.

PREMAX

Antennas for Commercial and Ship-to-Shore Uses



—Pan-American World Airways

Premax Products

Division Chisholm-Ryder Co., Inc.
4610 Highland Avenue, Niagara Falls, N. Y.

MOBILE RADIOTELETYPE

(Continued from page 37)

edges served to screen the antennas from each other.

Teletypewriter communication can be maintained with the car at all times. By patching through the War Department's station, WAR, in the Pentagon, the coach may be connected with similar systems anywhere in the world. The train has been in communication with Guam; Frankfurt, Germany; and Washington, while speeding along at 60 miles an hour.

System Components

The teletypewriter and associated equipment of the AN/MRC-2 consists of three components: Frequency shift exciter, dual diversity converter, and control unit. The frequency-shift exciter contains a master oscillator continuously tunable from 2 to 6 mc and has adequate driving power to permit multiplying in the low stages of the transmitter to an output frequency as high as 18 mc. Frequency-shift keying is accomplished in the exciter unit electronically by d-c signals, which are transmitted from the teletype shelter over field wire. An audio monitoring circuit is incorporated in the exciter unit to permit checking the amount of

frequency shift of transmitter output carrier.

The dual-diversity-converter unit operates from the i-f outputs of the two receivers which permit dual space diversity reception. The converter unit provides limiting over a wide range, instantaneous diversity action, and conversion of radio signals to polarized or neutral d-c pulses. Detection or conversion of the radio signals to d-c pulses is accomplished on an f-m discriminator principle, thereby permitting operation with frequency shifts of 200 to 1,000 cycles.

Bandwidth Filters

Either of two band-width filters may be used. One filter gives a band width of 1,500 cycles; the other, a width of 3,000 cycles. The dual-diversity converter is installed adjacent to the receivers. The neutral d-c pulses operate a monitoring teletypewriter. Polarized d-c pulses may be transmitted over a wire line up to a distance of 10 miles, terminating in the control unit.

Repeater Uses

The control unit is installed in the vicinity of the teletype machines and performs the functions of a repeater. It also provides the necessary control of transmitter and receivers for full duplex, half duplex, and one-way reversible operation of the system.

Shelters

The transmitting shelter is basically the same shelter as that used by SCR-399, with one receiver removed, and the frequency-shift exciter and 2-kw power amplifier added. Contained within the receiving shelter are three radio receivers, dual diversity converter, monitoring teletypewriter, a field telephone, and running spares for the receivers and other equipment. Two of the receivers are normally connected into the dual diversity converter. The third receiver is provided as a means of monitoring or guarding a channel other than the operating channel, and in an emergency it can be utilized as a spare receiver for the teletype circuit.

Other Uses of System

Although the system is primarily intended to provide teletype communication, the original operational features of the SCR-399 may be restored by disconnecting the 2-kilowatt power

(Continued on page 74)

Sensitive to a Pin Drop Yet Tough as a Bull



Turner 211 Dynamic BROADCAST TYPE

- Faithfully Reproduces All Gradations of Tone and Volume with Lifelike Clarity
- Designed for Critical Applications including FM Transmissions

Put this precision-built TURNER 211 Dynamic to the toughest performance tests you can give a microphone. Use it indoors or out under the most difficult acoustic and climatic conditions. It's built to take rough handling and perform like a veteran.

Engineered for Highest Quality recording, P.A., sound system and broadcast work (including FM), the TURNER 211 utilizes a new type magnet structure and acoustic network. The high frequency range is extended and the extreme lows raised 2 to 4 decibels. A unique diaphragm structure design results in extremely low harmonic and phase distortion without sacrifice of high output level. It has a range of 30-10,000 cycles with a very smooth response. Finished in rich chrome, the TURNER 211 Dynamic is equipped with tilting head for semi- or non-directional operation, balanced line output connection, and 20-ft. removable cable set.

Ask Your Distributor or Write

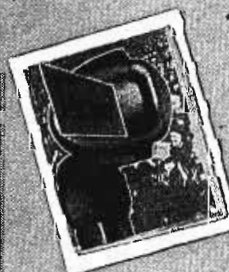

FREE Catalog

Write for complete catalog describing dependable, precision-built TURNER Microphones for all communications purposes.

The TURNER Co.

907 17th Street, N. E., Cedar Rapids, Iowa

Pioneers in the Communications Field



TURNER Microphones

CERTIFIED PERFORMANCE

Crystals Licensed Under Patents of the Brush Development Co.

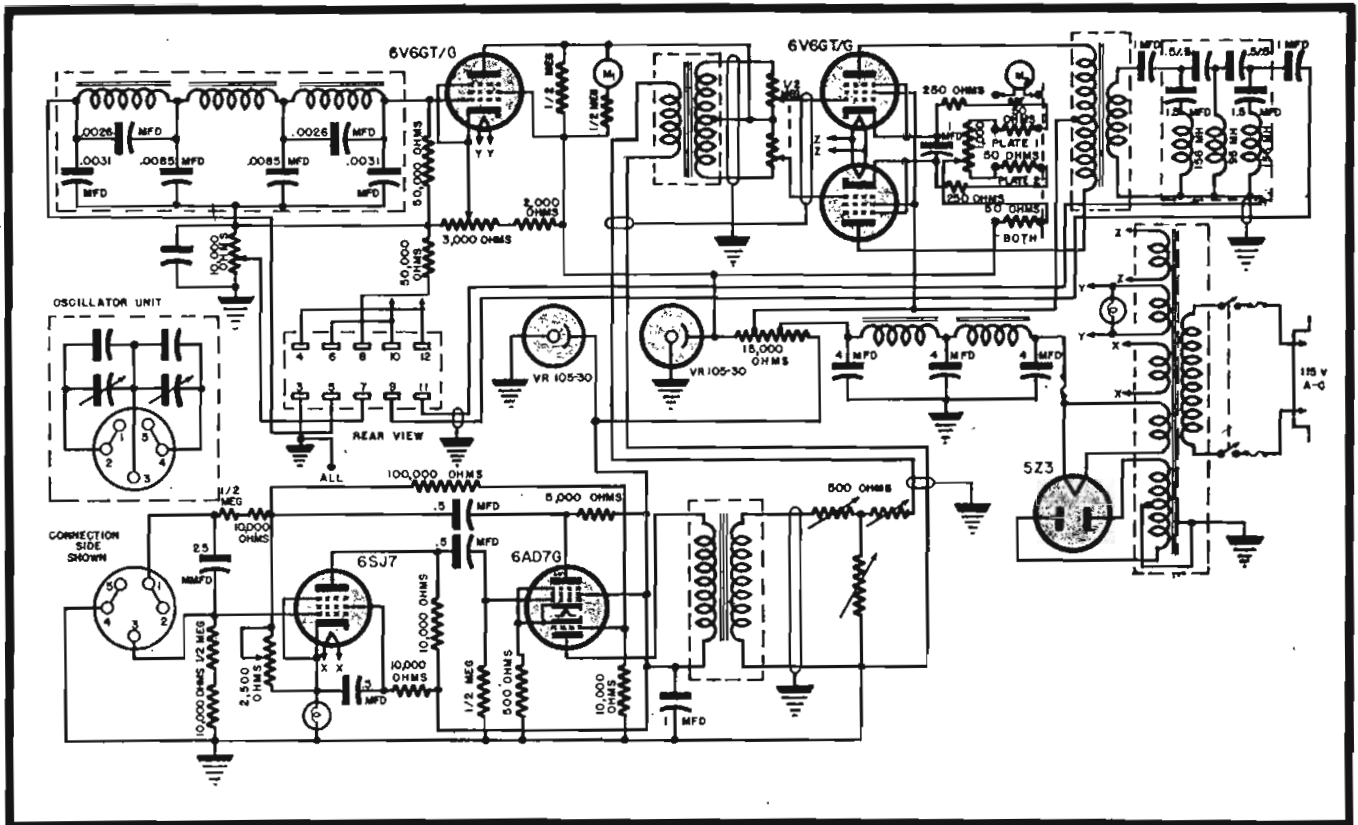

CAA ALASKAN DIVERSITY

TIME constant control is desirable wherever interrupted d-c is found; avc and c-o-n-s circuits in the receivers, the avc and bias circuits in the signal rectifier, and the v-t keyer circuits. In all cases the d-c variations are caused by the signal input to the receiver, whether it is noise or the desired keyed signal.

In general the time constant is dictated by the lowest speed of transmission and by the rapid fades. The time constant must be short enough to follow a rapid fade, and long enough to handle low-speed transmissions. A satisfactory compromise has been reached in this system, providing 5 to 250 wpm recording.

AVC Bias Bus

In the signal-rectifier avc bias bus, suitable resistors and capacitors chosen

to provide the application of a 35-volt signal to the input of the signal rectifier that results in a steady value of rectified grid bias between the limits of 0.05 and 0.25 second; and the removal of a 35-volt signal from the input of the signal rectifier to permit restoration of normal fixed bias at the rectifier between the 0.1 and 0.5 second.

Keyed D-C

The d-c output of the signal rectifiers, keyed by the received signal, is available at terminals 3 and 5, Figure 7. (See page 58.) The keyed d-c is then fed via terminals 3 and 5, Figure 10,

to the v-t keyer through the a-f filter.

The audio tone output of any receiver channel may be monitored by connecting headphones to jacks.

Some communications stations operated by the CAA have more than one diversity system in operation at the same time, since it is necessary to receive and record simultaneous transmissions of different traffic at these stations. Since telephone-line transmission of the signals between receiver and recorder is often necessary the same telephone line is used to carry more than one received signal. If each diversity system keys a different fre-

Figures 11 (below) and 12 (left)

Figure 11. Front view of the speaker amplifier unit. Two 6" p-m speakers are used. Controls permit adjustment of the input level and the monitor line level. Figure 12. Rear view of the speaker amplifier unit showing the two speakers, power supply, input and output components and terminal strip.

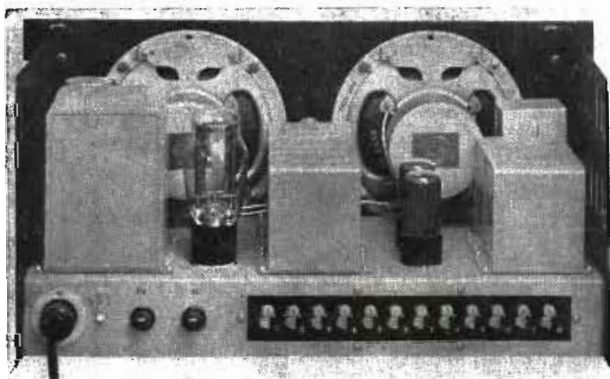

Figures 10 (left) and 13 (right)

Figure 10 (left). Schematic of the keyer oscillator unit. A Wien bridge type of adjustable frequency a-f oscillator generates the keyed tone. The keyer tube is a 6V6GT whose grid is fed through a low-pass filter. The keyer controls the bias of the balanced amplifier tubes, thereby making the amplifier operative and inoperative according to the received signals. Figure 13. Schematic of the speaker amplifier. Note the relays provided for remote control of the two speakers in the unit.

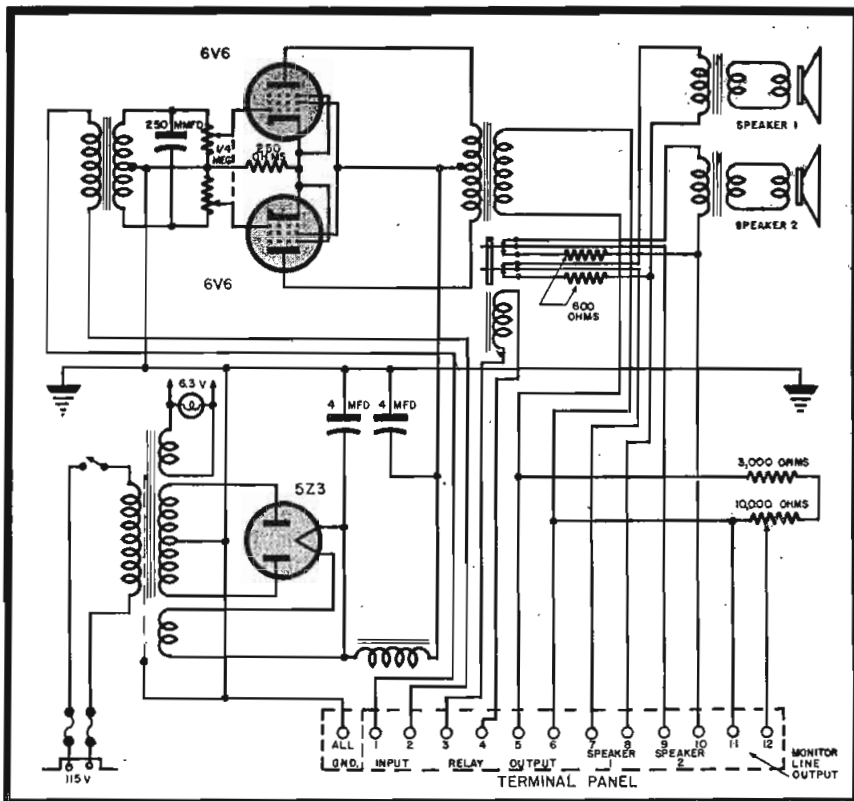

RECEIVING SYSTEM

quency tone oscillator, each keyed tone can be transmitted over the same transmission line and separated at the other end with correct band pass filters.

To insure dependable accuracy of signal separation and recording, stable and constant tones must be transmitted over land lines. Therefore a local oscillator having great stability is keyed by the received signals and transmitted to the recorder.

Constant Frequency A-F Oscillator

In this *diversity* system one group of eight channels keys a constant frequency a-f oscillator. The keyed a-f is generated by a Wien bridge type of oscillator employing a 6SJ7 and the pentode section of a 6AD7G. The triode section of the 6AD7G is used as a buffer amplifier feeding the push-pull 6V6GTs in the oscillator amplifier stage, Figure 10.

The waveform of the Wien-bridge oscillator is good and its frequency stability is excellent. Frequency tolerance is $\pm .2\%$ over the ambient temperatures of -10°C to $+50^{\circ}\text{C}$.

The range of the Wien-bridge oscillator may be varied from 600 to 2300 cps. Plug-in units having small range variable capacitors allow for frequency adjustments.

If the push-pull 6V6GTs in the os-

illator amplifier are unbalanced transients may be developed in the process of keying the a-f tone. Key clicks or thumps are the result. A 1000-ohm resistor allows for the balancing of the plate current in each 6V6GT so as to minimize the possibility of adding transient components to the desired a-f signal at the output of the amplifier.

High-Pass Filter

A high-pass filter in the output circuit of the oscillator amplifier, sharply attenuates signals below 600 cps helping to deliver a cleanly keyed tone to the output terminals.

Figure 10 also shows the v-t keyer, a 6V6GT, operated as a d-c amplifier. The input to the 6V6GT is passed through an *m*-derived filter network,

which has a low-pass characteristic of 0-500 cps attenuating sharply all signals above 500 cycles.

The d-c output of the signal rectifiers actuates the v-t keyer. With no d-c signal applied to the a-f filter, the 6V6GT draws large plate currents and the *IR* drop across the .5-megohm resistors serves to bias the oscillator amplifier to cut-off. When a d-c signal is applied to the filter the plate current of the v-t keyer is cut off and the drop becomes zero. This restores the bias on the oscillator amplifier grids to the proper class *A* value and the amplifier functions normally. A 3000-ohm resistor adjusts the preliminary fixed bias and sensitivity of the v-t keyer.

It may be seen that the Wien-bridge oscillator and buffer amplifier must remain operative constantly. The output of the buffer is fed, through a 500-ohm pad to the primary of the transformer.

Terminals 9 and 11, Figure 10, are used to feed the telephone line to the recorder and its associated amplifier and rectifier. They also feed the speaker amplifier used for aural reception and monitoring.

Speaker Amplifier

The speaker amplifier, Figures 11, 12 and 13, consists of a simple push-

[Part II]

by

JACK IVERS

Chief Electrical Engineer
National Company

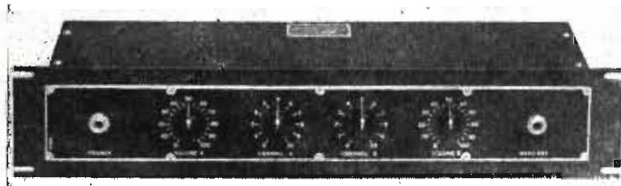
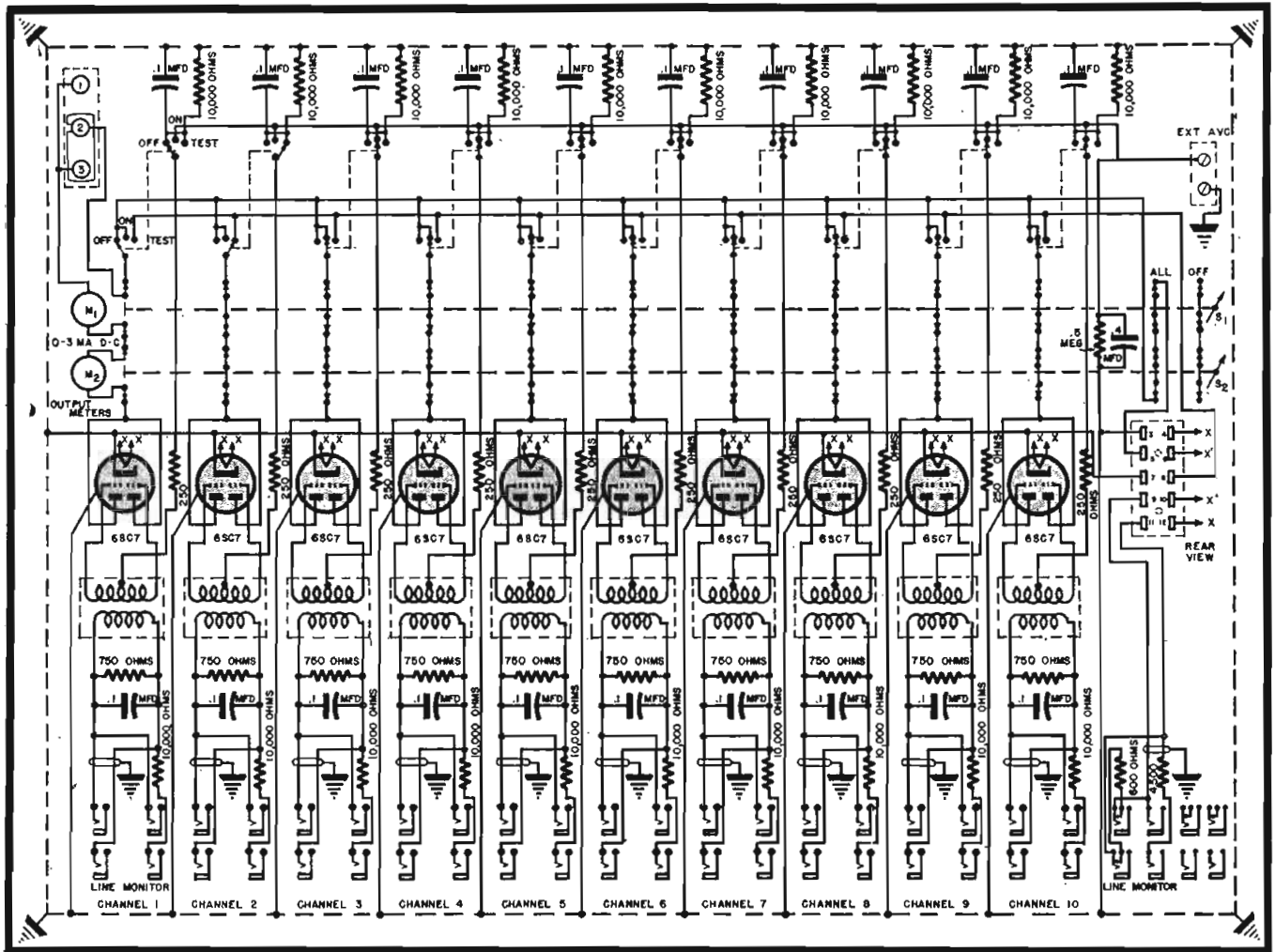

Figures 7 (above), 14 (left) and 15 (below) Figure 7. Signal rectifier circuit. Figure 14. Operator's control panel. Figure 15. Circuit of operator's control panel.

pull 6V6 class A-f amplifier stage, driven by a local tone generator, feeding two 6" p-m speakers and the monitor line. Means for remotely control-

(Continued on page 61)

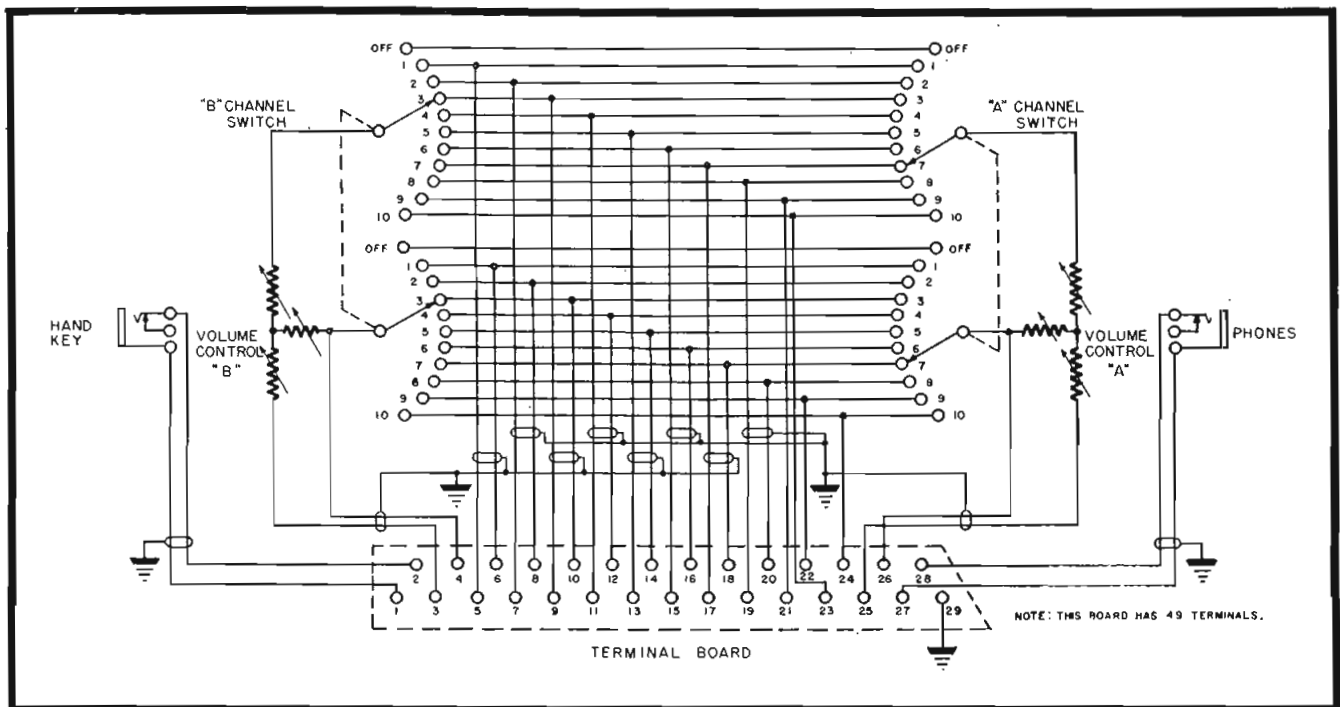

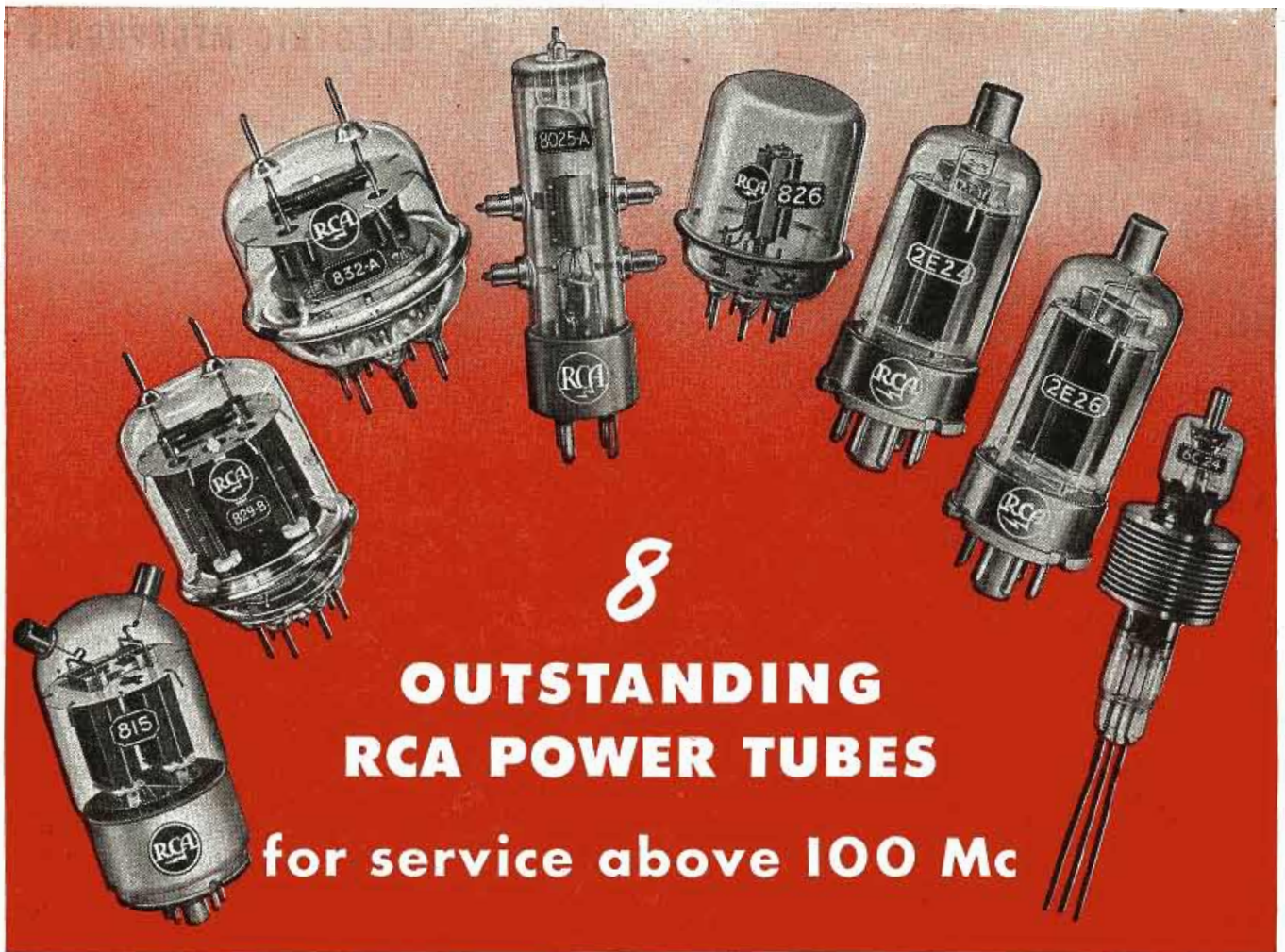

8 OUTSTANDING RCA POWER TUBES

for service above 100 Mc

Ideally suited to compact transmitter designs for emergency, aeronautical, and other upper-frequency applications

TWIN BEAM-POWER TYPES: The RCA 815, 829-B and 832-A push-pull beam-power tubes offer unusual compactness, combining high-power sensitivity with low plate-voltage requirements. Neutralization is seldom necessary.

SINGLE BEAM-POWER TYPES: The new RCA 2E24 is a quick-heating type for emergency stand-by service. Its sturdy *coated-type* filament reaches operating temperature in less than two seconds. The new RCA 2E26 is a slow-heating type particularly adaptable to FM transmitter designs.

POWER TRIODES: The RCA 826 and 8025-A triodes can be operated with unusual plate efficiency at frequencies as high as 250 and 500 Mc, respectively. Both tubes have a double-helical, center-tapped filament to minimize the effect of filament-lead

inductance. The 8025-A has double grid and plate connections that can be paralleled to reduce lead inductance. The new RCA-6C24 high-power triode employs forced-air cooling. Its relatively small size, center-tapped filament, and low inter-electrode capacitances account for its exceptional high-frequency performance.

RCA tube application engineers are ready to consult with you on any design problems you may have involving these or other RCA Electron Tubes. If you wish their services, or additional technical data on these tube types, write to RCA, Commercial Engineering Department, Section D-4B, Harrison, N. J.

COMPARATIVE TECHNICAL DATA
(Plate-Modulated Class C Telephony)

Tube Type No.	Plate Input Watts	Driving Power at Tube	Max. Rating Freq. Mc.	Plate Volts	List Price
2E24	ICAS 27	0.2	125	500	\$3.50
2E26	ICAS 27	0.2	125	500	3.20
6C24	CCS 1000	75.0	160	2500	45.00
815	ICAS 60	0.2	125	400	4.50
826	CCS 75	6.5	250	800	12.00
829-B	CCS 90	1.0	200	425	17.00
832-A	CCS 22	0.2	200	425	13.00
8025-A	ICAS 33	1.5	500	800	11.00

The Fountainhead of Modern Tube Development is RCA



TUBE DIVISION

RADIO CORPORATION of AMERICA
HARRISON, N. J.

BEAT FREQUENCY GENERATOR

Type 140-A

**A dependable
test instrument**



An accurate signal source capable of supplying a wide range of frequencies and voltages.

Frequency Range 20 C.P.S. to 5 MC.
Output Voltage 1 mv to 32 volts.
Power Output 1 watt.



BOONTON RADIO

BOONTON, N. J.

Corporation



DESIGNERS AND MANUFACTURERS OF THE "Q" METER . . . QX-CHECKER . . . FREQUENCY MODULATED SIGNAL GENERATOR . . . BEAT FREQUENCY GENERATOR . . . AND OTHER DIRECT READING TEST INSTRUMENTS

ELECTRIC MEGAPHONES

(Continued from page 34)

rected for uniform sound pressure over the frequency range at the front microphone. The loss of sound pressure from the loudspeaker at the microphone position is 24 db at 1,500 cycles. Note that this sound pressure rises 4 db at 1,000 cycles and 9 db at 500 cycles (referred to as 2,000 cycles), much less than that assumed for the equivalent piston. The microphones attenuate the sound fed back at 1,500 cycles by 2 db compared to a single microphone of the same dimensions with uniform response. The f-b margin, as shown in curve 3, is thus 26 db at 1,500 cycles. At 2,000 cycles the back pressure from the loudspeaker drops off 2 db from 1,500 cycles, but the microphones' discrimination to f-b sound is 2 db less than at 1,500 cycles, hence the f-b margin is also 26 db. The increased effectiveness of the phasing microphones at lower frequencies gives greater f-b margin in that range, as shown.

The sound pressure of 140 bars mentioned as that which can be expected on the axis of the loudspeaker at 4', with this combination of horn and microphone in an electric megaphone and with a suitable amplifier system, is found by applying the following basic data:

Test pressure in 1,250 to 1,750-cycle warble band at 1/8" from microphone	28 bars
Maximum permissible f-b pressure from speaker at microphone diaphragm before feedback will start	28 bars
Equivalent loss in sound pressure between point 1' from, and on axis of, speaker to output of phasing microphones	26 db
Maximum permissible pressure at 1' from, and on axis of, speaker (26 db = pressure ratio of 20)	560 bars
Maximum pressure developed at 4' on axis of speaker	140 bars

It can thus be seen that a definite advantage is gained with *phasing* microphones, although as we revealed, the dimensions of microphones that are available limit the degree of cancellation in the warble band region. Incidentally lip microphones of the noise-cancellation type, and even bone-conduction microphones, have been tested in an effort to obtain additional margin against feedback. However, the former have not proved promising, and the latter have either a low output, a poor response, or both. Each type

IT'S NEW! IT'S POST-WAR SUPREME Model 565 VACUUM TUBE VOLTMETER



NEW PROBE Streamlined Hand Fitting Incorporating new High Frequency Diode

RANGES:
DC 0-1, 2.5, 10, 50, 250, 500
AC 0-1, 2.5, 10, 50, 250
EXTENDED TO 5000 VOLTS BY EXTERNAL MULTIPLIERS

INPUT RESISTANCE:
DC—80 megohms on 1 volt range; 40 megohms on 500 volt range
AC—40 megohms on 1 volt range; 20 megohms on 250 volt range

INPUT CAPACITY OF PROBE: 5 micro-micro farads

FREQUENCY RANGE:
Negligible frequency error from 50 cycles to 100 megacycles.

SUPREME INSTRUMENTS CORPORATION

GREENWOOD MISSISSIPPI

requires close contact with a part of the talkers' face, which is quite inconvenient in practical usage of the megaphone.

Most Effective Microphone

The most successful microphone, which was the type finally used on the high-power megaphone, operated on a similar principle to that of the phasing microphones. Its dimensions, however, were such that the effective difference in path length from front to rear was small enough to provide some cancellation even at 2,000 cycles. This microphone gave an additional f-b margin of 4 db in the warble band, permitting a correspondingly greater maximum output pressure from the loudspeaker than that computed above.

CAA DIVERSITY SYSTEM

(Continued from page 58)

ling both speakers with a relay are provided, Figure 13.

Operator's Control Panel

The operator's control panel, designed to permit selective-channel monitoring of the multi-channel diversity equipment, is shown in Figure 14. Two-channel selector switches permit the selection of any one or two of the ten audio channels which may be patched into the control panel. Two level controls are provided to control the audio level of the selected channels. The operator's control panel is intended for installation in a separate rack removed some distance from the remainder of the multi-channel diversity equipment, and connections may be arranged to permit monitoring of the receiver outputs or any other keyed channels.

Antenna Coupling

The antenna coupling device to each receiver channel has been designed to cover a variety of antenna systems. It is possible to match a single wire antenna, a doublet antenna, or a 70-ohm coaxial feeder to the receiving channels. The r-f input impedance range of each receiving channel is 70 to 300 ohms.

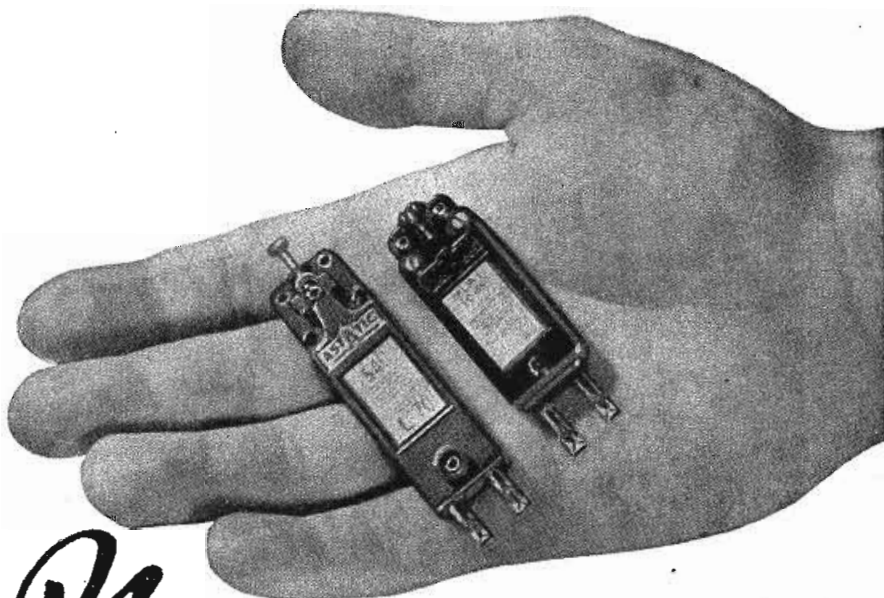

New Astatic Cartridges

Improve Phonograph Reproduction

INTENDED for use with both automatic record changers and manually operated equipment, these new Astatic Cartridges, in MLP and L-70 Series, assure a degree of fidelity heretofore unparalleled in the reproduction of recorded sound. All new Astatic Phonograph Pickup Arms will include these finer Cartridges.

L-70 Series Cartridges are of the replaceable needle type, are designed with streamlined housing, high output voltage and low needle pressure.

MLP Series Cartridges are of the permanent or fixed stylus type and are engineered to operate at one-ounce pressure, with increased vertical compliance, higher output voltage and reduced needle talk.

*"You'll HEAR MORE
from Astatic"*

• Astatic Crystal Devices
manufactured under Brush
Development Co. patents.

THE
Astatic
CORPORATION
CONNEAUT, OHIO
IN CANADA. CANADIAN ASTATIC LTD., TORONTO, ONTARIO

Wait for these new

HICKOK

Radio Service Instruments



Model 532
Tube Tester



Model 534
All Purpose Tube and Set Tester

**THE HICKOK
ELECTRICAL
INSTRUMENT CO.**

10529 Dupont Avenue
Cleveland 8, Ohio

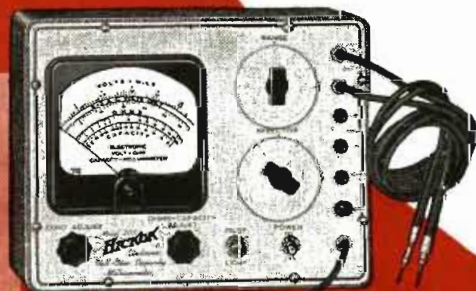

Model 203
Electronic Volt-Ohm Capacity Milliammeter

*If It Isn't A Hickok Indicating
Micromhos It's Not
Dynamic Mutual Conductance*

Your patience in waiting for these new 1946 HICKOK models will be richly rewarded for these new HICKOK tube and set testers make still closer tests, with finer accuracy, rejecting tubes that might get by with an ordinary tester.

Now you have 7 selector switches instead of 2. That aims to prevent obsolescence. Isn't that worth waiting for?

What's more, Dynamic Mutual Conductance, indicated in Micromhos, is a duplicate of the manufacturer's method of checking when he makes the tubes. Remember, if it isn't a HICKOK Indicating Micromhos, it isn't Dynamic Mutual Conductance.

The new Electronic Volt-Ohm-Capacity Milliammeter Model 203 reads as low as 1.0 mmf and up. It will measure at frequencies to over 10 mc with no frequency error and the ohm meter will measure up to 10,000 megohms.

Keep patiently in touch with your jobber and you will soon get the instruments that are held in highest esteem.

IRE REPORT

(Continued from page 28)

variation in phase created by different lengths of lines was also used. In another method the antennas were fed all in phase and then a quadrature current was fed to each antenna to create the proper phase shift. This quadrature current was then switched to create the lobing effect.

BEAM SHAPING METHODS IN ANTENNA DESIGN

L. C. VAN ATTA
Radiation Laboratory, M.I.T.

IN a discussion of parabolic reflectors and beam shapes, Mr. Van Atta pointed out that an antenna becomes effective as the aperture becomes large. The aperture was defined as a plane across which most of the energy from the antenna passes. This is illustrated in Figure 20, where changing the illumination across the aperture cut down the side radiation. By varying the illumination and the phase front, it is possible to shape the beam.

One application to which it was applied was an airplane radar. It was necessary to have uniform illumination over the sea. It was found that I at any angle θ had to be proportional to $(\csc \theta)^2$. To apply this theory it is necessary to determine the pattern to be desired, phase front and illumination necessary to produce this pattern and what antenna will produce this phase front and illumination. One approach to this is the application of geometrical optics to a parabolic reflector. To do this the focusing properties of the parabola can be varied or the source can be extended and varied.

In Figure 21 we have an extended and tapered source that provides the proper illumination and phase front for the $\csc^2 \theta$ pattern. A limitation is imposed by the focusing properties of the parabola which will only focus sources a small distance from the center. Another solution described used a parabolic top half of the

Figures 20 and 21 (Van Atta paper)

Figure 20 illustrates a parabolic reflector aperture with its accompanying phase and amplitude diagram, and its resultant antenna pattern. Figure 21 shows an antenna that will produce a $\csc^2 \theta$ pattern, employing a parabola and a distributed source with tapered feed currents.

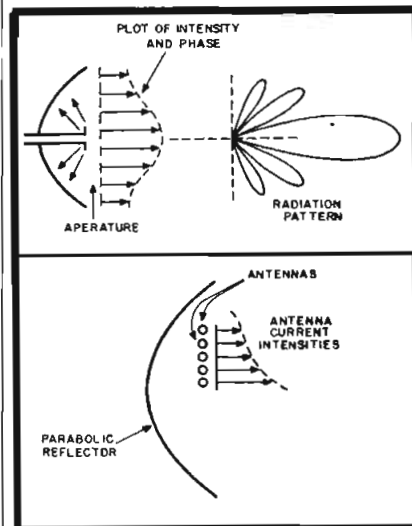

reflector and a spherical bottom half. This resulted in bad side lobes. The rigorous solution entailed a calculated dish that gave the proper phase and illumination. The ripples in the pattern can be determined by calculating the currents in the dish and then integrating over the area.

METAL-LENS ANTENNAS

W. E. KOCK
Bell Telephone Labs.

IT is possible to prepare lens antennas from solid dielectric material when their structure follows optical design, operating on the principle that the wave travels slower in the lens material. Since the phase velocity in a wave guide is greater than that of air, a number of adjacent wave guides whose length correspond to the proper thickness of a lens can be used. As shown in Figure 22, the shapes are complementary for the wave travels faster in a guide than in free space. Such a guide can be made of parallel metal plates parallel to the direction of travel of the wave and perpendicular to the H vector of the propagated wave. These plates can then be shaped in the form of a lens to produce the proper shape. For a saving in thickness a full wavelength can be subtracted from the width of the plates without any detrimental effect. This yields a serrated plate for a lens that was described and demonstrated by Mr. Kock, Figure 23. This step effect causes the lens to be narrower in bandwidth, but reduces the thickness of the lens.

As an example a 40-wavelength diameter lens was used on the mouth of a horn. It reduced the necessary length of the horn from 800 wavelengths to 38 wavelengths. A lens tilt was employed to prevent the reflected energy from entering and producing undesirable standing waves on the feed lines. Another lens described was a 480 wavelength lens which produced a beam 0.1° wide. When lenses like these are used in relay systems for the receiving and transmitting antennas it is claimed

(Continued on page 64)

Figures 22 and 23 (Kock paper)

Figure 22 illustrates that the shapes of dielectric and metal lenses are complementary, since the wave travels more slowly in the dielectric than in the free space, but more rapidly in the metal lens than in free space. Figure 23 shows how a full wavelength can be subtracted from a metal lens without loss of contour.

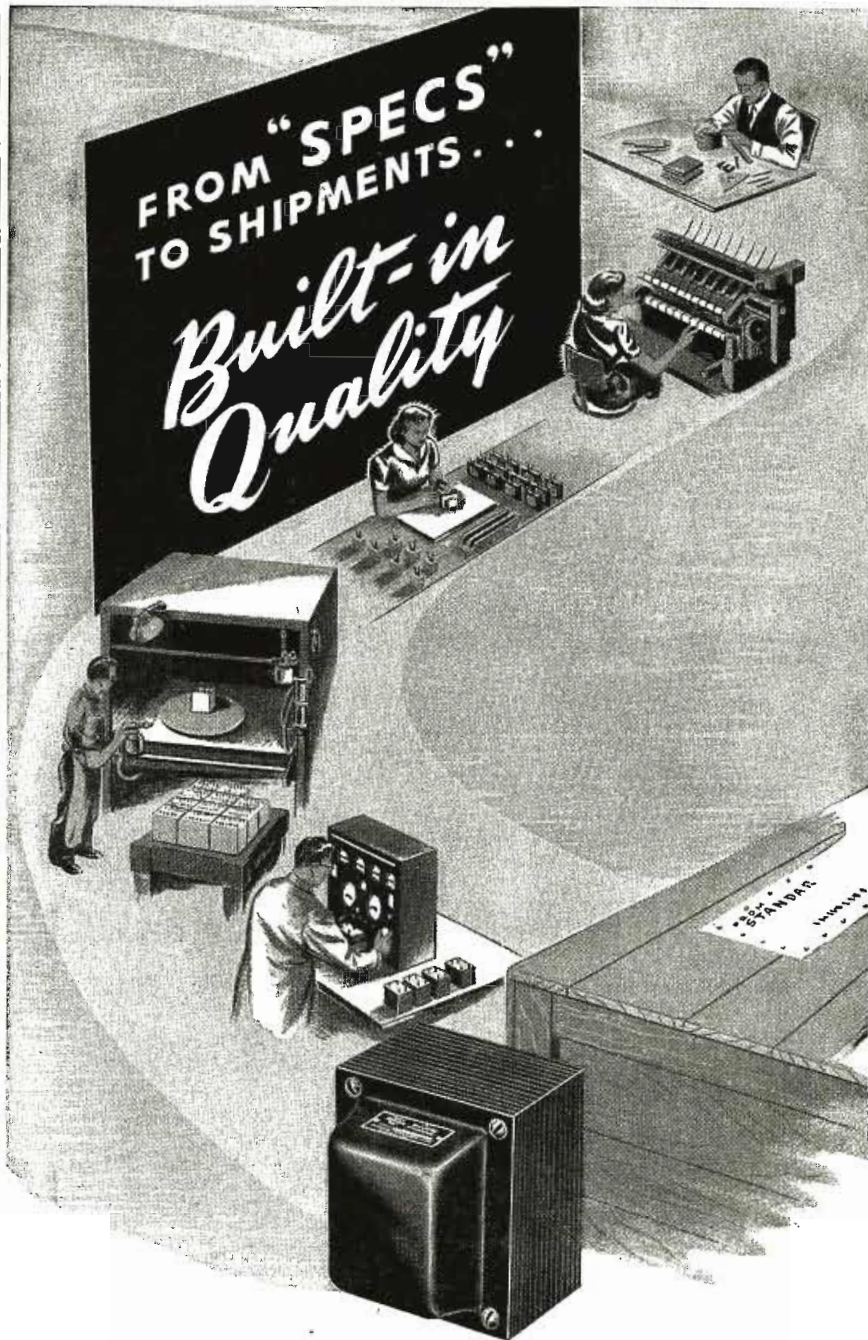
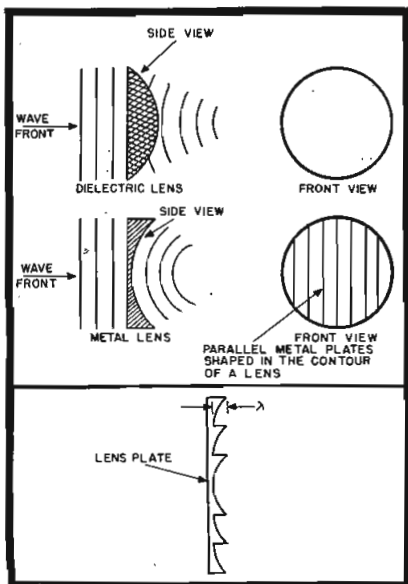

"The whole is equal to the sum of all its parts"—Elementary? Of course—as simple and unchanging as all great principles. This axiom is a fundamental manufacturing creed at Stancor. We know the established excellence of Stancor Transformers is vitally dependent upon the perfection of each successive manufacturing step—from engineering considerations of individual specifications—through coil-winding, laminating, assembling, finishing, testing—and, finally, to careful packing for shipment.

All individual manufacturing operations have one common denominator—QUALITY—uncompromising, changeless QUALITY that continues to prove—"IN TRANSFORMERS, STANCOR GIVES MORE."



STANCOR
STANDARD TRANSFORMER CORPORATION
1500 NORTH HALSTED STREET CHICAGO 22, ILLINOIS

PUR-A-TONE Reg. Trade Mark ANTENNAS



for AUTOS • HOMES • MARINE

Brach Pur-a-tone Antennas have long been recognized as the standard by which all others are judged. They're a byword for Quality and a buy-word for Satisfaction. Please your customers and increase your profits—ask your distributor for BRACH ANTENNAS.

Special-purpose transmitting antennas designed for volume production to your specifications. Collapsible — sectional — direction-finding — radar — and coaxial type. All sizes, lengths and materials. Consult us on your needs.

L. S. BRACH MFG. CO.
200 CENTRAL AVENUE NEWARK, N. J.



WORLD'S OLDEST AND LARGEST MANUFACTURERS OF RADIO ANTENNAS AND ACCESSORIES.

IRE REPORT

(Continued from page 63)

that there is an improvement in crosstalk effect.

In the demonstration a metal lens and a dielectric lens were used to focus a u-h-z beam. The metal lens was selective inasmuch as it was polarized by the direction of the waveguide slots.

MODEL AIRCRAFT-ANTENNA REQUIREMENTS

GEORGE SINCLAIR, E. W. VAUGHAN
and E. C. JORDAN
Ohio State University Foundation

SINCE the time and effort necessary to obtain radiation patterns of antennas on full size airplanes is prohibitive

model airplanes are used at the proper r-f frequency. A series of tests using this format of analysis, conducted at Ohio State, were discussed in this paper. It was pointed out the conditions necessary in a L/n scale model were:

Quantity	Full Scale	Model
Length	L	L/n
Frequency	f	nf
Wavelength	λ	λ/n
Conductivity	σ	$n\sigma$
Dielectric Constant	ϵ	ϵ
Permeability	μ	μ
Propagation Constant	k	nk

$$\text{where } K^2 = \Sigma \mu \omega^2 + i \omega \mu \sigma$$

All of the conditions except conductivity are easy to satisfy but the error is negligible since the conductivity of the metal is so high anyway that increasing it n times would hardly affect the results. Originally a hand-formed copper shell

formed over a wooden model was used for a model. All joints were carefully soldered. Later hollow wooden models with metal sprayed on were used.

A wave guide was used as the radiator and the receiver was mounted in the plane. The wave guide was rotated to change polarization, and complete horizontally polarized and vertically polarized patterns were taken. A crystal or a bolometer was used as the receiver in the plane; the bolometer was preferred. The resulting patterns were recorded directly on polar coordinate paper. For cases where the receiver cable was troublesome a modulator was used in the plane that reradiated a modulated signal. This signal was picked up in the transmitting wave guide and the pattern was plotted from its intensity. However, this involved phasing the two carriers and was used only where necessary.

WAVE PROPAGATION

SKY-WAVE PROPAGATION RESEARCH AND APPLICATIONS DURING THE WAR

Dr. J. H. DELLINGER and Dr. W. SMITH
National Bureau of Standards

TWENTY years ago Wright and Tuve had developed the method of projecting a sharp pulse of r-f energy and measuring the time for its reflection to return from the ionosphere. Ten years ago the possibilities of using the method in predicting radio propagation characteristics became apparent. During the war these possibilities were developed.

The application of pulsing to radar during the war overshadowed its value for determining propagation characteristics. Nevertheless, we recognized its value for predicting long-distance communications. The work that has been done justifies the belief in the possibilities of the tool.

Early in the war the British established a propagation station in England. The exigencies of air war in the Southwest Pacific prompted the Australians to establish a similar station. In 1940 the United States established an office near Washington for analyzing the data available and to disseminate predictions in practical form to the war forces.

The Army-Navy Joint Communication Board set up a propagation committee, IRPL, whose duties were:

- (1)—Maintenance of a continuous ionosphere watch
- (2)—Analyze the data secured
- (3)—Make new experiments and studies
- (4)—Prepare predictions and bulletins
- (5)—Issue data and bulletins
- (6)—Maintain a service for rapid reply to questions submitted by the forces

A pressing problem was that of obtaining data on oblique incidence of radio waves from the vertical incidence data collected by a worldwide station net. Also, long-path communications needed study. An empirical method was developed for handling this problem based on communications between paired control points. As the volume of information expanded, the effect of sporadic reflections from the ionized layer 100 kilometers above the earth proved of great significance in calculating propagation conditions.

For practical purposes, the world was

divided into three zones based on geomagnetic longitude and charts were drawn up showing critical frequencies for radio communications between any two points. The use of the sky wave was found necessary in some cases. In tropical jungle regions for example, the ground wave range proved less than one mile.

Another major problem lay in calculating distance ranges, or the sky-wave field intensity. This was also handled empirically. For practical communications a study of noise intensity was needed and it was found that major noise centers existed in South Africa, South America and the Dutch East Indies.

A close watch on North Atlantic communications made it possible to predict magnetic storms capable of blocking out signals by as much as 10 hours. Data from the radio companies were helpful in correlating and correcting predictions.

This ionospheric study and prediction of propagation characteristics will be continued in the postwar era. The results will continue to be invaluable to everyone in communications.

MICROWAVE TECHNIQUES

METALLIZED GLASS ATTENUATORS

ERNST WEBER
Polytechnic Institute of Brooklyn

WAVEGUIDE attenuators employing a waveguide below cutoff have high minimum attenuation. A dissipative attenuator with practically zero minimum attenuation was described in this paper. Dr. Weber said that several types of dissipative elements (a very thin metallic film coated on glass) were tried, with varying degrees of success. Nobel metals were employed first but their temperature coefficients were bad. Nichrome was found to be very good, as well as a platinum and poladium combination.

For coaxial lines the inner conductor was replaced with a glass rod coated with the dissipative metal. To prevent a bad mismatch a matching section of heavier film was used to introduce the main dissipative section. The ends were coated heavily so that they could be soldered in place. A variable attenuator for coaxial lines was built by sliding a conducting sleeve over part of the attenuation section.

The final waveguide attenuator consisted of a vane of glass that was properly coated. This glass vane was suspended on struts that were placed in holes in the glass. Between the struts and the glass was an eyelet to which the strut was soldered. For waveguides the metal was evaporated on in a vacuum, instead of being burnt on, a procedure that was used for the coaxial attenuator films. The metallic film was also covered with magnesium fluoride to protect it. This vane was then suspended in the guide as an attenuator. By varying its position in the guide the attenuation could be varied.

CRYSTAL RECTIFIERS IN SUPERHETERODYNE RECEIVERS

H. C. TORREY
Radiation Lab., M.I.T.

CRYSTALS have been extensively used in microwave superheterodyne converters. Discussing the merit of such

(Continued on page 66)



Where Will YOU Be in 1950?

Enjoy Security and Good Pay! Prepare Now With CREI Modern Technical Training and Step Ahead of Competition into a Good Radio Job!

CREI offers you a Proved Program of Self-Improvement to Keep Pace With Modern U.H.F. Advancements and Enables you to Go After — and Get a Secure Radio Job!



Yes, there are GOOD JOBS . . . for GOOD men! The easy jobs are gone and once again knowledge and ability are the requirements for the good-paying jobs. Competition is opening up. The fight to HOLD good jobs—to SECURE better ones is just starting. Employers once again can afford to be "choosy" . . . to select the best man for the best job. In the face of this show-down situation—where do YOU stand?

CREI home study training in Practical Radio-Electronics Engineering can equip you to meet the requirements to hold your job—or advance to a better one. No matter what your past radio-electronics experience has been—no matter what your training—you must actually start anew to gain the confidence born of knowledge. By adding CREI training to your present radio experience you can safeguard your future and keep pace with such new developments as U.H.F. Circuits, Cavity Resonators, Pulse Generators, Wave Guides, Klystrons, Magnetrons and other tubes. Are you equipped to handle them? CREI is equipped to help you, by providing the know-how and ability that is required.

In our proved method of instruction, you learn not only how, but why! Easy-to-read-and-understand lessons are provided well in advance, and each student has the benefit of personal guidance and supervision from a trained instructor. This is the basis of the CREI method of training for which many thousand professional radiomen have enrolled since 1927.

It costs you nothing to read the interesting facts . . . to learn how CREI can help you enjoy the security you want . . . the better-paying job that can be yours. Write for particulars now!



WRITE FOR FREE 36-PAGE BOOKLET

"Your Opportunity in the New World of Electronics"

If you have had professional or amateur radio experience and want to make more money, let us prove to you we have something you need to qualify for a better radio job. To help us intelligently answer your inquiry—PLEASE STATE BRIEFLY YOUR BACKGROUND OF EXPERIENCE, EDUCATION AND PRESENT POSITION.

CAPITOL RADIO ENGINEERING INSTITUTE

HOME STUDY COURSES IN PRACTICAL RADIO-ELECTRONICS
ENGINEERING FOR PROFESSIONAL SELF-IMPROVEMENT

Dept. CO-2, 3224 16th Street, N.W., Washington 10, D. C.

Contractors to U. S. Navy—U. S. Coast Guard—Canadian Broadcasting Corp.
Producers of Well-trained Technical Radiomen for Industry.

MEMBER, NATIONAL COUNCIL OF TECHNICAL SCHOOLS

Leading makes of RELAYS and SWITCHES



Stocks on Hand for Immediate Delivery

You get faster service from Allied, because many makes and types are centralized here—such as:

RELAYS: POTTER & BRUMFIELD—ALLIED CONTROL—EBY—GENERAL ELECTRIC—CUTLER-HAMMER—SIGMA—GUARDIAN—LEACH . . . Heavy-Duty Power; Plate Circuit, Sensitive; Overload; Keying; Antenna Transfer; Medium Duty in all Combinations of Contacts and Coil Voltages.

SWITCHES: MALLORY—CENTRALAB—CUTLER-HAMMER—HART & HEGEMAN—GENERAL ELECTRIC—FEDERAL—MU-SWITCH—ACRO—UTAH . . . Toggle, Simple Rotary; Multi-Ganged, Multi-Contact; Cam Lever Action; Mercury; Low-Pressure Actuating; Knife, Key, Button.

Save Time and Work—Call ALLIED First. Write, Wire, or Phone Haymarket 6800.

Everything in Radio and Electronics

ALLIED RADIO CORP.

833 W. Jackson Blvd. . Dept. 31-B-6 . Chicago 7

Helpful
**BUYING
GUIDE**
on request
Write for it!



THERMOSTATIC METAL TYPE **DELAY RELAYS** PROVIDE DELAYS RANGING FROM 1 TO 120 SECONDS

Other important features include:—

1. Compensated for ambient temperature changes from -40° to 110°F .
2. Contact ratings up to 115V-10a AC.
3. Hermetically sealed — not affected by altitude, moisture, or other climate changes . . . Explosion-proof.
4. Octal radio base for easy replacement.
5. Compact, light, rugged, inexpensive.
6. Circuits available: SPST Normally Open; SPST Normally Closed.

WHAT'S YOUR PROBLEM? Send for "Special Problem Sheet" and Descriptive Bulletin.

AMPERITE CO. 561 BROADWAY
NEW YORK 12, N. Y.

In Canada: Atlas Radio Corp., Ltd.
560 King St. W., Toronto



IRE REPORT

(Continued from page 65)

crystals, Mr. Torrey said that it is judged by:

- (a) Frequency conversion loss, $\frac{\text{input power}}{\text{output power}}$
- (b) Output noise ratio, $\frac{\text{actual output noise}}{\text{theoretical noise from a resistor}}$

Conversion loss is generally 5 to 7 db while the output noise ratio varies from one to two and may reach three. For typical conditions, the overall noise is 10 db. Therefore, the minimum detectable signal must be 10 db above the theoretical resistor or Johnson noise.

During the war, the mechanical stability of crystals was improved. Electrically, however, they are still delicate.

Decreasing the area of crystal contact reduces the capacity but gives rise to electric instability at the same time. It has been found that silicon crystal can be heat-treated to form an insulating layer at the surface. Under these conditions, the conductivity is increased without increasing the capacity. Improved conversion is therefore attained. The image frequency generated inside the crystal is important in the conversion loss.

Attempts have been made to make crystals more uniform; at present, their impedance varies considerably, said Mr. Torrey. The real need is for a method of testing crystal microwave impedance in factory production. The problem is difficult because there is no correlation between crystal d-c impedance and crystal microwave impedance. At 1 or 2 mc, however, there is a fair correlation.

NOISE SPECTRUM OF CRYSTAL MIXERS

P. H. MILLER
University of Pennsylvania

NOISE is the major limitation of crystals used in microwave converters. In an effort to explore the subject, a study was made of the relation between frequency and noise intensity of crystals.

The crystal under test is in the input. Although it is preferable to measure output in terms of voltage squared, it was found easier to measure the output directly in volts. The difficulty of using 60-cycle line-powered units was that the 60-cycle component was greater than the noise. Hence, a battery preamplifier had to be used. The noise voltage was found to vary as the square of the current through the crystal rectified. From a noise temperature test, there appeared to be a fluctuating resistance in the crystal. The noise temperature varied inversely with frequency between 50 cycles and 1 mc, disagreeing with theory which calls for an inverse relationship to the square of the frequency. The cause seemed to be a thermal fluctuation at the crystal contact. The phenomenon is electrical rather than mechanical; a germanium crystal with welded contacts exhibited the same noise characteristic.

In an effort to determine whether crystals could be chosen for low noise, measurements were made of manufactured lots. About 10% of those produced were low noise. No account was taken of shot noise nor of tube noise, these being negligible for the most part.

NEWS BRIEFS

(Continued from page 52)

CINCH BUYS HOWARD B. JONES CO.

The Cinch Manufacturing Corporation has purchased the assets of the Howard B. Jones Company, both of Chicago. The employeecs of the latter company will be retained for the most part, and Howard B. Jones will be retained by Cinch as a consultant on Jones units. Carey Wilson is general manager of the new division.



L. Tarr, Cinch president.

SCHANTZ PROMOTED BY FARNSWORTH

J. D. Schantz has been named assistant manager of the research department of the Farnsworth Television & Radio Corporation, Fort Wayne, Indiana.

Mr. Schantz came to Farnsworth in 1939 from a predecessor company, Farnsworth Television, Inc., of Philadelphia, which he joined in 1936, and where he conducted research on circuits and television terminal equipment.



RKO TELEVISION ELECTS AUSTRIAN PRESIDENT

Ralph B. Austrian has been named president of RKO Television Corporation, succeeding Frederic Ullman, Jr., who will continue to serve as a director.

HAM LICENSES BEING ISSUED AGAIN

The Federal Communications Commission has resumed issuance of new amateur radio station licenses.

Approximately 8,000 persons who took the FCC examination for amateur radio operator licenses during the war will be able to obtain licenses to operate.

Prior to Pearl Harbor, there were 60,000 ama-

(Continued on page 68)

AT PHASITRON IRE DISPLAY



E. H. Fritschel, right, manager of sales for the G. E. tube division, and J. E. Nelson, sales manager of G. E. transmitting and industrial tubes, discussing the applications of the Phasitron tube at the recent IRE G. E. exhibit in N. Y. City.

Unusual and Vital ELECTRONIC EQUIPMENT

PRODUCED BY

TECH LAB

SUBCONTRACTING DEPT.

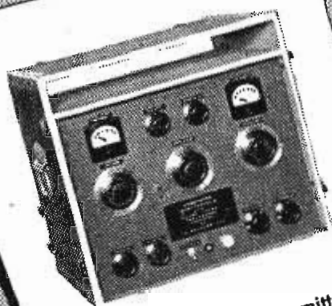

Special Short Wave Transmitter
Range: 1-16 megacycles on
one dial.



Development of special
hearing aid analyzer for
Western Electric Company.

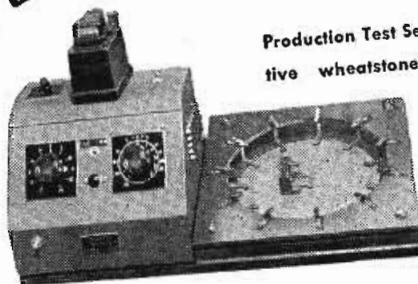

Production Test Set to test varistors. A sensitive wheatstone bridge arranged with switching means for quickly checking a number of varistors in rapid sequence.



Carbon filling machines for
precision filling of carbon
microphones.

Manufacturers have continually called upon the modern facilities of Tech Lab Subcontracting Department to assist them in the production of unusual and vital electronic equipment. Our Engineering Department is ready to assist you with your production problems.



MANUFACTURERS OF PRECISION
ELECTRICAL RESISTANCE INSTRUMENTS

15 LINCOLN STREET, JERSEY CITY 7, N. J.

PERFECTION

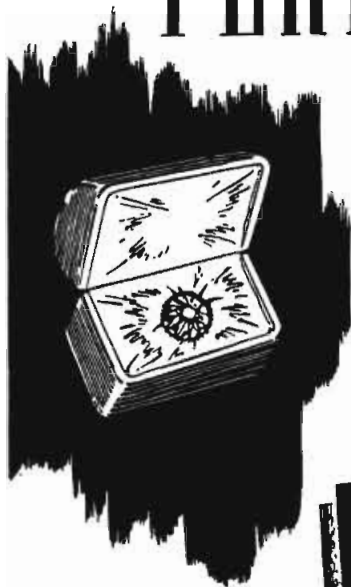

A fine-cut diamond is perfection in beauty and formation. But to you as a transformer-user, perfection lies in performance, day in, day out, under the exacting conditions of your particular application.

Finest engineering talent and most complete electronic laboratories are ready to consult with and help you with your problem—and to design and produce the transformer that will give you perfection in performance.

ELECTRONIC
Engineering
COMPANY
INC.

"SPECIALIZED
Transformer
ENGINEERS"

3223-9 W. ARMITAGE AVENUE • CHICAGO 47, ILLINOIS

NEWS BRIEFS

(Continued from page 67)

tear radio station licenses in the United States. It is estimated that this number will increase to 250,000 in the next five years.

FURR AND ANGEVINE PROMOTED BY STROMBERG-CARLSON

Roger T. Furr was named chief technical service engineer in charge of the drafting and blueprint sections, physical testing laboratory, model shop, standards and properties section, and the engineering procurement section of Stromberg-Carlson Company, Rochester, N. Y. Oliver L. Angevine, Jr., was appointed chief sound equipment engineer.

The instrument laboratory has become a part of the research department under the direction of Benjamin Olney, director of research.

KLUGE APPOINTS R. M. REILLY G-M

Ray M. Reilly has been named general manager, in charge of sales and production, of Kluge Electronics Company, 1031 North Alvarado Street, Los Angeles 26, Calif.

BRACH EXPANDS

L. S. Brach Manufacturing Company has moved to a new plant at Central Avenue, Hoyt and Bleeker Streets, Newark, N. J.

WILLIAMS APPOINTED G-S-M OF MILLEN CO.

E. Eugene Williams has become general sales manager of the James Millen Manufacturing Company of Malden, Massachusetts.

Mr. Williams was formerly with G. E. as sales manager of laboratory and measurement equipment.



COOPER-DI BLASI BECOME AMERTRAN REPS

Cooper-Di Blasi, 259 West 14th Street, New York City, has been appointed Amertran representatives for Metropolitan New York and lower New York State, by American Transformer Company, Newark, N. J.

VICTOR MUCHER NOW CLAROSTAT PRESIDENT

Victor Mucher has been elected president of the Clarostat Mfg. Co., Inc., Brooklyn, N. Y. George Mucher, in addition to holding the post of chief engineer, has become vice president. William Mucher is now treasurer and Charles Burnell is secretary. The new directors are the officers, together with B. G. Cantor, a New York financier.

DANIEL KARP REJOINS KARP METAL

Daniel S. Karp has rejoined the Karp Metal Products Co., Inc., as vice president in charge of engineering and sales.

Mr. Karp returns after four years of service in the U. S. Navy.



O. E. SIMMS JOINS SPRAGUE PRODUCTS

O. E. Simms has joined the Sprague Products

STANDARD CRYSTALS

Send for New Catalog

STANDARD PIEZO COMPANY

Established 1936

Quartz Crystals and Frequency Control Equipment

Office and Development Laboratory

SCRANTON, PA.

CARLISLE, PA., P. O. BOX 164

CARLISLE, PA.

Representatives

COOPER-DI BLASI

259 WEST 14th STREET, NEW YORK 11, N. Y.

HAL F. CORRY

3522 GILLON AVENUE, DALLAS 5, TEXAS

THE FOSTER COMPANY

409 LUMBER BLDG., MINNEAPOLIS, MINN.

GERBER SALES COMPANY

94 PORTLAND STREET, BOSTON 14, MASS.

A. SIDNEY HARDY

650 BOULEVARD N. E., ATLANTA, GA.

HARRY A. LASURE

2216 WEST 11th STREET, LOS ANGELES 6, CALIF.

L. D. LOWERY

1343 ARCH STREET, PHILADELPHIA, PA.

MANUFACTURERS SALES TERMINAL, Inc.

222 COLUMBIA BLDG., SPOKANE, WASHINGTON

HARRY B. SEGAR & COMPANY

ELLCOTT SQUARE BLDG., BUFFALO, N. Y.

E. J. WALL

1836 EUCLID AVENUE, CLEVELAND 15, OHIO

Company, North Adams, Mass., as assistant to sales manager Harry Kalker.



BLACK, VERONDA, GRACE AND WOUCK NOW WITH PHILIPS

Dr. James G. Black has joined Philips Laboratories, Inc., at Irvington, N. Y., as chief of the division of miscellaneous projects and analytical laboratories.

Carol M. Veronda has become assistant engineer, microwave section, of the laboratories.

Frank Grace, formerly with Reeves Sound Laboratories, has been also appointed assistant engineer, microwave section.

Dr. Victor Wouck, formerly with Westinghouse, has joined the engineering laboratories staff of North American Philips Company, Inc., at Dobbs Ferry, N. Y. Dr. Wouck will investigate circuit theory for Philips.

WILLIAM E. BRADLEY BECOMES PHILCO DIRECTOR OF RESEARCH

William E. Bradley has been appointed director of research of the Philco Corporation. He succeeds David B. Smith, who was recently named vice president in charge of engineering.

EUGENE BERMAN NOW G-S-M OF DE MORNAY-BUDD

Eugene L. Berman has been appointed general sales manager of De Mornay Budd, 475 Grand Concourse, New York 51, New York.

Recently released from the Army, Mr. Berman served as Chief of the Field Liaison Branch of Pictorial Engineering and Research Laboratory at the Signal Corps Photographic Center in Long Island City. He formerly was general sales manager of Shure Brothers.

STRUTHERS-DUNN RELAY ENGINEERING HANDBOOK

A 640-page pocket-size relay engineering handbook has been prepared by the engineering department of Struthers-Dunn, Inc., 1321 Arch St., Philadelphia 7, Pa.

In addition to discussing fundamental relay principles, the book presents an analysis of equipment and circuits ordinarily encountered in applying relays to modern electrical or electronic uses.

One section is devoted to the servicing and inspection of relays. Many original shortcuts are published for the first time, such as reading temperature rise directly from a slide rule.

Illustrated with 863 diagrams, 81 tables, 181 line and 89 halftone illustrations. Contents are cross-indexed. Available at \$3 per copy.

ASTATIC APPOINTS J. K. POFF SERVICE ENGINEER

J. K. Poff, formerly of the U. S. Naval Reserve, has been named service engineer of the jobber sales division of the Astatic Corporation, Conneaut, Ohio.



HALLICRAFTERS AND PILOT RADIO ADMITTED TO TBA MEMBERSHIP

The Hallcrafters Company, Chicago, Ill., and the Pilot Radio Corporation, Long Island City, N. Y., have been admitted to affiliate member-

(Continued on page 70)

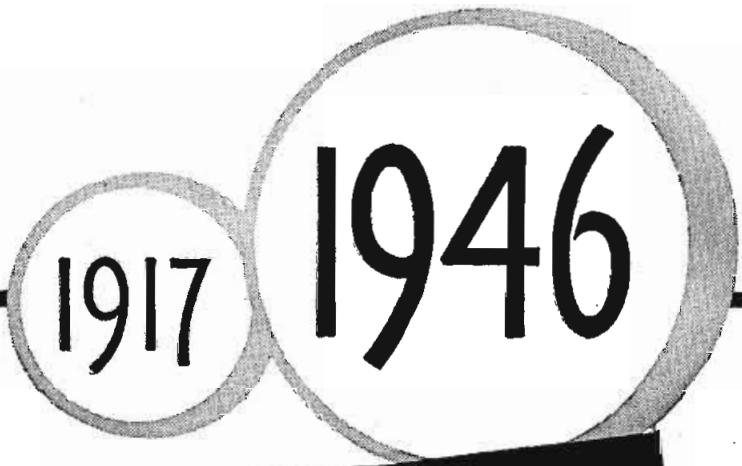

MODERN COIL WINDINGS

EXPERIENCE

COTO-COIL enters its 29th year of service to the electrical industry. For 28 years . . . through two wars . . . and the intervening years of peace, Coto-Coil has designed and produced coil windings of infinite variety and the highest standard of excellence.

FACILITIES

A modern building with a half-acre of floor space . . . equipped with advanced types of coil winding machines . . . is devoted exclusively to precision winding.

DESIGN

COTO-COIL engineers are ready at all times to work with you in designing coils to meet special requirements at minimum cost.

Let us know your requirements.
Coto-Coil can produce the windings.

COTO-COIL, INC.

COIL SPECIALISTS SINCE 1917

67 PAVILION AVE.

PROVIDENCE 5, R. I.

"T A B"

SPECIAL BUY

LIMITED QUANTITY

ELECTRONIC VOLT-OHMMETER

BRAND NEW U. S. ARMY TYPE
I-107-F PRECISION UNIT

Rugged design housed steel case 6" x 9 1/4" x 4 1/8" leather carrying handle. Contains Simpson 4" highly damped 400 microamps alnico meter. Clear visible scale, large numerals, easily readable at all points. All voltage ranges ten megohms sensitivity; reads 0.3 volts in .05 v steps; 0.10 volts in .2 v steps; 0.30 volts in .5 v steps; 0-100 volts in 2 v steps; 0.300 volts in 5 v steps—OHMS Rx1 from 0.2 to 1000 ohms; Rx10 from 2 to 10000 ohms; Rx100 from 20 to 100000 ohms; Rx1000 from 200 to 1 megohm; Rx10000 from 2000 to 10 megohms; (center scale is 10) Unit complete with 3 test leads; batteries add instructions. Cost gov't \$65. "TAB" special \$29.70. Additional V.T.V.M. Loctal tube 1 LE 3/SP Sig C \$1.15.
Relay W.E. Sens. S.P.D.T. 3500 contacts 5A97
Sylvania UHF Sil. C Crystal Det JANIN 2135
Condenser G.E. Pyranol 4MFD-600V incl. mtg. B. 1.15

OSCILLOSCOPE

5 inch made by Western Electric for U. S. Army type BC412-B*. Cost gov't over \$2000. Contains power supplies 115 v 60 cy; amplifiers and controls for Vertical and Horizontal positions, Focus intensity, Sensitivity, Spread, Sweep (fixed freq.) Tubes as follows 5BP4, 879, 5T4, Six 6L6, Two 6SJ7, 6AC7, 6H6. Easily adapted to laboratory Radio service work or television. Completely housed heavy steel case. Exceptional "TAB" price \$59.50. Ship. wt. 175 lbs.
Klystron W.E. 726 oscillates 10 CM 1.95
Klystron Raytheon 723 oscillates 3 CM 1.95
RCA 6AC7-1852 HiFreq. Metal Pent. (L.P. \$1.75)65

RADAR POWER SUPPLY

Rugged U. S. Army keying unit BC-409A* cost gov't over \$3000. Contains two power supplies 115 v—60 cy. H.V. 3000 at 1/2 amp.; L.V. 400 at 250 ma. well filtered. Tubes Eimac 304TL, 866A, 5T4, 6C5, two 6L6, two 6F6, three 6SJ7. Motors, relays, blowers and many other parts. A real "TAB" special at \$97.50. Ship. wt. 250 lbs.

*Used; like new, tested. \$1 Min. orders FOB, N. Y. C.
Add postage all orders and .25% deposit. Whitehall 3-3557. Send for catalog 300.
Don't wait. Rush orders as quantities are limited.

"TAB", Dept. E-3

Six Church Street, New York 6, N. Y.
Our Central Location

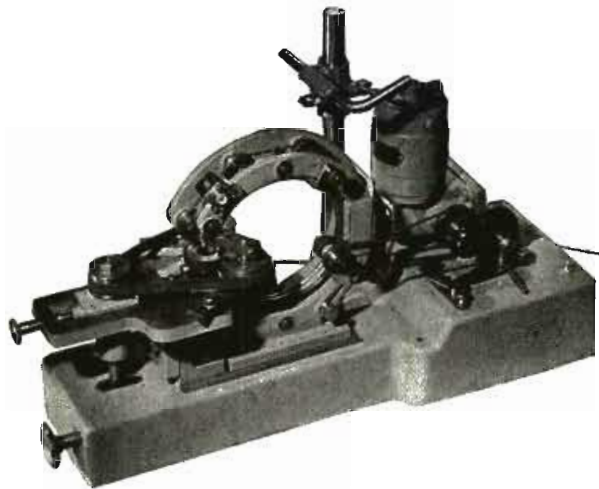

A NEW WINDER

For making Toroidal Coils
On small cores with fine wire

Larger Machines Available

Mico Instrument Co.

88 TROWBRIDGE STREET, CAMBRIDGE, MASS.

NEWS BRIEFS

(Continued from page 69)

ship in the Television Broadcasters Association.

Designated as representatives were W. J. Halligan from Hallcrafters, and Isidor Goldberg and E. L. Hall from Pilot Radio.

RCA GRANTS TELEVISION FILM RECORDING LICENSE TO RKO-PATHE

A license to record and distribute sound motion pictures for use in television broadcasting has been granted by RCA to RKO-Pathe, Inc. (formerly Pathe News, Inc.) as part of a ten-year recording agreement.

The contract calls for immediate delivery of RCA sound film recording equipment to the new RKO-Pathe studios, now under construction, at 106th Street and Park Avenue, New York City.

HOWARD MORGAN NOW WITH BENDIX

Howard K. Morgan, formerly director of engineering for TWA, Inc., has joined the engineering staff of Bendix radio division of Bendix Aviation Corporation, Baltimore, Maryland.



GOTHARD INDICATOR LIGHT REFERENCE BOOK

The selection, operation and maintenance of indicator lights are discussed in a book pub-

lished by Gothard Manufacturing Company, 2110 Clear Lake Ave., Springfield, Ill.

JOHNSON REJOINS SYLVANIA ELECTRIC

Lt. Henry C. L. Johnson has returned to Sylvania Electric Products, Inc., after three years of service in the United States Navy. He resumes his post as advertising manager of the radio division. In addition he will direct the advertising and sales promotion of the industrial electronics and international divisions.



JENSEN INDUSTRIES MOVES

Jensen Industries, Inc., have moved from 677 N. Michigan Ave. to 329 S. Wood St., Chicago 12, Ill.

REYLING AND FRAZIER NOW WITH FREELAND & OLSCHNER

Paul M. Reyling has been appointed manager of production and engineering of Freeland & Olschner Products, Inc., 611 Baronne Street, New Orleans 13, La.

Mr. Reyling was formerly with Tennessee Eastman Corporation where he was senior engineer in charge of the vacuum tube program for the Oak Ridge atomic bomb project.

Howard S. Frazier, former director of engineering of the NAB, has been elected vice president of Freeland & Olschner Products, Inc.

He will be in charge of sales and financing, operating from offices at 1730 Eye Street, N. W., Washington 6, D. C.

In addition to his duties with F & O, Mr. Frazier is conducting a radio management consulting practice for broadcast stations and manufacturers of broadcast equipment.



Paul M. Reyling

WOLIN PROMOTED BY SOLAR

Sylvan A. Wolin, formerly sales manager of the Solar Capacitor Sales Corp., has been named sales promotion manager of both the Solar Manufacturing Corp., and the Solar Capacitor Sales Corp.

George Jephson succeeds Mr. Wolin as sales manager of Solar Capacitor Sales.



S. Wolin



G. Jephson

SPECIAL N. Y. C. TRAIN FOR NEW YORKERS GOING TO PARTS SHOW

The New York Central will run a special train

from the Grand Central station at 4:15 P.M. Sunday, May 12th, for those going to the Radio Parts and Electronic Equipment show in Chicago at the Stevens Hotel, May 13th to 16th.

This train will only carry men affiliated with the radio industry. Dinner, midnight supper and breakfast, and taxicab transportation will be available.

Arrangements were made by Perry Saftler, 53 Park Place, New York City.

FLORANCE NOW CHIEF ENGINEER OF WGHF

Herbert C. Florance has been named chief engineer of the new f-m/iax broadcasting station, WGHF, 10 East 40th Street, New York City.

Mr. Florance was formerly with the Bureau of Ships, Electronics Division.



ALLIED CONTROL NAMES L. A. JONES, V-P

Lewis A. Jones has been elected vice president of the Allied Control Company, Inc., N. Y. City.

GARRARD RECORD CHANGER BROCHURE

A 4-page booklet describing automatic record changers has been released by the Garrard Sales Corporation, 401 Broadway, New York 13, N. Y.

MARION INSTRUMENT CATALOG

A 32-page catalog describing meters, multi-range metertesters, direct-reading fluxmeters, meter components, and meter production techniques, has been prepared by the Marion Electrical Instrument Co., Manchester, New Hampshire.

O'DONNELL CAPACITOR DATA

A 4-page bulletin describing tubular paper capacitors has been released by J. P. O'Donnell and Sons, 316 Stuart Street, Boston 16, Mass.

ELECTRO-TECH EQUIPMENT CATALOG

A 24-page catalog with data on d-c and a-c portable meters, instruments, and laboratory accessories has been released by Electro-Tech Equipment Company, 119 Lafayette Street, New York 13, N. Y.

EIMAC TUBE MANUAL

A 16-page bulletin with data on triodes, tetrodes, pulsed-type triodes, mercury vapor rectifiers, high-vacuum rectifiers, vacuum switches, external anode triodes and tetrodes, and diffusion pumps has been published by Eitel-McCullough, Inc., San Bruno, California.

G. E. AIRCRAFT AND MARINE RADIO BOOKLETS

A 4-page booklet describing personal plane radios has been released by the transmitter division of G. E.

The booklet describes the AS-1B, a 12-tube (200 to 420/550 to 1,500 kc) transmitter and receiver.

Marine communication systems and navigational aids are described in a 16-page booklet.

Some of the units discussed are: Electronic navigator, depth-indicating and recording equipment, radio-direction finders, public address systems, shipboard announcer systems, waterproof loudspeakers, broadcast receivers, transmitters and communications receivers.

SOLA TRANSFORMER BULLETIN

A 36-page bulletin, "Electrical Power, Disciplined," has been released by Sola Electric Company, 2525 Clybourn Avenue, Chicago 14, Illinois. Contains a discussion of the construction and operating theory of the constant voltage transformer, engineering and operating data, and a survey of line conditions.

The catalog section lists thirty-one standard types in capacities ranging from 15 va to 10,000 va with electrical and mechanical specifications.

Laboratory Standards

FM MODEL 78 SIGNAL GENERATOR



SPECIFICATIONS:

CARRIER FREQUENCY RANGE: 86 to 108 megacycles—individually calibrated dial.

OUTPUT SYSTEM: 1 to 100,000 microvolts with negligible carrier leakage.

OUTPUT IMPEDANCE: Constant at 17 ohms.

MODULATION: 400 cycle internal audio oscillator. Deviation directly calibrated in two ranges: 0 to 30 kc. and 0 to 300 kc.

Can be modulated from external audio source.

Audio fidelity is flat within two db from d.c. to 15,000 cycles.

Distortion is less than 1% at 75 kc. deviation.

PRICE: \$300.00 F.O.B. Boonton, New Jersey

PROMPT DELIVERY

MEASUREMENTS CORPORATION
BOONTON NEW JERSEY

CHASSIS • CABINETS • PANELS • RACKS

Skill in **METAL**

PAR-METAL . . . a specialized manufacturing plant employing modern high-speed methods. Nevertheless, Par-Metal products have a definite quality of Craftsmanship—a "handmade" quality born of genuine skill and long experience. Write for Catalogue.



Serving the Electronics Field Exclusively

PAR-METAL PRODUCTS CORPORATION

32-62—49th STREET . . . LONG ISLAND CITY, N. Y.

Export Dept.

118 E. 40th St., N. Y. 16, N. Y.

Crystalab

SPECIALISTS IN
SPECIAL CRYSTALS

TRADE MARK REG. U. S. PAT. OFF.

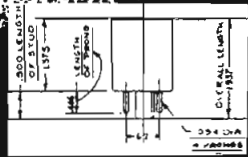
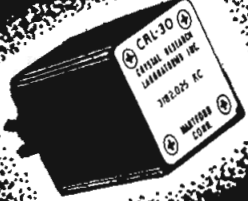
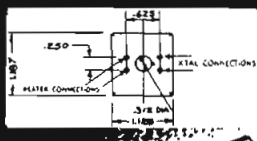

SPACE SAVING FREQUENCY STABILITY

Especially suitable for applications for close frequency tolerance . . . VHF services — police, aircraft, railway communications, etc. . . . works on 6.3v at 1 amp. . . . temp control within $\pm 3^{\circ}\text{C}$ operates at 60°C frequency control of $\pm .005\%$ frequency range 3MC to 14MC . . . fits octal socket . . .

Write Dept. C. O. for comprehensive Catalog, "Selectronic Crystals."



Blanke Ingenuity
makes us

SPECIALISTS IN SPECIAL CRYSTALS



CRYSTAL RESEARCH LABORATORIES INC.

29 ALLYN ST., HARTFORD, 3, CONN., PHONE 7-3215

Draftsman Wanted

Also

Designer, Detailer, Tracer and Engineer

We are one of the largest manufacturers of a wide variety of communication and electronic equipment in the world, fully prepared and ready to go ahead with a very ambitious, expansion program as quickly as we are permitted. There will be unlimited possibilities for creative, ambitious men to advance to key positions both in research development and production field.

Good Starting Salaries

Exceptionally fine working conditions

Apply: Personnel Office, 8 A. M. to 5 P. M.

Federal Telephone & Radio Corp.

the Mfg. unit of the International Tel. & Tel. Corp.

591 BROAD ST., NEWARK, N. J.

W M C Rules Observed

THE INDUSTRY OFFERS . . .

PRESTO RECORDING TURNTABLE

Recording turntables, type 14A, directly gear-driven at both 78.26 and 33.33 rpm by a synchronous motor, have been announced by Presto Recording Corporation, 242 W. 55th St., N. Y. 19, N. Y.

Speed regulation within a revolution is said to be held constant by the combination of a heavy cast iron turntable, flexibly coupled discs, and a precision gear train.

Reduction of mechanical vibration is said to be made possible by the use of a filter employing Prestoflex, a damping material developed in the Presto laboratories. Vibration is also said to be isolated by mounting the motor, gear box and transmission shaft on a separate cast-iron base, an assembly weighing 160 pounds.

The cutting head mounting is designed for the use of either a vertical or lateral recording assembly.

The cutting head feed screw is directly gear-driven. Any one of five pitches may be selected by moving a convenient gear-shift lever. A single feedscrew permits cutting outside-in or inside-out.



NATIONAL 10-TUBE SUPER

A 10-tube superheterodyne, NC-46, has been announced by the National Company, Malden, Mass.

Features include a series valve noise limiter with automatic threshold control, c-w oscillator, separate r-f and a-f gain controls, and amplified and delayed avc.

Power supplies are self-contained and operate on 105 to 130 volts, a-c or d-c. Audio output of 4 watts is provided by push-pull 2SL6s.

Variable capacitors have inertia type drive. A coil switch with silver-plated contacts selects four ranges from 550 kc to 30 mc. Provision is made for either headphone or speaker.



UTC SUB-OUNCERS

Sub-ounce (1/2 ounce) transformers, 9/16" x 5/8" x 3/8", have been announced by the United Transformer Corporation, 150 Varick Street, New York 13, N. Y.

The coil is layer-wound of Formex wire, on a molded nylon bobbin. Insulation is of cellulose acetate. Core material is Hipermalloy.

Five standard items are available. Frequency response is said to be $\pm 3\text{db}$ from 200 to 5,000 cycles.

Type SO-1 (input) level is 4 vu; primary impedance is 200 ohms; secondary impedance, 25,000 ohms (with 0 d-c on primary, primary impedance is 50 ohm, secondary impedance is 62,500 ohms). Interstage type SO-2 (3:1) has a

Portable POWER CLEANER

For Cleaning
Electrical Equipment,
Wiring, etc.



IDEAL "3-in-1" Electrical BLOWER

BLOWS • VACUUMS • SPRAYS

Super-powered, Heavy Duty, full 1 H.P. motor. Gently but effectively blows or vacuums dry air at low pressure; won't harm electrical insulation or wire connections, etc.; completely removes dust, dirt, etc. in all types of general cleaning, from floors and furniture to the most delicate mechanism. Easy to reach out-of-the-way places because of extreme portability. Wide selection of attachments available.

PROMPT DELIVERY
Write for Detailed Literature

IDEAL COMMUTATOR DRESSER CO.
4025 Park Ave. Sycamore, Ill.
Sales offices in all Principal Cities

IDEAL

Sycamore 1407

4 vu level; primary impedance is 10,000 ohms with 0 d-c in primary; secondary impedance is 90,000 ohms. Type SO-3 for plate to line has a 23-vu level; primary impedance of 10,000 ohms; secondary impedance of 200 ohms (with 3/1.5 mil d-c in primary, primary impedance is 25,000 ohms, secondary impedance is 500 ohms). The type SO-4 output has a 20-vu level, 30,000-ohm primary impedance and 50-ohm secondary impedance with 1.0 mil d-c in primary. The fifth type, SO-5, is a reactor with an inductance of 50 henrys at 1 mil d-c, 3000 ohms d-c resistance.

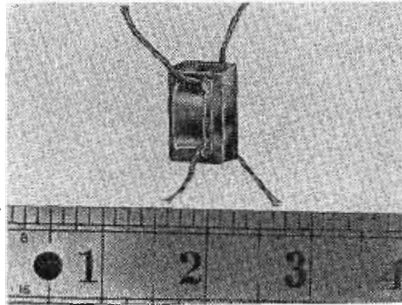

ELECTRO-VOICE CARDIOID CRYSTAL MICROPHONE

A cardioid unidirectional crystal microphone, model 950 Cardax, providing dual frequency response selection has been announced by Electro-Voice, Inc., 1239 South Bend Ave., South Bend 24, Indiana.

Utilizing the Mechanophase principle the microphone is said to have wide angle front pick-up, and be dead at rear; stops feedback, reduces pick-up of background noise and reverberation.

Supplied with standard 3/8"-27 thread for standing mounting, and 20' shielded cable.



WORKSHOP ASSOCIATES COAXIAL ANTENNA

A colinear coaxial beacon with a non-directional pattern in azimuth, vertically polarized for use on the 152 to 162-mc band has been produced by The Workshop Associates Inc., 66 Needham St., Newton Highlands 61, Mass. Antenna is enclosed in a non-metallic pressurized housing. By flattening out the vertical pattern, the cal-

(Continued on page 76)

IMMEDIATE SHIPMENT!

Radio Parts Electronic Equipment

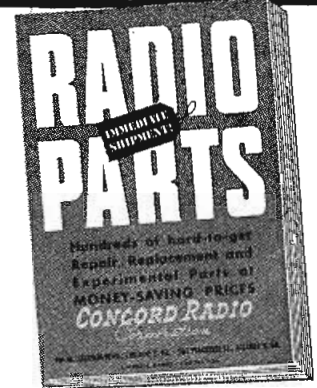

Mail Coupon Below for New
CONCORD CATALOG—Sent FREE

32 pages of money-saving bargains in hundreds of standard-line, top-quality radio and electronic parts. Note these typical CONCORD values—



Precision Resistor
12 Megohm
10 K. V.
Sprague ferrule mtg. type.

5B121 \$495

Time Delay Relay
15 Amp. contacts, timed at 60 sec. + or - 3 sec. for 115 v. 60 c. operation.



5B4097 \$495

Order Today for Shipment Tomorrow
from CHICAGO or ATLANTA

Huge stocks in TWO convenient warehouses—one in CHICAGO and one in ATLANTA—are ready NOW to make IMMEDIATE SHIPMENT of radio and electronic parts and equipment of dependable, nationally-known quality—and at Victory Clearance prices that mean important savings on Meters, Condensers, Transformers, Resistors, Controls, Switches, Relays, Test Equipment, Generators, Microphones, Tools, and hundreds of Repair, Replacement and Accessory Parts. Whatever your needs, see the surprising values offered in CONCORD'S NEW CATALOG. Mail the coupon for your FREE copy now.

CONCORD RADIO CORP.

Lafayette Radio Corporation

CHICAGO 7, ILL. ATLANTA 3, GA.
901 W. Jackson Blvd. 265 Peachtree Street

CONCORD RADIO CORPORATION
901 W. Jackson Blvd., Dept. R-26
Chicago 7, Illinois
Please rush free copy of CONCORD'S new 32-page CATALOG.

Name.....
Address.....
City..... State.....

HOPP Plastic RADIO DIALS

DIAL WINDOWS,
NAME PLATES,
SCALES, GAUGES,
CHARTS,
CALCULATORS, ETC.

PLASTIC RADIO DIALS combine the beauty of radiant color with the utility of perfect light transmission. The possibilities of design, size, shape and color combination are limitless.

Whether your problem is dials, or any of hundreds of allied applications, let Hopp artists and engineers "sit in" on your designing problem. Send us your blueprints or samples for quotation.

ESTABLISHED 1893
THE HOPP PRESS, INC.
460 W. 34th STREET, NEW YORK 1, N. Y.

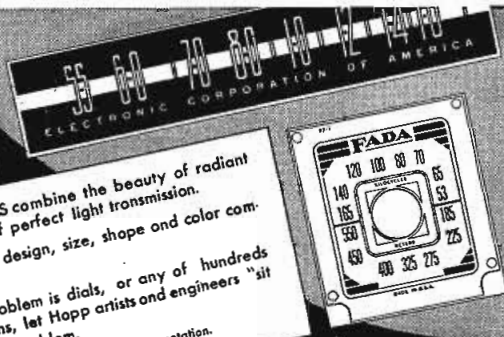

MOBILE RADIOTELETYPE

(Continued from page 55)

amplifier. Continuous-wave communication with a power output of 2 kw is also possible from the transmitting shelter, using the frequency-shift exciter as an extra oscillator or by using the oscillator units furnished with transmitter BC-610 (the 300-watt transmitter of SCR-399). Continuous-wave operation at hand-keying speeds is also possible from the receiving shelter by the proper adjustment of switching facilities of the control unit.

Antennas

The transmitting antenna is mounted on supports 50' high. The two doublet receiving antennas, separated by three wavelengths for efficient diversity reception, are carried on supports 35' high.

Credits

Some of the components of the set were designed at the Coles Signal Laboratory under the direction of Captain Bruce V. Magee, project officer, and J. C. Pearce and Leo Kugler, civilian engineers. Installations in the President's railway car were made by Thomas Wolstencroft, LeRoy Lindberg, and Lt. Clifford Garsuch.

Figure 6 (top, left) and 7 (bottom, left) Figure 6. Block diagram of equipment set-up. Figure 7 shows how the system is linked. In the transmitting shelter the modified SCR-399 (300-watt transmitter) is housed.

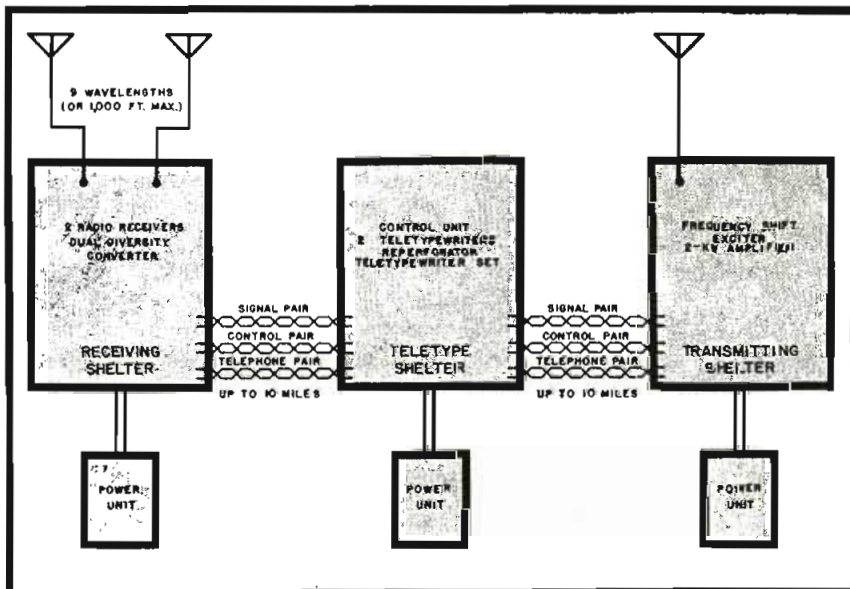
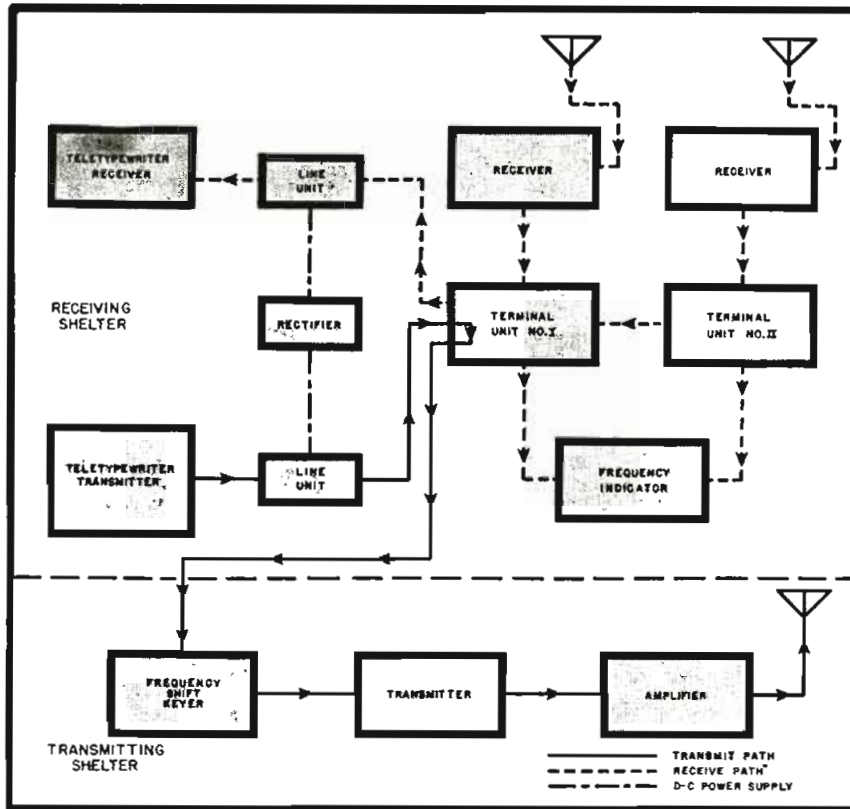

FIRST WITH THE BEST!

When any leading manufacturer brings out a new product, you're sure to find it at Newark—as fast as the product is available. Standard items, too, are always part of the giant stocks of both Newark stores.

BIG NEW CATALOG!

Newark's new catalog will include everything for radio and electronics, and by writing for it now, you will also be placed on the list of those who receive Newark's famous bargain lists each month. Write today, addressing Dept. C of nearest Newark branch.



CHICAGO

Newark ELECTRIC Company

115-117 W. 45th St. NEW YORK 19 323 W. Madison St. CHICAGO 6

ADOLPH GROSS SAM PONCHER

CRYSTALS
EXCLUSIVELY



SINCE
1934

PETERSEN RADIO CO., Council Bluffs, Iowa

Ted McElroy

World's Largest Manufacturer of
Wireless Telegraphic Apparatus
COMPLETE CENTRAL OFFICE EQUIPMENT
McElroy Manufacturing Corp.
82 Brookline Avenue • Boston, Massachusetts

PRODUCERS of:

- Variable Resistors
- Selector Switches
- Ceramic Copacitors, Fixed and Variable
- Steatite Insulators
- Silver Mica Capacitors (Button type)



Centralab

Division of GLOBE-UNION INC., Milwaukee

Electronic Research & Mfg. Corp.

A Service to INDUSTRY

DEVELOPMENT AND CONSTRUCTION OF ELECTRONIC EQUIPMENT FOR ANY APPLICATION

Write or telephone for a discussion of your problem—without obligation.

1420 East 25th Street, Cleveland 14, Ohio
SU. 1958

Remler Appointed as Agent for R.F.C.

... to handle and sell government owned electronic equipment released for civilian use.

Write for Bulletin Z-1 listing a wide variety of equipment covering entire electronic field.

Remler Co., Ltd. :: 2101 Bryant Street, San Francisco 11, Calif.

REMLER SINCE 1918

Radio • Communications • Electronics

FREE TO YOU
COLOR CODE AND OHMS LAW CALCULATOR

A great convenience. Easy to work. Solves many problems. Attach coupon to your letterhead. Free to radio men, engineers, etc.

BURSTEIN-APPLEBEE COMPANY
1012 McGee St. Kansas City 6, Mo.

Send me FREE Color Code and Ohms Law Calculator along with latest catalog.

I am _____ STATE CONNECTION IN INDUSTRY _____

NAME _____

ADDRESS _____

TOWN _____ STATE _____

BURSTEIN-APPLEBEE COMPANY
1012 McGee St. Kansas City 6, Mo.
Mail-Coupon Now

MEMO

TO: *Engineering*

FROM: *Sales Dept.*

112 volts - A.C. → [Diagram] → 12 volts D.C.

Please design this Rectifier transformer

Required:

Battery charger to maintain, fully charged at all times, the 12 volt 6 cell heavy duty battery; to rapidly recharge at 12 ampere rate and to automatically reduce to trickle rate at proper time. . . . Source of power—115 volts AC 60 cycle power line.

We solved this problem by designing the necessary rectifier power pack (to convert the AC to DC)—the heavy duty transformer to step this power down to 12 volts—the automatic charge rate control—and the heavy duty, weather-proof steel housing . . . We had designed and built another rugged, first quality B-L Rectifier Power Pack unit.

Why a *metallic* rectifier? Because the B-L Rectifier is outstanding in:

1. Durability.
2. Trouble-free long life.
3. The elimination of current reversals during primary power supply failures.
4. Freedom from atmospheric damage.

What is your problem?

SELENIUM  **COPPER SULPHIDE**

THE BENWOOD-LINZE COMPANY
1815 LOCUST STREET ST. LOUIS 3, MO.
Long Distance Telephone CEntral 5830

Designers and Manufacturers of Selenium and Copper Sulphide Rectifiers, Battery Chargers and DC Power Supplies for practically every requirement.

Radio Headquarters

for 25 years

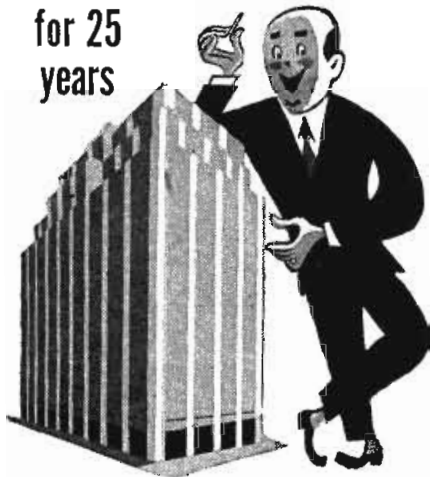

We ship at once—parts, equipment, whatever you need!

This house began its career almost as early as Broadcasting itself! Today, 25 years later, we're the world's largest radio supply house! **Standard Lines:** National, Hammarlund, R. C. A., Hallicrafters, Bud, Cardwell, Bliley, and all the others!



SUPERSPEED SERVICE Orders shipped out same day received, on most goods.



ENGINEERING SERVICE If your engineering problem requires special equipment, we'll make it

FREE!

Latest bargain flyer includes test instruments, record changers, communication receivers, ham transmitting tubes and a host of electronic items you need today.



Originators and Marketers of the Famous

Lafayette Radio

Radio Wire Television Inc.

NEW YORK 13 BOSTON 10 NEWARK 2

Cut out coupon, paste on penny post card, mail today

R. W. T. Dept. TB-6

100 AVENUE OF THE AMERICAS, NEW YORK 13

Gentlemen, Send me FREE copy of your Latest Bargain Flyer C-36, packed with recent electronic equipment and components.

NAME _____

ADDRESS _____

CITY _____ ZONE _____ STATE _____

THE INDUSTRY OFFERS...

(Continued from page 73)

culated power gain is said to be 25 over that of a dipole.

Antenna is expected to be part of Link Radio's police equipment.

CLIPPARD VOLT-OHMMETER

An electronic volt-ohmmeter, type 406, is now in production at the Clippard Instrument Laboratory, 1440 Chase Avenue, Cincinnati 23, Ohio. Has a high-impedance pen type dual-diode probe on a 36" detachable shielded cable.

Said to have a full scale sensitivity of 0-1, 0-3, 0-10, 0-100, 0-300 and 0-1000 volts a-c and d-c. Zero to 1000 megohms, in seven range 0-6 scale of -20 to + 51 provided; uses square-faced D'Arsonval type meter of 200 microampere sensitivity.

Uses a 6X5GT rectifier, two 6SN7GT dual-purpose tubes and one 6AL5 dual diode in a shielded probe.

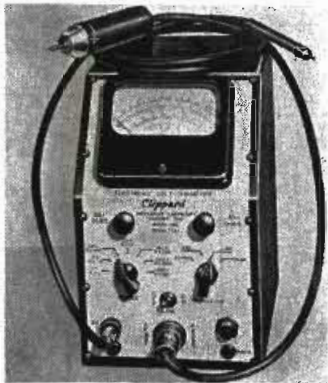

NEWCOMB P-A AMPLIFIERS

Audio amplifiers, pre-amplifiers and accessories, have been announced by Newcomb Audio Products Co., 2815 S. Hill St., Los Angeles 7, Calif. Two types, the K and H series are being made. The K series has a volume and overload indicator and master volume control.

Units are made in standard and portable systems. Plug-in, hum-free input transformers for instant conversion from high to low impedance are featured in the amplifiers.

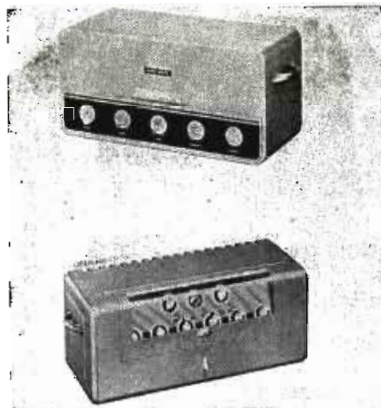

UNIVERSAL MICROPHONE DESK STAND

Microphone desk stands, type A31, with die cast base and wooden handle, finished in brown tone enamel, has been announced by Universal Microphone Co., Inglewood, Cal.

The upright (handle) section is demountable and can be used to convert an ordinary microphone to a hand-held instrument.

A series of rubber feet on the bottom of the base serves as protection for desk or table top.

The desk stand assembly uses a 5/8-27 thread brass ferrule at the top of the handle for attaching the microphone itself.

COLLINS A-M BROADCAST TRANSMITTER

A 250/100 watt a-m broadcast transmitter, 300G, has been announced by the Collins Radio Company, Cedar Rapids, Iowa.

High level class B modulation is used. The

frequency response is said to be flat from 30 to 10,000 cps, with a maximum deviation of ± 1.0 db. Two separate temperature controlled oscillator units are standard equipment, either of which are said to maintain the carrier frequency to within ± 10 cps. Power output may be reduced from 250 watts to 100 watts by a switch on the control panel.

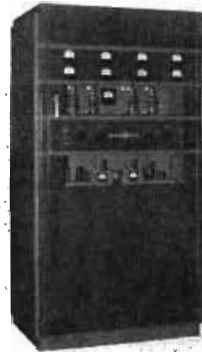

MARION INDUCTION HEATER FOR PRODUCTION SOLDERING

A portable bench-type induction heater, developed for soldering of small parts, and for soldering of metal to metallized glass and ceramics, is now available from Marion Electrical Instrument Co., Manchester, N. H. Said to consume 775 watts at full load and 100 watts on standby.

Coupling link of unit operating at low impedance, is provided with a grounded center tap. The frequency is 450 kc.

Furnished in a standard relay rack cabinet, and measures 15 3/4" x 21 1/2" x 15"; weighs 150 pounds. 115-volt, 60 cycle power supply is required.

GARRARD RECORD CHANGERS

A record changer, model RC 60, has been an-

CARTER DYNAMOTORS
Preferred in World Famous Communications Equipment

THOUSANDS of Carter Products are faithfully providing dependable, efficient service in leading communications equipment all over the globe. Send today for the latest catalogue of Dynamotors, Converters, Permanent Magnet Hand Generators, and Magmotors.

Carter Motor Co.

1603 MILWAUKEE AVE. CABLE: GENEMOTOR
CARTER, a well known name in radio for over twenty years.

nounced by Garrard Sales Corp., 401 Broadway, New York.

Changer has a patented non-slip record spindle and a selector mechanism to handle mixed 10" and 12" records in any combination. Governor-controlled motor can be adjusted to the proper playing speed with a finger-tip control. Comes with a choice of a magnetic pickup for interchangeable needles or a new one-ounce crystal cartridge.

INDUSTRIAL PRODUCTS CONNECTORS

R-f connectors for solid dielectric cables and gas-filled lines have been announced by Industrial Products Company, Danbury, Conn.

ATLAS BOOSTER PROJECTOR

A miniature reentrant p-m booster projector, HU-15, has been developed by Atlas Sound Corporation, 1451 39th Street, Brooklyn, N. Y.

Has a built-in, hermetically-sealed driver type unit. Supplied with adjustable mounting bracket that permits both a vertical as well as horizontal adjustment.

Voice coil impedance, 8 ohms; diaphragm material, unbreakable phenolic; input power, 12 watts; bell diameter 8 1/2 inches; overall depth, 8 1/2 inches; net weight, 6 pounds.



ALLIED CONTROL RELAY

A control relay, type CR, has been announced by Allied Control Co., Inc., 2 East End Avenue, New York, N. Y.

Heavy gram pressure is said to permit power switching. Available in two, three and four pole combinations, and if desired, hermetically sealed.

Contact rating with 3/4" silver contacts is 15 amperes at 24 volts d-c or 110 volts a-c, non-inductive.

Single pole type weighs 3 ounces. Size, 1 33/64" high, 1 3/32" wide and 1 25/32" long.

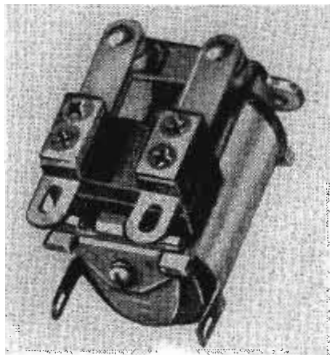

KAAR F-M TRANSMITTERS

Mobile 50 and 100 watt f-m 30 to 44-mc transmitters which operate from a 6-volt automobile battery, and a companion f-m receiver have been announced by Kaar Engineering Company, Palo Alto, California.

Transmitters use instant-heating tubes.

Transmitter features a patent pending system of modulating the phase modulator tubes.

Both the 50- and 100-watt transmitters have self-contained dynamotor power supplies. Transmitting and receiving units are housed in identical cabinets, 8 1/2" high, 8" wide and 18" long.



Kaar F-M Units.

SHURE GLIDER PICKUPS

A crystal phonograph pickup, the glider, with the lever-type cartridge and a low-mass tone arm, has been developed by Shure Brothers, Chicago.

No springs or counterweights are used. Output voltage, 1.6

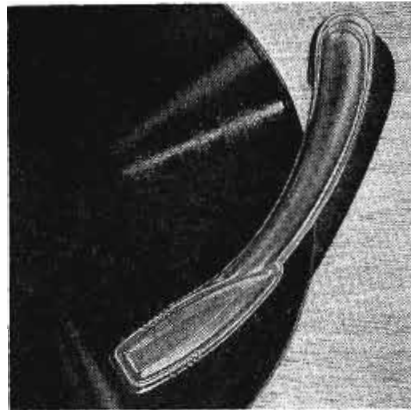

G.E. F-M/TELEVISION TUBES

A triode, type GL-9C24, designed particularly for application in a grounded-grid circuit as a class B r-f amplifier and a class C r-f amplifier and oscillator, has been announced by G.E.

Full ratings apply up to 220 megacycles. The tube has been tested under class B r-f power amplifier conditions with a bandwidth of 5 mc. Anode is water-cooled and capable of dissipating 5 kw.

As a class B r-f amplifier in a grounded-grid cavity the tube has a maximum d-c plate voltage rating of 5000 volts. Actual 220 mc tests under broad-band and synchronizing peak conditions show a useful power output of 3.4 kw per tube at a d-c plate voltage of 4000. The use of a grounded-grid cavity in this application minimizes the necessity for neutralization.

At 110 mc, tests under class C r-f power amplifier conditions in a grounded-grid circuit at a d-c plate voltage of 6000 have shown a useful power output per tube of 6.4 kw. Here the maximum plate dissipation rating is 5 kw and the maximum d-c plate voltage rating is 6500.

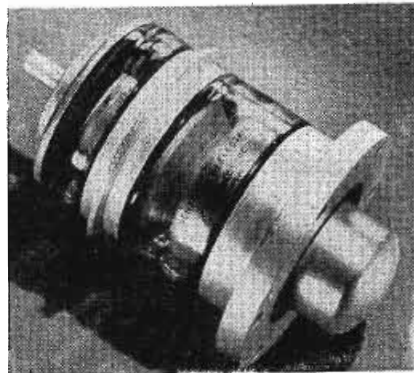

JENSEN COAXIAL SPEAKERS

Coaxial speakers, type H, are now being produced by Jensen Radio Manufacturing Company, Chicago, Ill.

Coaxial consists of two units, each repro-

(Continued on page 78)

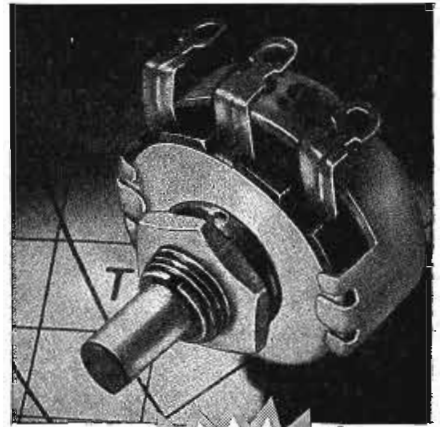

That means a tough, dependable, longer-lasting composition-element potentiometer or control.

★

The exclusive Clarostat stabilized element has established brand new performance standards for composition-element controls. Extreme immunity to humidity, temperature, and other climatic conditions, as well as age.

★

Only 1 1/8" in dia. Body 9/16" deep or 7/8" with switch.

★

Rated at 1 watt. Resistance values of 500 ohms to 5 megohms. Choice of tapers and taps. With or without power switch. Choice of shafts.

★

Available in widest choice of standard values and listed in new No. 46 Catalog. Other values and types made to order. Write for literature. Send us your control or resistance problem.



CLAROSTAT MFG. CO., Inc. • 285-7 N. 6th St., Brooklyn, N. Y.

At Long Last!

A FOLDED DIPOLE TURNSTILE

F.M. ANTENNA

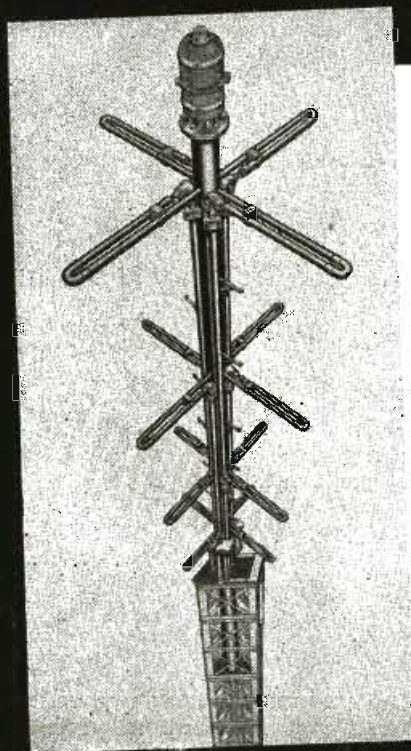

By **WINCHARGER**

- 1—**VERY BROAD BAND** — Incorporates features of ordinary turnstile with vast improvement of FOLDED DIPOLE principle.
- 2—**PROVED** by 4 years actual service in leading 50 K.W. station.
- 3—**FACTORY PRETUNED**—no field adjustment.
- 4—**LARGE SAFETY FACTOR**
- 5—**DESIGNED** by high frequency and Radar antenna engineers of Zenith Radio Corporation.
- 6—**COMPLETE "PACKAGE"** — one company supplies everything — And No Extras to Buy.

Phone, Write or Wire

Antenna Tower Dept.
WINCHARGER
CORPORATION
SIoux CITY 6, IOWA

F & O TRANSMITTING TUBES for RELIABLE LONGER SERVICE

F & O is NOW developing a full line of NEW transmitting tubes, including low power types. Many large and small types are now ready for immediate delivery.

Write today for details of our 1500 hour guarantee and latest revised price list. Inquiries invited from equipment manufacturers concerning development and manufacture of special tubes to fit their requirements.

FREELAND & OLSCHNER PRODUCTS, INC.

611 BARONNE STREET PHONE RAYMOND 4756

NEW ORLEANS 13, LA.

WHEN YOU CHANGE YOUR ADDRESS

Be sure to notify the Subscription Department of COMMUNICATIONS, 52 Vanderbilt Avenue, New York 17, N. Y., giving the old as well as the new address, and do this at least four weeks in advance. The Post Office Department does not forward magazines unless you pay additional postage, and we cannot duplicate copies mailed to the old address. We ask your cooperation.

THE INDUSTRY OFFERS...

(Continued from page 77)

ducing a portion of the total frequency range. A compression-type high-frequency unit is attached to the back of a 15" direct-radiator low-frequency unit. The horn for the h-f unit is formed by a passage of expanding cross section through the core of the l-f unit. The l-f diaphragm is driven by a conventional voice coil assembly. Mouth of the h-f horn is the full size of the l-f cone.

Since the cone of the l-f unit forms a smooth continuation of the h-f horn, there is said to be no large multi-resonant cavity into which the h-f radiation can spill over nor into which the l-f unit can radiate. Objectionable resonances in the cross-over frequency region are therefore said to be minimized.

The combined effect of the cone, acting as a horn and as a vibrating wave guide is said to give wide-angle distribution. Wide-angle radiation is said to be obtained in all directions.

Nominal input impedance is 16 ohms when no transformer is used. Power handling capacity is 25 watts maximum, in speech and music systems. The field is designed for a power dissipation of 20 watts, with 14 watts minimum. Preferred field resistance values which give a full field structure are approximately 320, 500, 820, 1300, 2050, 3300, 5200 and 8250 ohms.

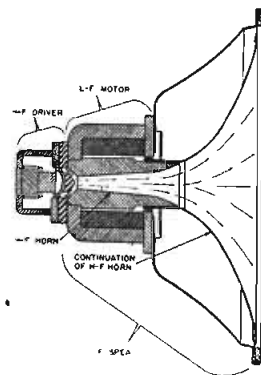

SYLVANIA CRYSTAL DIODES

Germanium crystal diodes (type IN34), .75" x .25", for use as second detectors and d-c restorers in television receivers; frequency discriminators in i-m circuits; first detectors; modulators and demodulators; low-frequency oscillators; voltage regulators; and polarizing devices have been announced by Sylvania Electric Products Inc., electronics division, Boston, Mass.

Other applications include volume limiters; square wave clippers; varistors; noise silencers; meter rectifiers; volume expanders and volume contractors.

Operating characteristics: Peak inverse plate voltage, 50 volts maximum; average plate current, 22.5 milliamperes maximum; peak plate current (a-c signal maximum), 60 milliamperes maximum; surge current (transient peak), 200 milliamperes maximum; back conduction at 50 v., 2 milliamperes maximum.



ALTEC LANSING INTERMODULATION TEST UNIT

Intermodulation test equipment has been announced by the Altec Lansing Corporation, 1210 Taft Building, Hollywood 28, Calif.

Instrument is designed to facilitate the measurement of intermodulation distortion in audio amplifiers, a-m and i-m broadcast transmitters; film, disc and tape recording and reproducing equipment; and loudspeaker systems.

Signal generator contains two independent sine wave oscillators and combining networks. A low-frequency oscillator supplies 40, 60, or 100 cycles; high-frequency oscillator, 1000, 7000

HARVEY

is now delivering
reasonable quantities of
ALTEC LANSING
FM MONITORING EQUIPMENT
and
RECORDING AMPLIFIERS

Designed in the famous Altec Lansing Hollywood laboratories for film recording. Takes the guess work out of FM... the only equipment of its kind. HARVEY'S experienced staff can answer technical questions and advise on installation.

604 DUPLEX SPEAKER

... combining high and low frequency units in one horn, eliminating intermodulation effects and distortion through entire FM range, 50 to 50,000 cycles.



A-323 AMPLIFIER

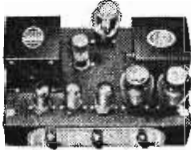

... compact, 6-tube, 18 watt linear amplifier, designed for operation with the Duplex speaker.

A-420 PRE-AMPLIFIER

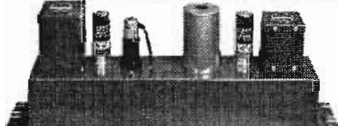

... high gain, low noise level pre-amplifier for use in connection with applications where high quality amplification is desired.

A-255 AMPLIFIER



... for exacting demands of high quality audio frequency power, intended primarily for operating disc recording equipment requiring full power at all frequencies up to 10,000. 40 watts...65 db gain.

A-127 AMPLIFIER

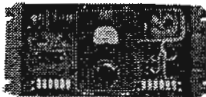

... a 15-watt power amplifier for disc recording, and as a monitor amplifier in recording work. Rated output, 1 db from 40 to 10,000 cycles; frequency response, 1 db from 20 to 20,000 cycles.

Telephone  Longacre 3-1800

HARVEY

RADIO COMPANY

103 West 43rd St., New York 18, N. Y.

or 12,000 cycles. By means of switches and controls any low-frequency may be combined with any high frequency for a two-tone test.

Intermodulation analyzer contains the necessary input controls, power absorbing network, filters, demodulator and meters to measure intermodulation distortion directly in per cent. Said to provide distortion readings from 0.1% up to 100%.

Switches are provided so that in addition to reading intermodulation, the internal vacuum-tube voltmeter can read volts and millivolts. Has a full scale sensitivity from 0.3 millivolts up to 100 volts.

The analyzer is said to be capable of directly reading intermodulation distortion, noise levels and output power over a range from 50 watts (+47 db) down to -90 db.



UNIVERSITY LABORATORY RADIAL CONE SPEAKER PROJECTOR

Radial cone projectors, types RBP-12 and RBP-8, have been developed by University Laboratories, 225 Varick Street, New York 14, New York.

Model RBP-12: Dispersion, 360°; frequency, down to 50 cycles; diameter, 27" x 11" high; weight, 19 pounds. Designed for use with standard 12" cone speaker. Model RBP-8: Dispersion, 360°; frequency, down to 80 cycles; diameter 18" x 9" high; weight, 9 pounds. Designed for use with standard 8" cone speaker.

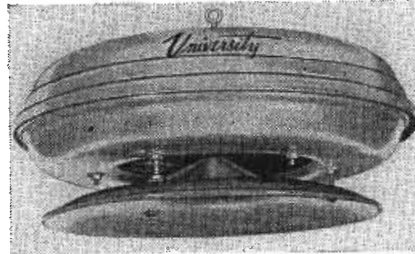

ANDREW V-H-F ANTENNA

A universal type joint, single clamp antenna, type 702, for 28 to 152 mc has been produced by Andrew Co., 363 East 75th St., Chicago 19, Ill. Supplied with 50' of solid dielectric coaxial cable with connectors attached.

RCP VOLT-OHM-MILLIAMMETER

A volt-ohm-milliammeter, model 424, has been announced by Radio City Products Co., 127 West 26th Street, New York.

Said to have a sensitivity of 2500 ohms-per-volt and a movement of 400 microamperes. High milliammeter range is ten megohms with a center to full scale ratio of 125. Low ohm scale reads 5 ohms at center and 0.1 ohm at each of the first ten divisions.

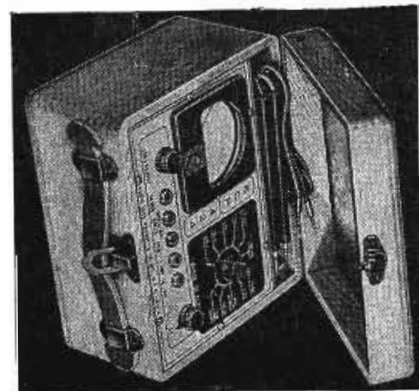

• That's the story. Aerovox Series "14" oil-filled capacitors are only 1 1/4" in diameter by 2 1/4 or 2 3/4" high. 3000 v. .01, .05, and .1 mfd. Unit here shown in actual size. And that's compactness for your ultra-compact "rigs." • Ask your Aerovox jobber for these compact capacitors. Ask for latest catalog—or write us direct. • Meanwhile, be sure to look for that yellow label on capacitors!



FOR RADIO-ELECTRONIC AND
INDUSTRIAL APPLICATIONS

AEROVOX CORP., NEW BEDFORD, MASS., U.S.A.
Export: 13 E. 40th St., New York 16, N.Y. • Cable: 'ARLAB'
In Canada: AEROVOX CANADA LTD., Hamilton, Ont.

EBY

60

SPEAKER CONNECTORS

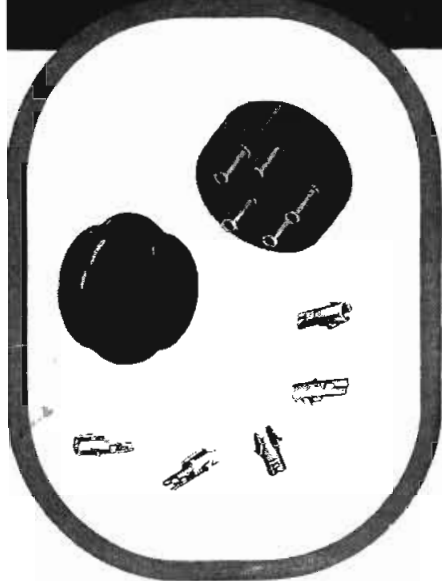

SAVE APPROXIMATELY 25% IN ASSEMBLY TIME

Only 2 parts to Female Assembly:

1. The bakelite casting.
2. Eby patented snap-lock contacts.

Here's assembly speed! It's as simple as this: Attach contact to wire and push into cavity. Contact automatically locks in place. (Casting and contacts supplied unassembled.)

Male Assembly — nickel-plated brass prongs. Bakelite casting — Standard arrangement for 3, 4, and 5 prongs. Other arrangements to specifications.

Write today for samples and prices.

Eby #60 Male and Female Speaker Connectors Are the Standard of the Industry



IF IT'S IN A CIRCUIT
... EBY COMPONENTS
AND SERVICES WILL
HELP YOU DO IT BETTER

ADVERTISERS IN THIS ISSUE

COMMUNICATIONS — FEBRUARY, 1946

AEROVOX CORPORATION	79	IDEAL COMMUTATOR DRESSER COMPANY..	73
Agency: Austin C. Lescarboursa & Staff		Agency: Van Auken & Bagland	
ALLIED RADIO CORP.	66		
Agency: Henry H. Teplitz, Advertising			
AMERICAN PHENOLIC CORP.	29	HOWARD B. JONES COMPANY.....	46
Agency: Evans Associates, Inc.		Agency: Merrill Symonds, Advtg.	
AMPERITE COMPANY	66		
Agency: H. J. Gold Co.		McELROY MANUFACTURING CORPORATION..	74
ANDREW COMPANY	47	Agency: Shappe-Wilkes Inc.	
Agency: Burton Browne, Advertising		MARION ELECTRICAL INSTRUMENT CO.....	6
THE ASTATIC CORPORATION	61	Agency: Shappe-Wilkes Inc.	
Agency: Wearsler Advertising, Inc.		MEASUREMENTS CORPORATION	71
		Agency: Frederick Smith	
BELL TELEPHONE LABORATORIES.....	4, 5	MICO INSTRUMENT CO.....	70
Agency: Newell-Emmett Co.		JAMES MILLEN MANUFACTURING CO., INC.	46
BENWOOD-LINZE COMPANY	75		
Agency: Major Advertising Agency		NATIONAL COMPANY, INC.	49
BLILEY ELECTRIC CO.....	9	Agency: Graydon Smith, Advtg.	
Agency: Hardy Advertising		NEWARK ELECTRIC COMPANY.....	74
BOONTON RADIO CORP.	60	Agency: Charles Brunelle	
Agency: Frederick Smith		PAR-METAL PRODUCTS CORPORATION.....	71
L. S. BRACH MFG. CORP.	64	Agency: H. J. Gold Co.	
Agency: United Adv. Agency		PERMOFLUX CORPORATION	53
BURGESS BATTERY CO.	46	Agency: Turner Advertising Agency	
Agency: Howard H. Monk & Associates		PETERSON RADIO COMPANY.....	74
BURSTEIN-APPLEBEE COMPANY	75	PREMAX PRODUCTS DIV. CHISHOLM-RYDER	54
Agency: Frank E. Whalen Adv. Co.		CO., INC.	
		Agency: Norton Advertising Service	
CAPITOL RADIO ENGINEERING INSTITUTE	65		
Agency: Henry J. Kaufman & Associates		RADIO CORPORATION OF AMERICA.....	35, 59
CARTER MOTOR COMPANY	76	Agency: J. Walter Thompson Co.	
Agency: Advertising Engineers Corp.		RADIO WIRE TELEVISION, INC.....	78
CENTRALAB	75	Agency: S. T. Seldman & Co.	
Agency: Gustav Marx Adv. Agency		RAYTHEON MANUFACTURING COMPANY..	51
CLAROSTAT MANUFACTURING CO., INC.....	77	Agency: J. M. Mathes, Inc.	
Agency: Austin C. Lescarboursa & Staff		REMLER COMPANY, LTD.....	75
COLLINS RADIC COMPANY	7	Agency: Albert A. Drennan	
Agency: McCann-Erickson, Inc.			
CONCORD RADIO CORPORATION.....	73	SPERRY GYROSCOPE COMPANY, INC.....	13
Agency: E. H. Brown Adv. Agency		Agency: Charles Dallas Reach Company	
COTO-COIL CO., INC.	69	SPRAGUE ELECTRIC COMPANY.....	41
Agency: Frank E. Dodge & Co., Inc.		Agency: The Harry P. Bridge Company	
CRYSTAL RESEARCH LABS., INC.....	72	STANDARD PIEZIC COMPANY	68
Agency: Post & Johnson & Livingston, Inc.		Agency: T. L. Dartnell Advertising Agency	
		STANDARD TRANSFORMER CORP.....	63
D-X RADIO PRODUCTS COMPANY	52	Agency: Burnet-Kuhn Adv. Company	
Agency: Michael P. Mayer		SUPREME INSTRUMENTS CORPORATION.....	60
		Agency: O'Callaghan Advertising Agency, Inc.	
HUGH H. EBY, INC.	80	SYLVANIA ELECTRIC PRODUCTS INC.....	3
Agency: Renner Advertisers		Agency: Newell-Emmett Company	
EITEL-McCULLOUGH, INC.	27		
Agency: L. C. Cole, Advertising		TAB	70
ELECTRICAL REACTANCE CORPORATION ...	54	TECH LABORATORIES	67
Agency: Scheel Advertising Agency		Agency: Lewis Advertising Agency	
ELECTRONIC ENGINEERING COMPANY, INC.	68	THOMAS & SKINNER STEEL PRODUCTS CO. ..	11
Agency: Burton Browne, Advertising		Agency: The Caldwell-Baker Company	
ELECTRONIC RESEARCH & MFG. CO.	75	TRANSMITTER EQUIPMENT MANUFACTURING	
ELECTRONICS RESEARCH PUBLISHING	52	CO., INC.	Back Cover
COMPANY		Agency: A. W. Levin Co., Inc.	
FEDERAL TELEPHONE & RADIO CORP... 21, 43		TURNER COMPANY	55
Agency: Marschalk & Prait		Agency: W. D. Lyon Company	
FEDERAL TELEPHONE & RADIO CORP.	72		
Agency: Commerce Agency, Inc.		UNITED TRANSFORMER CORP.....	10
FERRANTI ELECTRIC, INC.	1	Agency: Shappe-Wilkes Inc.	
FREELAND & OLSCHNER, INC.....	78		
		WESTERN ELECTRIC	4, 5
GENERAL RADIO COMPANY.....	Inside Back Cover	Agency: Newell-Emmett Co.	
		WINCHARGER CORPORATION	78
HAMMARLUND MANUFACTURING CO.....	14	Agency: Critchfield & Company	
Agency: Roeding & Arnold, Inc.			
HARVEY RADIO COMPANY.....	79		
Agency: Shappe-Wilkes Inc.			
HARVEY RADIO LABS., INC.....	Inside Front Cover		
Agency: Walter B. Snow & Staff, Inc.			
HEWLETT-PACKARD COMPANY	8		
Agency: L. C. Cole, Advertising			
HICKOK ELECTRICAL INSTRUMENT CO.....	62		
Agency: White Advertising Company			
THE HOPP PRESS, INC.	73		
Agency: Gallard Advertising Agency			



DIRECT-READING Capacitance Bridge

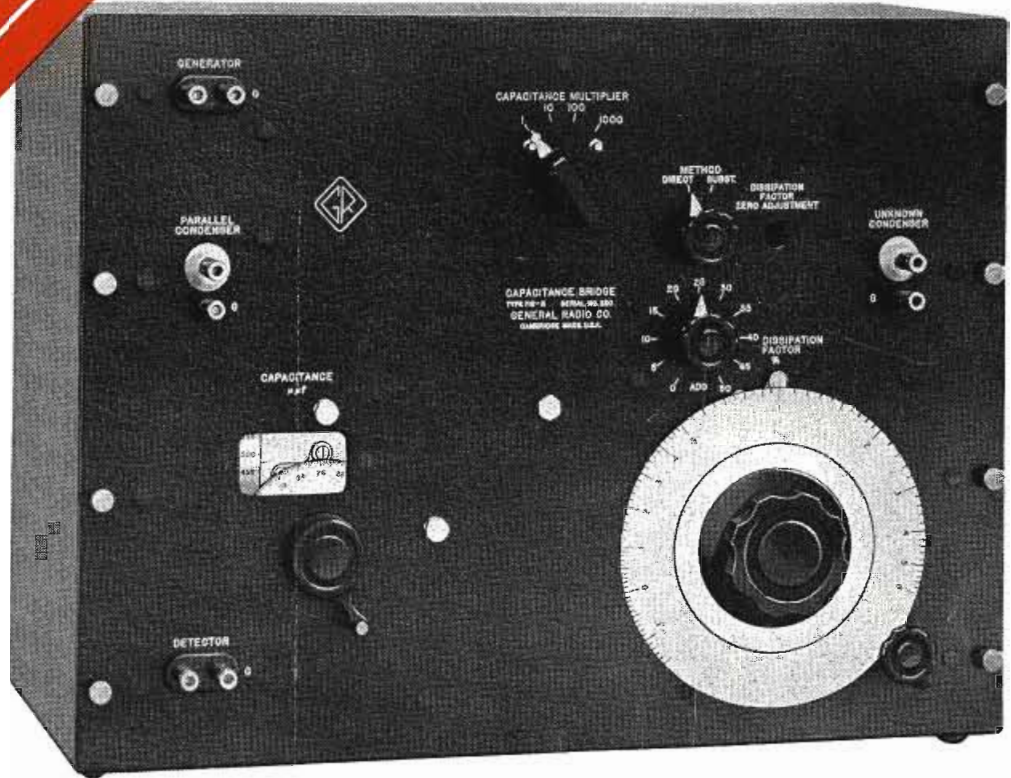

FOR THE MEASUREMENT of capacitance and dissipation factor this direct-reading bridge is finding wide application for such determinations as dielectric constant, phase angle, power factor, loss factor and other dielectric properties of insulating materials and changes in these properties with factors such as temperature and humidity. For the production adjustment and testing of fixed and variable condensers it is particularly effective.

This instrument is a modified Schering bridge, direct-reading in both capacitance and power factor at 1,000 cycles. By adding an external decade resistance box, it can be converted into a series- or parallel-resistance bridge.

WIDE RANGES—Direct-reading in capacitance from 100 micromicrofarads to 1 microfarad; in dissipation factor from 0.002% to 56%. Substitution method for capacitance the range is 0.1 micromicrofarad to 1,000 micromicrofarads with internal standard and to 1 microfarad with external standard.

HIGH ACCURACY—Direct-reading accuracy for capacitance is 0.2% of full scale for each range; substitution method accuracy for capacitance is $\pm 0.2\%$ or ± 2 micromicrofarads.

WIDE FREQUENCY RANGE—All calibration adjustments are for the 1 kc direct-reading settings; any frequency between 60 cycles and 10 kc can be used, in which case the dissipation-factor readings are corrected by multiplying the dial readings by the frequency in kilocycles.

This bridge is suitable for practically *any* type of capacitance measurement. Because of its design, the readily accessible terminals and the simplified controls it is a very flexible and simple-to-operate instrument.

TYPE 716—BR Relay Rack Mounting.....\$335
TYPE 716—BM Cabinet Model..... 360

Write for complete specifications

GENERAL RADIO COMPANY

Cambridge 39,
Massachusetts

90 West St., New York 6

920 S. Michigan Ave., Chicago 5

1000 N. Seward St., Los Angeles 38

See!

The New **TEMCO** High Fidelity **FM BROADCAST TRANSMITTER**

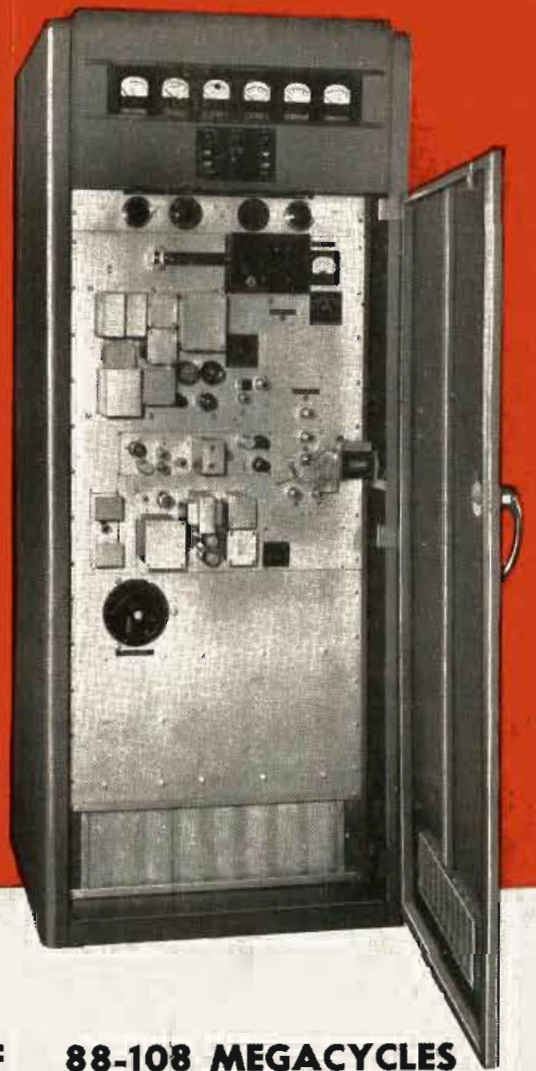

*Ready for delivery**

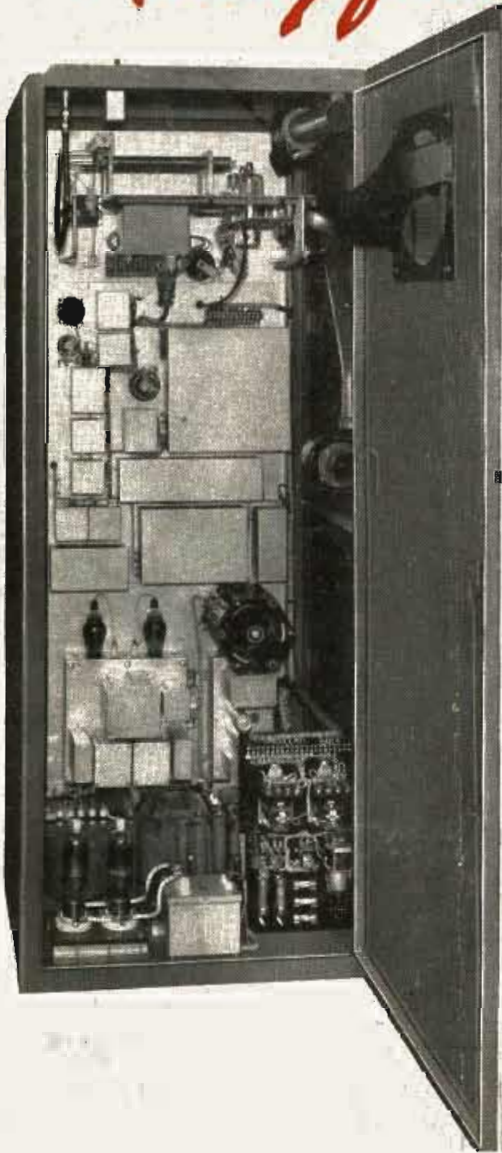

MODEL 250 BCF 88-108 MEGACYCLES

TEMCO proudly presents this outstanding achievement in FM engineering—the result of 10 years of pioneering in custom-built, superlative communication equipment.

HIGHLIGHTS OF THE TEMCO 250 BCF

- Normal rated output power 250 watts. Maximum rated output power 375 watts.
- Continuous monitoring of the carrier frequency by a center frequency deviation meter calibrated directly in cycles.
- An exciter unit—heart of the transmitter—characterized by tuning simplicity accomplished by employing only 4 stages to raise the primary oscillator frequency to the carrier frequency.
- A new circuit of technically advanced concept which maintains a high degree of center frequency stabilization without introduction of distortion.
- Peak efficiency and great dependability are obtained by the use of new miniature V-H-F tubes in the exciter.
- Improved design in the IPA and PA stages eliminating tank radiation, feedback, radio frequency and high voltage potentials from the tank circuits and transmitter frame.

*A limited quantity of the TEMCO Model 250 BCF will be available for January delivery. Orders will be filled in rotation as received. ACT NOW. Place your order at once.

NOW ON DISPLAY FOR YOUR INSPECTION.
Phone or wire for an appointment.

TEMCO

**RADIO COMMUNICATION EQUIPMENT
TRANSMITTER EQUIPMENT MFG. CO., INC.**

345 Hudson Street, New York 14, N. Y.