



374A

PENTODE

Western Electric

DESCRIPTION

The 374A is a filamentary type suppressor grid power pentode. It is designed for use as an audio-frequency power amplifier or as an oscillator.

CHARACTERISTICS

Filament Voltage, A-C	3.0 volts
Plate Current	24 milliamperes
Transconductance	3400 micromhos
Power Output	2.0 watts

$E_b = E_{c2} = 150$ volts;
 $E_{c1} = -18$ volts; $E_{cs} = 0$

GENERAL CHARACTERISTICS**ELECTRICAL DATA**

Filament Voltage, A-C	3.0 volts
Filament Current	0.53 ampere
Direct Interelectrode Capacitances	
Grid to Plate	0.18 uuf
Input	9.2 uuf
Output	6.5 uuf

MECHANICAL DATA

Cathode	Coated Filament
Bulb	T11
Base ¹	Short intermediate shell, 7-pin octal
Mounting Position	Vertical — or horizontal with plane of filament vertical.

Dimensions and pin connections shown in outline drawing on Page 6

MAXIMUM RATINGS, Design-Center Values

Plate Voltage	150 volts
Screen Grid Voltage	150 volts
Plate Dissipation	4.8 watts
Screen Grid Dissipation	1.0 watt

TYPICAL OPERATING CONDITIONS AND CHARACTERISTICS

Filament Voltage, A-C	3.0	3.0 volts
Plate Voltage	135	150 volts
Screen Grid Voltage	135	150 volts
Control Grid Voltage	-16	-18 volts
Suppressor Grid Voltage	0	0 volts
Peak A-F Grid Voltage	12	12 volts
Zero Signal Plate Current	22	24 milliamperes
Maximum Signal Plate Current	24.5	26 milliamperes
Zero Signal Screen Grid Current	1.1	1.2 milliamperes
Maximum Signal Screen Grid Current	5.5	4.8 milliamperes
Transconductance	3250	3400 micromhos
Plate Resistance	60000	60000 ohms
Load Resistance	4500	4000 ohms
Maximum Signal Power Output	1.8	2.0 watts
Total Harmonic Distortion	12.5	12.0 per cent

1. Pin # 6 is approximately 3/32 inch shorter than the other pins to minimize noise when changing tubes while in service.

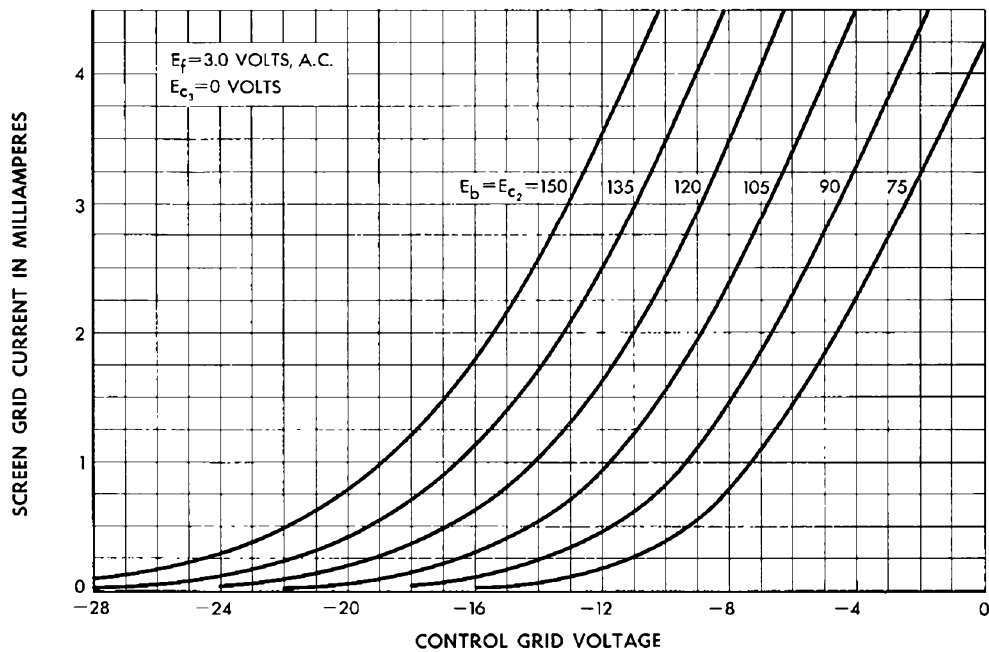
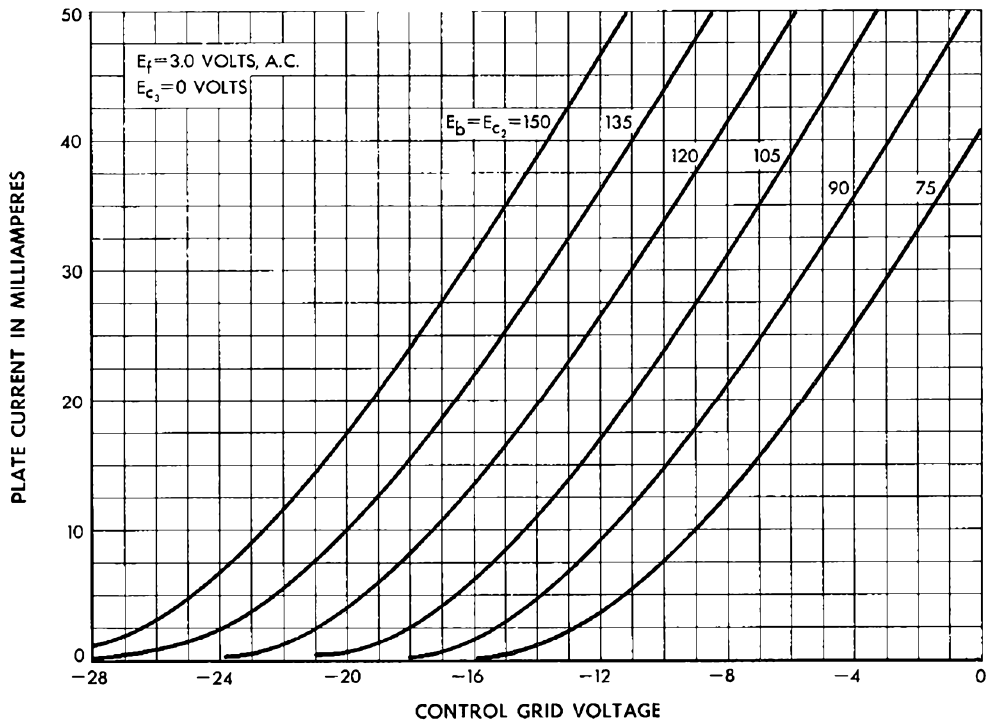

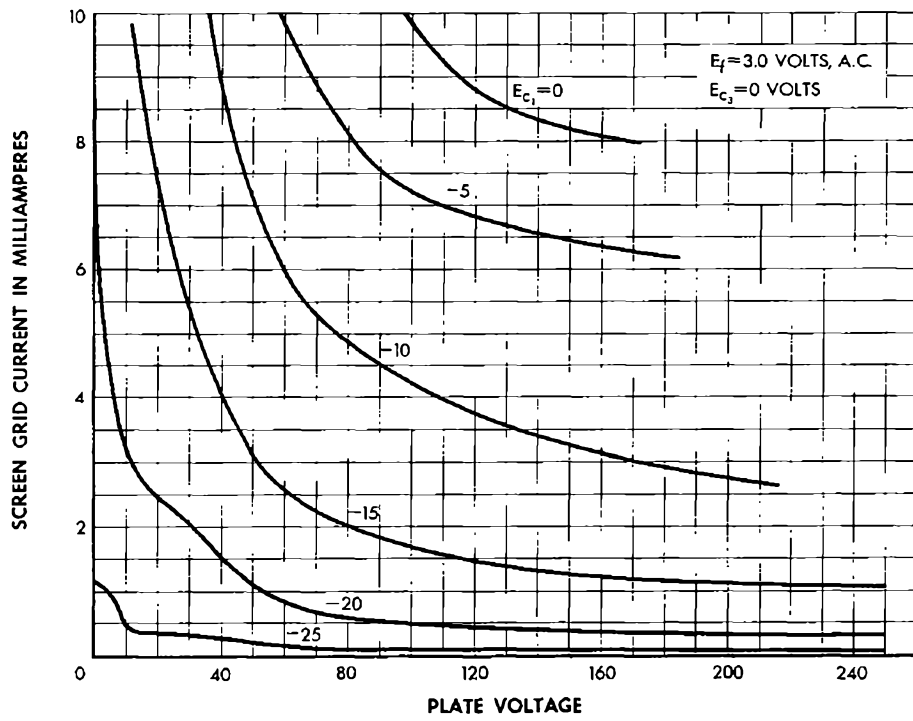
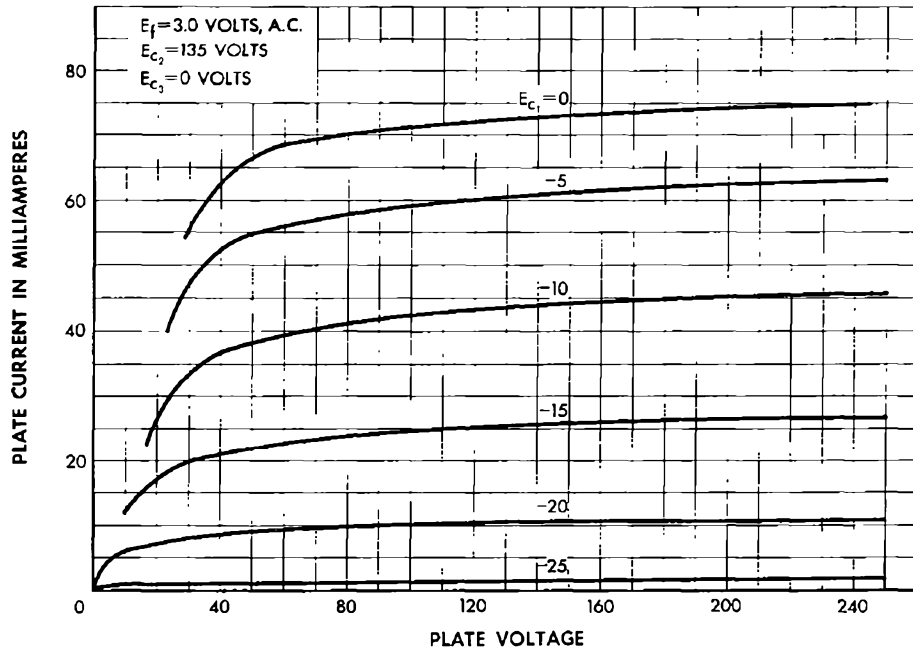

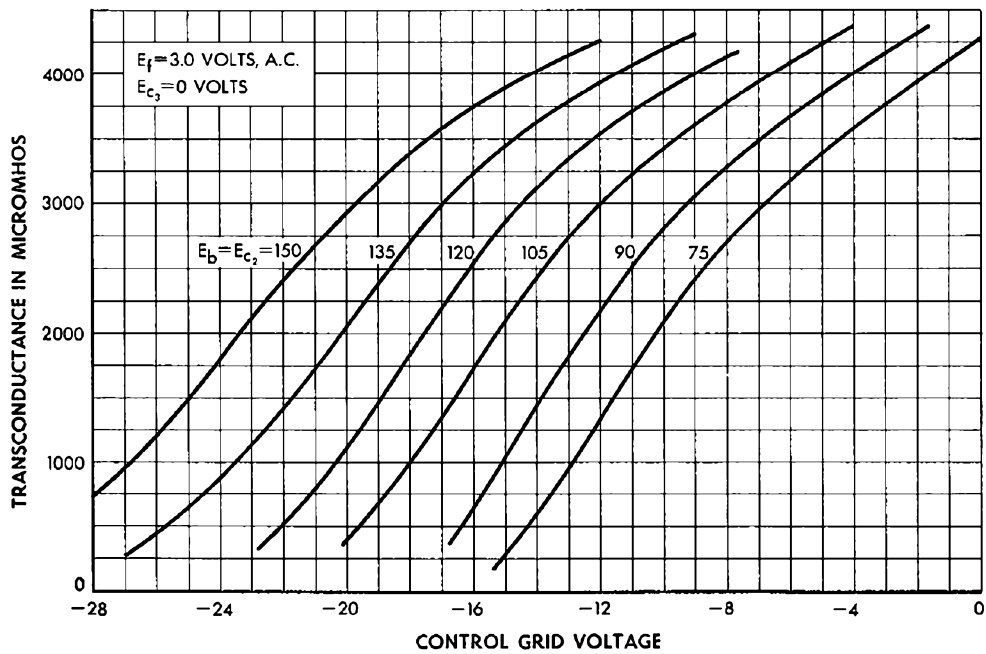
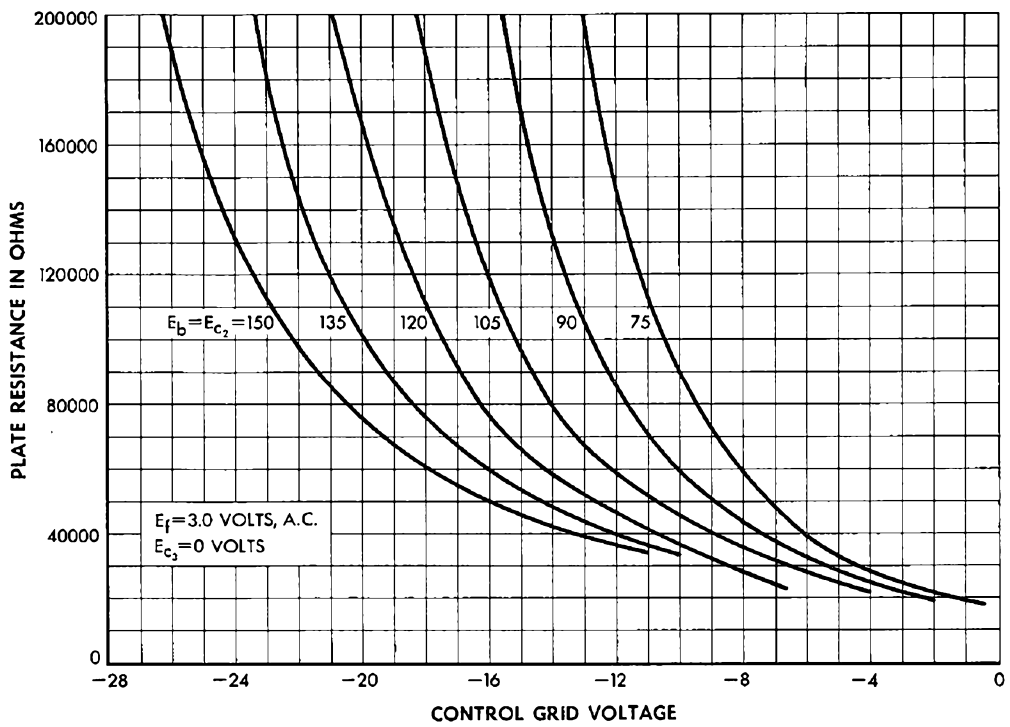

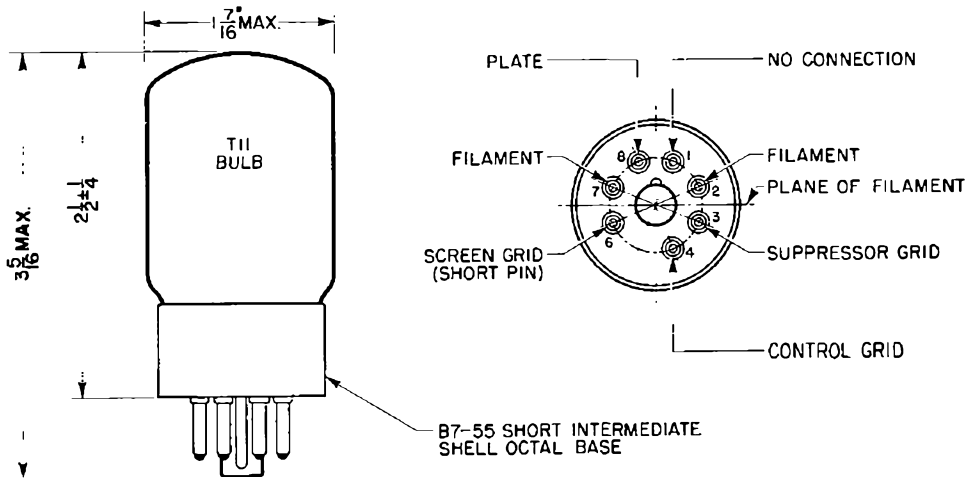
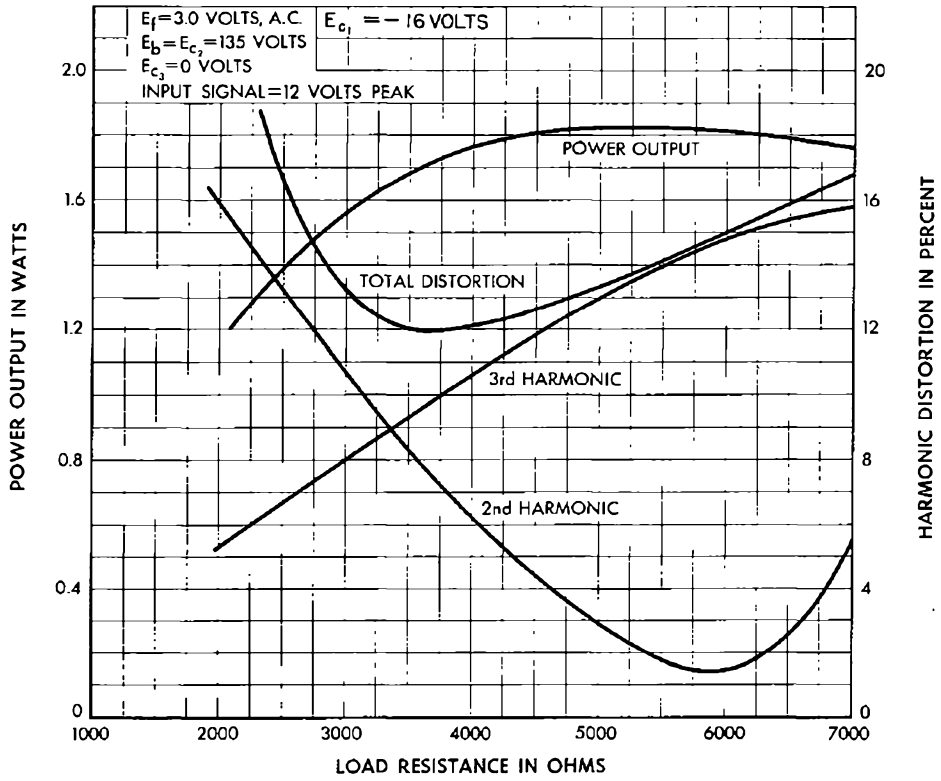

Western Electric

A development of Bell Telephone Laboratories, the research laboratories of the American Telephone and Telegraph Company and the Western Electric Company.



375A

PENTODE

Western Electric

DESCRIPTION

The 375A is a beam power pentode of the heater cathode type. It is designed for use as an audio-frequency amplifier at plate voltages up to 130 volts. It is particularly suitable for use in communication installations where the available plate supply is only 48 volts.

CHARACTERISTICS

Heater Voltage	$E_b = E_c = 45$ volts;	20 volts
Transconductance	} $E_{c1} = -4$ volts	}	4800 micromhos
Power Output

GENERAL CHARACTERISTICS**ELECTRICAL DATA**

Heater Voltage, A-C or D-C	20.0 volts
Heater Current	320 milliamperes
Direct Interelectrode Capacitances (without external shield)	
Grid to Plate	1.0 uuf
Input	13.5 uuf
Output	8.5 uuf

MECHANICAL DATA

Cathode	Coated Unipotential
Bulb	T11
Base	Medium shell, 6-pin octal
Mounting Position	Any

Dimensions and pin connections shown in outline drawing on Page 6

MAXIMUM RATINGS, Design-Center Values

Plate Voltage	130 volts
Screen Grid Voltage	130 volts
Maximum Signal Plate Current	50 milliamperes
Plate Dissipation	6 watts
Screen Grid Dissipation	1.3 watts

Maximum Grid Circuit Resistance for

Fixed Bias	0.1 megohm
Cathode Bias	0.5 megohm

TYPICAL OPERATING CONDITIONS AND CHARACTERISTICS

Plate Voltage	45	90	120 volts
Screen Grid Voltage	45	90	120 volts
Control Grid Voltage	-4	-7.5	-12 volts
Peak A-F Grid Voltage	4	7.5	12 volts
Zero Signal Plate Current	12.5	33	34 milliamperes
Maximum Signal Plate Current	13.8	34	37 milliamperes
Zero Signal Screen Grid Current	1.5	3.7	3.7 milliamperes
Maximum Signal Screen Grid Current	4.0	11.7	19.0 milliamperes
Transconductance	4800	6600	6200 micromhos
Plate Resistance	9300	7800	8000 ohms
Load Resistance	2800	2500	2500 ohms
Maximum Signal Power Output	0.25	1.4	2.5 watts
Total Harmonic Distortion	10	8	14 per cent

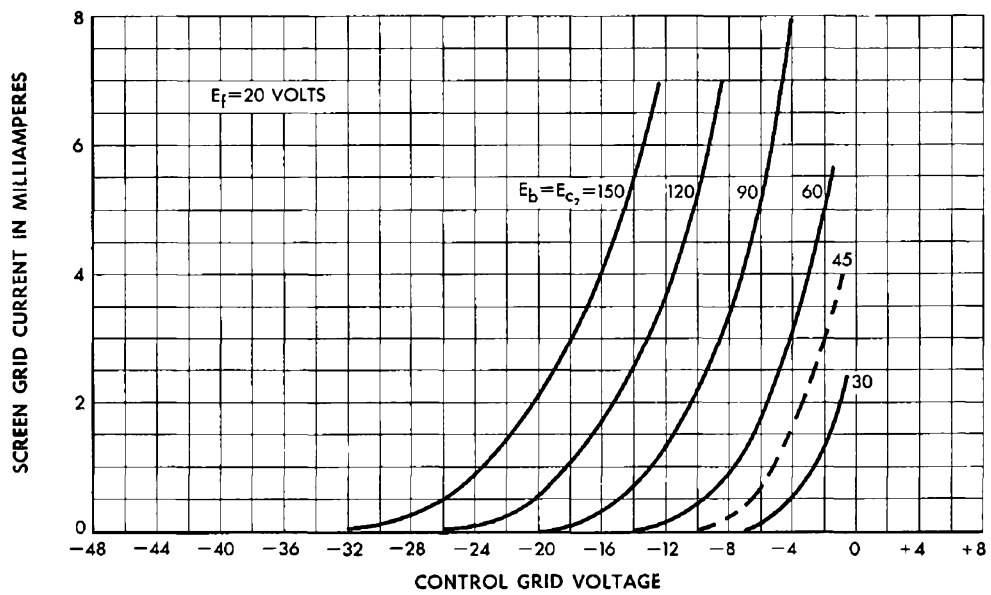
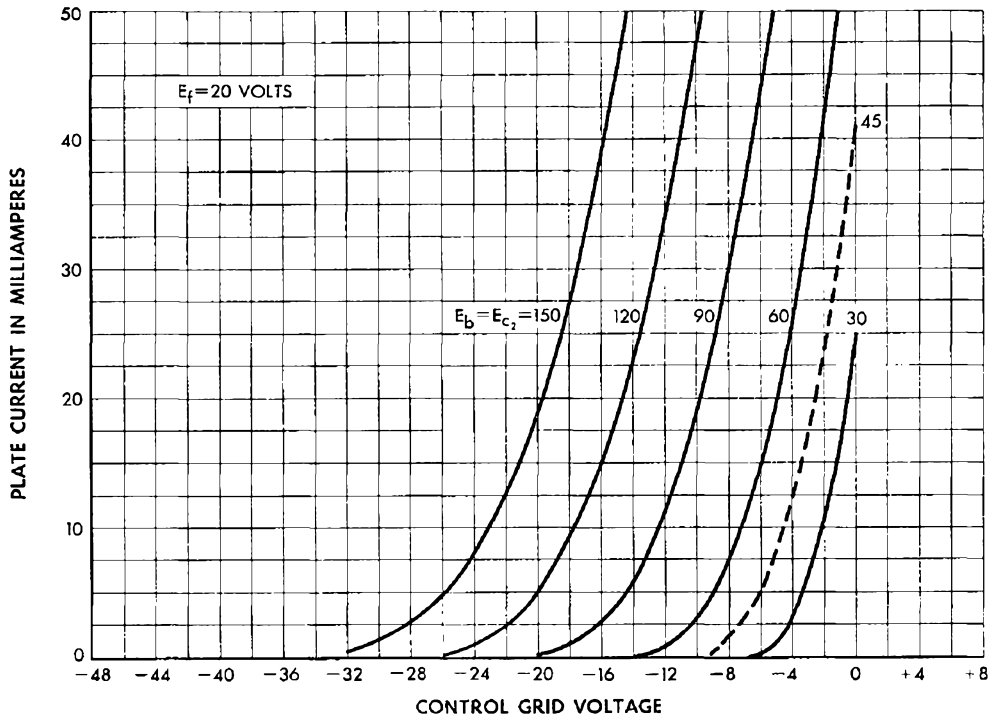

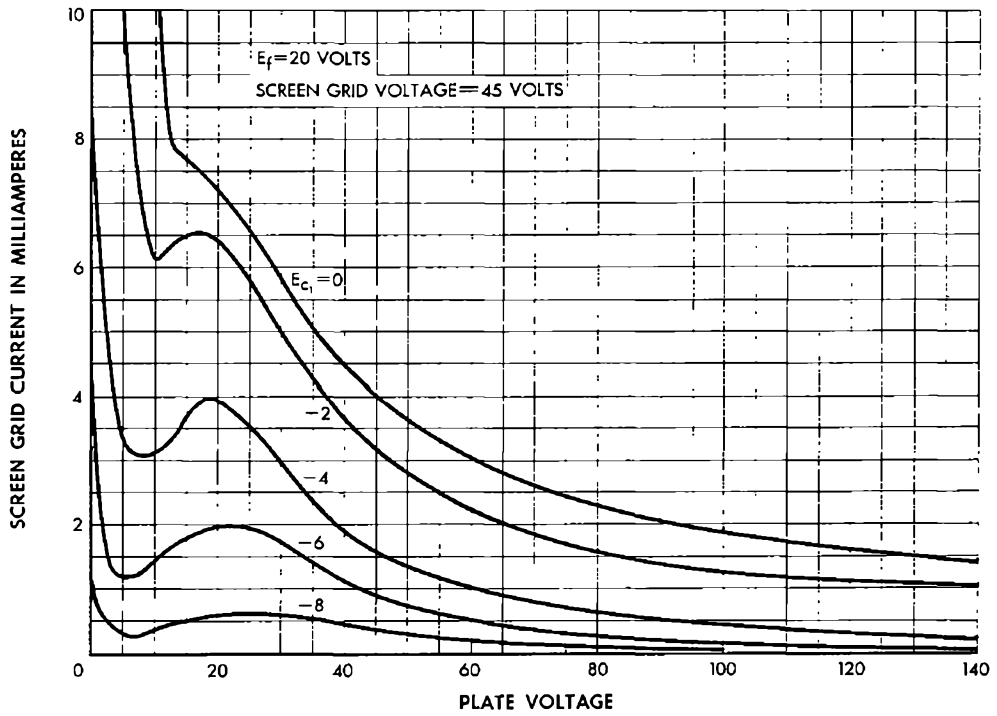
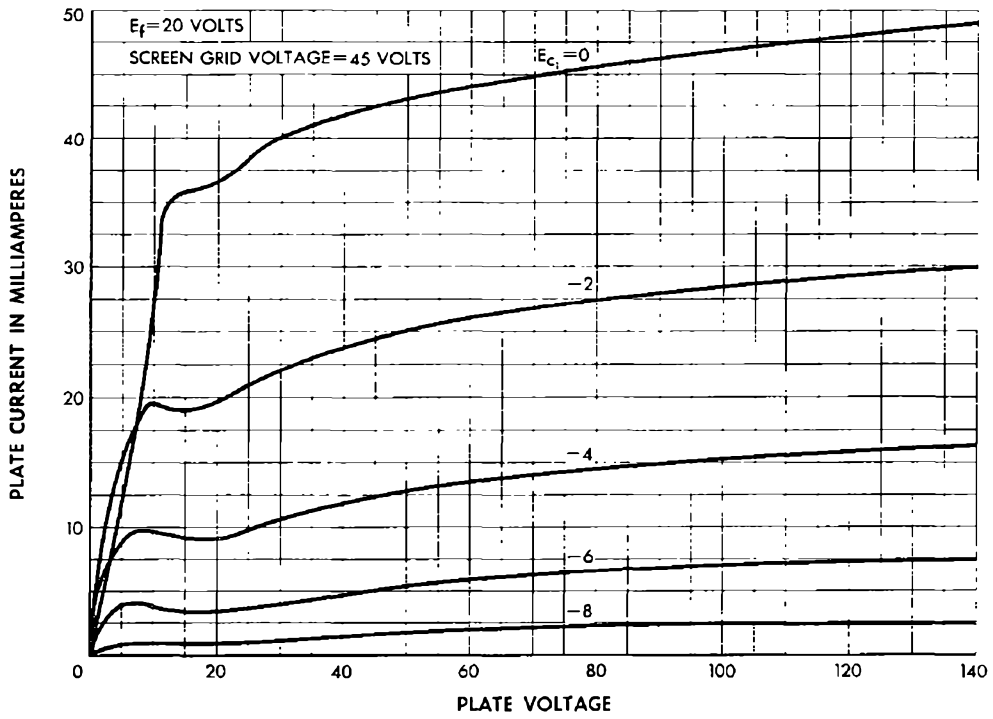

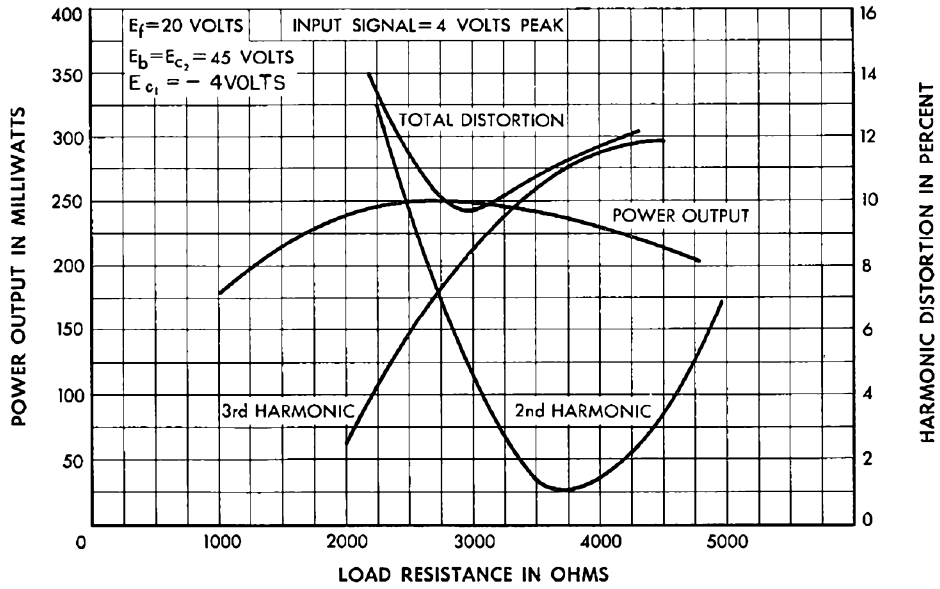
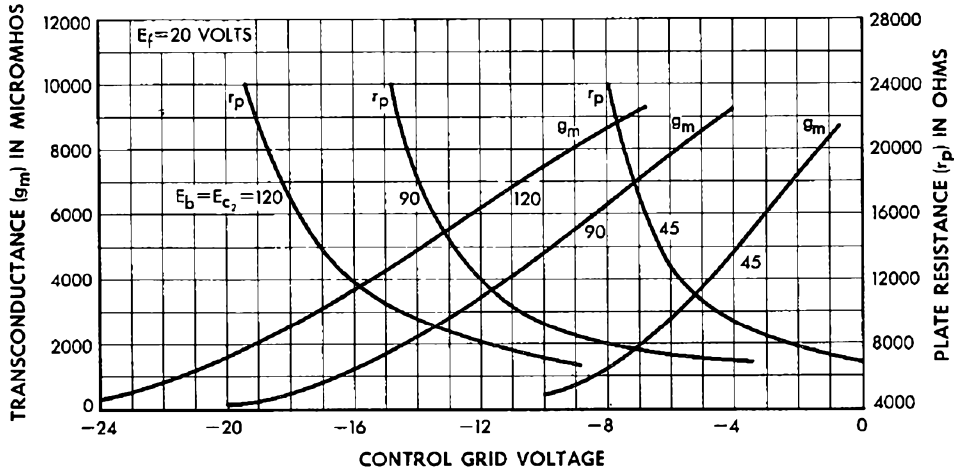

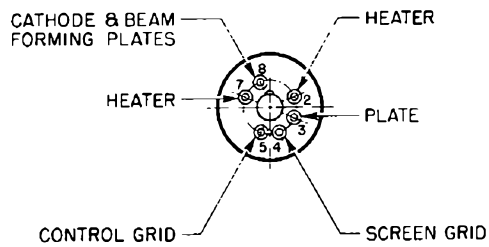
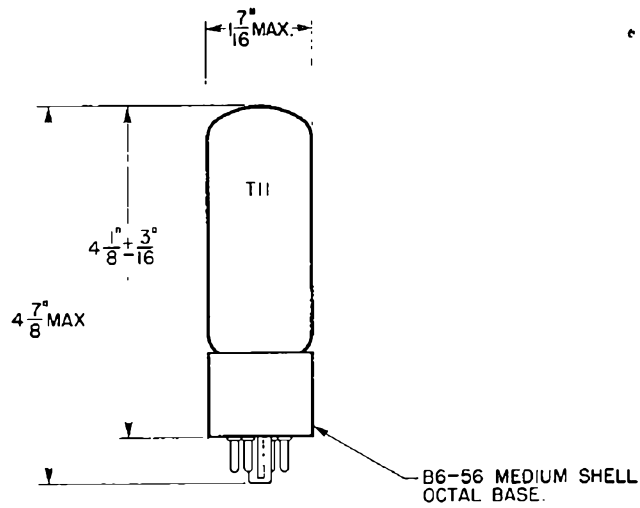

Western Electric

A development of Bell Telephone Laboratories, the research laboratories of the American Telephone and Telegraph Company and the Western Electric Company.

ELECTRON TUBE DATA SHEET
WESTERN ELECTRIC 376B ELECTRON TUBE

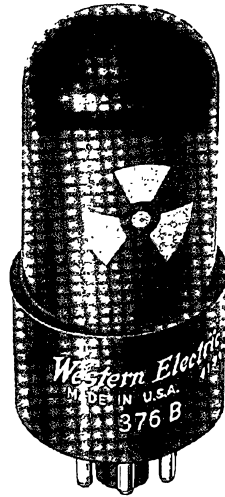

376B

DESCRIPTION

The 376B is a three-electrode, inert-gas-filled, cold cathode tube for use in relay, voltage regulator or rectifier circuits. This tube is especially suitable for use in control circuits such as in triggering, counting, or switching apparatus requiring a high current rated tube.

MAXIMUM RATINGS

Peak Anode Voltage	----	275 volts
Average Cathode Current	20	200 milliamperes
Average Life, Approximate	10000	10 hours

File: Cold Cathode Section
Issue 5, April 1956

376B

MAXIMUM RATINGS, Absolute Values

Inverse Peak Anode Voltage	200 volts
Forward Peak Anode Voltage	275 volts
Forward Cathode Current ¹	
Peak	200 milliamperes
Average	70 milliamperes
Averaging Time	2 seconds
Inverse Peak Anode Current ¹	5 milliamperes
Peak Starter Current	
Forward	100 milliamperes
Inverse	1 milliampere
Ambient Temperature Limits	-55 to +85 centigrade

ELECTRICAL DATA, Throughout Life

	<u>Min.</u>	<u>Bogey</u>	<u>Max.</u>
Starter Breakdown Voltage	67	75	85*volts
Starter Voltage Drop at 20 Milliamperes	52	60	74 volts
Anode Voltage Drop at 30 Milliamperes	60	70	80 volts
Transfer Current	See curve - Fig. 3		
Ionization Time, Starter Gap ²	---	2	---
Deionization Time, Main Gap, Approximate	---	3	---

MECHANICAL DATA

Mounting Position	Any
Net Weight, Approximate	1 ounce
Dimensions and pin connections shown in outline drawing	Page 4

* Limit applies immediately after tube has conducted current. If tube has been idle, this value initially may be as much as 3 volts higher or lower.

Note 1: Sufficient resistance must be used in series with the tube to assure that the electrode currents do not exceed their maximum rated values.

Note 2: With 15 volts starter overvoltage (15 volts above Starter Breakdown Voltage) with tube in total darkness.

HANDLING

Western Electric cold cathode tubes contain a minute amount of radium bromide which is a radioactive material. The amount in most types is too small to require any special care in use, handling or disposal.

A few types contain a larger quantity of radium bromide in which the radium approximates that found on a luminous watch dial. These types bear a red three-bladed propeller-shaped symbol on the tube envelope. Instructions for handling such tubes are given below and also in Bell System Practices for Central Office maintenance.

Installations ordinarily require no precautions against radiation. However, quantities of the tubes should not be so installed, or so stored outside the shipping carton, that they will be within a few inches of personnel or in proximity to photographic film for extended periods of time. For example, however, a 40-hour week exposure at about one (1) foot from a bank of 500 tubes (covering an area of 20 inches x 45 inches) is well within the accepted tolerance limits for personnel. Reasonable care should be exercised in handling and disposal of broken tubes. In general, attention should be given to the following:

- (a) Avoid breathing dust or vapors from broken tubes.
- (b) Avoid contacting broken parts with bare hands.
- (c) Use wet rag to pick up broken parts. Wrap broken parts in rag and tie securely so as to form a package. Thoroughly wash hands after disposal.
- (d) Dispose of broken or defective tubes as they are taken out of service. One or two tubes at a time may be disposed of with normal waste material. Accumulation of tubes in one concentrated area of the place of final disposition should be avoided.

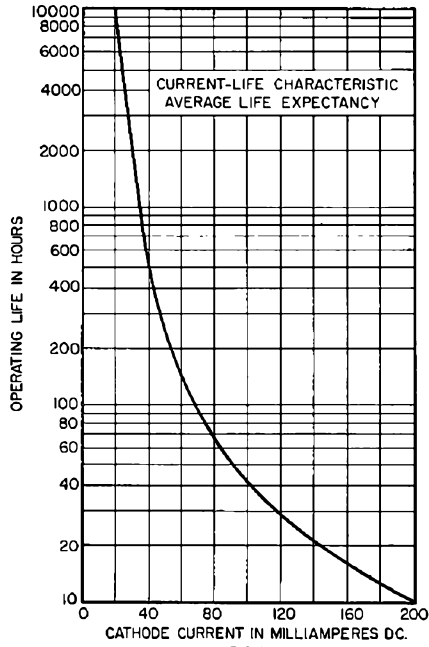

FIG 1

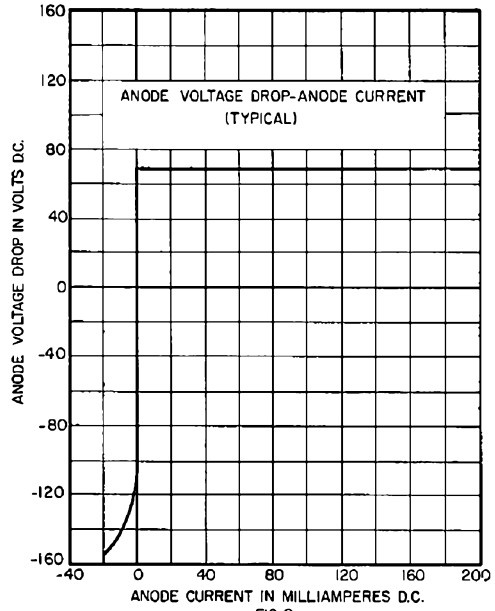

FIG. 2

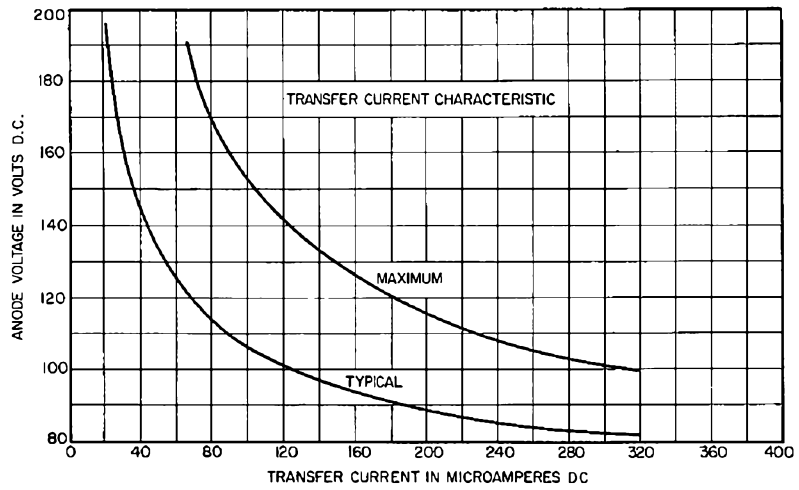
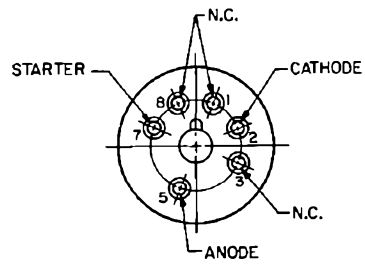
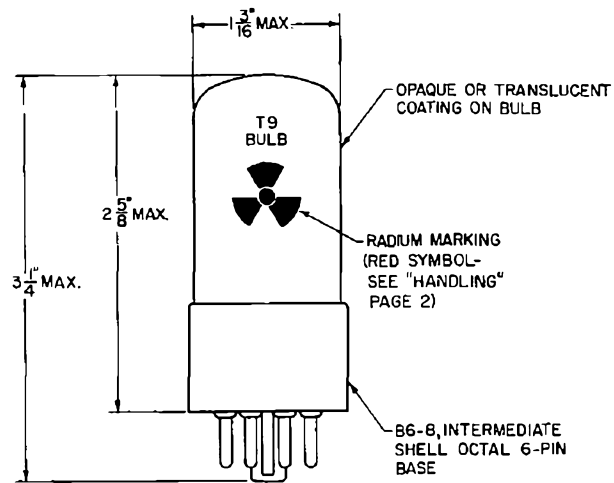

FIG 3



A development of Bell Telephone Laboratories, the research laboratories of the American Telephone and Telegraph Company and the Western Electric Company.

ELECTRON TUBE DATA SHEET
WESTERN ELECTRIC 376C ELECTRON TUBE



376C

DESCRIPTION

The 376C is a three-electrode, inert-gas-filled, cold cathode tube for use in relay, voltage regulator or rectifier circuits. This tube is especially suitable for use in control circuits such as in triggering, counting, or switching apparatus requiring a high current rated tube.

CHARACTERISTICS

Peak Anode Voltage	-	275	volts
Average Cathode Current	20	200	milliamperes
Average Life, Approximate	10000	10	hours

File: Cold Cathode Section

MAXIMUM RATINGS, Absolute System (Note 1)

Inverse Peak Anode Voltage	200	volts
Forward Peak Anode Voltage	275	volts
Forward Cathode Current (Note 2)		
Peak	200	milliamperes
Average	70	milliamperes
Averaging Time	2	seconds
Inverse Peak Anode Current (Note 2)	5	milliamperes
Peak Starter Current (Note 2)		
Forward	100	milliamperes
Inverse	1	milliampere
Ambient Temperature Limits	-55 to +85	centigrade

ELECTRICAL DATA, Throughout Life

	<u>Min.</u>	<u>Bogey</u>	<u>Max.</u>	
Starter Breakdown Voltage (Note 3)	67	75	85	volts
Starter Voltage Drop at 20 Milliamperes	52	60	74	volts
Anode Voltage Drop at 30 Milliamperes	60	70	80	volts
Transfer Current	See curve - Fig. 3			
Ionization Time, Starter Gap (Note 4)	-	2	-	milliseconds
Deionization Time, Main Gap, Approximate	-	3	-	milliseconds

MECHANICAL DATA

Mounting Position Any
 Net Weight, Approximate 1 Ounce
 Dimensions and pin connections shown in outline drawing on Page 4.

HANDLING

This tube contains a small amount of krypton-85 gas which is a by-product radioactive material. The amount of krypton-85 is less than five microcuries, which is too small an amount to require any special care in use.

Atomic Energy Commission regulations require that the individual tube carton for tubes containing by-product radioactive material be appropriately marked. The marking includes the statement that tube disposal should be in approved manner.

Approved instructions for disposal of tubes containing krypton-85 are as follows;

Tubes to be disposed of should be broken or crushed in a well ventilated place releasing any resulting vapors to the outside atmosphere. The residual broken or crushed tubes should be disposed of in a normal public trash disposal system. Tubes should be disposed of at a rate of not more than 100 each week from any one location. Avoid breathing vapors from broken tubes.

Note 1: In the "Absolute System" the maximum ratings specified are limiting values above which the serviceability of the device may be impaired from the viewpoint of life and satisfactory performance. Maximum ratings, as such, do not constitute a set of operating conditions and all values may not, therefore, be attained simultaneously.

Note 2: Sufficient resistance must be used in series with the tube to assure that the electrode currents do not exceed their maximum rated values.

Note 3: Limit applies immediately after tube has conducted current. If tube has been idle, this value initially may be as much as 3 volts higher or lower.

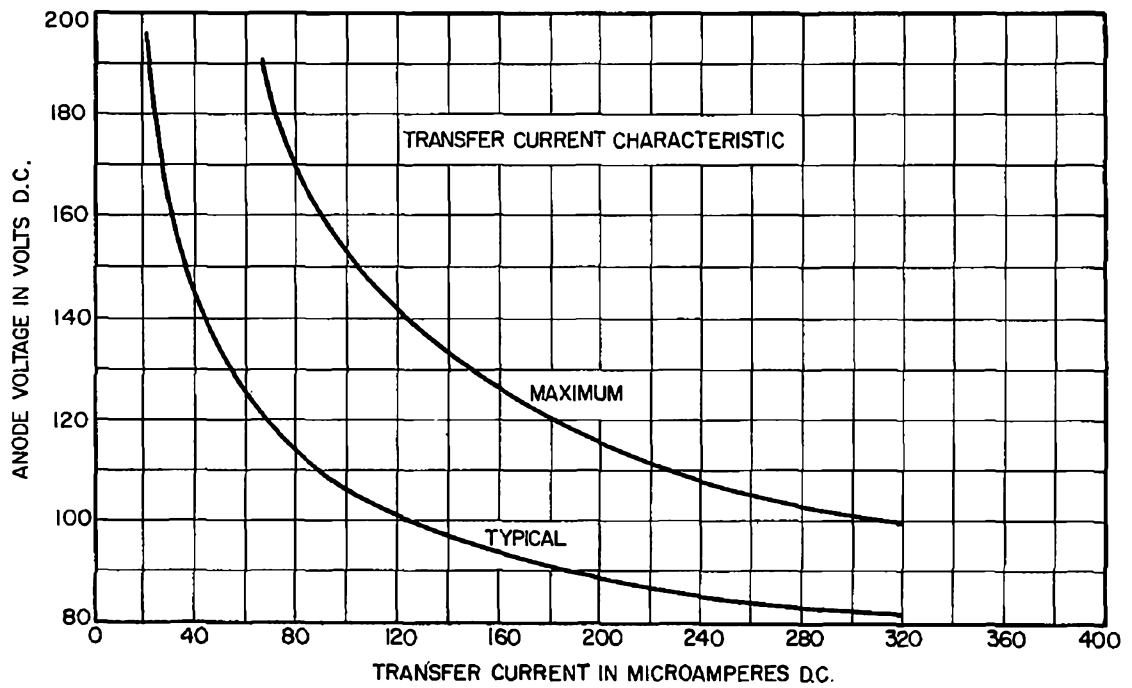
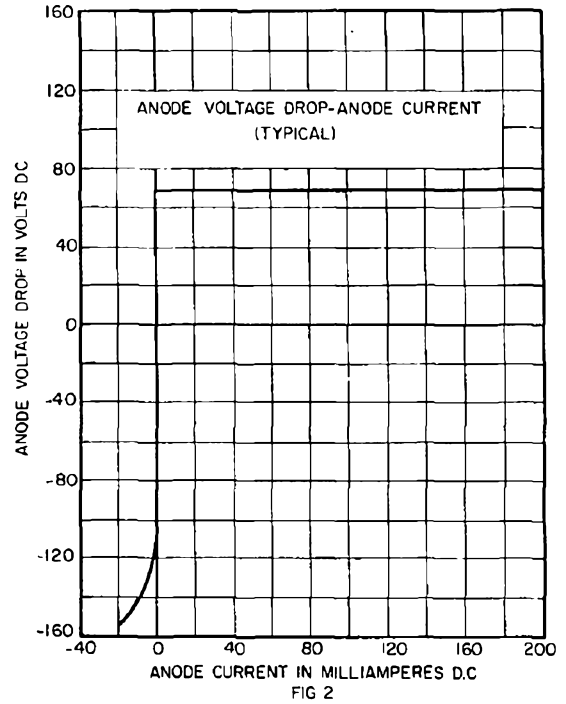
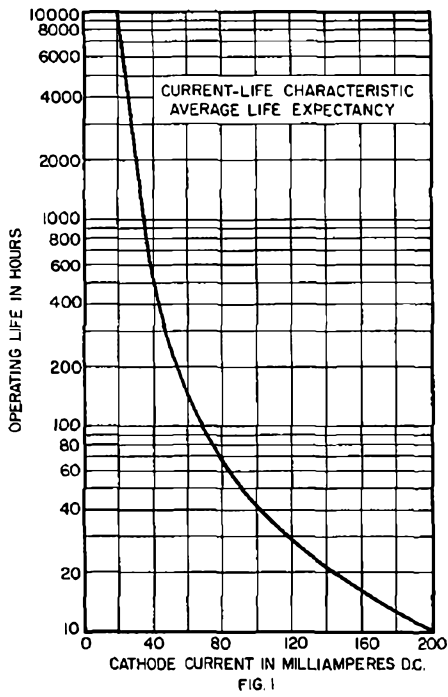
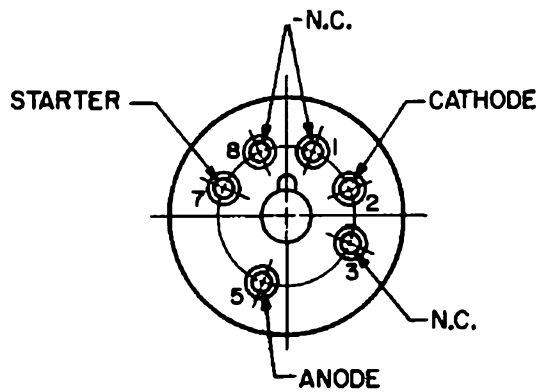
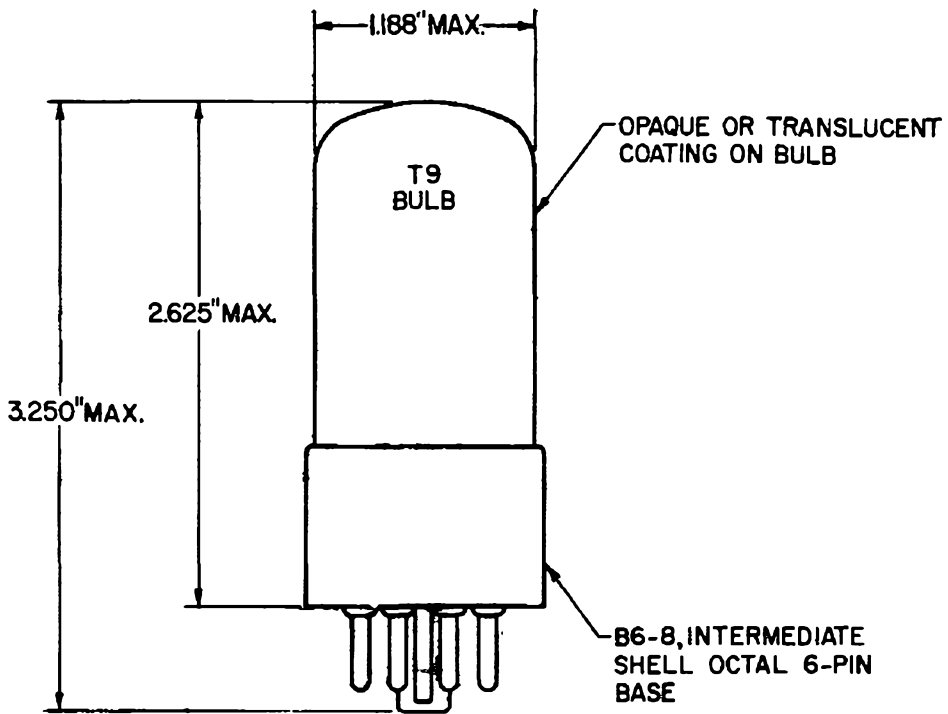

FIG. 3

Note 4: With 15 volts starter overvoltage (15 volts above Starter Breakdown Voltage) with tube in total darkness.



A development of Bell Telephone Laboratories, the research laboratories of the American Telephone and Telegraph Company and the Western Electric Company.

PRINTED IN U.S.A.

384A
385A

BELL SYSTEM PRACTICES
Transmission Engineering and Data
Vacuum Tube Data

SECTION AB46.640
Issue 1, August 1941
A T & T Co Standard

Western Electric

384A and 385A Vacuum Tubes

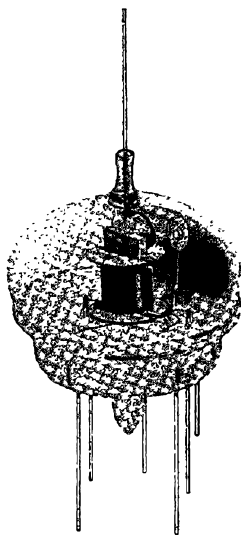

384A



385A

Classification—Voltage Amplifier, Suppressor-Grid Pentodes with Indirectly Heated Cathodes

The 384A and 385A vacuum tubes are identical except that the 385A is provided with a base.

Applications—These tubes are intended primarily for miscellaneous low-power applications at audio, carrier, and ultra-high frequencies. The connection for the suppressor-grid is brought out to an external terminal.

Dimensions—Figures 1, 2, 3 and 4 show dimensions, outline diagrams of the tubes and the arrangement of the electrode connections.

Base—384A—Not based or capped. Connections are made by soldering the leads directly to the circuit elements.

385A—Six-pin, short-shell, intermediate, octal type with silver-plated pins. Small metal cap plate terminal at the top of the bulb.

Socket—384A—No socket is required. Ordinarily, no additional support other than that of the leads will be required. Where the tube is subjected to vibration or where a definite orientation of the tube is desired, a felt-covered spring clip, bearing against the top of the bulb to hold the tube firmly in a circular seat located under the shoulder of the tube, may be provided.

385A—Standard octal type socket, preferably provided with silver-plated contacts.

Mounting Positions—The tubes may be mounted in any position.

384A
385A

Average Direct Inter-Electrode Capacitances

	<u>384A</u>	<u>385A</u>
Control-grid to plate.....	0.02	0.02 $\mu\mu\text{f}$
Control-grid to heater, cathode, screen-grid and suppressor-grid.....	3.1	3.6 $\mu\mu\text{f}$
Plate to heater, cathode, screen-grid and suppressor-grid.....	2.1	2.4 $\mu\mu\text{f}$

384A—The control-grid to plate capacitance is measured with the tube resting in a circular seat consisting of a one-inch-diameter hole in a metal sheet located under the shoulder of the tube. The metal sheet is connected to the cathode of the tube.

No shielding is used in the measurement of the input and output capacitances.

385A—The control-grid to plate capacitance is measured with the tube in an octal wafer socket located approximately one-half inch above a metal sheet. A close fitting metal shield is placed around the bulb and base of the tube and connected, together with the metal sheet, to the cathode. The lead from the control-grid terminal of the socket is brought through a small opening in the metal sheet.

No shielding or socket is used in the measurement of the input and output capacitances.

Heater Rating

Heater voltage.....	6.3 volts, a-c or d-c
Nominal heater current.....	0.15 ampere

The heaters of these tubes are designed to operate on a voltage basis and should be operated as near the rated voltage as practicable.

Cathode Connection—Where alternating heater voltage is used, the cathode should preferably be connected directly to the mid-point of the heater transformer winding or to the mid-point of a low resistance connected across the heater terminals. For direct current operation the cathode may be connected to either end of the heater. If voltage is applied between the heater and cathode, it should be kept low and must not exceed 50 volts.

Characteristics—Figures 5 and 6 show plate current and screen-grid current characteristics of typical tubes as functions of control-grid voltage for several values of screen-grid and plate voltage and zero suppressor-grid voltage. The screen-grid voltage for these characteristics is equal to the plate voltage. Figures 7, 8 and 9 show corresponding amplification factor, plate resistance, and transconductance characteristics. Figures 10 and 11 show plate current and screen-grid current characteristics as functions of plate voltage for three values of control-grid voltage, a screen-grid voltage of 120 volts, and zero suppressor-grid voltage. Figures 12, 13 and 14 show corresponding amplification factor, plate resistance, and transconductance characteristics.

Limiting Conditions for Safe Operation

Maximum plate voltage.....	250 volts
Maximum screen-grid voltage.....	120 volts
Maximum suppressor-grid voltage.....	120 volts
Maximum cathode current (total space current).	12 milliamperes
Maximum screen-grid current.....	5 milliamperes

Operating Conditions and Output—Nominal performance data are given in the table below for a number of typical operating conditions. Since the life of the tubes may be shortened when operated under the maximum conditions, less severe conditions should be selected wherever possible.

The performance data include the fundamental power output and the second and third harmonic levels for the indicated values of load resistance and input voltage. The power output is given in dbm (decibels above one milliwatt), and the harmonic levels in decibels below the fundamental.

TABLE

<u>Plate Voltage</u> Volts	<u>Screen-Grid Voltage</u> Volts	<u>Control-Grid Bias</u> Volts	<u>Sup-pressor-Grid Voltage</u> Volts	<u>Plate Current</u> Milli-amperes	<u>Load Resistance</u> Ohms	<u>Input Voltage</u> Peak Volts	<u>Output Power</u> dbm	<u>Second Harmonic</u> db	<u>Third Harmonic</u> db
120	120	-2	0	5.6	1,000	0.5	-1	35	69
					1,000	2.0	11	22	42
					10,000	0.5	9	37	66
					10,000	2.0	21	24	38
					30,000	0.5	13	46	59
					30,000	2.0	23	28	23
					60,000	0.5	15	36	45
					60,000	2.0	23	12	21
					100,000	0.5	17	25	37
					100,000	2.0	23	10	29
180	120	-2	0	5.7	10,000	0.5	9	36	69
					10,000	2.0	21	23	39
					30,000	0.5	14	40	68
					30,000	2.0	25	31	31
250*	120*	-2	0	5.7	10,000	0.5	9	36	68
					10,000	2.0	21	23	40
					30,000	0.5	14	37	67
					30,000	2.0	25	26	34

*Maximum voltages.

Curves showing the fundamental power output and the second and third harmonic levels as functions of input voltage for a number of values of load resistance and a typical operating condition are given in Figures 15, 16 and 17.

384A
385A

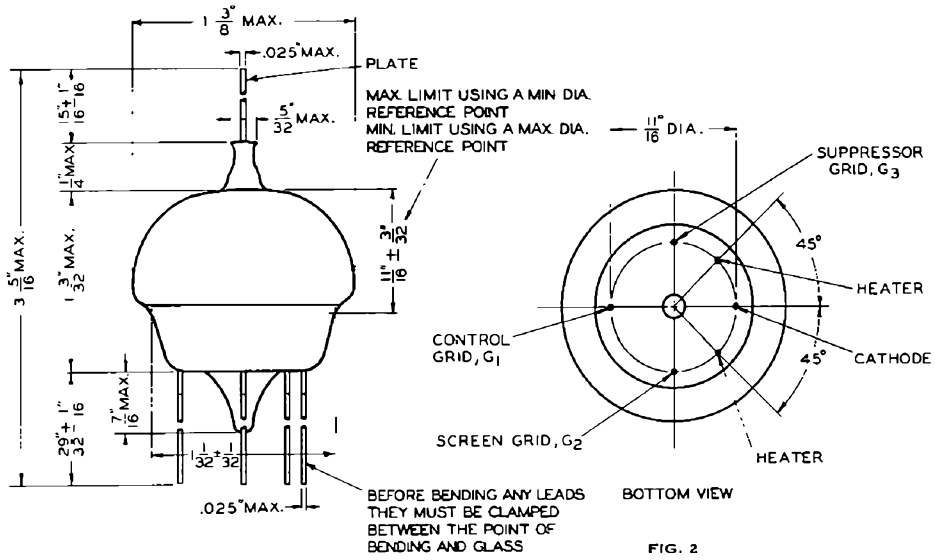

384 A

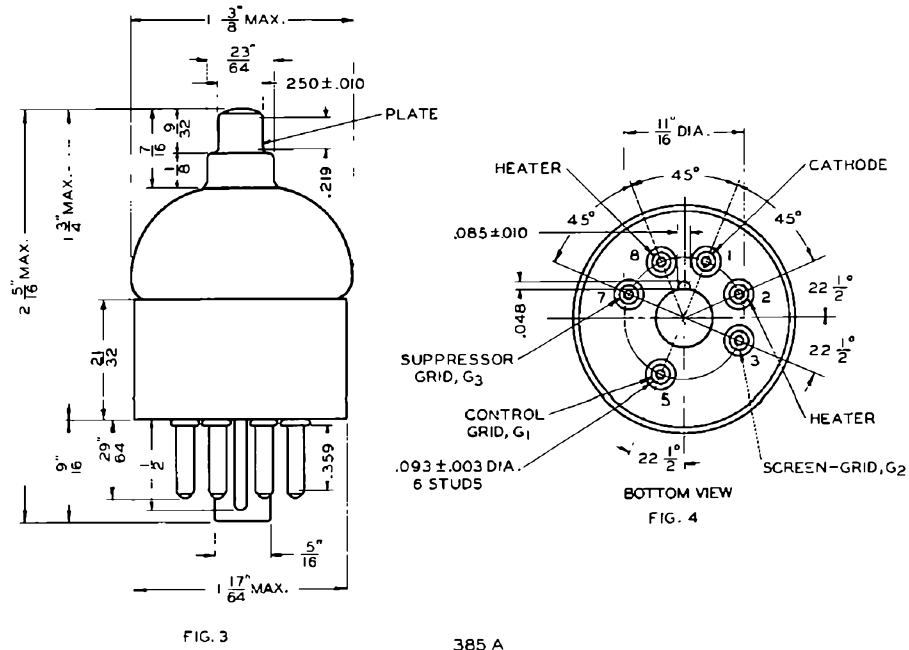

385 A

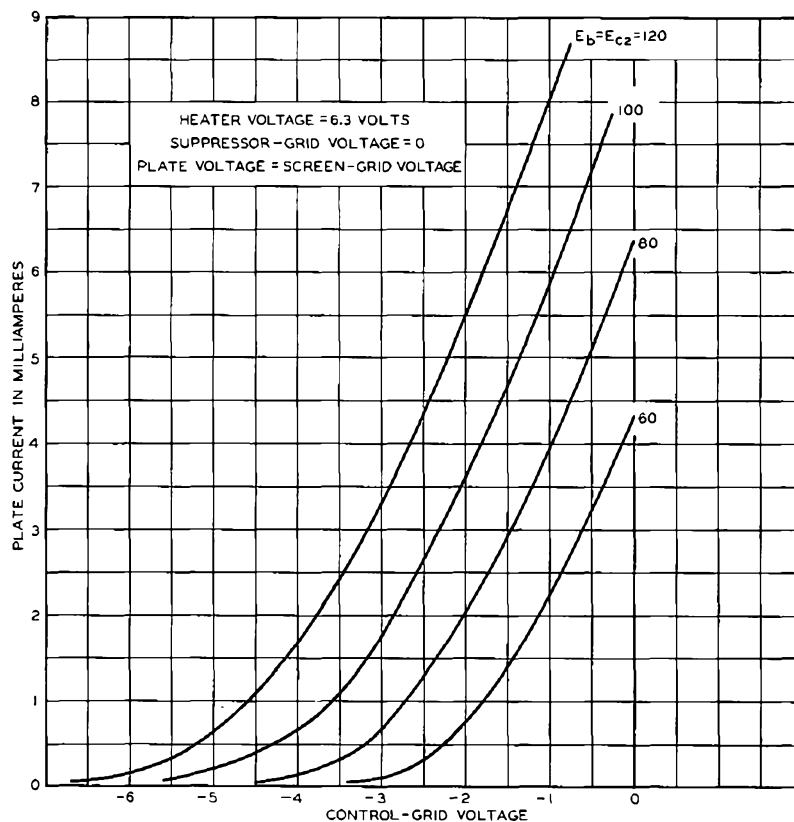

FIG. 5

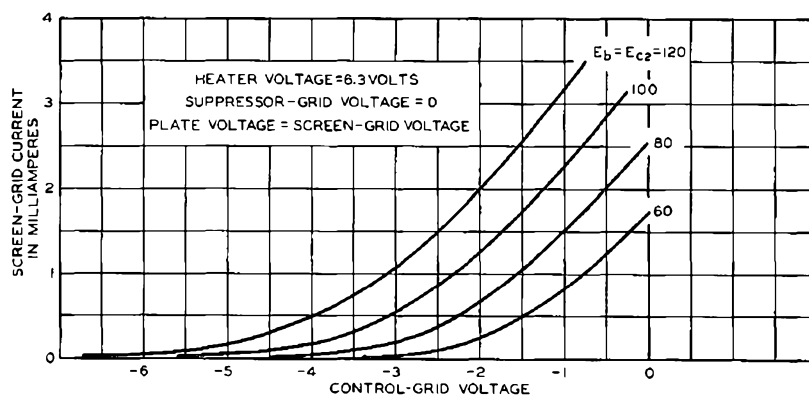

FIG. 6

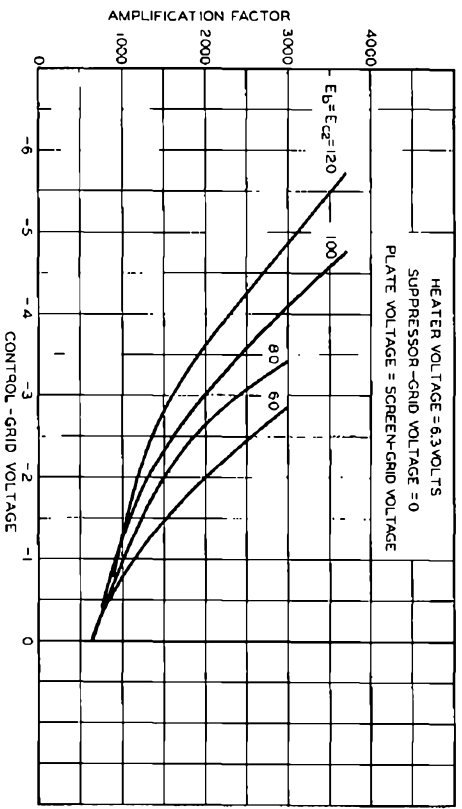

FIG. 7

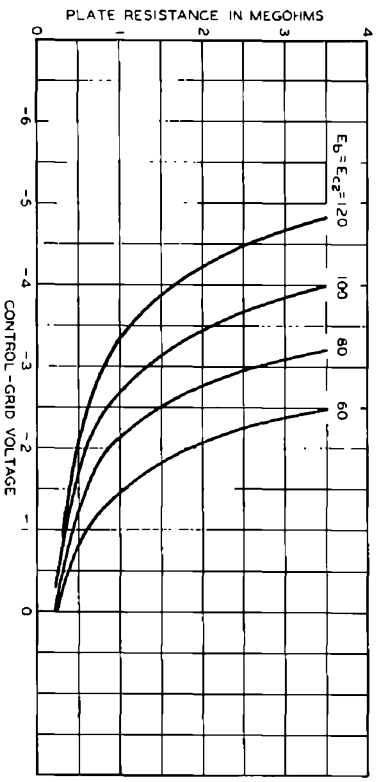

FIG. 8

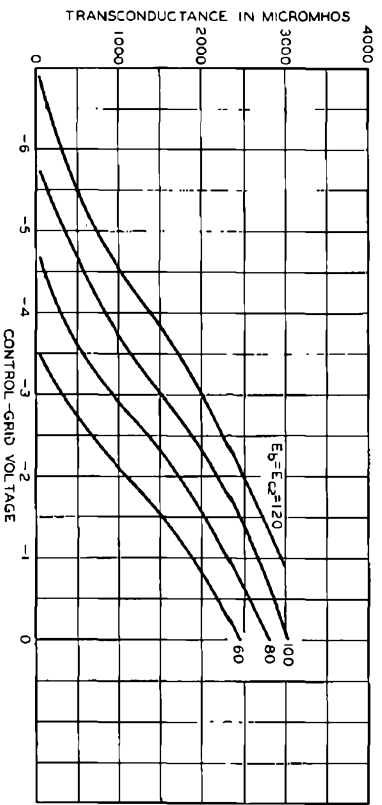

FIG. 9

[6]

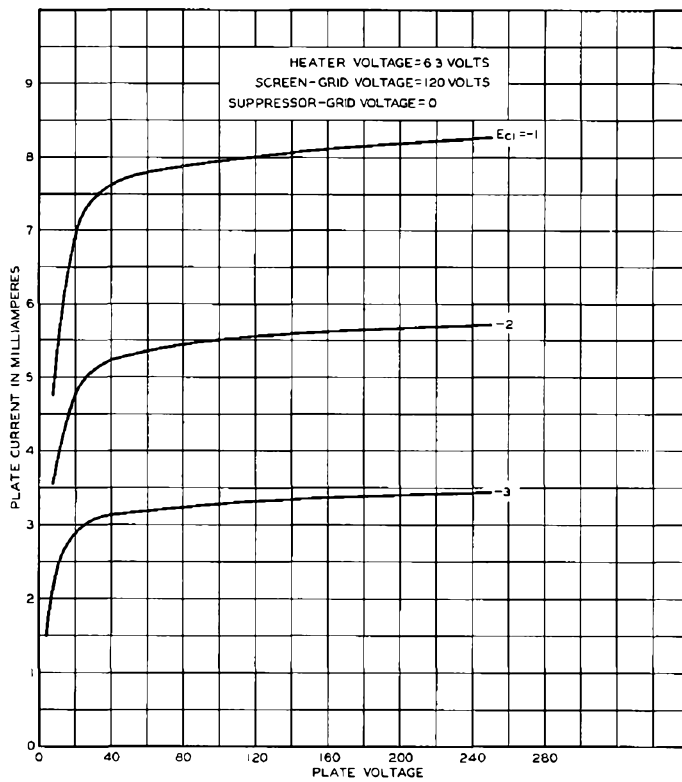

FIG. 10

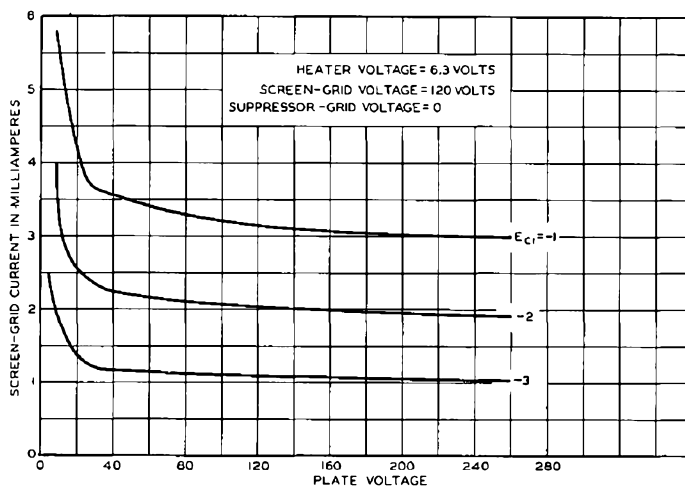

FIG. 11

384A
385A

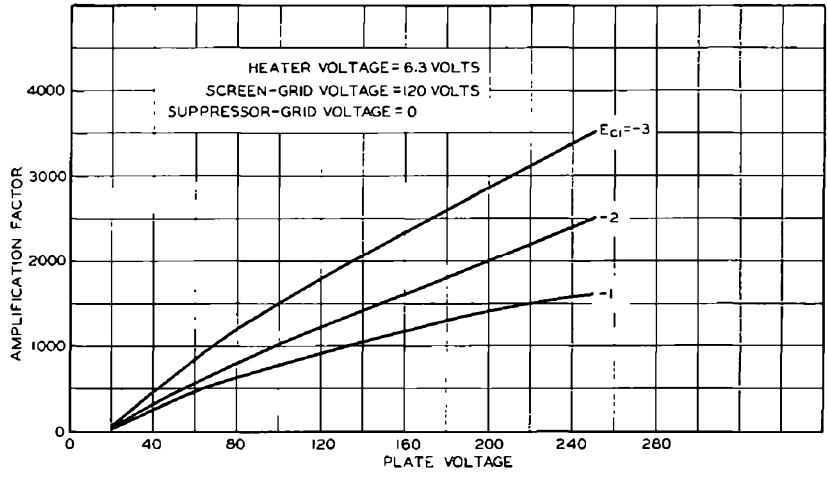

FIG. 12

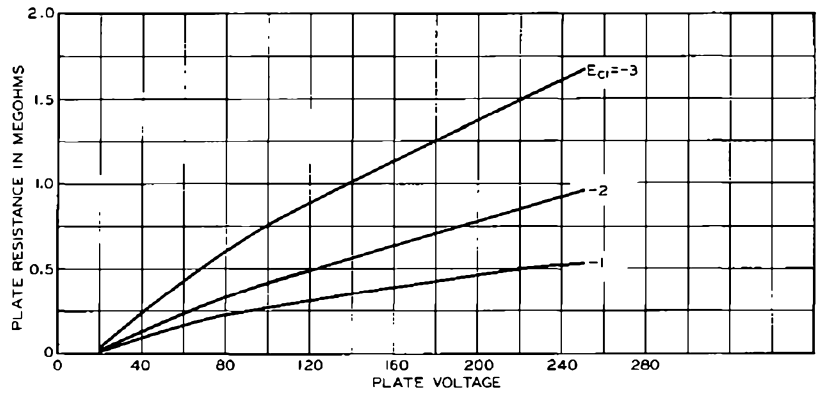

FIG. 13

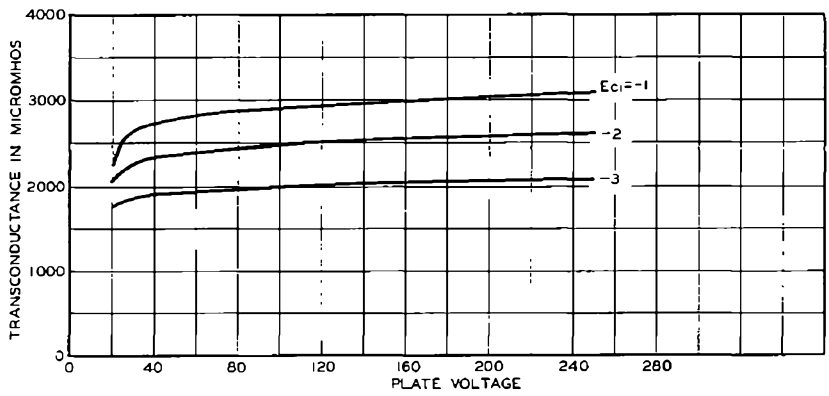

FIG. 14

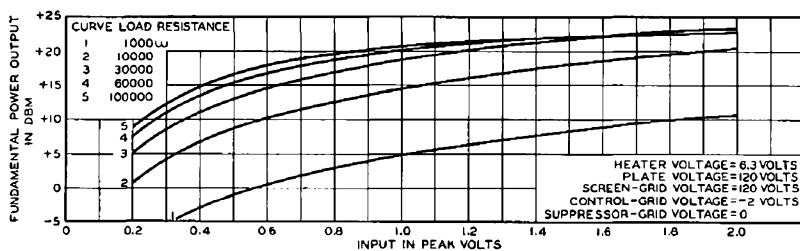

FIG. 15

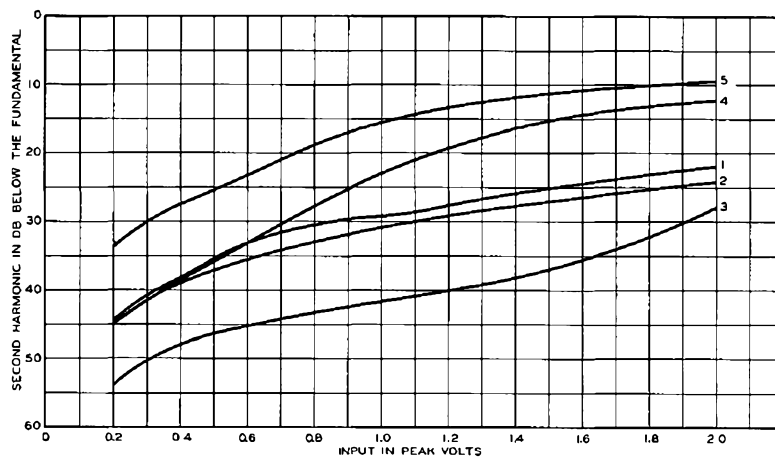

FIG. 16

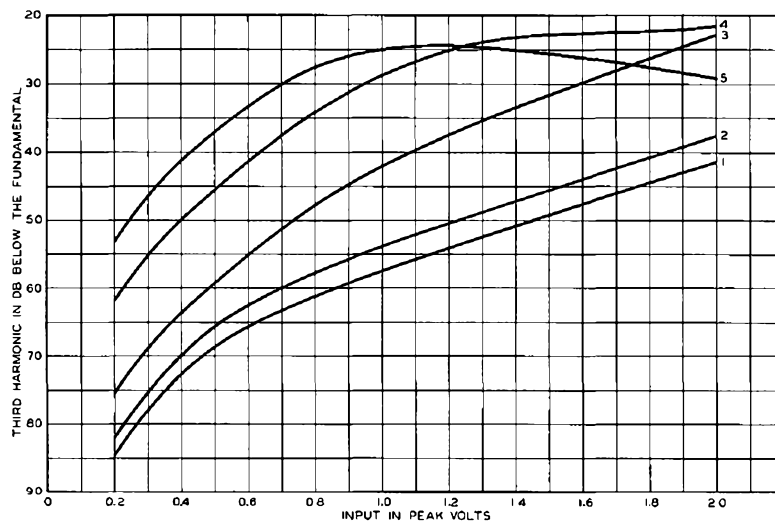
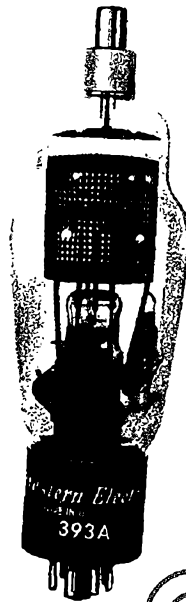

FIG. 17

ELECTRON TUBE DATA SHEET
WESTERN ELECTRIC 393A ELECTRON TUBE



ONLY

393A

DESCRIPTION

The 393A is a three-electrode mercury-vapor and gas-filled thyatron with a negative control characteristic. This tube is designed for use in regulated or controlled rectifiers.

MAXIMUM RATINGS

Peak Anode Voltage	1250 volts
Average Cathode Current	1.5 amperes

FILE:THYRATRON SECTION

MAXIMUM RATINGS, Absolute Values

Peak Anode Voltage	
Inverse	1250 volts
Forward	1250 volts
Cathode Current	
Peak	6 amperes
Average	1.5 amperes
Surge (maximum duration 0.1 second)	120 amperes
Averaging Time	5 seconds
Negative Grid Voltage	
Before Conduction	500 volts
During Conduction	10 volts
Positive Grid Current, Average (averaging time - one cycle)	
	.010 ampere
Condensed Mercury Temperature Limits ¹	
	-55 to +80 centigrade

ELECTRICAL DATA

	<u>Min.</u>	<u>Bogey</u>	<u>Max.</u>
Filament Voltage	2.37	2.5	2.62 volts
Filament Current at 2.5 Volts	---	7.0	7.75 amperes
Filament Heating Time Required	15	---	--- seconds
Anode to Grid Capacitance	---	1.8	---
Grid to Filament Capacitance	---	5.6	---
Deionization Time, Approximate ²			
$E_{bb}=1250$ volts: $THg=80C$; $I_b=6$ amperes;			
$E_{cc}=-18$ volts: $R_g=20,000$ ohms	---	1200	---
Ionization Time, Approximate ³			
$E_{bb}=100$ volts: $THg=40C$; grid overvoltage=5 volts	---	35	---
$E_{bb}=100$ volts: $THg=80C$; grid overvoltage=25 volts	---	0.5	---
Anode Voltage Drop	---	15	---
Critical Grid Current at 220 Anode Volts	---	---	5 microamperes
Change in Critical Grid Voltage at			
500 Anode Volts from +20 to +20 THg	---	0.2	---

MECHANICAL DATA

Type of Cooling	Convection
Equilibrium Condensed Mercury Temperature Rise Above Ambient, Approximate	
At Full Load	30 centigrade
At No Load	20 centigrade
Mounting Position	Vertical-base down
Net Weight, Approximate	3 ounces

Dimensions and pin connections shown in outline drawing on Page 4.

1. For starting conditions only. Equilibrium operation is limited to +20°C minimum condensed mercury temperature.
2. Deionization time decreases with an increase in negative grid voltage or with a decrease in (a) condensed mercury temperature (THg), (b) grid resistance or (c) anode current immediately preceding the end of conduction.
3. Ionization time decreases with an increase in (a) anode voltage, (b) condensed mercury temperature (THg) or (c) grid overvoltage. Grid overvoltage is defined as the magnitude by which the applied voltage exceeds, in a positive direction, the critical grid voltage value. Critical grid voltage is the instantaneous value of grid voltage at the time when anode current starts to flow.

TYPICAL CONTROL CHARACTERISTICS,
 SHADED AREA SHOWS RANGE OF CHARACTERISTICS,
 CONDENSED MERCURY TEMPERATURE -55°C. TO +80°C.

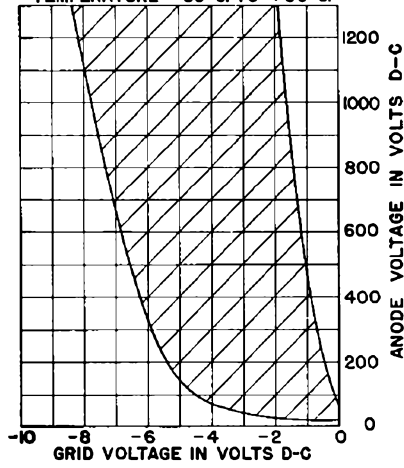

TYPICAL GRID CURRENT CHARACTERISTICS
 DURING ANODE CONDUCTION

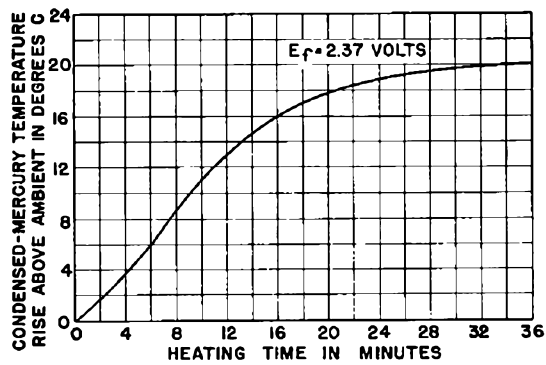
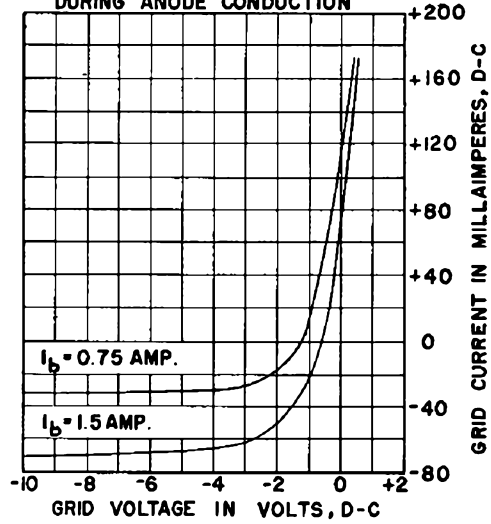

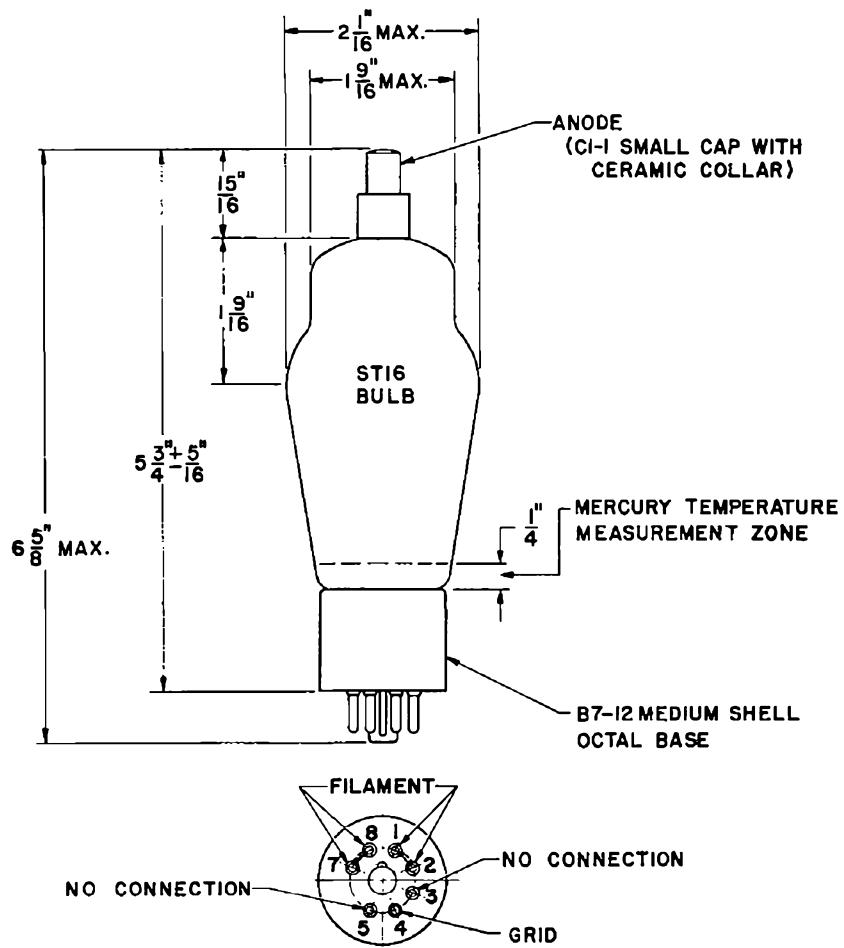

A development of Bell Telephone Laboratories, the research laboratories of the American Telephone and Telegraph Company and the western Electric Company.

PRINTED IN U.S.A.

ELECTRON TUBE DATA SHEET
WESTERN ELECTRIC 394A ELECTRON TUBE

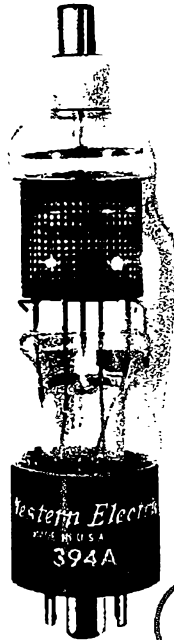

ONLY

394A

DESCRIPTION

The 394A is a three-electrode mercury-vapor and gas-filled thyatron with a negative control characteristic. This tube is designed for regulated or controlled rectifiers.

MAXIMUM RATINGS

Peak Anode Voltage	1250 volts
Average Cathode Current	0.64 ampere

FILE:THYRATRON SECTION

394A

MAXIMUM RATINGS, Absolute Values

Peak Anode Voltage	
Inverse	1250 volts
Forward	1250 volts
Cathode Current	
Peak	2.5 amperes
Average	0.64 ampere
Surge (maximum duration 0.1 second)	25 amperes
Averaging Time	5 seconds
Negative Grid Voltage	
Before Conduction	500 volts
During Conduction	10 volts
Positive Grid Current, Average (Averaging time=one cycle)	0.010 ampere
Condensed Mercury Temperature Limits ¹	-55 to +80 centigrade

ELECTRICAL DATA

	<u>Min.</u>	<u>Boyer</u>	<u>Max.</u>
Filament Voltage	2.37	2.5	2.62 volts
Filament Current at 2.5 Volts	---	3.25	3.50 amperes
Filament Heating Time Required	15	---	--- seconds
Anode to Grid Capacitance	---	1.6	--- uuf.
Grid to Filament Capacitance	---	5.5	--- uuf.
Deionization Time, Approximate ²			
E_{bb} =1250 volts; I_b =2.5 amperes; E_{cc} =-18 volts; THg =80C; R_g =20000 ohms	---	1000	--- microseconds
Ionization Time, Approximate ³			
E_{bb} =100 volts; THg =40C; Grid Overvoltage=5 volts	---	25	--- microseconds
E_{bb} =100 volts; THg =80C; Grid Overvoltage=25 volts	---	0.5	--- microseconds
Anode Voltage Drop	---	15	--- volts
Critical Grid Current at 220 Anode Volts	---	---	5 microamperes
Change in Critical Grid Voltage at 500 Anode Volts from +20 to +80THg			
	---	0.2	--- volts

MECHANICAL DATA

Type of Cooling	Convection
Equilibrium Condensed Mercury Temperature Rise Above Ambient	
At Full Load (Approximate)	17 Centigrade
At No Load (Approximate)	12 Centigrade
Mounting Position	Vertical-base down
Net Weight, Approximate	3 ounces
Dimensions and pin connections shown in outline drawing on Page 4.	

1. For starting conditions only. Equilibrium operation is limited to +20C minimum condensed mercury temperature.
2. Deionization time decreases with an increase in negative grid voltage or with a decrease in (a) condensed mercury temperature (THg), (b) grid resistance or (c) anode current immediately preceding the end of conduction.
3. Ionization time decreases with an increase in (a) anode voltage, (b) condensed mercury temperature (THg) or (c) grid overvoltage. Grid overvoltage is defined as the magnitude by which the applied voltage exceeds, in a positive direction, the critical grid voltage value. Critical grid voltage is the instantaneous value of grid voltage at the time when anode current starts to flow.

TYPICAL CONTROL CHARACTERISTICS.
 SHADED AREA SHOWS RANGE OF CHARACTERISTICS, CONDENSED MERCURY TEMPERATURE -55°C . TO $+80^{\circ}\text{C}$.

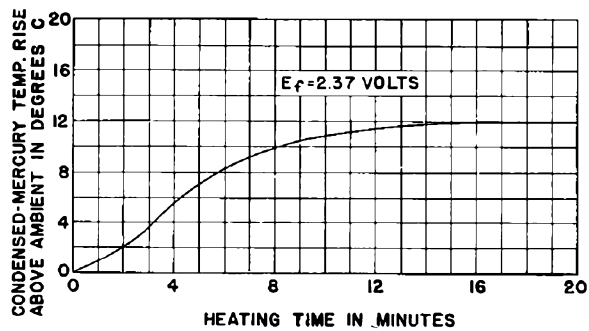
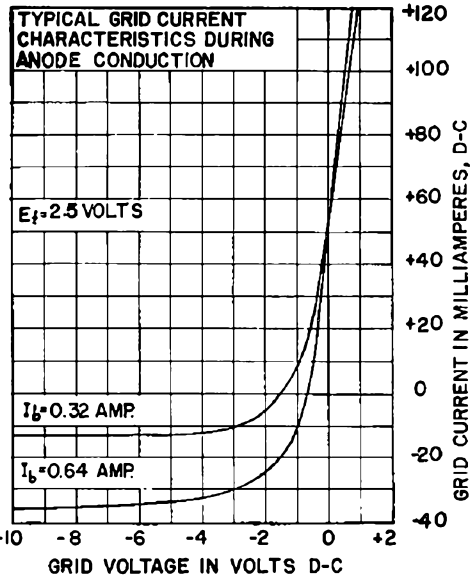
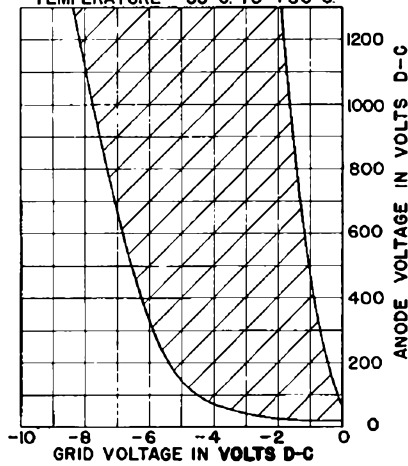

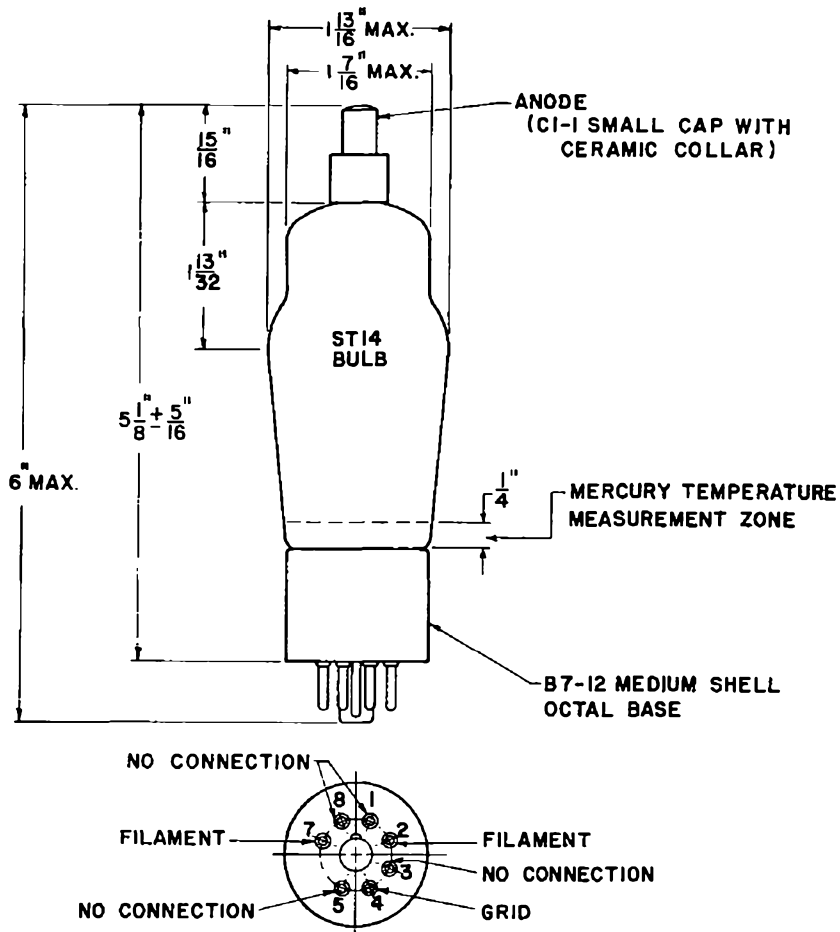

A development of Bell Telephone Laboratories, the research laboratories of the American Telephone and Telegraph Company and the Western Electric Company.

PRINTED IN U.S.A.

ELECTRON TUBE DATA SHEET
WESTERN ELECTRIC 395A ELECTRON TUBE



395A

DESCRIPTION

The 395A electron tube is a ruggedized three-electrode inert-gas-filled cold cathode tube for use primarily in triggering circuits. This tube is designed to withstand a 1000 G centrifuge test. The 395A is also suitable for use in control circuits such as in relay, counting or switching apparatus. Small size and provisions for wiring directly into the circuits makes this tube especially suitable for use in small equipment.

CHARACTERISTICS

Peak Anode Voltage	140	volts
Average Cathode Current	4	35 milliamperes
Average Life, Approximate	10000	10 hours

File: Cold Cathode Section

Indicates a change ←

MAXIMUM RATINGS, Absolute System (Note 1)

Peak Anode Voltage (Note 2)			
Forward	140	volts	
Inverse	140	volts	
→ Forward Cathode Current (Note 3)			
Peak	35	milliamperes	
Average	13	milliamperes	
Averaging Time	1	second	
→ Peak Inverse Current, Anode or Starter (Note 3).	1	milliampere	
Ambient Temperature Limits.	-55 to +85	centigrade	

ELECTRICAL DATA, Throughout Life

	<u>Min.</u>	<u>Bogey</u>	<u>Max.</u>	
Starter Breakdown Voltage (Notes 2 & 4)	71	80	84	volts
Starter Voltage Drop at 10 Milliamperes	52	65	74	volts
Anode Voltage Drop at 10 Milliamperes	68	80	85	volts
Transfer Current				See Curve - Fig. 1
Required Transfer Current at 130 Anode Volts	10	-	-	microamperes
Deionization Time, Main Gap	-	2	-	milliseconds
Ionization Time, Starter Gap (Note 5)	-	0.05	-	millisecond

MECHANICAL DATA

Mounting Position	Any
Net Weight, Approximate	0.4 ounce
Ruggedness (Note 6)	1000 G

Dimensions and lead connections shown in outline drawing on Page 4.

HANDLING

This tube contains a small amount of krypton-85 gas which is a by-product radioactive material. The amount of krypton-85 is less than five microcuries, which is too small an amount to require any special care in use.

Atomic Energy Commission regulations require that the individual tube carton for tubes containing by-product radioactive material be appropriately marked. The marking includes the statement that tube disposal should be in approved manner.

Approved instructions for disposal of tubes containing krypton-85 are as follows;

Tubes to be disposed of should be broken or crushed in a well ventilated place releasing any resulting vapors to the outside atmosphere. The residual broken or crushed tubes should be disposed of in a normal public trash disposal system. Tubes should be disposed of at a rate of not more than 100 each week from any one location. Avoid breathing vapors from broken tubes.

Note 1: In the "Absolute System" the maximum ratings specified are limiting values above which the serviceability of the device may be impaired from the viewpoint of life and satisfactory performance. Maximum ratings, as such, do not constitute a set of operating conditions and all values may not, therefore, be attained simultaneously.

Note 2: Values apply with the tube exposed to light in the order of 5 to 30 foot-candles. Exposure to direct sunlight may reduce peak anode voltage rating by as much as 45 volts and starter breakdown voltage as much as 5 volts.

→ Indicates a change

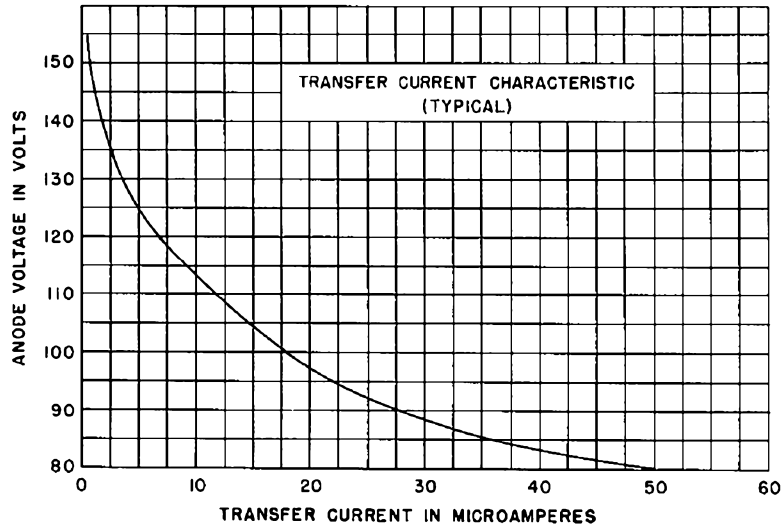

FIG. 1

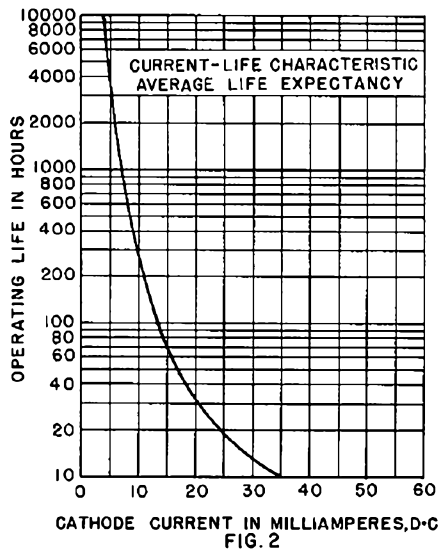

FIG. 2

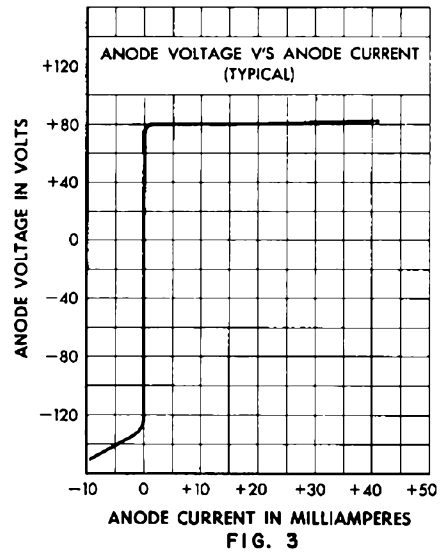

FIG. 3

Note 3: Sufficient resistance must be used in series with the tube to assure that the electrode currents do not exceed their maximum rated values. ↗ ↘

Note 4: Limits apply immediately after the tube has conducted current. If the tube has been idle, initially these values may be as much as 3 volts higher or lower.

Note 5: With 15 volts starter overvoltage. This value applies with the tube exposed to light in the order of 5 to 30 foot-candles. In total darkness ionization time will increase to a bogey of 5 milliseconds.

Note 6: Determined by centrifuge test.

Indicates a change ←

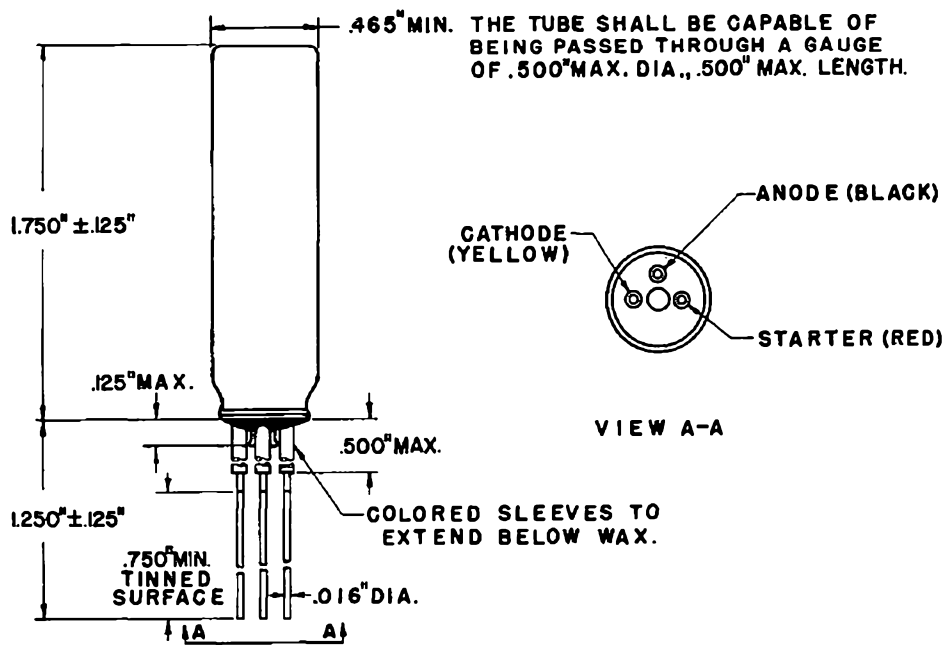

A development of Bell Telephone Laboratories, the research laboratories of the American Telephone and Telegraph Company and the Western Electric Company.

PRINTED IN U.S.A.

ELECTRON TUBE DATA SHEET
WESTERN ELECTRIC 396A* ELECTRON TUBE



396A

DESCRIPTION

The 2C51/396A* is a 9-pin miniature double triode having separate indirectly heated cathodes. It is designed for use in amplifier, mixer, oscillator, multivibrator and clamp circuits. The useful frequency extends through the VHF range.

CHARACTERISTICS

Heater Voltage	6.3 volts
Plate Current per Section } $E_b = 150$ volts; $E_c = -2.0$ volts	8.2 milliamperes
Transconductance per Section	5500 micromhos

File: Miniature Section
Issue 5, 11-54

396A*

GENERAL CHARACTERISTICS

ELECTRICAL DATA

Heater Voltage		6.3 volts
Heater Current		300 milliamperes
Direct Interelectrode Capacitances	without	with
	external shield	external shield
		(RETMA #315)
Grid to Plate per Section	1.3	*1.3 uuf
Input per Section; g to (h+k+i.s.)	2.2	*2.3 uuf
Output per Section; p to (h+k+i.s.)	1.0	*1.3 uuf
Plate-to-Plate	0.04	**0.03 uuf
Plate-to-Plate, Maximum	0.11	**0.10 uuf

MECHANICAL DATA

Cathode	Coated Unipotential
Bulb	T6 1/2
Base	Small Button, 9-pin
Mounting Position	Any
Dimensions and pin connections shown in outline drawing on Page 4	

MAXIMUM RATINGS, Design-Center Values (Each Section)

Plate Voltage	300 volts
Plate Dissipation	1.5 watts
Plate Current	18 milliamperes
Grid Dissipation	0.1 watt
Heater-Cathode Voltage	90 volts
Bulb Temperature	120° centigrade

Maximum Grid Circuit Resistance for

Fixed Bias	1 megohm
Cathode Bias	2 megohms

TYPICAL OPERATING CONDITIONS AND CHARACTERISTICS - CLASS A₁ AMPLIFIER

(Each Section)

Plate Voltage	150	150 volts
Grid Voltage	-2.0	--- volts
Cathode Resistor	---	240 ohms
Plate Current	8.2	8.2 milliamperes
Transconductance	5500	5500 micromhos
Amplification Factor	35	35
Grid Voltage (approximate) for		
Plate Current of 10 microamperes	-8	--- volts

- * Pin 5 and external shield (RETMA #315) connected to cathode pin of section under test. Elements of other section grounded.
- ** Pin 5 and external shield (RETMA #315) connected to ground with other elements.

TYPICAL OPERATING CONDITIONS - CLASS AB₁ PUSH-PULL AMPLIFIER

Plate Voltage	200	300 volts
Cathode Resistor (Cathodes Tied Together)	400	800 ohms
Peak A-F Grid-to-Grid Voltage	9.0	20 volts
Zero Signal Plate Current per Section	5.0	4.7 milliamperes
Maximum Signal Plate Current per Section	5.6	6.0 milliamperes
Load Impedance, Plate-to-Plate	30000	40000 ohms
Signal Power Output	0.40	0.95 watt
Total Harmonic Distortion Less Than	5	10 percent

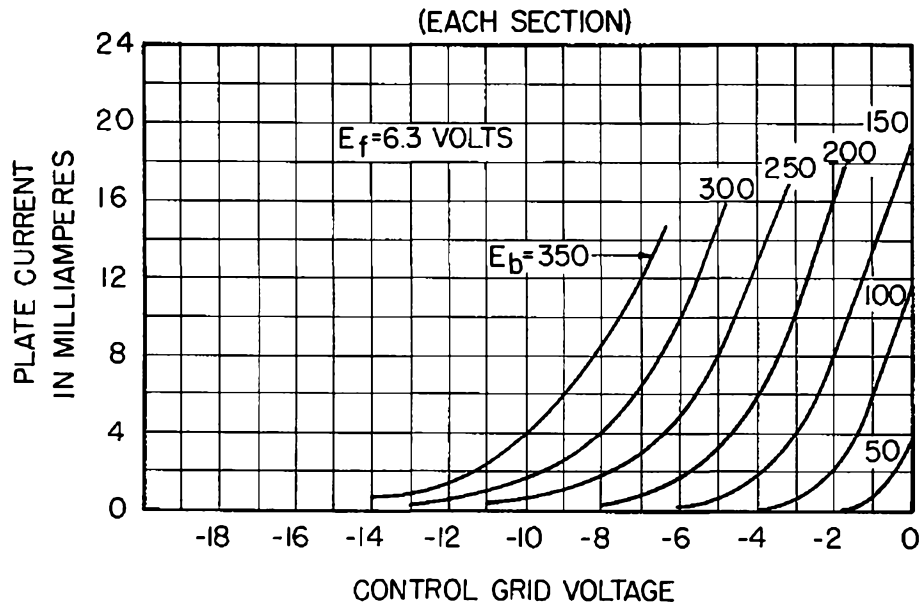
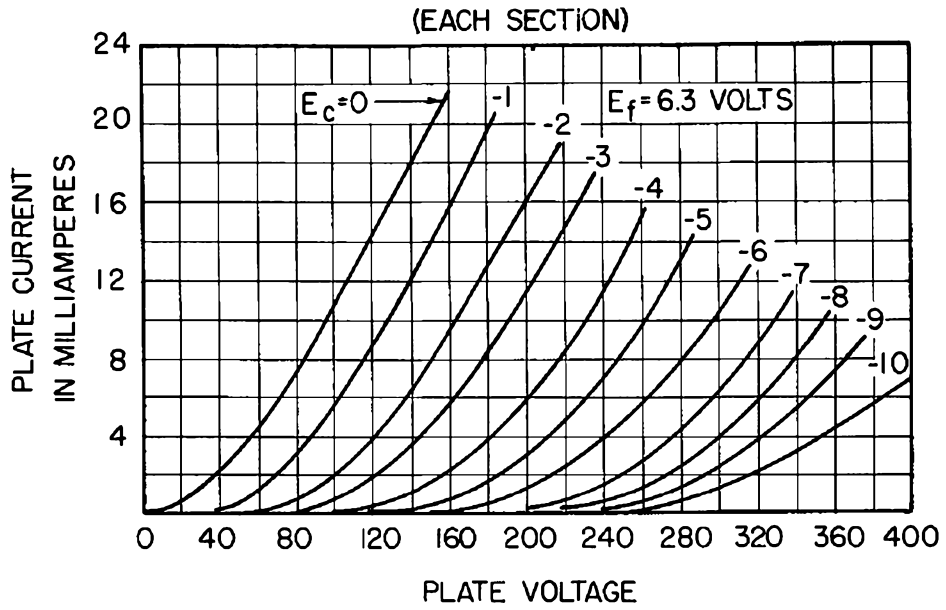

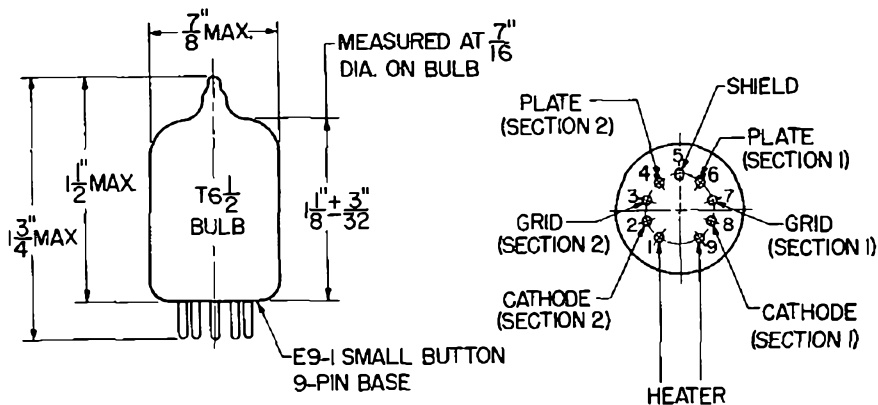
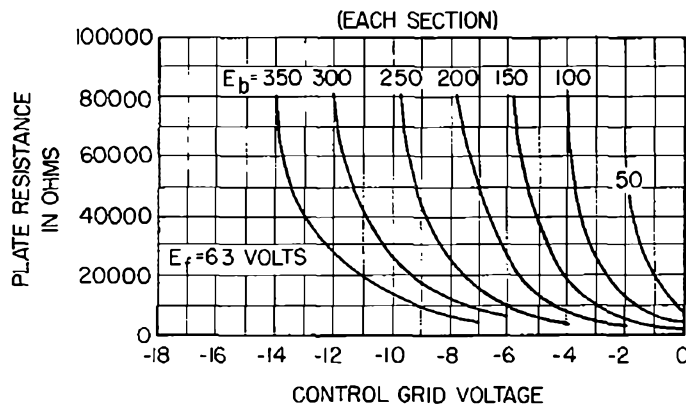
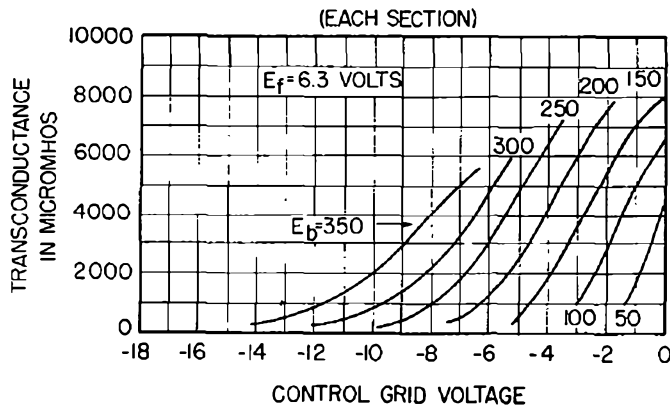

A development of Bell Telephone Laboratories, the research laboratories of the American Telephone and Telegraph Company and the Western Electric Company

ADVANCE ELECTRON TUBE DATA SHEET
WESTERN ELECTRIC 5603/398A ELECTRON TUBE

5603/398A
POWER PENTODE
AMPLIFIER

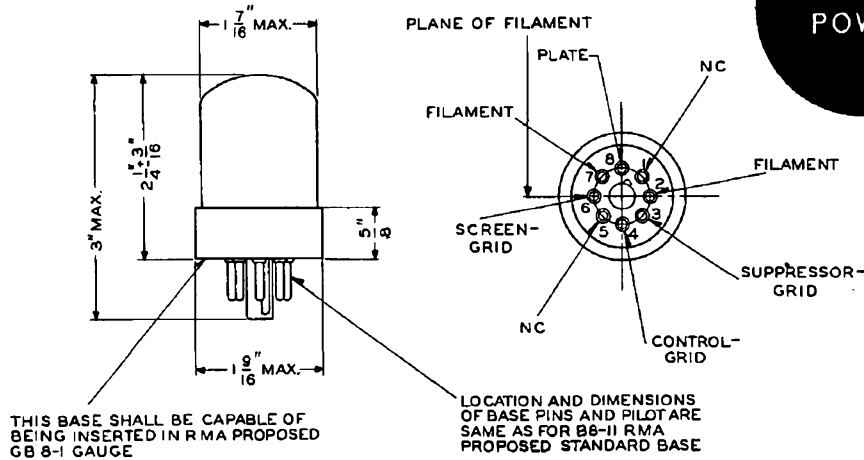

398A
5603

CLASSIFICATION

Filamentary Power Pentode Amplifier

MOUNTING

The tube should be mounted preferably in a vertical position. If mounted in a horizontal position, the plane through contact pins 2 and 6 must be vertical.

MAXIMUM RATINGS (DESIGN-CENTER VALUES)

Plate Voltage	150 volts
Plate Dissipation	8.0 watts
Screen Voltage	150 volts
Screen Dissipation	2.5 watts
Cathode Current	75 milliamperes

OPERATING CONDITIONS AND CHARACTERISTICS

Filament Voltage	6.3 volts
Filament Current	0.5 amp.
Plate Voltage	135 volts
Plate Current	50 milliamperes
Screen Voltage	135 volts
Screen Current	4 milliamperes
Suppressor-Grid Voltage	0 volts
Cathode Bias Resistor	230 ohms
Amplification Factor	92
Plate Resistance	17000 ohms
Transconductance	5400 micromhos
Signal Grid Voltage	8.5 volts a-c
Load Resistance	2500 ohms
Power Output	2.2 watts

INTERELECTRODE CAPACITANCES (NO SHIELD)

Control-grid to filament, screen-grid and suppressor-grid	9.5 μ f
Plate to control-grid	0.3 μ f
Plate to filament, screen-grid and suppressor-grid	7.5 μ f



ADVANCE ELECTRON TUBE DATA SHEET
 WESTERN ELECTRIC 400A ELECTRON TUBE

400A
MINIATURE
PENTAGRID
CONVERTER

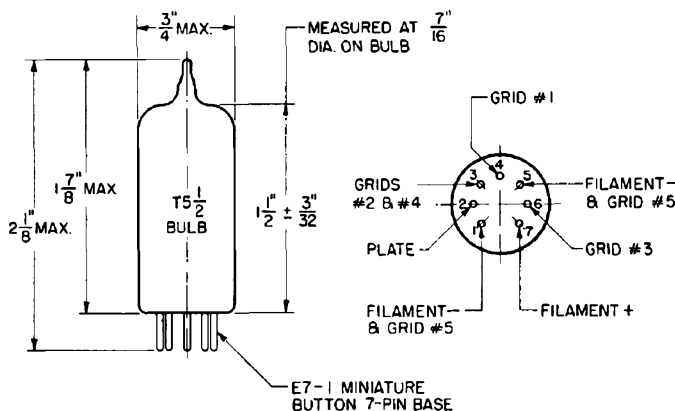

400A

CLASSIFICATION

Miniature Pentagrid Converter

MOUNTING

This tube may be mounted in any position

MAXIMUM RATINGS (Design Center Values)

Plate Voltage	135 volts
Grids #2 and #4 Voltage	135 volts
Cathode Current	7 milliamperes

OPERATING CONDITIONS AND CHARACTERISTICS

Filament Voltage	1.3 volts
Filament Current	200 milliamperes
Plate Voltage	90 volts
Grids #2 and #4 Voltage	45 volts
Grid #1 Resistor	100,000 ohms
Plate Current	0.9 milliamperes
Cathode Current	2.7 milliamperes
Conversion Transconductance	230 micromhos

INTERELECTRODE CAPACITANCES (No Shield)

Grid #3 to All Other Electrodes	8.0 μmf
Plate to All Other Electrodes	8.0 μmf
Grid #3 to Plate	0.25 μmf

ISSUE 1 8-18-47

PRINTED IN U.S.A.

Western Electric

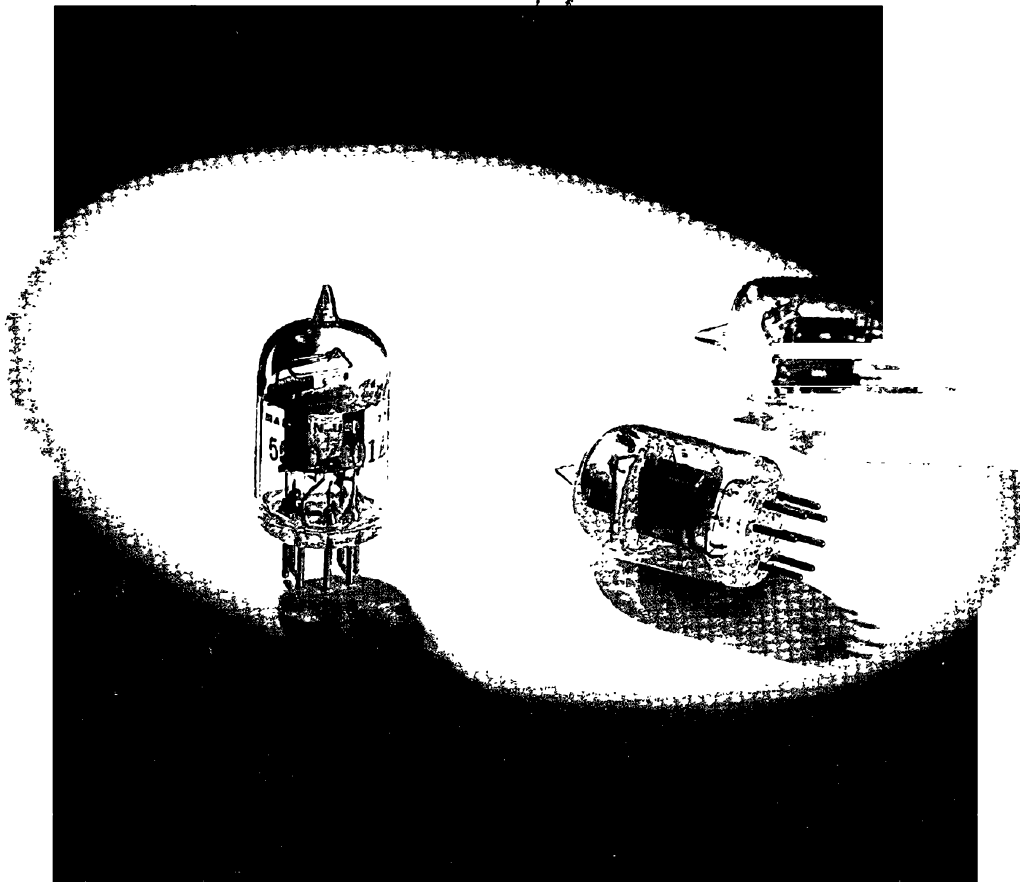

**PENTODE
MINIATURE**

Western Electric

DESCRIPTION

The 5590/401A* is a 7-pin miniature pentode having an indirectly heated cathode. It is designed for use in amplifier circuits at high and ultra high frequencies.

CHARACTERISTICS

Heater Voltage	6.3 volts
Plate Current ($E_b = E_{c2} = 90$ volts, $E_{c1} = -5.0$ volts)	3.9 milliamperes
Transconductance ($E_b = E_{c2} = 90$ volts, $E_{c1} = -5.0$ volts)	2000 micromhos



GENERAL CHARACTERISTICS

ELECTRICAL DATA

Heater Voltage		6.3 volts
Heater Current		150 milliamperes
Direct Interelectrode Capacitances	without external shield	with external shield (RMA #315)
Grid to Plate (max.)	0.017	*0.010 uuf
Input	3.2	* 3.4 uuf
Output	2.0	* 2.9 uuf

MECHANICAL DATA

Cathode	Coated Unipotential
Bulb	T 5½
Base	Small Button 7-pin
Mounting Position	Any
Dimensions and pin connections shown in outline drawing on Page 4	

MAXIMUM RATINGS, Design-Center Values

Plate Voltage	180 volts
Screen Voltage	140 volts
Plate Dissipation	1.7 watts
Screen Dissipation	0.5 watts
Cathode Current	18 milliamperes
Heater-Cathode Voltage	90 volts
Bulb Temperature	120 centigrade

TYPICAL OPERATING CONDITIONS AND CHARACTERISTICS, CLASS A₁ AMPLIFIER

Plate Voltage	45	90	90	120 volts
Screen Grid Voltage	45	90	90	120 volts
Control Grid Voltage	-1.5	-5.0	-7.0 volts
Cathode Bias Resistor	820 ohms
Plate Current	3.0	3.9	4.3	5.1 milliamperes
Screen Grid Current	1.1	1.3	1.4	1.8 milliamperes
Plate Resistance	0.29	0.45	0.41	0.41 megohm
Transconductance	2000	2000	2100	2200 micromhos
Grid Voltage (approximate) for Plate Current of 10 microamperes	-5.3	-10.6	-14.3 volts

⊕External shield connected to cathode pins 2 and 7

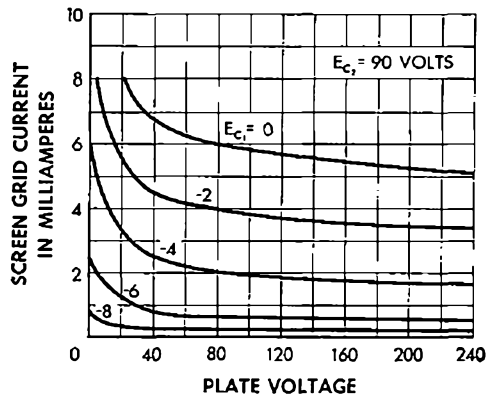
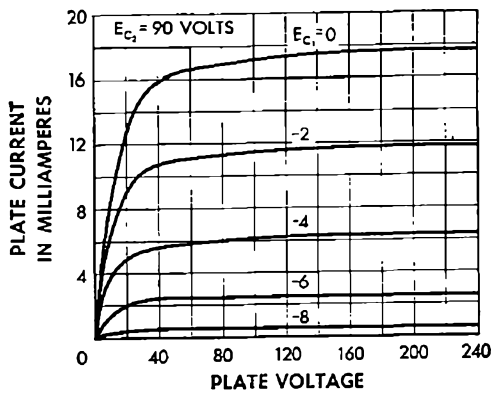

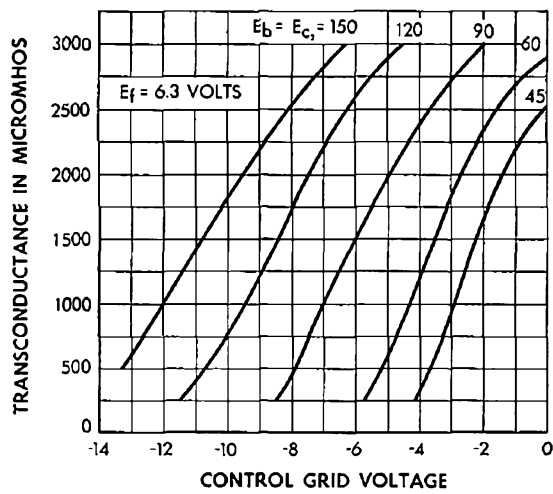
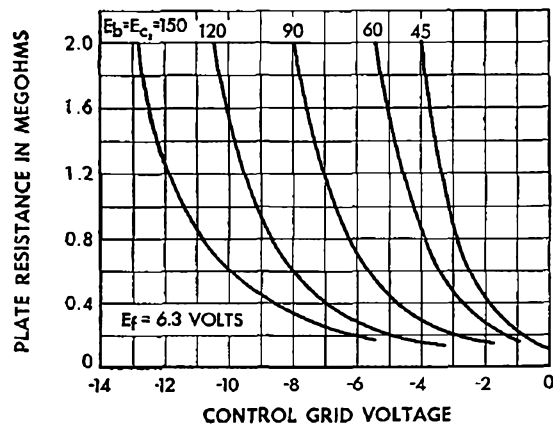
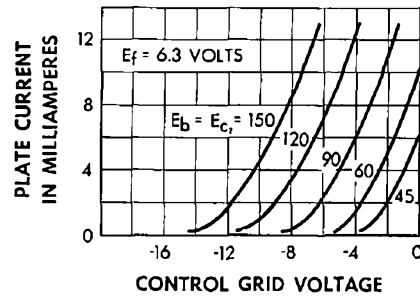
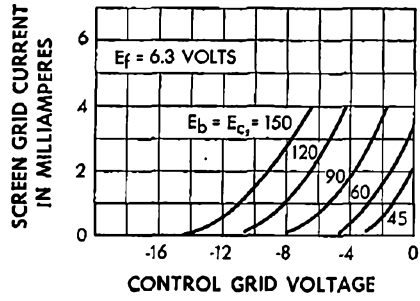

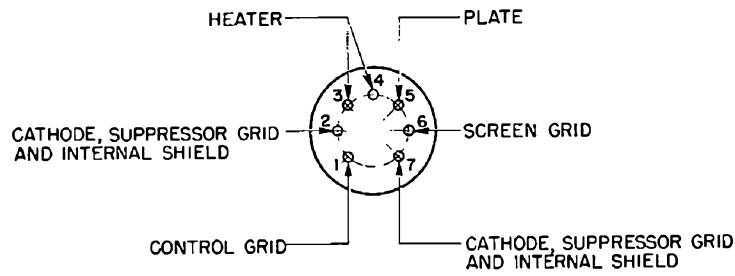
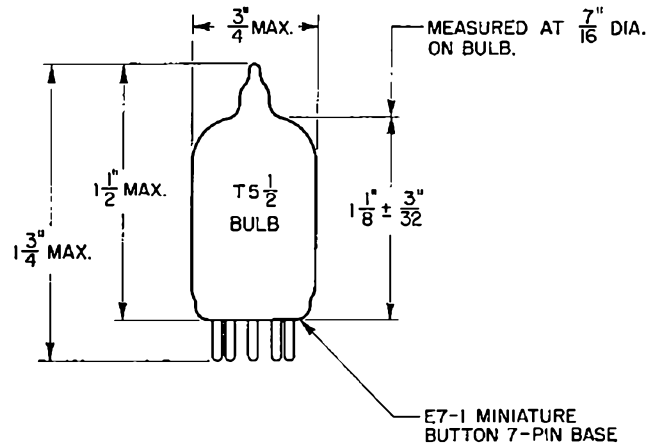

Western Electric

A development of Bell Telephone Laboratories, the research laboratories of the American Telephone and Telegraph Company and the Western Electric Company

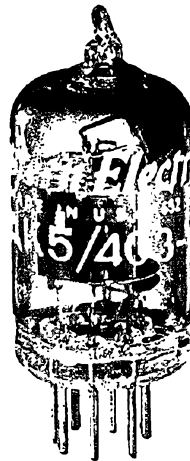

403A

**PENTODE
MINIATURE**

Western Electric

DESCRIPTION

The 6AK5/403A* is a 7-pin miniature pentode having an indirectly heated cathode. It is designed for use in amplifier circuits at high and ultra high frequencies.

CHARACTERISTICS

Heater Voltage	6.3 volts
Plate Current	7.5 milliamperes
Transconductance	5000 micromhos

{ $E_b = E_{c2} = 120$ volts; }
{ Cathode-Bias Resistor = 200 ohms }

GENERAL CHARACTERISTICS

ELECTRICAL DATA

Heater Voltage, A-C or D-C		6.3 volts
Heater Current		175 milliamperes
Direct Interelectrode Capacitances	without external shield	with external shield (RMA #316)
Grid to Plate (maximum)019	*.010 uuf
Input	3.9	*4.0 uuf
Output	2.0	*2.9 uuf

MECHANICAL DATA

Cathode	Coated Unipotential
Bulb	T5½
Base	Miniature Button 7-pin
Mounting Position	Any

Dimensions and pin connections shown in outline drawing on Page 4

MAXIMUM RATINGS, Design-Center Values

Plate Voltage	180 volts
Screen Grid Voltage	140 volts
Plate Dissipation	1.7 watts
Screen Grid Dissipation	0.5 watt
Cathode Current	18 milliamperes
Heater-Cathode Voltage	90 volts
Bulb Temperature	120 centigrade

TYPICAL OPERATING CONDITIONS AND CHARACTERISTICS — CLASS A₁ AMPLIFIER

Plate Voltage	120	150	180 volts
Screen Grid Voltage	120	140	120 volts
Cathode-Bias Resistor	200	330	200 ohms
Plate Current	7.5	6.6	7.7 milliamperes
Screen Grid Current	2.5	2.1	2.4 milliamperes
Plate Resistance	0.30	0.40	0.45 megohm
Transconductance	5000	4500	5100 micromhos
Grid Voltage, Approximate, for Plate Current of 10 Microamperes	-6.8	-7.8	-6.9 volts

*External shield connected to cathode pins 2 and 7.

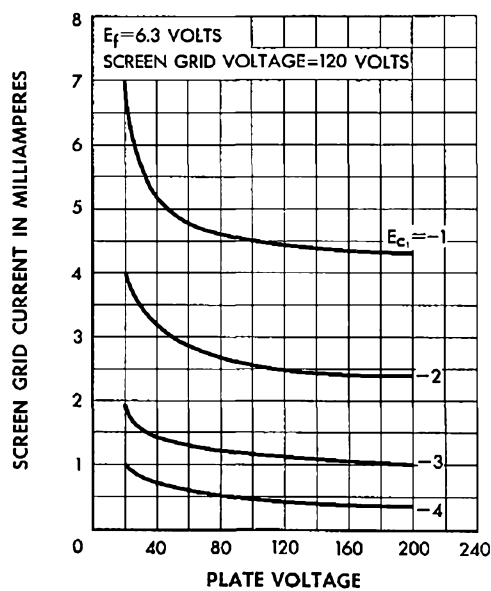
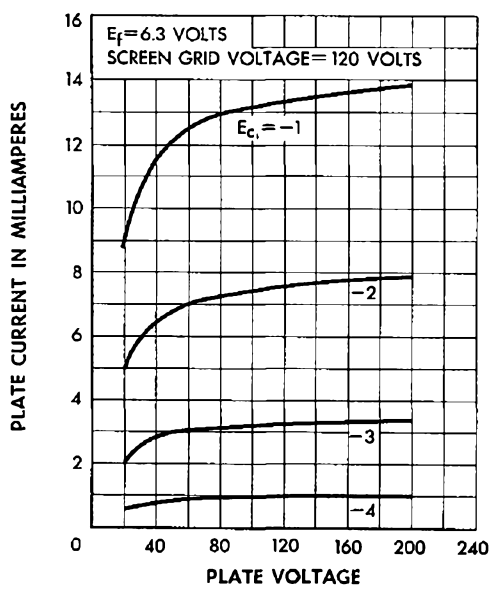
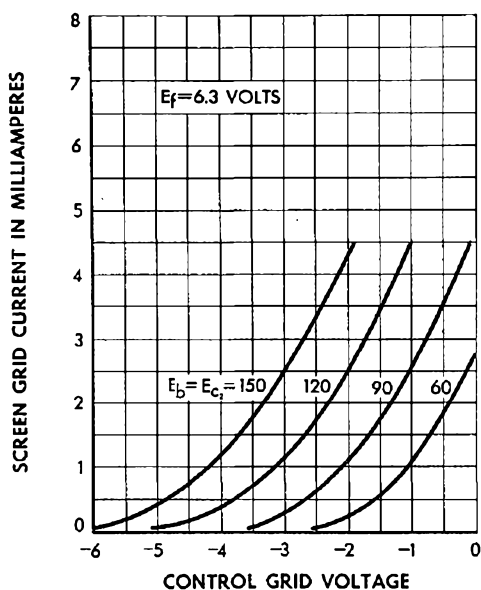
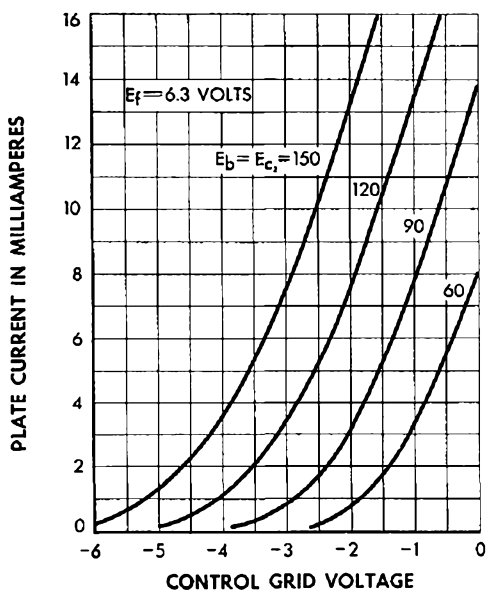

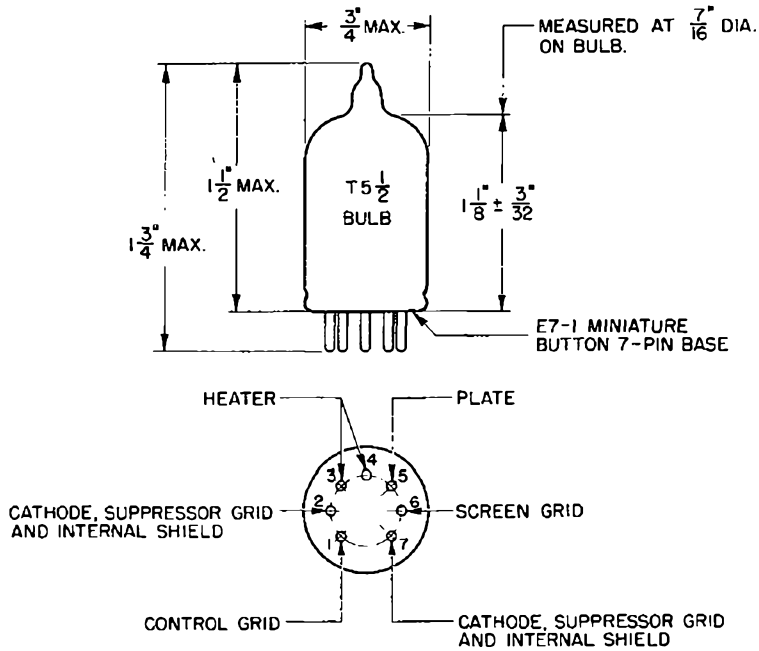
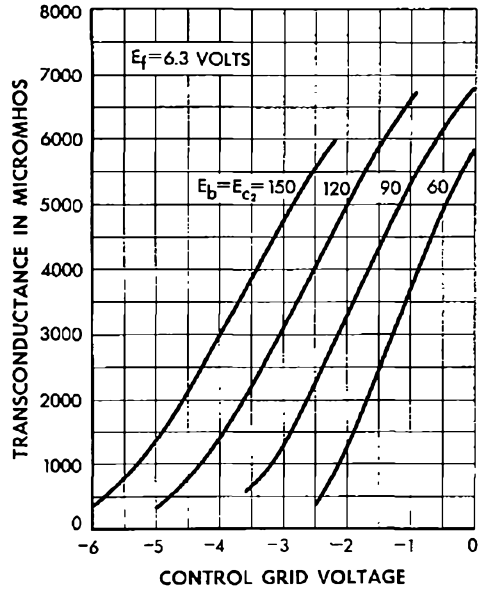
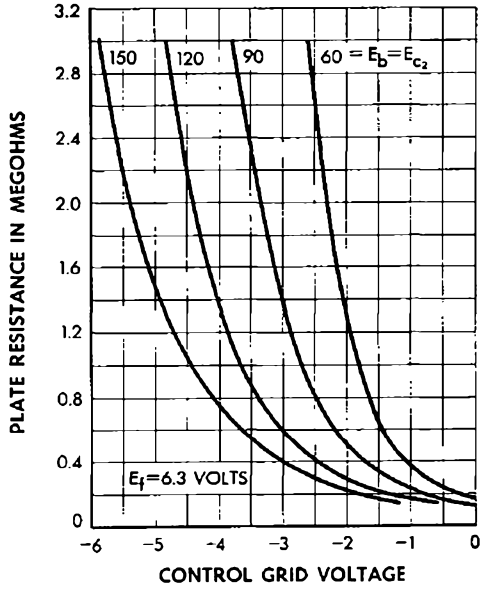

Western Electric

A development of Bell Telephone Laboratories, the research laboratories of the American Telephone and Telegraph Company and the Western Electric Company.

ELECTRON TUBE DATA SHEET
WESTERN ELECTRIC 403 B ELECTRON TUBE



403B

DESCRIPTION

The 403B is a 7 pin miniature pentode with an indirectly heated cathode. It is designed for use in amplifier circuits at high and ultra high frequencies.

CHARACTERISTICS

Heater Voltage	6.3	volts
Plate Current	} $E_b = E_{c2} = 120$ volts;	} 7.5 milliamperes
Transconductance		

FILE: MINIATURE SECTION

403 B

GENERAL CHARACTERISTICS

Electrical Data

Heater Voltage, A-C or D-C (Note 1)	6.3	volts
Heater Current	150	milliamperes
Direct Interelectrode Capacitances	without external shield	with external shield
		(JEDEC #316)
Grid to Plate (maximum)019	*.010 $\mu\mu\text{f}$
Input: g1 to (h+k+g2+g3+i.s.)	3.9	* 4.0 $\mu\mu\text{f}$
Output: p to (h+k+g2+g3+i.s.)	2.0	* 2.9 $\mu\mu\text{f}$

Mechanical Data

Cathode	Coated Unipotential
Bulb	T 5½
Base	Miniature Button 7 pin
Mounting Position	Any

Dimensions and pin connections shown in outline drawing on Page 4.

MAXIMUM RATINGS, Absolute System (Note 2)

Plate Voltage	200	volts
Screen Grid Voltage	155	volts
Plate Dissipation	1.85	watts
Screen Grid Dissipation	0.55	watt
Cathode Current	20	milliamperes
Heater Cathode Voltage	130	volts
Bulb Temperature	130	centigrade
Maximum Grid Circuit Resistance		
For Fixed Bias	1.0	megohm
For Cathode Bias	2.0	megohms

TYPICAL OPERATING CONDITIONS AND CHARACTERISTICS - Class A₁ Amplifier

Plate Voltage	120	150	180	volts
Screen Grid Voltage	120	140	120	volts
Cathode Bias Resistor (Note 3)	200	330	200	ohms
Plate Current	7.0	6.6	7.4	milliamperes ←
Screen Grid Current	2.2	2.1	2.1	milliamperes ←
Plate Resistance	0.30	0.40	0.45	megohm
Transconductance	5000	4500	5100	micromhos
Grid Voltage, Approximate, for				
Plate Current of 10 Microamperes	-6.8	-7.8	-6.9	volts

* External shield connected to cathode pins 2 and 7. ←

Note 1: For optimum tube life the heater voltage specified (6.3 volts) should be regulated to ±5%.

Note 2: In the "Absolute System" the maximum ratings specified are limiting values above which the serviceability of the device may be impaired from the viewpoint of life and satisfactory performance. Maximum ratings, as such, do not constitute a set of operating conditions and all values may not, therefore, be attained simultaneously.

Note 3: Operation with the control grid positive with respect to the cathode is not recommended.

← Indicates a change

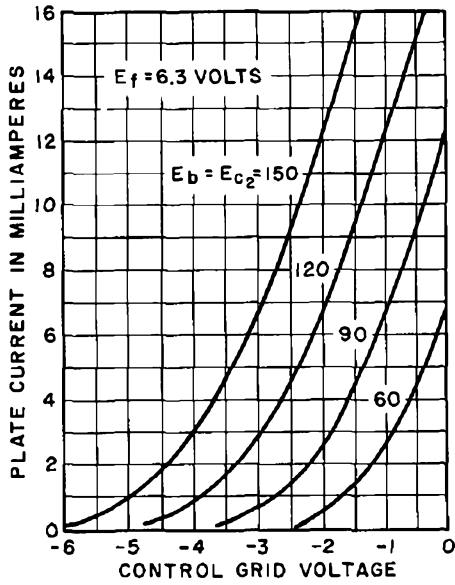

FIG. 1

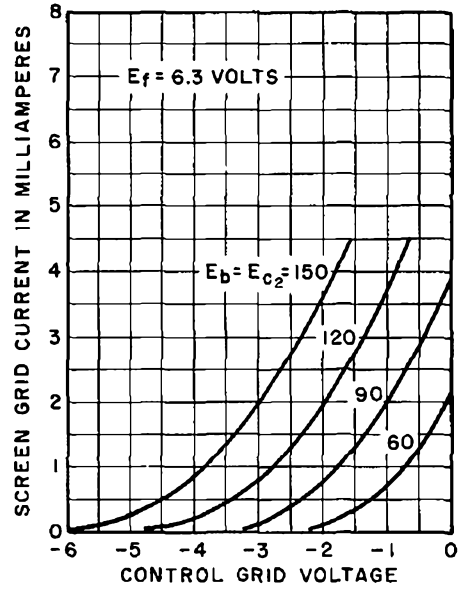

FIG. 2

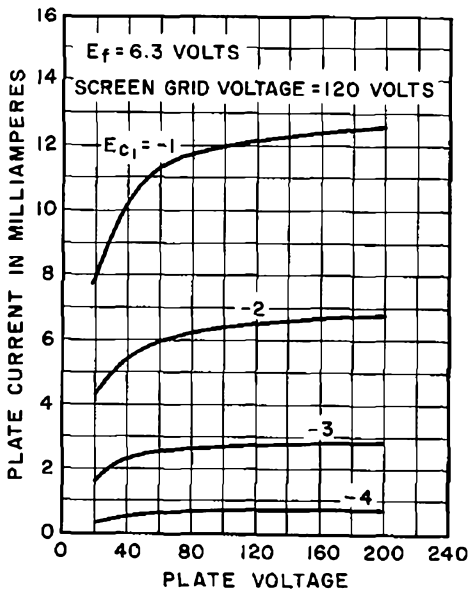

FIG. 3

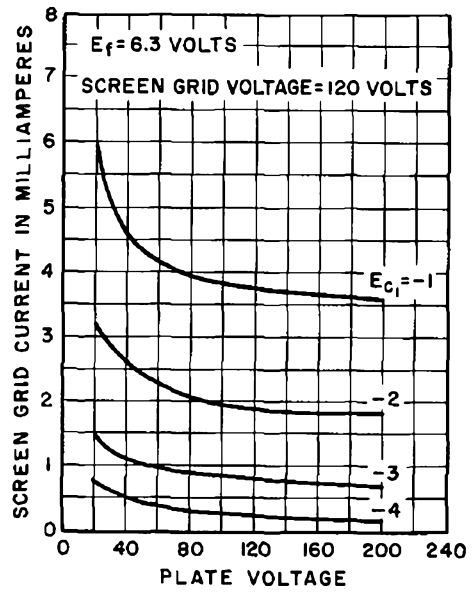

FIG. 4

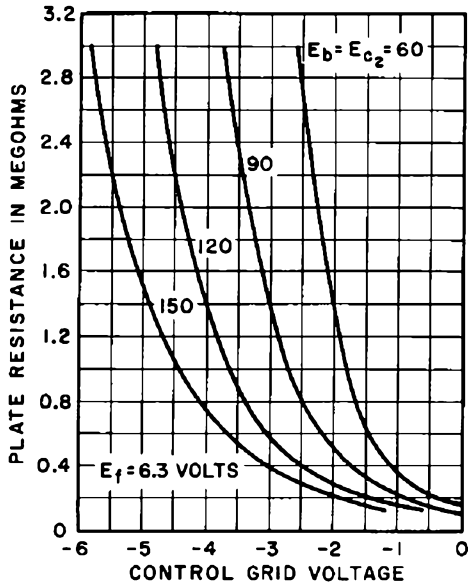

FIG. 5

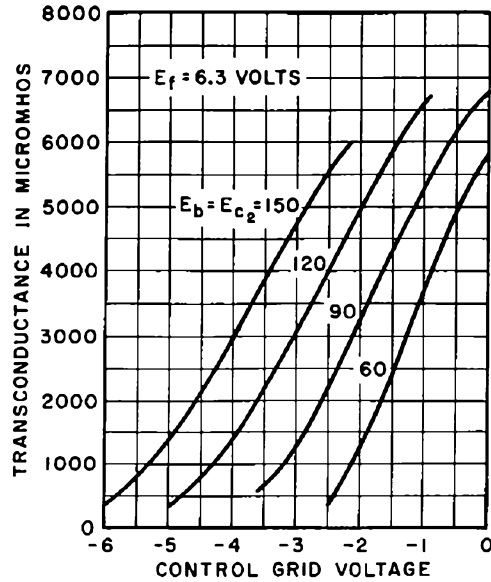
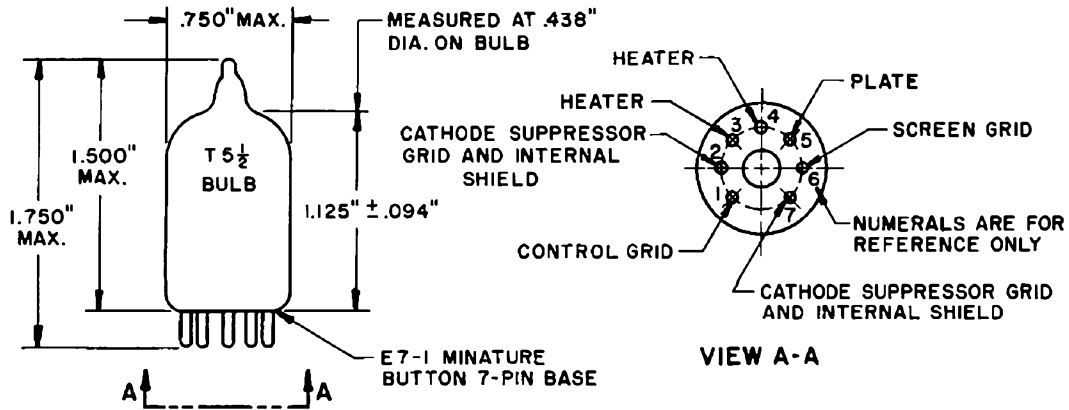

FIG. 6



A development of Bell Telephone Laboratories, the research laboratories of the American Telephone and Telegraph Company and the Western Electric Company.

PRINTED IN U.S.A.

ELECTRON TUBE DATA SHEET
WESTERN ELECTRIC 404A ELECTRON TUBE



404A

DESCRIPTION

The 404A electron tube is an indirectly heated cathode type miniature pentode. It is intended primarily for use in high-gain amplifiers at high and very high frequencies.

CHARACTERISTICS

Heater Voltage	6.3 volts
Cathode Current	17.5 milliamperes
Transconductance	13500 micromhos

$(E_b = 150 \text{ volts}; E_{c2} = 150 \text{ volts})$
 $(E_{c1} = 0; R_k = 110 \text{ ohms})$

File: Miniature Section
Issue 3, 11-55

404A

GENERAL CHARACTERISTICS

ELECTRICAL DATA

Heater Voltage		6.3 volts
Heater Current		300 milliamperes
Direct Interelectrode Capacitances	Without External Shield	With External Shield (RETMA #315)
Grid to Plate (maximum)	0.05	0.04 μ mf
Input: g1 to (h+k+g2+g3+i.s.) . . .	7.0	7.1 μ mf
Output: p to (h+k+g2+g3+i.s.) . . .	2.5	2.9 μ mf

MECHANICAL DATA

Cathode	Coated Unipotential
Bulb	T6 1/2
Base	Small Button, 9-Pin
Mounting Position	Any
Dimensions and Pin Connections	See Outline Drawing-Page 4

MAXIMUM RATINGS, Design-Center Values

Plate Voltage	250 volts
Screen Grid Voltage	150 volts
Plate Dissipation	3 watts
Screen Grid Dissipation	0.75 watt
Control Grid Dissipation	See footnote *
Cathode Current	35 milliamperes
Heater-Cathode Voltage	50 volts
Bulb Temperature	120° centigrade

MAXIMUM CIRCUIT VALUES

Grid Circuit Resistance:	
For Fixed Bias	50000 ohms
For Cathode Bias	100000 ohms

TYPICAL OPERATING CONDITIONS AND CHARACTERISTICS

Plate Voltage	130	150 volts
Screen Grid Voltage	130	150 volts
Control Grid Supply Voltage ¹	+7.5	--- volts
Cathode Bias Resistor ¹	430	110 ohms
Plate Current	15.5	14.0 milliamperes
Screen Grid Current	4.5	3.5 milliamperes
Plate Resistance	95000	90000 ohms
Transconductance	14700	13500 micromhos
Control Grid Voltage (approximate) for Plate Current of 10 Microamperes	- 4.3	-5.0 volts
Modulation:		
Second Order (2F)**	43	46 db
Third Order (3F)***	21	28 db
Load Resistance	200	200 ohms

* Operation with the control grid positive with respect to the cathode is not recommended.

** Ratio of product to fundamental at output for 0.1 volt rms signal from grid to cathode.

*** Ratio of product to fundamental at output for a 0.2 volt rms signal from grid to cathode.

Note 1: Reference point for control grid voltage is the negative end of the cathode bias resistor.

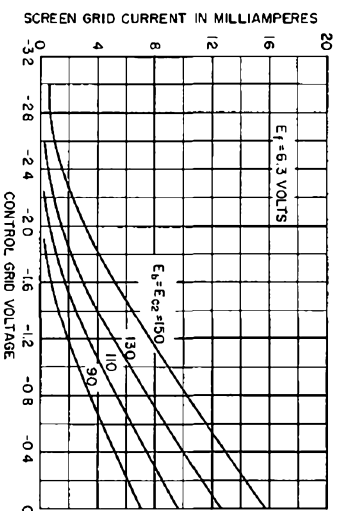
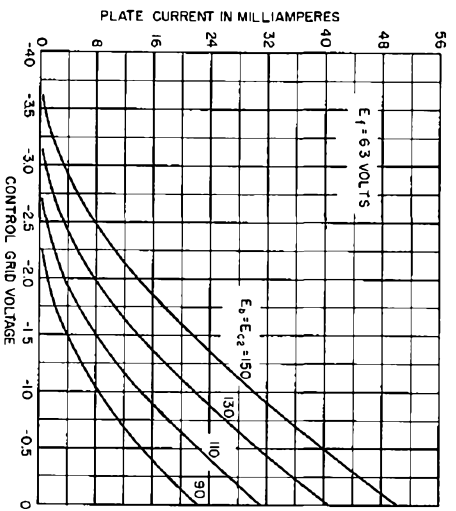
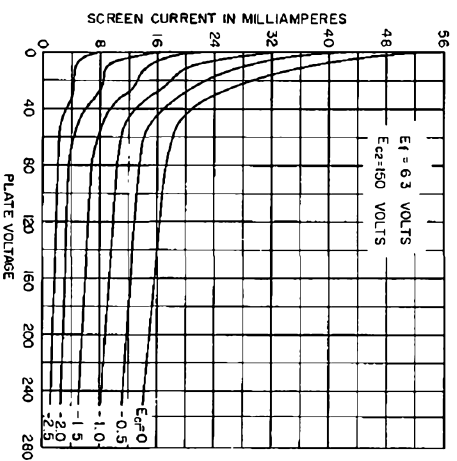
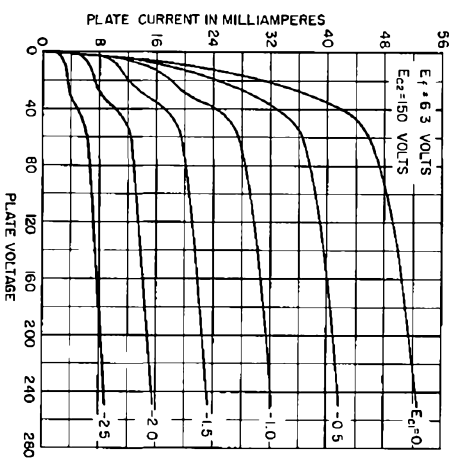
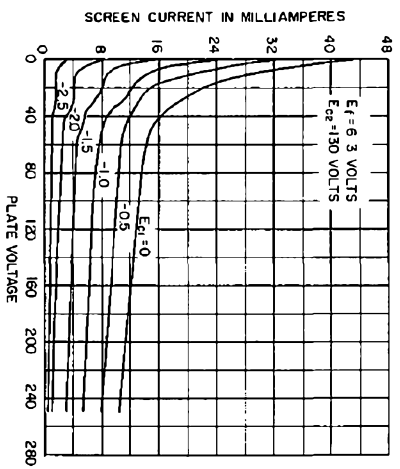
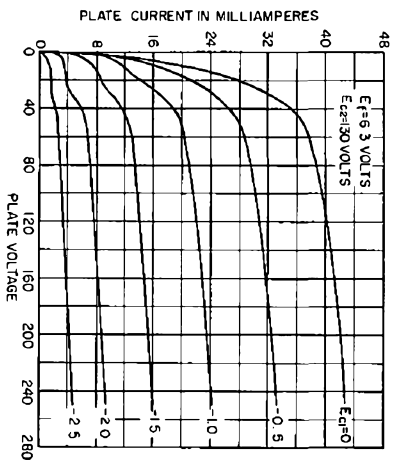

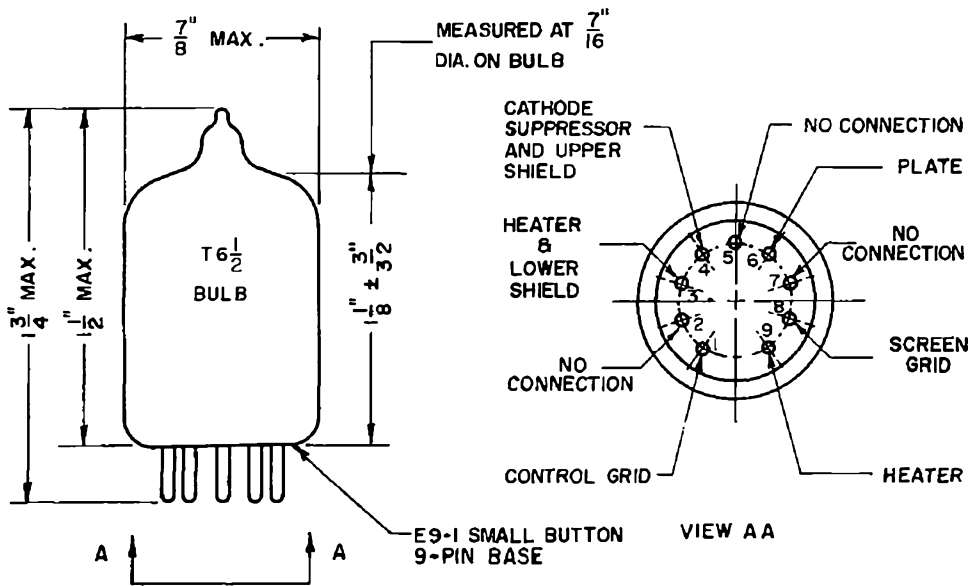
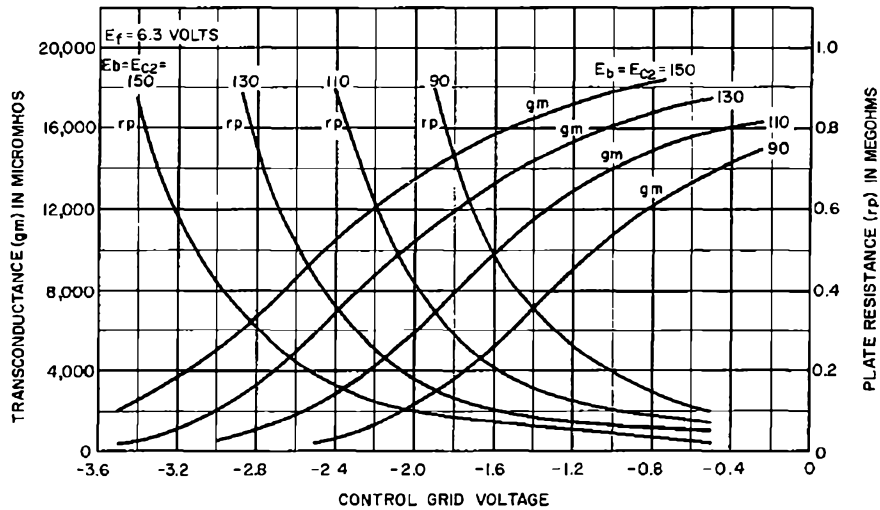

A development of Bell Telephone Laboratories, the research laboratories of the American Telephone and Telegraph Company and the Western Electric Company

OK for Plants Dept use.
S. F. H. 6/15/50

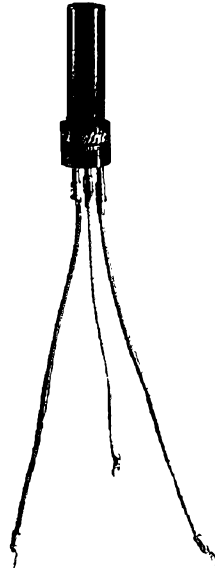

405A

COLD CATHODE

Western Electric

DESCRIPTION

The 405A is a three-electrode, inert-gas-filled, cold cathode tube for use primarily as a relay in communication circuits. It is also suitable for use in control circuits such as in triggering, counting or switching

apparatus. This tube, because of its small size, flexible connector leads and ease in mounting, may be used to advantage in equipment where space is a factor.

MAXIMUM RATINGS

Peak Anode Voltage	165 volts
Average Cathode Current	4	40 milliamperes
Average Life	10000	10 hours

405A
COLD CATHODE

MAXIMUM RATINGS, Absolute Values

Peak Anode Voltage		
Forward		165 volts
Inverse		165 volts
Forward Cathode Current		
Peak		40 milliamperes
Average		15 milliamperes
Averaging Time		1 second
Peak Inverse Anode Current		1 milliampere
Ambient Temperature Limits		-55 to +85 centigrade

ELECTRICAL DATA

	Min.	Bogey	Max.
Starter Breakdown Voltage*	67	75	89 volts
Starter Voltage Drop at 10 milliamperes	52	60	74 volts
Anode Voltage Drop at 10 milliamperes	66	75	90 volts
Required Transfer Current at 130 Anode Volts (D. C.)	50 microamperes
Deionization Time, Approximate			
Starter Gap	2	... milliseconds
Main Gap	8	... milliseconds

MECHANICAL DATA

Mounting Position	Any
Net Weight, Approximate	0.4 ounce

*Limits apply immediately after tube has conducted current. If tube has been idle, these values may be as much as 3 volts higher or lower.

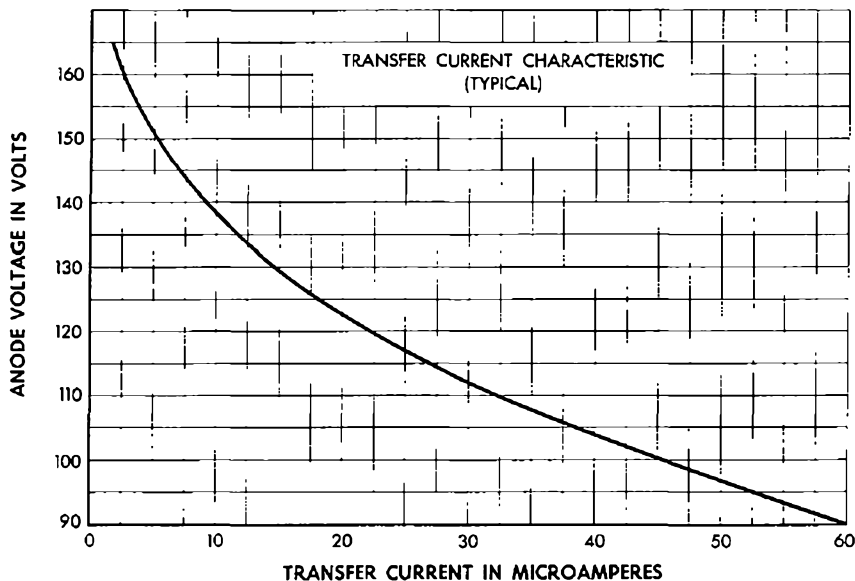

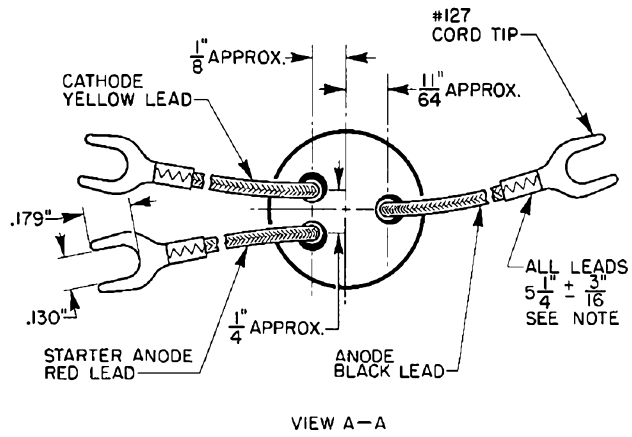
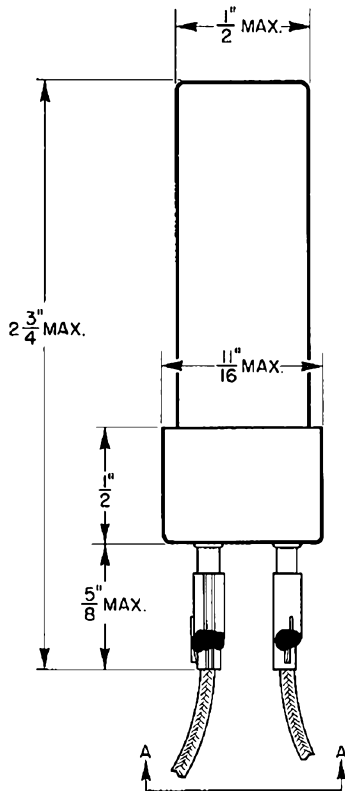
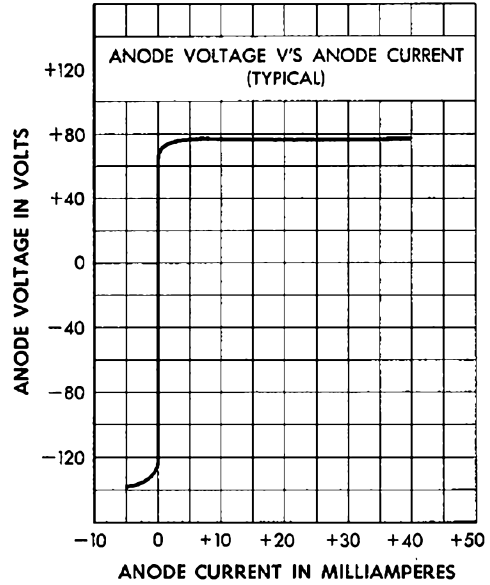
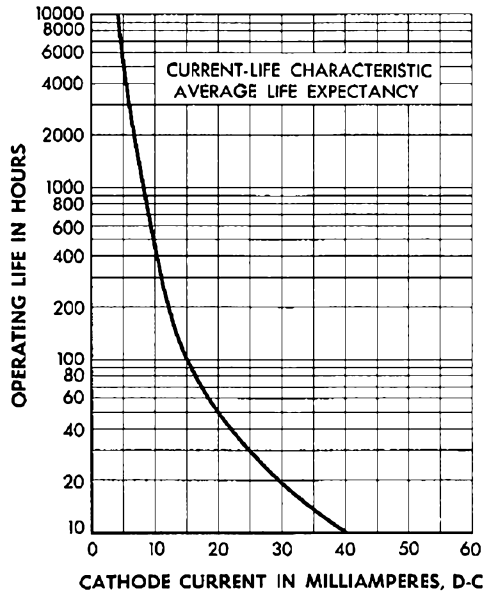

NOTE: LEAD LENGTHS SPECIFIED REFER TO LENGTH FROM END OF BASE SHELL TO END OF SPADE.

ELECTRON TUBE DATA SHEET
WESTERN ELECTRIC 407A ELECTRON TUBE



407A

DESCRIPTION

The 407A is a 9-pin miniature double triode with separate indirectly heated cathodes. It is designed for use in amplifier, mixer, oscillator, multivibrator and clamp circuits. The useful frequency range extends through the VHF range.

CHARACTERISTICS

	<u>Parallel</u>	<u>Series</u>	
Heater Voltage	20	or 40	volts
Plate Current per Section. . . }	$E_b = 150$ volts { $E_c = -2.0$ volts {		8.2 milliamperes
Transconductance per Section. . }			5500 micromhos

FILE: MINIATURE SECTION

GENERAL CHARACTERISTICS

<u>Electrical Data</u>	<u>Parallel</u>	<u>Series</u>	
Heater Voltage, A-C or D-C (Note 1)	20	40	volts
Heater Current	100	50	milliamperes
Direct interelectrode Capacitances	without	with	
	external shield.	external shield	
		(JEDEC #315)	
→ Grid-to-Plate per Section	1.3	* 1.3	μμf
Input per Section	2.2	* 2.3	μμf
Output per Section	1.0	* 1.3	μμf
Plate-to-Plate	0.04	**0.03	μμf
Plate-to-Plate (maximum)	0.11	**0.10	μμf

Mechanical Data

Cathode Coated unipotential
 Bulb T 6½
 Base Small button, 9-pin
 Mounting Position Any
 Dimensions and pin connections shown in outline drawing on page 4.

MAXIMUM RATINGS, Absolute System (Note 2)

↗ Values are for each section

Plate Voltage	330	volts
Plate Dissipation	1.6	watts
Plate Current	20	milliamperes
Heater Cathode Voltage	130	volts
Maximum Grid Circuit Resistance for		
↙ Fixed Bias	1	megohm
Cathode Bias	2	megohm

TYPICAL OPERATING CONDITIONS AND CHARACTERISTICS - Class A₁ Amplifier

Values are for each section

Plate Voltage	150	150	volts
Grid Voltage	-2.0	-	volts
Cathode Resistor	-	240	ohms
Plate Current	8.2	8.2	milliamperes
Transconductance	5500	5500	micromhos
Amplification Factor	35	35	
Grid Voltage (Approximate) for			
Plate Current of 10 microamperes	- 8	-	volts

* Pin 5 and external shield (EIA #315) connected to cathode pin of section under test. Elements of other section grounded.

** Pin 5 and external shield (EIA #315) connected to ground with other elements.

→ Indicates a change

TYPICAL OPERATING CONDITIONS - Class AB₁ Amplifier

Plate Voltage	200	300	volts
Cathode Resistor (Cathodes Tied Together).	400	800	ohms
Peak A-F Grid-to-Grid Voltage.	9.0	20	volts
Zero Signal Plate Current per Section	5.0	4.7	milliamperes
Maximum Signal Plate Current per Section	5.6	6.0	milliamperes
Load Impedance, Plate-to-Plate	30000	40000	ohms
Signal Power Output.	0.40	0.95	watt
Total Harmonic Distortion Less Than	5	10	per cent

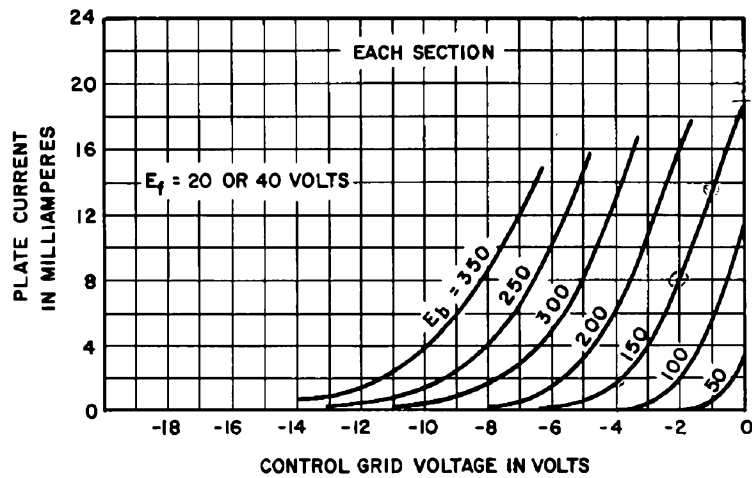

FIG. 1

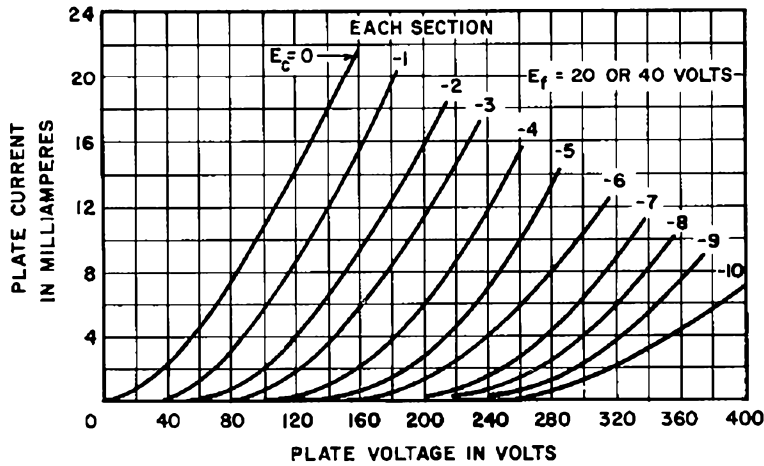

FIG. 2

- Note 1: For optimum tube life the heater voltage specified (20 or 40 volts) should be regulated to $\pm 5\%$.
- Note 2: In the "Absolute System" the maximum ratings specified are limiting values above which the serviceability of the device may be impaired from the viewpoint of life and satisfactory performance. Maximum ratings, as such, do not constitute a set of operating conditions and all values may not, therefore, be attained simultaneously.

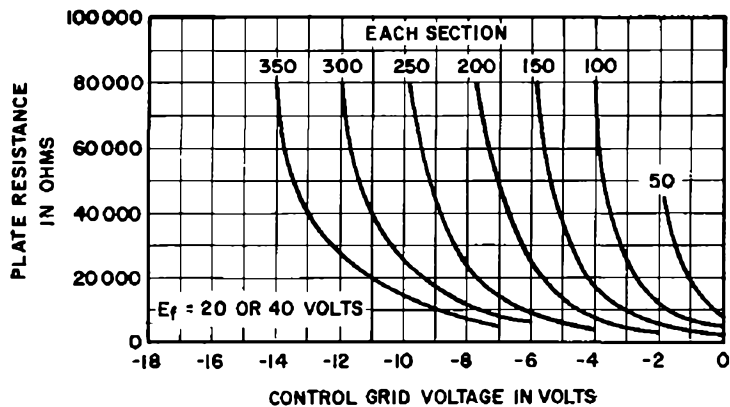

FIG. 3

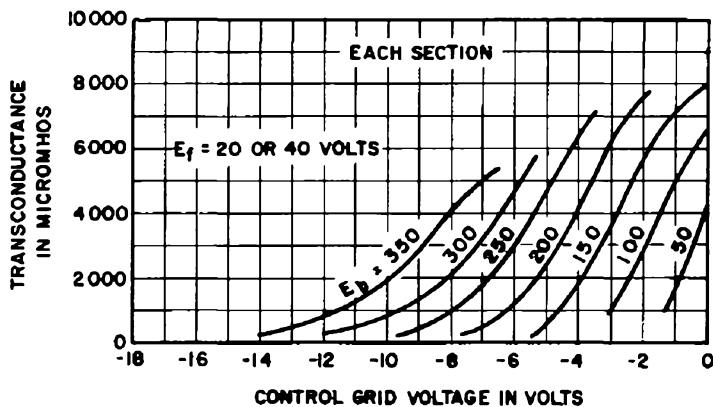
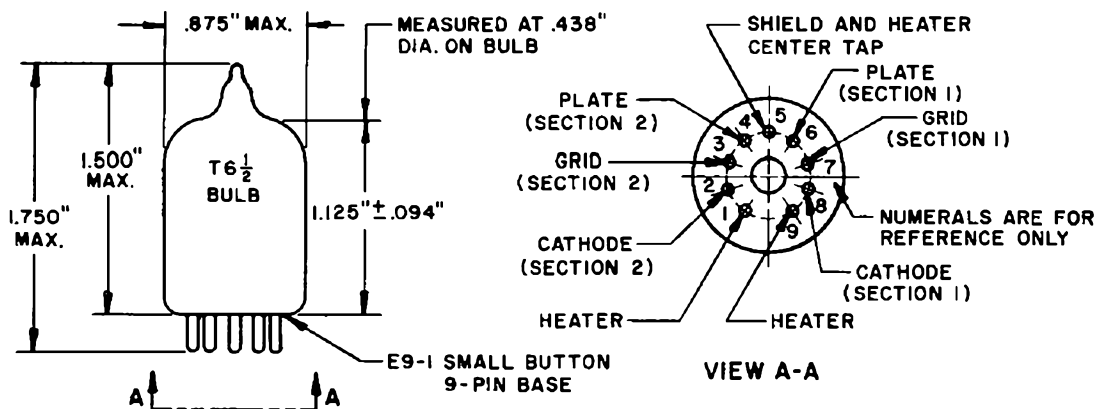
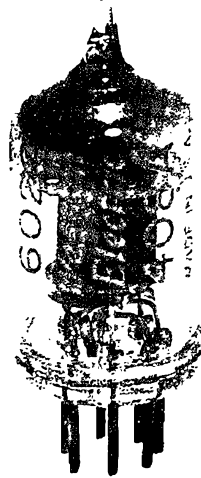

FIG. 4



A development of Bell Telephone Laboratories, the research laboratories of the American Telephone and Telegraph Company and the Western Electric Company.

ELECTRON TUBE DATA SHEET
WESTERN ELECTRIC 408A* ELECTRON TUBE



408A

DESCRIPTION

The 6028/408A* is a 7-pin miniature pentode having an indirectly heated cathode. It is designed for use in amplifier circuits at high and ultra high frequencies. It is also suitable for audio-frequency applications where exceptionally low microphonic noise is not a requirement.

CHARACTERISTICS

Heater Voltage	20 volts
Plate Current	} $E_b = E_{c2} = 120$ volts; { . 7.5 milliamperes
Transconductance	

FILE: MINIATURE SECTION
Issue 3 11-53

408A*

GENERAL CHARACTERISTICSELECTRICAL DATA

Heater Voltage, A-C or D-C		20 volts
Heater Current		50 milliamperes
Direct Interelectrode Capacitances	without external shield	with external shield (RMA # 316)
Grid to Plate (maximum)019	*.010 uuf
Input	3.9	*4.0 uuf
Output	2.0	*2.9 uuf

MECHANICAL DATA

Cathode	Coated Unipotential
Bulb	T5 1/2
Base	Miniature Button 7-pin
Mounting Position	Any

Dimensions and pin connections shown in outline drawing on Page 5

MAXIMUM RATINGS, Design-Center Values

Plate Voltage	180 volts
Screen Grid Voltage	140 volts
Plate Dissipation	1.7 watts
Screen Grid Dissipation	0.5 watt
Cathode Current	18 milliamperes
Heater-Cathode Voltage ¹	120 volts
Bulb Temperature	120°centigrade
Maximum Grid Current Resistance for	
Fixed Bias	1.0 megohm
Cathode Bias	2.0 megohms

TYPICAL OPERATING CONDITIONS AND CHARACTERISTICS - CLASS A₁ AMPLIFIER

Plate Voltage	120	120 volts
Screen Grid Voltage	120	120 volts
Cathode-Bias Resistor	200	130 ohms
Peak A-F Grid Voltage	2.0	1.5 volts
Zero Signal Plate Current	7.5	9.4 milliamperes
Maximum Signal Plate Current	7.7	9.2 milliamperes
Zero Signal Screen Grid Current	2.5	3.2 milliamperes
Maximum Signal Screen Grid Current	3.3	3.9 milliamperes
Plate Resistance	0.30	0.25 megohm
Transconductance	5000	5600 micromhos
Load Resistance	15000	15000 ohms
Power Output	325	265 milliwatts
Total Harmonic Distortion	12	5.5 per cent
Grid Voltage, Approximate, for		
Plate Current of 10 Microamperes	-6.8	-6.8 volts

* External shield connected to cathode pins 2 and 7.

Note 1. For optimum tube life it is recommended that heater-cathode voltage should not exceed 90 volts.

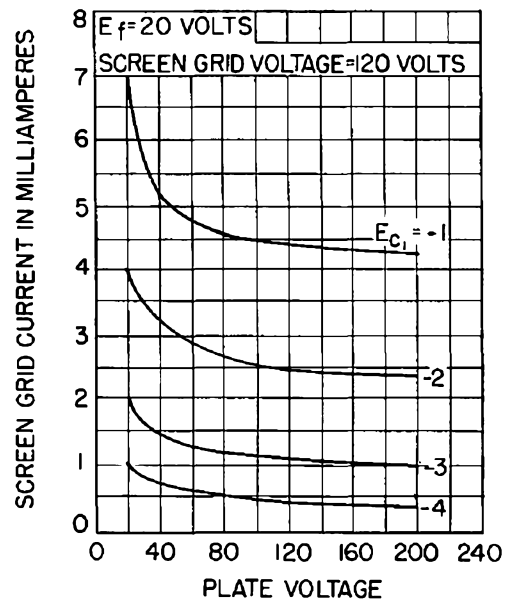
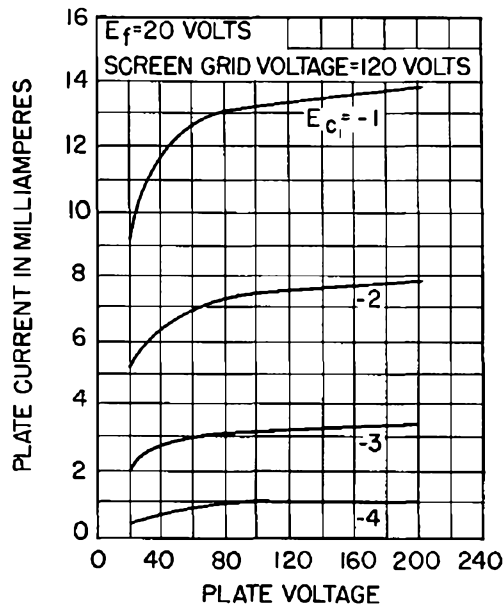
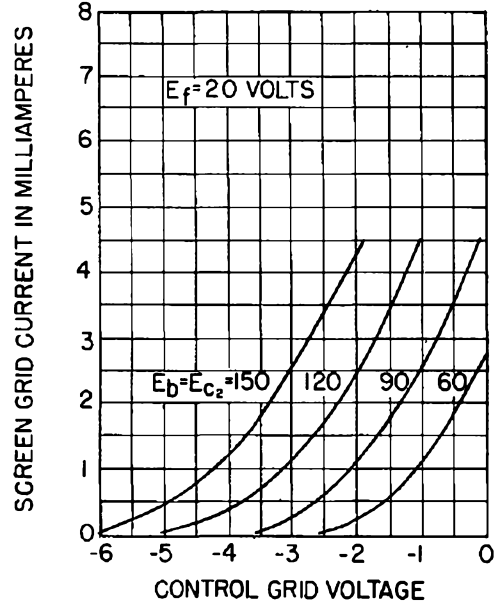
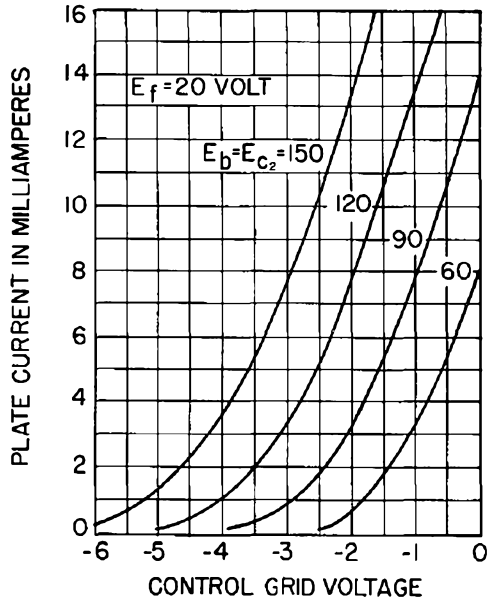

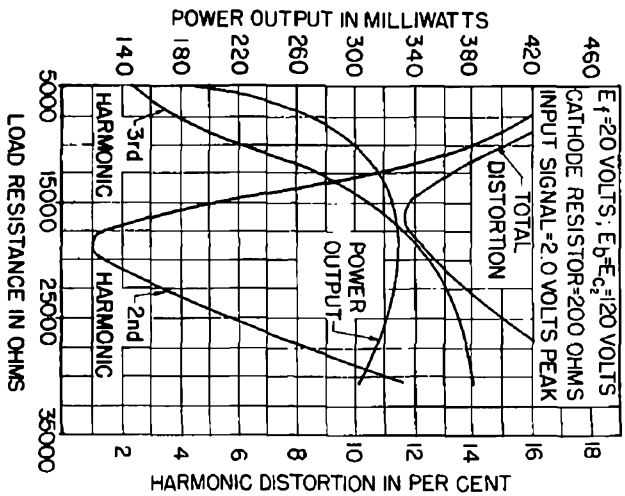
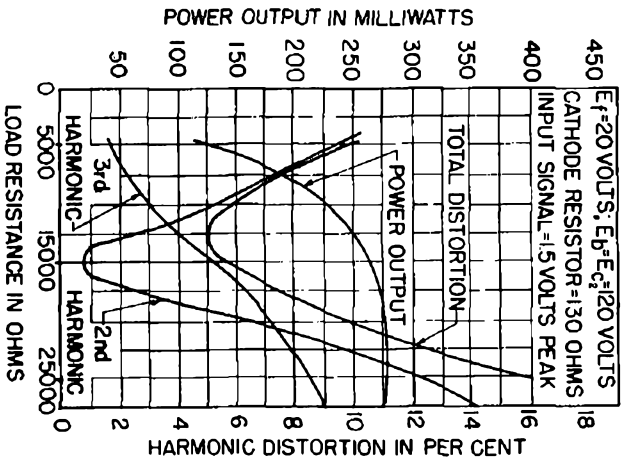
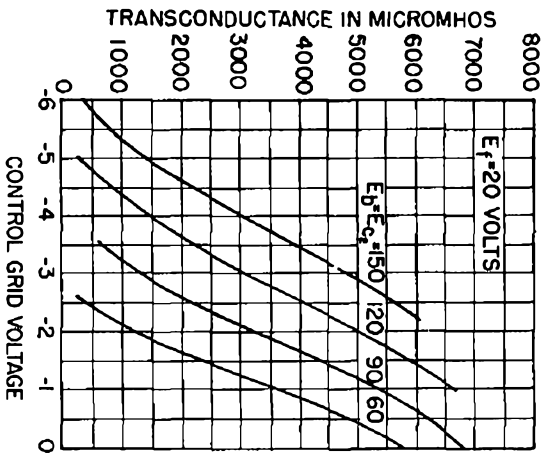
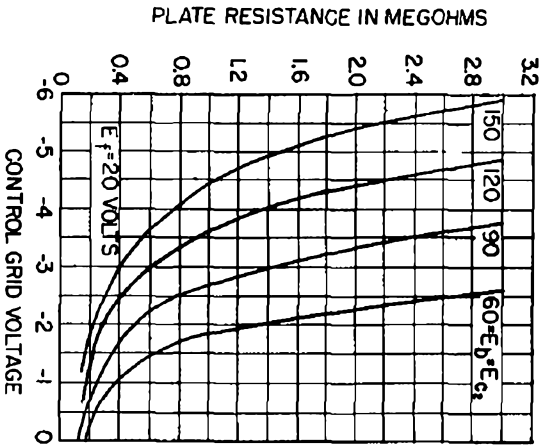

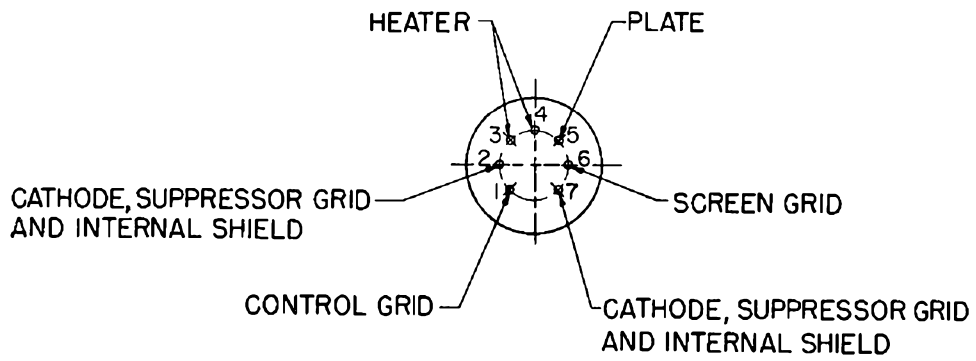
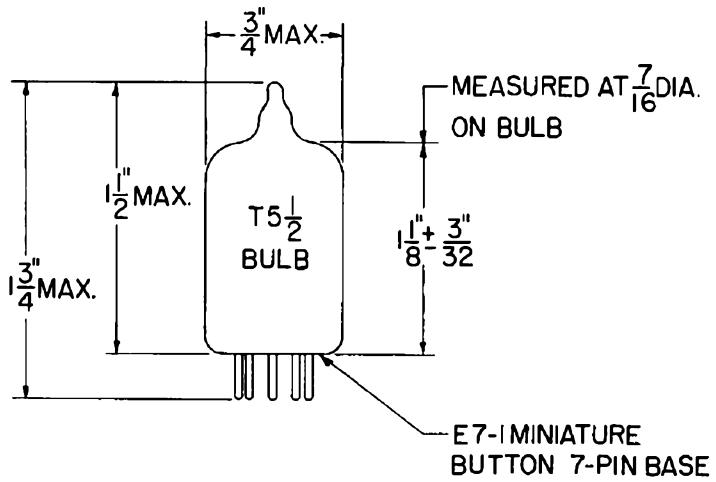

A development of Bell Telephone Laboratories, the research laboratories of the American Telephone and Telegraph Company and the Western Electric Company.

ADVANCE ELECTRON TUBE DATA SHEET

WESTERN ELECTRIC 6AS6/409A ELECTRON TUBE

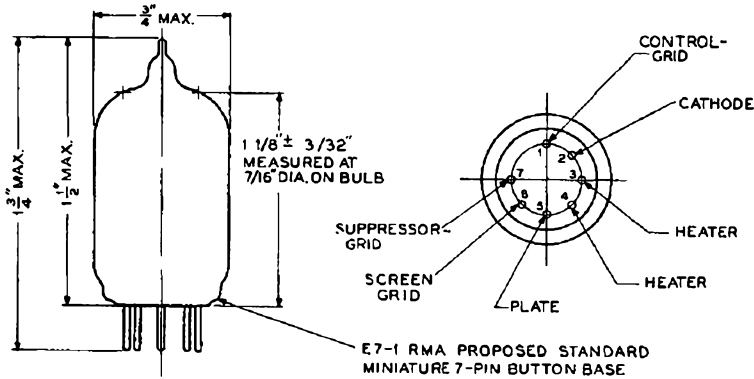

6AS6/409A
MINIATURE
PENTODE
U. H. F.

409A
6AS6

CLASSIFICATION

The 6AS6/409A electron tube is a 7-pin miniature, triple-grid pentode with an indirectly heated cathode. It is intended for low power applications at high and ultra-high frequencies. The usual control-grid and the suppressor-grid can be used as independent control elements. The tube is suitable for use in gated amplifiers, gain controlled amplifiers, delay circuits, and mixers.

MOUNTING

The dimensions and arrangement of terminal connections are as shown above. The tube may be mounted in any position.

HEATER RATING

Heater voltage, a-c or d-c	5.3 volts
Nominal heater current	0.175 ampere

MAXIMUM RATINGS (Design-center values)

Plate voltage	180 volts
Screen voltage	140 volts
Positive suppressor voltage	27 volts
Plate dissipation	1.7 watts
Screen dissipation	0.75 watt
Cathode current	18 milliamperes
Heater-cathode voltage	90 volts
Bulb temperature	120°Centigrade

OPERATING CONDITIONS AND CHARACTERISTICS

Plate voltage	120	120 volts
Screen voltage	120	120 volts
Suppressor voltage	- 3	0 volts
Grid voltage	- 2	- 2 volts
Plate current	3.6	5:2 milliamperes
Screen current	4.8	3.5 milliamperes
Transconductance, control-grid	1850	3200 umhos
Transconductance, suppressor-grid	810	470 umhos

CONTROL-GRID PLATE CURRENT CUT-OFF CHARACTERISTICS

Plate voltage	120	volts
Screen voltage	120	volts
Suppressor voltage	0	volts
Nominal cut-off, control-grid	- 6	volts
Guaranteed cut-off, control-grid	-10	volts

SUPPRESSOR-GRID PLATE CURRENT CUT-OFF CHARACTERISTICS

Plate voltage	120	120 volts
Screen voltage	120	60 volts
Grid voltage	- 2	0 volts
Nominal cut-off, suppressor-grid	-10	- 8 volts
Guaranteed cut-off, suppressor-grid	-15	-10 volts

INTERELECTRODE CAPACITANCES (With JAN 1A No. 314 shield connected to cathode)

Control-grid to heater, cathode, screen and suppressor-grid	3.9 uuf
Plate to control-grid	0.01 uuf
Plate to heater, cathode, screen and suppressor-grid	3.0 uuf
Control-grid to suppressor-grid	0.1 uuf



NORMAL PENTODE CHARACTERISTICS

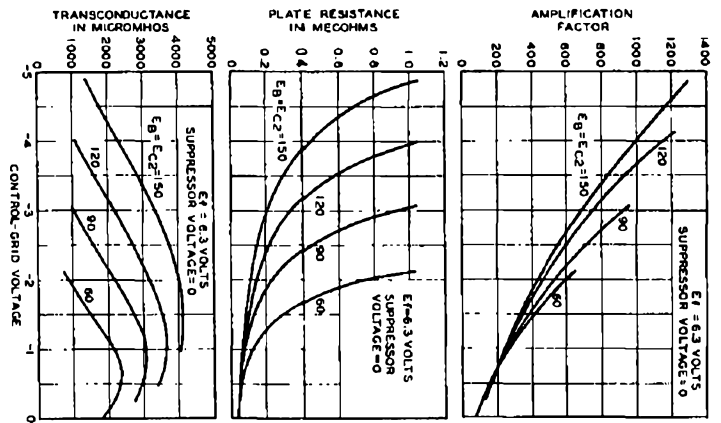
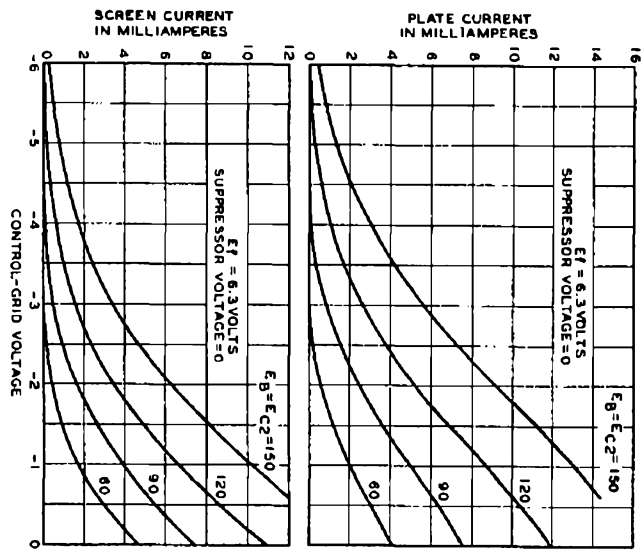
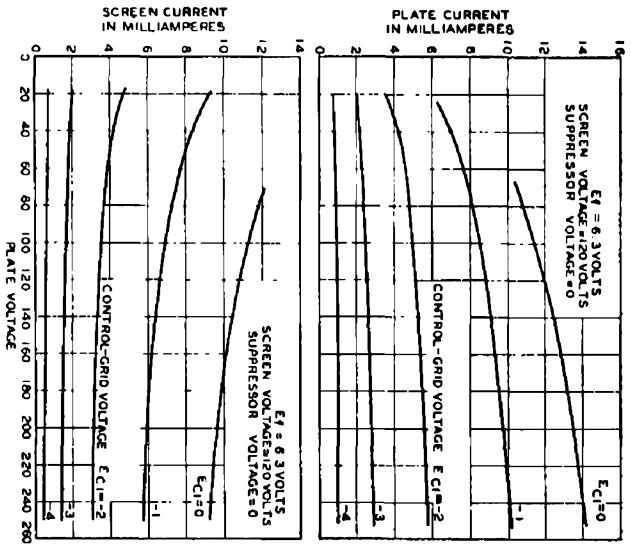

SUPPRESSOR - GRID CHARACTERISTICS

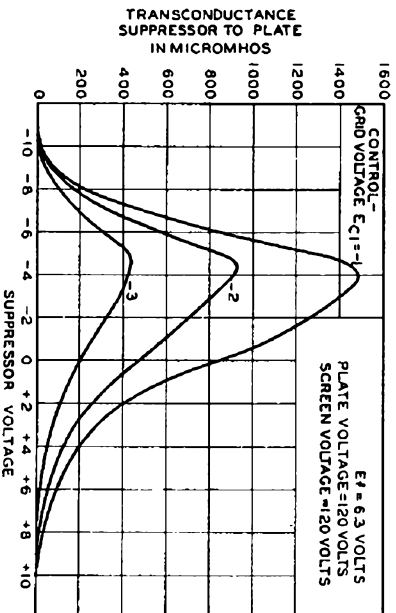
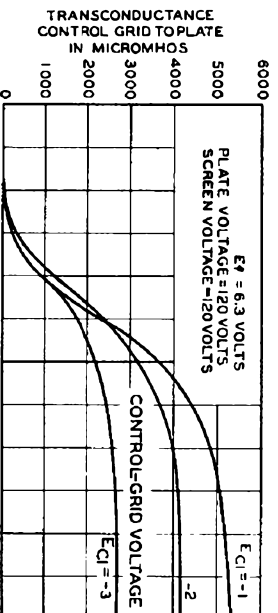
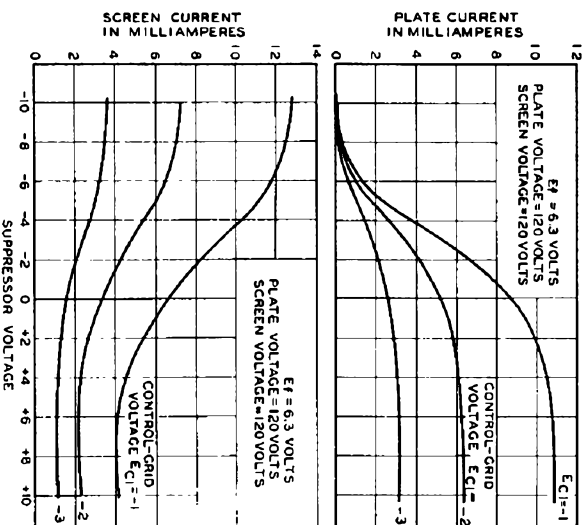
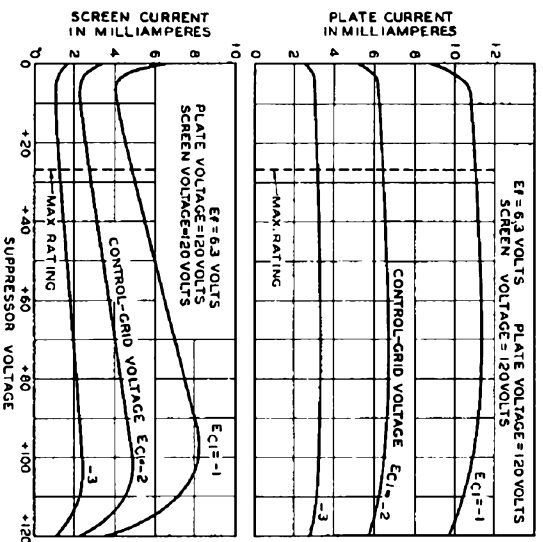

ELECTRON TUBE DATA, SHEET
WESTERN ELECTRIC 410A ELECTRON TUBE

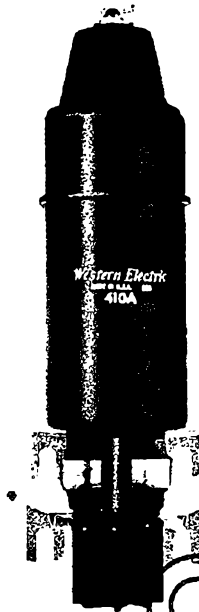

410A

DESCRIPTION

The 410A is a three-electrode mercury-vapor thyatron with a negative control characteristic. This tube is designed for use in controlled rectifier or inverter circuits.

MAXIMUM RATINGS

Peak Anode Voltage 1500 volts
Average Cathode Current 8 amperes

FILE:THYRATRON SECTION

MAXIMUM RATINGS, ABSOLUTE VALUES

Peak Anode Voltage	
Inverse	1500 volts
Forward	1500 volts
Cathode Current	
Peak	32 amperes
Average	8 amperes
Surge (maximum duration 0.1 second)	320 amperes
Averaging Time	15 seconds
Negative Grid Voltage	
Before Conduction	500 volts
During Conduction	10 volts
Positive Grid Current, Average	
(Averaging time - one cycle)	0.25 ampere
Condensed Mercury Temperature Limits	
	+30 to +80 centigrade

ELECTRICAL DATA

	Min.	Bogey	Max.
Filament Voltage	2.37	2.5	2.62 volts
Filament Current at 2.5 volts	----	18	21 amperes
Filament Heating Time Required	60	----	seconds
Anode to Grid Capacitance	----	15	uuf.
Grid to Filament Capacitance	----	15	uuf.
Deionization Time, Approximate ¹			
E _{bb} -1500 volts; I _b -16 amperes;	} ----	1500	---- microseconds
E _{cc} --30 volts; THg-80C; Rg-50000 ohms			
E _{bb} -500 volts; I _b -16 amperes;	} ----	300	---- microseconds
E _{cc} --30 volts; THg-50C; Rg-50000 ohms			
Ionization Time, Approximate ²			
E _{bb} -100 volts; THg-40C; Grid Overvoltage-5 volts	----	15	---- microseconds
E _{bb} -100 volts; THg-80C; Grid Overvoltage-25 volts	----	2	---- microseconds
Anode Voltage Drop	----	12	---- volts

MECHANICAL DATA

Type of Cooling	Convection
Equilibrium Condensed Mercury Temperature	
Rise Above Ambient	
At Full Load (approximate)	28 Centigrade
At No Load (approximate)	16 Centigrade
Mounting Position	Vertical, filament terminals down
Net Weight, Approximate	1.8 pounds

1. Deionization time decreases with an increase in negative grid voltage or with a decrease in (a) condensed mercury temperature (THg) (b) grid resistance or (c) anode current immediately preceding the end of conduction.
2. Ionization time decreases with an increase in (a) anode voltage, (b) condensed mercury temperature (THg) or (c) grid overvoltage. Grid overvoltage is defined as the magnitude by which the applied voltage exceeds, in a positive direction, the critical grid voltage value. Critical grid voltage is the instantaneous value of grid voltage at the time when anode current starts to flow.

TYPICAL CONTROL CHARACTERISTICS
 SHADED AREA SHOWS RANGE OF CHARACTERISTICS,
 CONDENSED MERCURY TEMPERATURE AS SHOWN

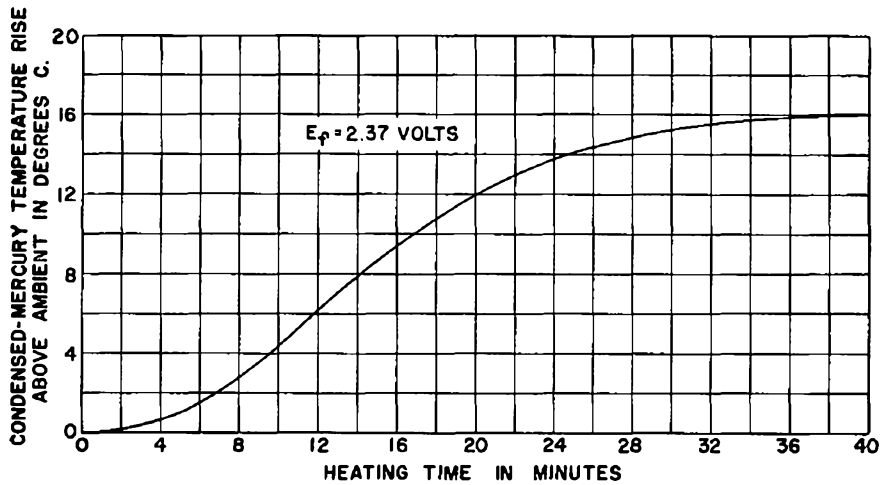
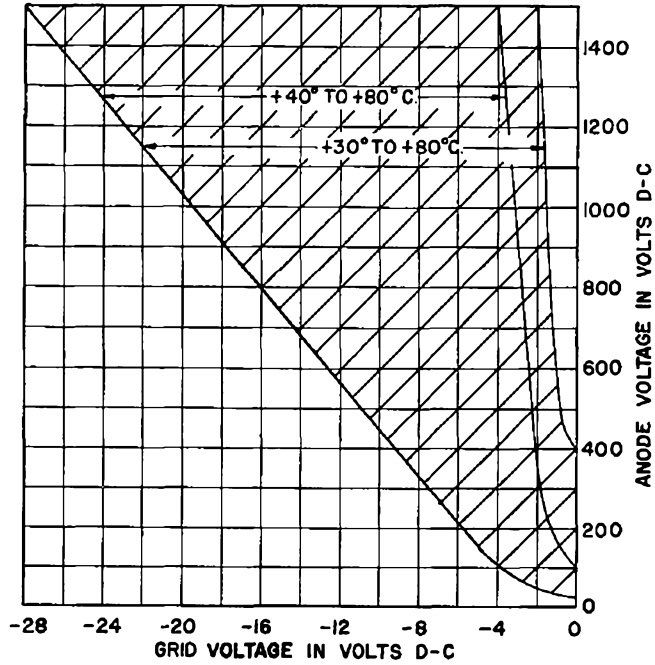

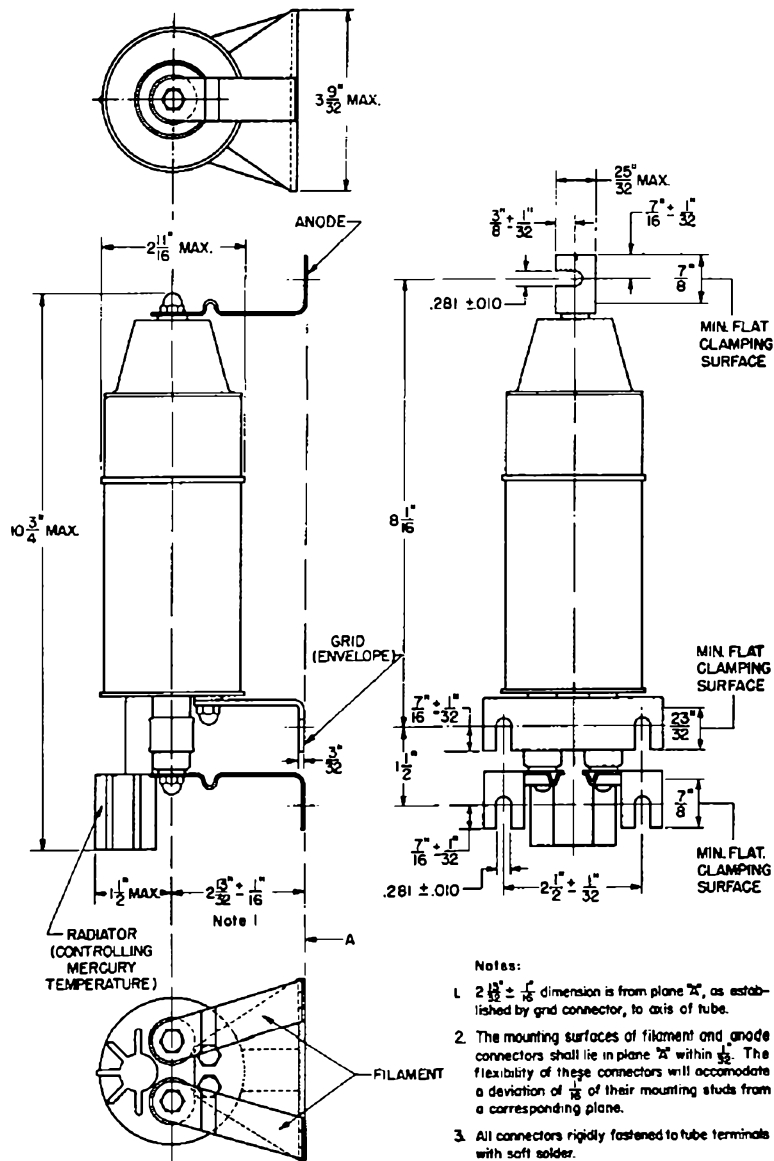

A development of Bell Telephone Laboratories, the research laboratories of the American Telephone and Telegraph Company and the Western Electric Company.

PRINTED IN U.S.A.

ADVANCE ELECTRON TUBE DATA SHEET

WESTERN ELECTRIC 411 A ELECTRON TUBE



411A

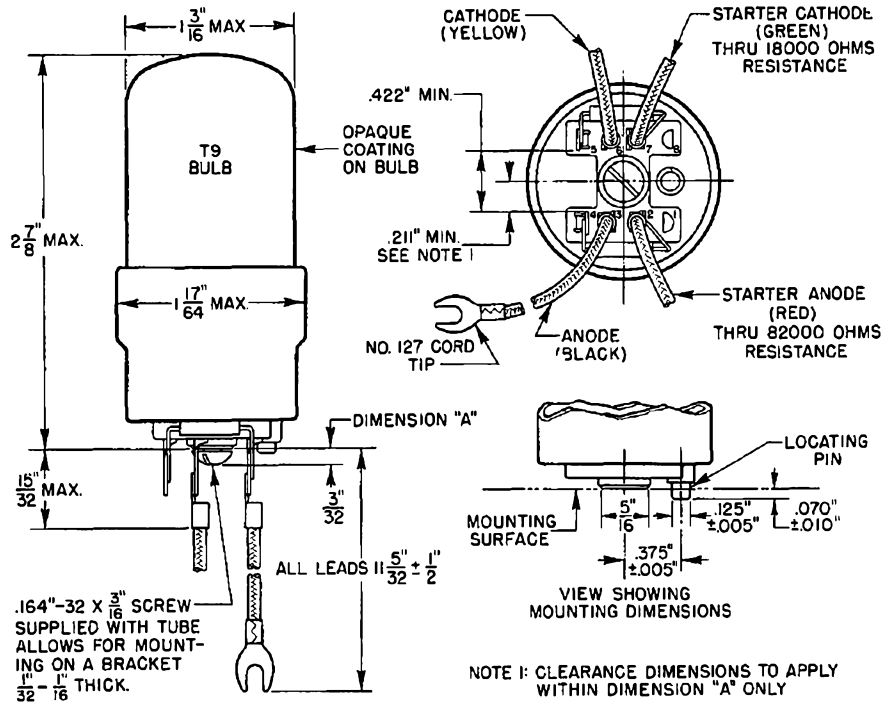

DESCRIPTION

The 411A is a four-electrode, inert-gas-filled, cold cathode tube for use as a relay.

MAXIMUM RATINGS, Absolute Values

Maximum Peak Voltage, Forward or Inverse	
Anode to Cathode	180 volts
Anode to Starter Cathode	180 volts
Cathode to Starter Cathode	180 volts
Maximum Cathode Current	
Peak	100 milliamperes
Average	35 milliamperes
Maximum Averaging Time	2 seconds
Maximum Starter Cathode Current	
Peak	10 milliamperes
Average	3.5 milliamperes
Maximum Averaging Time	2 seconds
Maximum Peak Inverse Current	
Anode	5 milliamperes
Starter Anode	1 milliampere
Frequency	60 cycles/second
Ambient Temperature Limits	-40 to +80 centigrade

Electrical and Mechanical Data on reverse side



SECTION AB46.411A

ELECTRICAL DATA

	Min.	Bogey	Max.	
Starter Breakdown Voltage	62	70	85	volts
Starter Voltage Drop at 3 Milliamperes	50	60	70	volts
Anode Voltage Drop at 20 Milliamperes	58	70	80	volts
Required Transfer Current at 110 Anode Volts D.C.*	600	microamperes
Required Negative Cathode Transfer Voltage**	45	volts
Deionization Time, Approximate				
Starter Gap05	milliseconds
Main Cap	5	milliseconds

MECHANICAL DATA

Mounting Position	Any
Net Weight, Approximate	1.3 ounces

*To assure transfer of conduction from the starter anode - starter cathode gap to the anode - starter cathode gap.

**To assure transfer of conduction from the anode - starter cathode gap to the anode - cathode gap with 1.0 milliamperes flowing from anode to starter cathode. Voltage measured with respect to starter cathode.

ADVANCE ELECTRON TUBE DATA SHEET

WESTERN ELECTRIC 412A ELECTRON TUBE

412A
MINIATURE
FULL-WAVE
RECTIFIER

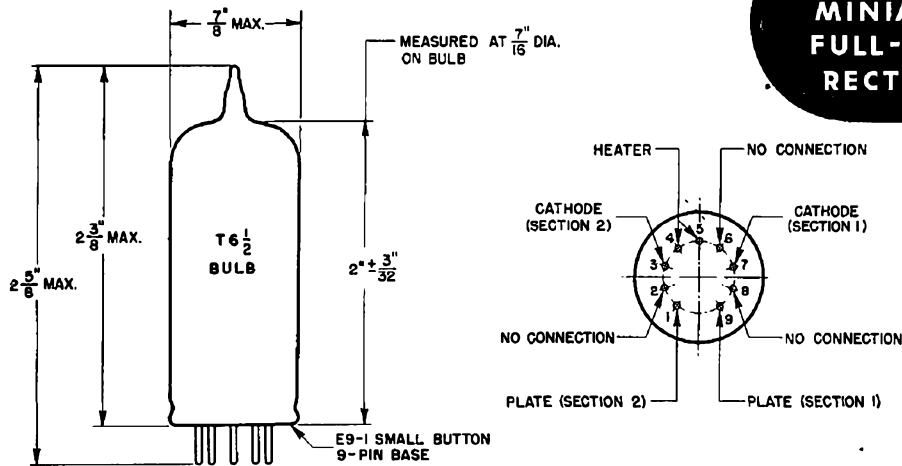

DESCRIPTION

Miniature Full-Wave Rectifier

MOUNTING

This tube may be mounted in any position

MAXIMUM RATINGS (Design Center Values)

Peak Inverse Voltage	1250 volts
Peak Plate Current per Plate	300 milliamperes
D-C Output Current	100 milliamperes
D-C Heater-Cathode Potential	450 volts

GENERAL CHARACTERISTICS

ELECTRICAL DATA

Heater Voltage	6.3 volts
Heater Current	1.0 ampere

MECHANICAL DATA

Cathode	Coated Unipotential
Bulb	T 6-1/2
Base	Small button 9-pin

TYPICAL OPERATION WITH CONDENSER INPUT FILTER

A-C Plate Voltage per Plate (RMS)	300 volts
D-C Output Current	90 milliamperes
D-C Output Voltage at Input Filter, Approximate	340 volts
Total Effective Plate Supply Impedance per Plate	150 ohms
Filter Input Condenser	4 microfarads

ISSUE 1 8-4-48

PRINTED IN U.S.A

Western Electric

ELECTRON TUBE DATA SHEET
WESTERN ELECTRIC 413A ELECTRON TUBE

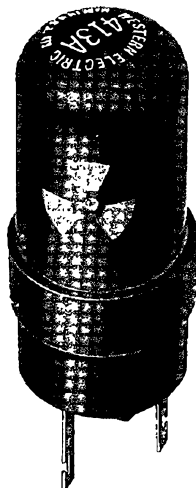

413A

DESCRIPTION

The 413A is a two-electrode inert-gas-filled cold cathode tube having a high current rating. In addition to its initial field of use in telephone message register circuits it is especially suitable also for use in control circuits such as in switching or pulse counting apparatus.

MAXIMUM RATINGS

Forward or Inverse Average Cathode Current	20	200 milliamperes
Average Life, Approximate.	10000	10 hours

File: Cold Cathode Section
Issue 2, April 1956

413A

MAXIMUM RATINGS, Absolute Values

Cathode Current ¹		
Peak, Forward or Inverse		200 milliamperes
Average, Forward or Inverse		70 milliamperes
Averaging Time		2 seconds
Ambient Temperature Limits		-55 to +65 centigrade

ELECTRICAL DATA, Throughout Life

	<u>Min.</u>	<u>Bogey</u>	<u>Max.</u>
Anode Breakdown Voltage			
Forward	180	200	255 volts
Inverse	180	200	--- volts
Anode Voltage Drop, Forward or Inverse	55	62	75 volts
Ionization Time ²	---	1	--- millisecond
Deionization Time, Approximate	---	2	--- milliseconds

MECHANICAL DATA

Mounting Position		Any
Net Weight, Approximate		1.2 ounces
Dimensions and pin connections shown in outline drawing on page 3.		

Note 1: Sufficient resistance must be used in series with the tube to assure that the electrode currents do not exceed their maximum rated values.

Note 2: With 15 volts overvoltage (15 volts above anode breakdown voltage) when tube is in total darkness.

HANDLING

Western Electric cold cathode tubes contain a minute amount of radium bromide which is a radioactive material. The amount in most types is too small to require any special care in use, handling or disposal.

A few types contain a larger quantity of radium bromide in which the radium approximates that found on a luminous watch dial. These types bear a red three-bladed propeller-shaped symbol on the tube envelope. Instructions for handling such tubes are given below and also in Bell System Practices for Central Office maintenance.

Installations ordinarily require no precautions against radiation. However, quantities of the tubes should not be so installed, or so stored outside the shipping carton, that they will be within a few inches of personnel or in proximity to photographic film for extended periods of time. For example, however, a 40-hour week exposure at about one (1) foot from a bank of 500 tubes (covering an area of 20 inches x 45 inches) is well within the accepted tolerance limits for personnel. Reasonable care should be exercised in handling and disposal of broken tubes. In general, attention should be given to the following:

- (a) Avoid breathing dust or vapors from broken tubes.
- (b) Avoid contacting broken parts with bare hands.
- (c) Use wet rag to pick up broken parts. Wrap broken parts in rag and tie securely so as to form a package. Thoroughly wash hands after disposal.
- (d) Dispose of broken or defective tubes as they are taken out of service. One or two tubes at a time may be disposed of with normal waste material. Accumulation of tubes in one concentrated area of the place of final disposition should be avoided.

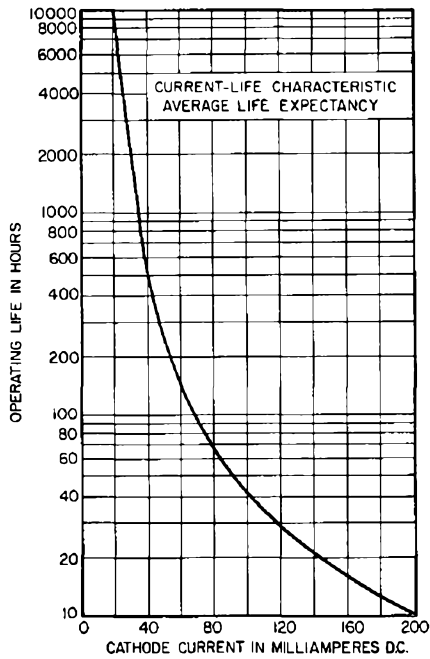

FIG 1

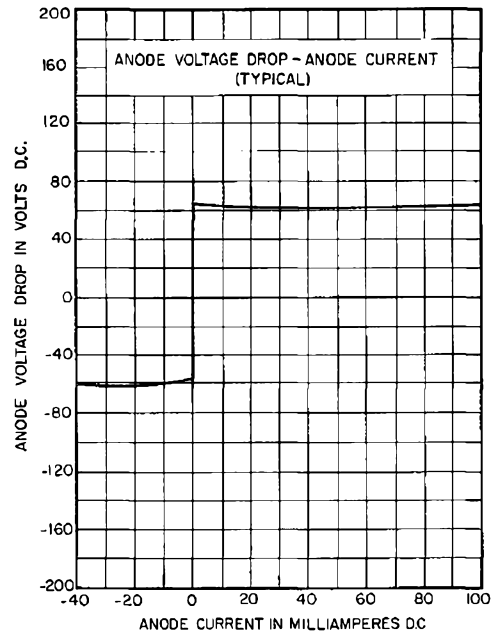
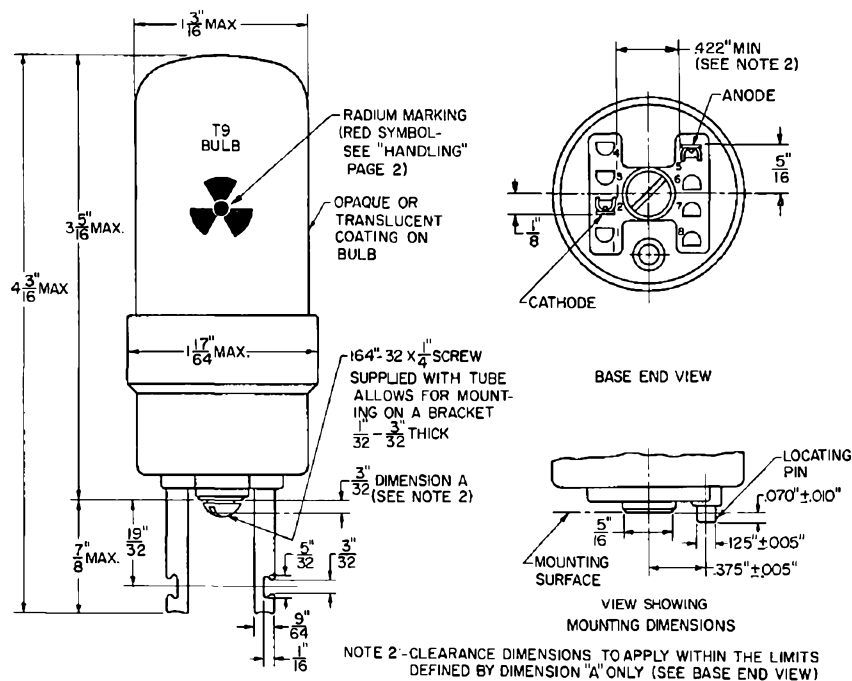

FIG 2



ELECTRON TUBE DATA SHEET
WESTERN ELECTRIC 413B ELECTRON TUBE



413B

DESCRIPTION

The 413B is a two-electrode inert-gas-filled cold cathode tube having a high current rating. In addition to its initial field of use in telephone message register circuits it is especially suitable also for use in control circuits such as in switching or pulse counting apparatus.

CHARACTERISTICS

Forward or Inverse Average Cathode Current	20	200 milliamperes
Average Life, Approximate	10000	10 hours

File: Cold Cathode Section

MAXIMUM RATINGS, Absolute System (Note 1)

Cathode Current (Note 2)	
Peak, Forward or Inverse	200 milliamperes
Average, Forward or Inverse	70 milliamperes
Averaging Time	2 seconds
Ambient Temperature Limits	-55 to +85 centigrade

ELECTRICAL DATA, Throughout Life

	<u>Min.</u>	<u>Bogey</u>	<u>Max.</u>	
Anode Breakdown Voltage				
Forward	180	200	255	volts
Inverse	180	200	-	volts
Anode Voltage Drop, Forward or Inverse	55	62	75	volts
Ionization Time (Note 3)	-	1	-	millisecond
Deionization Time, Approximate	-	2	-	milliseconds

MECHANICAL DATA

Mounting Position Any
 Net Weight, Approximate 1.2 Ounces
 Dimensions and pin connections shown in outline drawing on page 3.

HANDLING

This tube contains a small amount of krypton-85 gas which is a by-product radioactive material. The amount of krypton-85 is less than five microcuries, which is too small an amount to require any special care in use.

Atomic Energy Commission regulations require that the individual tube carton for tubes containing by-product radioactive material be appropriately marked. The marking includes the statement that tube disposal should be in approved manner.

Approved instructions for disposal of tubes containing krypton-85 are as follows;

Tubes to be disposed of should be broken or crushed in a well ventilated place releasing any resulting vapors to the outside atmosphere. The residual broken or crushed tubes should be disposed of in a normal public trash disposal system. Tubes should be disposed of at a rate of not more than 100 each week from any one location. Avoid breathing vapors from broken tubes.

Note 1: In the "Absolute System" the maximum ratings specified are limiting values above which the serviceability of the device may be impaired from the viewpoint of life and satisfactory performance. Maximum ratings, as such, do not constitute a set of operating conditions and all values may not, therefore, be attained simultaneously.

Note 2: Sufficient resistance must be used in series with the tube to assure that the electrode currents do not exceed their maximum rated values.

Note 3: With 15 volts overvoltage (15 volts above anode breakdown voltage) when tube is in total darkness.

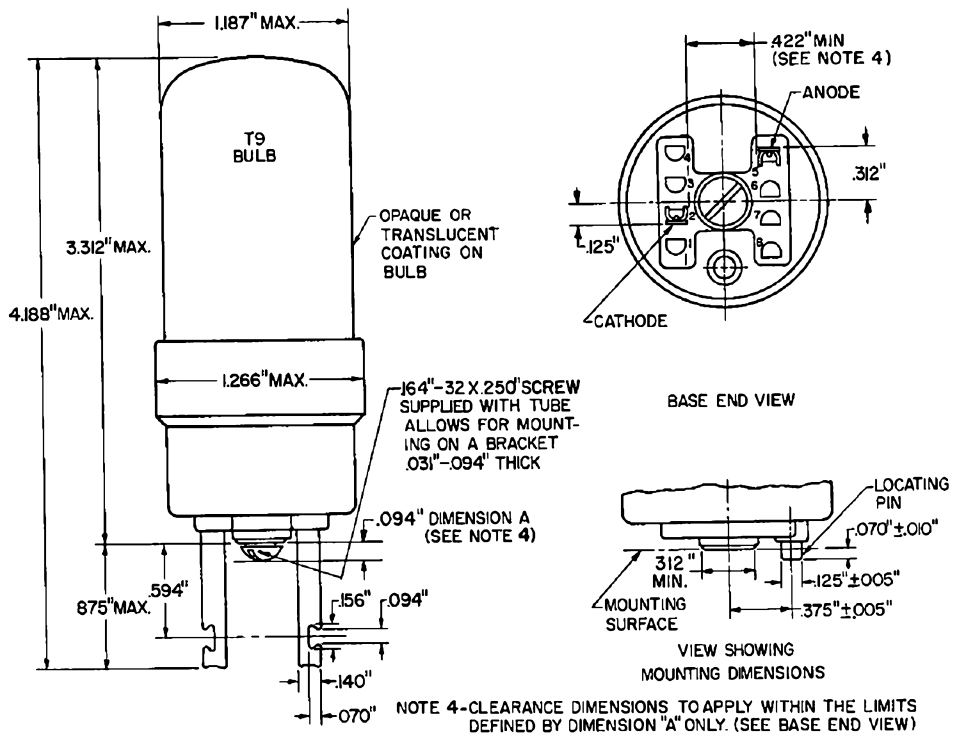
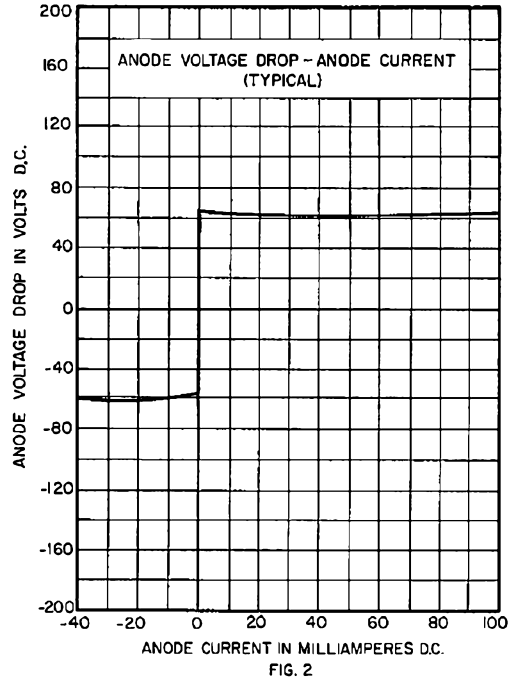
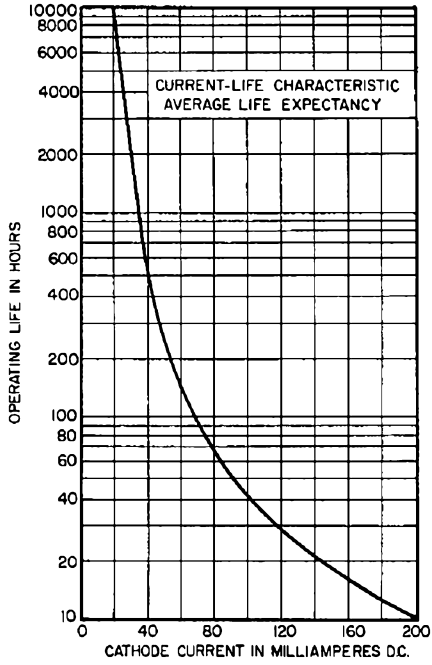

ADVANCE ELECTRON TUBE DATA SHEET

WESTERN ELECTRIC 414A ELECTRON TUBE

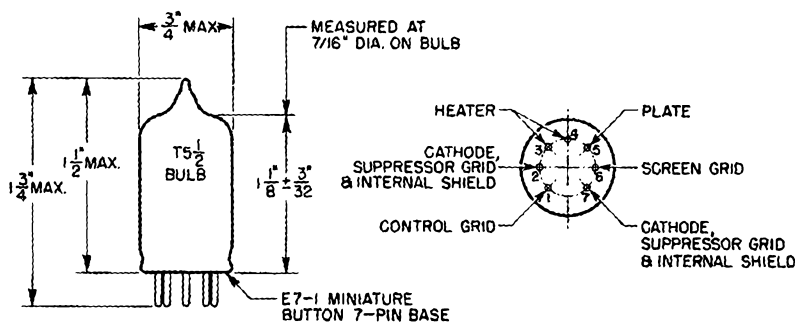

DESCRIPTION

The 414A is a miniature pentode with an indirectly heated cathode.

MAXIMUM RATINGS (Design Center Values)

Plate Voltage	180 volts
Screen-Grid Voltage	140 volts
Plate Dissipation	1.7 watts
Screen-Grid Dissipation	0.5 watt
Cathode Current	12 milliamperes
Heater Cathode Voltage	90 volts
Bulb Temperature	120° centigrade

GENERAL CHARACTERISTICS

ELECTRICAL DATA

Heater Voltage, A-C or D-C	6.3 volts
Heater Current	150 milliamperes
Direct Interelectrode Capacitances	Without External Shield With External Shield (RMA #31G)
Plate to Grid, Maximum	0.02 *0.012 uuf
Input	4.1 *4.3 uuf
Output	2.0 *2.9 uuf

MECHANICAL DATA

Cathode	Coated Unipotential
Bulb	T5-1/2
Base	Miniature Button, 7-pin
Mounting Position	Any

*External shield (RMA #31G) connected to cathodes-pins #2 and #7.

Operating Conditions and Characteristics on Reverse Side

414A



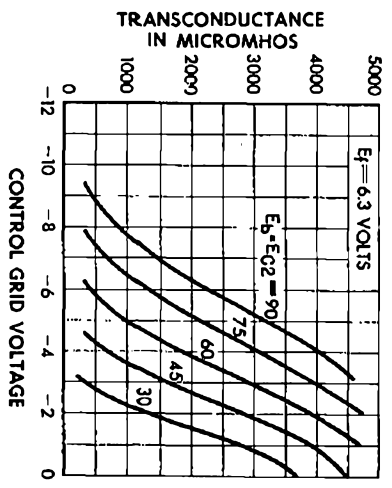
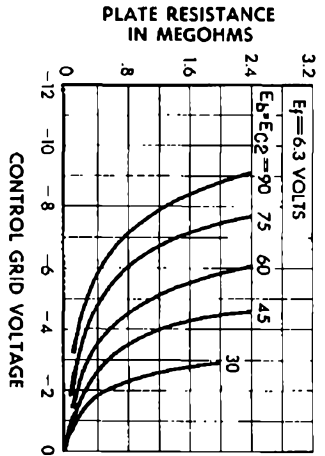

PRINTED IN U.S.A.

OPERATING CONDITIONS AND CHARACTERISTICS

- Plate Voltage 60 volts
- Screen-Grid Voltage 60 volts
- Cathode Resistor 510 ohms
- Plate Current 4.3 milliamperes
- Screen-Grid Current 1.5 milliamperes
- Plate Resistance 0.35 megohm
- Transconductance 2750 micromhos
- Grid Voltage (approximate) for 10 Microamperes Plate Current -9.5 volts

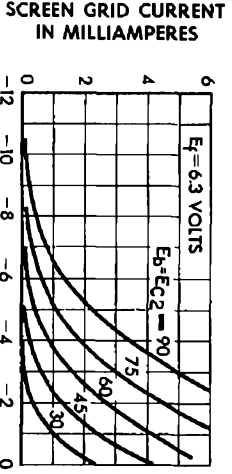
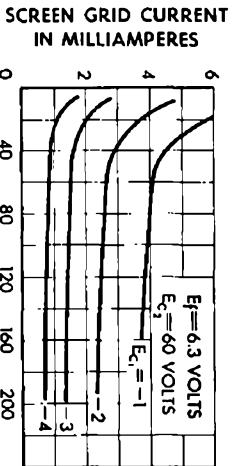
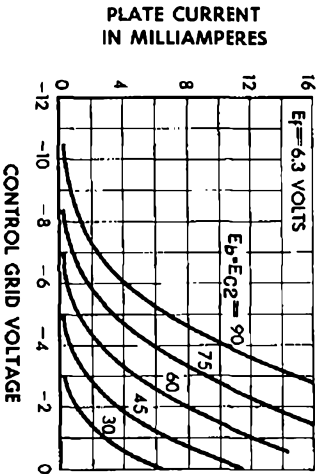
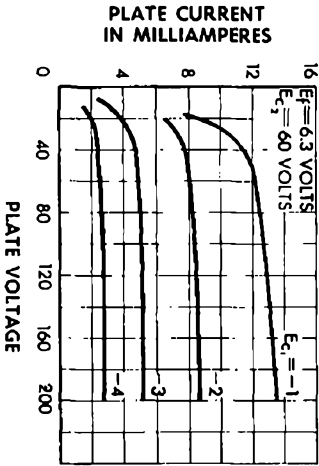

ADVANCE ELECTRON TUBE DATA SHEET

WESTERN ELECTRIC 415A ELECTRON TUBE

415A
 MINIATURE
 PENTODE
 UHF

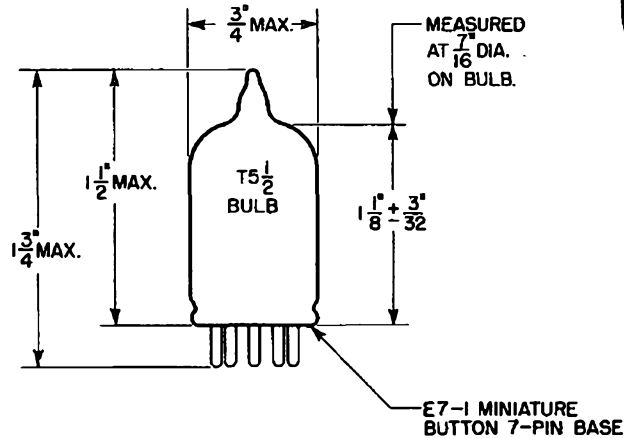

415A

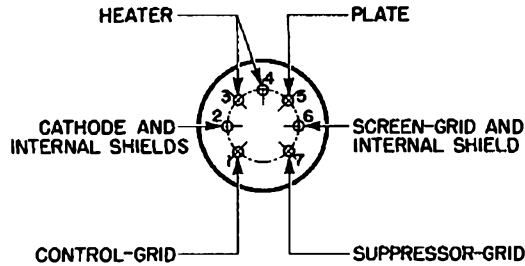

DESCRIPTION

Miniature Suppressor-Grid Pentode

MOUNTING

This tube may be mounted in any position.

HEATER RATING

Heater Voltage, A-C or D-C	6.3 volts
Nominal Heater Current	150 milliamperes

MAXIMUM RATINGS (Design Center Values)

Plate Voltage	180 volts
Screen-Grid Voltage	140 volts
Positive Suppressor-Grid Voltage	27 volts
Plate Dissipation	1.7 watts
Screen-Grid Dissipation	0.75 watt
Cathode Current	18 milliamperes
Heater-Cathode Voltage	90 volts
Bulb Temperature	120 centigrade

OPERATING CONDITIONS AND CHARACTERISTICS

Plate Voltage	120	120 volts
Screen-Grid Voltage	120	120 volts
Suppressor-Grid Voltage	-3	0 volts
Control-Grid Voltage	-2	-2 volts
Plate Current	3.6	5.2 milliamperes
Screen-Grid Current	4.8	3.6 milliamperes
Transconductance, Control-Grid	1850	3200 μ hos
Transconductance, Suppressor-Grid	810	470 μ hos



CONTROL-GRID PLATE CURRENT CUT-OFF CHARACTERISTICS

Plate Voltage	120 volts
Screen-Grid Voltage	120 volts
Suppressor-Grid Voltage	0 volts
Control-Grid Voltage (approximate) for Plate Current of 10 Microamperes	-7.5 volts

SUPPRESSOR-GRID PLATE CURRENT CUT-OFF CHARACTERISTICS

Plate Voltage	120 volts
Screen-Grid Voltage	120 volts
Control-Grid Voltage	-2 volts
Suppressor-Grid Voltage (approximate) for Plate Current of 10 Microamperes	-10 volts

INTERELECTRODE CAPACITANCES (With RMA No. 316 Shield)

Plate to Control-Grid, Maximum	*0.014 μ f
Input (G1 to Heater, Cathode, G2 & G3)	*3.9 μ f
Output (Plate to Heater, Cathode, G2 & G3)	*3.0 μ f
Control-Grid to Suppressor-Grid	*0.1 μ f

*External shield connected to cathode-pin #2.

NORMAL PENTODE CHARACTERISTICS

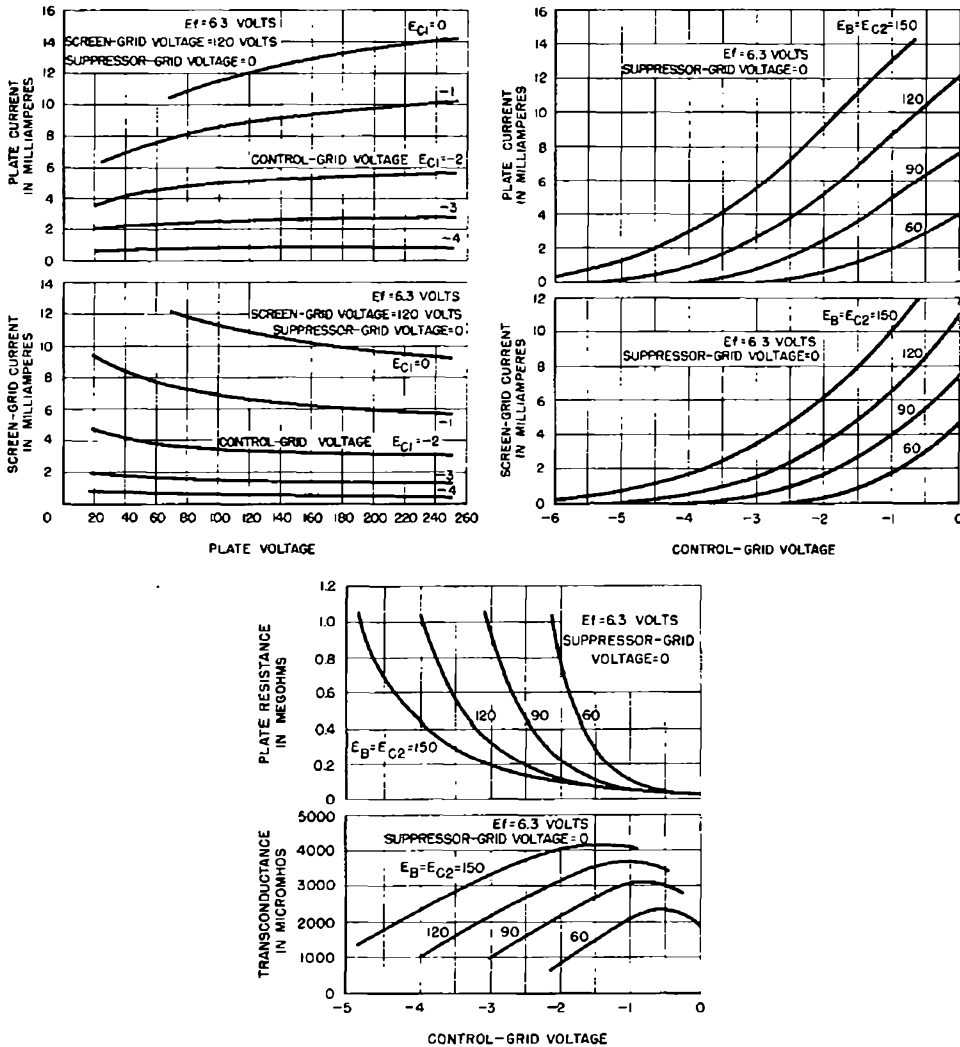

SUPPRESSOR-GRID CHARACTERISTICS

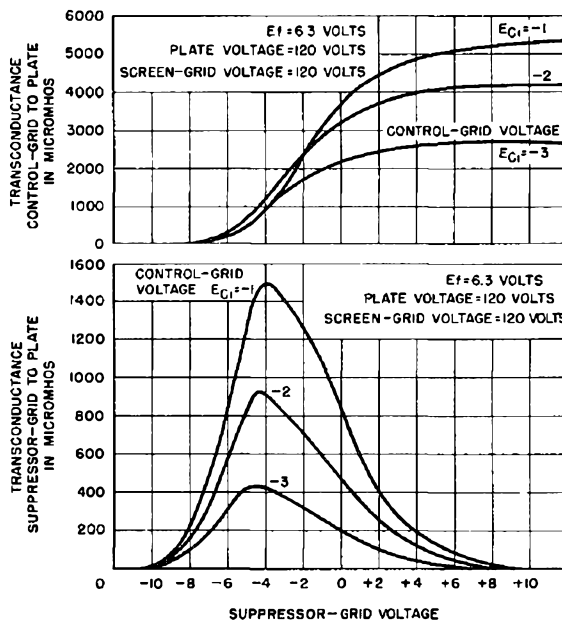
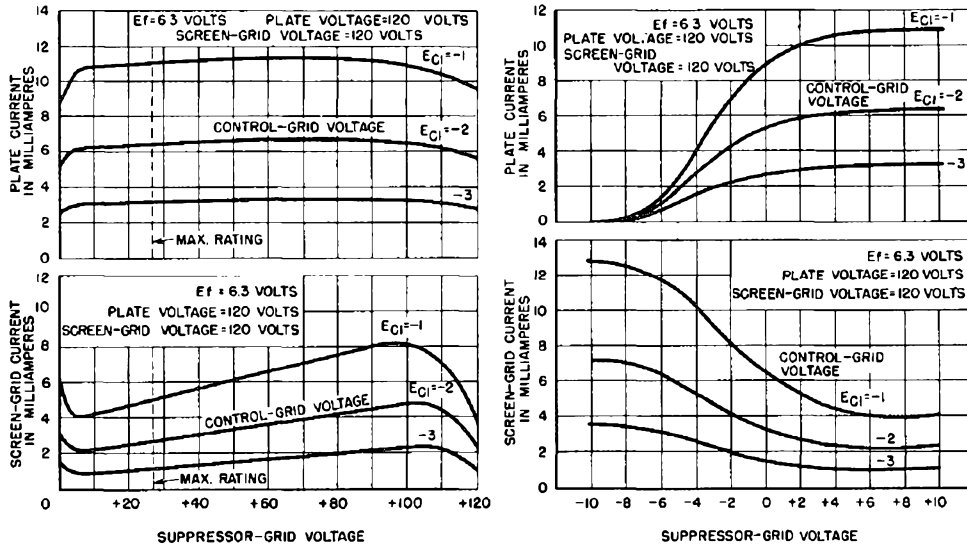

*OK to send to
Plant Dept.*

ADVANCE ELECTRON TUBE DATA SHEET

*S.F.H.
7/2/49*

WESTERN ELECTRIC 416 A ELECTRON TUBE



416A

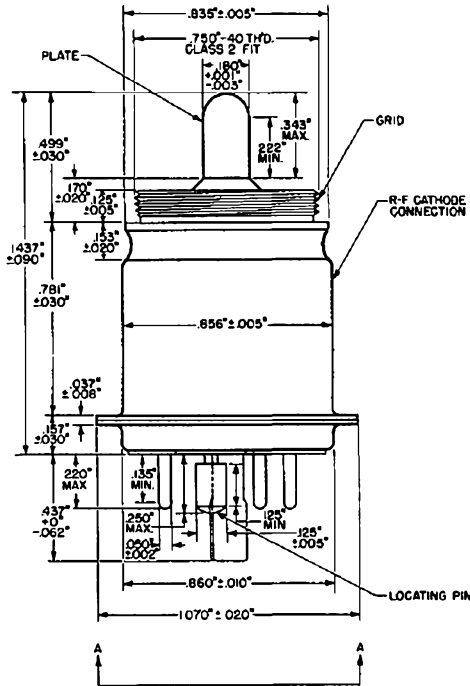

NOTE: SURFACES OF R-F CATHODE, GRID AND PLATE CONNECTIONS GOLD PLATED

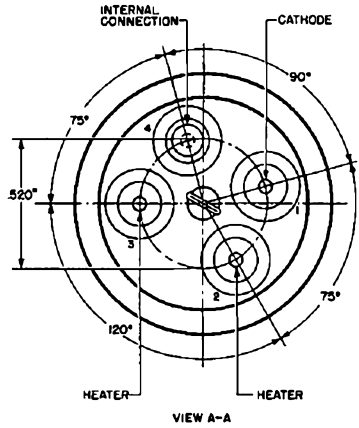
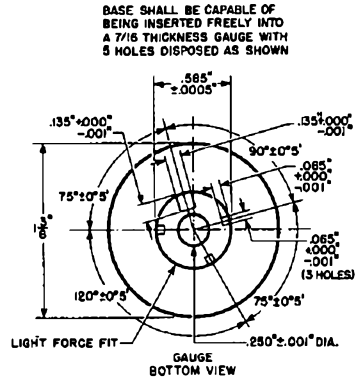

DESCRIPTION

The 416A is a disc-seal planar type triode designed for use as an amplifier or frequency multiplier at frequencies in the order of 4000 megacycles.

MAXIMUM RATINGS, ABSOLUTE VALUES

Plate Voltage	250	volts
Grid Voltage	+1.0	volt
Plate Current	33	milliamperes
Grid Current	10	milliamperes
Plate Dissipation	7.5	watts
Plate Seal Temperature	125°	Centigrade
Grid Seal Temperature	100°	Centigrade
Heater-Cathode Voltage	45	volts



GENERAL CHARACTERISTICS

ELECTRICAL DATA

Heater Voltage	6.3	volts
Heater Current	1.85	amperes
Amplification Factor	300	
Transconductance ($I_b = 30$ ma)	50000	micromhos
Direct Interelectrode Capacitances		
Grid to Plate	1.25	μ f
Grid to Shell*	7.5	μ f
Plate to Shell*	0085	μ f
Cathode to Shell	42.5	μ f

*Cathode connected to shell through cathode to shell capacitance

MECHANICAL DATA

Cathode	Unipotential
Mounting Position	Any
Weight, Approximate	1 ounce

TYPICAL OPERATING CONDITIONS AND CHARACTERISTICS

Plate Voltage	200	volts
Plate Current	30	milliamperes
Plate Dissipation	6	watts
Cathode Bias Resistor	250	ohms
Grid Supply Voltage	8	volts
Frequency	4000	megacycles
Gain (50 Milliwatts Output)	9	decibels
Gain (500 Milliwatts Output)	3	decibels
Band Width (3 db Down)	100	megacycles

ADVANCE ELECTRON TUBE DATA SHEET
 WESTERN ELECTRIC 416B* ELECTRON TUBE

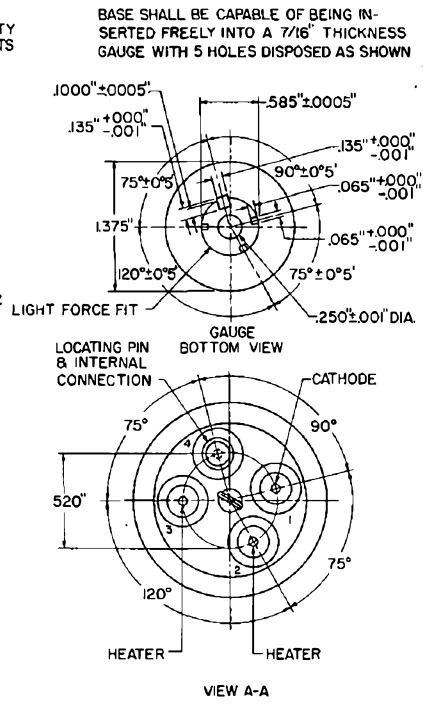
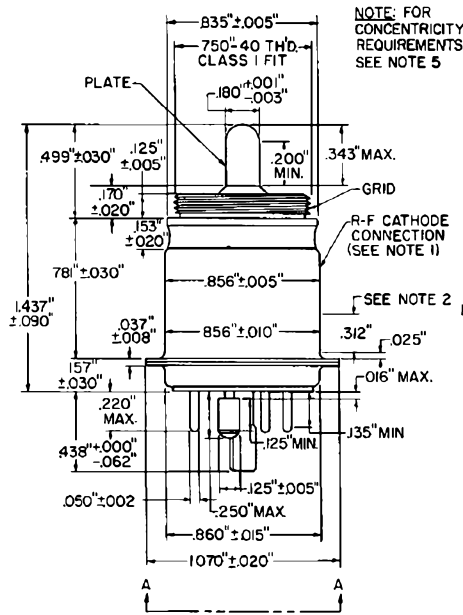

416B

DESCRIPTION

The 6280/416B* is a planar type triode designed for use as an amplifier or frequency multiplier at frequencies in the order of 4000 megacycles.

CHARACTERISTICS

Heater Voltage	6.3 volts
Plate Voltage	200 volts
Frequency	4000 megacycles
Gain (50 milliwatts output)	9 decibels
Bandwidth (3 db down)	100 megacycles

6280/416B

GENERAL CHARACTERISTICS**ELECTRICAL DATA**

	<u>Min.</u>	<u>Bogey</u>	<u>Max.</u>	
Heater Voltage(3)	---	6.3	---	volts
Heater Current	---	1.18	---	amperes
Amplification Factor	---	200	---	
Transconductance ($I_b = 30 \text{ ma}$)	---	50000	---	micromhos
Direct Interelectrode Capacitances				
Grid to Plate	1.25	1.45	1.60	uuf
Grid to Shell(4)	8.5	11.2	17.0	uuf
Grid to Shell(4) Hot ($E_f = 6.1 \text{ v}$; $E_b = 0 \text{ v}$)	7.6	8.7	10.3	uuf
Plate to Shell(4)	---	.019	.050	uuf
Cathode to Shell	30	42.5	57	uuf

MECHANICAL DATA

Cathode	Unipotential
Mounting Position	Any
Weight, Approximate	1 ounce
Socket (Equivalent to or).	KS14134

MAXIMUM RATINGS, ABSOLUTE VALUES

Plate Voltage	270 volts
Grid Voltage	{ +1.5 volts -15.0 volts
Plate Current	33 milliamperes
Grid Current	15 milliamperes
Plate Dissipation	7.5 watts
Plate Seal Temperature	150° Centigrade
Grid Seal Temperature	100° Centigrade
Heater-Cathode Voltage	45 volts

TYPICAL OPERATING CONDITIONS AND CHARACTERISTICS

Plate Voltage	200 volts
Plate Current	30 milliamperes
Bias Circuit	
Cathode Bias Resistor	260 ohms
Grid Supply Voltage	8 volts
Frequency	4000 megacycles
Gain (50 Milliwatts Output)	9 decibels
Gain (500 Milliwatts Output)	5 decibels
Band Width (3 db Down)	100 megacycles

Note (3): For optimum life, heater may be supplied from a source of 10.8 ± 0.2 volts through a circuit resistance of 4.16 ohms.

Note (4): Cathode connected to shell through cathode to shell capacitance.

Note (5): With the .750"-40 thread screwed into a gauge having a thread with a .750"-40 class 1 fit, the .856", 1.070" and .180" diameters must fit in cylinders concentric with the .750"-40 thread and having diameters of .895" x .720" long; 1.135" x .157" long; and .210" x .375" long. Allowances for these tolerances must be made in any circuit design.

ELECTRON TUBE DATA SHEET
WESTERN ELECTRIC 417A ELECTRON TUBE



417A

DESCRIPTION

The 417A is a 9-pin miniature triode with an indirectly heated cathode. It is intended primarily for grounded-grid operation in the input stage of broad band amplifiers.

CHARACTERISTICS

Heater Voltage	6.3 volts
Maximum Plate Voltage	200 volts
Amplification Factor	43

FILE: MINIATURE SECTION

GENERAL CHARACTERISTICSElectrical Data

Heater Voltage (Note 1)	6.3	volts
Heater Current	300	milliamperes
Direct Interelectrode Capacitances	(without external shield)	
Input (cathode to grid and heater)	9.0	$\mu\mu\text{f}$
Output (plate to grid and heater)	1.8	$\mu\mu\text{f}$
Plate to Cathode and Heater	0.48	$\mu\mu\text{f}$

Mechanical Data

Cathode	coated unipotential
Bulb	T 6½
Base	Small button 9 pin
Mounting Position	Any

MAXIMUM RATINGS, Absolute System (Note 2)

Plate Voltage	200	volts
Plate Dissipation	4.5	watts
Cathode Current	40	milliamperes
Heater Cathode Voltage	55	volts
Bulb Temperature	130°	centigrade

TYPICAL OPERATING CONDITIONS AND CHARACTERISTICS

Plate Supply Voltage	130	150	volts
Grid Voltage (Note 3)	+7.5	-	volts
Cathode Resistor	360	62	ohms
Plate Current	23.0	22.5	milliamperes
Plate Resistance	1850	1700	ohms
Transconductance25000	25000	micromhos
Amplification Factor	44	43	

Note 1: For optimum tube life the heater voltage specified (6.3 volts) should be regulated to $\pm 5\%$.

Note 2: In the "Absolute System" the maximum ratings specified are limiting values above which the serviceability of the device may be impaired from the viewpoint of life and satisfactory performance. Maximum ratings, as such, do not constitute a set of operating conditions and all values may not, therefore, be attained simultaneously.

Note 3: Reference point for "Grid Voltage" is the negative end of the cathode resistor. Operation with the control grid positive with respect to the cathode is not recommended.

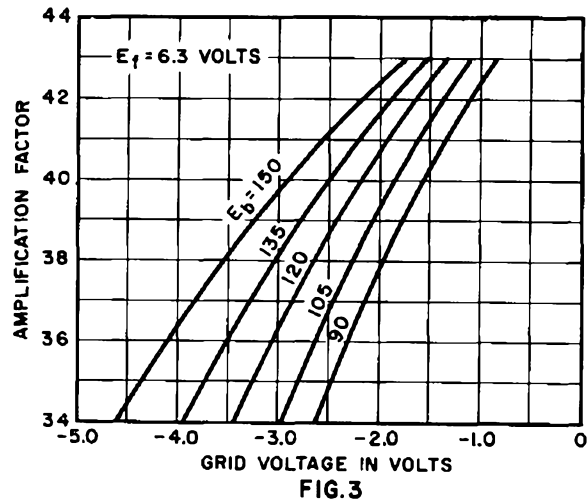
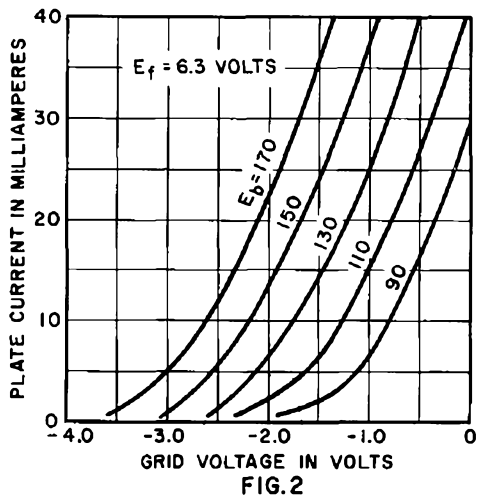
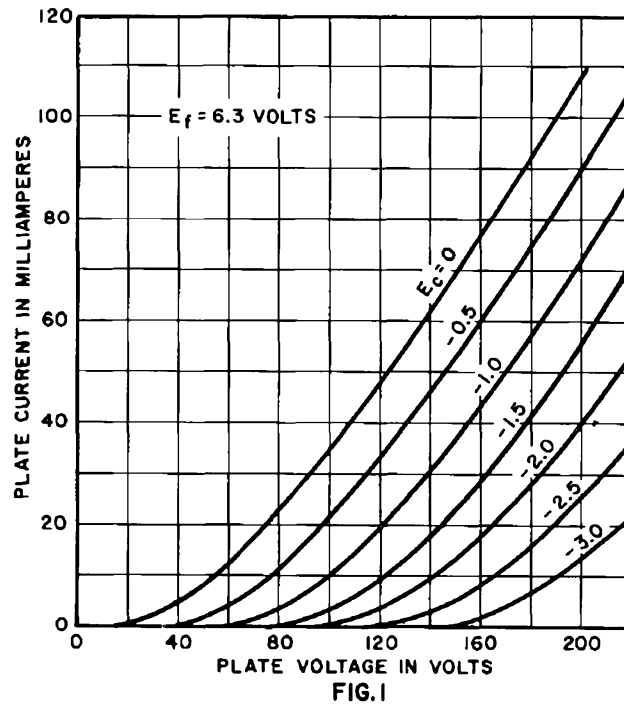

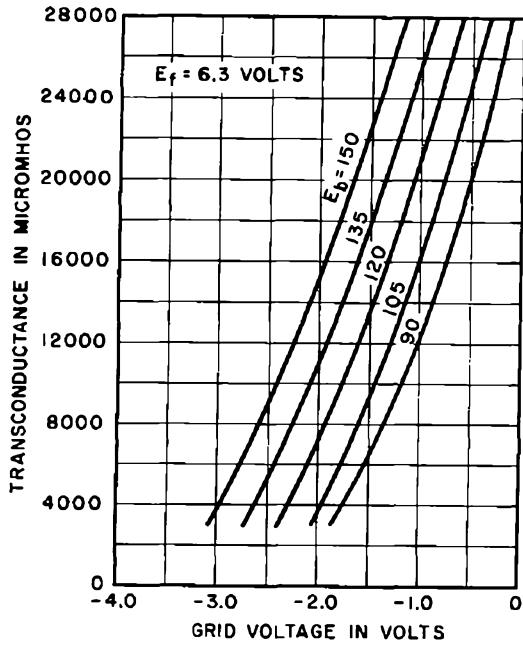

FIG. 4

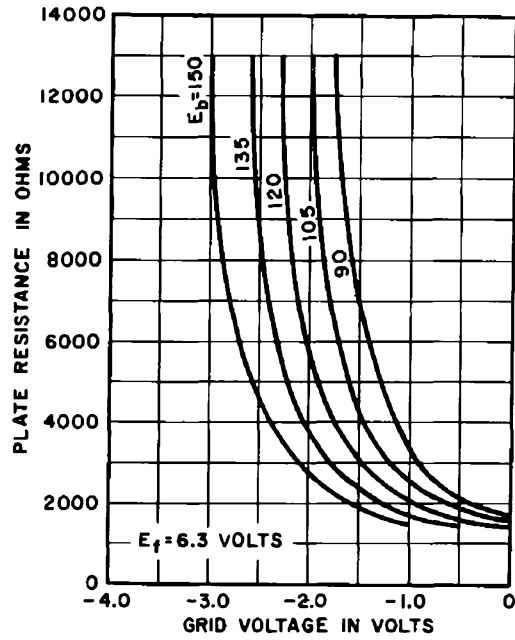
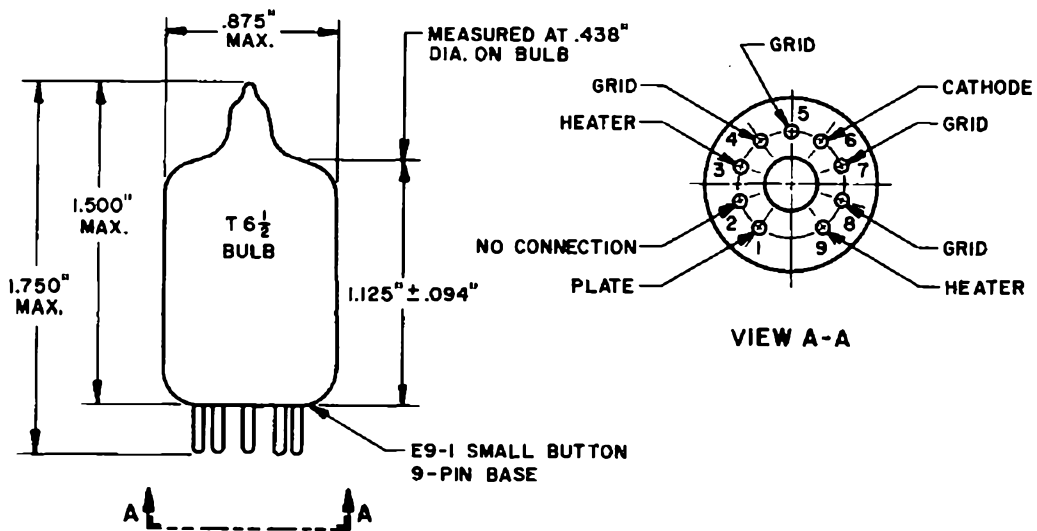

FIG. 5



A development of Bell Telephone Laboratories, the research laboratories of the American Telephone and Telegraph Company and the Western Electric Company.

PRINTED IN U.S.A.

ELECTRON TUBE DATA SHEET
WESTERN ELECTRIC 418A ELECTRON TUBE



418A

DESCRIPTION

The 418A electron tube is an indirectly heated cathode type tetrode. This tube was designed primarily for use as a power output tube in broad-band video and intermediate-frequency amplifiers.

CHARACTERISTICS

Heater Voltage	6.3 volts
Cathode Current	70 milliamperes
Transconductance	26500 micromhos

$(E_b = E_{c2} = 150 \text{ volts})$
 $(E_{c1} = 0 \quad R_k = 27 \text{ ohms})$

File: General Purpose Section
Issue 2, 4-56

418A

GENERAL CHARACTERISTICSELECTRICAL DATA

Heater Voltage	6.3 volts
Heater Current	0.6 ampere
Direct Interelectrode Capacitances	Without External <u>Shield</u>
Grid to Plate	0.055 μ f
Input: g1 to (h+k+g2+i.s)	15.0 μ f
Output: p to (h+k+g2+i.s)	2.8 μ f

MECHANICAL DATA

Cathode	Coated Unipotential
Bulb	T9
Base	See outline drawing page 4
Mounting Position	Any
Dimensions and pin connections shown in outline drawing on page 4	

MAXIMUM RATINGS, Design Center Values

Plate Voltage	250 volts
Screen Grid Voltage	150 volts
Plate Dissipation	8.5 watts
Screen Grid Dissipation	3.0 watts
Control Grid Dissipation	see footnote *
Cathode Current	90 milliamperes
Heater-Cathode Voltage	90 volts
Bulb Temperature	130 centigrade

MAXIMUM CIRCUIT VALUES

Grid Circuit Resistance:	
For Fixed Bias	0.05 megohm
For Cathode Bias	0.10 megohm

TYPICAL OPERATING CONDITIONS AND CHARACTERISTICS

Plate Voltage	120	150	volts
Screen Grid Voltage	120	150	volts
Control Grid Voltage	-1.0	---	volts
Cathode Bias Resistor	---	27	ohms
Plate Current	47	50	milliamperes
Screen Grid Current	20	20	milliamperes
Plate Resistance	18000	18000	ohms
Transconductance	26500	26500	micromhos
Control Grid Voltage (approximate) for Plate Current of 10 microamperes	-9.5	---	volts

* Operation with the control grid positive with respect to the cathode is not recommended.

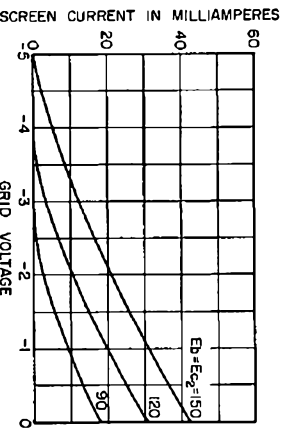
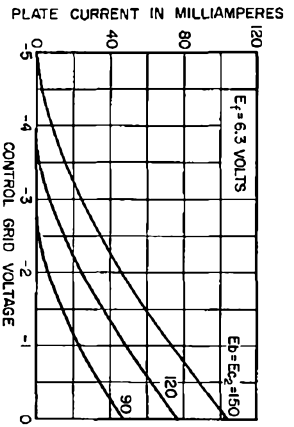
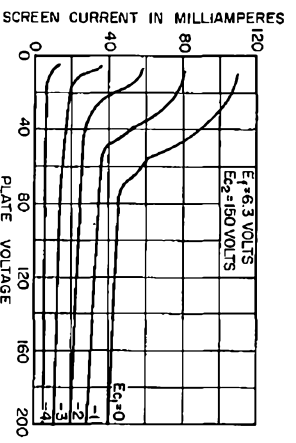
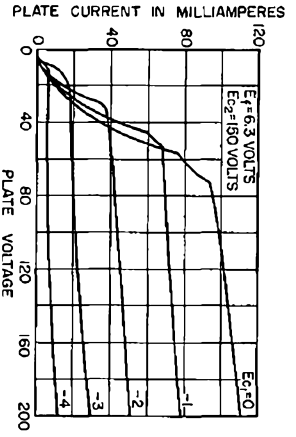
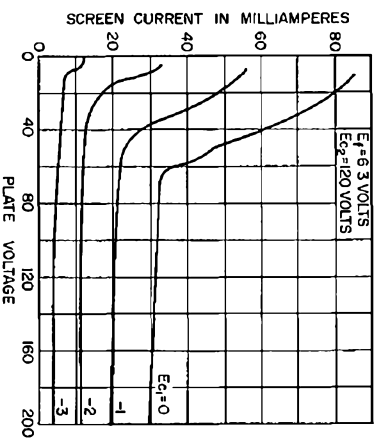
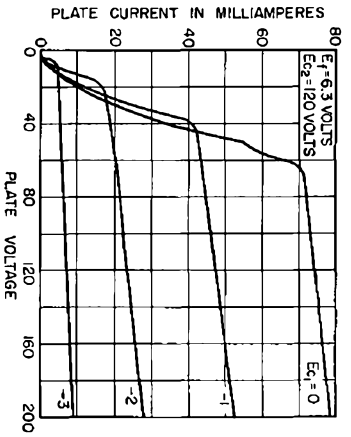
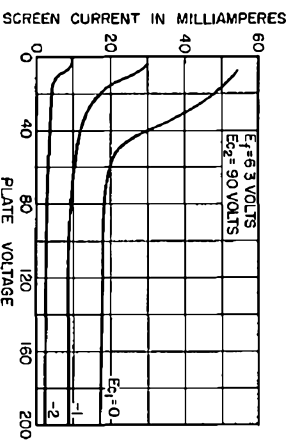
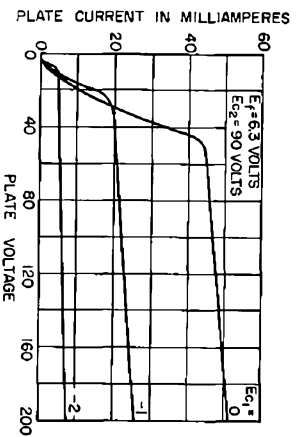

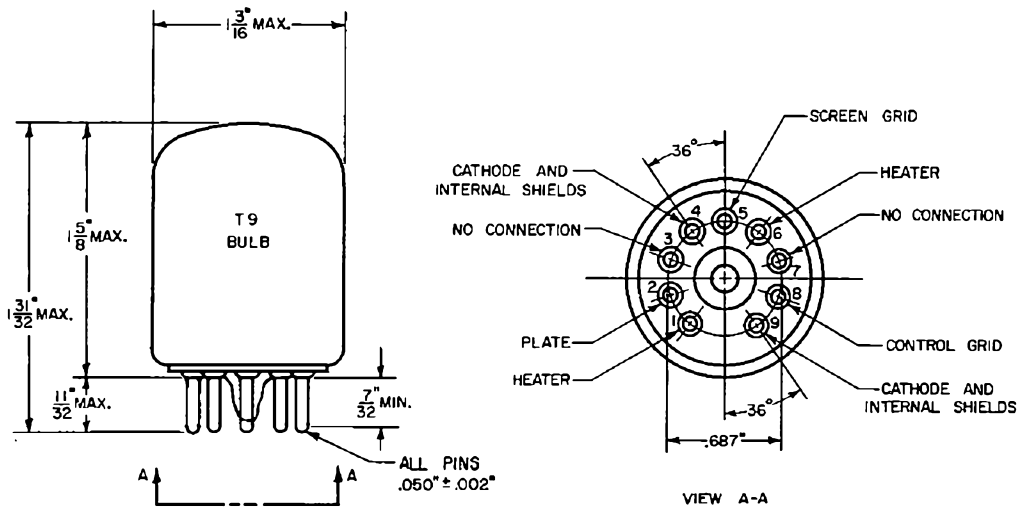
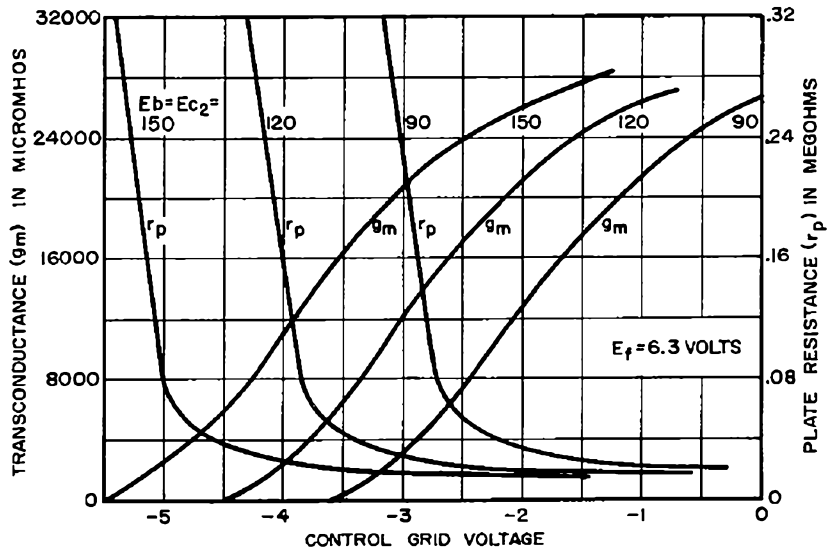

A development of Bell Telephone Laboratories, the research laboratories of the American Telephone and Telegraph Company and the Western Electric Company.

ELECTRON TUBE DATA SHEET
WESTERN ELECTRIC 420A ELECTRON TUBE

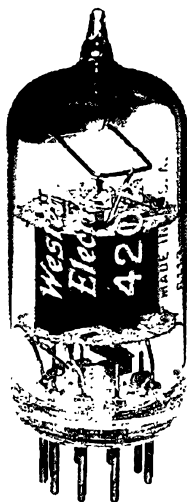

420A

DESCRIPTION

→ The 420A electron tube is a double-triode having separate indirectly heated cathodes. The heater is center-tapped to permit operation from a 6.3 or 12.6 volt filament supply. This tube has been designed for use in d-c amplifier circuits where tube requirements include a high order of mechanical and thermionic stability as well as long life expectancy.

CHARACTERISTICS

Heater Voltage 6.3 volts
Plate Current (each section) } $E_b = 110$ volts; $E_c = -0.6$ volt { 0.15 milliampere
Transconductance (each section) } 500 micromhos

FILE: MINIATURE SECTION

→ Indicates a change

GENERAL CHARACTERISTICS

Electrical Data

	<u>Parallel</u>	<u>Series</u>	
Heater Voltage	6.3	12.6	volts
Heater Current	360	180	milliamperes
Direct Interelectrode Capacitances	without external shield	with external shield (EIA #315)	
Grid to plate (each section)	1.4	(a) 1.4	$\mu\mu f$
Input (each section)	1.5	(a) 1.7	$\mu\mu f$
Output (Section #1)	0.8	(a) 1.5	$\mu\mu f$
Output (Section #2)	0.6	(a) 1.3	$\mu\mu f$
Plate 1 to Plate 2	0.9	(b) 0.8	$\mu\mu f$
Grid 1 to Plate 2	0.01	(b) 0.01	$\mu\mu f$
Grid 2 to Plate 1	0.01	(b) 0.01	$\mu\mu f$

Mechanical Data

Cathode	Coated Unipotential
Bulb	T 6½
Base	Small Button 9-pin
Mounting Position	Any
Dimensions and pin connections shown in outline drawing on Page 4	

MAXIMUM RATINGS, Absolute System (Each Section)

Plate Voltage	225	volts
Plate Dissipation	1.0	watt ←
Plate Current	5	milliamperes
Heater-Cathode Voltage	75	volts ←

TYPICAL OPERATING CONDITIONS AND CHARACTERISTICS, D-C AMPLIFIER (See Fig. 1)

(Values are for each section unless otherwise specified)

Heater Supply Voltage	12.6	volts
Heater Ballast Resistor	35	ohms
Plate Supply Voltage	310	volts
Cathode Bias Resistor (Cathodes tied together)	150,000	ohms
Plate Current	0.15	milliampere
Grid Current (max.)	10^{-9}	ampere
Plate Resistance	0.14	megohm
Load Resistance	0.9	megohm
Transconductance	500	micromhos
Amplification Factor	70	
Balance ¹	0.3	volt
Stability ²	5	millivolts

(a) With external shield #315 connected to cathode pin of section under test.

(b) With external shield #315 connected to ground with other elements.

→ Indicates a change

1. Balance is the condition obtained when grid voltages have been adjusted so that resulting plate current values are equal in both sections of the tube. Value shown above is the maximum grid voltage differential necessary to obtain balance.
2. Stability is defined as the capability of the tube to maintain the condition of balance described in Note 1 in a circuit such as shown in Fig. 1. The arithmetic average value of input voltage change necessary to maintain balance for a production sample group of tubes will not be greater than the value given. This average value of input voltage change is determined over a 7-hour testing period immediately following a 9-hour circuit acclimation schedule. (A 5 millivolt change in input voltage is equivalent to a 0.26 volt change in the output voltage.)

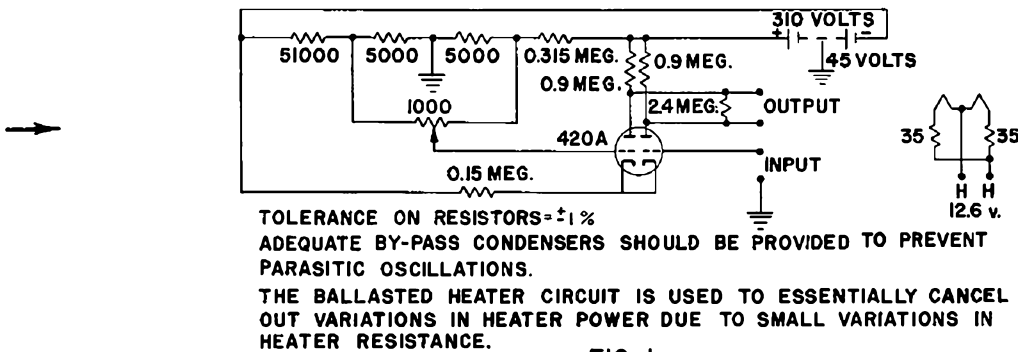
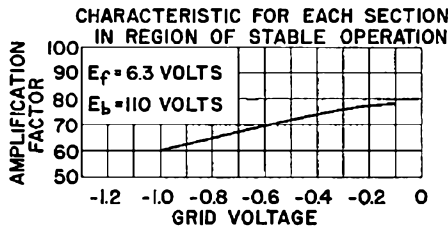
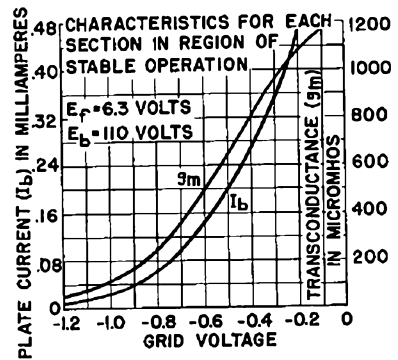
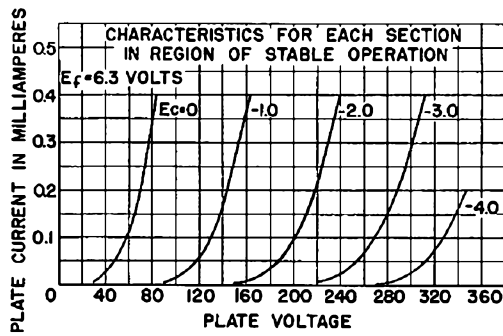
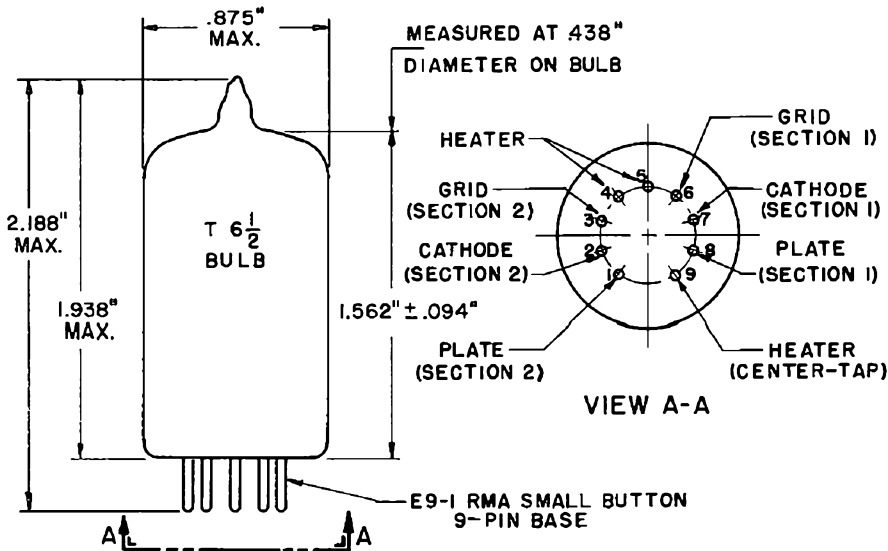
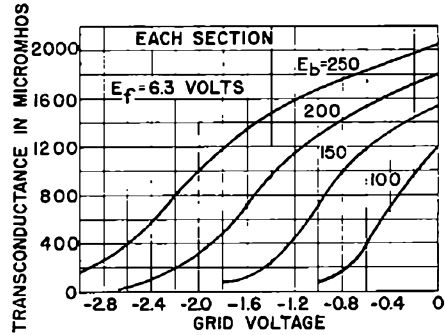
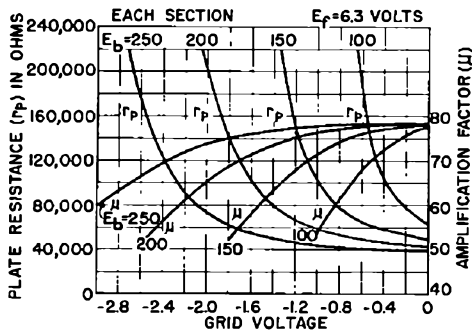
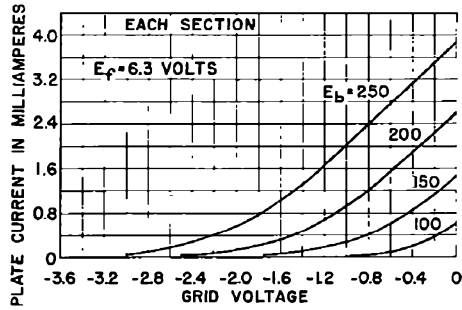
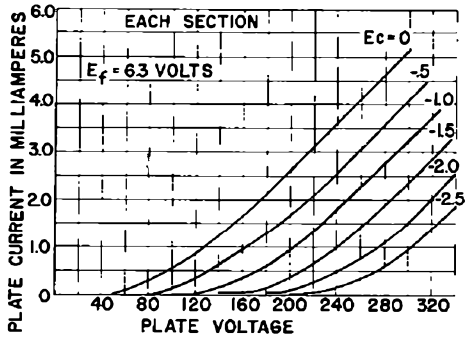

FIG. 1



→ Indicates a change



A development of Bell Telephone Laboratories, the research laboratories of the American Telephone and Telegraph Company and the Western Electric Company.

PRINTED IN U.S.A.

ELECTRON TUBE DATA SHEET
WESTERN ELECTRIC 421A* ELECTRON TUBE



421A

DESCRIPTION

The 5998/421A* is a double triode having separate indirectly heated cathodes.
It is intended for use as a series tube in regulated rectifier circuits.

CHARACTERISTICS

Heater Voltage	-----	6.3 volts
Plate Current per Section	{ E _{bb} = 110 volts; } ---	125 milliamperes
Transconductance per Section	{ R _k = 65 ohms } ---	20000 micromhos

FILE: GENERAL PURPOSE SECTION
Issue 2, 10-53

421A*

GENERAL CHARACTERISTICS

ELECTRICAL DATA

Heater Voltage - - - - -	6.3 volts
Heater Current - - - - -	2.4 amperes

MECHANICAL DATA

Cathode - - - - -	Coated Unipotential
Bulb - - - - -	ST 16
Base - - - - -	Medium 8-pin octal
Mounting Position - - - - -	Any
Dimensions and Pin Connections - - - - -	See Outline drawing page 4

MAXIMUM RATINGS, Design-Center Values (Each Triode)

Plate Voltage - - - - -	250 volts
Plate Dissipation - - - - -	13 watts
Cathode Current - - - - -	125 milliamperes
Heater-Cathode Voltage ¹ - - - - -	150 volts
Bulb Temperature ¹ - - - - -	200°Centigrade
Maximum Grid Circuit Resistance for Cathode Bias - -	0.1 megohm

OPERATING CONDITIONS AND CHARACTERISTICS (Each Triode)

Plate Supply Voltage - - - - -	110	110 volts
Cathode Bias Resistance - - - - -	90	65 ohms
Plate Current - - - - -	100	125 milliamperes
Amplification Factor - - - - -	5.9	6.1
Plate Resistance - - - - -	330	305 ohms
Transconductance - - - - -	18000	20000 micromhos

Note 1: For optimum life expectancy the heater-cathode voltage should not exceed 90 volts and forced-air cooling should be provided. The air flow should be sufficient to keep the bulb temperature below 150°C.

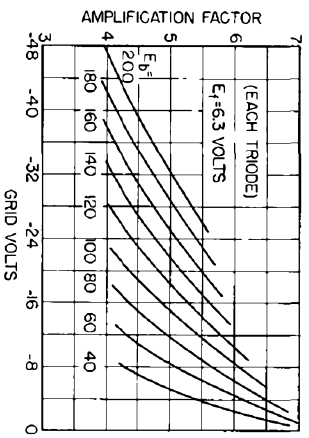
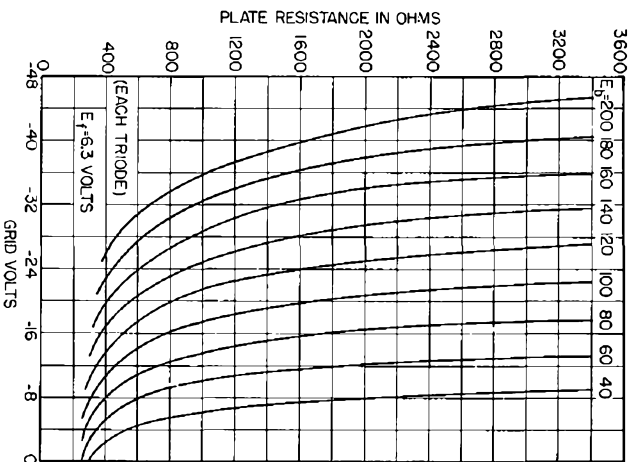
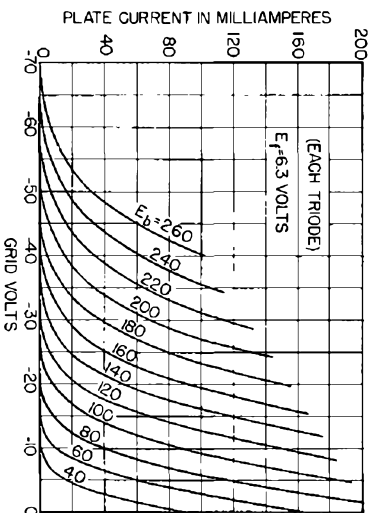
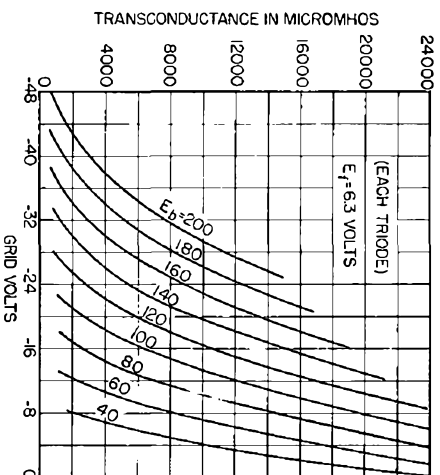
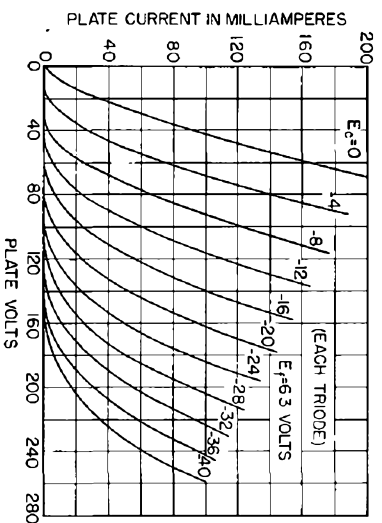

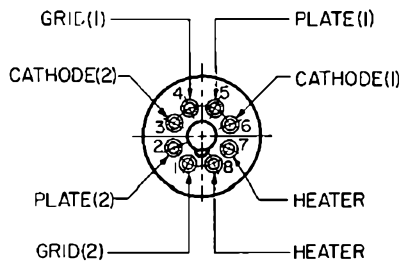
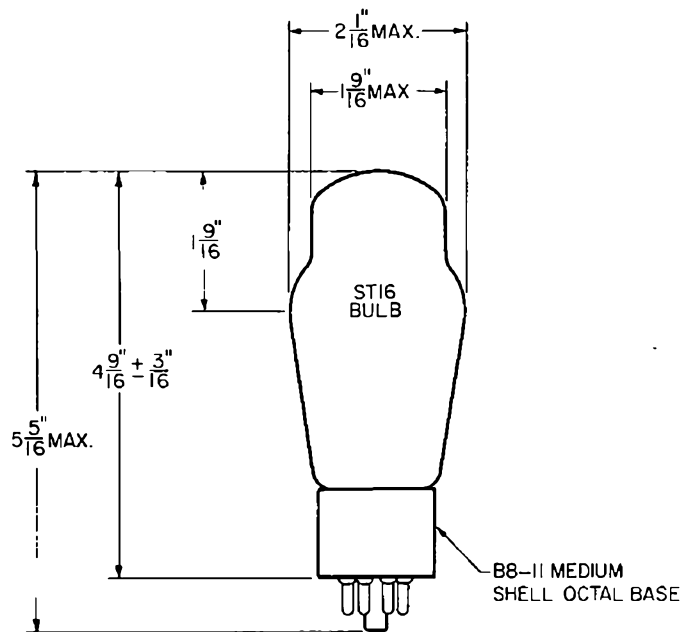

A development of Bell Telephone Laboratories, the research laboratories of the American Telephone and Telegraph Company and the Western Electric Company

ELECTRON TUBE DATA SHEET
WESTERN ELECTRIC 422A ELECTRON TUBE

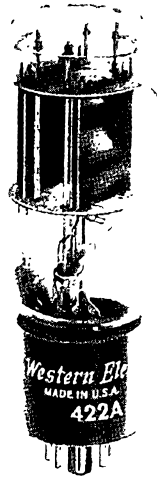

422A

DESCRIPTION

The 422A is a double diode with indirectly heated cathodes. It is used as a full wave rectifier to supply direct current from an alternating current source.

CHARACTERISTICS

Heater Voltage - - - - - 5 volts
Maximum Peak Inverse Voltage - - - - - 1800 volts
Maximum D-C Output Current - - - - - 400 milliamperes

FILE: RECTIFIER SECTION
ISSUE 2 9-52

422A

GENERAL CHARACTERISTICS

ELECTRICAL DATA

Heater Voltage - - - - - 5 volts
 Heater Current - - - - - 3 amperes

MECHANICAL DATA

Cathode - - - - - Coated unipotential
 Bulb - - - - - ST16
 Base - - - - - Medium Shell Octal
 Mounting Position - - - - - Any

Dimensions and pin connections shown in outlined drawing on page 4.

RATINGS, Design-Center Values

Maximum Peak Inverse Voltage - - - - - 1800 volts
 Maximum Steady State Peak Plate Current per Plate - - - - - 0.9 ampere
 Maximum Transient Peak Plate Current per Plate - - - - - 4 amperes
 Maximum A-C Plate Supply Voltage per Plate - - - - - See rating chart
 Maximum Steady State D-C Output Current per Plate - - - - - See rating chart
 Minimum Effective Plate Supply Impedance per Plate - - - - - 100 ohms
 Tube Voltage Drop (at 300 milliamperes per plate) - - - - - 26 volts
 Maximum Bulb Temperature¹ - - - - - 150 centigrade

TYPICAL OPERATING CONDITIONS

Full Wave Rectifier

	<u>Input To Filter</u>	
	<u>Capacitor</u>	<u>Choke</u>
A-C Plate Supply Voltage per Plate - - - - -	385	450 volts
Input Capacitor - - - - -	10	--- microfarads
Input Choke (minimum) - - - - -	---	10 henrys
Effective Plate Supply Impedance per Plate - - -	100	--- ohms
D-C Output Current - - - - -	300	350 milliamperes
D-C Output Voltage - - - - -	395	360 volts

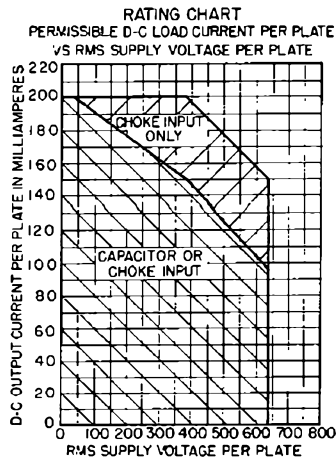

Note: Operating point for capacitor input to filter must be within the lower cross-hatched area designated "Capacitor or Choke Input" while that for choke input to filter must be at some point within either cross-hatched area.

Note 1: Temperature limit given is that required to obtain optimum tube life. Forced-air cooling is necessary to meet this limit. Maximum permissible bulb temperature is 200 centigrade.

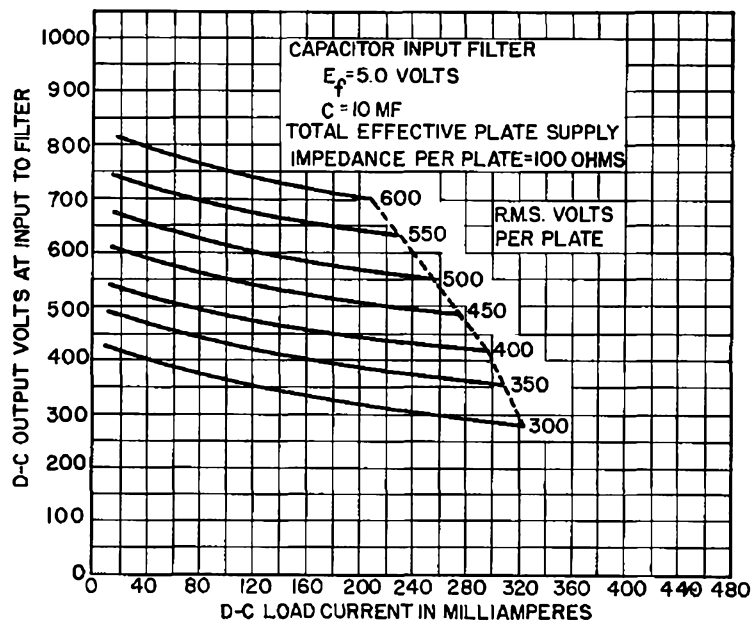
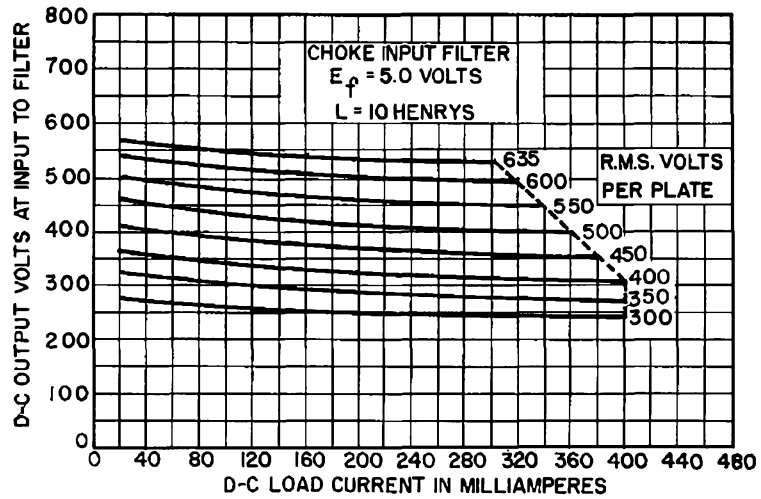

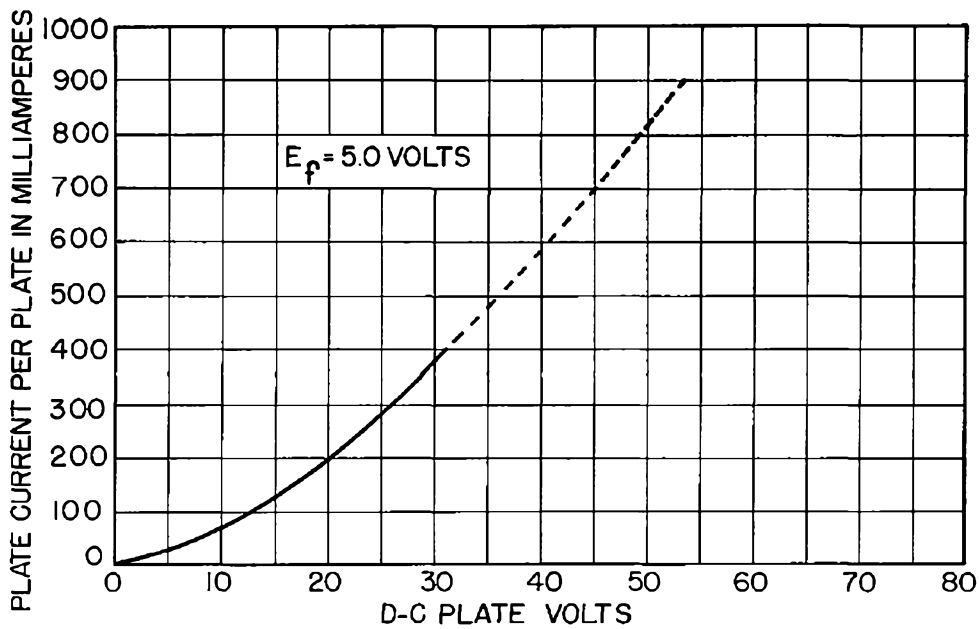
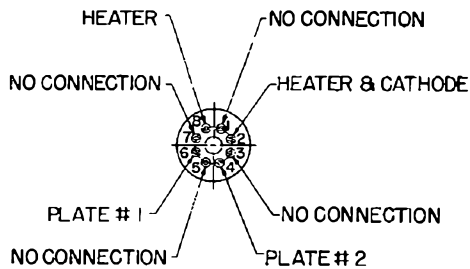
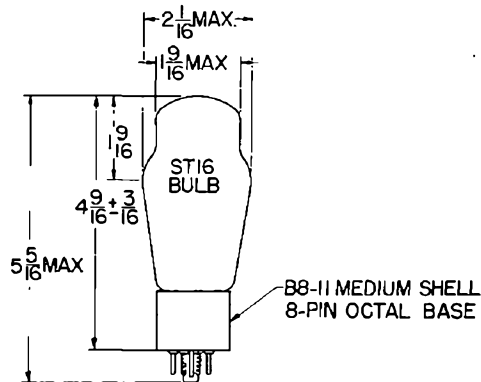

A development of Bell Telephone Laboratories, the research laboratories of the American Telephone and Telegraph Company and the Western Electric Company.

ELECTRON TUBE DATA SHEET
WESTERN ELECTRIC 423A* ELECTRON TUBE



423A

DESCRIPTION

The 6140/423A* is a two-electrode inert-gas filled cold cathode tube designed primarily for use as a voltage reference tube. This tube has characteristics which are exceptionally stable with life and with variations in ambient temperature.

CHARACTERISTICS

Cathode Current	4 to 8 milliamperes
Anode Voltage Drop	100 volts
Regulation, Max. (4 to 6 Milliamperes D-C)	0.75 volt

FILE: COLD CATHODE SECTION
ISSUE 3, 11-52

423A*

RATINGS, Absolute Values

Cathode Current, Forward	
Maximum	8 milliamperes
Minimum	4 milliamperes
Maximum Inverse Anode Current	0.0 milliamperes
Ambient Temperature Limits	-55 to + 60 centigrade

ELECTRICAL DATA

	<u>Min.</u>	<u>Bogey</u>	<u>Max.</u>
Anode Breakdown Voltage	---	135	160 volts
Anode Voltage Drop at 6 Milliamperes (D-C) ¹	99	100	103 volts
Regulation (4 to 6 Milliamperes, D-C).	---	0.3	0.75 volt
Temperature Sensitivity of Anode Voltage Drop			
Anode Current, 4 Milliamperes (D-C)	---	-0.01	--- volt/c
Anode Current, 8 Milliamperes (D-C)	---	-0.02	--- volt/c
Fluctuation ²	---	0.02	0.1 volt
Stability ³	---	0.05	0.2 volt

MECHANICAL DATA

Mounting Position	Any
Net Weight, Approximate	0.3 ounce
Bulb	T 6-1/2
Base	Small Button 9-pin

Note 1: These values are for new tubes. Anode voltage drop will stabilize within 3 minutes after starting. The stability characteristic should be considered during tube life.

Note 2: The anode voltage drop variation during a short period of time (one to ten minutes), with the tube operating at one value of current and temperature within its ratings, will not exceed the above stated maximum value.

Note 3: The drift of anode voltage drop over a period of 1000 hours, with the tube operating at one value of current and temperature within its ratings, will not exceed the above stated maximum value.

Note 4: Pins marked "NO CONNECTION" should not be connected to any portion of an external circuit. Failure to observe this precaution may result in improper operation of the tube.

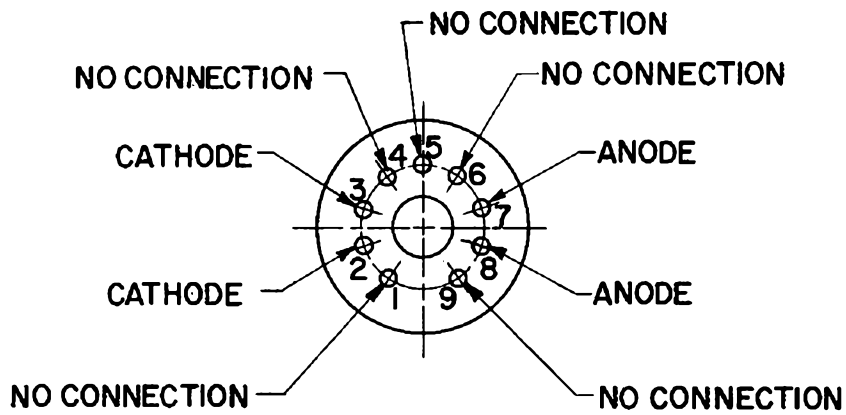
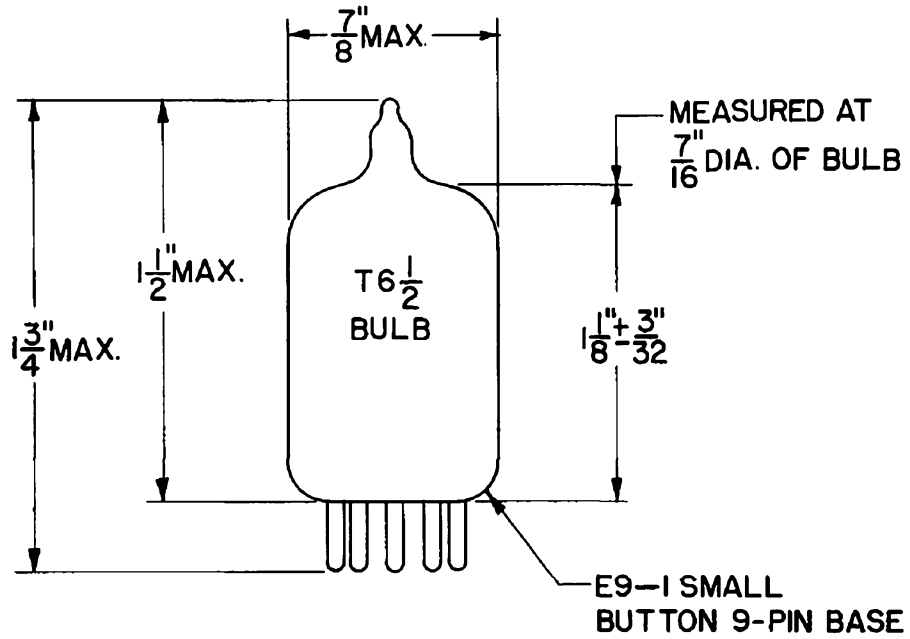

SEE NOTE 4 ON PIN CONNECTIONS

ELECTRON TUBE DATA SHEET
WESTERN ELECTRIC 423C ELECTRON TUBE

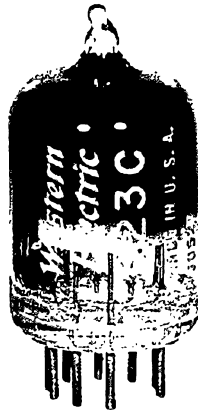

423C

DESCRIPTION

The 423C is a two-electrode inert-gas filled cold cathode tube designed primarily for use as a voltage reference tube. This tube has characteristics which are exceptionally stable with life and with variations in ambient temperature.

CHARACTERISTICS

Cathode Current4 to 8 milliamperes
Anode Voltage Drop	100 volts
Regulation at 4 to 6 milliamperes d-c (Note 5-page 3)	0.75 volt

File: Cold Cathode Section

RATINGS, Absolute System (Note 1)

Cathode Current, Forward		
Maximum		8 milliamperes
Minimum		4 milliamperes
Maximum Inverse Anode Current		0.0 milliampere
Ambient Temperature Limits.	-55 to +60	centigrade

ELECTRICAL DATA, Throughout Life

	<u>Min.</u>	<u>Bogey</u>	<u>Max.</u>	
Anode Breakdown Voltage	-	135	160	volts
Anode Voltage Drop (E_{td}) at 6 Milliampere (D-C) Note 299	100	103	volts
Regulation (4 to 6 Milliampere, D-C) (Note 5)	-	0.3	0.75	volt
Temperature Sensitivity of Anode Voltage Drop				
Anode Current, 4 Milliampere (D-C)	-0.01	-	-	volt/c
Anode Current, 8 Milliampere (D-C)	-0.02	-	-	volt/c
Fluctuation (Note 3)	-	0.02	0.1	volt
Average Ionization Time (Note 4)	-	4.0	6.0	milliseconds

MECHANICAL DATA

Mounting Position		Any
Net Weight, Approximate		0.3 ounce
Bulb		T 6½
Base		Small Button 9 pin

Dimensions and connections shown in outline drawing on page 4.

LIFE DATA

Regulation (4 to 6 mAdc) after 1000 hours at 5 mAdc (Note 5)	See Figure 1
Drift in Anode Voltage Drop (E_{td}) in 1000 hours at 5 mAdc	See Figure 2

HANDLING

This tube contains a small amount of krypton-85 gas which is a by-product radioactive material. The amount of krypton-85 is less than five microcuries, which is too small an amount to require any special care in use.

Atomic Energy Commission regulations require that the individual tube carton for tubes containing by-product radioactive material be appropriately marked. The marking includes the statement that tube disposal should be in approved manner.

Approved instructions for disposal of tubes containing krypton-85 are as follows;

Tubes to be disposed of should be broken or crushed in a well ventilated place releasing any resulting vapors to the outside atmosphere. The residual broken or crushed tubes should be disposed of in a normal public trash disposal system. Tubes should be disposed of at a rate of not more than 100 each week from any one location. Avoid breathing vapors from broken tubes.

Note 1: In the "Absolute System" the maximum ratings specified are limiting values above which the serviceability of the device may be impaired from the viewpoint of life and satisfactory performance. Maximum ratings, as such, do not constitute a set of operating conditions and all values may not, therefore, be attained simultaneously.

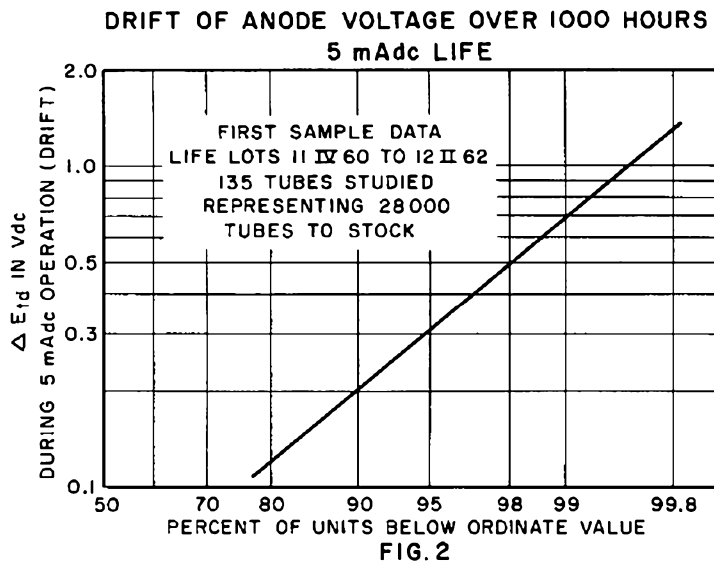
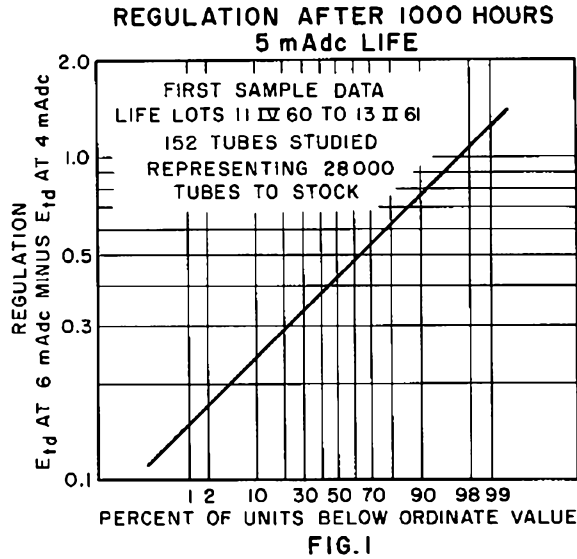

Note 2: These values are for new tubes. Anode voltage drop will stabilize within 3 minutes after starting.

Note 3: The anode voltage drop variation during a short period of time (one to ten minutes), with the tube operating at one value of current and temperature within its ratings, will not exceed the above stated maximum value.

Note 4: With 15 volts overvoltage (15 volts above Anode Breakdown Voltage) with tube in total darkness. Average of 10 measurements taken at 1 second intervals.

Note 5: Regulation is defined to be Anode Voltage Drop (E_{td}) at 6 mAdc minus Anode Voltage Drop (E_{td}) at 4 mAdc.

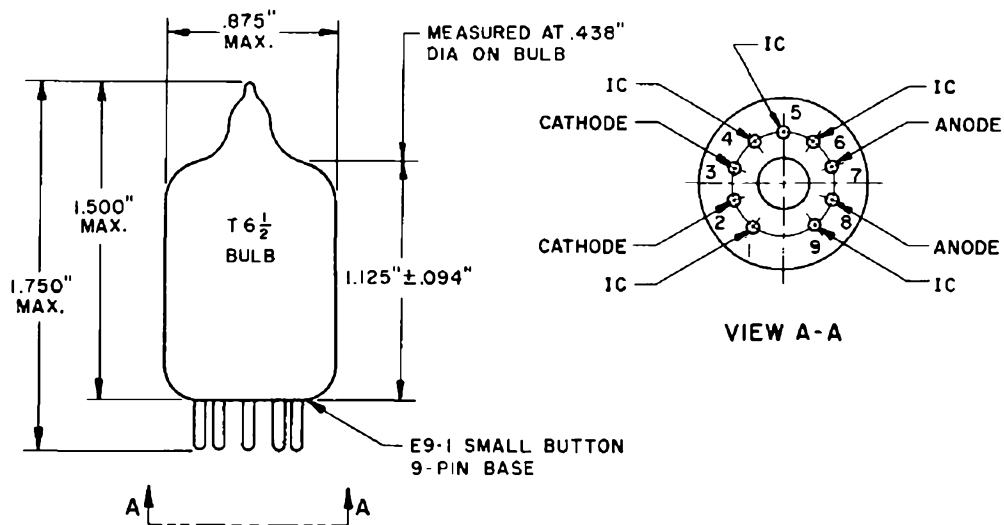

NOTE: PINS MARKED IC (INTERNAL CONNECTION) SHOULD NOT BE CONNECTED TO ANY PORTION OF AN EXTERNAL CIRCUIT. FAILURE TO OBSERVE THIS PRECAUTION MAY RESULT IN IMPROPER OPERATION OF THE TUBE.

A development of Bell Telephone Laboratories, the research laboratories of the American Telephone and Telegraph Company and the Western Electric Company.

PRINTED IN U.S.A.

ELECTRON TUBE DATA SHEET
WESTERN ELECTRIC 425A ELECTRON TUBE **425A**

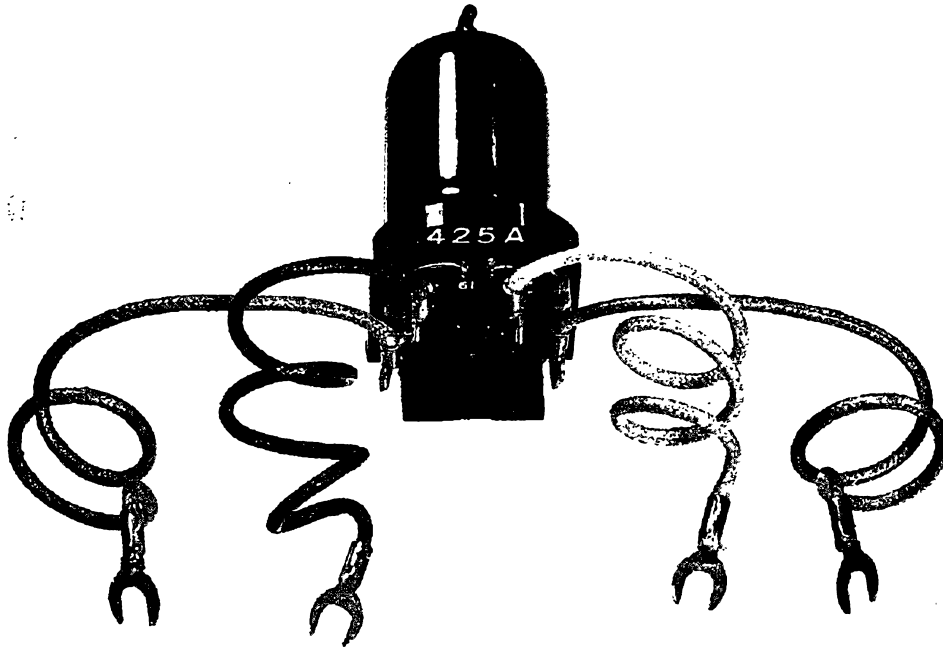

DESCRIPTION

The 425A is a four-electrode, inert-gas filled cold cathode tube for use as a relay device. The tube is provided with an anode-cathode gap and a starter anode-starter cathode gap such that isolation of the control (starter gap) and controlled (main gap) portions of a circuit may be obtained.

This tube is designed with an integral special mounting bracket. It is available in an electrically equivalent, socket mounting form, as the 451A.

CHARACTERISTICS

Peak Anode Voltage	180	180	volts ←
Average Starter Cathode Current	0.7	7.0	milliamperes
Average Main Cathode Current	5.0	50	milliamperes
Average Life, Approximate	10000	10	hours

FILE: COLD CATHODE SECTION

← Indicates a change

© American Telephone and Telegraph Company 1962

425A

MAXIMUM RATINGS, Absolute System (Note 1)

Peak Voltage, Forward or Inverse		
Anode to all Other Electrodes	180	volts
Cathode to all Other Electrodes	180	volts
→ Cathode Current (Note 2)		
Peak	50	milliamperes
Average	20	milliamperes
Averaging Time	2	seconds
Starter Cathode Current (Note 2)		
Peak	7	milliamperes
Average	2.5	milliamperes
Averaging Time	2	seconds
→ Peak Inverse Current (Note 2)		
Anode	5	milliamperes
Starter Anode	1	milliamperes
Ambient Temperature Limits	-55° to +85°	centigrade

ELECTRICAL DATA, Throughout Life

	<u>Min.</u>	<u>Bogey</u>	<u>Max.</u>	
Starter Breakdown Voltage (Note 3)	67	80	90	volts
Starter Voltage Drop at 2.5 Milliamperes	55	70	75	volts
Anode Voltage Drop at 10 Milliamperes	58	70	80	volts
→ Transfer Current (Note 4)	See Curve, Figure 3, Page 4			
Negative Cathode Transfer Voltage (Note 5)	-	-25	-40	volts
Ionization Time, Starter Gap (Approx.) (Note 6)	-	5	-	milliseconds
Deionization Time, Main Gap (Approx.)	-	1	-	millisecond

MECHANICAL DATA

Mounting (Note 7)	Any position
New Weight, Approximate	0.7 ounce
Dimensions and Connections	See outline drawing on page 4

HANDLING

This tube contains a small amount of krypton-85 gas which is a by-product radioactive material. The amount of krypton-85 is less than five microcuries, which is too small an amount to require any special care in use.

Atomic Energy Commission regulations require that the individual tube carton for tubes containing by-product radioactive material be appropriately marked. The marking includes the statement that tube disposal should be in approved manner.

Approved instructions for disposal of tubes containing krypton-85 are as follows;

Tubes to be disposed of should be broken or crushed in a well ventilated place releasing any resulting vapors to the outside atmosphere. The residual broken or crushed tubes should be disposed of in a normal public trash disposal system. Tubes should be disposed of at a rate of not more than 100 each week from any one location. Avoid breathing vapors from broken tubes.

→ Indicates a change

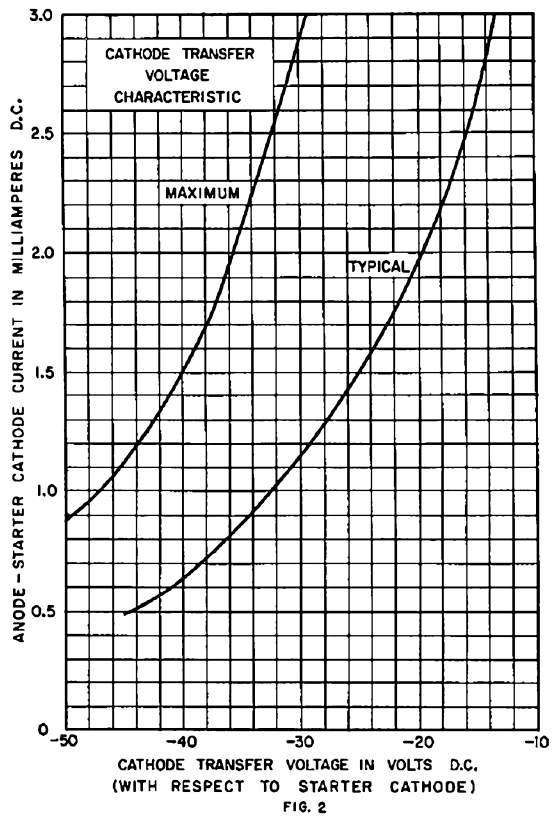
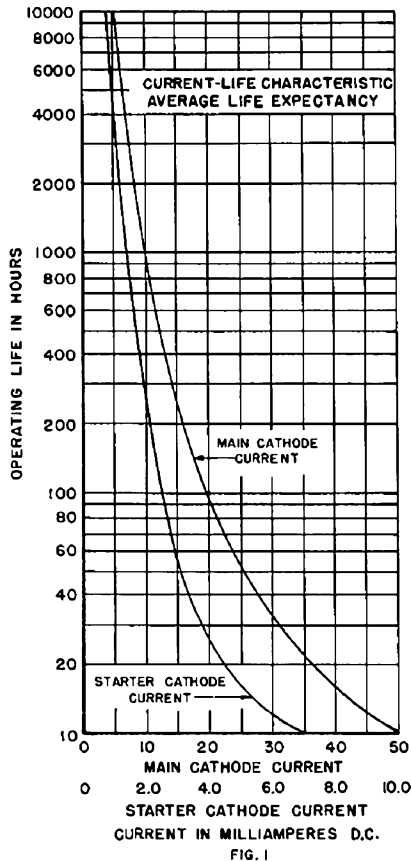

Note 1: In the "Absolute System" the maximum ratings specified are limiting values above which the serviceability of the device may be impaired from the viewpoint of life and satisfactory performance. Maximum ratings, as such, do not constitute a set of operating conditions and all values may not, therefore, be attained simultaneously.

Note 2: Sufficient resistance must be used in series with the tube discharge paths to assure that the electrode currents do not exceed their maximum rated values.

Note 3: Limits apply immediately after the tube has conducted current. These values may be initially as much as 3 volts higher or lower if the tube has been idle.

Note 4: To assure transfer of conduction from the starter anode-starter cathode gap to the anode-starter cathode gap.

Note 5: To assure transfer of conduction from the anode-starter gap to the anode-cathode gap with 1.5 milliamperes flowing from anode to starter cathode. Cathode voltage is measured with respect to starter cathode.

Note 6: With 15 volts starter overvoltage (15 volts above Starter Breakdown Voltage) and with the tube in total darkness.

Note 7: Tube is permanently mounted on plastic angle bracket. Pin connections are terminated in flexible connector leads.

→ Indicates a change

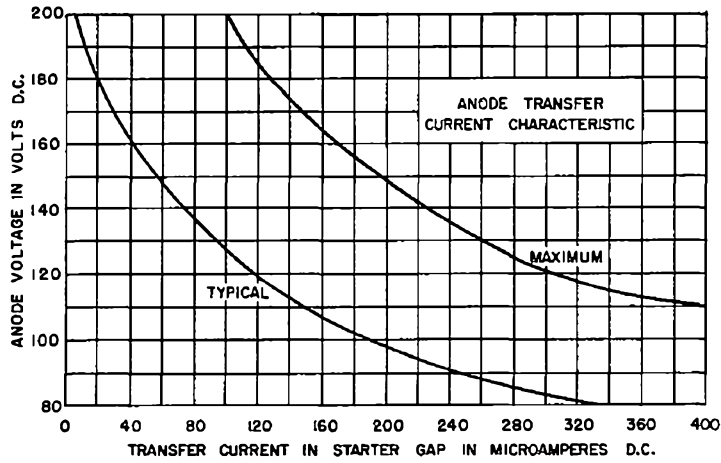
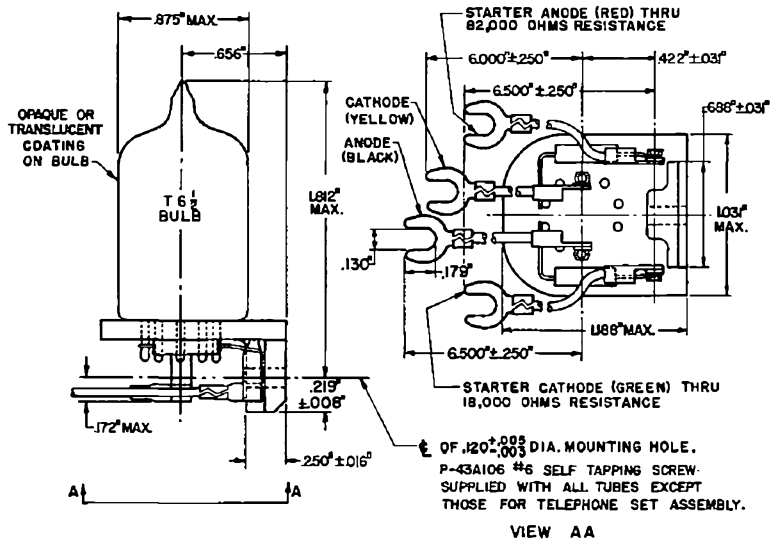

FIG. 3



A development of Bell Telephone Laboratories, the research laboratories of the American Telephone and Telegraph Company and the Western Electric Company.

PRINTED IN U.S.A.

ELECTRON TUBE DATA SHEET
WESTERN ELECTRIC 426A ELECTRON TUBE

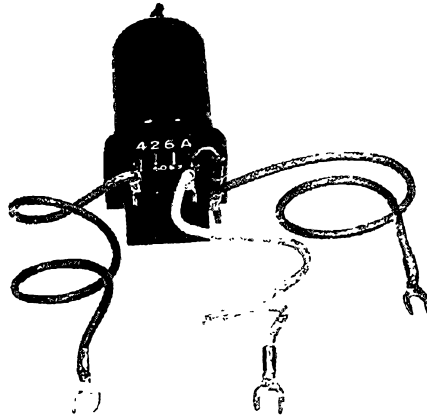

426A

DESCRIPTION

The 426A is a three-electrode inert-gas-filled miniature cold cathode tube for use in relay, voltage regulator or rectifier circuits. This tube is especially suitable for use in control circuits such as in triggering, counting or switching apparatus.

CHARACTERISTICS

Peak Anode Voltage	180	volts
Average Cathode Current 7.5	60	milliamperes
Average Life, Approximate 10000	10	hours

File: Cold Cathode Section

MAXIMUM RATINGS, Absolute System (Note 1)

Forward Peak Anode Voltage	180	volts
Forward Cathode Current (Note 2)		
Peak	60	milliamperes
Average	30	milliamperes
Averaging Time	2	seconds
Peak Inverse Current (Note 2)		
Anode	5	milliamperes
Starter	1	milliampere
Ambient Temperature Limits	-55 to +85	centigrade

ELECTRICAL DATA, Throughout Life

	<u>Min.</u>	<u>Bogey</u>	<u>Max.</u>	
Starter Breakdown Voltage65	72	85	volts
Starter Voltage Drop at 3 Milliamperes (Note 3)53	63	72	volts
Anode Voltage Drop at 10 Milliamperes (Notes 4 & 5)63	69	75	volts
Transfer Current	See Figure 1, Page 3			
Ionization Time, Starter Gap (Note 6)	-	10	-	milliseconds
Deionization Time, Main Gap	-	6	-	milliseconds
Inverse Current at -120 Volts Anode Potential (Note 7)	-	-	3	milliamperes

MECHANICAL DATA

Mounting (Note 8) Any Position
 Net Weight 0.7 Ounce
 Dimensions and connections shown in outline drawing on page 4.

HANDLING

This tube contains a small amount of krypton-85 gas which is a by-product radioactive material. The amount of krypton-85 is less than five microcuries, which is too small an amount to require any special care in use.

Atomic Energy Commission regulations require that the individual tube carton for tubes containing by-product radioactive material be appropriately marked. The marking includes the statement that tube disposal should be in approved manner.

Approved instructions for disposal of tubes containing krypton-85 are as follows;

Tubes to be disposed of should be broken or crushed in a well ventilated place releasing any resulting vapors to the outside atmosphere. The residual broken or crushed tubes should be disposed of in a normal public trash disposal system. Tubes should be disposed of at a rate of not more than 100 each week from any one location. Avoid breathing vapors from broken tubes.

Note 1: In the "Absolute System" the maximum ratings specified are limiting values above which the serviceability of the device may be impaired from the viewpoint of life and satisfactory performance. Maximum ratings, as such, do not constitute a set of operating conditions and all values may not, therefore, be attained simultaneously.

Note 2: Sufficient resistance must be used in series with the tube to assure that the electrode currents do not exceed the maximum rated values.

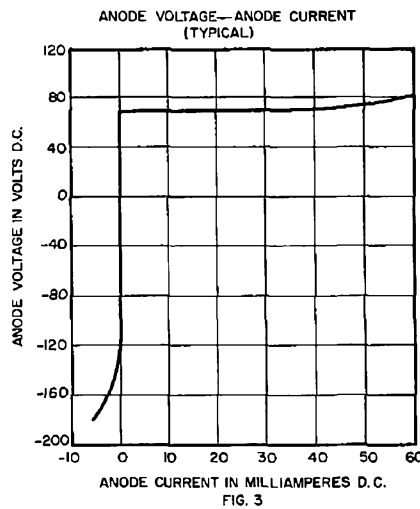
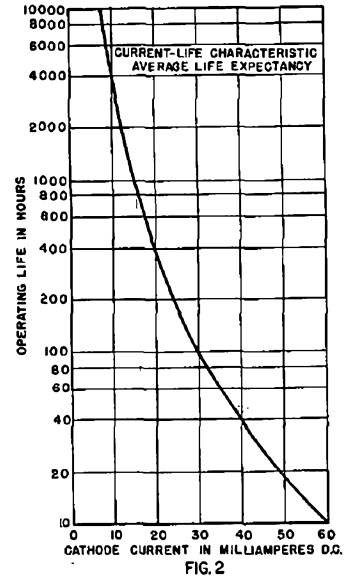
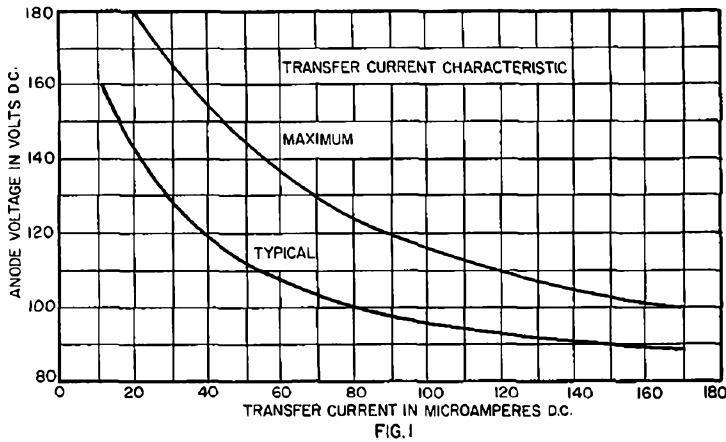

- Note 3: Starter voltage oscillations of approximately 1 to 10 kilocycles and 12 volts peak-to-peak will be present at starter current values below 0.05 milliampere.
- Note 4: Approximately 95% of tubes will be within limits of ± 2.8 volts from the bogey value
- Note 5: Anode voltage oscillations of approximately 5 to 20 kilocycles and 3 volts peak-to-peak will be present at anode currents within the ratings.
- Note 6: With 15 volts starter overvoltage (15 volts above starter breakdown voltage) with tube in total darkness.
- Note 7: Negative anode voltage applied through 8000 ohms. Starter connected to anode through 100,000 ohms.
- Note 8: Tube is permanently mounted on a plastic angle bracket. Pin connection are terminated in flexible connector leads.

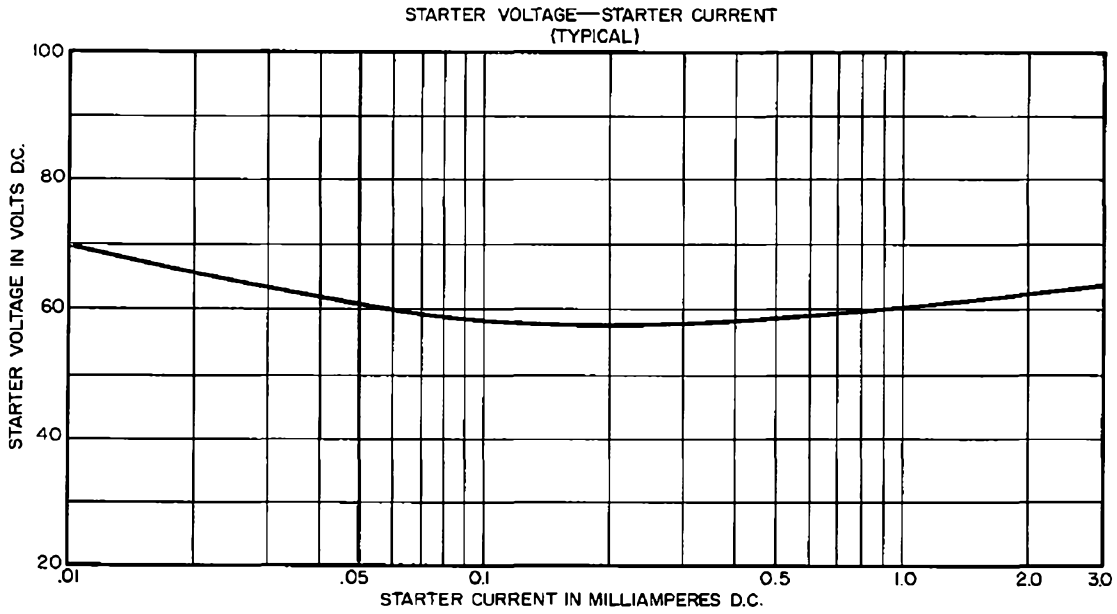
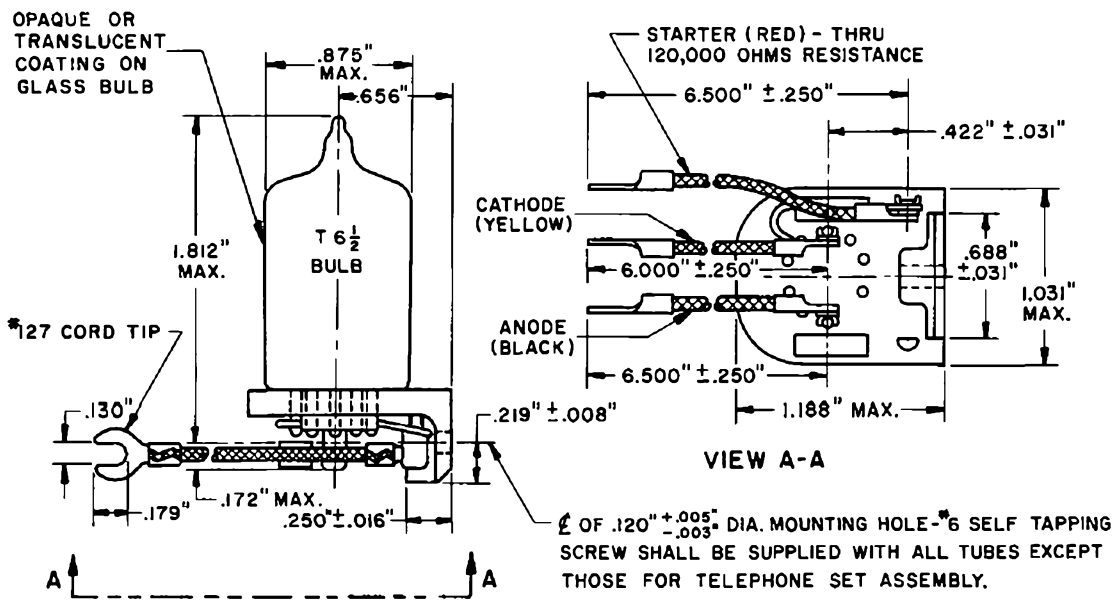

FIG. 4



A development of Bell Telephone Laboratories, the research laboratories of the American Telephone and Telegraph Company and the Western Electric Company.

ELECTRON TUBE DATA SHEET
WESTERN ELECTRIC 427A ELECTRON TUBE



427A

DESCRIPTION

The 427A is a three-electrode inert-gas-filled cold cathode tube designed for use as a voltage regulator and has characteristics which are exceptionally stable with life and with variation in ambient temperature. The third electrode is primarily a starting element.

CHARACTERISTICS

Cathode Current5 to 40	milliamperes
Anode Voltage Drop (E_{td})	100	volts
Regulation at 5 to 40 milliamperes d-c (Note 6).	± 1.5	volts

File: Cold Cathode Section

© American Telephone and Telegraph Company 1962

427A

RATINGS, Absolute System (Note 1)

Cathode Current, Forward	
Maximum	40 milliamperes
Minimum	5 milliamperes
Starter Current, Forward	
Maximum	5 milliamperes
Minimum (Note 2)	0.5 milliampere
Maximum Inverse Starter or Anode Current	0.0 milliampere
Ambient Temperature Limits	-55 to +85 centigrade

ELECTRICAL DATA

	<u>Min.</u>	<u>Bogey</u>	<u>Max.</u>	
Anode Breakdown Voltage	-	165	-	volts
Anode Voltage Drop (E_{td}) at 40 Milliamperes, (D-C) (Note 3)	99	100	103	volts
Regulation (5 to 40 Milliamperes, D-C) (Notes 4 & 6)	-	-0.3	±1.5	volts
Starter Breakdown Voltage	115	125	135	volts
Starter Voltage Drop at 5 Milliamperes, (D-C)	100	110	120	volts
Transfer Current	See Curve - Figure 1			
Temperature Sensitivity, Anode Voltage Drop				
Anode Current, 5 milliamperes (D-C)	-	-0.007	-	volt/c
Anode Current, 40 milliamperes (D-C)	-	-0.004	-	volt/c

LIFE DATA

Starter Breakdown Voltage (Max.) after 500 hours at 40 mAdc 135 volts
 Regulation (5 to 40 mAdc) after 500 hours at 40 mAdc (Note 6) See Figure 3, Page 4
 Drift in Anode Voltage Drop (E_{td}) in 500 hours at 40 mAdc See Figure 2 and Note 5

MECHANICAL DATA

Mounting Position Any
 Net Weight, Approximate 0.4 Ounce
 Base Small Button 9-pin
 Bulb T6-1/2
 Dimensions and connections shown in outline drawing on page 4.

HANDLING

This tube contains a small amount of krypton-85 gas which is a by-product radioactive material. The amount of krypton-85 is less than five microcuries, which is too small an amount to require any special care in use.

Atomic Energy Commission regulations require that the individual tube carton for tubes containing by-product radioactive material be appropriately marked. The marking includes the statement that tube disposal should be in approved manner.

Approved instructions for disposal of tubes containing krypton-85 are as follows;

Tubes to be disposed of should be broken or crushed in a well ventilated place releasing any resulting vapors to the outside atmosphere. The residual broken or crushed tubes should be disposed of in a normal public trash disposal system. Tubes should be disposed of at a rate of not more than 100 each week from any one location. Avoid breathing vapors from broken tubes.

Note 1: In the "Absolute System" the maximum ratings specified are limiting values above which the serviceability of the device may be impaired from the viewpoint of life and satisfactory performance. Maximum ratings, as such, do not constitute a set of operating conditions and all values may not, therefore, be attained simultaneously.

Note 2: The minimum starter current requirement applies only when the tube is operated for extended periods (hundreds of hours) between starting operations to assure maintaining starter breakdown and transfer current characteristics.

Note 3: These values are for new tubes. Anode voltage drop will stabilize within 3 minutes after starting.

Note 4: Continuous operation at a current value in the low portion of the operating range for an extended period (hundreds of hours) may result temporarily in regulation exceeding the stated values.

Note 5: The drift of anode voltage drop improves with operating life. After 1000-2000 hours operation the drift of anode voltage drop per 1000 hours will not exceed 0.3 volt.

Note 6: Regulation is defined to be Anode Voltage Drop (E_{td}) at 40 mAdc minus Anode Voltage Drop (E_{td}) at 5 mAdc.

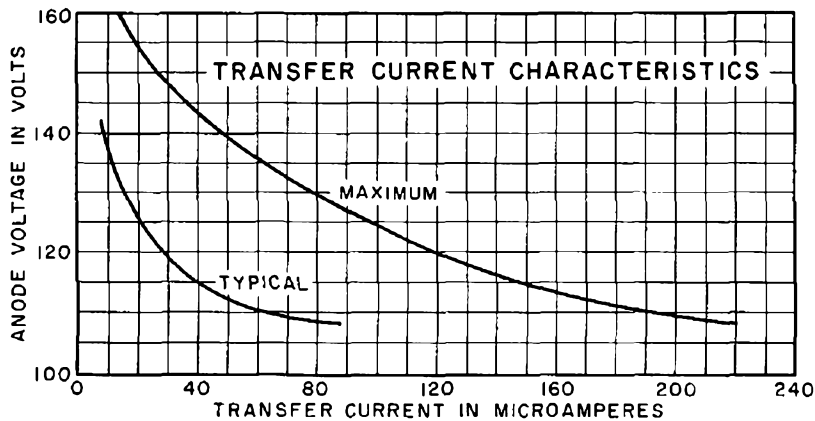

FIG. 1

**DRIFT OF ANODE VOLTAGE OVER 500 HOURS
40 mAdc LIFE**

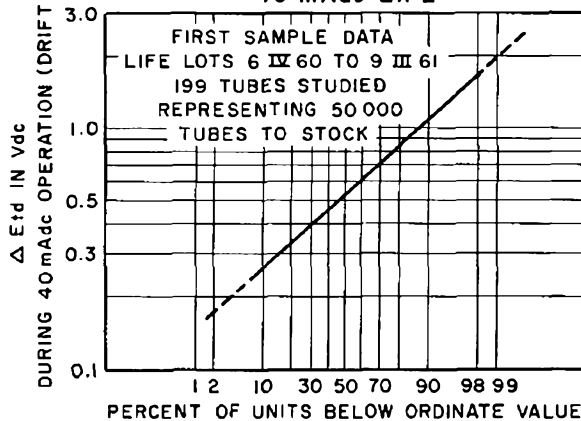
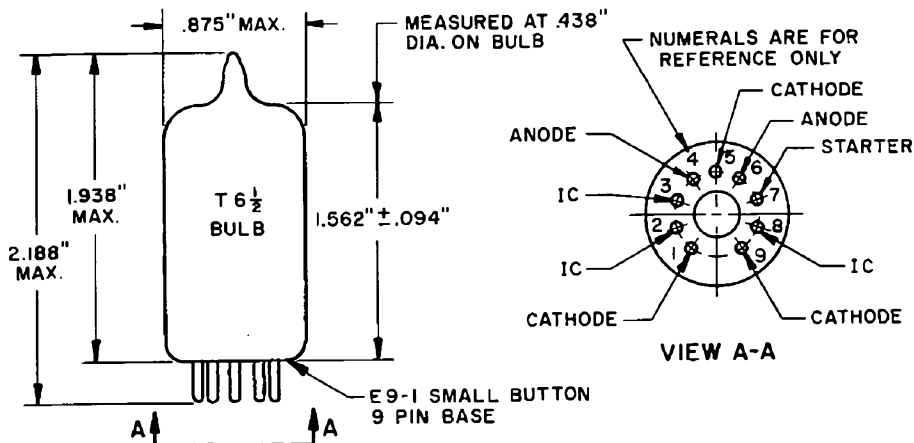
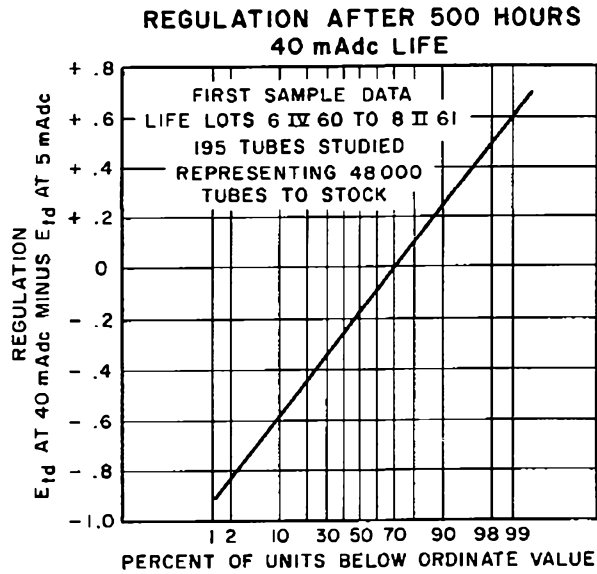

FIG. 2



NOTE: PINS MARKED IC (INTERNAL CONNECTION) SHOULD NOT BE CONNECTED TO ANY PORTION OF AN EXTERNAL CIRCUIT. FAILURE TO OBSERVE THIS PRECAUTION MAY RESULT IN IMPROPER OPERATION OF THE TUBE.

A development of Bell Telephone Laboratories, the research laboratories of the American Telephone and Telegraph Company and the Western Electric Company.

PRINTED IN U.S.A.

ELECTRON TUBE DATA SHEET
WESTERN ELECTRIC 429A ELECTRON TUBE

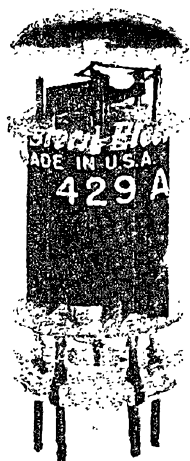

429A

DESCRIPTION

The 429A is a beam pentode of the indirectly heated cathode type. The tube was designed, initially, for use in the #2 and #9B Telegraph Service Board Circuits. It is also suitable for use as an audio-frequency amplifier.

CHARACTERISTICS

Heater Voltage	20 volts
Plate Current	41 milliamperes
Transconductance $\left(\begin{array}{l} E_{c1} = -3 \text{ volts} \\ E_b = E_{c2} = 130 \text{ volts} \end{array} \right)$	6600 micromhos

File: General Purpose Section
Data Sheet Issue 3, 2-61

429A

GENERAL CHARACTERISTICSELECTRICAL DATA

Heater Voltage (Note 1)	20 volts
Heater Current	140 milliamperes
Direct Interelectrode Capacitances (without external shield)	
Grid to Plate (maximum)	1.5 μ f
Input	6.5 μ f
Output	5.0 μ f

MECHANICAL DATA

Cathode	Coated unipotential
Bulb	T9
Base	Button Stem 9-Pin
Mounting Position	Any

MAXIMUM RATINGS, Absolute System (Note 2)

Plate Voltage	275 volts
Screen Grid Voltage	150 volts
Plate Current	75 ma
Plate Dissipation	12.0 watts
Screen Grid Dissipation	2.0 watts
Heater-Cathode Voltage	130 volts
Bulb Temperature	130°C Centigrade

MAXIMUM CIRCUIT VALUES

Grid Circuit Resistance:	
For Fixed Bias	0.1 megohms
For Cathode Bias	0.3 megohms

TYPICAL OPERATING CONDITIONS AND CHARACTERISTICS

Plate Voltage	130 volts
Screen Grid Voltage	130 volts
Control Grid Voltage	-3 volts
Peak A-F Grid Voltage	3 volts
Zero Signal Plate Current	41 ma
Maximum Signal Plate Current	43 ma
Zero Signal Screen Grid Current	2.0 ma
Maximum Signal Screen Grid Current	3.5 ma
Transconductance (Note 3, See Page 4)	6600 μ mhos
Plate Resistance	37000 ohms
Load Resistance	5000 ohms

Note 1: For optimum life, the heater voltage should be regulated to within $\pm 2\%$ of the rated value.

Note 2: In the "Absolute System" the maximum ratings specified are limiting values above which the serviceability of the tube may be impaired from the viewpoint of life and satisfactory performance. Maximum ratings, as such, do not constitute a set of operating conditions and all values may not, therefore, be attained simultaneously.

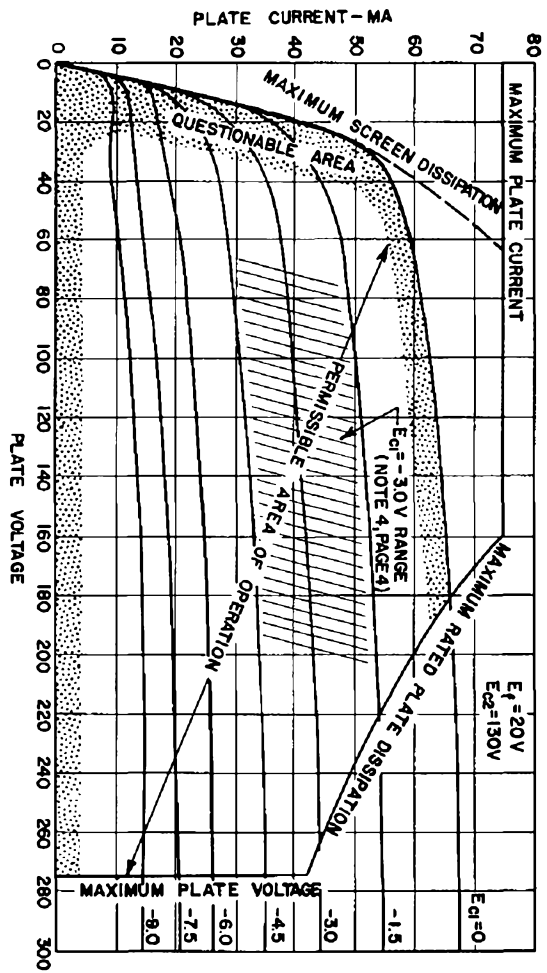
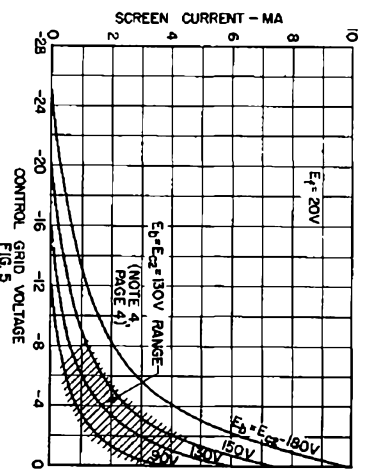
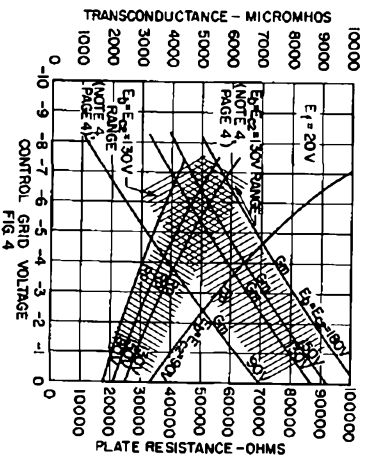
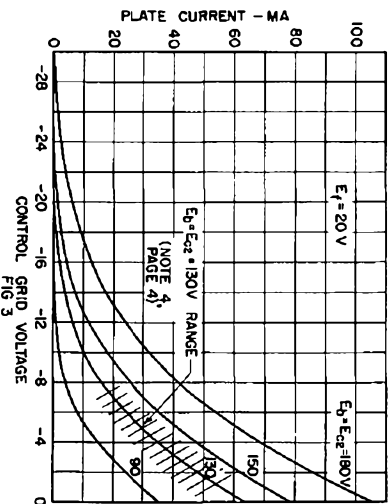
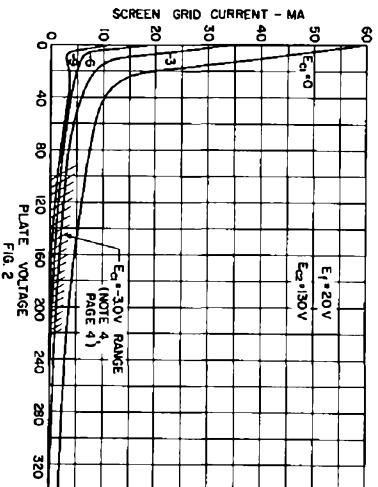
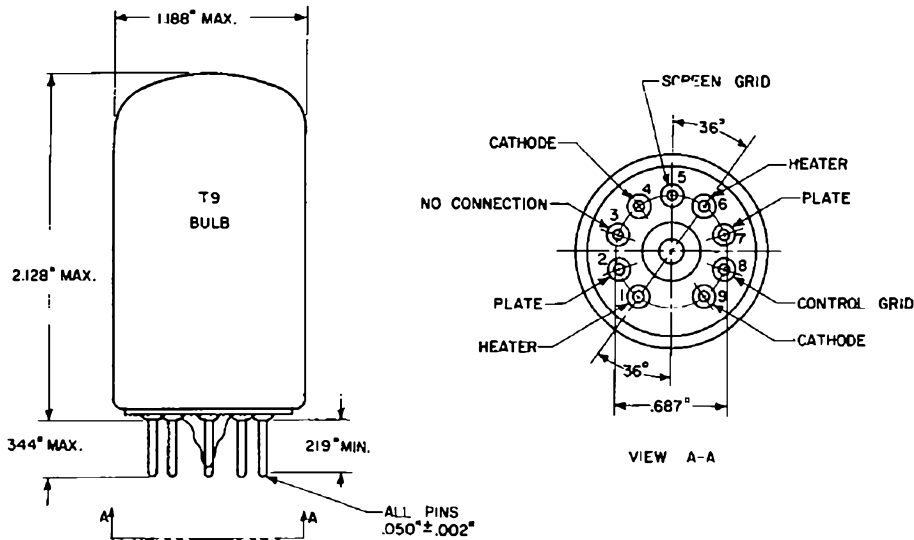

FIG. 1



↓ Indicates a change



Note 3: The 429A tube is considered to have reached the end of useful life when one or more of the following conditions occur under the conditions shown: a) The transconductance decreases to 65% of the typical value shown, b) The change in transconductance exceeds 30% when the heater voltage is reduced 10%, c) The grid current exceeds 5 microamperes. To obtain optimum life the equipment should be capable of tolerating this order of tube parameter degradation.

Note 4: These curves represent electrical characteristics exhibited by typical tubes. While it is expected that characteristics will be centered around the bogey values shown by the curves, individual tubes will deviate to some extent from these values. The shaded areas (unless stated otherwise) are intended to define the approximate limits of such deviation.

A development of Bell Telephone Laboratories, the research laboratories of the American Telephone and Telegraph Company and the Western Electric Company.

ELECTRON TUBE DATA SHEET
WESTERN ELECTRIC 430A ELECTRON TUBE



430A

DESCRIPTION

The 430A is a three-electrode, inert-gas-filled, cold cathode tube for use in relay, voltage regulator or rectifier circuits. This tube is mechanically and electrically identical to the 313C except that it has a much faster starter gap ionization time. The tube is especially suitable for use in fast switching circuits.

MAXIMUM RATINGS

Peak Anode Voltage		185 volts
Average Cathode Current	10	100 milliamperes
Average Life, Approximate	10,000	10 hours

File: Cold Cathode Section
Issue 2, April 1956

430A

MAXIMUM RATINGS, Absolute Values

Forward Peak Anode Voltage	185 volts
Forward Cathode Current ¹	
Peak	100 milliamperes
Average	35 milliamperes
Averaging Time	2 seconds
Inverse Peak Anode Current ¹	5 milliamperes
Ambient Temperature Limits	-55 to +85 centigrade

ELECTRICAL DATA, Throughout Life

	Min.	Bogey	Max.	
Starter Breakdown Voltage ²	65	70	85	volts
Starter Voltage Drop at 20 Milliamperes	52	50	74	volts
Anode Voltage Drop at 20 Milliamperes	68	75	85	volts
Transfer Current	See curve - Fig. 3			
Ionization Time, Starter Gap ³	0.07	0.20	milliseconds
Deionization Time, Approximate				
Starter Gap	3	...	milliseconds
Main Gap	10	...	milliseconds
Inverse Current at -120 Volts Anode Potential ⁴	3	milliamperes

MECHANICAL DATA

Mounting Position	Any
Net Weight, Approximate	1 ounce
Dimensions and pin connections shown in outline drawing on page 4.	

- Note 1: Sufficient resistance must be used in series with the tube to assure that the electrode currents do not exceed their maximum rated values.
- Note 2: Limits apply immediately after tube has conducted current. If the tube has been idle, these values initially may be as much as 3 volts higher or lower.
- Note 3: With 15 volts starter overvoltage (15 volts above Starter Breakdown Voltage) with the tube in total darkness (See Fig. 4.)
- Note 4: Negative anode voltage applied through 8000 ohms. Starter connected to anode through 100,000 ohms.

HANDLING

Western Electric cold cathode tubes contain a minute amount of radium bromide which is a radioactive material. The amount in most types is too small to require any special care in use, handling or disposal.

A few types contain a larger quantity of radium bromide in which the radium approximates that found on a luminous watch dial. These types bear a red three-bladed propeller-shaped symbol on the tube envelope. Instructions for handling such tubes are given below and also in Bell System Practices for Central Office maintenance.

Installations ordinarily require no precautions against radiation. However, quantities of the tubes should not be so installed, or so stored outside the shipping carton, that they will be within a few inches of personnel or in proximity to photographic film for extended periods of time. For example, however, a 40-hour week exposure at about one (1) foot from a bank of 500 tubes (covering an area of 20 inches x 45 inches) is well within the accepted tolerance limits for personnel. Reasonable care should be exercised in handling and disposal of broken tubes. In general, attention should be given to the following:

- (a) Avoid breathing dust or vapors from broken tubes.
- (b) Avoid contacting broken parts with bare hands.
- (c) Use wet rag to pick up broken parts. Wrap broken parts in rag and tie securely so as to form a package. Thoroughly wash hands after disposal.
- (d) Dispose of broken or defective tubes as they are taken out of service. One or two tubes at a time may be disposed of with normal waste material. Accumulation of tubes in one concentrated area of the place of final disposition should be avoided.

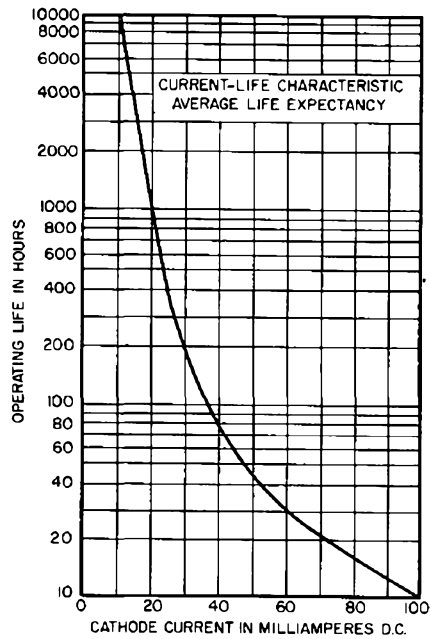

FIG 1

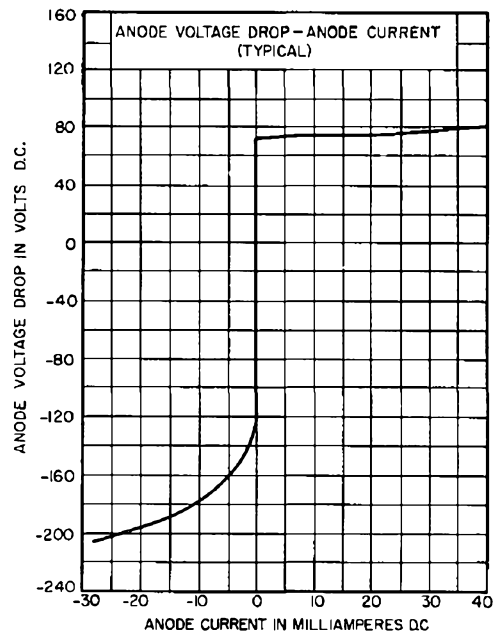

FIG 2

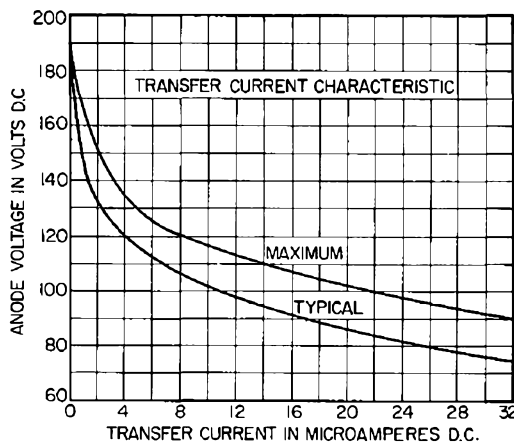

FIG 3

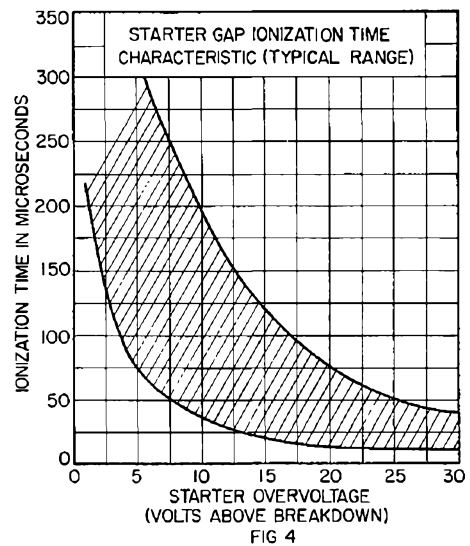
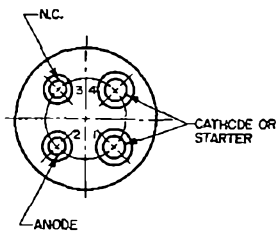
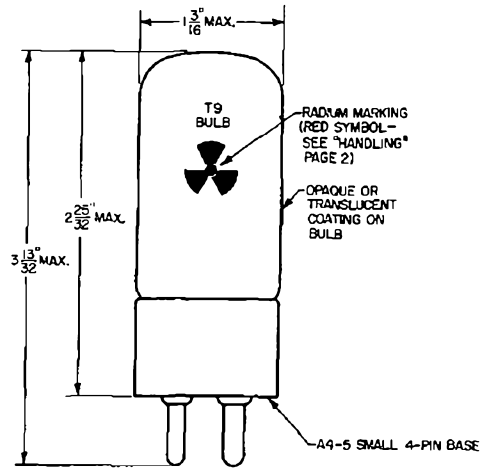

FIG 4



A development of Bell Telephone Laboratories, the research laboratories of the American Telephone and Telegraph Company and the Western Electric Company.

ELECTRON TUBE DATA SHEET
WESTERN ELECTRIC 430B ELECTRON TUBE



430B

DESCRIPTION

The 430B is a three-electrode, inert-gas-filled, cold cathode tube for use in relay, voltage regulator or rectifier circuits. This tube is mechanically and electrically identical to the 313C except that it has a much faster starter gap ionization time. The tube is especially suitable for use in fast switching circuits.

CHARACTERISTICS

Peak Anode Voltage		185	volts
Average Cathode Current	10	100	milliamperes
Average Life, Approximate	10,000	10	hours

File: Cold Cathode Section

MAXIMUM RATINGS, Absolute System (Note 1)

Forward Peak Anode Voltage	185	volts
Forward Cathode Current (Note 2)		
Peak	100	milliamperes
Average	35	milliamperes
Averaging Time	2	seconds
Inverse Peak Anode Current (Note 2)	5	milliamperes
Ambient Temperature Limits	-55 to +85	centigrade

ELECTRICAL DATA, Throughout Life

	<u>Min.</u>	<u>Bogey</u>	<u>Max.</u>	
Starter Breakdown Voltage (Note 3)	65	70	89	volts
Starter Voltage Drop at 20 Milliamperes	52	60	74	volts
Anode Voltage Drop at 20 Milliamperes	68	75	90	volts
Transfer Current	See curve - Fig. 3			
Ionization Time, Starter Gap (Note 4)				
Average (Note 5)	-	0.07	0.20	milliseconds
Maximum	See curve - Fig. 5, Page 4			
Deionization Time, Approximate				
Starter Gap	-	3	-	milliseconds
Main Gap	-	10	-	milliseconds
Inverse Current at -120 Volts Anode Potential (Note 6)	-	-	3	milliamperes

MECHANICAL DATA

Mounting Position Any
 Net Weight, Approximate 1 Ounce
 Dimensions and pin connections shown in outline drawing on page 4.

HANDLING

This tube contains a small amount of krypton-85 gas which is a by-product radioactive material. The amount of krypton-85 is less than five microcuries, which is too small an amount to require any special care in use.

Atomic Energy Commission regulations require that the individual tube carton for tubes containing by-product radioactive material be appropriately marked. The marking includes the statement that tube disposal should be in approved manner.

Approved instructions for disposal of tubes containing krypton-85 are as follows;

Tubes to be disposed of should be broken or crushed in a well ventilated place releasing any resulting vapors to the outside atmosphere. The residual broken or crushed tubes should be disposed of in a normal public trash disposal system. Tubes should be disposed of at a rate of not more than 100 each week from any one location. Avoid breathing vapors from broken tubes.

Note 1: In the "Absolute System" the maximum ratings specified are limiting values above which the serviceability of the device may be impaired from the viewpoint of life and satisfactory performance. Maximum ratings, as such, do not constitute a set of operating conditions and all values may not, therefore, be attained simultaneously.

Note 2: Sufficient resistance must be used in series with the tube to assure that the electrode currents do not exceed their maximum rated values.

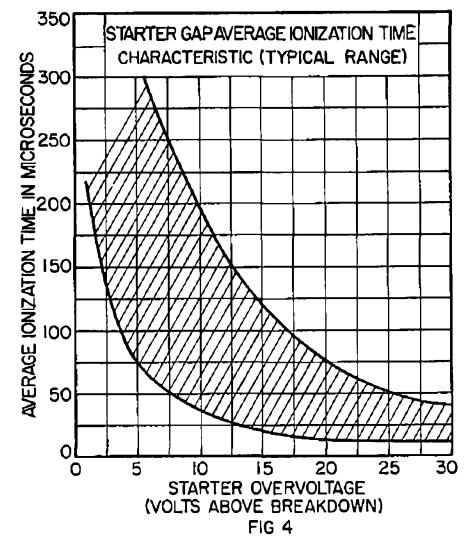
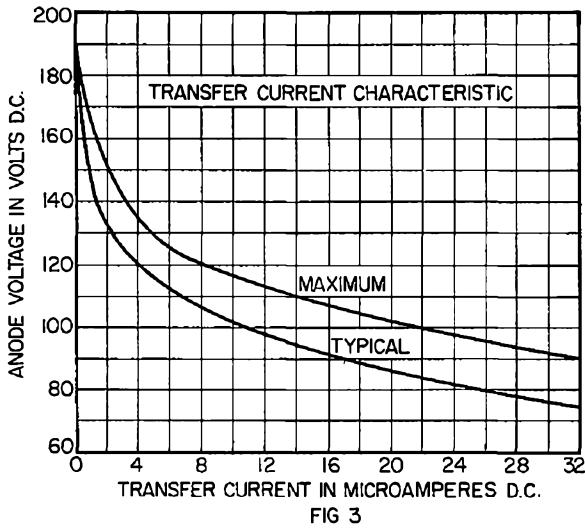
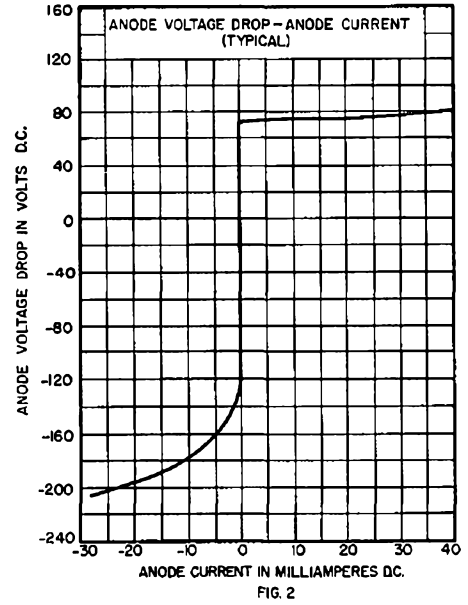
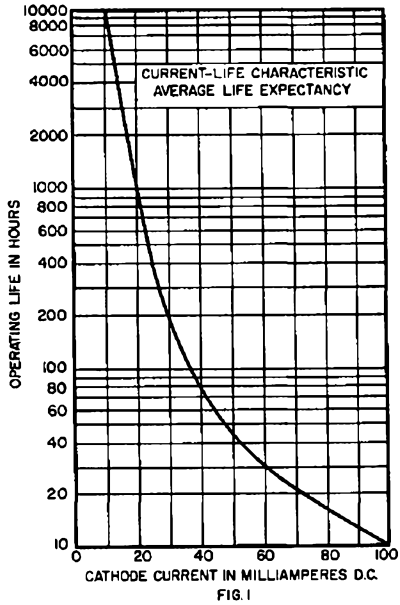

Note 3: Limits apply immediately after tube has conducted current. If the tube has been idle, these values initially may be as much as 3 volts higher or lower.

Note 4: With 15 volts starter overvoltage (15 volts above Starter Breakdown Voltage) with the tube in total darkness (See Fig. 4.)

Note 5: Average of 10 measurements taken at 1 second intervals.

Note 6: Negative anode voltage applied through 8000 ohms. Starter connected to anode through 100,000 ohms.

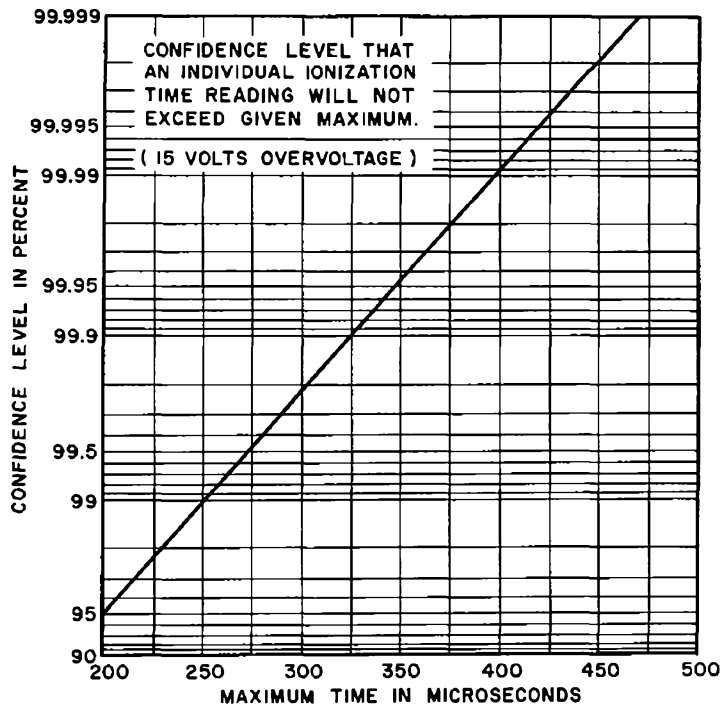
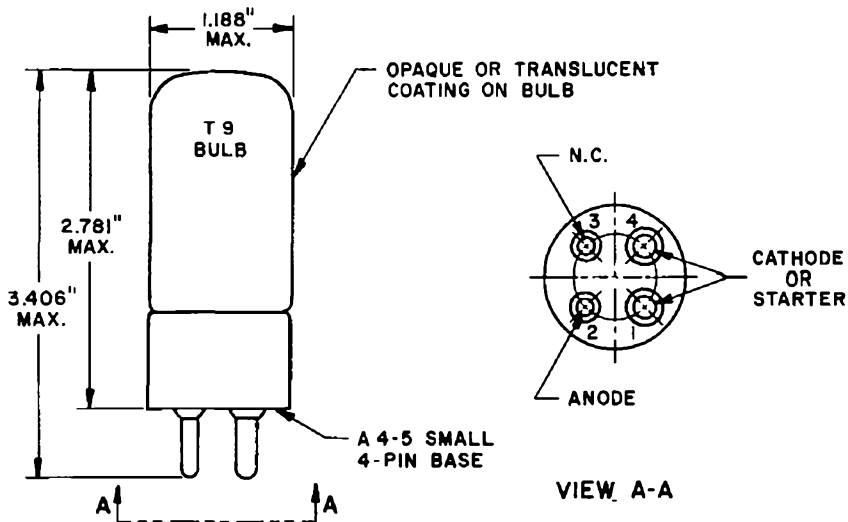

FIG.5



A development of Bell Telephone Laboratories, the research laboratories of the American Telephone and Telegraph Company and the Western Electric Company.

PRINTED IN U.S.A.

ADVANCE ELECTRON TUBE DATA SHEET
WESTERN ELECTRIC 432A ELECTRON TUBE

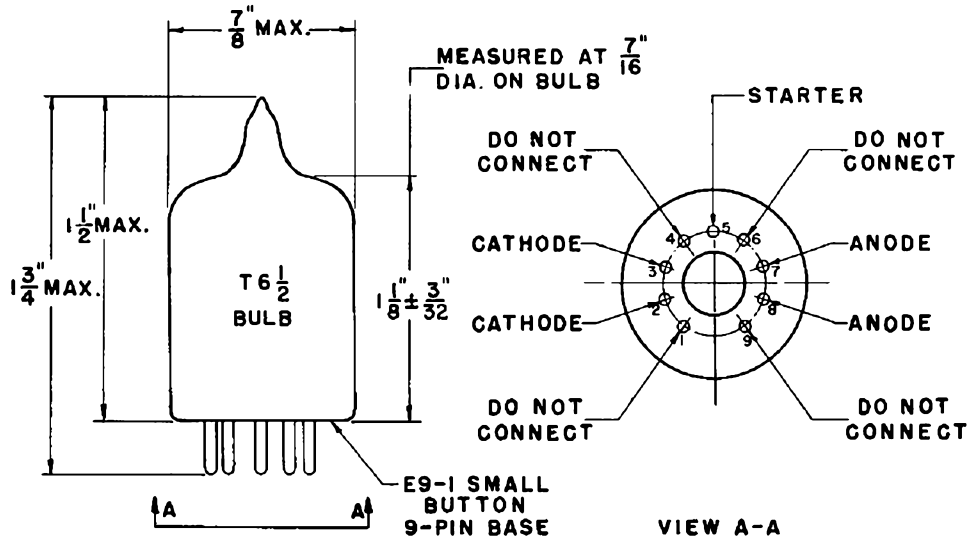

432A

DESCRIPTION

The 432A is a three-electrode inert-gas filled cold cathode tube designed primarily for use as a voltage reference tube. This tube has exceptionally stable characteristics.

CHARACTERISTICS

Cathode Current	4 to 8 milliamperes
Anode Voltage Drop	100 volts
Regulation, Max. (4 to 6 Milliamperes D-C).	0.5 volt

FILE: GOLD CATHODE SECTION
 ISSUE 1, 9-50

432A

RATINGS, Absolute Values

Cathode Current

Maximum	8 milliamperes
Minimum	4 milliamperes
Maximum Inverse Starter or Anode Current	0.0 milliampere
Starter Current (Minimum)	0.2 milliampere
Ambient Temperature Limits	-55 to + 60 centigrade

ELECTRICAL DATA

	<u>Min.</u>	<u>Ecgsy</u>	<u>Max.</u>
Anode Breakdown Voltage	---	---	160 volts
Anode Voltage Drop at 6 Milliamperes (D-C) ¹	99	100	103 volts
Starter Breakdown Voltage	---	---	200 volts
Starter Voltage Drop	---	115	--- volts
Required Transfer Current at 110 Anode Volts	200	---	--- microamperes
Regulation (4 to 6 Milliamperes, D-C)	---	---	0.5 volt
Temperature Sensitivity of Anode Voltage Drop			
Anode Current, 4 Milliamperes (D-C)	---	-0.01	--- volt/c
Anode Current, 8 Milliamperes (D-C)	---	-0.02	--- volt/c
Fluctuation ²	---	---	0.1 volt
Stability ³	---	---	0.3 volt

MECHANICAL DATA

Mounting Position	Any
Net Weight, Approximate	0.3 ounce
Bulb	T 6-1/2
Base	Small Button 9-pin

Note 1: These values are for new tubes. The stability characteristic should be considered during tube life.

Note 2: The anode voltage drop variation during a short period of time (one to ten minutes), with the tube operating at one value of current and temperature within its ratings, will not exceed the above stated maximum value.

Note 3: The drift of anode voltage drop over a period of 1000 hours, with the tube operating at one value of current and temperature within its ratings, will not exceed the above stated maximum value.

A development of Bell Telephone Laboratories, the research laboratories of the American Telephone and Telegraph Company and the Western Electric Company.

ELECTRON TUBE DATA SHEET
WESTERN ELECTRIC 432B ELECTRON TUBE



432B

DESCRIPTION

The 432B is a three-electrode inert-gas-filled cold cathode tube designed for use as a voltage reference tube. The third electrode is a starting element for use in circuits having insufficient voltage available for breakdown at the voltage reference point or requiring negligible overshoot of the reference voltage when starting. This tube is free of parasitic oscillations and has an exceptionally stable anode voltage drop characteristic.

CHARACTERISTICS

Cathode Current	4 to 8 milliamperes
Anode Voltage Drop	100 volts
Regulation, Max. (4 to 6 Milliamperes D-C)	0.75 volt

FILE: COLD CATHODE SECTION
Issue 2, December 1956

432B

RATINGS, Absolute Values

Cathode Current ¹	
Maximum	8 milliamperes
Minimum ²	4 milliamperes
Inverse Starter or Anode Current, Maximum	0.0 milliampere
Starter Current, Minimum ³	0.2 milliampere
Ambient Temperature Limits	-55 to + 60 centigrade

ELECTRICAL DATA, Throughout Life

	<u>Min.</u>	<u>Bogey</u>	<u>Max.</u>	
Anode Breakdown Voltage	---	135	160	volts
Anode Voltage Drop at 6 Milliamperes (D-C) ⁴	99	100	103	volts
Starter Breakdown Voltage	---	135	200	volts
Starter Voltage Drop at 0.2 ma	---	102	---	volts
Transfer Current at 110 Anode Volts	---	60	200	microamperes
Regulation (⁴ to 6 Milliamperes, D-C)	---	0.3	0.75	volt
Temperature Sensitivity of Anode Voltage Drop				
Anode Current, ⁴ Milliamperes (D-C)	---	-0.01	---	volt/c
Anode Current, ⁸ Milliamperes (D-C)	---	-0.02	---	volt/c
Fluctuation ⁵	---	0.02	0.1	volt
Stability ⁶	---	0.2	0.8	volt

MECHANICAL DATA, Throughout Life

Mounting Position	Any
Net Weight, Approximate	0.3 ounce
Bulb	T 6-1/2
Base	Small Button 9-pin
Dimensions and Connections	See outline drawing Page 3

- Note 1: Sufficient resistance must be used in series with the tube to assure that electrode currents do not exceed their maximum rated values.
- Note 2: The tube is capable of operating at current values below the rated "Minimum" value of 4 milliamperes in regulator applications where lower current is required, however, operation at values below 4 milliamperes for extended periods of time (hundreds of hours) may result in an increase in regulation.
- Note 3: The minimum starter current requirement applies
(a) when tube is operated for extended periods (hundreds of hours) between starting operations to assure maintaining starter breakdown and transfer characteristics.
(b) to assure oscillation-free operation.
- Note 4: These values are for new tubes. Anode voltage drop will stabilize within 3 minutes after starting. The stability characteristic should be considered during tube life.
- Note 5: The anode voltage drop variation during a short period of time (one to ten minutes), with the tube operating at one value of current and temperature within its ratings, will not exceed the above stated maximum value.
- Note 6: The drift of anode voltage drop over a period of 1000 hours, with the tube operating at one value of current and temperature within its ratings, will not exceed the above stated maximum value. Stability improves with operating life. After 1000-2000 hours operation the drift of anode voltage drop per 1000 hours will not exceed 0.3 volt.

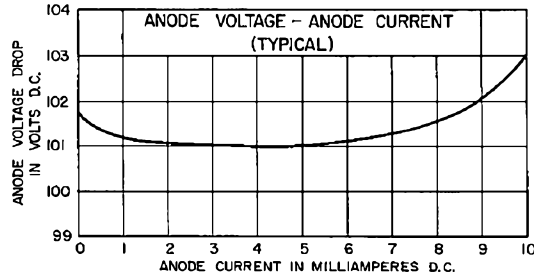

FIG. 1

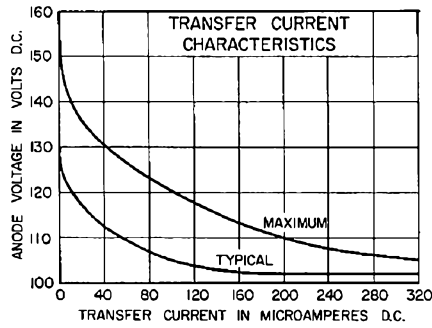
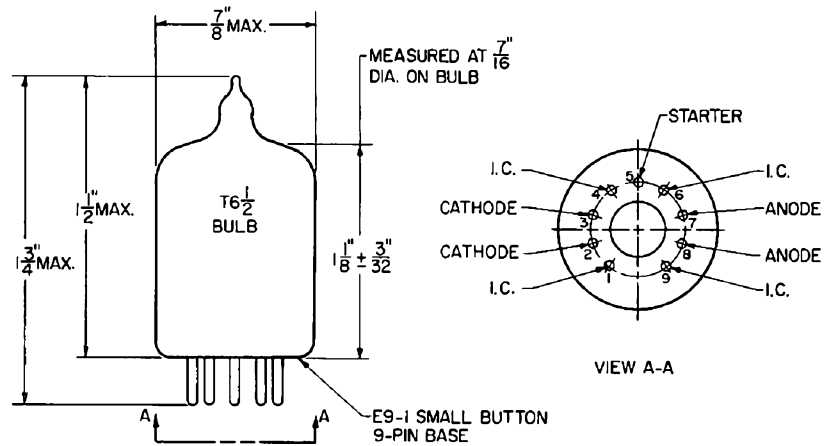

FIG. 2



NOTE: PINS MARKED I.C. (INTERNAL CONNECTION) SHOULD NOT BE CONNECTED TO ANY PORTION OF AN EXTERNAL CIRCUIT.

A development of Bell Telephone Laboratories, the research laboratories of the American Telephone and Telegraph Company and the Western Electric Company

ELECTRON TUBE DATA SHEET
WESTERN ELECTRIC 435A ELECTRON TUBE



435A

DESCRIPTION

The 435A electron tube is a high figure of merit miniature tetrode with an indirectly heated cathode. It was designed primarily for the input amplifier of the L-3 tandem two stage amplifier.

CHARACTERISTICS

Heater Voltage	- - - - -	6.3 volts
Cathode Current	} $E_b = 190$ volts; $E_{c2} = 160$ volts {	} 14.3 milliamperes
Transconductance		

GENERAL CHARACTERISTICS

ELECTRICAL DATA

Heater Voltage - - - - -		6.3 volts	
Heater Current - - - - -		300 milliamperes	
Direct Interelectrode Capacitances	Without External Shield	With External Shield (RETMA #315)	
Grid to Plate (maximum) - - - - -	.035	.030	uuf
Input - - - - -	7.9	8.1	uuf
Output - - - - -	2.9	3.3	uuf

MECHANICAL DATA

Cathode - - - - -	Coated Unipotential
Bulb - - - - -	T6 1/2
Base - - - - -	Small Button 9 Pin
Mounting Position - - - - -	Any
Dimensions and pin connections shown in outline drawing on page 4	

MAXIMUM RATINGS, Design Center Values

Plate Voltage- - - - -	190 volts
Screen Grid Voltage- - - - -	160 volts
Plate Dissipation - - - - -	3.0 watts
Screen Grid Dissipation- - - - -	0.75 watt
Control Grid Dissipation - - - - -	See footnote *
Cathode Current - - - - -	36 milliamperes
Heater-Cathode Voltage - - - - -	50 volts
Bulb Temperature - - - - -	130 centigrade
<u>Maximum Grid Circuit Resistance for</u>	
Fixed Bias - - - - -	0.05 megohm
Cathode Bias - - - - -	0.10 megohm

TYPICAL OPERATING CONDITIONS AND CHARACTERISTICS

Plate Voltage - - - - -	130	160	190 volts
Screen Grid Voltage - - - - -	130	160	160 volts
Control Grid Voltage ¹ - - - - -	-1.0	-1.5	+7.5 volts
Cathode Bias Resistor - - - - -	---	---	630 ohms
Plate Current - - - - -	10.3	11.6	11.5 milliamperes
Screen Grid Current - - - - -	3.8	4.3	2.8 milliamperes
Plate Resistance - - - - -	13000	13000	65000 ohms
Transconductance - - - - -	15300	15600	15500 micromhos
Control Grid Voltage (approximate) for Plate Current of 10 microamperes - -	-3.2	-3.9	--- volts
<u>Modulation</u>			
Second Order (2F)** - - - - -	----	----	35 db
Third Order (3F)** - - - - -	----	----	52 db
Load Resistance - - - - -	----	----	270 ohms

* Operation with the control grid positive with respect to cathode is not recommended.

** Ratio of product to fundamental at output for 0.1 volt rms signal from grid to cathode.

*** Ratio of product to fundamental at output for a 0.2 volt rms signal from grid to cathode.

Note 1: Reference point for "Control Grid Voltage" is the negative end of the cathode bias resistor.

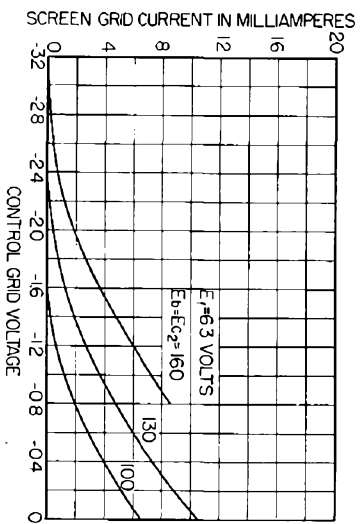
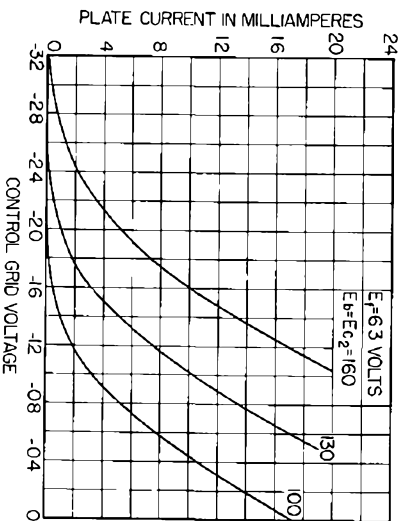
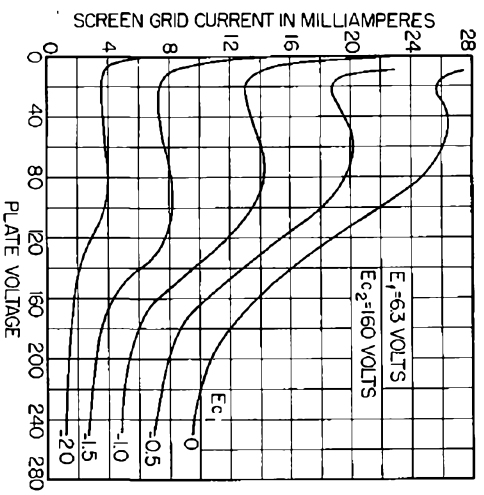
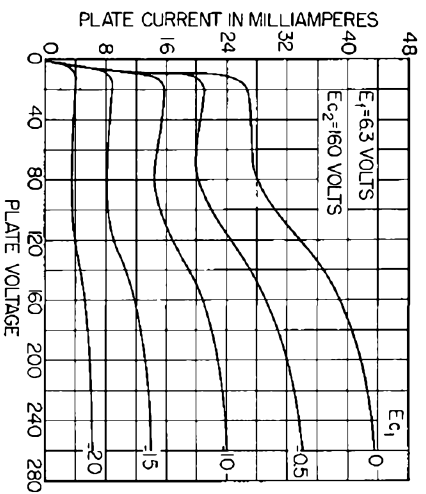
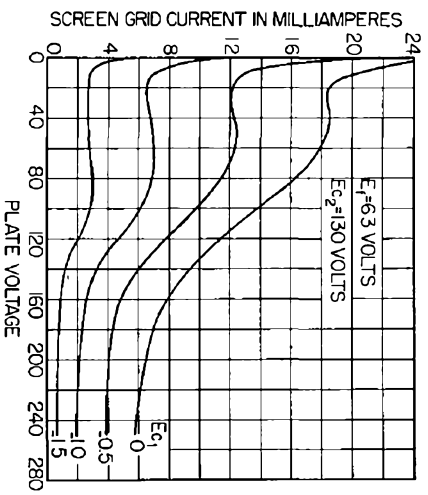
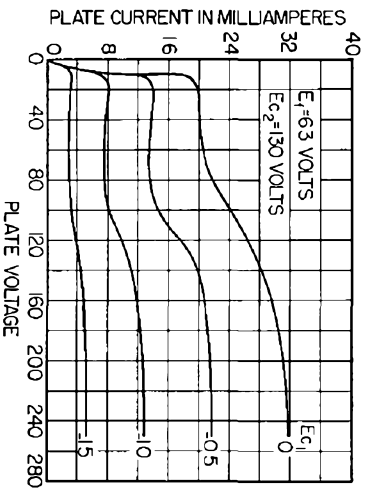

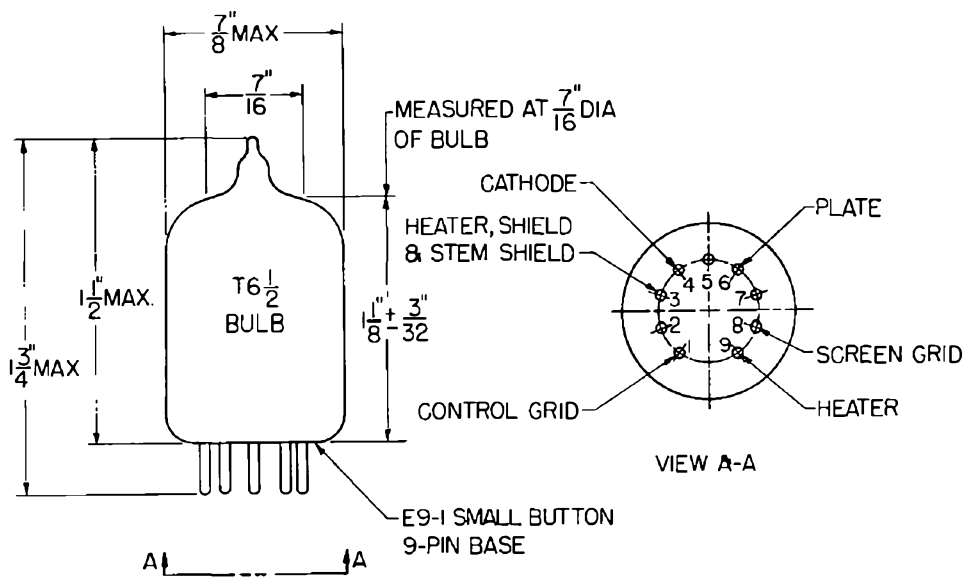
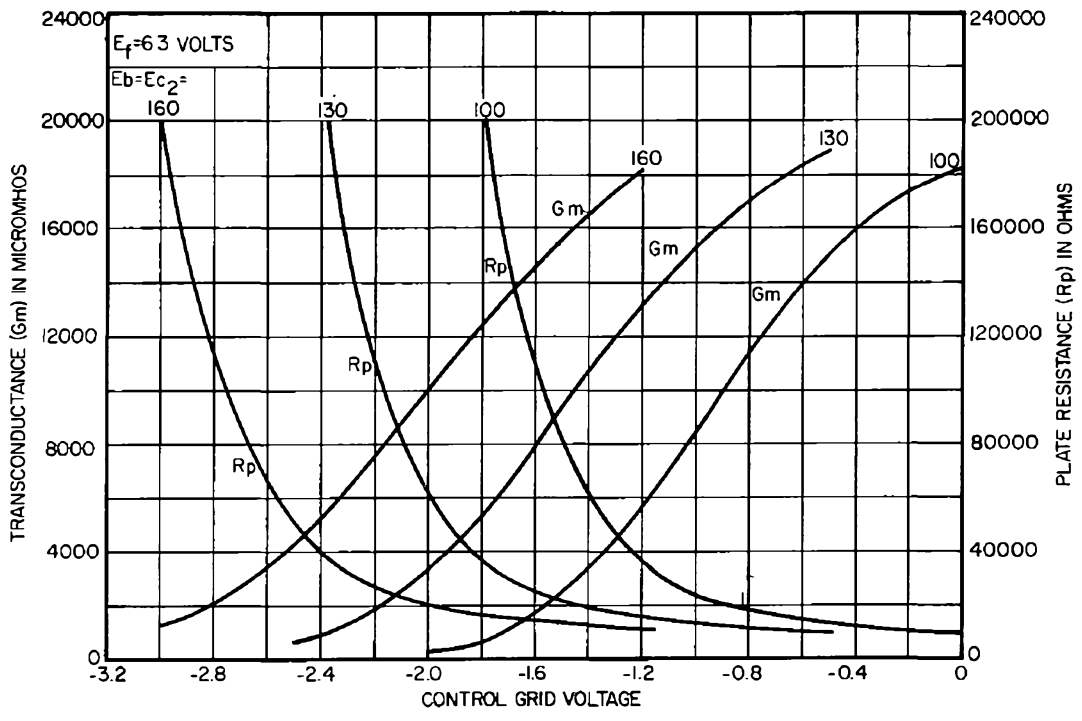

ELECTRON TUBE DATA SHEET
WESTERN ELECTRIC 436A ELECTRON TUBE



436A

DESCRIPTION

The 436A electron tube is a high figure of merit tetrode with an indirectly heated cathode. It was designed primarily for use in the L-3 amplifier. ←

CHARACTERISTICS

Heater Voltage	6.3	volts
Cathode Current ($E_b = 190$ volts; $E_{c2} = 160$ volts)	28.4	milliamperes ←
Transconductance ($E_{cc1} = +7.5$ volts; $R_k = 315$ ohms)	30000	micromhos

Note 1: In the "Absolute System" the maximum ratings specified are limiting values above which the serviceability of the device may be impaired from the viewpoint of life and satisfactory performance. Maximum ratings, as such, do not constitute a set of operating conditions and all values may not, therefore, be attained simultaneously.

Note 2: Reference point for Control Grid Voltage is the negative end of the cathode bias resistor.

File: General Purpose Section

Indicates a change ←

GENERAL CHARACTERISTICS

Electrical Data

Heater Voltage	6.3	volts
Heater Current	450	milliamperes
Direct Interelectrode Capacitances	Without External Shield	With External Shield (JEDEC #309)
→ Grid to Plate (maximum)07	.06 $\mu\mu f$
Input: g1 to (h+k+g2+i.s.)	14.0	14.2 $\mu\mu f$
→ Output: p to (h+k+g2+i.s.)	3.5	4.7 $\mu\mu f$

Mechanical Data

Cathode Coated Unipotential
 Bulb T 9
 Base See outline drawing page 4
 Mounting Position Any
 Dimensions and pin connections shown in outline drawing on page 4.

MAXIMUM RATINGS, Absolute System (Note 1, See Page 1)

Plate Voltage	210	volts
Screen Grid Voltage	175	volts
Plate Dissipation	5.0	watts
Screen Grid Dissipation	2.2	watts
Control Grid Dissipation	See footnote *	
Cathode Current	50	milliamperes
Heater-Cathode Voltage	55	volts
→ Bulb Temperature	130	centigrade
Maximum Grid Circuit Resistance for		
Fixed Bias0.05	megohm
Cathode Bias0.10	megohm

TYPICAL OPERATING CONDITIONS AND CHARACTERISTICS

Plate Voltage	130	160	190	volts
Screen Grid Voltage	130	160	160	volts
Control Grid Voltage	-1.0	-1.75	-	volts
Control Grid Supply Voltage (Note 2, See Page 1)	-	-	+7.5	volts
Cathode Bias Resistor (Note 2, See Page 1)	-	-	315	ohms
→ Plate Current	21.5	18.8	20.2	milliamperes
Screen Grid Current	12.5	10.8	8.2	milliamperes
Plate Resistance	5000	5000	36000	ohms
Transconductance30000	28000	30000	micromhos
Control Grid Voltage (approximate) for				
Plate Current of 10 microamperes	-3.7	-4.7	-	volts
Modulation				
Second Order (2F)**	-	-	-32	db
Third Order (3F)***	-	-	-54	db
Load Resistance	-	-	270	ohms

* Operation with the control grid positive with respect to cathode is not recommended.
 ** Ratio of product to fundamental at output for 0.1 volt rms signal from grid to cathode.
 *** Ratio of product to fundamental at output for a 0.2 volt rms signal from grid to cathode.
 → Indicates a change

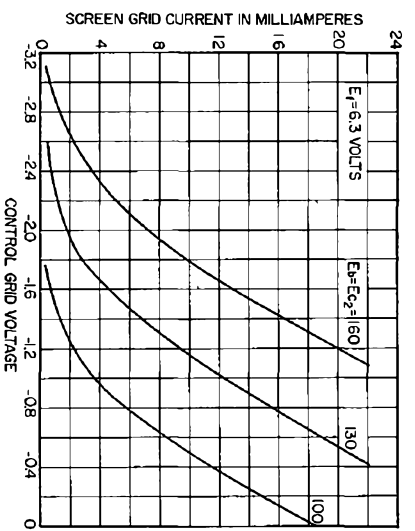
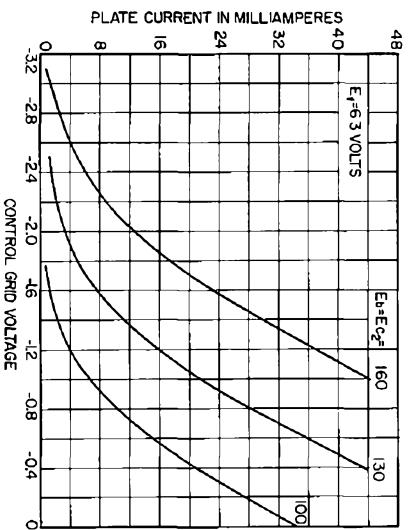
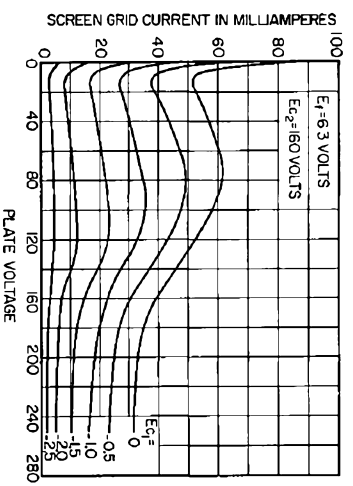
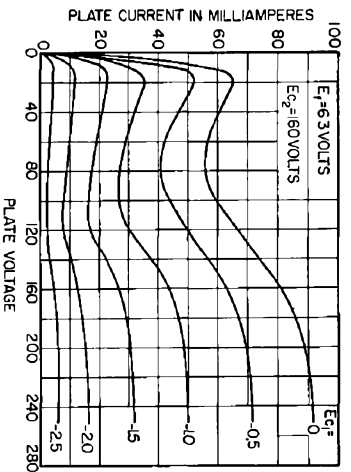
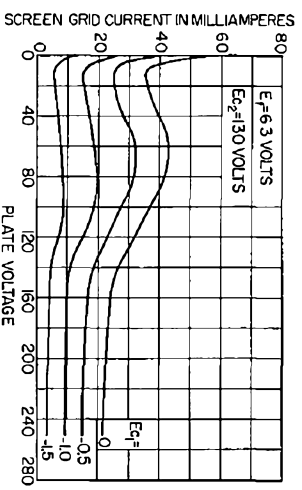
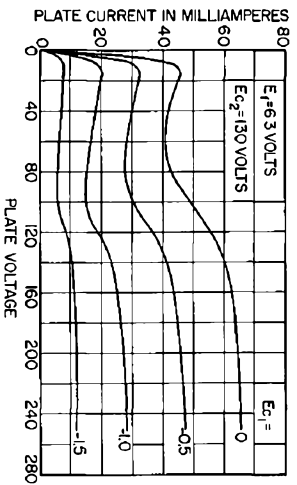

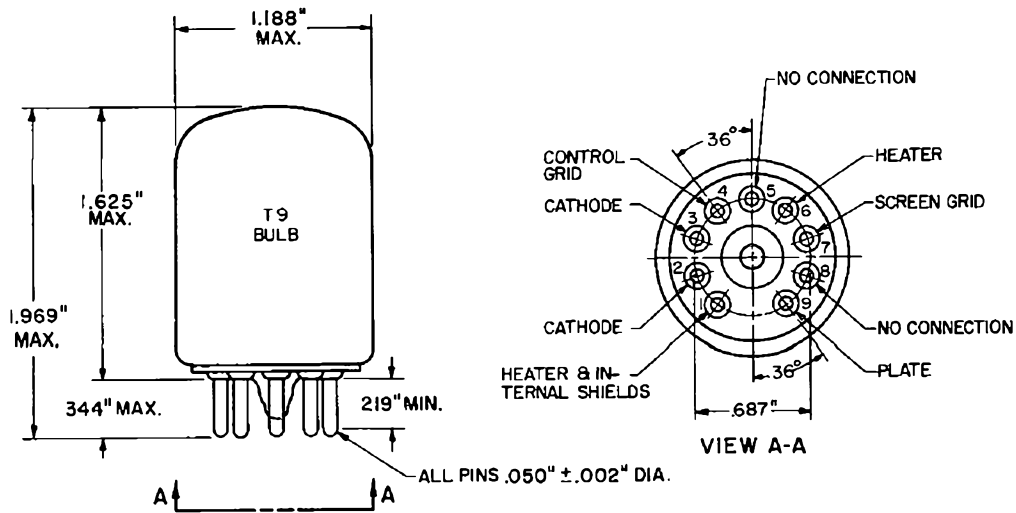
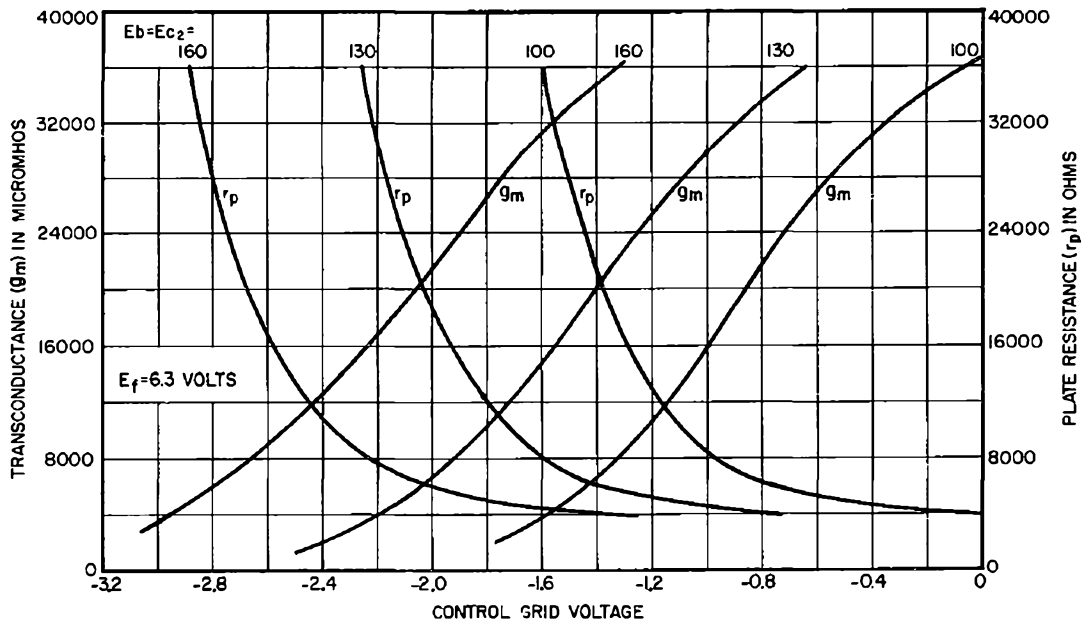

A development of Bell Telephone Laboratories, the research laboratories of the American Telephone and Telegraph Company and the Western Electric Company.

PRINTED IN U.S.A.

ELECTRON TUBE DATA SHEET
WESTERN ELECTRIC 437A ELECTRON TUBE

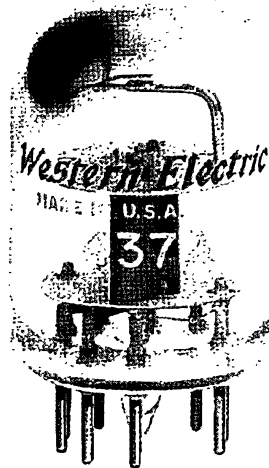

437A

DESCRIPTION

The 437A electron tube is a high figure of merit triode with an indirectly heated cathode. It was designed primarily for the output amplifier of the L-3 tandem two stage amplifier.

CHARACTERISTICS

Heater Voltage 6.3 volts
Cathode Current $\left(\begin{array}{l} E_b = 160 \text{ volts;} \\ E_{ccl} = +7.5 \text{ volts;} R_k = 262 \text{ ohms} \end{array} \right)$ 36.5 milliamperes
Transconductance 46000 micromhos

File: General Purpose Section
Issue 1, 10-55

437A

GENERAL CHARACTERISTICSELECTRICAL DATA

Heater Voltage		6.3 volts
Heater Current		450 milliamperes
Direct Interelectrode Capacitances	Without	With External
	External	Shield
	Shield	(RETMA #309)
Grid to Plate (maximum)	3.8	3.8 uuf
Input: g to (n+k+i.s.)	11.1	11.3 uuf
Output: \bar{y} to (n+k+i.s.)	1.0	2.1 uuf

MECHANICAL DATA

Cathode	Coated Unipotential
Bulb	T9
Base	See outline drawing page 4
Mounting Position	Any
Dimensions and pin connections shown in outline drawing on page 4	

MAXIMUM RATINGS, Design Center Values

Plate Voltage	250 volts
Plate Dissipation	7.0 watts
Control Grid Dissipation	see footnote 1
Cathode Current	45 milliamperes
Heater-Cathode Voltage	50 volts
Bulb Temperature	130 centigrade

MAXIMUM CIRCUIT VALUES

Grid Circuit Resistance:	
For Fixed Bias	0.05 megohm
For Cathode Bias	0.10 megohm

TYPICAL OPERATING CONDITIONS AND CHARACTERISTICS

Plate Voltage	140	180	160	volts
Control Grid Voltage	-2.0	-3.0	---	volts
Control Grid Supply Voltage ²	---	---	+7.5	volts
Cathode Bias Resistor ²	---	---	262	ohms
Plate Current	29.0	25.0	36.5	milliamperes
Amplification Factor	41.0	41.0	41.0	
Plate Resistance	950	960	900	ohms
Transconductance	43000	42000	46000	micromhos
Control Grid Voltage (approximate) for				
Plate Current of 10 microamperes	-5.0	-6.3	---	volts
Modulation				
Second Order (2F) ³	---	---	-37	db
Third Order (3F) ⁴	---	---	-56	db
Load Resistance	---	---	270	ohms

Note 1: Operation with the control grid positive with respect to cathode is not recommended.

Note 2: Reference point for Control Grid Voltage is the negative end of the cathode bias resistor.

Note 3: Ratio of product to fundamental at output for 0.1 volt rms signal from grid to cathode.

Note 4: Ratio of product to fundamental at output for a 0.2 volt rms signal from grid to cathode.

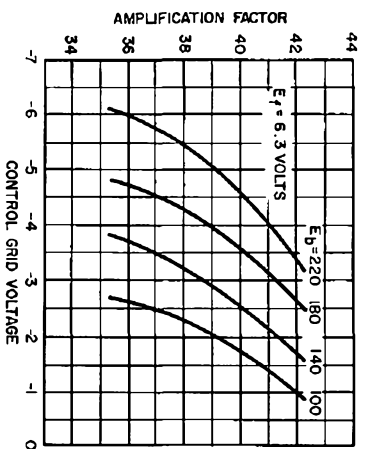
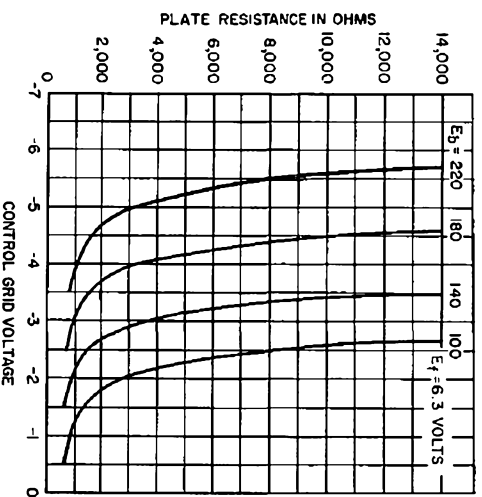
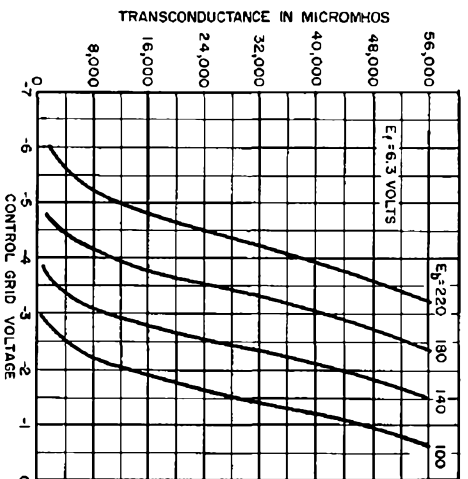
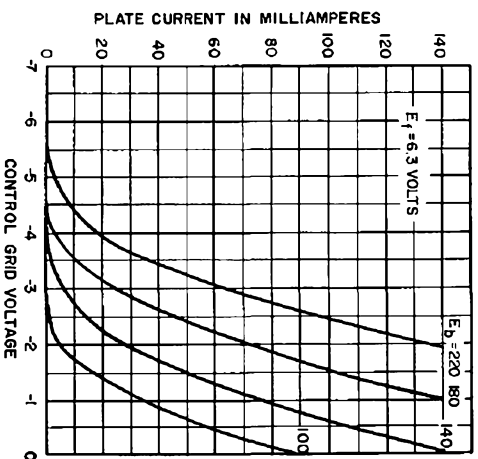
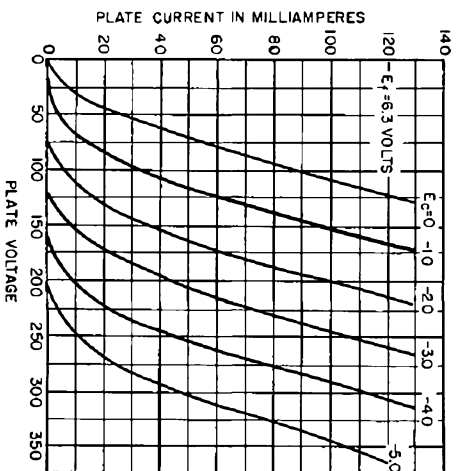

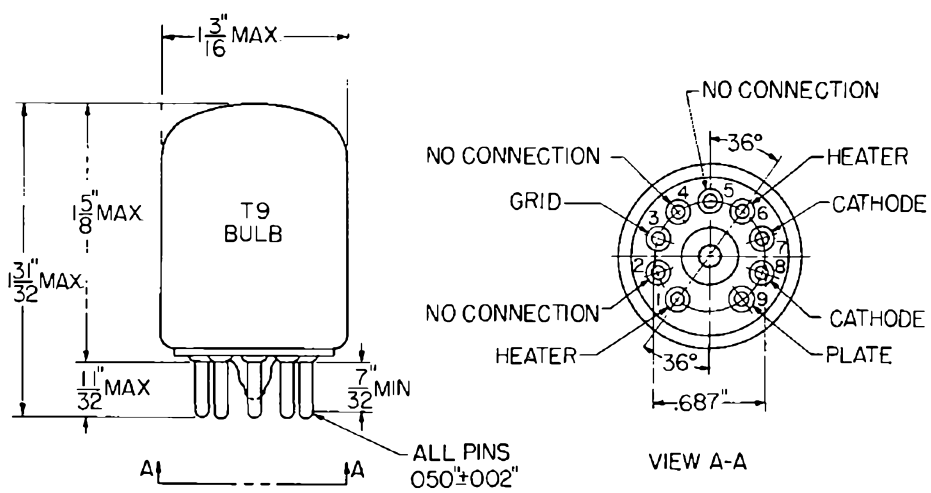

A development of Bell Telephone Laboratories, the research laboratories of the American Telephone and Telegraph Company and the Western Electric Company

ELECTRON TUBE DATA SHEET
WESTERN ELECTRIC 440A ELECTRON TUBE

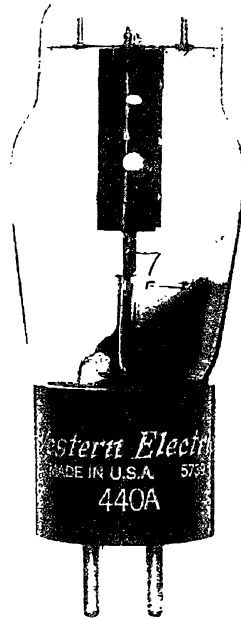

TRIODE
LOW-POWER AMPLIFIER

440A

DESCRIPTION

The 440A is a filamentary triode designed for use as a voice frequency and carrier frequency amplifier where low power output is required, also as an oscillator, a modulator, or a demodulator. The 440A is identical to the 101F electron tube except that it is fitted with a standard A4-9 medium 4-pin push type base.

CHARACTERISTICS

Filament Current (Note 1, Page 2)	0.50	ampere	
Plate Current	{ $E_b = 130$ volts $E_c = -8$ volts $R_1 = 12000$ ohms }	6.8 milliamperes	
Power Output			53 milliwatts

ELECTRON TUBE DATA SHEET
FILE: GENERAL PURPOSE SECTION

GENERAL CHARACTERISTICS

Electrical Data

Filament Voltage (D-C)	4.15	volts
Filament Current (D-C) (Note 1)	0.50	ampere
Direct Interelectrode Capacitance		
Grid To Plate	5.9	$\mu\mu\text{f}$
Grid To Filament	4.2	$\mu\mu\text{f}$
Plate To Filament	2.7	$\mu\mu\text{f}$

Mechanical Data

Cathode	Coated Filament
Bulb	ST 14
Base	A4-9 medium 4-pin
Mounting Position	Preferably vertical, if horizontal the position of the plane of the filament should be vertical

MAXIMUM RATINGS, Absolute System (Note 2)

Filament Voltage	4.30	volts
Plate Voltage	200	volts
Plate Power	2.0	watts

Dimensions and pin connections shown in outline drawing on page 6.

TYPICAL OPERATING CONDITIONS AND CHARACTERISTICS

Filament Current	0.50	0.50	0.50	0.50	ampere
Plate Voltage	130	160	190	190	volts
Grid Voltage	-8	-10	-14	-14	volts
Plate Current	6.8	10.0	10.9	10.9	milliamperes
Transconductance	1120	1300	1330	1330	micromhos
Plate Resistance	5800	5000	4900	4900	ohms
Amplification Factor	6.5	6.5	6.5	6.5	
Load Resistance	12000	5000	4900	12000	ohms
Power Output	53	100	205	180	milliwatts
Total Harmonic Distortion	1.4	3.2	4.5	1.4	per cent

Note 1: The filament of this tube is designed to operate on a current basis and should be operated at as near the rated current as practicable.

Note 2: In the "Absolute System" the maximum ratings specified are limiting values above which the serviceability of the device may be impaired from the viewpoint of life and satisfactory performance. Maximum ratings, as such, do not constitute a set of operating conditions and all values may not, therefore, be attained simultaneously.

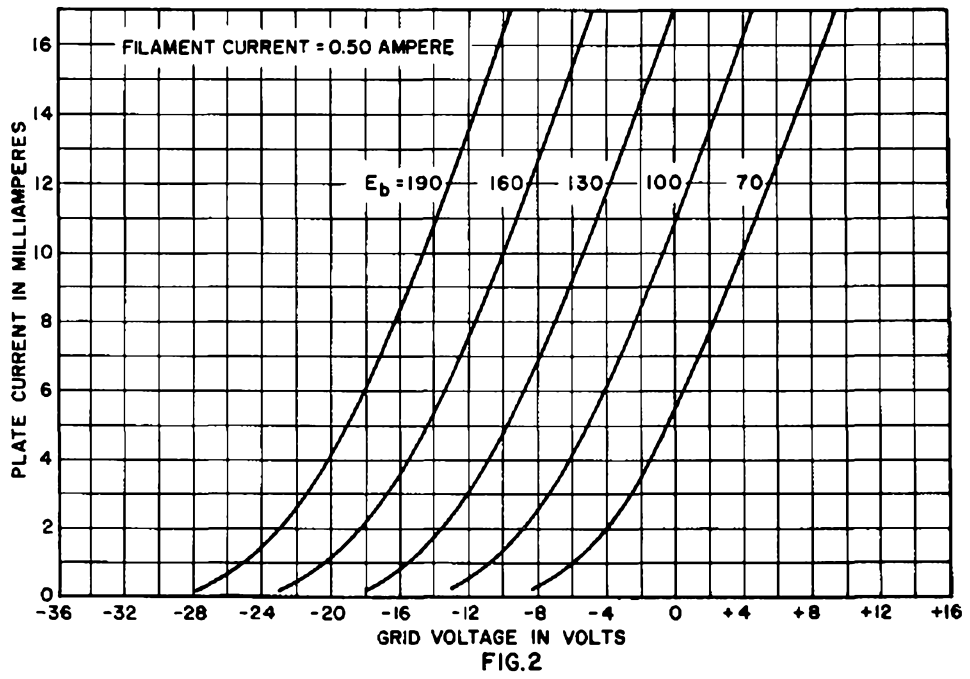
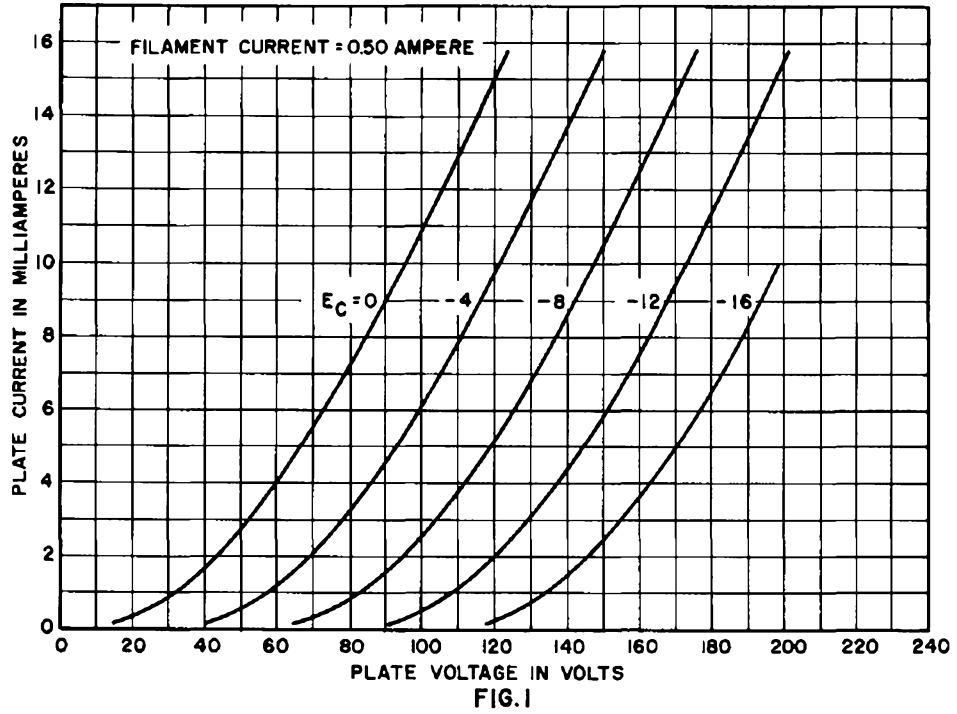

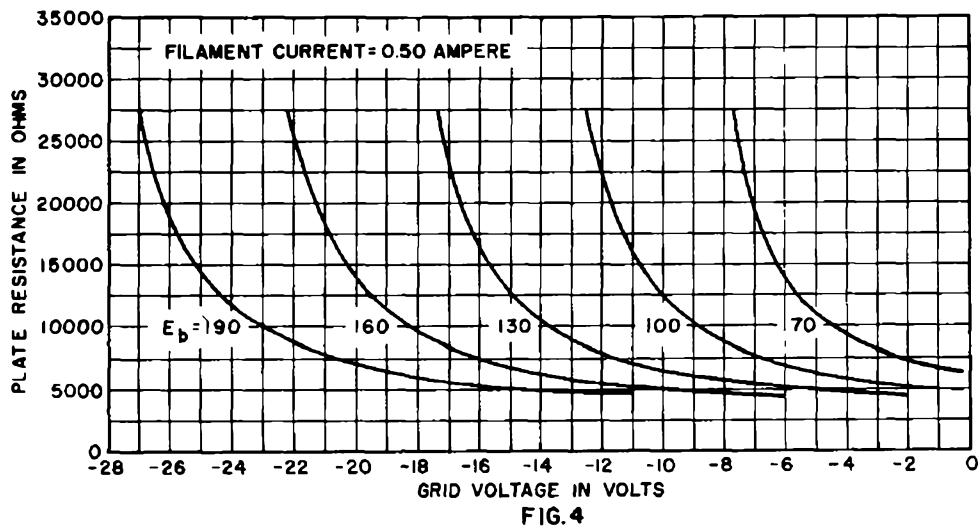
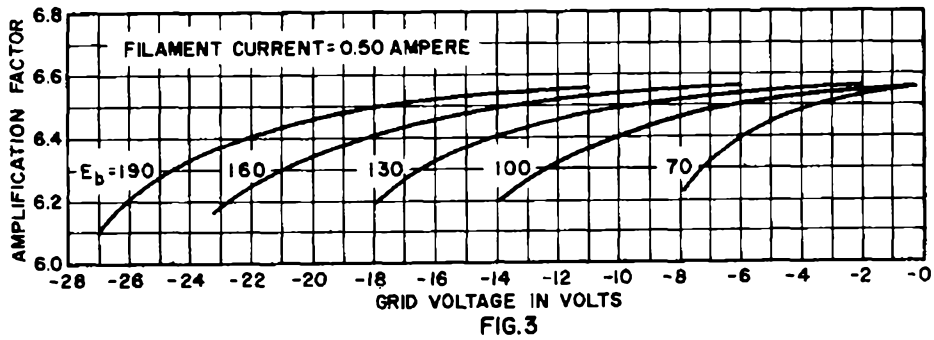

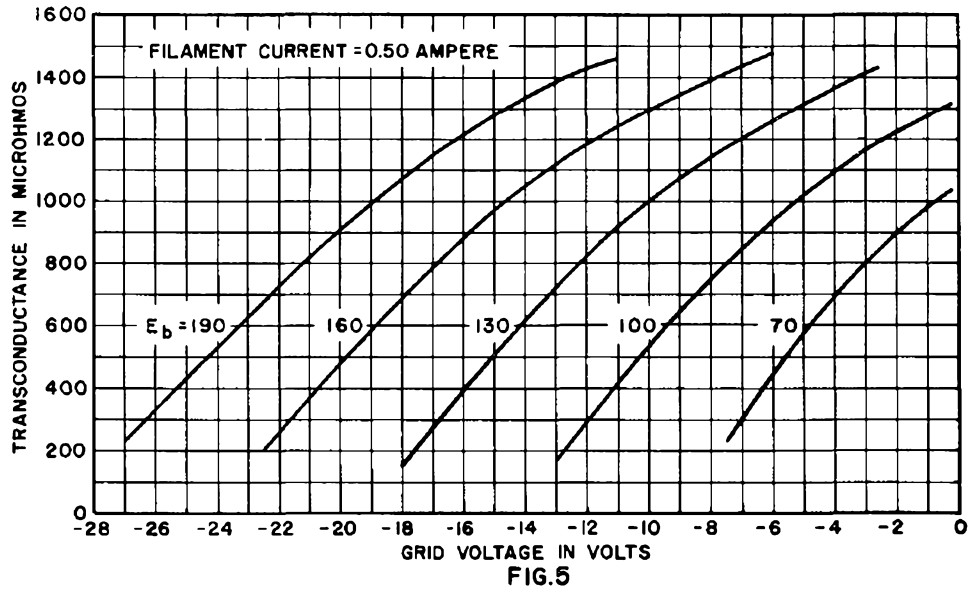

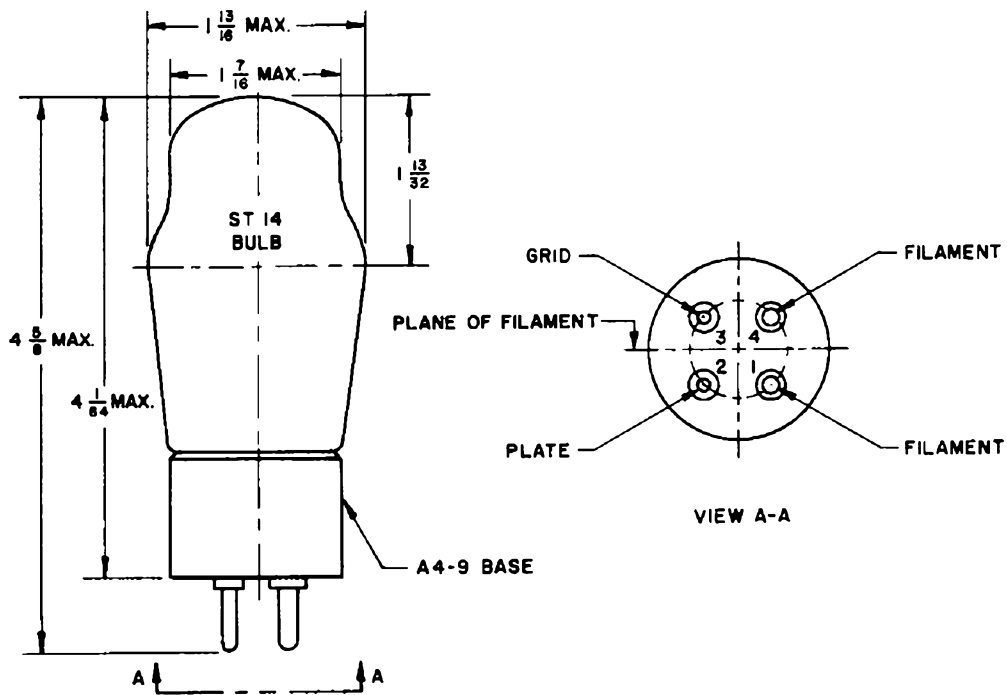

A development of Bell Telephone Laboratories, the research laboratories of the American Telephone and Telegraph Company and the Western Electric Company.

PRINTED IN U.S.A.

ELECTRON TUBE DATA SHEET
WESTERN ELECTRIC 441A ELECTRON TUBE

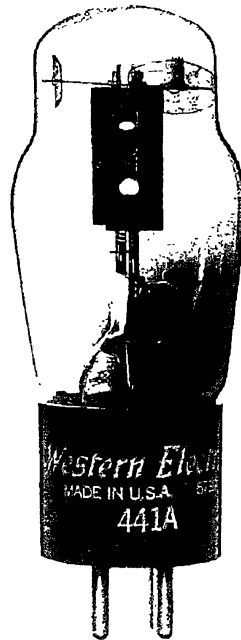

441A

**TRIODE
 VOLTAGE AMPLIFIER**

DESCRIPTION

The 441A is a filamentary triode designed for use as a voice frequency and carrier frequency voltage amplifier, detector, or modulator. The 441A is identical to the 102F electron tube except that it is fitted with a standard A4-9 medium 4-pin push type base.

CHARACTERISTICS

Filament Current (Note 1, Page 2)	0.50	ampere
Plate Current	$\left\{ \begin{array}{l} E_b = 130 \text{ volts} \\ E_c = -2.0 \text{ volts} \end{array} \right\}$	0.60 milliampere
Peak Output Voltage		

ELECTRON TUBE DATA SHEET
 FILE: GENERAL PURPOSE SECTION

GENERAL CHARACTERISTICS

Electrical Data

Filament Voltage (D-C)	2.1	volts
Filament Current (D-C) (Note 1)	0.5	amperes
Direct Interelectrode Capacitances		
Grid To Plate	5.1	$\mu\mu\text{f}$
Grid To Filament	4.0	$\mu\mu\text{f}$
Plate To Filament	2.3	$\mu\mu\text{f}$

Mechanical Data

Cathode	Coated Filament
Bulb	ST 14
Base	A4-9 medium 4-pin
Mounting Position	Preferably vertical, if horizontal the position of the plane of the filament should be vertical

Dimensions and pin connections shown in outline drawing on page 6.

MAXIMUM RATINGS, Absolute System (Note 2)

Filament Voltage	2.2	volts
Plate Voltage	200	volts
Plate Power	0.5	watts

TYPICAL OPERATING CONDITIONS AND CHARACTERISTICS

Filament Current	0.5	0.5	0.5	0.5	ampere
Plate Voltage	130	160	190	190	volts
Grid Voltage	-2.0	-3.0	-2.0	-2.0	volts
Plate Current	0.60	0.55	1.85	1.85	milliamperes
Transconductance	530	520	800	800	micromhos
Plate Resistance	58000	60000	39000	39000	ohms
Amplification Factor	30.9	30.9	31.0	31.0	
Load Resistance	0.1	0.1	0.1	0.3	megohms
Peak Output Voltage	37	53	41	50	volts

Note 1: The filament of this tube is designed to operate on a current basis and should be operated at as near the rated current as practicable.

Note 2: In the "Absolute System" the maximum ratings specified are limiting values above which the serviceability of the device may be impaired from the viewpoint of life and satisfactory performance. Maximum ratings, as such, do not constitute a set of operating conditions and all values may not, therefore, be attained simultaneously.

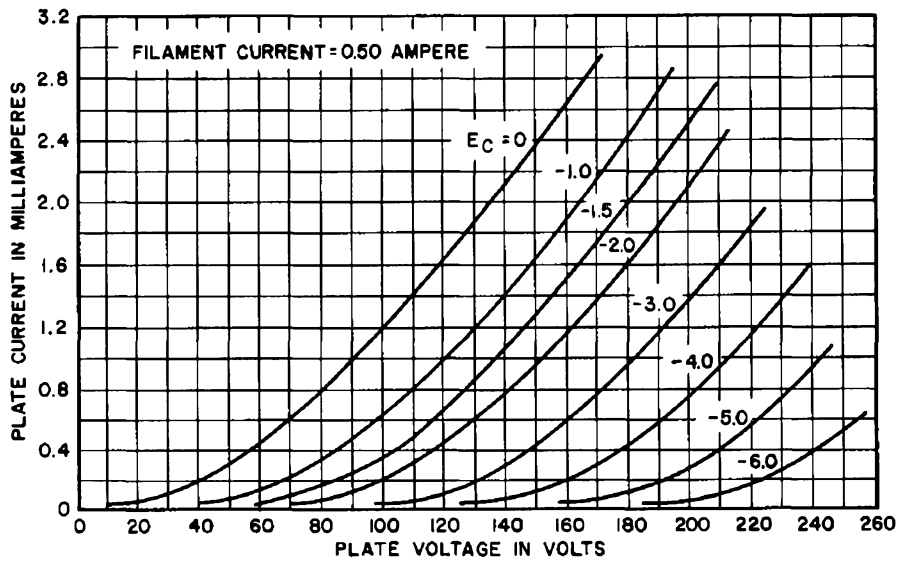

FIG. 1

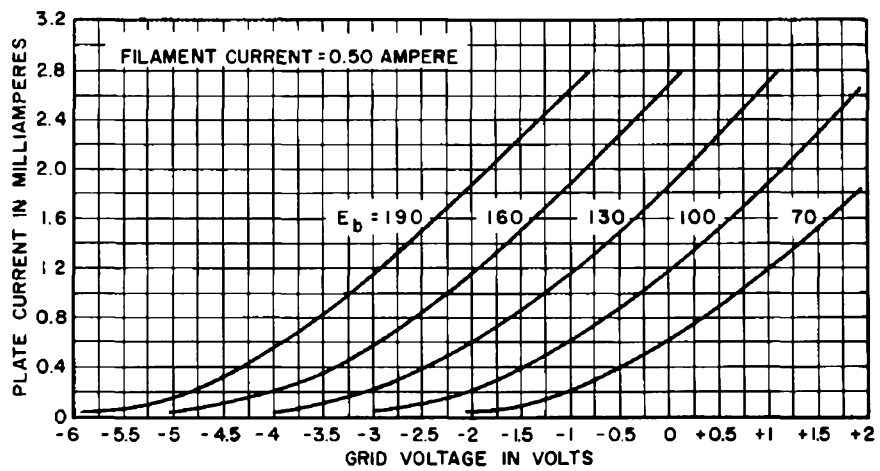
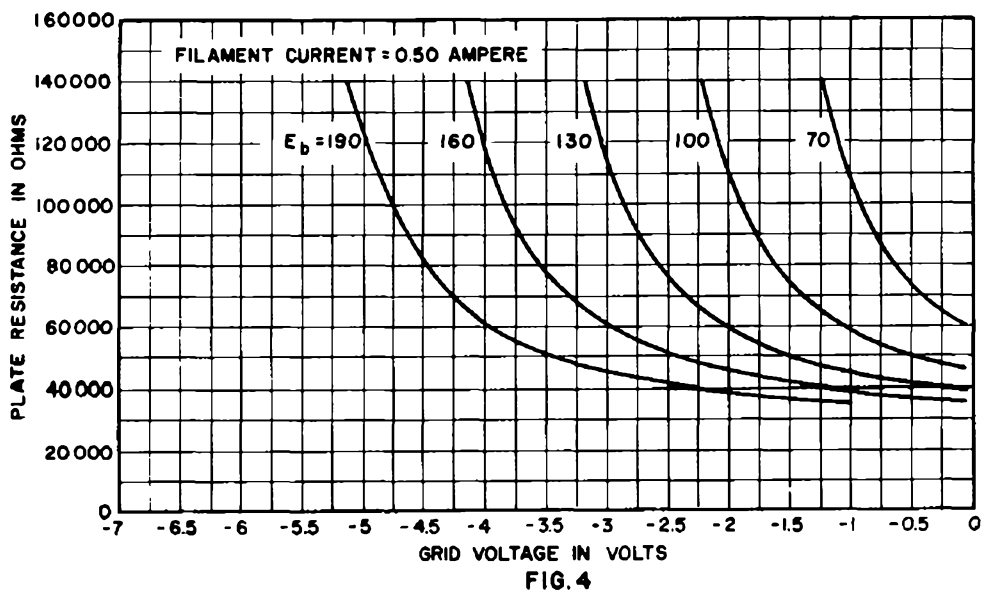
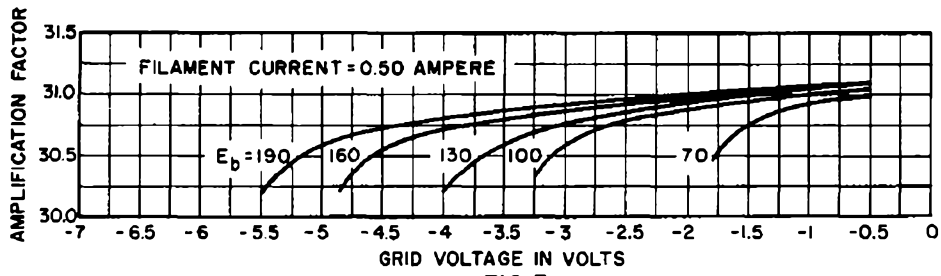

FIG. 2



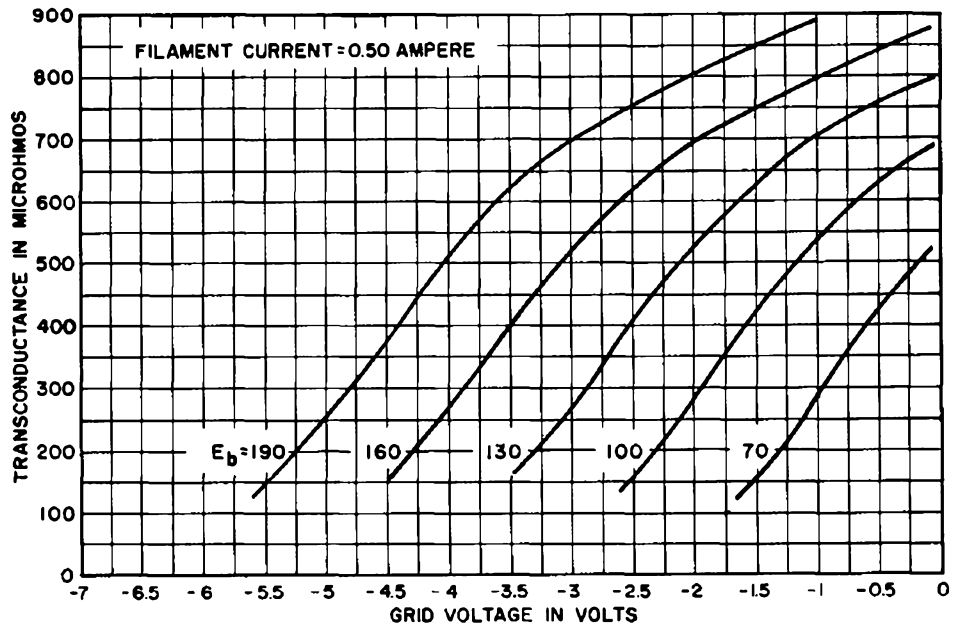
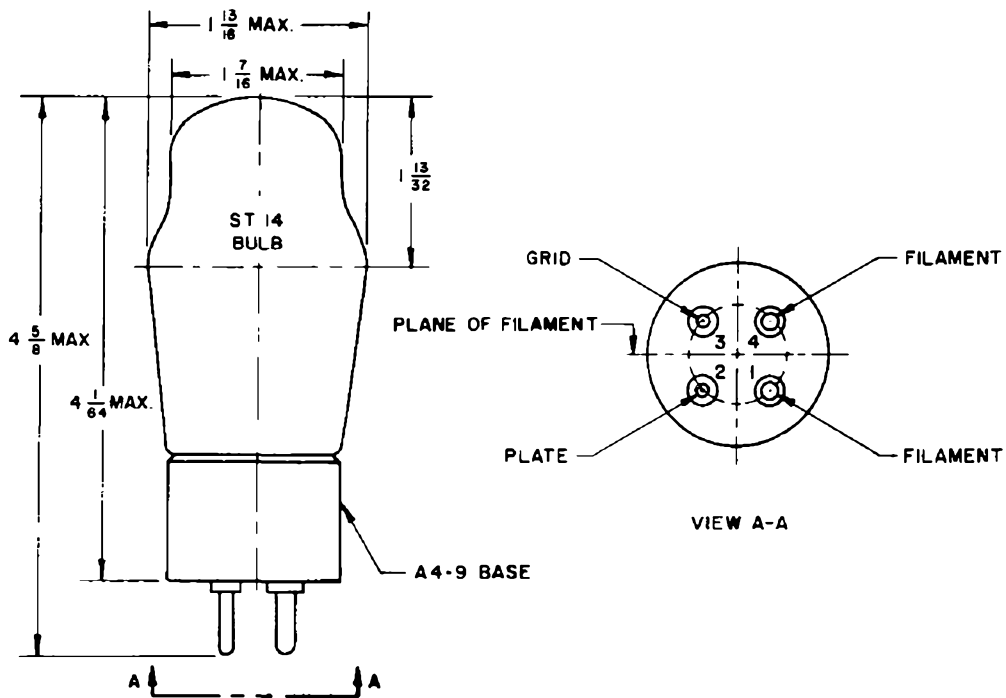

FIG. 5



A development of Bell Telephone Laboratories, the research laboratories of the American Telephone and Telegraph Company and the Western Electric Company.

PRINTED IN U.S.A.

ELECTRON TUBE DATA SHEET
WESTERN ELECTRIC 442A ELECTRON TUBE

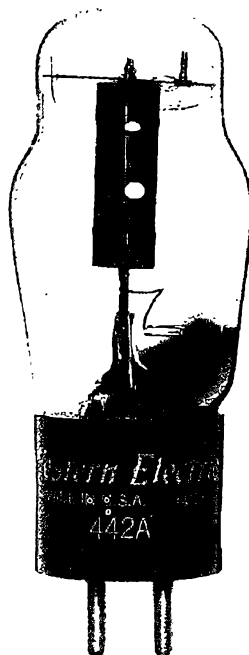

442A

TRIODE
POWER AMPLIFIER

DESCRIPTION

The 442A is a filamentary triode designed for use as an audio-frequency power amplifier or modulator. The 442A is identical to the 205F electron tube except that it is fitted with a standard A4-9 medium 4-pin push type base.

CHARACTERISTICS

Filament Voltage	4.5	volts
Plate Current	{ $E_b = 350$ volts }	35 milliamperes
Power Output	{ $E_c = -22.5$ volts }	880 milliwatts

File: General Purpose Section

GENERAL CHARACTERISTICS

Electrical Data

Filament Voltage (A-C) or (D-C)	4.5	volts
Filament Current	1.6	amperes
Direct Interelectrode Capacitances		
Grid To Plate	5.9	$\mu\mu\text{f}$
Input	4.1	$\mu\mu\text{f}$
Output	2.2	$\mu\mu\text{f}$

Mechanical Data

Cathode	Coated Filament
Bulb	ST 14
Base	A4-9 medium 4-pin
Mounting Position	Preferably vertical; if horizontal, pins #1 and #2 must lie in same vertical plane

Dimensions and pin connections shown in outline drawing on page 6.

MAXIMUM RATINGS, Absolute System

Plate Voltage	400	volts
Plate Current	55	milliamperes
Plate Dissipation	14	watts

TYPICAL OPERATING CONDITIONS AND CHARACTERISTICS

Filament Voltage (A-C)	4.5	4.5	4.5	4.5	volts
Plate Voltage	250	300	350	350	volts
Grid Voltage *	-22	-18	-22.5	-22.5	volts
Peak A-F Signal Voltage	22	18	22.5	22.5	volts
Zero Signal Plate Current	11.5	30	35	35	milliamperes
Maximum Signal Plate Current	12	30.5	36	36	milliamperes
Transconductance	1350	1880	1950	1950	micromhos
Plate Resistance	5300	3800	3700	3700	ohms
Load Resistance	12000	8000	4000	8000	ohms
Amplification Factor	7.2	7.2	7.2	7.2	
Maximum Signal Power Output	550	450	880	760	milliwatts
Total Harmonic Distortion	4.6	1.6	2.8	1.4	per cent

* If filament is operated on D-C the characteristics will be approximately the same if the grid voltage, measured from the negative filament, is decreased by 2.3 volts.

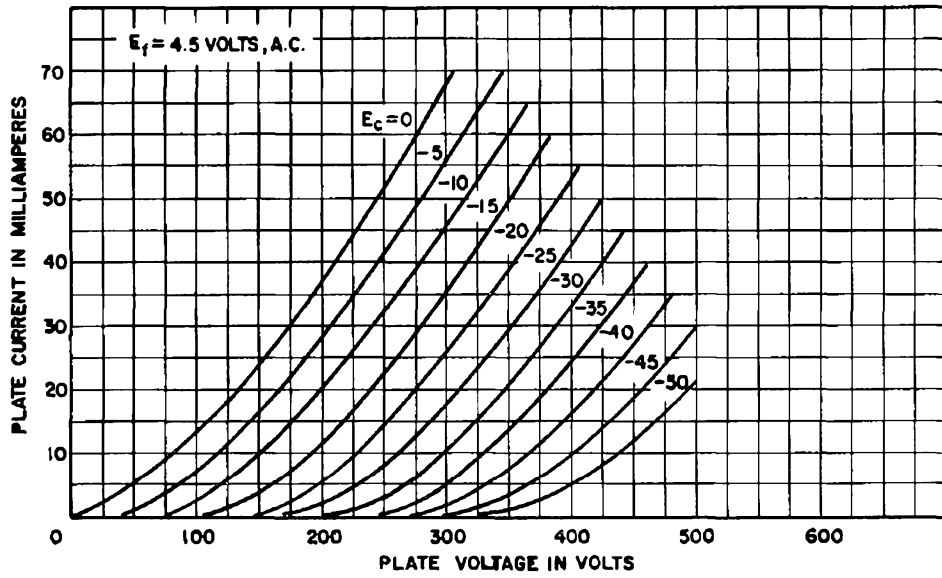

FIG. 1

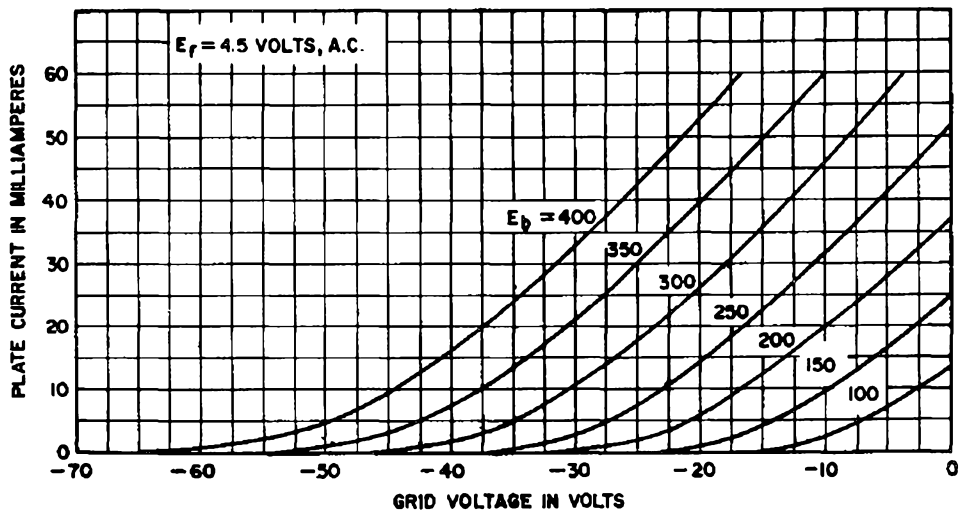
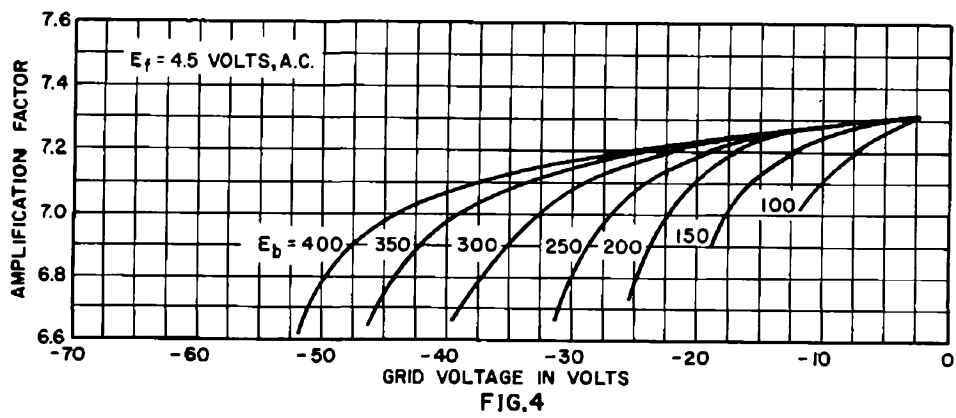
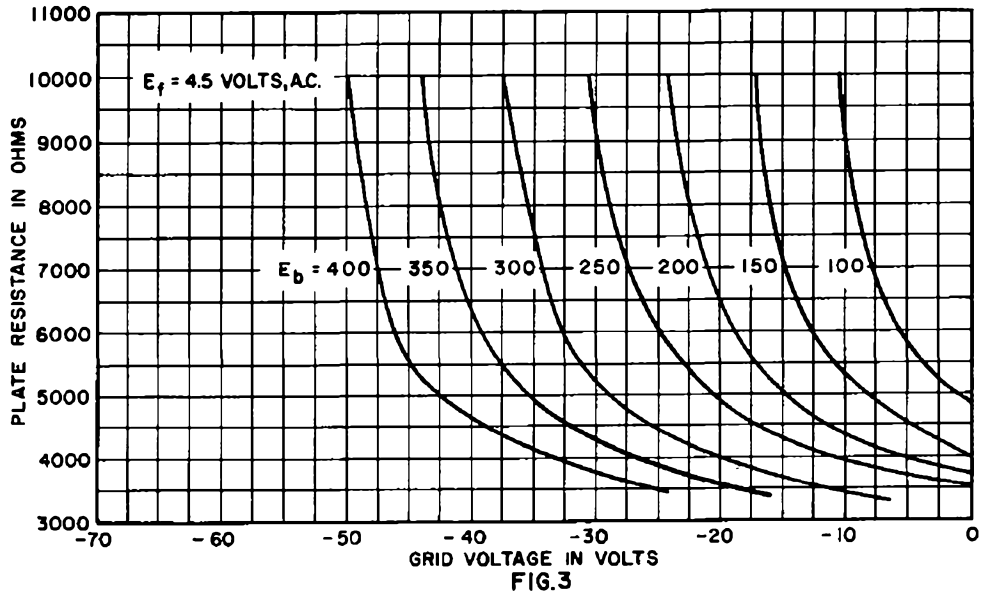

FIG. 2



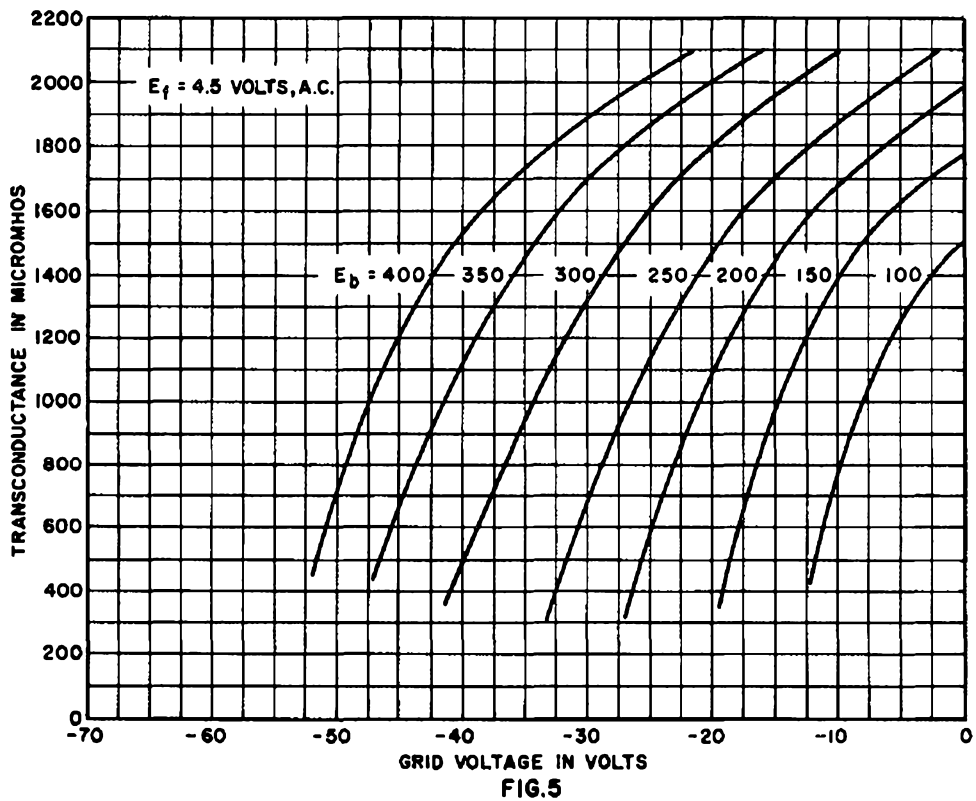
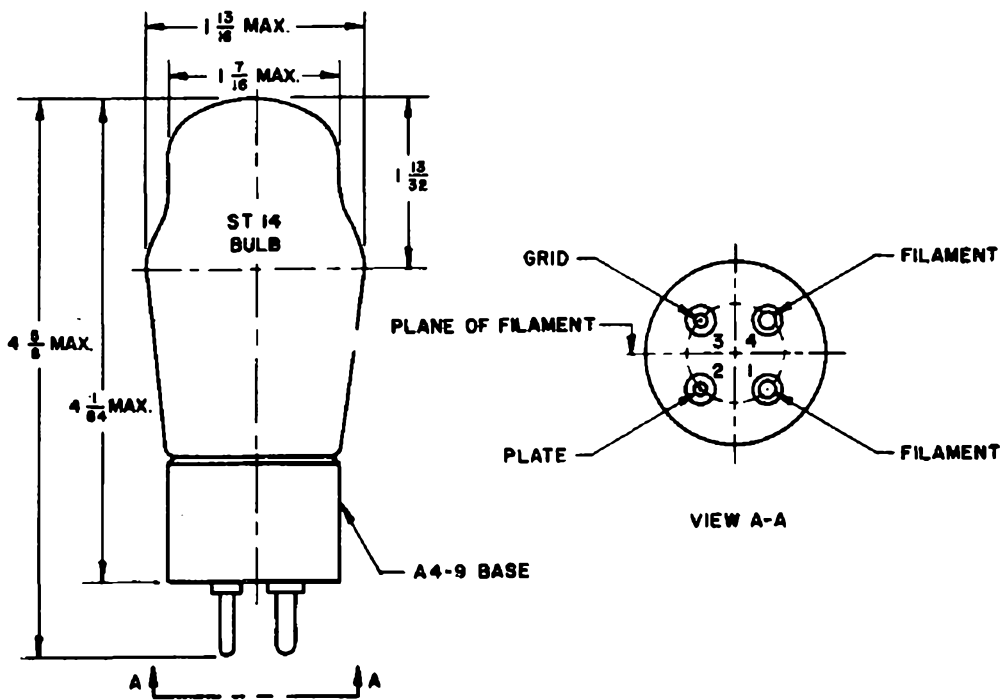

FIG.5



ELECTRON TUBE DATA SHEET
WESTERN ELECTRIC 443A ELECTRON TUBE



443A

DESCRIPTION

The 443A is a three-electrode inert-gas filled miniature cold cathode tube for use in relay, voltage regulator or rectifier circuits. This tube is especially suitable for use in control circuits such as in triggering, counting or switching apparatus.

This tube is designed for socket mounting. It is identical, electrically and mechanically, to the 426A except that it is not attached to a plastic angle mounting bracket.

CHARACTERISTICS

Peak Anode Voltage		180	volts
Average Cathode Current	7.5	60	milliamperes
Average Life, Approximate	10000	10	hours

File: Cold Cathode Section

MAXIMUM RATINGS, Absolute System (Note 1)

Forward Peak Anode Voltage	180	volts
Forward Cathode Current (Note 2)		
Peak	60	milliamperes
Average	30	milliamperes
Averaging Time	2	seconds
Peak Inverse Current (Note 2)		
Anode	5	milliamperes
Starter	1	milliampere
Ambient Temperature Limits	-55 to +85	centigrade

ELECTRICAL DATA, Throughout Life

	<u>Min.</u>	<u>Bogey</u>	<u>Max.</u>	
Starter Breakdown Voltage	65	72	85	volts
Starter Voltage Drop at 3 Milliamperes (Note 3)	53	63	72	volts
Anode Voltage Drop at 10 Milliamperes (Notes 4 & 5)	63	69	75	volts
Transfer Current	See Curve - Fig. 1			
Ionization Time, Starter Gap (Note 6).	-	10	-	milliseconds
Deionization Time, Main Gap	-	6	-	milliseconds
Inverse Current at -120 Volts Anode Potential (Note 7).	-	-	3	milliamperes

MECHANICAL DATA

Mounting Any Position
 Net Weight 0.3 Ounce
 Dimensions and Pin Connections shown in outline drawing on Page 4.

HANDLING

This tube contains a small amount of krypton-85 gas which is a by-product radioactive material. The amount of krypton-85 is less than five microcuries, which is too small an amount to require any special care in use.

Atomic Energy Commission regulations require that the individual tube carton for tubes containing by-product radioactive material be appropriately marked. The marking includes the statement that tube disposal should be in approved manner.

Approved instructions for disposal of tubes containing krypton-85 are as follows;

Tubes to be disposed of should be broken or crushed in a well ventilated place releasing any resulting vapors to the outside atmosphere. The residual broken or crushed tubes should be disposed of in a normal public trash disposal system. Tubes should be disposed of at a rate of not more than 100 each week from any one location. Avoid breathing vapors from broken tubes.

Note 1: In the "Absolute System" the maximum ratings specified are limiting values above which the serviceability of the device may be impaired from the viewpoint of life and satisfactory performance. Maximum ratings, as such, do not constitute a set of operating conditions and all values may not, therefore, be attained simultaneously.

Note 2: Sufficient resistance must be used in series with the tube to assure that the electrode currents do not exceed the maximum rated values.

Note 3: Starter voltage oscillations of approximately 1 to 10 kilocycles and 12 volts peak-to-peak will be present at starter current values below 0.05 milliampere.

Note 4: Approximately 95% of tubes will be within limits of ± 2.8 volts from the bogey value.

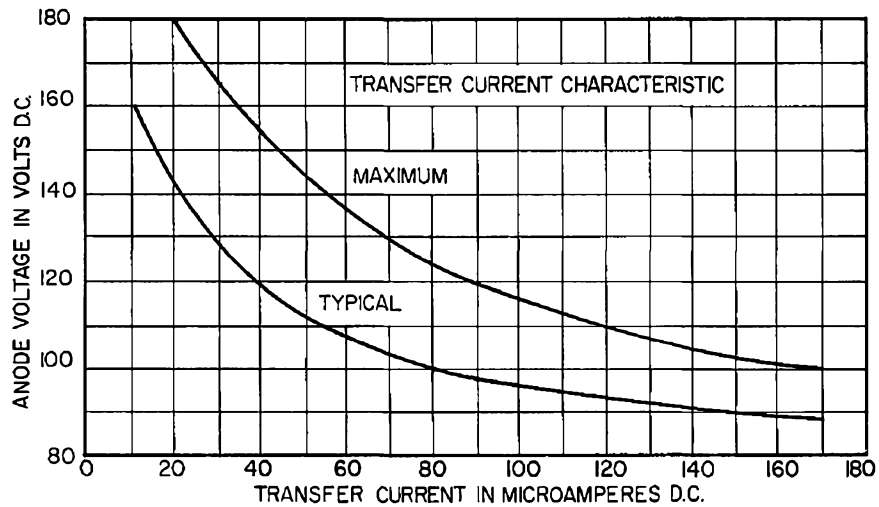

FIG. 1

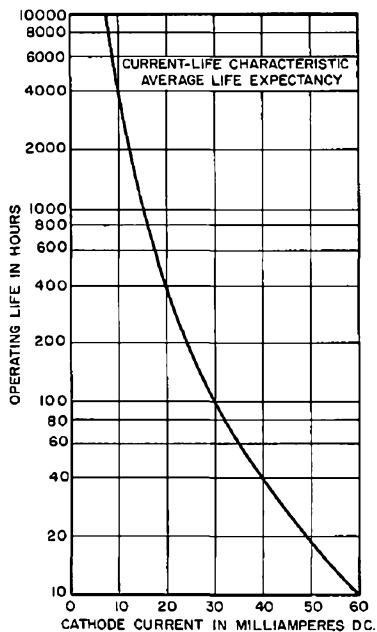

FIG. 2

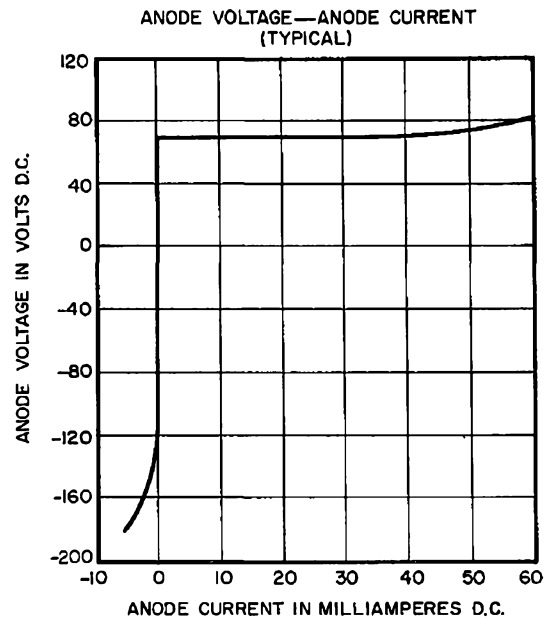
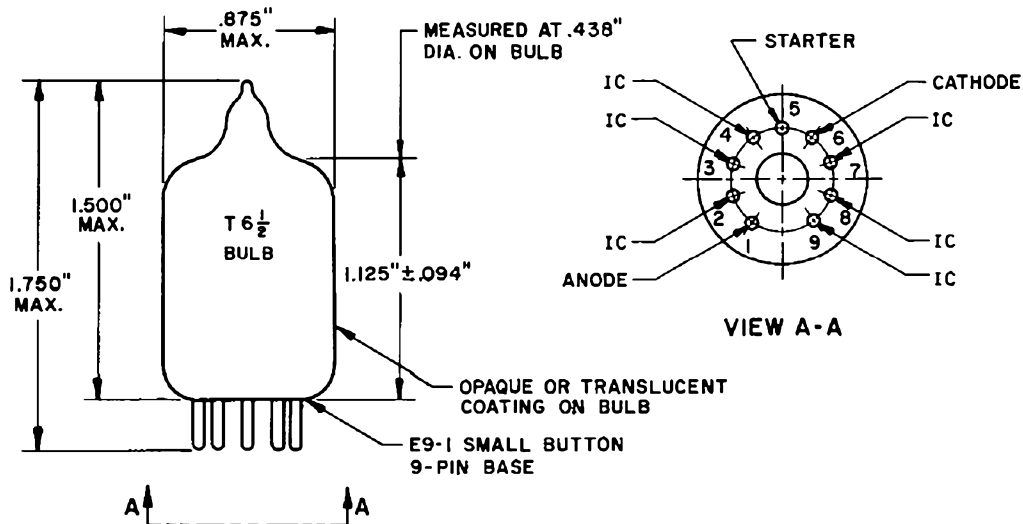
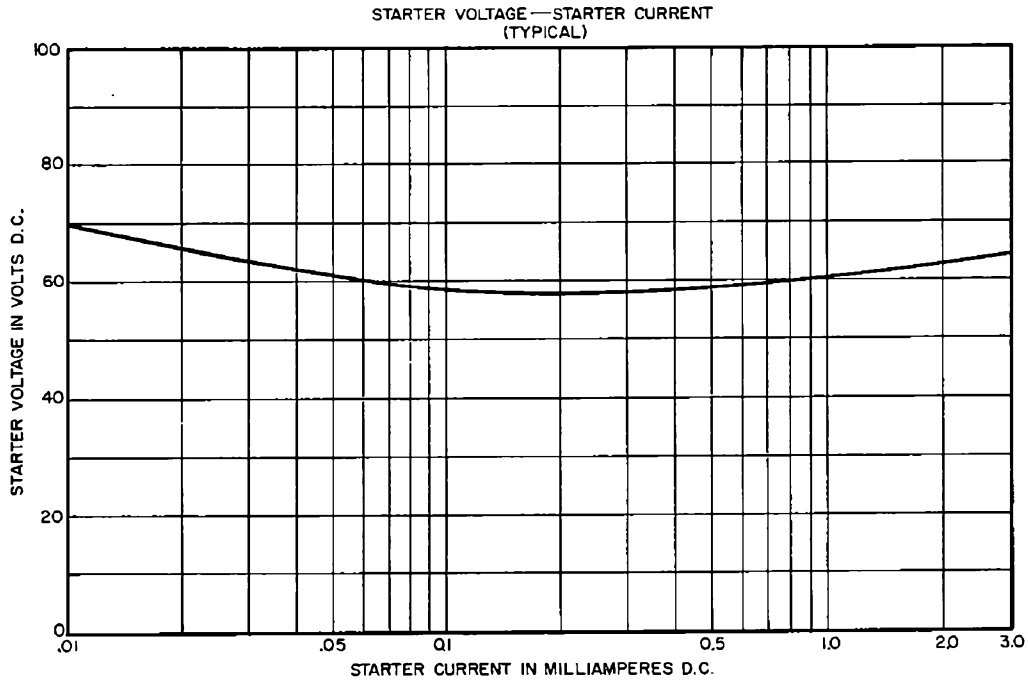

FIG. 3

Note 5: Anode voltage oscillations of approximately 5 to 20 kilocycles and 3 volts peak-to-peak will be present at anode currents within the ratings.

Note 6: With 15 volts starter overvoltage (15 volts above Starter Breakdown Voltage) with tube in total darkness.

Note 7: Negative anode voltage applied through 8000 ohms. Starter connected to anode through 100,000 ohms.



NOTE: PINS MARKED IC (INTERNAL CONNECTION) SHOULD NOT BE CONNECTED TO ANY PORTION OF AN EXTERNAL CIRCUIT. FAILURE TO OBSERVE THIS PRECAUTION MAY RESULT IN IMPROPER OPERATION OF THE TUBE.

A development of Bell Telephone Laboratories, the research laboratories of the American Telephone and Telegraph Company and the Western Electric Company.

ELECTRON TUBE DATA SHEET
WESTERN ELECTRIC 444A ELECTRON TUBE

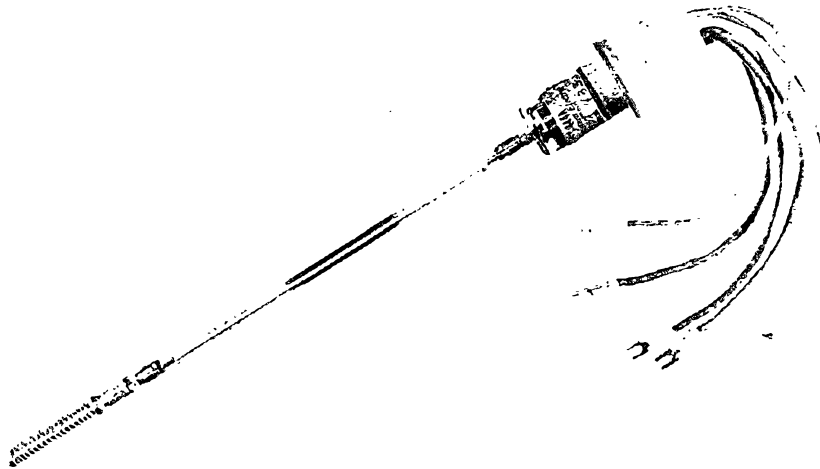

444A

DESCRIPTION

The 444A tube is a medium power helix-type traveling wave amplifier for application in the 6000 megacycle frequency region. It is intended primarily for operation as a transmitting amplifier in the repeater stations of long-distance radio relay stations.

CHARACTERISTICS

Heater Voltage	6.3 volts
Heater Current	0.92 amp.
Accelerator Anode Voltage	2700 volts
Helix Voltage	2400 volts
Collector Voltage	1200 volts
Power Output (Min.)	5 watts

File: Microwave Type Section
Data Sheet Issue 1, 8-60

444A

GENERAL CHARACTERISTICS (Notes 1 & 2)

ELECTRICAL DATA

Heater Voltage	6.3 volts
Heater Current092 ampere
Acceleration Anode Voltage (Note 3).	2700 volts
Accelerator Anode Current.(Max.)	0.60 milliampere
Helix Voltage (Note 4)	2400 volts
Helix Current.(Max.)	0.4 milliampere
Collector Voltage.	1200 volts
Power Output(Min.)	5.0 watts
Gain at 5 watts (37 dbm) Output.	32.5 db
Noise Figure(Max.)	30 db
Gain Variation (Note 5).20 db
Input Match (Note 6)(Min.)	21 db
Output Match (Note 6).(Min.)	11 db
Spurious Noise (Note 7).(Max.)	10 db

MECHANICAL DATA

Cathode.	Unipotential
Mounting Position.	Any
External Leads	5" Flexible with lugs

MAXIMUM RATINGS, Absolute System

Heater Voltage	6.6 volts
Accelerator Anode Voltage.	3000 volts
Anode Current.	2.0 milliamperes
Anode Power.	2.5 watts
Helix Voltage.	2700 volts
Helix Current.	2.0 milliamperes
Helix Power.	2.5 watts
Collector Voltage.	2000 volts
Cathode Current.	50 milliamperes
Collector Power.	80 watts
Heater Cathode Voltage	± 45 volts
Bulb Temperature	125°C
Collector Temperature (requires forced-air cooling. See Operating precautions - Paragraph A Page 4).	150°C

TYPICAL OPERATING DATA (Notes 1 & 2)

Heater Voltage	6.3 volts
Accelerator Anode Voltage (Note 3)	2700 volts
Helix Voltage (Note 4)	2400 volts
Collector Voltage	1200 volts
Accelerator Anode Current.	0.2 milliamperes
Helix Intercept Current.	0.2 milliamperes
Collector Current	40 milliamperes
Power Output	5 watts
Gain	32 db
Gain Variation With Frequency Change (Note 5).	0.15 db
Noise Figure	28.5 db
Input Match (Note 6)	23 db
Output Match (Note 6).	19 db
Spurious Noise (Note 7).	5 db

Note 1: Operated in a straight-field permanent magnetic circuit, using WR 159 wave guide coupling, with the following magnetic characteristics: (a) a straight field of 580 gauss minimum which tapers off to 20 gauss nominal at the cathode location (b) a cross field, in the wave guide region, of 1.2 gauss maximum in each of two orthogonal planes (c) a cross field, between wave guides, of 1.7 gauss maximum in each of two orthogonal planes.

Note 2: Operated with the input frequency being swept over the range of 5925 to 6425 mc.

Note 3: Adjusted for collector current of 40 milliamperes.

Note 4: Adjusted for maximum gain while the output power is maintained at 5 watts.

Note 5: Measured over the 50 mc segment of the 5925 - 6425 mc band having the greatest gain variation.

Note 6: The match is measured on the basis of return loss, i.e. the amount by which a reflected signal is down from an incident signal, expressed in decibels. The values given are at the points of minimum return loss in the frequency band of 5925 to 6425 mc with match adjusted to its best position for the entire band. The match is measured with the tube in its maximum gain condition per Note 4.

Note 7: Spurious noise includes all wide-band or narrow-band spikes. For this test the tube input is single frequency (not swept). The limit given is the level above the normal tube thermal noise output, when thermal noise and spurious noise are measured simultaneously in a bandwidth of 2500 cycles, the 2500 cycle bandwidth being examined over the frequency range of 0.3 to 10 mc away from the driver frequency.

OPERATING PRECAUTIONS

- (a) The tube should not be operated without cooling air on the collector terminal. The required air flow will depend on the physical configuration of the housing surrounding the collector.
- (b) The operating voltages are arranged to facilitate the flow of positive ions toward the collector rather than toward the cathode. Therefore, for optimum cathode life the accelerator anode voltage should be maintained at least 25 volts above the helix voltage. However, this voltage condition is violated initially when putting the tube into operation. The sequence of voltage application should be - heater, collector, helix and anode. The reverse order is used when terminating operation of the tube.
- (c) For optimum tube life the current to the helix should be maintained at the minimum value obtainable.

TYPICAL OPERATION RANGE FOR 100 MC BANDWIDTH

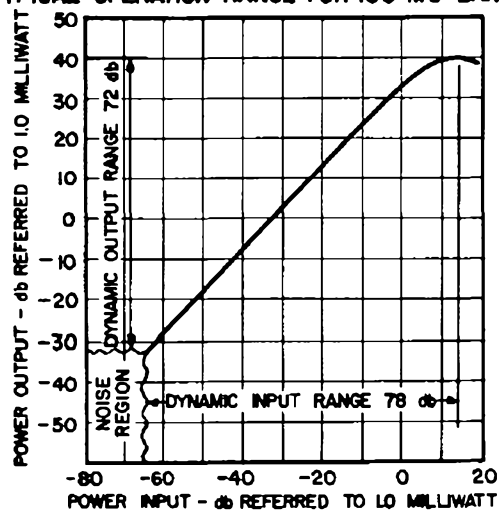

FIG 1

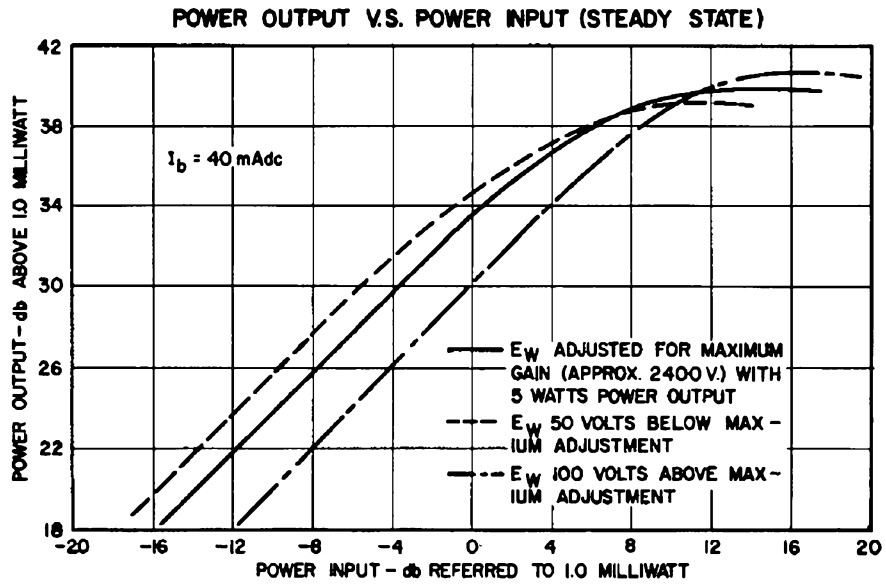

FIG. 2

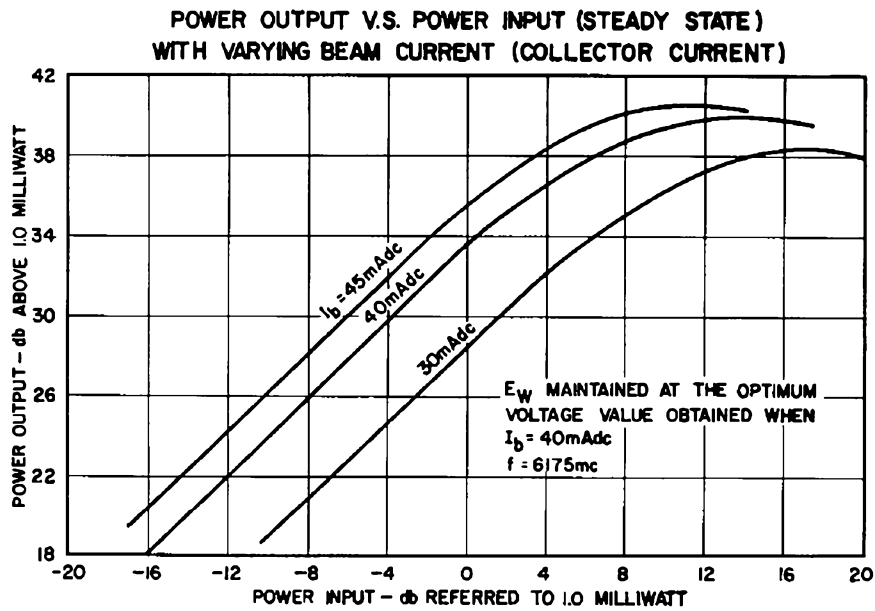

FIG. 3

ELECTRON TUBE DATA SHEET
WESTERN ELECTRIC 446 A ELECTRON TUBE



446A

DESCRIPTION

The 446A is a three-electrode inert-gas filled cold cathode tube designed for use as a voltage regulator and has characteristics which are exceptionally stable with life. The third electrode is primarily a starting element.

CHARACTERISTICS

Cathode Current	5 to 40 milliamperes
Anode Voltage Drop (E_{td})	81 volts
Regulation at 5 to 40 milliamperes d-c (Note 6)	±1.5 volts

File: Cold Cathode Section

446A

RATINGS, Absolute System (Note 1)

Cathode Current, Forward	
Maximum	40 milliamperes
Minimum	5 milliamperes
Starter Current, Forward	
Maximum	5 milliamperes
Minimum (Note 2).	0.5 milliampere
Maximum Inverse Starter or Anode Current.	0.0 milliampere
Ambient Temperature Limits	-55 to +85 centigrade

ELECTRICAL DATA

	<u>Min.</u>	<u>Bogey</u>	<u>Max.</u>	
Anode Breakdown Voltage.	-	108	-	volts
Anode Voltage Drop (E_{td}) at 40 Milliampere, (D-C) (Note 3) 80	81.2		82.5	volts
Regulation (5 to 40 Milliampere, D-C) (Notes 4 & 6)	-0.1		±1.0	volts
Starter Breakdown Voltage.	90	95	105	volts
Starter Voltage Drop at 5 Milliampere, (D-C).	81	83	86	volts
Transfer Current at 90 volts Anode Voltage.	-	10	50	microampere

LIFE DATA

Starter Breakdown Voltage (Max.) after 500 hours at 40 mAdc.	110 volts
Regulation (5 to 40 mAdc) after 500 hours at 40 mAdc (Note 6).	1.5 volts max.
Drift in Anode Voltage Drop (E_{td}) in 500 hours at 40 mAdc (Note 5)	+0.8 Volts max.

MECHANICAL DATA

Mounting Position	Any
Net Weight, Approximate	0.4 Ounce
Base	Small Button 9 pin
Bulb	T 6½
Dimensions and connections shown in outline drawing on page 4.	

HANDLING

This tube contains a small amount of krypton-85 gas which is a by-product radioactive material. The amount of krypton-85 is less than five microcuries, which is too small an amount to require any special care in use.

Atomic Energy Commission regulations require that the individual tube carton for tubes containing by-product radioactive material be appropriately marked. The marking includes the statement that tube disposal should be in approved manner.

Approved instructions for disposal of tubes containing krypton-85 are as follows:

Tubes to be disposed of should be broken or crushed in a well ventilated place releasing any resulting vapors to the outside atmosphere. The residual broken or crushed tubes should be disposed of in a normal public trash disposal system. Tubes should be disposed of at a rate of not more than 100 each week from any one location. Avoid breathing vapors from broken tubes.

Note 1: In the "Absolute System" the maximum ratings specified are limiting values above which the serviceability of the device may be impaired from the viewpoint of life and satisfactory performance. Maximum ratings, as such, do not constitute a set of operating conditions and all values may not, therefore, be attained simultaneously.

Note 2: The minimum starter current requirement applies only when the tube is operated for extended periods (hundreds of hours) between starting operations to assure maintaining starter breakdown and transfer current characteristics.

Note 3: These values are for new tubes. Anode voltage drop will stabilize within 3 minutes after starting.

Note 4: Continuous operation at a current value in the low portion of the operating range for an extended period (hundreds of hours) may result temporarily in regulation exceeding the stated values.

Note 5: The drift of anode voltage drop improves with operating life. After 1000-2000 hours operation the drift of anode voltage drop per 1000 hours will not exceed 0.3 volt.

Note 6: Regulation is defined to be Anode Voltage Drop (E_{td}) at 40 mAdc minus Anode Voltage Drop (E_{td}) at 5 mAdc.

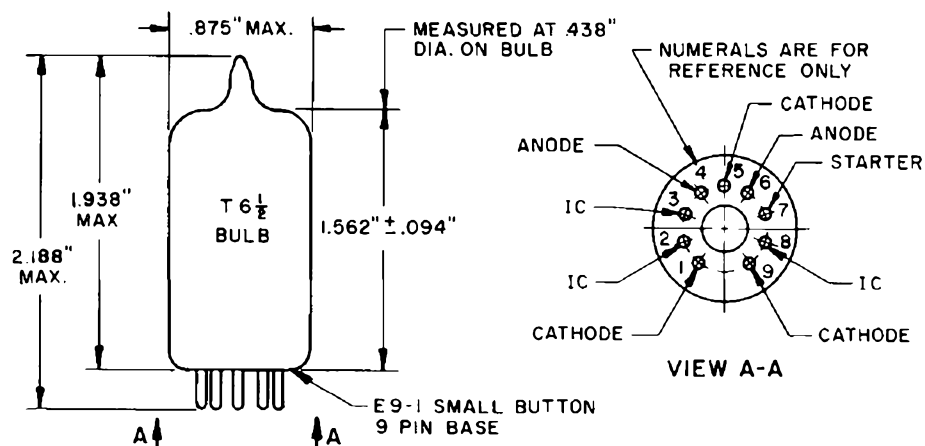

NOTE: PINS MARKED IC (INTERNAL CONNECTION) SHOULD NOT BE CONNECTED TO ANY PORTION OF AN EXTERNAL CIRCUIT. FAILURE TO OBSERVE THIS PRECAUTION MAY RESULT IN IMPROPER OPERATION OF THE TUBE.

A development of Bell Telephone Laboratories, the research laboratories of the American Telephone and Telegraph Company and the Western Electric Company.

PRINTED IN U. S. A.

ELECTRON TUBE DATA SHEET
WESTERN ELECTRIC 447A ELECTRON TUBE

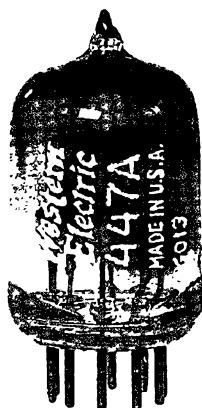

447A

DESCRIPTION

The 447A is a two-electrode inert-gas filled cold cathode tube designed primarily for use as a voltage reference and trouble indicator tube. The cathode red glow is visible through a hole in the anode for indicator use.

CHARACTERISTICS

Cathode Current	8 milliamperes max.
Anode Voltage Drop	82 volts
Regulation at 2 to 4 milliamperes d-c (Note 3, page 3)	0.5 volt

File: Cold Cathode Section

447A

RATINGS, Absolute System (Note 1)

Cathode Current, Forward			
Maximum			8 milliamperes
Maximum Inverse Anode Current			0.0 milliampere
Ambient Temperature Limits		-55 to +60	centigrade

ELECTRICAL DATA, Throughout Life

	<u>Min.</u>	<u>Bogey</u>	<u>Max.</u>	
Anode Breakdown Voltage	110	115	120	volts
Anode Voltage Drop (E_{td}) at 4 Milliamperes (D-C) (Note 2)	81	82	83	volts
Regulation (2 to 4 Milliamperes, D-C) (Note 3)	-	0.2	0.5	volt
Coverage Current (Note 4)	-	3.0	4.0	milliamperes

MECHANICAL DATA

Mounting Position		Any
New Weight, Approximate		0.3 ounce
Bulb		T 6½
Base		Small Button 9 pin
Light Spot Size, approximate		0.20 inches
Dimensions and connections shown in outline drawing on page 4.		

LIFE DATA

Drift in Anode Voltage Drop (E_{td}) in 500 hours at 8 mAdc. 0.6 volts (max.)

HANDLING

This tube contains a small amount of krypton-85 gas which is a by-product radioactive material. The amount of krypton-85 is less than five microcuries, which is too small an amount to require any special care in use.

Atomic Energy Commission regulations require that the individual tube carton for tubes containing by-product radioactive material be appropriately marked. The marking includes the statement that tube disposal should be in approved manner.

Approved instructions for disposal of tubes containing krypton-85 are as follows:

Tubes to be disposed of should be broken or crushed in a well ventilated place releasing any resulting vapors to the outside atmosphere. The residual broken or crushed tubes should be disposed of in a normal public trash disposal system. Tubes should be disposed of at a rate of not more than 100 each week from any one location. Avoid breathing vapors from broken tubes.

Note 1: In the "Absolute System" the maximum ratings specified are limiting values above which the serviceability of the device may be impaired from the viewpoint of life and satisfactory performance. Maximum ratings, as such, do not constitute a set of operating conditions and all values may not, therefore, be attained simultaneously.

Note 2: These values are for new tubes. Anode voltage drop will stabilize within 3 minutes after starting.

Note 3: Regulation is defined to be Anode Voltage Drop (E_{td}) at 4 mAdc minus Anode Voltage Drop (E_{td}) at 2 mAdc.

Note 4: The current at which cathode glow will entirely cover the area defined by the anode hole. Such current should not exceed the above stated value.

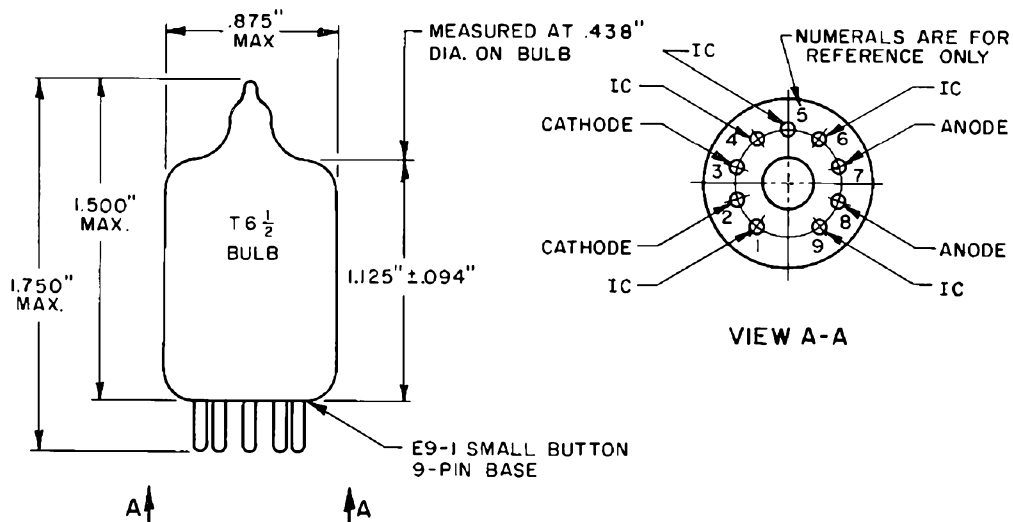

NOTE: PINS MARKED IC (INTERNAL CONNECTION) SHOULD NOT BE CONNECTED TO ANY PORTION OF AN EXTERNAL CIRCUIT. FAILURE TO OBSERVE THIS PRECAUTION MAY RESULT IN IMPROPER OPERATION OF THE TUBE.

A development of Bell Telephone Laboratories, the research laboratories of the American Telephone and Telegraph Company and the Western Electric Company.

PRINTED IN U. S. A.

ELECTRON TUBE DATA SHEET
WESTERN ELECTRIC 448A, 448B, 454A ELECTRON TUBE

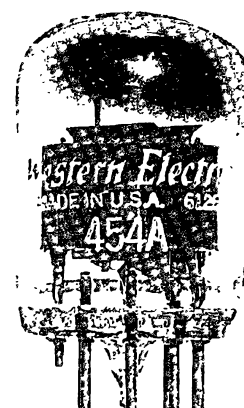
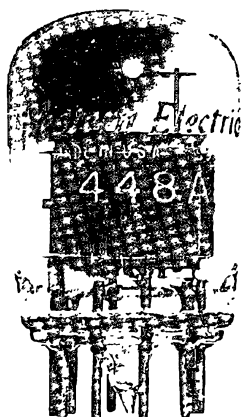

448A 448B 454A

DESCRIPTION

The 448A, 448B and 454A electron tubes are high figure of merit tetrodes of the indirectly heated cathode type. They have plate characteristics approaching those of a pentode and were designed primarily for use in the TH Radio Relay System.

These three tubes have the same electrical characteristics. The 448B has the same mechanical dimensions and appearance as the 448A except the bulb is aquadag coated to suppress fluorescence effects. The 454A is mechanically equivalent to the 448A except that pin #1 (plate) is shortened to permit its use in a special test probe. (See outline drawing - page 4).

CHARACTERISTICS

Heater Voltage	. . .	$\left(\begin{array}{l} E_b = 135 \text{ volts; } E_{c2} = 135 \text{ volts} \\ E_{cc1} = +9.5 \text{ volts; } R_k = 323 \text{ ohms} \end{array} \right)$. . .	6.3	volts
Cathode Current	33.7	milliamperes
Transconductance	31500	micromhos

GENERAL CHARACTERISTICS

Electrical Data

Heater Voltage	6.3	volts
Heater Current	450	milliamperes
Direct Interelectrode Capacitances (without external shield)		
Grid to Plate	0.03	$\mu\mu\text{f}$
Input: g to (h + k - \bar{g}_2 + i.s.)	15.4	$\mu\mu\text{f}$
Output: p to (h + k - \bar{g}_2 + i.s.)	2.03	$\mu\mu\text{f}$

Mechanical Data

Cathode	Coated Unipotential
Bulb	T-9
Base	See outline drawing Page 4
Mounting Position	Any
Dimensions and pin connections shown in outline drawing on Page 4	

Maximum Ratings, Absolute System

Plate Voltage	150	volts
Screen Grid Voltage	150	volts
Control Grid Voltage	-50	volts
Plate Dissipation	6.0	watts
Screen Grid Dissipation	1.75	watts
Control Grid Dissipation	See Footnote *	
Cathode Current	50	milliamperes
Heater - Cathode Voltage	+50	volts
Bulb Temperature	130*	centigrade
Maximum Grid Circuit Resistance for:		
Fixed Bias	0.05	megohm
Cathode Bias	0.10	megohm

* Operation with the control grid positive with respect to the cathode is not recommended.

TYPICAL OPERATING CONDITIONS AND CHARACTERISTICS

Plate Voltage	135	volts
Screen Grid Voltage	135	volts
Control Grid Voltage (Note 1)	+9.5	volts
Cathode Bias Resistor (Note 1)	323	ohms
Plate Current	24.9	milliamperes
Screen Grid Current	8.8	milliamperes
Plate Resistance	33000	ohms
Transconductance	31500	micromhos

Note 1: Reference point for control grid voltage is the negative end of the cathode bias resistor.

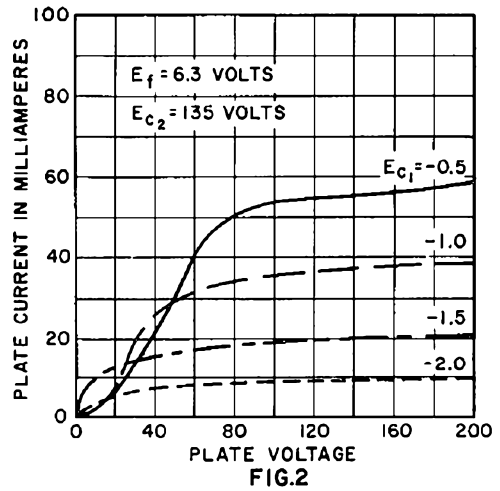
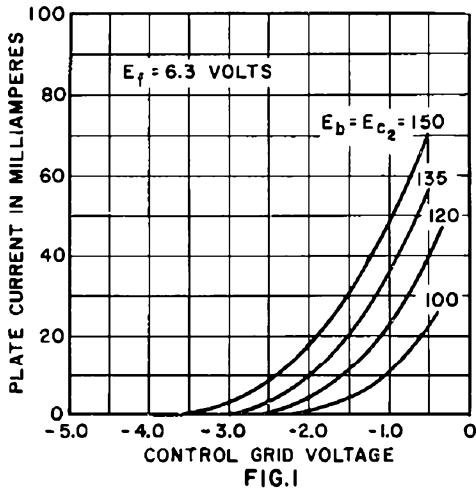

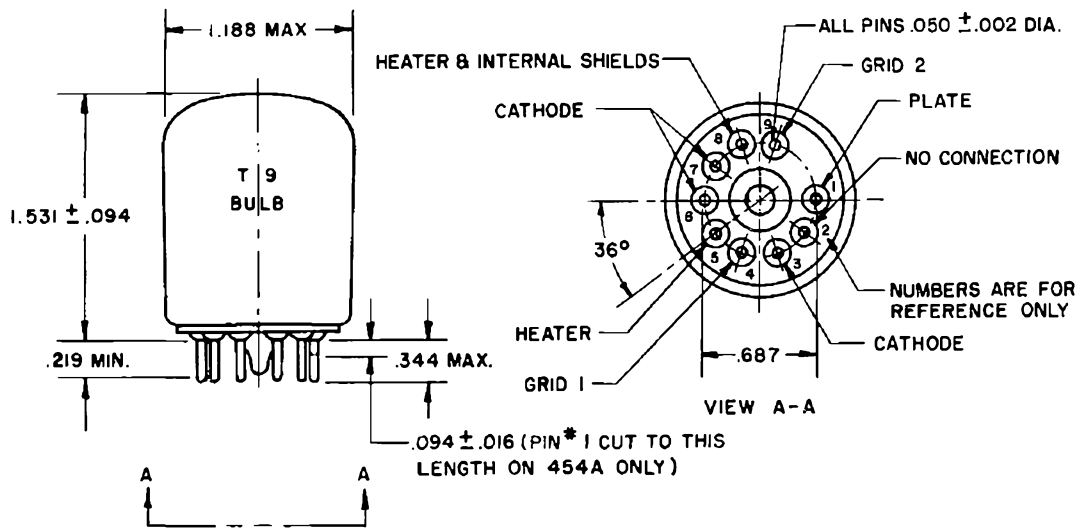

A development of Bell Telephone Laboratories, the research laboratories of the American Telephone and Telegraph Company and the Western Electric Company.

PRINTED IN U.S.A.

ELECTRON TUBE DATA SHEET
WESTERN ELECTRIC 451A ELECTRON TUBE



451A

DESCRIPTION

The 451A is a four-electrode, inert-gas filled cold cathode tube for use as a relay device. The tube is provided with an anode-cathode gap and a starter anode-starter cathode gap such that isolation of the control (starter gap) and controlled (main gap) portions of a circuit may be obtained.

This tube is designed for socket mounting. It is identical, electrically and mechanically, to the 425A except that it is not attached to a plastic angle mounting bracket assembly.

CHARACTERISTICS

Peak Anode Voltage	180	180	volts
Average Starter Cathode Current	0.7	7.0	milliamperes
Average Main Cathode Current	5.0	50	milliamperes
Average Life, Approximate	10000	10	hours

FILE: COLD CATHODE SECTION

MAXIMUM RATINGS, Absolute System (Note 1)

Peak Voltage, Forward or Inverse		
Anode to all Other Electrodes	180	volts
Cathode to all Other Electrodes	180	volts
Cathode Current (Note 2)		
Peak	50	milliamperes
Average	20	milliamperes
Averaging Time	2	seconds
Starter Cathode Current (Note 2)		
Peak	7	milliamperes
Average	2.5	milliamperes
Averaging Time	2	seconds
Peak Inverse Current (Note 2)		
Anode	5	milliamperes
Starter Anode.	1	milliamperes
Ambient Temperature Limits.	-55° to +85°	centigrade

ELECTRICAL DATA, Throughout Life

	<u>Min.</u>	<u>Bogey</u>	<u>Max.</u>	
Starter Breakdown Voltage (Note 3).	67	80	90	volts
Starter Voltage Drop at 2.5 Milliamperes.	55	70	75	volts
Anode Voltage Drop at 10 Milliamperes	58	70	80	volts
Transfer Current (Note 4).	See Curve, Figure 3, Page 4			
Negative Cathode Transfer Voltage (Note 5).	-	-25	-40	volts
Ionization Time, Starter Gap (Approx.) (Note 6).	-	5	-	milliseconds
Deionization Time, Main Gap (Approx.)	-	1	-	millisecond

MECHANICAL DATA

Mounting	Any position
New Weight, Approximate.	0.3 ounce
Dimensions and Connections.	See outline drawing on page 4

HANDLING

This tube contains a small amount of krypton-85 gas which is a by-product radioactive material. The amount of krypton-85 is less than five microcuries, which is too small an amount to require any special care in use.

Atomic Energy Commission regulations require that the individual tube carton for tubes containing by-product radioactive material be appropriately marked. The marking includes the statement that tube disposal should be in approved manner.

Approved instructions for disposal of tubes containing krypton-85 are as follows;

Tubes to be disposed of should be broken or crushed in a well ventilated place releasing any resulting vapors to the outside atmosphere. The residual broken or crushed tubes should be disposed of in a normal public trash disposal system. Tubes should be disposed of at a rate of not more than 100 each week from any one location. Avoid breathing vapors from broken tubes.

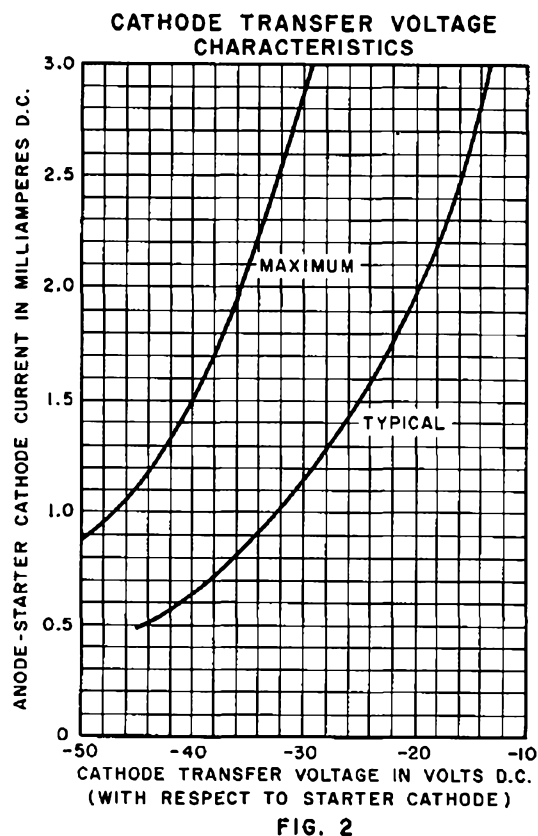
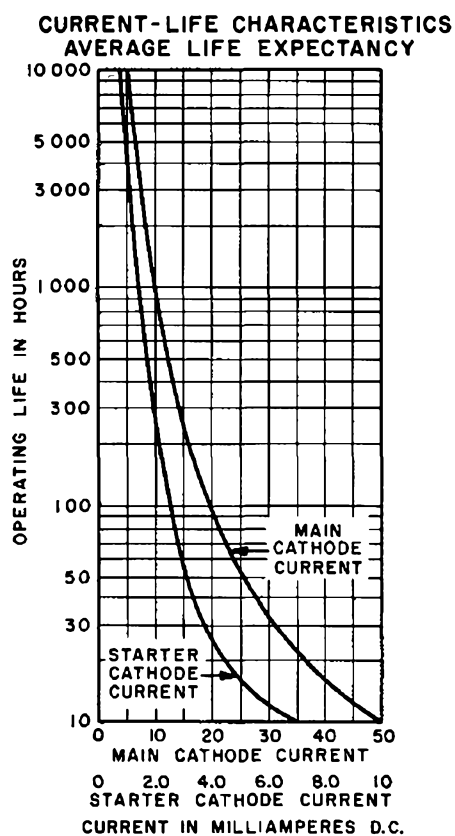

- Note 1: In the "Absolute System" the maximum ratings specified are limiting values above which the serviceability of the device may be impaired from the viewpoint of life and satisfactory performance. Maximum ratings, as such, do not constitute a set of operating conditions and all values may not, therefore, be attained simultaneously.
- Note 2: Sufficient resistance must be used in series with the tube discharge paths to assure that the electrode currents do not exceed their maximum rated values.
- Note 3: Limits apply immediately after the tube has conducted current. These values may be initially as much as 3 volts higher or lower if the tube has been idle.
- Note 4: To assure transfer of conduction from the starter anode-starter cathode gap to the anode-starter cathode gap.
- Note 5: To assure transfer of conduction from the anode-starter gap to the anode-cathode gap with 1.5 milliamperes flowing from anode to starter cathode. Cathode voltage is measured with respect to starter cathode.
- Note 6: With 15 volts starter overvoltage (15 volts above Starter Breakdown Voltage) and with the tube in total darkness.

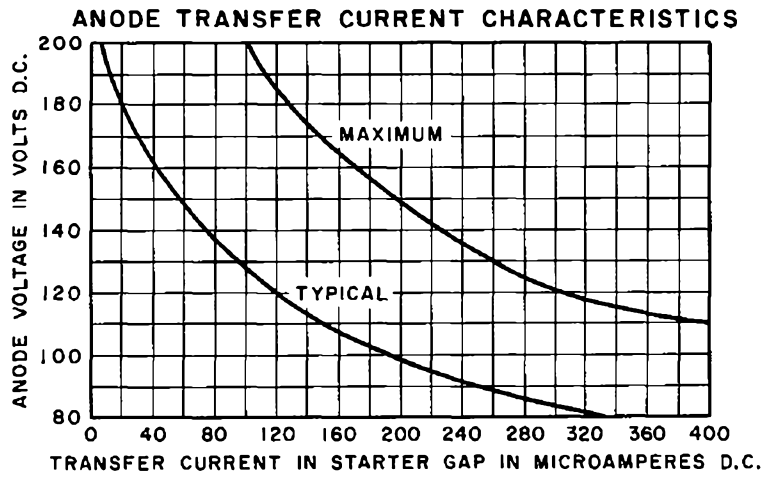
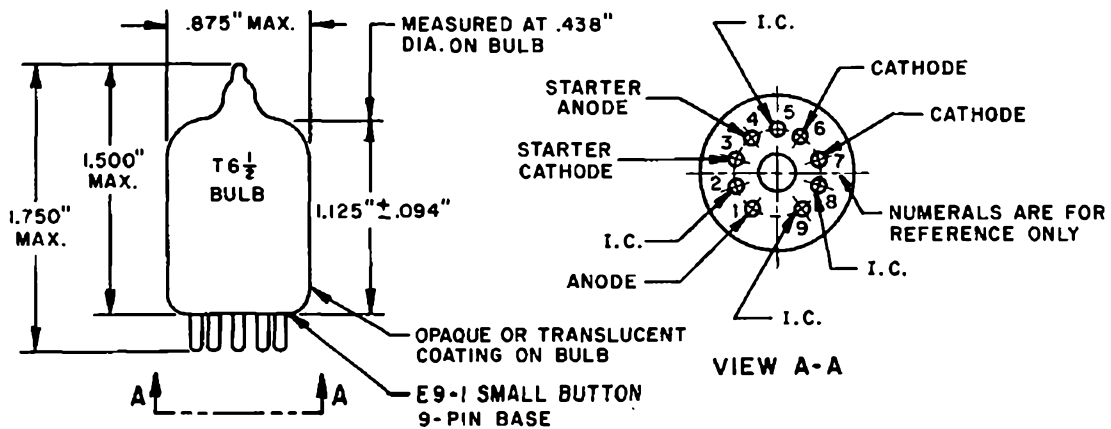

FIG. 3



NOTE: PINS MARKED I.C. (INTERNAL CONNECTION) SHOULD NOT BE CONNECTED TO ANY PORTION OF AN EXTERNAL CIRCUIT. FAILURE TO OBSERVE THIS PRECAUTION MAY RESULT IN IMPROPER OPERATION OF THE TUBE.

A development of Bell Telephone Laboratories, the research laboratories of the American Telephone and Telegraph Company and the Western Electric Company.

PRINTED IN U.S.A.

ELECTRON TUBE DATA SHEET
WESTERN ELECTRIC 453A ELECTRON TUBE



453A

DESCRIPTION

The 453A is a two-electrode inert-gas filled cold cathode tube designed primarily for use as a voltage reference tube. This tube has characteristics which are exceptionally stable with life and with variations in ambient temperature. The tube is relatively free from voltage jumps. (See Note 6, page 3.)

CHARACTERISTICS

Cathode Current	4 to 6 milliamperes
Anode Voltage Drop	83 volts
Regulation at 4 to 6 milliamperes d-c (Note 5, Page 3).	1.2 volts

File: Cold Cathode Section



RATINGS, Absolute System (Note 1)

Cathode Current, Forward

Maximum.	8 milliamperes
Minimum.	4 milliamperes
Maximum Inverse Anode Current.	0.0 milliampere
Ambient Temperature Limits	-55 to +60 centigrade

ELECTRICAL DATA, Throughout Life

	<u>Min.</u>	<u>Bogey</u>	<u>Max.</u>	
Anode Breakdown Voltage	95	100	105	volts
Anode Voltage Drop (E_{td}) at 6 Milliamperes (D-C) (Note 2)	81	83	87	volts
Regulation (4 to 6 Milliamperes, D-C) (Note 5)	-	0.75	1.2	volts
Temperature Sensitivity of Anode Voltage Drop				
Anode Current, 5 Milliamperes (D-C)	-0.0035	-	-	volt/c
Fluctuation (Note 3)	-	0.002	0.005	volt
Average Ionization Time (Note 4)	-	5.0	-	milliseconds
Voltage Jump (Note 6)	-	5.0	-	millivolts

MECHANICAL DATA

Mounting Position.	Any
New Weight, Approximate	0.3 ounce
Bulb	T 6½
Base	Small Button 9 pin
Dimensions and connections shown in outline drawing on page 4.	

LIFE DATA

Typical Drift in Anode Voltage Drop (E_{td}) at 5 mAdc See Figure 1

HANDLING

This tube contains a small amount of krypton-85 gas which is a by-product radioactive material. The amount of krypton-85 is less than five microcuries, which is too small an amount to require any special care in use.

Atomic Energy Commission regulations require that the individual tube carton for tubes containing by-product radioactive material be appropriately marked. The marking includes the statement that tube disposal should be in approved manner.

Approved instructions for disposal of tubes containing krypton-85 are as follows:

Tubes to be disposed of should be broken or crushed in a well ventilated place releasing any resulting vapors to the outside atmosphere. The residual broken or crushed tubes should be disposed of in a normal public trash disposal system. Tubes should be disposed of at a rate of not more than 100 each week from any one location. Avoid breathing vapors from broken tubes.

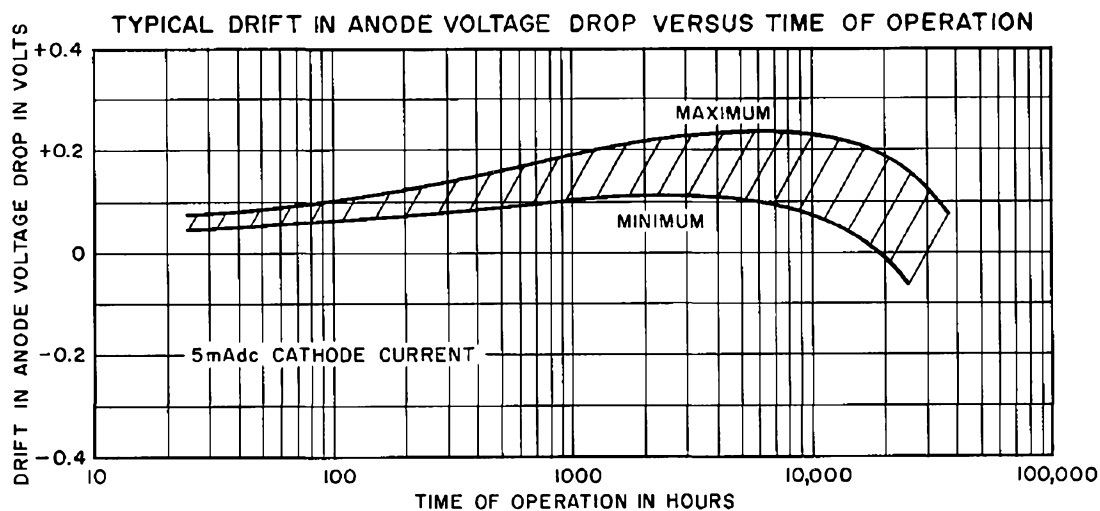

Note 1: In the "Absolute System" the maximum ratings specified are limiting values above which the serviceability of the device may be impaired from the viewpoint of life and satisfactory performance. Maximum ratings, as such, do not constitute a set of operating conditions and all values may not, therefore, be attained simultaneously.

Note 2: These values are for new tubes. Anode voltage drop will stabilize within 3 minutes after starting.

Note 3: The anode voltage drop variation during a short period of time (one to ten minutes), with the tube operating at one value of current and temperature within its ratings, will not exceed the above stated maximum value.

Note 4: With 15 volts overvoltage (15 volts above Anode Breakdown Voltage) with tube in total darkness. Average of 10 measurements taken at 1 second intervals.

Note 5: Regulation is defined to be Anode Voltage Drop (E_{td}) at 6 mAdc minus Anode Voltage Drop (E_{td}) at 4 mAdc.

Note 6: Voltage jump is an abrupt change or discontinuity in tube anode voltage drop when the tube current is varied. Voltage jumps greater than the specified value are relatively rare in the range of anode current of 4 to 6 mAdc.

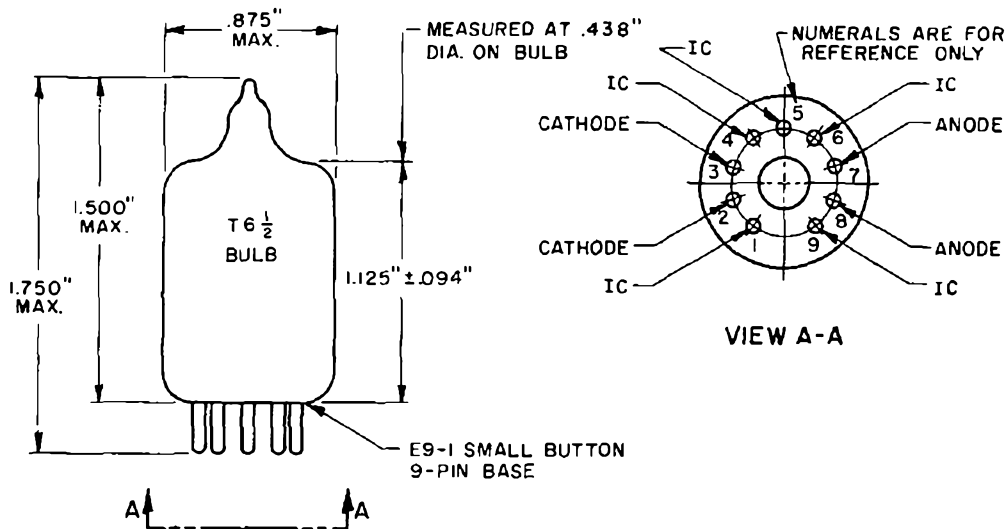

NOTE: PINS MARKED IC (INTERNAL CONNECTION) SHOULD NOT BE CONNECTED TO ANY PORTION OF AN EXTERNAL CIRCUIT. FAILURE TO OBSERVE THIS PRECAUTION MAY RESULT IN IMPROPER OPERATION OF THE TUBE.

A development of Bell Telephone Laboratories, the research laboratories of the American Telephone and Telegraph Company and the Western Electric Company.

PRINTED IN U. S. A.

ELECTRON TUBE DATA SHEET
WESTERN ELECTRIC 6167 ELECTRON TUBE

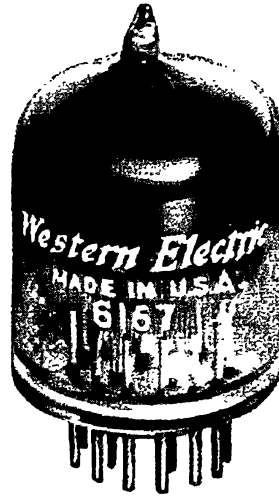

6167

DESCRIPTION

The 6167 is a ten-stage cold-cathode gas-discharge stepping tube designed for continuous counting or registration of pulses at rates up to 1000 pulses per second. Each stage consists of a stepping cathode (Bn) followed by an output cathode (Kn). Connections to each output cathode permit obtaining an output signal from each or any stage. A normal (zero) cathode is provided outside the counting ring and operates into the first stepping cathode (B1). The auxiliary anode can be operated to supply an additional output signal when current is carried from K10 cathode. The direction of forward transfer of discharge is in a clockwise direction and the position of the cathode glow may be observed through the top of the envelope.

FILE: COLD CATHODE SECTION
ISSUE 1, 6-52

6167

RATINGS, Absolute Values

Cathode Current	
Maximum Peak - - - - -	10 milliamperes
Maximum Average - - - - -	3 milliamperes
Minimum Average - - - - -	.1 milliampere
Maximum Averaging Time - - - - -	0.5 second
Maximum Inverse Anode or Auxiliary Anode Current	0.0 milliampere
Ambient Temperature Limits - - - - -	-55 to +60 centigrade

ELECTRICAL DATA¹

	<u>Min.</u>	<u>Bogey</u>	<u>Max.</u>	
Anode Voltage Drop - - - - -	---	110	---	volts
Anode Breakdown Voltage				
Output Cathodes and Normal Cathode - - - -	180	225	300	volts
Stepping Cathodes (B1-B10) - - - - -	150	190	250	volts
Auxiliary Anode				
Voltage Drop to Cathode K10 - - - - -	---	112	---	volts
Breakdown Voltage - - - - -	260	300	---	volts
Transfer Voltage ² to Cathode K10 - - - -	See Curve			
Transfer Voltage ^{2, 3} , to any Cathode except K10 - - - - -	260	290	---	volts
Cathode				
Forward Transfer Voltage ⁴ - - - - -	---	-10	-20	volts
Transfer Voltage Between Adjacent Output Cathodes ^{5, 6} - - - - -	-45	---	---	volts
Transfer Voltage Between Normal Cathode and Output Cathodes ⁶ - - - - -	-30	---	---	volts

MECHANICAL DATA

Mounting Position - - - - - Any
 Bulb - - - - - T9
 Dimensions and pin connections shown in outline on Page 4

- Note 1 All data are based on operation of the tube within average current ratings at the time of stepping or transfer of the discharge.
- Note 2 Voltage, with respect to an operating cathode, at which conduction occurs from the auxiliary anode to cathode indicated.
- Note 3 Measured with maximum K10 voltage of +50 volts with respect to the operating cathode.
- Note 4 Voltage, with respect to an operating cathode, applied to the adjacent forward cathode to transfer the discharge to that cathode.
- Note 5 Measured under static conditions. This is an absolute limit on output voltage but as frequency of operation is increased, the available output voltage is decreased because of residual ionization in the preceding cathodes.

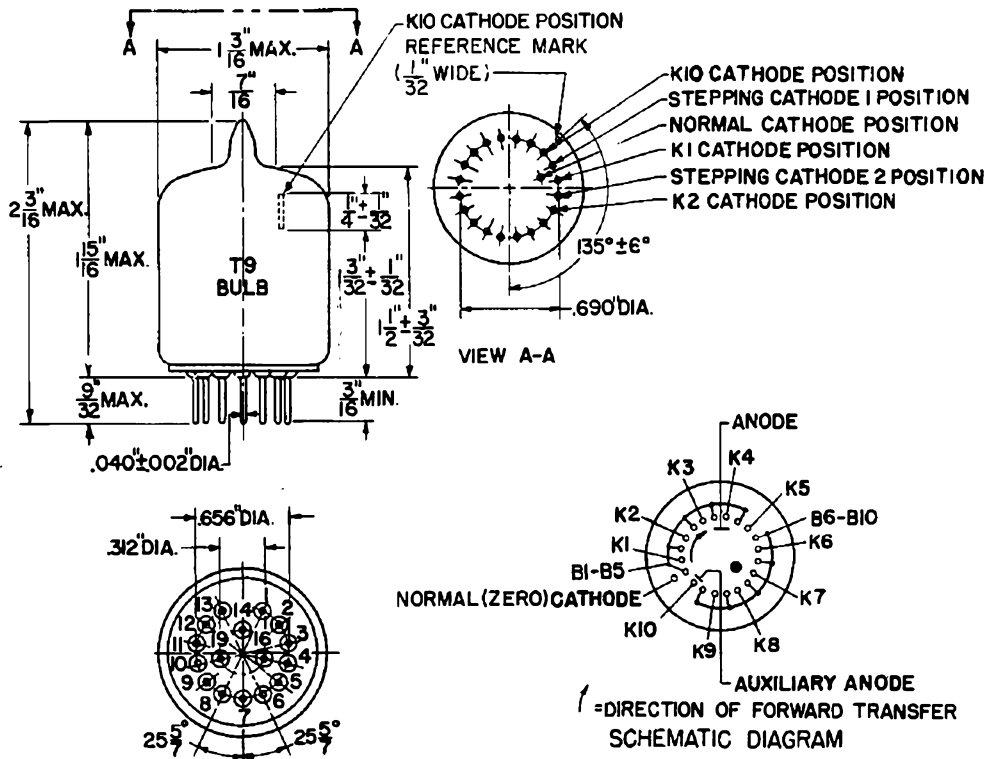

- PIN 1. OUTPUT CATHODE (K3)
- PIN 2. OUTPUT CATHODE (K2)
- PIN 3. OUTPUT CATHODE (K1)
- PIN 4. OUTPUT CATHODE (K10)
- PIN 5. AUXILIARY ANODE
- PIN 6. INTERNAL CONNECTION
- PIN 7. OUTPUT CATHODE (K9)
- PIN 8. OUTPUT CATHODE (K8)

- PIN 9. OUTPUT CATHODE (K7)
- PIN 10. OUTPUT CATHODE (K6)
- PIN 11. STEPPING CATHODES B6-B10
- PIN 12. OUTPUT CATHODE (K5)
- PIN 13. OUTPUT CATHODE (K4)
- PIN 14. STEPPING CATHODES B1-B5
- PIN 16. NORMAL CATHODE
- PIN 19. ANODE

NOTE - BASE PIN NO 6 MARKED "INTERNAL CONNECTION" SHOULD NOT BE CONNECTED TO ANY PORTION OF AN EXTERNAL CIRCUIT. FAILURE TO OBSERVE THIS PRECAUTION MAY RESULT IN IMPROPER OPERATION OF THE TUBE.

A development of Bell Telephone Laboratories, the research laboratories of the American Telephone and Telegraph Company and the Western Electric Company.

Note 6 Measured with maximum B1-B10 voltage of +20 volts with respect to the operating cathode.

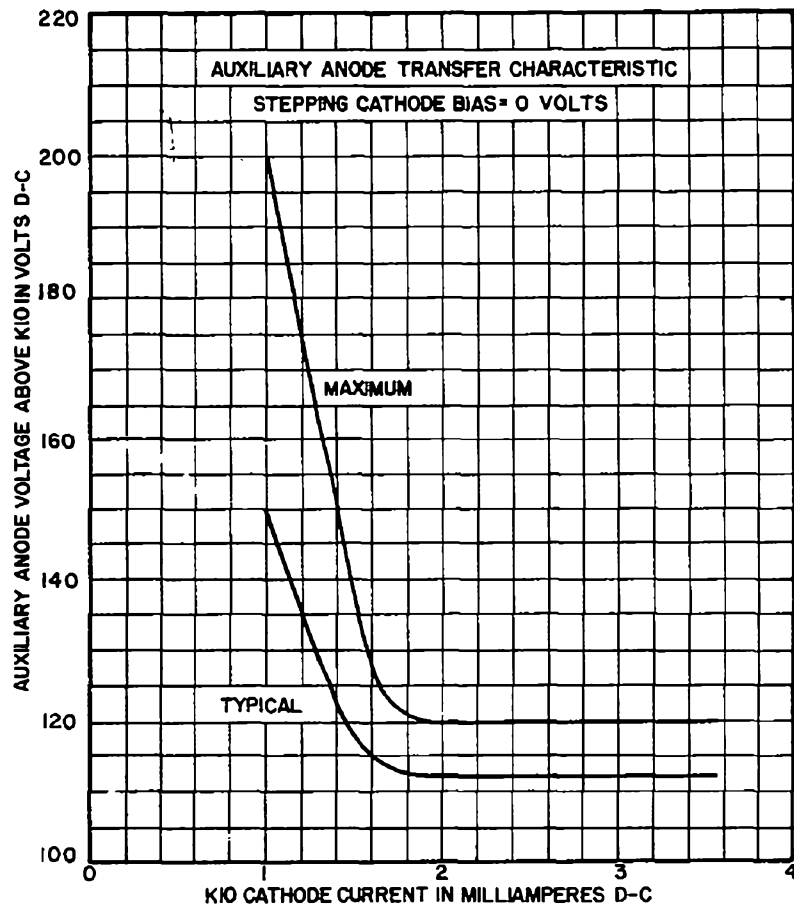

audiophile VALVE COMPARISON CHART

2002

12A7 = ECC81 = CV4024 = M8162 = 6201 = 6060 = B309 = CV455

12AU7 = ECC82 = CV4003 = M8136 = 5814 = 6189 = B329 = CV491

12AX7 = ECC83 = CV4004 = M8137 = 6057 = 5751 = B339 = CV492

12AY7 = 6072

6DJ8 = ECC35 = 6922

6SL7GT = ECC35 = CV1985 = 6188 = 5691

6SN7 = 5692

CV378 = CV729 = GZ37 = 5AR4 = GZ34

CV575 = 5U4G

6BQ5 = EL84

6550 = KT88

EL34 = KY77 = 6CA7

KT66 = 7581 = 6SL6 = 5881 = 6L6

300B = 6300B

2A3

211 = VT4C

845

We believe this list to be correct at the time of writing. If you have any comments or wish to add to the above list please feel free to do so.
You can e-mail your comments to audio@corplink.com.au