

**Mullard
technical
handbook**



**Book two
Valves and tubes**

Part one

**Receiving valves
Television picture tubes**

May 1973

RECEIVING VALVES, TELEVISION PICTURE TUBES

CONTENTS

SELECTION GUIDE



GENERAL SECTION—TV PICTURE TUBES

A



COLOUR PICTURE TUBES

B



MONOCHROME PICTURE TUBES

C



GENERAL SECTION—RECEIVING VALVES

D



RECEIVING VALVES

E



SPECIAL QUALITY RECEIVING VALVES

F



ABRIDGED DATA FOR EARLIER TYPES

G



INDEX



The issue of the information contained in this publication does not imply any authority or licence for the utilisation of any patented feature.

'Mullard' is the trademark of Mullard Limited and is registered in most of the principal countries of the world.

© Mullard Limited, May, 1973

Book 2 comprises the following parts—

- Part 1 Receiving valves, television picture tubes.
- Part 2 Electro-optical devices, radiation detectors.
- Part 3 Gasfilled tubes.
- Part 4 Transmitting and industrial heating tubes.
- Part 5 Microwave tubes and components.

Made and printed in England by WIGHTMAN & CO. LTD.



BOOK 2 (Part 1)

VALVES AND TUBES

Receiving valves

Television picture tubes

**MULLARD LTD., MULLARD HOUSE, TORRINGTON PLACE,
LONDON, WC1E 7HD**

Telephone: 01-580 6633

Telex: 264341

DATA HANDBOOK SYSTEM

The Mullard data handbook system is made up of three sets of books, each comprising several parts.

The three sets of books, easily identifiable by the colours of their covers, are as follows:

Book 1	(blue)	Semiconductor devices and integrated circuits
Book 2	(orange)	Valves and tubes
Book 3	(green)	Passive components, materials, and assemblies.

New editions will be issued at approximately yearly intervals.

The data contained in these books are as accurate and up to date as it is reasonably possible to make them at the time of going to press. It must however be understood that no guarantee can be given here regarding the availability of the various devices or that their specifications may not be changed before the next edition is published.

The devices on which full data are given in these books are those around which we would recommend equipment to be designed. Where appropriate, other types no longer recommended for new equipment designs, but generally available for equipment production are listed separately with abridged data. Data sheets for these types may be obtained on request. Older devices on which data may still be obtained on request are also included in the index of the appropriate part of each book.

Requests for information on the data handbook system and for individual data sheets should be made to

Central Technical Services
Mullard Limited
New Road
Mitcham
Surrey CR4 4XY.

Telephone: 01-648 3471

Telex: 22194

Information regarding price and availability of devices must be obtained from our authorised agents or from our representatives.

SELECTION GUIDE

SELECTION GUIDE — BOOK 2, PART 1

Section B

COLOUR PICTURE TUBES

All tubes are of the 3-gun, shadow mask type having push-through super square presentation and reinforced envelopes.

Overall diagonal cm in		Deflection angle	Type No.
56	22	90°	A56-120X
56	22	110°	A56-140X
66	26	90°	A66-120X
66	26	110°	A66-140X

Section C

MONOCHROME PICTURE TUBES

All types have reinforced envelopes.

Overall diagonal cm in		Presentation	Deflection angle	Type No.
31	12	Push-through	110°	A31-120W
31	12	Push-through. Quick heating	110°	A31-410W
44	17	Push-through. Super square	110°	A44-120W/R
50	20	Push-through. Super square	110°	A50-120W/R
61	24	Push-through. Super square	110°	A61-120W/R

In the type number, the suffix/R indicates that a ring trap base is fitted to the tube. Tubes without a ring trap base are available under the same type number but with the suffix omitted.

Section E — RECEIVING VALVES

Diodes and rectifiers

Description	Type No.
Disc seal diode for measurements at frequencies up to 1 MHz	EA52
E.H.T. rectifier. P.I.V. max. 25kV. I_{oat} max. 500 μ A	DY802
Booster diode. P.I.V. max. 5.6kV. I_a (av) max. 440 μ A. For colour TV	PY500A
Booster diode. P.I.V. max. 5.75kV. I_a (av) max. 175mA	PY800
Booster diode. P.I.V. max. 6.6kV. I_a (av) max. 220mA	PY88

Section E—RECEIVING VALVES (cont.)

Double triodes

Description	Type No.
Double triode. $\mu = 17$	ECC82
Double triode. $\mu = 60$	ECC81
Double triode. $\mu = 100$	ECC83

R.F. pentodes

Description	g_m (mA/V)	V_a (V)	V_{g2} (V)	V_{g1} (V)	Base	Type No.
Sharp cut-off	7.4	170	170	-2	B9A	EF80
Sharp cut-off. Frame grid	15	200	200	-2.5	B9A	EF184
Dual control, g_1 and g_3	3.2	120	120	-2	B7G	6AS6
Variable-mu. Frame grid	12.5	200	90	-2	B9A	EF183

Power pentodes

Description	Type No.
Line output	PL504
Line output for colour TV	PL509
Field output for colour TV	PL508
Video output for colour TV	PL802

Triode pentodes

Description	Type No.
Audio amplifier and output for TV	PCL86
Line oscillator	PCF802
Field oscillator and output	PCL805
Video output and sync circuits	PCL84

Double pentode

Description	Type No.
R.F. pentode and video output pentode	PFL200

Section F—SPECIAL QUALITY RECEIVING VALVES

Special quality triodes and double triodes

Description	Type No.
R. F. power triode	M8080
Double triode. $\mu = 17$	M8136
Double triode. $\mu = 90$	M8137
V.H.F. double triode. Common cathode	M8081
Double triode for computers and cascode circuits. $\mu = 33$	E88CC

Special quality pentodes

Description	Type No.
High slope wideband output pentode $g_m = 45 \text{ mA/V}$	E55L
High slope wideband r.f. pentode $g_m = 16.5 \text{ mA/V}$	E180F
High slope wideband r.f. pentode $g_m = 50 \text{ mA/V}$	E810F
Sharp cut-off r.f. pentode $g_m = 7.6 \text{ mA/V}$	M8083
Low noise r.f. pentode	M8100
Dual control r.f. pentode (g_1 and g_3)	M8196
Variable- μ r.f. pentode	M8161
L.F. output pentode	M8082

Special quality voltage indicator

Description	Type No.
Long life, subminiature tube for voltage indication, e.g. the output level of flip-flops in computer circuits, etc.	DM160

GENERAL SECTION
TELEVISION PICTURE TUBES

A 



TELEVISION PICTURE TUBES

PICTURE TUBE NOMENCLATURE

TYPE NUMBER SYSTEM

Mullard cathode ray tubes are registered by Pro-Electron. The type number consists of a single letter followed by two sets of figures and ending with a letter.

The first letter indicates the prime application of the tube:—

A—Television picture tube for domestic application.

The first group of figures indicates the diameter or diagonal of the screen in cm.

The second group of figures is a two- or three-figure serial number indicating a particular design or development.

The concluding letter indicates the properties of the phosphor screen:—

W—White screen for television picture tubes

X—Three colour screen for television picture tubes.

Example

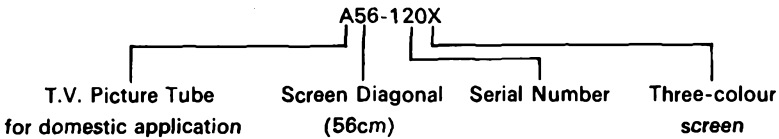



The following recommendations should be interpreted in conjunction with British Standard Code of Practice No. CP1005: (1962), 'The Use of Electronic Valves', upon which these notes have, in part, been based.

RATING SYSTEMS (in accordance with I.E.C. Publication 134)

Note: Limiting conditions may be either maxima or minima.

Absolute maximum rating system

Absolute maximum ratings are limiting values of operating and environmental conditions applicable to any electronic device of a specified type as defined by its published data, which should not be exceeded under the worst probable conditions.

These values are chosen by the device manufacturer to provide acceptable serviceability of the device, taking no responsibility for equipment variations, environmental variations, and the effects of changes in operating conditions due to variations in the characteristics of the device under consideration and of all other electronic devices in the equipment.

The equipment manufacturer should design so that, initially and throughout life, no absolute-maximum value for the intended service is exceeded with any device under the worst probable operating conditions with respect to supply voltage variation, equipment component variation, equipment control adjustment, load variation, signal variation, environmental conditions and variations in characteristics of the device under consideration and of all other electronic devices in the equipment.

Design-maximum rating system

Design-maximum ratings are limiting values of operating and environmental conditions applicable to a bogey electronic device of a specified type as defined by its published data, and should not be exceeded under the worst probable conditions.

These values are chosen by the device manufacturer to provide acceptable serviceability of the device, taking responsibility for the effects of changes in operating conditions due to variations in the characteristics of the electronic device under consideration.

The equipment manufacturer should design so that, initially and throughout life, no design-maximum value for the intended service is exceeded with a bogey device under the worst probable operating conditions with respect to supply-voltage variation, equipment component variation, variation in characteristics of all other devices in the equipment, equipment control adjustment, load variation, signal variation and environmental conditions.

Design-centre rating system

Design-centre ratings are limiting values of operating and environmental conditions applicable to a bogey electronic device of a specified type as defined by its published data, and should not be exceeded under normal conditions.

These values are chosen by the device manufacturer to provide acceptable serviceability of the device in average applications, taking responsibility for



normal changes in operating conditions due to rated supply-voltage variation, equipment component variation, equipment control adjustment, load variation, signal variation, environmental conditions, and variations in the characteristics of all electronic devices.

The equipment manufacturer should design so that, initially, no design-centre value for the intended service is exceeded with a bogey electronic device in equipment operating at the stated normal supply-voltage.

HEATER

Parallel Operation

The heater voltage must be within $\pm 7\%$ of the rated value when the supply voltage is at its nominal rated value, and when a tube having the published heater characteristics is employed.

This figure is permissible only if the voltage variation is dependent upon more than one factor. In these circumstances the total tolerance may be taken as the square root of the sum of the squares of the individual deviations arising from the effects of the tolerances of the separate factors, providing no one of these deviations exceeds $\pm 5\%$. Should the voltage variation depend on one factor only, the voltage variation must not exceed $\pm 5\%$.

Series Operation

The heater current must be within $\pm 5\%$ of the rated value when the supply voltage is at its nominal rated value, and when a tube having the published heater characteristics is employed.

This figure is permissible only if the current variation is dependent upon more than one factor. In these circumstances, the total tolerance may be taken as the square root of the sum of the squares of the individual deviations arising from the effects of the tolerances of the separate factors, providing no one of these deviations exceeds $\pm 3.5\%$. Should the total current variation depend upon one factor only, the current variation must not exceed $\pm 3.5\%$.

When calculating the tolerances of associated components, the ratio of the change of heater voltage to the change of heater current in a typical series chain including a cathode ray tube is taken as 1.8, both deviations being expressed as percentages.

With certain combinations of valves and tube, differences in the thermal inertia may result in particular heaters being run at exceedingly high temperature during the warming-up period. During this period, unless otherwise stated in the published data, it is permissible for the heater voltage of the tube to rise to a maximum value of 50% in excess of the nominal rated value when using a tube with the published heater characteristics. A surge limiting device may be necessary in order to meet this requirement. When measuring the surge value of heater voltage, it is important to employ a peak reading device, such as an oscilloscope.

Mains Variations

In addition to the tolerances quoted above, fluctuations in the mains supply voltage not exceeding $\pm 10\%$ are permissible. These conditions are, however, the worst which are acceptable and it is better practice to maintain the heater as close as possible to its published nominal, particularly in television equip-

ment where changes in valve characteristics can have an appreciable effect upon the picture. Furthermore, in all types of equipment closer adjustment of heater voltage or current will react favourably upon valve and tube life and performance.

Stand-by Operation

It is permissible to operate picture tubes in the 'stand-by' condition (for 'instant on' applications). In order to ensure satisfactory life the heater voltage should be decreased to 75% of its nominal value.

CATHODE

The potential difference between cathode and heater should be as low as possible and in any case must not exceed the limiting value given on the data sheets for individual tubes. Operation with the heater positive with respect to cathode is not recommended. In order to avoid excessive hum the a.c. component of the heater-to-cathode voltage should be as low as possible and should be less than $20V_{r.m.s.}$. When the heater is in a series chain or earthed, the 50Hz impedance between heater and cathode should not exceed $100k\Omega$. If the heater is supplied from a separate transformer winding the resistance between heater and cathode should not exceed $1M\Omega$.

INTERMEDIATE ELECTRODES (between cathode and final anode)

In no circumstances should the tube be operated without a d.c. connection between each electrode and the cathode. The total effective impedance between any electrode and the cathode should be as low as possible and must never be allowed to exceed the published maximum value.

However, no electrode should be connected directly to a high energy source such as the h.t. line. When such a connection is required, it should be made via a series resistor of not less than $1k\Omega$.

Grid

The value of grid bias must not be allowed to become positive with respect to the cathode, except during the period immediately after switching the receiver on or off when it may be allowed to rise to +2V. The maximum positive grid excursion of the video signal under normal operating conditions is permitted to reach 5V (peak). In order to ensure that this limit is not exceeded it is suggested that an unbypassed resistor of $10k\Omega$ is inserted in series with the lead to the control grid.

Grid cut-off voltages

Curves showing the limits of grid cut-off voltage for specific values of first anode voltage are included in the data for individual tubes. The brightness control should be arranged so that it can handle any tube within the limits shown, at the appropriate first anode voltage (which is measured with respect to cathode).

LUMINESCENT SCREEN

To prevent permanent damage to the screen material care should be taken

- (a) not to operate the tube with a stationary picture at high beam currents for extended periods
- (b) not to operate the tube with a stationary or slowly moving spot except at extremely low beam currents
- (c) that immediately after switching off the equipment the screen be discharged. This can be effected by choosing the time constants of the grid and the first anode circuits such that a beam current is maintained during a period sufficiently long to discharge the screen.

EXTERNAL CONDUCTIVE COATING

Picture tubes are provided with an external conductive layer which, in conjunction with the internal conductive layer, forms a high voltage capacitor of specified value. This capacitor is intended to provide smoothing for the e.h.t. supply.

In making contact with the external coating it is necessary to take into account large currents which flow during a discharge inside the picture tube. In order not to exceed the current carrying capacity of the coating, the contact should be made over a large area. As a minimum requirement, a copper braid should be stretched diagonally across the cone and a connection taken from its centre to the receiver.

A further improvement would be to provide two diagonal braids, connected at their point of crossing. Since the coating is not a perfect conductor, a well executed connection helps to reduce r.f. radiation.

During a flashover, large voltages are expected to be produced across the coating. In order to minimise circulating currents in the chassis, there should be only one point connection between the coating and chassis. The coating itself should be well insulated from the rest of the receiver. See section headed 'Flashover'.

FINAL ANODE

Every care should be taken to prevent discharges from the e.h.t. line. During such occurrences, currents of high amplitude are injected into the chassis and these can significantly alter the operating conditions of the devices employed. With semiconductor devices there is a risk of permanent damage. In addition a repeated discharge of this nature may damage the contact between the internal conductive coating of the tube and the final anode connector, thus impairing performance.

In applications where it is not possible to ensure complete freedom from discharges, a series resistor of not less than 10 k Ω should be fitted to the final anode connector. The resistor and its mounting should be able to withstand full e.h.t. voltage.

Similarly, when it is required to discharge the picture tube capacity, connection should be made via a resistor of not less than 10k Ω , capable of handling high voltages.

MOUNTING BAND

An appreciable capacity is formed between the metal mounting band and the internal conductive layer of the tube; its value is quoted in the individual data sheets. In order to avoid a possibility of electric shock, a d.c. connection should be provided between the metal band and the rest of the receiver.

In receivers where the chassis can be connected directly to the mains there is a risk of electric shock if access is gained to the metal band through the mask at the front of the receiver. In order to reduce the magnitude of the shock to the safe limit, it is suggested that a $2M\Omega$ resistor, capable of handling peak voltages of full e.h.t. value, be inserted between the metal band and the point of contact to the external coating. This safety arrangement will provide the necessary isolation from the mains but in the event of flashover, high voltages of low energy will be induced on the metal band. Any electric shock is within safe limits if the above precautions have been adopted but it is normally desirable to avoid access to the band.

FLASHOVER

Picture tubes, in common with other high voltage vacuum devices, are prone to internal flashover. During a breakdown, an arc is established between an electrode connected to the e.h.t. capacitor and an electrode terminated in a pin on the foot of the tube. Resulting transient currents and voltages produced in external circuits may be of sufficient magnitude to cause damage to various components on the chassis. The discharge is terminated when the e.h.t. capacitor is unloaded and during the subsequent recharging period an additional load is imposed on the e.h.t. generator. It is of vital importance to provide protective measures, particularly when semiconductor devices are employed.

A sufficient degree of protection against transients can be obtained by connecting suitable spark-gaps between each pin and a common point. From this common point a direct connection should be made to the external coating of the tube. In place of the normal connection between the coating and the chassis a connection should be made between the chassis and the common point. In addition, resistors should be fitted in series with each supply lead to the pins of the tube. These resistors should be able to handle high voltages; their value is a function of the degree of protection needed. As a guide, the following values are suggested: cathode— $1.5k\Omega$, grid— $8.2k\Omega$, first anode— $22k\Omega$, focus electrode (monochrome)— $22k\Omega$, focus electrode (colour)— $100k\Omega$. The resistors and the spark-gaps should be mounted close to the tube socket.

In the case of transistor circuits, protection against overload of the e.h.t. generator may consist of a resistor placed in series with the supply line to the output transformer. Its value should be adjusted to limit the increase in the peak collector voltage to, say, 20%. Similar results can be obtained with desaturated line output transformers, provided that a small coupling capacitor is used.

HANDLING

A large amount of potential energy is stored in the picture tube by virtue of its vacuum. Modern tubes are provided with integral implosion protection

which conforms with internationally agreed standards. With these tubes no additional protection is needed.

When a tube is not in its equipment or original packing it should be placed screen downwards on a soft pad of suitable material free from abrasive substances.

All tubes should be handled by the bulb end. Stresses on the neck should be avoided.

Attention is called to the fact that a high voltage charge may be carried by the internal conductive coating which is connected to the final anode connector and also by the external coating if not earthed, even after a tube has been removed from equipment. Anyone handling such a tube may receive a shock which, while generally not dangerous to the person, might cause an involuntary reaction resulting in damage to the tube, which might, for example, be dropped.

For discharging the capacitor see the section 'Final Anode'.

MOUNTING

Unless otherwise specified there is no restriction on the mounting position. Picture tubes with integral implosion protection are provided with mounting lugs. Published data give tolerances of the positioning of the lugs with respect to each other and with respect to the place they expect to occupy. This information should be taken into account in the design of suitable supports.

The deflection coils and other ancillary components should be mounted directly on the neck of the tube, care being taken to avoid scratches. No support is required for the neck which should be allowed to assume its own position.

Similarly, the tube socket should not be rigidly mounted but should have flexible leads and be allowed to move freely.

STRAY MAGNETIC FIELDS

Picture tubes are sensitive to any magnetic fields in their vicinity (including the earth's magnetic field). In a television receiver, stray magnetic fields may be generated by such components as the loudspeaker, mains transformers, chokes, field output transformer etc. Under influence of these fields there may be distortion in the raster geometry and in some cases they may be responsible for the astigmatic appearance of the focused spot. With colour tubes there can be additional difficulties with purity and convergence. Thus, every effort should be made to reduce stray magnetic fields to an acceptable level.

DIMENSIONS

Allowance should be made in the design of the equipment for the dimensional tolerances of the tube envelope and reliance should not be placed upon dimensions taken from individual tubes.

REFERENCE LINE

The reference line indicated on the tube outline drawing is determined by means of a suitable gauge. Drawings of several gauges follow these general operational recommendations.

X-RADIATION

Unless otherwise stated, picture tubes for television applications are designed not to exceed the permissible limit dose rate of 0.5mr/h as measured in the manner specified by the I.E.C. This is provided that they are operated within their published data limits and in applications for which they are primarily intended.

X-radiation from a picture tube increases very rapidly with applied voltage. This should be taken as a warning for any experiments involving potentials in excess of values quoted in the published data.

CORNER CUTTING OR NECK SHADOWING

Corner cutting is caused by a direct interception of the deflected electron beam before it reaches the screen and results in a non-scanned corner of the raster and in some cases piercing of the tube neck. It may be avoided by an appropriate deflection unit correctly adjusted.

RASTER CENTRING (see also Colour Tube Notes)

To centre the raster on the screen it is recommended that either a magnetic field just behind (viewed from the screen) the deflection coils be used or a direct current be passed through the deflection coils.

The centring device should provide a shift to allow for non-centrality of the spot with respect to the geometric centre of the screen. In addition, the centring device should provide the shift needed to allow for non-centrality of the visible raster (i.e. to compensate for line blanking and also time base non-linearity, if any) and the earth's magnetic field.



COLOUR TUBE NOTES

INTRODUCTION

Mullard shadow-mask colour television tubes are capable of displaying pictures in full colour or in black and white. They have reinforced envelopes and therefore do not need any additional implosion protection. Integral mounting lugs are provided on the tubes.

OPERATING PRINCIPLES

The tube has three electron guns, spaced 120° apart, with their axes tilted towards the screen. Because of the different angles at which the electron beams from the three guns reach the shadow-mask, the beam from one gun lands only on phosphor dots of one primary colour. Thus three colour signals applied to the three guns produce three superimposed colour pictures in the primary colours. These colour pictures are integrated by the eye, and are seen as one picture either in full colour or in black and white.

The beams from the three guns are made to converge at the screen by means of external magnetic convergence components. The radial convergence assembly provides radial adjustment of the three beams, whilst the lateral convergence assembly provides lateral adjustment of the blue beam relative to the red and green beams.

The three electron guns have tri-potential focus lenses, and focusing of the beams is carried out by adjusting the voltage on the common focus pin.

Correct landing of the electron beams on phosphor dots of the intended colour is accomplished by means of a purity magnet external to the tube neck, together with correct positioning of the deflection coil assembly.

It is essential that the electron beam is shielded from extraneous magnetic fields (including the earth's magnetic field) and that both the tube and the shielding are effectively degaussed.

APPLICATION NOTES

Magnetic shielding

The 90° colour tube should be provided with a magnetic shield on the cone of the tube. Essential dimensions of this shield are shown in the data. It should be constructed from cold-rolled mild steel of minimum thickness 0.5mm, annealed at 850°C . Since the tube reinforcing band is an essential part of the magnetic circuit used for degaussing, the air gap between the band and the shield should be as small as possible and should not exceed 10mm. Degaussing is described under 'Adjustment Procedures'.

The 110° colour tube incorporates an internal magnetic shield.

Raster centring

Contrary to common practice with black and white television, where centring of the raster on the screen is accomplished by means of centring magnets which are mounted on the deflection coil, with a shadow-mask type of colour tube such magnets would impair colour purity and convergence. Raster centring is therefore attained by passing direct current of the required value through each pair of deflection coils. The values of raster displacement given in the data apply when all components are correctly adjusted.

Component considerations

For optimum purity, the electrical centre of deflection of the deflection coil must coincide with that used for the positioning of the phosphor dots on the screen during manufacture of the tube. The coil must, therefore, be designed so that axial adjustment of its position on the tube neck is provided.

The radial convergence assembly has to be positioned so that its pole pieces are opposite the internal pole pieces which form part of the gun structure. (See drawings in the data). Small rotational adjustment of the radial convergence assembly may be used during adjustment of the blue lateral positioning to obtain optimum lateral convergence.

The purity magnets should be positioned over the gap between the focus electrodes and the final anodes of the electron gun structure. Placing them nearer than this to the cathodes of the gun may adversely affect tube performance (due to a deterioration of spot shape, and in some cases to beam shadowing resulting in lower brightness and poor grey scale tracking).

The blue lateral convergence assembly should be placed as near as possible to the rear side of the purity magnets, and should always be nearer to the screen than the centre of the focus electrodes.

Convergence

Static convergence, i.e. convergence of the three beams at the centre of the screen, is usually accomplished with permanent magnets which are part of the radial convergence assembly, or with direct currents through the convergence coils, in combination with the lateral magnet.

The strength of the magnetic field that is coupled to the radial convergence pole pieces of the gun should be such that each beam can be moved radially over the distance given in the data at the centre of the screen. The static lateral convergence magnet should provide a magnetic field adjustable in magnitude and polarity. This field causes a movement of the blue beams and simultaneously a movement in the opposite direction of the green and red beams.

The maximum lateral displacement of the blue beam opposite to the movement of the red and green beams is given in the data. With these four adjustable magnetic fields, static convergence of the three beams can be attained.

For convergence over the entire screen, dynamic radial convergence is required together with a small amount of dynamic blue lateral convergence in line direction.

The radial convergence assembly consists fundamentally of three cores with associated windings. Through the windings are passed the necessary convergence currents for maintaining convergence when the beams are deflected over the screen. The required form of the currents can be obtained by adding a parabolic current waveform to one with a sawtooth waveform. Two separate windings per core are required for correction in horizontal and vertical directions. The parabolic and sawtooth currents should be adjustable in amplitude, and the sawtooth currents and the vertical blue parabola should also be adjustable in polarity.

The lateral convergence assembly, with a core and associated windings, provides dynamic blue lateral convergence in the line direction.

Purity

Optimum purity is achieved by means of adjustments to both the purity magnet and the deflection coil.

(a) Purity magnet

This magnet is required to compensate for the effects of extraneous magnetic fields, including the earth's magnetic field, and manufacturing variations within the shadow-mask picture tube, which could cause purity errors. The magnet should be designed to provide a field which is adjustable in both strength and direction.

(b) Deflection coil

The deflection coil should be free to move a minimum of 13mm axially along the tube neck in order to achieve optimum purity on all tubes. If purity is to be set by the 'Red ball' method (see section 'Purity adjustment') this movement is required to be 20mm.

Drive requirements

In order to calculate the voltages which should be supplied by the drive output stages in a colour television receiver, the following points should be taken into consideration:

(a) The equation for the luminance signal is given by $Y = 0.30R + 0.59G + 0.11B$. The two chrominance signals, after subcarrier detection, give colour difference signals of $R-Y$, $G-Y$ and $B-Y$, which, when combined with the luminance signal in a matrixing circuit, give the red, green and blue signals. This matrixing may be performed either (i) by the tube itself (this is known as colour difference drive) or (ii) by means of a separate matrixing circuit (R, G, B drive). Method (i) can be achieved by driving the cathodes with the luminance signal and the control grids with the colour difference signals. However, there is a difference in slope between grid drive and cathode drive, and to compensate for this, higher drive voltages are required for grid drive. The relationships between drive voltage (V_{dr}) and beam current (I) for both cathode drive and grid drive are given by the following equations:

(i) for grid drive

$$I = k \frac{V_{dr}^3}{V_{co}^{\frac{3}{2}}} \quad (\text{where } V_{co} \text{ is the cut-off voltage for grid drive),}$$

(ii) for cathode drive

$$I = \frac{k(1+D)^3 V_{dr}^3}{\left[1 + D \frac{V_{dr}}{V_{co}}\right]^{\frac{3}{2}} V_{co}^{\frac{3}{2}}} \quad (\text{where } D \text{ is the penetration factor).}$$

These equations illustrate that there is a difference in slope between the two driving methods, and also that the relationships are slightly non-linear. As in practice only a constant ratio between grid and cathode drive can be achieved a compromise has to be chosen, and the most favourable results are obtained when the grid signals are made 20% larger than the corresponding cathode signals for the nominal tube.

For method (ii) a separate matrixing circuit is required which delivers red, green and blue signals to the picture tube. These signals may be applied either to the cathodes or to the grids, but if to the latter, higher drive voltages are required.

- (b) There are 3 spreads in picture tube properties which influence the drive requirements. These are perveance, penetration and phosphor efficiencies. Perveance has a nominal value of 3.0, with a spread of 2.6 to 3.1. Penetration has a nominal value of 0.29 with a spread of 0.18 to 0.40. The spread in phosphor efficiencies is shown by the ratios of cathode currents to produce white of colour co-ordinates $x = 0.281$, $y = 0.311$:

$$\frac{I_R}{I_G} = 0.9 \text{ nominal, } 0.65 \text{ min, } 1.25 \text{ max.}$$

$$\frac{I_R}{I_B} = 1.0 \text{ nominal, } 0.75 \text{ min, } 1.35 \text{ max.}$$

By reference to the equation for the luminance signal given in (a), it is possible to calculate the maximum voltage ranges for the colour difference signals. These are reached when the primary colours and the complementaries are produced at maximum brightness. These values are tabulated below. All values are referred to the maximum value $Y = R = G = B = 1$ for peak white and are considered as positive if they cause an increase in beam current.

Colour	R	G	B	Y	R-Y	G-Y	B-Y
Red	1	0	0	0.3	0.7	-0.3	-0.3
Green	0	1	0	0.59	-0.59	0.41	-0.59
Blue	0	0	1	0.11	-0.11	-0.11	0.89
Cyan	0	1	1	0.7	-0.7	0.3	0.3
Magenta	1	0	1	0.41	0.59	-0.41	0.59
Yellow	1	1	0	0.89	0.11	0.11	-0.89

Signal	Minimum	Maximum	Total Range
R-Y	-0.7	0.7	1.4
G-Y	-0.41	0.41	0.82
B-Y	-0.89	0.89	1.78

Raster shape correction

Unlike black and white television, where correction for raster shape can be obtained by adding small permanent magnets to the deflection coil, with colour television such magnets would cause an unacceptable deterioration of purity and convergence. Raster shape correction can therefore be obtained by dynamic correction of the scanning current waveforms.

ADJUSTMENT PROCEDURES



For detailed, illustrated information on adjustment procedures for colour television picture tubes, a Mullard publication (Ref. No. TP1020) is available under the title "Colour Television—a background to colour tube adjustments for the Service engineer."

Initial adjustments

The following procedures are recommended to provide optimum colour purity and convergence of the three beams over the entire screen area, and to provide correct grey-scale tracking.

Before any adjustments are carried out, the tube and its surroundings must be degaussed. This can be achieved either by an automatic degaussing circuit built into the receiver, or by manual degaussing. If it is to be done manually a suitable coil for 240 V_{r.m.s.} consists of 840 turns of 0.7mm dia. enamelled copper wire wound on a former of approximately 300mm diameter. The coil should be moved so that the entire screen and the magnetic shield are subjected to its magnetic field, and after about 10 seconds it should be moved away from the tube to a distance of at least 2.5 metres before it is disconnected from the a.c. supply. All ferrous material in the vicinity of the tube must also be degaussed in a similar manner, with the receiver switched on.

Before deflection power and high voltage are applied to the tube, the bias control should be set to cut-off. After deflection power and high voltage are applied, the bias should be gradually reduced to minimise the possibility of tube damage in the event of circuit faults. Whilst the tube is reaching a stable operating temperature (which takes about 15 minutes at 25kV and the recommended average current) initial adjustment of focus, height, width, linearity and raster centring should be made.

Static convergence adjustment

A crosshatch pattern is the most suitable signal for convergence adjustments, and for maximum accuracy it should be displayed at medium brightness.

It is recommended that the red and green beams are converged first, with the blue gun biased off, followed by convergence of the blue beam on to the yellow pattern formed by the coincident red and green lines. The red and green lines are made to converge in the centre by means of the permanent magnets (or direct current through the coils) of the radial convergence assembly. The blue lines are then made to converge in a vertical direction on to the yellow lines formed by red and green, by means of the blue control on the radial convergence assembly. Any residual horizontal displacement of the blue lines is corrected by means of the blue lateral control situated further back on the tube neck. When these adjustments have been properly carried out, all three patterns will be converged in the centre of the screen, resulting in a white crosshatch.

Purity adjustment

Purity adjustments are best carried out on an unmodulated raster, and the sequence of operation is (i) adjustment of the purity magnet and (ii) axial adjustment of the position of the deflection coil. Adjustment of the purity magnet may be carried out by one of three methods:

Method 1

A microscope is used to observe the landing of the electron beam triads relative to the screen phosphor dot triads. The phosphor dots may be illuminated by means of an external light source, shining on the screen at an angle of approximately 10° to 15° . With all three guns on, a microscope with a magnification of $40\times$ to $50\times$ is used to observe the relative positions of the electron beam triads and the phosphor dot triads at the centre of the screen. The purity magnet should be adjusted so that the geometric centres of the two triads coincide. (It should be noted that for optimum overall purity, the colour tube is manufactured with a centre landing such that the electron spots are slightly inset from the phosphor dots in each triad.)

Method 2 (Red ball method)

The green and blue guns are biased off and the deflection coil is pulled back towards the base until a red area of approximately 100mm diameter is visible on the screen, surrounded by discoloured and blue and green areas. This requires a movement of the deflection coil of approximately 20mm from its most forward position when it is in contact with the cone of the tube. The purity magnet is then adjusted so that the centre of the red area is positioned approximately 20mm in the 8 o'clock direction from the screen centre (i.e. in the direction of the red gun). The deflection coil should then be pushed forward (see note).

Method 3 (Improved red ball method)

The red ball is obtained by writing a normal red raster and placing a specially made coil in front of the screen. This coil, which is thin and circular in shape, is placed in intimate contact with the tube face, its axis coincidental with the tube axis. The coil is fed with a direct current and the resulting field causes a rotation of the beam landing so that a clearly defined red ball appears within the area of the coil. Adjustment of the purity magnets will enable the correct positioning of the red ball.

For full description of the method see 'Mullard Product Note TP1264'.

After the purity magnet has been adjusted by one of the methods given above, the red gun only is turned on, and the deflection coil is positioned so that a pure red raster is achieved all over the screen area. The green and blue rasters should now be checked, and very slight adjustments of the deflection coil position should be made, if necessary, to obtain pure red, green and blue rasters. If this cannot be achieved, the procedure should be repeated.

Note:

Purity adjustment by means of a microscope affords direct visual indication of the beam landings within phosphor dots. In addition, the results can be accurately checked when the deflection coils are adjusted for the best overall purity. Hence, any errors arising out of repositioning of deflection coils are eliminated.

In contrast, the 'red ball' method is an indirect approach to the problem of purity adjustment. There is no way of offsetting the errors which may be produced when the coils are moved to the position giving overall purity. For the majority of tubes the total errors thus generated may be small but with some, however, they can reach significant proportions.

The red ball method may lead to local overheating of the tube neck by intercepted electrons if a heavy beam current is drawn while the scan coils are pulled back. This may result in electrostatic piercing of the neck. To avoid this effect, the scan coils must be fully forward during the warming up and pre-adjustment period. The adjustment time during which the scan coils are pulled back must be kept to an absolute minimum. During this time the average beam current must not exceed 200 μ A per gun.

Dynamic convergence adjustment

As with static convergence, a crosshatch pattern at medium brightness is recommended. During the dynamic convergence adjustment, it may be found that static convergence needs re-adjusting to maintain correct convergence. The actual procedure for dynamic convergence depends upon the receiver circuitry, but it is recommended that vertical convergence be carried out first, using the centre vertical line of the pattern as the criterion, followed by horizontal convergence, using the horizontal line as the criterion. By repeated adjustments of the controls, the lines in the three colours on these two axes ultimately become parallel to each other, and can be made to coincide by means of the static controls. After convergence on these two axes is obtained, the maximum misconvergence in the corners of the screen area should not exceed 2.5mm. Slight re-adjustment may be tried to improve the overall convergence.

After dynamic convergence has been completed, purity should again be checked, and re-adjusted, if necessary, by means of the purity magnet.

Grey scale tracking

This adjustment takes place last of all, and again the detailed procedure for the adjustments depends upon the receiver circuitry.

The general sequence of operations is as follows:—

- (a) With the cathode-to-grid voltages of all three guns set to the potential which corresponds to black level, adjust the a_1 voltages of each gun so that each of the three rasters is just not visible.
- (b) Increase the brightness, and adjust the drive voltages to obtain white.
- (c) Reduce the brightness so that the picture just remains visible. Re-adjust the cut-off voltages to obtain the same white as in (b).
- (d) Repeat (b) and (c) until passage through the whole black-to-white scale ceases to affect the colour.

REFERENCE LINE GAUGES

D4403

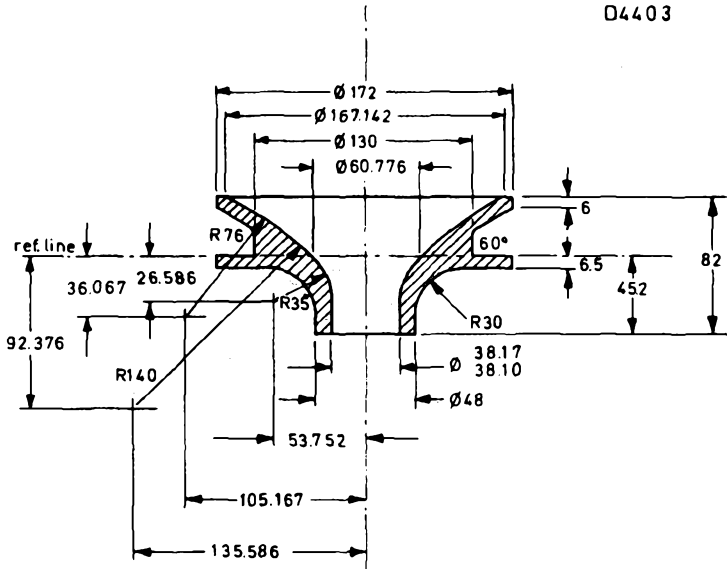

Reference line gauge

All dimensions in mm

REFERENCE LINE GAUGE FOR COLOUR CATHODE RAY TUBES HAVING
110° SCANNING ANGLES AND A NECK DIAMETER OF 36.5mm

GENERAL OPERATIONAL RECOMMENDATIONS

TELEVISION PICTURE TUBES

B6084

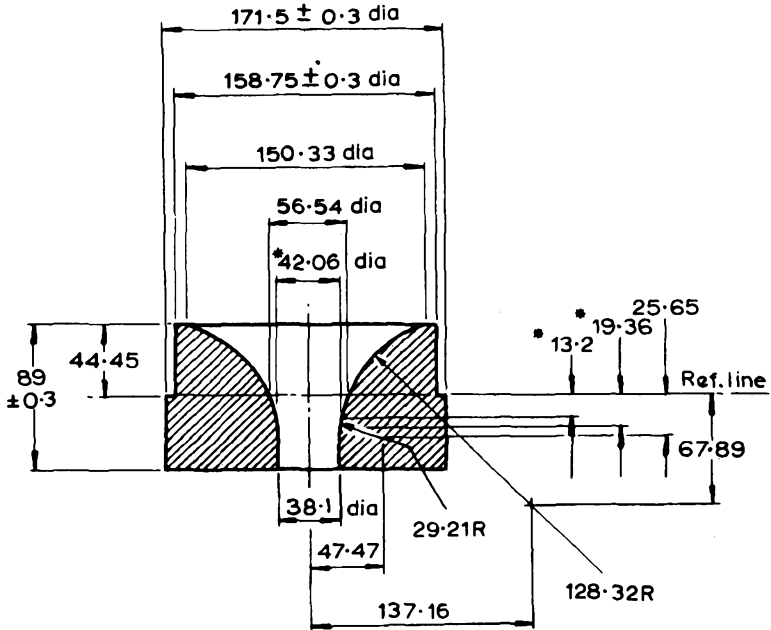

Reference line gauge

All dimensions in mm.

• These dimensions define extent of $29.21R$

REFERENCE LINE GAUGE FOR COLOUR CATHODE RAY TUBES HAVING
90° SCANNING ANGLES AND A NECK DIAMETER OF 36.5mm

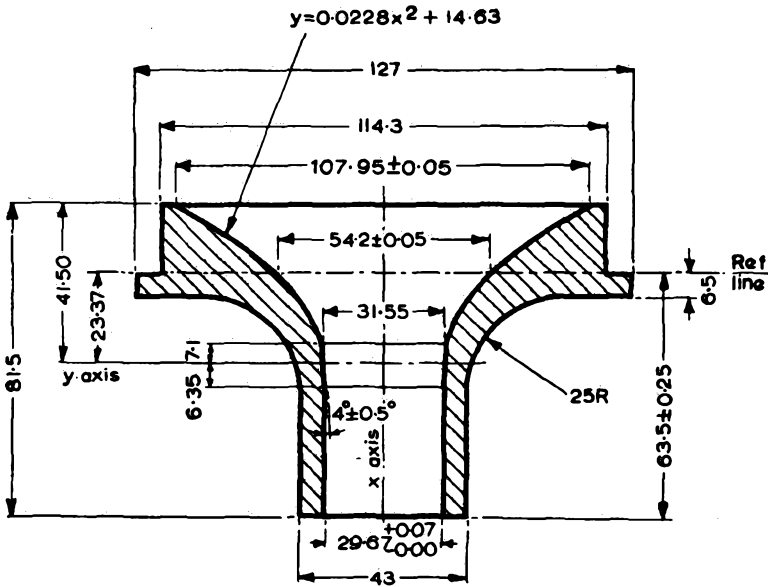

All dimensions in mm.

5697

REFERENCE LINE GAUGE J.E.D.E.C. 126 FOR MONOCHROME CATHODE
RAY TUBES HAVING 110° SCANNING ANGLES AND A NECK DIAMETER
OF 28.6mm

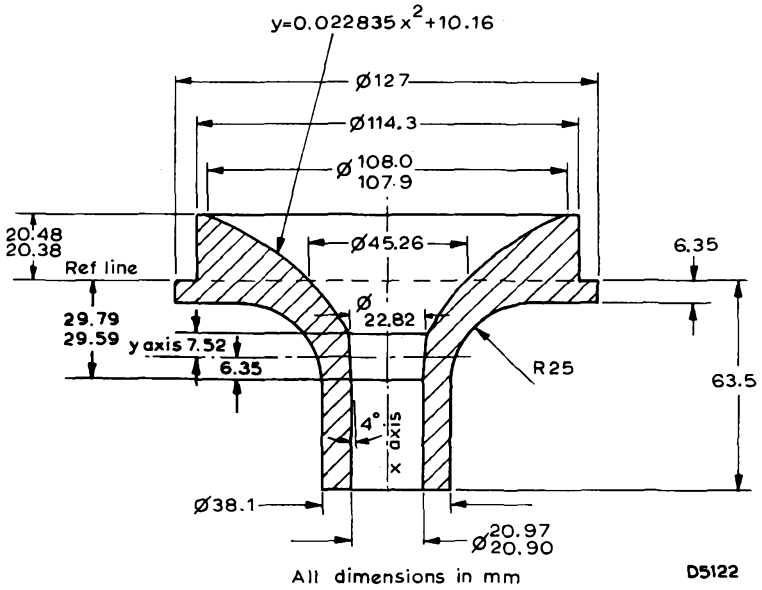

REFERENCE LINE GAUGE

REFERENCE LINE GAUGE FOR MONOCHROME CATHODE RAY TUBES
HAVING 110° SCANNING ANGLES AND A NECK DIAMETER OF 20mm

CATHODE RAY TUBE SCREEN TYPE W

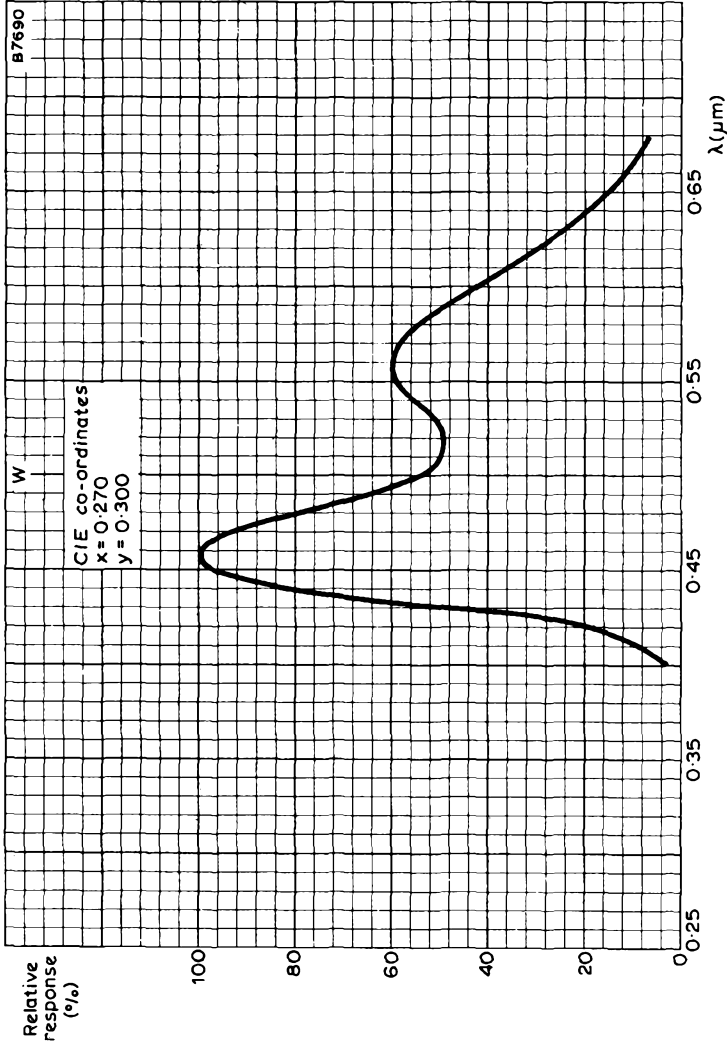

RELATIVE SPECTRAL ENERGY DISTRIBUTION CURVE
FOR TYPE W LUMINESCENT SCREEN



CATHODE RAY TUBE SCREEN TYPE X

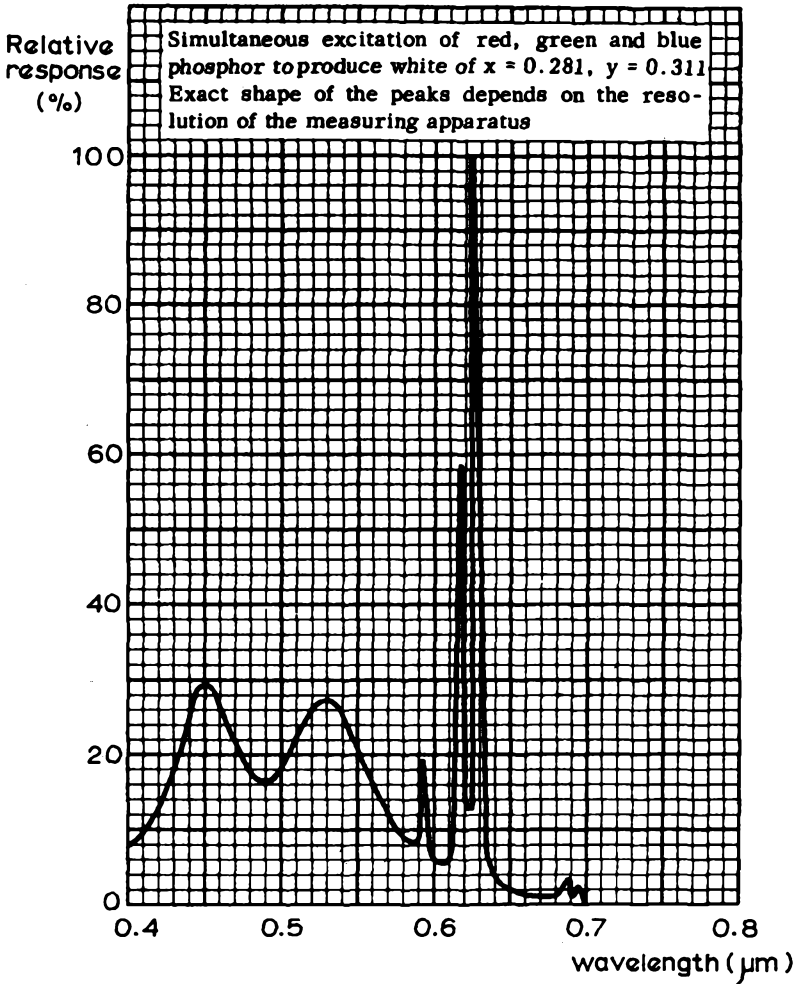

RELATIVE SPECTRAL ENERGY DISTRIBUTION CURVE
FOR TYPE X LUMINESCENT SCREEN

	Colour coordinates	
	x	y
Red	0.630	0.340
Green	0.315	0.600
Blue	0.150	0.065



COLOUR PICTURE TUBES

B





QUICK REFERENCE DATA

56cm (22in) rectangular shadow-mask colour television tube incorporating three guns and a metal-backed three-colour phosphor dot screen.

Advanced red phosphor, europium activated.

Increased white brightness.

Unity current ratio for white point $x = 0.281$, $y = 0.311$.

Temperature compensated shadow-mask maintains purity during warm-up. Shadow-mask optimised for minimum moiré effect on 625 line system.

Reinforced tube envelope-separate safety screen not required.

Suitable for receivers with push-through presentation.

Deflection angle	92	deg
Focusing	Electrostatic	
Light transmission (approx.)	53	%
Maximum overall length	482	mm

This data should be read in conjunction with **GENERAL OPERATIONAL RECOMMENDATIONS - TELEVISION PICTURE TUBES**

HEATER

V_h (see note 1)	6.3	V
I_h	900	mA

The limits of heater voltage and current are contained in General Operational Recommendations - Television Picture Tubes.

OPERATING CONDITIONS (each gun)

$V_{a3, a4}$	25	kV
V_{a2} (focus electrode control range)	4.2 to 5.0	kV
V_{a1} (at $V_g = -100V$ for visual extinction of focused raster)	210 to 495	V
V_g (at $V_{a1} = 300V$ for visual extinction of focused raster)	-65 to -135	V



SCREEN

Metal backed

Phosphor types for separate fluorescent colours;

Red	Europium activated rare earth
Green	Sulphide
Blue	Sulphide

Useful screen area See page 7

Spacing between centres of adjacent phosphor dot triads (approx.) 0.68 mm

Light transmission (approx.) 53 %

FOCUSING

Electrostatic

DEFLECTION

Magnetic

Diagonal deflection angle 92 deg

Horizontal deflection angle 79 deg

Vertical deflection angle 61 deg

CONVERGENCE

Magnetic

CAPACITANCES (approx.)

c_{g-all} (each gun)	7.0	pF
$c_{(kR+kG+kB)}$ - all	15	pF
c_{kR} - all	5.0	pF
c_{kG} - all	5.0	pF
c_{kB} - all	5.0	pF
c_{a2} - all	7.0	pF
$c_{a3, a4-M}$	1700 to 2300	pF
$c_{a3, a4-B}$	400	pF

EXTERNAL CONDUCTIVE COATING

This tube has an external conductive coating, M, which must be connected to chassis, and the capacitance of this coating to the final anode is used to provide smoothing for the e.h.t. supply. The electrical connection to this coating must be made within the area specified on the tube outline drawing.

REFERENCE LINE GAUGE

See page 10



MOUNTING POSITION

Any. The tube socket should not be rigidly mounted but should have flexible leads and be allowed to move freely. The bottom circumference of the base shell will fall within a circle of 55mm diameter which is centred upon the perpendicular from the centre of the face.

MAGNETIC SHIELDING

Magnetic shielding must be provided to minimise the effects of extraneous magnetic fields, including the earth's magnetic field. This shielding, in the form of a metal shell extending 250mm over the cone of the tube measured from the centre of the screen, should be constructed of cold-rolled mild steel of 0.5mm minimum thickness. The magnetic shield should be connected to the outer conductive coating. See page 10 for physical dimensions.

RATINGS (DESIGN CENTRE SYSTEM)

$V_{a3, a4}$ max. (absolute rating) (see notes 2 and 3)	27.5	kV
$V_{a3, a4}$ min. (absolute rating) (see note 4)	20	kV
$I_{a3, a4}$ (long term average max. for three guns: see note 5)	1.0	mA
V_{a2} max. (see note 3)	6.0	kV
v_{a1} (pk) max.	1.0	kV
$-V_g$ max.	400	V
V_g max. (see note 6)	0	V ←
V_{h-k} max. (see note 7)		
Cathode positive		
d.c. max.	250	V
pk max.	300	V
Cathode negative		
d.c. max.	135	V
pk max.	180	V
R_{g-k} max.	750	kΩ



EQUIPMENT DESIGN VALUES (each gun if applicable)

Valid for $V_{a3, a4} = 20$ to 27.5 kV

V_{a2}		16.8 to 20% of $V_{a3, a4}$
V_{a1}		see page 16
V_g		see page 16
Variation in cut-off voltage between guns		Minimum value is at least 65% of the maximum value.
I_{a2}		-15 to +15 μA
I_{a1}		-5 to +5 μA
I_g at $V_g = -150V$		-5 to +5 μA

White point reference (see notes)

		Note 8	Note 9	Note 10
To produce white of colour	x	0.313	0.265	0.281
co-ordinates:	y	0.329	0.290	0.311

Percentage of total anode current supplied by each gun (typical)

Red gun		43.1	27.9	32.2	%
Green gun		32.0	34.9	35.6	%
Blue gun		24.9	37.2	32.2	%

Ratio of cathode currents

Red gun to green gun	min.	0.95	0.60	0.65	
	av.	1.35	0.80	0.90	
	max.	1.85	1.10	1.25	
Red gun to blue gun	min.	1.30	0.55	0.75	
	av.	1.75	0.75	1.00	
	max.	2.35	1.05	1.35	

Maximum electron beam shift required from purity magnets

± 115 μm

Maximum required raster shift

± 13 mm

Maximum lateral convergence shift of blue beam with respect to the converged red and green beams

± 6 mm

Maximum radial convergence shift, excluding effects of dynamic convergence (each beam, see note 11)

± 9 mm

WEIGHT

Tube alone (approx.)

15 kg



NOTES

1. For maximum cathode life, it is recommended that the heater supply be regulated at 6.3V.
2. The tube does not emit X-radiation above the internationally accepted maximum dosage rate if it is operated from an e.h.t. source supplying an absolute maximum voltage of 27.5kV at zero beam current and with an internal impedance $\geq 500k\Omega$.
3. Adequate precautions should be taken to ensure that the receiver is protected from damage which may be caused by a possible high voltage flash-over within the cathode ray tube. In view of the high voltage on a2, adequate precautions should be taken to ensure freedom from flashover on all connections to this electrode.
4. Operation at lower voltages impairs brightness and resolution and may have a detrimental effect on colour purity.
5. The limiting value "long term average maximum current" of 1.0mA will be met provided a device is incorporated in the circuit to limit the short term average current to 1.5mA.
6. The d.c. value of bias must not be such as to allow the grid to become positive with respect to the cathode, except during the period immediately after switching the receiver on or off when it may be allowed to rise to +2V.
7. In order to avoid excessive hum the a.c. component of v_{h-k} should be as low as possible ($\leq 20Vr.m.s.$).
During an equipment warm-up period not exceeding 15 seconds $v_{h-k(pk)}$ max. (cathode positive) is allowed to rise to 410V. Between 15 and 45 seconds after switching on a decrease in $v_{h-k(pk)}$ max. (cathode positive) proportional with time from 410 to 250V is permissible.
8. The transmission systems are adjusted to this white point (illuminant D).
9. These co-ordinates are as used on monochrome tubes.
10. This is a traditional reference white point that is a compromise between illuminant D and X = 0.265, y = 0.290.
11. The dynamic convergence to be effected by currents of approximately parabolic waveshape synchronised with scanning.
12. The metal band (B) should be connected directly to the chassis in an a.c. receiver operating from an isolating transformer, or via a suitable leakage path in an a.c./d.c. receiver.



OUTLINE DRAWING

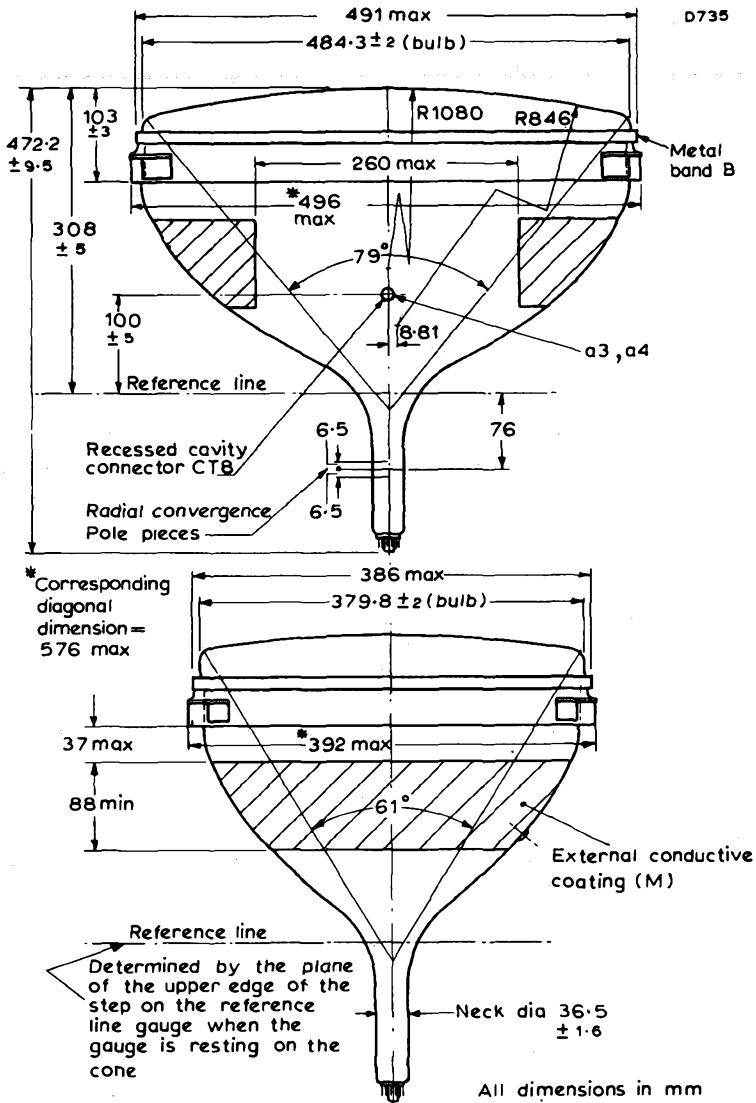

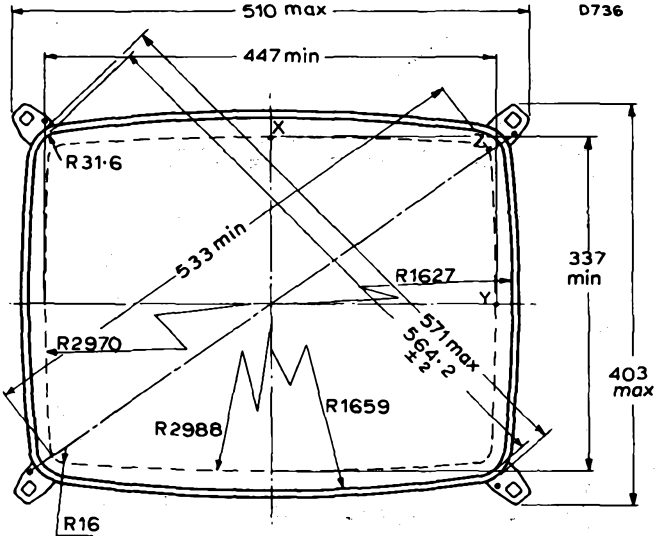

Useful screen area within dotted line.

All dimensions in mm

Bulb dimensions

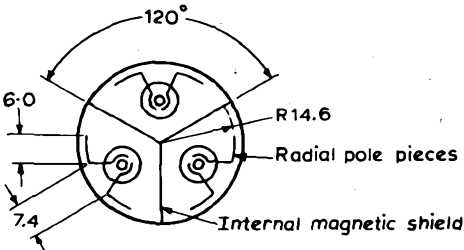

Location of radial convergence pole pieces viewed from screen end of guns.

All dimensions in mm



BB773

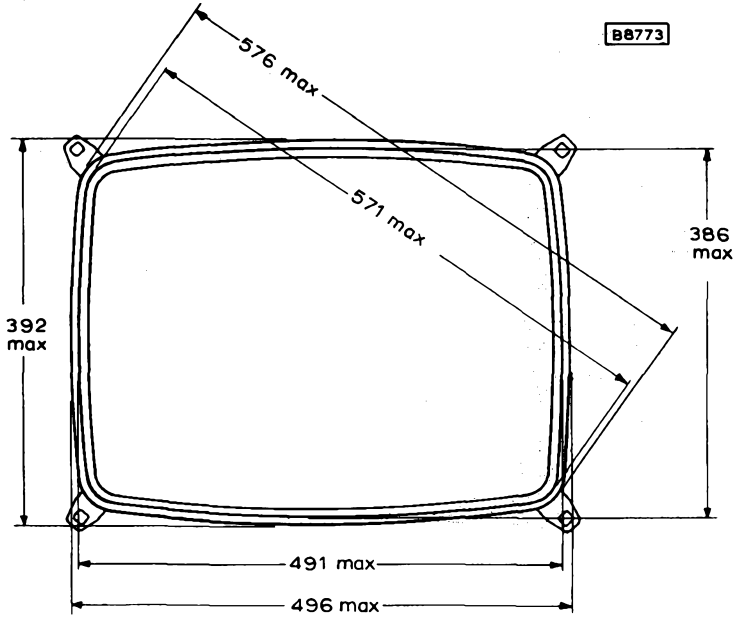

Dimensions of rimband

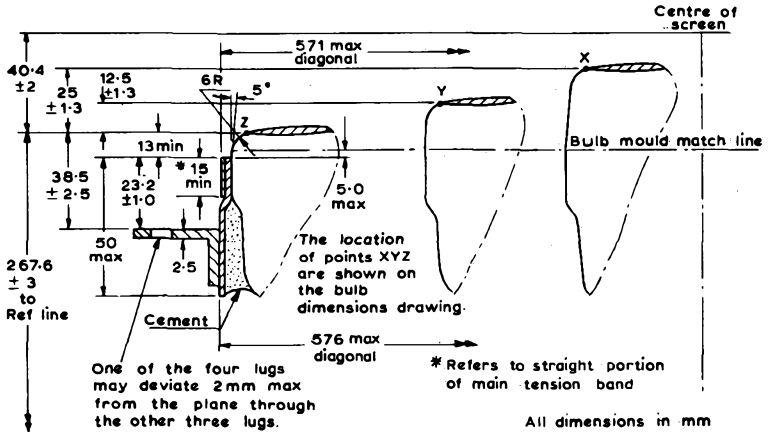

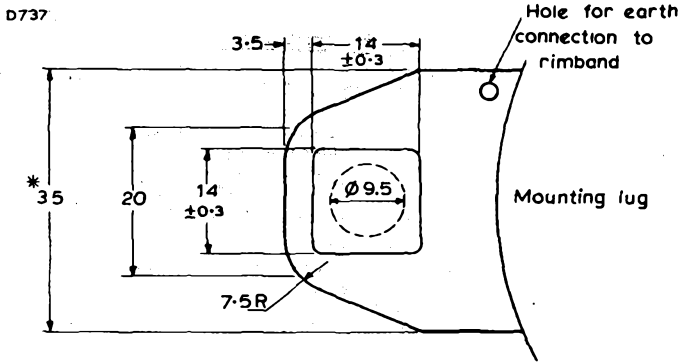

* Minimum space to be reserved for mounting lugs = 40mm

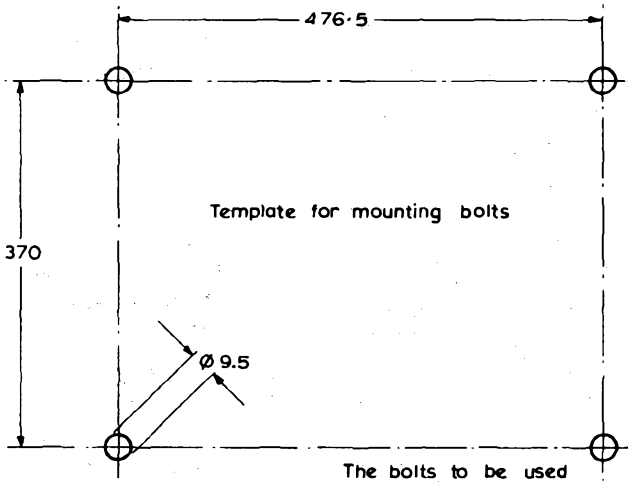

All dimensions in mm

The bolts to be used for mounting the tube must be within the circles of 9.5mm diameter shown in the template drawing.



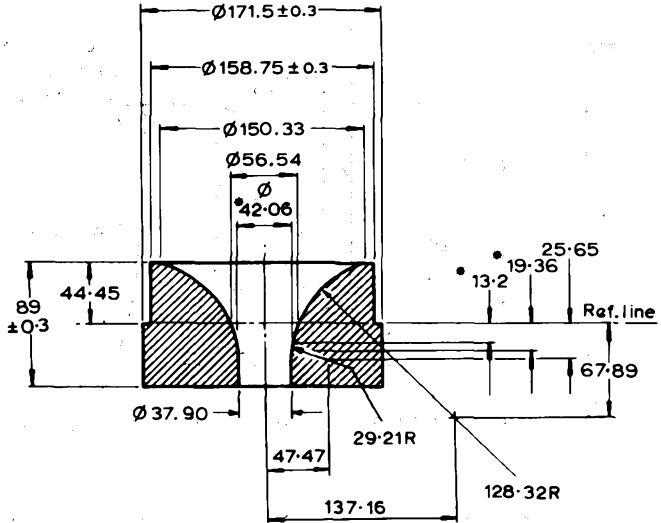

Reference line gauge

• These dimensions define extent of 29.21R

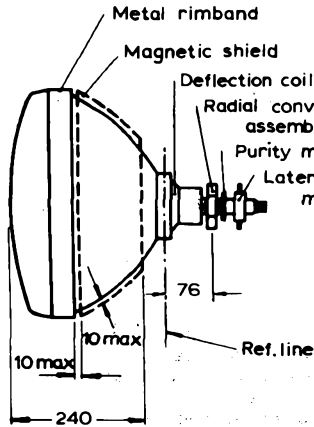

Outline of tube with components

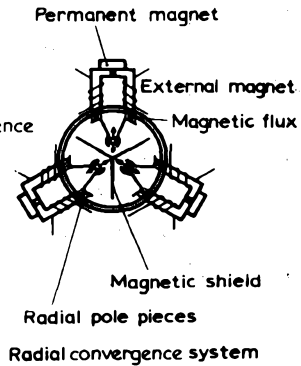

All dimensions in mm



D739

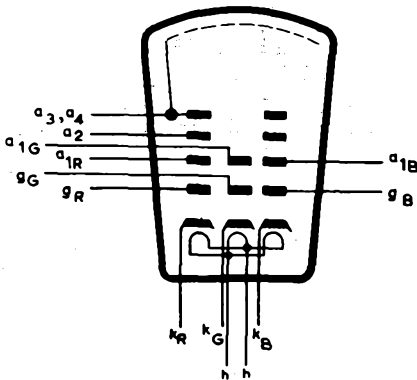
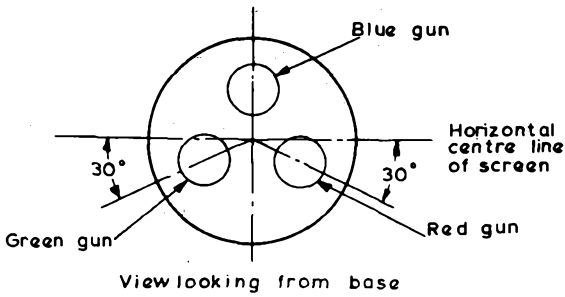
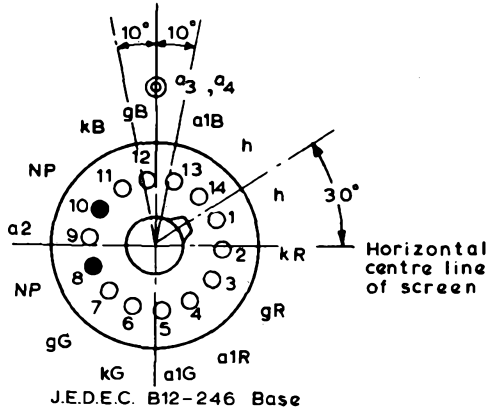



MAXIMUM CONE CONTOURS

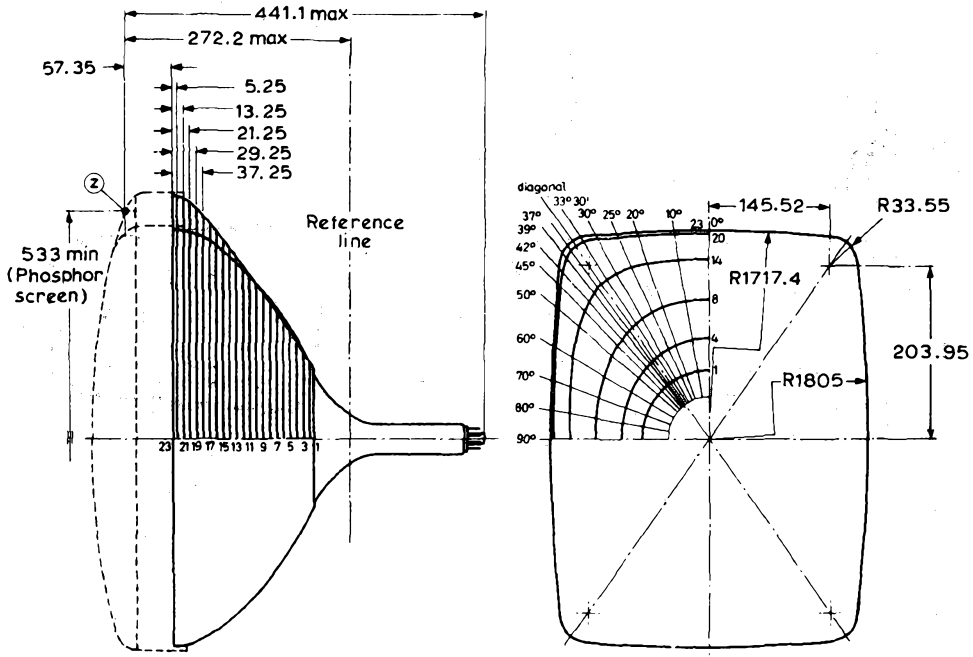

All dimensions in mm



DIMENSIONS FOR MAXIMUM CONE CONTOUR DRAWING (Page 12)

Section	Nominal distance from point 'Z'	Distance from centre (max. values)															
		0° Long axis	10°	20°	25°	30°	33°30'	35°30'	37° Diagonal	39°	42°	45°	50°	60°	70°	80°	90° Short axis
1	227-2	79-9	79-9	79-9	79-9	79-9	79-9	79-9	79-9	79-9	79-9	79-9	79-9	79-9	79-9	79-9	79-9
2	222-6	87-7	87-7	87-6	87-6	87-5	87-5	87-5	87-4	87-4	87-4	87-4	87-3	87-2	87-2	87-1	87-1
3	214-6	103-3	103-0	102-1	101-6	101-0	100-6	100-4	100-2	100-0	99-6	99-3	98-9	98-1	97-5	97-4	97-3
4	208-6	118-0	117-5	116-0	115-1	114-1	113-3	112-9	112-6	112-2	111-6	101-0	110-0	108-3	107-1	106-4	106-2
5	198-6	131-0	130-5	129-0	127-9	126-6	125-7	125-1	124-7	124-1	123-2	122-4	120-9	118-3	116-2	114-9	114-4
6	190-6	142-7	142-4	141-1	140-1	138-8	137-7	137-0	136-5	135-8	134-7	133-5	131-6	127-9	124-8	122-8	122-1
7	182-6	153-3	153-3	152-6	151-7	150-5	149-3	148-6	148-0	147-2	145-8	144-4	142-0	137-1	132-9	130-1	129-2
8	174-6	163-0	163-4	163-4	162-9	161-8	160-7	159-9	159-3	158-3	156-8	155-0	152-0	145-8	140-5	137-0	135-8
9	166-6	172-1	172-8	173-7	173-6	172-8	171-7	170-9	170-2	169-2	167-4	165-4	161-6	154-0	147-6	143-4	141-9
10	158-6	180-6	181-6	183-5	183-9	183-5	182-5	181-7	180-9	179-8	177-7	175-3	170-9	161-7	154-2	149-4	147-7
11	150-6	188-6	190-0	192-7	193-7	193-8	193-0	192-2	191-4	190-1	187-8	185-0	179-7	169-0	160-3	154-9	153-1
12	142-6	196-2	197-8	201-6	203-2	203-8	203-3	202-5	201-6	200-2	197-5	194-3	188-1	175-8	166-0	160-1	158-1
13	134-6	203-3	205-3	209-9	212-2	213-5	213-3	212-5	211-6	210-1	206-9	203-1	196-1	182-1	171-4	164-9	162-8
14	126-6	210-1	212-3	217-8	220-8	222-9	223-1	222-3	221-4	219-7	216-0	211-6	203-5	187-9	176-3	169-4	167-2
15	118-6	216-4	218-9	225-3	229-0	231-9	232-6	231-9	231-0	229-0	224-7	219-6	210-4	193-2	180-8	173-6	171-2
16	110-6	222-5	225-1	232-3	236-8	240-6	241-9	241-4	240-3	238-1	233-0	227-1	216-7	198-1	184-9	177-4	175-0
17	102-6	228-2	231-0	239-0	244-2	249-0	251-0	250-6	249-4	247-0	241-0	234-1	222-5	202-5	188-3	181-0	178-5
18	94-6	233-4	236-3	245-0	250-9	256-9	259-9	259-6	258-4	255-6	248-5	240-6	227-8	206-4	192-2	184-3	181-7
19	86-6	237-4	240-5	249-7	256-5	264-0	268-3	268-4	267-3	264-2	255-7	246-6	232-3	209-9	195-3	187-2	184-6
20	78-6	240-3	243-5	253-2	260-7	269-8	276-1	276-9	275-9	272-6	262-4	251-7	236-1	212-8	198-1	189-9	187-3
21	70-6	242-3	245-5	255-4	263-3	273-2	280-6	281-8	281-0	277-6	266-4	254-9	238-6	214-9	200-1	191-9	189-3
22	62-6	243-4	246-6	256-6	264-5	274-7	282-4	283-7	283-0	279-5	268-2	256-4	240-0	216-2	201-3	193-1	190-4
23	57-35	243-9	247-1	257-1	265-0	275-2	282-8	284-2	283-4	280-0	268-7	257-0	240-5	216-7	201-8	193-5	190-9

All dimensions in mm



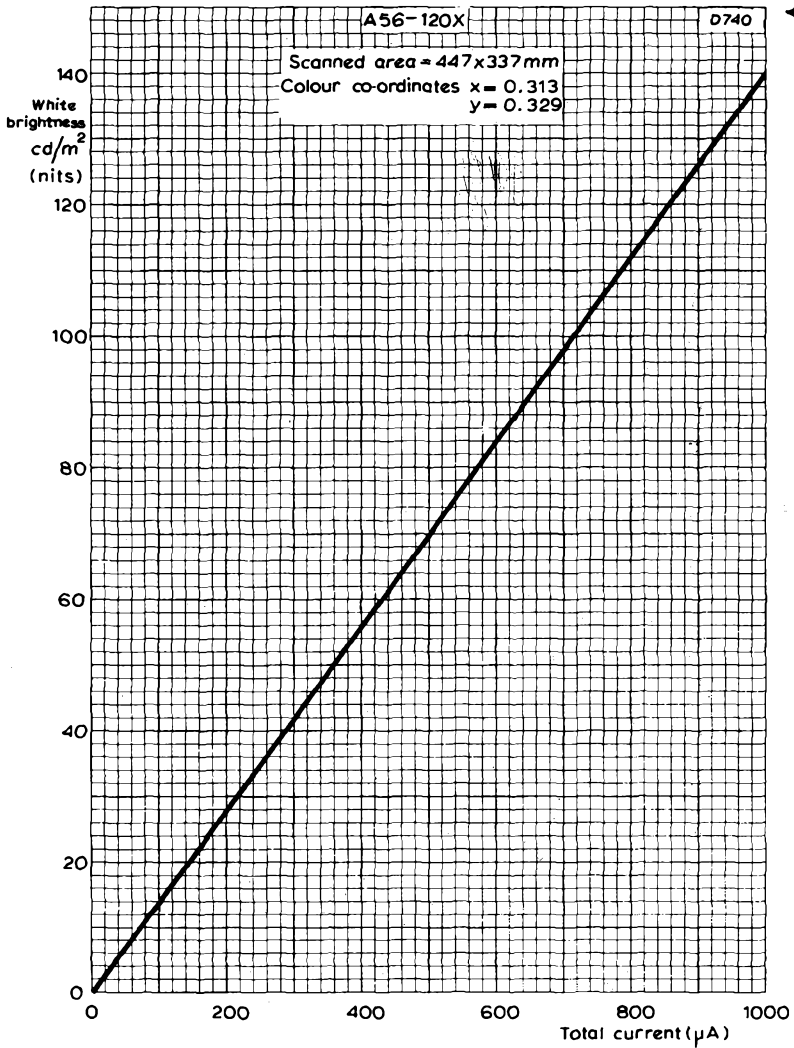

BRIGHTNESS AT CENTRE OF SCREEN PLOTTED AGAINST TOTAL CURRENT
FOR WHITE OF COLOUR COORDINATES $x = 0.313$, $y = 0.329$



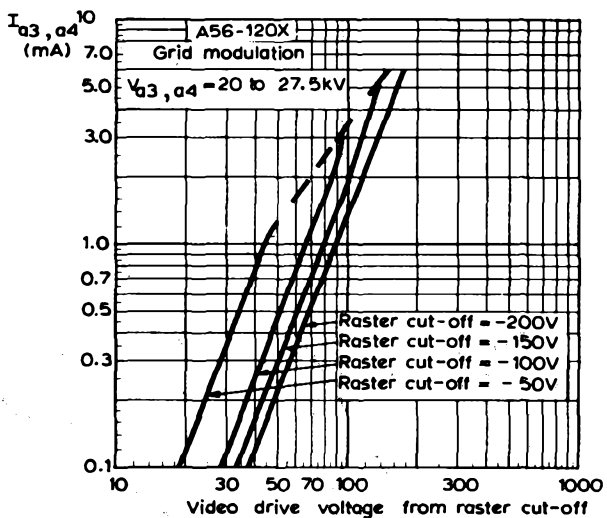

FINAL ANODE CURRENT PLOTTED AGAINST GRID VOLTAGE.
GRID MODULATION.

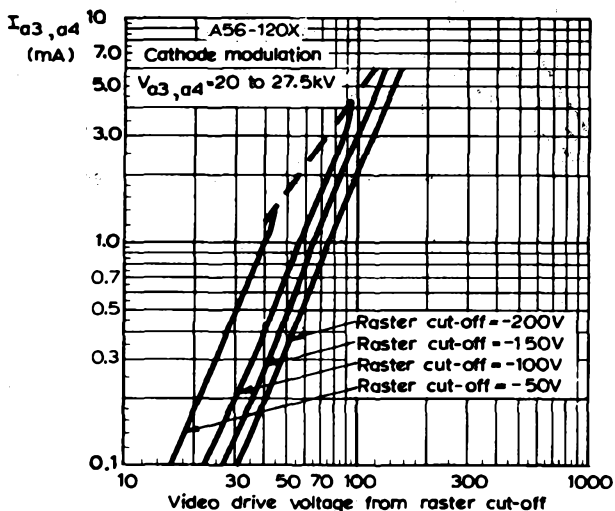

FINAL ANODE CURRENT PLOTTED AGAINST CATHODE-TO-GRID
VOLTAGE. CATHODE MODULATION



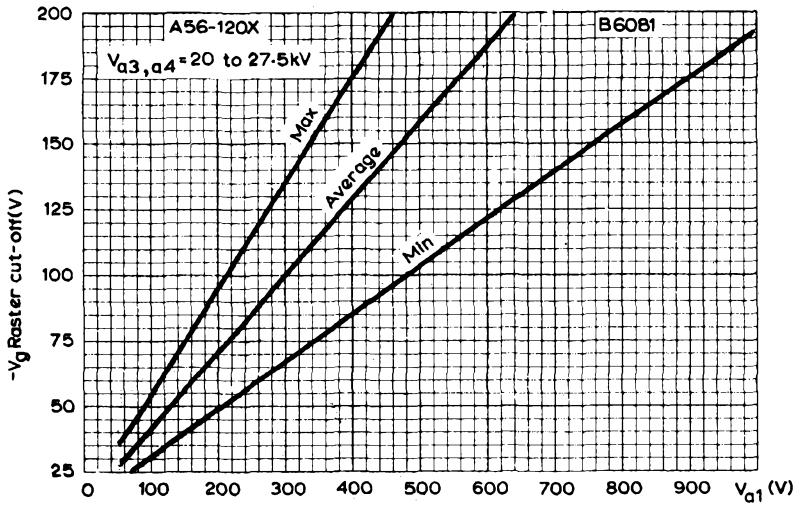

CUT-OFF DESIGN CHART



QUICK REFERENCE DATA

56cm (22in) rectangular shadow-mask colour television tube incorporating three guns, a metal-backed three-colour phosphor dot screen and internal magnetic shield.

Advanced red phosphor, europium activated.

Increased white brightness.

Unity current ratio for white point $x=0.281$, $y=0.311$.

Temperature compensated shadow-mask maintains purity during warm-up with minimum moiré effect on 625 line system.

Reinforced tube envelope-separate safety screen not required.

Suitable for receivers with push-through presentation.

Deflection angle	110	deg
Neck diameter	36.5	mm
Focusing	Bipotential	
Light transmission (approx.)	54.5	%
Maximum overall length	400.3	mm

This data should be read in conjunction with GENERAL OPERATIONAL RECOMMENDATIONS - TELEVISION PICTURE TUBES

HEATER

V_h (see note 1)	6.3	V
I_h	900	mA

The limits of heater voltage and current are contained in General Operational Recommendations - Television Picture Tubes.

OPERATING CONDITIONS (each gun)

$V_{a3,a4}$	25	kV
V_{a2} (focus electrode control range)	4.2 to 5.0	kV
V_{a1} (at $V_g = -100V$ for visual extinction of focused raster)	212 to 495	V
V_g (at $V_{a1} = 300V$ for visual extinction of focused raster)	-65 to -135	V

SCREEN

Metal backed

Phosphor types for separate fluorescent colours:

Red	Europium activated rare earth	
Green		Sulphide
Blue		Sulphide
Useful screen area		See page 7
Spacing between centres of adjacent phosphor dot triads (approx.)	0.81	mm
Light transmission (approx.)	54.5	%

FOCUSING

Electrostatic bipotential

DEFLECTION

Magnetic

Diagonal deflection angle	110	deg
Horizontal deflection angle	97	deg
Vertical deflection angle	77	deg

CONVERGENCE

Magnetic

CAPACITANCES (approx.)

c_{g-all} (each gun)	7.0	pF
$c_{(kR+kG+kB)}$ - all	15	pF
c_{kR} - all	5.0	pF
c_{kG} - all	5.0	pF
c_{kB} - all	5.0	pF
c_{a2-all}	7.0	pF
$c_{a3,a4-M}$	1300 to 1800	pF
$c_{a3,a4-B}$	400	pF

EXTERNAL CONDUCTIVE COATING

This tube has an external conductive coating, M, which must be connected to chassis, and the capacitance of this coating to the final anode is used to provide smoothing for the e. h. t. supply. The electrical connection to this coating must be made within the area specified on the tube outline drawing.

REFERENCE LINE GAUGE

See page 10

COLOUR TELEVISION TUBE

A56-140X

MOUNTING POSITION

Any. The tube socket should not be rigidly mounted but should have flexible leads and be allowed to move freely. The bottom circumference of the base shell will fall within a circle of 55mm diameter which is centred upon the perpendicular from the centre of the face.

MAGNETIC SHIELDING

The tube is provided with an internal magnetic shield. The rimband has rectangular holes for mounting the degaussing coils.



RATINGS (DESIGN CENTRE SYSTEM)

$V_{a3, a4}$ max. (absolute rating) (see notes 2 and 3)	27.5	kV
$V_{a3, a4}$ min. (absolute rating) (see note 4)	20	kV
$I_{a3, a4}$ (long term average max. for three guns: see note 5)	1.0	mA
V_{a2} max. (see note 3)	6.0	kV
V_{a1} (pk) max.	1.0	kV
$-V_g$ max.	400	V
$-V_g$ max. (operating cut-off)	200	V
V_g max. (see note 6)	0	V
V_{h-k} max. (see note 7)		
Cathode positive		
d. c. max.	250	V
pk max.	300	V
Cathode negative		
d. c. max.	135	V
pk max.	180	V
R_{g-k} max.	750	k Ω

EQUIPMENT DESIGN VALUES (each gun if applicable)

Valid $V_{a3, a4} = 20$ to 27.5kV

V_{a2} 16.8 to 20% of $V_{a3, a4}$

V_{a1} see page 15

V_g see page 15

Variation in cut-off voltage between guns

Minimum value is at least 65% of the maximum value.

I_{a2} -5 to +5 μA

I_{a1} -5 to +5 μA

I_g at $V_g = -150V$ -5 to +5 μA

White point reference (see notes) Note 8 Note 9 Note 10

To produce white of colour	x	0.313	0.265	0.281
co-ordinates:	y	0.329	0.290	0.311

Percentage of total anode current supplied by each gun (typical)

Red gun	41.0	25.8	30.2	%
Green gun	31.3	33.5	34.5	%
Blue gun	27.7	40.7	35.3	%

Ratio of cathode currents

Red gun to green gun	min.	0.95	0.55	0.65
	av.	1.3	0.75	0.9
	max.	1.8	1.1	1.25
Red gun to blue gun	min.	1.15	0.5	0.65
	av.	1.5	0.65	0.85
	max.	2.0	0.85	1.15

Maximum electron beam shift required from purity magnets ± 100 μm

Maximum required raster shift ± 11 mm

Maximum lateral convergence shift of blue beam with respect to the converged red and green beams ± 4.5 mm

Maximum radial convergence shift excluding effects of dynamic convergence (each beam, see note 11) ± 7 mm

WEIGHT

Tube alone (approx.) 14.5 kg

NOTES

1. For maximum cathode life, it is recommended that the heater supply be regulated at 6.3V.
2. The tube does not emit X-radiation above the internationally accepted maximum dosage rate if it is operated from an e.h.t. source supplying an absolute maximum voltage of 27.5kV at zero beam current and with an internal impedance $\geq 500k\Omega$.
3. Adequate precautions should be taken to ensure that the receiver is protected from damage which may be caused by a possible high voltage flashover within the cathode ray tube. In view of the high voltage on a2, adequate precautions should be taken to ensure freedom from flashover on all connections to this electrode.
4. Operation at lower voltages impairs brightness and resolution and may have a detrimental effect on colour purity.
5. The limiting value "long term average maximum current" of 1.0mA will be met provided a device is incorporated in the circuit to limit the short term average current to 1.5mA.
6. The d. c. value of bias must not be such as to allow the grid to become positive with respect to the cathode, except during the period immediately after switching the receiver on or off when it may be allowed to rise to +2V.
7. In order to avoid excessive hum the a. c. component of V_{h-k} should be as low as possible ($\leq 20V$ r. m. s.).
During an equipment warm-up period not exceeding 15 seconds, V_{h-k} max. (cathode positive) is allowed to rise to 410V. Between 15 and 45 seconds after switching on, a decrease in V_{h-k} max. (cathode positive) proportional with time from 410 to 250V is permissible.
8. The transmission systems are adjusted to this white point (illuminant D).
9. These co-ordinates are as used on monochrome tubes.
10. This is a traditional reference white point that is a compromise between illuminant D and $X=0.265$, $y=0.290$.
11. The dynamic convergence to be effected by currents of approximately parabolic waveform synchronised with scanning
12. The metal band (B) should be connected directly to the chassis in an a. c. receiver operating from an isolating transformer, or via a suitable leakage path in an a. c./d. c. receiver.

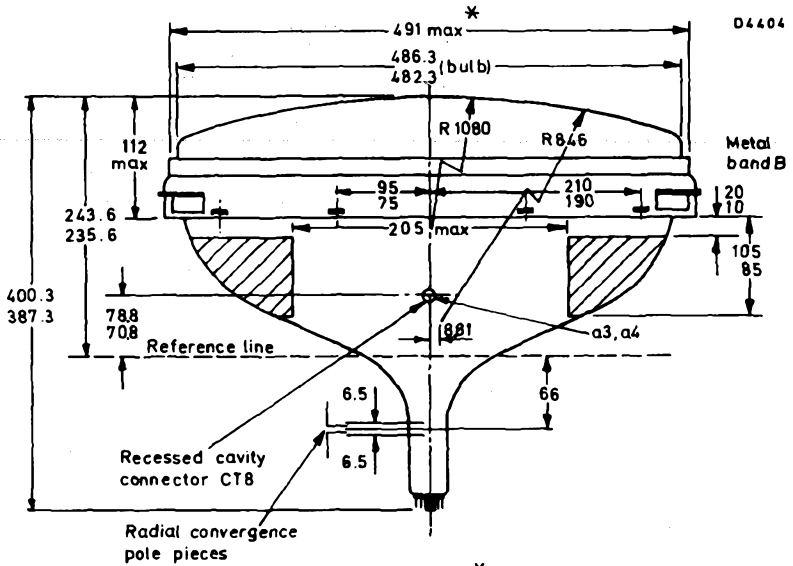

* Corresponding diagonal dimension = 571 max

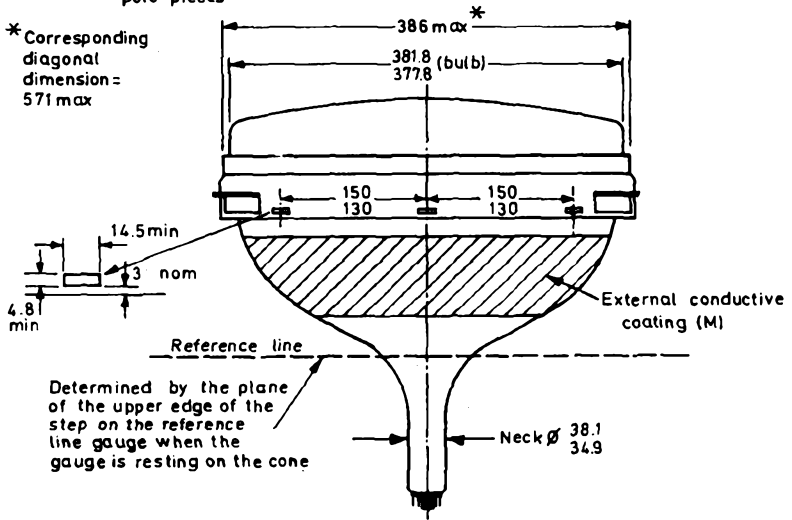

All dimensions in mm

Mullard

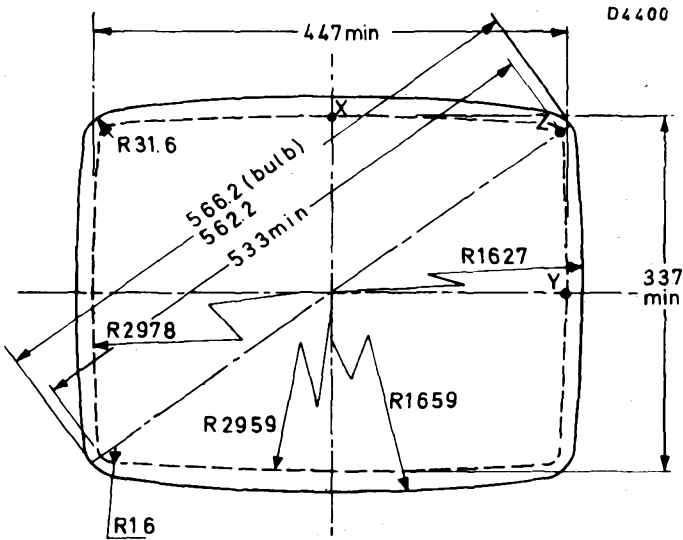

Useful screen area within dotted line.

All dimensions in mm

Bulb and screen dimensions

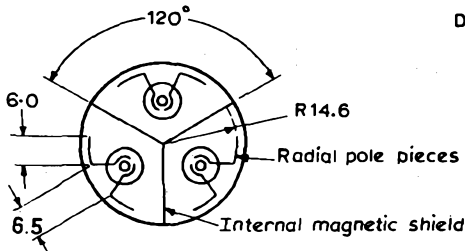

Location of radial convergence pole pieces viewed from screen end of guns.

All dimensions in mm

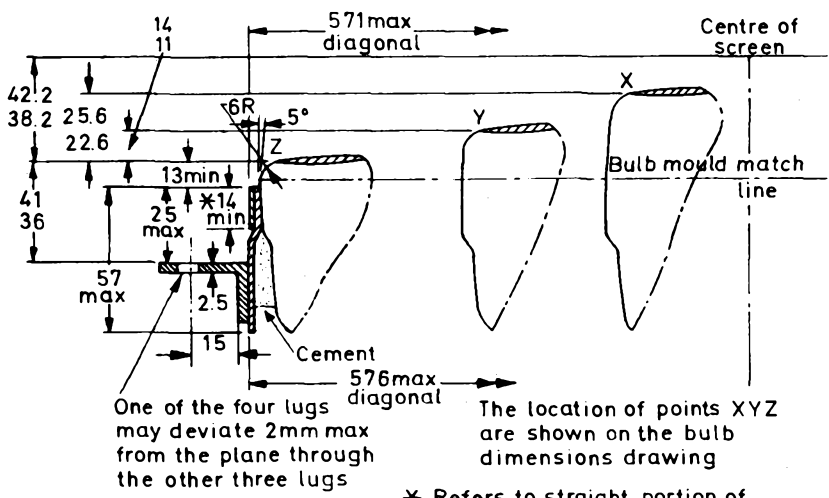
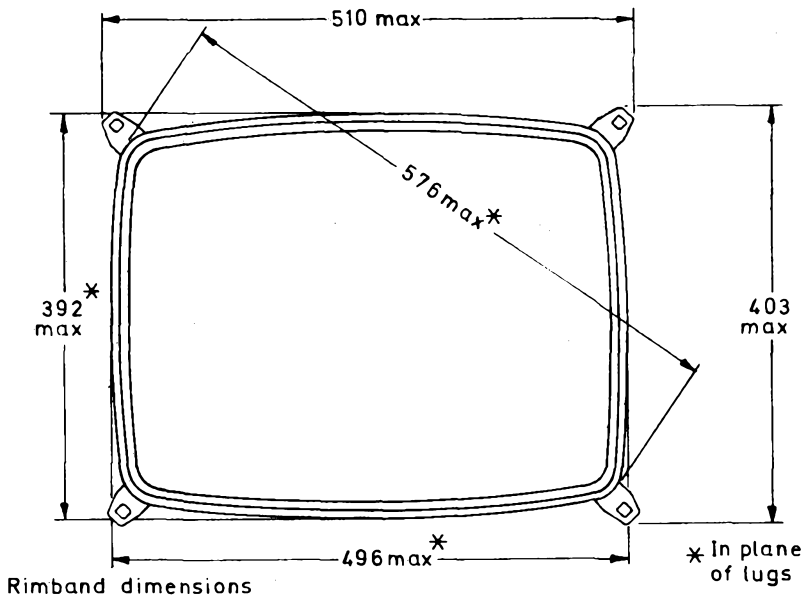

All dimension in mm

D4401

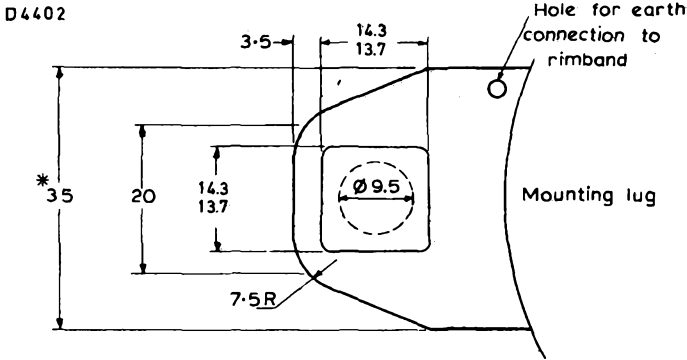

* Minimum space to be reserved for mounting lugs = 40mm

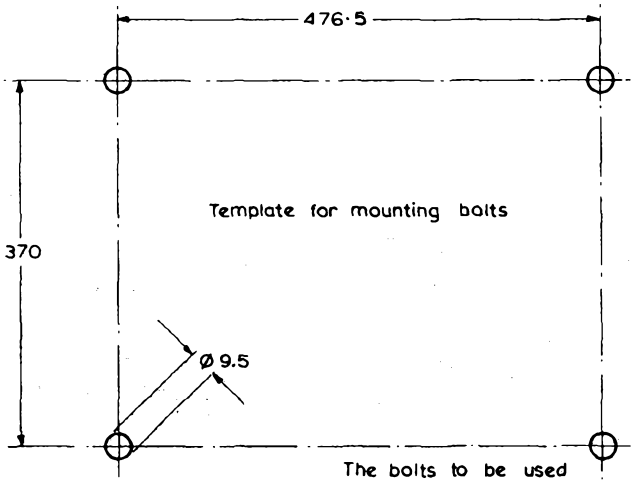

The bolts to be used for mounting the tube must be within the circles of Ø 9.5mm diameter shown in the template drawing.

All dimensions in mm

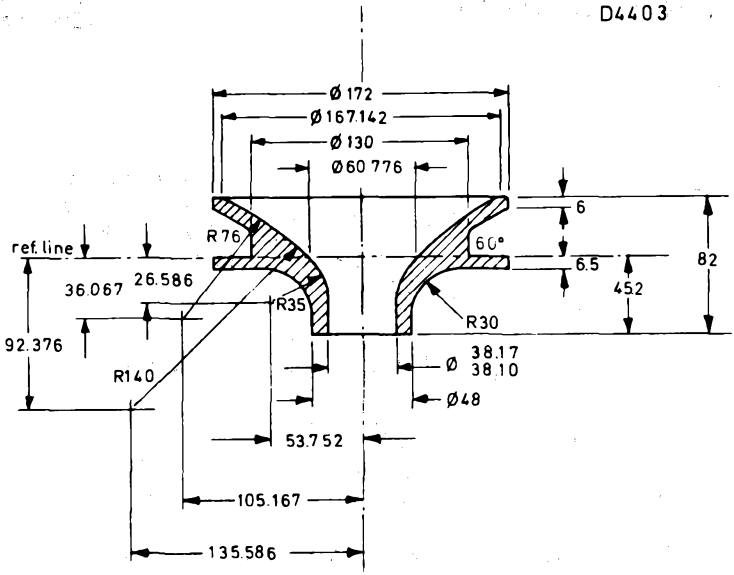

Reference line gauge

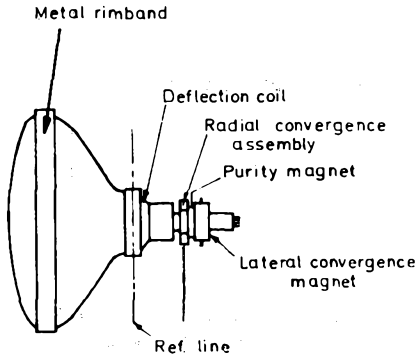

Outline of tube with components

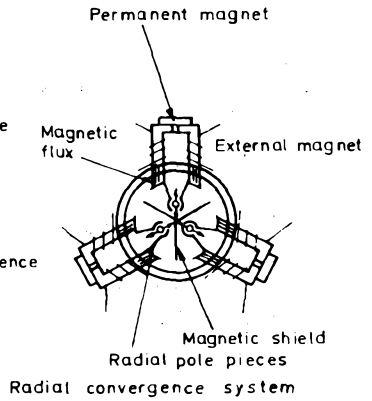

All dimensions in mm

**COLOUR TELEVISION
TUBE**

A56-140X

D4405

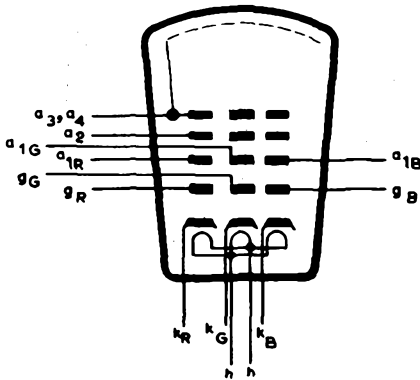
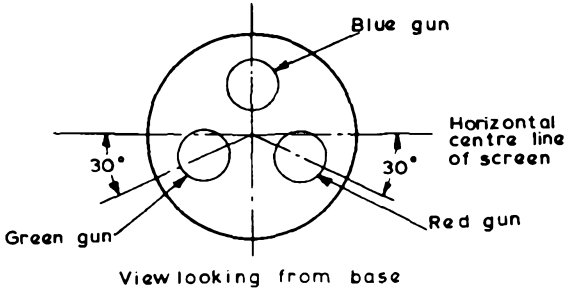
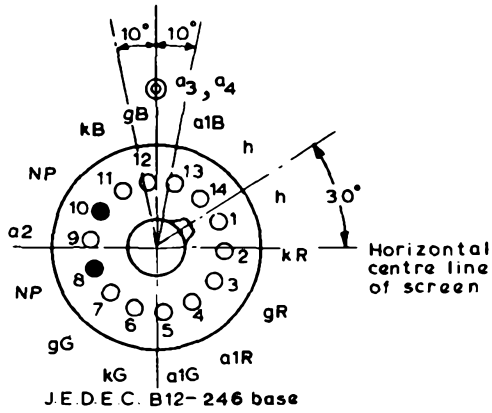

Mullard

MAXIMUM CONE CONTOURS

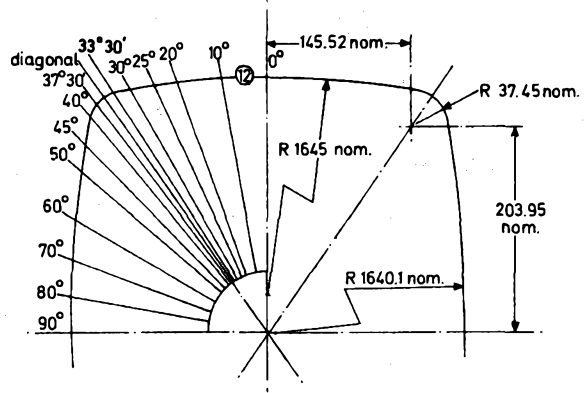
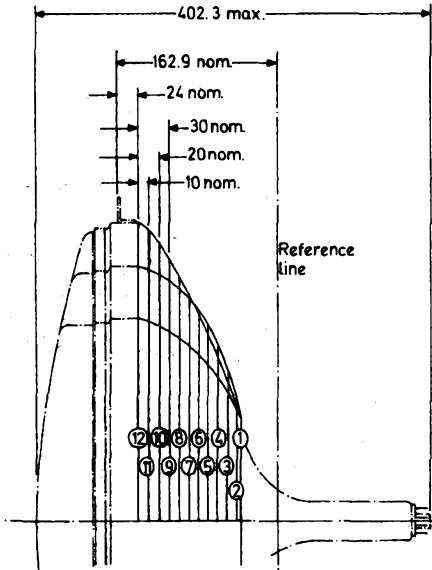

All dimensions in mm

DIMENSIONS FOR MAXIMUM CONE CONTOUR DRAWING

Distance from centre (maximum values)

Section	Nominal distance from section 12	0° long axis	10°	20°	25°	30°	33°30'	diagonal							90° short axis	
							37°30'	40°	45°	50°	60°	70°	80°			
1	102.1	100.6	100.4	100.0	99.7	99.5	99.4	99.3	99.2	99.2	99.0	99.0	99.1	99.3	99.6	99.8
2	100	109.3	109.0	108.2	107.8	107.4	107.2	107.0	106.9	106.8	106.6	106.6	106.7	107.1	107.6	107.9
3	90	147.0	144.8	140.5	138.3	136.3	135.0	134.3	133.6	132.9	131.7	130.8	130.0	130.3	131.3	132.0
4	80	172.5	170.8	166.8	164.4	161.9	160.1	159.1	158.2	157.0	154.8	152.9	149.7	147.6	146.5	146.2
5	70	191.6	190.9	188.5	186.6	184.1	182.2	181.0	179.8	178.2	175.0	171.7	165.7	160.8	157.7	156.6
6	60	206.4	206.8	206.8	205.8	204.0	202.2	200.9	199.5	197.5	193.2	188.4	179.2	171.6	166.8	165.2
7	50	218.2	219.6	222.2	222.9	222.3	220.8	219.6	218.1	215.8	210.1	203.6	190.9	180.8	174.7	172.6
8	40	227.7	229.9	235.2	237.8	239.1	238.7	237.6	236.0	233.3	225.8	217.3	201.0	188.8	181.6	179.2
9	30	235.0	237.8	245.4	250.2	254.4	255.7	255.0	253.3	249.9	239.4	228.3	208.6	194.8	186.9	184.3
10	20	240.5	243.6	252.9	259.6	267.0	271.2	271.3	269.7	265.3	250.6	236.6	214.2	199.6	191.4	188.8
11	10	244.4	247.6	257.5	265.4	275.3	282.3	283.3	282.0	276.8	257.8	241.6	218.0	203.2	195.0	192.4
12	0	248.0	251.2	261.3	269.3	279.5	286.8	288.0	286.8	281.7	262.3	245.9	222.0	207.0	198.7	196.0

All dimensions in millimetres



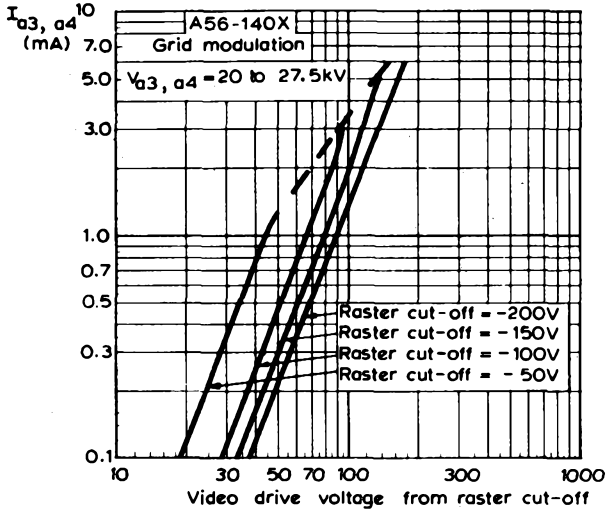

FINAL ANODE CURRENT PLOTTED AGAINST CATHODE-TO-GRID VOLTAGE. CATHODE MODULATION

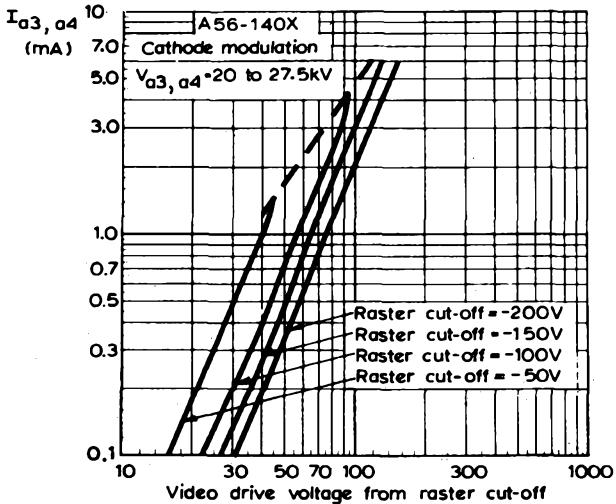

FINAL ANODE CURRENT PLOTTED AGAINST GRID VOLTAGE. GRID MODULATION

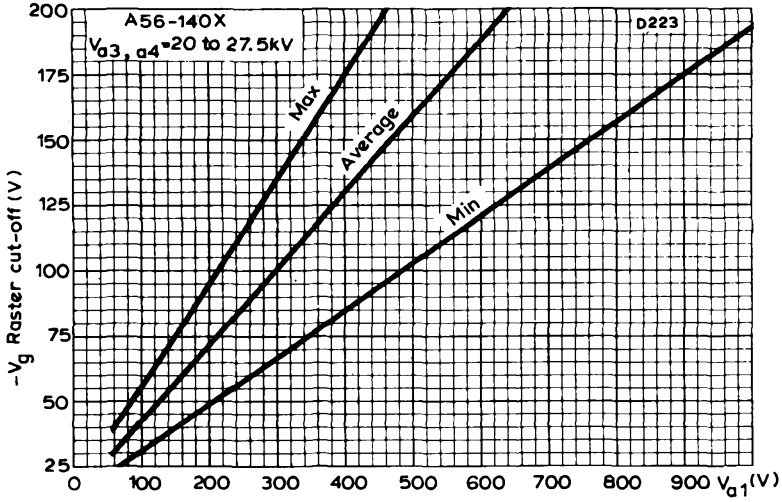

CUT-OFF DESIGN CHART



QUICK REFERENCE DATA

66cm (26in) rectangular shadow-mask colour television tube incorporating three guns and a metal-backed three-colour phosphor dot screen.

Advanced red phosphor, europium activated.

Increased white brightness.

Unity current ratio for white point $x = 0.281$, $y = 0.311$.

Temperature compensated shadow-mask maintains purity during warm-up.

Shadow-mask optimised for minimum moiré effect on 625 line system.

Reinforced tube envelope-separate safety screen not required.

Suitable for receivers with push-through presentation.

Deflection angle	92	deg
Focusing	Electrostatic	
Light transmission (approx.)	52.5	%
Maximum overall length	528.3	mm

This data should be read in conjunction with **GENERAL OPERATIONAL RECOMMENDATIONS - TELEVISION PICTURE TUBES**

HEATER

V_h (see note 1)	6.3	V
I_h	900	mA

The limits of heater voltage and current are contained in General Operational Recommendations - Television Picture Tubes.

OPERATING CONDITIONS (each gun)

$V_{a3, a4}$	25	kV
V_{a2} (focus electrode control range)	4.2 to 5.0	kV
V_{a1} (at $V_g = -100V$ for visual extinction of focused raster)	210 to 495	V
V_g (at $V_{a1} = 300V$ for visual extinction of focused raster)	-65 to -135	V



SCREEN

Metal backed

Phosphor types for separate fluorescent colours:

Red

Europium activated rare earth

Green

Sulphide

Blue

Sulphide

Useful screen area

See page 7

Spacing between centres of adjacent phosphor dot triads (approx.)

0.81 mm ←

Light transmission (approx.)

52.5 % ←

FOCUSING

Electrostatic

DEFLECTION

Magnetic

Diagonal deflection angle

92 deg

Horizontal deflection angle

79 deg

Vertical deflection angle

61 deg

CONVERGENCE

Magnetic

CAPACITANCES (approx.)

c_{g-all} (each gun)

7.0 pF

$c_{(kR+kG+kB)}$ - all

15 pF

c_{kR} - all

5.0 pF

c_{kG} - all

5.0 pF

c_{kB} - all

5.0 pF

c_{a2-all}

7.0 pF

$c_{a3, a4-M}$

2000 to 2500 pF

$c_{a3, a4-B}$

500 pF

EXTERNAL CONDUCTIVE COATING

This tube has an external conductive coating, M, which must be connected to chassis, and the capacitance of this coating to the final anode is used to provide smoothing for the e.h.t. supply. The electrical connection to this coating must be made within the area specified on the tube outline drawing.

REFERENCE LINE GAUGE

See page 10



COLOUR TELEVISION TUBE

A66-120X

MOUNTING POSITION

Any. The tube socket should not be rigidly mounted but should have flexible leads and be allowed to move freely. The bottom circumference of the base shell will fall within a circle of 55mm diameter which is centred upon the perpendicular from the centre of the face.

MAGNETIC SHIELDING

Magnetic shielding must be provided to minimise the effects of extraneous magnetic fields, including the earth's magnetic field. This shielding, in the form of a metal shell extending 285mm over the cone of the tube measured from the centre of the screen, should be constructed of cold-rolled mild steel of 0.5mm minimum thickness. The magnetic shield should be connected to the outer conductive coating. See page 10 for physical dimensions.

RATINGS (DESIGN CENTRE SYSTEM)

$V_{a3, a4}$ max. (absolute rating) (see notes 2 and 3)	27.5	kV
$V_{a3, a4}$ min. (absolute rating) (see note 4)	20	kV
$I_{a3, a4}$ (long term average max. for three guns: see note 5)	1.0	mA
V_{a2} max. (see note 3)	6.0	kV
$v_{a1(pk)}$ max.	1.0	kV
$-V_g$ max.	400	V
V_g max. (see note 6)	0	V
V_{h-k} max. (see note 7)		
Cathode positive		
d.c. max.	250	V
pk max.	300	V
Cathode negative		
d.c. max.	135	V
pk max.	180	V
R_{g-k} max.	750	k Ω



EQUIPMENT DESIGN VALUES (each gun if applicable)

Valid for $V_{a3, a4} = 20$ to 27.5kV

V_{a2}	16.8 to 20% of $V_{a3, a4}$
V_{a1}	see page 14
V_g	see page 14

Variation in cut-off voltage between guns

Minimum value is at least 65% of the maximum value.

I_{a2}	-15 to +15	μA
I_{a1}	-5 to +5	μA
I_g at $V_g = -150V$	-5 to +5	μA

White point reference (see notes)

Note 8 Note 9 Note 10

To produce white of colour	x	0.313	0.265	0.281
co-ordinates:	y	0.329	0.290	0.311

Percentage of total anode current supplied by each gun (typical)

Red gun	43.1	27.9	32.2	%
Green gun	32.0	34.9	35.6	%
Blue gun	24.9	37.2	32.2	%

Ratio of cathode currents

Red gun to green gun	min.	0.95	0.55	0.65	←
	av.	1.35	0.80	0.90	
	max.	1.85	1.10	1.25	
Red gun to blue gun	min.	1.30	0.55	0.75	
	av.	1.75	0.75	1.00	
	max.	2.35	1.00	1.35	←

Maximum electron beam shift required from purity magnets

±100 μm

Maximum required raster shift

±15 mm

Maximum lateral convergence shift of blue beam with respect to the converged red and green beams.

±6.4 mm

Maximum radial convergence shift, excluding effects of dynamic convergence (each beam, see note 11)

±9.4 mm

WEIGHT

Tube alone (approx.)	21.5	kg
----------------------	------	----



NOTES

1. For maximum cathode life, it is recommended that the heater supply be regulated at 6.3V.
2. The tube does not emit X-radiation above the internationally accepted maximum dosage rate if it is operated from an e.h.t. source supplying an absolute maximum voltage of 27.5kV at zero beam current and with an internal impedance $\geq 500k\Omega$.
3. Adequate precautions should be taken to ensure that the receiver is protected from damage which may be caused by a possible high voltage flashover within the cathode ray tube. In view of the high voltage on a2, adequate precautions should be taken to ensure freedom from flashover on all connections to this electrode.
4. Operation at lower voltages impairs brightness and resolution and may have a detrimental effect on colour purity.
5. The limiting value "long term average maximum current" of 1.0mA will be met provided a device is incorporated in the circuit to limit the short term average current to 1.5mA.
6. The d. c. value of bias must not be such as to allow the grid to become positive with respect to the cathode, except during the period immediately after switching the receiver on or off when it may be allowed to rise to +2V.
7. In order to avoid excessive hum the a. c. component of v_{h-k} should be as low as possible ($\leq 20V$ r. m. s.).
During an equipment warm-up period not exceeding 15 seconds $v_{h-k(pk)}$ max. (cathode positive) is allowed to rise to 410V. Between 15 and 45 seconds after switching on a decrease in $v_{h-k(pk)}$ max. (cathode positive) proportional with time from 410 to 250V is permissible.
8. The transmission systems are adjusted to this white point (illuminant D).
9. These co-ordinates are as used on monochrome tubes.
10. This is a traditional reference white point that is a compromise between illuminant D and $x = 0.265, y = 0.290$.
11. The dynamic convergence to be effected by currents of approximately parabolic waveshape synchronised with scanning.
12. The metal band (B) should be connected directly to the chassis in an a. c. receiver operating from an isolating transformer, or via a suitable leakage path in an a. c./d. c. receiver.



OUTLINE DRAWING

D219

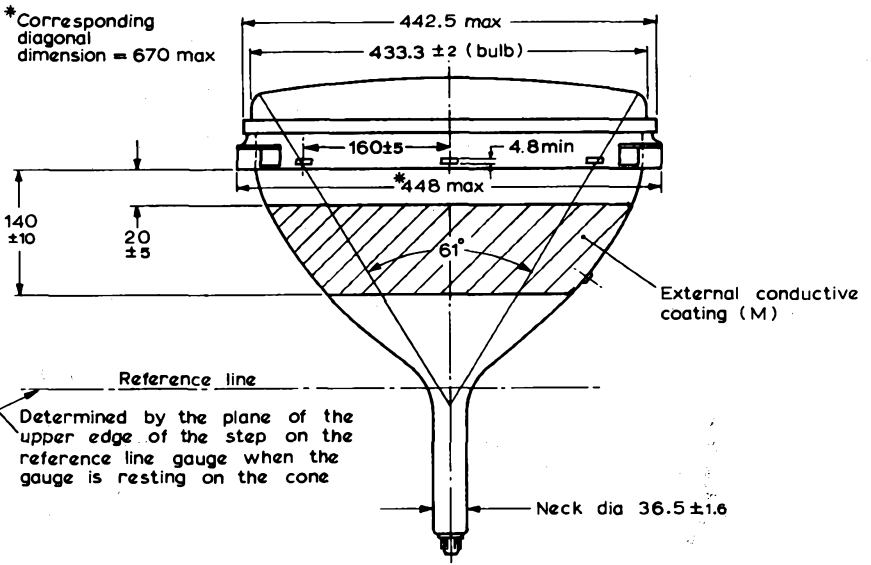
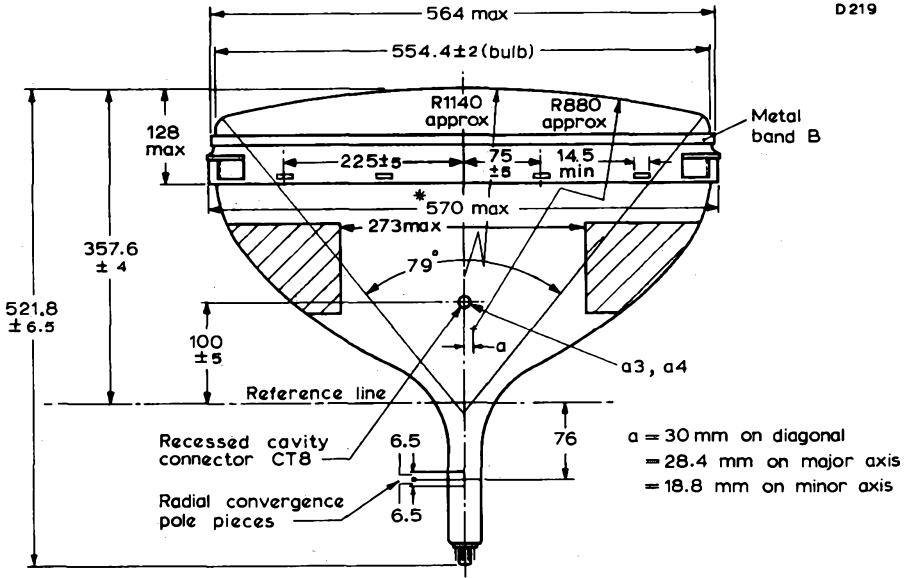

**COLOUR TELEVISION
TUBE**

A66-120X

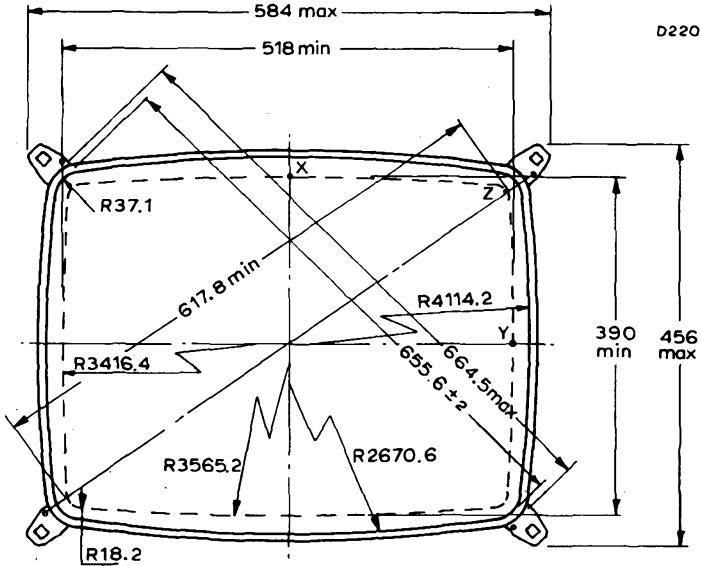

Useful screen area within dotted line.

All dimensions in mm

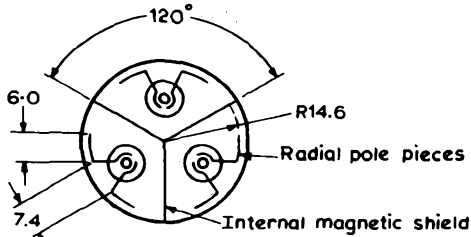

Location of radial convergence pole pieces viewed from screen end of guns.

All dimensions in mm



D221

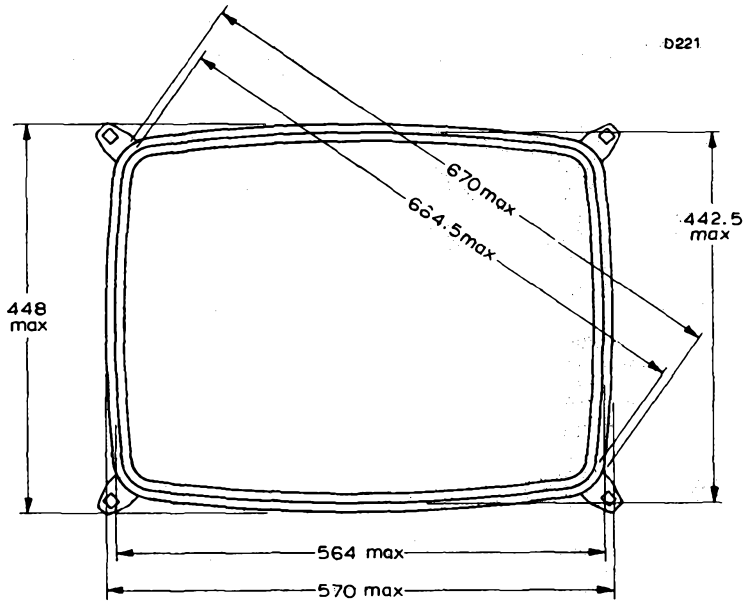

Dimensions of rimband

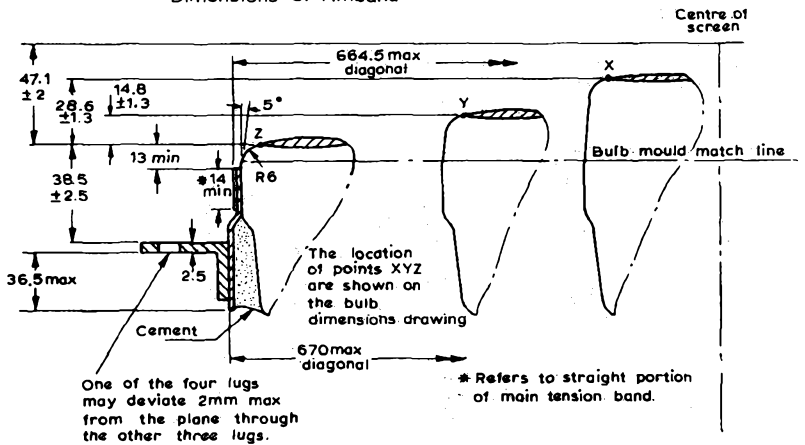

One of the four lugs may deviate 2mm max from the plane through the other three lugs.

All dimensions in mm



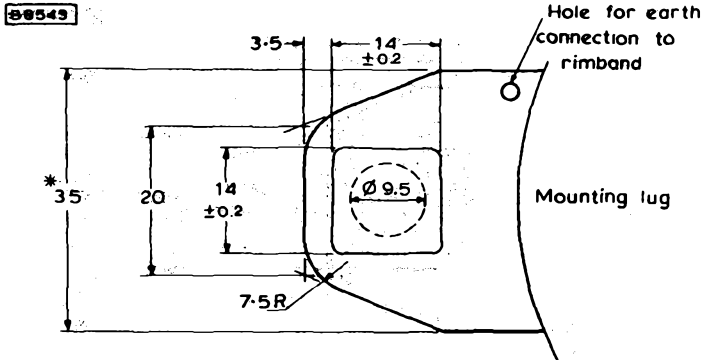

* Minimum space to be reserved for mounting lugs = 41mm

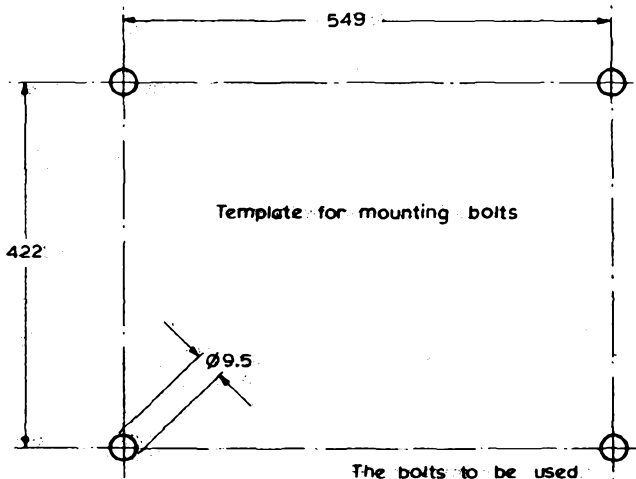

The bolts to be used for mounting the tube must be within the circles of 9.5mm diameter shown in the template drawing.

All dimensions in mm



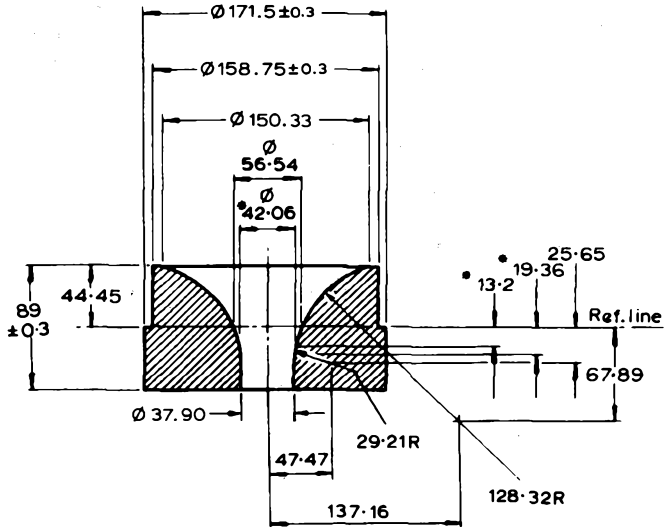

Reference line gauge

• These dimensions define extent of 29.21R

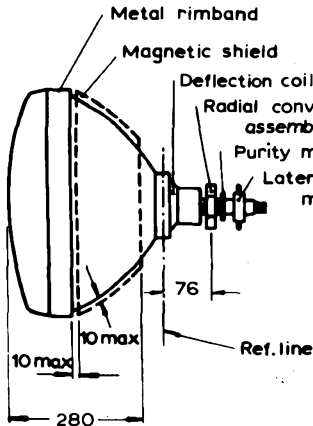

Outline of tube with components

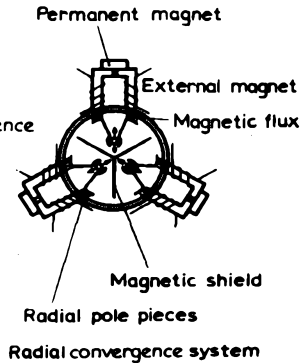

All dimensions in mm



**COLOUR TELEVISION
TUBE**

A66-120X

BB469

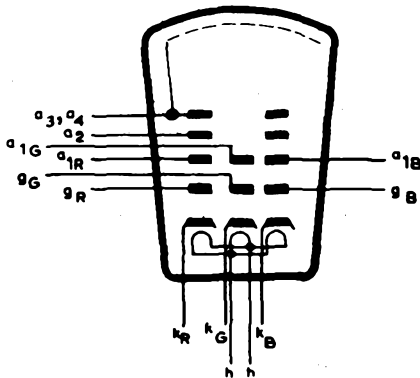
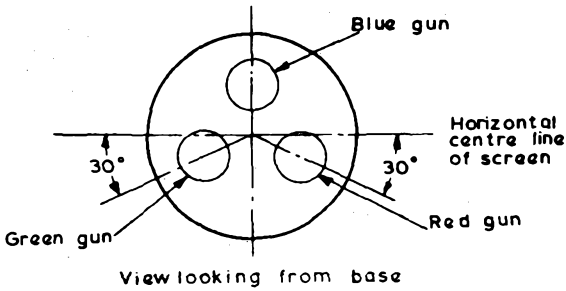
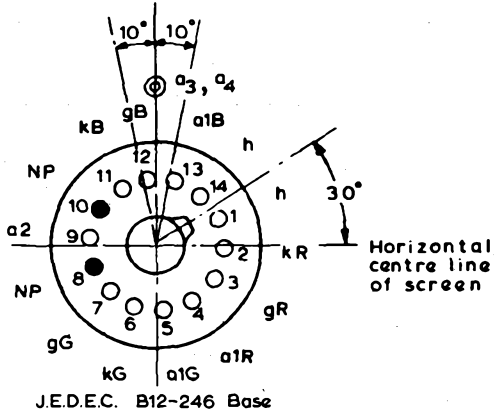

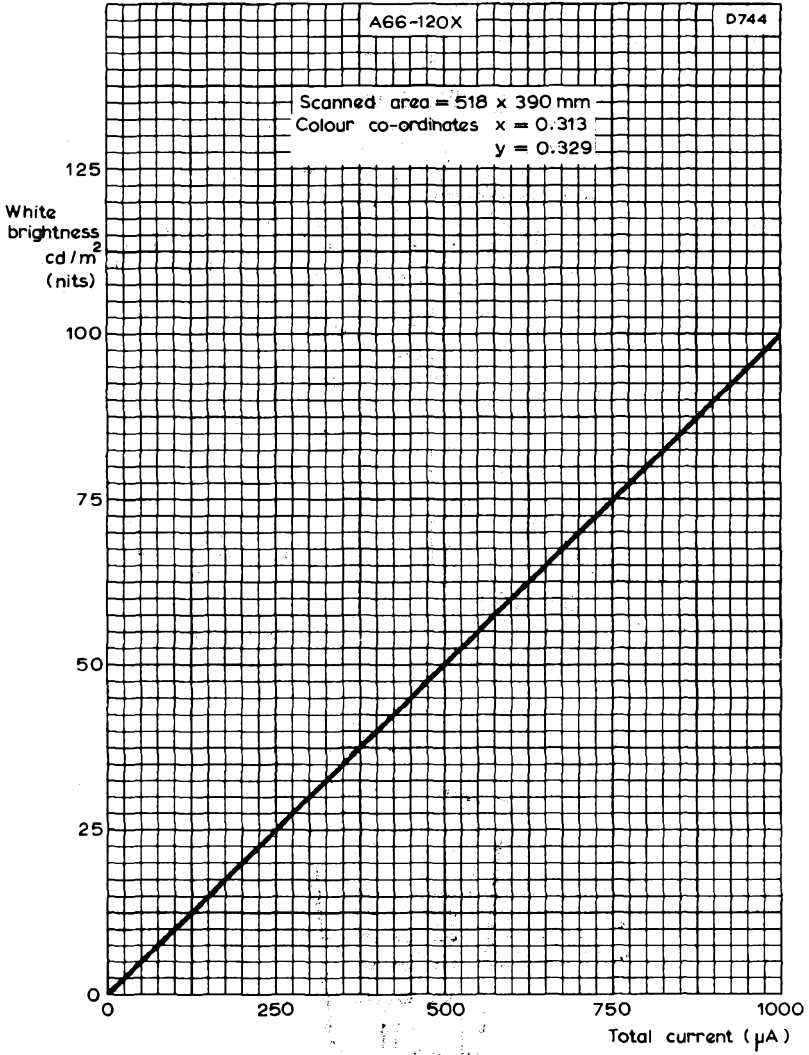

BRIGHTNESS AT CENTRE OF SCREEN PLOTTED AGAINST TOTAL CURRENT
FOR WHITE OF COLOUR COORDINATES $x = 0.313$, $y = 0.329$



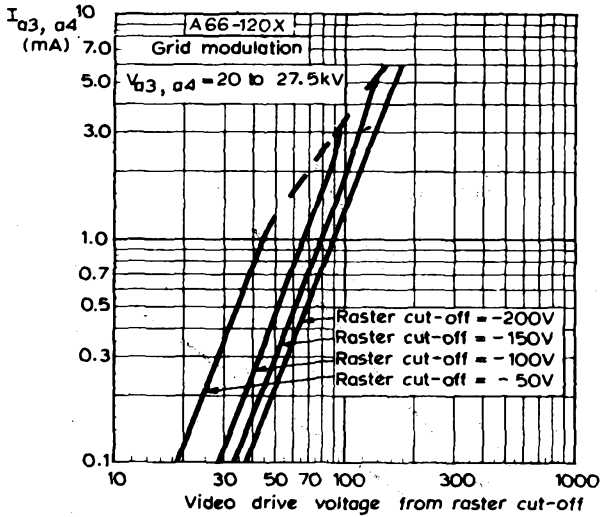

FINAL ANODE CURRENT PLOTTED AGAINST GRID VOLTAGE.
GRID MODULATION.

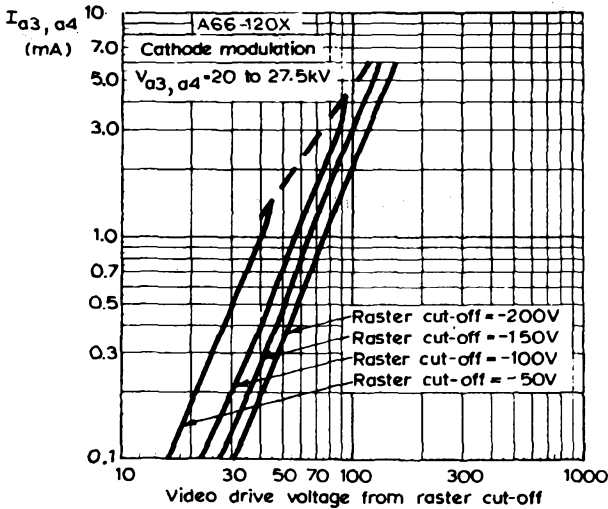

FINAL ANODE CURRENT PLOTTED AGAINST CATHODE-TO-GRID
VOLTAGE. CATHODE MODULATION



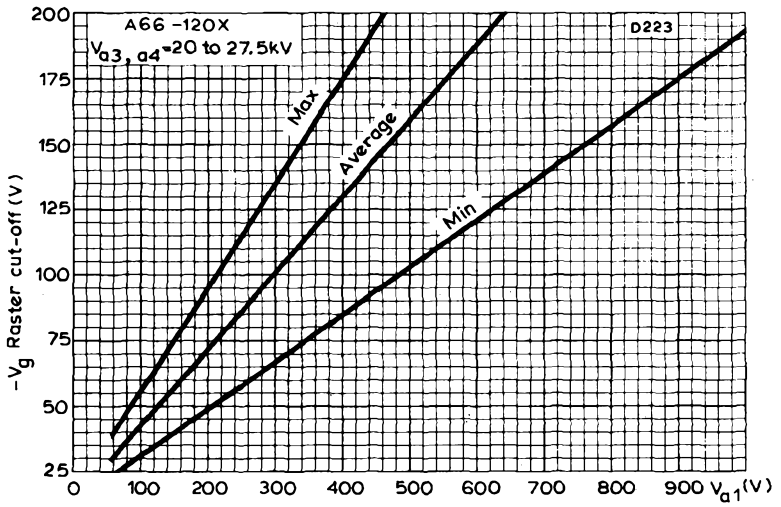

CUT-OFF DESIGN CHART



QUICK REFERENCE DATA

66cm (26in) rectangular shadow-mask colour television tube incorporating three guns, a metal-backed three-colour phosphor dot screen and internal magnetic shield.

Advanced red phosphor, europium activated.

Increased white brightness.

Unity current ratio for white point $x \approx 0.281$, $y = 0.311$.

Temperature compensated shadow-mask maintains purity during warm-up with minimum moiré effect on 625 line system.

Reinforced tube envelope - separate safety screen not required.

Suitable for receivers with push-through presentation.

Deflection angle	110	deg
Neck diameter	36.5	mm
Focusing	Bipotential	
Light transmission	52.5	%
Maximum overall length	438.1	mm

This data should be read in conjunction with GENERAL OPERATIONAL RECOMMENDATIONS - TELEVISION PICTURE TUBES

HEATER

V_h (see note 1)	6.3	V
I_h	900	mA

The limits of heater voltage and current are contained in General Operational Recommendations - Television Picture Tubes.

OPERATING CONDITIONS (each gun)

$V_{a3, a4}$	25	kV
V_{a2} (focus electrode control range)	4.2 to 5.0	kV
V_{a1} (at $V_g = -100V$ for visual extinction of focused raster)	212 to 495	V
V_g (at $V_{a1} = 300V$ for visual extinction of focused raster)	-65 to -135	V

SCREEN

Metal backed

Phosphor types for separate fluorescent colours:

Red	Europium activated rare earth
Green	Sulphide
Blue	Sulphide

Useful screen area See page 7

Spacing between centre of adjacent phosphor dot triads (approx.) 0.81 mm

Light transmission 52.5 %

FOCUSING

Electrostatic bipotential

DEFLECTION

Magnetic

Diagonal deflection angle 110 deg

Horizontal deflection angle 97 deg

Vertical deflection angle 77 deg

CONVERGENCE

Magnetic

CAPACITANCES (approx.)

c_g -all (each gun) 7.0 pF

$c^{(kR+kG+kB)}$ - all 15 pF

c^{kR} - all 5.0 pF

c^{kG} - all 5.0 pF

c^{kB} - all 5.0 pF

c_{a2} -all 7.0 pF

$c_{a3,a4-M}$ 1600 to 2100 pF

$c_{a3,a4-B}$ 500 pF

EXTERNAL CONDUCTIVE COATING

This tube has an external conductive coating, M, which must be connected to chassis, and the capacitance of this coating to the final anode is used to provide smoothing for the e. h. t. supply. The electrical connection to this coating must be made within the area specified on the tube outline drawing.

REFERENCE LINE GAUGE

See page 10

MOUNTING POSITION

Any. The tube socket should not be rigidly mounted but should have flexible leads and be allowed to move freely. The bottom circumference of the base shell will fall within a circle of 55mm diameter which is centred upon the perpendicular from the centre of the face.

MAGNETIC SHIELDING

The tube is provided with an internal magnetic shield. The rimband has rectangular holes for mounting the degaussing coils.

RATINGS (DESIGN CENTRE SYSTEM)

$V_{a3,a4}$ max. (absolute rating) (see notes 2 and 3)	27.5	kV
$V_{a3,a4}$ min. (absolute rating) (see note 4)	20	kV
$I_{a3,a4}$ (long term average max. for three guns: see note 5)	1.0	mA
V_{a2} max. (see note 3)	6.0	kV
V_{a1} (pk) max.	1.0	kV
$-V_g$ max.	400	V
$-V_g$ max. (operating cut-off)	200	V
V_g max. (see note 6)	0	V
V_{h-k} max. (see note 7)		
Cathode positive		
d. c. max.	250	V
pk max.	300	V
Cathode negative		
d. c. max.	135	V
pk max.	180	V
R_{g-k} max.	750	k Ω

EQUIPMENT DESIGN VALUES (each gun if applicable)

Valid for $V_{a3,a4} = 20$ to 27.5kV

V_{a2} 16.8 to 20% of $V_{a3,a4}$

V_{a1} see page 15

V_g see page 15

Variation in cut-off voltage between guns Minimum value is at least 65% of the maximum value.

I_{a2} -5 to +5 μA

I_{a1} -5 to +5 μA

I_g at $V_g = -150V$ -5 to +5 μA

White point reference (see notes) Note 8 Note 9 Note 10

To produce white of colour	x	0.313	0.265	0.281
co-ordinates:	y	0.329	0.290	0.311

Percentage of total anode current supplied by each gun (typical)

Red gun	41.0	25.8	30.2	%
---------	------	------	------	---

Green gun	31.3	33.5	34.5	%
-----------	------	------	------	---

Blue gun	27.7	40.7	35.3	%
----------	------	------	------	---

Ratio of cathode currents

Red gun to green gun	min.	0.95	0.55	0.65
----------------------	------	------	------	------

av.	1.3	0.75	0.9
-----	-----	------	-----

max.	1.8	1.10	1.25
------	-----	------	------

Red gun to blue gun	min.	1.15	0.5	0.65
---------------------	------	------	-----	------

av.	1.5	0.65	0.85
-----	-----	------	------

max.	2.0	0.85	1.15
------	-----	------	------

Maximum electron beam shift required from purity magnets ± 100 μm

Maximum required raster shift ± 12 mm

Maximum lateral convergence shift of blue beam with respect to the converged red and green beams ± 5 mm

Maximum radial convergence shift, excluding effects of dynamic convergence (each beam, see note 11) ± 8 mm

WEIGHT

Tube alone (approx.) 20 kg

NOTES

1. For maximum cathode life, it is recommended that the heater supply be regulated at 6.3V.
2. The tube does not emit X-radiation above the internationally accepted maximum dosage rate if it is operated from an e. h. t. source supplying an absolute maximum voltage of 27.5kV at zero beam current and with an internal impedance $\geq 500k\Omega$.
3. Adequate precautions should be taken to ensure that the receiver is protected from damage which may be caused by a possible high voltage flashover within the cathode ray tube. In view of the high voltage on a2, adequate precautions should be taken to ensure freedom from flashover on all connections to this electrode.
4. Operation at lower voltages impairs brightness and resolution and may have a detrimental effect on colour purity.
5. The limiting value "long term average maximum current" of 1.0mA will be met provided a device is incorporated in the circuit to limit the short term average current to 1.5mA.
6. The d. c. value of bias must not be such as to allow the grid to become positive with respect to the cathode, except during the period immediately after switching the receiver on or off when it may be allowed to rise to +2V.
7. In order to avoid excessive hum the a. c. component of V_{h-k} should be as low as possible ($\leq 20V$ r. m. s.).

During an equipment warm-up period not exceeding 15 seconds, V_{h-k} max. (cathode positive) is allowed to rise to 410V. Between 15 and 45 seconds after switching on, a decrease in V_{h-k} max. (cathode positive) proportional with time from 410 to 250V is permissible.

8. The transmission systems are adjusted to this white point (illuminant D).
9. These co-ordinates are as used on monochrome tubes.
10. This is a traditional reference white point that is a compromise between illuminant D and $x=0.265$, $y=0.290$.
11. The dynamic convergence to be effected by currents of approximately parabolic waveform synchronised with scanning
12. The metal band (B) should be connected directly to the chassis in an a. c. receiver operating from an isolating transformer, or via a suitable leakage path in an a. c./d. c. receiver.

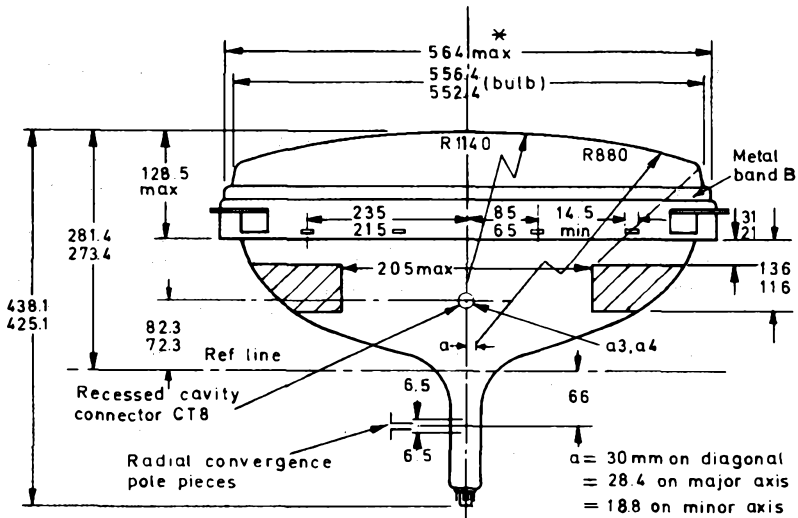

* Corresponding diagonal dimension = 664.5 max

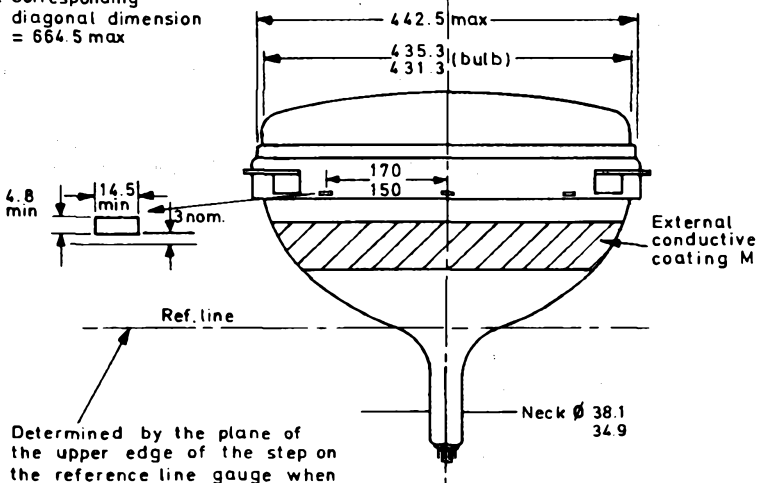

D4691

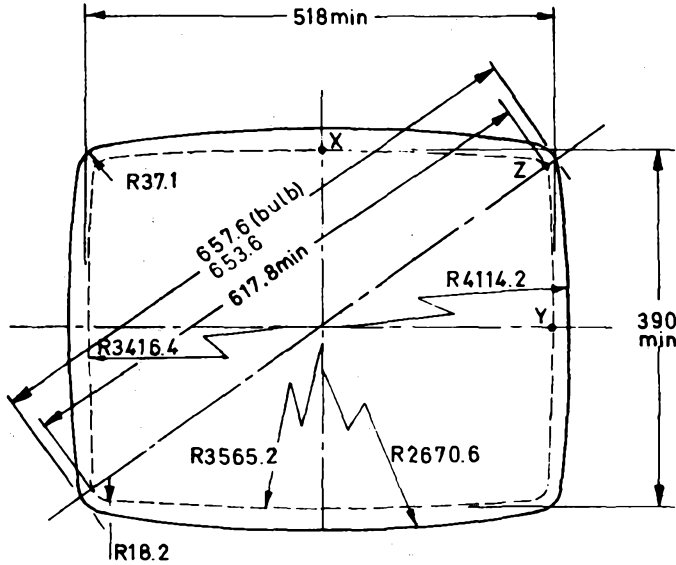

Useful screen area within
dotted line

All dimensions in mm

Bulb and screen dimensions

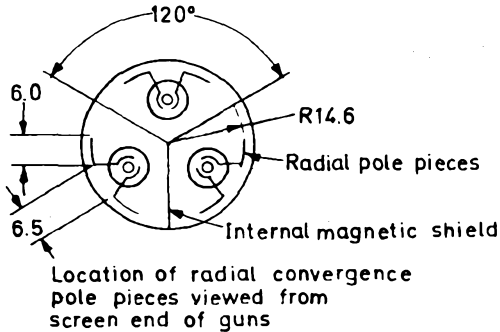

Location of radial convergence
pole pieces viewed from
screen end of guns

All dimensions in mm

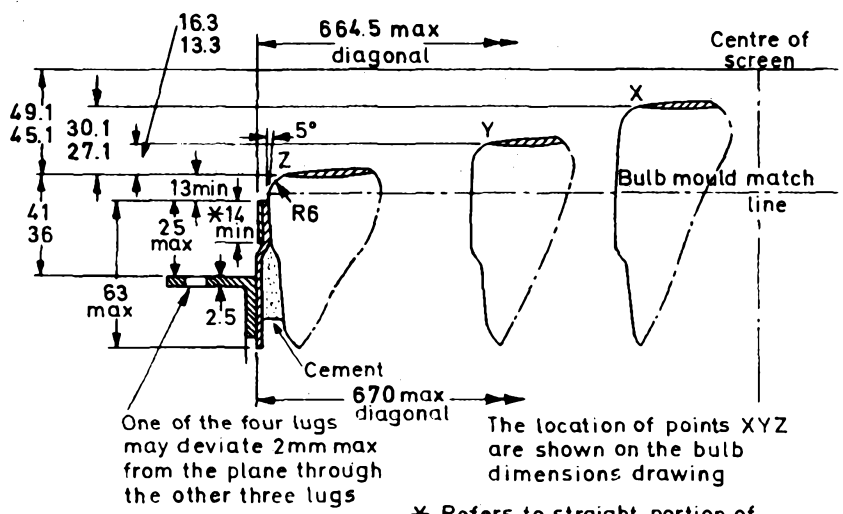
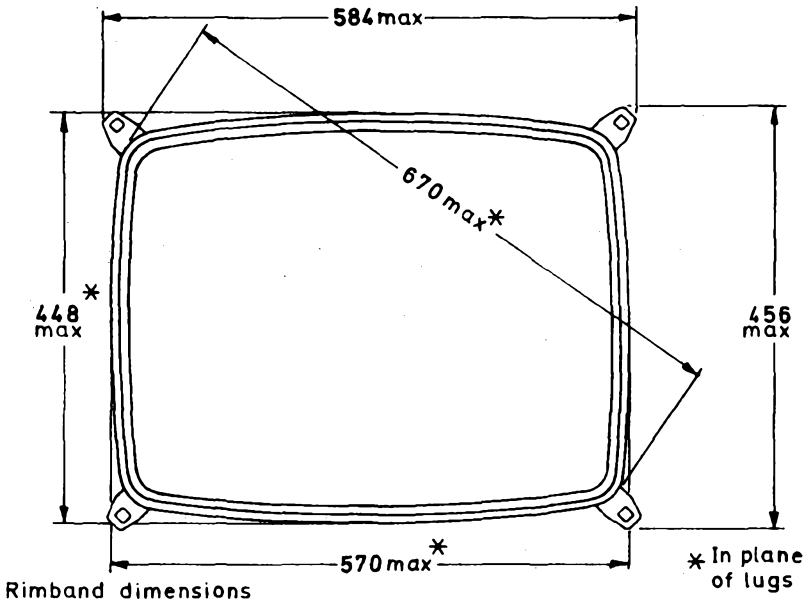

All dimension in mm

D4690

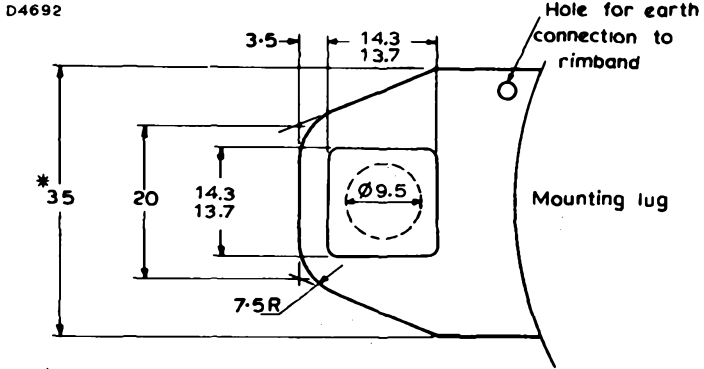

* Minimum space to be reserved for mounting lugs = 41mm

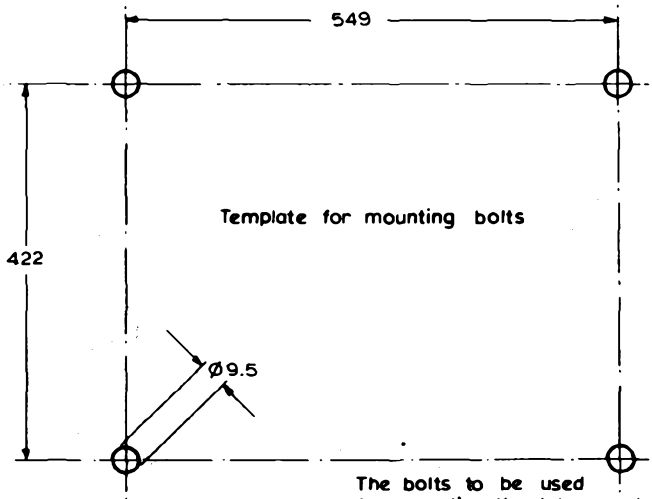

All dimensions in mm

The bolts to be used for mounting the tube must be within the circles of 9.5mm diameter shown in the template drawing.

D4403

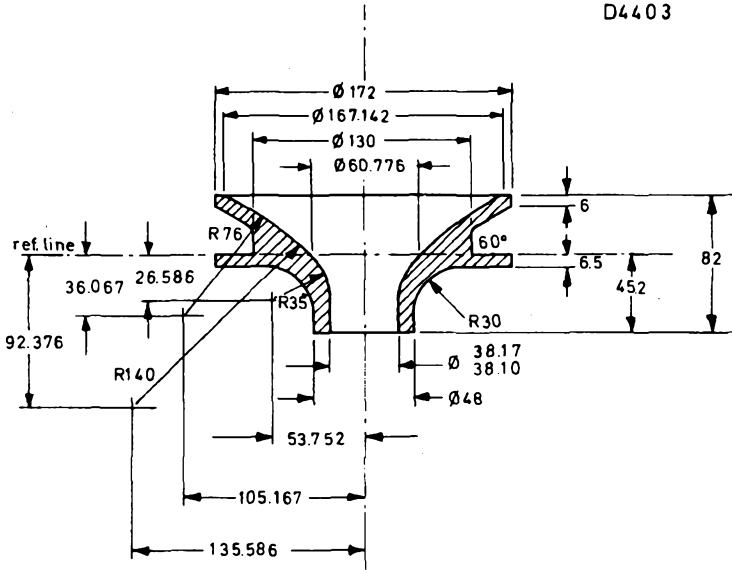

Reference line gauge

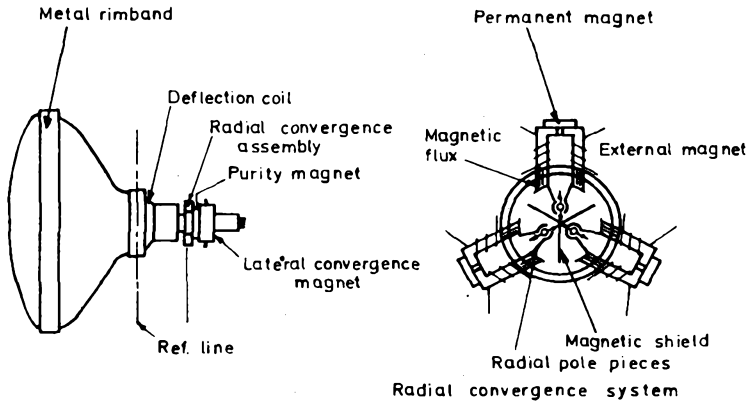

Outline of tube with components

All dimensions in mm

COLOUR TELEVISION TUBE

A66-140X

D4693

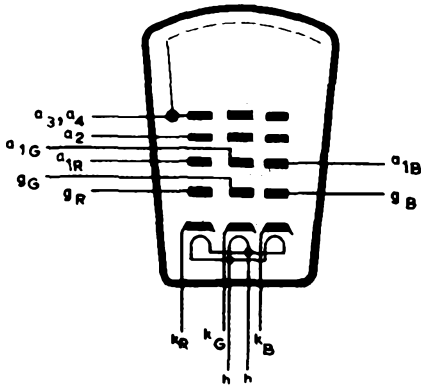
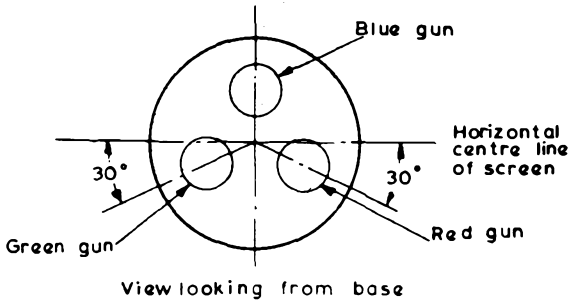
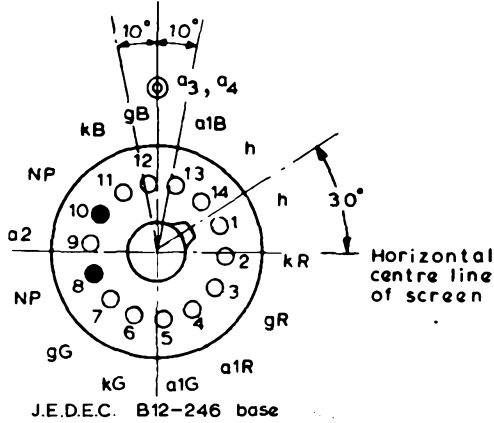

Mullard



MAXIMUM CONE CONTOURS

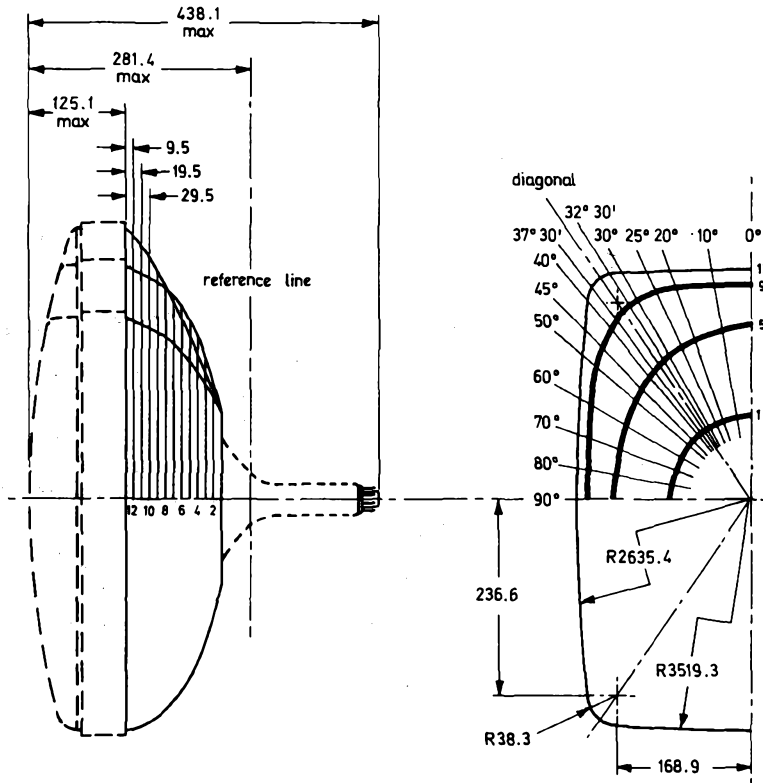

All dimensions in mm

D1271

DIMENSIONS FOR MAXIMUM CONE CONTOUR DRAWING

Section	Nominal distance from section 13	Distance from centre														
		0° long axis	10°	20°	25°	30°	32°30'	35°31'	37°30'	40° diagonal	45°	50°	60°	70°	80°	90° short axis
1	119.5	99.4	99.2	98.7	98.5	98.3	98.2	98.1	98.1	98.0	98.0	98.1	98.5	99.1	99.6	99.9
2	109.5	142.1	139.1	133.9	131.5	129.4	128.4	127.4	126.9	126.3	125.4	124.9	125.2	126.9	129.5	131.1
3	99.5	171.8	168.1	161.4	158.0	154.9	153.5	152.0	151.1	150.0	148.2	146.9	145.6	146.0	147.2	148.2
4	89.5	194.0	191.4	185.6	182.2	178.9	177.3	175.4	174.2	172.8	170.1	167.8	164.2	162.1	161.1	161.0
5	79.5	213.3	211.9	207.8	204.9	201.7	199.9	197.8	196.3	194.5	190.9	187.4	181.2	176.4	173.4	172.4
6	69.5	230.1	229.8	227.8	225.7	222.8	221.0	218.6	217.0	214.8	210.1	205.3	196.2	188.9	184.3	182.6
7	59.5	243.5	244.4	245.3	244.6	242.7	241.2	238.8	237.0	234.4	228.5	222.1	209.6	199.7	193.4	191.3
8	49.5	254.0	255.9	260.0	261.4	261.2	260.2	258.1	256.2	253.2	245.8	237.4	221.0	208.5	201.0	198.4
9	39.5	262.2	265.0	272.0	275.7	277.9	278.0	276.4	274.4	270.9	261.4	250.5	230.4	215.7	207.2	204.3
10	29.5	268.8	272.1	281.5	287.4	292.7	294.3	293.4	291.3	287.1	274.6	261.1	237.5	221.3	212.1	209.1
11	19.5	273.4	277.1	288.2	296.2	304.8	308.6	309.2	307.0	301.8	285.1	268.8	242.5	225.3	215.8	212.8
12	9.5	276.4	280.3	292.5	302.0	313.8	320.4	323.1	321.3	314.8	292.5	273.5	245.6	228.1	218.5	215.5
13	0	279.0	283.0	295.4	305.2	318.0	325.4	329.0	327.5	320.7	296.5	276.7	248.3	230.7	221.1	218.0

All dimensions in millimetres



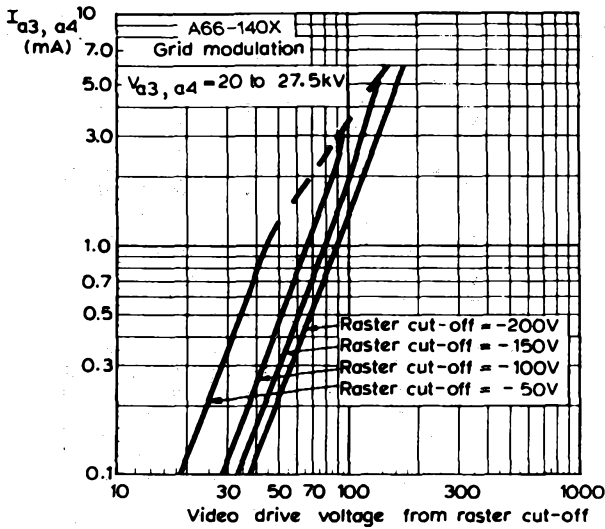

FINAL ANODE CURRENT PLOTTED AGAINST GRID VOLTAGE. GRID MODULATION.

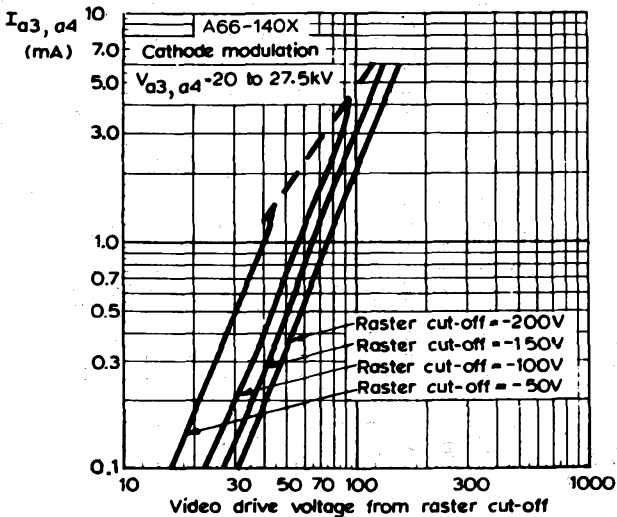

FINAL ANODE CURRENT PLOTTED AGAINST CATHODE-TO-GRID VOLTAGE. CATHODE MODULATION

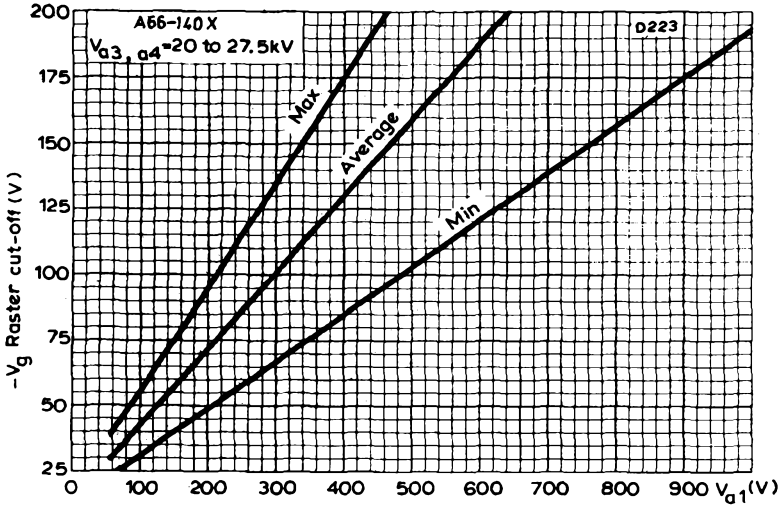

CUT-OFF DESIGN CHART



MONOCHROME PICTURE TUBES





QUICK REFERENCE DATA

31cm (12in) rectangular direct viewing television tube with metal backed screen and reinforced envelope. A separate safety screen is not required. Especially for use in portable receivers with push-through presentation.

Deflection angle	110	deg
Focusing	Electrostatic	
Light transmission	50	%
Maximum overall length	233	mm

This data should be read in conjunction with
GENERAL OPERATIONAL RECOMMENDATIONS - TELEVISION PICTURE TUBES

HEATER

V_h	11	V
I_h	75	mA

The maximum total deviation from the nominal heater voltage is 15%.

The deviation consists of 7% maximum continuous deviation, for example, due to component spread and 10% maximum temporary deviation.

For supply direct from a battery, the heater voltage cycle must be within the limits of the graph on page 10.

OPERATING CONDITIONS

$V_{a2, a4}$	11	kV
V_{a3} (focus electrode) control range	0 to 350	V
V_{a1}	250	V
V_g for visual extinction of focused raster	-35 to -69	V
* V_k for visual extinction of focused raster	32 to 58	V

*For cathode modulation, all voltages are measured with respect to grid.

SCREEN

Metal backed		
Fluorescent colour	White	
Light transmission (approx.)	50	%
Useful screen area	see page 7	

FOCUSING

Electrostatic

DEFLECTION

Magnetic

Diagonal deflection angle	110	deg
Horizontal deflection angle	99	deg
Vertical deflection angle	80	deg

The deflection coils should be designed so that their internal contour is in accordance with the reference line gauge shown on page 4.

CAPACITANCES

^c _g -all	7.0	pF
^c _k -all	3.0	pF
^c _{a2, a4-M}	450 to 900	pF
^c _{a2, a4-B}	300	pF

EXTERNAL CONDUCTIVE COATING

This tube has an external conductive coating, M, which must be connected to chassis, and the capacitance of this coating to the final anode is used to provide smoothing for the e.h.t. supply. The electrical connection to this coating must be made within the area specified on the tube outline drawing.

RASTER CENTRING

See notes under this heading in 'General Operational Recommendations - Television Picture Tubes'.

Centring magnet field intensity	0 to 800	A/m
Maximum distance of centre of centring field from reference line	47	mm

Adjustment of the centring magnet should not be such that a general reduction in brightness of the raster occurs.

REFERENCE LINE GAUGE

see page 4

MOUNTING POSITION

Any

The tube socket should not be rigidly mounted but should have flexible leads and be allowed to move freely.

This tube is fitted with a pin protector in order to avoid damage to the glass base due to bending of the base pins whilst handling the tube.

It is advisable to keep this pin protector on the base until it can be replaced by the socket after the installation of the tube in any equipment.

TELEVISION TUBE

A31-120W

RATINGS (DESIGN CENTRE SYSTEM unless otherwise stated)

$V_{a2, a4}$ max. (at $I_{a2, a4} = 0$) (see note 1)	12	kV
$V_{a2, a4}$ min. (absolute limit)	8.5	kV
$+V_{a3}$ max.	500	V
$-V_{a3}$ max.	50	V
V_{a1} max.	350	V
V_{a1} min.	200	V
$-v_g(pk)$ max. (see note 2)	350	V
$-V_g$ max. (see note 3)	100	V
$\pm I_{a3}$ max.	25	μA
$\pm I_{a1}$ max.	5.0	μA
V_{h-k} (cathode positive)		
d.c. max.	110	V
pk max.	130	V
R_{h-k} max.	1.0	$M\Omega$
Z_{k-e} max. ($f=50Hz$)	100	$k\Omega$
R_{g-k} max.	1.5	$M\Omega$
Z_{g-k} max. ($f=50Hz$)	500	$k\Omega$
R_{M-B} min.	2.0	$M\Omega$

Notes

1. Adequate precautions should be taken to ensure that the receiver is protected from damage which may be caused by a possible high voltage flashover within the tube.
2. Maximum pulse duration 22% of one cycle with a maximum of 1.5ms.
3. The d.c. value of bias must not be such as to allow the grid to become positive with respect to the cathode, except during the period immediately after switching the receiver on or off when it may be allowed to rise to +2.0V. It is advisable to limit the positive excursion of the video signal to +5V(pk) max. This may be achieved automatically by the series connection of a 10k Ω resistor.
4. The metal band must be earthed by means of the tag provided.

The mounting lugs will not necessarily be in electrical contact with the metal band.

WEIGHT

Tube alone (approx.)	2.8	kg
----------------------	-----	----

Mullard

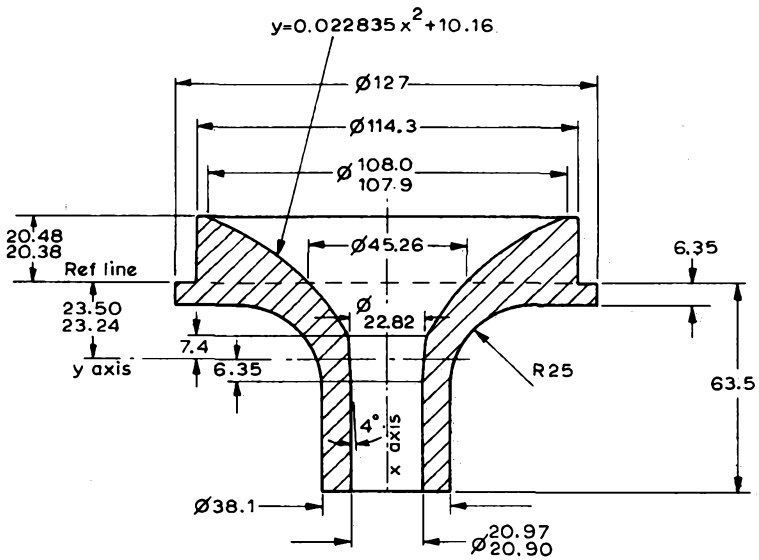

All dimensions in mm

D478

REFERENCE LINE GAUGE

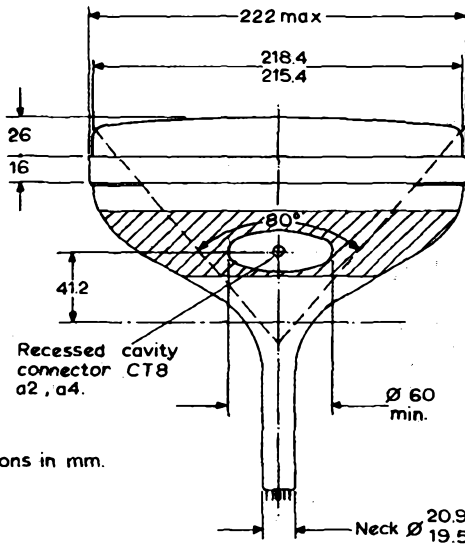
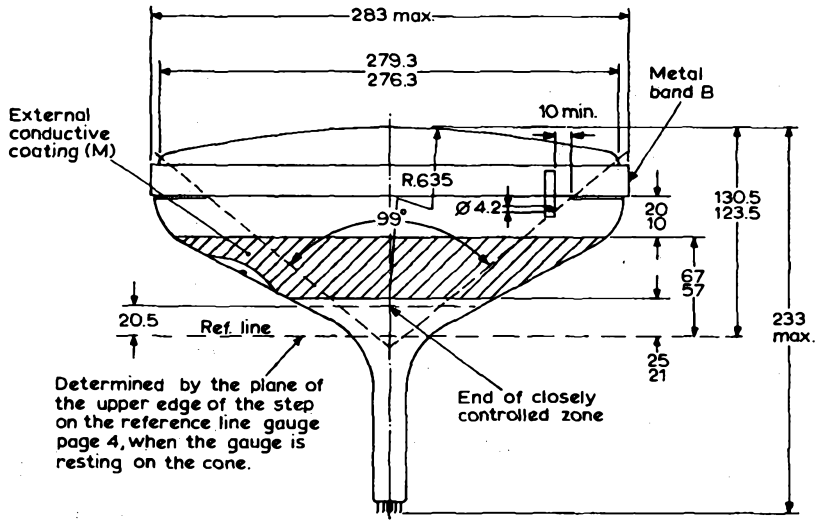

All dimensions in mm.

Dimensions of metal band

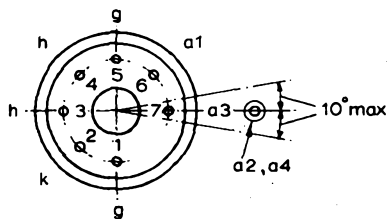
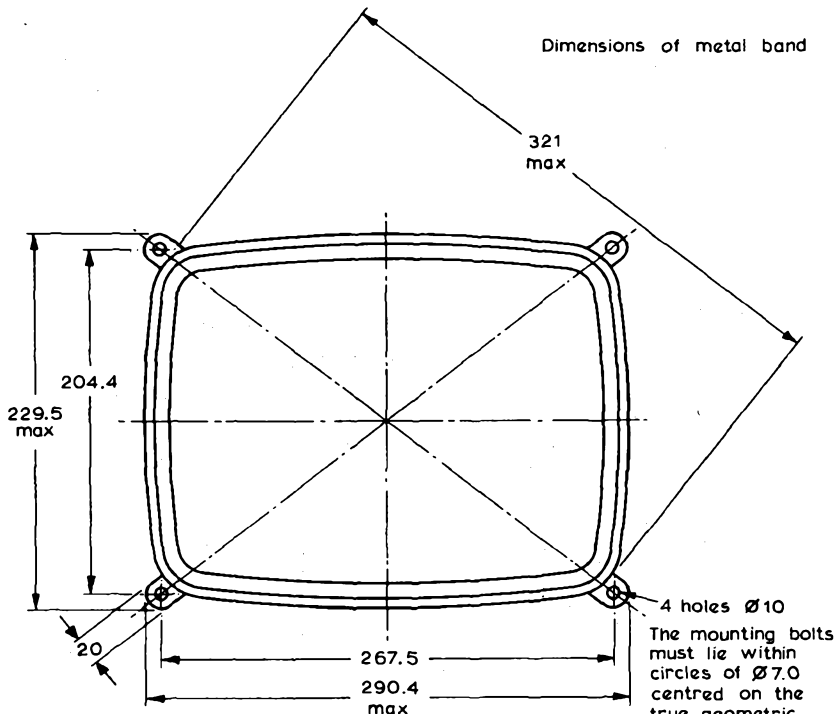

Pin dimensions as in B7G base

The centre of the socket must allow entry of the pump stem

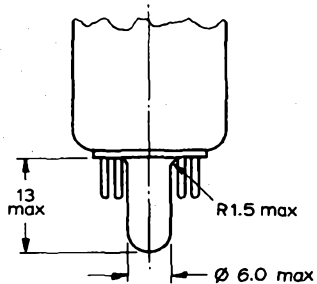
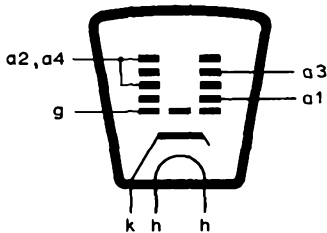

All dimensions in mm

D475

TELEVISION TUBE

A31-120W

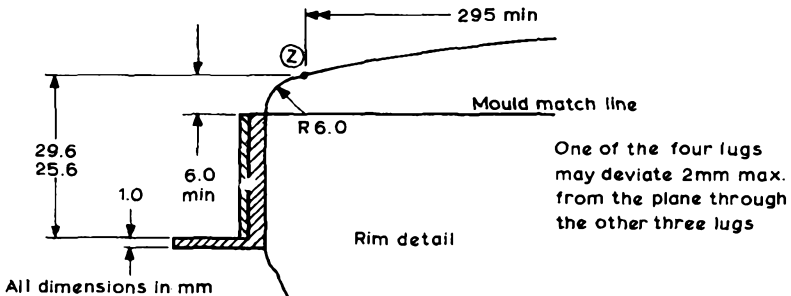
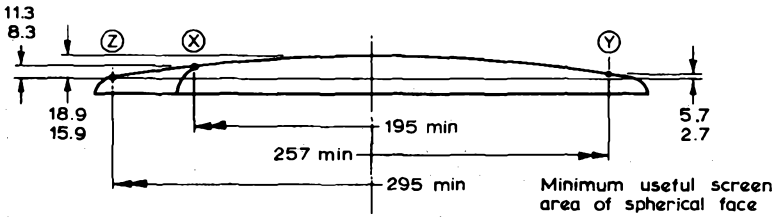
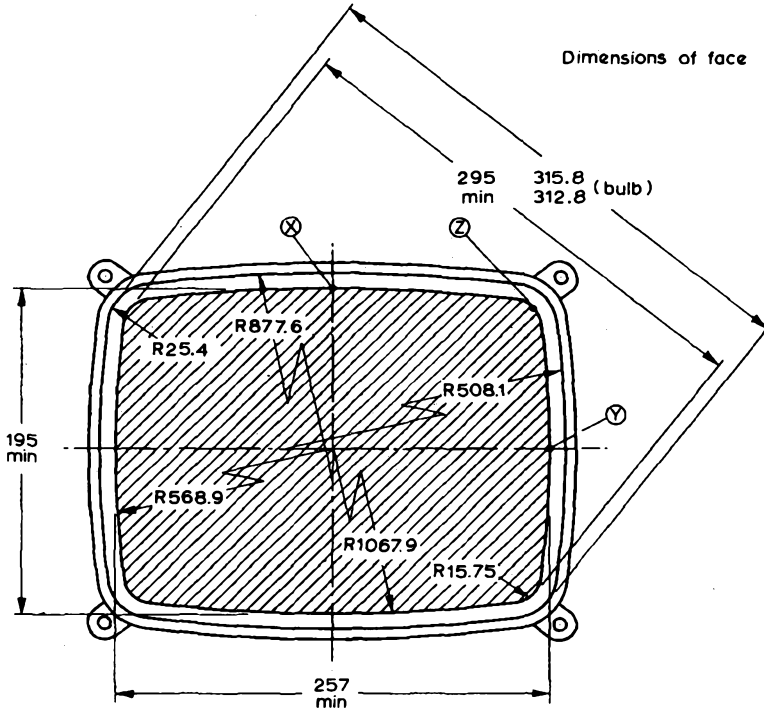

Mullard

MAXIMUM CONE CONTOURS

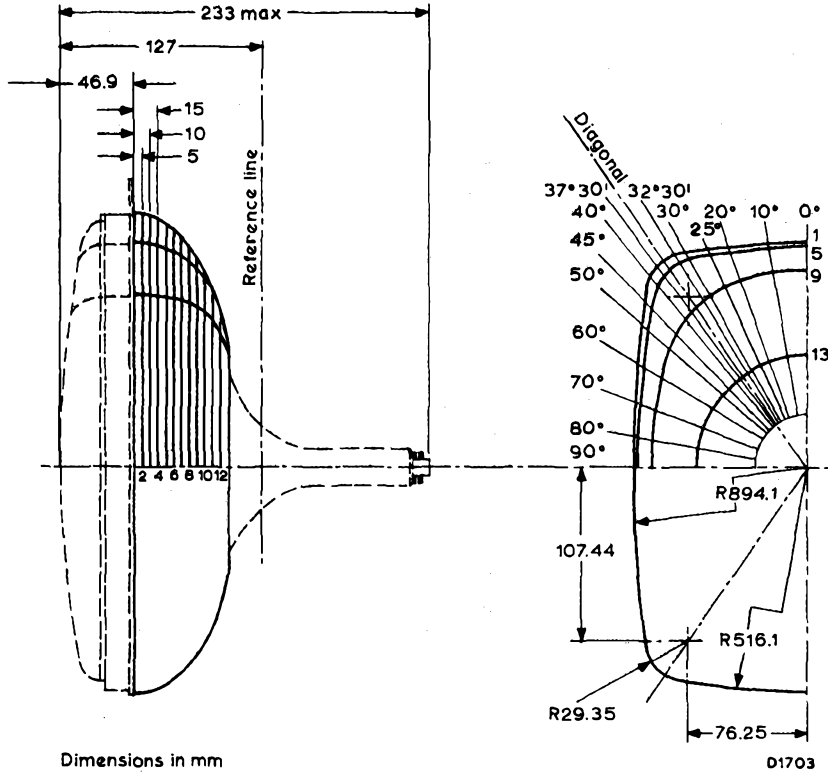

Dimensions in mm

DIMENSIONS FOR MAXIMUM CONE CONTOUR DRAWING (Page 8)

Distance from centre (max. values)

Section	Nominal distance from section 1	0° Long axis	10°	20°	25°	30°	32°30'	Diagonal										90° Short axis
								37°30'	40°	45°	50°	60°	70°	80°				
1	0	142.8	144.4	149.3	153.1	157.9	160.2	161.1	160.6	158.7	149.9	140.6	127.1	118.5	113.8	112.3		
2	5.0	142.4	143.9	148.8	152.6	157.4	159.8	160.7	160.2	158.2	149.4	140.1	126.6	118.1	113.4	111.9		
3	10.0	141.6	143.2	148.0	151.8	156.5	158.7	159.5	159.0	157.1	148.5	139.4	126.0	117.6	112.9	111.4		
4	15.0	140.3	141.9	146.6	150.2	154.6	156.6	157.4	156.8	155.1	147.1	138.5	125.4	117.0	112.3	110.8		
5	20.0	138.4	140.0	144.5	147.8	151.6	153.2	153.7	153.2	151.7	144.8	137.1	124.7	116.4	111.8	110.3		
6	25.0	136.0	137.5	141.6	144.4	147.2	148.3	148.4	147.9	146.5	140.9	134.3	122.9	115.0	110.5	109.0		
7	30.0	132.6	134.0	137.4	139.3	140.8	141.2	140.8	140.2	138.9	134.6	129.4	119.7	112.5	108.2	106.8		
8	35.0	127.9	128.9	131.2	132.1	132.5	132.3	131.6	130.9	129.7	126.5	122.7	114.9	108.8	105.0	103.7		
9	40.0	121.3	121.9	122.8	122.8	122.4	121.9	121.2	120.5	119.5	117.1	114.3	108.6	103.8	100.7	99.7		
10	45.0	112.3	112.4	112.2	111.7	110.9	110.4	109.7	109.1	108.3	106.6	104.7	100.9	97.6	95.5	94.7		
11	50.0	99.4	99.4	98.9	98.5	97.9	97.5	97.1	96.8	96.3	95.4	94.4	92.4	90.7	89.5	89.1		
12	55.0	85.9	85.6	84.9	84.4	84.0	83.8	83.5	83.3	83.1	82.7	82.4	81.9	81.6	81.5	81.5		
13	59.6	72.2	72.0	71.7	71.4	71.2	71.1	71.0	71.0	70.9	70.8	70.7	70.6	70.7	70.8	70.9		

All dimensions in mm



Mullard

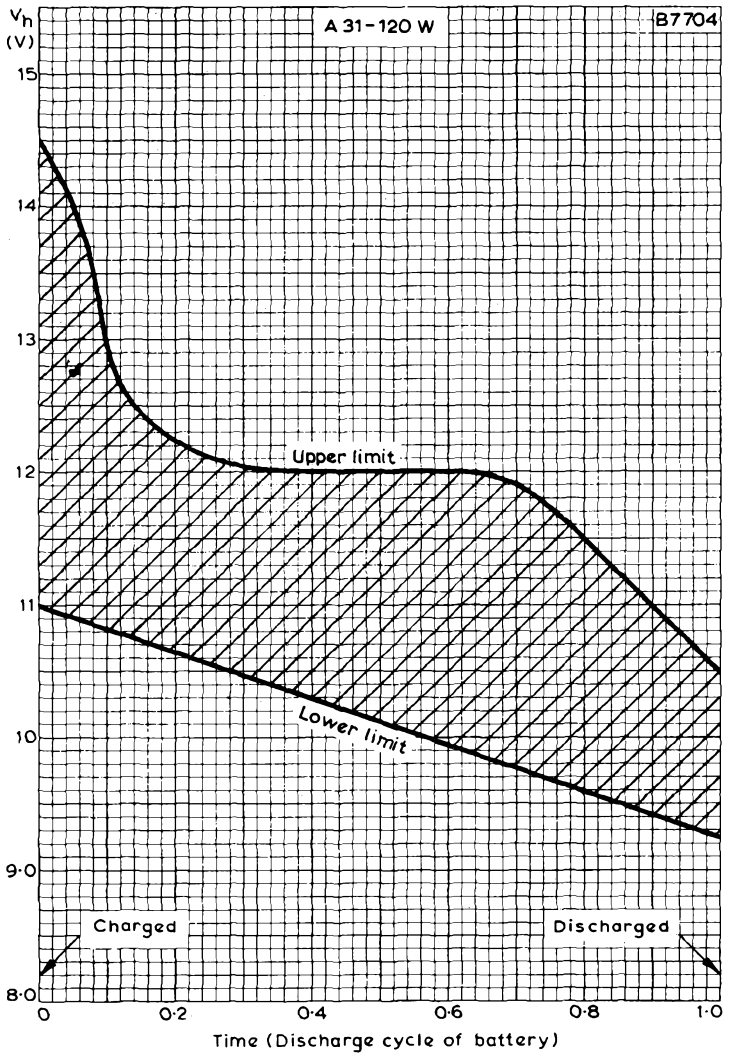

HEATER VOLTAGE PLOTTED AGAINST BATTERY DISCHARGE CYCLE

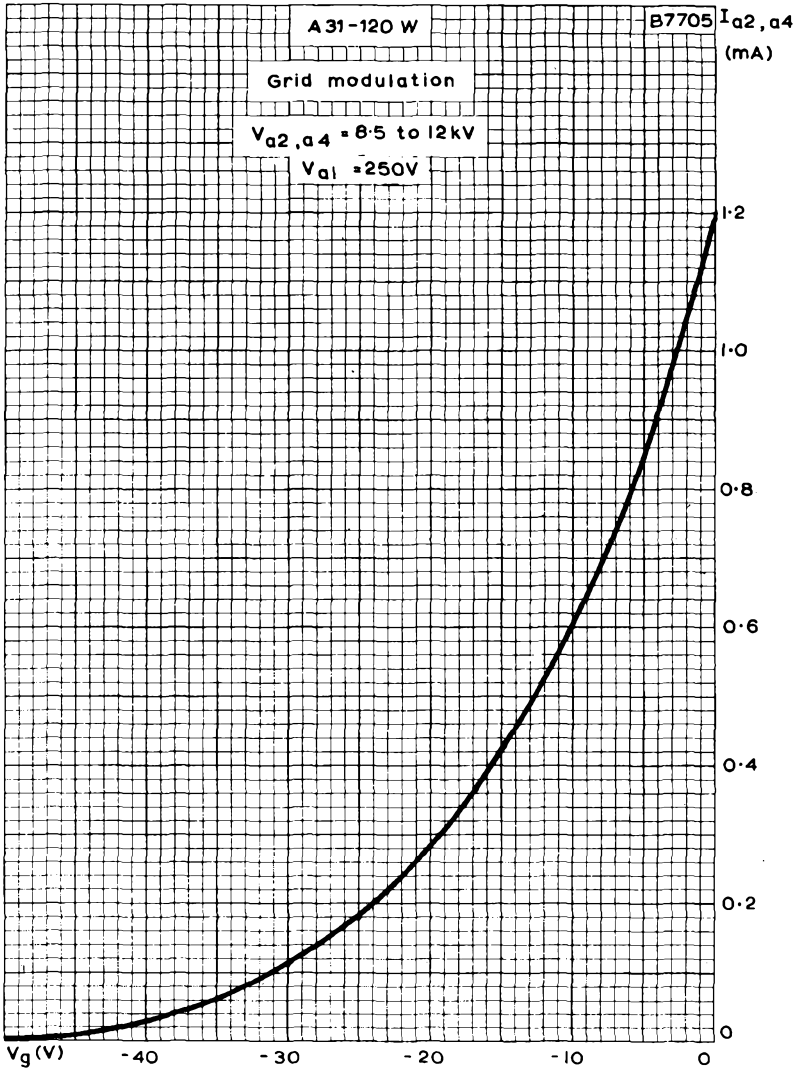

FINAL ANODE CURRENT PLOTTED AGAINST GRID VOLTAGE.
GRID MODULATION

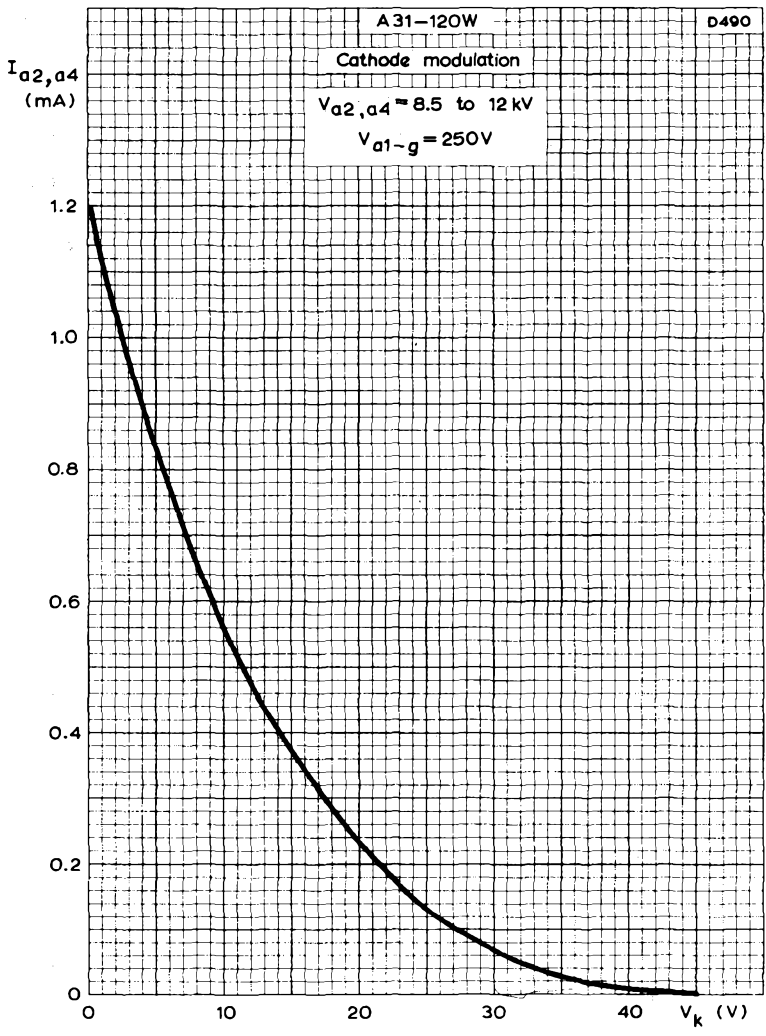

FINAL ANODE CURRENT PLOTTED AGAINST CATHODE-TO-GRID VOLTAGE. CATHODE MODULATION

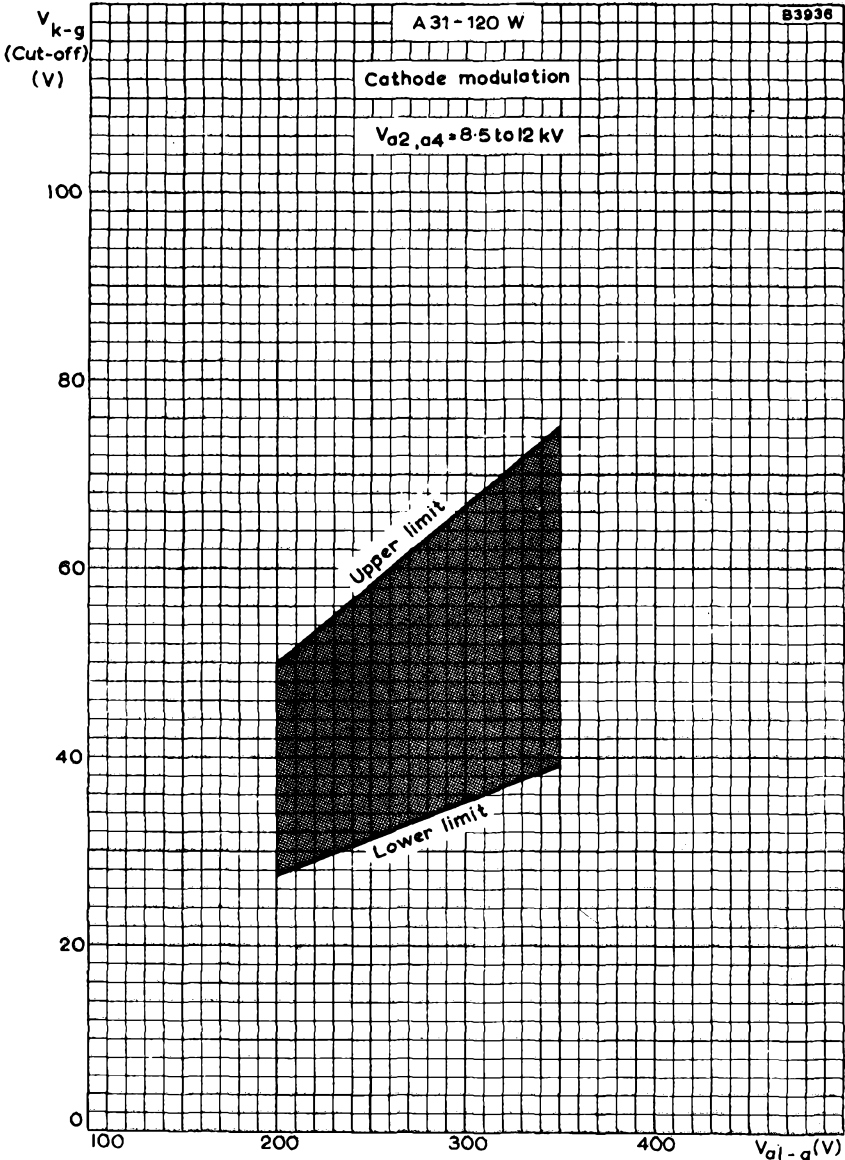

LIMITS OF CATHODE-TO-GRID CUT-OFF VOLTAGE PLOTTED AGAINST FIRST ANODE-TO-GRID VOLTAGE. CATHODE MODULATION



QUICK REFERENCE DATA

31cm (12in) rectangular direct viewing television tube. A separate safety screen is not required. Especially for use in portable receivers with push-through presentation.

A special feature of this tube is its short warm-up time.

Deflection angle	110	deg
Final accelerator voltage max.	15	kV
Neck diameter	20	mm
Light transmission	50	%
Maximum overall length	233	mm

A legible picture appears within 5 seconds (typ.)

This data should be read in conjunction with
GENERAL OPERATIONAL RECOMMENDATIONS - TELEVISION PICTURE TUBES

HEATER

V_h	11	V
I_h	140	mA
Cathode warm-up time (typ.)	5	s

OPERATING CONDITIONS

$V_{a2, a4}$	12	kV
V_{a3} (focus electrode) control range	0 to 350	V
V_{a1}	250	V
V_g for visual extinction of focused raster	-35 to -69	V
* V_k for visual extinction of focused raster	32 to 58	V

*For cathode modulation, all voltages are measured with respect to grid.

SCREEN

Metal backed		
Fluorescent colour	White	
Light transmission (approx.)	50	%
Useful screen area	see page 7	

FOCUSING

Electrostatic

DEFLECTION

Magnetic		
Diagonal deflection angle	110	deg
Horizontal deflection angle	99	deg
Vertical deflection angle	80	deg

The deflection coils should be designed so that their internal contour is in accordance with the reference line gauge shown on page 4.

CAPACITANCES

C_{g-all}	7.0	pF
C_{k-all}	3.0	pF
$C_{a2, a4-M}$	450 to 900	pF
$C_{a2, a4-B}$	150	pF

EXTERNAL CONDUCTIVE COATING

This tube has an external conductive coating, M, which must be connected to chassis, and the capacitance of this coating to the final anode is used to provide smoothing for the e.h.t. supply. The electrical connection to this coating must be made within the area specified on the tube outline drawing.

RASTER CENTRING

See notes under this heading in 'General Operational Recommendations - Television Picture Tubes'.

Centring magnet field intensity	0 to 800	A/m
Maximum distance of centre of centring field from reference line	47	mm

Adjustment of the centring magnet should not be such that a general reduction in brightness of the raster occurs.

REFERENCE LINE GAUGE

see page 4

MOUNTING POSITION

Any

The tube socket should not be rigidly mounted but should have flexible leads and be allowed to move freely.

This tube is fitted with a pin protector in order to avoid damage to the glass base due to bending of the base pins whilst handling the tube.

It is advisable to keep this pin protector on the base until it can be replaced by the socket after the installation of the tube in any equipment.

RATINGS (DESIGN MAXIMUM SYSTEM)

$V_{a2, a4}$ max. (at $I_{a2, a4} = 0$) (see note 1)	13	kV
$V_{a2, a4}$ min.	8, 5	kV
$+V_{a3}$ max.	500	V
$-V_{a3}$ max.	50	V
V_{a1} max.	350	V
V_{a1} min.	200	V
$-v_{g(pk)}$ max. (see note 2)	350	V
$-V_g$ max. (see note 3)	100	V
$\pm I_{a3}$ max.	25	μA
$\pm I_{a1}$ max.	5.0	μA
V_{h-k} (cathode positive)		
d. c. max.	110	V
pk max.	130	V
R_{h-k} max.	1.0	M Ω
Z_{k-e} max. ($f = 50\text{Hz}$)	100	k Ω
R_{g-k} max.	1.5	M Ω
Z_{g-k} max. ($f = 50\text{Hz}$)	500	k Ω
R_{M-B} min.	2.0	M Ω

Notes

1. Adequate precautions should be taken to ensure that the receiver is protected from damage which may be caused by a possible high voltage flashover within the tube.
2. Maximum pulse duration 22% of one cycle with a maximum of 1.5ms.
3. The d. c. value of bias must not be such as to allow the grid to become positive with respect to the cathode, except during the period immediately after switching the receiver on or off when it may be allowed to rise to +2.0V. It is advisable to limit the positive excursion of the video signal to +5V(pk) max. This may be achieved automatically by the series connection of a 10k Ω resistor.
4. The metal band must be earthed by means of the tag provided.

The mounting lugs will not necessarily be in electrical contact with the metal band.

Weight

Tube alone (approx.)	2.8	kg
----------------------	-----	----

GENERAL OPERATIONAL RECOMMENDATIONS

TELEVISION PICTURE TUBES

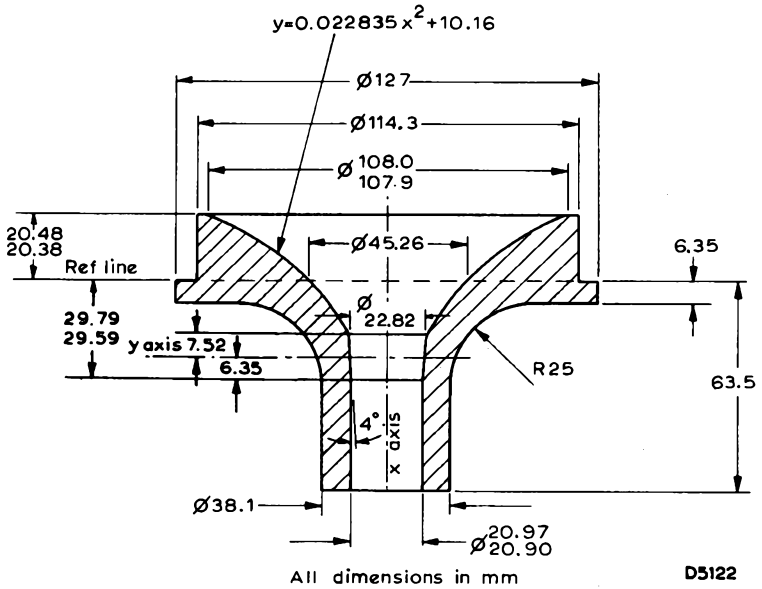

REFERENCE LINE GAUGE

REFERENCE LINE GAUGE FOR MONOCHROME CATHODE RAY TUBES
HAVING 110° SCANNING ANGLES AND A NECK DIAMETER OF 20mm

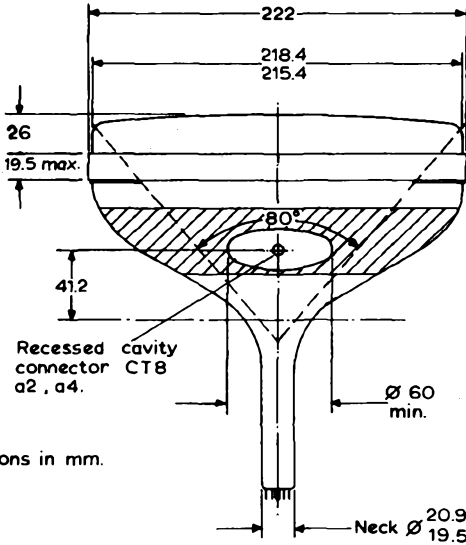
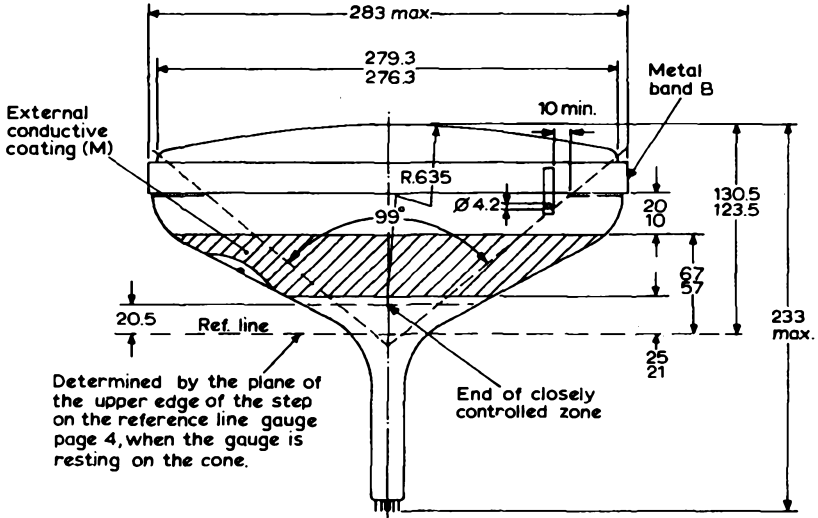

All dimensions in mm.

D5123

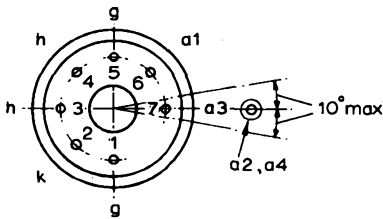
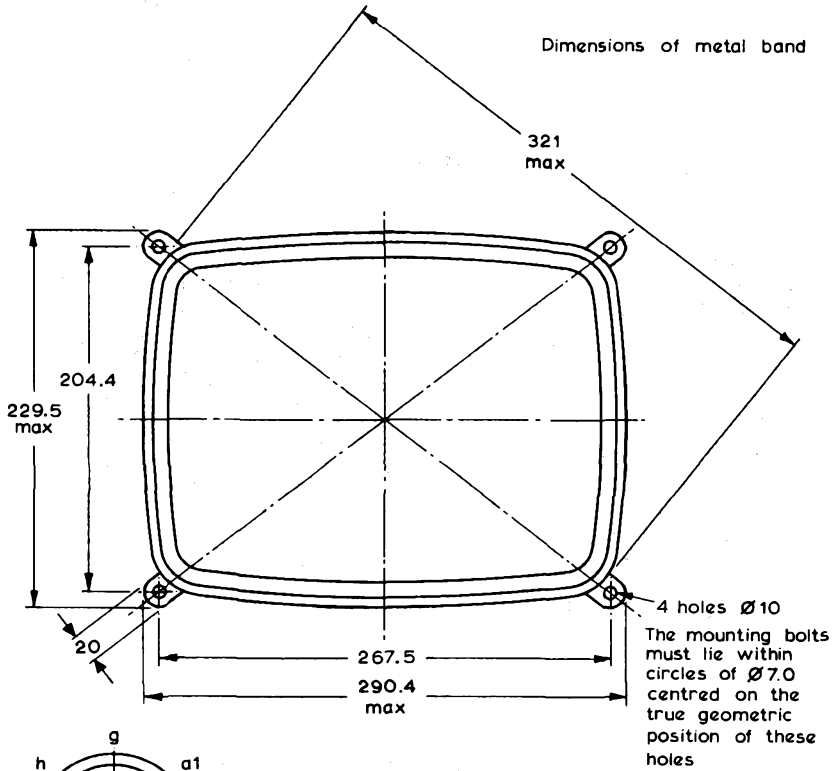

Pin dimensions as in B7G base
The centre of the socket must allow entry of the pump stem

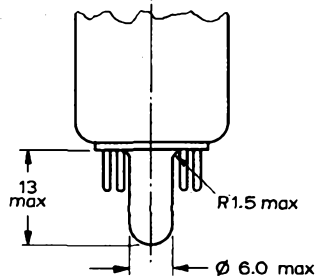
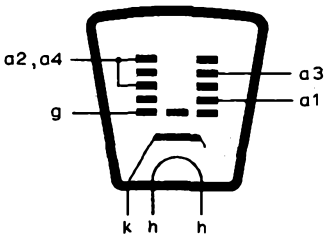

All dimensions in mm

D475

Mullard

TELEVISION TUBE

A31-410W

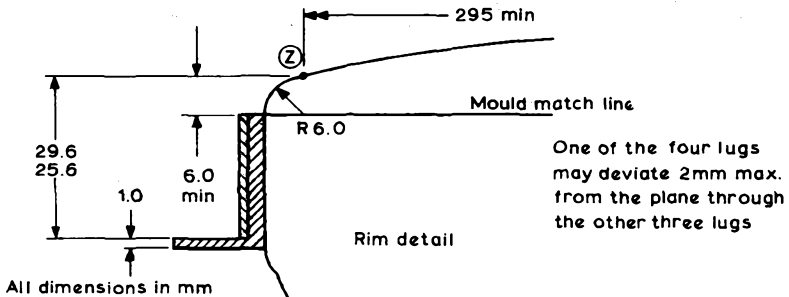
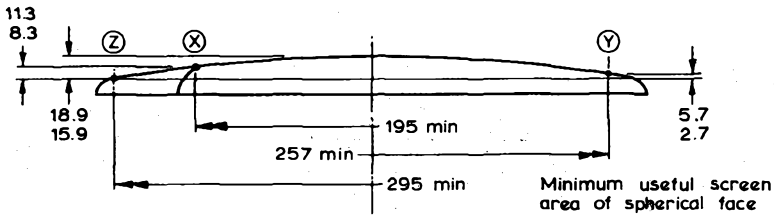
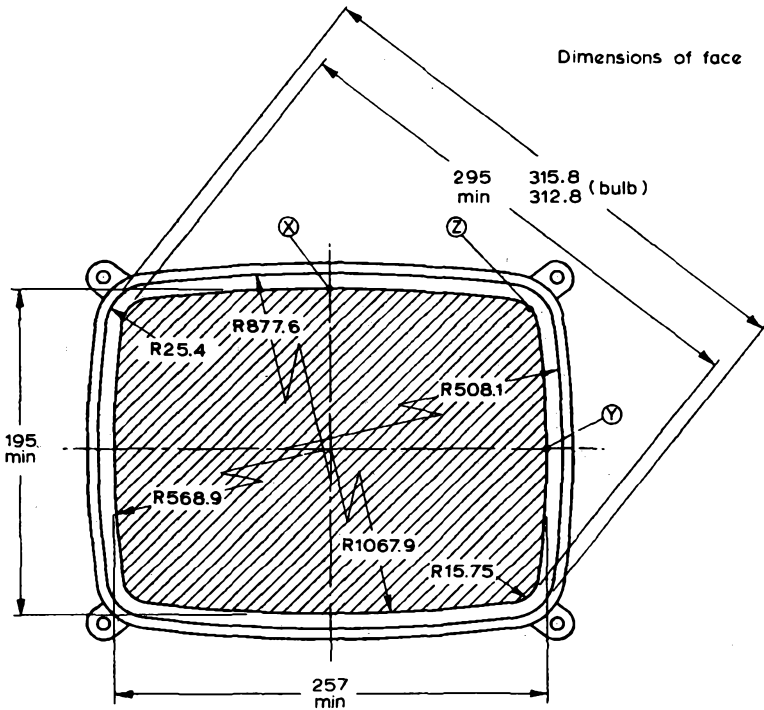

Mullard



MAXIMUM CONE CONTOURS

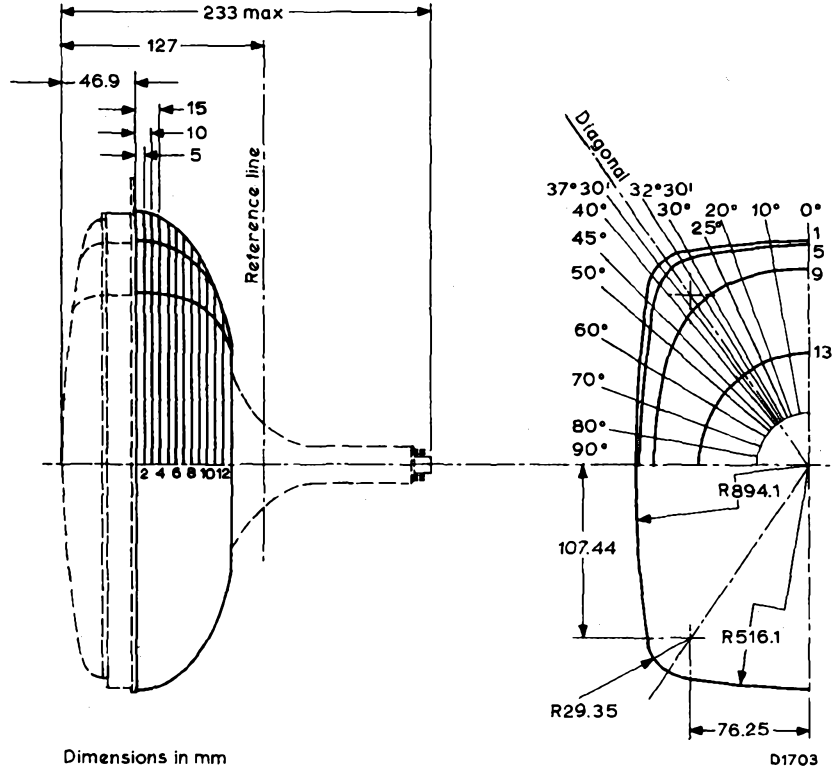

Dimensions in mm

D1703

DIMENSIONS FOR MAXIMUM CONE CONTOUR DRAWING (page 8)

Distance from centre (max. values)

Section	Nominal distance from section 1	0° Long axis	10°	20°	25°	30°	32°30'	Diagonal								90° Short axis
								37°30'	40°	45°	50°	60°	70°	80°		
1	0	142.8	144.4	149.3	153.1	157.9	160.2	161.1	160.6	158.7	149.9	140.6	127.1	118.5	113.8	112.3
2	5.0	142.4	143.9	148.8	152.6	157.4	159.8	160.7	160.2	158.2	149.4	140.1	126.6	118.1	113.4	111.9
3	10.0	141.6	143.2	148.0	151.8	156.5	158.7	159.5	159.0	157.1	148.5	139.4	126.0	117.6	112.9	111.4
4	15.0	140.3	141.9	146.6	150.2	154.6	156.6	157.4	156.8	155.1	147.1	138.5	125.4	117.0	112.3	110.8
5	20.0	138.4	140.0	144.5	147.8	151.6	153.2	153.7	153.2	151.7	144.8	137.1	124.7	116.4	111.8	110.3
6	25.0	136.0	137.5	141.6	144.4	147.2	148.3	148.4	147.9	146.5	140.9	134.3	122.9	115.0	110.5	109.0
7	30.0	132.6	134.0	137.4	139.3	140.8	141.2	140.8	140.2	138.9	134.6	129.4	119.7	112.5	108.2	106.8
8	35.0	127.9	128.9	131.2	132.1	132.5	132.3	131.6	130.9	129.7	126.5	122.7	114.9	108.8	105.0	103.7
9	40.0	121.3	121.9	122.8	122.8	122.4	121.9	121.2	120.5	119.5	117.1	114.3	108.6	103.8	100.7	99.7
10	45.0	112.3	112.4	112.2	111.7	110.9	110.4	109.7	109.1	108.3	106.6	104.7	100.9	97.6	95.5	94.7
11	50.0	99.4	99.4	98.9	98.5	97.9	97.5	97.1	96.8	96.3	95.4	94.4	92.4	90.7	89.5	89.1
12	55.0	85.9	85.6	84.9	84.4	84.0	83.8	83.5	83.3	83.1	82.7	82.4	81.9	81.6	81.5	81.5
13	59.6	72.2	72.0	71.7	71.4	71.2	71.1	71.0	71.0	70.9	70.8	70.7	70.6	70.7	70.8	70.9

All dimensions in mm



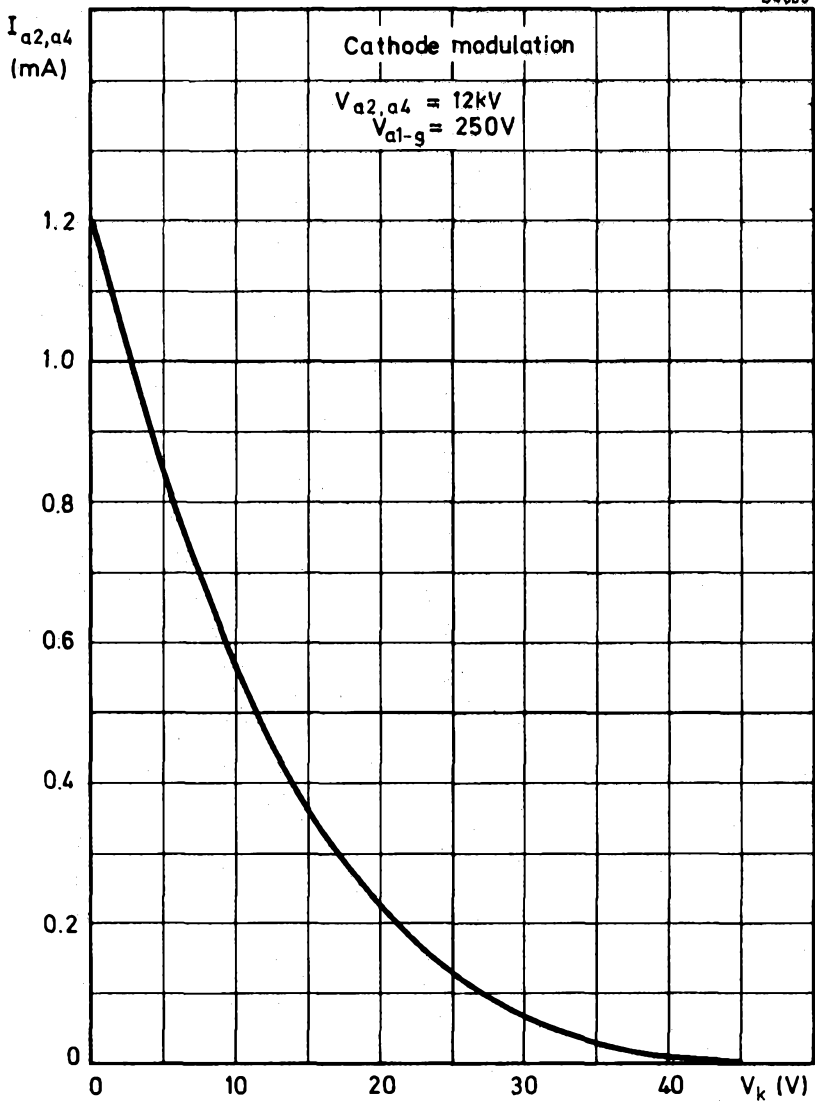

FINAL ANODE CURRENT PLOTTED AGAINST CATHODE-TO-GRID VOLTAGE. CATHODE MODULATION

D4664

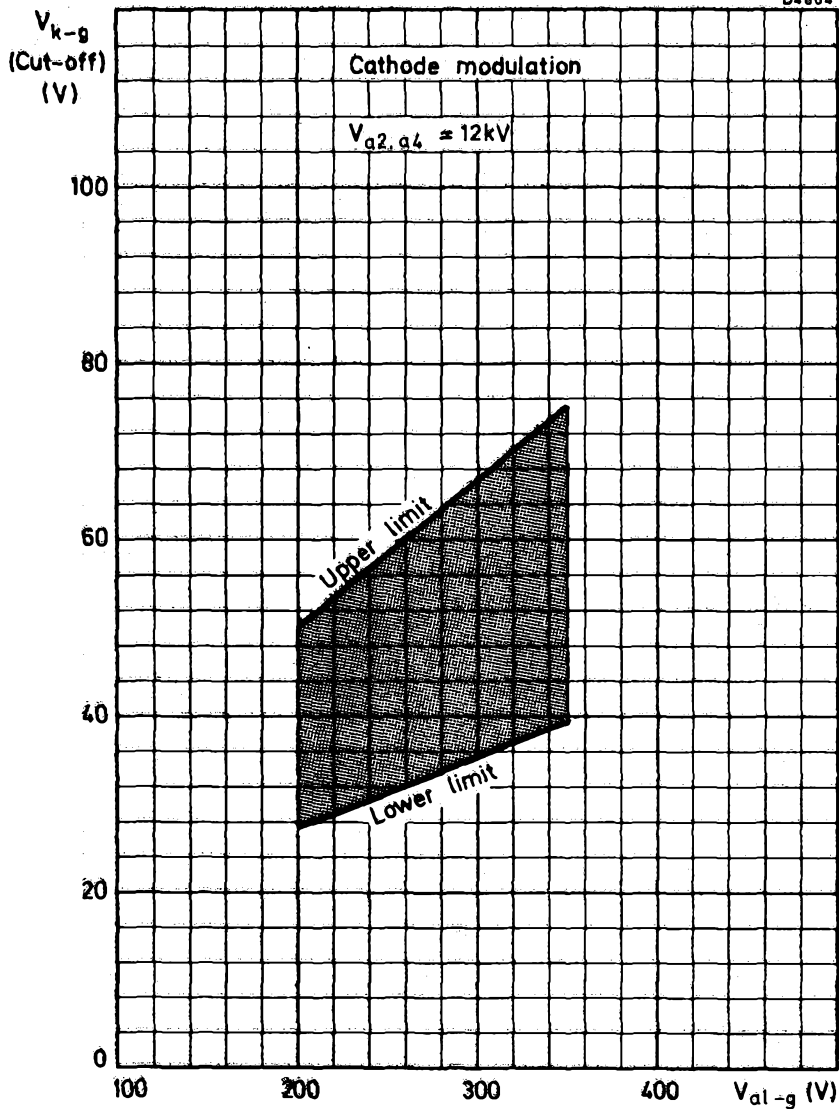

LIMITS OF CATHODE-TO-GRID CUT-OFF VOLTAGE PLOTTED AGAINST FIRST ANODE-TO-GRID VOLTAGE. CATHODE MODULATION

D4662

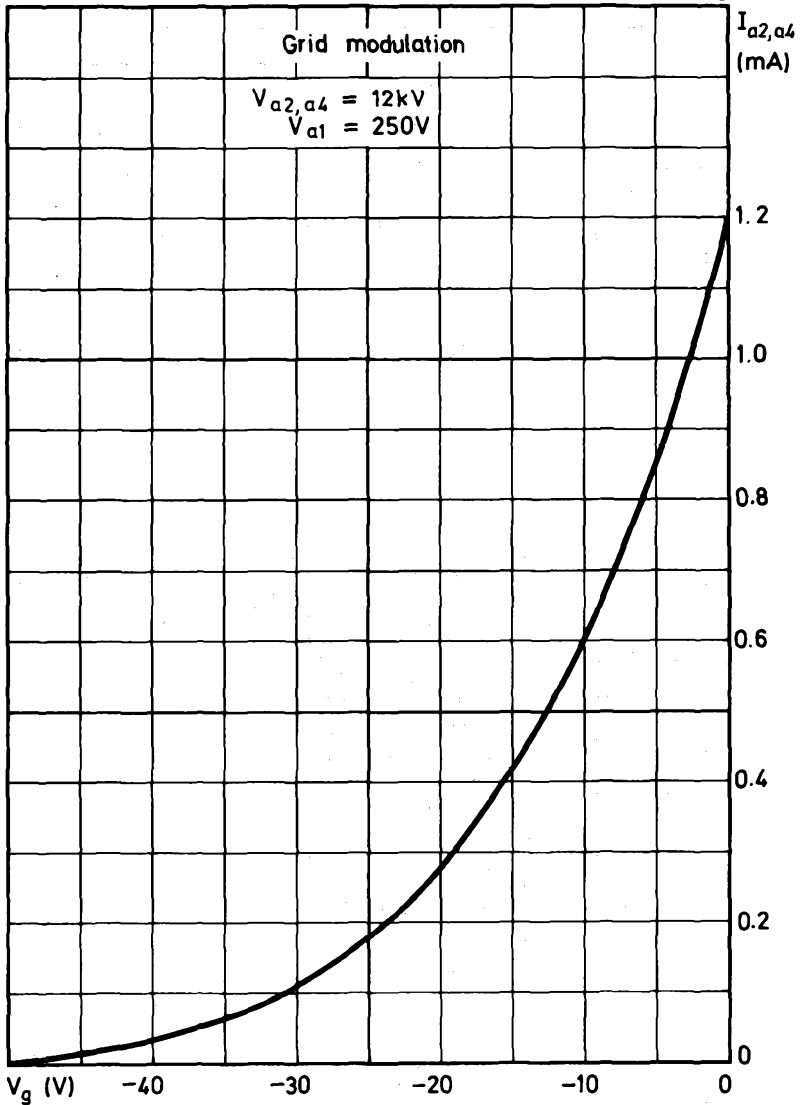

FINAL ANODE CURRENT PLOTTED AGAINST GRID VOLTAGE
GRID MODULATION

Mullard

QUICK REFERENCE DATA

44cm (17in) direct viewing television tube with metal backed screen and reinforced envelope. A separate safety screen is not required. Suitable for use in receivers with push-through presentation. This tube is fitted with a ring trip base.

Deflection angle	110	deg
Focusing		Electrostatic
Light transmission	48	%
Maximum overall length	291	mm

This data should be read in conjunction with GENERAL OPERATIONAL RECOMMENDATIONS - TELEVISION PICTURE TUBES

HEATER

Suitable for series or parallel operation

V_h	6.3	V
I_h	300	mA

The limits of heater voltage and current are contained in 'General Operational Recommendations - Television Picture Tubes'.

Note - applies to series operation only

The surge heater voltage must not exceed 9.5V r.m.s. when the supply is switched on. A current limiting device may be necessary in the circuit, to ensure that this voltage is not exceeded.

OPERATING CONDITIONS

$V_{a2, a4}$	18	kV
V_{a3} (focus electrode control range)	0 to 400	V
V_{a1}	400	V
V_g for visual extinction of focused raster	-40 to -77	V
* V_k for visual extinction of focused raster	36 to 66	V

*For cathode modulation, all voltages are measured with respect to the grid.

SCREEN (Metal backed)

Fluorescent colour		White
Light transmission	48	%
Useful screen area		See page 6

FOCUSING (Electrostatic)

The range of focus voltage shown in 'Operating Conditions' results in optimum overall focus at a beam current of $250\mu\text{A}$.

DEFLECTION (Magnetic)

Diagonal deflection angle	110	deg
Horizontal deflection angle	100	deg
Vertical deflection angle	83	deg

CAPACITANCES

^c g-all	7.0	pF
^c k-all	5.0	pF
^c a2, a4-M	700 to 1300	pF
^c a2, a4-B	200	pF

EXTERNAL CONDUCTIVE COATING

This tube has an external conductive coating, M, and in accordance with the General Operational Recommendations this should be connected directly to pin 5 and not to chassis. The electrical connection to this coating must be made within the area specified on the tube outline drawing. The capacitance of this coating to the final anode is used to provide smoothing for the e.h.t. supply.

RING TRAP

For flashover protection of the receiver, parallel spark gaps are included for all the electrodes in the base of this tube, and the common connection is made to pin 5. These spark gaps are intended as part of a system for full flashover protection. A direct connection must always be made from pin 5 to chassis, and the external conductive coating returned to chassis only via pin 5, using short leads. Any electrode supplied directly from a high energy source (such as the h. t. line) should be provided with a series resistor.

RASTER CENTRING

See note under this heading in 'General Operational Recommendations - Television Picture Tubes'.

Centring magnet field intensity	0 to 800	A/m
Maximum distance between centre of centring field and reference line	57	mm

Adjustment of the centring magnet should not be such that a general reduction in brightness of the raster occurs.

REFERENCE LINE GAUGE

J. E. D. E. C. 126. For details see 'General Operational Recommendations - Television Picture Tubes'.

MOUNTING POSITION

Any. The tube socket should not be rigidly mounted but should have flexible leads and be allowed to move freely. The bottom circumference of the base shell will fall within a circle of 40mm diameter which is centred on the perpendicular from the centre of the face.

This tube is fitted with a pin protector in order to avoid damage to the glass base due to bending of the base pins whilst handling the tube.

It is advisable to keep this pin protector on the base until it can be replaced by the socket after installation of the tube in any equipment.

RATINGS (DESIGN CENTRE SYSTEM)

$V_{a2, a4}$ max. (at $I_{a2, a4} = 0$) (see note 1)	18	kV
$V_{a2, a4}$ min.	13	kV
$+V_{a3}$ max.	1.0	kV
$-V_{a3}$ max.	500	V
V_{a1} max.	700	V
V_{a1} min.	350	V
$-v_g$ (pk) max. (see note 2)	400	V
$-V_g$ max. (see note 3)	150	V
$\pm I_{a3}$ max.	25	μA
$\pm I_{a1}$ max.	5	μA
V_{h-k} (see note 4)		
Cathode positive		
d.c. max.	250	V
pk max.	300	V
Cathode negative		
d.c. max.	135	V
pk max.	180	V
R_{h-k} max.	1.0	M Ω
Z_{k-e} max. ($f = 50\text{Hz}$)	100	k Ω
R_{g-k} max.	1.5	M Ω
Z_{g-k} max. ($f = 50\text{Hz}$)	500	k Ω

NOTES

1. Adequate precautions should be taken to ensure that the receiver is protected from damage which may be caused by a possible high voltage flashover within the cathode ray tube.
2. Maximum pulse duration 22% of one cycle with a maximum of 1.5ms.
3. The d.c. value of bias must not be such as to allow the grid to become positive with respect to the cathode, except during the period immediately after switching the receiver on or off when it may be allowed to rise to +2V.

It is advisable to limit the positive excursion of the video signal to +5V(pk) max. This may be achieved automatically by the series connection of a 10k Ω resistor.

4. During an equipment warm-up period not exceeding 15 seconds V_{h-k} max. (cathode positive) is allowed to rise to 410V. Between 15 and 45 seconds after switching on, a decrease in V_{h-k} max. (cathode positive) proportional with time from 410V to 250V is permissible.
5. The metal band (B) should be connected directly to the chassis in an a.c. receiver operating from an isolating transformer, or via a suitable leakage path in an a.c./d.c. receiver, for example 2.0M Ω .

The mounting lugs will be in electrical contact with the metal band.

WARNING

X-ray shielding is advisable to give protection against possible danger of personal injury arising from prolonged exposure at close range to this tube when operated above 18kV.

WEIGHT

Tube alone (approx.) 5.5 kg

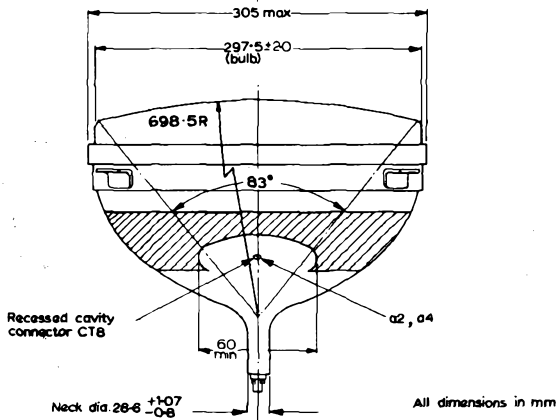
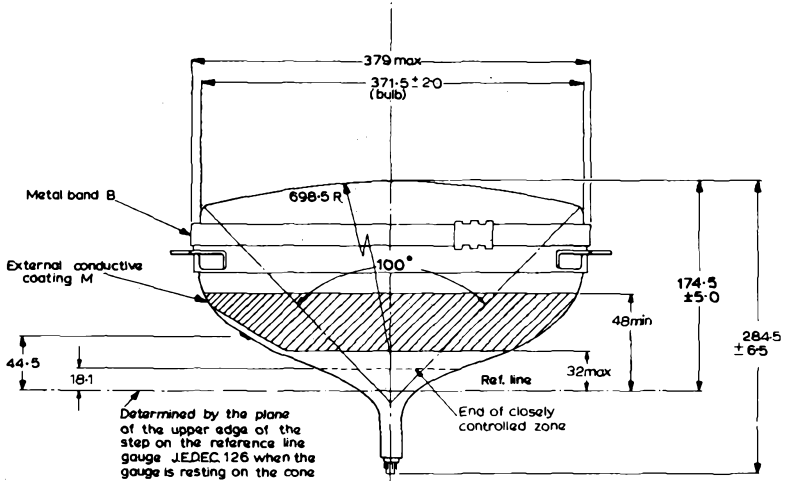

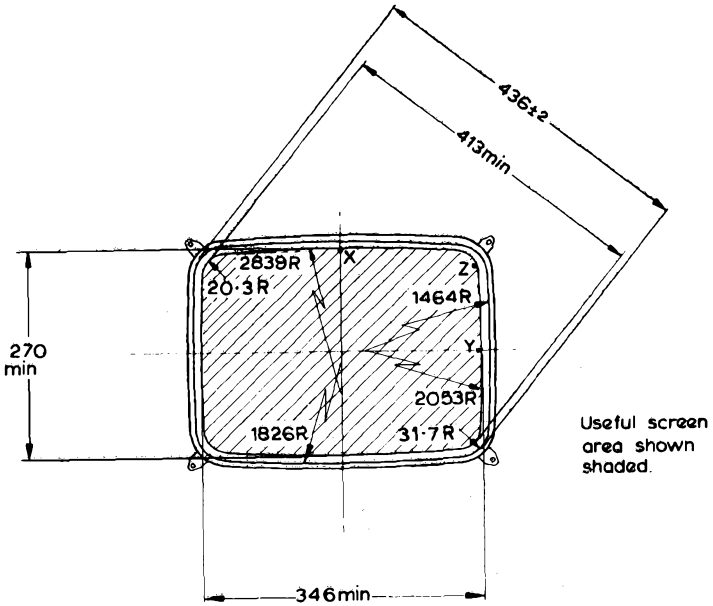

Useful screen area shown shaded.

Bulb dimensions

All dimensions in mm

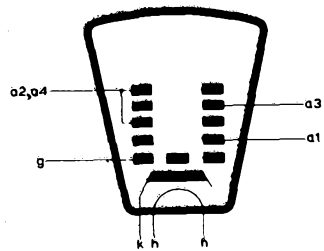
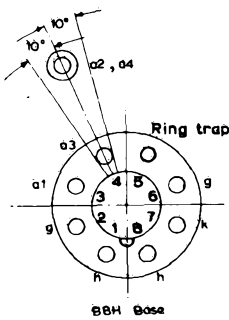

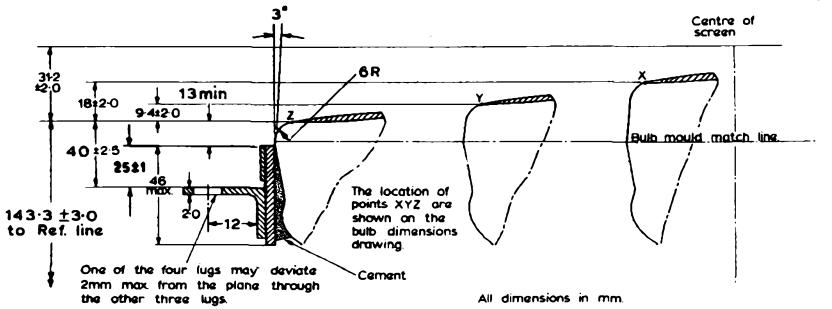
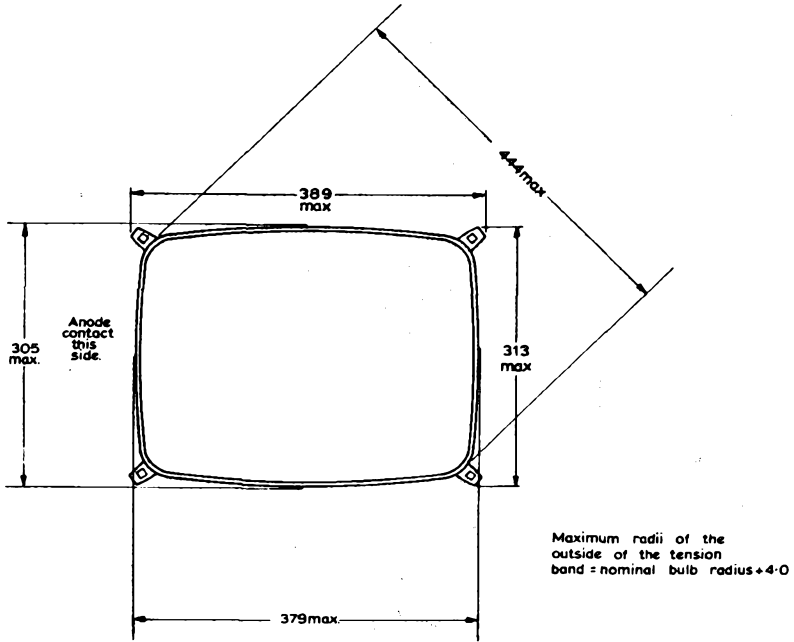

Mullard

A44-120W/R Page 8

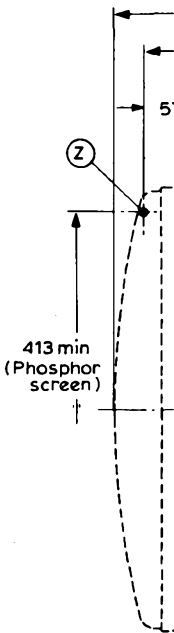



MAXIMUM CONE CONTOURS

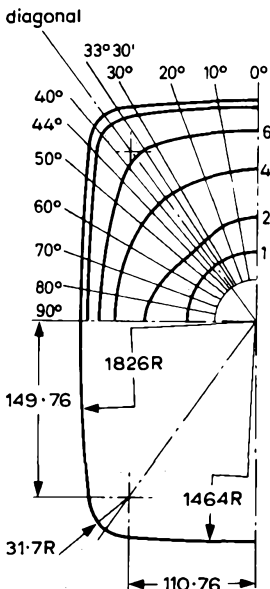
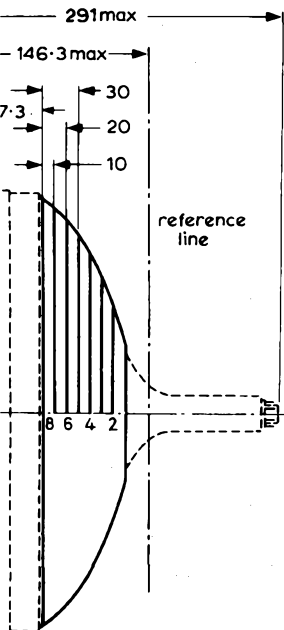

DIMENSIONS FOR MAXIMUM CONE CONTOUR DRAWING (Page 8)

Section	Nominal distance from point "Z"	Distance from centre (max. values)												
		0° Long axis	10°	20°	30°	33°30'	36°30' Diagonal	40°	44°	50°	60°	70°	80°	90° Short axis
1	128	60.0	60.0	60.0	60.0	60.0	60.0	60.0	60.0	60.0	60.0	60.0	60.0	60.0
2	117.3	95.9	95.2	93.0	92.3	92.1	92.1	92.3	92.6	93.1	93.8	94.6	94.9	95.1
3	107.3	118.1	117.8	118.3	118.3	118.6	119.2	117.8	117.7	117.2	115.5	113.3	111.2	109.8
4	97.3	135.0	136.1	138.3	139.9	141.0	141.6	141.1	138.5	135.4	130.5	125.6	121.8	120.8
5	87.3	149.5	151.1	155.1	159.1	161.3	162.0	161.5	157.5	151.0	142.0	135.8	130.8	129.5
6	77.3	162.5	164.0	168.8	176.0	179.0	179.5	178.0	173.5	163.4	150.8	143.3	138.3	136.4
7	67.3	172.5	174.4	180.1	190.0	194.1	196.3	194.9	186.8	174.5	159.1	149.3	143.9	141.7
8	57.3	179.7	183.1	189.3	201.1	207.4	210.9	206.1	196.0	182.8	165.5	154.0	147.9	145.6

All dimensions in millimetres



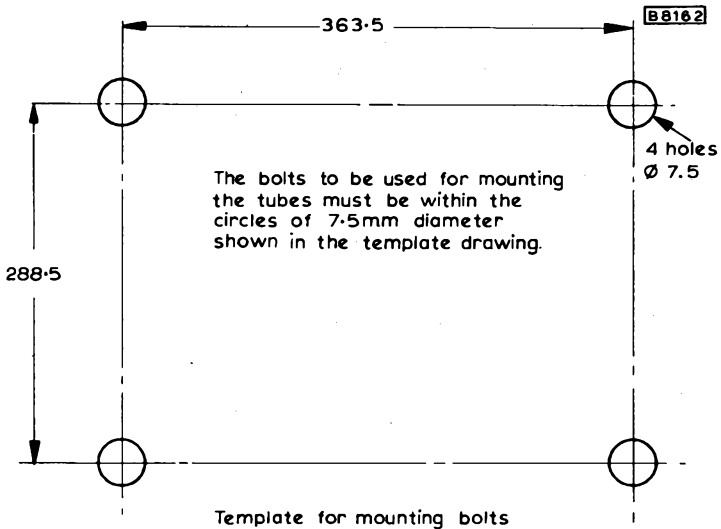
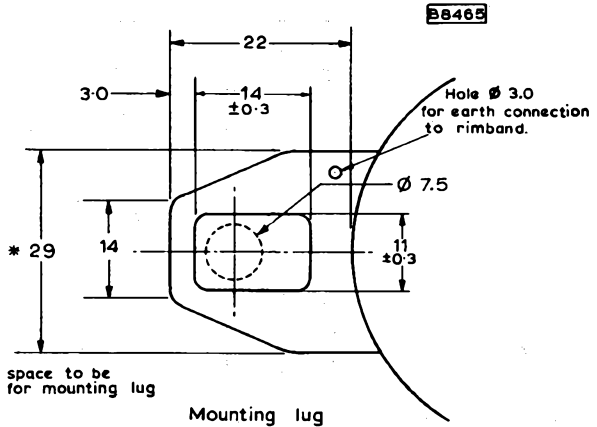

All dimensions in mm

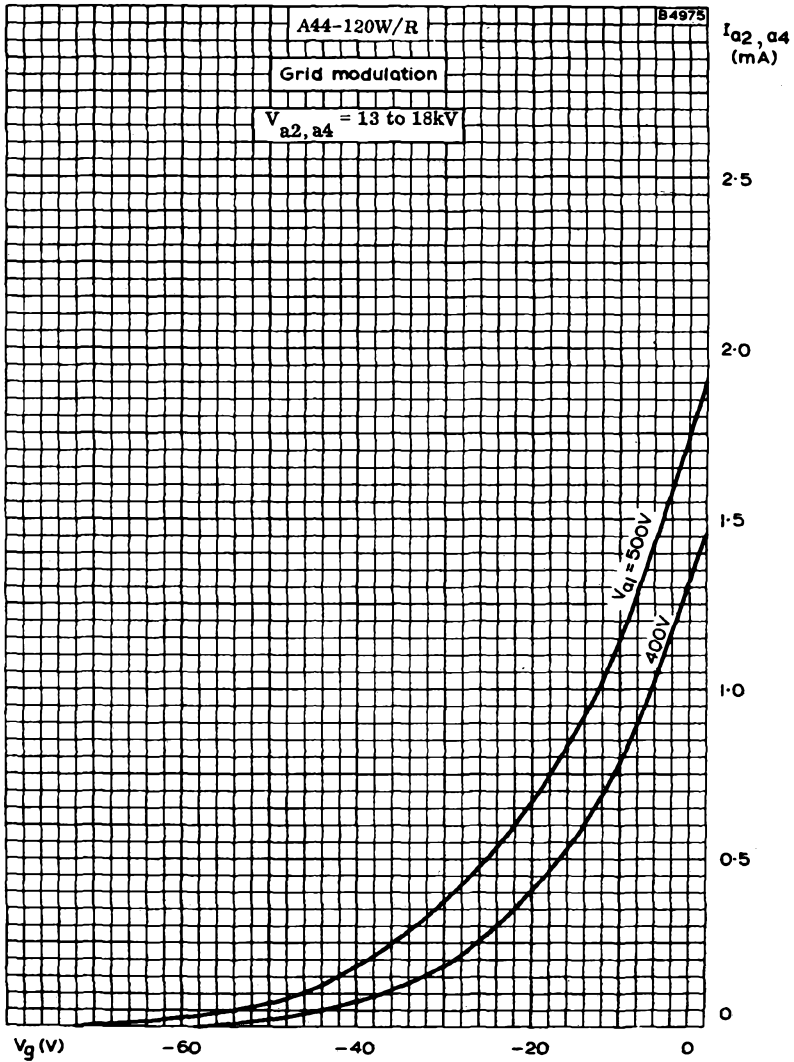

FINAL ANODE CURRENT PLOTTED AGAINST GRID VOLTAGE.
GRID MODULATION

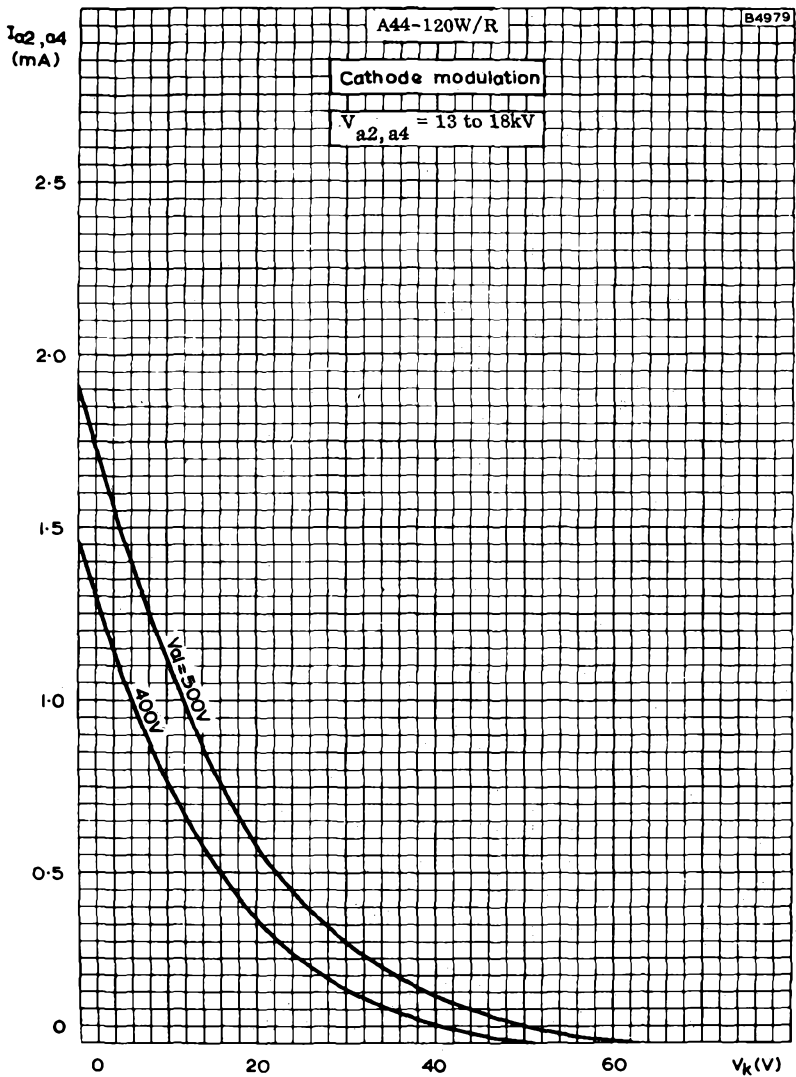

FINAL ANODE CURRENT PLOTTED AGAINST CATHODE-TO-GRID VOLTAGE
CATHODE MODULATION

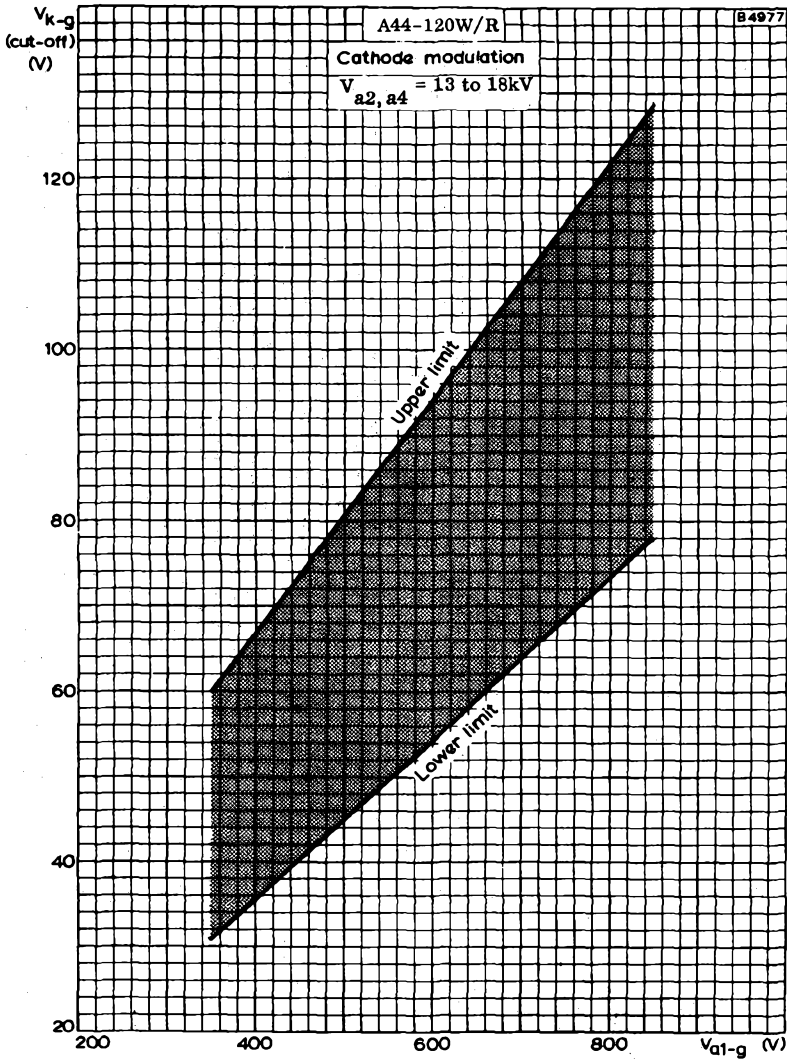

LIMITS OF CATHODE-TO-GRID CUT-OFF VOLTAGE PLOTTED AGAINST
FIRST ANODE-TO-GRID VOLTAGE.
CATHODE MODULATION

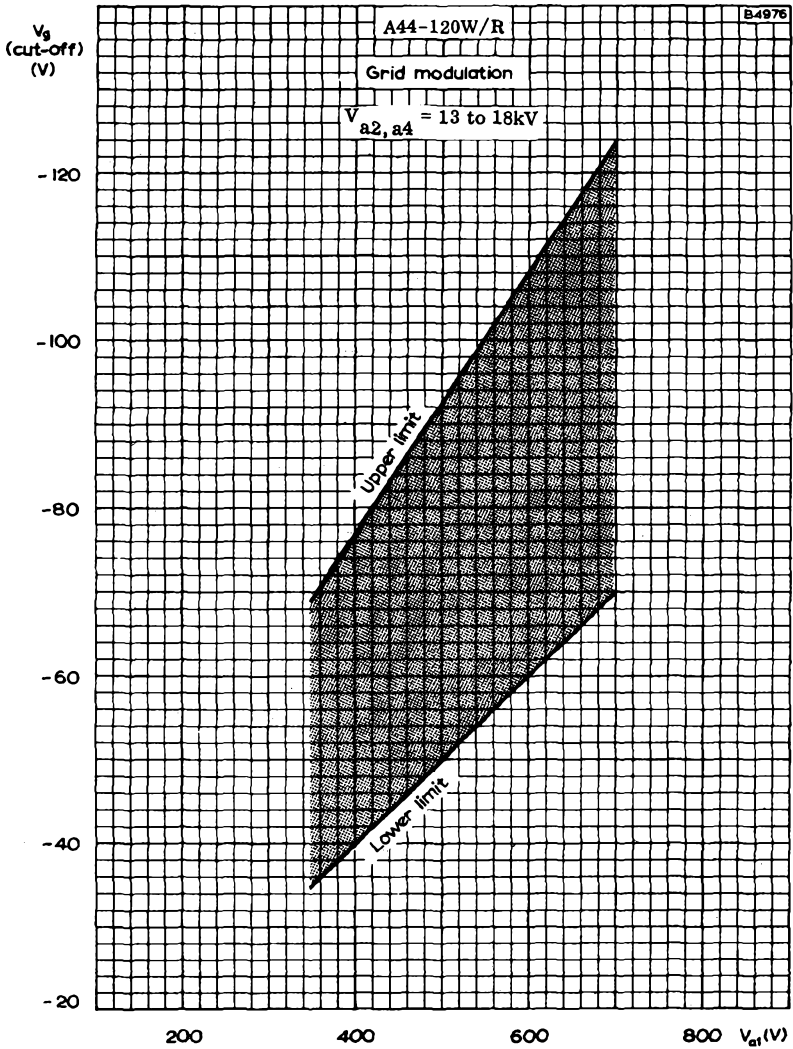

LIMITS OF GRID CUT-OFF VOLTAGE PLOTTED AGAINST
FIRST ANODE VOLTAGE, GRID MODULATION

QUICK REFERENCE DATA

50cm (20in) direct viewing television tube with metal backed screen and reinforced envelope. A separate safety screen is not required. Suitable for use in receivers with push-through presentation. This tube is fitted with a ring trap base.

Deflection angle	110	deg
Focusing	Electrostatic	
Light transmission (approx.)	45	%
Maximum overall length	319	mm

This data should be read in conjunction with GENERAL OPERATIONAL RECOMMENDATIONS - TELEVISION PICTURE TUBES

HEATER

Suitable for series or parallel operation

V_h	6.3	V
I_h	300	mA

The limits of heater voltage and current are contained in 'General Operational Recommendations - Television Picture Tubes'.

Note - applies to series operation only

The surge heater voltage must not exceed 9.5V r.m.s. when the supply is switched on. A current limiting device may be necessary in the circuit, to ensure that this voltage is not exceeded.

OPERATING CONDITIONS

$V_{a2, a4}$	20	20	kV
V_{a3} (focus electrode control range)	0 to 400	0 to 400	V
V_{a1}	400	500	V
V_g for visual extinction of focused raster	-40 to -77	-50 to -93	V
* V_k for visual extinction of focused raster	36 to 66	45 to 80	V

*For cathode modulation, all voltages are measured with respect to the grid.

SCREEN (Metal backed)

Fluorescent colour	White	
Light transmission (approx.)	45	%
Useful screen area	See page 6	

FOCUSING (Electrostatic)

The range of focus voltage shown in 'Operating Conditions' results in optimum overall focus at a beam current of 250 μ A. In general, acceptable resolution will be obtained with a fixed focus voltage.

DEFLECTION (Magnetic)

Diagonal deflection angle	110	deg
Horizontal deflection angle	98	deg
Vertical deflection angle	81	deg

The deflection coils should be designed to provide a pull-back of 4.0mm on a nominal tube.

CAPACITANCES

^c g-all	7.0	pF
^c k-all	5.0	pF
^c a2, a4-M	850 to 1300	pF ←
^c a2, a4-B	500	pF

EXTERNAL CONDUCTIVE COATING

This tube has an external conductive coating, M, and in accordance with the General Operational Recommendations this should be connected directly to pin 5 and not to chassis. The electrical connection to this coating must be made within the area specified on the tube outline drawing. The capacitance of this coating to the final anode is used to provide smoothing for the e.h.t. supply.

RING TRAP

For flashover protection of the receiver, parallel spark gaps are included for all the electrodes in the base of this tube, and the common connection is made to pin 5. These spark gaps are intended as part of a system for full flashover protection. A direct connection must always be made from pin 5 to chassis, and the external conductive coating returned to chassis only via pin 5, using short leads. Any electrode supplied directly from a high energy source (such as the h.t. line) should be provided with a series resistor.

RASTER CENTRING

See note under this heading in 'General Operational Recommendations - Television Picture Tubes'.

Centring magnet field intensity	0 to 800	A/m
Maximum distance of centre of centring field from reference line	57	mm

Adjustment of the centring magnet should not be such that a general reduction in brightness of the raster occurs.

REFERENCE LINE GAUGE

J. E. D. E. C. 126. For details see 'General Operational Recommendations - Television Picture Tubes'.

MOUNTING POSITION

Any. The tube socket should not be rigidly mounted but should have flexible leads and be allowed to move freely. The bottom circumference of the base shell will fall within a circle of 40mm diameter which is centred on the perpendicular from the centre of the face.

This tube is fitted with a pin protector in order to avoid damage to the glass base due to bending of the base pins whilst handling the tube.

It is advisable to keep this pin protector on the base until it can be replaced by the socket after installation of the tube in any equipment.



RATINGS (DESIGN CENTRE SYSTEM)

$V_{a2, a4}$ max. (at $I_{a2, a4} = 0$) (see note 1)	20	kV
$V_{a2, a4}$ min.	13	kV
$+V_{a3}$ max.	1.0	kV
$-V_{a3}$ max.	500	V
V_{a1} max.	700	V
V_{a1} min.	350	V
$-v_{g(pk)}$ max. (see note 2)	400	V
$-V_g$ max. (see note 3)	150	V
$\pm I_{a3}$ max.	25	μA
$\pm I_{a1}$ max.	5	μA
V_{h-k} (see note 4)		
Cathode positive		
d.c. max.	250	V
pk max.	300	V
Cathode negative		
d.c. max.	135	V
pk max.	180	V
R_{h-k} max.	1.0	M Ω
Z_{k-e} max. (f=50Hz)	100	k Ω
R_{g-k} max.	1.5	M Ω
Z_{g-k} max. (f=50Hz)	500	k Ω

NOTES

1. Adequate precautions should be taken to ensure that the receiver is protected from damage which may be caused by a possible high voltage flash-over within the cathode ray tube.
2. Maximum pulse duration 22% of one cycle with a maximum of 1.5ms.
3. The d.c. value of bias must not be such as to allow the grid to become positive with respect to the cathode, except during the period immediately after switching the receiver on or off when it may be allowed to rise to +2V.

It is advisable to limit the positive excursion of the video signal to +5V(pk) max. This may be achieved automatically by the series connection of a 10k Ω resistor.

4. During an equipment warm-up period not exceeding 15 seconds V_{h-k} max. (cathode positive) is allowed to rise to 410V. Between 15 and 45 seconds after switching on, a decrease in V_{h-k} max. (cathode positive) proportional with time from 410V to 250V is permissible.
5. The metal band (B) should be connected directly to the chassis in an a.c. receiver operating from an isolating transformer, or via a suitable leakage path in an a.c./d.c. receiver, for example 2.0M Ω .

The mounting lugs will be in electrical contact with the metal band.

WARNING

X-ray shielding is advisable to give protection against possible danger of personal injury arising from prolonged exposure at close range to this tube when operated above 20kV.

WEIGHT

Tube alone (approx.)	8.5	kg
----------------------	-----	----

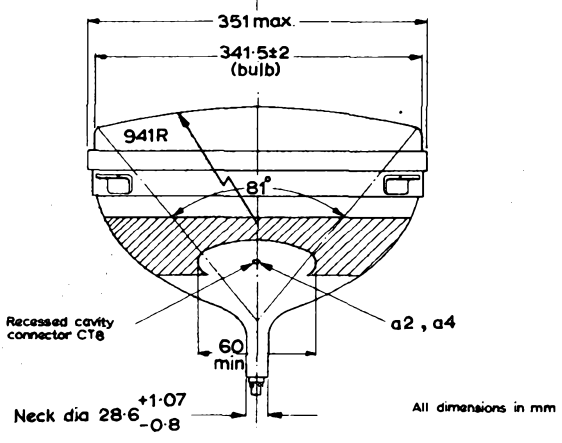
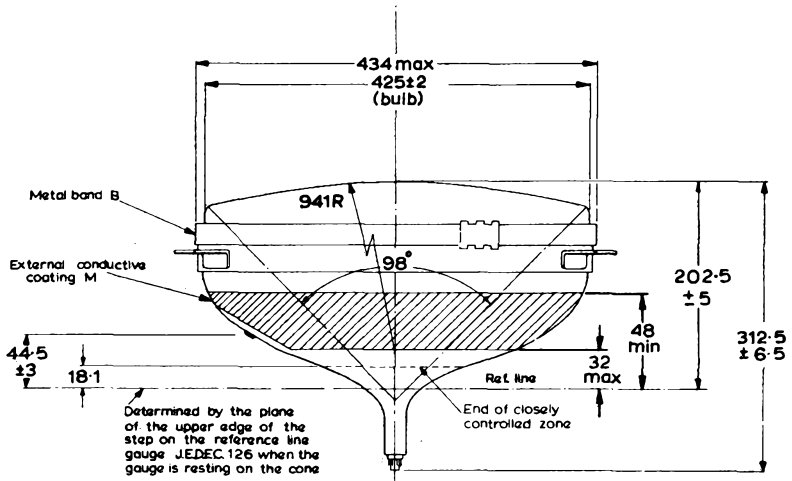

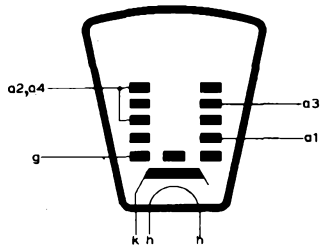
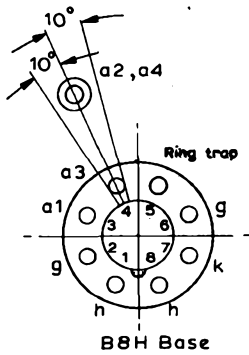
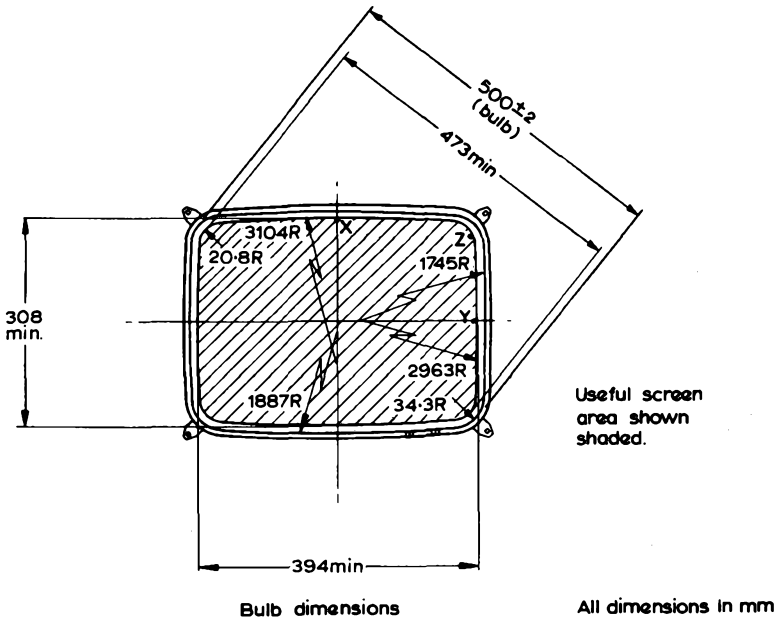

TELEVISION TUBE

A50-120W/R

B9686

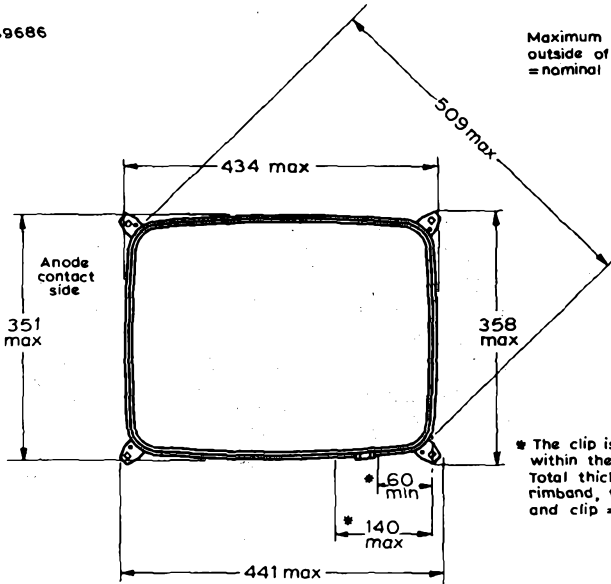

Maximum radii of the outside of tension band = nominal bulb radius + 4

* The clip is located within these dimensions. Total thickness of rimband, tension band and clip = 8 max.

Centre of screen

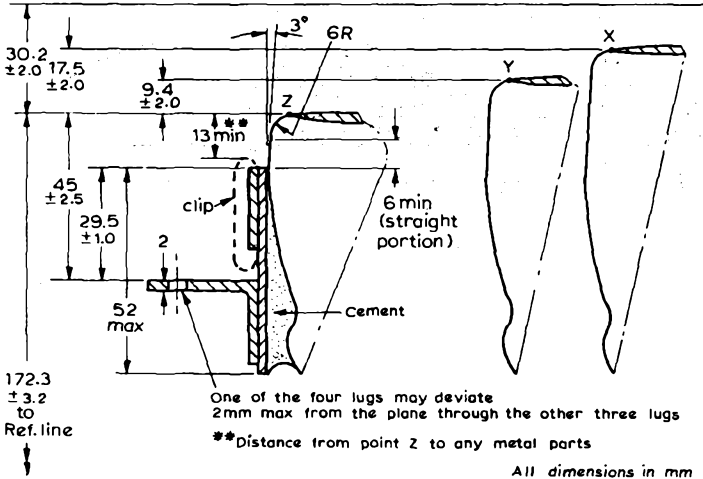



MAXIMUM CONE CONTOURS

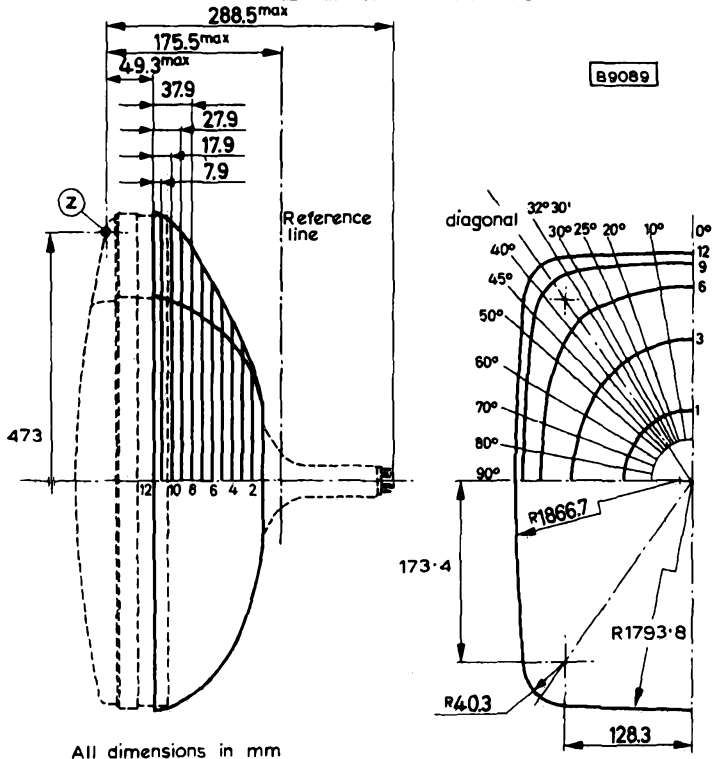

All dimensions in mm

DIMENSIONS FOR MAXIMUM CONE CONTOUR DRAWING (Page 8)

Section	Section distance from point "Z"	0° Long axis	Distance from centre (max. values)												
			10°	20°	25°	30°	32° 30'	36° 30'	40°	45°	50°	60°	70°	80°	90° Short
1	157.2	69.0	69.0	69.0	69.0	69.0	69.0	69.0	69.0	69.0	69.0	69.0	69.0	69.0	69.0
2	147.2	109.2	107.8	107.1	106.4	106.0	105.9	105.5	105.0	104.5	103.9	102.8	102.6	102.8	103.4
3	137.2	136.7	134.5	133.7	133.0	132.3	131.8	130.7	129.3	127.5	125.3	121.9	120.7	120.2	120.2
4	127.2	157.2	156.5	155.7	154.8	153.8	153.0	151.5	150	147.5	144.7	138.7	134.9	133.4	132.5
5	117.2	174.2	174.0	174.4	174.3	173.4	172.8	171.0	169.3	165.7	160.8	152.0	146.5	143.7	142.3
6	107.2	185.8	186.3	186.4	186.4	186.4	186.4	186.4	186.7	181.7	174.7	163.2	156.0	151.7	150.4
7	97.2	194.5	195.7	202.2	203.8	206.9	207.3	206.4	203.5	196.4	187.4	173.0	163.5	158.6	156.9
8	87.2	201.7	203.8	210.2	215.4	220.6	222.1	222.2	218.8	210.5	198.8	181.2	170.3	164.7	162.7
9	77.2	208.2	210.6	218.5	224.8	231.4	234.8	236.5	233.5	222.2	208.5	188.5	176.6	169.9	167.9
10	67.2	213.1	215.9	225.2	231.9	239.8	244.3	248.5	244.8	230.3	216.0	194.7	181.6	174.5	172.0
11	57.2	215.6	219.0	228.2	235.4	244.5	249.6	253.7	250.2	235.7	220.5	198.6	184.8	177.2	174.7
12	49.3	217.0	219.8	229.3	236.6	246.0	251.2	254.5	251.7	237.2	222.0	199.6	185.6	177.8	175.7

All dimensions in mm.



B8165

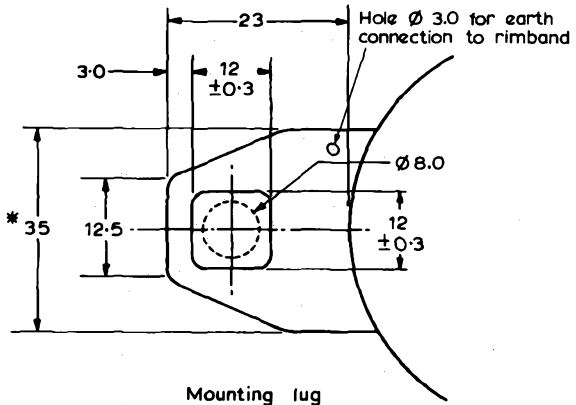

* Minimum space to be reserved for mounting lug-39

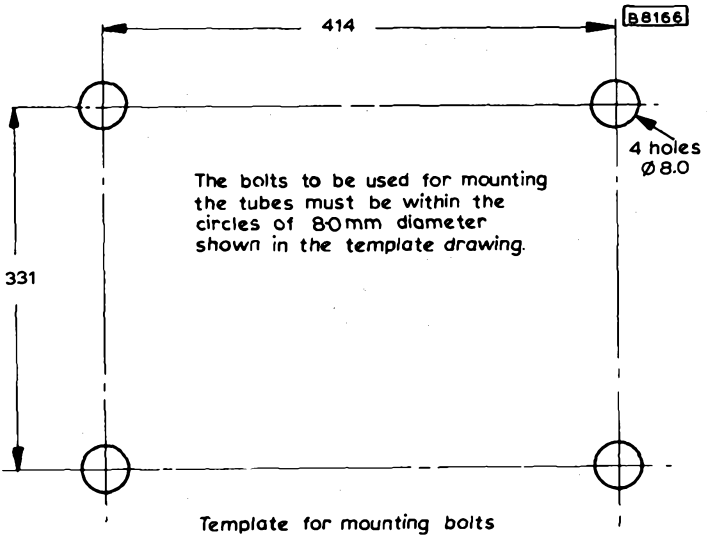

Template for mounting bolts

All dimensions in mm

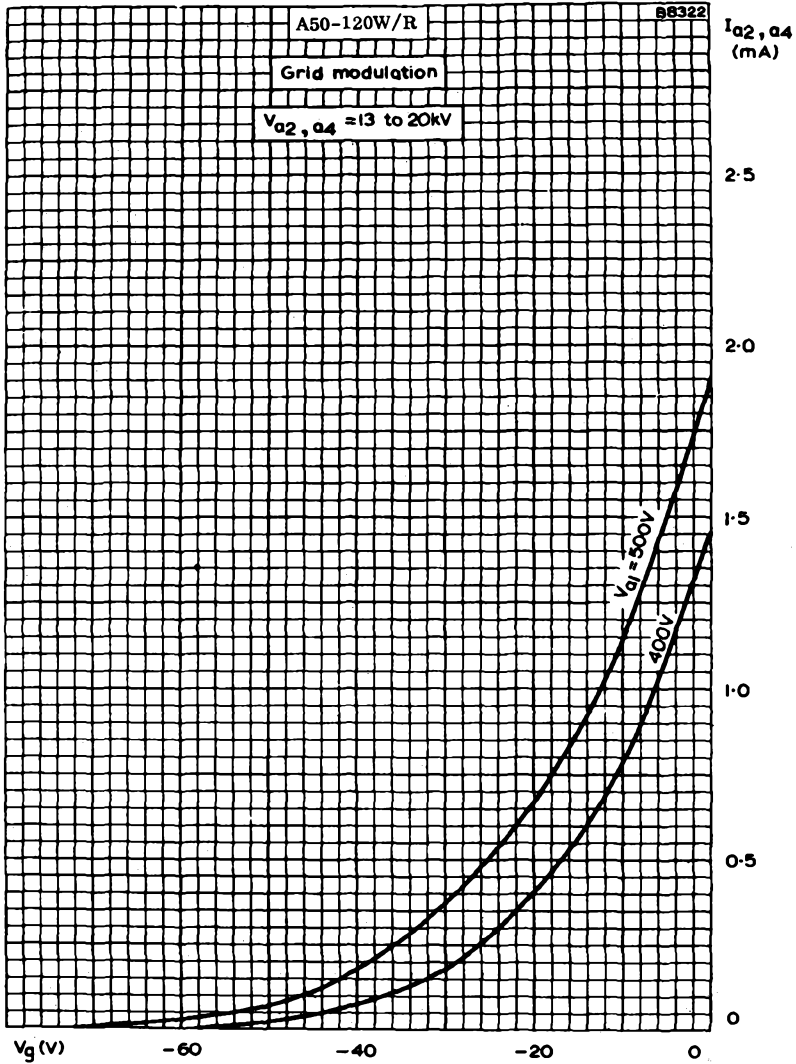

FINAL ANODE CURRENT PLOTTED AGAINST GRID VOLTAGE,
GRID MODULATION.

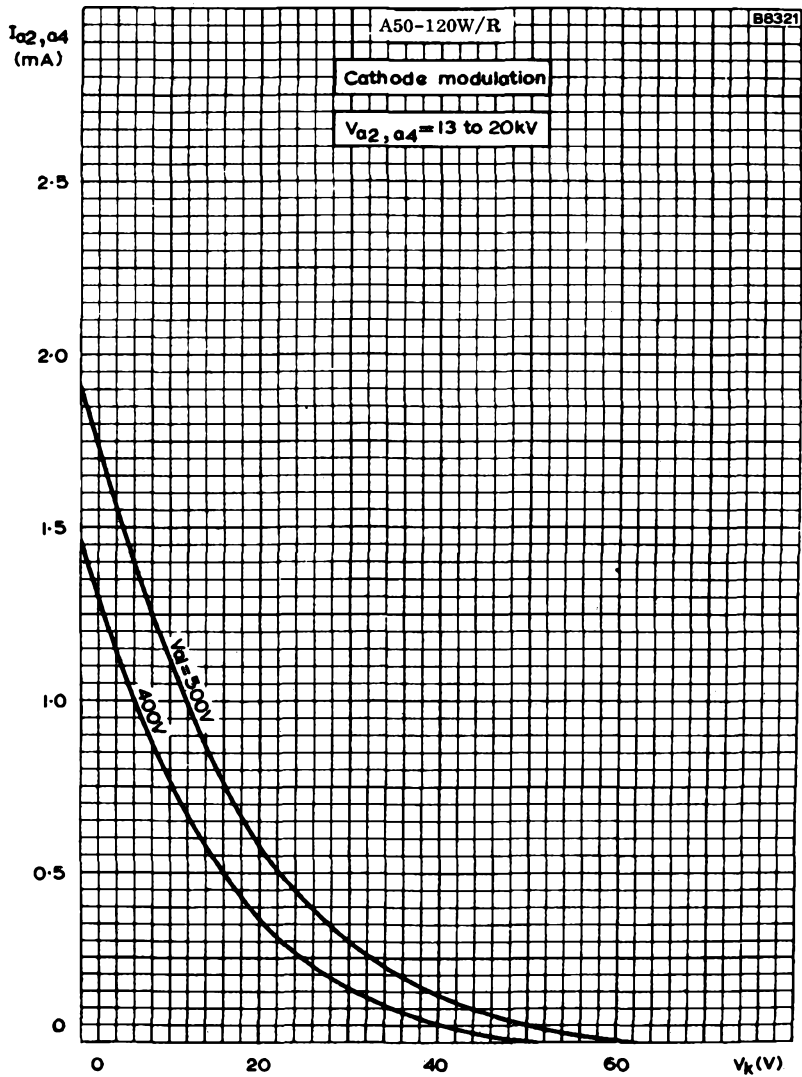

FINAL ANODE CURRENT PLOTTED AGAINST CATHODE-TO-GRID VOLTAGE. CATHODE MODULATION.

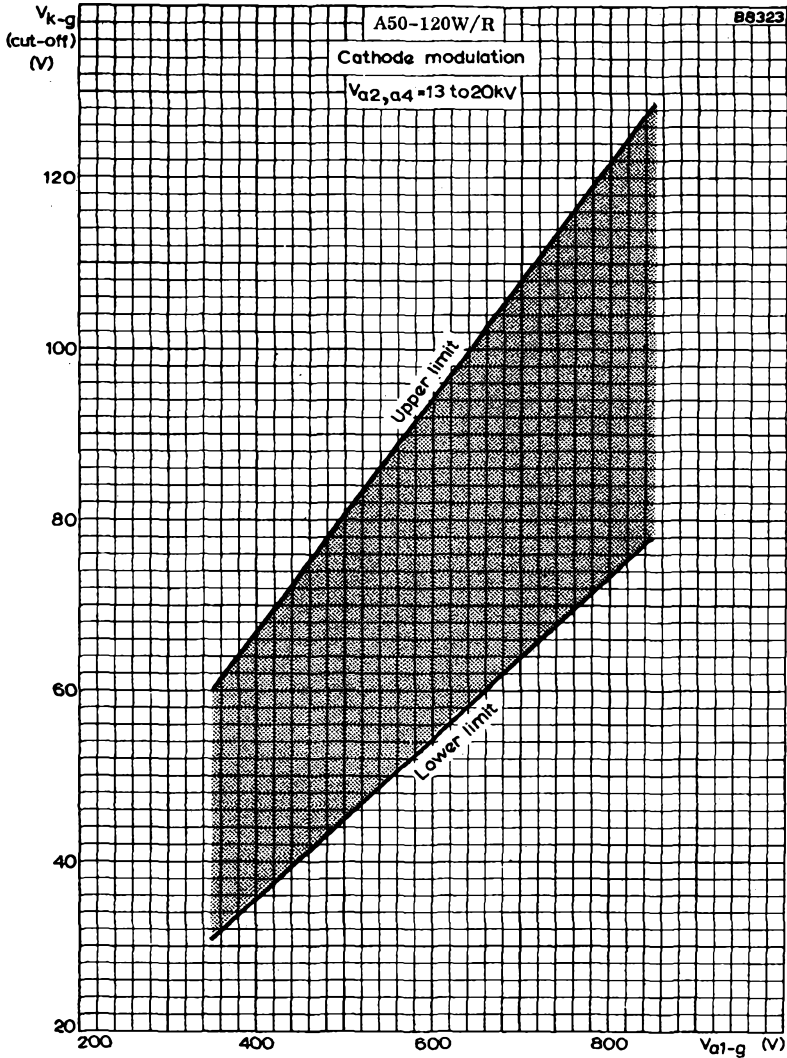

LIMITS OF CATHODE-TO-GRID CUT-OFF VOLTAGE PLOTTED
AGAINST FIRST ANODE-TO-GRID VOLTAGE.
CATHODE MODULATION

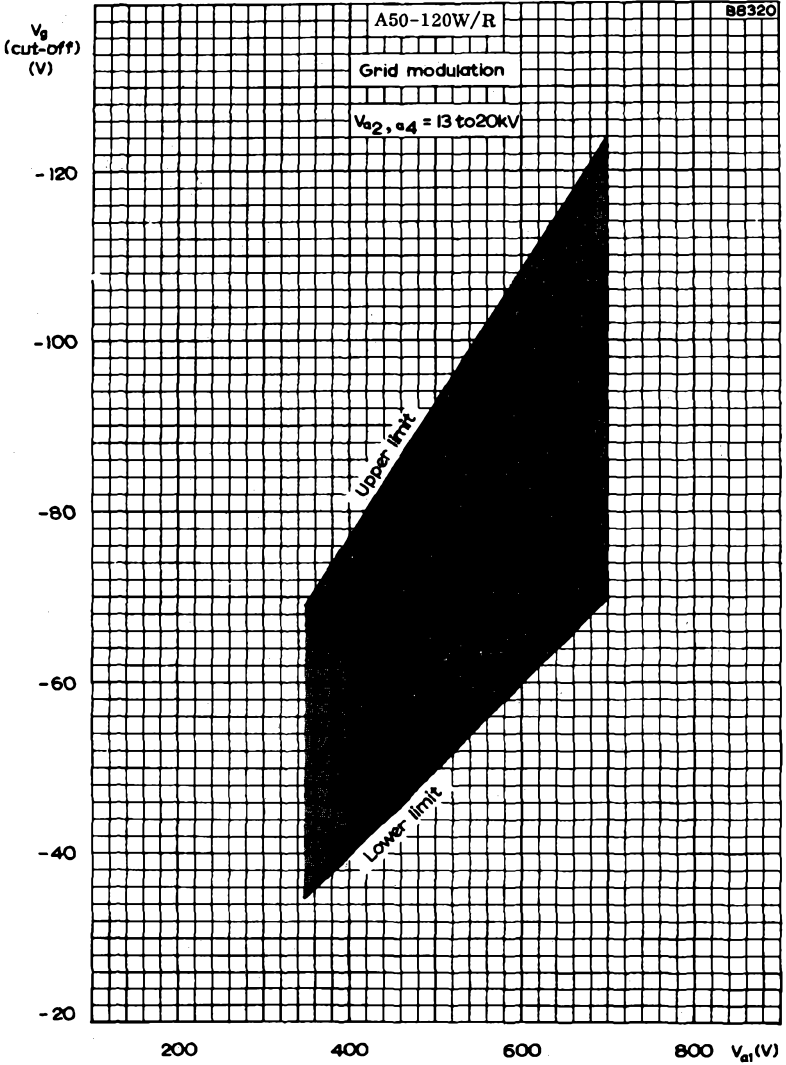

LIMITS OF GRID CUT-OFF VOLTAGE PLOTTED AGAINST
FIRST ANODE VOLTAGE. GRID MODULATION

QUICK REFERENCE DATA

61 cm (24in) direct viewing television tube with metal backed screen and reinforced envelope. A separate safety screen is not required. Suitable for use in receivers with push-through presentation. This tube is fitted with a ring trap base.

Deflection angle	110	deg
Focusing	Electrostatic	
Light transmission (approx.)	42	%
Maximum overall length	370	mm

This data should be read in conjunction with GENERAL OPERATIONAL RECOMMENDATIONS - TELEVISION PICTURE TUBES

HEATER

Suitable for series or parallel operation

V_h	6.3	V
I_h	300	mA

The limits of heater voltage and current are contained in 'General Operational Recommendations - Television Picture Tubes.

Note - applies to series operation only

The surge heater voltage must not exceed 9.5V r.m.s. when the supply is switched on. A current limiting device may be necessary in the circuit, to ensure that this voltage is not exceeded.

OPERATING CONDITIONS

V_{a2+a4}	20	20	kV
V_{a3} (focus electrode control range)	0 to 400	0 to 400	V
V_{a1}	400	500	V
V_g for visual extinction of focused raster	-40 to -77	-50 to -93	V
* V_k for visual extinction of focused raster	36 to 66	45 to 80	V

*For cathode modulation, all voltages are measured with respect to the grid.

SCREEN (metal backed)

Fluorescent colour	White
Light transmission (approx.)	42 %
Useful screen area	See page 6

FOCUSING (Electrostatic)

The range of focus voltage shown in 'Operating Conditions' results in optimum overall focus at a beam current at 250 μ A.

DEFLECTION (Magnetic)

Diagonal deflection angle	110	deg
Horizontal deflection angle	98	deg
Vertical deflection angle	81	deg

The deflection coils should be designed to provide a pull-back of 4.0mm on a nominal tube.

CAPACITANCES

^c _{g-all}	7.0	pF
^c _{k-all}	5.0	pF
^c _{a2+a4-M}	1500 to 2300	pF ←
^c _{a2+a4-B}	600	pF

EXTERNAL CONDUCTIVE COATING

This tube has an external conductive coating, M, and in accordance with the General Operating Recommendations this should be connected directly to pin 5 and not to chassis. The electrical connection to this coating must be made within the area specified on the tube outline drawing. The capacitance of this coating to the final anode is used to provide smoothing for the e.h.t. supply.

RING TRAP

For flashover protection of the receiver, parallel spark gaps are included for all the electrodes in the base of this tube, and the common connection is made to pin 5. These spark gaps are intended as part of a system for full flashover protection. A direct connection must always be made from pin 5 to chassis, and the external conductive coating returned to chassis only via pin 5, using short leads. Any electrode supplied directly from a high energy source (such as the h.t. line) should be provided with a series resistor.

RASTER CENTRING

See note under this heading in 'General Operational Recommendations - Television Picture Tubes'.

Centring magnet field intensity	0 to 800	A/m
Maximum distance of centre of centring field from reference line	57	mm

Adjustment of the centring magnet should not be such that a general reduction in the brightness of the raster occurs.

REFERENCE LINE GAUGE

J. E. D. E. C. 126. For details see 'General Operational Recommendations - Television Picture Tubes'.

MOUNTING POSITION

Any. The tube socket should not be rigidly mounted but should have flexible leads and be allowed to move freely. The bottom circumference of the base shell will fall within a circle of 40mm diameter which is centred on the perpendicular from the centre of the face.

This tube is fitted with a pin protector in order to avoid damage to the glass base due to bending of the base pins whilst handling the tube.

It is advisable to keep this pin protector on the base until it can be replaced by the socket after installation of the tube in any equipment.

RATINGS (DESIGN CENTRE SYSTEM)

V_{a2+a4} max. (at $I_{a2+a4} = 0$) (see note 1)	20	kV
V_{a2+a4} min.	13	kV
+ V_{a3} max.	1.0	kV
- V_{a3} max.	500	V
V_{a1} max.	700	V
V_{a1} min.	350	V
- $v_{g(pk)}$ max. (see note 2)	400	V
- V_g max. (see note 3)	150	V
$\pm I_{a3}$ max.	25	μA
$\pm I_{a1}$ max.	5	μA
V_{h-k} (see note 4)		
Cathode positive		
d.c. max.	250	V
pk max.	300	V
Cathode negative		
d.c. max.	135	V
pk max.	180	V
R_{h-k} max.	1.0	M Ω
Z_{k-e} max. ($f = 50\text{Hz}$)	100	k Ω
R_{g-k} max.	1.5	M Ω
Z_{g-k} max. ($f = 50\text{Hz}$)	500	k Ω



NOTES

1. Adequate precautions should be taken to ensure that the receiver is protected from damage which may be caused by a possible high voltage flash-over within the cathode ray tube.
2. Maximum pulse duration 22% of one cycle with a maximum of 1.5ms.
3. The d.c. value of bias must not be such as to allow the grid to become positive with respect to the cathode, except during the period immediately after switching the receiver on or off when it may be allowed to rise to +2V.

It is advisable to limit the positive excursion of the video signal to +5V(pk) max. This may be achieved automatically by the series connection of a 10k Ω resistor.

4. During an equipment warm-up period not exceeding 15 seconds V_{h-k} max. (cathode positive) is allowed to rise to 410V. Between 15 and 45 seconds after switching on, a decrease in V_{h-k} max. (cathode positive) proportional with time from 410V to 250V is permissible.
5. The metal band (B) should be connected directly to the chassis in an a.c. receiver operating from an isolating transformer, or via a suitable leakage path in an a.c./d.c. receiver, for example 2.0M Ω .

The mounting lugs will be in electrical contact with the metal band.

WARNING

X-ray shielding is advisable to give protection against possible danger of personal injury arising from prolonged exposure at close range to this tube when operated above 20kV.

WEIGHT

Tube alone (approx.) 13.5 kg

TELEVISION TUBE

A61-120W/R

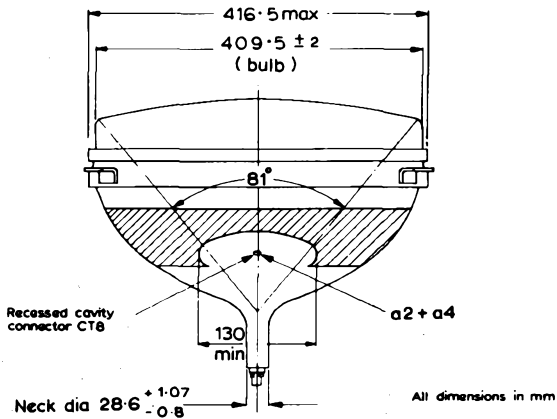
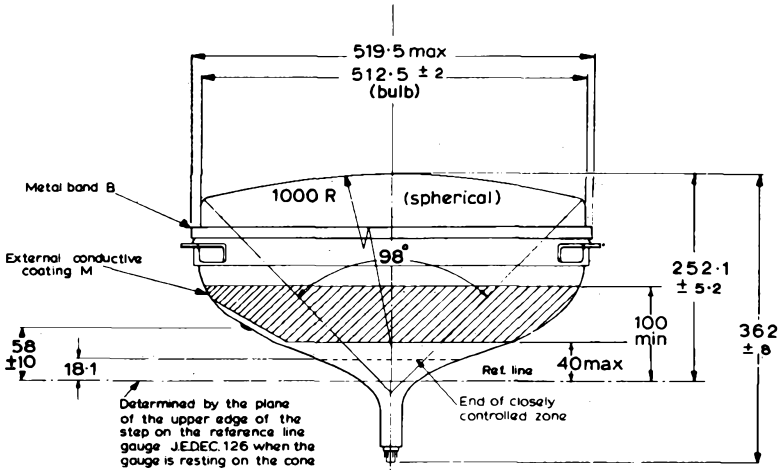

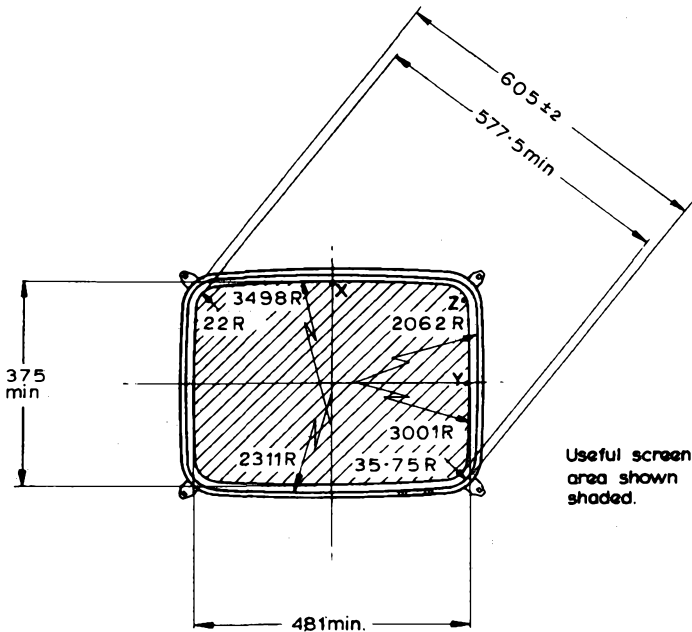

Useful screen area shown shaded.

Bulb dimensions

All dimensions in mm

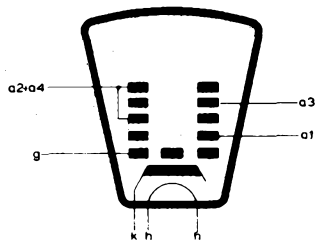
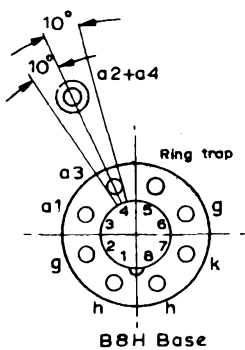

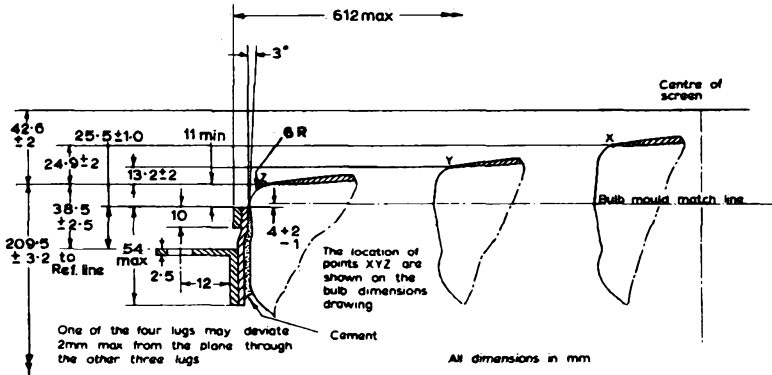
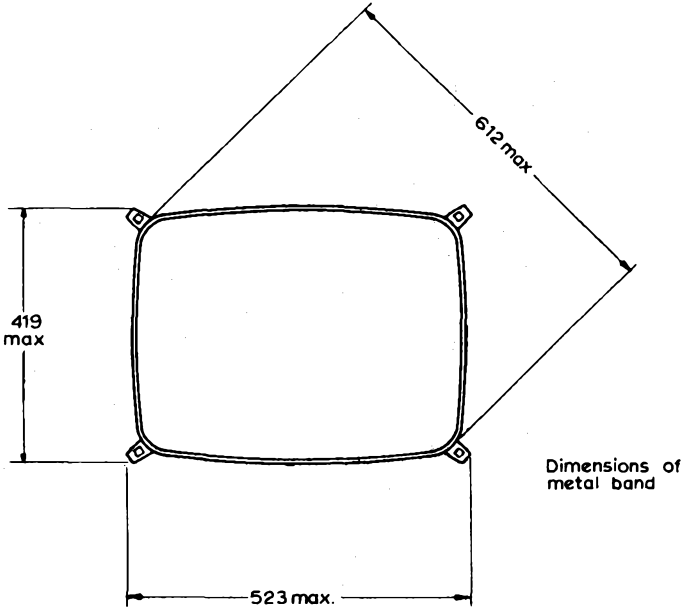



MAXIMUM CONE CONTOURS

D629

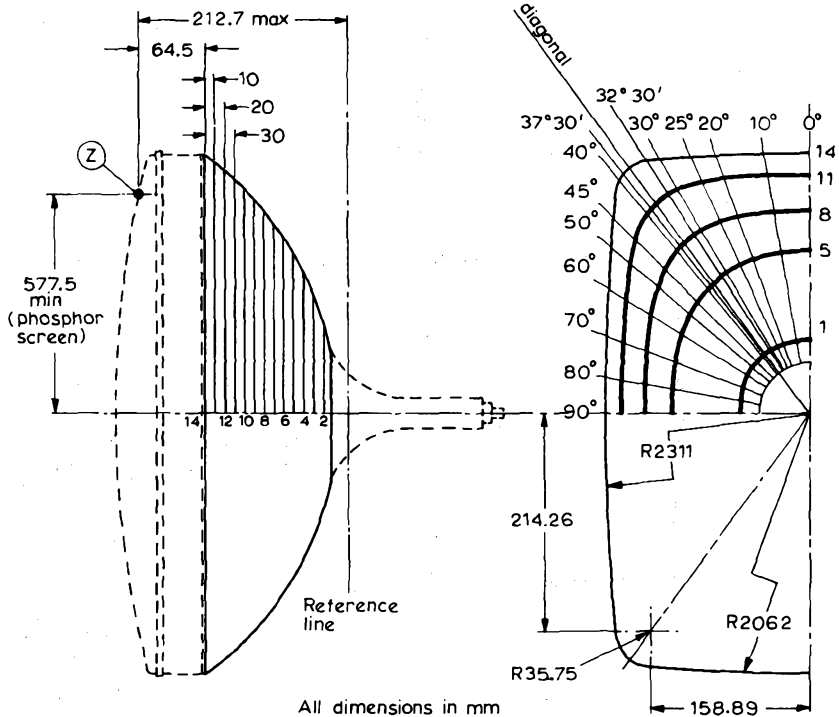

DIMENSIONS FOR MAXIMUM CONE CONTOUR DRAWING

Section	Nominal distance from point 'Z'	Distance from centre (maximum values)														
		0° long axis	10°	20°	25°	30°	32°30'	36°34'	37°30'	40°	45°	50°	60°	70°	80°	90° short axis
1	194.5	72.9	72.4	71.6	71.1	70.7	70.5	70.3	70.2	70.2	70.0	70.0	70.2	70.8	71.5	71.8
2	184.5	104.4	102.6	99.4	97.8	96.5	96.0	95.2	95.0	94.7	94.2	94.0	94.5	96.0	98.0	99.2
3	174.5	134.3	131.5	126.5	124.2	122.1	121.2	119.9	119.6	119.0	118.0	117.4	117.4	118.7	120.7	122.0
4	164.5	160.4	157.1	151.1	148.1	145.3	144.0	142.2	141.8	140.8	139.2	137.9	136.7	136.9	137.9	138.7
5	154.5	178.7	176.9	172.7	170.1	167.5	166.1	164.0	163.5	162.3	159.9	157.8	154.3	151.9	150.6	150.3
6	144.5	193.3	193.0	191.4	189.9	187.8	186.6	184.4	183.9	182.4	179.2	175.9	169.6	164.4	161.0	159.8
7	134.5	205.7	206.5	207.6	207.5	206.4	205.5	203.4	202.8	201.0	196.9	192.2	182.7	174.8	169.7	168.0
8	124.5	216.8	212.5	222.1	223.5	223.8	223.4	221.5	220.9	218.9	213.6	207.2	194.3	183.9	177.6	175.4
9	114.5	226.9	229.2	235.0	238.0	240.0	240.3	238.8	238.2	235.9	229.0	220.7	204.4	192.1	184.7	182.3
10	104.5	236.0	238.7	246.3	250.9	254.9	256.1	255.4	254.7	252.1	243.2	232.7	213.2	199.3	191.2	188.6
11	94.5	243.7	246.8	255.8	262.0	268.1	270.6	271.0	270.3	267.4	256.0	243.1	220.8	205.6	197.1	194.3
12	84.5	250.0	253.4	263.5	270.9	279.3	283.5	285.5	284.8	281.6	267.2	251.8	227.2	211.1	202.2	199.4
13	74.5	255.0	258.5	269.3	277.6	288.0	293.9	298.0	297.6	294.1	276.2	258.5	232.1	215.6	206.5	203.6
14	64.5	258.5	262.0	273.1	281.9	293.2	300.0	305.4	305.1	301.5	281.6	262.7	235.6	218.8	209.6	206.6

All dimensions in millimetres



B 8165

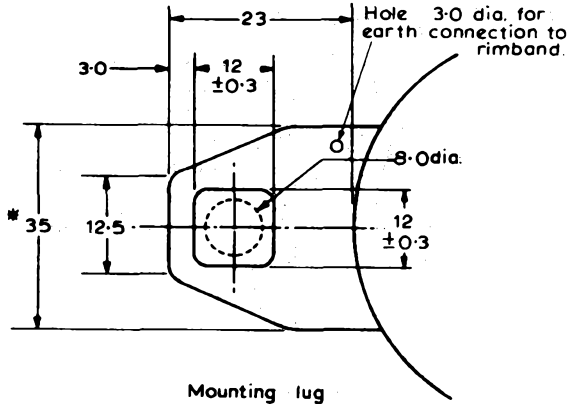

* Minimum space to be reserved for mounting lug-39

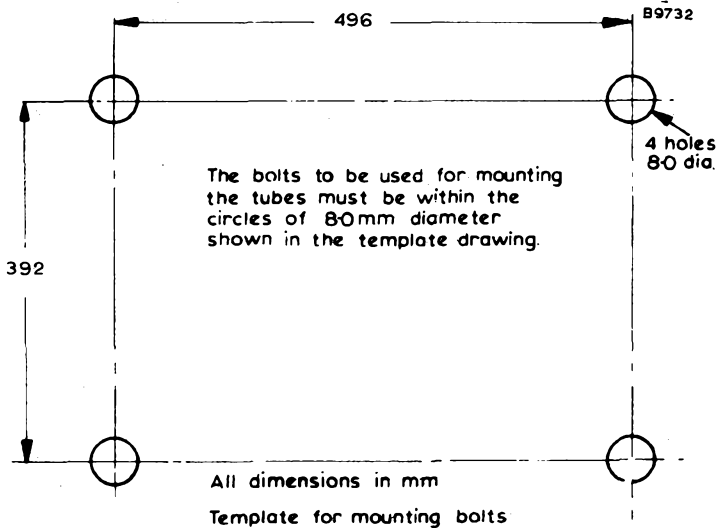

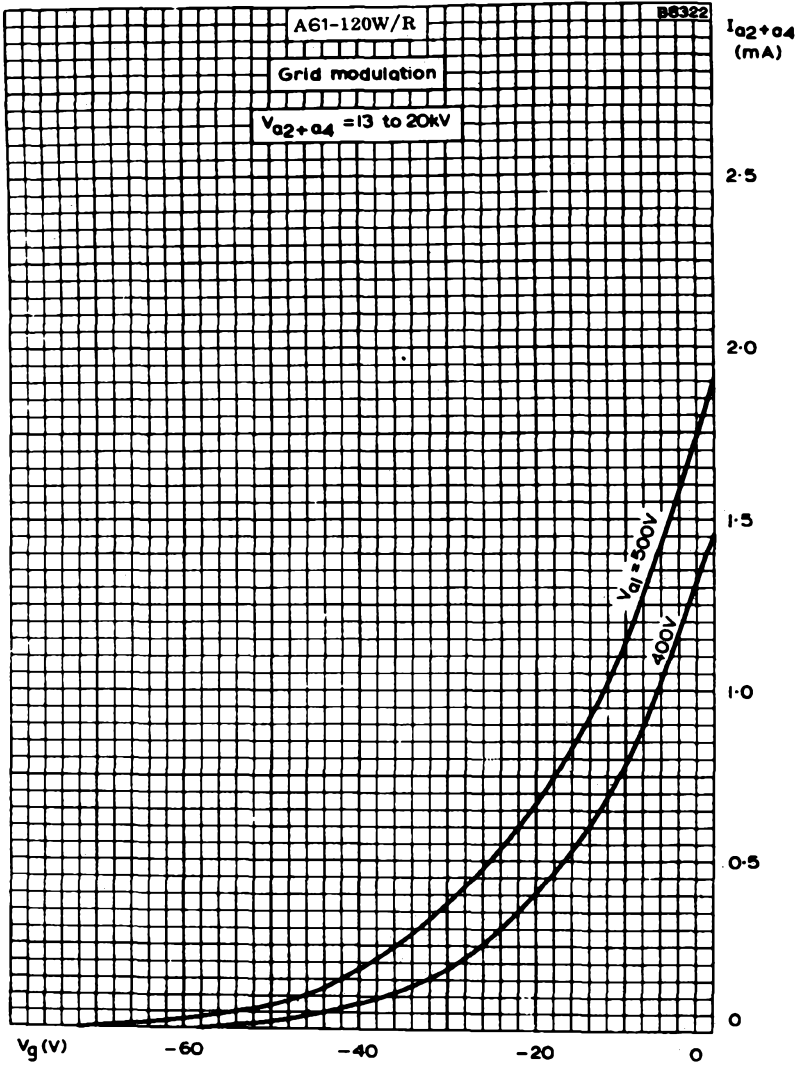

FINAL ANODE CURRENT PLOTTED AGAINST GRID VOLTAGE.
GRID MODULATION.

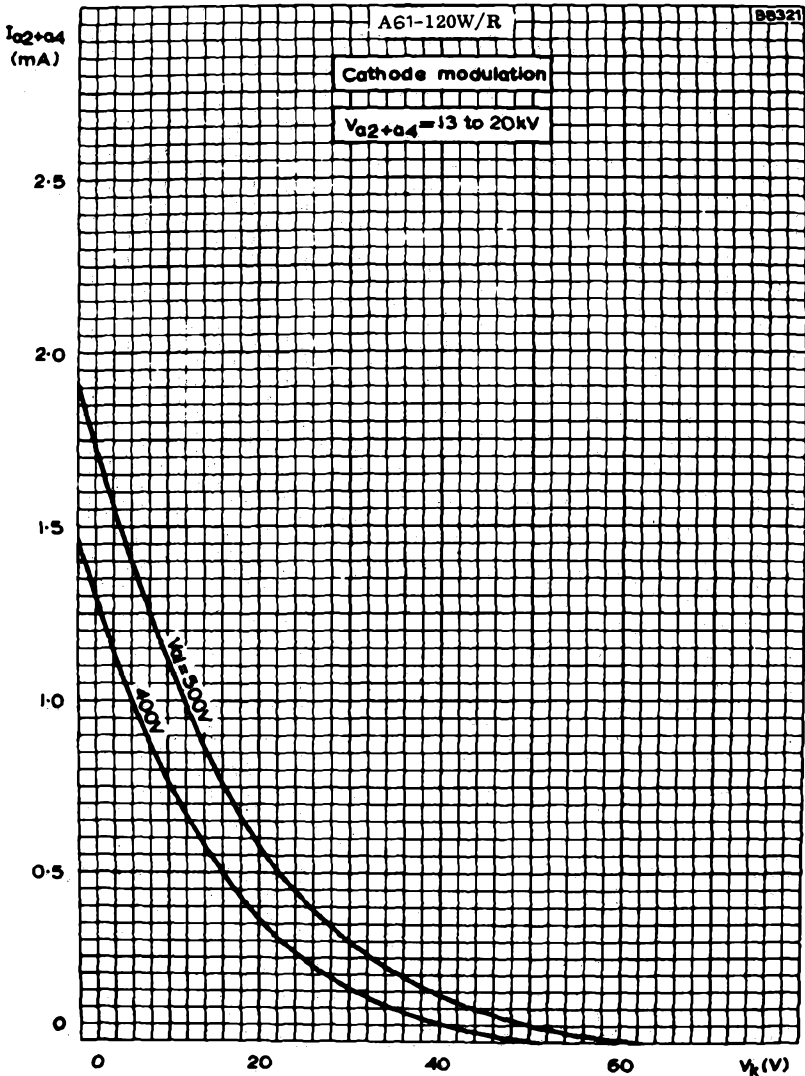

FINAL ANODE CURRENT PLOTTED AGAINST CATHODE-TO-GRID VOLTAGE. CATHODE MODULATION.

Mullard

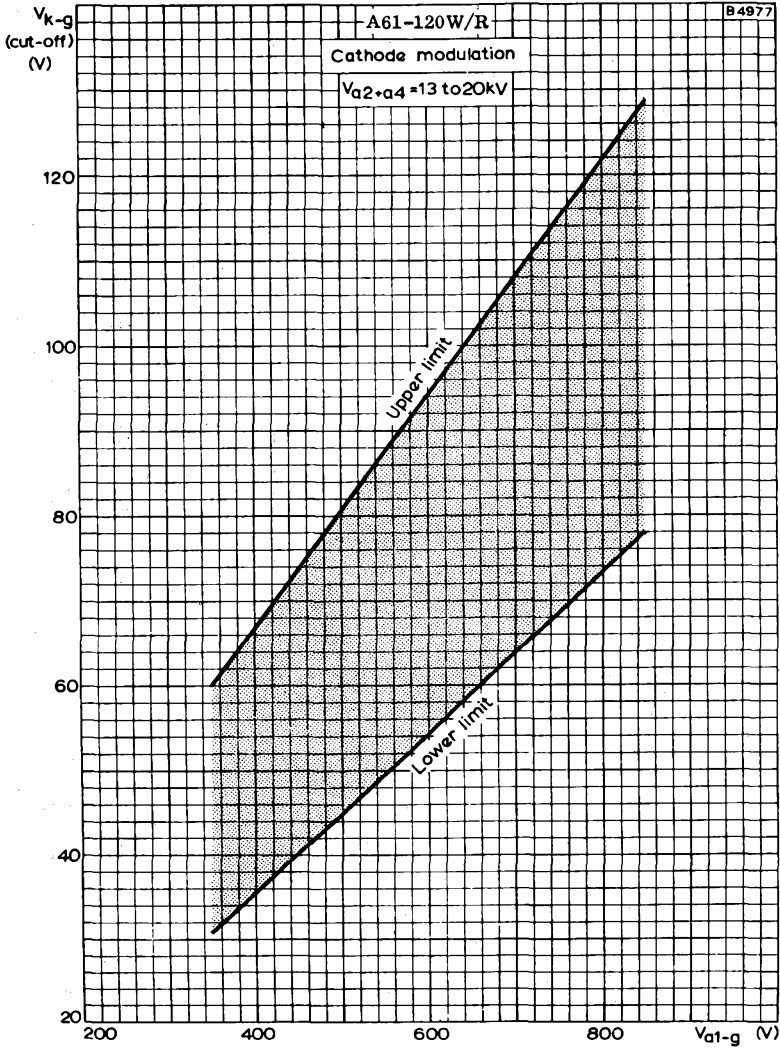

LIMITS OF CATHODE-TO-GRID CUT-OFF VOLTAGE PLOTTED AGAINST FIRST ANODE-TO-GRID VOLTAGE. CATHODE MODULATION.

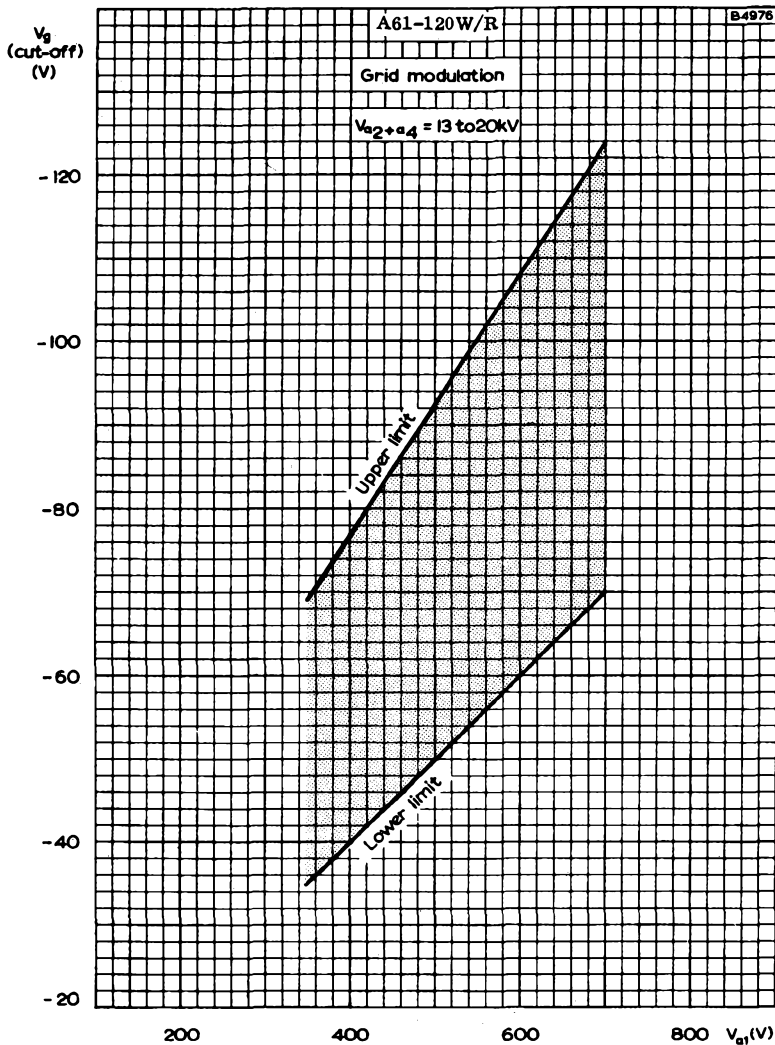

LIMITS OF GRID CUT-OFF VOLTAGE PLOTTED AGAINST
FIRST ANODE VOLTAGE. GRID MODULATION

GENERAL SECTION RECEIVING VALVES





RECEIVING VALVES

VALVE TYPE NOMENCLATURE

The type nomenclature for Mullard receiving and amplifying valves generally consists of two or more letters followed by two, three or four figures. These symbols provide information concerning the principal uses of the valves, the heater or filament rating, and the type of base, according to the following code.

The first letter indicates the filament or heater voltage or current:

D—0.5 to 1.5V filament	H—150mA heater
E—6.3V filament	P—300mA heater
G—5.0V filament	U—100mA heater

Letters A(4.0V), C(200mA) and K(2.0V) have also been used.

The second and subsequent letters indicate the general class of valve:

A—single diode	H—hexode or heptode
B—double diode	K—heptode or octode
C—triode	L—output tetrode or pentode
D—output triode	M—electron beam indicator
E—tetrode	Y—half-wave rectifier
F—voltage amplifying pentode	Z—full-wave rectifier

Two or three of the above letters may be combined, e.g. BC—double-diode triode.

The first figure of the serial number indicates the type of base:

- 1—Miscellaneous bases (see note below)
- 2—B10B(10-pin) base (previously used for B8G base)
- 3—Octal base
- 4—B8A base
- 5—B9D(magnoval) base (previously used for miscellaneous bases)
- 6 and 7—Previously used for subminiature bases
- 8—B9A (noval) base
- 9—B7G base

In some earlier type numbers with three figures, if the first figure is 1 then the second figure indicates the type of base, e.g., ECC189—B9A base.

The remaining figures make up the serial number indicating a particular design or development. In future, all valves designed for 'entertainment' applications will have a serial number of three figures. Valves designed for 'professional' applications will have a serial number of four figures.



VALVE TYPE NOMENCLATURE

RECEIVING VALVES

Exceptions

Some valves for 'professional' applications have a type number in which the figures follow the first letter and precede the second and subsequent letters, e.g., E88CC. Other 'professional' valves have a type number consisting of the letter 'M' followed by a four-figure serial number commencing with the figure '8', e.g. M8080.

Examples

PCF806	P 300mA heater	C triode	F voltage amplifying pentode	806 B9A base 'Entertainment' applications
EC1000	E 6.3V heater	C triode	1000 Miscellaneous (subminiature) base 'Professional' applications	



LIST OF SYMBOLS

These symbols are based on British Standard Specification No. 1409 : 1950,
" Letter Symbols for Electronic Valves "

1. SYMBOLS FOR ELECTRODES

Anode	a	Fluorescent Screen or Target...	t
Cathode	k	External Metallisation	M
Grid	g	Internal Metallisation	m
Heater	h	Deflector Electrodes	x or y
Filament	f	Internal Shield	s
Beam Plates	bp	Resonator	Res

NOTE 1. In valves having more than one grid, the grids are distinguished by numbers— g_1, g_2 , etc., g_1 being the grid nearest the cathode.

NOTE 2. In multiple valves, electrodes of the different sections may be distinguished by adding one of the following letters:

Diode	d	Hexode	} h
Triode... ..	t	Heptode	
Tetrode	q	Octode	
Pentode	p	Rectifier	

Thus, the grid of the triode section of a triode-hexode is denoted by g_t .

NOTE 3. Two or more similar electrodes which cannot be distinguished by any of the above means may be denoted by adding one or more primes to indicate to which electrode system the electrode forms a part.

Thus, the anode of the first diode in a double diode valve is denoted a' .

2. SYMBOLS FOR ELECTRIC MAGNITUDES

Voltages		Current	
Direct Voltage	V	Direct Current	I
Alternating Voltage (r.m.s.)	$V_{r.m.s.}$	Alternating Current (r.m.s.)	$I_{r.m.s.}$
Alternating Voltage (mean)	V_{av}	Alternating Current (mean)	I_{av}
Alternating Voltage (peak)	V_{pk}	Alternating Current (peak)	I_{pk}
Peak Inverse Voltage	P.I.V.	No Signal Current	I_0

Miscellaneous

Frequency	f	Anode Efficiency	η
Amplification Factor	μ	Sensitivity	S
Mutual Conductance	g_m	Brightness	B
Conversion Conductance...	g_c	Temperature	T
Distortion	D	Time	t



LIST OF SYMBOLS

	Inside Valve	Outside Valve
Resistance	r	R
Reactance	x	X
Impedance	z	Z
Admittance	y	Y
Mutual Inductance	m	M
Capacitance	c	C
Capacitance at Working Temperature	c _w	
Power	p	P

3. AUXILIARY SYMBOLS

Battery or other source of supply	b
Inverse (Voltage or Current)	inv
Ignition (Voltage)	ign
Extinction (Voltage)	ext
No Signal	o
Input	in
Output	out
Total	tot
Centre Tap	ct

4. COMPLEX SYMBOLS

Symbols in Sections 1 and 3 above may be used as subscripts to symbols in Section 2, to denote such magnitudes as Anode Current, Grid Volts, etc., e.g.:-

Anode Voltage ...	V_a	Anode Current (A.C. r.m.s.)	$I_{a(r.m.s.)}$
Control-Grid Voltage	V_{g1}	No Signal Anode Current	$I_{a(o)}$
Anode Supply Voltage	$V_{a(b)}$	Control-Grid Current	I_{g1}
Filament Voltage	V_f	Total Distortion	D_{tot}
Heater Voltage	V_h	3rd Harmonic Distortion	D_3
Anode Dissipation	p_a	Equivalent Noise	
Output Power	P_{out}	Resistance	$R_{e q}$
Drive Power	P_{drive}	Limiting Resistor	R_{lim}
Anode Current (D.C.)	I_a	Cathode Bias Resistor	R_k

	Internal	External
Anode Resistance	r_a	R_a
Insulation Resistance (heater to cathode)	r_{h-k}	
Resistance between Control-Grid and Cathode	r_{g1-k}	R_{g1-k}
Capacitance (cold)—		
Anode to all other electrodes		C_{a-all}
Anode to control-grid		C_{a-g1}
Control-grid to cathode at working temperature		$C_{g1-k(w)}$
Control-grid to all other electrodes except anode (Input Capacitance)		C_{in}
Anode to all other electrodes except control-grid (Output Capacitance)		C_{out}
Inner Amplification Factor		μ_{g1-g2}



The following recommendations have been based on the British Standard Code of Practice No. C.P.1005: (1962), "The Use of Electronic Valves."

1. DEFINITIONS OF RATING SYSTEMS

Unless otherwise stated, all limiting values given in the Receiving Valve section of the Mullard Technical Handbook are in accordance with the design-centre rating system. The design-maximum and absolute-maximum rating systems may be used in certain circumstances. The following definitions of these three rating systems are based on those agreed by the International Electrotechnical Commission:—

1.1 Design-centre rating system

Design-centre ratings are limiting values of operating and environmental conditions applicable to a bogey valve of a specified type as defined by its published data, and should not be exceeded under normal conditions.

These values are chosen by the valve manufacturer to provide acceptable serviceability of the valve in average applications, taking responsibility for normal changes in operating conditions due to rated supply voltage variation, equipment component variation, equipment control adjustment, load variation, signal variation, environmental conditions, and variations in the characteristics of all electron devices in the equipment.

The equipment manufacturer should design so that initially no design-centre value for the intended service is exceeded with a bogey valve in equipment operating at the stated normal supply voltage. A bogey valve is one whose characteristics have the published nominal values for the type. For a bogey valve for any particular application, only those characteristics which are directly related to the application need be considered.

1.2 Design-maximum rating system

Design-maximum ratings are limiting values of operating and environmental conditions applicable to a bogey valve of a specified type as defined by its published data, and should not be exceeded under the worst probable conditions.

These values are chosen by the valve manufacturer to provide acceptable serviceability of the valve, taking responsibility for the effects of changes in operating conditions due to variations in the characteristics of the valve under consideration.

The equipment manufacturer should design so that initially and throughout life no design-maximum value for the intended service is exceeded with a bogey valve under the worst probable operating conditions with respect to supply-voltage variation, equipment component variation, equipment control adjustment, load variation, signal variation, environmental conditions and variations in characteristics of all other electron devices in the equipment.

1.3 Absolute-maximum rating system

Absolute-maximum ratings are limiting values of operating and environmental conditions applicable to any valve of a specified type as defined by its published data, and should not be exceeded under the worst probable conditions.



These values are chosen by the valve manufacturer to provide acceptable serviceability of the valve, taking no responsibility for equipment variations, environmental variations, and the effects of changes in operating conditions due to variations in the characteristics of the valve under consideration and all other electron devices in the equipment.

The equipment manufacturer should design so that initially and throughout life no absolute-maximum value for the intended service is exceeded with any valve under the worst probable operating conditions with respect to supply voltage variations, equipment component variations, equipment control adjustment, load variations, signal variation, environmental conditions, and variations in characteristics of the valve under consideration and of all other devices in the equipment.

2. INTERPRETATION OF DESIGN-CENTRE RATINGS

When the circuit designer uses the design-centre system he should realise that the valve manufacturer takes into account the effects of normal random variations in conditions and components and assumes that normal good practice is followed in the design and use of components. No allowance is made for discrete changes in conditions or components.

2.1 Rated supply voltage and its variation

In equipment which is to operate from the normal supply mains a voltage tap should be provided for every declared mains voltage. Where this is not practicable however, and two or more declared voltages are covered by one tap, compliance with the design-centre system must be checked on the highest and lowest declared voltages in each tap. For the purpose of checking, all devices must be bogey.

If the equipment is checked in this way and the designer has complied with all other relevant sections in these recommendations the equipment can be operated from a supply that has normally-encountered voltage variations of up to $\pm 10\%$. (The normal ratio of power variation to voltage variation of approximately 2 : 1 is assumed. If the ratio is greater than 2 : 1 in a particular circuit, the maximum permissible dissipation at which any valve can operate must be reduced accordingly below the limiting value.) Where a valve is recommended solely for low voltage operation (as in the car-radio range) allowance has already been made for the variations in accumulator voltage, which can be greater than 10%. For further recommendations see section 3.1.5.

2.2 Equipment components and their variations

In an equipment the operation of any one component is to some extent dependent on every other component in that equipment. It is good practice to use self bias, such as provided by a cathode resistor or grid current bias (see section 5.3), rather than fixed bias. When this is done, further components can be added as long as the added variations are not large compared with those already existing, as in general the addition of a component to a circuit reduces the effects of the variations of the other components already in that circuit. besides adding the effect of its own variations.

If a power valve or high-slope valve is operated within 20% of its maximum dissipation rating, a $\pm 10\%$ tolerance cathode-bias resistor should be used. If a cathode-bias resistor cannot be used, then with a pentode or other multigrid valve a screen-grid dropping resistor having a $\pm 10\%$ tolerance should be incorporated (see section 5.4). Similarly, with a triode a dropping resistor should be used in the anode circuit (see section 5.6). Valves should not be used in circuits where their operating conditions are dependent on another circuit or valve, unless the more important transferred variations are small compared with the variations in the operating conditions. When two valves are used in push-pull, for example, separate cathode-bias resistors should be used.

2.3 Equipment control adjustment

The valve manufacturer's responsibilities do not include conditions produced by gross maladjustment of controls which result in incorrect operation of the equipment.

When a pentode or other multigrid valve is used under conditions where the equipment control adjustment effects the valve operating conditions, special attention must be paid to the screen-grid operating conditions (see section 5.4).

In equipment which has multiple functions (e.g. transmitter/receivers, t.v./f.m. receivers, etc.), it is assumed that the valves are used within their ratings in all modes of equipment operation.

2.4 Load variation

The valve manufacturer takes responsibility for the changes in valve operating conditions which are caused by the normal random variations of any component connected externally as a load, provided that normal good practice has been followed in the design and use of the component. Where definite changes occur in the load, all ratings should be checked at the worst long period running condition.

2.5 Signal variation

The valve manufacturer accepts responsibility for changes in the operating conditions due to random variations in signal (fading etc.) but not due to discrete changes (switching, or tuning to stations of varying strengths). When a.g.c. is used, the operating conditions of the valves will change with the strength of signal received. The operating conditions of all the stages (controlled and uncontrolled) must therefore be checked under their worst long period running conditions.

2.6 Environment

It is good practice to ensure that the bulb and base temperatures are kept low. They should not exceed the published limiting values in the environment for which the equipment is designed. Where equipment may be run under more than one condition it should be checked at each condition. If the maximum temperature ratings are not given on the data sheet of the valve in question, see Fig. 1 (Appendix III).

Care should be taken to ensure that the minimum pressure in the environment for which the equipment is designed is not less than the published limit. In general, B7G and B9A based valves can be used at pressures down to approximately 50mm Hg (that is up to altitudes of about 60,000ft). The manufacturer's advice should be sought if it is desired to operate octal-based valves at pressures below 525mm Hg (that is above altitudes of about 10,000ft).

2.7 Other electron devices

The valve manufacturer takes responsibility for changes in operating conditions caused by the variations in the characteristics of all other electron devices in the equipment, provided that normal good practice has been followed in the use of each electron device, i.e. the added variations are not large compared with those already existing.

3. HEATER RATINGS

3.1. Parallel operation (mains supply)

The heater voltage of individual valves must be within $\pm 7\%$ of the rated value (unless otherwise stated) when the supply voltage is at its nominal value, and valves with bogey heater characteristics are employed.

This variation is normally dependent upon more than one factor. The total variation may be taken as the square root of the sum of the squares of the individual variations arising from the effects of the tolerances of the separate factors, provided that no one of these deviations exceeds $\pm 5\%$.

If a tap is used for more than one input voltage (as provided for in paragraph 2.1) the heater voltage of each valve must be checked on the highest and lowest declared voltages covered by the tap and should be within $\pm 4\%$ of the rated value.

3.2 Series operation (mains supply)

The heater current of series connected valves should be within $\pm 3.5\%$ of the rated value when the supply voltage is at its nominal value, and valves with bogey heater characteristics are employed.

This variation is normally dependent upon more than one factor. The total variation may be taken as the square root of the sum of the squares of the individual variations arising from the effects of the tolerances of the separate factors, provided that no one of these variations exceeds $\pm 2.5\%$.

If a tap is used for more than one input voltage (as provided for in paragraph 2.1) the heater current must be checked on the highest and lowest declared voltages covered by the tap and should be within $\pm 2\%$ of the rated value.

In applications where a wide variation in the dynamic characteristics of the valve is acceptable, as for example in simple a.m. broadcast receivers and low-cost amplifiers, the heater current tolerance may be increased from $\pm 3.5\%$ to $\pm 5\%$. This allows for the use of three taps to cover the range 200 to 250V even in applications where the chain consists mainly of a dropping resistor.

3.2.1 Supply from a voltage source via a series diode

Source voltage = total heater voltage $\times \sqrt{2}$

No restrictions but the d.c. component of the resulting heater voltage should preferably be negative with respect to the cathodes of the valves.

3.2.2 Supply from a voltage source via a series diode and series resistor

Source voltage = (total heater voltage + series resistor voltage) $\times \sqrt{2}$

The voltages are in rms values and the maximum permitted ratio of series resistor voltage to total heater voltage can be read from the following diagram.

For calculation of the required series resistance, divide the rms value of the series resistor voltage by the nominal heater current.

The d.c. component of the resulting heater voltage should preferably be negative with respect to the cathodes of the valves.

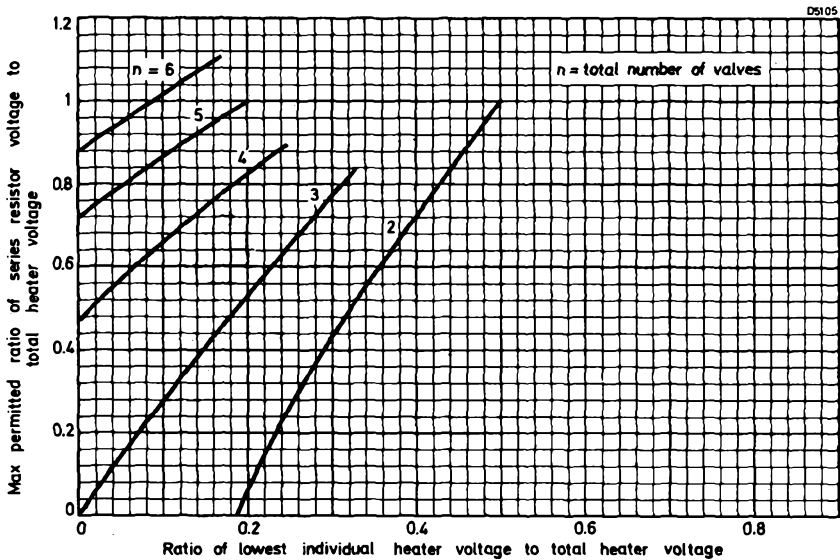

3.3 Pulse and r.f. operation of heaters

When a valve heater is operated from a pulse or r.f. supply, special care should be taken to ensure that the correct power is delivered to the heater and that the peak voltage across the heater is not excessive.

In many rectifier applications, the valve will be required to supply only small currents. In these cases a relaxation of the normal $\pm 7\%$ heater voltage tolerance is allowed for some valve types. Details of the permissible relaxation are given on the appropriate data sheets.

3.4 Fluctuations in mains supply voltage

In addition to the tolerances quoted in 3.1, 3.2, and 3.3 above, fluctuations in the mains supply voltage not exceeding $\pm 10\%$ are permissible. These conditions are, however, the worst which are acceptable, and it is better practice to maintain the heater as close to its nominal rating as is possible.

Closer adherence to the rated heater voltage or current produces optimum valve life and performance.

3.5 Parallel, series or series-parallel operation from accumulators

When valve heaters are supplied in parallel from a 6.3V "on charge" accumulator, a resistor must be included to make up the difference between the heater voltage and the "on charge" battery voltage of 7V.

When valve heaters are supplied from an accumulator and are connected in a series-parallel arrangement, as is common for mobile operation, equalising bars should be used: that is, the points in the parallel chains which are at equal potential should be interconnected. It is necessary to have at least two, and preferably three, heaters connected in parallel in the resulting series-parallel arrangements, so that the variations are reduced to those which are expected with parallel operation. If this is done, up to four 6.3V valves can be connected in series and fed from an "on charge" 24V accumulator, or two from a 12V accumulator, provided that a resistor is included to make up the difference between the total heater voltage and the nominal "on charge" battery voltage. The nominal "on charge" battery voltages may be taken as 28V and 14V respectively.

If it is then required to operate from an accumulator that is not on charge, e.g. under emergency conditions, the equipment designer must ensure that his circuits will operate satisfactorily with any valves of the types in question, both when new and throughout life. It is suggested that the series dropping resistor should be switched out of circuit during "off charge" operation. The advice of the valve manufacturer can be sought on any specific points. Where life and reliability are of particular importance, with a series-parallel heater arrangement the supply voltage variation should be kept to a minimum, preferably less than $\pm 2\%$.

4. CAPACITANCES

Unless otherwise stated, the capacitances quoted are measured at 1MHz with the valve cold in a fully screened socket, with or without an external shield, as stated on the individual data sheets. In practice, allowance should be made for the increase in capacitances due to space-charge effects in the valve, the capacitance of the valve holder itself, and the wiring.

An explanation of symbols for capacitances is given in Appendix II.

5. VALVE ELECTRODES

5.1 General

Valves should always be operated with a d.c. connection between each electrode and the cathode.

It should be noted that the secondary-emission characteristics of valve electrodes may vary from valve to valve, and the use of these characteristics is not in general recommended, except in the case of valves designed as secondary-emission valves.

5.2 Cathode

5.2.1 Voltage between cathode and heater

The maximum values of cathode-to-heater voltage quoted on individual data sheets are the maximum d.c. values (unless otherwise stated) and apply to that side of the heater where the cathode-to-heater voltage is greater.

Where a.c. or a.c. and d.c. exist between heater and cathode, the d.c. component must not exceed the published value, and in addition the maximum instantaneous value occurring must never exceed twice the published value, or 300V whichever is the lesser, unless a specific rating is quoted. This applies to pulse voltages as well as sine-wave voltages.

The cathode-to-heater voltage should always be kept as low as possible and it is preferable to have the cathode positive with respect to the heater. Where the cathode-to-heater voltage cannot be kept low, it is helpful, in the interests of reliability, if the d.c. resistance is kept as high as possible, consistent with the circuit requirements for hum and cathode-to-heater leakage current.

5.2.2 External resistance between cathode and heater

When cathode resistors of high value are used, the valve performance may be influenced by leakage between heater and cathode, which may give rise to difficulties when valves are replaced or the leakage between heater and cathode varies during life. A maximum value of 20k Ω is therefore recommended for the external resistance between cathode and heater. The maximum may however be increased up to 1M Ω if the d.c. component of the cathode-to-heater voltage is such that its instantaneous value never drops below three times the r.m.s. value of the heater voltage. The hum voltage produced across the resistance might assume a rather high value under these conditions.

5.2.3 Rectifier cathodes

Disintegration of the cathode coating may occur in both indirectly heated and directly heated rectifiers if the total resistance in series with the anode is less than that specified on the data sheet for the particular valve. The value of the resistance depends upon the effective resistance, R_t due to the transformer.

$$R_t = R_s + n^2 R_p$$

Where:

R_s = Resistance of the transformer secondary in anode circuit.

R_p = Resistance of the transformer primary.

n = Secondary to primary ratio in half-wave circuits or half-secondary to primary ratio in full-wave circuits.

If the resistance R_t is less than the minimum specified value for the limiting resistance, an additional series resistance must be included in the lead to each anode. The wattage rating of this resistor should be at least three times that required for d.c. only.

5.3 Control grid

In general, it is good practice to keep the resistance of the circuit between the control grid and the cathode as low as possible. It should not exceed the maximum value quoted on the data sheet.

Unless otherwise stated the value of R_{g1-k} max. given in the limiting values refers to operation of the valve with fixed bias. The maximum value for cathode bias operation can be obtained from Fig. 3 (Appendix III)

If grid current biasing is employed, the value of grid resistor will depend on the application. For a.f. voltage amplifiers the grid resistor value should be high (preferably greater than $10M\Omega$) but not greater than $22M\Omega$. For r.f. and i.f. valves the value for normal cathode bias should not be exceeded (i.e. twice the fixed bias value).

The values of currents and dissipations should be checked when the grid is connected to cathode. High-slope valves ($g_m > 5mA/V$) should not generally be operated with grid current bias only unless some d.c. feedback is included in the form of a screen-grid dropper (in the case of a pentode) or an anode dropper (in the case of a triode), and a low value of cathode resistor (such as that required to compensate for variations in input capacitance with a.g.c.) is incorporated. Compliance with the design-centre limiting values must then be checked with the grid connected directly to the negative end of this cathode resistor.

When valves are operated under conditions chosen to give low control-grid currents, the grid resistor value may be very high. If this mode of operation is required the advice of the valve manufacturer should be sought.

In circuits where positive control-grid current flows, either continuously or intermittently, the limiting values relevant to the control grid must never be exceeded.

Where large signals are applied to the grid of a valve, a grid resistor should be used so that the bias is obtained by grid current rectification, and the variations in the drive will not noticeably affect the valve operating conditions. When this is done, it should be ascertained that limiting values will not be exceeded in the event of loss of drive. This risk may be avoided by providing sufficient cathode bias.

If fixed bias is used for a valve, provision should be made for adjusting the bias so that the nominal value of anode current flows. This is particularly important in the case of class "B" output valves when separate adjustment should be provided for each valve.

5.4 Screen grid

The rating chart in Fig. 2 (Appendix III) can be used to relate screen-grid dissipation to screen-grid voltage, provided that other limiting values are not exceeded, and that a resistor is used in the screen-grid circuit.

For large signal applications, in which the operating conditions of the valve can be varied (for example, by varying the drive) the screen-grid dissipation must be checked at the worst long period running conditions and also during the warm-up period. With speech and music the average level is low compared with the peaks, and operation will be satisfactory if the screen-grid dissipation is checked at points up to one third of the output power.

In general, the effect of the cathode resistor is reduced by large signals, and a screen-grid resistor becomes necessary. This resistor normally need not drop more than 20% of the h.t. line voltage. If this resistor is unbypassed, it need only drop about 10% of the h.t. line voltage.

When a valve with a screen grid is connected as a triode, and specific recommendations are not given in the data, the dissipations of the anode and screen grid should not exceed their individual maximum ratings.

5.5 Suppressor grid

The suppressor grid should normally be connected directly to the cathode or to the negative end of the cathode resistor whichever is more convenient. The suppressor grid should not be used as a control grid unless specific recommendations are made in the data. Where the suppressor grid is so used, care should be taken not to exceed the maximum screen-grid dissipation. When a valve is connected as a triode, the suppressor grid should be connected directly to the cathode, except where other recommendations are given in the data. In applications where the suppressor grid is liable to be driven positive, the value of R_{g3-k} should not exceed 50k Ω unless otherwise stated.

5.6 Anode

The rating chart given in Fig. 2 can be used to relate anode dissipation to anode voltage, providing that other limiting values are not exceeded, and that the load used in the anode circuit is a resistor. For large signal applications, the anode dissipation must be checked at the worst long period running condition.

When a triode is used in large signal applications, some resistance should be included in series with its anode. The value required is very dependent on the application, and in the extreme when a triode is biased beyond cut-off and driven well into the positive grid region, e.g. as in class "C" operation, the load impedance in the anode circuit may be sufficient. In this application, however, the use of a cathode resistor is generally recommended to safeguard the valve in the event of loss of drive. If class "B" operation is to be used without a cathode resistor, it must be remembered that large variations can occur near the cut-off point. It is therefore necessary to ensure that all valves will operate at about the same condition, e.g. adjust the bias of each valve to give the required no-signal anode current.

6. MECHANICAL CONSIDERATIONS

6.1 Mounting position

Unless otherwise stated in the published data, valves can be mounted in any position.

6.2 Valve holders

Detailed drawings of pin spacing, diameter and length are given in BS448:1953 "Electronic-valve Bases, Caps and Holders". When wiring a valve holder for an all-glass based valve, a wiring jig should be inserted to prevent the contacts being displaced. Such displacement could cause damage to the pins when a valve is inserted in the holder. Dimensions for suitable jigs are given in BS448. Pins marked IC on the base diagram in the data sheet may have been used for connections within the valve. The corresponding contacts on the valve holder must be left free and not be used as anchoring points when wiring.

6.3 Valves with flexible leads

Valves with flexible leads do not normally employ plug-in valve holders and it is usually necessary to secure them in position solely by means of the envelope. Any such support should not cause undue stress to be placed on the flexible leads. Attention should also be given to the effect this mounting may have upon bulb temperature.

Direct soldered connections to the leads must be at least 5mm from the seal and any bending of the leads must be at least 1.5mm from the seal.

Precautions should be taken during soldering to ensure that the glass temperature at the seal is not allowed to rise excessively. One simple method is to clamp a thermal shunt to the wire between the glass and the point being soldered.

6.4 Dimensions

Only the dimensions given on the data sheets should be used in the design of equipment. Dimensions taken from individual valves must never be used for this purpose.

7. COOLING

As stated in Section 2.6 the bulb and/or base temperatures must not exceed the published maxima, and it is in general good practice to take steps to ensure that the bulb and base temperatures are kept low.

Use may be made of all three methods of cooling, namely convection, radiation and conduction.

7.1 Convection and radiation cooling

A valve mounted in free air is cooled by convection currents and by radiation to its surroundings. In order to make these methods most efficient it is necessary to ensure as free a circulation of air round the valve as possible and to maintain neighbouring bodies at as low a temperature as possible.

The design of valve screening or retaining devices should conform to the above principles; that is to say, the device should permit free circulation of cooling air and should reflect as little heat as possible back to the bulb. Where adequate convection cooling cannot be realised because of mechanical limitations, high altitude, or high temperature of the air available for circulation, forced-air cooling or conduction cooling must be adopted.

7.2 Conduction cooling

Conduction cooling is obtained by mounting the valve in contact with a mass of material which has good heat-conducting properties. This material then acts as a "heat sink". The clamp or can which is used to couple the valve to the heat sink should ensure good thermal contact with the bulb and base of the valve, and should also ensure that the maximum base temperature of 165°C is never exceeded. Heat-sink cooling is particularly suitable for use with flexible-lead valves, as the mechanical arrangements are not likely to allow "free air" cooling, although it should be remembered that the base temperature may be higher than with plug-in valves.

8. MICROPHONY

Whenever a valve is subjected to vibration, some disturbance in the output of the valve occurs. The effect of this disturbance will depend on the individual application. The published data often make reference to the microphonic sensitivity of different valve types, and this should be noted when a valve type is chosen for a specific application. Where the effects of microphony are found to be objectionable, special steps may have to be taken to reduce the vibration reaching the valve. The chassis itself may show wide variations in amplitude of vibration over its area, due to resonances; therefore favourable location of the valve, or local strengthening of the chassis, may appreciably reduce microphony.

A further reduction may be obtained by the use of antivibration mountings, but these are likely to be completely ineffective if the vibrations reaching the valve are being transmitted through the air and not through the chassis.

9. HUM

If an a.c. supply is used for valve heaters, the cathode current may be modulated by capacitance and leakage effects between the heater and other electrodes, or by the magnetic field of the heater. This modulation can give rise to hum. The most important electrodes in this respect are the cathode and the control grid. The published limiting value of V_{h-k} does not give any information about the resulting hum level, but is the maximum permissible voltage below which there is reasonably little danger of breakdown occurring between cathode and heater. The greater the a.c. component between heater and cathode (or control grid), the greater will be the hum. With a.f. valves the hum frequency will appear in the audio output; with i.f. and r.f. valves it will appear as modulation hum.

Hum can also be caused if the leakage resistance between cathode and heater is included in an a.f. or r.f. circuit. If it is included in a tuned circuit, the frequency to which the circuit is tuned may be altered by changes in the physical or electrical properties of the cathode-heater insulation (e.g. by vibration of the heater at the supply frequency), resulting in modulation hum.

The presence of leakage currents may become apparent as hum or background noise. It is particularly important that idle valve-holder contacts in the proximity of the control-grid contact should not be used as anchoring points for wires which are connected to the a.c. supply, as this practice may introduce hum via the capacitances or leakages between valve-holder contacts. This consideration is of particular importance at high supply frequencies.

APPENDIX I – DEFINITIONS AND INTERPRETATION OF DATA

The principal characteristics quoted for each receiving valve in this Handbook are normally those corresponding to the given value of anode current.

The values given are the mean values of measurements made on a large number of valves. All voltages are measured with respect to the cathode, unless otherwise stated.

The following definitions are intended to assist in interpreting the data, as some of these are not sufficiently well known:

V_a max. (V_{g2} max. etc.) The maximum positive voltage which can be applied to the electrode at full dissipation. At higher electrode voltages the electrode dissipation must be reduced in accordance with the rating chart (Fig. 2).

$V_{a(b)}$ max. ($V_{g2(b)}$ max. etc.) The maximum voltage (positive or negative) which can be applied to the valve electrode when the valve is cold. If semiconductor diodes or metal rectifiers are used to supply the h.t. in an equipment for instance, the h.t. rail may rise to this value after switching on but before the valves have warmed up.

$i_{a(pk)}$ max. (Rectifiers) The maximum permissible steady-state peak anode current.

$i_{a(\text{surge})}$ max. (Rectifiers)

The maximum permissible instantaneous anode current under switching conditions with the valve hot.

V_{g1} ($I_{g1} = +0.3\mu\text{A}$)

The control-grid voltage at which the positive grid current (with no other electrode voltages applied, unless otherwise stated) is $0.3\mu\text{A}$. The value is normally not more negative than -1.3V , and with a limit valve $+0.3\mu\text{A}$ will flow at this voltage. In any application where positive grid current is not permissible, the grid must always be biased more negative than this value.

g_m

The mutual conductance is the relation between a change in anode current and the corresponding change in control-grid voltage, with the anode (and screen-grid) voltage constant.

$$g_m = \frac{\delta I_a}{\delta V_g} \quad (V_a \text{ constant})$$

μ

The amplification factor is defined as the ratio of a change in anode voltage to the corresponding change in control-grid voltage, the anode current remaining constant.

$$\mu = \frac{\delta V_a}{\delta V_g} \quad (I_a \text{ constant})$$

r_a

The anode impedance is the ratio of a change in anode voltage to the corresponding change in anode current, with control-grid (and screen-grid) voltage constant.

$$r_a = \frac{\delta V_a}{\delta I_a} \quad (V_{g1} \text{ constant})$$

g_m , μ and r_a are related by the expression:

$$\mu = g_m \cdot r_a$$

$g_m(\text{eff})$

When a valve is used as a class "C" oscillator, the anode current contains components at the fundamental and harmonics of this frequency because the valve is driven over the whole of the grid base. The simple value of g_m is no longer useful for making calculations, so the effective mutual conductance is given. This is defined as:

$$g_m(\text{eff}) = \frac{\text{Fundamental frequency component of anode current}}{\text{Fundamental frequency component of grid voltage}}$$

g_c The conversion conductance of a frequency changer is the relation between the intermediate frequency component of anode current to the grid input voltage at signal frequency.

$$g_c = \frac{\text{Intermediate frequency component of anode current}}{\text{Signal frequency component of grid input voltage}}$$

$\mu_{k1 \ 2}$ The "inner-mu" is the amplification factor from control grid to screen grid.

$$\mu_{k1 \ 2} = \frac{\delta V_{g2} (I_k \text{ constant})}{\delta V_{g1}}$$

r_{g1} Input damping resistance. This is given at a particular frequency and is the resistive component of the input impedance that the valve presents to the input circuit between grid and cathode. Over a limited range, the value at other frequencies can be calculated approximately from the formula:

$$r_{g1} (\text{at } f_1) = r_{g1} (\text{at } f_2) \times \left(\frac{f_2}{f_1}\right)^2$$

R_{eq} Equivalent noise resistance. This is the value of a resistance which, if introduced into the grid circuit of a perfectly noiseless valve, would produce noise of the same level as that of the shot and partition noise occurring in the actual valve. It does not include flicker effect which occurs mainly in the audio frequency band. The figures quoted in the data are measured values. Curves showing R_{eq} plotted against g_m or I_a are given for some valve types.

Noise factor The noise factor of a circuit is the ratio of the signal-to-noise ratio at the input to the signal-to-noise ratio at the output. It is dependent upon the equivalent noise resistance, the transit time component of input resistance, circuit resistance and source resistance. The figures quoted in the data are measured values.

K Cross-modulation factor. This is the ratio of the modulation depth of the wanted signal caused by a modulated interfering carrier, to the modulation depth of the wanted signal appearing on the wanted carrier at the output of the valve. This assumes that both carriers are modulated to the same depth. It may be considered to be

independent of the amplitude of the wanted signal where this amplitude is small, and to be proportional to the square of the amplitude of the interfering signal.

Cross-modulation figures and curves are given for valve types which are designed for a.g.c. operation. The curves given in the valve data show the amplitude of the interfering signal required to give a cross-modulation factor of 1%, plotted against g_m or g_c .

m_b

Modulation hum. Curves of hum input voltage plotted against g_m or g_c are also given for valve types which are designed for a.g.c. operation. These curves show the input voltage at the control grid which will cause the carrier to be modulated to a depth of 1%.



APPENDIX II – CAPACITANCE SYMBOLS

The symbol for inter-electrode capacitance consists of a letter c followed by subscript letters indicating the valve electrodes between which the capacitance is measured.

Examples

- | | |
|-------------|---|
| C_{in} | Capacitance measured between the input electrode (g_1) and all other electrodes except the output electrode (a). |
| C_{out} | Capacitance measured between the output electrode (a) and all other electrodes except the input electrode (g_1). |
| $C_{a'g'}$ | Capacitance measured between anode and grid of the first section of a double triode. Cathode of first section, all electrodes of second section, heater and any shield etc., earthed. |
| C_{g-k+h} | Capacitance between triode grid and cathode + heater (in a triode pentode). Triode anode and pentode section earthed. |

APPENDIX III – RATING CHARTS

Bulb Temperature Rating Chart

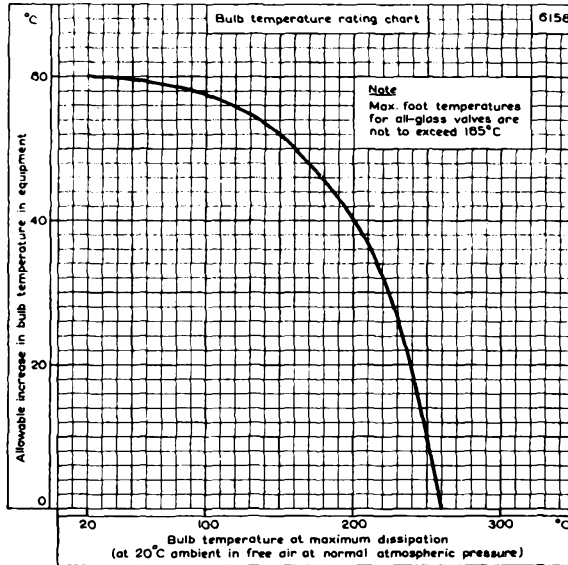

Fig. 1

The above chart shows the increase in bulb temperature that may be allowed, plotted against the bulb temperature attained by the valve when operated at full dissipation in free air at an ambient temperature of 20°C and normal atmospheric pressure.

To use the chart a measurement must first be made of the bulb temperature at the hottest point of the bulb under the conditions specified above. The hottest point of the bulb is normally opposite the centre of the anode, on the minor axis.

The chart can then be used to read off the permissible increase in bulb temperature, and hence establish a maximum bulb temperature for the valve type concerned.

For example, a power valve operated at full dissipation may be found to have a bulb temperature of 220°C. Reference to the chart shows the allowable increase in bulb temperature to be 32°C. The maximum bulb temperature for this type is therefore 252°C. A valve which has very little dissipation may have a bulb temperature of 120°C. The chart shows that in this case the bulb temperature may be allowed to rise (due to increased ambient) by 56°C, giving a final bulb temperature of 176°C.

This curve allows approximately 60°C increase in ambient temperature for valves having bulb temperatures up to 200°C (or 165°C in the case of sub-miniature valves).

The designer should ensure that the maximum bulb temperature rating given by the above chart is not exceeded in his equipment under normal operating conditions.

The maximum foot temperature of all-glass valves must not exceed 165°C, measured on the glass adjacent to the hottest pin. This is generally the anode pin in the case of high dissipation valves, or the heater pins in the case of low dissipation valves.

Electrode Dissipation Plotted Against Electrode Voltage

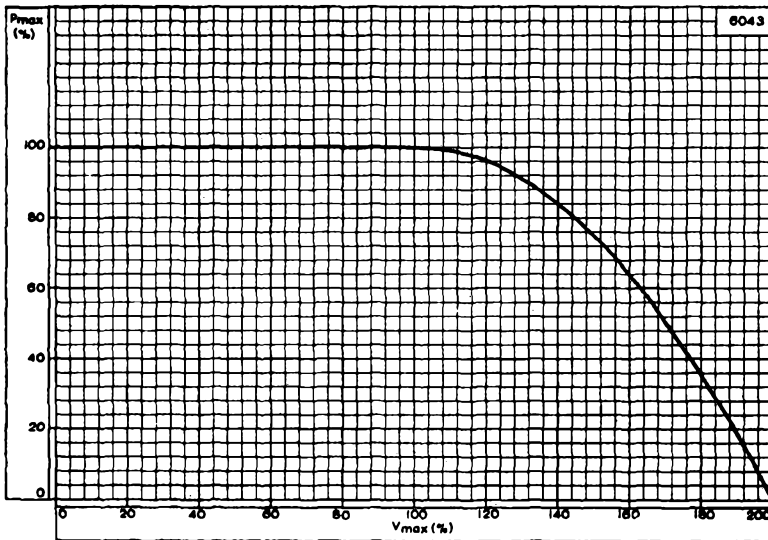

Fig. 2

The above chart shows the relation between the maximum positive electrode voltage and electrode dissipation. At voltage up to the maximum quoted in the data sheet, the maximum electrode dissipation can be used. At voltages in excess of this, the dissipation must be reduced in accordance with the above chart. This permits a supply voltage of twice the maximum permissible electrode voltage to be used, provided that a resistance is included in the circuit.

In cases where a value of $V_{a(b) \text{ max.}}$ or $V_{r2(b) \text{ max.}}$ is given which is less than twice the $V_a \text{ max.}$ or $V_{r2} \text{ max.}$ for the valve, the supply voltage must not exceed this value.

Maximum Value of Grid-to-Cathode Resistor

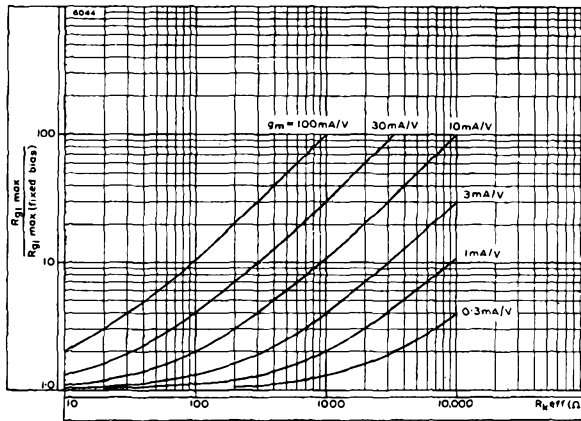

Fig. 3

To find the maximum value of grid-to-cathode resistor which can be used in a given circuit, the mutual conductance of the valve in circuit and the effective cathode resistor must be known. The mutual conductance of the valve in circuit can be determined by measurement.

The effective cathode resistor for a triode is given approximately by:

$$R_{k(\text{eff})} = R_k + \frac{R_u}{\mu}$$

and for a tetrode or pentode by:

$$R_{k(\text{eff})} = \frac{I_k}{I_a} R_k + \frac{I_{g2}}{I_a} \cdot \frac{R_{g2}}{\mu_{g1-g2}}$$

From these two values, the value of $R_{g1-k \text{ max}}$, which may be used in the circuit can be obtained from the graph.

Example

A pentode is to be used in a circuit under the following conditions:

$$\begin{array}{llll} I_a & = & 8\text{mA} & \mu_{g1-g2} = 47 & R_k & = & 200\Omega \\ I_{g2} & = & 2\text{mA} & g_m & = & 5\text{mA/V} & R_{g2} & = & 47\text{k}\Omega \end{array}$$

The value of $R_{g1-k \text{ max}}$, (fixed bias) is $1.0\text{M}\Omega$. The effective cathode resistor is therefore

$$\frac{10}{8} \times 0.2 + \frac{2}{8} \cdot \frac{47}{47} = 0.5\text{k}\Omega.$$

From the chart a value of $\frac{R_{g1 \text{ max.}}}{R_{g1 \text{ max.}} \text{ (fixed bias)}}$ of 3.5 is obtained for these two values.

The maximum value which can be used in this case is therefore $3.5\text{M}\Omega$.

RECEIVING VALVES

E 

11111

HALF-WAVE RECTIFIER

DY802

High voltage half-wave rectifier for television line fly-back e.h.t. supply. The bulb is chemically treated to prevent flashover under conditions of high humidity and low atmospheric pressure (60kN/m² or 450mm Hg).

HEATER

Suitable for parallel operation only, a.c. or d.c.

V_h	1.4	V
I_h	575	mA

Heater voltage tolerances:-

(a) As e.h.t. rectifier in television receivers.

The heater voltage should be adjusted to its nominal value at a d.c. output current of 200 μ A. When the d.c. output current is increased to 500 μ A, heater voltage decrease must not exceed 15%. These requirements hold for nominal mains voltage and full horizontal scanning of the tube. If the picture width control also affects the heater voltage of the e.h.t. rectifier, the variation due to this cause must be kept within the 15% limit stated above.

(b) For all other applications.

The limits are as given in "General Operational Recommendations".

CAPACITANCE

$C_{a-h, k, s}$	1.0	pF
-----------------	-----	----

TOTAL OPERATING CONDITIONS

I_{out}	200	μ A
V_{out}	20	kV

RATINGS (DESIGN CENTRE SYSTEM)

Inverse voltage, d.c. component max.	20	kV
Peak inverse voltage max. (see note 1)	25	kV
Average output current max. (see note 2)	500	μ A
Peak output current max.	50	mA
Filter input capacitance max.	3000	pF

NOTES

1. Maximum duration 22% of a line scanning cycle with a maximum of 18 μ s. The negative peak anode voltage due to ringing in the line-output transformer must be taken into account.
2. For short periods, as in television operation, the d.c. output current can be allowed to reach a value of 800 μ A.

OUTLINE DRAWING OF DY802

D129

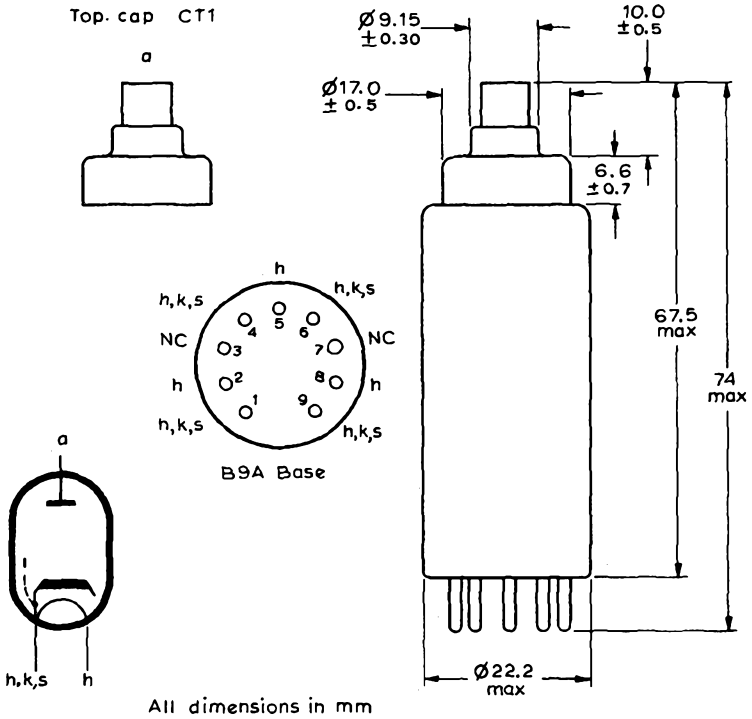

Pins 1, 4, 6 and 9 may be used to connect an anti-corona ring.

Circuit elements having the same potential as the heater, e.g. a series resistor, may be connected to pins 3 and 7. These pins must not be earthed.

To avoid corona phenomena, the metal top cap and connector should be protected by insulating material if the valve is operated at a high value of peak inverse voltage and/or under conditions of high relative humidity or low pressure.



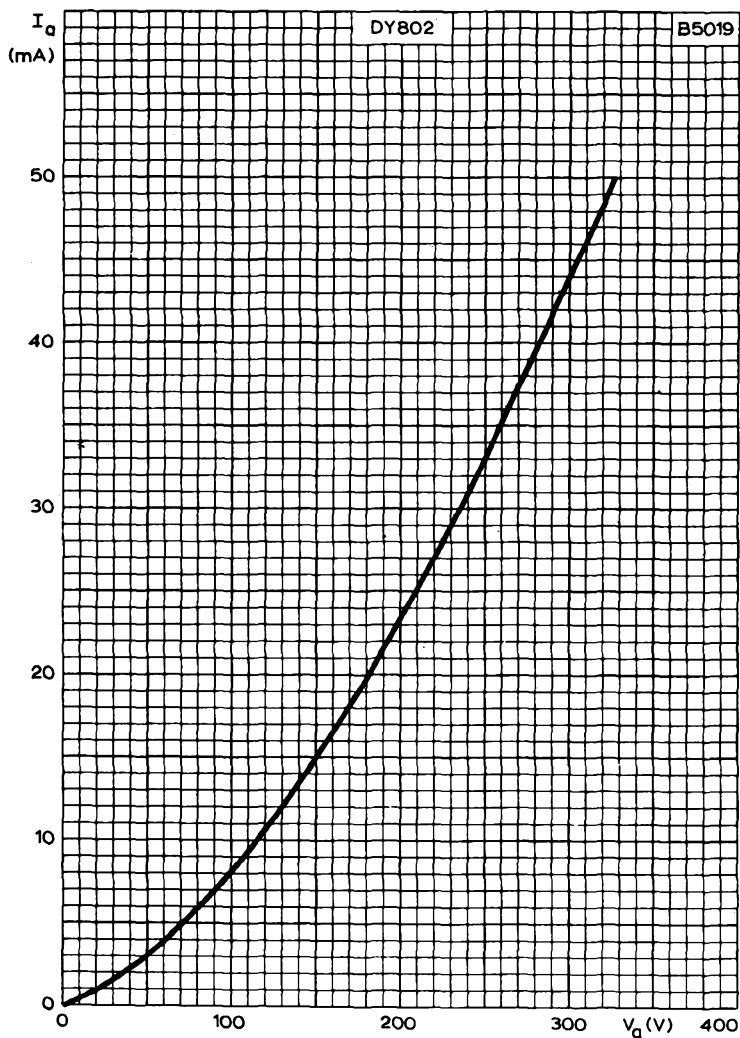

ANODE CURRENT PLOTTED AGAINST ANODE VOLTAGE





U.H.F. DIODE

EA52

Disc seal diode primarily intended for use as a measurement diode at frequencies up to 1GHz.

HEATER

Suitable for series or parallel operation, a.c. or d.c.

V_h (see note 1)	6.3	V
I_h	300	mA

CAPACITANCE

c_{a-k}	< 0.5	pF
-----------	-------	----

CHARACTERISTICS

I_a	500	μ A
V_a	< 3.0	V

RATINGS (ABSOLUTE MAXIMUM SYSTEM)

P.I.V. max. ($f < 100$ MHz) (see note 2)	1.0	kV
I_k max.	300	μ A
$i_{k(pk)}$ max. (see note 3)	5.0	mA
V_{h-k} max.	50	V
R_{h-k} max.	20	k Ω

NOTES

1. The absolute maximum variation of heater voltage is $\pm 0.7V$.
2. At frequencies greater than 100MHz, the maximum P.I.V. is $\frac{10^5}{f}$ V, where f is the frequency in MHz.
3. At frequencies less than 100Hz, $i_{k(pk)}$ max. = $0.3 + 0.047f$ mA, where f is in Hz.

Mullard

OUTLINE DRAWING OF EA52

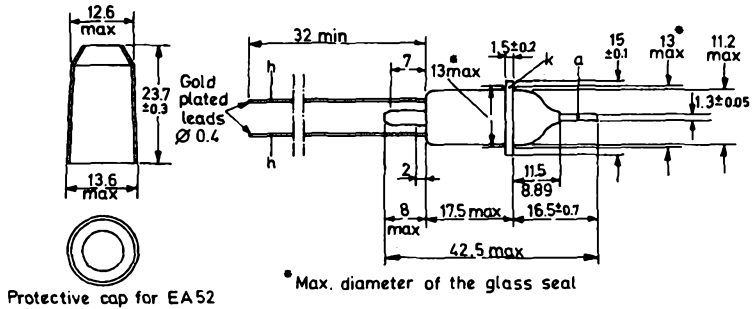

All dimensions in mm

NOTES

1. For protection during transport the EA52 is fitted with a plastic cap which should preferably be removed when the tube is mounted into position. If the cap is not removed, make sure that its temperature never exceeds 100°C.
2. Connections should not be soldered nearer than 7mm from the seal.
3. The leads should not be bent nearer than 2mm from the seal.

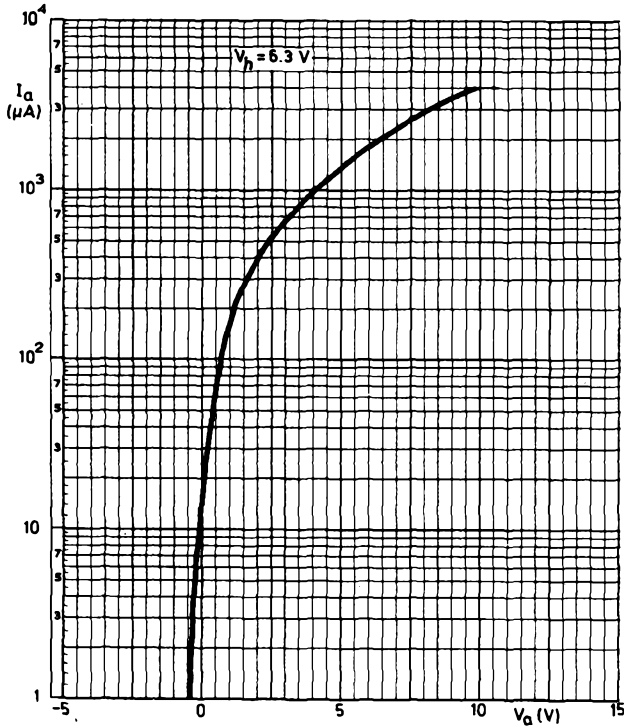

ANODE CURRENT PLOTTED AGAINST ANODE VOLTAGE



DOUBLE TRIODE

ECC81

Double triode primarily intended for use as a frequency changer or r.f. amplifier at frequencies up to 300Mc/s.

HEATER

Suitable for series or parallel operation, a.c. or d.c.

The heater is centre-tapped and the two sections may be operated in series or in parallel with one another.

Series

V_h applied between pins 4 and 5

Parallel

V_h applied between pin 9 and pins 4 and 5 connected together

	Series	Parallel	V
V_h	12.6	6.3	
I_h	150	300	mA

CAPACITANCES

* C_{a-g}	1.6	pF
* C_{in}	2.3	pF
$C_{a-k} + h$	0.45	pF
$C_{a-k} + b$	0.35	pF
* C_{a-k}	0.2	pF
* C_{h-k}	2.5	pF
* C_{k-g+h}	4.7	pF
$C_{a-g} + h$	1.9	pF
$C_{a-g} + b$	1.8	pF
C_{a-b}	<0.4	pF
C_{g-h}	<0.17	pF
$C_{g-g'}$	<0.005	pF
$C_{a-g'}$	<0.07	pF
$C_{a-g''}$	<0.04	pF

*Each section

CHARACTERISTICS (each section)

	100	170	200	250	V
V_a					
I_a	3.0	8.5	11.5	10	mA
V_g	-1.0	-1.0	-1.0	-2.0	V
g_m	3.75	5.9	6.7	5.5	mA/V
μ	62	66	70	60	
r_a	16.5	11	10.5	11	k Ω
* r_{g-k}	21	16	14	25	k Ω

*Measured at $f=50\text{Mc/s}$

LIMITING VALUES (each section)

$V_{a(b)}$ max.	550	V
V_a max.	300	V
p_a max.	2.5	W
I_k max.	15	mA
$-V_g$ max.	50	V
V_g ($I_g = +0.3\mu\text{A}$)	-1.3	V
R_{g-k} max. (self-bias)	1.0	M Ω
V_{h-k} max.	150	V
R_{h-k} max.	20	k Ω



ECC81

DOUBLE TRIODE

Double triode primarily intended for use as a frequency changer or r.f. amplifier at frequencies up to 300Mc/s.

2678

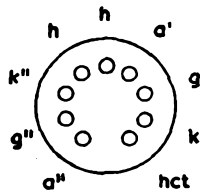
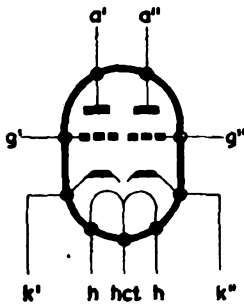

B9A Base

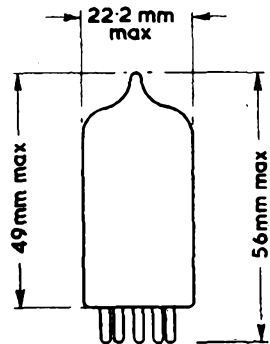

DOUBLE TRIODE

ECC81

Double triode primarily intended for use as a frequency changer or r.f. amplifier at frequencies up to 300 Mc/s.

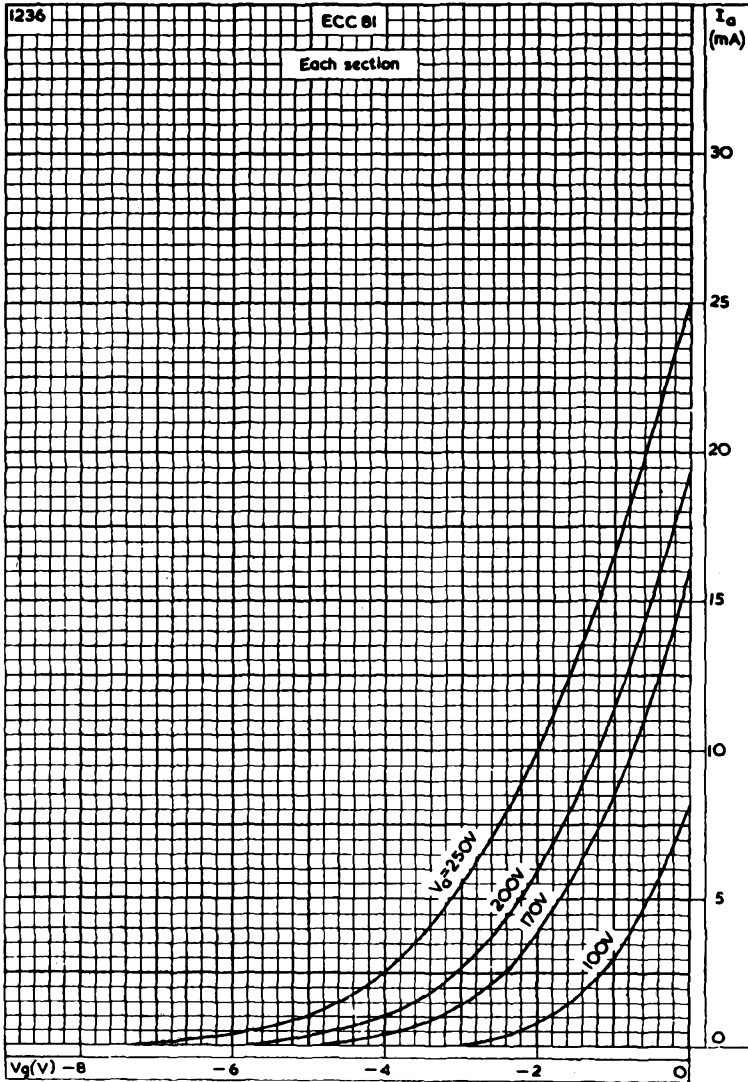

ANODE CURRENT PLOTTED AGAINST GRID VOLTAGE, WITH ANODE VOLTAGE AS PARAMETER (EACH SECTION)



ECC81

DOUBLE TRIODE

Double triode primarily intended for use as a frequency changer or r.f. amplifier at frequencies up to 300Mc/s.

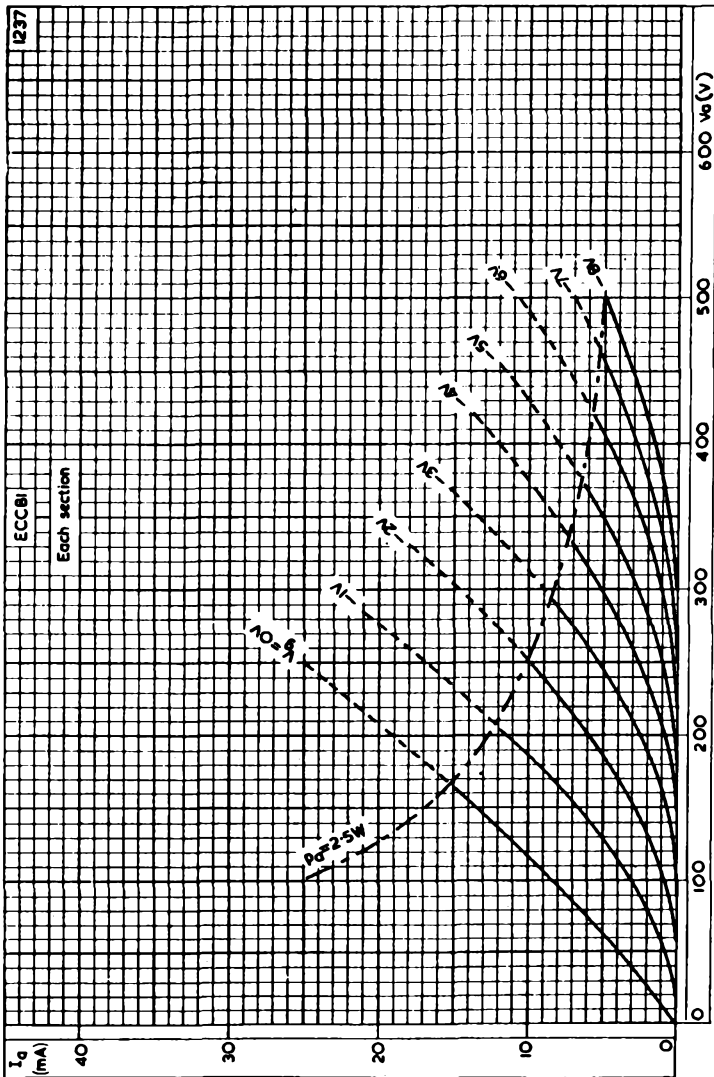

ANODE CURRENT PLOTTED AGAINST ANODE VOLTAGE, WITH GRID VOLTAGE AS PARAMETER (EACH SECTION)



DOUBLE TRIODE

ECC81

Double triode primarily intended for use as a frequency changer or r.f. amplifier at frequencies up to 300Mc/s.

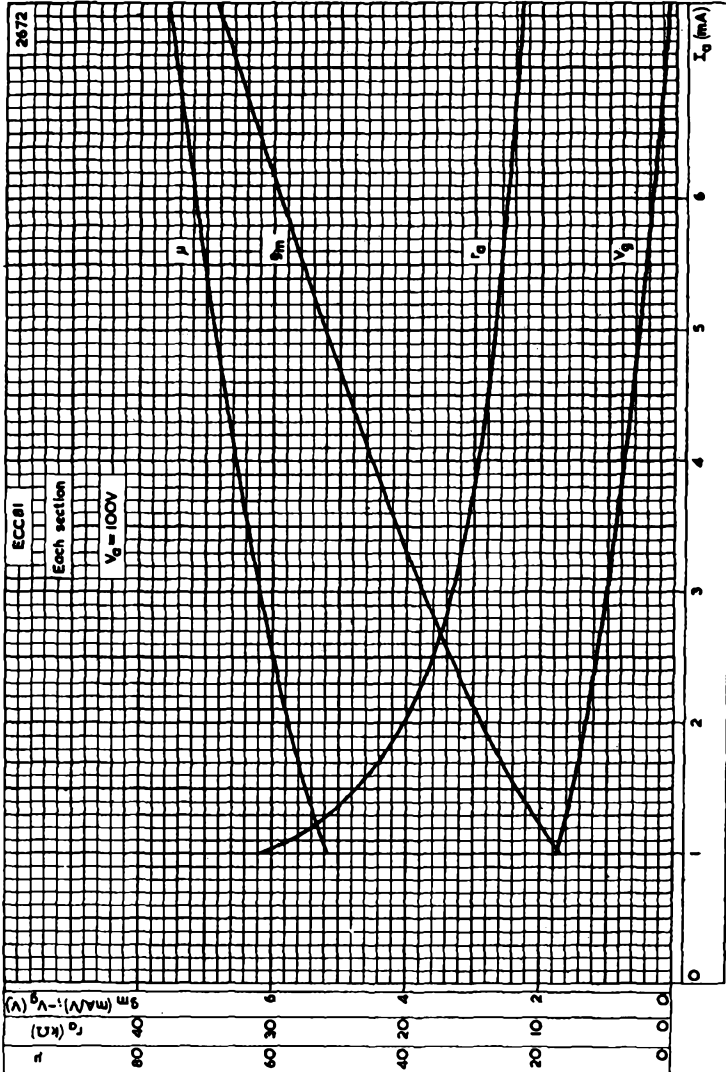

GRID VOLTAGE, MUTUAL CONDUCTANCE, AMPLIFICATION FACTOR AND INTERNAL RESISTANCE PLOTTED AGAINST ANODE CURRENT, FOR ANODE VOLTAGE OF 100V (EACH SECTION)



ECC81

DOUBLE TRIODE

Double triode primarily intended for use as a frequency changer or r.f. amplifier at frequencies up to 300Mc/s.

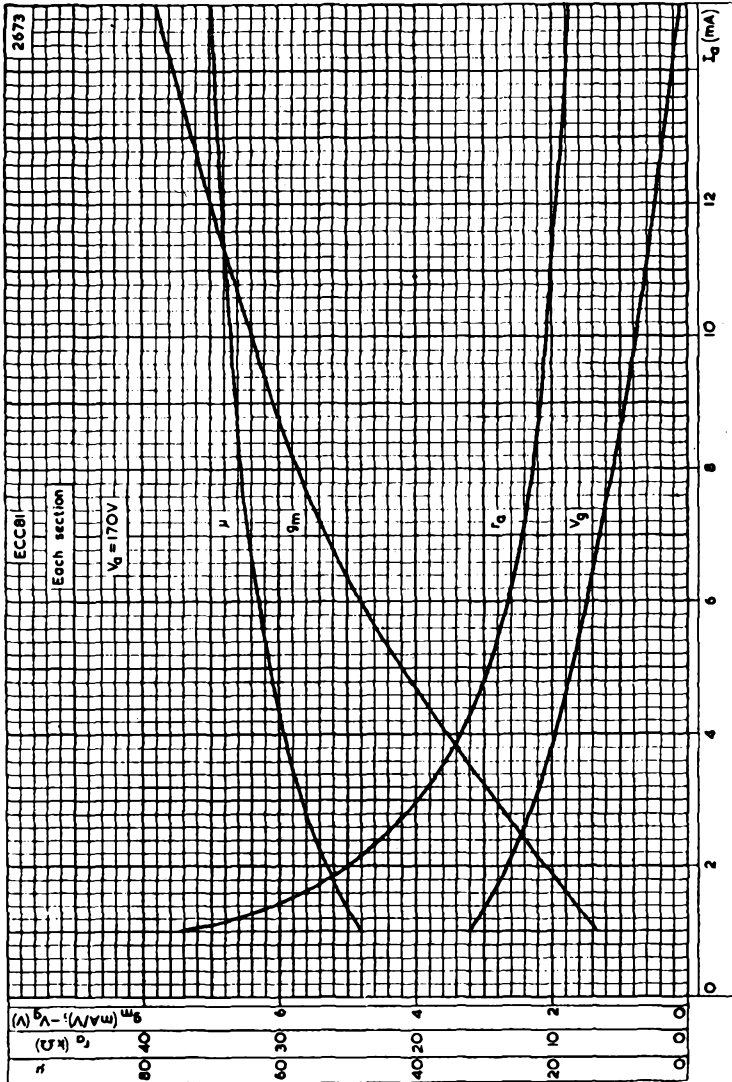

GRID VOLTAGE, MUTUAL CONDUCTANCE, AMPLIFICATION FACTOR, AND INTERNAL RESISTANCE PLOTTED AGAINST ANODE CURRENT, FOR ANODE VOLTAGE OF 170V (EACH SECTION)



DOUBLE TRIODE

ECC81

Double triode primarily intended for use as a frequency changer or r.f. amplifier at frequencies up to 300Mc/s.

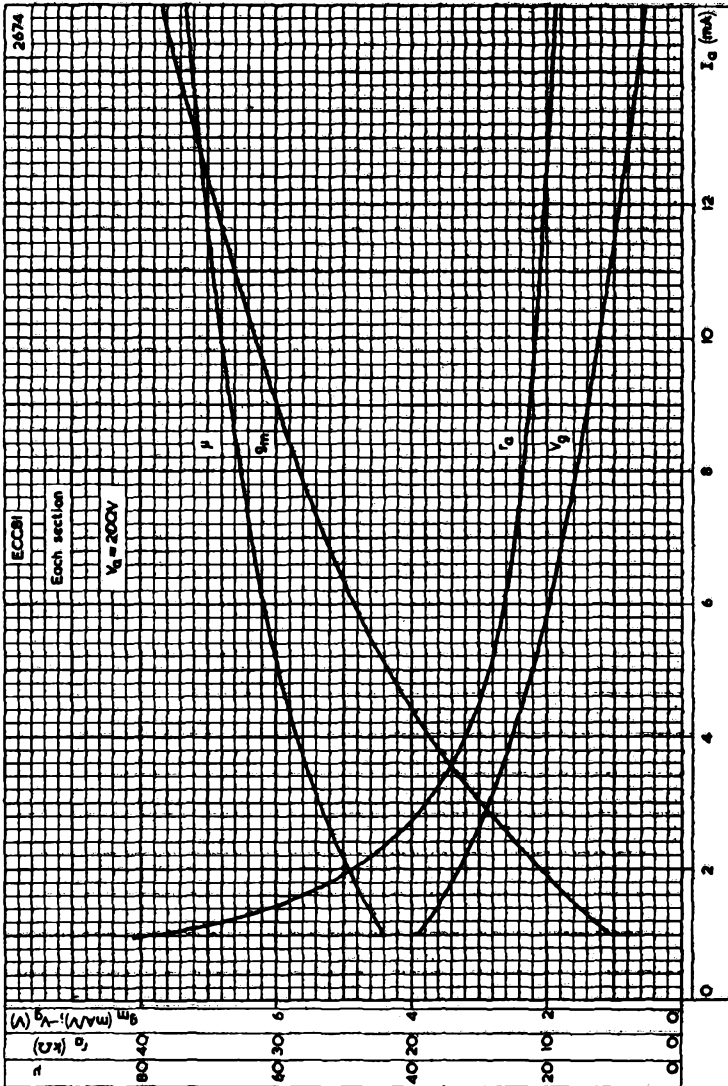

GRID VOLTAGE, MUTUAL CONDUCTANCE, AMPLIFICATION FACTOR AND INTERNAL RESISTANCE PLOTTED AGAINST ANODE CURRENT, FOR ANODE VOLTAGE OF 200V (EACH SECTION)



ECC81

DOUBLE TRIODE

Double triode primarily intended for use as a frequency changer or r.f. amplifier at frequencies up to 300Mc/s.

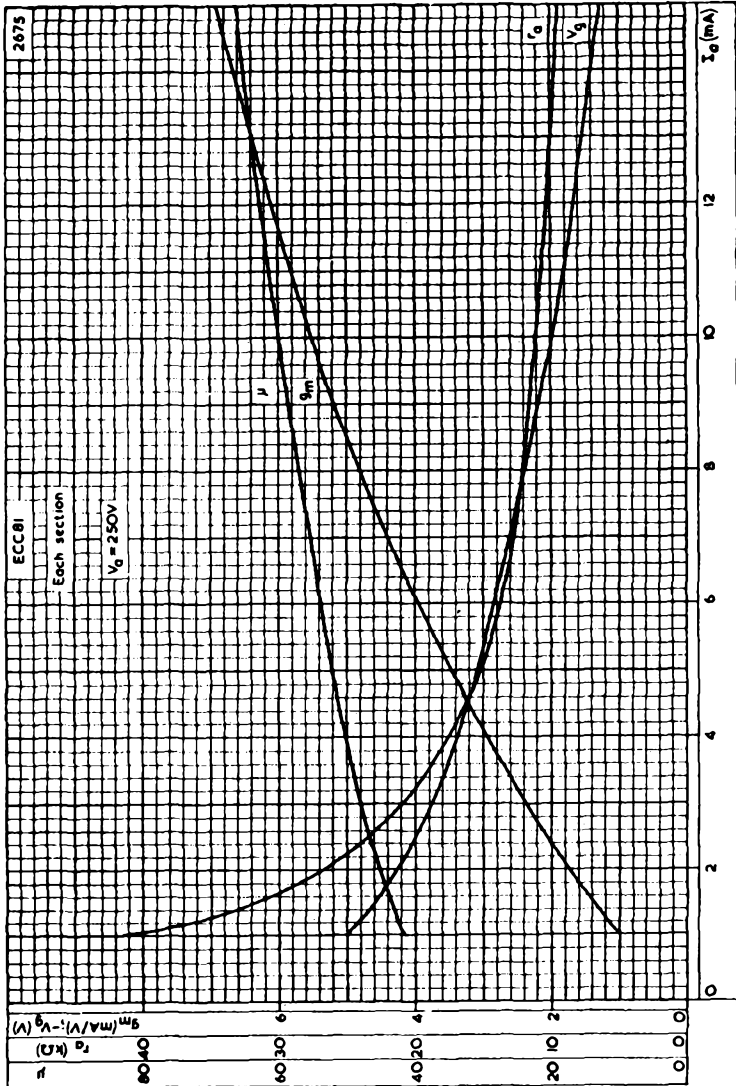

GRID VOLTAGE, MUTUAL CONDUCTANCE, AMPLIFICATION FACTOR AND INTERNAL RESISTANCE PLOTTED AGAINST ANODE CURRENT, FOR ANODE VOLTAGE OF 250V (EACH SECTION)



DOUBLE TRIODE

ECC81

Double triode primarily intended for use as a frequency changer or r.f. amplifier at frequencies up to 300Mc/s.

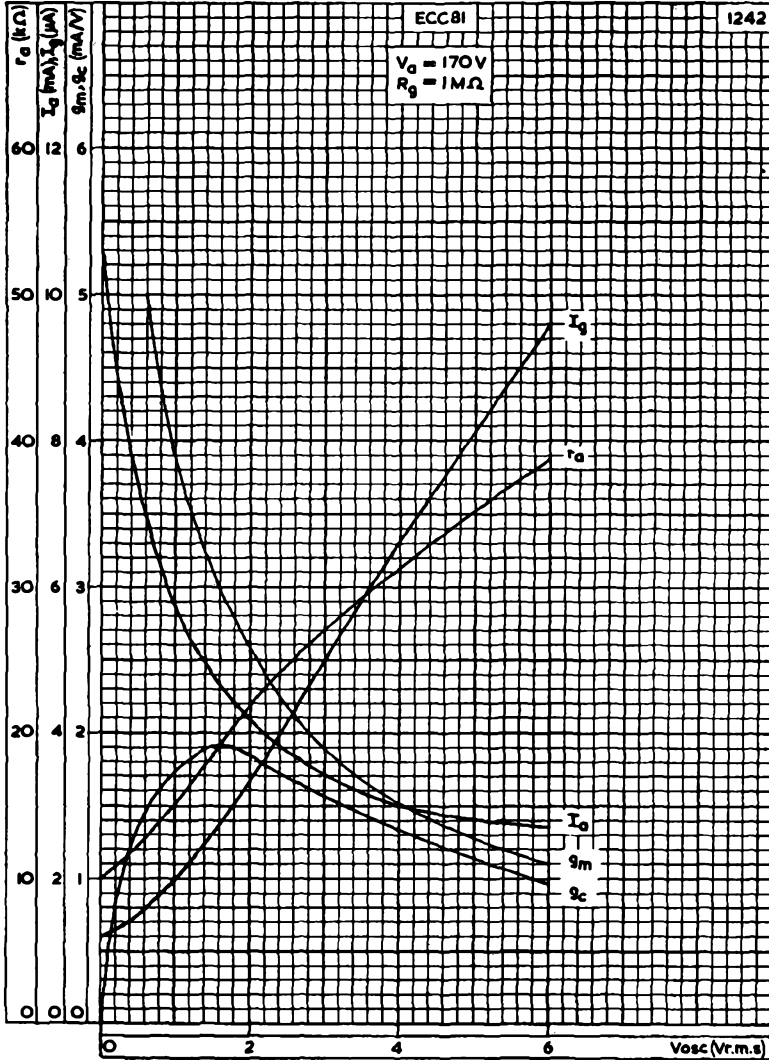

PERFORMANCE CURVES AS FREQUENCY CHANGER AT ANODE VOLTAGE OF 170V



ECC81

DOUBLE TRIODE

Double triode primarily intended for use as a frequency changer or r.f. amplifier at frequencies up to 300Mc/s.

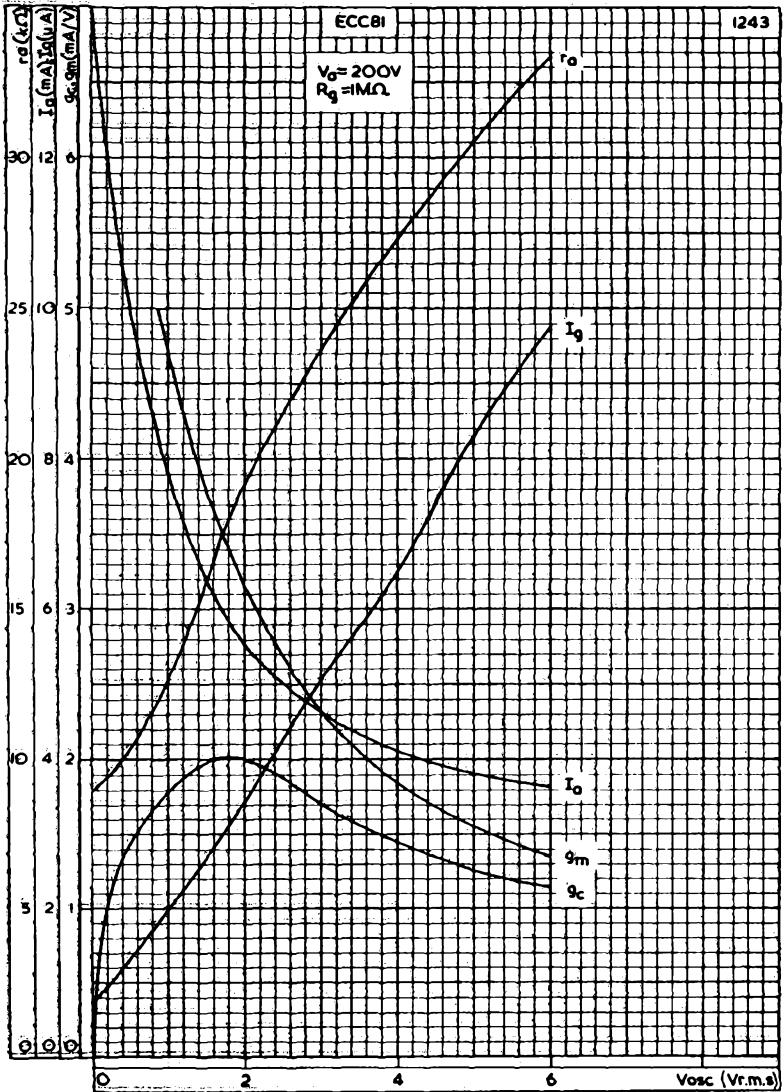

PERFORMANCE CURVES AS FREQUENCY CHANGER AT ANODE VOLTAGE OF 200V



DOUBLE TRIODE

ECC81

Double triode primarily intended for use as a frequency changer or r.f. amplifier at frequencies up to 300Mc/s.

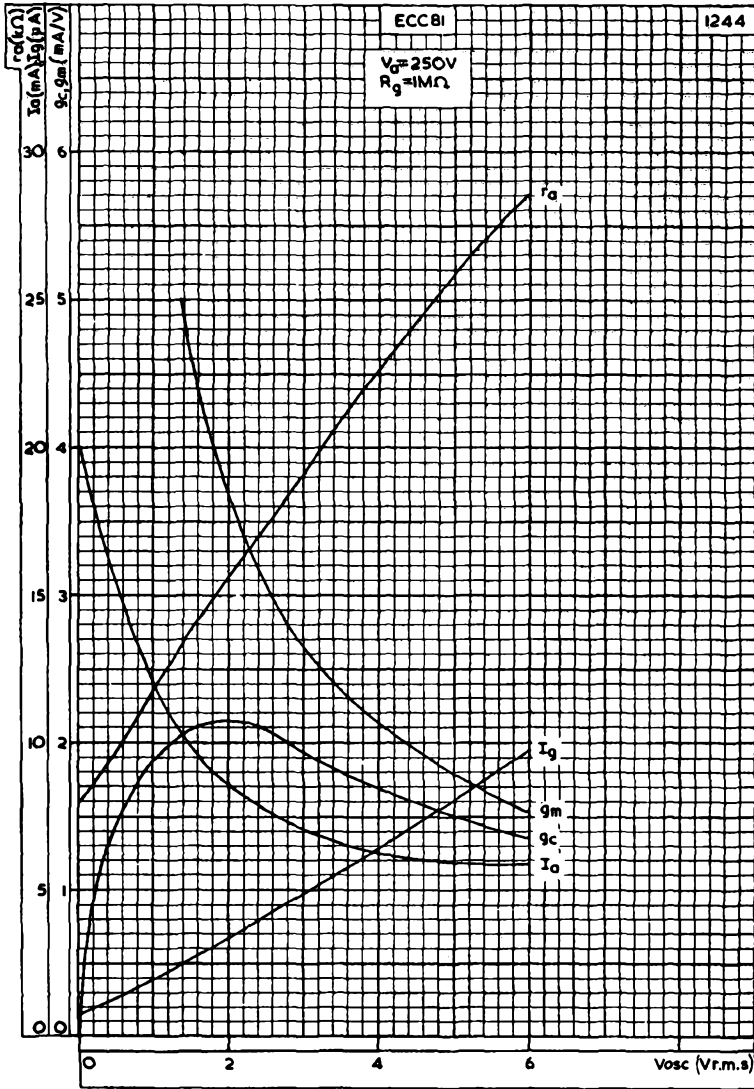

PERFORMANCE CURVES AS FREQUENCY CHANGER AT ANODE VOLTAGE OF 250V





DOUBLE TRIODE

ECC82

Low μ double triode having separate cathodes, primarily intended for use as an amplifier or oscillator.

HEATER

Suitable for series or parallel operation, a.c. or d.c. The heater is centre-tapped and the two sections may be operated in series or in parallel with one another.

Series

V_h applied between pins 4 and 5

Parallel

V_h applied between pin 9 and pins 4 and 5 connected together

	Series	Parallel	
V_h	12.6	6.3	V
I_h	150	300	mA

CAPACITANCES (measured without an external shield)

* C_{a-g}	1.5	pF
* C_{in}	1.8	pF
$C_{out'}$	370	mpF
$C_{out''}$	250	mpF
* C_{g-h}	<135	mpF
$C_{a'-a''}$	<1.1	pF
$C_{a'-g'}$	<60	mpF
$C_{a'-g''}$	<110	mpF
$C_{g'-g''}$	<10	mpF

*Each section

CHARACTERISTICS (each section)

V_a	100	250	V
I_a	11.8	10.5	mA
V_g	0	-8.5	V
g_m	3.1	2.2	mA/V
μ	19.5	17	
r_a	6.25	7.7	k Ω
V_g max. ($I_g = +0.3\mu A$)		-1.3	V

OPERATING CONDITIONS (each section)

As an a.f. amplifier

V_b (V)	R_a (k Ω)	I_k (mA)	R_k (k Ω)	$\frac{V_{out}}{V_{in}}$	V_{out}^* ($V_{r.m.s.}$)	D_{tot}^* (%)	R_g^\dagger (k Ω)
400	47	5.0	1.2	13.5	59	6.7	150
350	47	4.3	1.2	13.5	51	6.6	150
300	47	3.7	1.2	13.5	43	6.5	150
250	47	3.0	1.2	13.5	34	6.4	150
200	47	2.4	1.2	13.5	26	6.3	150
150	47	1.8	1.2	13.5	18	6.1	150
100	47	1.2	1.2	13.5	11	5.6	150
400	100	2.6	2.2	14	57	6.2	330
350	100	2.3	2.2	14	49	6.1	330
300	100	2.0	2.2	14	41	6.0	330
250	100	1.6	2.2	14	32	5.9	330
200	100	1.3	2.2	14	25	5.8	330
150	100	1.0	2.2	14	17	5.6	330
100	100	0.7	2.2	14	10	4.8	330
400	220	1.3	3.9	14.5	50	5.1	680
350	220	1.2	3.9	14.5	43	5.0	680
300	220	1.0	3.9	14.5	36	4.9	680
250	220	0.8	3.9	14.5	28	4.8	680
200	220	0.7	3.9	14.5	22	4.7	680
150	220	0.5	3.9	14.5	15	4.4	680
100	220	0.3	3.9	14.5	8.0	4.0	680

*Output voltage and distortion at start of positive grid current. At lower output voltage, the distortion is approximately proportional to the output voltage.

† R_g = grid resistor of following valve.

LIMITING VALUES (each section)

$V_{a(b)}$ max.	550	V
V_a max.	300	V
p_a max.	2.75	W
I_k max.	20	mA
* $i_{k(pk)}$ max.	150	mA
$-V_g$ max.	100	V
$-v_{g(pk)}$ max.	250	V
R_{g-k} max. (fixed bias)	1.5	M Ω
V_{h-k} max.	180	V
† R_{h-k} max.	20	k Ω

†When used as a phase inverter immediately preceding the output stage, R_{h-k} max. may be 150k Ω .

*Maximum pulse duration = 200 μ s.

OPERATING NOTES

This valve can be used without special precautions against microphony in equipment where the input voltage is not less than 10mV for an output of 50mW (or 100mV for 5W output).

With V_h applied between pin 9 and pins 4 and 5 connected together, and with the centre tap of the heater transformer earthed the section connected to pins 6, 7 and 8 is the most favourable with regard to hum.

6922

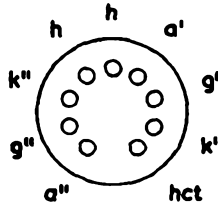
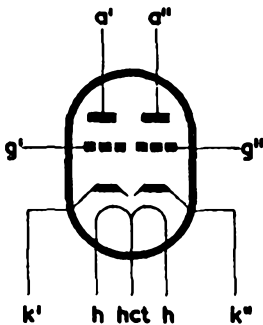

B9A Base

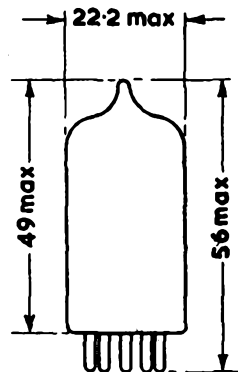

All dimensions in mm





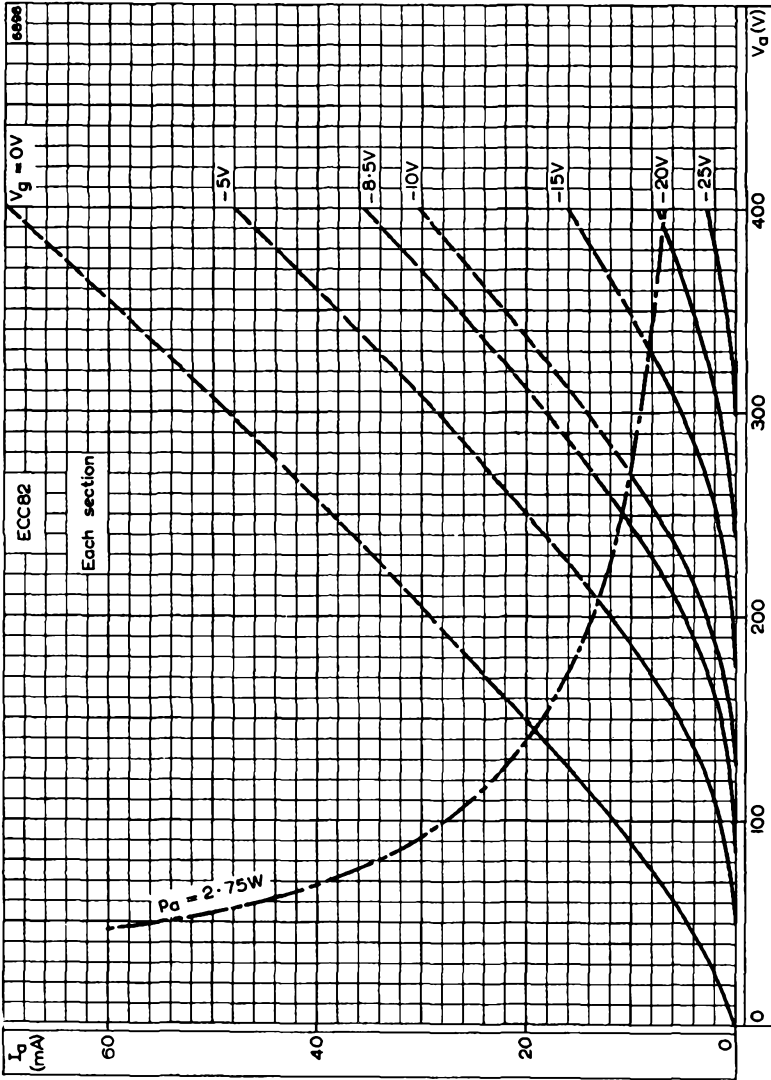

ANODE CURRENT PLOTTED AGAINST ANODE VOLTAGE WITH GRID VOLTAGE AS PARAMETER



ECC82

DOUBLE TRIODE

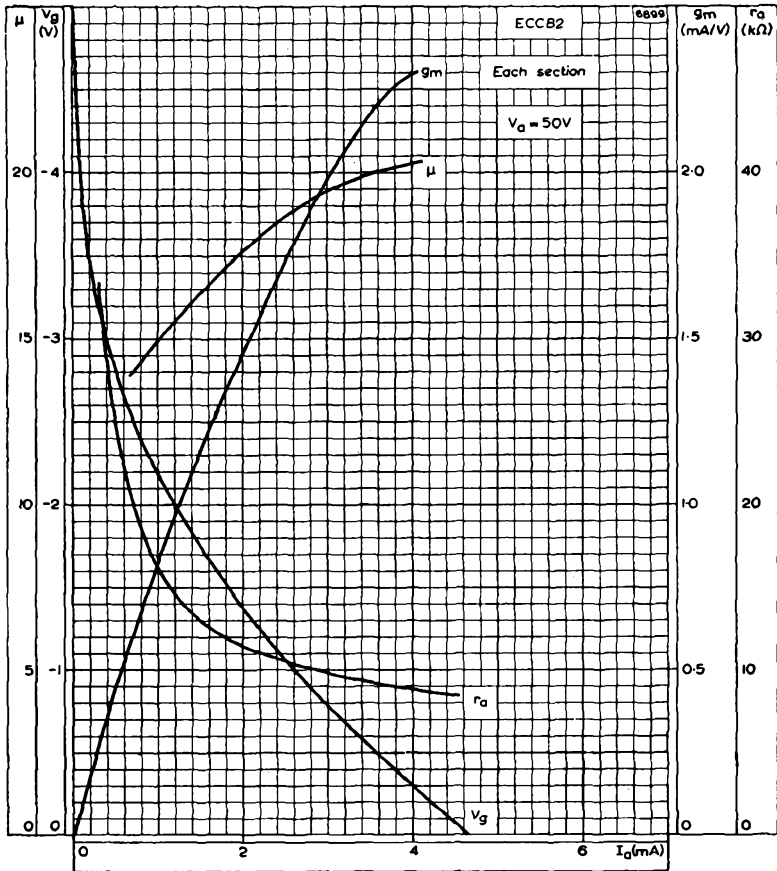

ANODE IMPEDANCE, AMPLIFICATION FACTOR, MUTUAL CONDUCTANCE AND GRID VOLTAGE PLOTTED AGAINST ANODE CURRENT. $V_a = 50V$



DOUBLE TRIODE

ECC82

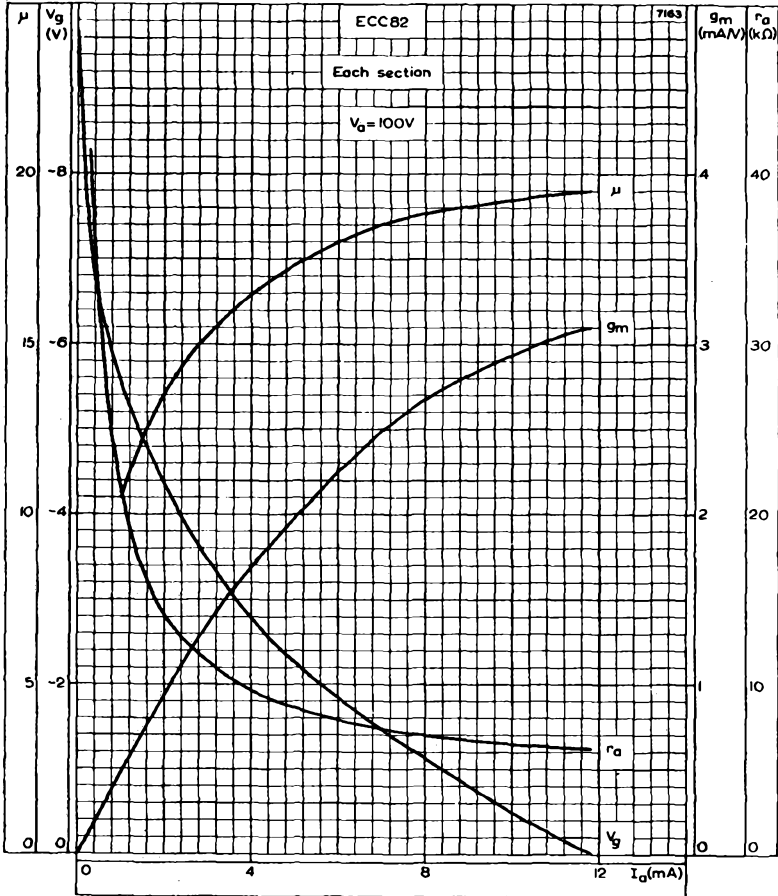

ANODE IMPEDANCE, AMPLIFICATION FACTOR, MUTUAL CONDUCTANCE AND GRID VOLTAGE PLOTTED AGAINST ANODE CURRENT. $V_a = 100V$



ECC82

DOUBLE TRIODE

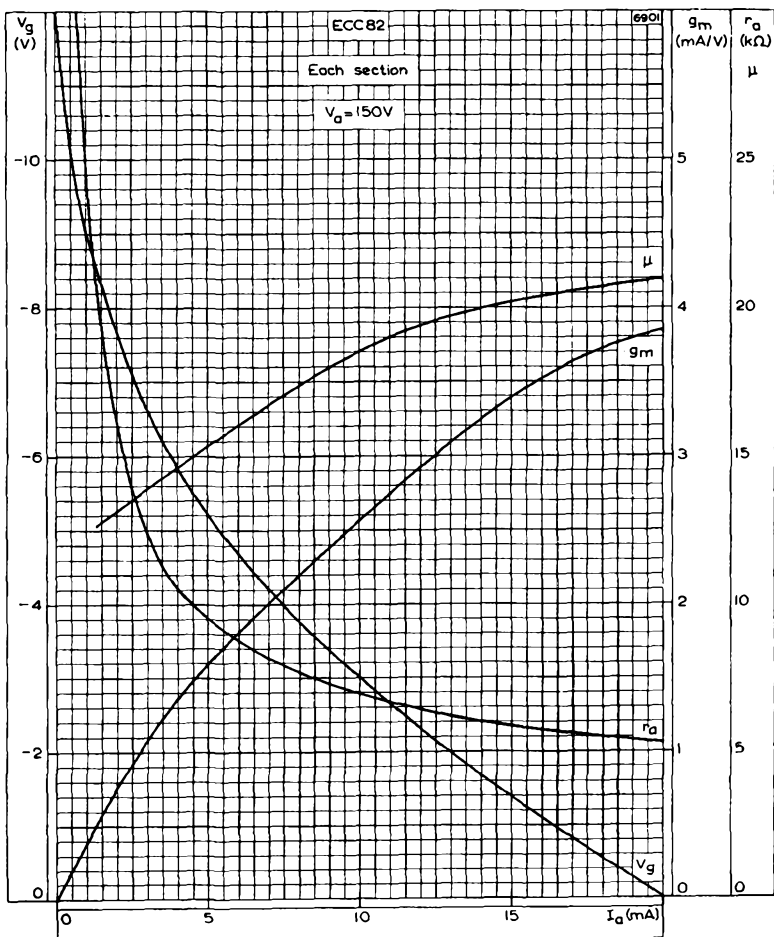

ANODE IMPEDANCE, AMPLIFICATION FACTOR, MUTUAL CONDUCTANCE AND GRID VOLTAGE PLOTTED AGAINST ANODE CURRENT. $V_a = 150V$



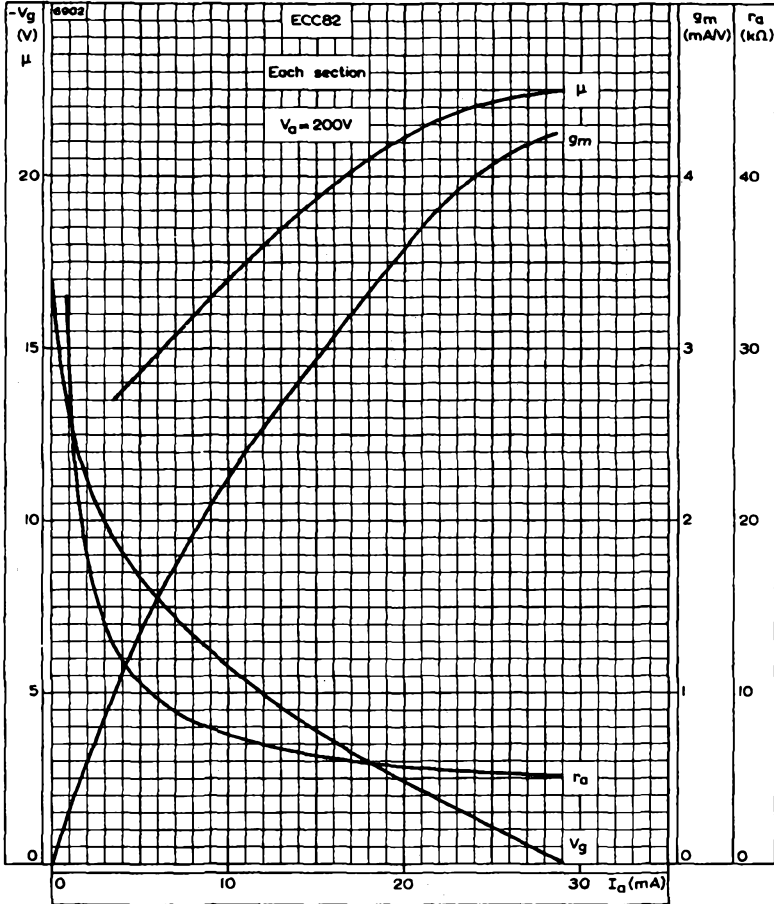

ANODE IMPEDANCE, AMPLIFICATION FACTOR, MUTUAL CONDUCTANCE AND GRID VOLTAGE PLOTTED AGAINST ANODE CURRENT. $V_a = 200V$



ECC82

DOUBLE TRIODE

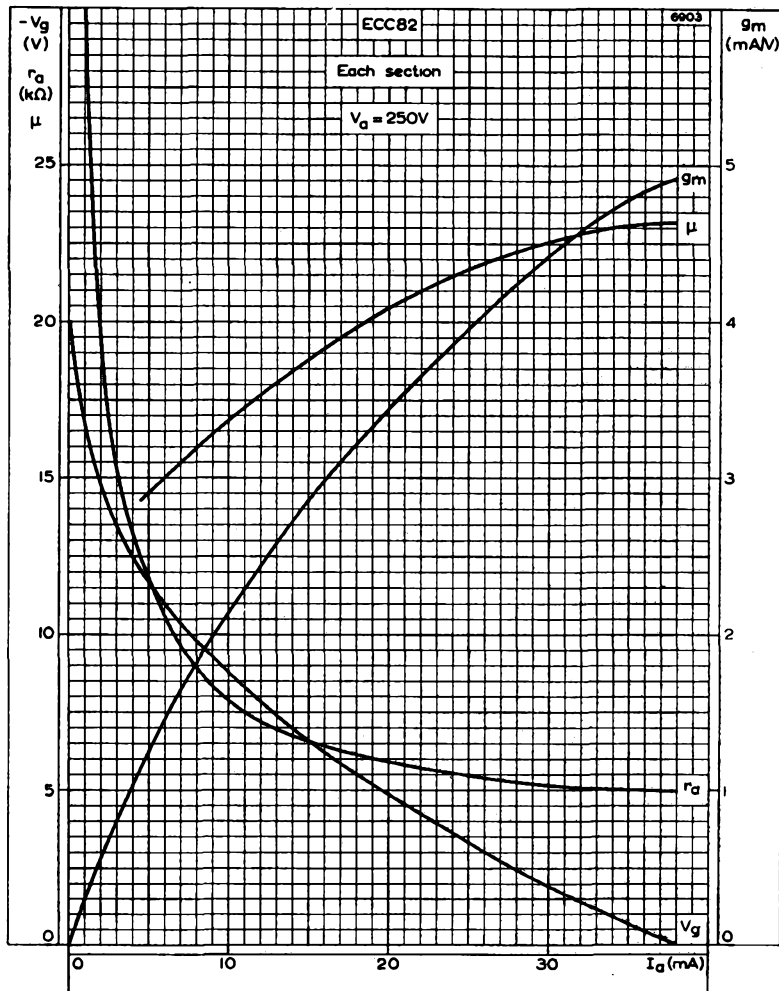

ANODE IMPEDANCE, AMPLIFICATION FACTOR, MUTUAL CONDUCTANCE AND GRID VOLTAGE PLOTTED AGAINST ANODE CURRENT. $V_a = 250V$

DOUBLE TRIODE

ECC82

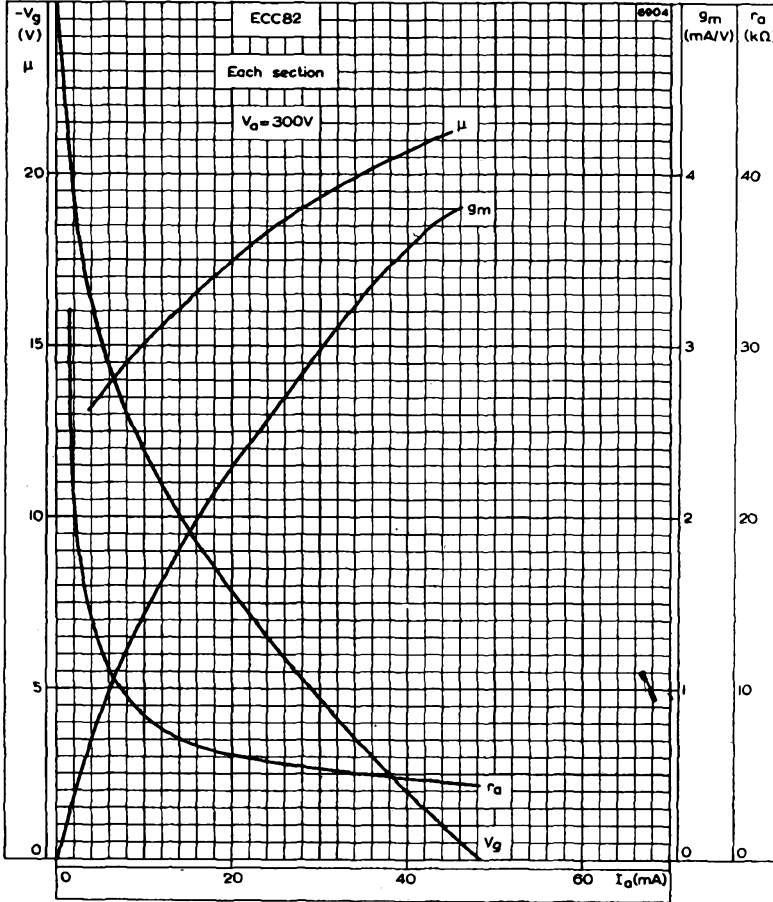

ANODE IMPEDANCE, AMPLIFICATION FACTOR, MUTUAL CONDUCTANCE AND GRID VOLTAGE PLOTTED AGAINST ANODE CURRENT. $V_a = 300V$





DOUBLE TRIODE

ECC83

High μ double triode, having separate cathodes, primarily intended for use as a resistance-coupled amplifier or phase inverter.

HEATER

Suitable for series or parallel operation, a.c. or d.c.

The heater is centre-tapped and the two sections may be operated in series or in parallel with one another.

Series	V_h applied between pins 4 and 5		
Parallel	V_h applied between pin 9 and pins 4 and 5 connected together		
	Series	Parallel	
V_h	12.6	6.3	V
I_h	150	300	mA

CAPACITANCES

$C_{out'}$	330	mpF
$C_{out''}$	230	mpF
* C_{in}	1.6	pF
* C_{a-g}	1.6	pF
$C_{a'-a''}$	<1.2	pF
$C_{a'-g'}$	<100	mpF
$C_{a'-g''}$	<110	mpF
$C_{g'-g''}$	<10	mpF
* C_{g-h}	<150	mpF

*Each section

CHARACTERISTICS (each section)

V_a	100	250	V
I_a	0.5	1.2	mA
V_g	-1.0	-2.0	V
g_m	1.25	1.6	mA/V
μ	100	100	
r_a	80	62.5	k Ω
V_g max. ($I_g = +0.3\mu A$)		-0.9	V \leftarrow



OPERATING CONDITIONS AS RESISTANCE COUPLED A.F. AMPLIFIER with grid current bias ($R_g = 10M\Omega$)

V_b (V)	R_a (k Ω)	R_g^{**} (k Ω)	I_a (mA)	$Z_s = 0k\Omega$		$Z_s = 220k\Omega$	
				$\frac{V_{out}}{V_{in}}$	$V_{out(r.m.s.)}^*$ (V)	$\frac{V_{out}}{V_{in}}$	$V_{out(r.m.s.)}^\dagger$ (V)
400	47	150	3.4	47	43	38	46
350	47	150	2.8	46	36	37	38
300	47	150	2.2	44	29	36	30
250	47	150	1.7	42	22	34	24
200	47	150	1.2	39	15	32	17
400	100	330	2.1	61	59	49	62
350	100	330	1.75	60	49	48	52
300	100	330	1.4	58	39	47	42
250	100	330	1.1	56	30	46	33
200	100	330	0.8	54	21	43	23
400	220	680	1.2	73	71	58	75
350	220	680	1.0	72	59	57	63
300	220	680	0.8	70	47	56	52
250	220	680	0.6	68	36	54	40
200	220	680	0.45	65	25	52	29

*Output voltage measured at $D_{tot} = 5\%$.

$\frac{V_{out}}{V_{in}}$ measured with $V_{In(r.m.s.)} = 100mV$

**Grid resistor of following valve.

†When operating this valve with grid current bias and a high source impedance, the second harmonic distortion rises to a peak at quite low levels of output (about $10V_{r.m.s.}$) and then falls with increasing drive. The third harmonic then begins to rise, and D_{tot} finally reaches 5% at a much higher output level than with zero source impedance. The maximum value of this distortion peak varies inversely with the anode load, being about 5.5% with $R_a = 47k\Omega$, 4.5% with $R_a = 100k\Omega$ and 4% with $R_a = 220k\Omega$.

OPERATING CONDITIONS AS RESISTANCE COUPLED A.F. AMPLIFIER with cathode bias

V_b (V)	R_a (k Ω)	I_a (mA)	R_k (k Ω)	$\frac{V_{out}}{V_{in}}$	$V_{out(r.m.s.)*}$ (V)	$D_{tot}*$ (%)	$R_g \dagger$ (k Ω)
400	47	2.2	1.0	43	40.5	5.0	150
350	47	1.7	1.2	42	31	5.0	150
300	47	1.3	1.5	40	22	5.0	150
250	47	0.9	2.2	36	12.5	5.0	150
400	100	1.4	1.5	59	59	5.0	330
350	100	1.1	1.8	57	45	5.0	330
300	100	0.88	2.2	55	32.5	5.0	330
250	100	0.6	3.3	50	18.5	5.0	330
400	220	0.88	2.2	71	63	3.7	680
350	220	0.7	2.7	69	60	5.0	680
300	220	0.5	3.9	65	38.5	5.0	680
250	220	0.38	4.7	62	27	5.0	680

*Output voltage measured at $D_{tot} = 5\%$ or at start of positive grid current. At lower output voltages the distortion is approximately proportional to the output voltage.

†Grid resistor of following valve.

At lower values of V_b , grid current bias should be used.



OPERATING CONDITIONS AS A PHASE INVERTER

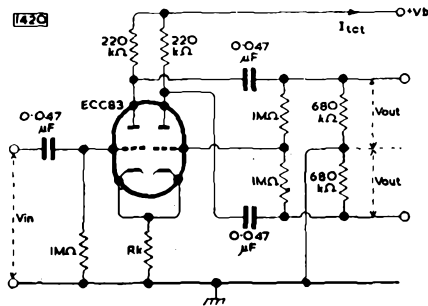

V_b (V)	I_{tot} (mA)	R_k (k Ω)	$V_{out(r.m.s.)}^*$ (V)	$\frac{V_{out}}{V_{in}}$
350	1.3	1.5	44	65
250	0.8	2.2	23	60

*Output voltage measured at $D_{tot} = 5\%$.

LIMITING VALUES (each section)

V_a max.	300	V
P_a max.	1.0	W
I_k max.	8.0	mA
$-V_g$ max.	50	V
R_{g-k} max. (fixed bias)	1.0	M Ω
V_{h-k} max.	180	V
$\dagger R_{h-k}$ max.	20	k Ω

\dagger When used as a phase inverter immediately preceding the output stage, R_{h-k} max. may be 150k Ω .

OPERATING NOTES

1. Microphony

This valve may be used without special precautions against microphony in equipment where the input voltage is not less than 5mV for an output of 50mW (or 50mV for 5W output).

2. Hum

With V_h applied between pin 9 and pins 4 and 5 connected together and the centre tap of the heater transformer earthed, the section connected to pins 6, 7 and 8 is the most favourable with regard to hum, and should be used for the input section when the two sections are used in cascade.

When used as a normal voltage amplifier with $V_b = 250V$, $R_a = 100k\Omega$, $R_g = 330k\Omega$, $R_k = 1.5k\Omega$ (suitably decoupled), the maximum hum level of the input triode is $10\mu V$, the average value being $6\mu V$. If one side of the heater is earthed, rather than the centre tap, it is preferable to earth pins 4 and 5. The average value of hum under these conditions may be $50\mu V$.



6922

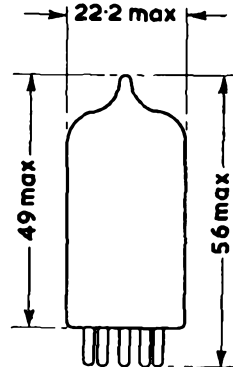
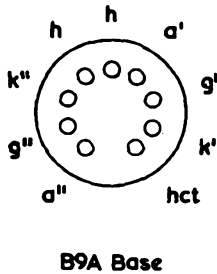
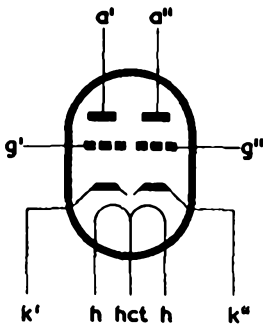

All dimensions in mm





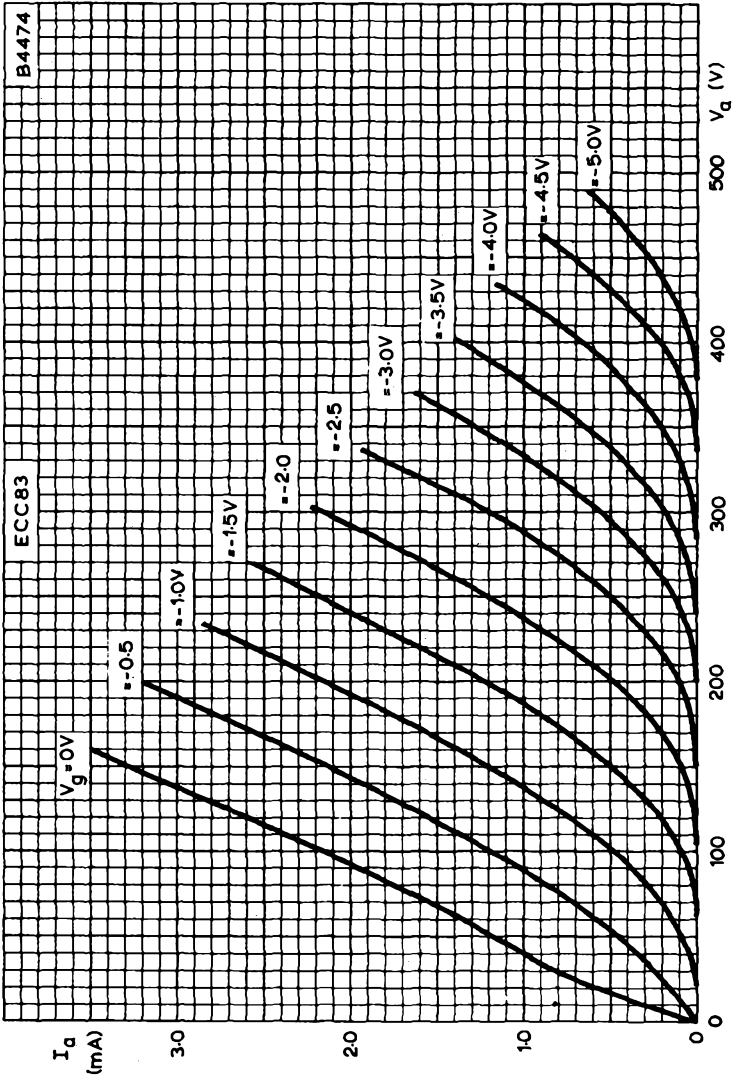

ANODE CURRENT PLOTTED AGAINST ANODE VOLTAGE WITH GRID VOLTAGE AS PARAMETER (each section)



ECC83

DOUBLE TRIODE

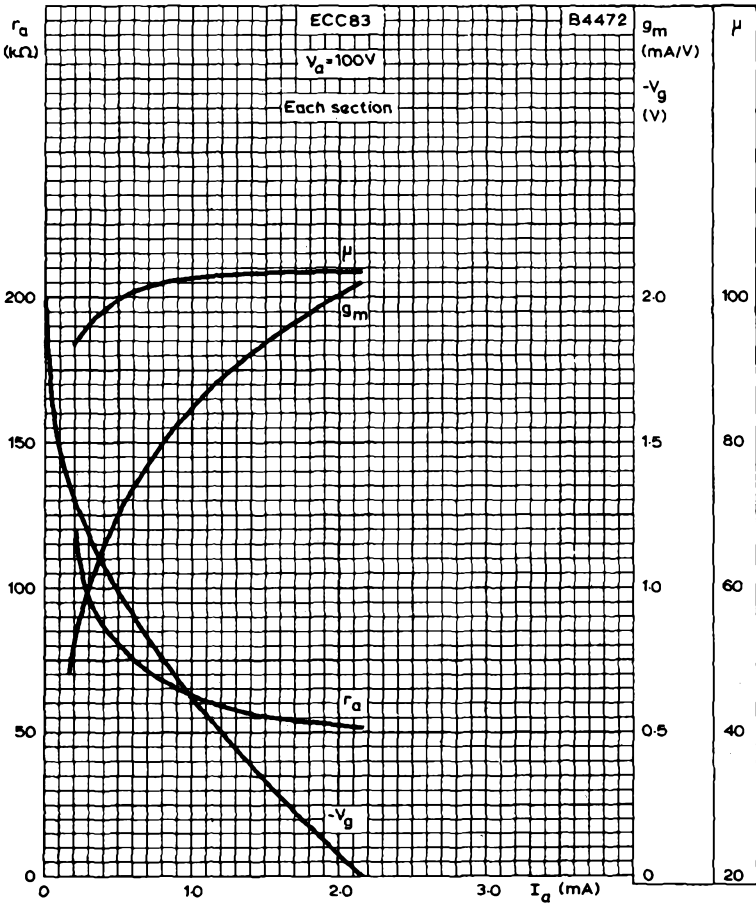

MUTUAL CONDUCTANCE, ANODE IMPEDANCE, AMPLIFICATION FACTOR AND GRID VOLTAGE PLOTTED AGAINST ANODE CURRENT.

$V_d = 100V$



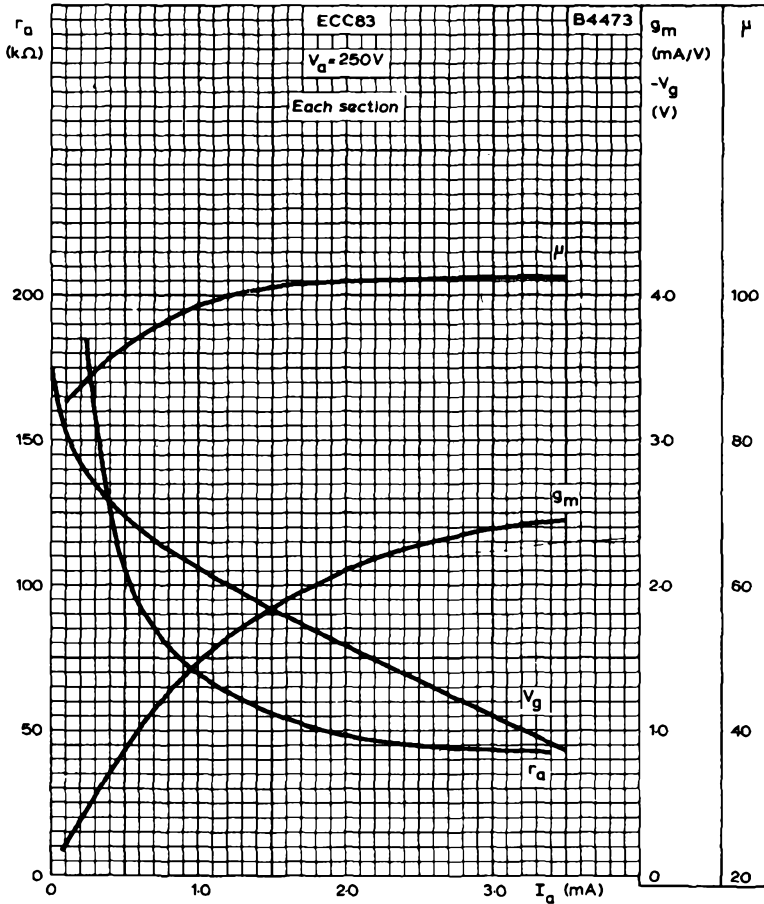

MUTUAL CONDUCTANCE, ANODE IMPEDANCE, AMPLIFICATION FACTOR AND GRID VOLTAGE PLOTTED AGAINST ANODE CURRENT.

$V_a = 250V$





R.F. PENTODE

EF80

High slope r.f. pentode primarily intended for r.f. or i.f. amplification in television receivers. It is suitable for use as a video amplifier, mixer or synchronising pulse separator.

HEATER

Suitable for series or parallel operation a.c. or d.c.

V_h	6.3	V
I_h	300	mA

CAPACITANCES

$C_{in(g1)}$	7.0	pF
$C_{in(g2)}$	5.4	pF
C_{out}	3.1	pF
C_{a-k1}	<7.0	mpF
C_{g2-g1}	2.6	pF
C_{a-k}	<10	mpF
C_{r1-h}	<150	mpF

CHARACTERISTICS

V_a	170	V
V_{g2}	170	V
V_{g3}	0	V
I_a	10	mA
I_{g2}	2.5	mA
V_{r1}	-2.0	V
g_m	7.4	mA/V
r_a	400	k Ω
μ_{g1-k2}	50	
R_{eq}	1.0	k Ω
$r_{r1} (f = 50Mc/s)$	10	k Ω
$V_{k1} \text{ max. } (I_{r1} = +0.3\mu A)$	-1.3	V

LIMITING VALUES

$V_{a(b)} \text{ max.}$	550	V
$V_a \text{ max.}$	300	V
$p_a \text{ max.}$	2.5	W
$V_{g2(b)} \text{ max.}$	550	V
$V_{g2} \text{ max.}$	300	V
$p_{g2} \text{ max.}$	700	mW
$I_k \text{ max.}$	15	mA
$R_{g1-k} \text{ max.}$	500	k Ω
$V_{h-k} \text{ max.}$	150	V
$R_{h-k} \text{ max.}$	20	k Ω



EF80

R.F. PENTODE



3785

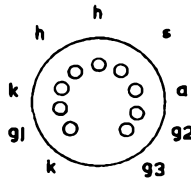
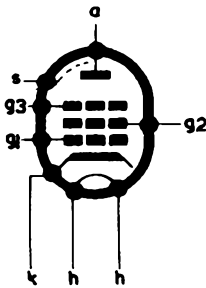

B9A Base

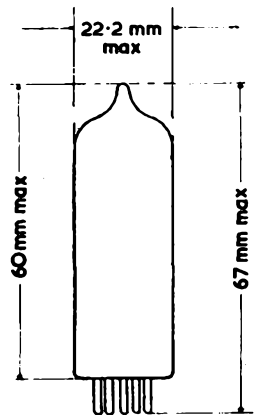

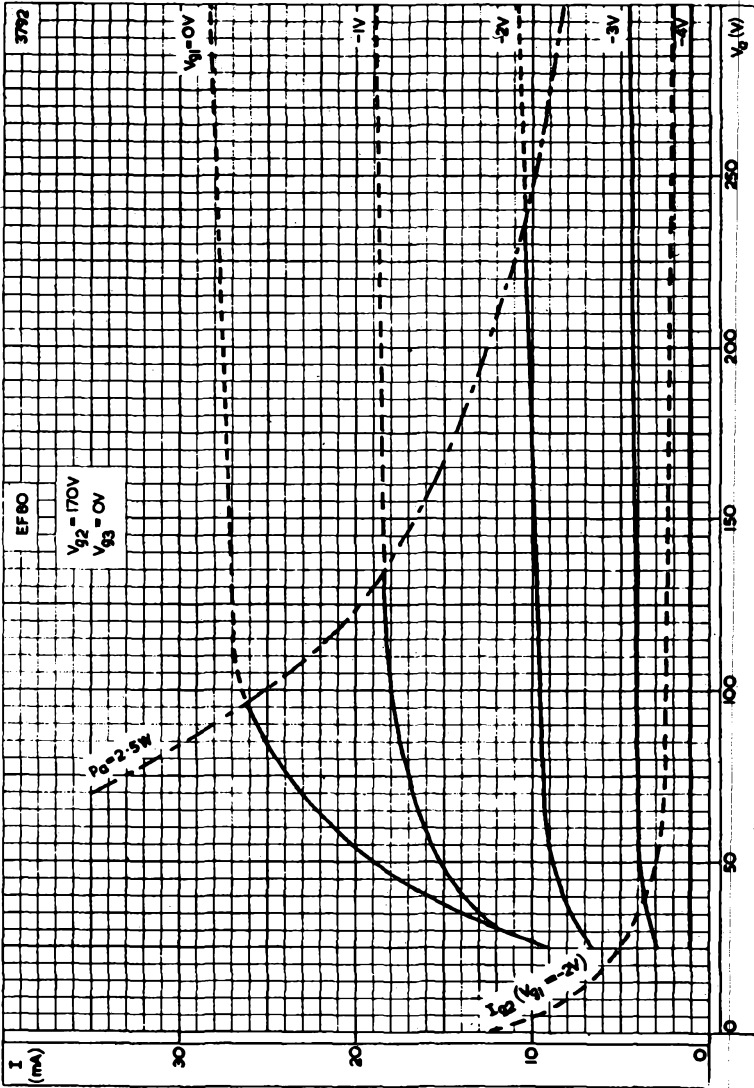

ANODE AND SCREEN-GRID CURRENTS PLOTTED AGAINST ANODE VOLTAGE, WITH SCREEN-GRID VOLTAGE AS PARAMETER. $V_{g2} = 170V$



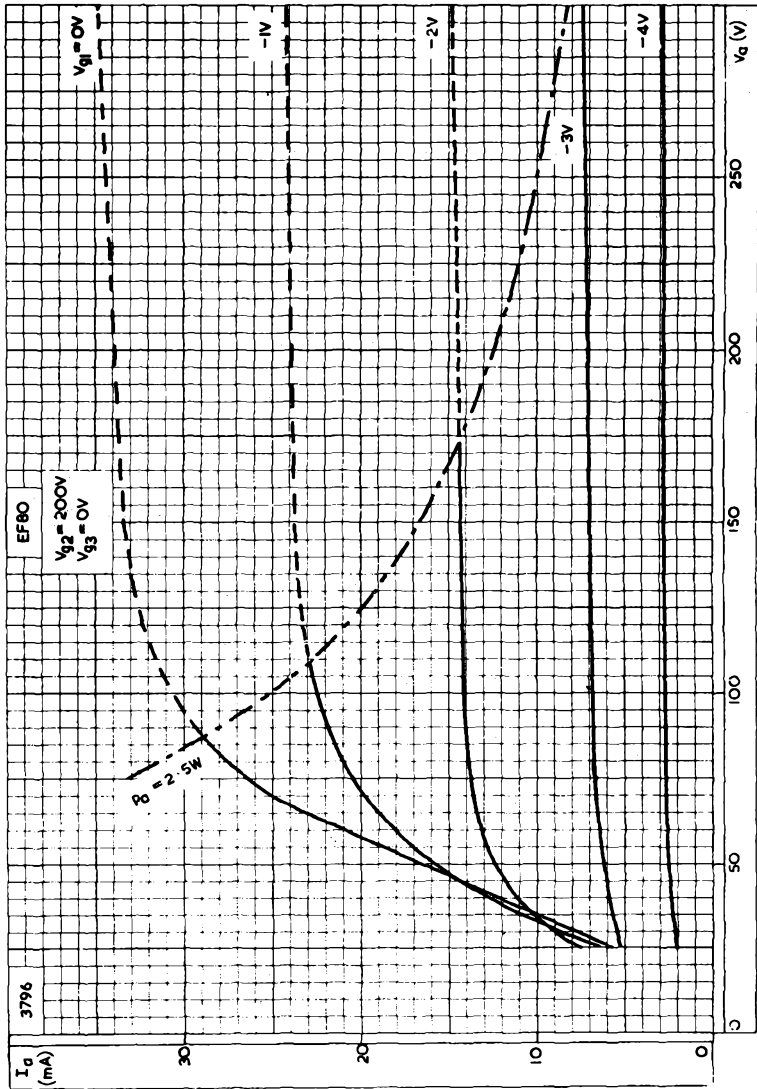

ANODE CURRENT PLOTTED AGAINST ANODE VOLTAGE WITH CONTROL-GRID VOLTAGE AS PARAMETER. $V_{g2} = 200V$

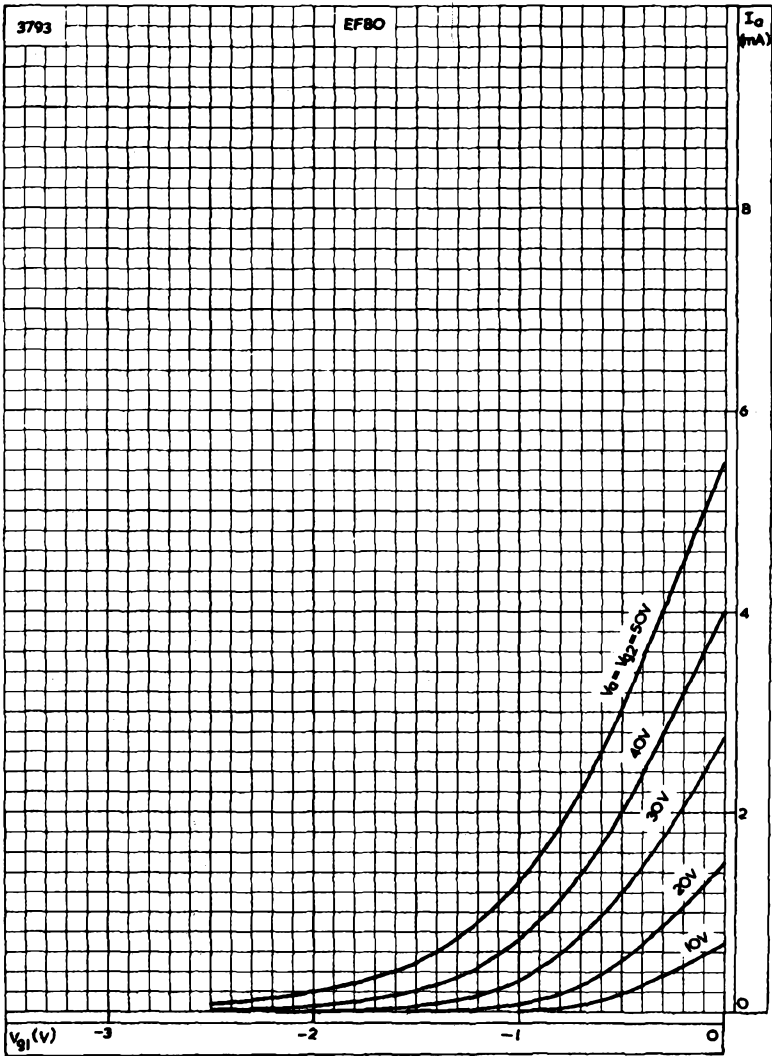

ANODE CURRENT IN THE REGION OF THE ORIGIN PLOTTED AGAINST CONTROL-GRID VOLTAGE WITH ANODE AND SCREEN-GRID VOLTAGES AS PARAMETER



EF80

R.F. PENTODE

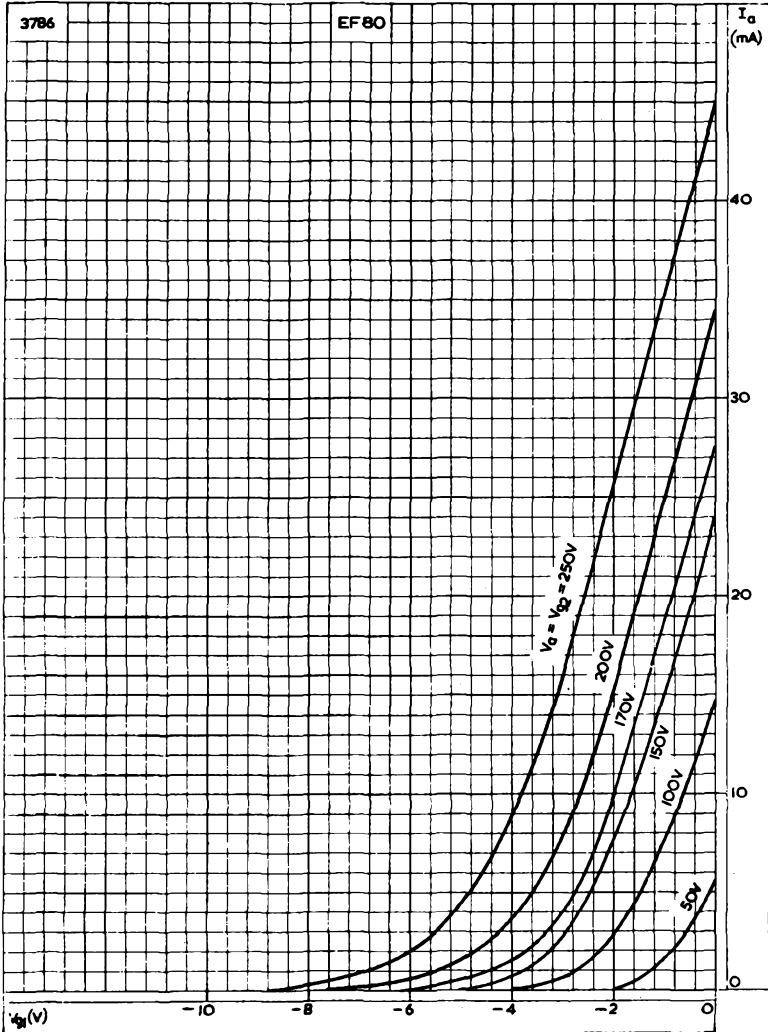

ANODE CURRENT PLOTTED AGAINST CONTROL-GRID VOLTAGE WITH ANODE AND SCREEN-GRID VOLTAGES AS PARAMETER



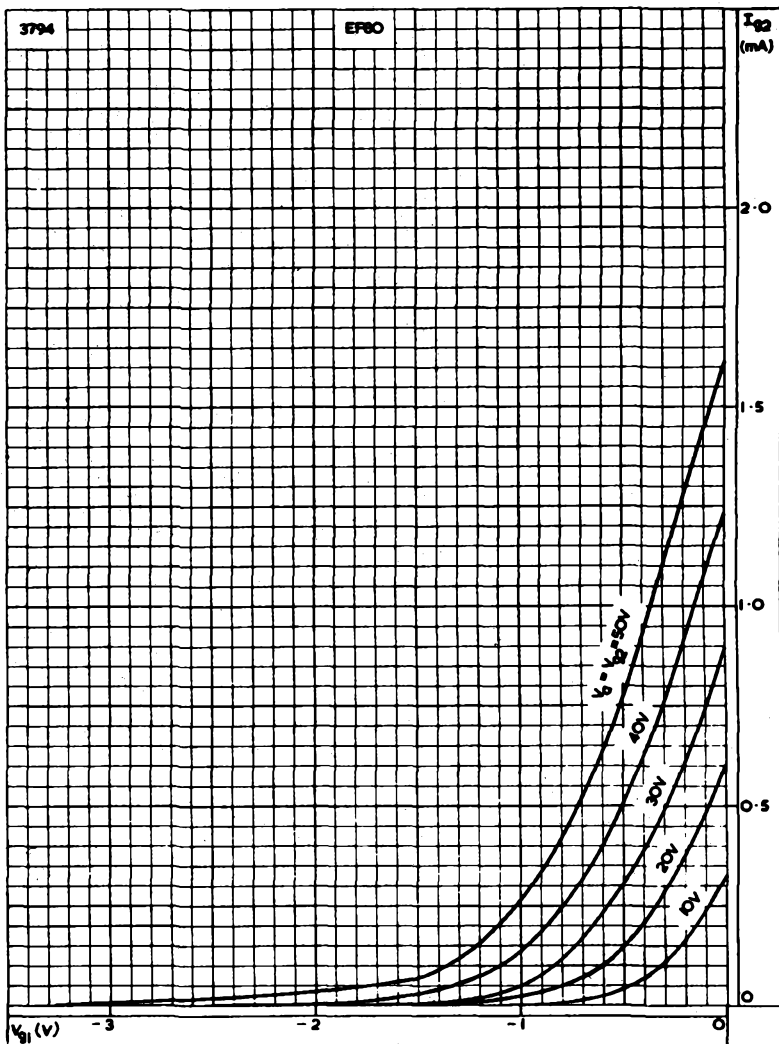

SCREEN-GRID CURRENT IN THE REGION OF THE ORIGIN PLOTTED AGAINST CONTROL-GRID VOLTAGE WITH ANODE AND SCREEN-GRID VOLTAGES AS PARAMETER



EF80

R.F. PENTODE

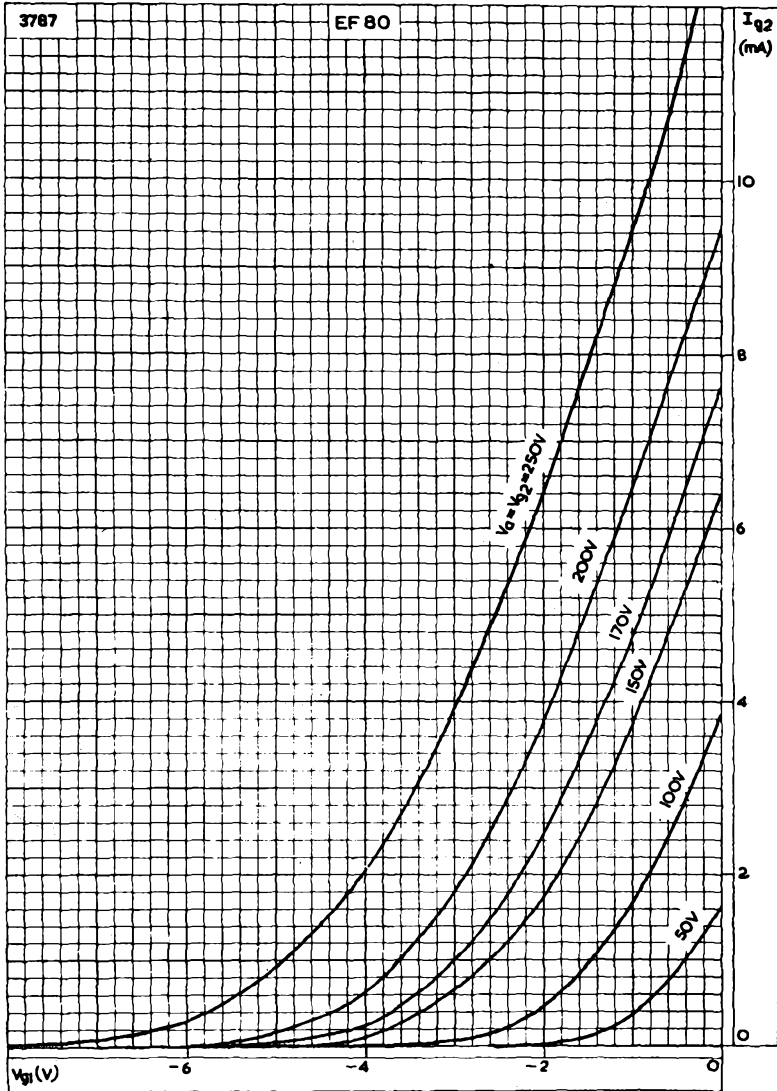

SCREEN-GRID CURRENT PLOTTED AGAINST CONTROL-GRID VOLTAGE WITH ANODE AND SCREEN-GRID VOLTAGES AS PARAMETER



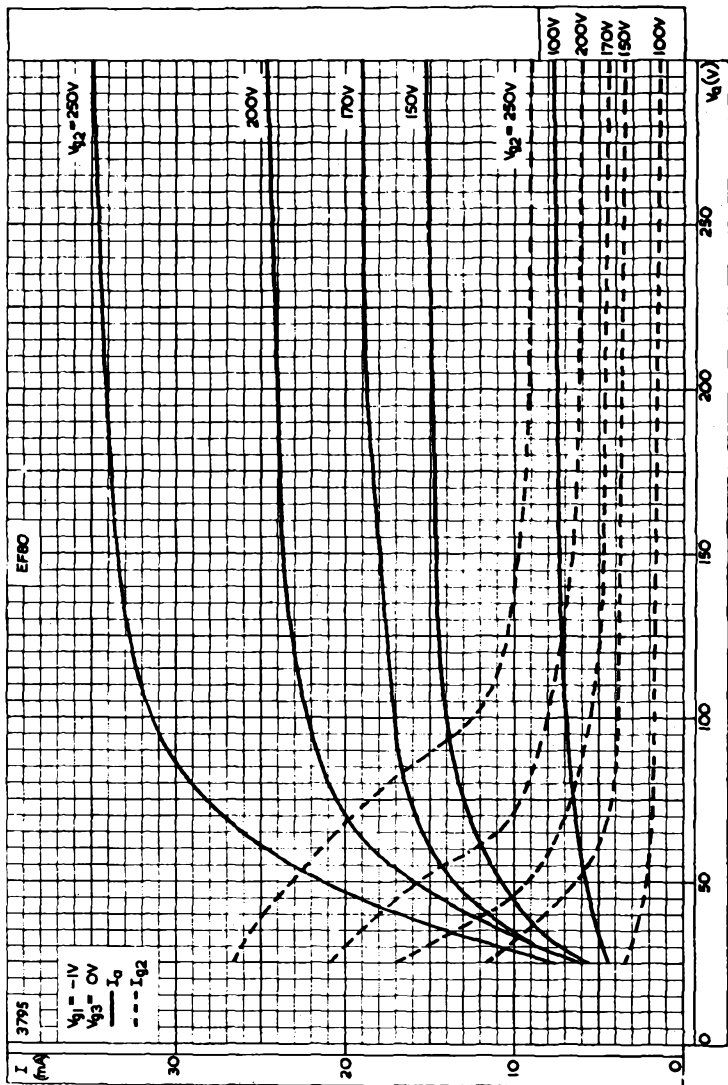

ANODE AND SCREEN-GRID CURRENTS PLOTTED AGAINST ANODE VOLTAGE WITH SCREEN-GRID VOLTAGE AS PARAMETER



EF80

R.F. PENTODE

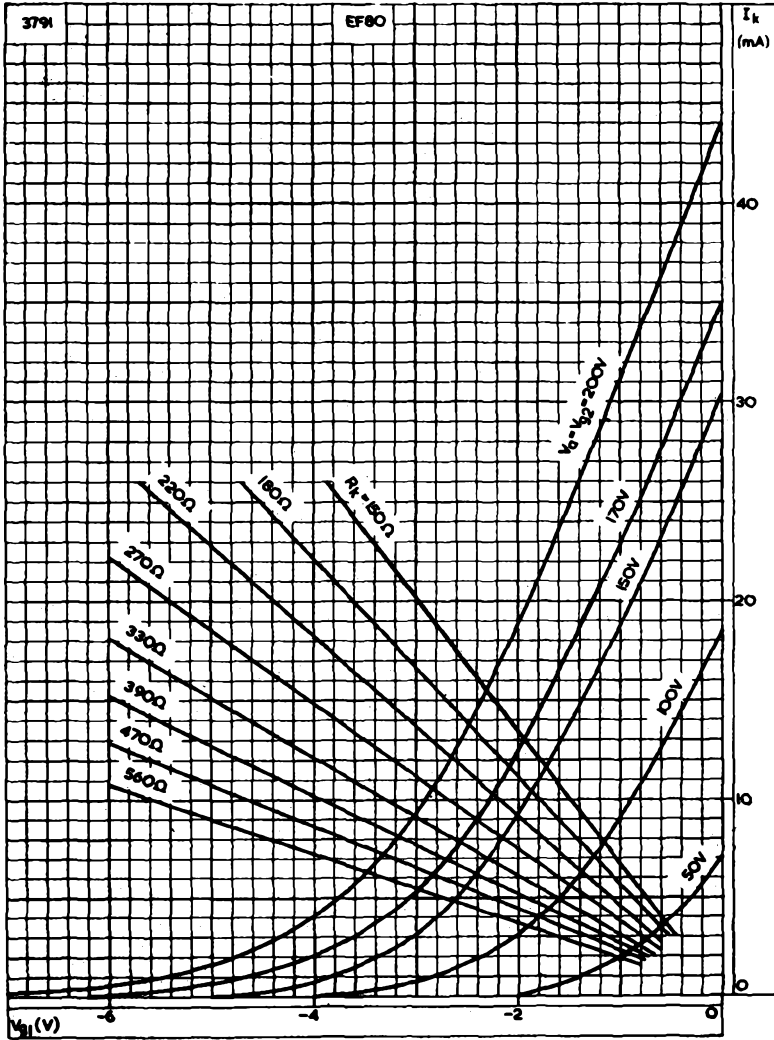

CATHODE CURRENT PLOTTED AGAINST CONTROL-GRID VOLTAGE WITH ANODE AND SCREEN-GRID VOLTAGES AS PARAMETER



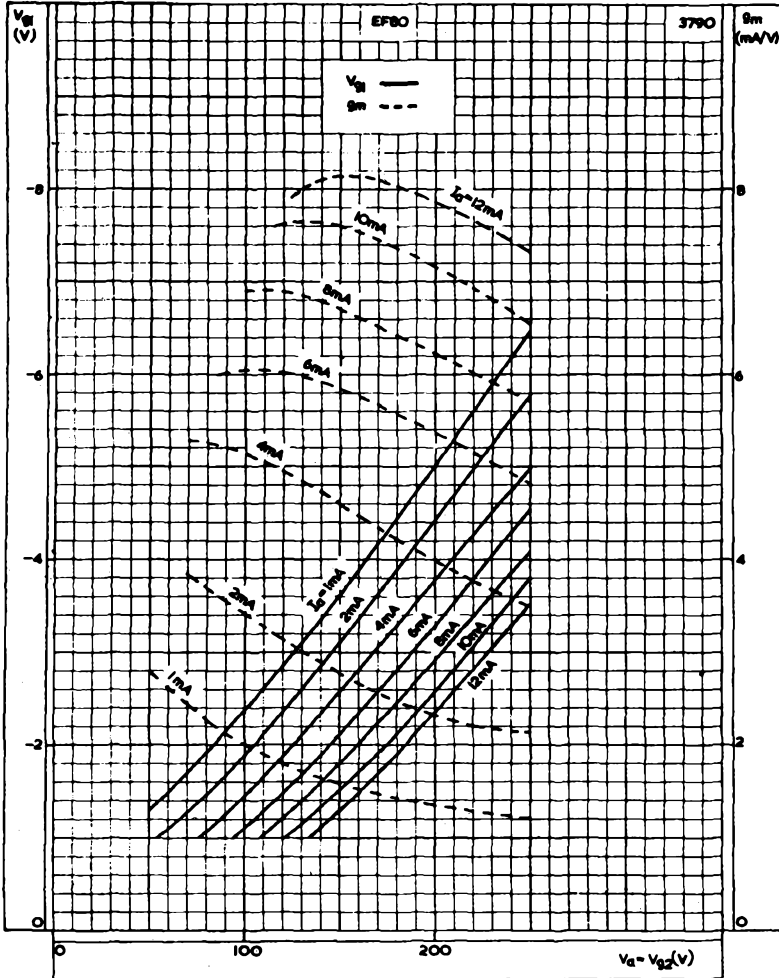

RELATION BETWEEN CONTROL-GRID VOLTAGE, MUTUAL CONDUCTANCE AND ANODE AND SCREEN-GRID VOLTAGES, WITH ANODE CURRENT AS PARAMETER



EF80

R.F. PENTODE

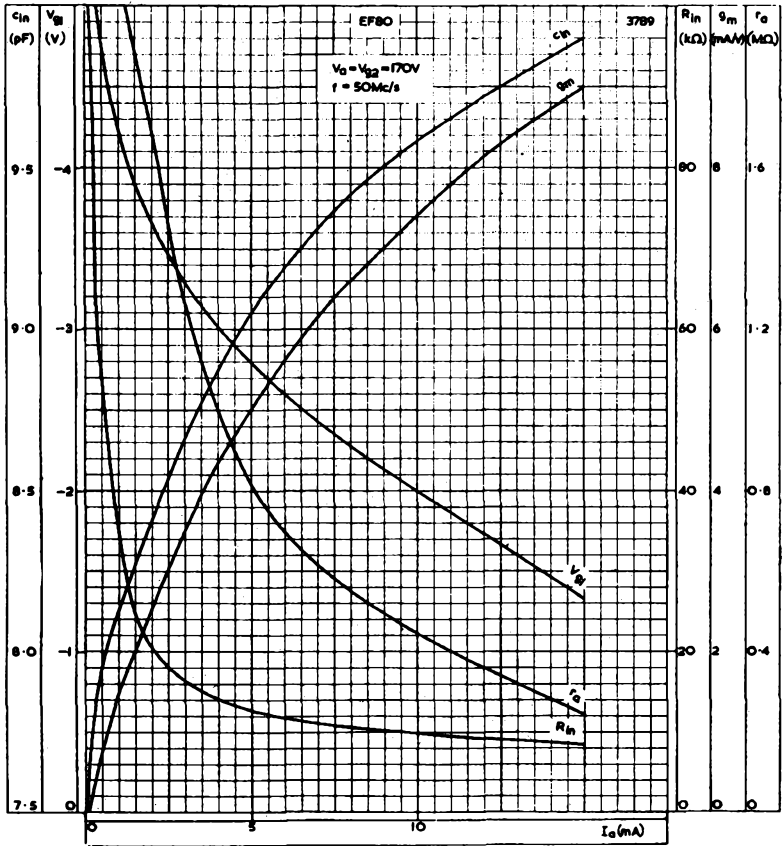

CONTROL-GRID VOLTAGE, MUTUAL CONDUCTANCE, ANODE IMPEDANCE, INPUT CAPACITANCE AND INPUT DAMPING PLOTTED AGAINST ANODE CURRENT



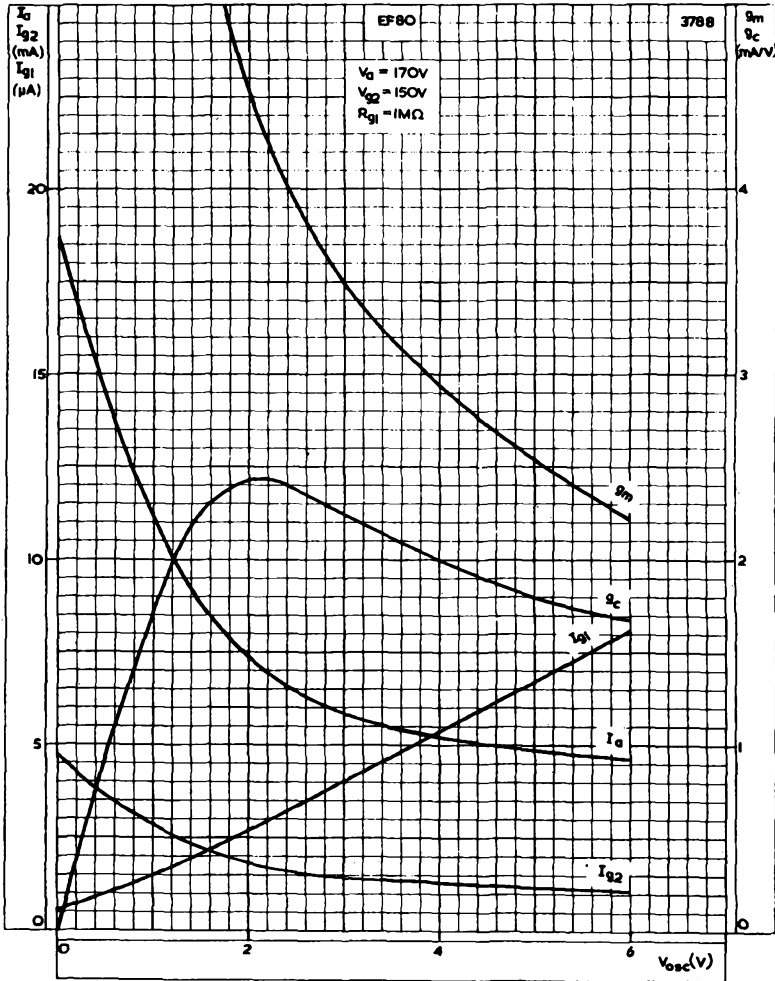

PERFORMANCE CURVES AS FREQUENCY CHANGER. $V_{g1} = 170V$, $V_{g2} = 150V$





VARIABLE-MU R.F. PENTODE

EF183

Frame-grid variable-mu r.f. pentode for use as an automatic gain controlled i.f. amplifier in television receivers.

HEATER

Suitable for series or parallel operation, a.c. or d.c.

V_h	6.3	V
I_h	300	mA

CAPACITANCES

C_{in}	9.5	pF
C_{out}	3.0	pF
C_{a-g1}	5.5	mpF
C_{g1-g2}	2.8	pF

CHARACTERISTICS

V_a	170	200	230	V
V_{g2}	90	90	90	V
V_{g3}	0	0	0	V
I_a	14	12	10.5	mA
I_{g2}	5.3	4.5	3.6	mA
V_{g1}	-1.8	-2.0	-2.1	V
g_m	14	12.5	10.6	mA/V
r_a	350	500	650	k Ω
r_{g1} ($f = 40\text{Mc/s}$)	11.6	13	15.3	k Ω
R_{eq} ($f = 40\text{Mc/s}$)	—	490	—	Ω



OPERATING CONDITIONS

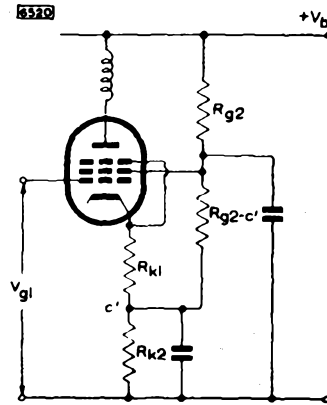

With compensating resistor R_{k1} (e.g. vision i.f. amplifier)

Condition	1	2	3	4	
$*V_b$	190	190	190	190	V
R_{g2}	22	6.8	8.2	10	k Ω
$R_{g2-c'}$	—	8.2	12	18	k Ω
R_{k1}	22	22	22	22	Ω
R_{k2}	100	56	68	82	Ω
R_{g1}	—	—	—	—	k Ω
I_a	11.6	11.8	11.7	11.4	mA
I_{g2}	4.3	4.4	4.4	4.3	mA
g_m	12.3	12.4	12.2	12	mA/V
V_{g1} for 100 : 1 reduction in g_m	-18.5	-9.0	-10	-11	V
I_{total}	16	27	24	21	mA
Condition	5	6	7	8	
$*V_b$	190	190	190	190	V
R_{g2}	12	15	18	33	k Ω
$R_{g2-c'}$	27	47	82	—	k Ω
R_{k1}	22	22	22	22	Ω
R_{k2}	82	82	82	0	Ω
R_{g1}	—	—	—	470	k Ω
I_a	11.8	11.9	12	11.6	mA
I_{g2}	4.4	4.5	4.5	4.4	mA
g_m	12.3	12.5	12.5	15.5	mA/V
V_{g1} for 100 : 1 reduction in g_m	-12	-13.5	-14.5	-17	V
I_{total}	19.7	18.5	14.7	16	mA

*For other values of V_b up to 210V, the above conditions can be used providing the values of R_{g2} are changed to keep V_{g2} at approx. 90V.

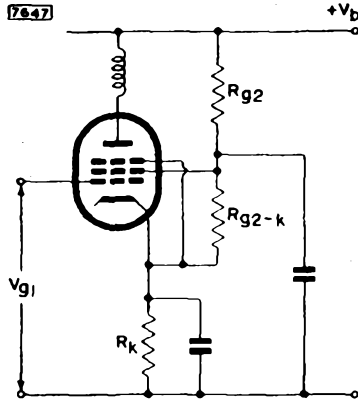

Without compensating resistor (e.g. sound i.f. amplifier)

<i>Condition</i>	1	2	3	4	
*V _b	190	190	190	190	V
R _{g2}	22	6.8	8.2	10	kΩ
R _{g2-k}	—	8.2	12	18	kΩ
R _k	120	68	82	100	Ω
I _a	11.7	12	11.8	11.4	mA
I _{g2}	4.3	4.5	4.4	4.3	mA
g _m	12.4	13	12.3	12	mA/V
V _{g1} for 10 : 1 reduction in g _m	-5.0	-3.0	-3.25	-3.5	V
V _{g1} for 100 : 1 reduction in g _m	-18.5	-9.0	-10	-11	V
I _{total}	16	27	24	21	mA
<i>Condition</i>	5	6	7		
*V _b	190	190	190		V
R _{g2}	12	15	18		kΩ
R _{g2-k}	27	47	82		kΩ
R _k	100	100	100		Ω
I _a	11.8	12	12		mA
I _{g2}	4.4	4.5	4.5		mA
g _m	12.4	12.5	12.5		mA/V
V _{g1} for 10 : 1 reduction in g _m	-4.0	-4.4	-4.6		V
V _{g1} for 100 : 1 reduction in g _m	-12	-13.5	-14.5		V
I _{total}	19.7	18.5	17.5		mA

*For other values of V_b up to 210V, the above conditions can be used providing the values of R_{g2} are changed to keep V_{g2} at approx. 90V.

EF183

VARIABLE-MU R.F. PENTODE

DESIGN CENTRE RATINGS

$V_{a(b)}$ max.	550	V
V_a max.	250	V
p_a max.	2.5	W
$V_{g2(b)}$ max.	550	V
V_{g2} max.	250	V
p_{g2} max.	650	mW
$-V_{g1(pk)}$ max.	50	V
I_k max.	20	mA
R_{g1-k} max.	1.0	M Ω
R_{g3-k} max.	50	k Ω
V_{h-k} max.	150	V
R_{h-k} max.	20	k Ω
T_{bulb} max.	180	$^{\circ}$ C

6666

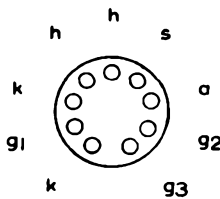
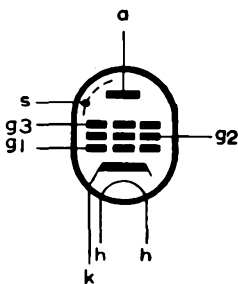

B9A Base

All dimensions in mm

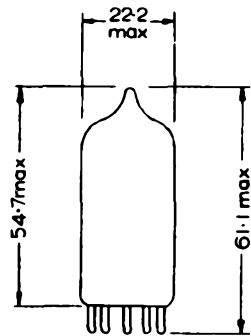

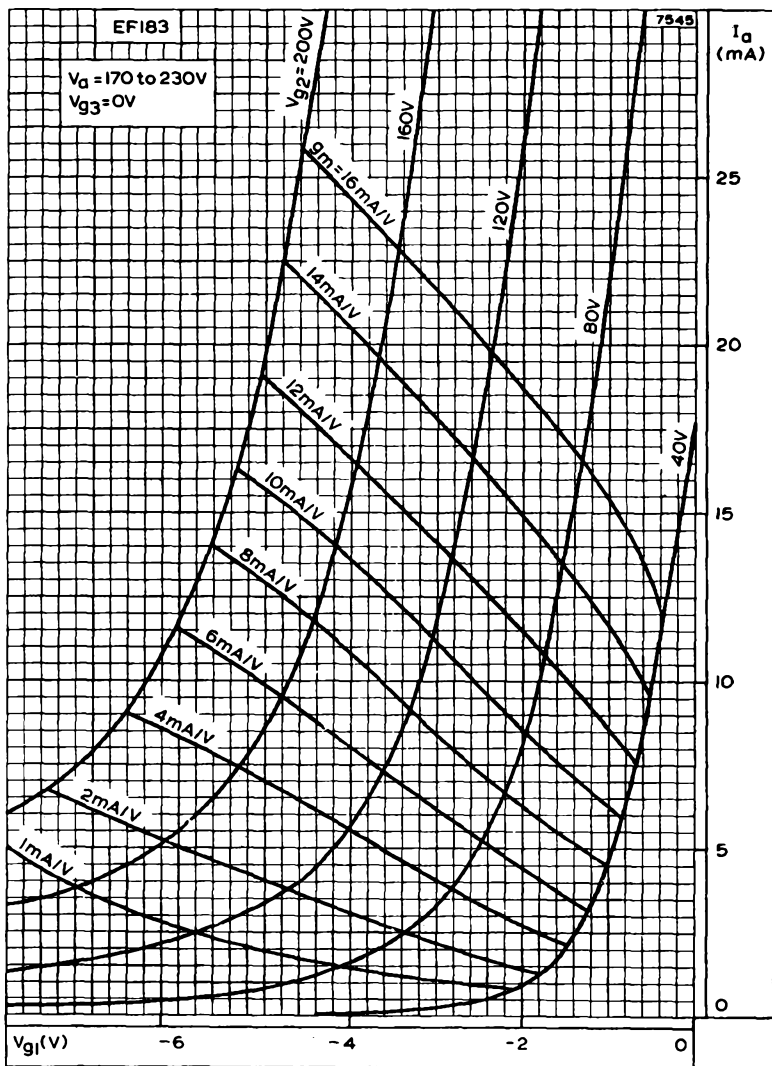

ANODE CURRENT PLOTTED AGAINST CONTROL-GRID VOLTAGE WITH SCREEN-GRID VOLTAGE AS PARAMETER AND WITH MUTUAL CONDUCTANCE CONTOURS



EF183

VARIABLE-MU R.F. PENTODE

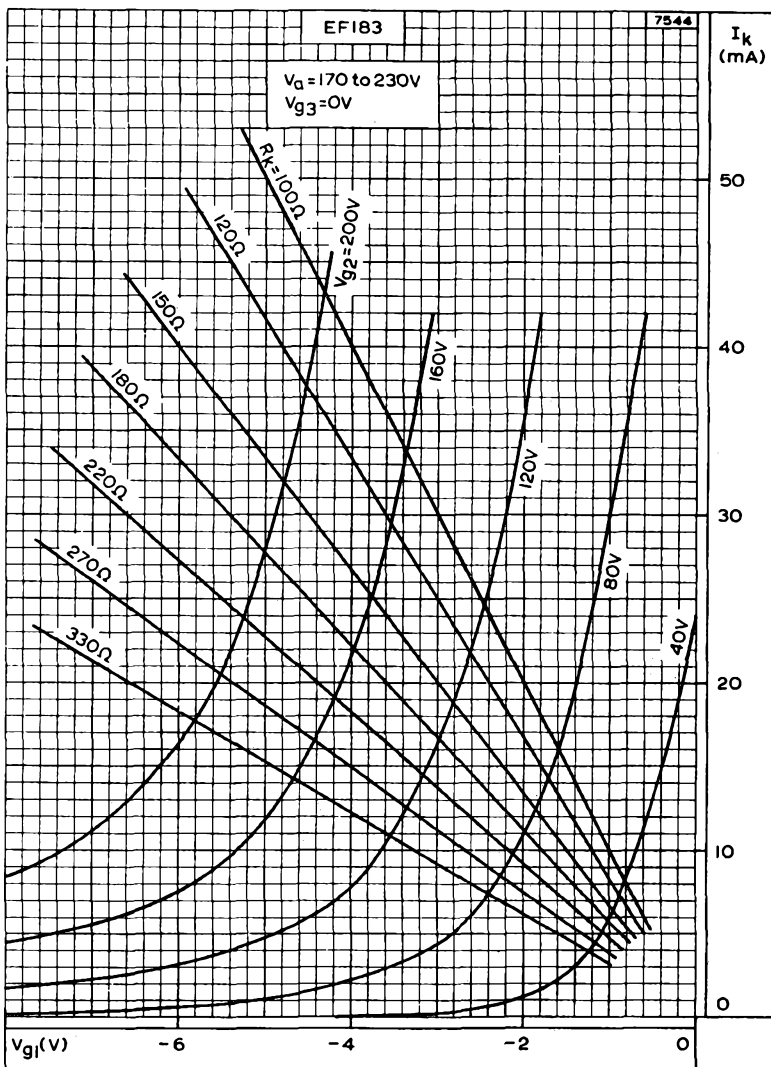

CATHODE CURRENT PLOTTED AGAINST CONTROL-GRID VOLTAGE WITH SCREEN-GRID VOLTAGE AS PARAMETER



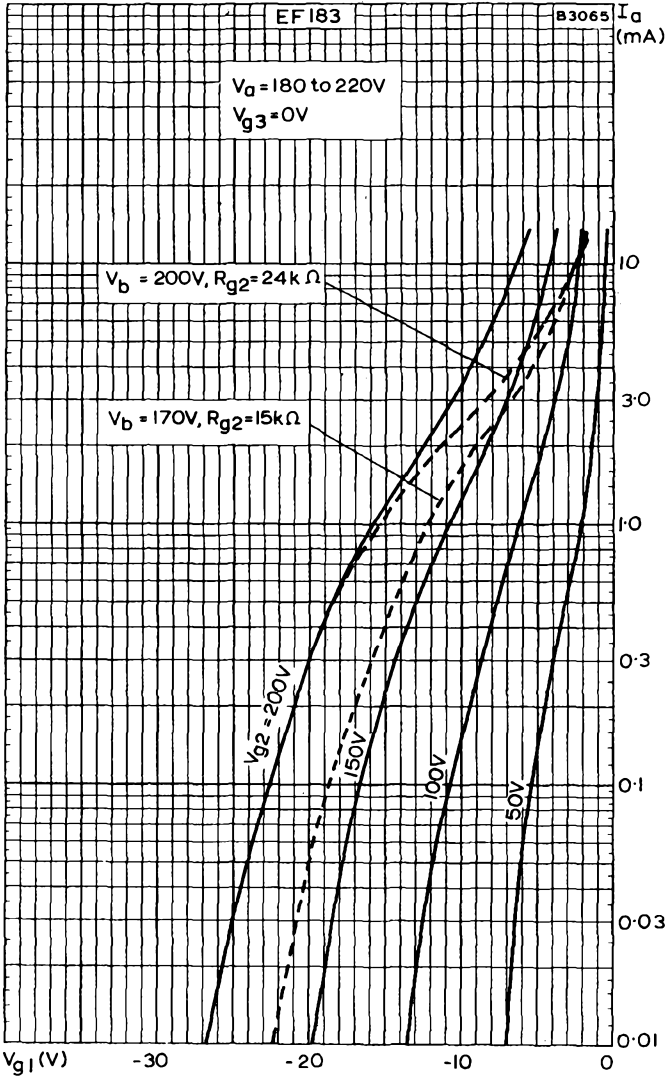

ANODE CURRENT PLOTTED AGAINST CONTROL-GRID VOLTAGE WITH SCREEN-GRID VOLTAGE AS PARAMETER



EF183

VARIABLE-MU R.F. PENTODE

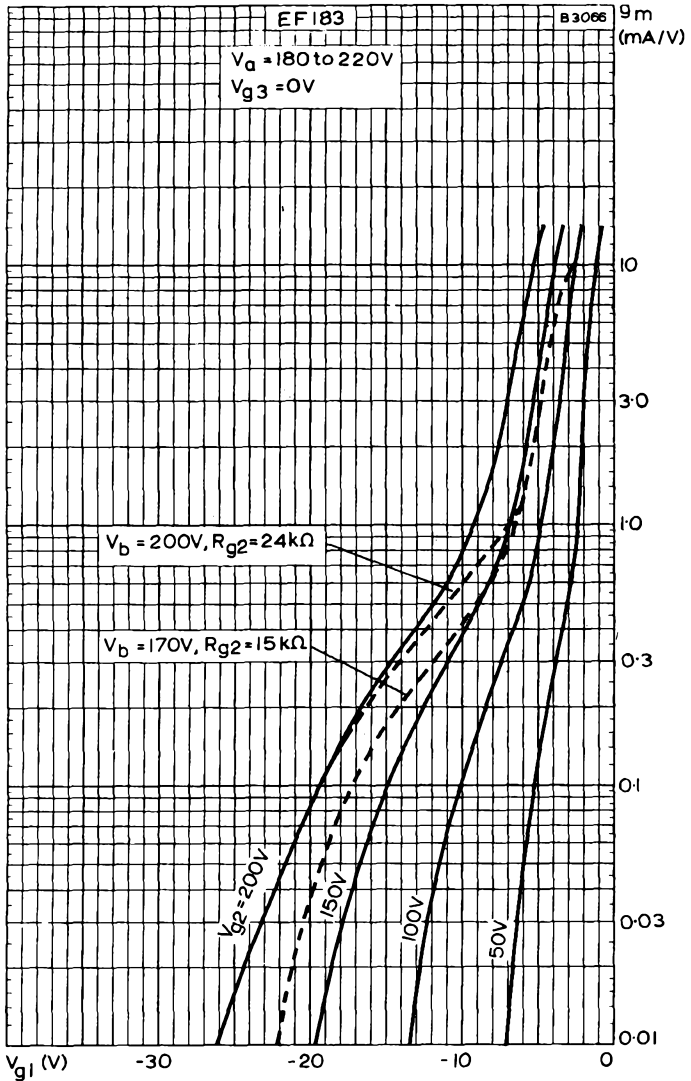

MUTUAL CONDUCTANCE PLOTTED AGAINST CONTROL-GRID VOLTAGE WITH SCREEN-GRID VOLTAGE AS PARAMETER



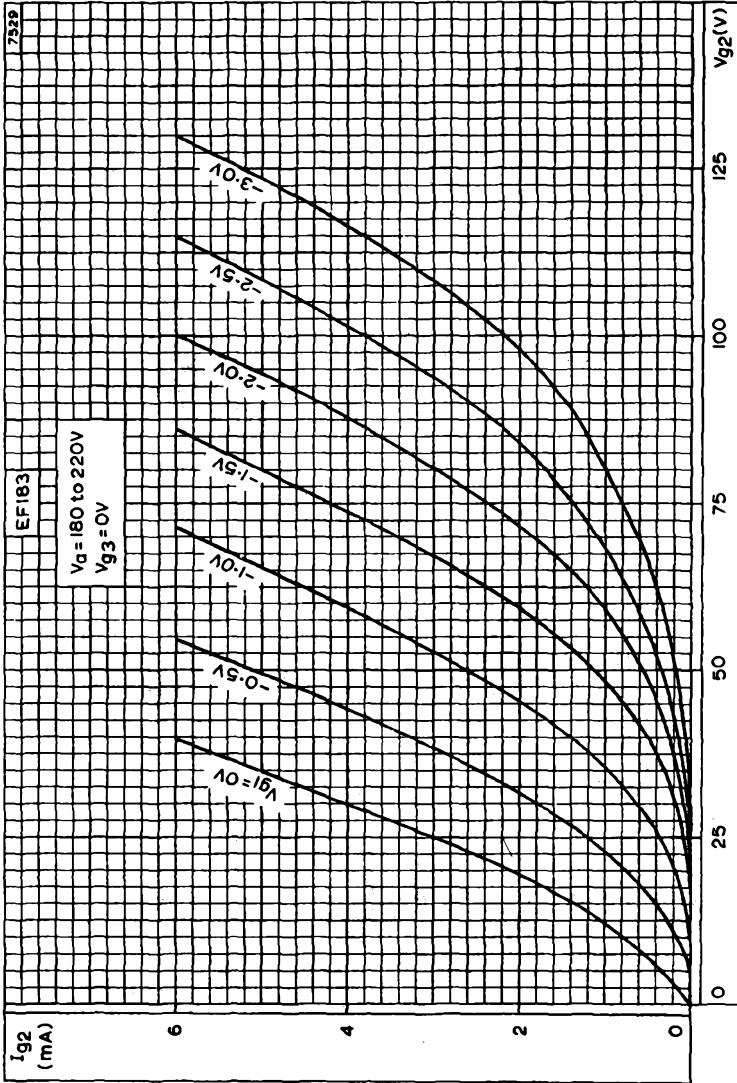

SCREEN-GRID CURRENT PLOTTED AGAINST SCREEN-GRID VOLTAGE WITH CONTROL-GRID VOLTAGE AS PARAMETER



EF183

VARIABLE-MU R.F. PENTODE

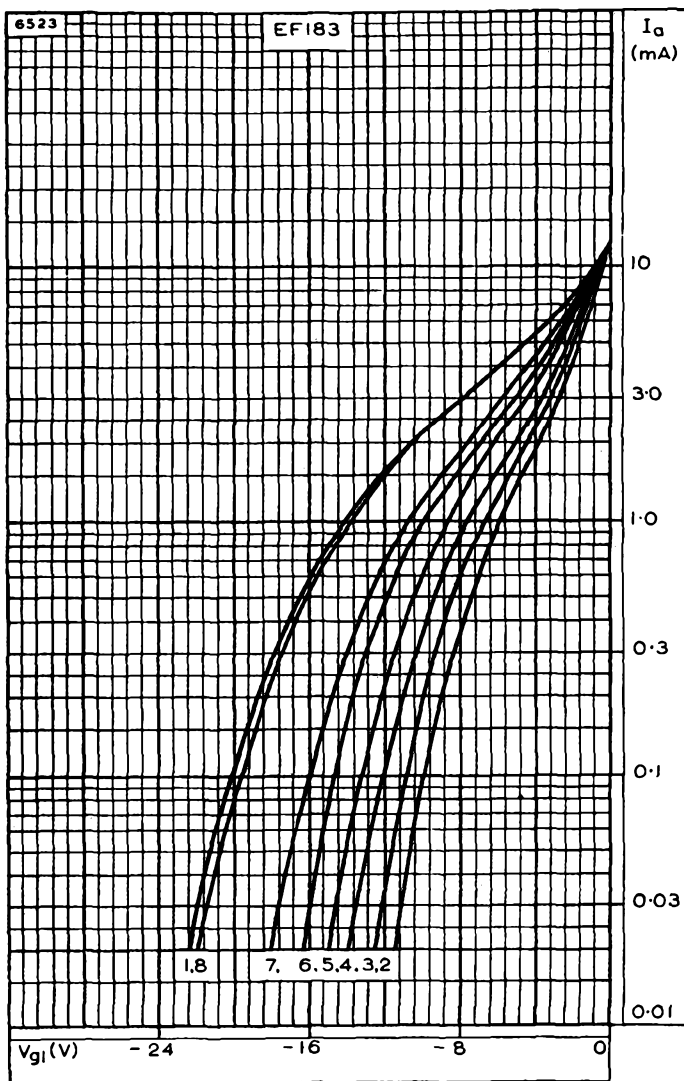

ANODE CURRENT PLOTTED AGAINST CONTROL-GRID VOLTAGE.
Curve numbers refer to operating conditions on pages D2, D3



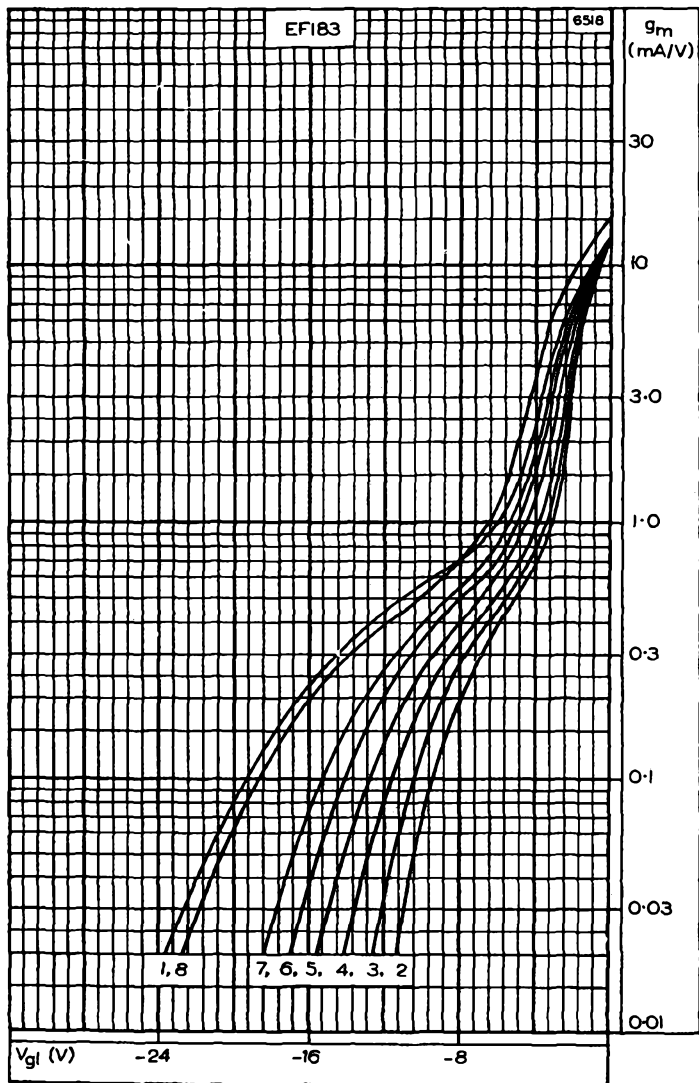

MUTUAL CONDUCTANCE PLOTTED AGAINST CONTROL-GRID VOLTAGE.
Curve numbers refer to operating conditions on pages D2, D3



EF183

VARIABLE-MU R.F. PENTODE

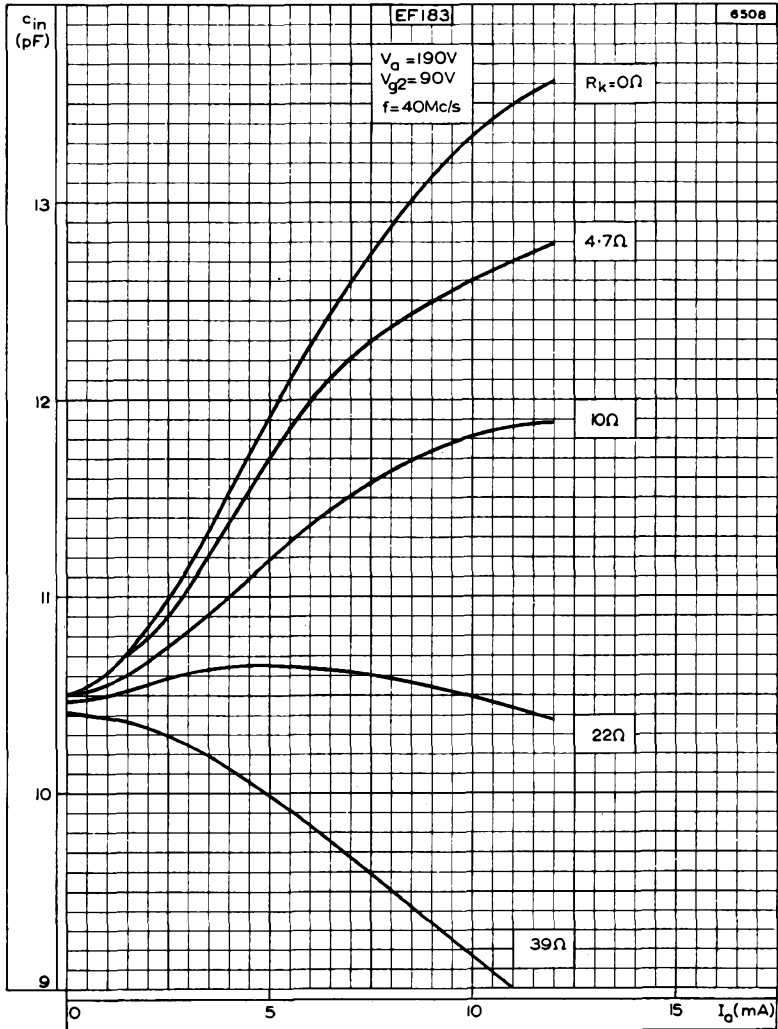

INPUT CAPACITANCE PLOTTED AGAINST ANODE CURRENT FOR VARIOUS VALUES OF CATHODE RESISTOR



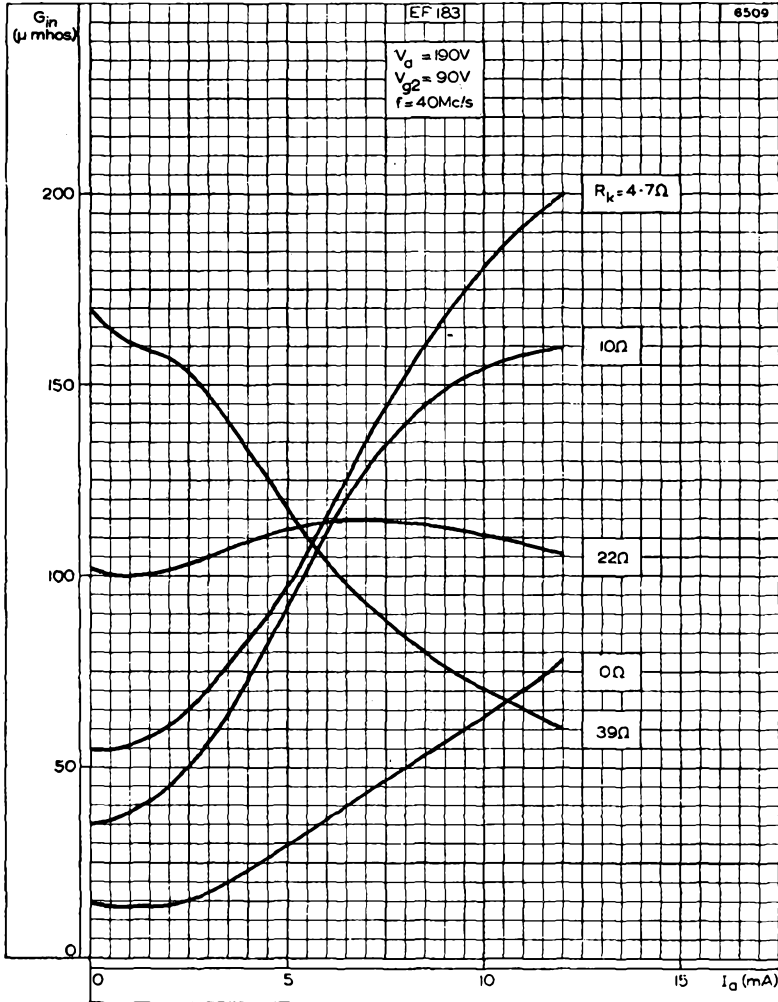

INPUT CONDUCTANCE PLOTTED AGAINST ANODE CURRENT FOR VARIOUS VALUES OF CATHODE RESISTOR



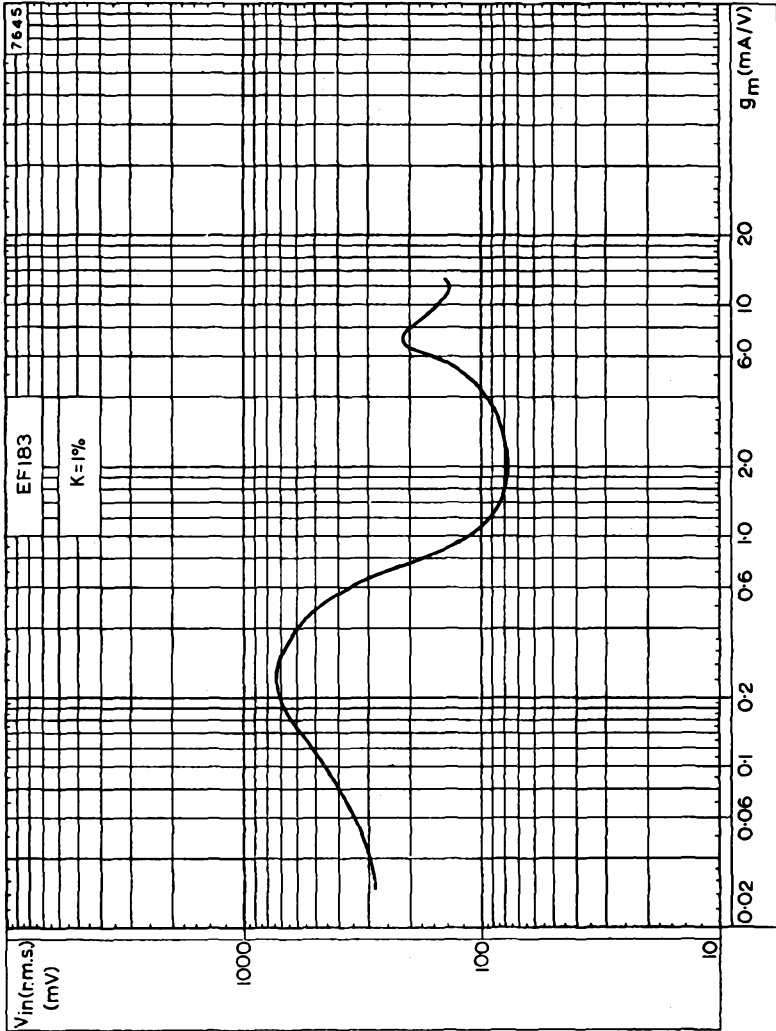

CROSS-MODULATION CURVE

R.F. PENTODE

EF184

Frame-grid sharp cut-off pentode for use as an i.f. amplifier in television receivers.

HEATER

Suitable for series or parallel operation, a.c. or d.c.

V_h	6.3	V
I_h	300	mA

CAPACITANCES

C_{in}	10	pF
C_{out}	3.0	pF
C_{a-g1}	5.5	mpF
C_{g1-g2}	2.8	pF

CHARACTERISTICS

V_a	170	200	V
V_{g2}	170	200	V
V_{g2}	0	0	V
I_a	10	10	mA
I_{g2}	4.1	4.1	mA
V_{g1}	-2.0	-2.5	V
g_m	15.6	15	mA/V
r_a	330	380	k Ω
μ_{g1-g2}	60	60	
r_{g1} (f = 40Mc/s)	9.5	11	k Ω
R_{eq} (f = 40Mc/s)	—	330	Ω

OPERATING CONDITIONS

$V_a(b)$	170	200	230	V
$V_{g2(b)}$	0	0	0	V
$V_{g2(b)}$	170	200	230	V
R_k	140	140	140	Ω
R_{g2}	0	7.5	15	k Ω
I_a	10	10	10	mA
I_{g2}	4.1	4.1	4.1	mA
g_m	15.6	15.6	15.6	mA/V
r_a	330	510	680	k Ω
r_{g1} (f = 40Mc/s)	10	10	10	k Ω
R_{eq} (f = 40Mc/s)	300	300	300	Ω



DESIGN CENTRE RATINGS

$V_{a(b)}$ max.	550	V
V_a max.	250	V
p_a max.	2.5	W
$V_{g1(b)}$ max.	550	V
V_{g2} max.	250	V
p_{g2} max.	900	mW
$-v_{g1(pk)}$ max.	50	V
I_x max.	25	mA
R_{g1-k} max.	1.0	MΩ
V_{h-k} max.	150	V
R_{h-k} max.	20	kΩ
T_{bulb} max.	180	°C

6606

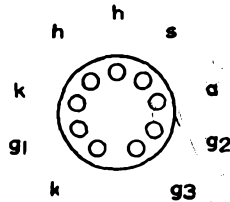
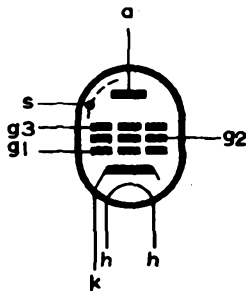

BSA Base

All dimensions in mm

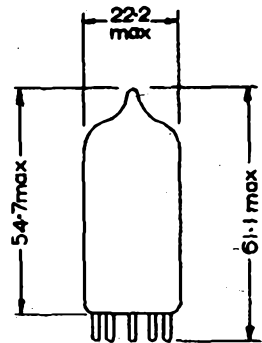

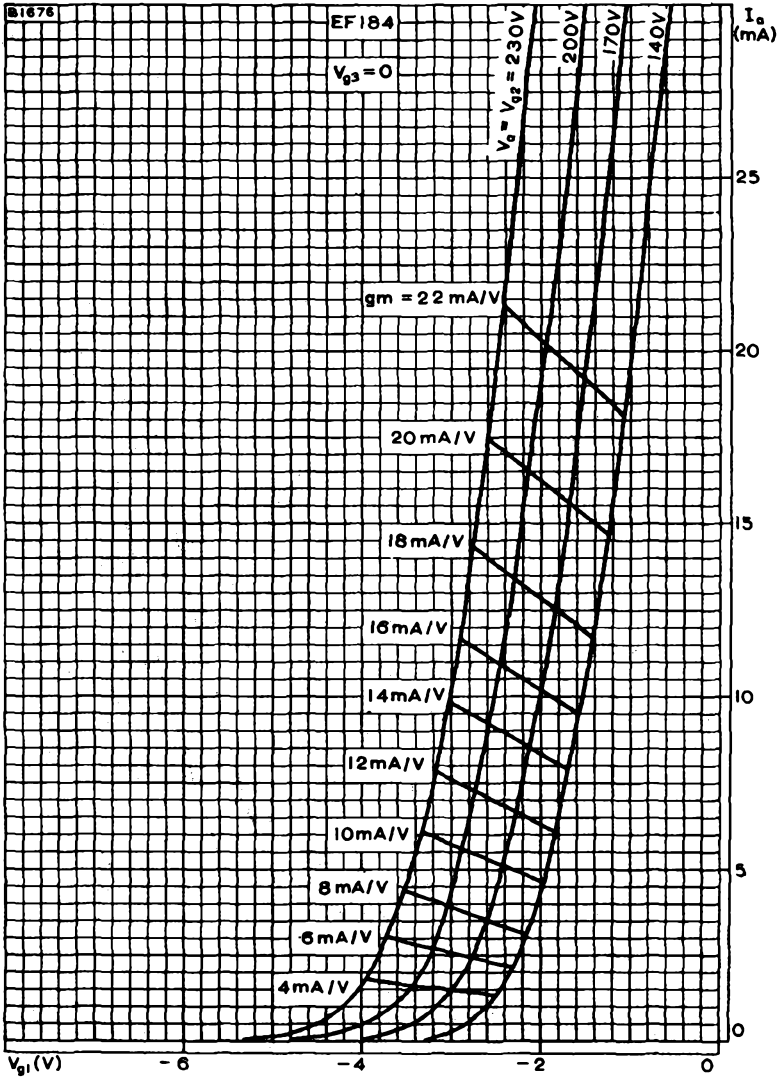

ANODE CURRENT PLOTTED AGAINST CONTROL-GRID VOLTAGE WITH ANODE AND SCREEN-GRID VOLTAGES AS PARAMETER AND WITH MUTUAL CONDUCTANCE CONTOURS



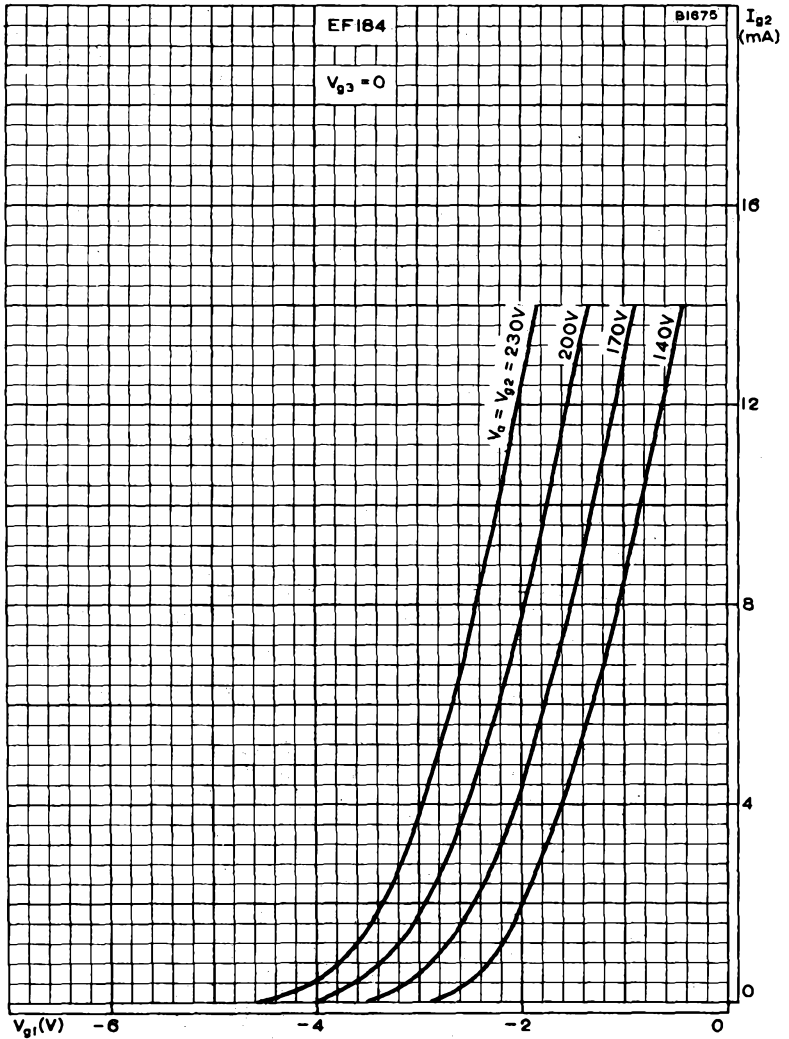

SCREEN-GRID CURRENT PLOTTED AGAINST CONTROL-GRID VOLTAGE WITH ANODE AND SCREEN-GRID VOLTAGES AS PARAMETER



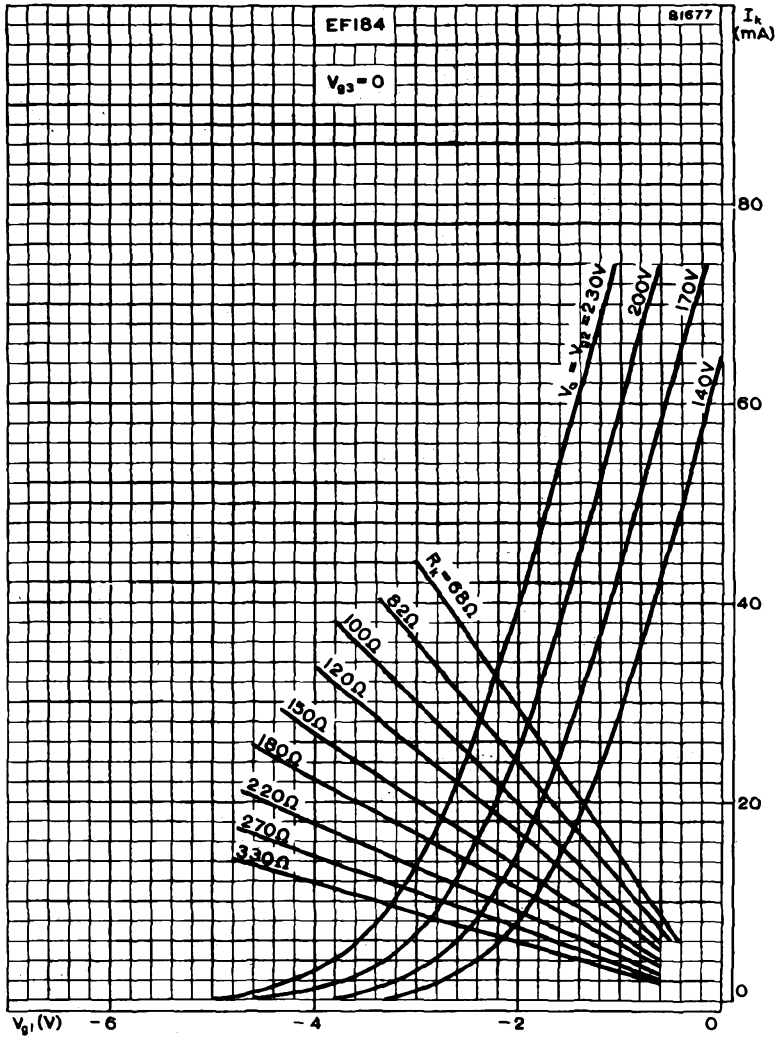

CATHODE CURRENT PLOTTED AGAINST CONTROL-GRID VOLTAGE WITH ANODE AND SCREEN-GRID VOLTAGES AS PARAMETER



EF184

R.F. PENTODE

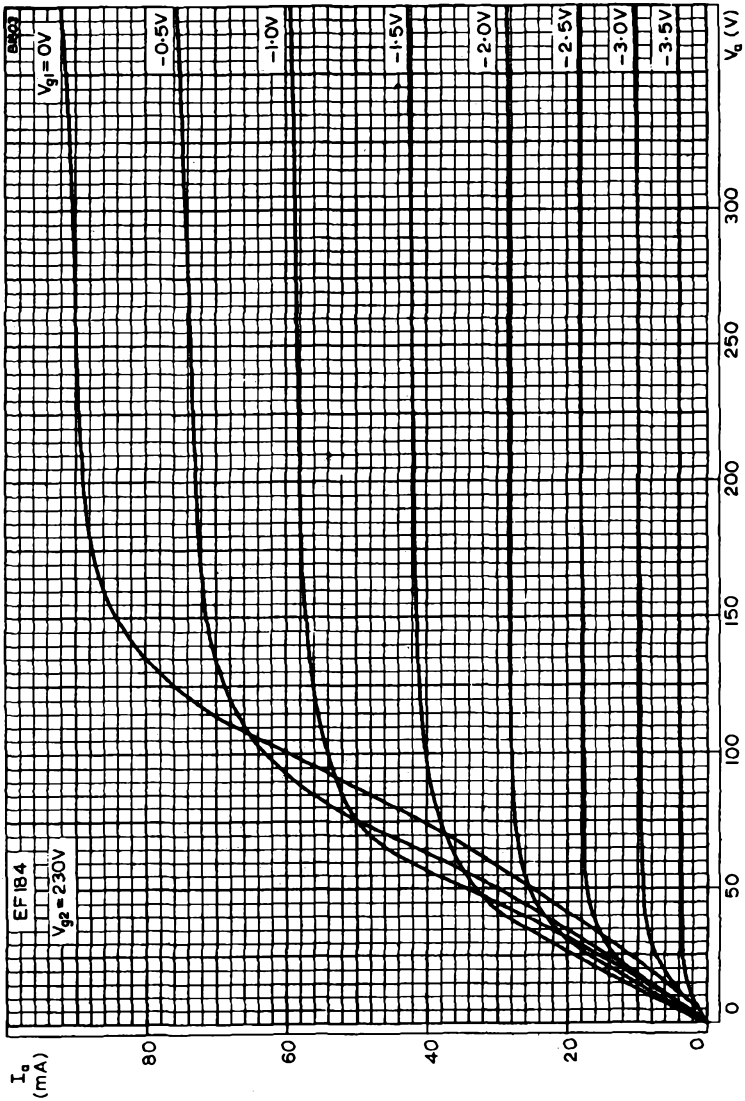

ANODE CURRENT PLOTTED AGAINST ANODE VOLTAGE WITH CONTROL-GRID VOLTAGE AS PARAMETER. $V_{g2} = 230V$



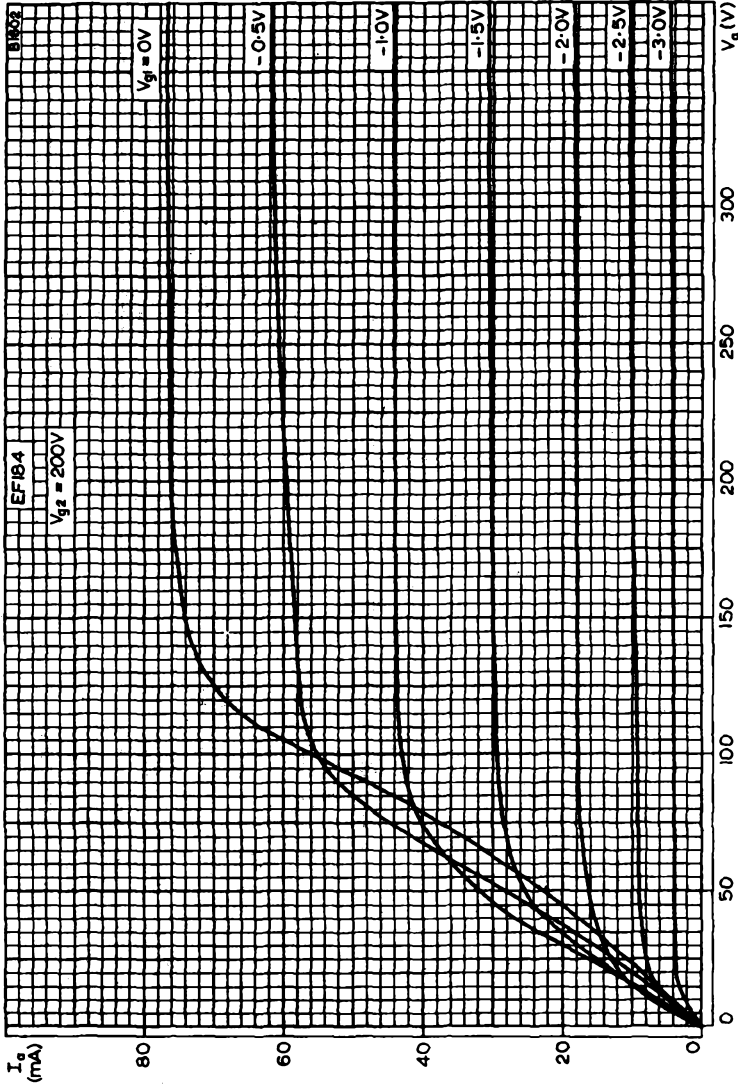

ANODE CURRENT PLOTTED AGAINST ANODE VOLTAGE WITH CONTROL-GRID VOLTAGE AS PARAMETER. $V_{g2} = 200V$





ANODE CURRENT PLOTTED AGAINST ANODE VOLTAGE WITH CONTROL-GRID VOLTAGE AS PARAMETER. $V_{g2} = 170V$

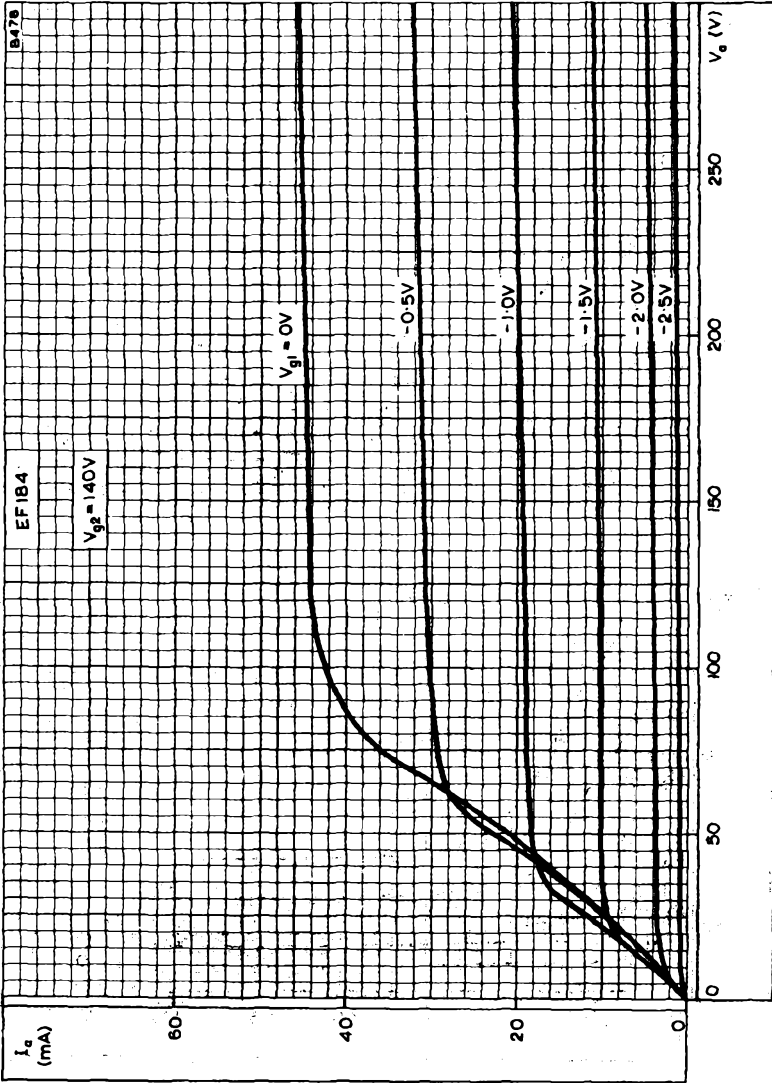

ANODE CURRENT PLOTTED AGAINST ANODE VOLTAGE WITH CONTROL-GRID VOLTAGE AS PARAMETER. $V_{g2} = 140V$



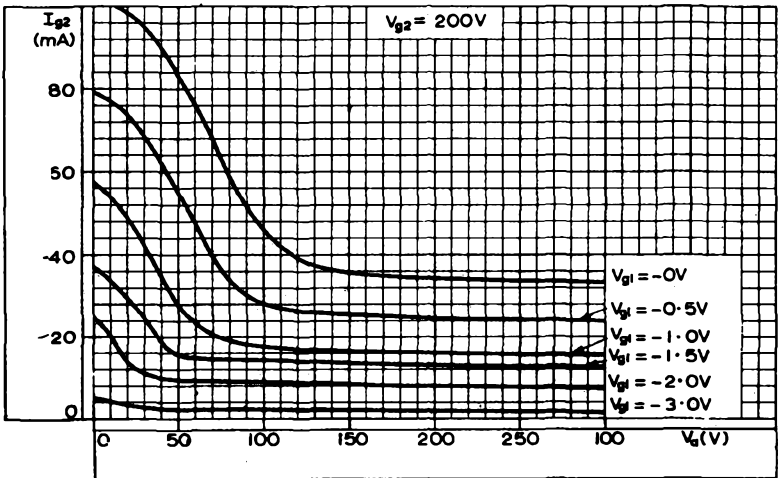
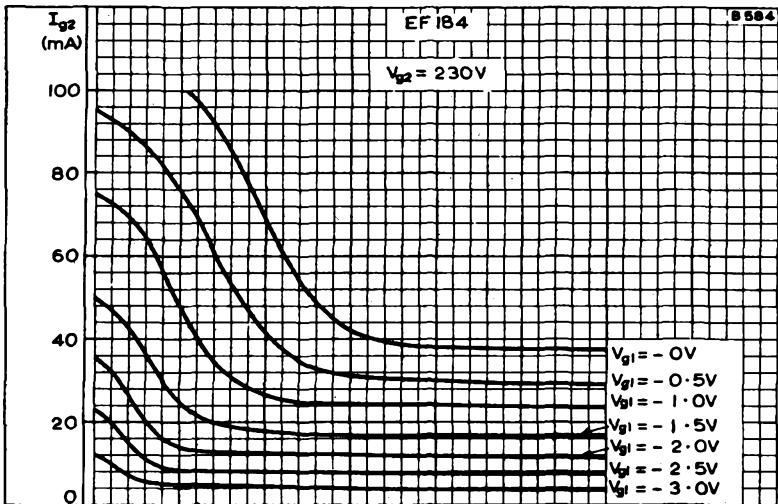

SCREEN-GRID CURRENT PLOTTED AGAINST ANODE VOLTAGE WITH CONTROL-GRID VOLTAGE AS PARAMETER



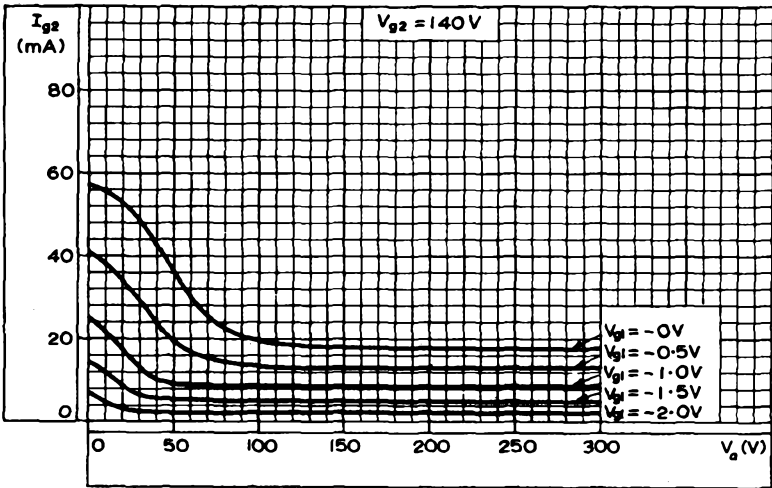
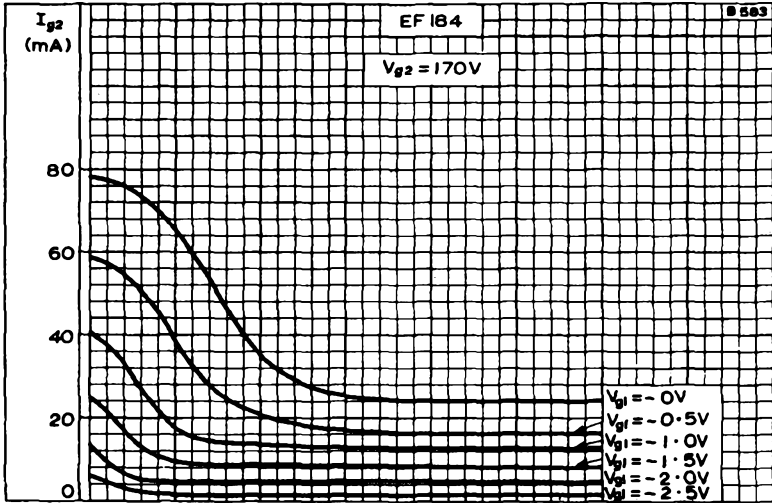

SCREEN-GRID CURRENT PLOTTED AGAINST ANODE VOLTAGE WITH CONTROL-GRID VOLTAGE AS PARAMETER



EF184

R.F. PENTODE

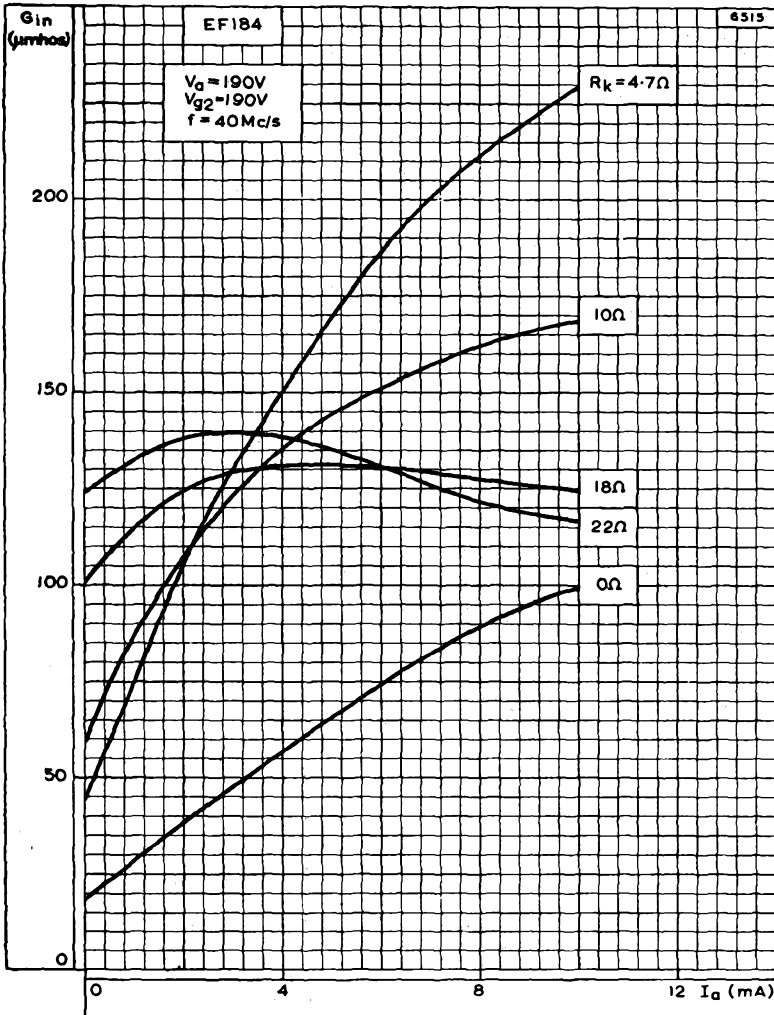

INPUT CONDUCTANCE PLOTTED AGAINST ANODE CURRENT WITH VARIOUS VALUES OF CATHODE RESISTOR



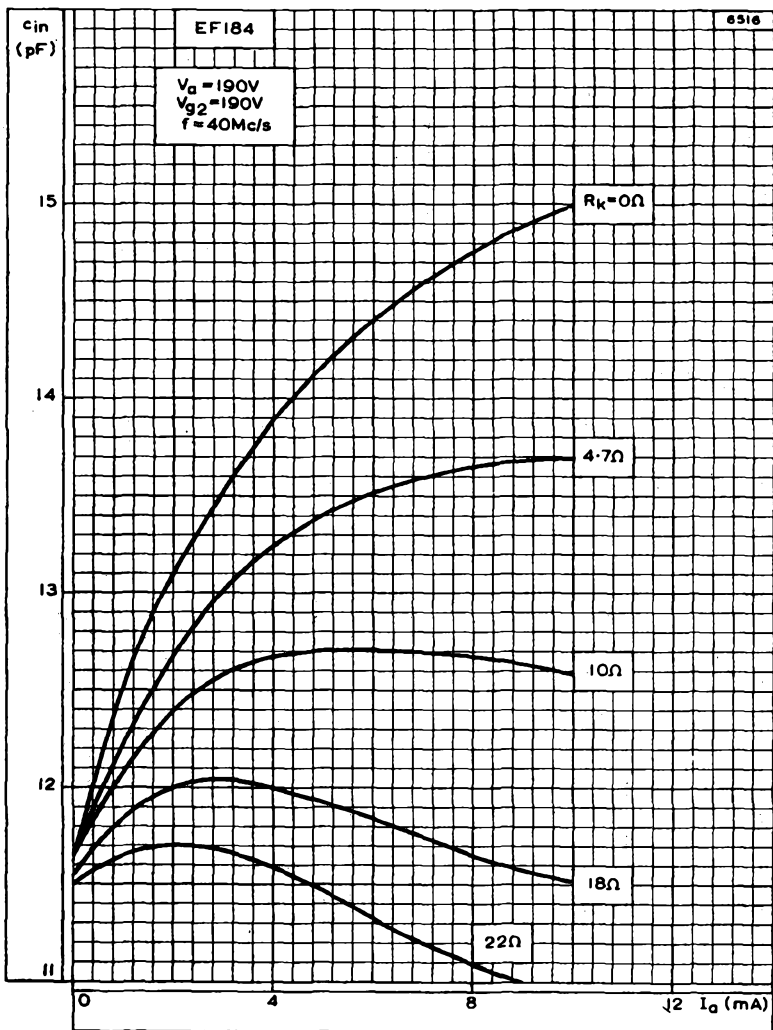

INPUT CAPACITANCE PLOTTED AGAINST ANODE CURRENT WITH VARIOUS VALUES OF CATHODE RESISTOR



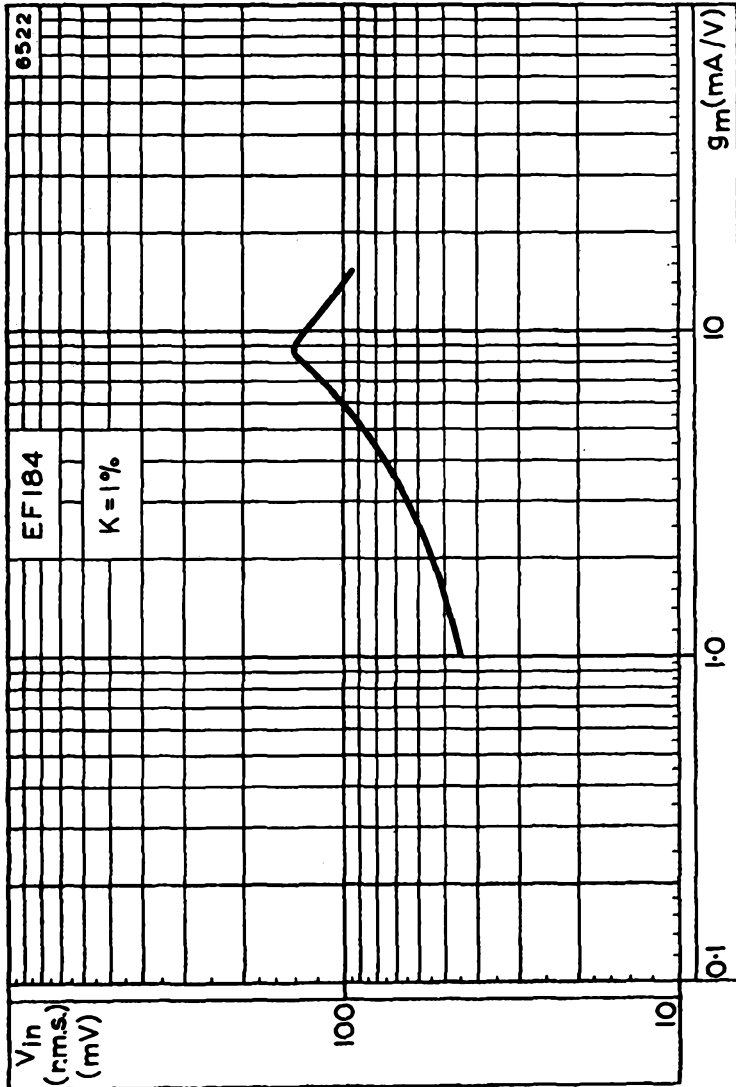

CROSS-MODULATION CURVE



Triode pentode for use in line oscillator circuits, the pentode section as a sinewave oscillator or pulse shaper in television receivers and the triode section as a reactance valve.

HEATER

Suitable for series operation, a.c. or d.c.

I_h	300	mA
V_h	9.0	V

CAPACITANCES

Pentode section

c_{a-g1}	0.06	pF
c_{g1-h} max.	0.1	pF
c_{in}	5.4	pF

Triode section

c_{a-g}	1.5	pF
c_{g-h} max.	0.1	pF
c_{in}	2.4	pF

CHARACTERISTICS

Pentode section

V_a	100	V
V_{g2}	100	V
V_{g1}	-1.0	V
V_{g1} max. ($V_a = V_{g2} = 200V, I_a = 10\mu A$)	-16	V
V_{g1} max. ($I_a = 0.3\mu A$)	-1.3	V
I_a	6.0	mA
I_a ($V_{g1} = 0V$)	12.5	mA
I_{g2}	1.7	mA
I_{g2} ($V_{g1} = 0V$)	3.5	mA
g_m	5.5	mA/V
μ_{g1-g2}	47	
r_a	400	k Ω

CHARACTERISTICS (contd.)

Triode section

V_a	200	V
V_g	-2.0	V
V_g max. ($I_g = 0.3\mu A$)	-1.3	V
I_a	3.5	mA
I_a ($V_a = 200V, I_g = 10\mu A$)	10	mA
g_m	3.5	mA/V
μ	70	
r_a	20	k Ω

RATINGS (DESIGN CENTRE SYSTEM) ←

Pentode section

$V_{a(b)}$ max.	550	V
V_a max.	250	V
p_a max.	1.2	W
$V_{g2(b)}$ max. (see note 1)	550	V
V_{g2} max.	250	V
p_{g2} max.	800	mW
V_{g1} max. (see note 1)	-220	V
I_k max.	15	mA
$i_{k(pk)}$ max.	50	mA
R_{g1-k} max. (fixed bias)	560	k Ω
R_{g1-k} max. (automatic bias)	1.0	M Ω
V_{h-k} max. (see note 2)	100	V
Z_{g1-k} max. ($f = 50Hz$) (see note 2)	300	k Ω

Triode section

$V_{a(b)}$ max.	550	V
V_a max.	250	V
p_a max.	1.4	W
I_k max.	10	mA
R_{gt-k} max.	3.0	M Ω
V_{h-k} max. (see note 3)	100	V
Z_{gt-k} max. ($f = 50Hz$) (see note 3)	50	k Ω

NOTES

1. The instantaneous voltage between g_1 and g_2 must not exceed 550V.
2. To avoid hum interference the a.c. component of V_{h-k} should not exceed 65V at the specified value of Z_{gt-k} .
3. To minimise hum interference, decoupling of R_k is recommended. In circuits where R_k is not decoupled, the hum interference between grid and cathode will remain below 1mV when the a.c. component of V_{h-k} does not exceed 25V and R_k is not higher than 1.2k Ω at the specified value of Z_{gt-k} .

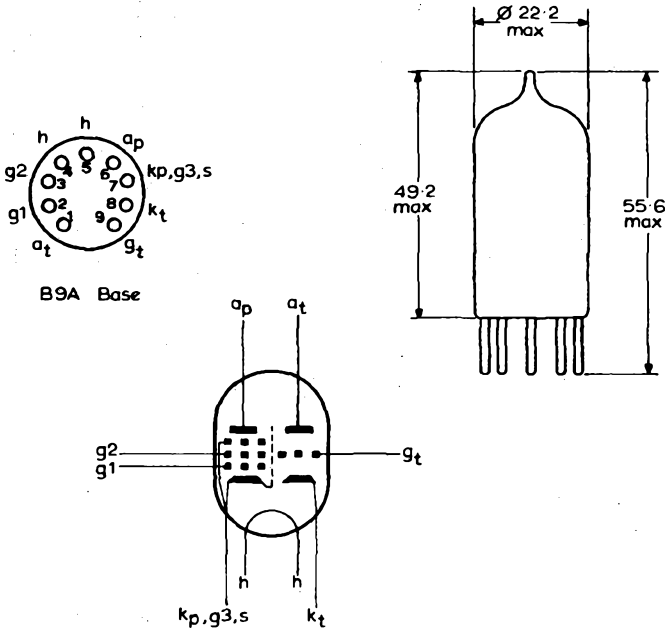

All dimensions in mm

D 1653

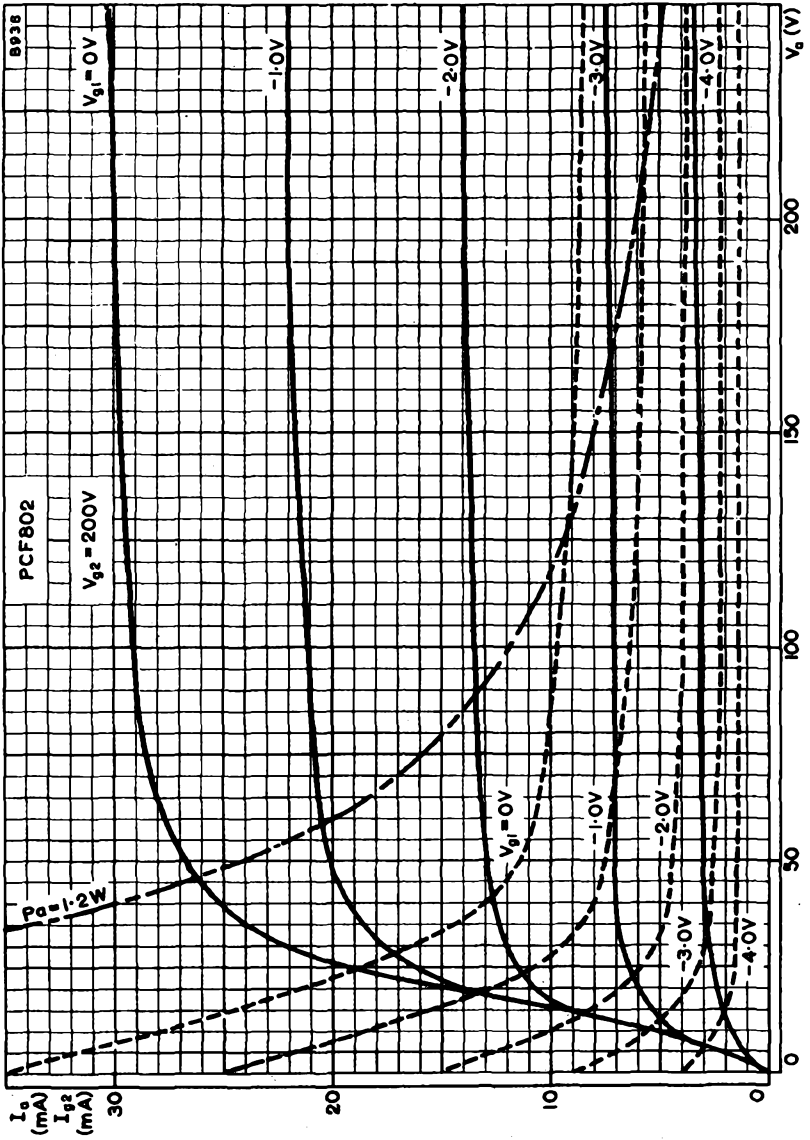

ANODE AND SCREEN-GRID CURRENTS PLOTTED AGAINST ANODE VOLTAGE WITH CONTROL-GRID VOLTAGE AS PARAMETER. $V_{g2} = 200V$

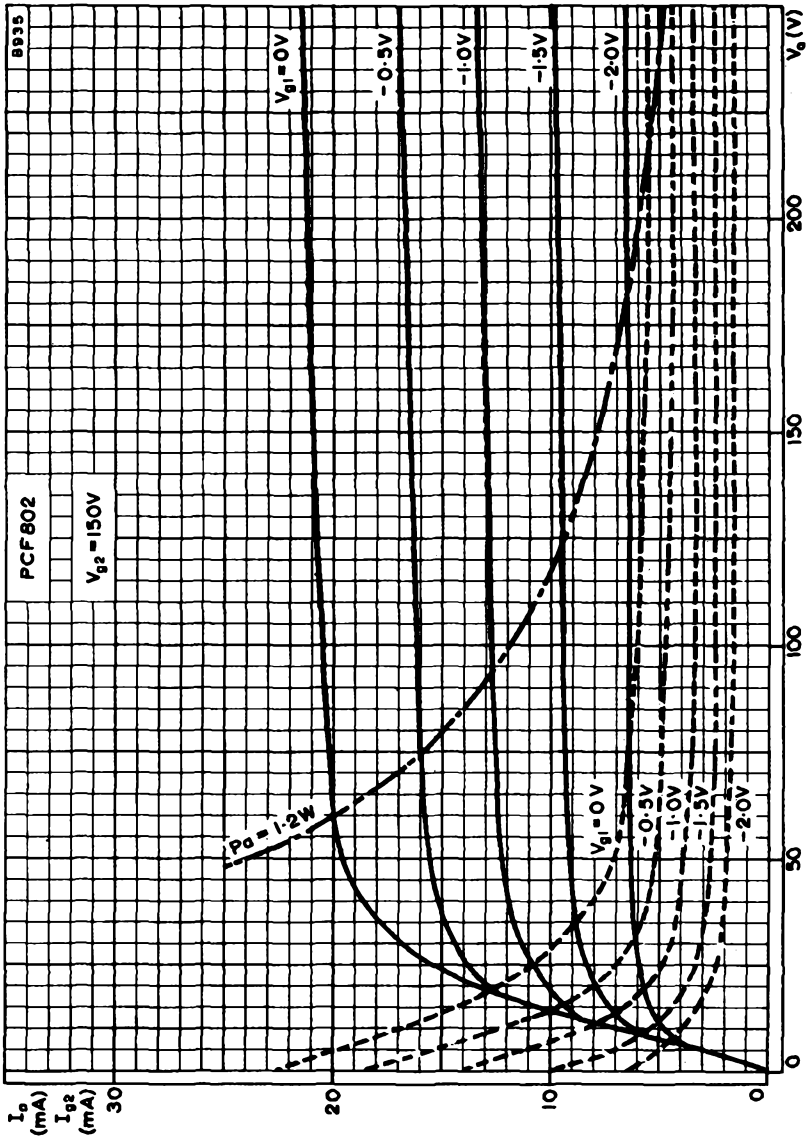

ANODE AND SCREEN-GRID CURRENTS PLOTTED AGAINST ANODE VOLTAGE WITH CONTROL-GRID VOLTAGE AS PARAMETER. $V_{g2} = 150V$

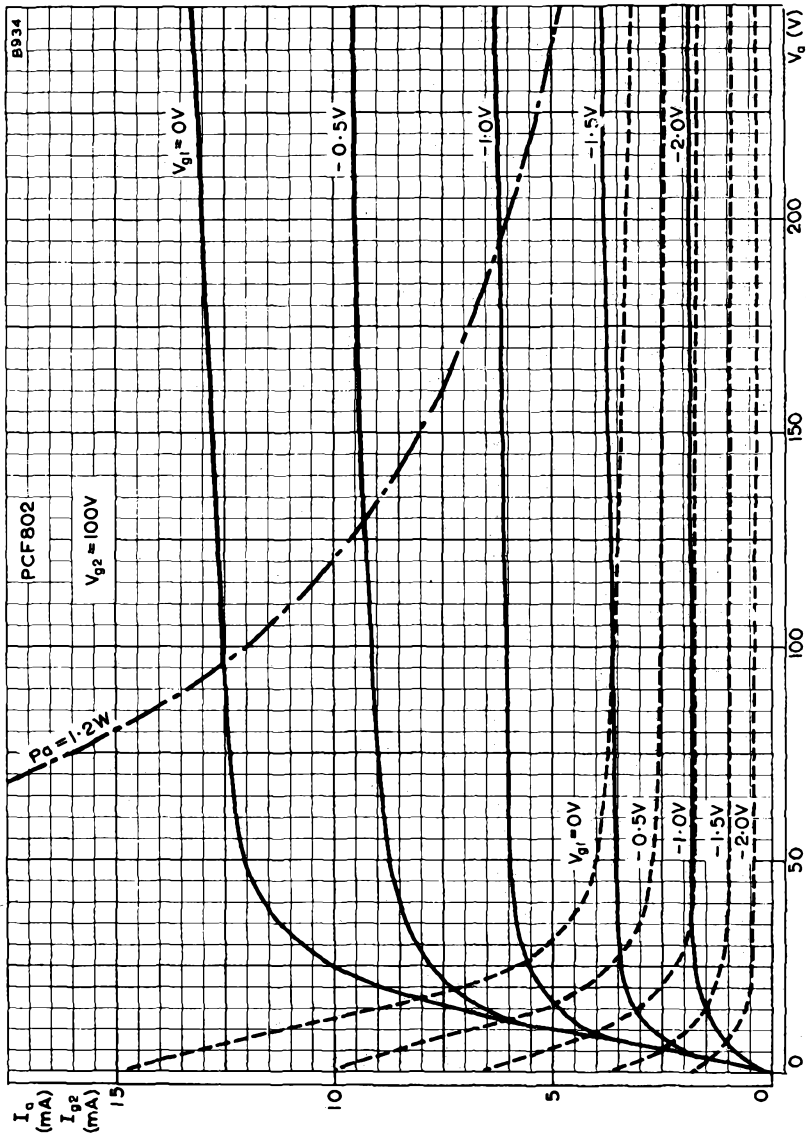

ANODE AND SCREEN-GRID CURRENTS PLOTTED AGAINST ANODE VOLTAGE WITH CONTROL-GRID VOLTAGE AS PARAMETER. $V_{g2} = 100V$

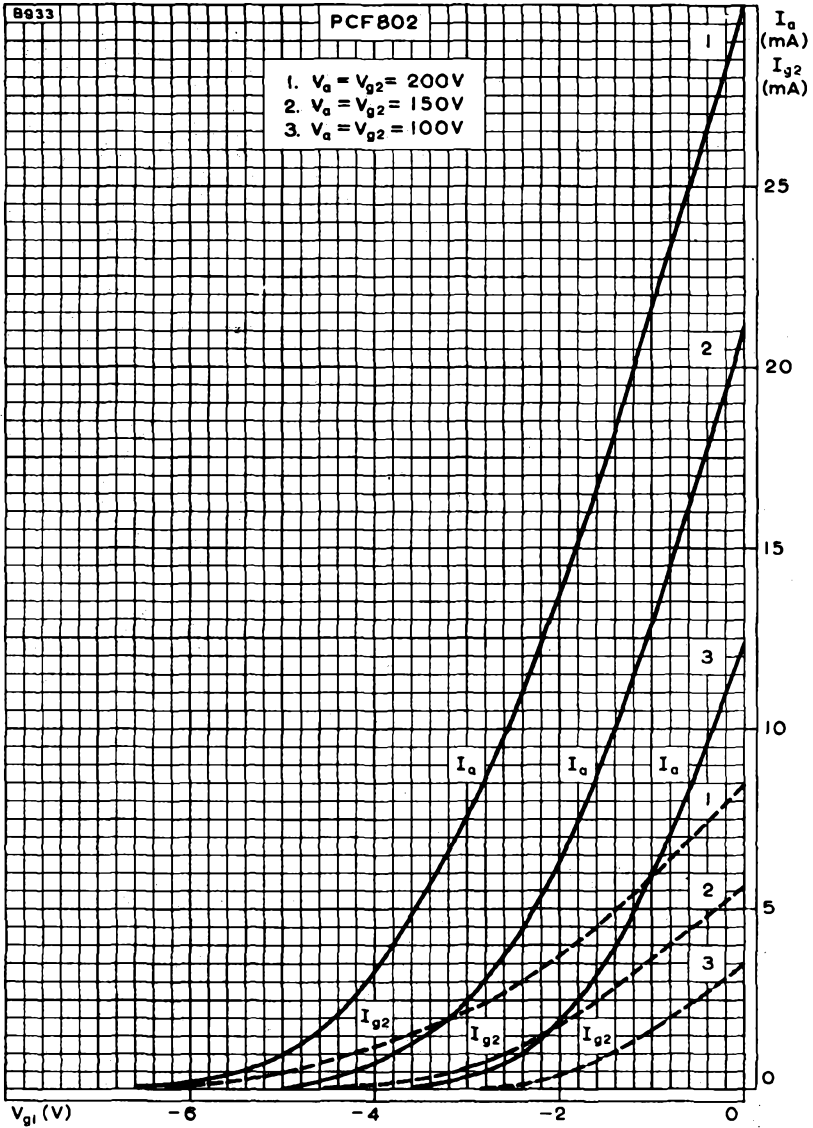

ANODE AND SCREEN-GRID CURRENTS PLOTTED AGAINST CONTROL-GRID VOLTAGE WITH ANODE AND SCREEN-GRID VOLTAGE AS PARAMETER

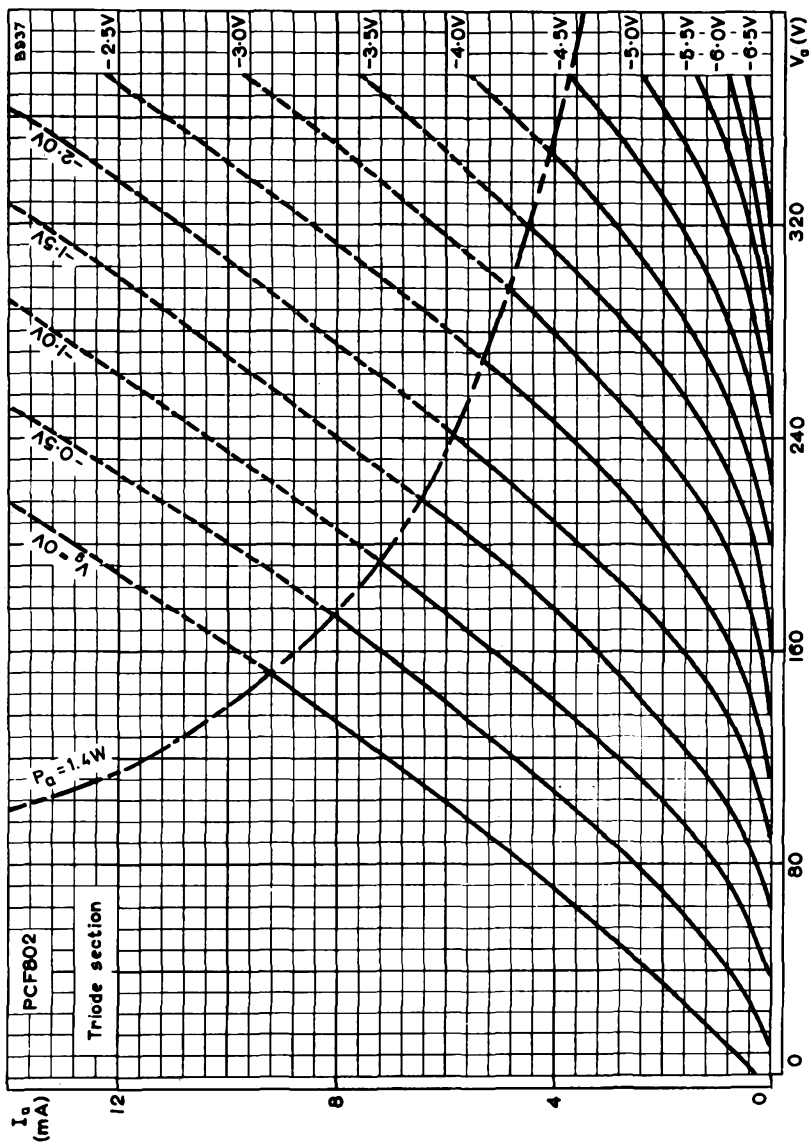

ANODE CURRENT PLOTTED AGAINST ANODE VOLTAGE WITH CONTROL-GRID VOLTAGE AS PARAMETER. TRIODE SECTION

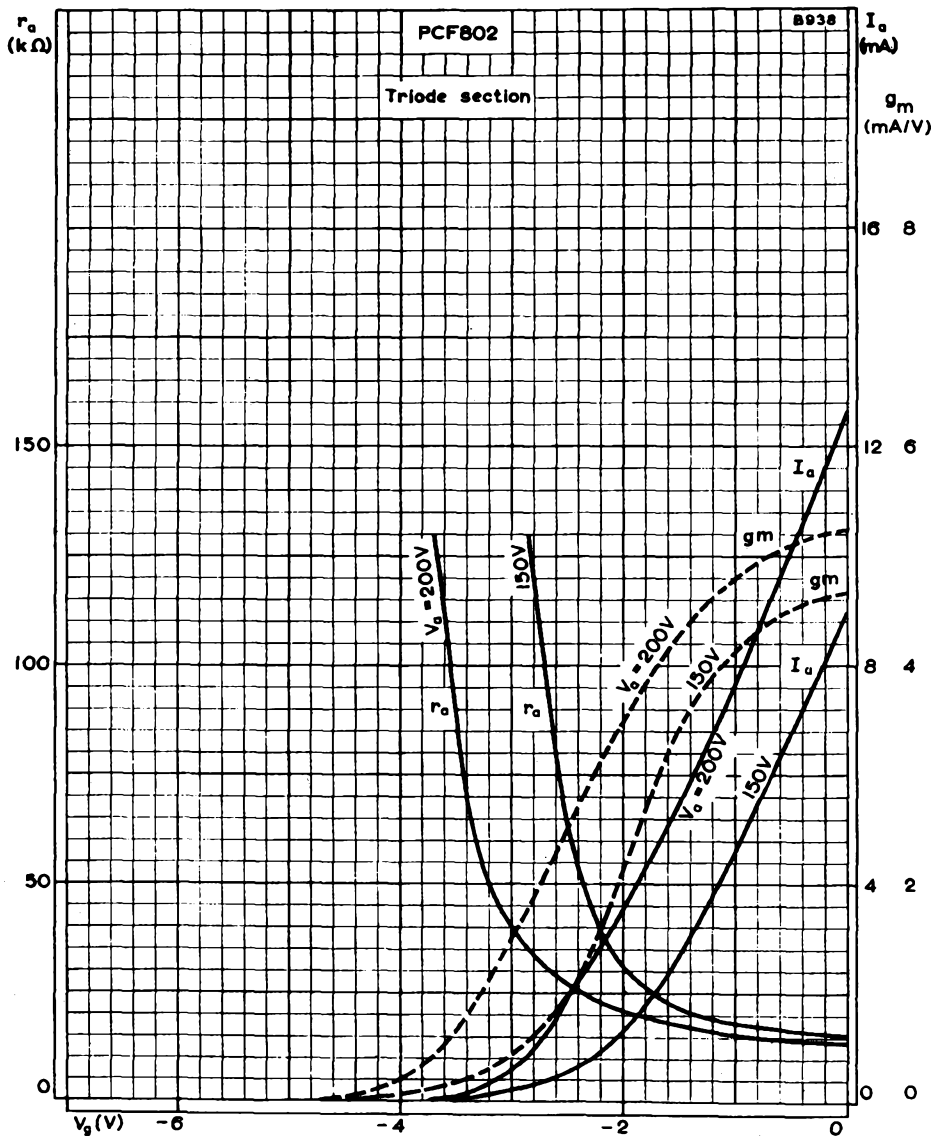

ANODE CURRENT, MUTUAL CONDUCTANCE, AND ANODE IMPEDANCE
 PLOTTED AGAINST CONTROL-GRID VOLTAGE. TRIODE SECTION



TRIODE PENTODE

PCL84

Triode pentode for use in television circuits as keyed a.g.c. valve, sync-separator, sync-amplifier or in noise suppression circuits. Pentode section for use as video output valve.

HEATER

I_h	300	mA
V_h	15	V

CAPACITANCES

C_{a1-g1}	<10	mpF
C_{g1-g1}	<10	mpF
Pentode section		
C_{in}	8.7	pF
C_{out}	4.2	pF
C_{a-g1}	<100	mpF
Triode section		
C_{g-k}	3.8	pF
C_{a-k}	2.3	pF
C_{a-g}	2.7	pF
C_{g-h}	<100	mpF

CHARACTERISTICS

Pentode section

V_a	170	200	220	V
V_{g2}	170	200	220	V
V_{g1}	-2.1	-2.9	-3.4	V
I_a	18	18	18	mA
I_{g2}	3.0	3.0	3.0	mA
g_m	11	10.4	10	mA/V
r_a	100	130	150	k Ω
μ_{g1-g2}	36	36	36	
V_{g1} max. ($I_{g1} = +0.3\mu A$)			-1.3	V

Triode section

V_a	200	V
V_g	-1.7	V
I_a	3.0	mA
g_m	4.0	mA/V
r_a	16.2	k Ω
μ	65	
V_g max. ($I_g = +0.3\mu A$)	-1.3	V



PENTODE SECTION AS VIDEO OUTPUT VALVE

$V_b = V_{g2}$	170	200	220	V
V_{g1}	-2.0	-2.8	-3.3	V
R_a	3.0	3.0	3.0	k Ω
I_a	18	18	18	mA
I_{g2}	3.2	3.1	3.1	mA
g_m	10.4	10	9.7	mA/V

LIMITING VALUES

Pentode section

$V_{a(b)}$ max.	550	V
V_a max.	250	V
p_a max.	4.0	W
$V_{g2(b)}$ max.	550	V
V_{g2} max.	250	V
p_{g2} max.	1.7	W
I_k max.	40	mA
R_{g1-k} max. (fixed bias)	1.0	M Ω
R_{g1-k} max. (self bias)	2.0	M Ω
V_{h-k} max.	200	V
R_{h-k} max.	20	k Ω

Triode section

$V_{a(b)}$ max.	550	V
V_a max.	250	V
$V_{a(pk)}$ max.	600	V
p_a max.	1.0	W
* $I_{k(pk)}$ max.	160	mA
I_k max.	12	mA
R_{g-k} max. (fixed bias)	1.0	M Ω
R_{g-k} max. (self bias)	3.0	M Ω
V_{h-k} max. (cathode negative)	150	V
† V_{h-k} max. (cathode positive)	350	V
R_{h-k} max.	20	k Ω

*Maximum pulse duration = 800 μ s.

†Maximum d.c. component = 200V.

4690

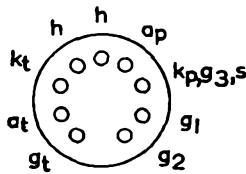
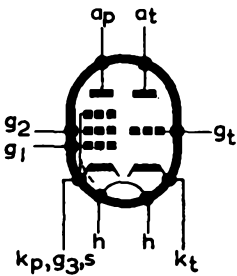

B9A Base

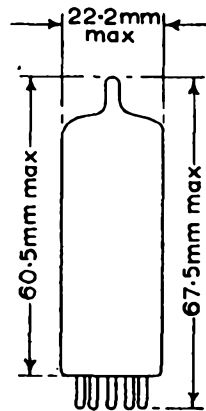



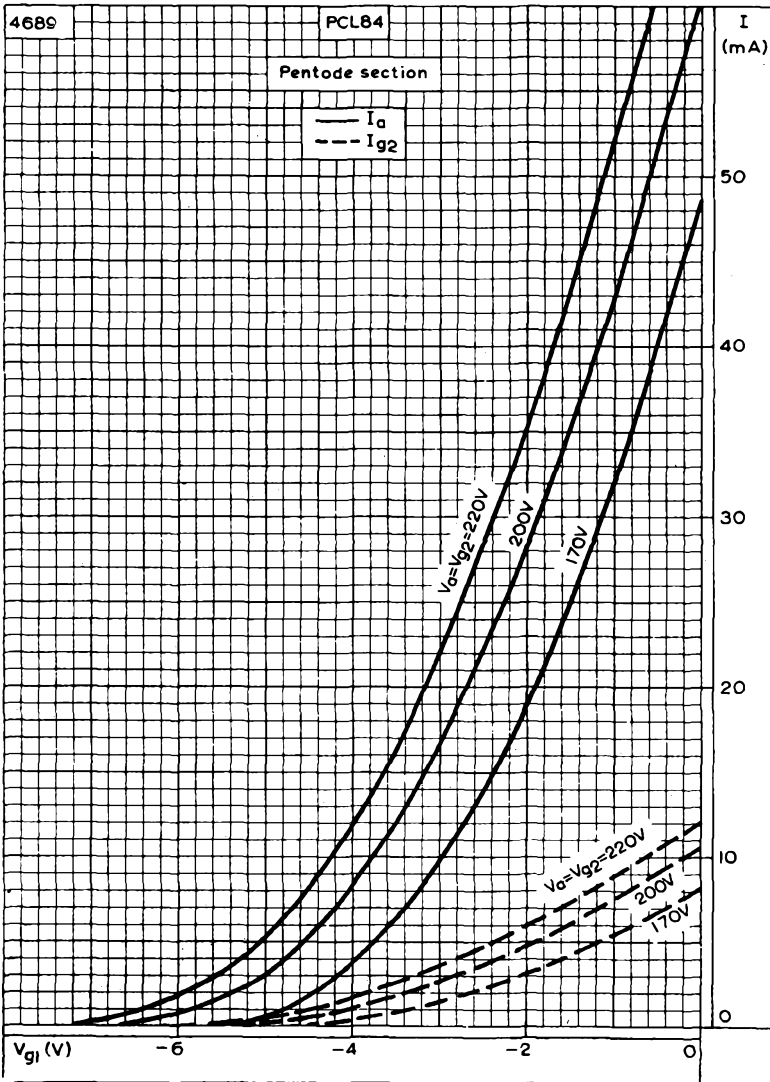

ANODE AND SCREEN-GRID CURRENTS PLOTTED AGAINST CONTROL-GRID VOLTAGE FOR VARIOUS ANODE AND SCREEN-GRID VOLTAGES



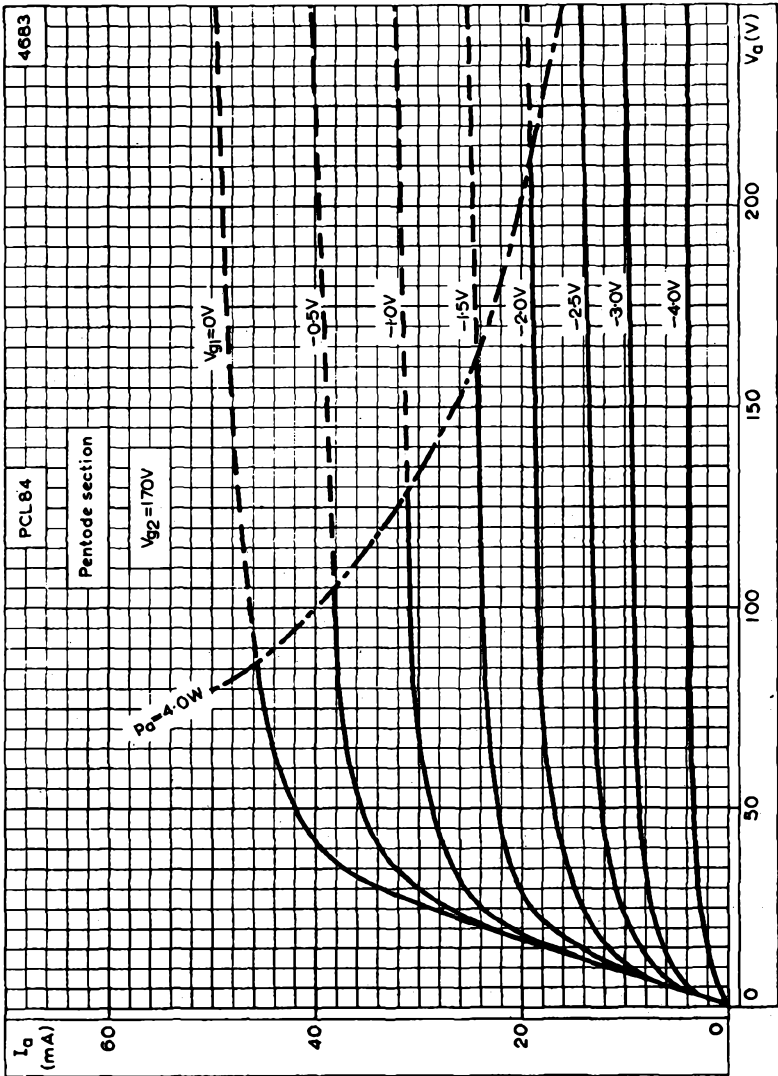

ANODE CURRENT PLOTTED AGAINST ANODE VOLTAGE
WITH CONTROL-GRID VOLTAGE AS PARAMETER.
 $V_{g2} = 170V$

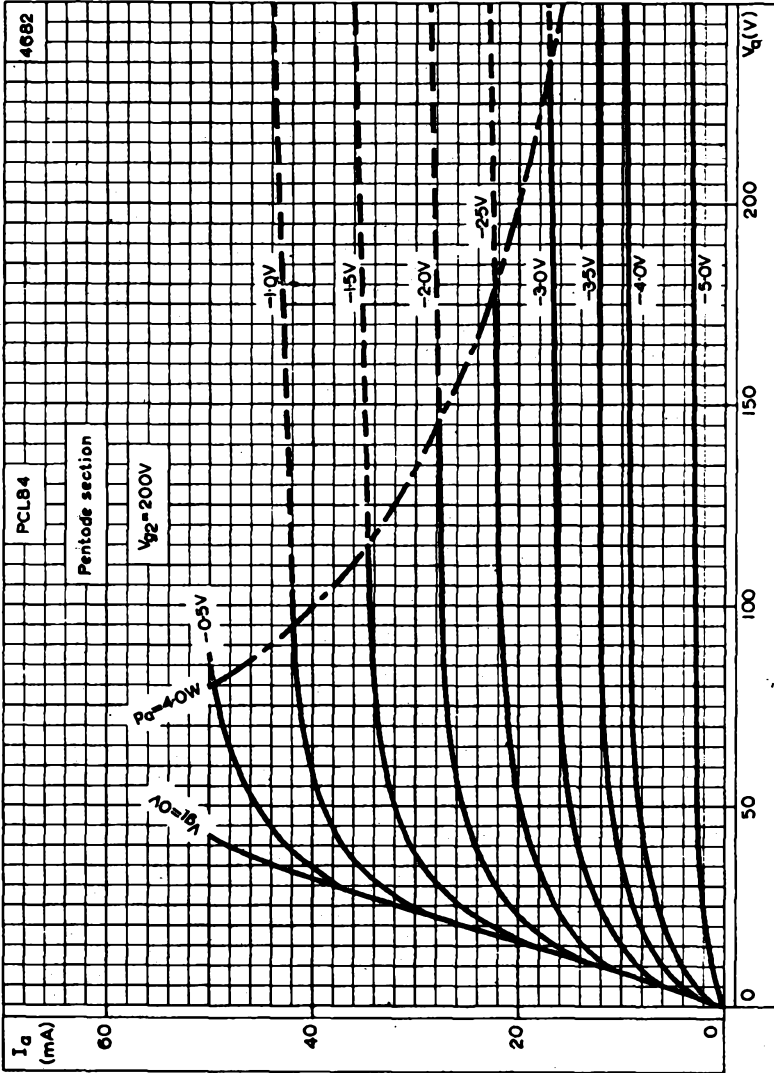

ANODE CURRENT PLOTTED AGAINST ANODE VOLTAGE
WITH CONTROL-GRID VOLTAGE AS PARAMETER
 $V_{g2} = 200V$



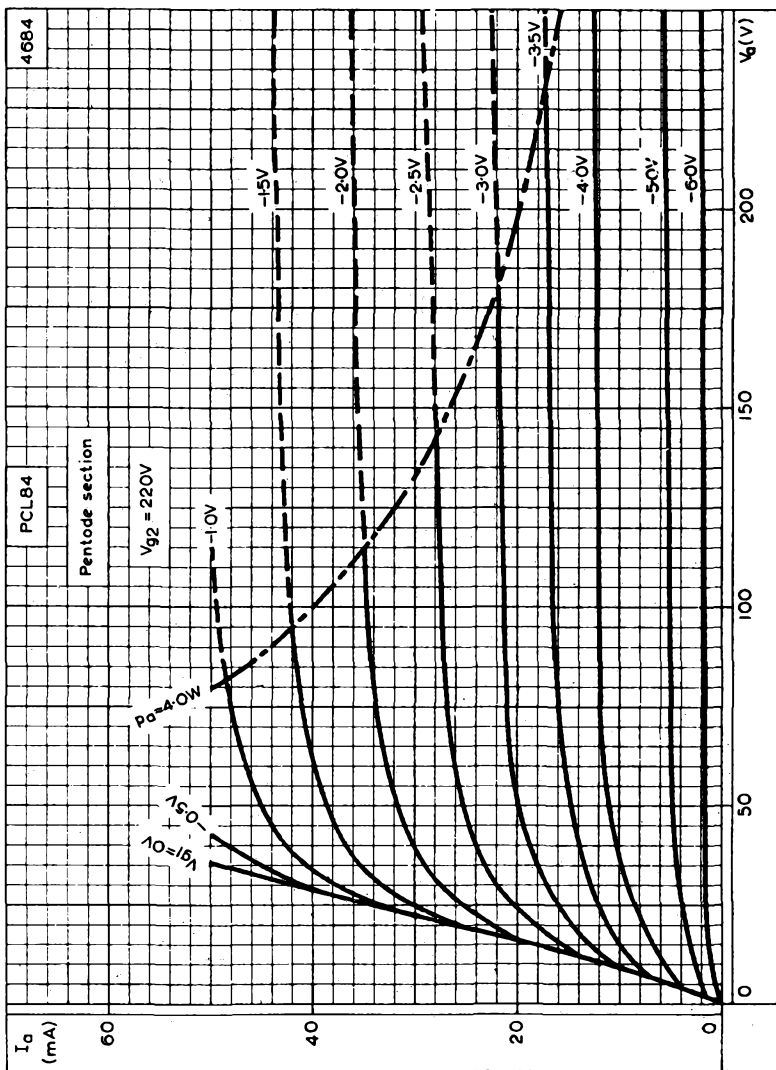

ANODE CURRENT PLOTTED AGAINST ANODE VOLTAGE
WITH CONTROL-GRID VOLTAGE AS PARAMETER
 $V_{g2} = 220V$



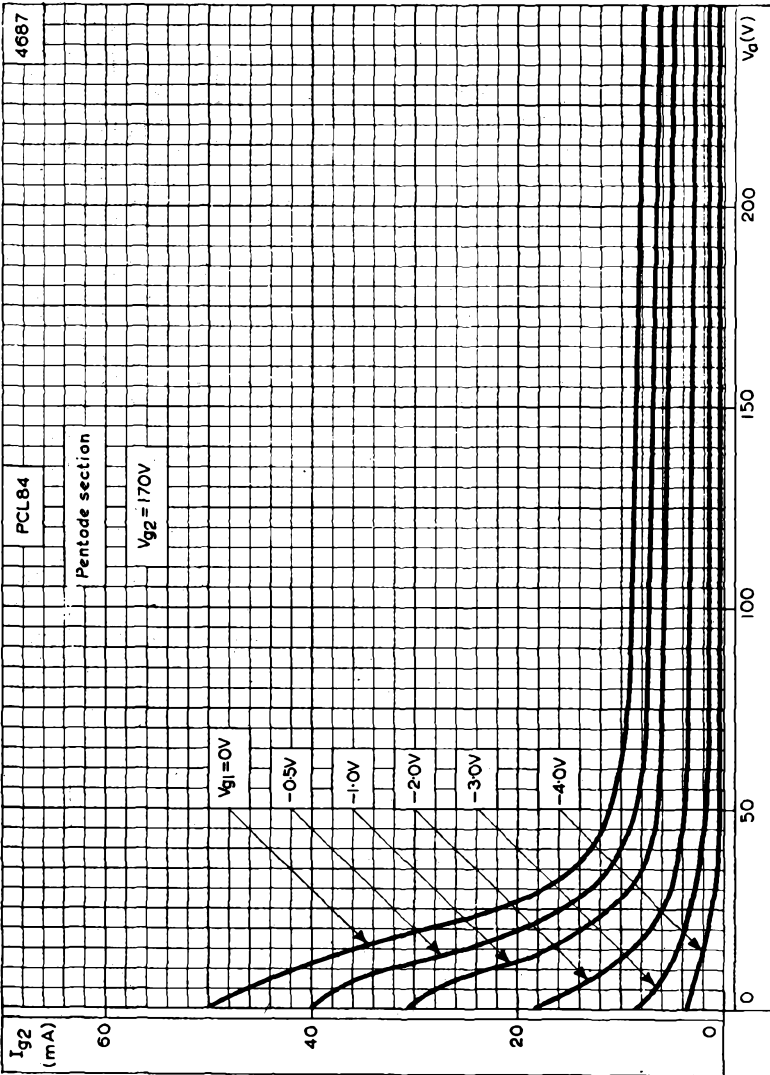

SCREEN-GRID CURRENT PLOTTED AGAINST ANODE VOLTAGE
WITH CONTROL-GRID VOLTAGE AS PARAMETER
 $V_{g2} = 170V$



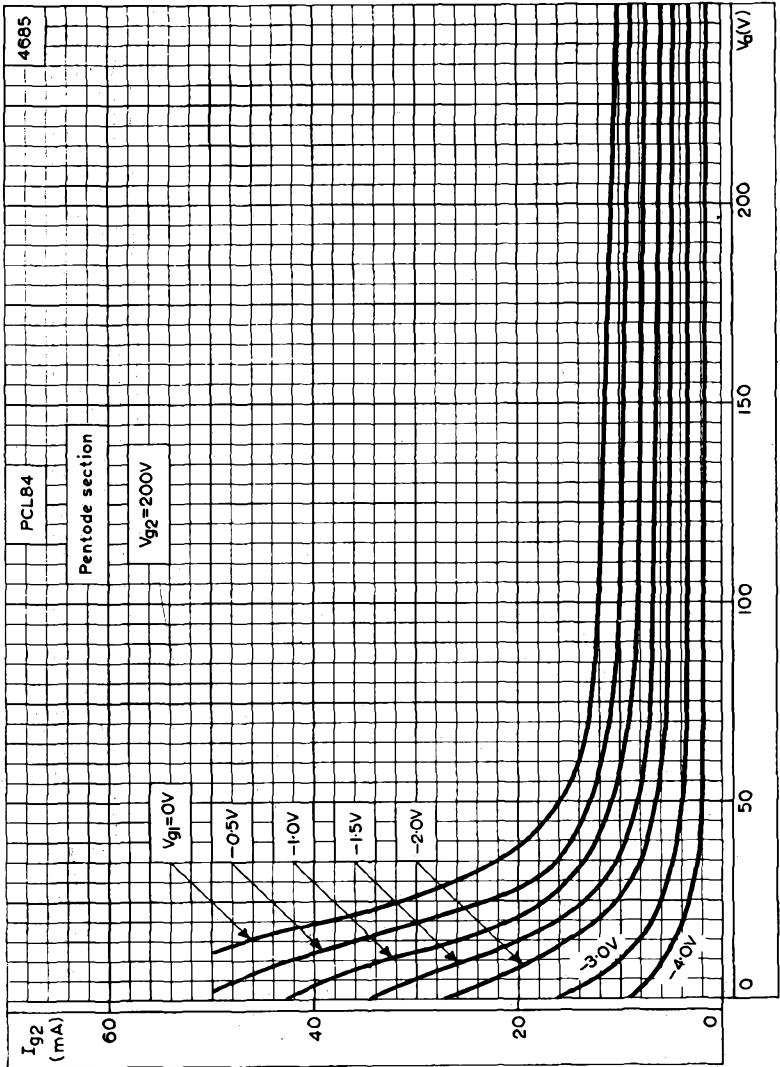

SCREEN-GRID CURRENT PLOTTED AGAINST ANODE VOLTAGE
WITH CONTROL-GRID VOLTAGE AS PARAMETER
 $V_{g2} = 200V$



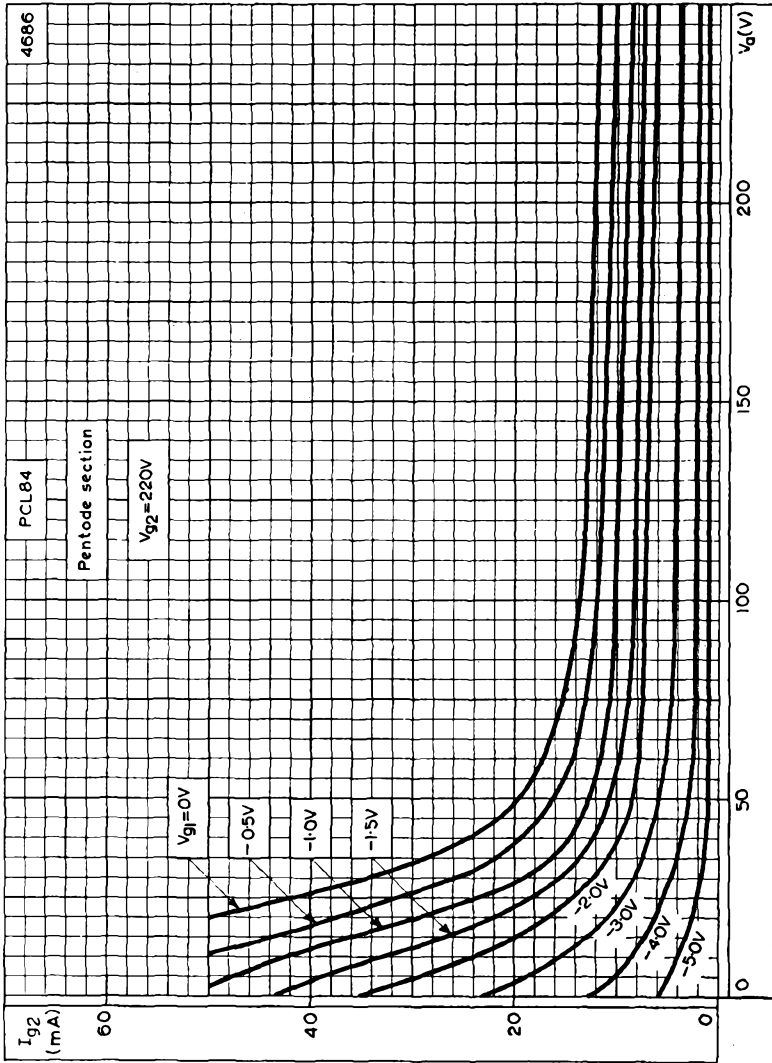

SCREEN-GRID CURRENT PLOTTED AGAINST ANODE VOLTAGE WITH CONTROL-GRID VOLTAGE AS PARAMETER
 $V_{g2} = 220V$



PCL84

TRIODE PENTODE

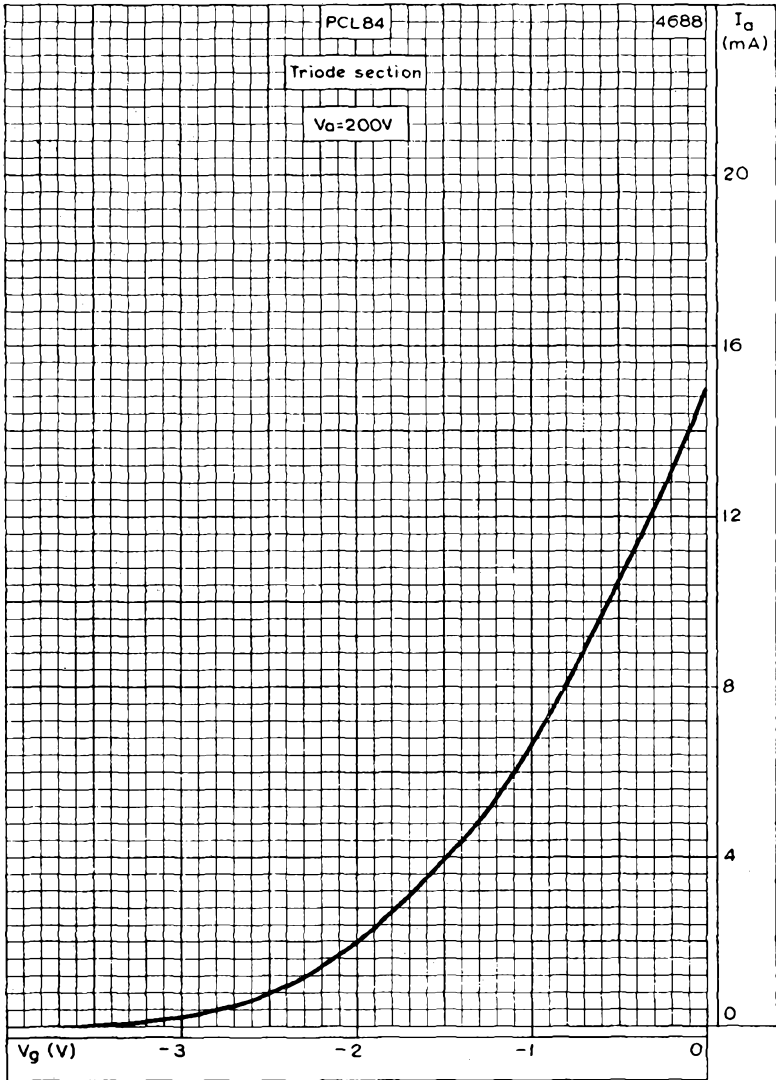

ANODE CURRENT PLOTTED AGAINST GRID VOLTAGE
FOR TRIODE SECTION



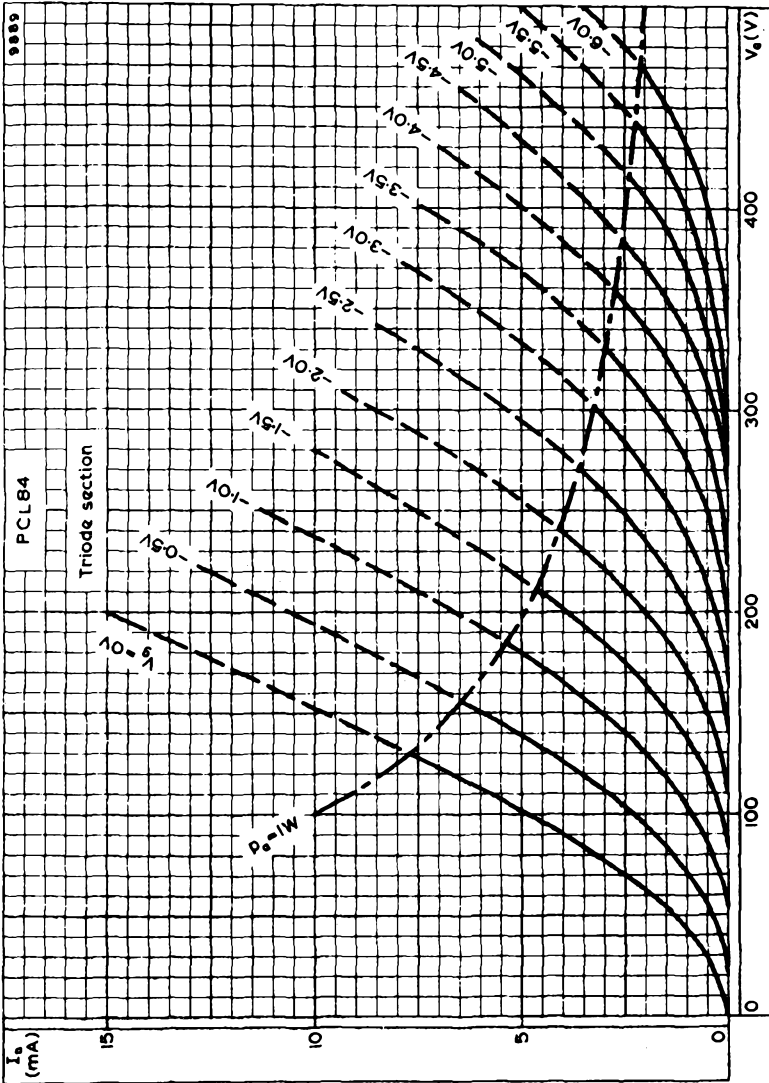

ANODE CURRENT PLOTTED AGAINST ANODE VOLTAGE WITH CONTROL-GRID VOLTAGE AS PARAMETER. TRIODE SECTION





TRIODE PENTODE

PCL86

Combined high- μ triode and output pentode for use in the audio amplifier stage of television receivers.

HEATER

I_h	300	mA
V_h	13.3	V

CAPACITANCES

C_{sp-gt}	< 6.0	mpF
C_{at-g1}	< 200	mpF
C_{gt-g1}	< 20	mpF
C_{at-sp}	< 150	mpF

Pentode section

C_{in}	10	pF
C_{a-g1}	< 400	mpF
C_{g1-h}	< 240	mpF

Triode section

C_{in}	2.3	pF
C_{out}	2.5	pF
C_{a-g}	1.4	pF
C_{g-h}	< 6.0	mpF

CHARACTERISTICS

Pentode section

V_a	230	V
V_{g2}	230	V
V_{g1}	-5.7	V
I_a	39	mA
I_{g2}	6.5	mA
g_m	10.5	mA/V
r_a	45	k Ω
μ_{g1-g2}	21	

$-V_{g1} \max (I_{g1} = + 0.3\mu A)$	1.3	V
--------------------------------------	-----	---

Triode section

V_a	230	V
V_g	-1.7	V
I_a	1.2	mA
g_m	1.6	mA/V
μ	100	
r_a	62	k Ω

$-V_{g1} \max (I_{g1} = + 0.3\mu A)$	1.3	V
--------------------------------------	-----	---

OPERATING CONDITIONS AS SINGLE VALVE AMPLIFIER

Pentode section

V_a	230	200	V
V_{g2}	230	200	V
V_{g1}	-5.7	-4.7	V
R_k	125	115	Ω
I_a	41	34	mA
I_{g2}	10.5	9.0	mA
R_a	5.1	5.6	k Ω
P_{out}	4.1	3.1	W
$V_{in(r.m.s.)}$	3.6	3.2	V
D_{tot}	10	10	$^{\circ}C$
$V_{in(r.m.s.)} (P_{out} = 50mW)$	300	290	mV

OPERATING CONDITIONS FOR TRIODE SECTION AS RESISTANCE COUPLED A.F. AMPLIFIER

Grid current bias ($R_g = 10M\Omega$)

V_b (V)	R_a (k Ω)	$R_{g\uparrow}$ (k Ω)	I_a (mA)	$Z_s = 0k\Omega$		$Z_s = 220k\Omega$	
				V_{out} V_{in}	$V_{out(r.m.s.)}^*$ (V)	V_{out} V_{in}	$V_{out(r.m.s.)}^{**}$ (V)
230	47	150	1.37	40	15	32	18
170	47	150	0.82	36	9	29	11
230	100	330	0.90	57	22	45	26
170	100	330	0.58	53	13	42	16
230	220	680	0.57	72	26	55	33
170	220	680	0.37	67	15	52	21

*Output voltage measured at $D_{tot} = 5\%$.

$\frac{V_{out}}{V_{in}}$ measured with $V_{in(r.m.s.)} = 100mV$.

†Grid resistor of following valve.

**When operating this valve with grid current bias and a high source impedance, the second harmonic distortion rises to a peak at quite low levels of output (about $10V_{r.m.s.}$) and then falls with increasing drive. The third harmonic then begins to rise, and D_{tot} finally reaches 5% at a much higher output level than with zero source impedance. The maximum value of this distortion peak varies inversely with the anode load, being about 5.5% with $R_a = 47k\Omega$, 4.5% with $R_a = 100k\Omega$ and 4% with $R_a = 220k\Omega$.

LIMITING VALUES

Pentode section

$V_{a(b)}$ max.	550	V
V_a max.	250	V
p_a max.	9.0	W
$V_{g2(b)}$ max.	550	V
V_{g2} max.	250	V
p_{g2} max.	1.8	W
I_k max.	55	mA
R_{g1-k} max.	1.0	M Ω
V_{h-k} max.	100	V
R_{h-k} max.	20	k Ω

Triode section

$V_{a(b)}$ max.	550	V
V_a max.	250	V
p_a max.	500	mW
I_k max.	4.0	mA
R_{g-k} max.	1.0	M Ω
V_{h-k} max.	100	V
† R_{h-k} max.	20	k Ω

†When used as a phase inverter immediately preceding the output stage, R_{h-k} max. may be 120k Ω .

OPERATING NOTES

1. Microphony

This valve may be used without special precautions against microphony in equipment where the input voltage is not less than 10mV for an output of 50mW.

2. Hum

To obtain the minimum value of hum, the a.c. voltage between pin 4 and triode cathode should not exceed 30V.

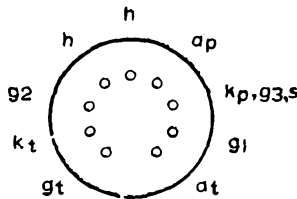
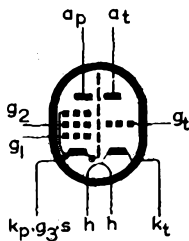

B9A Base

All dimensions in mm

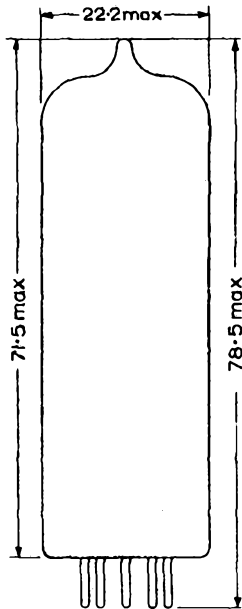

7471





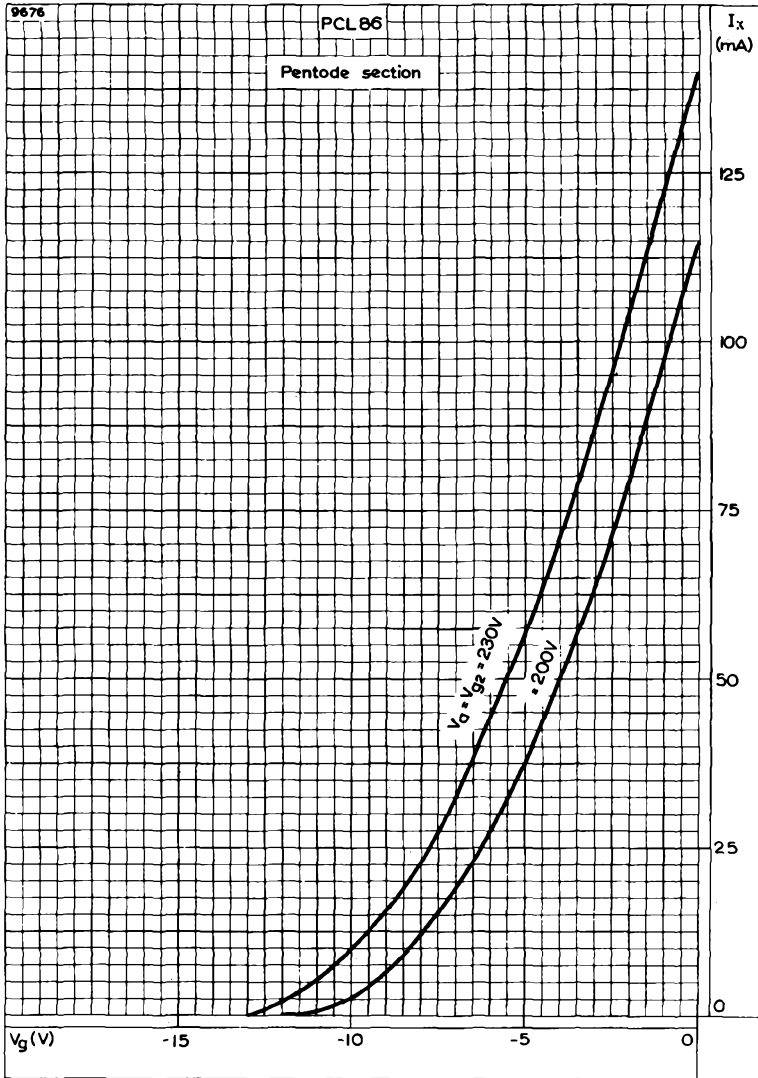

CATHODE CURRENT PLOTTED AGAINST CONTROL GRID VOLTAGE WITH ANODE AND SCREEN GRID VOLTAGES AS PARAMETER. PENTODE SECTION



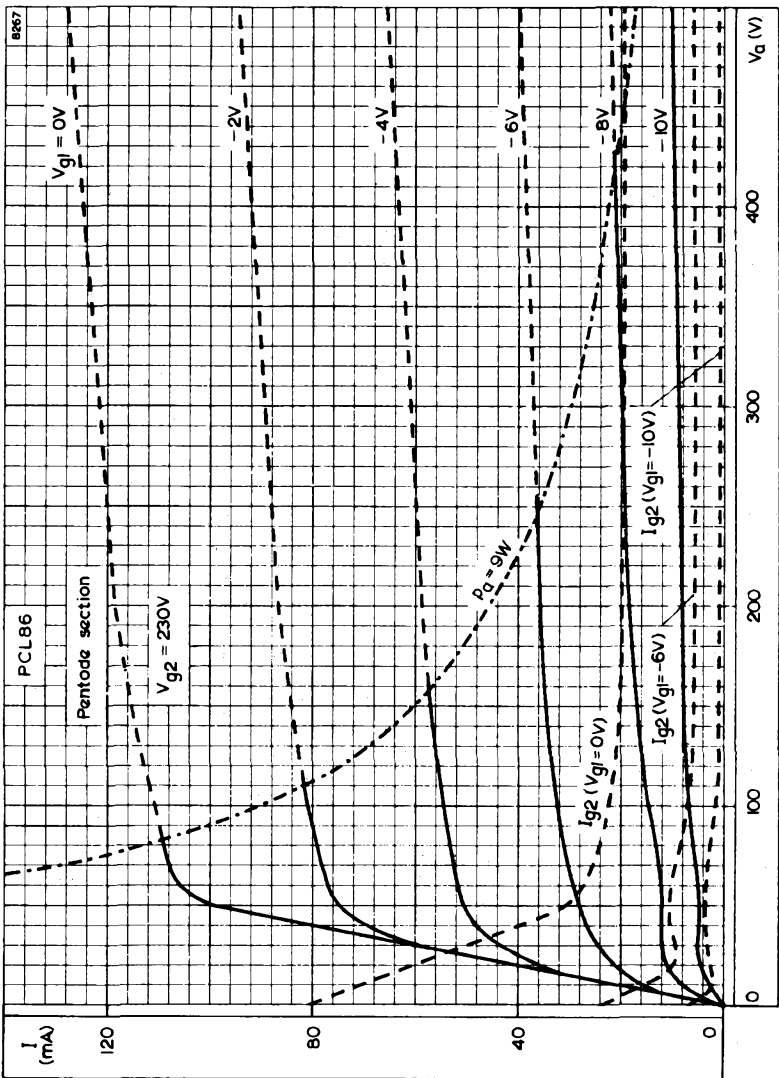

ANODE AND SCREEN GRID CURRENTS PLOTTED AGAINST ANODE VOLTAGE WITH CONTROL GRID VOLTAGE AS PARAMETER.
 PENTODE SECTION $V_{g2} = 230V$

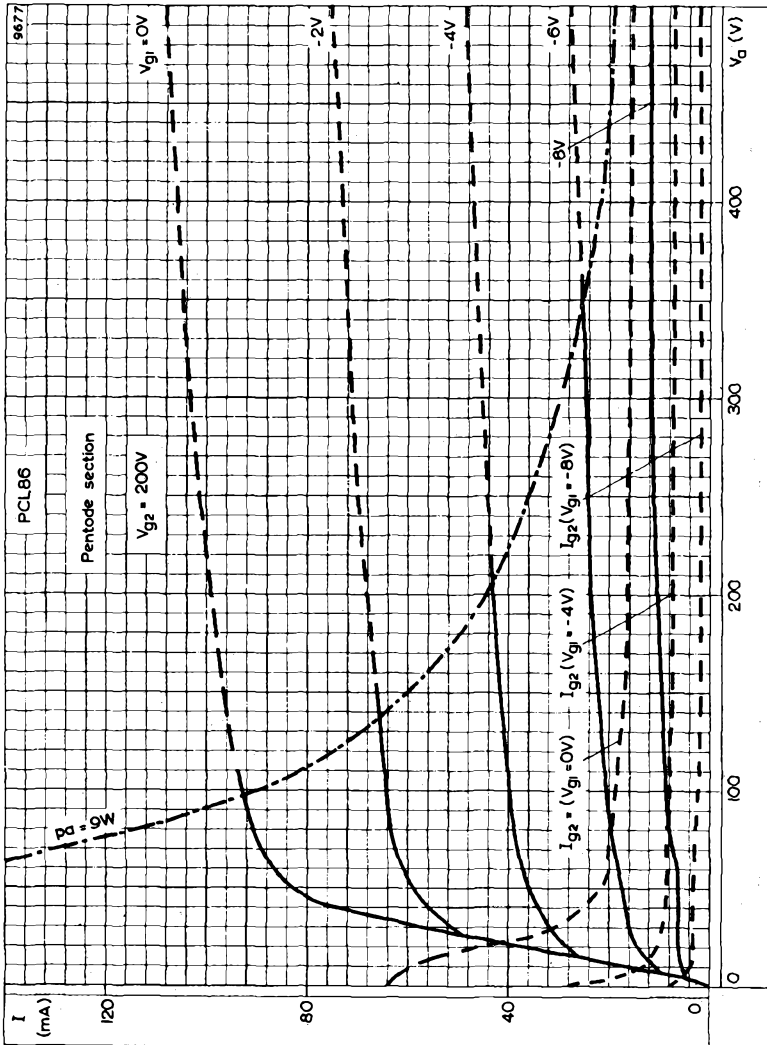

ANODE AND SCREEN GRID CURRENTS PLOTTED AGAINST ANODE VOLTAGE WITH CONTROL GRID VOLTAGE AS PARAMETER. PENTODE SECTION $V_{g2} = 200V$





PCL86

TRIODE PENTODE

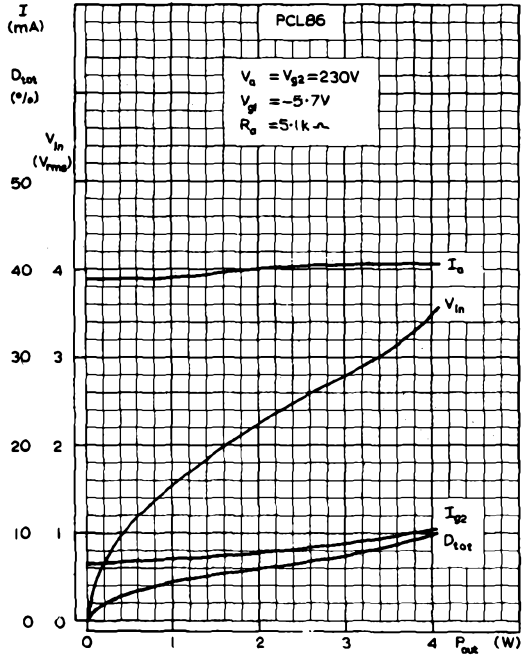

PERFORMANCE OF PCL86 AS SINGLE VALVE AMPLIFIER. PENTODE SECTION $V_a = V_{g2} = 230V$, $R_k = 125\Omega$

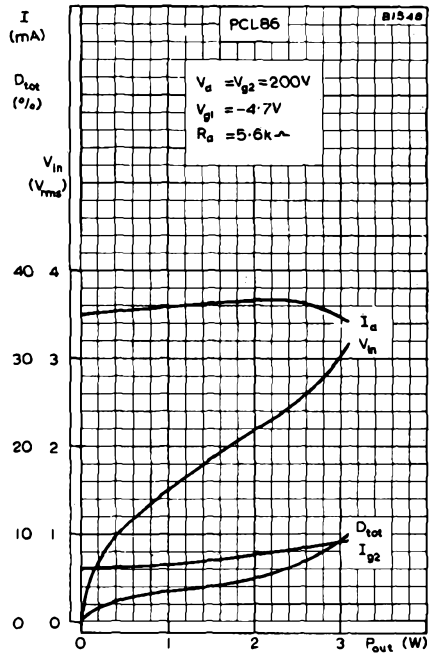

PERFORMANCE OF PCL86 AS SINGLE VALVE AMPLIFIER. PENTODE SECTION $V_a = V_{g2} = 200V$, $R_k = 115\Omega$



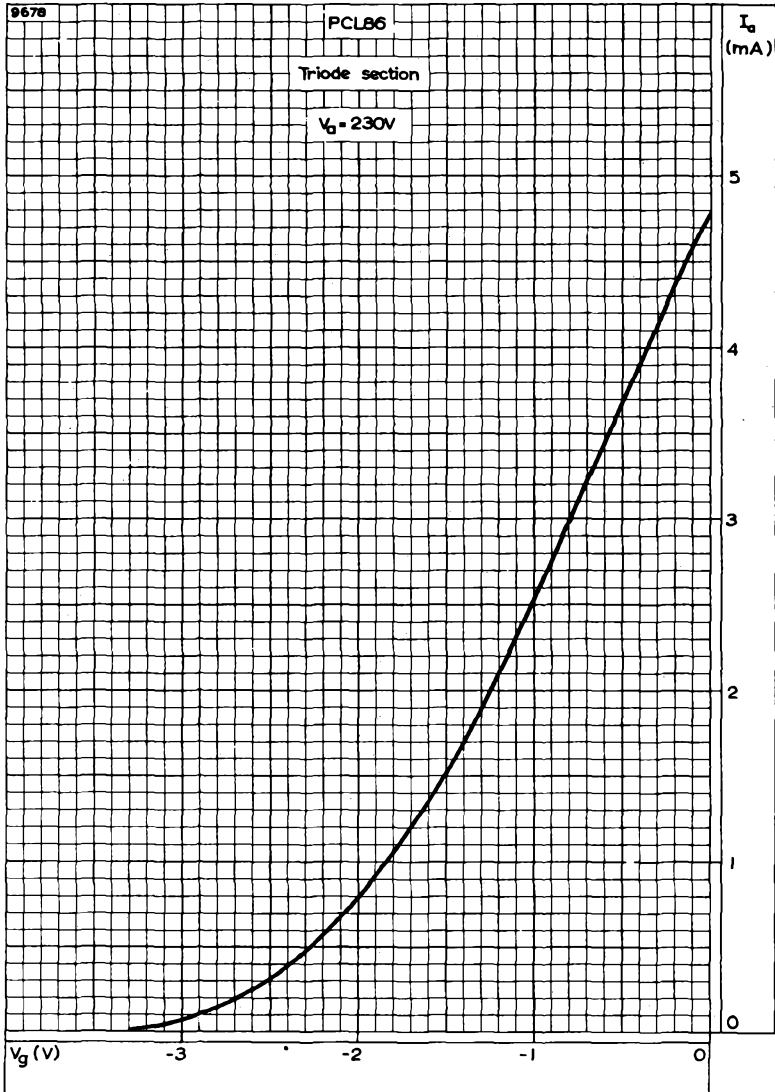

ANODE CURRENT PLOTTED AGAINST CONTROL GRID VOLTAGE.
TRIODE SECTION $V_a = 230V$



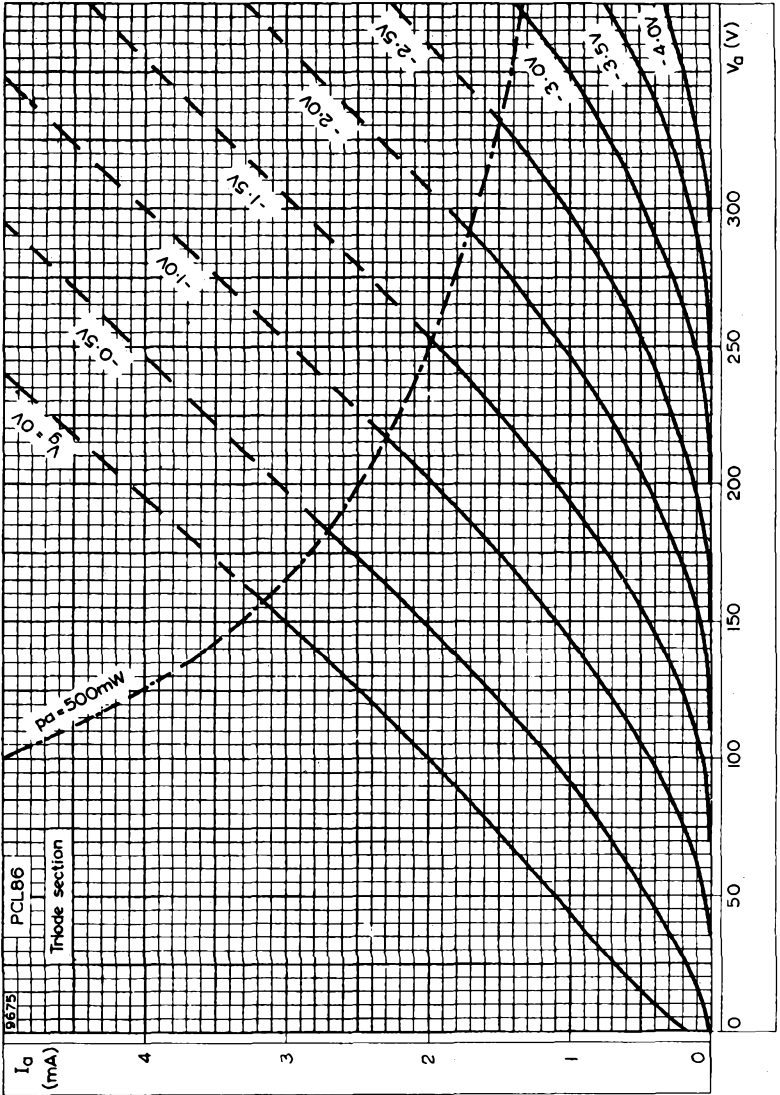

ANODE CURRENT PLOTTED AGAINST ANODE VOLTAGE WITH CONTROL GRID VOLTAGE AS PARAMETER.
TRIODE SECTION



TRIODE PENTODES

PCL805
PCL85

Combined triode pentode with separate cathodes for use as a field oscillator and field output valve in television receivers
Data is applicable to both types

HEATER

Suitable for series operation, a.c. or d.c.

I_h	300	mA
V_h	17.5	V

CAPACITANCES

c_{ap-gt}	< 0.03	pF
c_{ap-g1}	< 0.6	pF
c_{at-g1}	< 0.08	pF
c_{g1-h}	< 0.2	pF
c_{gt-h}	< 0.15	pF

CHARACTERISTICS (See NOTES)

Pentode section (field output application)

V_a	50	65	V
V_{g2}	170	210	V
V_{g1}	-1	-1	V
$I_a(pk)$	200	285	mA
$I_{g2}(pk)$	35	45	mA

Triode section

V_a	100	100	V
V_g	-0.85	0	V
I_a	5	10.5	mA
g_m	5.5	7	mA/V
μ	60	63	
r_a	11	9	k Ω

HUM

The equivalent pentode grid hum voltage without negative feedback is $\leq 10mV$ when $Z_{g1} (f = 50Hz) \leq 500k\Omega$, $c_{g1-h} = 0.2pF$ and $V_{h-k} = 150V$ r.m.s.



RATINGS (DESIGN CENTRE SYSTEM unless otherwise stated)

Pentode section

$V_{a(b)}$ max.	550	V
V_a max.	300	V
* $v_{a(pk)}$ max.	2.0	kV
P_a max.	8.0	W
P_a max. (design maximum rating)	10.5	W
$V_{g2(b)}$ max.	550	V
V_{g2} max.	250	V
P_{g2} max.	1.5	W
P_{g2} max. (design maximum rating)	2.0	W
I_k max.	75	mA
R_{g1-k} max. (fixed bias)	1.0	MΩ
R_{g1-k} max. (automatic bias)	2.2	MΩ
V_{h-k} max.	200	V

*Maximum pulse duration 5% of one cycle with a maximum of 1ms.

Triode section

$V_{a(b)}$ max.	550	V
V_a max.	300	V
P_a max.	0.5	W
I_k max.	15	mA
** $i_{k(pk)}$ max.	150	mA
*** $i_{k(pk)}$ max.	100	mA
R_{g-k} max. (fixed bias)	1.0	MΩ
R_{g-k} max. (automatic bias)	3.3	MΩ
† V_{h-k} max.	200	V

**Maximum pulse duration 2% of one cycle with a maximum of 0.4ms.

***Maximum pulse duration 4% of one cycle with a maximum of 0.8ms.

†During warm-up the d.c. component of V_{h-k} may rise to a maximum of 315V, cathode positive.



NOTES

The minimum value of $i_{a(pk)}$ (pentode section) to be expected as a result of spread in valve characteristics, valve deterioration during life and decrease of the mains voltage by 10% of its nominal value, can be derived from the curves on page 9 by applying the formula:

$$i_{a(pk) \text{ min.}} = 0.6 I_{a(1)}$$

where $I_{a(1)}$ is the value of I_a at the intersection of line AB and the curve for the value of V_{g2} at the reduced mains voltage.

OUTLINE AND SCHEMATIC DRAWINGS

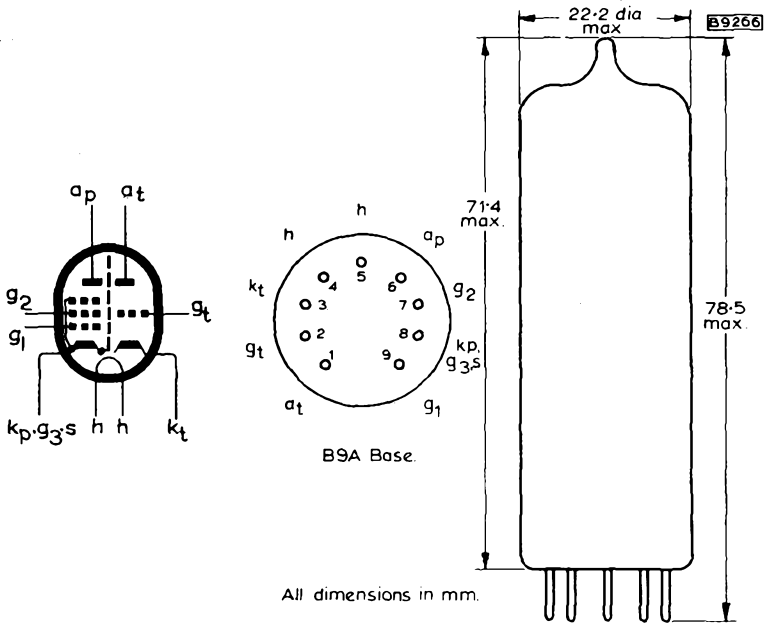

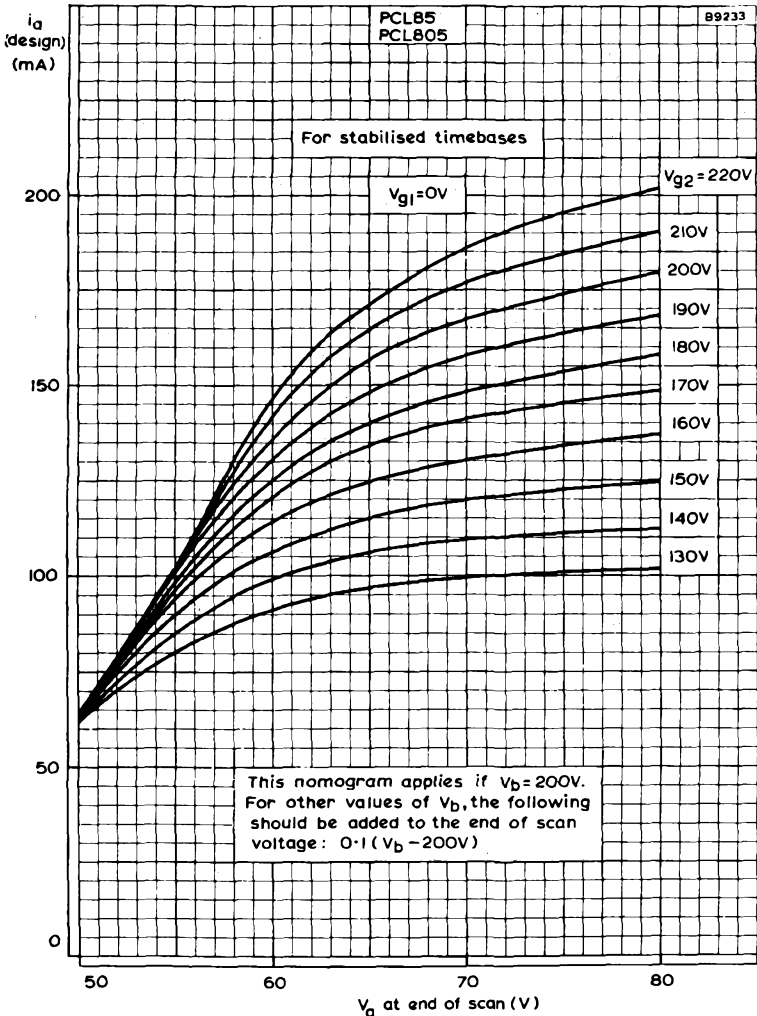

DESIGN CHART FOR STABILISED TIME BASES:
PENTODE SECTION



TRIODE PENTODES

PCL805
PCL85

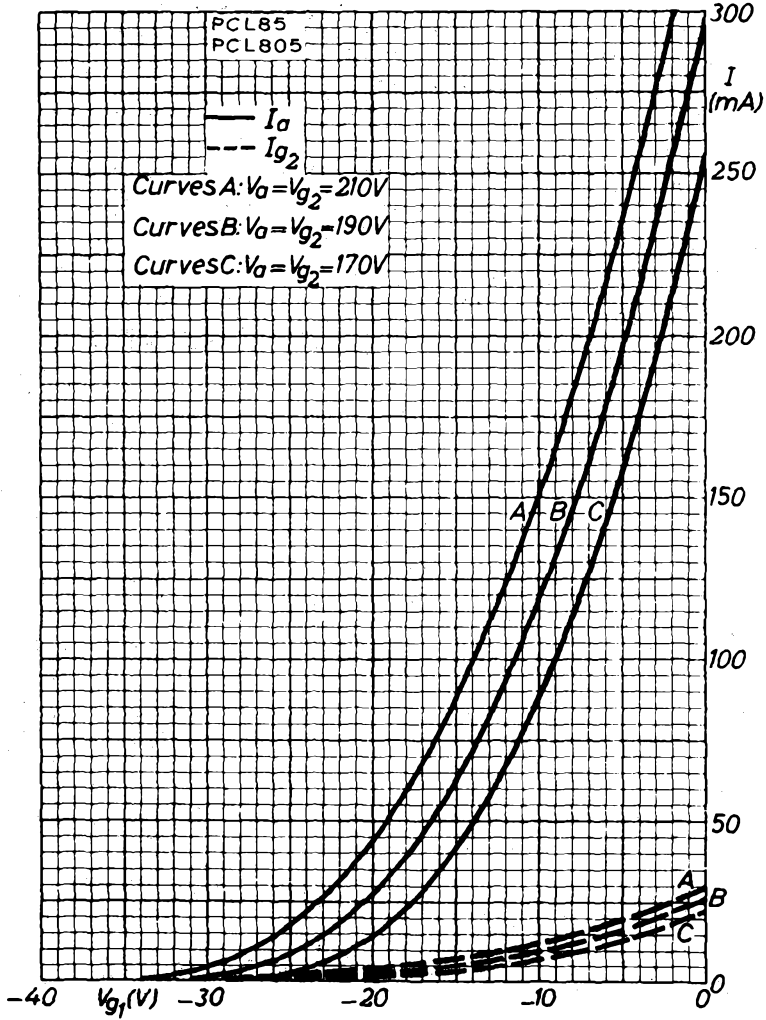

ANODE AND SCREEN GRID CURRENTS PLOTTED AGAINST GRID VOLTAGE WITH ANODE AND SCREEN GRID VOLTAGE AS PARAMETER, PENTODE SECTION



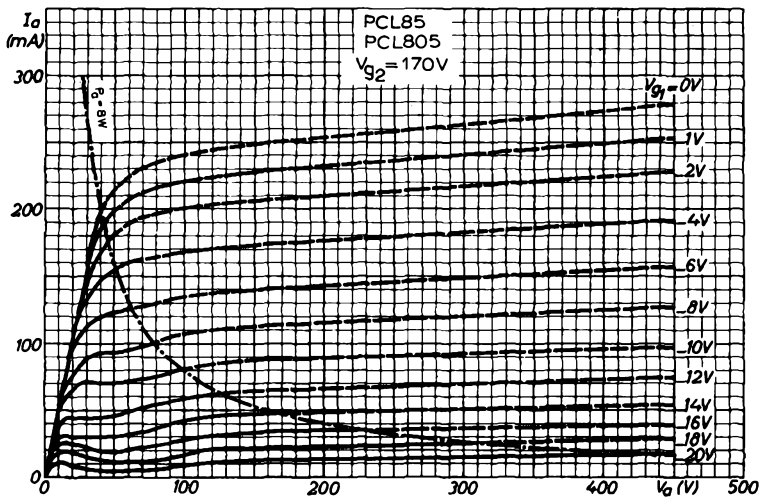

ANODE CURRENT PLOTTED AGAINST ANODE VOLTAGE
WITH GRID VOLTAGE AS PARAMETER:
PENTODE SECTION

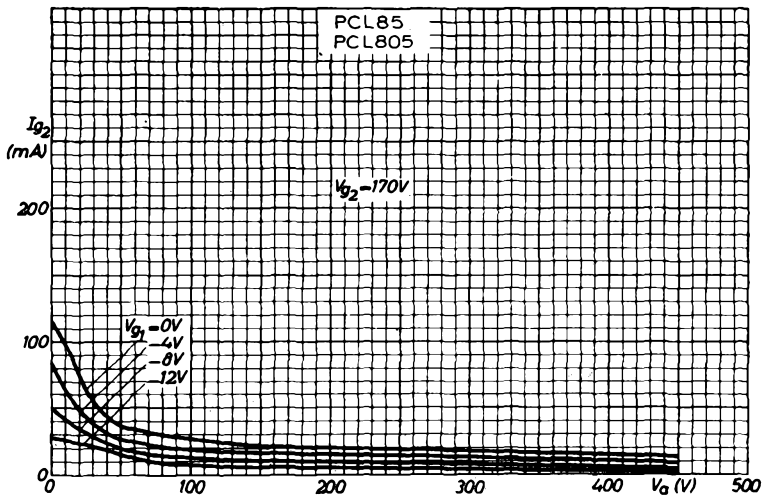

SCREEN GRID CURRENT PLOTTED AGAINST ANODE VOLTAGE
WITH CONTROL GRID AS PARAMETER:
PENTODE SECTION



TRIODE PENTODES

PCL805 PCL85

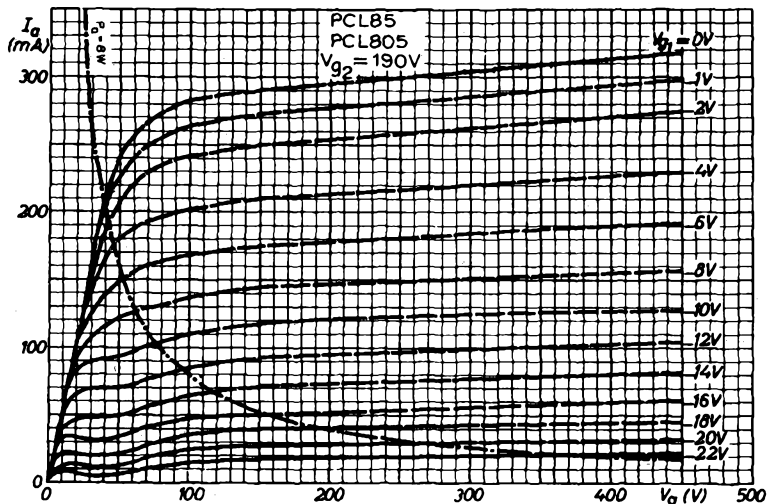

ANODE CURRENT PLOTTED AGAINST ANODE VOLTAGE
WITH GRID VOLTAGE AS PARAMETER:
PENTODE SECTION

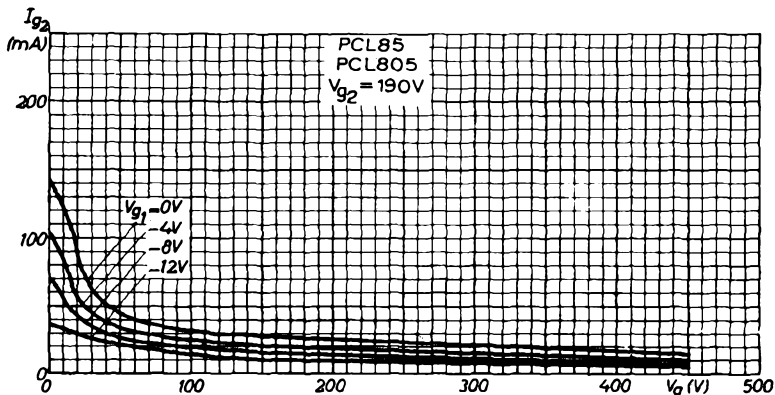

SCREEN GRID CURRENT PLOTTED AGAINST ANODE VOLTAGE
WITH CONTROL GRID AS PARAMETER:
PENTODE SECTION



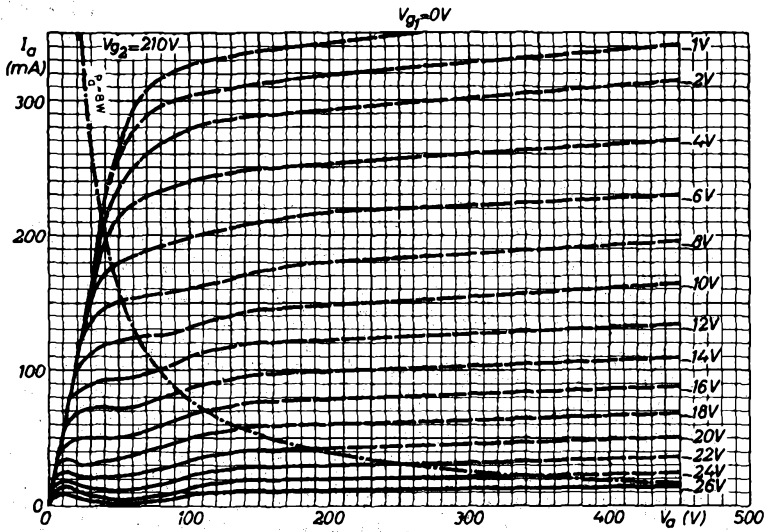

ANODE CURRENT PLOTTED AGAINST ANODE VOLTAGE
WITH GRID VOLTAGE AS PARAMETER,
PENTODE SECTION

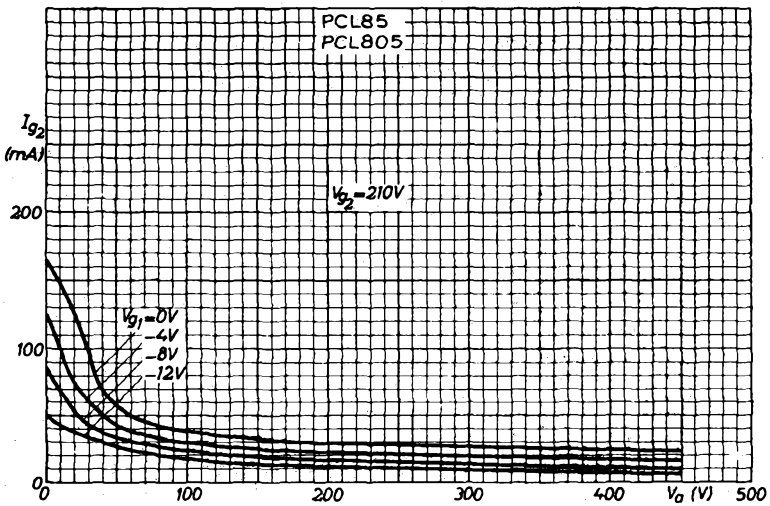

SCREEN GRID CURRENT PLOTTED AGAINST ANODE VOLTAGE
WITH CONTROL GRID AS PARAMETER:
PENTODE SECTION



TRIODE PENTODES

PCL805 PCL85

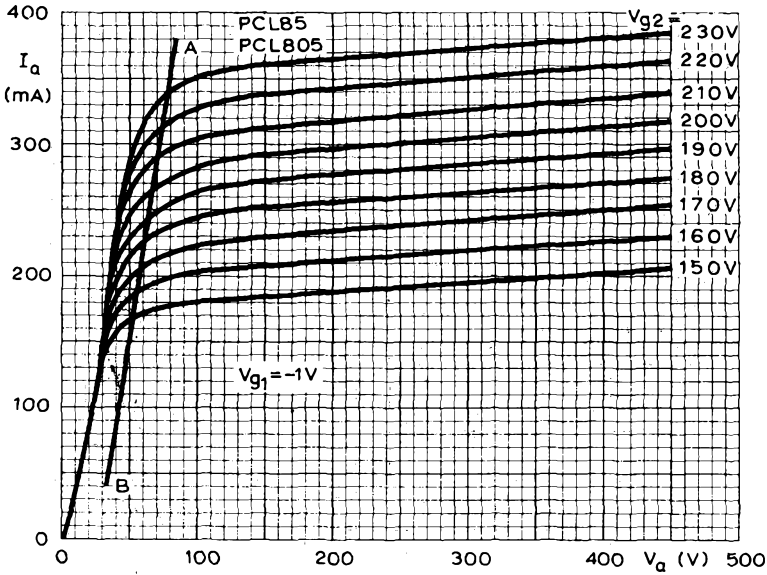

ANODE CURRENT PLOTTED AGAINST ANODE VOLTAGE
WITH SCREEN GRID VOLTAGE AS PARAMETER:
PENTODE SECTION

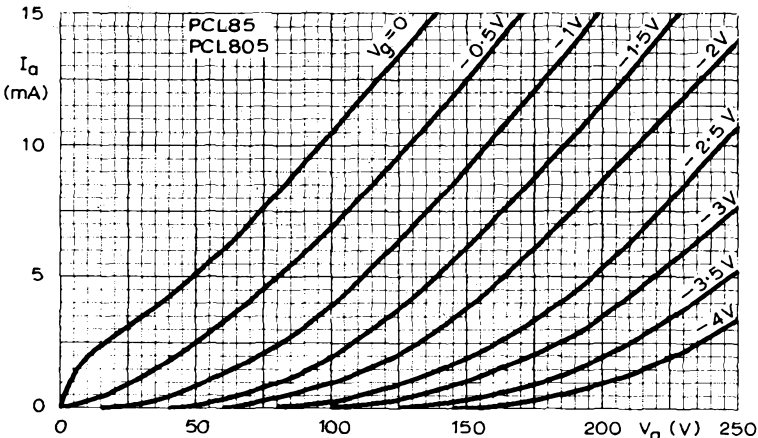

ANODE CURRENT PLOTTED AGAINST ANODE VOLTAGE
WITH CONTROL GRID VOLTAGE AS PARAMETER:
TRIODE SECTION



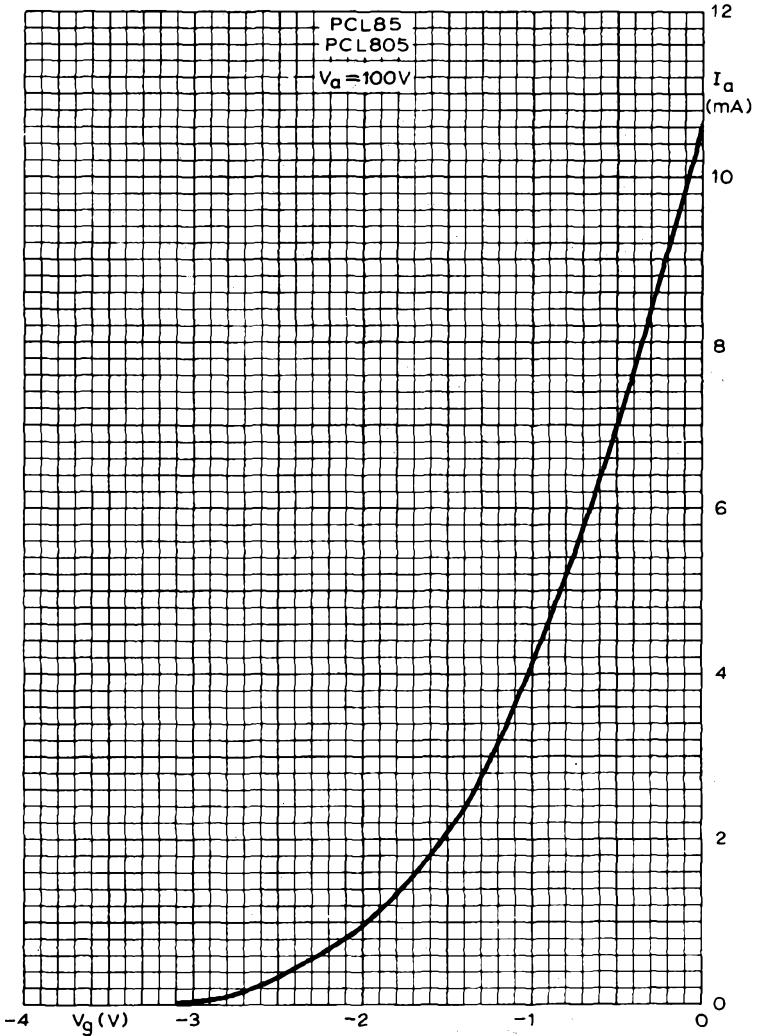

ANODE CURRENT PLOTTED AGAINST CONTROL GRID VOLTAGE:
 TRIODE SECTION



DOUBLE PENTODE

PFL200

Double pentode for video output plus sync, separator, a.g.c. amplifier or i.f. amplifier applications.

HEATER

Suitable for series operation, a.c. or d.c.

I_h	300	mA
V_h	17	V<--

CAPACITANCES (unshielded)

$c_{a' - a''}$	<150	mpF
$c_{g1' - g1''}$	<10	mpF
$c_{a' - g1''}$	<100	mpF
$c_{a'' - g1'}$	<5.0	mpF

L Section

$c_{in'}$	12.5	pF
$c_{out'}$	6.5	pF
$c_{a' - g1'}$	100	mpF

F Section

$c_{in''}$	10.5	pF
$c_{a'' - g2'' + k''g3'' + h + k'g3', s}$	10.5	pF
$c_{a'' - g1''}$	150	mpF
$c_{g1'' - h}$	<150	mpF

CHARACTERISTICS

	Amplifier section		Output section	
	150	50	170	V
V_a	150	50	170	V
V_{g2}	150	75	170	V
I_a	10	5.0	30	mA
I_{g2}	3.0	1.6	7.0	mA
V_{g1}	-2.1	-0.65	-2.7	V
g_m	8.5	6.8	22	mA/V
$\mu_{g1 - g2}$	38	34	38	
r_a	150	110	33	k Ω



RATINGS (DESIGN CENTRE SYSTEM)

Output section

V_a max.	250	V
V_{g2} max.	250	V
p_a max.	5.0	W
p_{g2} max.	2.5	W
p_{g2} max. (intermittent rating, short duration)	3.2	W
I_k max.	60	mA
I_k max. (intermittent rating, short duration)	85	mA
R_{g1-k} max.	1.0	MΩ
V_{h-k} max.	200	V

Amplifier section

$V_{a(b)}$ max.	550	V
$V_{g2(b)}$ max.	550	V
V_a max.	250	V
V_{g2} max.	250	V
p_a max.	1.5	W
p_{g2} max.	0.5	W
I_k max.	15	mA
R_{g1-k} max.	1.0	MΩ
V_{h-k} max.	200	V

B4679

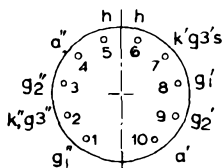
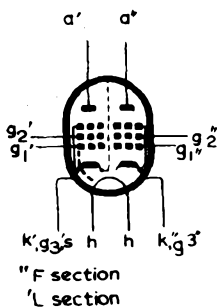

B10B base

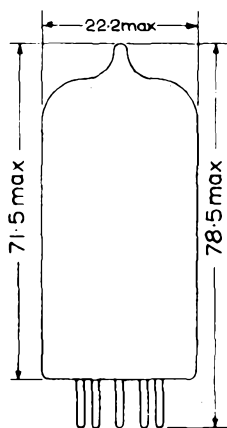

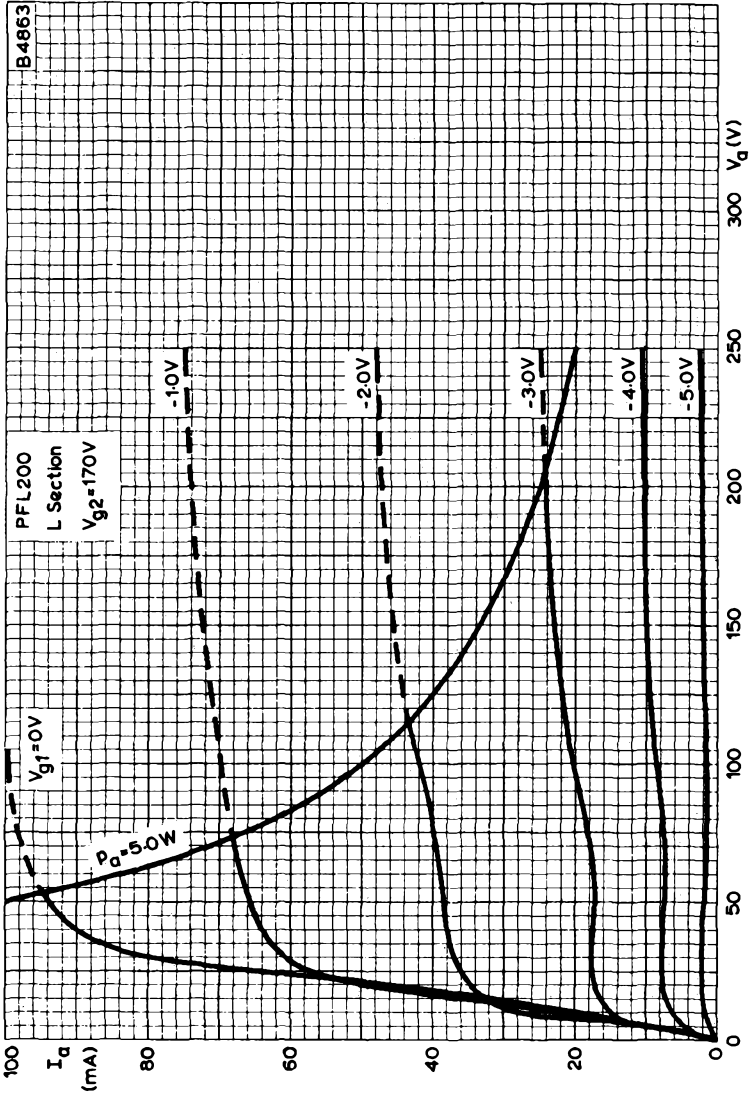

ANODE CURRENT PLOTTED AGAINST ANODE VOLTAGE WITH CONTROL-GRID VOLTAGE AS PARAMETER, $V_{g2} = 170V$.
L SECTION



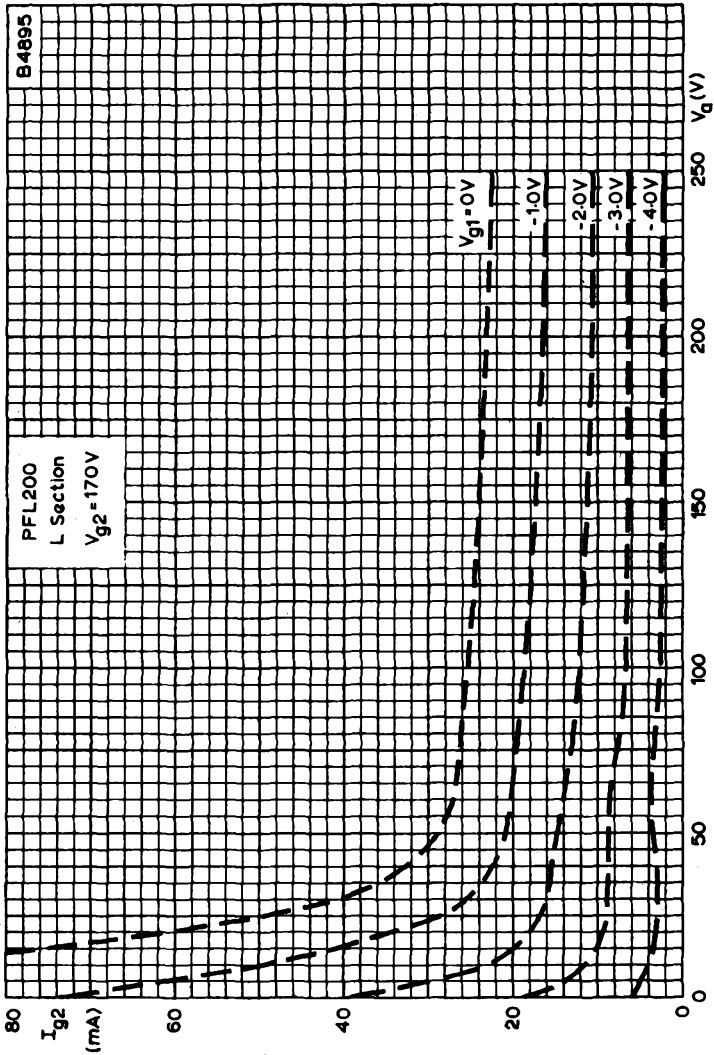

SCREEN-GRID CURRENT PLOTTED AGAINST ANODE VOLTAGE, WITH CONTROL-GRID VOLTAGE AS PARAMETER. $V_{g2} = 170V$.
 L SECTION



DOUBLE PENTODE

PFL200

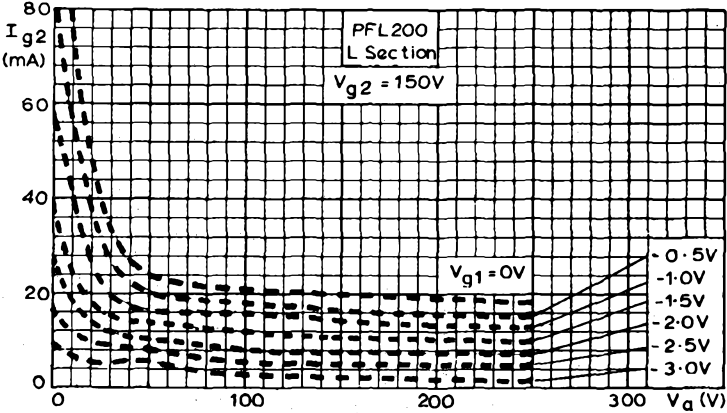
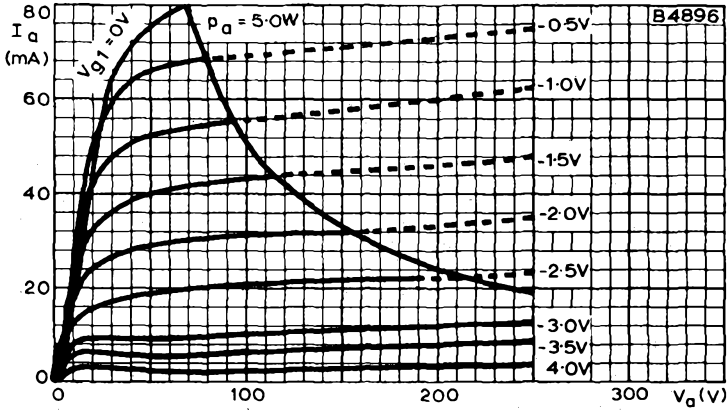

ANODE AND SCREEN-GRID CURRENTS PLOTTED AGAINST ANODE VOLTAGE WITH CONTROL-GRID VOLTAGE AS PARAMETER, $V_{g2} = 150V$. L SECTION



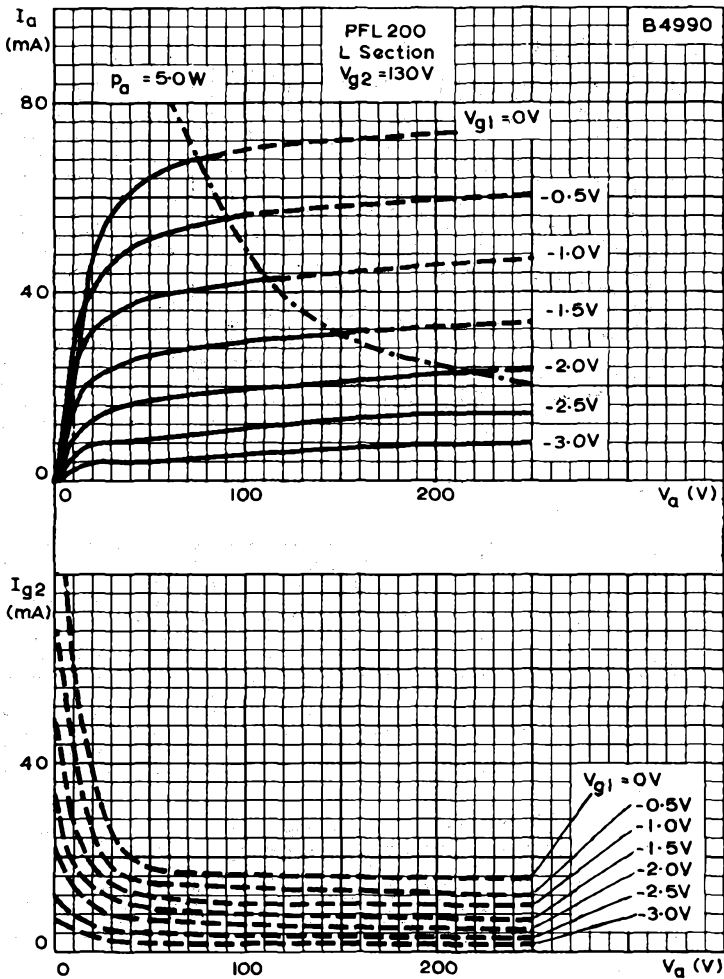

ANODE AND SCREEN-GRID CURRENTS PLOTTED AGAINST ANODE VOLTAGE WITH CONTROL-GRID VOLTAGE AS PARAMETER. $V_{g2} = 130V$.
L SECTION



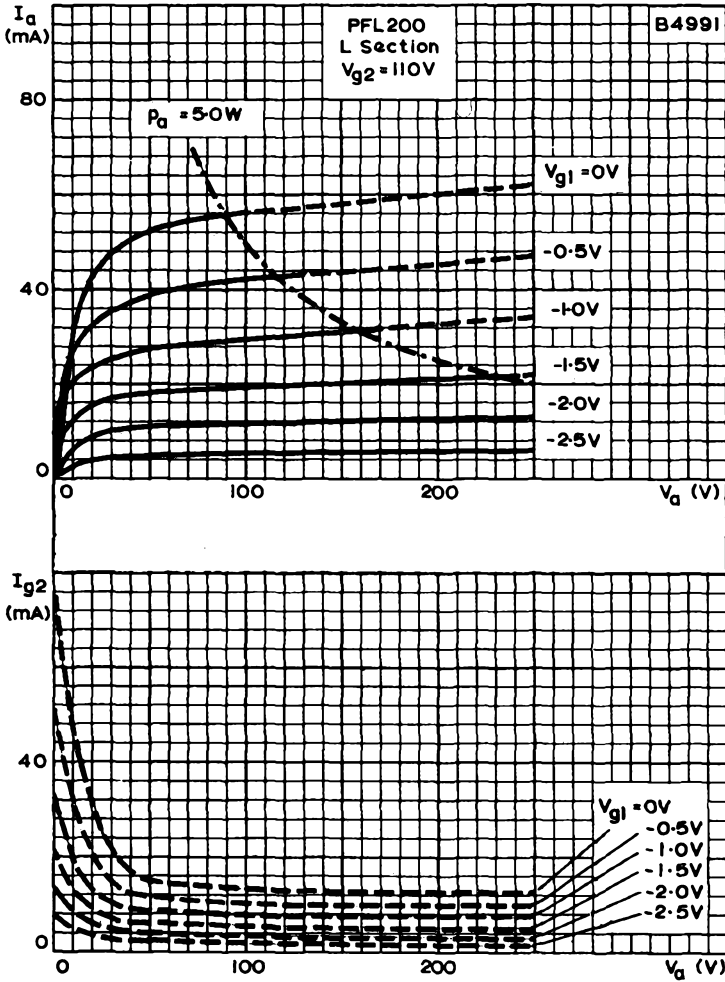

ANODE AND SCREEN-GRID CURRENTS PLOTTED AGAINST ANODE VOLTAGE WITH CONTROL-GRID VOLTAGE AS PARAMETER. $V_{g2} = 110V$. L SECTION



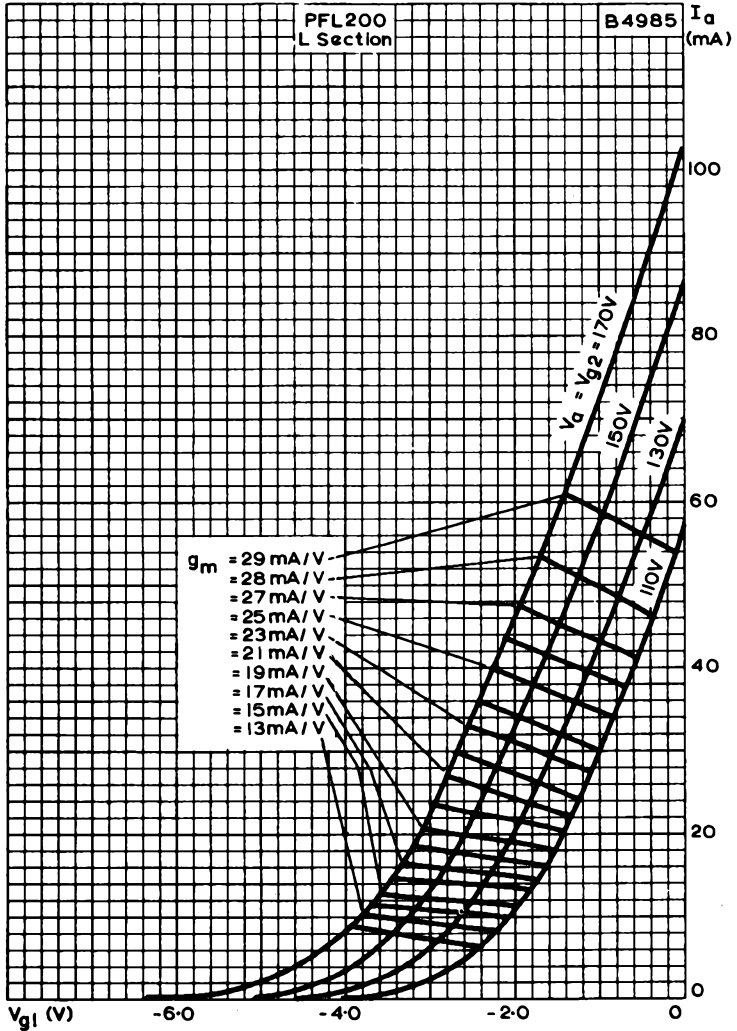

ANODE CURRENT PLOTTED AGAINST CONTROL-GRID VOLTAGE WITH ANODE AND SCREEN-GRID VOLTAGES AS PARAMETERS AND WITH MUTUAL CONDUCTANCE CONTOURS,
L SECTION

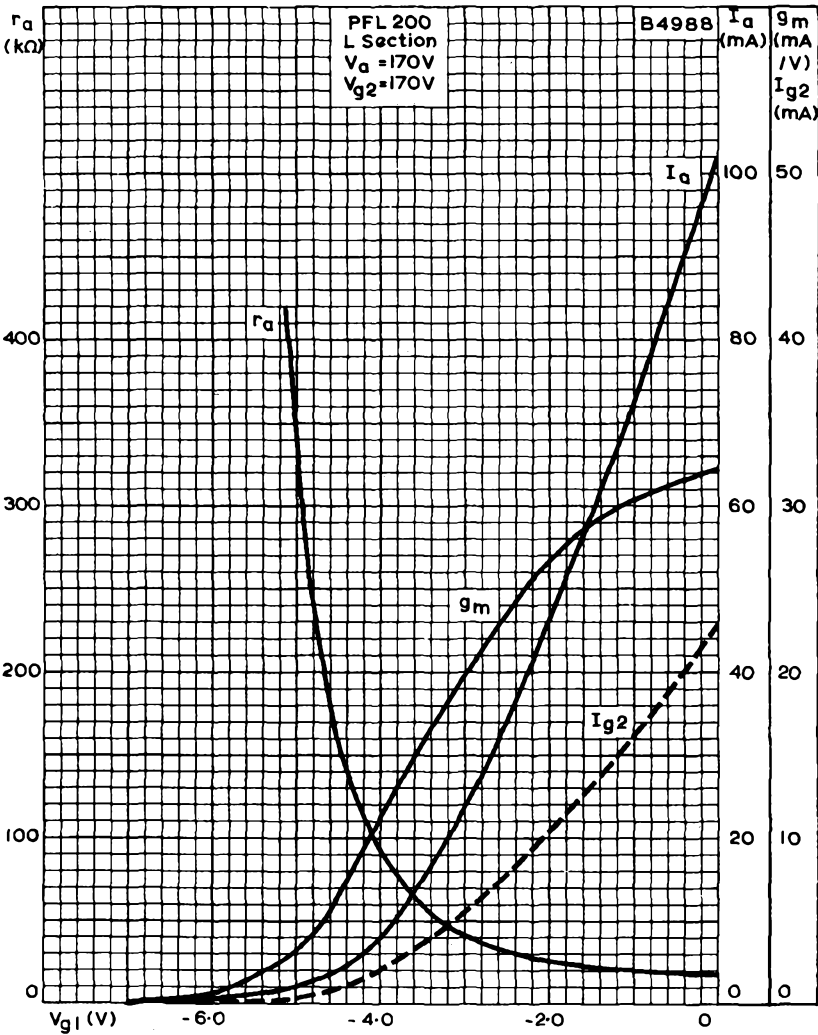

ANODE AND SCREEN-GRID CURRENTS, MUTUAL CONDUCTANCE AND ANODE IMPEDANCE PLOTTED AGAINST CONTROL-GRID VOLTAGE.

$V_a = V_{g2} = 170V.$

L SECTION



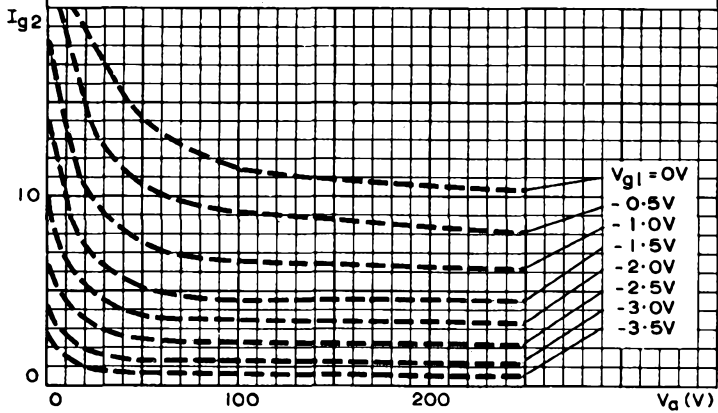
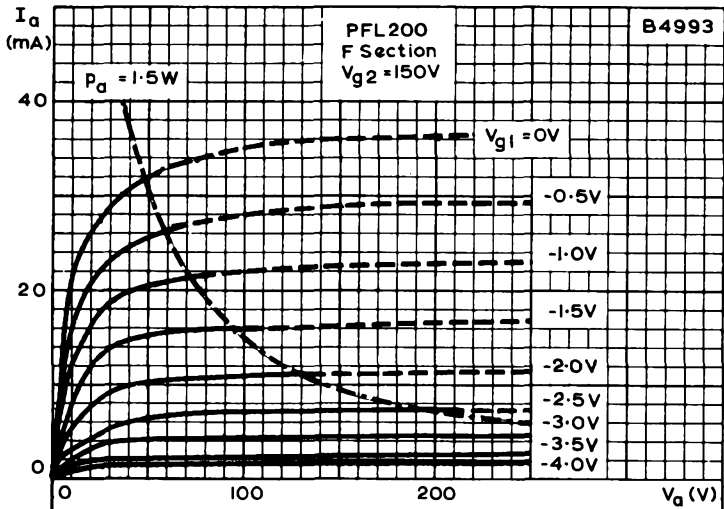

ANODE AND SCREEN-GRID CURRENTS PLOTTED AGAINST ANODE VOLTAGE WITH CONTROL-GRID VOLTAGE AS PARAMETER. $V_{g2} = 150V$.
F SECTION



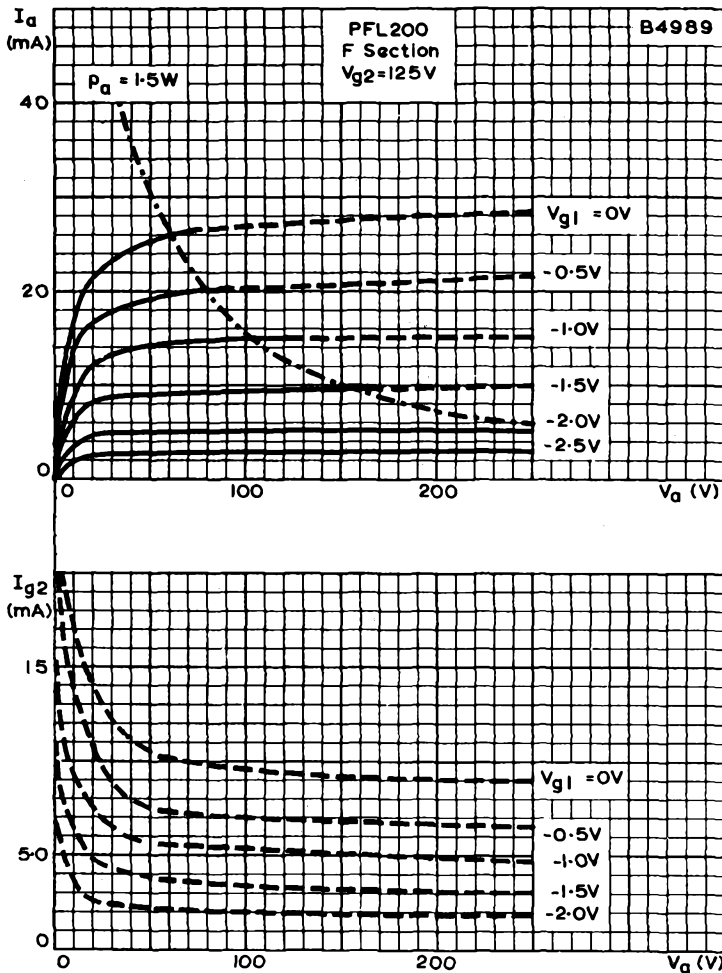

ANODE AND SCREEN-GRID CURRENTS PLOTTED AGAINST ANODE VOLTAGE WITH CONTROL-GRID VOLTAGE AS PARAMETER, $V_{g2} = 125V$. F SECTION



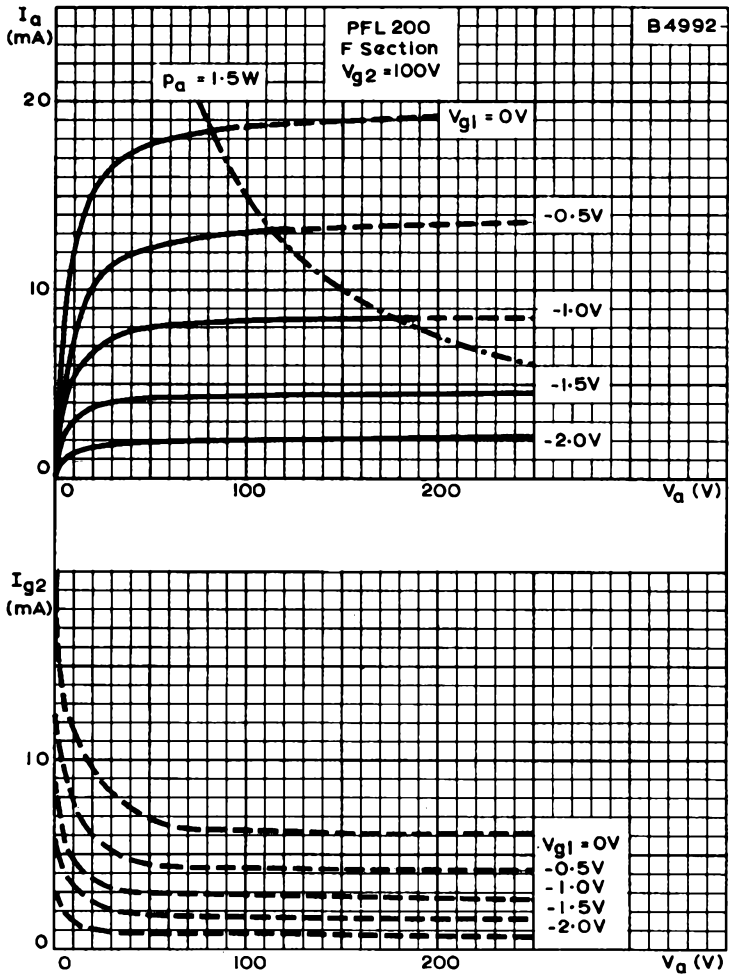

ANODE AND SCREEN-GRID CURRENTS PLOTTED AGAINST ANODE VOLTAGE WITH CONTROL-GRID VOLTAGE AS PARAMETER. $V_{g2} = 100V$.
F SECTION



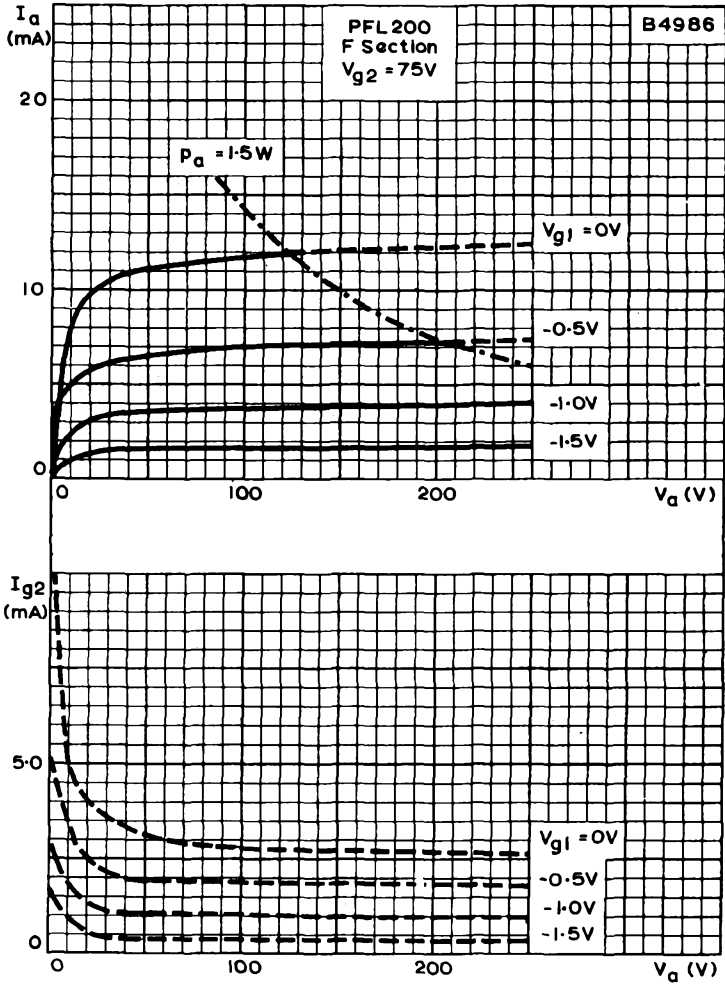

ANODE AND SCREEN-GRID CURRENTS PLOTTED AGAINST ANODE VOLTAGE WITH CONTROL-GRID VOLTAGE AS PARAMETER. $V_{g2} = 75V$.
F SECTION



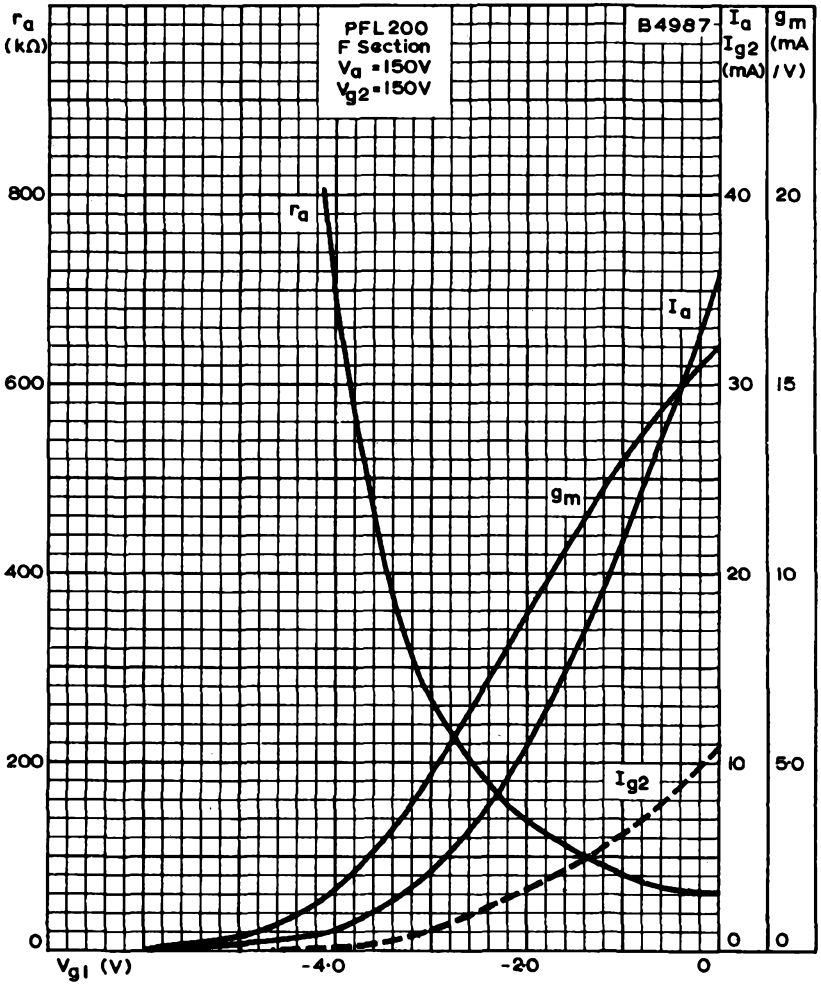

ANODE AND SCREEN-GRID CURRENTS, MUTUAL CONDUCTANCE AND ANODE IMPEDANCE PLOTTED AGAINST CONTROL-GRID VOLTAGE.

$$V_a = V_{g2} = 150V.$$

F SECTION



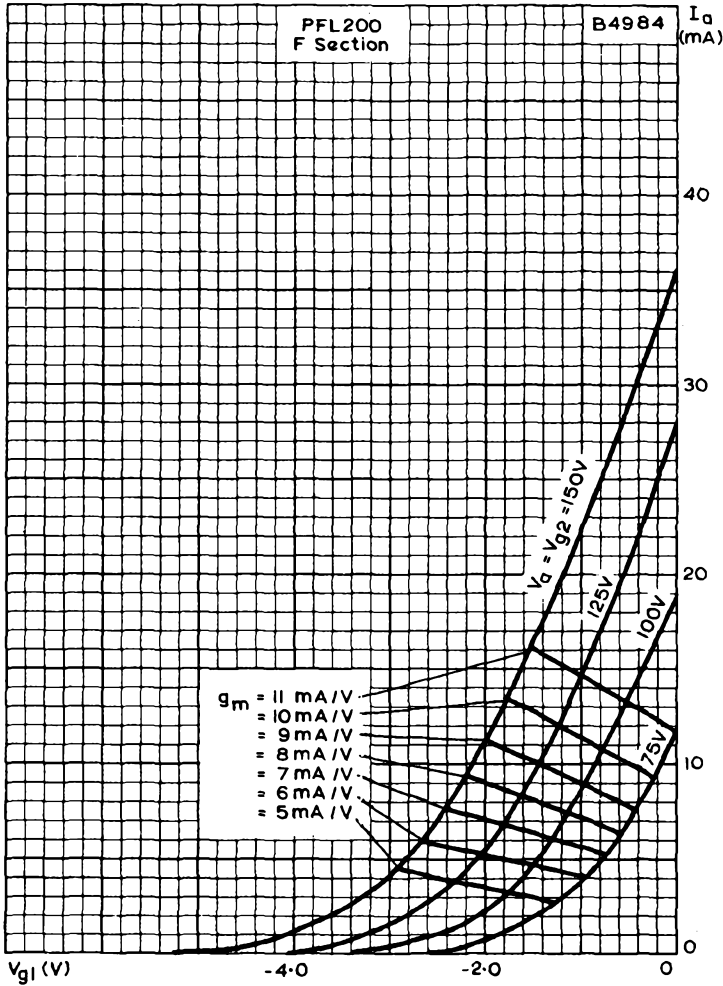

ANODE CURRENT PLOTTED AGAINST CONTROL-GRID VOLTAGE WITH ANODE AND SCREEN-GRID VOLTAGES AS PARAMETERS AND WITH MUTUAL CONDUCTANCE CONTOURS.
F SECTION





Output pentode primarily intended for use in the line timebase of television receivers.

HEATER

Suitable for series operation a.c. or d.c.

I_h	300	mA
V_h	27	V

CAPACITANCES

c_{in}	22	pF
c_{out}	9.0	pF
c_{a-g1}	< 1.75	pF
c_{g1-h}	< 200	mpF

CHARACTERISTICS

V_a	75	V
V_{g2}	200	V
V_{g1}	-10	V
I_a	440	mA
I_{g2}	30	mA

OPERATION AS LINE OUTPUT VALVE

Circuit design

Operation so that the anode potential of the output valve at the end of the scan is above the knee of the anode characteristic is recommended. An effective feedback stabilising circuit should be employed. A design chart is given on page C7.

Minimum values of R_{g2} required to prevent excessive screen-grid dissipation during the warming-up period;

V_b	170	200	230	V
R_{g2} min.	1.0	1.5	1.8	k Ω

High voltage cut-off

The minimum value of V_{g1} for cut-off during the fly-back period, when $v_a(pk) = 7.0kV$, is $-120V$.



PEAK ANODE CURRENT DESIGN CHARTS

Stabilised timebases

The design chart shown on page C7 gives directly the values of peak anode current and end-of-scan anode voltage which should be used in designing a stabilised line timebase. The design chart is based on an h.t. line voltage of 200V, and a correction factor is included for other h.t. voltages.

Measurements

When measurements are made specifically for the purpose of comparison with the design chart, all the components comprising the timebase, including the valves, should be nominal. The h.t. line should also be nominal. In receivers designed for a range of declared values of mains voltage, measurements should be made at the nominal declared value of mains voltage producing the lowest nominal h.t. voltage. The timebase should be synchronised and the raster adjusted to nominal scan. The beam current drawn from the e.h.t. supply should be 300 μ A.

The use of the design chart does not exempt the designer from checking that the valve is operating within its limiting values.

RATINGS (DESIGN CENTRE SYSTEM)

$V_{a(b)}$ max.	550	V
V_a max.	250	V
* $v_{a(pk)}$ max.	7.0	kV
p_a max.	see page C6	
$p_a + p_{g2}$	see page C6	
$V_{g2(b)}$ max.	550	V
V_{g2} max.	250	V
p_{g2} max.	see page C6	
I_k max.	250	mA
R_{g1-k} max.	500	k Ω
R_{g1-k} max. (line timebase applications)	2.2	M Ω

*Maximum pulse duration of 22% of one cycle with a maximum of 22 μ s.



B4757

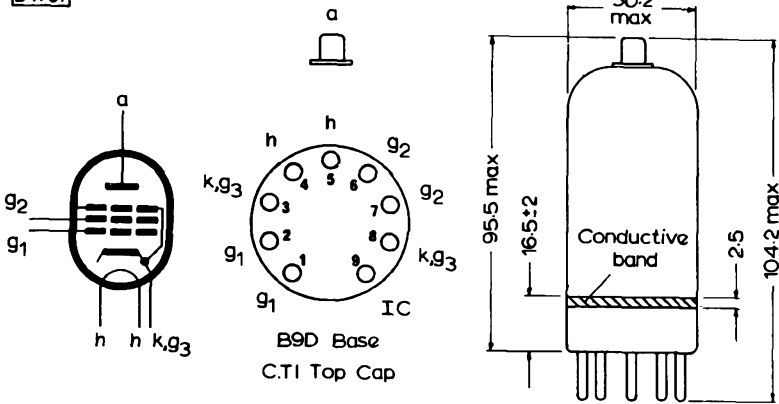

All dimensions in mm





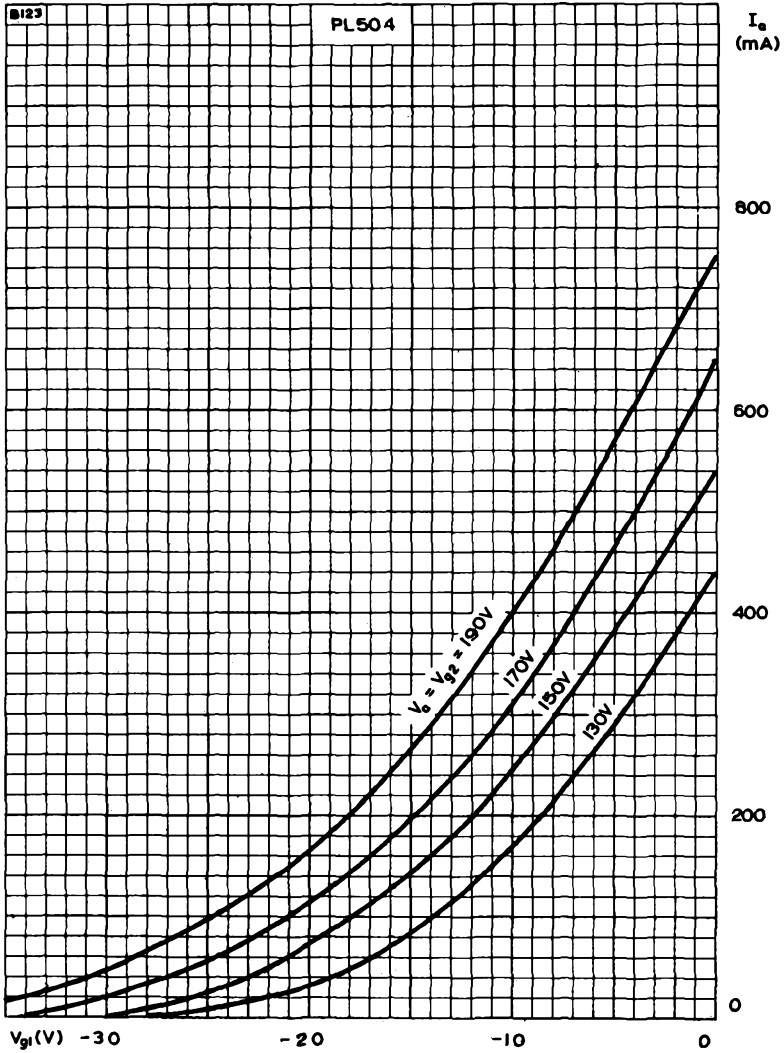

ANODE CURRENT PLOTTED AGAINST CONTROL-GRID VOLTAGE WITH ANODE AND SCREEN-GRID VOLTAGE AS PARAMETER



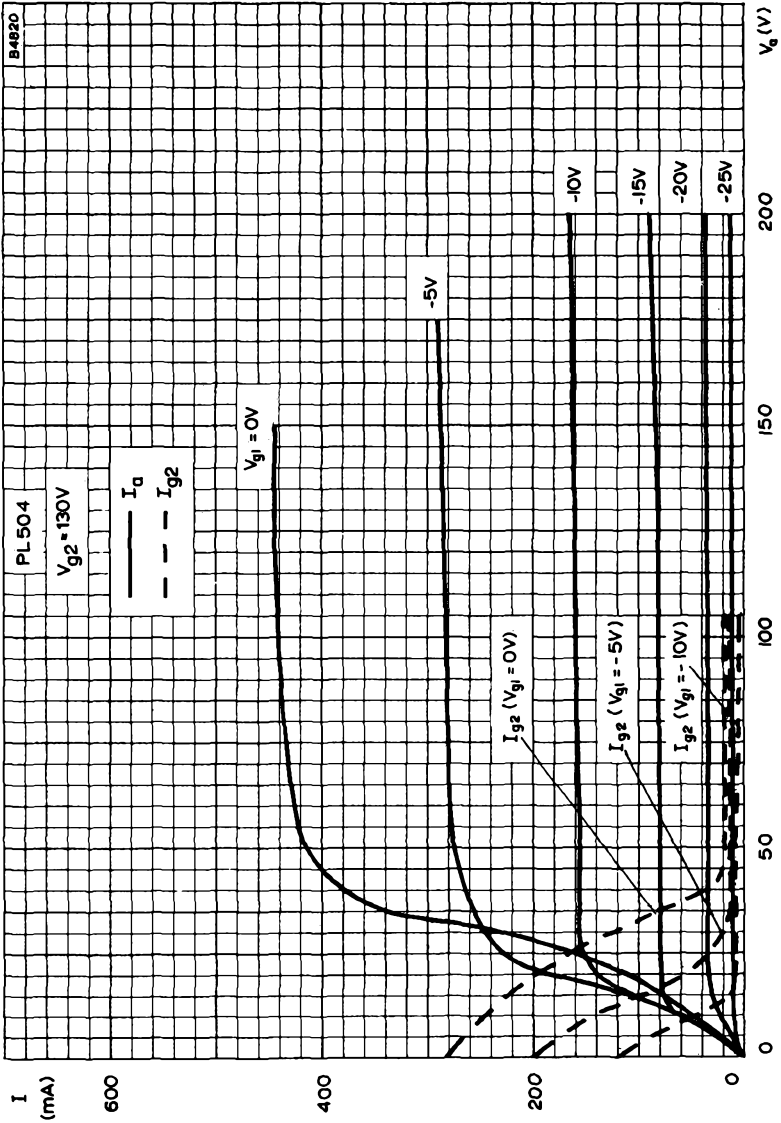

ANODE AND SCREEN CURRENTS PLOTTED AGAINST ANODE VOLTAGE WITH CONTROL-GRID VOLTAGE AS PARAMETER. $V_{g2} = 130V$



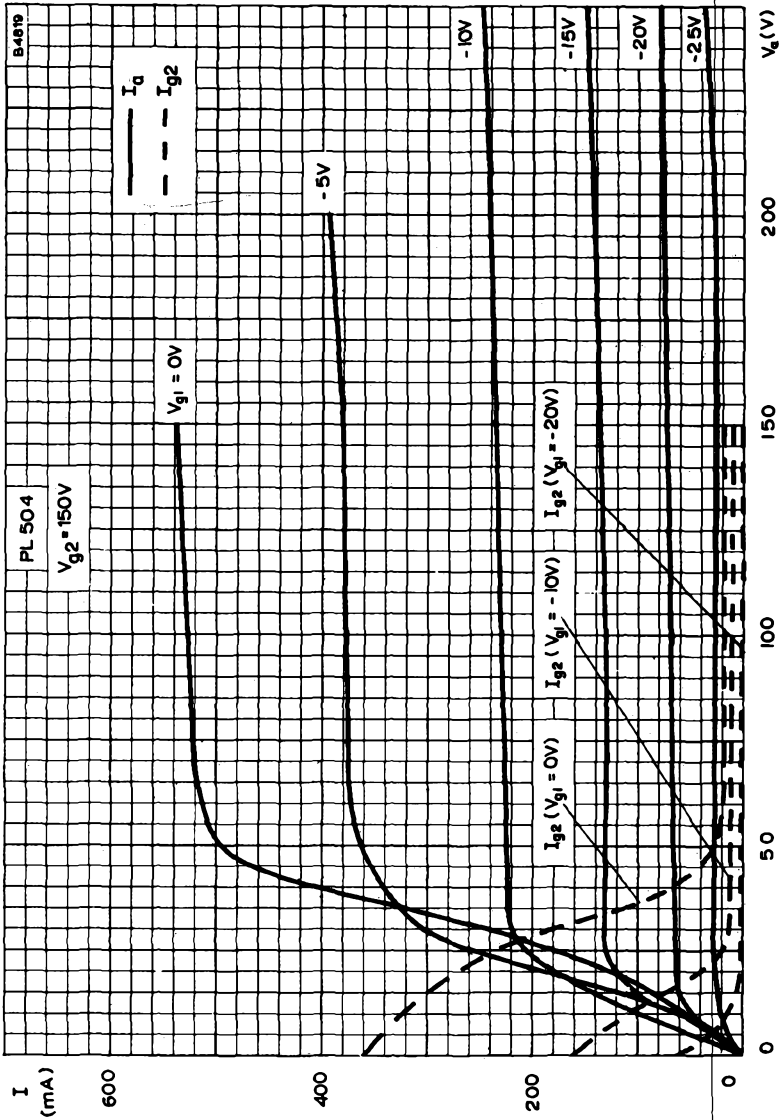

ANODE AND SCREEN CURRENTS PLOTTED AGAINST ANODE VOLTAGE WITH CONTROL-GRID VOLTAGE AS PARAMETER. $V_{g2} = 150V$



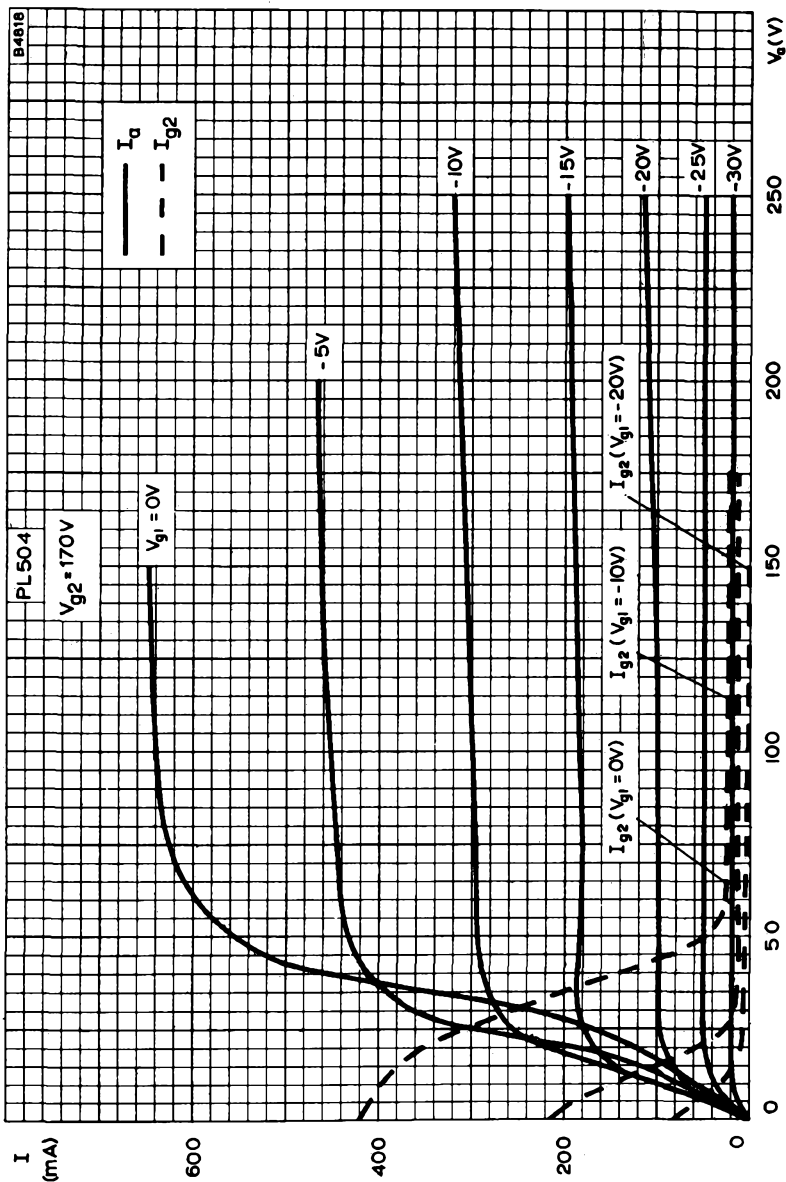

ANODE AND SCREEN CURRENTS PLOTTED AGAINST ANODE VOLTAGE WITH CONTROL-GRID VOLTAGE AS PARAMETER. $V_{g2} = 170V$



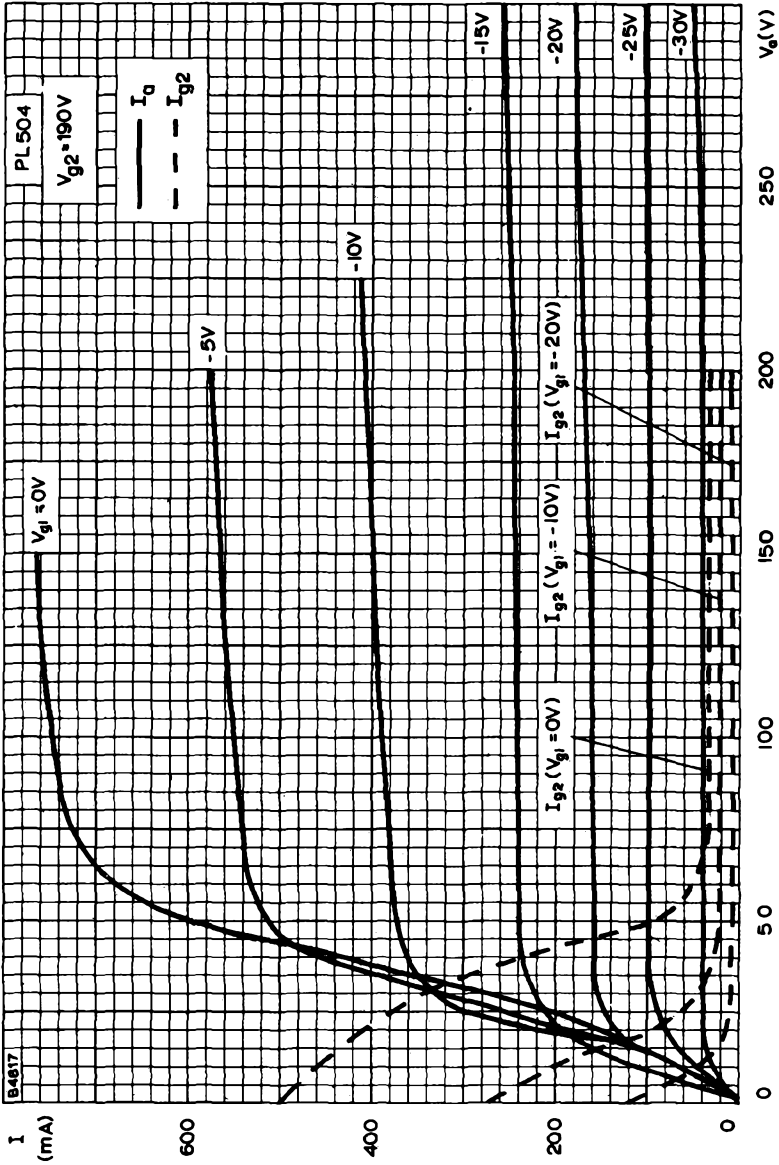

ANODE AND SCREEN CURRENTS PLOTTED AGAINST ANODE VOLTAGE WITH CONTROL-GRID VOLTAGE AS PARAMETER, $V_{g2} = 190V$



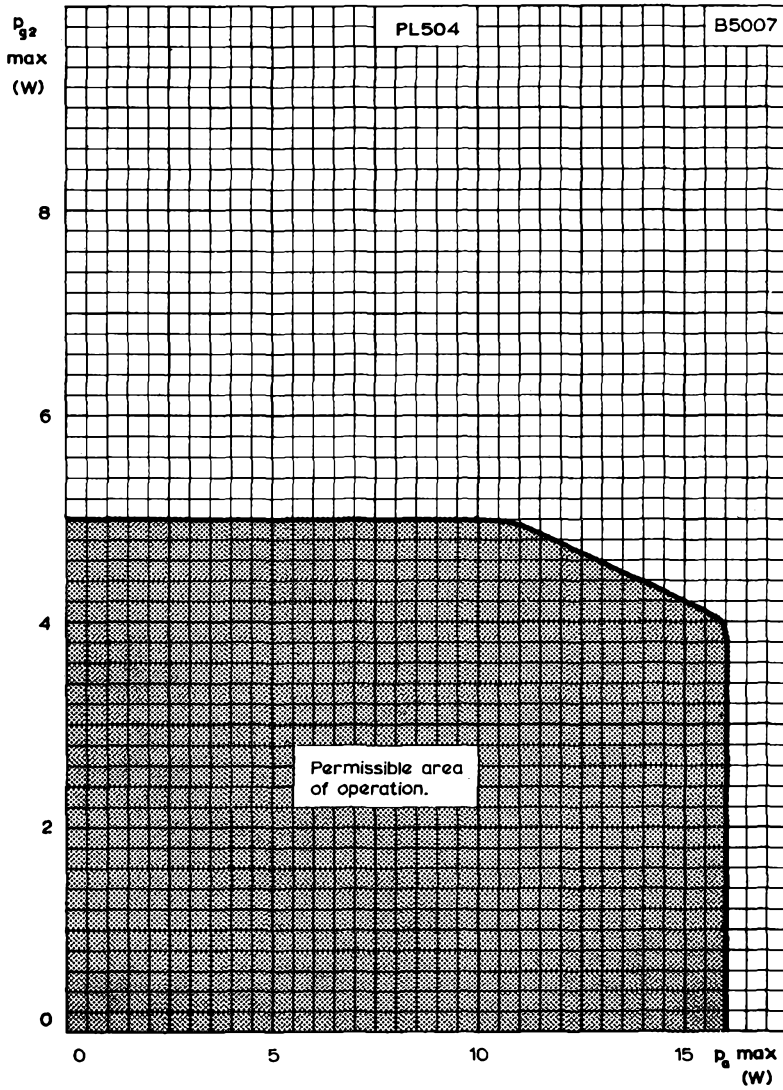

DESIGN CENTRE RATINGS FOR $p_a \text{ max.}$ AND $p_{g2} \text{ max.}$



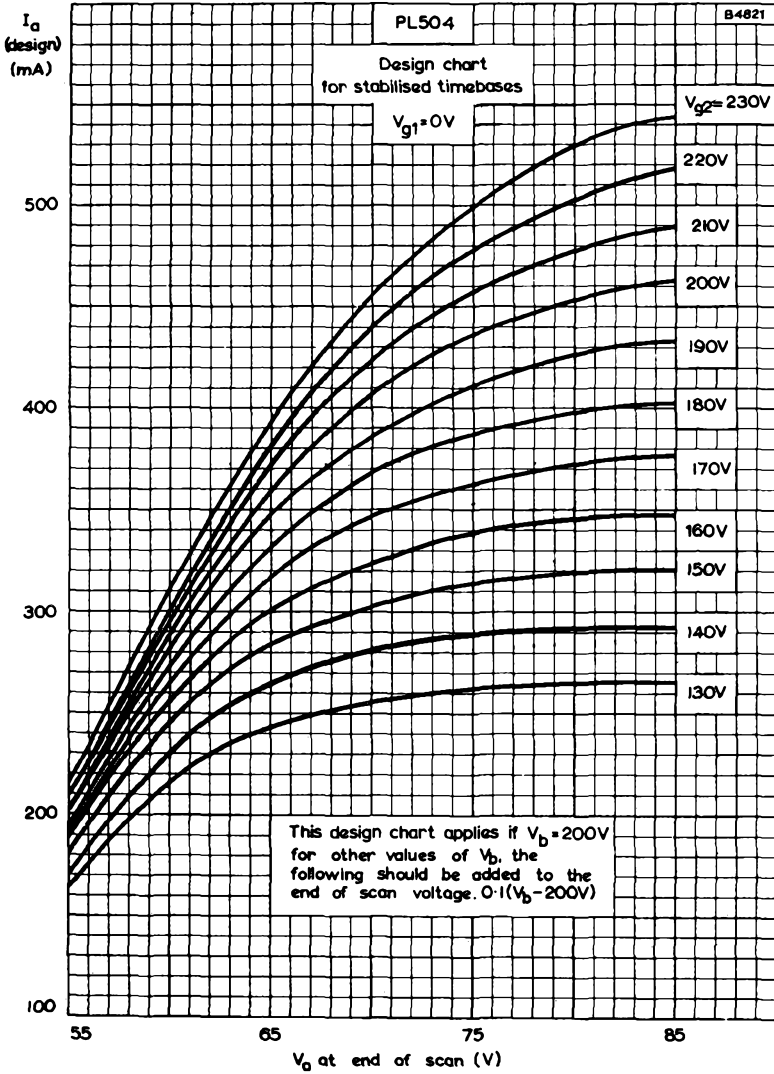

DESIGN CHART FOR STABILISED TIMEBASES





OUTPUT PENTODE

PL508

Field output pentode for colour television

HEATER

Suitable for series operation, a.c. or d.c.

I_h	300	mA
V_h	17	V

CAPACITANCES (unshielded)

c_{a-g1}	1.4	pF
c_{g1-h}	< 0.2	pF

CHARACTERISTICS

V_a	50	190	V
V_{g2}	190	190	V
I_a	320 pk	60	mA
I_{g2}	approx. 60	5.0	mA
V_{g1}	-1.0	-17	V
g_m		9.0	mA/V
μ_{g1-g2}		8.0	
r_a		10	k Ω

OPERATING CONDITIONS

For operating conditions when used as a field output valve in stabilised timebases, see graph on page 5.

RATINGS (DESIGN CENTRE SYSTEM)

$V_{a(b)}$ max.	700	V
V_a max.	400	V
* $v_{a(pk)}$ max.	2.5	kV
p_a max.	12	W
$V_{g2(b)}$ max.	700	V
V_{g2} max.	275	V
p_{g2} max.	3.0	W
I_k max.	100	mA
R_{g1-k} max. (fixed bias)	1.0	MΩ
R_{g1-k} max. (automatic bias)	2.2	MΩ
V_{h-k} max.	220	V

* Maximum pulse duration 5% of one cycle with a maximum of 1ms.

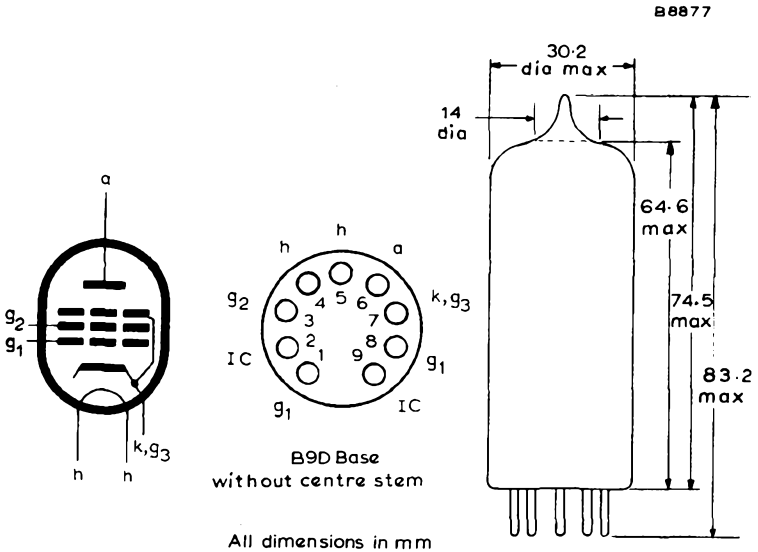

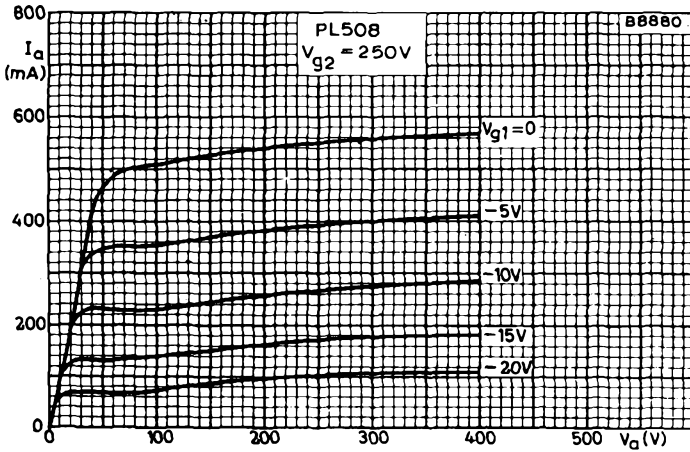
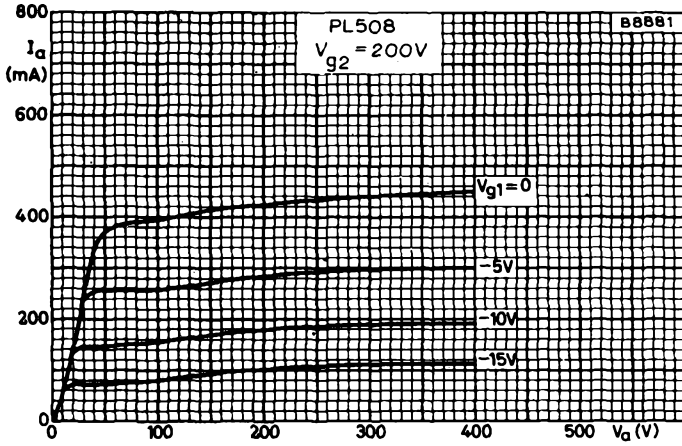

ANODE CURRENT PLOTTED AGAINST ANODE VOLTAGE
WITH CONTROL GRID VOLTAGE AS PARAMETER



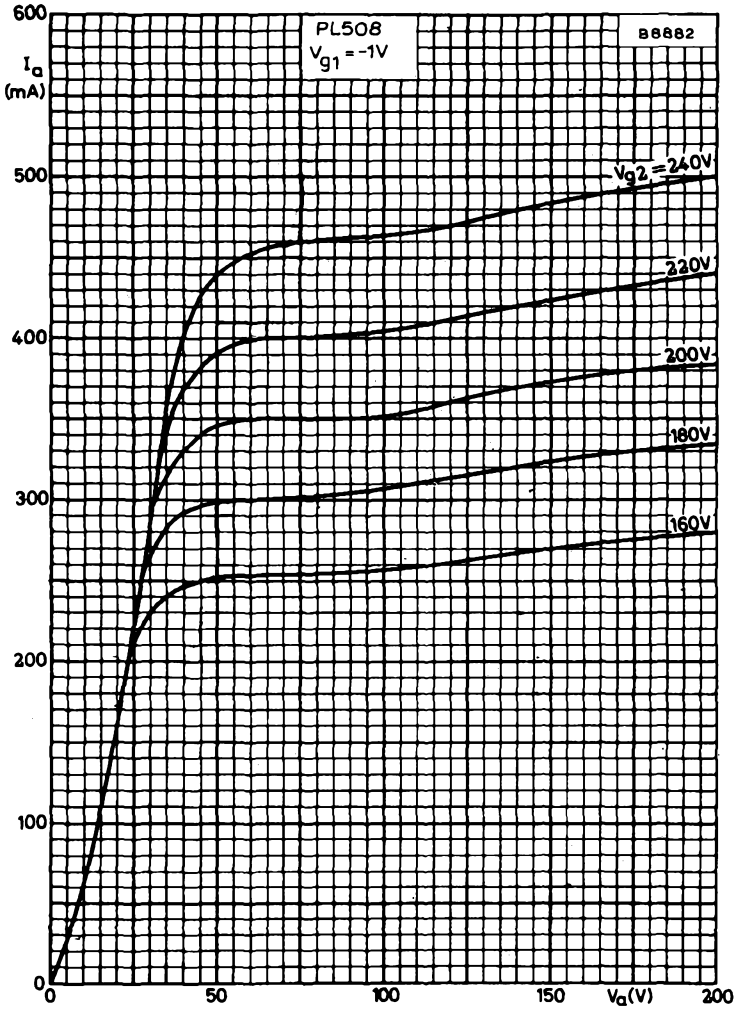

ANODE CURRENT PLOTTED AGAINST ANODE VOLTAGE
 WITH SCREEN GRID VOLTAGE AS PARAMETER



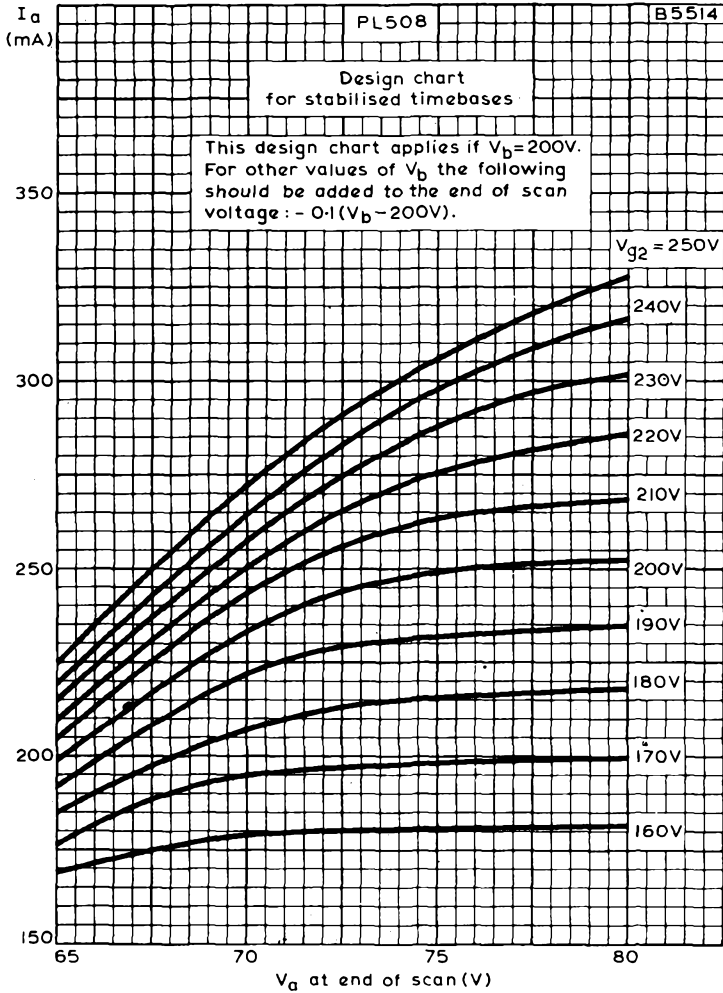

DESIGN CHART FOR STABILISED TIMEBASES





OUTPUT PENTODE

PL509

Output pentode for colour television line deflection circuits

HEATER

Suitable for series operation, a.c. or d.c.

I_h	300	mA
V_h	40	V

CAPACITANCES

c_{a-g1}	2.5	pF
c_{a-g1} max.	3.0	pF
c_{g1-h} max.	0.2	pF

DYNAMIC CHARACTERISTICS

V_a	160	50	V
V_{g3}	0	0	V
V_{g2}	160	175	V
V_{g1}	0	-10	V
I_a	1.4	0.8	A
I_{g2}	45	70	mA

OPERATING CONDITIONS

Stabilised circuits (d.c. feedback)

The minimum required cut-off voltage ($-V_{g1}$) during flyback at $V_a=7.0kV$ and $Z_{g1}=1.0k\Omega$ at line frequency is:-

$$V_{g2} = 150V; V_{g1} = -175V$$

$$V_{g2} = 200V; V_{g1} = -195V$$

$$V_{g2} = 250V; V_{g1} = -215V$$

Design chart for stabilised timebases

See page 4

In order to prevent Barkhausen interference and loss of stabilisation, care should be taken to ensure that the anode voltage never drops below the specified minimum value during the scanning period.

When optimum suppression of Barkhausen oscillations is required, $g3$ may be connected to a positive voltage of approximately 20V.

Hum

At $Z_{g1}=200k\Omega$ ($f=50Hz$), $V_{h-k}=220Vr.m.s.$ and without wiring and socket capacitances, the equivalent grid hum voltage is less than 5.0mV.



RATINGS (DESIGN CENTRE SYSTEM)

$V_{a(b)}$ max.	700	V
$v_{a(pk)}$ max. (see note 1)	7.0	kV
V_{g3} max.	50	V
$V_{g2(b)}$ max.	700	V
V_{g2} max.	275	V
$-v_{g1(pk)}$ max. (design maximum system) (see note 1)	550	V
p_a max.	30	W
p_{a+g2} max. (triode connected)	31	W
p_{g2} max. (see note 2)	7.0	W
I_k max.	500	mA
R_{g1} max. (fixed bias) (see note 3)	0.5	M Ω
R_{g1} max. (stabilised line timebases) (see note 3)	2.2	M Ω
R_{g3} max. (see note 4)	10	k Ω
V_{h-k} max.	250	V
T_{bulb} max. (absolute maximum rating)	300	$^{\circ}$ C

NOTES

1. Maximum pulse duration 22% of one cycle with a maximum of 18 μ s.
2. To prevent an excessive value of p_{g2} the minimum values of series resistance are given below.

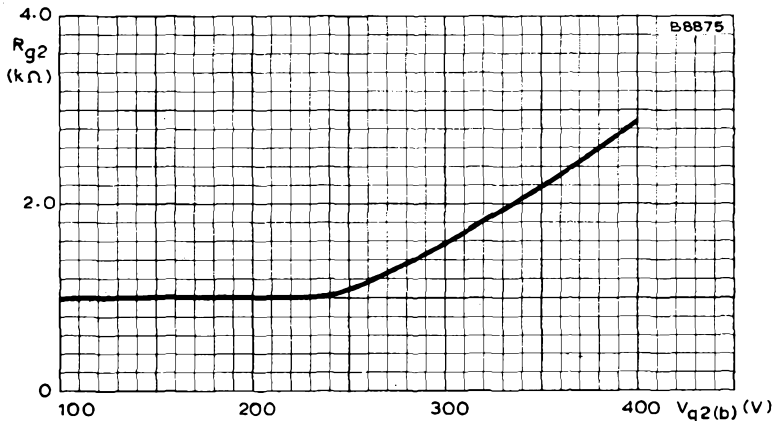

3. The circuit design must be such that negative control grid currents up to 5 μ A do not have any detrimental effect upon performance. Care should be taken that with 5 μ A grid current the limiting values for I_k , p_a and p_{g2} are not exceeded.
4. With $R_{g3} \leq 10k\Omega$ capacitive decoupling of $g3$ is not required.



OUTPUT PENTODE

PL509

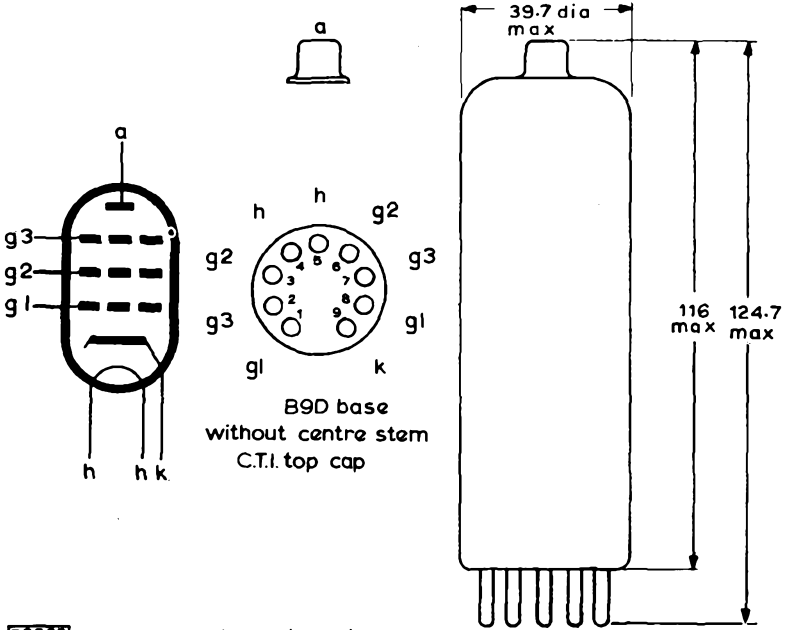

B9D base
without centre stem
C.T.I. top cap

3533

All dimensions in mm



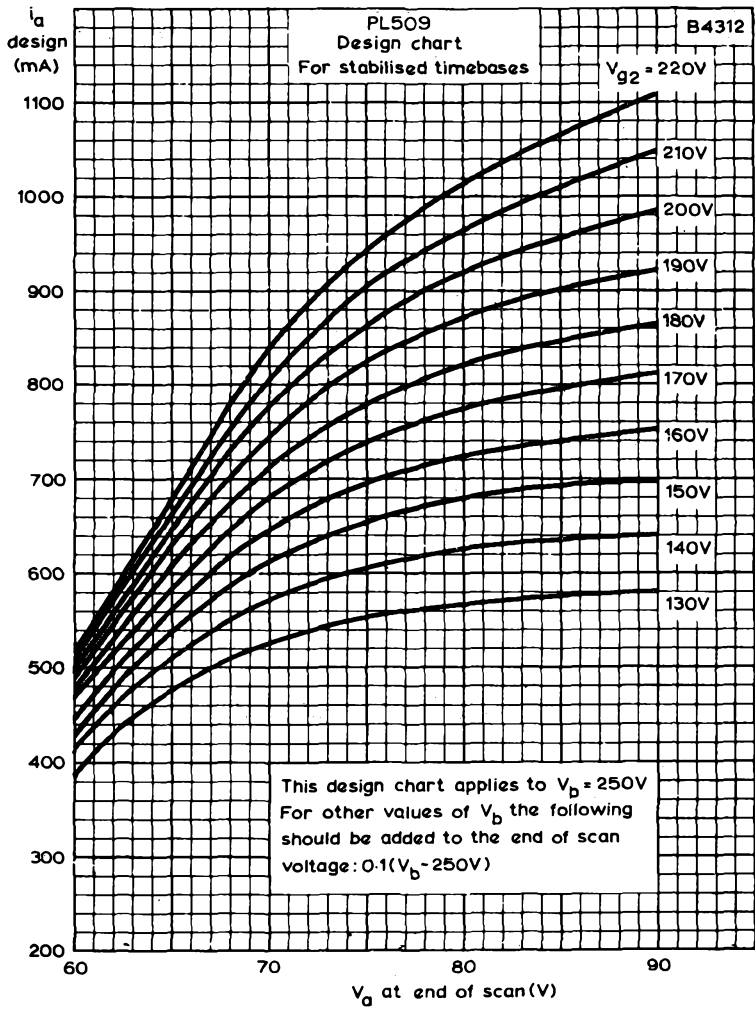

DESIGN CHART FOR STABILISED TIMEBASES



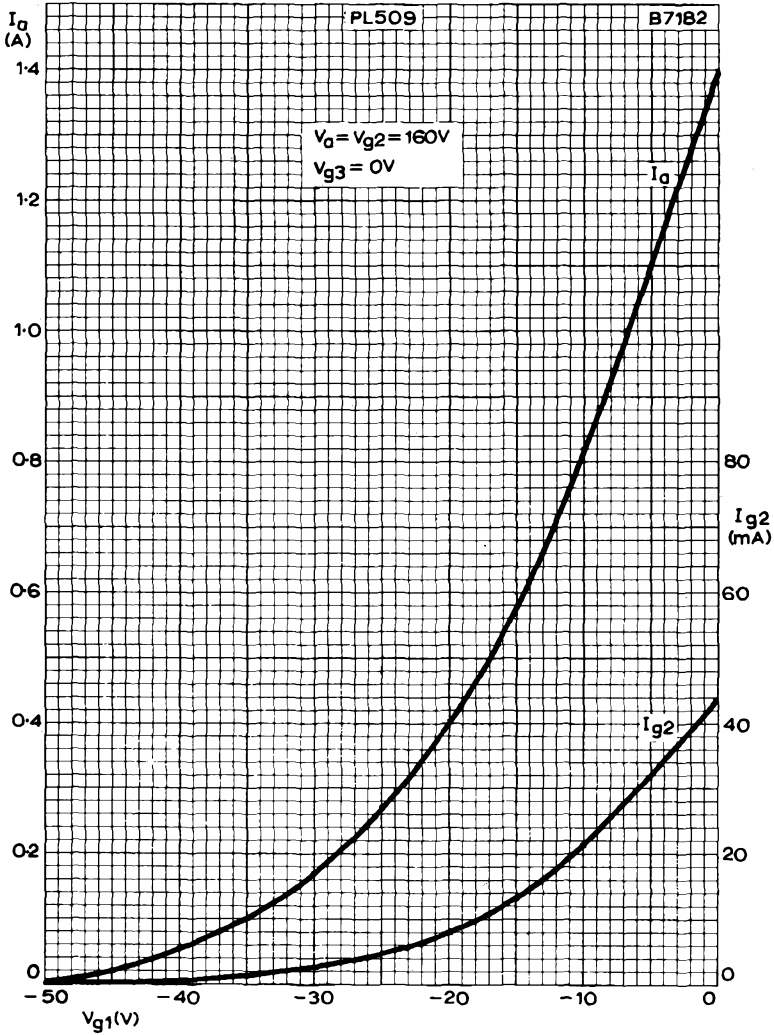

ANODE AND SCREEN CURRENTS PLOTTED AGAINST CONTROL GRID VOLTAGE



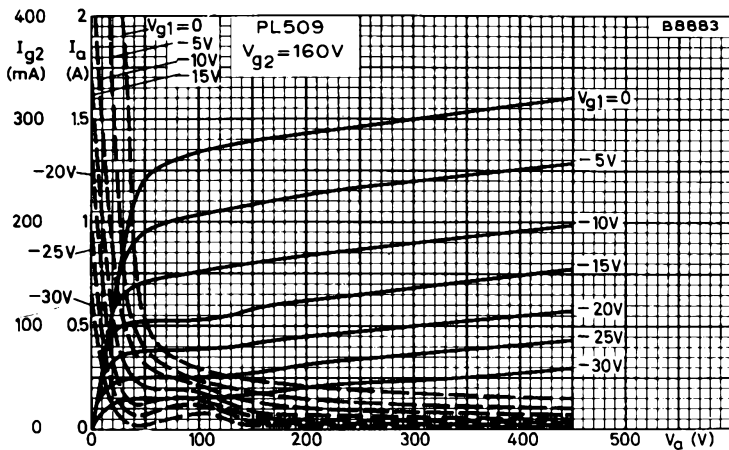

ANODE AND SCREEN GRID CURRENTS PLOTTED AGAINST
 ANODE VOLTAGE: $V_{g2} = 160V$

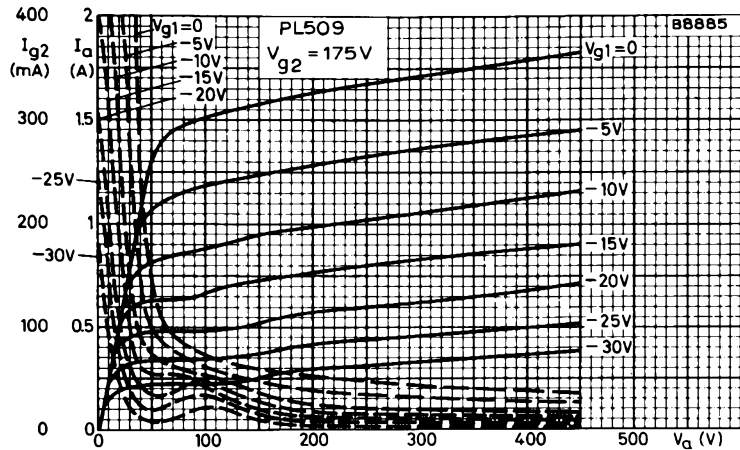

ANODE AND SCREEN GRID CURRENTS PLOTTED AGAINST
 ANODE VOLTAGE: $V_{g2} = 175V$



OUTPUT PENTODE

PL509

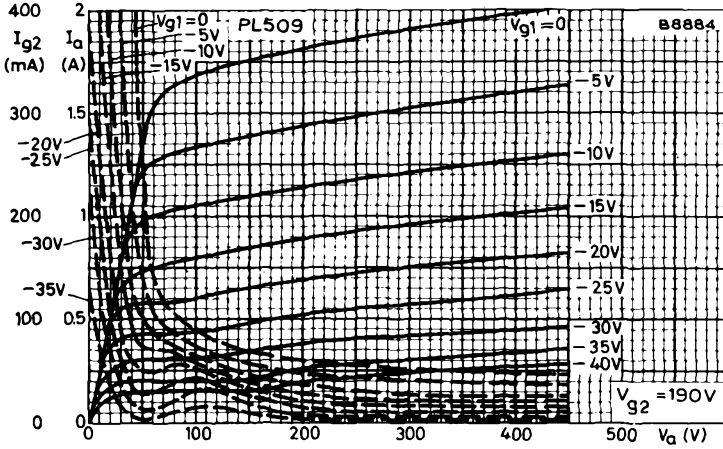

ANODE AND SCREEN GRID CURRENTS PLOTTED AGAINST
ANODE VOLTAGE: $V_{g2} = 190V$





VIDEO OUTPUT PENTODE PL802

Video output pentode for colour television receivers

HEATER

Suitable for series operation, a.c. or d.c.

I_h	300	mA
V_h	16	V

CAPACITANCES

c_{in}	20	pF
c_{out}	4.0	pF
c_{a-g1}	0.075	pF
$c_{a-g1 \text{ max.}}$	0.1	pF ←

CHARACTERISTICS

V_a	170	V
V_{g3}	0	V
V_{g2}	170	V
V_{g1}	-1.3	V
I_a	30	mA
I_{g2}	6.5	mA
g_m	40	mA/V
μ_{g1-g2}	70	



OPERATING CONDITIONS (negative modulation)

V_b	250V
R_b	330Ω
R_D	560Ω
C_D	16μF
R_a	2.7kΩ
R_{g2}	5.6kΩ
C_{g2}	2.0μF
R_k	39Ω
(no bypass capacitor)	
$V_{g1(b)}$	+4.0V

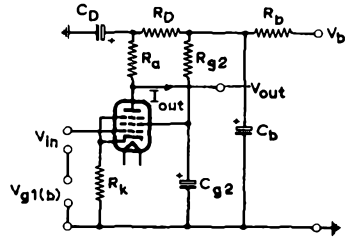

$V_{out(1)}$	100V
$V_{out(2)}$ p-p	≥140V
Video linearity	≥0.8
V_{in} p-p	approx. 5.0V
I_{out} max.	7.0mA

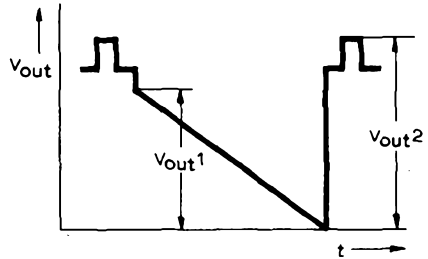

The issue of the information contained in this publication does not imply any authority or licence for the utilisation of any patented feature.



VIDEO OUTPUT PENTODE PL802

RATINGS (DESIGN CENTRE SYSTEM)

$V_{a(b)}$ max. (supply)	400	V
V_a max. (long term average)	300	V
V_a max. ($I_k = 0$)	550	V
p_a max.	6.0	W
V_{g2} max.	300	V
V_{g2} max. ($I_k = 0$)	550	V
p_{g2} max.	2.5	W
p_{g2} max. (intermittent rating, short duration)	3.0	W
I_k max.	100	mA
R_{g1-k} max.	100	k Ω
R_{g1-k} max. ($R_k \geq 39\Omega$)	500	k Ω
V_{h-k} max.	200	V

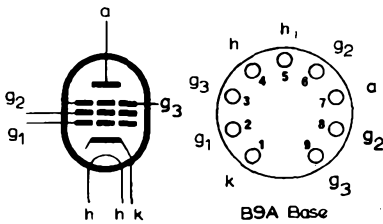

All dimensions in mm

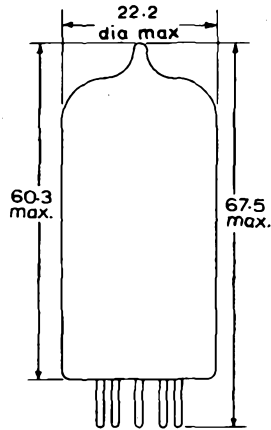

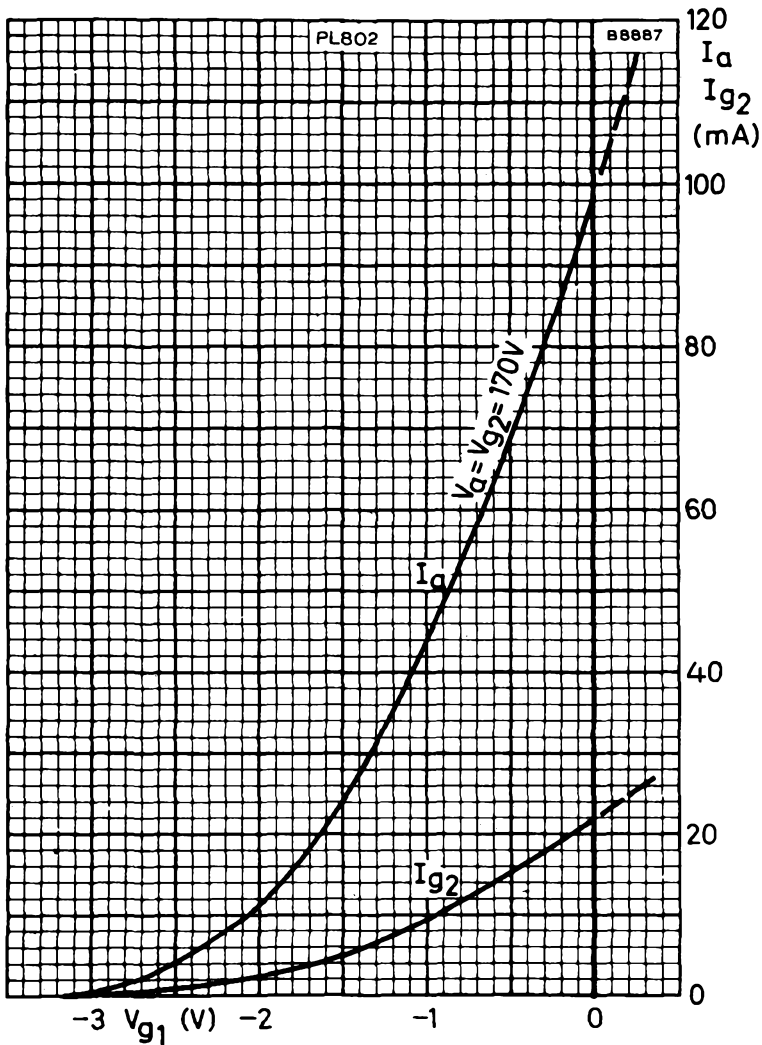

ANODE AND SCREEN GRID CURRENTS PLOTTED AGAINST CONTROL GRID VOLTAGE



VIDEO OUTPUT PENTODE PL802

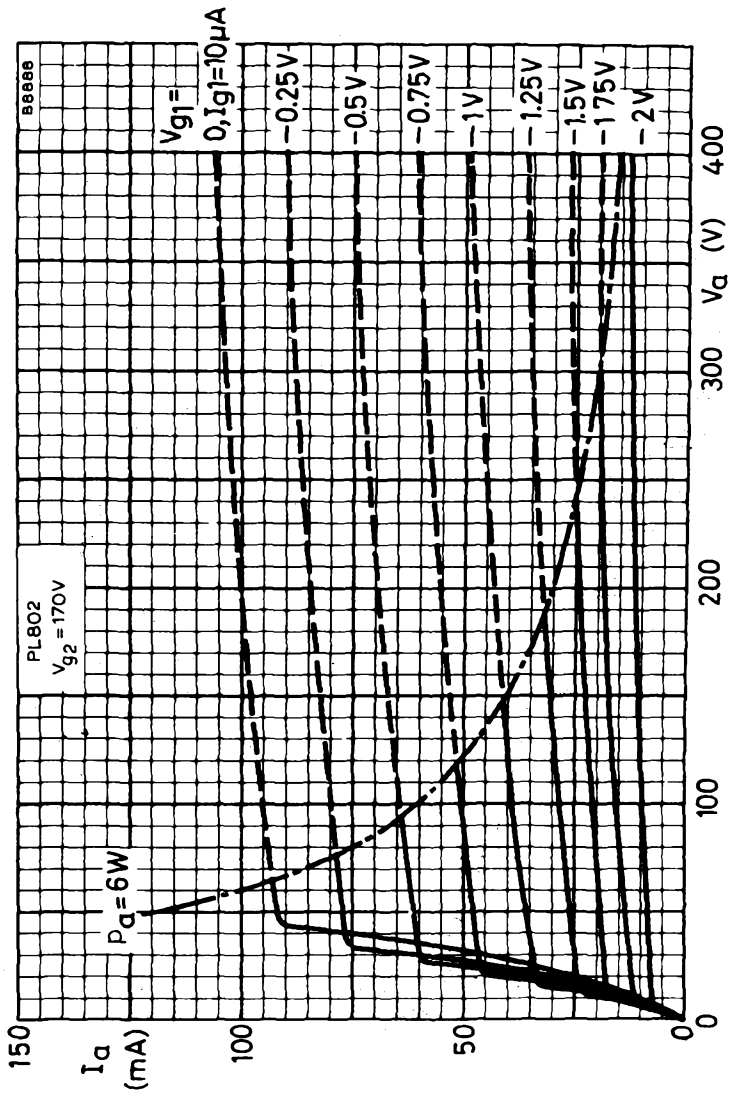

ANODE CURRENT PLOTTED AGAINST ANODE VOLTAGE
WITH CONTROL GRID VOLTAGE AS PARAMETER



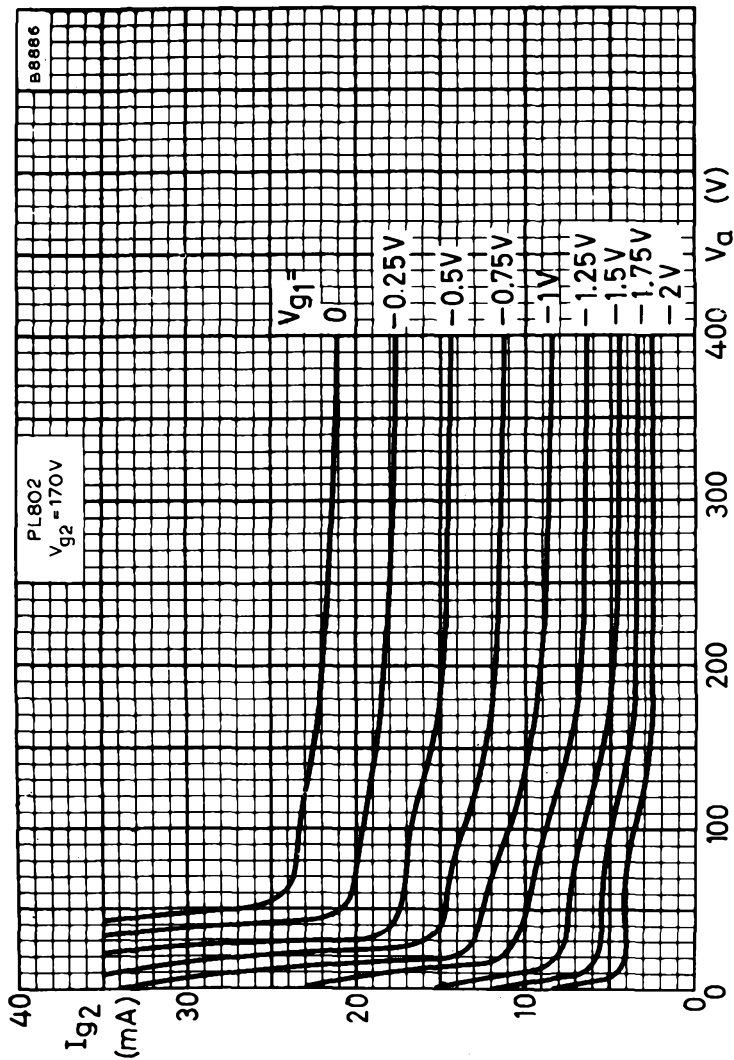

SCREEN GRID CURRENT PLOTTED AGAINST ANODE VOLTAGE
WITH CONTROL GRID VOLTAGE AS PARAMETER



BOOSTER DIODE

PY88

Booster diode with a maximum peak inverse voltage of 6.6kV intended for use in transformerless television receivers with 110° deflection angle cathode ray tubes.

HEATER

Suitable for series operation a.c. or d.c.

I_h	300	mA
V_h	30	V

CAPACITANCES

C_{a-k}	8.6	pF
C_{h-k}	2.0	pF

LIMITING VALUES

*P.I.V. max.	6.6	kV
* $i_{s(pk)}$ max.	550	mA
$I_{s(av)}$ max.	220	mA
$V_{h-e(r.m.s.)}$ max.	220	V
* $V_{h-k(pk)}$ max. (cathode positive)	6.6	kV

*Maximum pulse duration 22% of a cycle with a maximum of 18μs.

4947

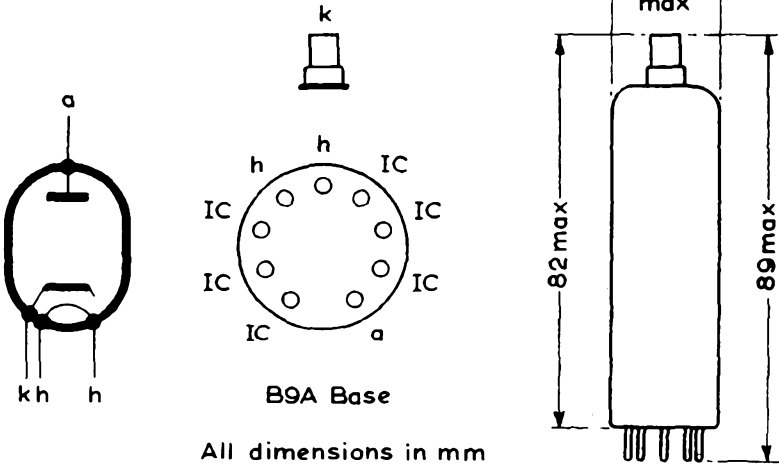

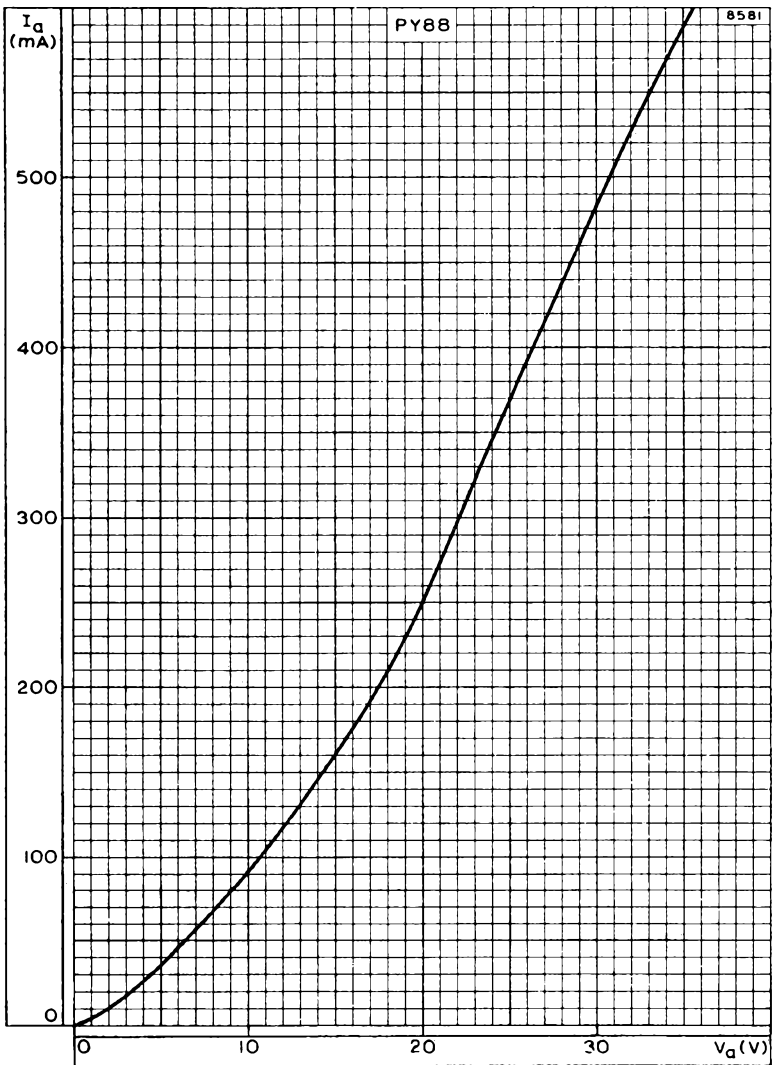

ANODE CURRENT PLOTTED AGAINST ANODE VOLTAGE



BOOSTER DIODE

PY500A

Booster diode for colour television timebase circuits. In existing equipment the PY500A is a direct replacement for the PY500. In new equipment designs the 300 Ω protection resistance from pin 3 to pin 4 or 5 is not required with the PY500A.

HEATER: Suitable for series operation, a.c. or d.c.

I_h	300	mA
V_h	42	V

During operation the minimum resistance between any heater pin and any mains terminal for the heater chain should be 100 Ω . The hot heater resistances of the other valves in the chain can serve for this resistance.

CAPACITANCES

c_{a-k}	13	pF
c_{h-k}	3.7	pF

CHARACTERISTICS

I_a	440	mA
r_i	45.5	Ω

RATINGS (DESIGN CENTRE SYSTEM)

*P.I.V. max.	5.6	kV
*P.I.V. max. (absolute rating)	7.0	kV
i_a (pk) max.	800	mA
I_a max.	440	mA
* v_{h-k} (pk) max. (cathode positive)	6.3	kV
P_a max.	11	W

*Maximum pulse duration 22% of one cycle with a maximum of 18 μ s.

OUTLINE DRAWING

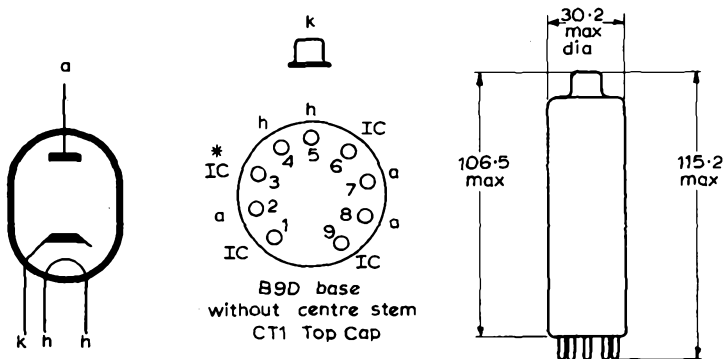

All dimensions in mm

*In existing equipment using the PY500 a resistor may be wired from pin 3 to pin 4 or 5, or pins 3 and 4 may be interconnected. When replacing the PY500 with the PY500A the resistor or interconnection need not be removed. In new equipment designs using the PY500A pin 3 should be left unconnected.

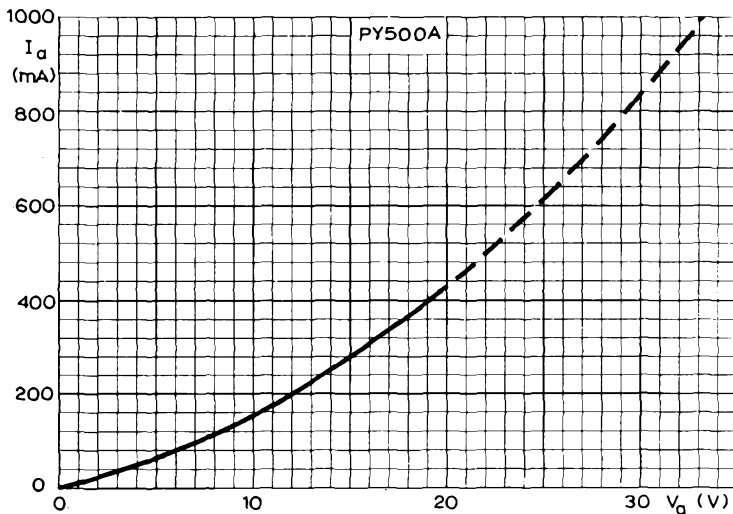

ANODE CURRENT PLOTTED AGAINST ANODE VOLTAGE



BOOSTER DIODE

PY800

Booster diode for use in television receivers employing 110° deflection angle cathode ray tubes.

HEATER

I_h	300	mA
V_h	19	V

CAPACITANCES

C_{a-k}	6.0	pF
C_{h-k}	2.2	pF

LIMITING VALUES

*P.I.V. max.	5.75	kV
i_a (pk) max.	450	mA
I_a (av) max.	175	mA
* v_{h-k} (pk) max. (cathode positive)	6.0	kV

*Maximum pulse duration 22% of one cycle with a maximum of 18μs.

6151

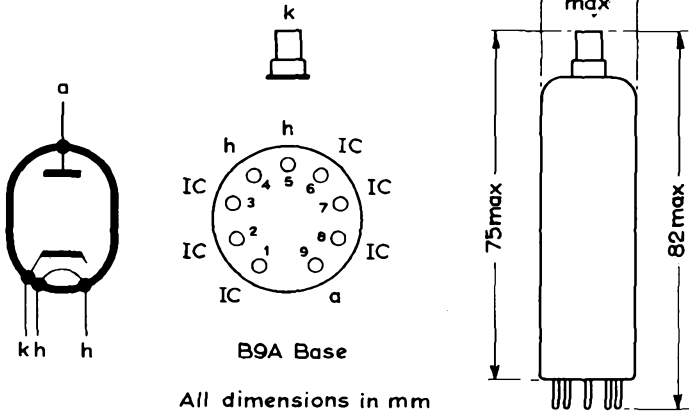

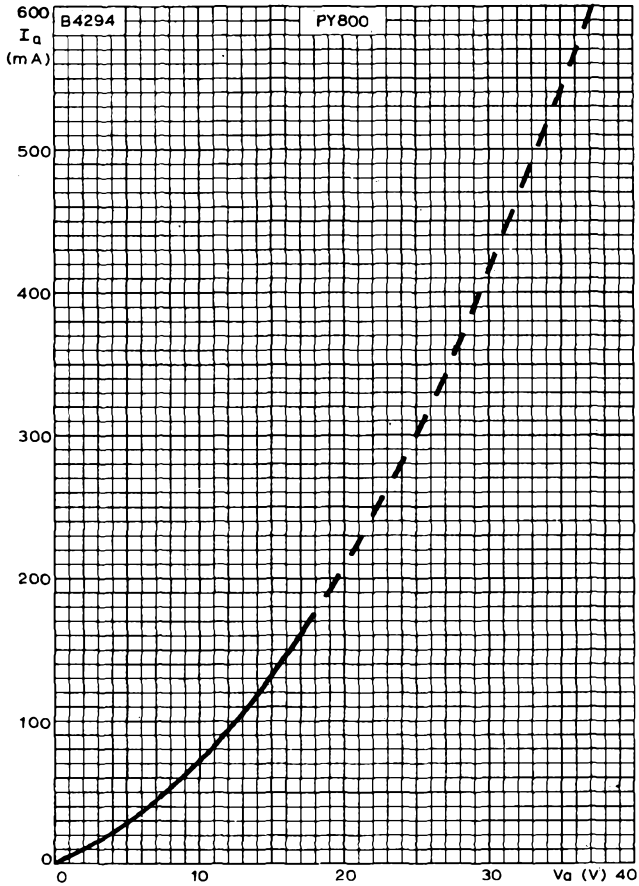

ANODE CURRENT PLOTTED AGAINST ANODE VOLTAGE



PENTODE

6AS6

Dual control pentode for switching or gating control or for use as a frequency changer.

HEATER

V_h	6.3	V
I_h	175	mA

MOUNTING POSITION

Any

CAPACITANCES

	Shielded	Unshielded
C_a-g1	<20	<25 mpF
C_a-g2	700	700 mpF
C_{1a}	4.0	3.9 pF
C_{g2-a11}	3.4	3.3 pF
C_{out}	3.0	2.2 pF
C_{g1-g2}	<150	<150 mpF

CHARACTERISTICS

V_a	120	120	V
V_{g2}	120	120	V
V_{g1}	-3.0	0	V
I_a	3.5	5.1	mA
I_{g2}	4.8	3.5	mA
V_{g1}	-2.0	-2.0	V
$g_{m(g1-a)}$	2.0	3.2	mA/V
$g_{m(g2-a)}$	660	450	$\mu A/V$
r_a	—	150	k Ω
$V_{g1}(I_a = 100\mu A)$	—	<-7.5	V
$V_{g2}(I_a = 20\mu A)$	-10	<-15	V

OPERATING CONDITIONS

Frequency changer with oscillator voltage on g_a

V_a	120	V
V_{g2}	120	V
V_{g1}	-2.0	V
I_a	2.1	mA
I_{g2}	5.8	mA
$V_{osc}(r.m.s.)$	6.0	V
I_{g3}	70	μA
R_{g2}	100	k Ω
g_c	1.0	mA/V
r_a	130	k Ω
R_{eq}	12	k Ω

DESIGN CENTRE RATINGS

$V_{a(b)} \text{ max.}$	300	V
$V_a \text{ max.}$	180	V
$P_a \text{ max.}$	1.7	W
$V_{g1(b)} \text{ max.}$	300	V
$V_{g2} \text{ max.}$	140	V
$P_{g2} \text{ max.}$	750	mW
$V_{g3} \text{ max.}$	27	V
$R_{g1-k} \text{ max.}$	4.0	M Ω
$I_k \text{ max.}$	18	mA
$V_{b-k} \text{ max.}$	90	V

6AS6

PENTODE

4491

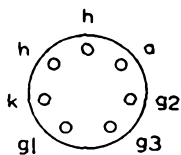
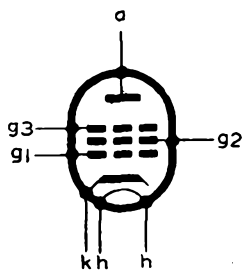

B7G Base

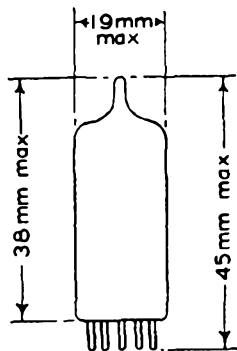

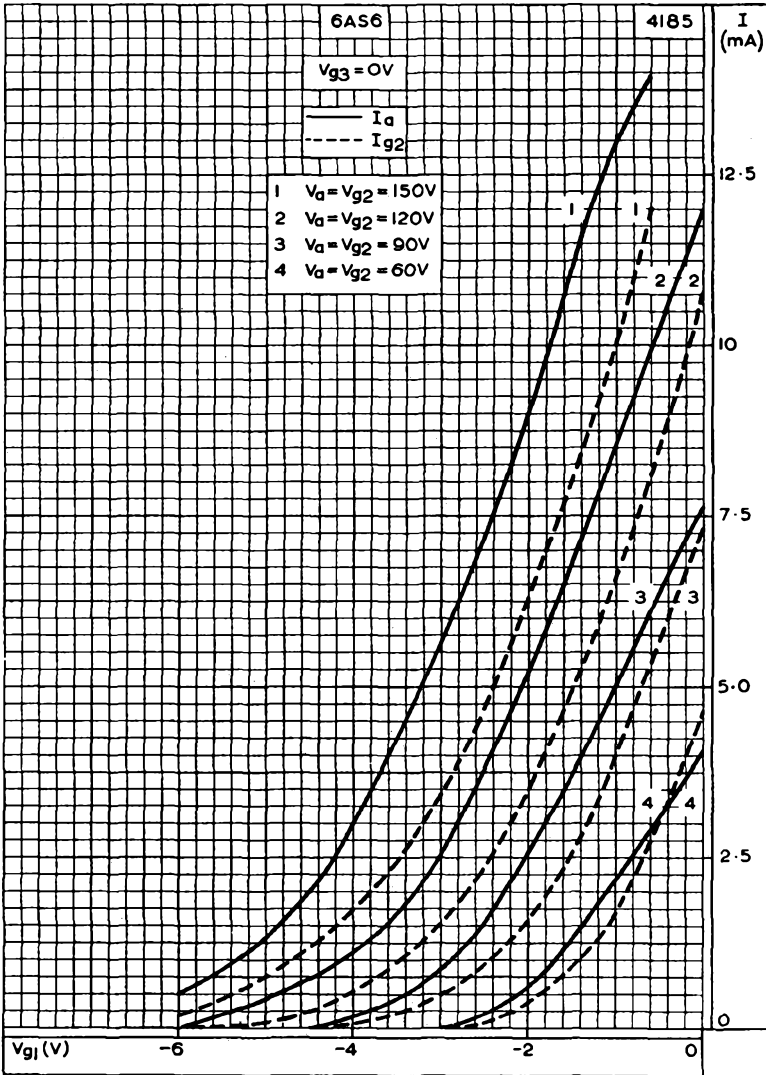

ANODE AND SCREEN-GRID CURRENTS PLOTTED AGAINST CONTROL-GRID VOLTAGE WITH ANODE AND SCREEN-GRID VOLTAGES AS PARAMETERS



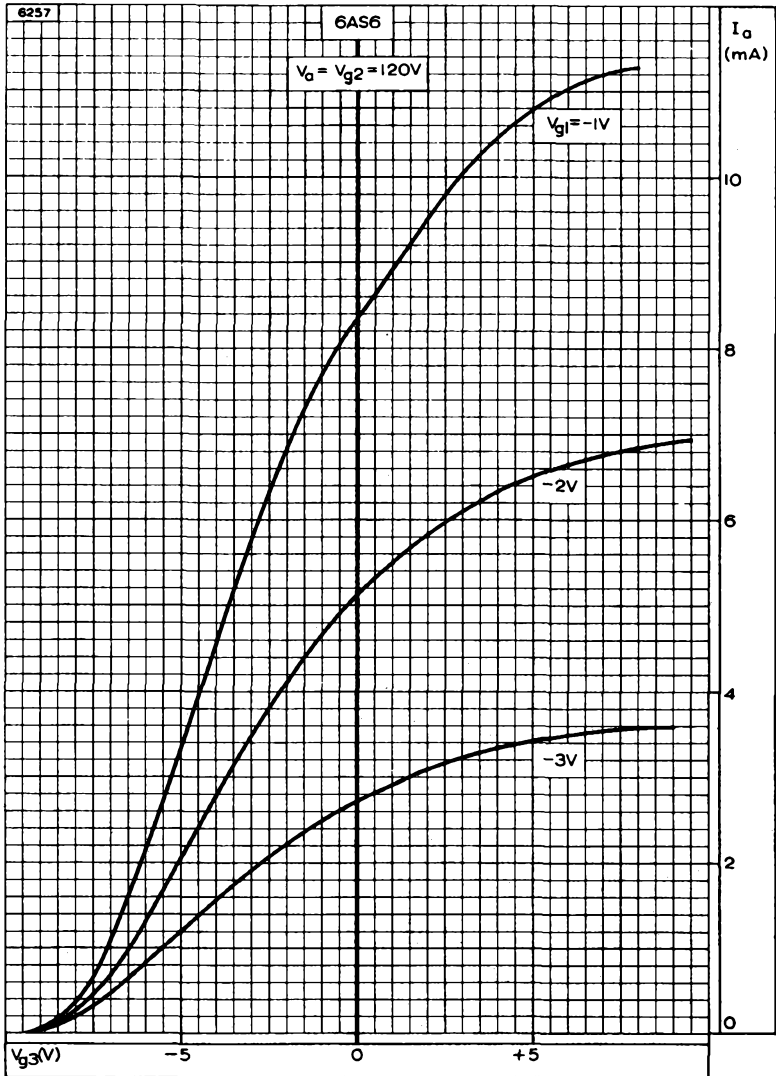

ANODE CURRENT PLOTTED AGAINST SUPPRESSOR-GRID VOLTAGE WITH CONTROL-GRID VOLTAGE AS PARAMETER

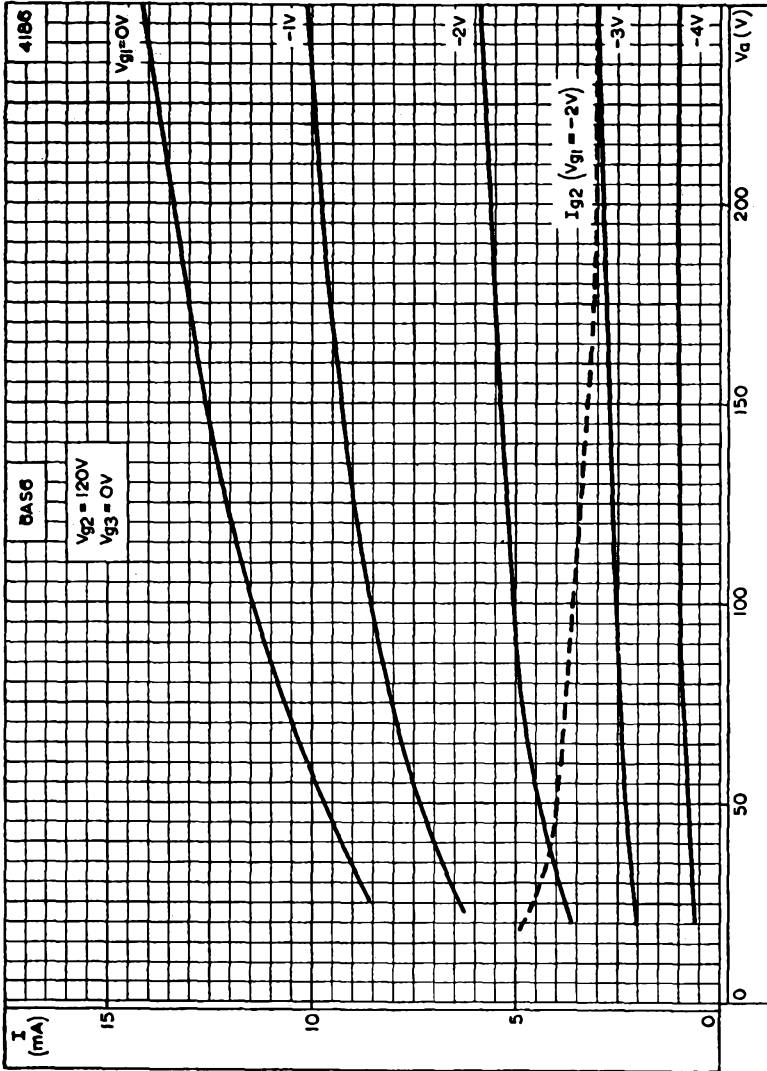

ANODE AND SCREEN-GRID CURRENTS PLOTTED AGAINST ANODE VOLTAGE WITH CONTROL-GRID VOLTAGE AS PARAMETER



6AS6

PENTODE

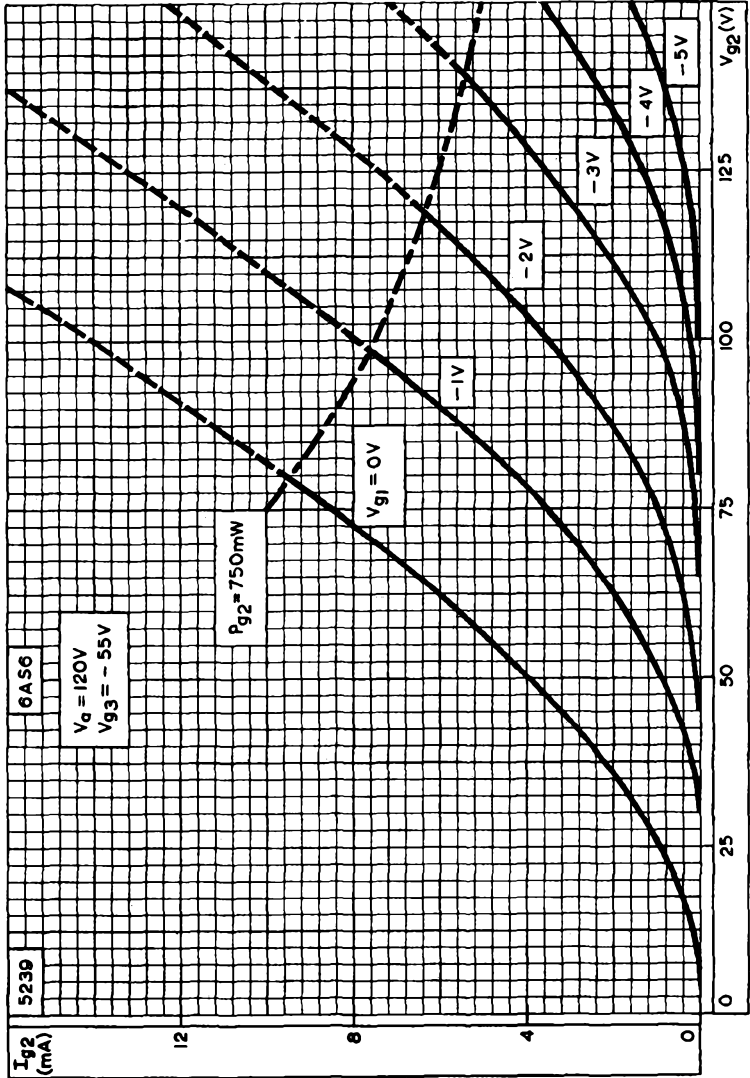

SCREEN-GRID CURRENT PLOTTED AGAINST SCREEN-GRID VOLTAGE WITH CONTROL-GRID VOLTAGE AS PARAMETER



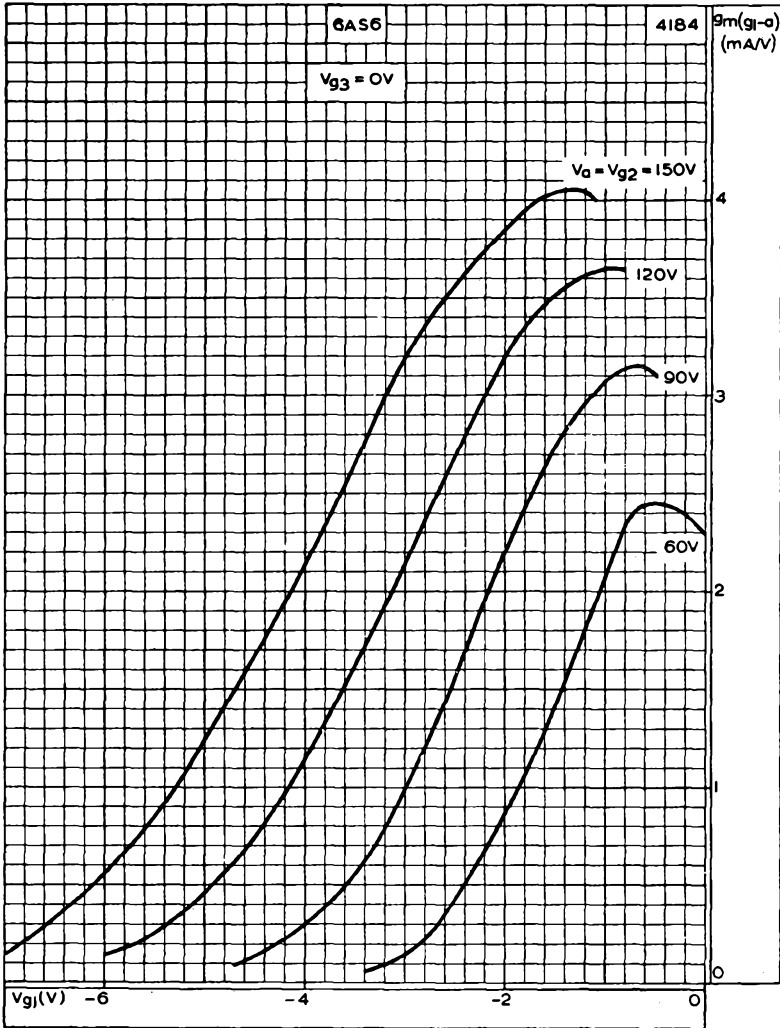

MUTUAL CONDUCTANCE (g_{1-a}) PLOTTED AGAINST CONTROL-GRID VOLTAGE WITH ANODE AND SCREEN-GRID VOLTAGES AS PARAMETERS



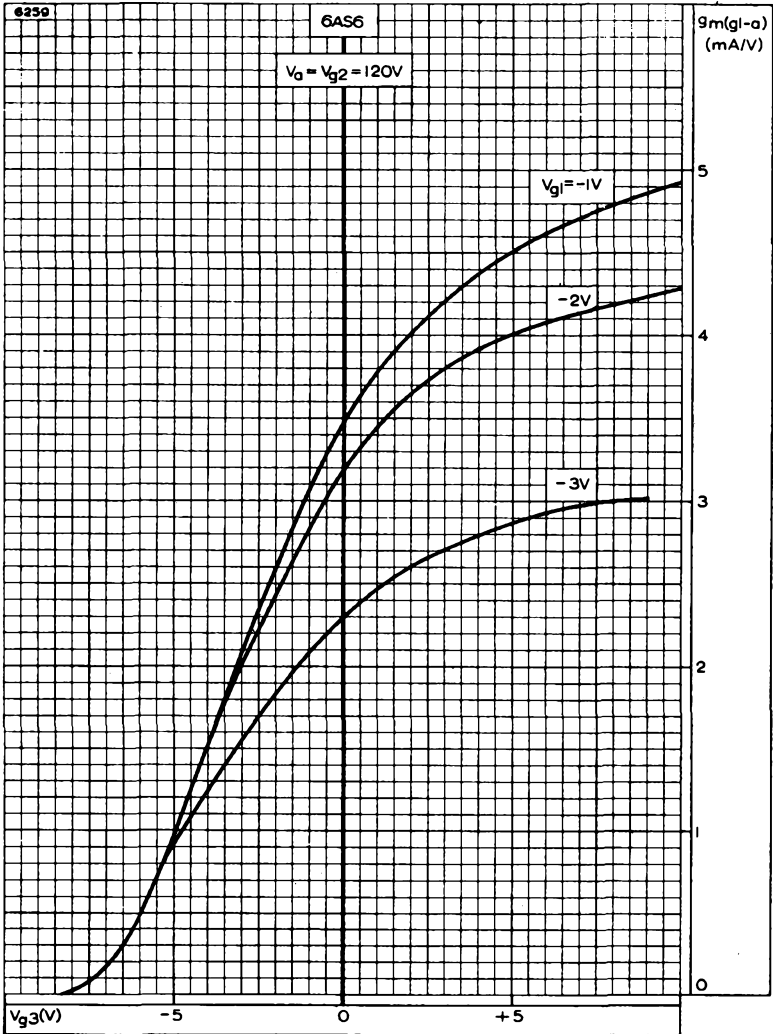

MUTUAL CONDUCTANCE (g_{1-a}) PLOTTED AGAINST SUPPRESSOR-GRID VOLTAGE WITH CONTROL-GRID VOLTAGE AS PARAMETER

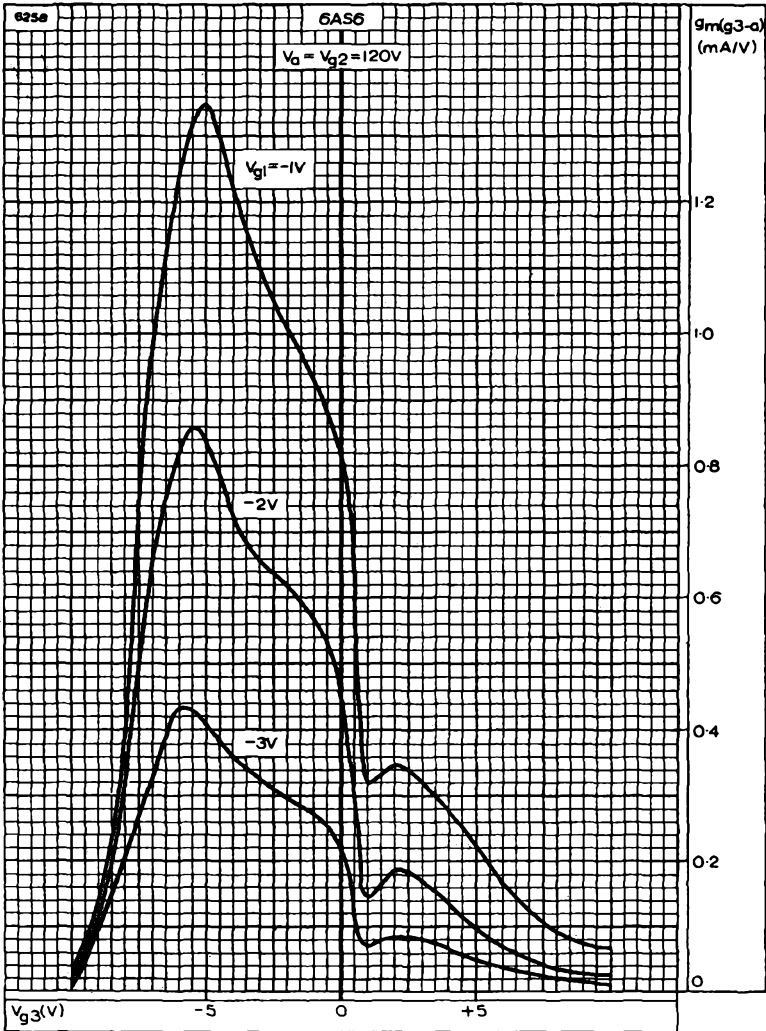

MUTUAL CONDUCTANCE (g_{3-a}) PLOTTED AGAINST SUPPRESSOR-GRID VOLTAGE WITH CONTROL-GRID VOLTAGE AS PARAMETER



6AS6

PENTODE

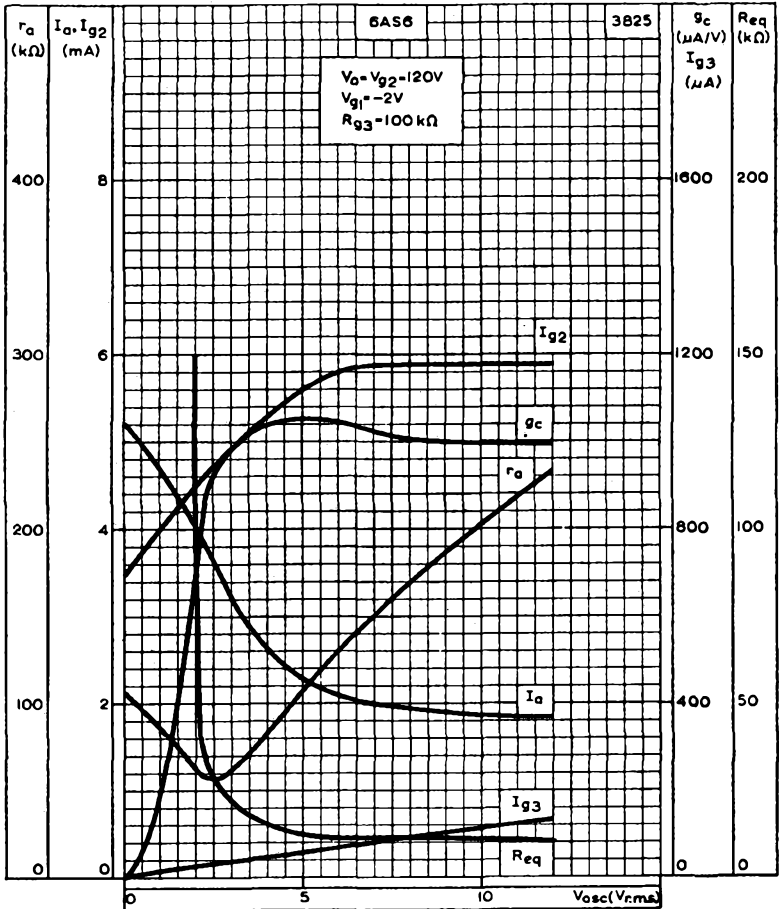

PERFORMANCE CURVES FOR USE AS A FREQUENCY CHANGER



SPECIAL QUALITY RECEIVING VALVES





These general notes include definitions and general test procedures. They should be read in conjunction with the data sheets for Special Quality Valves. Where reference should be made to a specific note, this is indicated on the data sheet by an index number, e.g. Group Quality Level.¹⁰

1. **Heater voltage.** Life and reliability of performance are a function of the value and degree of regulation of the heater voltage. In order to achieve the maximum useful life the heater should be maintained as close as possible to its rated value, and unless specific recommendations are made on individual data sheets, designers should aim to maintain the voltage at the valve pins within $\pm 5\%$ of the published nominal value. The tolerance quoted includes variations in the supply voltage.
2. **Capacitances.** Unless otherwise stated the capacitances quoted are measured with the valve cold in a fully screened socket. The measurements are made with or without an external shield, as stated on the individual data sheets.
3. **Electrode voltages.** The reference point for electrode voltages is normally the cathode, and the symbols V_a , V_{g2} etc., are used to indicate the anode and screen-grid voltages with respect to the cathode.

In some cases however, a cathode resistor is used when measuring characteristics, and in such cases the symbols V_{a-k} , V_{g2-k} are used when voltages are measured with respect to the cathode and V_{a-e} , V_{g2-e} , when the voltages are measured with respect to the negative end of the cathode resistor.

4. **Limiting values.** Unless otherwise stated the Limiting Values of Special Quality Valves are Absolute Ratings.

Absolute maximum ratings are limiting values of operating and environmental conditions applicable to any valve of a specified type as defined by its published data, and should not be exceeded under the worst probable conditions.

These values are chosen by the valve manufacturer to provide acceptable serviceability of the valve, taking no responsibility for equipment variations, environmental variations, and the effects of changes in operating conditions due to variations in the characteristics of the valve under consideration and of all other electron devices in the equipment.

The equipment manufacturer should design so that initially and throughout life no absolute maximum value for the intended service is exceeded with any valve under the worst probable operating conditions with respect to supply voltage variations, equipment component variation, equipment control adjustment, load variations, signal variation, environmental conditions, and variations in characteristics of the valve under consideration and of all other devices in the equipment.

The life expectancy may be reduced if conditions other than those specified for life test are imposed on the valve and will be reduced appreciably if absolute maximum ratings are exceeded.

Heater to cathode voltage. In the interests of reliability the heater to cathode voltage should always be kept as low as possible, and it is preferable to have the cathode positive with respect to the heater.

Bulb temperature. In the interests of reliability the bulb temperature should always be kept as low as possible.

5. *The A.Q.L. (Acceptable quality level)* is the limit below which the average percentage of defectives is controlled.
6. *Maximum and minimum values for the individuals* are the limits to which valves are tested.
7. *Maximum and minimum for lot average* are the limits between which the average value of the characteristic of a lot or batch is controlled.
8. *Lot standard deviation* is the standard deviation of a single lot or batch.
9. *Bogey value* is the target value.
10. *Group quality level.* This is the A.Q.L. (Acceptable quality level) over a whole group of tests.

Sub-group quality level. The A.Q.L. over a number of tests, which do not constitute a complete group.



-
11. *Glass envelope strain test.*
- (A) This test is carried out on a sampling basis and consists of completely submerging the valves in boiling water at a temperature between 97 and 100°C for 15 seconds and then immediately plunging them in ice cold water for 5 seconds. The valves are then examined for glass cracks.
 - (B) This test is carried out on a sampling basis and consists of completely submerging the valves in boiling water not less than 85°C for 15 seconds and then immediately plunging them in ice cold water not more than 5°C for 5 seconds. The valves are then examined for glass cracks.
12. *Base strain test.* This test is carried out on a sampling basis and consists of forcing the pins of the valves over specified cones and then completely submerging the valves and cones in boiling water at a temperature between 97 and 100°C for 10 seconds. The valves and cones are allowed to cool to room temperature before examining for glass cracks.
13. *Lead fragility test.*
- (A) This test is carried out on a sampling basis and consists of holding the valves vertically and having a 1-lb weight freely suspended from the lead under test. The valves are inclined slowly so as to bend the weighted lead through 45°, brought to 45° in the other direction, back again to 45° in the first direction and finally returned to the vertical, the entire action taking place in one vertical plane. The valves are examined for cracks and broken leads.
 - (B) This test is carried out on a sampling basis and consists of holding the valves vertically and having a 1-lb weight freely suspended from the lead under test. The valves are inclined slowly so as to bend the weighted lead through 90° and then returned to the vertical, the entire action taking place in one vertical plane. This cycle is repeated for the number of times shown on the data sheet. The valves are examined for broken leads.
14. This test is carried out on a sampling basis under the conditions detailed in the data.
15. *Shock test.* This test is carried out on a sampling basis and subjects the valves to 5 blows of the specified acceleration in each of 4 directions.
16. *Inoperatives.* An inoperative is defined as a valve having an open or short circuited electrode, an air leak or a broken pin.



SPECIAL QUALITY SUBMINIATURE VOLTAGE INDICATOR

DM160

Special quality, directly heated subminiature voltage indicator for use in industrial equipment such as transistorised computers.

This data should be read in conjunction with GENERAL NOTES - SPECIAL QUALITY VALVES, and the index numbers are used to indicate where reference should be made to a specific note.

FILAMENT

Suitable for parallel operation only, a.c. or d.c.

V_f (see RATINGS section)	1.0	V
I_f nom.	30	mA
I_f (initial range)	24 to 36	mA

CHARACTERISTICS, OPERATING CONDITIONS AND RANGE VALUES FOR EQUIPMENT DESIGN³

	Nominal value	Initial range	End of life	
V_a	50			V
R_g	100			k Ω
* $V_{g(b)}$ (max. light output)	0			V
* $V_{g(b)}$ (zero light output)	-3	-3	-3	V
I_a at $V_{g(b)} = 0V$	585	430 to 740	>250	$\mu A \leftarrow$
** I_a at $V_{g(b)} = -3V$		<5.0	<5.0	μA
Insulation resistance between any two electrodes at 50V		>100		M Ω

*Voltage with respect to the centre tap of the filament transformer.

**The residual electron current may be concentrated on one spot which may then be visible in dark surroundings. This effect cannot be mistaken for the indicator being in the conducting condition.

RATINGS (ABSOLUTE MAXIMUM SYSTEM)⁴

$V_{a(b)}$ max.	100	V
V_a max.	65	V
I_a max.	850	μ A
$V_{g(b)}$ max. ($R_g = 100k\Omega \pm 10\%$)	0	V
$V_{g(b)}$ max. ($R_g = 1M\Omega \pm 10\%$)	6.0	V
$-V_g$ max.	50	V
R_g max.	1.1	M Ω
R_g min.	90	k Ω
Filament voltage		

The average filament voltage should be 1.0V. Variations exceeding +0 or -10% will shorten the life of the valve.

SHOCK RESISTANCE¹⁵

The valve is subjected to an acceleration of 50g, 5 times in each of four positions in an NRL shock machine with the hammer lifted over an angle of 30°.

LIFE

Production samples are checked for the end of life values given on page 1 under the following conditions for 10 000 hours:

V_f (r.m.s.)	1.0	V
V_a	50	V
* $V_{g(b)}$	0	V
R_g	100	k Ω

*Voltage with respect to the centre tap of the filament transformer.

DIMENSIONS AND CONNECTIONS

99003

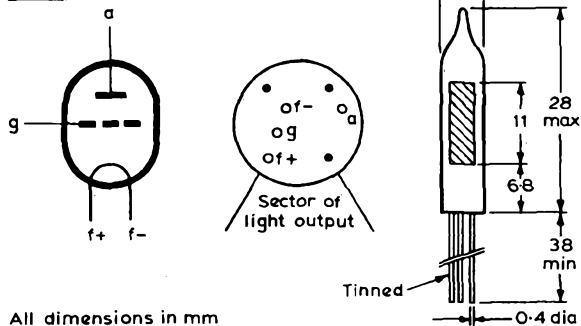

All dimensions in mm

Connections should not be soldered nearer than 5mm from the seal.
The leads should not be bent nearer than 1.5mm from the seal.



SPECIAL QUALITY SUBMINIATURE VOLTAGE INDICATOR

DM160

APPLICATION NOTES

The visibility of the phosphorescent light produced by the anode when the indicator is conducting depends upon the grid voltage and the illumination level of the surroundings. With $V_g = -3V$ for zero light output the visibility is best when $\Delta V_g = 3V$, but an unambiguous indication is still obtained at $\Delta V_g = 1.4V$ under nominal conditions and a low level of ambient light. With still smaller values of drive voltage a pre-amplifier is required. These points being taken into account, one can use the DM160 for reading out digital information from logic circuits. Figs. 1 and 2 show typical arrangements for negative and positive logic, respectively.

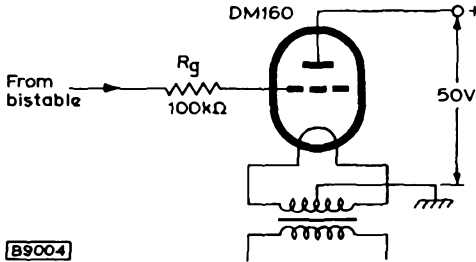

Fig. 1 Digital read-out circuit with DM160 connected to negative logic circuit which uses bistables equipped with p-n-p transistors. The 'High' output level of the bistable may vary between 0V and -0.3V, and the 'Low' level between -3V and -6.8V.

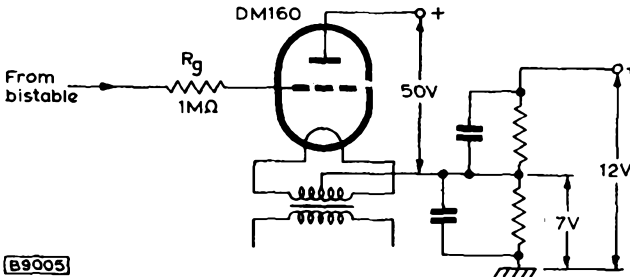

Fig. 2 Digital read-out circuit with DM160 connected to positive logic circuit which uses bistables equipped with n-p-n transistors. The 'High' output level of the bistable may vary between +7.5V and +12V, and the 'Low' level between 0V and +0.4V. R_g protects the valve against excessive anode currents and positive grid currents in case the grid voltage exceeds the cathode potential.

When the minimum ΔV_g lies below 3V the spread in the 'High' level of the bistable will give rise to an extra spread in the brightness of the phosphorescent light. If this is undesirable the spread may be reduced by clamping the grid voltage (see page 4).



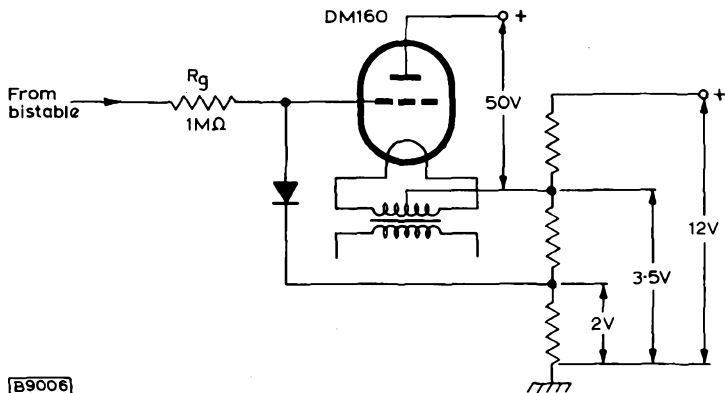
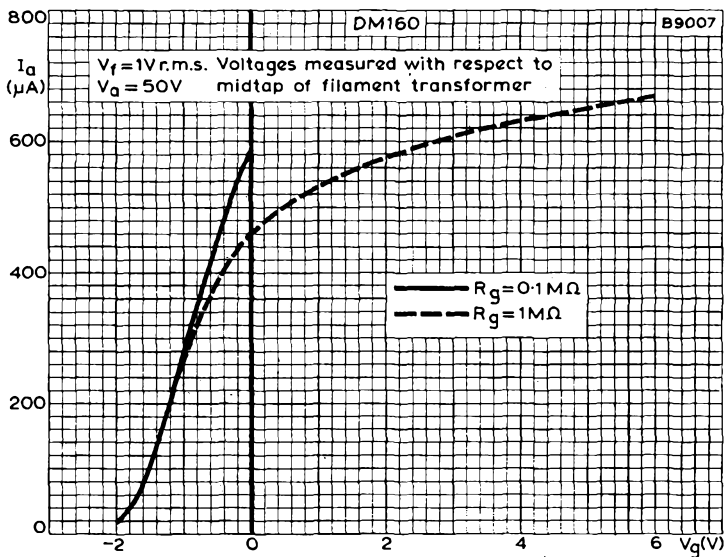
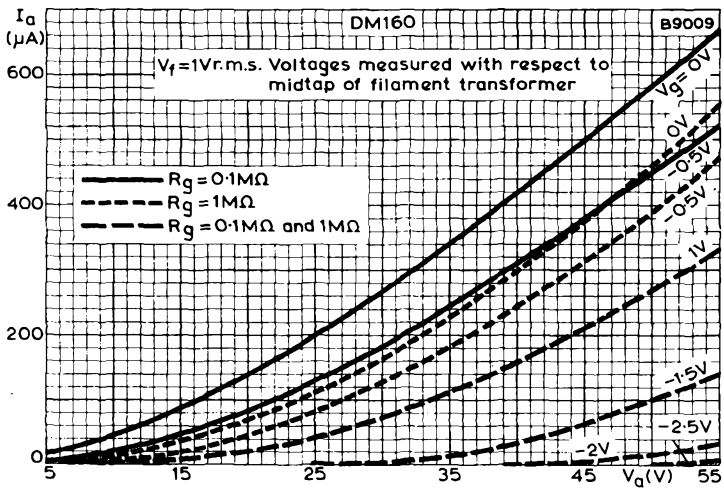
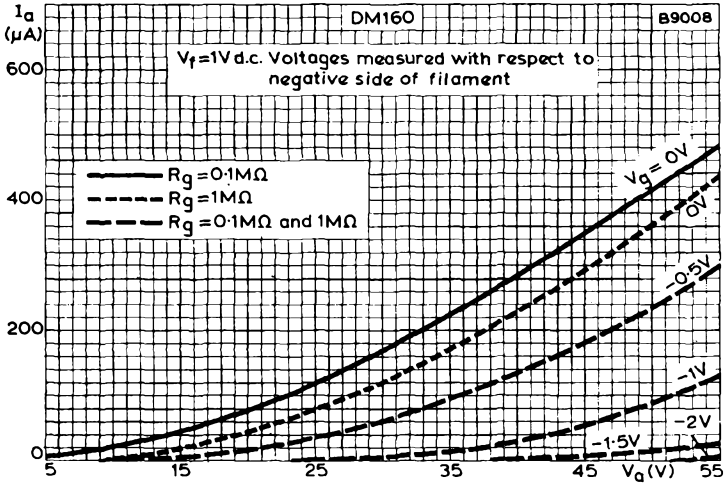

Fig. 3 As Fig. 2: 'High' voltage between +2V and +7V, and 'Low' level between 0V and +0.5V; grid voltage clamped.



ANODE CURRENT PLOTTED AGAINST GRID VOLTAGE





**ANODE CURRENT PLOTTED AGAINST ANODE VOLTAGE
WITH GRID VOLTAGE AS PARAMETER**

The issue of the information contained in this publication does not imply any authority or licence for the utilisation of any patented feature.





SPECIAL QUALITY WIDEBAND OUTPUT PENTODE

E55L

Special quality high slope output pentode intended for general industrial applications where stability of characteristics and long life are required.

This data should be read in conjunction with GENERAL NOTES—SPECIAL QUALITY VALVES which precede this section of the handbook, and the index numbers are used to indicate where reference should be made to a specific note.

HEATER

V_h^1	6.3	V
I_h	600	mA

CAPACITANCES²

Pentode connected

Shielded

	Minimum	Average	Maximum	
C_{a-g1}	—	80	120	mpF
C_{in}	15	18	21	pF
$C_{in} (w) (I_k = 55.5mA)$	—	28	—	pF
C_{out}	5.8	6.5	7.2	pF

Unshielded

C_{a-g1}	—	110	150	mpF
C_{in}	15	18	20	pF
$C_{in} (w) (I_k = 55.5mA)$	—	28	—	pF
C_{out}	3.6	4.0	4.4	pF

Triode connected

Shielded

C_{a-g}	5.5	6.2	6.9	pF
C_{in}	10	11.8	13.6	pF
C_{out}	9.4	10.5	11.6	pF
C_{h-k}	—	6.0	—	pF

Unshielded

C_{a-g}	5.6	6.3	7.0	pF
C_{in}	10	11.8	13.6	pF
C_{out}	7.0	7.8	8.6	pF
C_{h-k}	—	6.0	—	pF

CHARACTERISTICS³

Pentode connected

V_a	125	V
V_{g2}	125	V
V_{g3}	0	V
V_{g1}	-3.0	V
R_k	0	Ω
I_a	50	mA
I_{g2}	5.5	mA
g_m	45	mA/V
r_a	20	k Ω
μ_{g1-g2}	30	
r_{g1} ($f = 50\text{Mc/s}$)	1.0	k Ω

Triode connected

V_a	125	V
I_a	55.5	mA
V_g	-3.0	V
g_m	50	mA/V
μ	30	
r_a	600	Ω

OPERATING CONDITIONS

V_{a-e}	140	V
V_{g2-e}	140	V
V_{g3-k}	0	V
V_{g1-e}	+12	V
R_k	270	Ω
I_a	50	mA
I_{g2}	5.5	mA
g_m	45	mA/V

CHARACTERISTIC RANGE VALUES FOR EQUIPMENT DESIGN

	Average	Initial range	End of life*	
Anode Current at $V_{a-e} = 140\text{V}$, $V_{g2-e} = 140\text{V}$ $V_{g1-e} = +12\text{V}$, $R_k = 270\Omega$	50	48 to 52	—	mA
Grid-cathode voltage at $V_{a-e} = 140\text{V}$, $V_{g2-e} = 140\text{V}$ $V_{g1-e} = +12\text{V}$, $R_k = 270\Omega$	-3.0	-2.3 to -3.7	-1.8	V
Screen-grid current at $V_{a-e} = 140\text{V}$, $V_{g2-e} = 140\text{V}$ $V_{g1-e} = +12\text{V}$, $R_k = 270\Omega$	5.5	4.5 to 6.5	—	mA
Mutual conductance at $V_{a-e} = 140\text{V}$, $V_{g2-e} = 140\text{V}$ $V_{g1-e} = +12\text{V}$, $R_k = 270\Omega$	45	38 to 52	Δg_m max. = 25%	mA/V
Negative control-grid current (max.) at $V_{a-e} = 140\text{V}$, $V_{g2-e} = 140\text{V}$ $V_{g1-e} = +12\text{V}$, $R_k = 270\Omega$	—	—	2.0	μA

*To allow for valve deterioration during life, circuits should be designed to function with a valve in which one or more of the characteristics have changed to the values stated.

**SPECIAL QUALITY WIDEBAND
OUTPUT PENTODE**

E55L

ABSOLUTE MAXIMUM RATINGS:

$V_{a(b)}$ max.	400	V
V_a max.	200	V
p_a max.	10	W
$V_{g2(b)}$ max.	350	V
V_{g2} max.	175	V
p_{g2} max.	1.5	W
$-V_{g1}$ max.	55	V
$+V_{g1}$ max.	0	V
$*I_k$ max.	75	mA
R_{g1-k} max.	125	k Ω
V_{h-k} max.	200	V
$*T_{bulb}$ max.	180	$^{\circ}$ C

*In applications where a long life is not required, I_k max. can be increased to 100mA and T_{bulb} max. to 220 $^{\circ}$ C.

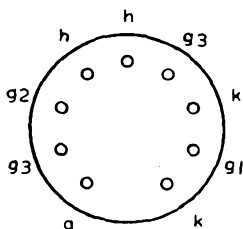
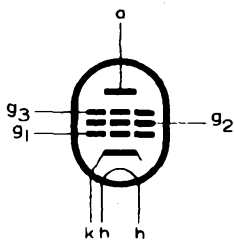

B9D Base

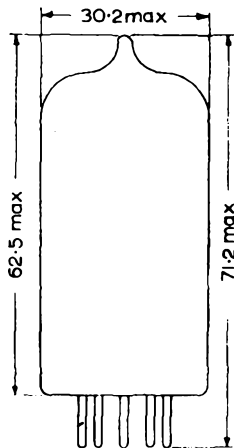

9862

All dimensions in mm





**SPECIAL QUALITY WIDEBAND
OUTPUT PENTODE**

E55L

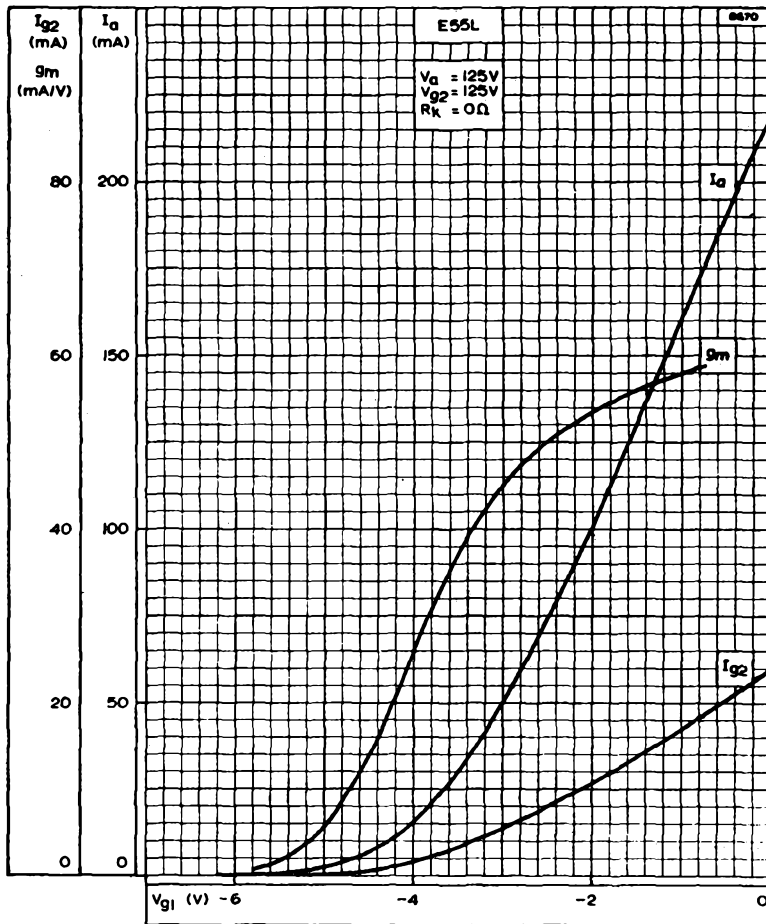

**ANODE AND SCREEN-GRID CURRENT AND MUTUAL CONDUCTANCE
PLOTTED AGAINST CONTROL-GRID VOLTAGE. $V_{g2} = 125V$**



E55L

SPECIAL QUALITY WIDEBAND OUTPUT PENTODE

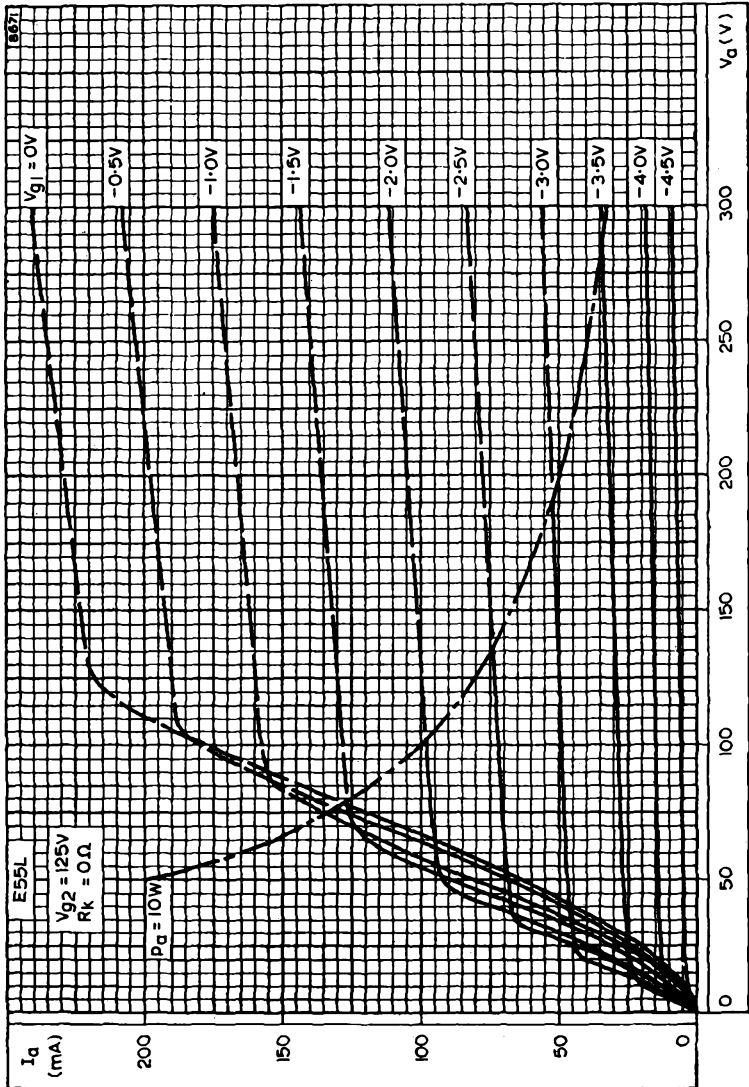

ANODE CURRENT PLOTTED AGAINST ANODE VOLTAGE WITH CONTROL-
GRID VOLTAGE AS PARAMETER



SPECIAL QUALITY WIDEBAND
OUTPUT PENTODE

E55L

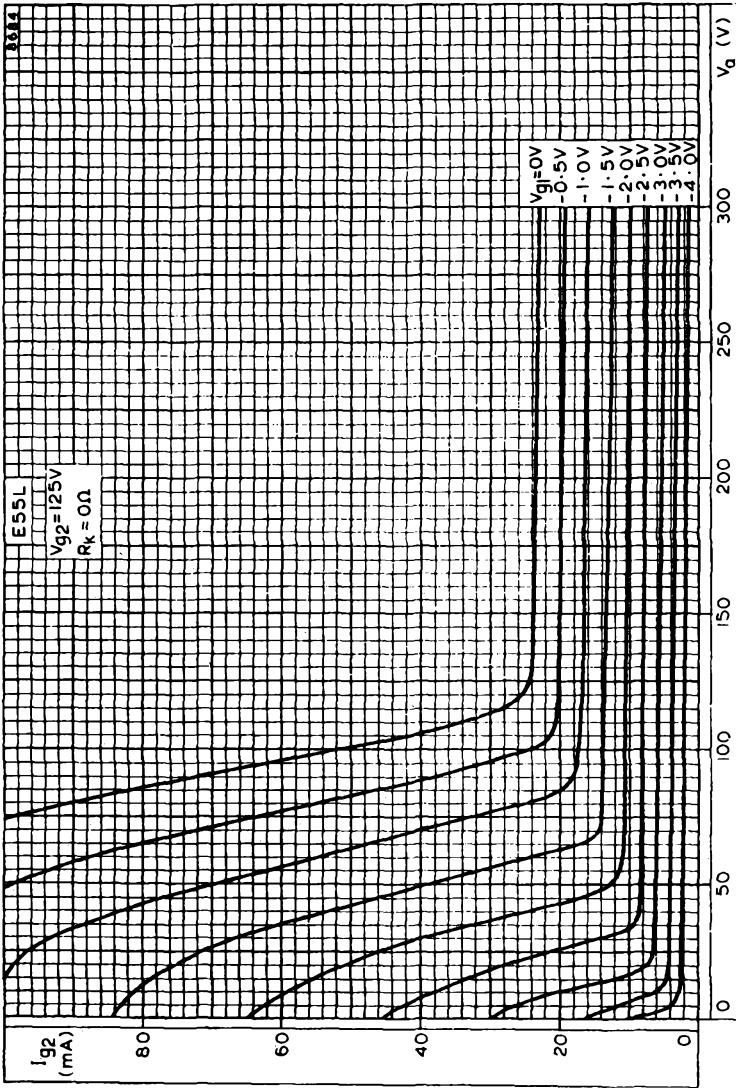

SCREEN-GRID CURRENT PLOTTED AGAINST ANODE VOLTAGE WITH CONTROL-GRID VOLTAGE AS PARAMETER. $V_{g2} = 125V$



E55L

SPECIAL QUALITY WIDEBAND OUTPUT PENTODE

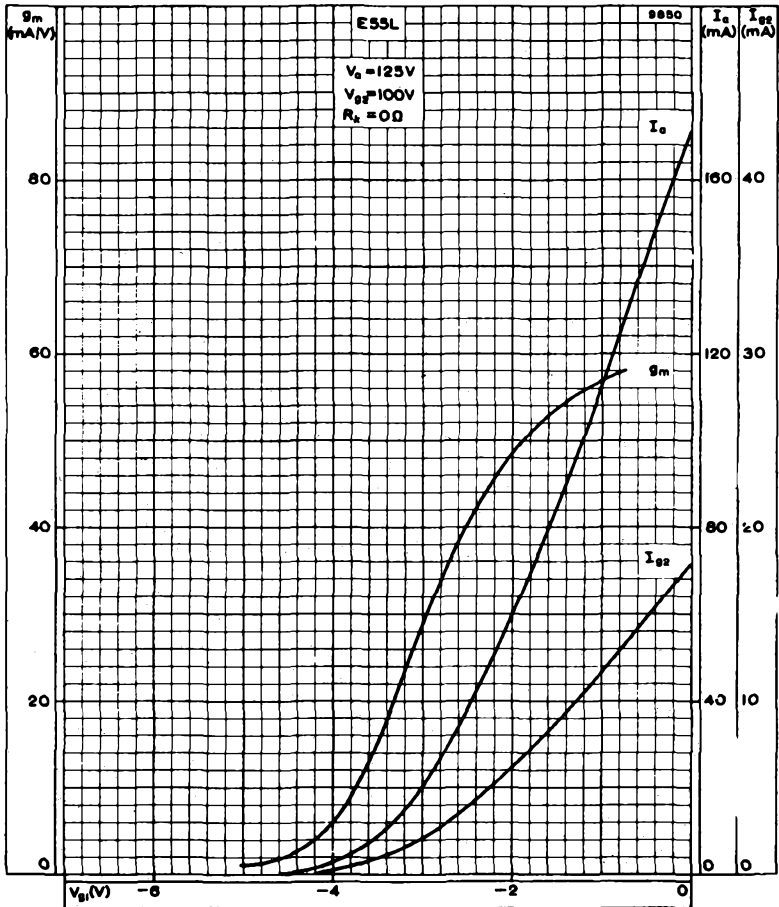

ANODE AND SCREEN-GRID CURRENT AND MUTUAL CONDUCTANCE
PLOTTED AGAINST CONTROL-GRID VOLTAGE. $V_{g2} = 100V$



**SPECIAL QUALITY WIDEBAND
OUTPUT PENTODE**

E55L

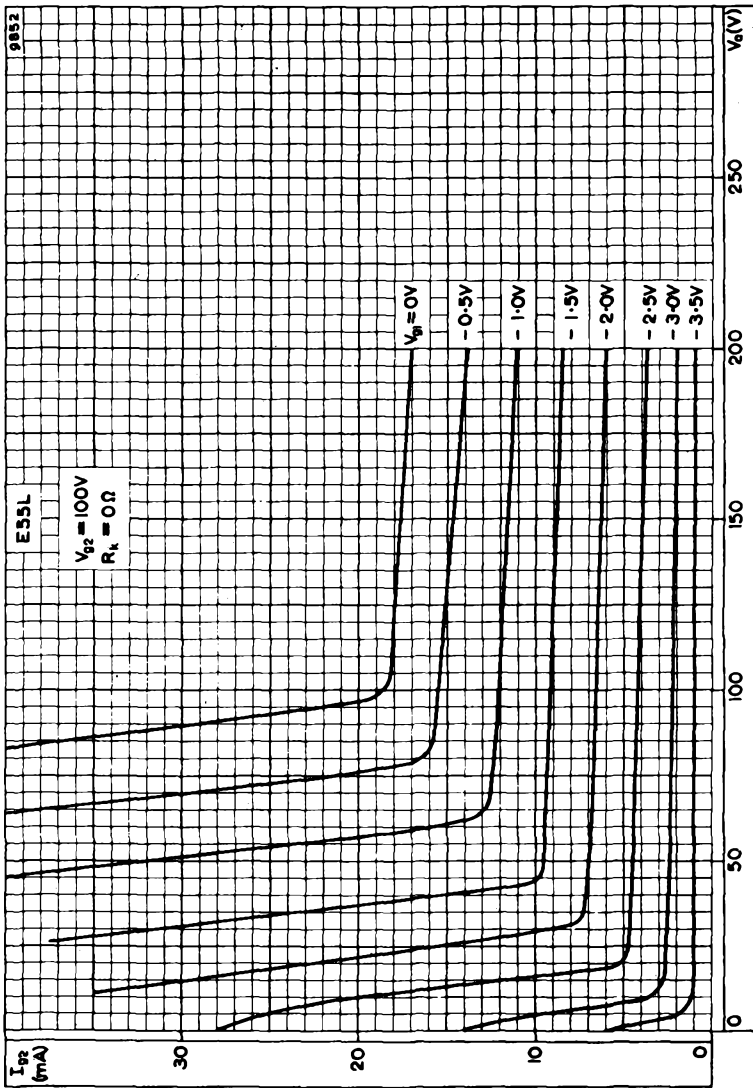

SCREEN-GRID CURRENT PLOTTED AGAINST ANODE VOLTAGE WITH CONTROL-GRID VOLTAGE AS PARAMETER. $V_{g2} = 100V$



E55L

SPECIAL QUALITY WIDEBAND OUTPUT PENTODE

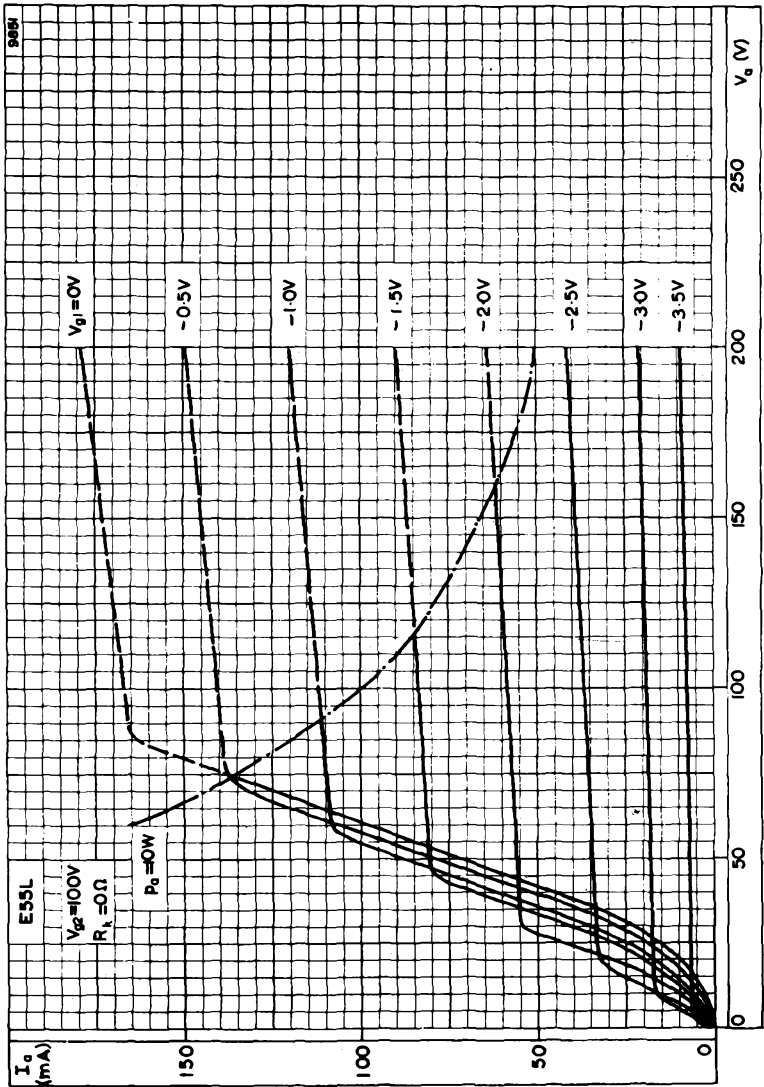

ANODE CURRENT PLOTTED AGAINST ANODE VOLTAGE WITH CONTROL-GRID VOLTAGE AS PARAMETER. $V_{g2} = 100V$



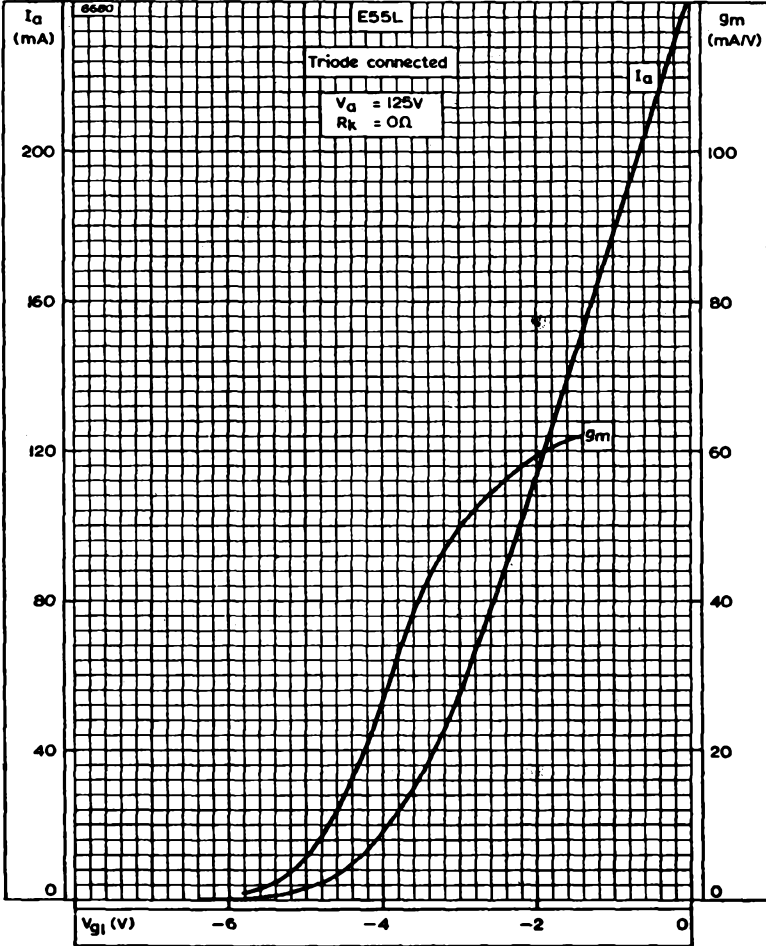

ANODE CURRENT AND MUTUAL CONDUCTANCE PLOTTED AGAINST
CONTROL-GRID VOLTAGE, WHEN TRIODE CONNECTED



E55L

SPECIAL QUALITY WIDEBAND OUTPUT PENTODE

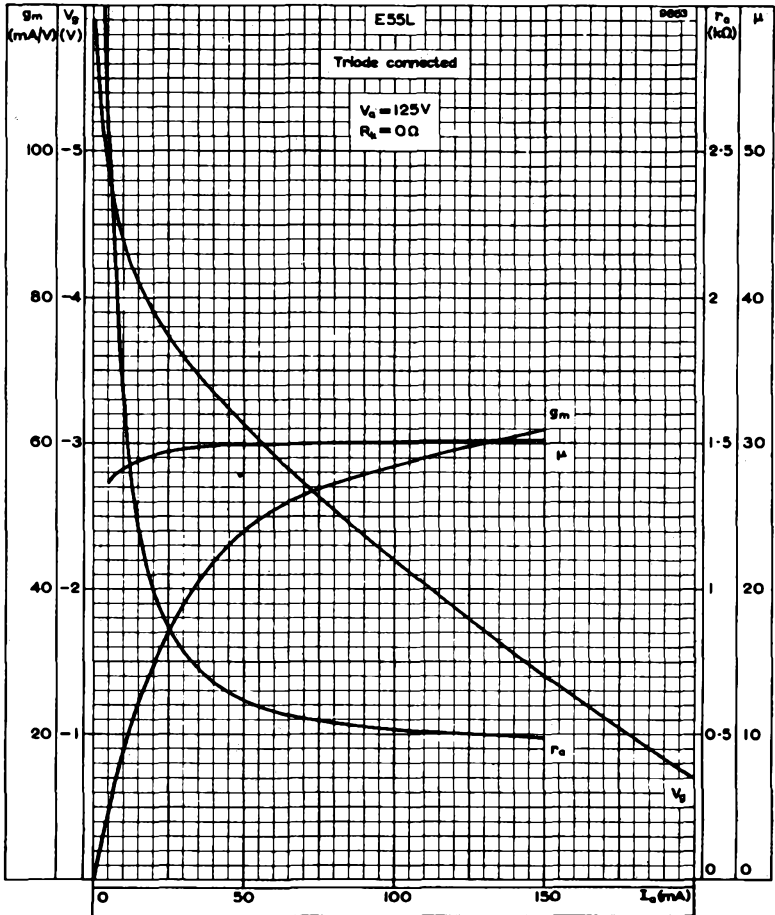

ANODE IMPEDANCE, AMPLIFICATION FACTOR, MUTUAL CONDUCTANCE
AND GRID VOLTAGE PLOTTED AGAINST ANODE CURRENT, WHEN
TRIODE CONNECTED



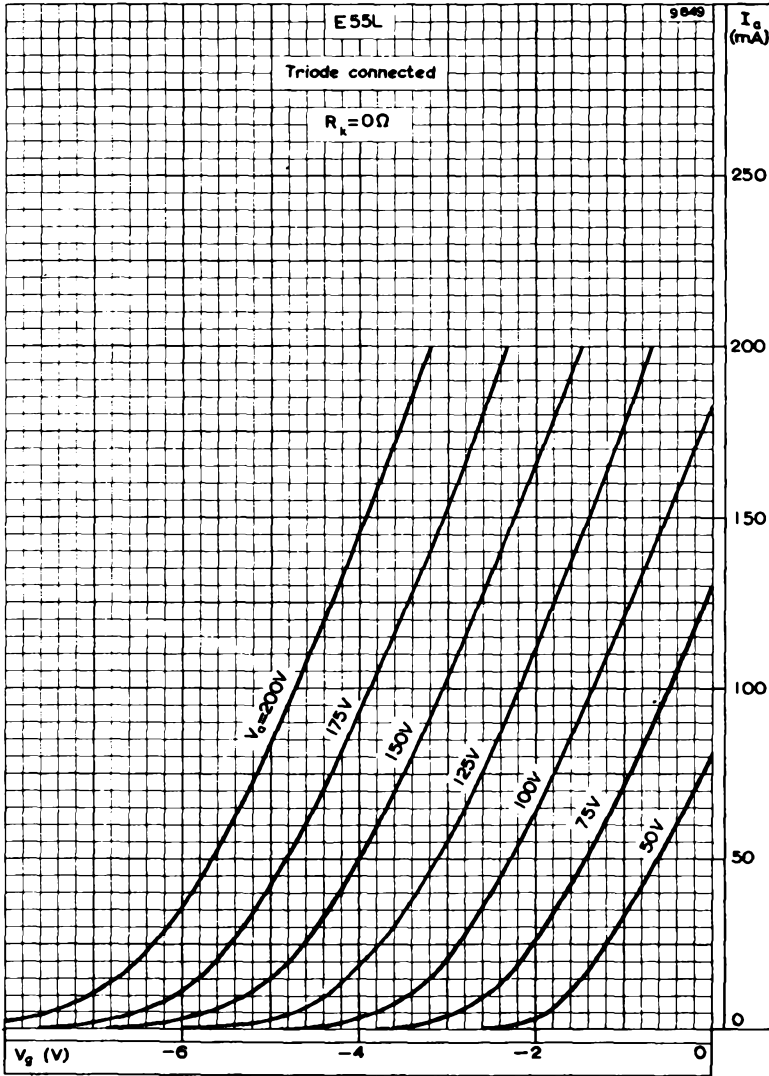

ANODE CURRENT PLOTTED AGAINST CONTROL-GRID VOLTAGE WITH ANODE VOLTAGE AS PARAMETER, WHEN TRIODE CONNECTED



E55L

SPECIAL QUALITY WIDEBAND OUTPUT PENTODE

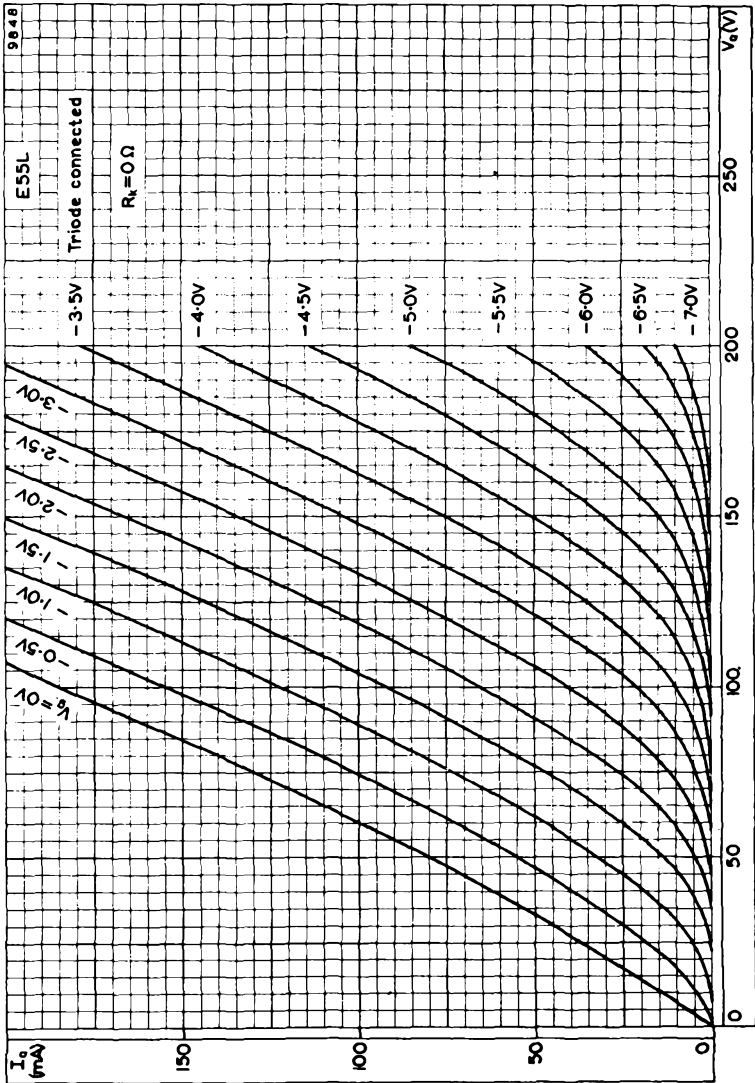

ANODE CURRENT PLOTTED AGAINST ANODE VOLTAGE WITH CONTROL-GRID VOLTAGE AS PARAMETER, WHEN TRIODE CONNECTED



SPECIAL QUALITY DOUBLE TRIODE

E88CC

Special quality double triode with separate cathodes for use as a cascode amplifier and in pulse circuits, where stability of characteristics and long life are required.

This data should be read in conjunction with GENERAL NOTES—SPECIAL QUALITY VALVES which precede this section of the handbook and the index numbers are used to indicate where reference should be made to a specific note.

HEATER

Suitable for parallel operation, a.c. or d.c.

V_h^1	6.3	V
I_h	300	mA

The maximum variation of heater current at $V_h = 6.3V$ is $\pm 15mA$.

CAPACITANCE² (measured without external shield)

	Minimum	Average	Maximum	
*C _{s-g}	1.2	1.4	1.6	pF
*C _{s-k}	140	180	220	mpF
*C _{s-s}	1.1	1.3	1.5	pF
C _{a'-k'+h+s}	1.55	1.75	1.95	pF
C _{a'-k'+h+s}	1.45	1.65	1.85	pF
C _{a'-k'+h}	0.4	0.5	0.6	pF
C _{a'-k'+h}	0.3	0.4	0.5	pF
*C _{g-k+h+s}	2.7	3.3	3.9	pF
*C _{g-k+h}	2.7	3.3	3.9	pF
C _{a'-a'}	—	25	45	mpF←
C _{g'-g'}	—	—	5.0	mpF
C _{a'-g'}	—	—	5.0	mpF
C _{a'-g'}	—	—	5.0	mpF
C _{g'-k'}	—	—	5.0	mpF
C _{g'-k'}	—	—	5.0	mpF
C _{k'-h}	—	2.6	—	pF
C _{k'-h}	—	2.7	—	pF

Grounded grid operation

C _{a'-g'+h+s}	2.7	3.0	3.3	pF
C _{a'-g'+h+s}	2.6	2.9	3.2	pF
*C _{k-g+h+s}	5.1	6.0	6.9	pF

*each section

CHARACTERISTICS² (each section)

V_a	90	V
V_g	-1.2	V
I_a	15	mA
g_m	12.5	mA/V
μ	33	
$V_{g(r.m.s.)}$ ($I_g = +0.3\mu A$)	750	mV

OPERATING CONDITIONS AS R.F. AMPLIFIER (each section)

V_{a-e}	90	100	V
V_{g-e}	0	+9.0	V
R_k	120*	680	Ω
I_a	12	15	mA
g_m	—	12.5	mA/V
R_{eq} (r.f.)	—	300	Ω
r_{g1} ($f = 50\text{Mc/s}$)	—	6.0	k Ω
N.F. ($f = 200\text{Mc/s}$)	—	4.6	dB

*Recommended minimum value for $V_{a-e} = 90\text{V}$

OPERATING CONDITIONS AS ADDITIVE MIXER

$V_{a(b)}$	60	90	150	V
R_a	0	1.0	3.9	k Ω
R_g	1.0	1.0	1.0	M Ω
$V_{osc(r.m.s.)}$	2.0	2.5	3.0	V
I_a	4.7	7.7	11	mA
g_c	2.9	3.5	4.1	mA/V
r_a	8.3	7.0	6.1	k Ω

TYPICAL CHARACTERISTICS FOR PULSE OPERATION (each section)

$V_{a(b)}$	60	150	V	V_a	150	V
R_a	2.5	2.5	k Ω	V_g ($I_a = 100\mu\text{A}$)	-6.5	V
$V_{g(b)}$	+60	+150	V	V_g ($I_a \leq 5\mu\text{A}$)	-15	V
R_{g-k}	300	300	k Ω	$V_{g' \sim g''}$ ($I_a = 100\mu\text{A}$)	<2.0	V
I_a	> 9.0	33 ± 5	mA			

CHARACTERISTIC RANGE VALUES FOR EQUIPMENT DESIGN

	Bogey ^b	Initial range	End of Life ^a	
Anode current $V_{a(b)} = 100\text{V}$, $R_k = 680\Omega$, $V_{g(b)} = +9\text{V}$	15	14.2 to 15.8	> 13.5	mA
Mutual conductance $V_{a(b)} = 100\text{V}$, $R_k = 680\Omega$, $V_{g(b)} = +9\text{V}$	12.5	10.5 to 15	> 9.0	mA/V
Negative grid current $V_a = 90\text{V}$, $I_a = 15\text{mA}$, $R_{g-k} = 100\text{k}\Omega$	—	< 0.1	< 1.0	μA
Anode current $V_{a(b)} = 150\text{V}$, $V_{g(b)} = 150\text{V}$, $R_a = 2.5\text{k}\Omega$, $R_{g-k} = 300\text{k}\Omega$	33	28 to 38	—	mA
Anode current $V_{a(b)} = 60\text{V}$, $V_{g(b)} = 60\text{V}$, $R_a = 2.5\text{k}\Omega$, $R_{g-h} = 300\text{k}\Omega$	—	> 9.0	—	mA

Negative grid voltage $V_a = 150V, I_a = 100\mu A$	6.5	5.0 to 8.5	—	V
Grid voltage difference (between sections) $V_{a'} = V_{a''} = 150V,$ $I_{a'} = I_{a''} = 100\mu A$	—	< 2.0	< 2.0	V
Insulation resistance (between any two electrodes) $V_{d.c.} = 200V$	—	> 100	> 20	M Ω
Heater-cathode insulation (I_{h-k}) V_{h-k} (120V k positive) (60V k negative)	—	< 6.0	< 12	μA
Heater current $V_h = 6.3V$	300	285 to 315	285 to 315	mA

*To allow for valve deterioration during life, circuits should be designed to function with a valve in which one or more of the characteristics have changed to the values stated.

SHOCK AND VIBRATION

The E88CC can withstand vibrations of 2.5g and 50c/s for 96 hours and is proof against impact accelerations of approximately 500g.

DESIGN CENTRE RATINGS⁴ (unless otherwise stated) each section

$V_{a(b)}$ max.	400	V
V_a max.	220	V
V_a max. ($p_a < 800mW$)	250	V
p_a max.	1.5	W
p_a max. ($p_{a'} + p_{a''} < 2W$)	1.8	W
$p_{a'} + p_{a''}$ max.	3.0	W
p_g max.	30	mW
$-V_g$ max.	100	V
$-V_{g(pk)}$ max.	200	V
I_k max.	20	mA
* $I_{k(pk)}$ max.	100	mA
V_{h-k} max. (k positive)	150	V
(k negative)	100	V
** R_{g-k} max.	1.0	M Ω
T_{bulb} max. (absolute)	170	$^{\circ}C$
V_h max. (absolute)	6.6	V
V_h min. (absolute)	6.0	V

*Maximum duty factor 0.1 maximum pulse duration = 200 μs .

**Operation with fixed bias is only permitted for $I_a < 5mA$.



E88CC

SPECIAL QUALITY DOUBLE TRIODE

OPERATING NOTES

The hum voltage referred to *g* has a maximum value of $50\mu\text{V}$ and is measured with the centre tap of the heater winding earthed, at a supply frequency of 50c/s (including 3% at 500c/s), with a fully screened valve holder and a linear band-pass characteristic under the following conditions:

V_b	90	V
I_a	15	mA
R_k	80	Ω
C_k	1000	μF
R_{g-k}	500	$k\Omega$

B560

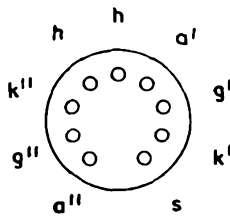
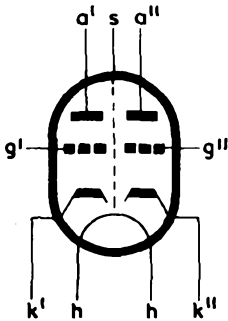

B9A Base

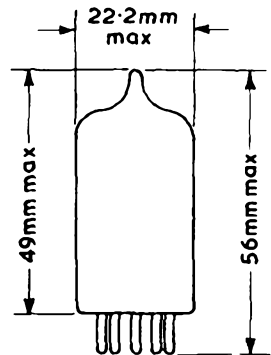

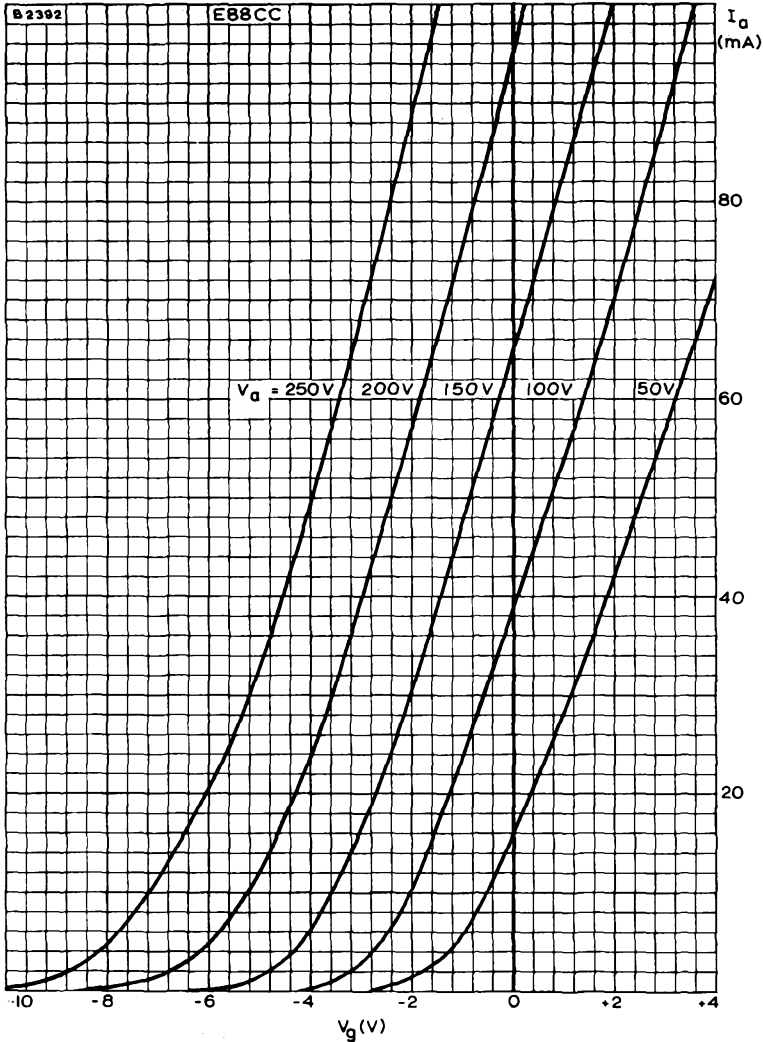

ANODE CURRENT PLOTTED AGAINST GRID VOLTAGE WITH ANODE VOLTAGE AS PARAMETER.



E88CC

SPECIAL QUALITY
DOUBLE TRIODE

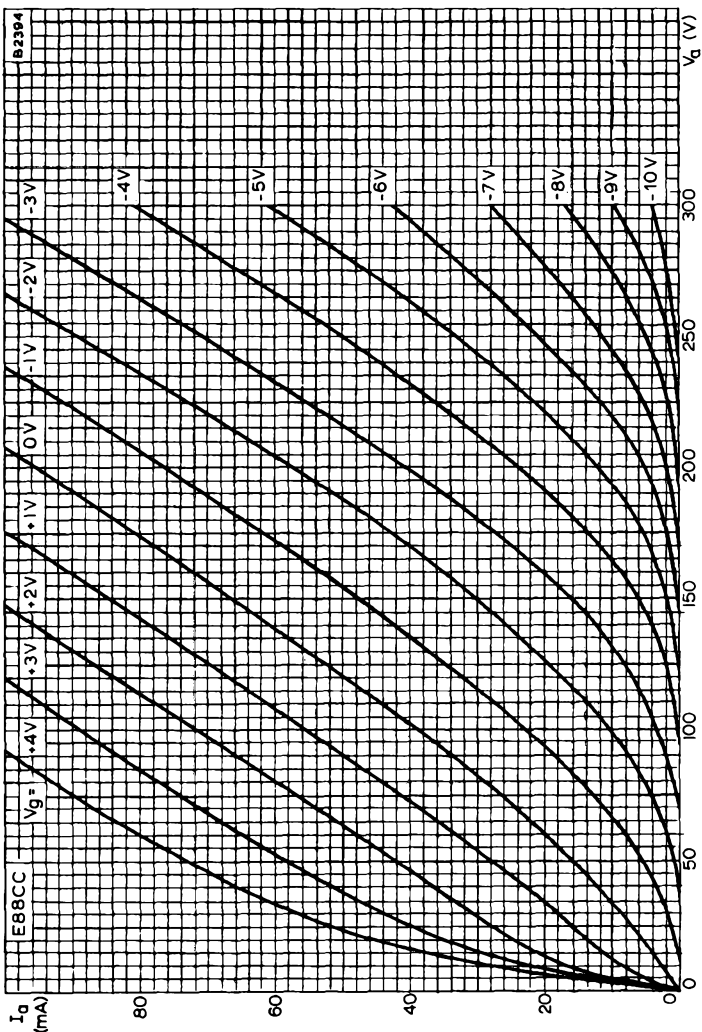

ANODE CURRENT PLOTTED AGAINST ANODE VOLTAGE WITH GRID VOLTAGE AS PARAMETER



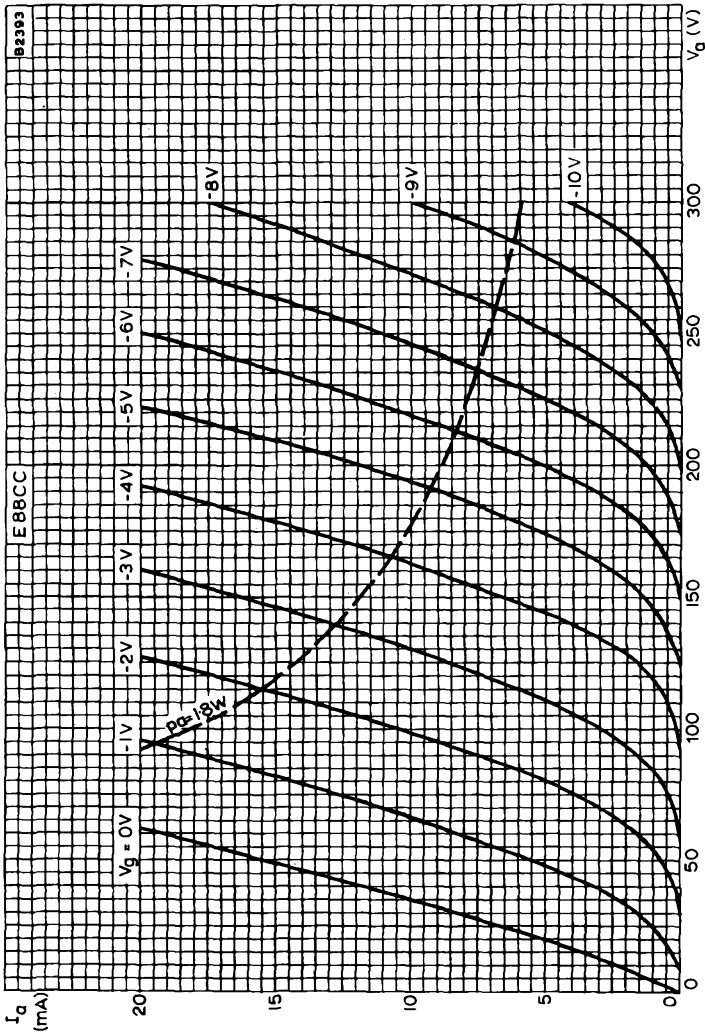

ANODE CURRENT PLOTTED AGAINST ANODE VOLTAGE WITH GRID VOLTAGE AS PARAMETER IN THE REGION OF THE ORIGIN.



E88CC

SPECIAL QUALITY
DOUBLE TRIODE

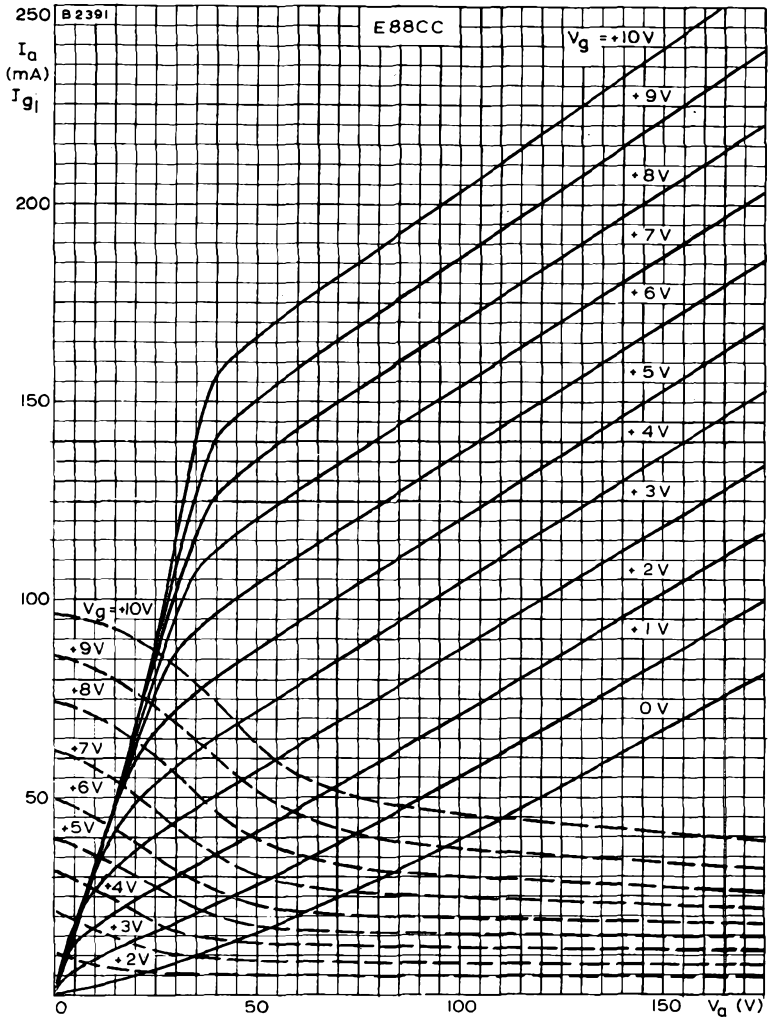

ANODE AND GRID CURRENTS PLOTTED AGAINST ANODE VOLTAGE
WITH POSITIVE GRID VOLTAGE AS PARAMETER



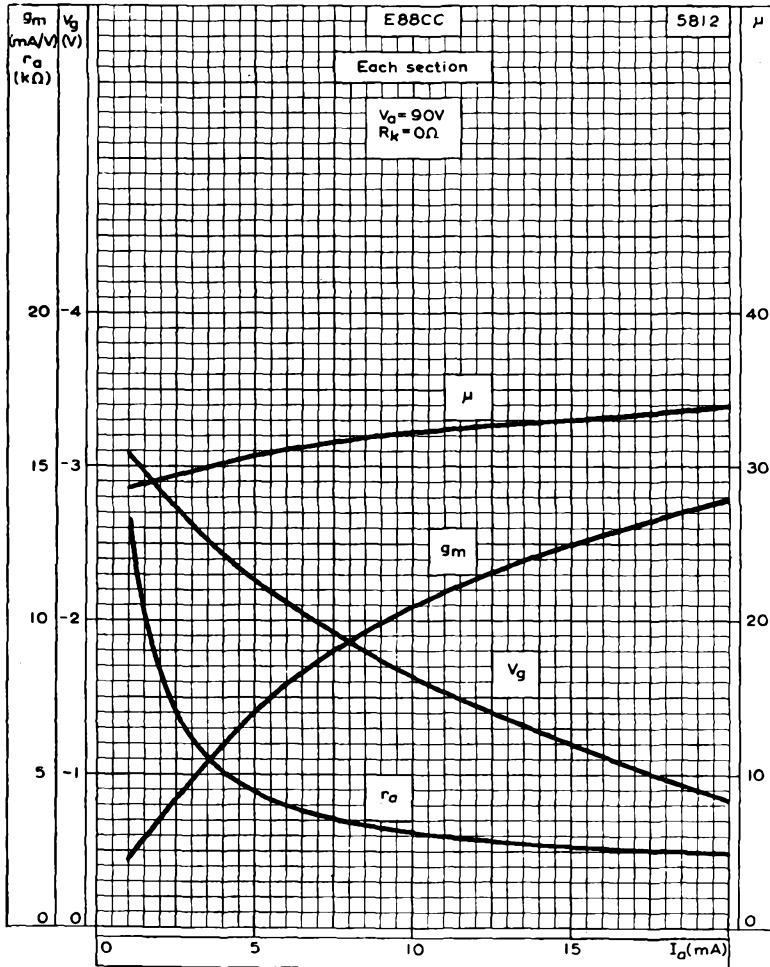

AMPLIFICATION FACTOR, MUTUAL CONDUCTANCE AND GRID VOLTAGE
PLOTTED AGAINST ANODE CURRENT. $V_a = 90V$



E88CC

SPECIAL QUALITY
DOUBLE TRIODE

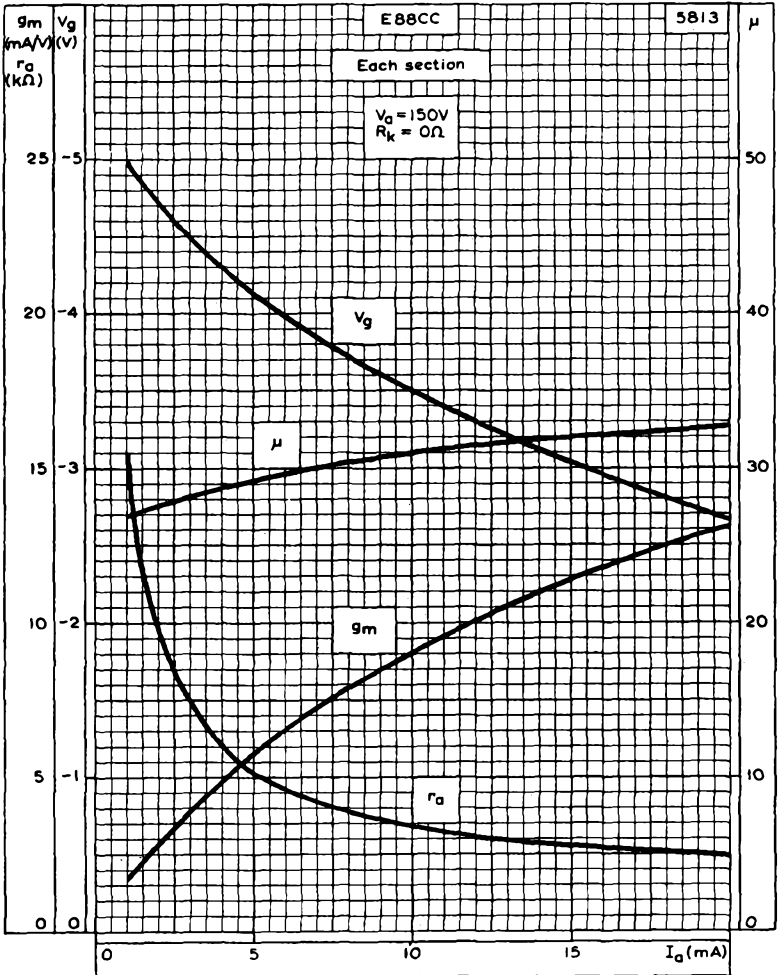

AMPLIFICATION FACTOR, MUTUAL CONDUCTANCE AND GRID VOLTAGE
PLOTTED AGAINST ANODE CURRENT. $V_a = 150V$



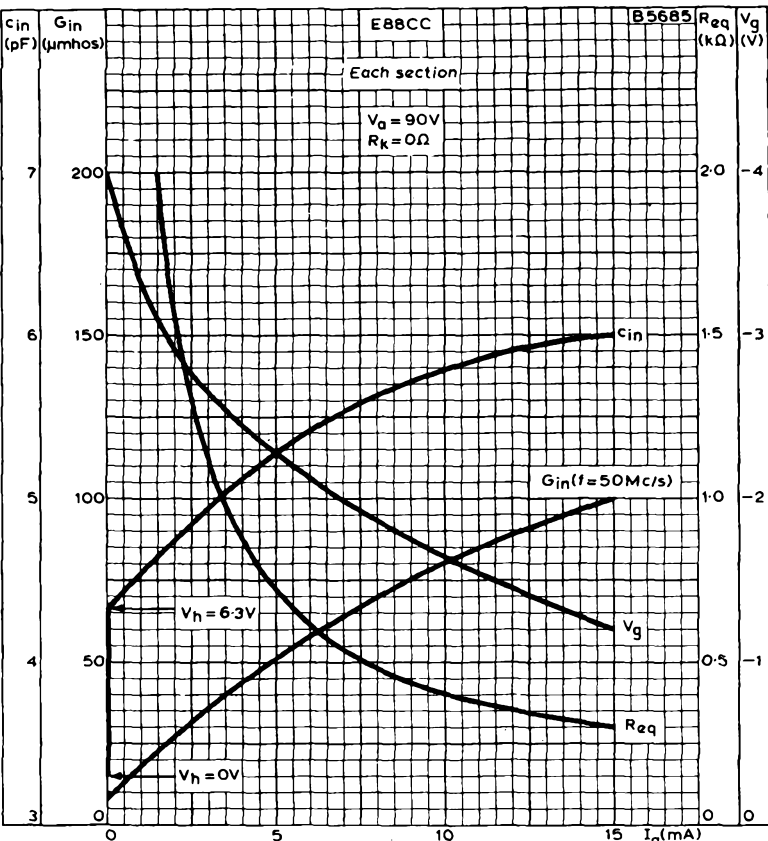

INPUT CAPACITANCE, INPUT CONDUCTANCE, EQUIVALENT NOISE RESISTANCE AND GRID VOLTAGE PLOTTED AGAINST ANODE CURRENT.



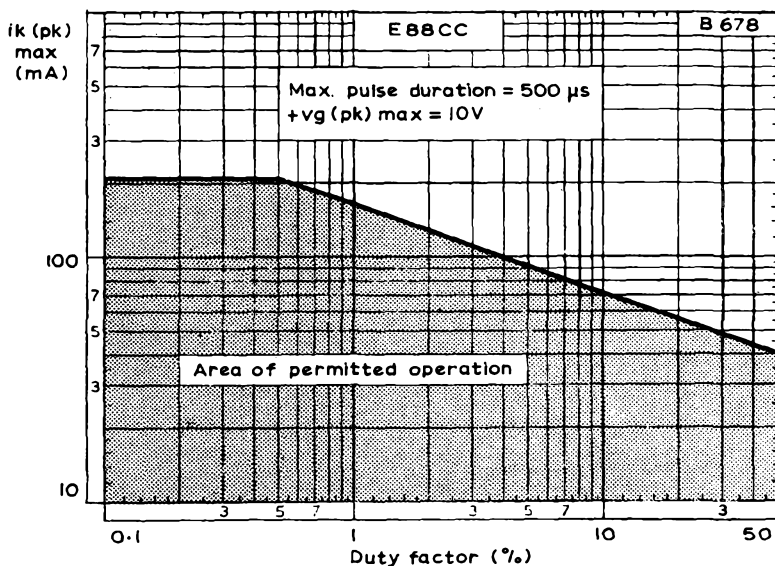

PULSE RATING CHART

Special quality high slope r.f. pentode intended for general industrial applications where stability of characteristics and long life are required.

This data should be read in conjunction with GENERAL NOTES - SPECIAL QUALITY VALVES which precede this section of the handbook, and the index numbers are used to indicate where reference should be made to a specific note.

HEATER

Suitable for parallel operation, a.c. or d.c.

V_h^1	6.3	V
I_h	300	mA

The maximum variation of heater current at $V_h = 6.3V$ is ± 15 mA.

MOUNTING POSITION

Any

CAPACITANCES (measured with an external shield)

	Minimum	Average	Maximum	
ca - g1	-	18	30	mpF
ca - k	-	-	100	mpF
* cin	6.6	7.5	8.4	pF
cin ($I_k = 16.3$ mA)	-	11.1	-	pF
* cout	2.5	3.0	3.5	pF
cg1 - h	-	-	0.1	pF

* Pin 6 is left floating during the capacitance measurements.

CHARACTERISTICS

Pentode connected			Triode connected g2 to a, g3 to k		
Va	180	V	Va	150	V
Vg3	0	V	Vg1	- 1.25	V
Vg2	150	V	Ia	16.5	mA
Vg1	- 1.25	V	gm	21	mA/V
Ia	13	mA	μ	50	
Ig2	3.3	mA	ra	2.4	k Ω
gm	16.5	mA/V			
ra	90	k Ω			
μ g1-g2	50				
- Vg1 max.,	500	mV			
(I _{g1} = 0.3 μ A)					

OPERATING CONDITIONS AS R. F. AMPLIFIER

Pentode connected				Triode connected		
Va - e	180	190	V	Va - e	160	V
Vg3 - k	0	0	V	Vg3	0	V
Vg2 - e	150	160	V	Vg1 - e	+ 9.0	V
Vg1 - e	0	+ 9.0	V	Rk	620	Ω
Rk	100	630	Ω	Ia	16.5	mA
Ia	11.5	13	mA	gm	21	mA/V
Ig2	2.9	3.3	mA	Req(r.f.)	225	Ω
gm	15.5	16.5	mA/V			
Vg1 max.,						
(I _a = 800 μ A)	- 4.5	-	V			
Req(r.f.)	-	460	Ω			
* rg1(f=50Mc/s) -		6.0	k Ω			
* \emptyset gm(f=50Mc/s)-		9.0	deg			

* Cathode connections strapped together

CHARACTERISTIC RANGE VALUES FOR EQUIPMENT DESIGN

	Average	Initial range	End of life*	
Anode current	13	12.2 to 13.8	11.5	mA
Va-e = 190V, Vg2-e = 160V				
Vg1-e = +9V, Rk = 630 Ω				



	Average	Initial range	End of life*	
Screen-grid current	3.3	2.9 to 3.7	-	mA
Va-e=190V, Vg2-e=160V Vg1-e=+9V, Rk = 630Ω				
Mutual conductance	16.5	14.2 to 18.8	11	mA/V
Va-e=190V, Vg2-e=160V Vg1-e=+9V, Rk = 630Ω				
Negative control-grid current	-	< 0.5	< 1.0	μA
Va-e=190V, Vg2-e=160V Vg1-e=+9V, Rk = 78Ω Rg1-k = 100kΩ				
Insulation resistance	-	> 20	-	MΩ
Between any two electrodes Vd.c.=100V				
Heater cathode insulation	-	> 4.0	-	MΩ
Vh-k = 60V				
Heater current	300	285 to 315	285 to 315	mA

* To allow for valve deterioration during life, circuits should be designed to function with a valve on which one or more of the characteristics have changed to the values stated.

SHOCK AND VIBRATION RATINGS

The E180F can withstand vibrations of 2.5 g and 50 c/s for 96 hours and is proof against impact accelerations of approximately 300 g.

ABSOLUTE MAXIMUM RATINGS⁴

Va(b) max.	400	V
Va max.	210	V
pa max.	3.0	W
Vg2 (b) max.	400	V
Vg2 max.	175	V
pg2 max.	0.9	W



I_k max.	25	mA
+ V_{g1} max.	0	V
- V_{g1} max.	50	V
- v_{g1} (pk) max.	100	V
R_{g1-k} max. (fixed bias)	250	$k\Omega$
V_{h-k} max.	60	V
R_{h-k} max.	20	$k\Omega$
T_{bulb} max.	155	$^{\circ}C$
V_h min.	6.0	V
V_h max.	6.6	V

OPERATING NOTE

Hum

The hum voltage referred to $g1$ has a maximum value of $100 \mu V$ and is measured with centre tap of the heater winding earthed, a supply frequency of 50 c/s (including 3 % at 500 c/s) and a linear band-pass characteristic under the following conditions.

V_h	6.3	V
C_k	1000	μF
R_{g1-k}	500	$k\Omega$

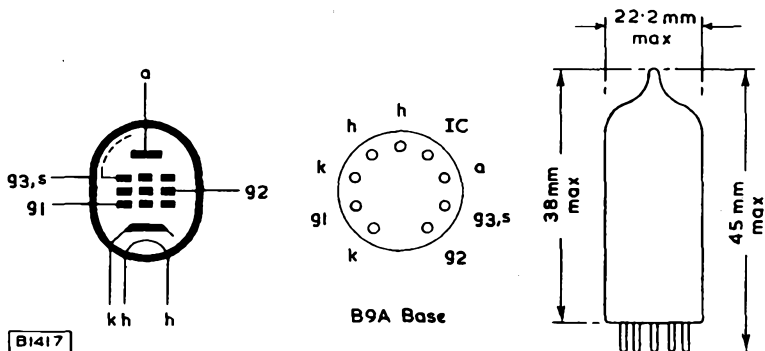

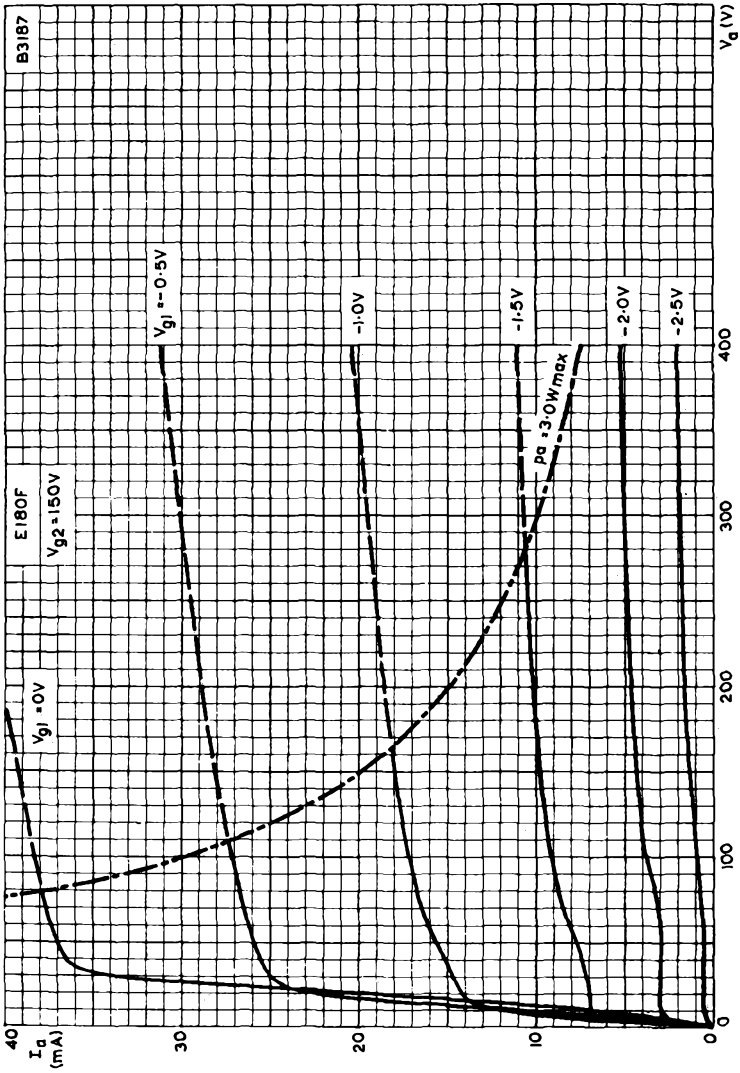

ANODE CURRENT PLOTTED AGAINST ANODE VOLTAGE WITH CONTROL-GRID VOLTAGE AS PARAMETER. $V_{g2} = 150V$



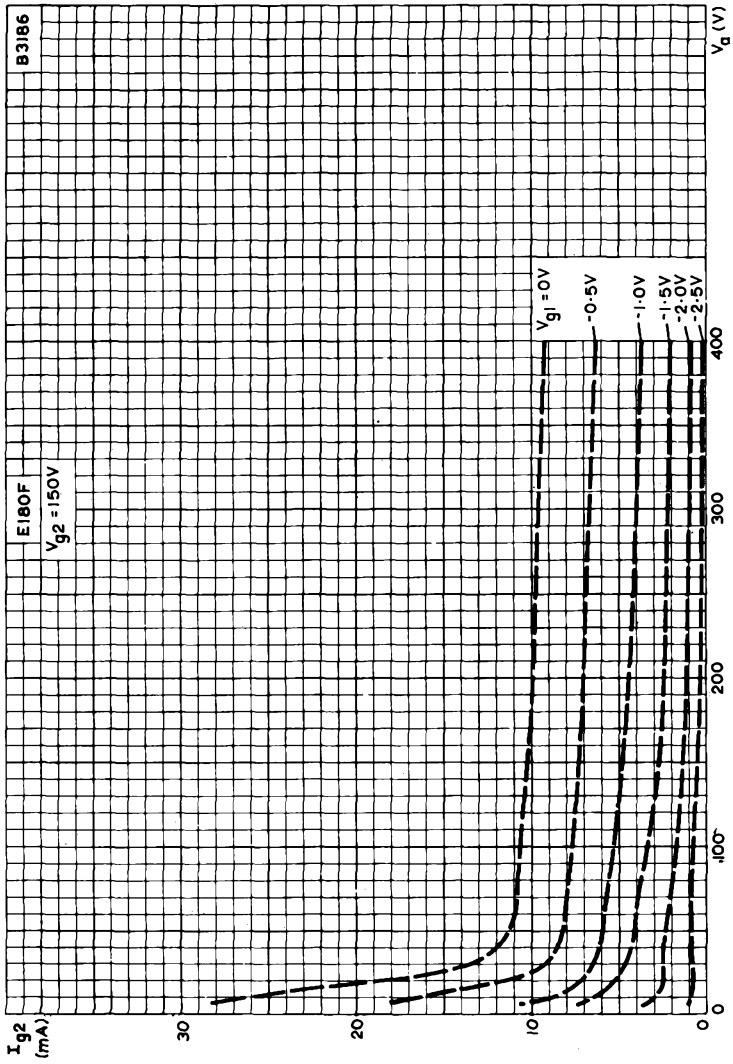

SCREEN-GRID CURRENT PLOTTED AGAINST ANODE VOLTAGE
WITH CONTROL-GRID VOLTAGE AS PARAMETER. $V_{g2} = 150V$



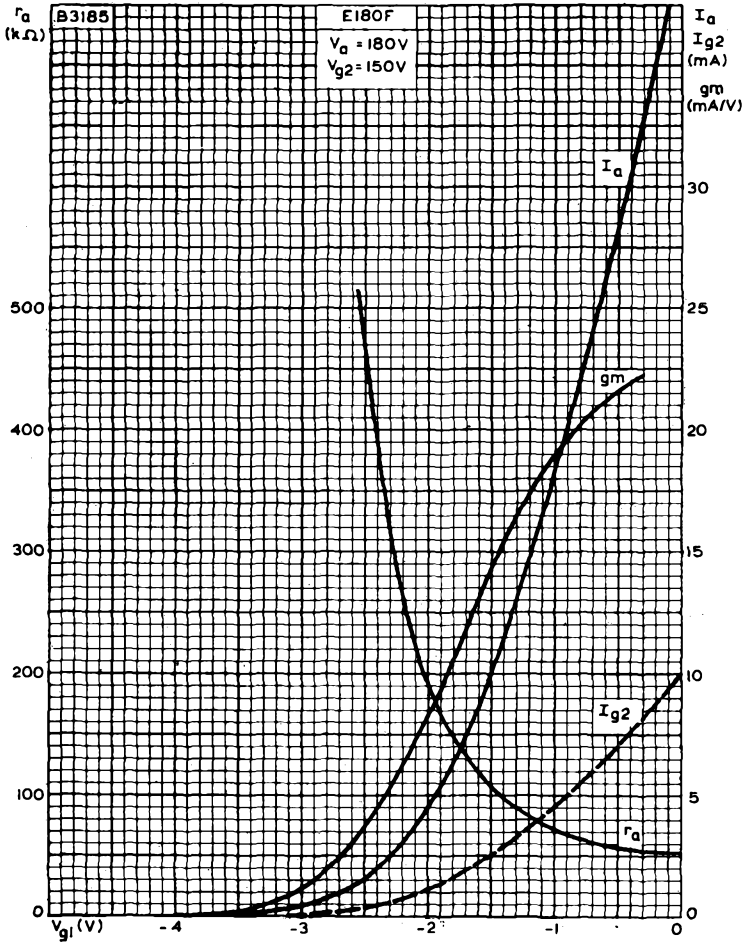

ANODE CURRENT, SCREEN-GRID CURRENT, MUTUAL CONDUCTANCE AND ANODE IMPEDANCE PLOTTED AGAINST CONTROL-GRID VOLTAGE.

$V_a = 180V, V_{g2} = 150V.$



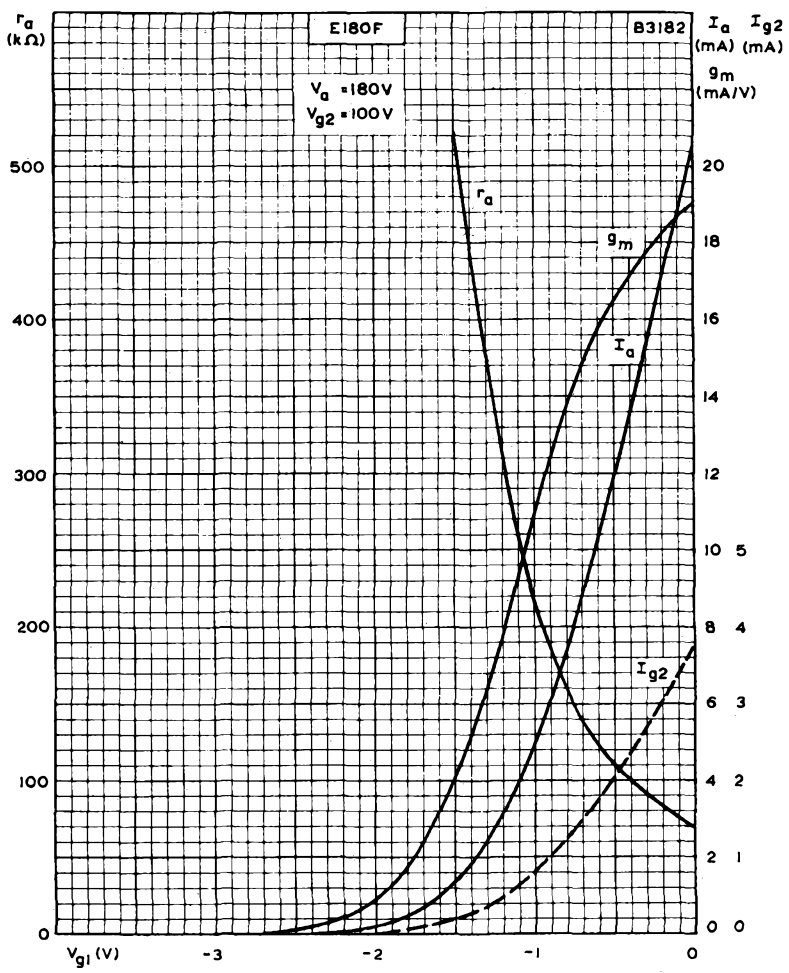

ANODE CURRENT, SCREEN-GRID CURRENT, MUTUAL CONDUCTANCE AND ANODE IMPEDANCE PLOTTED AGAINST COLTROL-GRID VOLTAGE.

$V_a = 180V, V_{g2} = 100V$



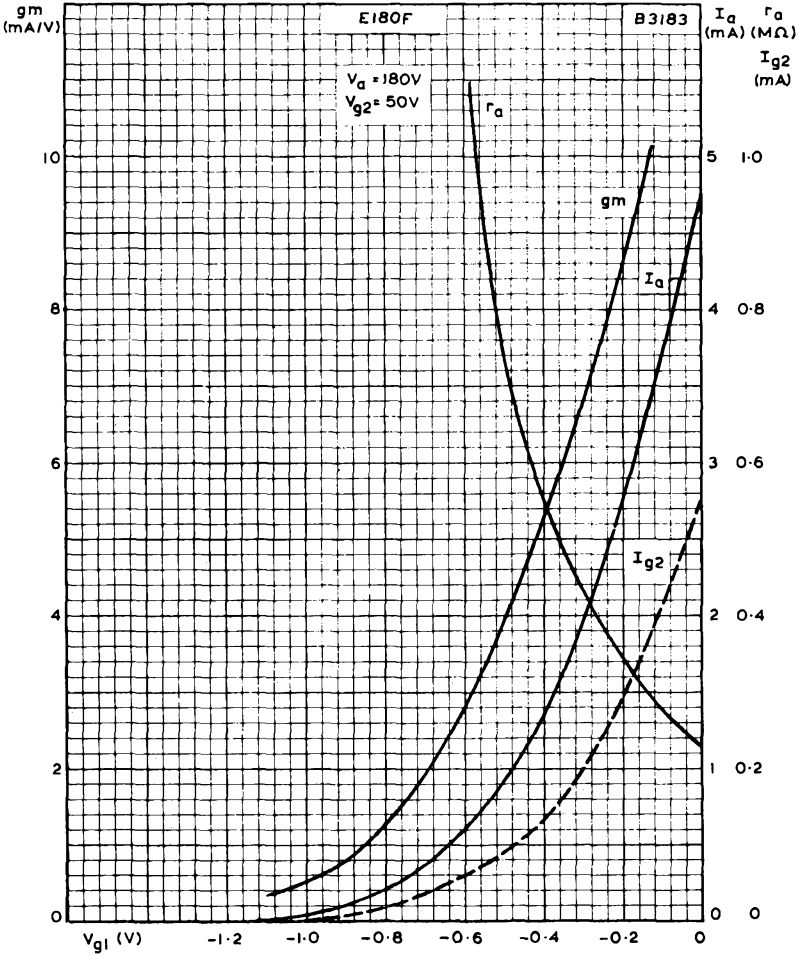

ANODE CURRENT, SCREEN-GRID CURRENT, MUTUAL CONDUCTANCE AND ANODE IMPEDANCE PLOTTED AGAINST CONTROL-GRID VOLTAGE.

$V_a = 180V, V_{g2} = 50V$



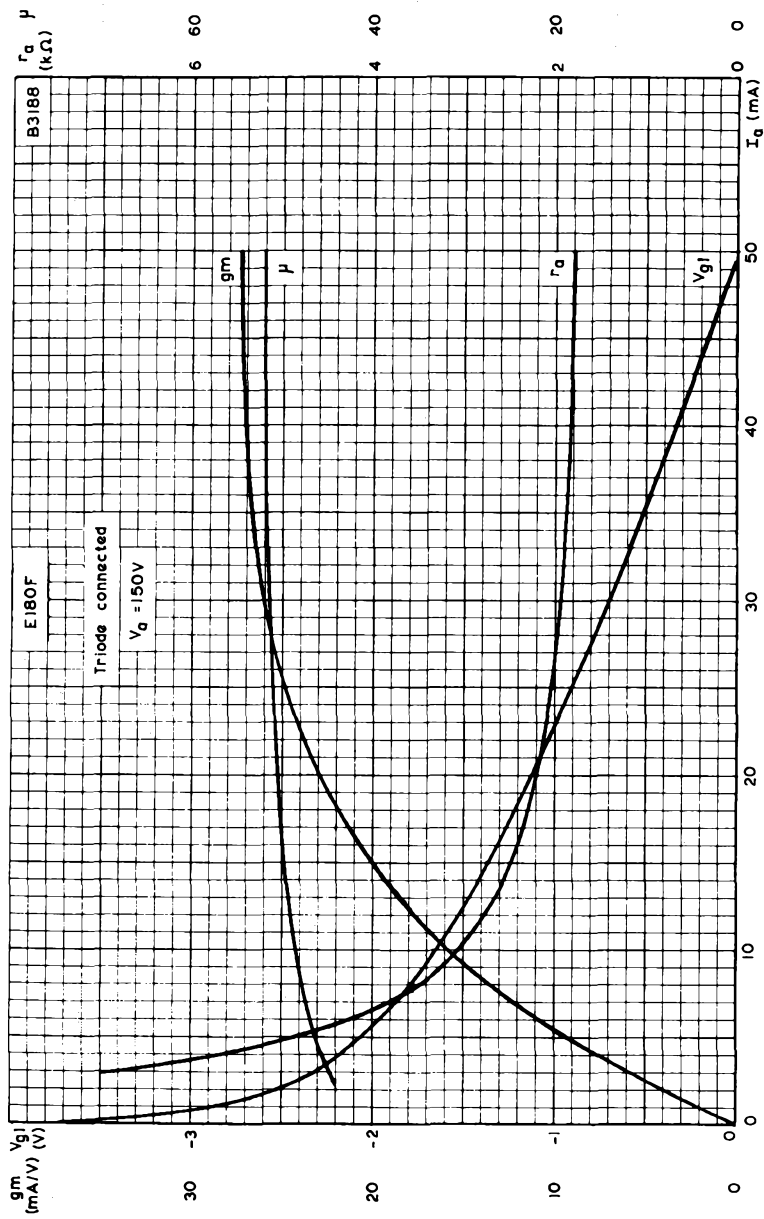

MUTUAL CONDUCTANCE, AMPLIFICATION FACTOR, ANODE IMPEDANCE, AND CONTROL-GRID VOLTAGE PLOTTED AGAINST ANODE CURRENT TRIODE CONNECTED.



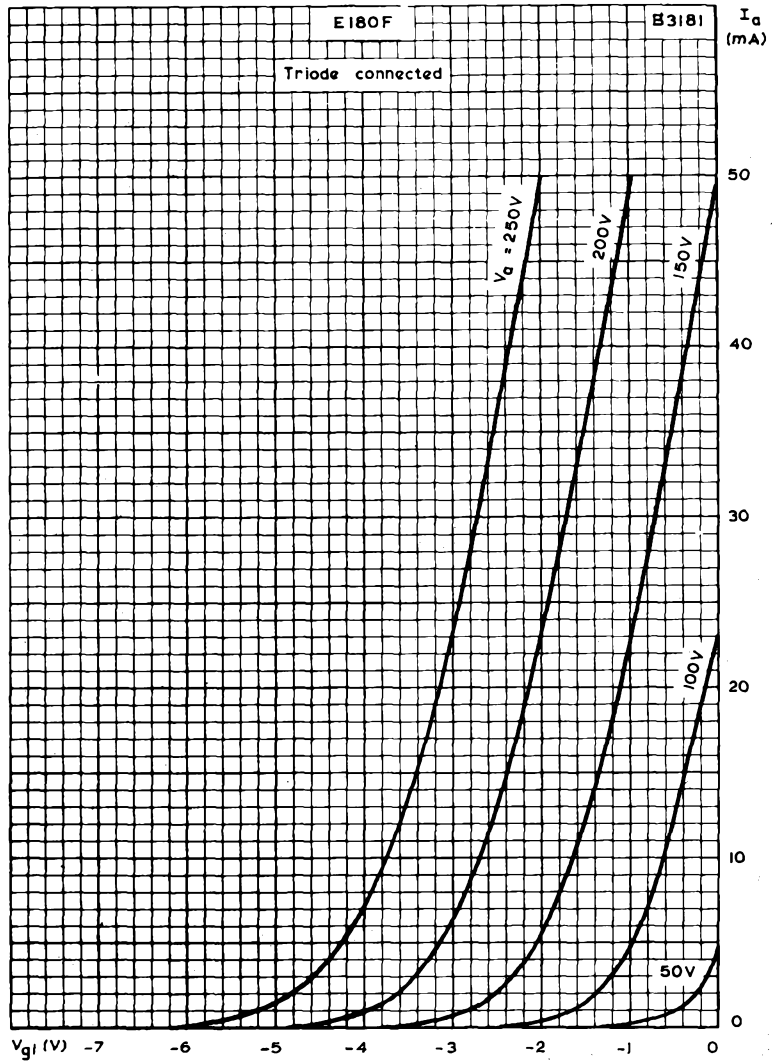

ANODE CURRENT PLOTTED AGAINST CONTROL-GRID VOLTAGE WITH ANODE VOLTAGE AS PARAMETER. TRIODE CONNECTED.



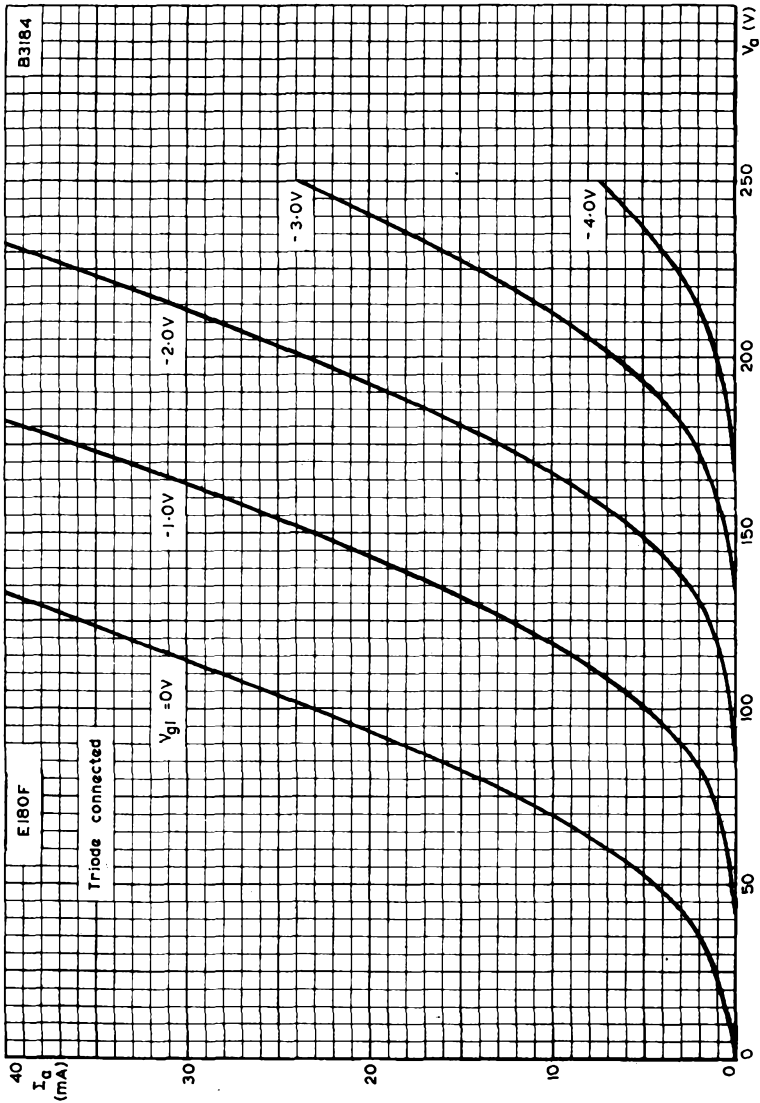

ANODE CURRENT PLOTTED AGAINST ANODE VOLTAGE WITH CONTROL-GRID VOLTAGE AS PARAMETER. TRIODE CONNECTED.



SPECIAL QUALITY WIDEBAND R.F. PENTODE

E810F

Special quality high slope pentode designed for use in industrial equipment where stability of characteristics and long life are required.

This data should be read in conjunction with GENERAL NOTES - SPECIAL QUALITY VALVES which precede this section of the handbook, and the index numbers are used to indicate where reference should be made to a specific note.

HEATER

Suitable for parallel operation only, a.c. or d.c.

V_h	6.3	V
I_h	340	mA

The maximum variation of heater current at 6.3V is ± 20 mA.

CAPACITANCES²

Heptode connected

Shielded	Min.	Av.	Max.	
c_{a-g1}	-	-	32	mpF
c_{in}	13	14.5	16	pF
$c_{in(w)}$ ($I_k = 40$ mA)	22	24	26	pF
c_{out}	3.9	4.1	4.3	pF
c_{a-k}	26	33	40	mpF
c_{g1-h}	35	55	75	mpF
c_{a-h}	12	20	28	mpF
c_{h-k}	4.2	5.2	6.2	pF

Unshielded

c_{a-g1}	-	-	36	mpF
c_{in}	13	14.5	16	pF
$c_{in(w)}$ ($I_k = 40$ mA)	22	24	26	pF
c_{out}	3.2	3.5	3.8	pF
c_{a-k}	53	60	67	mpF
c_{g1-h}	40	60	80	mpF
c_{a-h}	26	31	36	mpF

Triode connected

	Unshielded	Shielded	
c_{in}	10	10	pF
c_{out}	7.2	8.2	pF
c_{a-g}	4.7	4.6	pF



CHARACTERISTICS³

Pentode connected

V_a	120	V
V_{g3}	0	V
V_{g2}	150	V
V_{g1}	-1.9	V
R_k	0	Ω
I_a	35	mA
I_{g2}	5.0	mA
g_m	50	mA/V
r_a	42	k Ω
μ_{g1-g2}	57	
r_{g1} (f = 100MHz)	420	Ω
R_{eq} (f = 40MHz)	110	Ω

Triode connected (g_2 to a, g_3 to k)

V_a	150	V
V_{g1}	-2	V
I_a	35	mA
g_m	53	mA/V
r_a	1.1	k Ω
μ	57	

CHARACTERISTIC RANGE VALUE FOR EQUIPMENT DESIGN

	Average	Initial range	End of Life*	
Anode current				
at $V_{a-e} = 135V$, $V_{g2-e} = 165V$, $V_{g1-e} = 0V$, $R_k = 47\Omega$	35	31 to 39	25	mA
at $V_{a-e} = 135V$, $V_{g2-e} = 165V$, $V_{g1-e} = +12.5V$, $R_k = 360\Omega$	35	34 to 36	-	mA
Screen-grid current				
at $V_{a-e} = 135V$, $V_{g2-e} = 165V$, $V_{g1-e} = +12.5V$, $R_k = 360\Omega$	5	4.4 to 5.6	-	mA
Mutual conductance				
at $V_{a-e} = 135V$, $V_{g2-e} = 165V$, $V_{g1-e} = +12.5V$, $R_k = 360\Omega$	50	42 to 58	35	mA/V
Negative control-grid current				
at $V_{a-e} = 135V$, $V_{g2-e} = 165V$, $V_{g1-e} = +12.5V$, $R_k = 360\Omega$	-	<0.1	<0.2	μA

*To allow for valve deterioration during life, circuits should be designed to function with a valve in which one or more of the characteristics have changed to the values stated.



SPECIAL QUALITY WIDEBAND R.F. PENTODE

E810F

Insulation

	Initial Range	End of Life	
Between heater and cathode measured at $V_{h-k} = 100V$			
Leakage current	<10	<20	μA
Between any two arbitrary electrodes except k-g1 measured at 250V	>100	>40	M Ω

OPERATING CONDITIONS

V_{a-e}	135	V
V_{g3-e}	0	V
V_{g2-e}	165	V
V_{g1-e}	+12.5	V
R_k	360	Ω
I_a	35	mA
I_{g2}	5.0	mA
g_m	50	mA/V

SHOCK AND VIBRATION

The E810F can withstand vibrations of 2.5g at 50Hz for 32 hours and is proof against impact accelerations of approximately 500g.

RATINGS (ABSOLUTE MAXIMUM SYSTEM)

$V_{a(b)} \text{ max.}$	400	V
$V_a \text{ max.}$	250	V
$p_a \text{ max.}$	5.0	W
$V_{g2(b)} \text{ max.}$	400	V
$V_{g2} \text{ max.}$	200	V
$p_{g2} \text{ max.}$	1.0	W
$-v_{g1(pk)} \text{ max.}$	50	V
$-V_{g1} \text{ max.}$	25	V
$+V_{g1} \text{ max.}$	0	V
$*I_k \text{ max.}$	50	mA
$R_{g1-k} \text{ max.}$	200	k Ω
$V_{h-k} \text{ max.}$	100	V
$*T_{bulb} \text{ max.}$	200	$^{\circ}C$

*In applications where a long life is not required, $I_k \text{ max.}$ can be increased to 65mA and $T_{bulb} \text{ max.}$ to 220 $^{\circ}C$.



OPERATING NOTES

1. Hum

The hum referred to g_1 has a maximum value of $150\mu V$ r.m.s. measured under the following conditions:

V_h (centre tap earthed)	6.3	V
V_{a-k}	120	V
V_{g2-k}	150	V
V_{g3-k}	0	V
R_{g1-k}	500	k Ω
R_k	47	Ω
C_k	1000	pF

2. Microphony

The microphonic noise voltage has a maximum value of $25mV$ r.m.s. at 50Hz and a maximum value of $500mV$ r.m.s. over the frequency range 50 to 2000Hz measured at the anode, under the following conditions:

V_h	6.3	V
$V_{a(b)}$	155	V
V_{g2-e}	160	V
V_{g3-k}	0	V
V_{g1-e}	+7	V
R_a	680	Ω
R_k	220	Ω
C_k	0	μF
peak acceleration	10	g

3. Distortion

The average value of harmonic distortion is 7.5% when $i_{a(pk)} = 40mA$ measured under the following conditions:

V_h	6.3	V
$V_{a(b)}$	155	V
V_{g2-e}	165	V
V_{g3-k}	0	V
V_{g1-e}	+12.5	V
I_a	35	mA
R_a	560	Ω
R_k	360	Ω
C_k	1000	μF

SPECIAL QUALITY WIDEBAND R.F. PENTODE

E810F

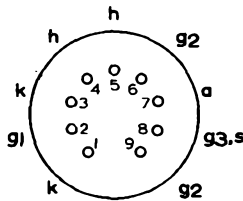
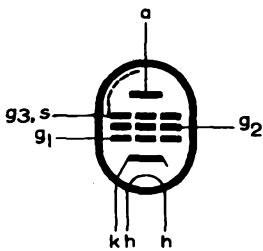

B9A Base

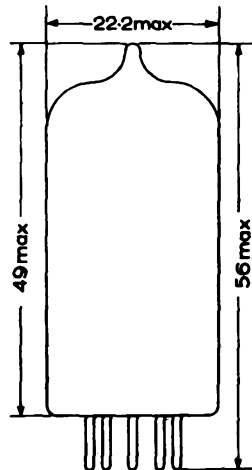

7360

All dimensions in mm





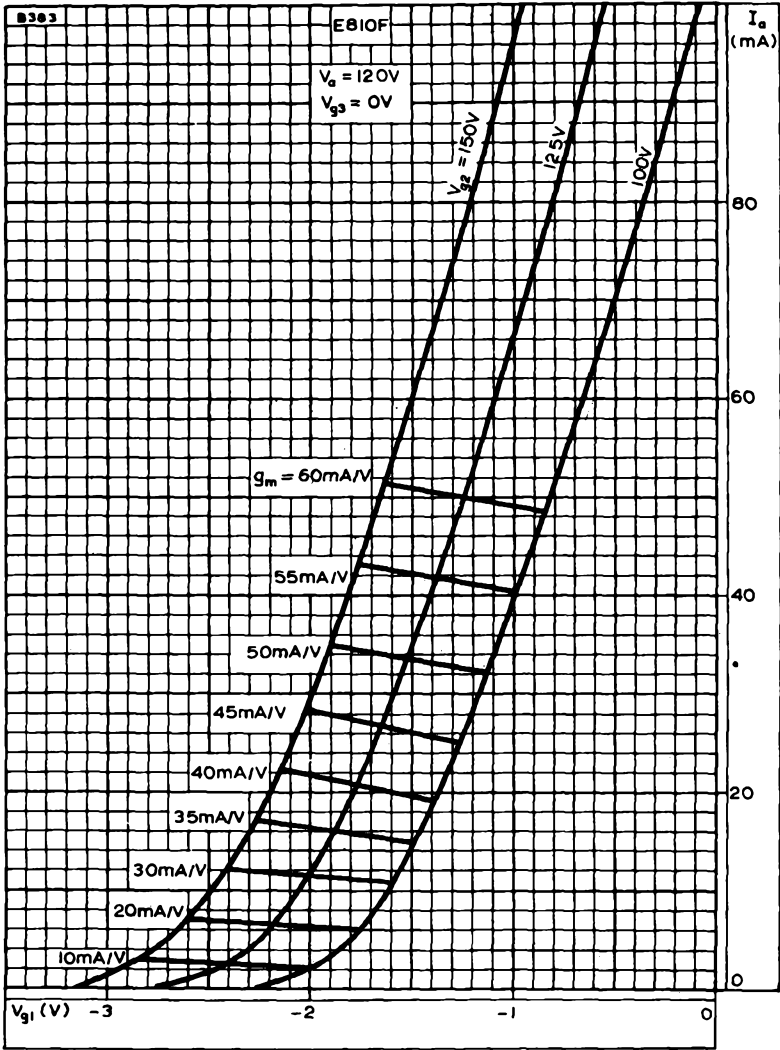

ANODE CURRENT PLOTTED AGAINST CONTROL-GRID VOLTAGE WITH SCREEN-GRID VOLTAGE AS PARAMETER AND WITH MUTUAL CONDUCTANCE CONTOURS



E810F

SPECIAL QUALITY
WIDEBAND R.F. PENTODE

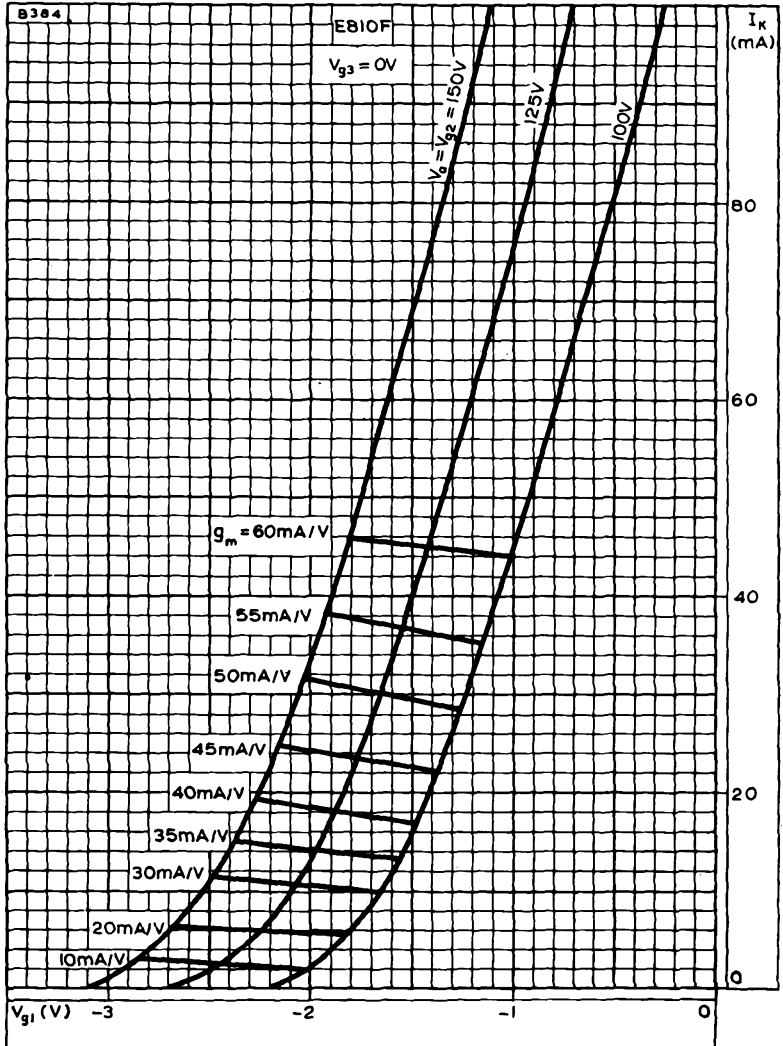

CATHODE CURRENT PLOTTED AGAINST CONTROL-GRID VOLTAGE
WITH ANODE VOLTAGE AS PARAMETER AND WITH MUTUAL
CONDUCTANCE CONTOURS



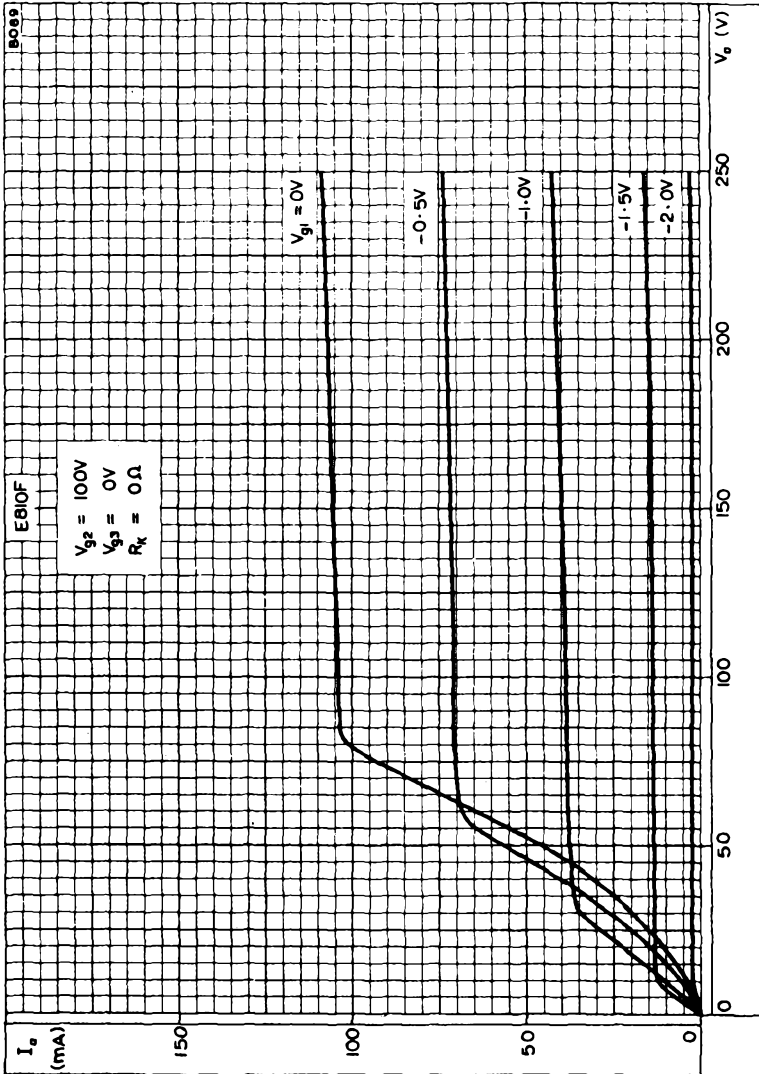

ANODE CURRENT PLOTTED AGAINST ANODE VOLTAGE WITH CONTROL-GRID VOLTAGE AS PARAMETER. $V_{g2} = 100V$



E810F

SPECIAL QUALITY
WIDEBAND R.F. PENTODE

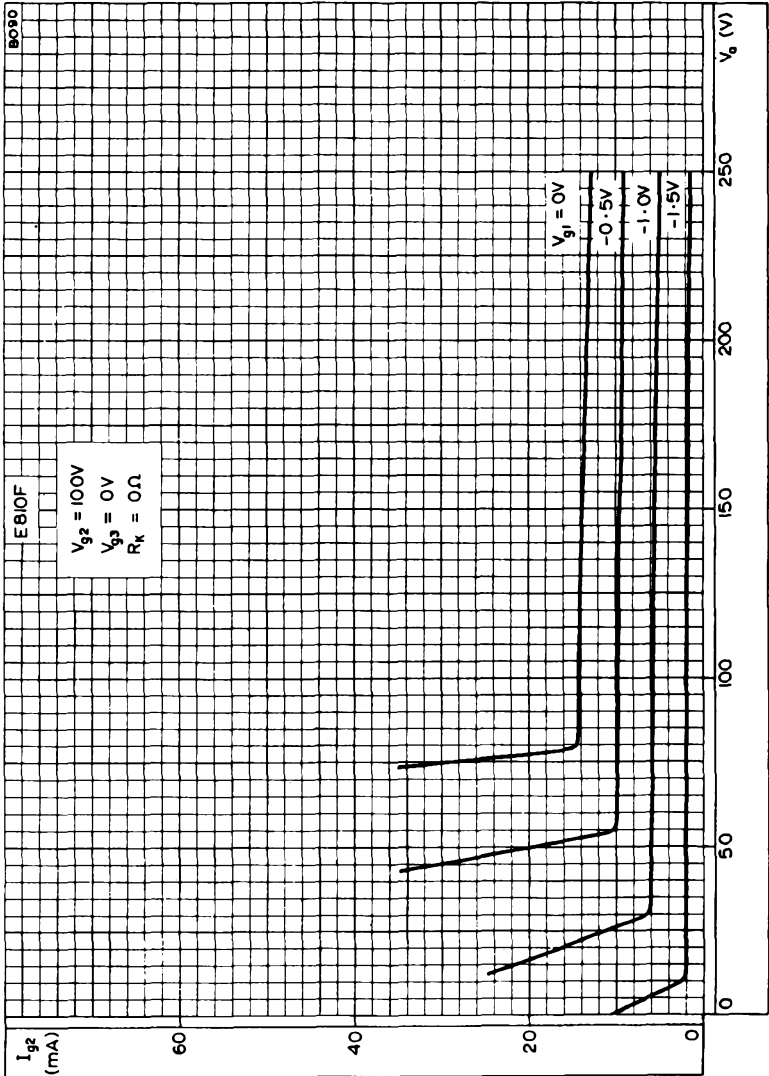

SCREEN GRID CURRENT PLOTTED AGAINST ANODE VOLTAGE WITH CONTROL-GRID VOLTAGE AS PARAMETER. $V_{g2} = 100V$



**SPECIAL QUALITY
WIDEBAND R.F. PENTODE**

E810F

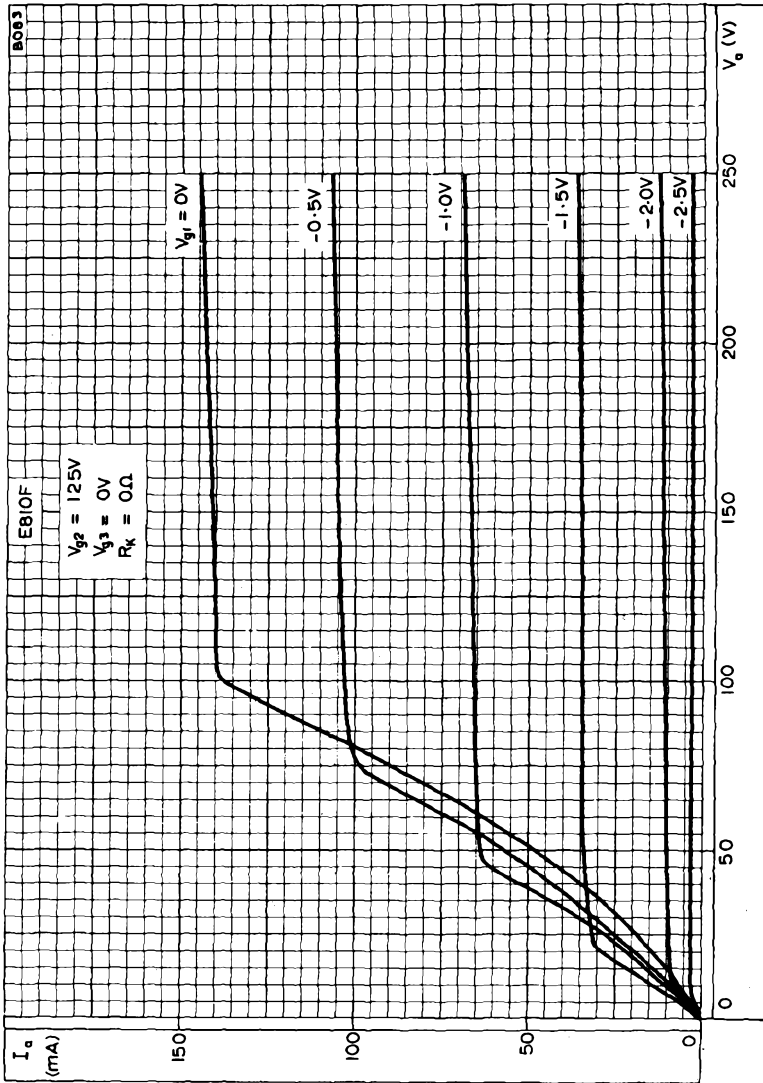

ANODE CURRENT PLOTTED AGAINST ANODE VOLTAGE WITH CONTROL-GRID VOLTAGE AS PARAMETER. $V_{g2} = 125V$



E810F

SPECIAL QUALITY
WIDEBAND R.F. PENTODE

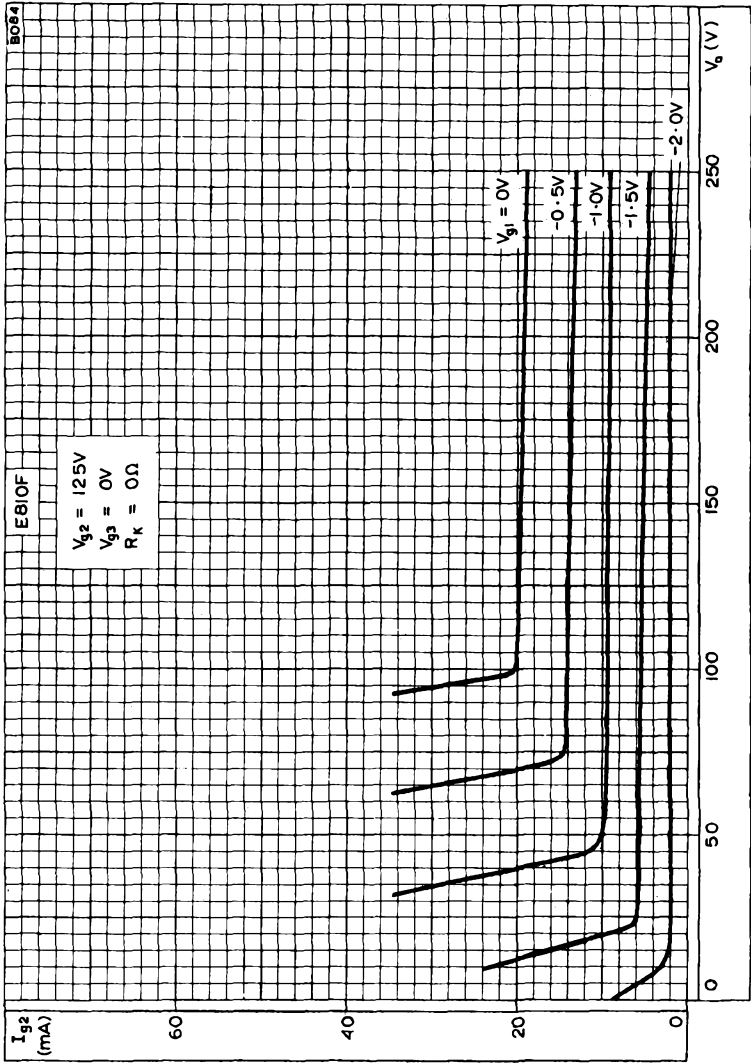

SCREEN GRID CURRENT PLOTTED AGAINST ANODE VOLTAGE WITH
CONTROL-GRID VOLTAGE AS PARAMETER. $V_{g2} = 12.5V$



**SPECIAL QUALITY
WIDEBAND R.F. PENTODE**

E810F

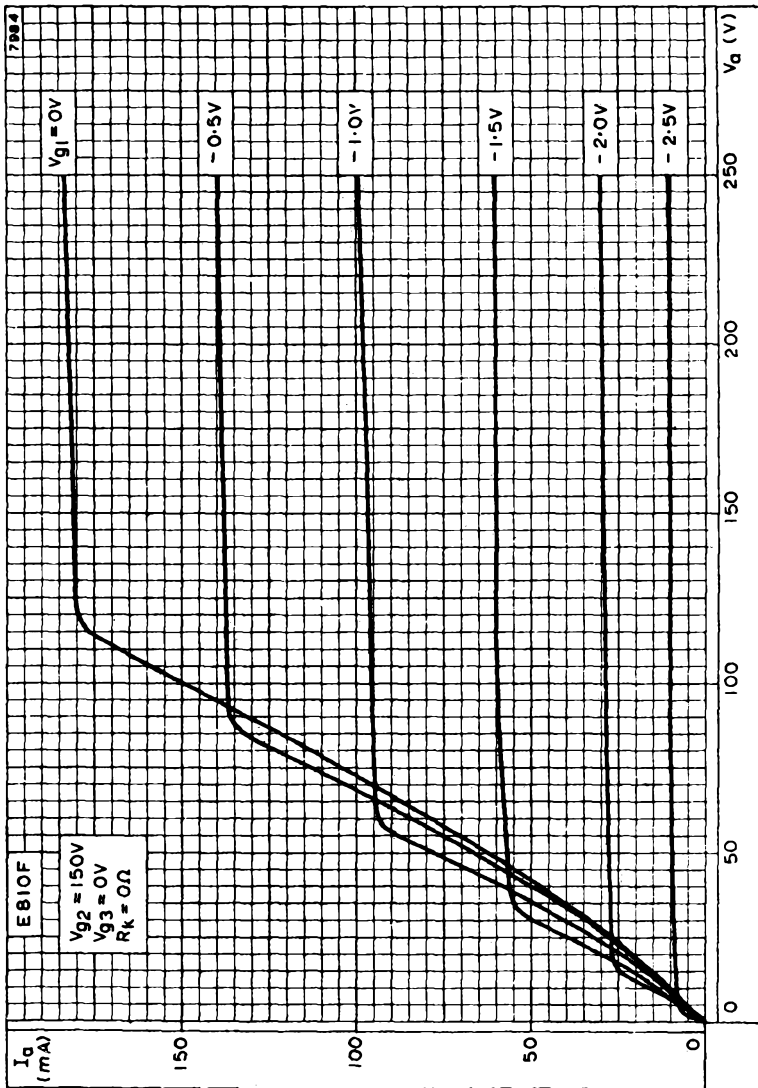

ANODE CURRENT PLOTTED AGAINST ANODE VOLTAGE WITH CONTROL-GRID VOLTAGE AS PARAMETER. $V_{g2} = 150V$



E810F

SPECIAL QUALITY
WIDEBAND R.F. PENTODE

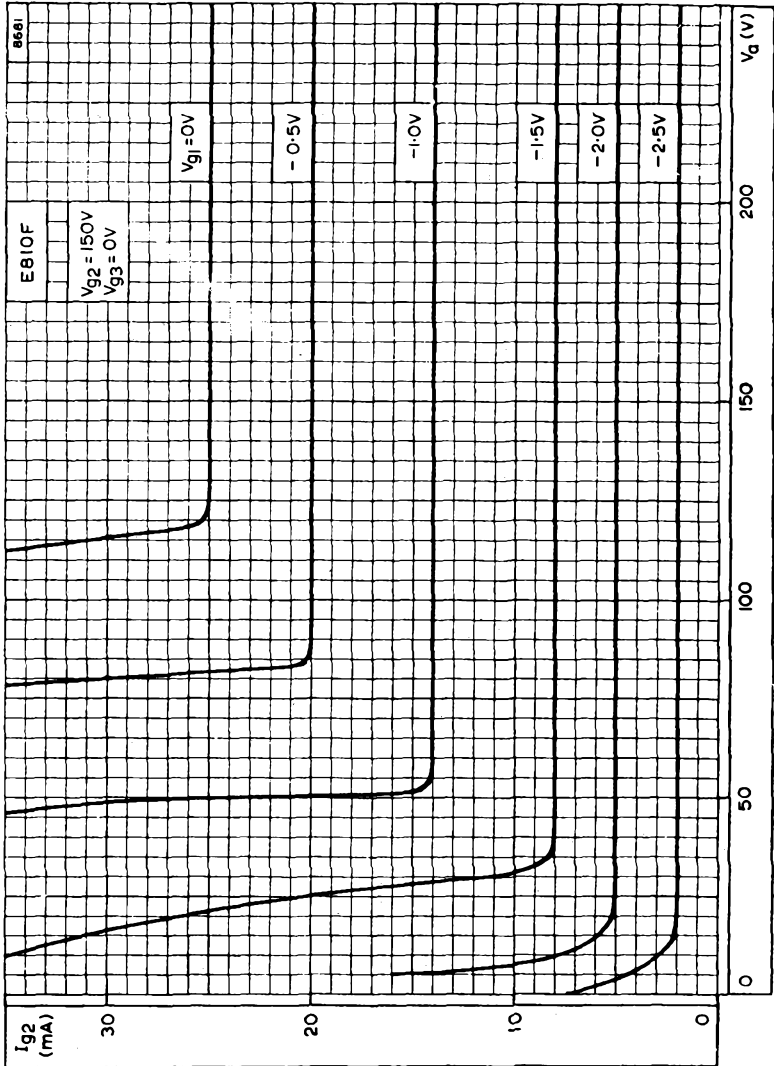

SCREEN-GRID CURRENT PLOTTED AGAINST ANODE VOLTAGE WITH CONTROL-GRID VOLTAGE AS PARAMETER. $V_{g2} = 150V$



**SPECIAL QUALITY
WIDEBAND R.F. PENTODE**

E810F

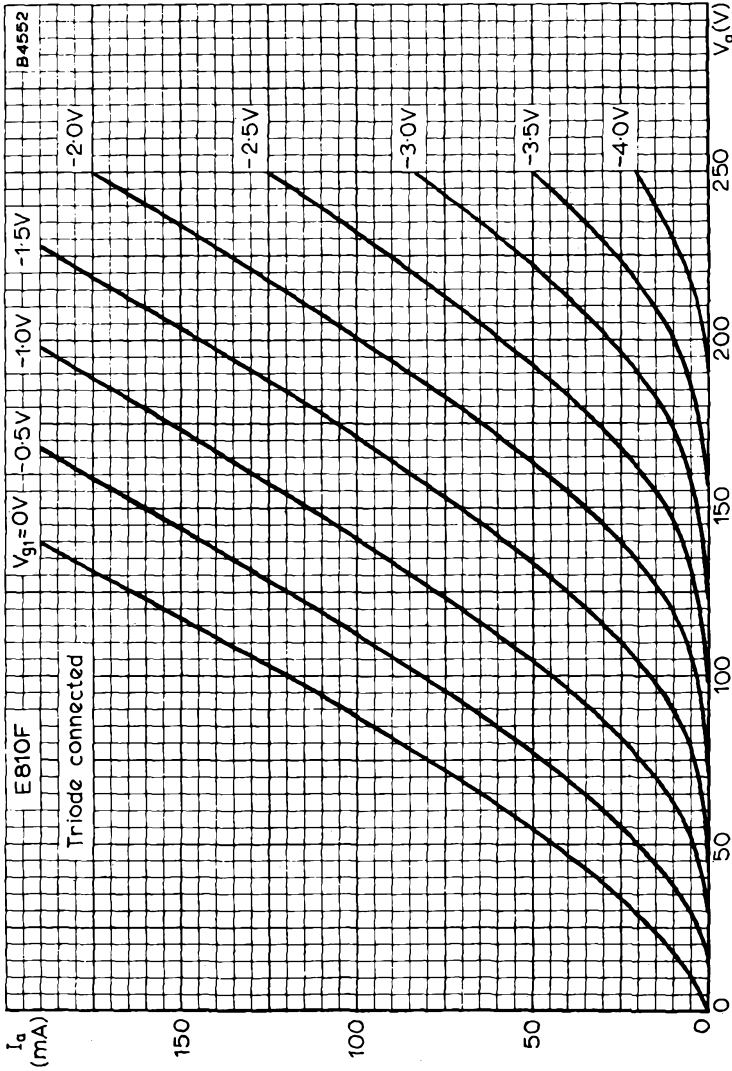

ANODE CURRENT PLOTTED AGAINST ANODE VOLTAGE WITH CONTROL GRID VOLTAGE AS PARAMETER



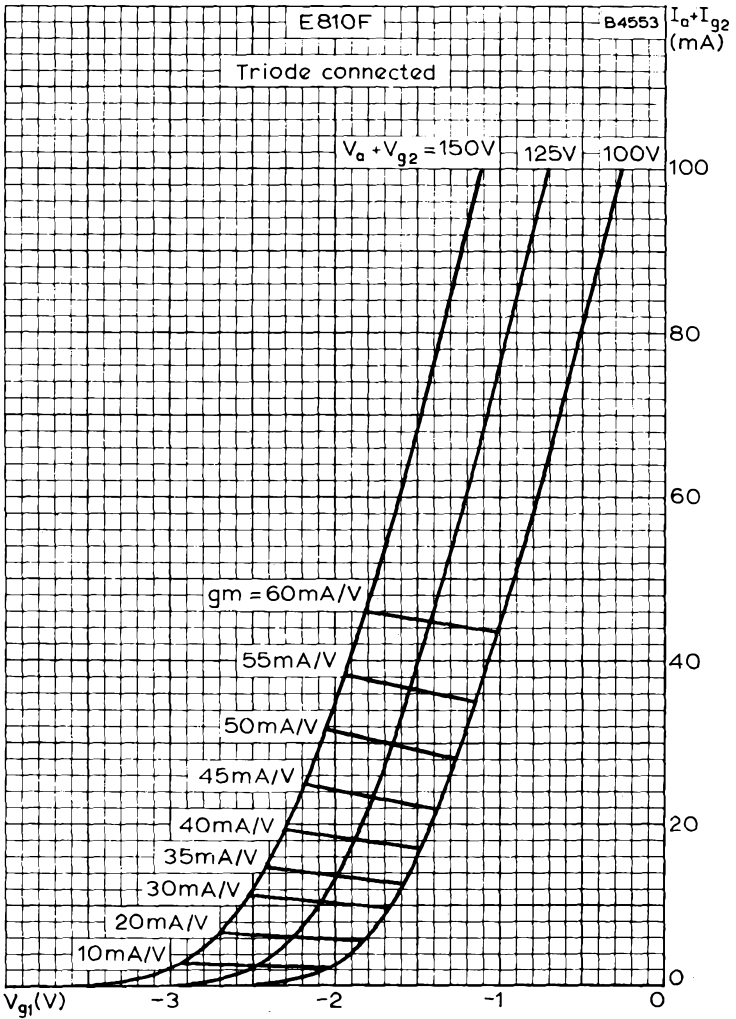

ANODE CURRENT PLOTTED AGAINST CONTROL GRID VOLTAGE WITH ANODE VOLTAGE AS PARAMETER AND WITH MUTUAL CONDUCTANCE CONTOURS



**SPECIAL QUALITY
WIDEBAND R.F. PENTODE**

E810F

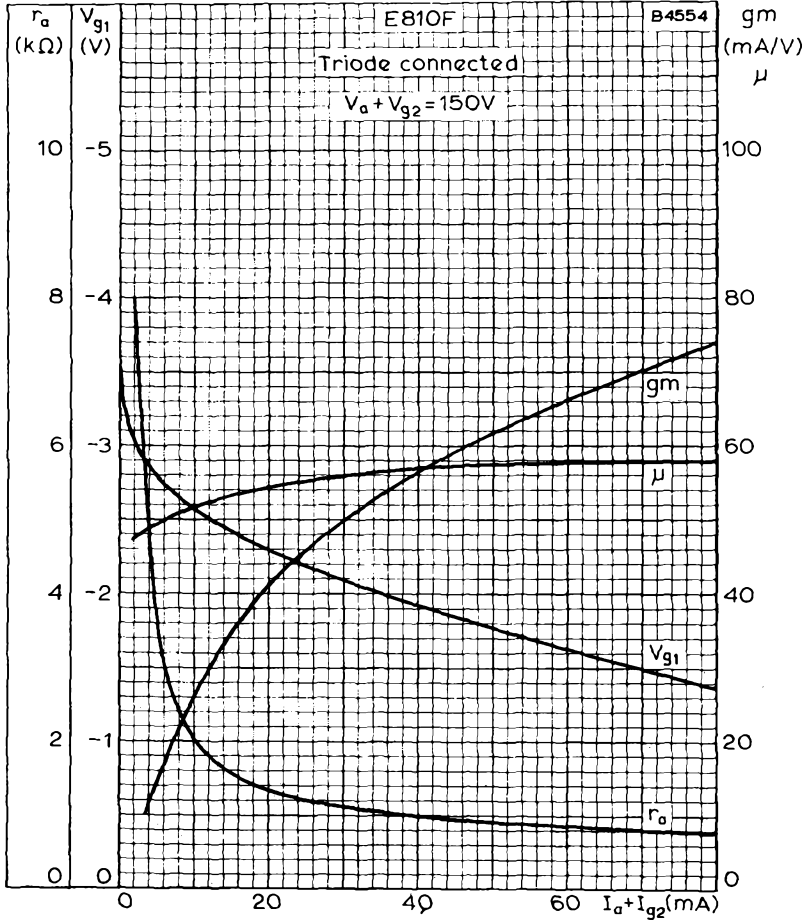

MUTUAL CONDUCTANCE, ANODE IMPEDANCE AND CONTROL GRID VOLTAGE PLOTTED AGAINST ANODE CURRENT





SPECIAL QUALITY R.F. POWER TRIODE

M8080

Special quality power triode for use as an r.f. power amplifier or oscillator in equipment where mechanical vibration and shocks are unavoidable and where statistically controlled major electrical characteristics are required.

This data should be read in conjunction with GENERAL NOTES - SPECIAL QUALITY VALVES which precede this section of the handbook, and the index numbers are used to indicate where reference should be made to a specific note.

HEATER

V_{h1}	6.3	V
I_h	150	mA

CAPACITANCES² (measured without an external shield)

C_{in}	1.5	pF
C_{out}	1.2	pF
C_{a-r}	1.4	pF

CHARACTERISTICS³

V_R	250	V
I_R	10.5	mA
V_R	-8.5	V
g_m	2.2	mA/V
μ	17	
r_R	7.7	k Ω
R_k	0	Ω



LIMITING VALUES⁴ (absolute ratings)

f max.	150	Mc/s
$V_{R(b)}$ max.	550	V
V_R max.	330	V
p_a max.	3.8	W
$-V_g$ max.	110	V
I_g max.	5.5	mA
I_k max.	21	mA
R_{g-k} max. (cathode bias)	1.0	M Ω
R_{g-k} max. (fixed bias)	250	k Ω
V_{h-k} max.	150	V
Maximum acceleration (continuous operation)	2.5	g
Maximum shock (short duration)	500	g
T_{bulb} max.	170	$^{\circ}$ C



TEST CONDITIONS (unless otherwise specified)

V_h	V_a	V_g	R_k	V_{h-k}
(V)	(V)	(V)	(Ω)	(V)
6.3	250	-8.5	0	0

TESTS

A.Q.L.⁵

(%)

GROUP A

Insulation

a-rest measured at -300V

0.25

g-rest measured at -100V

0.25

Reverse grid current, R_{g1} max. = 500k Ω

0.25

GROUP B

Heater current

0.65

Heater cathode leakage current

0.65

V_{h-k} = 100V (cathode negative)

—

V_{h-k} = 100V (cathode positive)

—

Anode current

{ 0.65
—

Mutual conductance

{ 0.65
—

Group quality level¹⁰

1.0





M8080

SPECIAL QUALITY
R.F. POWER TRIODE

Bogey ⁹	Individuals ⁶		Lot average ⁷		Lot standard deviation ⁸	
	Min.	Max.	Min.	Max.	Max.	
—	100	—	—	—	—	MΩ
—	100	—	—	—	—	MΩ
—	—	0.5	—	—	—	μA
—	138	162	—	—	—	mA
—	—	—	—	—	—	μA
—	—	10	—	—	—	μA
—	—	10	—	3.0	—	μA
10.5	6.5	14.5	—	—	—	mA
—	—	—	9.0	12	1.22	mA
2.2	1.75	2.65	—	—	—	mA/V
—	—	—	2.0	2.4	0.157	mA/V
—	—	—	—	—	—	

GROUP C

Anode current. $V_g = -30V$	2.5
Reverse grid current. $V_h = 6.9V$, $V_{a-e} = 250V$ $V_{g-e} = 0V$, $R_k = 810\Omega$	2.5
Microphonic noise at the anode at 50c/s and 2.5g min. peak acceleration, $V_b = 250V$, $R_a = 2k\Omega$, $V_{g-c} = 0V$, $R_k = 810\Omega$, $C_k = 1000\mu F$	2.5
Group quality level ¹⁰	6.5

GROUP D

Glass strain test ^{11A} . No applied voltages	6.5
Base strain test ¹² . No applied voltages	6.5
Capacitances (unshielded). No applied voltages; pin 2 connected to pin 7	6.5
C_{in}	—
C_{out}	—
C_{a-g}	—
Mutual conductance. $V_a = 100V$, $V_g = 0V$	{ 6.5 —
Change of mutual conductance. $V_a = 100V$, $V_g = 0V$, $V_h = 5.7V$	6.5
Amplification factor	{ 6.5 —
Power oscillation. $V_a = 300V$, $R_g = 8.5k\Omega$, $f = 150Mc/s$	4.0



**SPECIAL QUALITY
R.F. POWER TRIODE**

M8080

—	—	50	—	—	—	μA
—	—	1.0	—	—	—	μA
—	—	7.0	—	—	—	mV (r.m.s.)
—	—	—	—	—	—	
—	—	—	—	—	—	
—	—	—	—	—	—	
—	1.35	2.25	—	—	—	pF
—	0.98	1.62	—	—	—	pF
—	1.2	2.0	—	—	—	pF
3.25	2.5	4.0	—	—	—	mA/V
—	—	—	2.82	3.68	0.33	mA/V
—	—	15	—	—	—	%
17	15.5	18.5	—	—	—	
—	—	—	16.15	17.85	0.66	
—	1.8	—	—	—	—	W



TESTSA.Q.L.⁵

(%)

GROUP E**Fatigue¹⁴**

$V_h = 6.9V$, 1 minute on 3 minutes off.
No other voltages applied, 5g min. peak
acceleration, $f = 170 \pm 5c/s$ for 33 hours in
each of 3 mutually perpendicular planes

Post fatigue tests

Heater to cathode leakage current

$$V_{h-k} = \pm 100V$$

2.5

Reverse grid current

$$R_{gmax.} = 500k\Omega$$

2.5

Mutual conductance

2.5

Microphonic noise as in group C

2.5

Shock¹⁵

No applied voltages, 500g

Post shock tests

Heater to cathode leakage current

$$V_{h-k} = \pm 100V$$

2.5

Reverse grid current

$$R_{gmax.} = 500k\Omega$$

2.5

Mutual conductance

2.5

Microphonic noise as in group C

2.5





<i>Individuals</i> ⁶			<i>Lot average</i> ⁷		<i>Lot standard deviation</i> ⁸	
<i>Bogey</i> ⁹	<i>Min.</i>	<i>Max.</i>	<i>Min.</i>	<i>Max.</i>	<i>Max.</i>	
—	—	20	—	—	—	μA
—	—	1.0	—	—	—	μA
—	1.6	2.65	—	—	—	mA/V
—	—	15	—	—	—	mV (r.m.s.)
—	—	20	—	—	—	μA
—	—	1.0	—	—	—	μA
—	1.6	2.65	—	—	—	mA/V
—	—	15	—	—	—	mV (r.m.s.)

M8080

**SPECIAL QUALITY
R.F. POWER TRIODE**

TESTS

GROUP F

*Stability life test*¹⁴

Running conditions. $V_{a-e} = 250V$, $R_k = 500\Omega$,
 $V_{h-k} = 150V$ (cathode negative)

Stability life test end point

Change in mutual conductance after 1 hour 1.0

Intermittent life test

Running conditions. $V_{a-e} = 250V$, $R_k = 500\Omega$,
 $V_{h-k} = 150V$ (cathode negative)

Intermittent life test end points

Sub-group (a)

Inoperatives¹⁶

Heater current

Heater to cathode leakage current

$$V_{h-k} = \pm 100V$$

Reverse grid current. $R_g \text{ max.} = 500k\Omega$

Mutual conductance

Average change in mutual conductance

Sub-group (b)

Anode current

Insulation as in group A

Group quality level¹⁰



**SPECIAL QUALITY
R.F. POWER TRIODE**

M8080

	10				%
		A.Q.L. ⁵ (%)	Min.	Max.	
{ 500 hours		2.5	—	—	
{ 1000 hours		4.0	—	—	
{ 500 hours		2.5	138	162	mA
{ 500 hours		2.5	—	20	μA
{ 1000 hours		4.0	—	20	μA
{ 500 hours		2.5	—	0.5	μA
{ 1000 hours		4.0	—	0.5	μA
{ 500 hours		2.5	1.6	2.65	mA/V
{ 1000 hours		4.0	1.5	2.65	mA/V
{ 500 hours		—	—	15	%
{ 500 hours		4.0	5.5	14.5	mA
{ 1000 hours		6.5	5.0	14.5	mA
{ 500 hours		4.0	50	—	MΩ
{ 1000 hours		6.5	30	—	MΩ
{ 500 hours		6.5	—	—	
{ 1000 hours		10	—	—	



M8080

**SPECIAL QUALITY
R.F. POWER TRIODE**

GROUP G

Valves are held for 28 days and retested for

Inoperatives¹⁶

Reverse grid current. R_g max. = 500k Ω

A.Q.L. ⁵ (%)	Min.	Max ¹	
0.5	—	—	
0.5	—	0.5	μA

5606

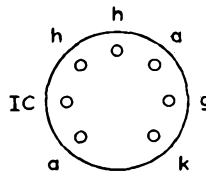
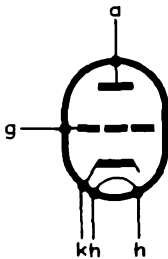

B7G Base

All dimensions in mm

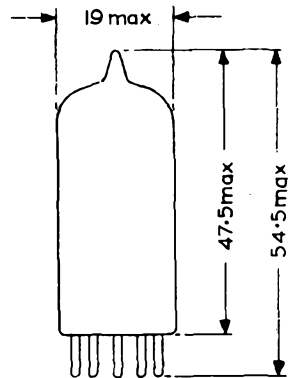

The bulb and base dimensions of this valve are in accordance with BS448 Section B7G.



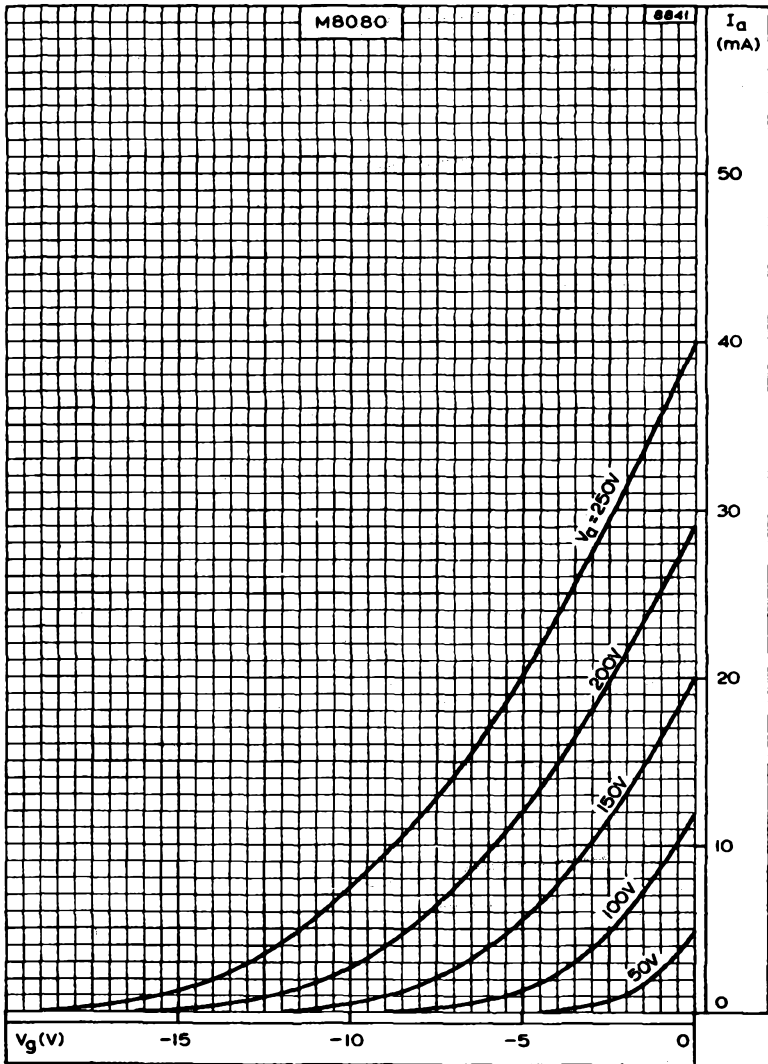

ANODE CURRENT PLOTTED AGAINST GRID VOLTAGE WITH ANODE VOLTAGE AS PARAMETER



M8080

SPECIAL QUALITY
R.F. POWER TRIODE

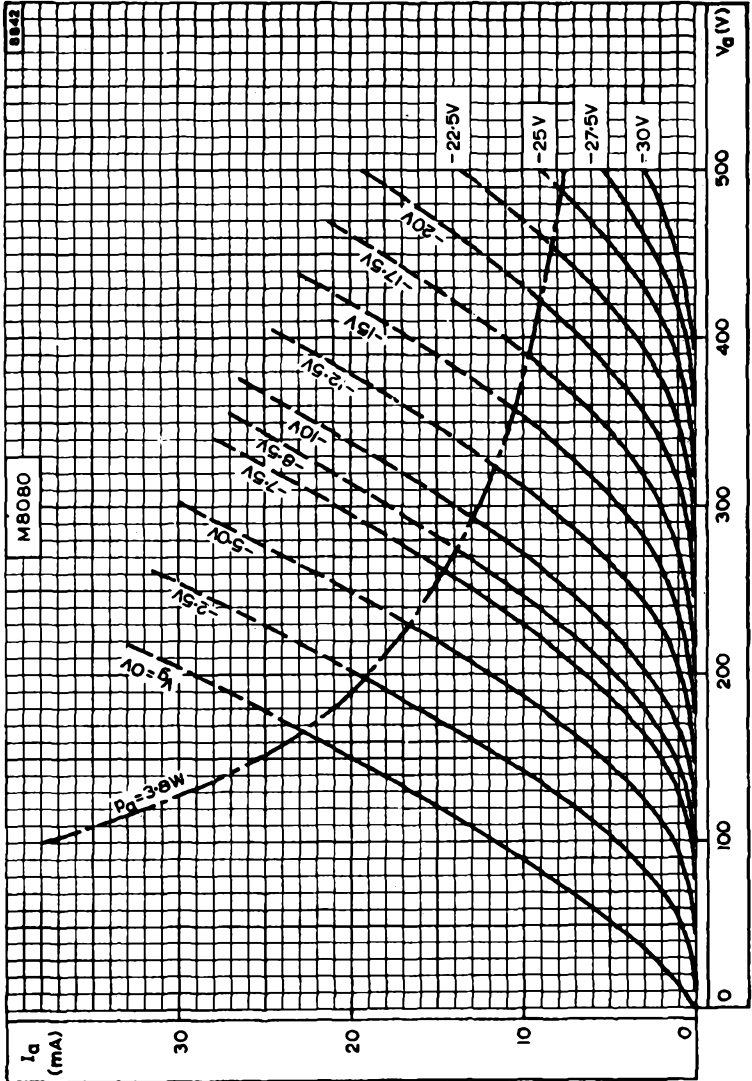

ANODE CURRENT PLOTTED AGAINST ANODE VOLTAGE WITH GRID VOLTAGE AS PARAMETER



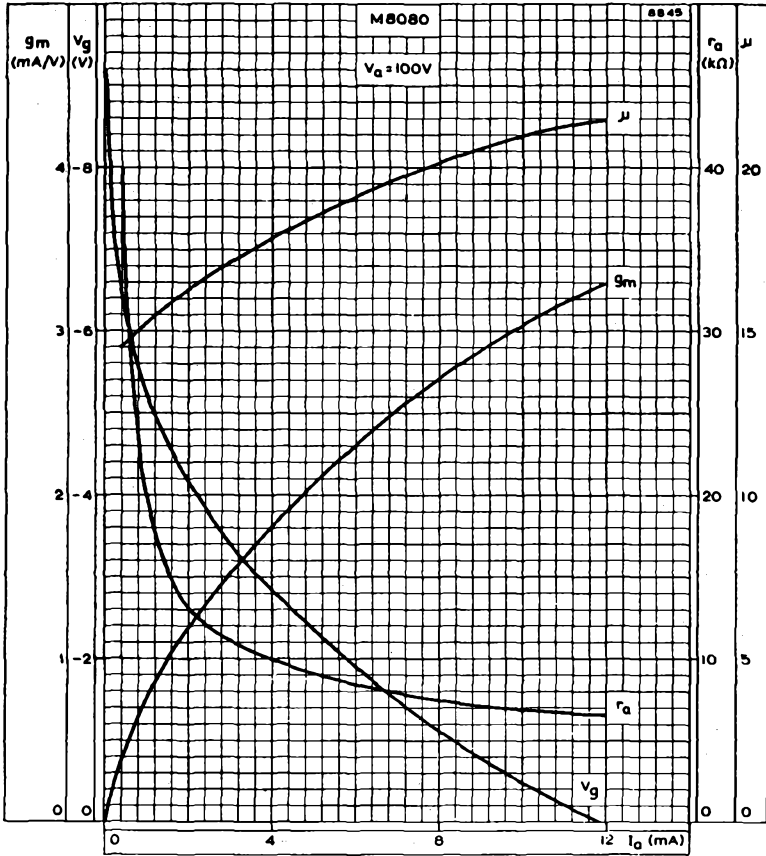

ANODE IMPEDANCE, AMPLIFICATION FACTOR, MUTUAL CONDUCTANCE AND GRID VOLTAGE PLOTTED AGAINST ANODE CURRENT. V_a = 100V



M8080

SPECIAL QUALITY
R.F. POWER TRIODE

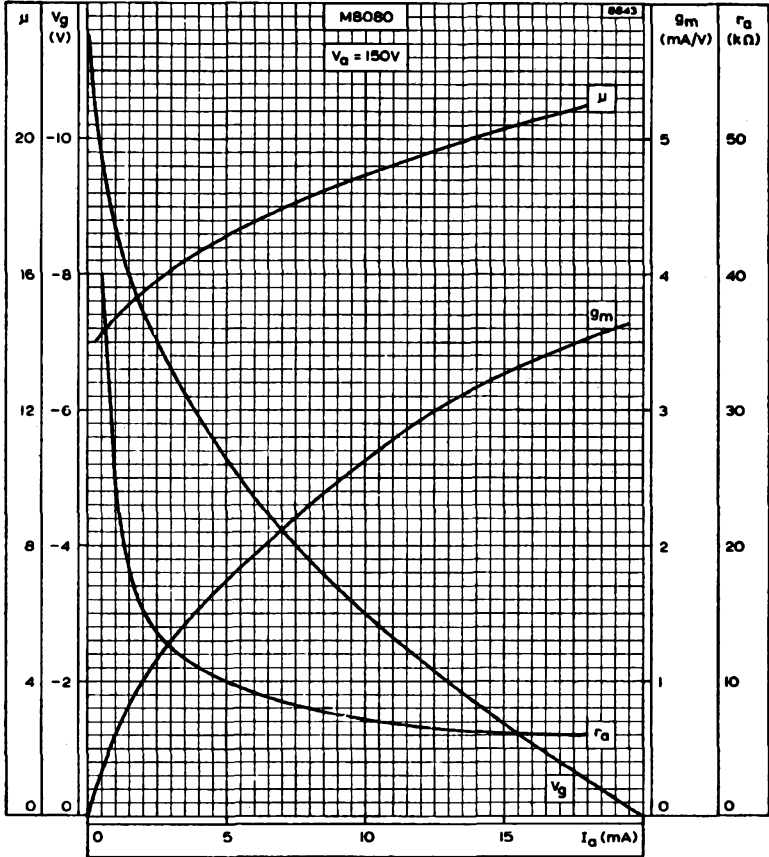

ANODE IMPEDANCE, AMPLIFICATION FACTOR, MUTUAL CONDUCTANCE
AND GRID VOLTAGE PLOTTED AGAINST ANODE CURRENT. V_a = 150V



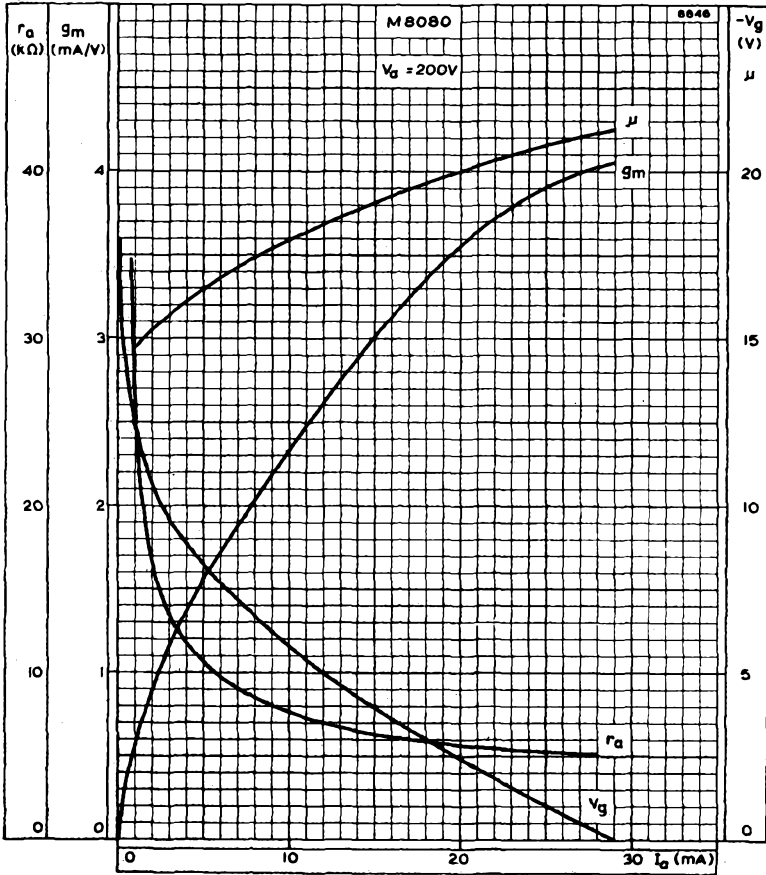

ANODE IMPEDANCE, AMPLIFICATION FACTOR, MUTUAL CONDUCTANCE AND GRID VOLTAGE PLOTTED AGAINST ANODE CURRENT. $V_g \approx 200V$



M8080

SPECIAL QUALITY
R.F. POWER TRIODE

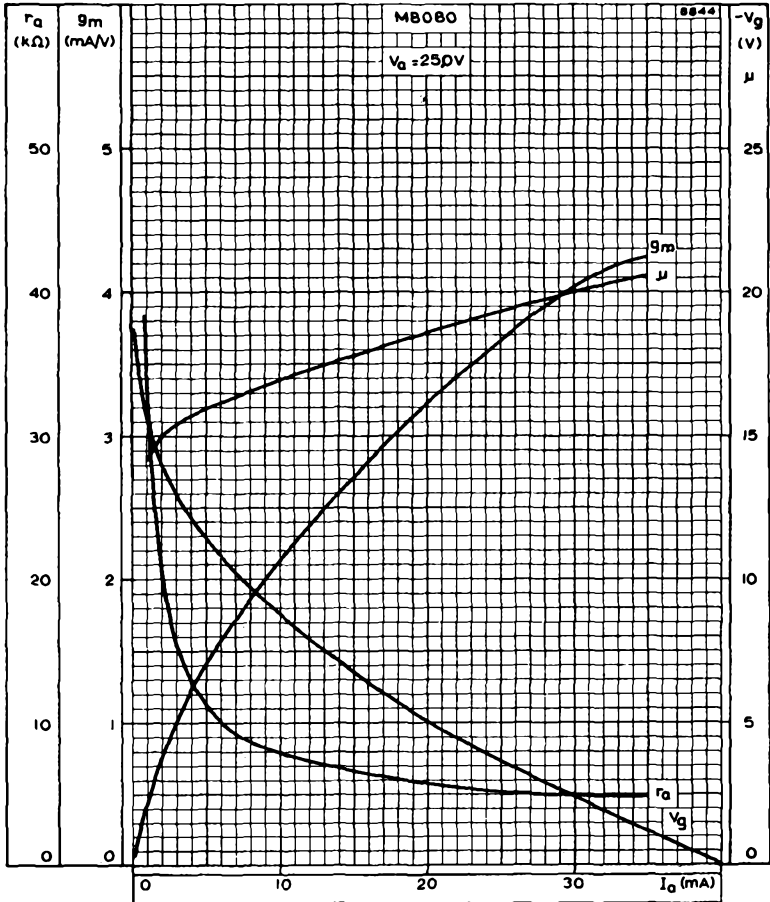

ANODE IMPEDANCE, AMPLIFICATION FACTOR, MUTUAL CONDUCTANCE
AND GRID VOLTAGE PLOTTED AGAINST ANODE CURRENT. $V_a = 250V$



SPECIAL QUALITY V.H.F. DOUBLE TRIODE

M808 I

Special quality double triode for use in equipment where mechanical vibration and shocks are unavoidable and where statistically controlled major electrical characteristics are required.

This data should be read in conjunction with GENERAL NOTES - SPECIAL QUALITY VALVES which precede this section of the handbook, and the index numbers are used to indicate where reference should be made to a specific note.

HEATER

V_{h1}	6.3	V
I_{h1}	450	mA

CAPACITANCES² (measured without an external shield)

* C_{a-g}	1.6	pF
* C_{in}	2.1	pF
C_{out}^*	450	mpF
C_{out}^*	350	mpF
C_{h-k}	4.0	pF

*Each section

CHARACTERISTICS³ (each section)

V_{a1}	100	V
I_{a1}	9.0	mA
* V_g	-0.9	V
g_m	5.6	mA/V
I_c	38	
r_{a1}	6.8	k Ω
R_k	0	Ω

* Fixed bias operation is not recommended

LIMITING VALUES (absolute ratings)

f max.	250	Mc/s
$V_{a(b)}$ max.	550	V
V_{a1} max.	330	V
p_a max.	2 / 1.6	W
I_k max.	25	mA
$-V_g$ max.	110	V
I_g max.	2 x 4.5	mA
V_{h-k} max.	100	V
R_{g-k} max. (cathode resistor bias)	500	k Ω
Maximum acceleration (continuous operation)	2.5	g
Maximum shock (short duration)	500	g
T_{bulb} max.	165	$^{\circ}$ C





M8081

SPECIAL QUALITY
V.H.F. DOUBLE TRIODE

TEST CONDITIONS (unless otherwise specified)

V_h	V_{a-e}	V_{g-e}	R_k	C_k
(V)	(V)	(V)	(Ω)	(μF)
6.3	100	0	50	1000

Voltagcs are applied simultaneously to both sections. The measurements apply to each section, unless otherwise stated.

TESTS	A.Q.L. ⁵	Individuals ⁶		Lot average ⁷		Lot standard deviation ⁸	
	(%)	Bogey ⁹	Min.	Max.	Min.	Max.	
GROUP A							
Insulation							
a-rest, measured at -300V	0.25	—	100	—	—	—	M Ω
g-rest, measured at -100V	0.25	—	100	—	—	—	M Ω
Reverse grid current							
$R_{gmax.} = 1M\Omega, V_{a-e} = 250V,$ $R_k = 500\Omega$ both sections strapped	0.25	—	—	0.5	—	—	μA
GROUP B							
Heater current	0.65	—	420	480	—	—	mA
Heater to cathode leakage current	0.65	—	—	—	—	—	—
$V_{h-k} = 100V$ cathode negative	—	—	—	10	—	—	μA
$V_{h-k} = 100V$ cathode positive	—	—	—	10	—	—	μA
Anode current	0.65	—	6.5	11.5	—	—	mA
Mutual conductance	0.65	—	4.0	7.5	—	—	mA/V
Anode current $V_{g-e} = -30V, V_{a-e} = 250V$	0.65	—	—	75	—	—	μA
Group quality level ¹⁰	1.0	—	—	—	—	—	—



GROUP C

Change in mutual conductance. $V_h = 5.7V$	2.5
Microphonic noise at the anode at 50c/s and 2.0g min. peak acceleration, both sections connected in parallel, $V_b = 250V$, $R_a = 2k\Omega$, $R_k = 1.5k\Omega$, $R_{g'} = R_{g''} = 0\Omega$.	2.5

GROUP D

Glass strain test ^{11A} . No applied voltages	6.5
Base strain test ¹² . No applied voltages	6.5
Capacitances (unshielded). No applied voltages	6.5
C_{in}	—
$C_{out'}$	—
$C_{out''}$	—
C_{a-g}	—
C_{h-k}	—
Amplification factor	6.5
Reverse grid current. $V_h = 7.0V$, $R_g = 1M\Omega$ both sections connected in parallel	6.5



**SPECIAL QUALITY
V.H.F. DOUBLE TRIODE**

M8081

—	—	15	—	—	—	%
—	—	15	—	—	—	mV (r.m.s.)
—	—	—	—	—	—	
—	—	—	—	—	—	
—	—	—	—	—	—	
—	1.4	2.8	—	—	—	pF
—	250	650	—	—	—	mpF
—	250	550	—	—	—	mpF
—	1.2	1.8	—	—	—	pF
—	3.3	7.5	—	—	—	pF
—	28	48	—	—	—	
—	—	1.0	—	—	—	μA



TESTS

A.Q.L.

(%)

GROUP E

*Fatigue*¹⁴

$V_h = 6.9V$, 1 minute on 3 minutes off. No other voltages applied, 2g min. peak acceleration, $f = 170c/s$ for 33 hours in each of 3 mutually perpendicular planes.

Post fatigue tests

Heater to cathode leakage current.

$$V_{h-k} = \pm 100V$$

2.5

Reverse grid current as in group A

2.5

Mutual conductance

2.5

Microphonic noise as in group C

2.5

Sub-group quality level¹⁰

4.0

*Shock*¹⁵

No applied voltages, 500g

Post shock tests

Heater to cathode leakage current.

$$V_{h-k} = \pm 100V$$

2.5

Reverse grid current as in group A

2.5

Mutual conductance

2.5

Microphonic noise as in group C

2.5

Sub-group quality level¹⁰

4.0





Individuals ⁶			Lot average ⁷		Lot standard deviation ⁸	
Bogey ⁹	Min.	Max.	Min.	Max.	Max.	
—	—	20	—	—	—	μA
—	—	1.0	—	—	—	μA
—	3.5	7.5	—	—	—	mA/V
—	—	35	—	—	—	mV (r.m.s.)
—	—	—	—	—	—	
—	—	20	—	—	—	μA
—	—	1.0	—	—	—	μA
—	3.5	7.5	—	—	—	mA/V
—	—	35	—	—	—	mV (r.m.s.)
—	—	—	—	—	—	

M8081

SPECIAL QUALITY
V.H.F. DOUBLE TRIODE

GROUP F

Stability life test¹⁴

Running conditions: $V_{a-e} = 125V$, $R_k = 50\Omega$,
 $V_{h-k} = 180V$ (cathode negative)

Stability life test end points

Change in mutual conductance after 1 hour 1.0

Intermittent life test

Running conditions: $V_{a-e} = 125V$, $R_k = 50\Omega$,
 $V_{h-k} = 180V$ (cathode negative)

Intermittent life test end points

Sub-group (a)

Inoperatives¹⁶

Heater current

Heater to cathode leakage current. $V_{h-k} = \pm 100V$..

Reverse grid current as in group A

Mutual conductance

Average change in mutual conductance

Sub-group (b)

Insulation as in group A

Group quality level¹⁰



**SPECIAL QUALITY
V.H.F. DOUBLE TRIODE**

M8081

		A.Q.L. ⁵ (%)	Min.	Max.	
—	—	15	—	—	%
..	{ 500 hours	2.5	—	—	
	{ 1000 hours	4.0	—	—	
..	500 hours	2.5	420	480	mA
..	{ 500 hours	2.5	—	20	μA
	{ 1000 hours	4.0	—	20	μA
..	{ 500 hours	2.5	—	0.75	μA
	{ 1000 hours	4.0	—	1.0	μA
..	{ 500 hours	2.5	3.5	7.5	mA/V
	{ 1000 hours	4.0	3.25	7.5	mA/V
..	500 hours	—	—	15	%
..	{ 500 hours	4.0	50	—	MΩ
	{ 1000 hours	6.5	30	—	MΩ
..	{ 500 hours	6.5	—	—	
	{ 1000 hours	10	—	—	



M808 I

**SPECIAL QUALITY
V.H.F. DOUBLE TRIODE**

GROUP G

Valves are held for 28 days and retested for
Inoperatives¹⁶

Reverse grid current as in group A.

A.Q.L. ⁵ (%)	Min.	Max.
0.5	—	—
0.5	—	0.75 μ A

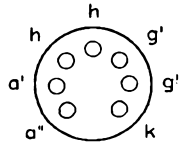
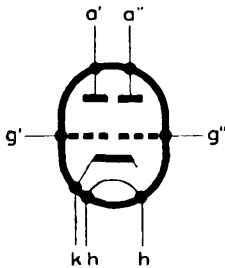

B7G Base

4749

All dimensions in mm

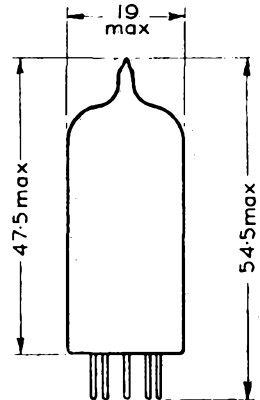

The bulb and base dimensions of this valve are in accordance with BS448, Section B7G



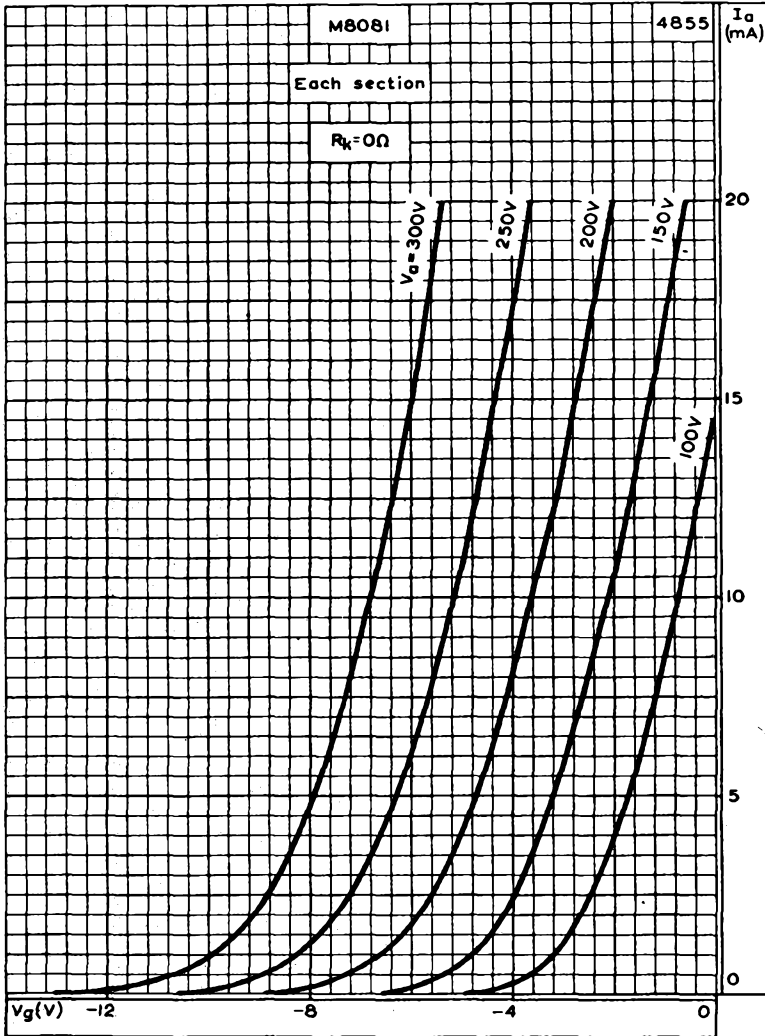

ANODE CURRENT PLOTTED AGAINST GRID VOLTAGE WITH ANODE VOLTAGE AS PARAMETER.



M808 I

SPECIAL QUALITY MINIATURE V.H.F. DOUBLE TRIODE

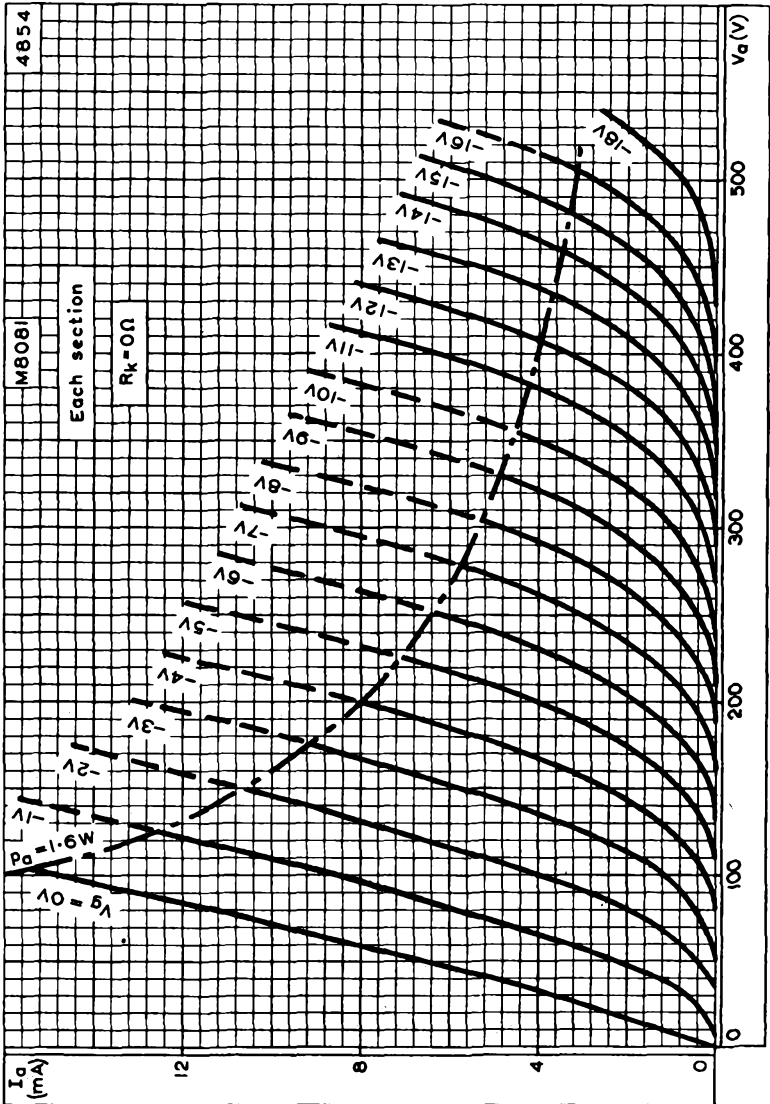

ANODE CURRENT PLOTTED AGAINST ANODE VOLTAGE WITH GRID VOLTAGE AS PARAMETER.



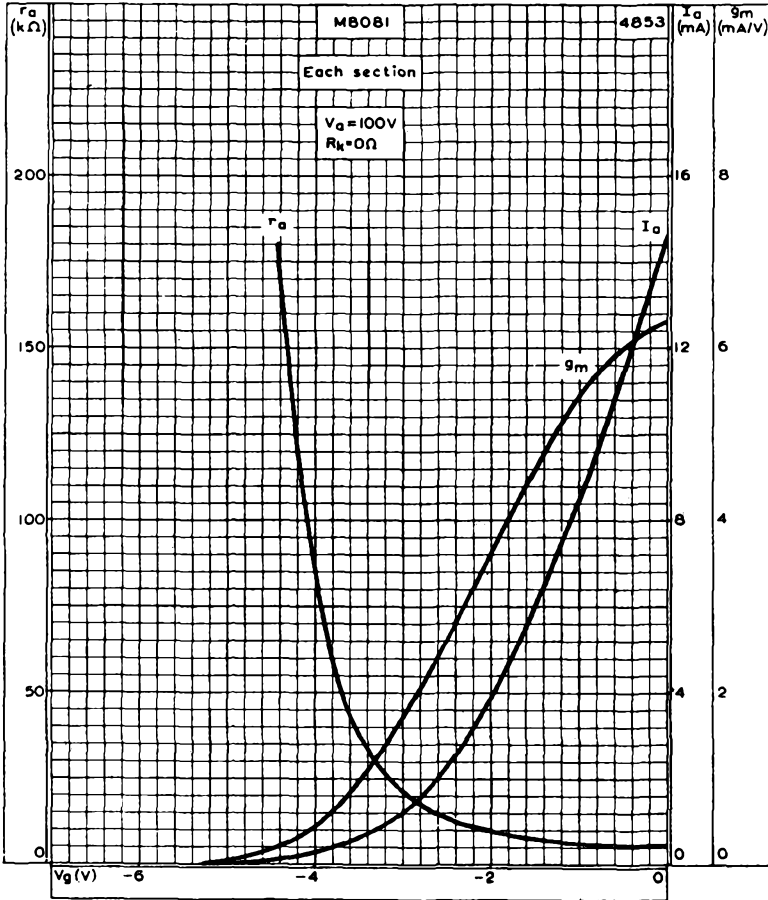

ANODE CURRENT, MUTUAL CONDUCTANCE AND ANODE IMPEDANCE
PLOTTED AGAINST GRID VOLTAGE FOR EACH SECTION



M8081

SPECIAL QUALITY MINIATURE
V.H.F. DOUBLE TRIODE

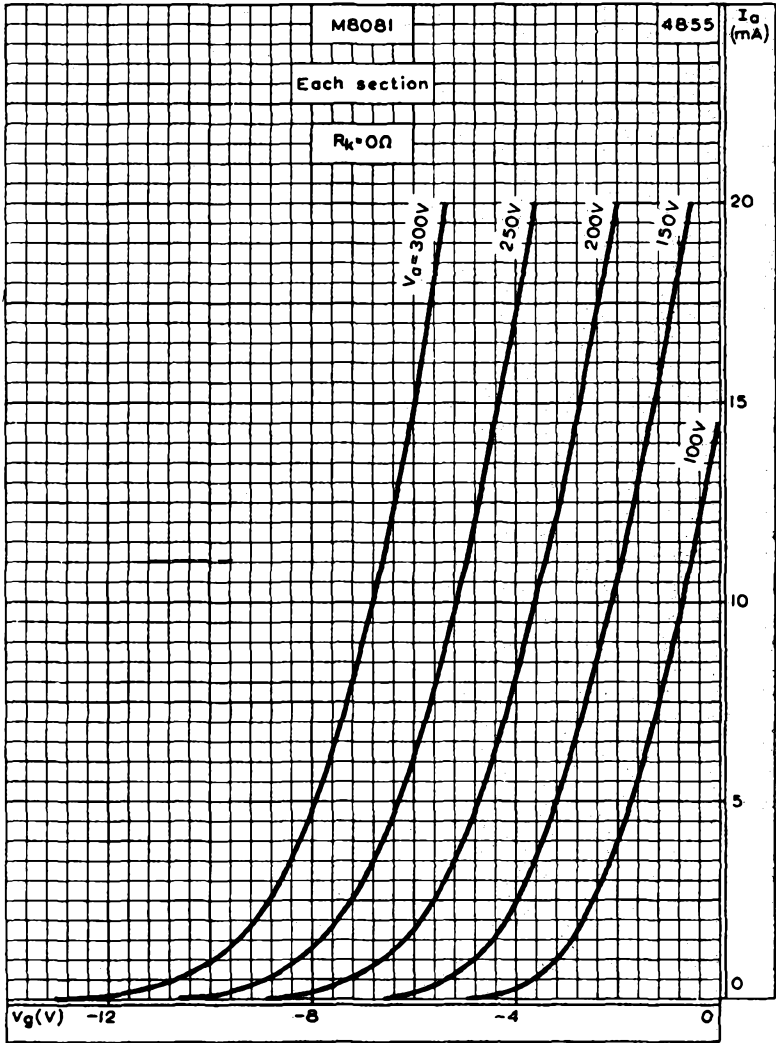

ANODE CURRENT PLOTTED AGAINST GRID VOLTAGE WITH ANODE VOLTAGE AS PARAMETER FOR EACH SECTION



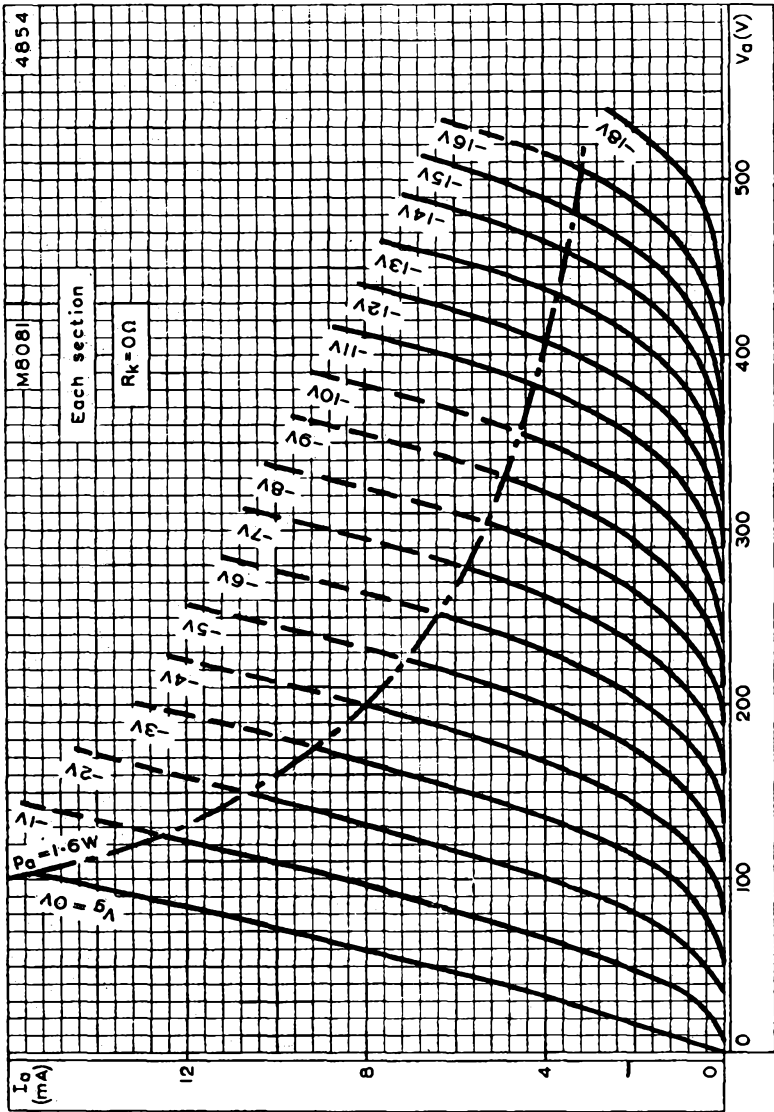

ANODE CURRENT PLOTTED AGAINST ANODE VOLTAGE WITH GRID VOLTAGE AS PARAMETER FOR EACH SECTION



M8081

SPECIAL QUALITY MINIATURE V.H.F. DOUBLE TRIODE

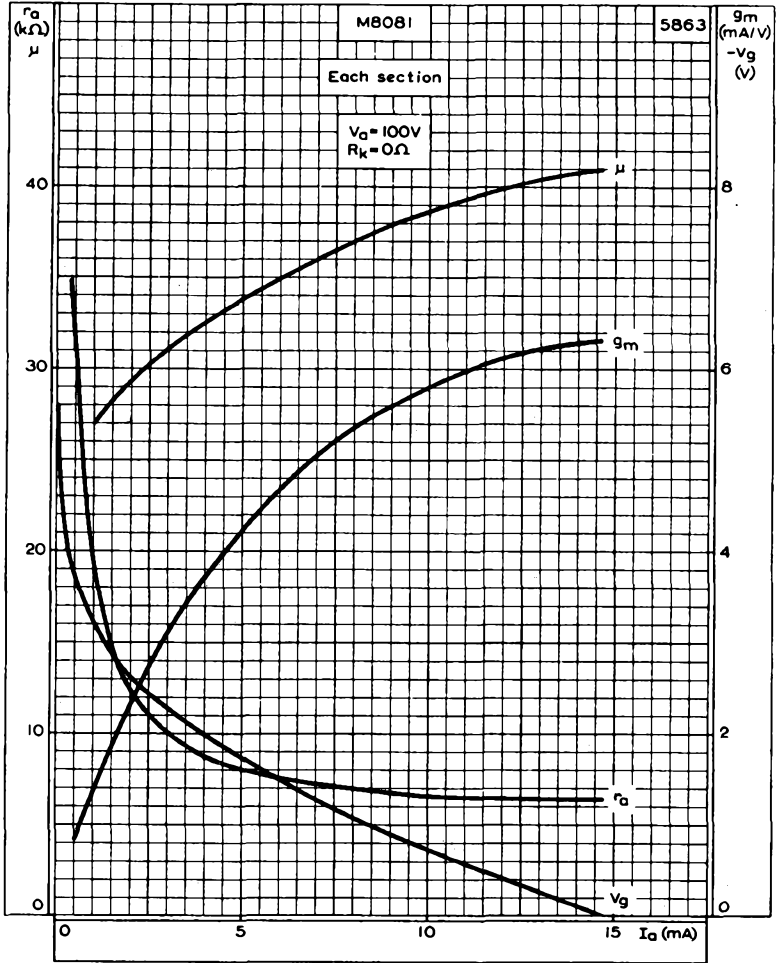

ANODE IMPEDANCE, AMPLIFICATION FACTOR, MUTUAL CONDUCTANCE
AND GRID VOLTAGE PLOTTED AGAINST ANODE CURRENT FOR EACH
SECTION



SPECIAL QUALITY OUTPUT PENTODE

M8082

Special quality output pentode for use in equipment where mechanical vibration and shocks are unavoidable and where statistically controlled major electrical characteristics are required.

This data should be read in conjunction with the GENERAL NOTES - SPECIAL QUALITY VALVES which precede this section of the handbook, and the index numbers are used to indicate where reference should be made to a specific note.

HEATER

V_h^1	6.3	V
I_h	200	mA

MOUNTING POSITION

Any

CAPACITANCES² (measured with an external shield)

C_{in}	3.8	pF
C_{out}	6.5	pF
C_{a-g1}	< 300	mpF

CHARACTERISTICS³

V_a	250	V
V_{g2}	250	V
I_a	16	mA
I_{g2}	2.3	mA
g_m	2.5	mA/V
r_a	130	k Ω
μ_{g1-g2}	12	
R_k	0	Ω
V_{g1}	-13.5	V

ABSOLUTE MAXIMUM RATINGS⁴

f max.	100	Mc/s
$V_{a(b)}$ max.	550	V
V_a max.	300	V
P_a max.	4.75	W
$V_{g2(b)}$ max.	550	V
V_{g2} max.	275	V
P_{g2} max.	800	mW
$-V_{g1}$ max.	110	V
V_{g1-g2} max.	300	V
I_{g1} max.	3.3	mA
I_k max.	23	mA
R_{g1-k} max. (fixed bias)	220	k Ω
V_{h-k} max.	150	V
Maximum acceleration (continuous operation)	2.5	g
Maximum shock (short duration)	500	g
T_{bulb} max.	180	$^{\circ}$ C

TEST CONDITIONS (unless otherwise specified)

V_{h1} (V)	$V_{a1(b1)}$ (V)	V_{g2-e} (V)	V_{g1-e} (V)
6.3	250	250	0

TESTS

A.Q.L.⁵

GROUP A

(%)

Insulation

a-rest, g_2 -rest measured at $-300V$ }
 g_1 -rest measured at $-100V$ }

0.25

Reverse control-grid current

R_{g1} max. = $500k\Omega$

0.25

GROUP B

Heater current

0.65

Heater to cathode leakage current

$V_{h-k} = 100V$ cathode alternately
 positive and negative

0.65

$V_{h-k} = 100V$ cathode positive

Anode current

{ 0.65
 —

Screen-grid current

{ 0.65
 —

Mutual conductance

{ 0.65
 —

Group quality level¹⁰

1.0





M8082

SPECIAL QUALITY OUTPUT
PENTODE

R _k (Ω) 740	R _{g1} (Ω) 0		C _k (μF) 1000		Lot standard deviation ⁸	
	Individuals ⁶		Lot average ⁷		Max.	
Bogey ⁹	Min.	Max.	Min.	Max.		
—	100	—	—	—	—	MΩ
—	—	0.5	—	—	—	μA
—	184	216	—	—	—	mA
—	—	10	—	—	—	μA
—	—	—	—	3.0	—	μA
15	12	18	—	—	—	mA
—	—	—	13.9	16.1	0.86	mA
2.0	1.3	2.7	—	—	—	mA
—	—	—	1.74	2.26	0.2	mA
2.55	1.95	3.15	—	—	—	mA/V
—	—	—	2.33	2.77	0.17	mA/V
—	—	—	—	—	—	

GROUP C

Anode current. $V_{g1-e} = -50V$	2.5	—	—	50	—	—	—	μA
Change in mutual conductance. $V_h = 5.7V$	2.5	—	—	15	—	—	—	%
Reverse control-grid current. $V_h = 6.9V$, $V_{a-e} = 300V$, $V_{g2-e} = 235V$	2.5	—	—	1.0	—	—	—	μA
Microphonic noise at the anode at 50c/s 2.0g min. peak acceleration, $V_{a(b)} = 250V$, $R_a = 2k\Omega$, $V_{g2-e} = 250V$.	2.5	—	—	15	—	—	—	mV (r.m.s.)
Group quality level ¹⁰	6.5	—	—	—	—	—	—	—

GROUP D

Glass strain test ^{11A} . No applied voltages	6.5	—	—	—	—	—	—	—
Base strain test ¹² . No applied voltages	6.5	—	—	—	—	—	—	—
Capacitances (shielded). No applied voltages	6.5	—	—	—	—	—	—	—
C_{in}	—	—	3.5	5.0	—	—	—	μF
C_{out}	—	—	5.8	7.2	—	—	—	μF
C_{a-g1}	—	—	—	300	—	—	—	mpF
Amplification factor (μ_{g1-g2})	6.5	—	10	14	—	—	—	—



TESTS

A.Q.L

GROUP E

(%)

*Fatigue*¹⁴

$V_h = 6.9V$, 1 minute on, 3 minutes off. No other voltages applied, 5g min. peak acceleration, $f = 170c/s$, for 33 hours in each of 3 mutually perpendicular planes.

Post fatigue tests

Heater to cathode leakage current.

$$V_{h-k} = \pm 100V$$

2.5

Reverse control-grid current

$$R_{g1} \text{ max} = 500k\Omega$$

2.5

Mutual conductance

2.5

Microphonic noise as in group C

2.5

Sub-group quality level¹⁰

4.0

*Shock*¹⁸

No applied voltages, 500g

Post shock tests

Heater to cathode leakage current.

$$V_{h-k} = \pm 100V$$

2.5

Reverse control-grid current

$$R_{g1} \text{ max} = 500k\Omega$$

2.5

Mutual conductance

2.5

Microphonic noise as in group C

2.5

Sub-group quality level¹⁰

4.0



GROUP F

Stability life test¹⁴

Running conditions. $R_{g1} = 100k\Omega \pm 20\%$,
 $R_k = 740\Omega \pm 10\%$, $V_{h-k} = 150V$ (cathode
negative)

Stability life test end point

Change in mutual conductance after 1 hour 1.0

Intermittent life test

Running conditions. $R_{g1} = 100k\Omega \pm 20\%$,
 $R_k = 740\Omega \pm 10\%$, $V_{h-k} = 150V$ (cathode
negative)

Intermittent life test end points

Sub-group (a)

Inoperatives¹⁶

Heater current

Heater to cathode leakage current. $V_{h-k} = \pm 100V$..

Reverse control-grid current. $R_{g1} \text{ max} = 500k\Omega$..

Mutual conductance

Average change in mutual conductance

Sub-group (b)

Insulation as in group A

Group quality level¹⁰



**SPECIAL QUALITY OUTPUT
PENTODE**

M8082

	10				%
		A.Q.L. ⁵ (%)	Min.	Max.	
{ 500 hours		2.5	—	—	
{ 1000 hours		4.0	—	—	
500 hours		2.5	184	216	mA
{ 500 hours		2.5	—	30	μA
{ 1000 hours		4.0	—	30	μA
{ 500 hours		2.5	—	1.0	μA
{ 1000 hours		4.0	—	1.0	μA
{ 500 hours		2.5	1.7	3.2	mA/V
{ 1000 hours		4.0	1.6	3.2	mA/V
500 hours		—	—	15	%
{ 500 hours		4.0	50	—	MΩ
{ 1000 hours		6.5	30	—	MΩ
{ 500 hours		6.5	—	—	
{ 1000 hours		10	—	—	



M8082

SPECIAL QUALITY OUTPUT PENTODE

	A.Q.L. ⁵ (%)	Min.	Max.	
Dynamic life test 100 hours				
Running conditions as a trebler. $V_b = 300V$, decoupling resistor = $1.0k\Omega$				
$I_a + I_{g2} = 20mA$, $I_{g1} = 1.6mA$, $f = 70$ to $75Mc/s$				
$P_{out} = 900mW$				
Dynamic life test end point				
Change in P_{out}	—	—	20	%
GROUP G				
Valves are held for 28 days and retested for Inoperatives ¹⁶	0.5	—	—	
Reverse control-grid current. R_{g1} max. = $500k\Omega$	0.5	—	0.75	μA

2831

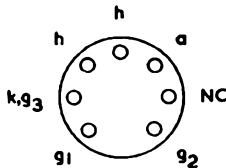
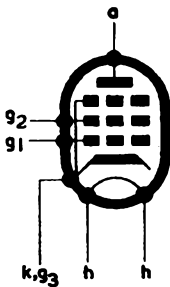

B7G Base

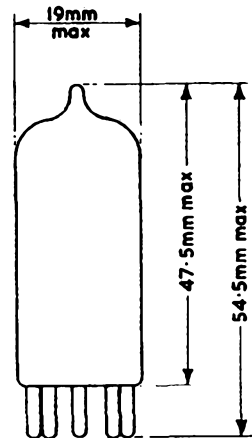

The bulb and base dimensions of this valve are in accordance with BS448, Section B7G



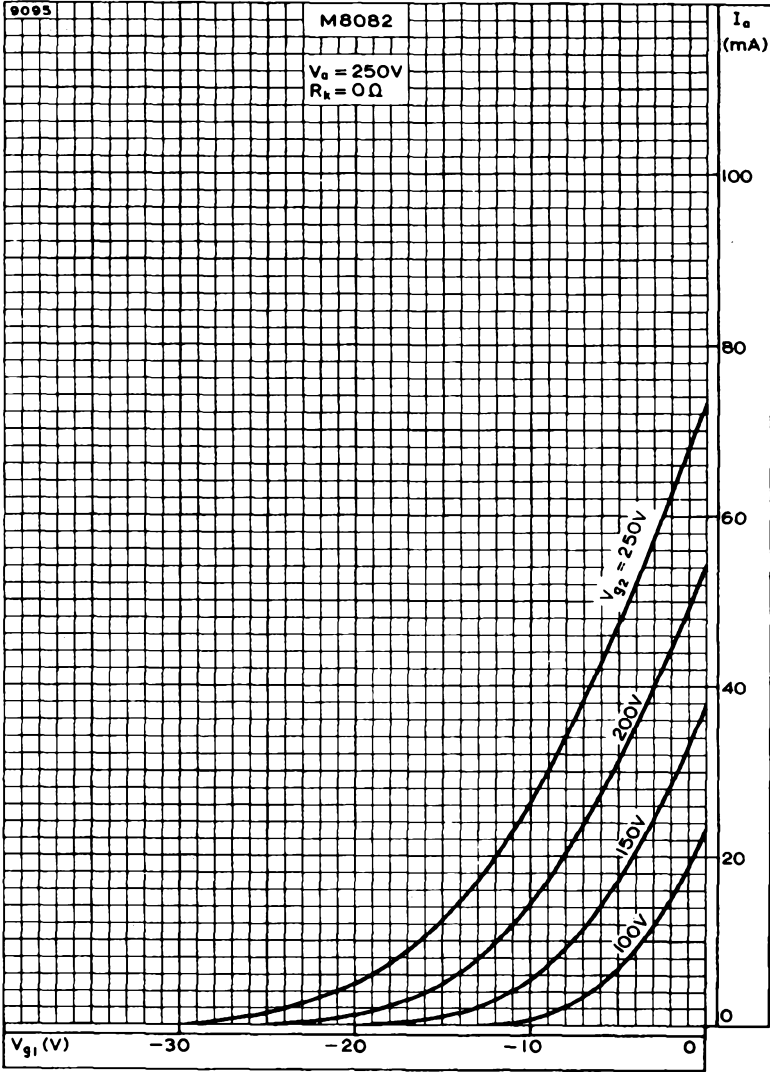

ANODE CURRENT PLOTTED AGAINST CONTROL-GRID VOLTAGE WITH
SCREEN-GRID VOLTAGE AS PARAMETER



M8082

SPECIAL QUALITY OUTPUT PENTODE

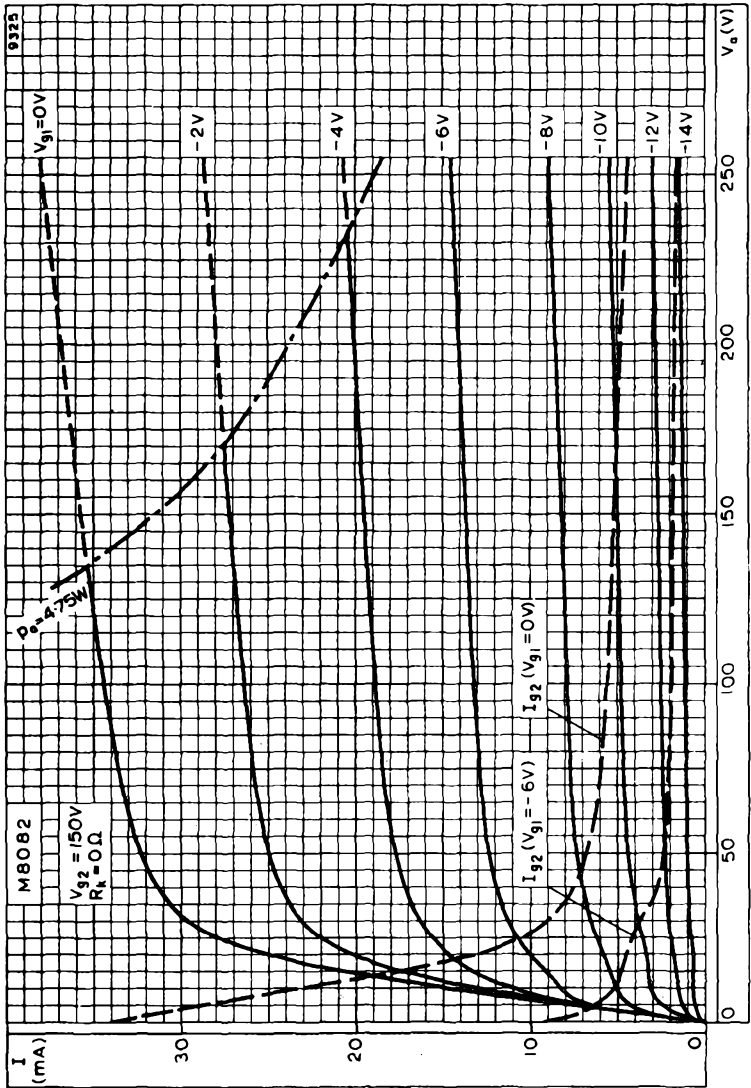

ANODE AND SCREEN-GRID CURRENTS PLOTTED AGAINST ANODE VOLTAGE WITH CONTROL-GRID VOLTAGE AS PARAMETER. $V_{g2} = 150V$



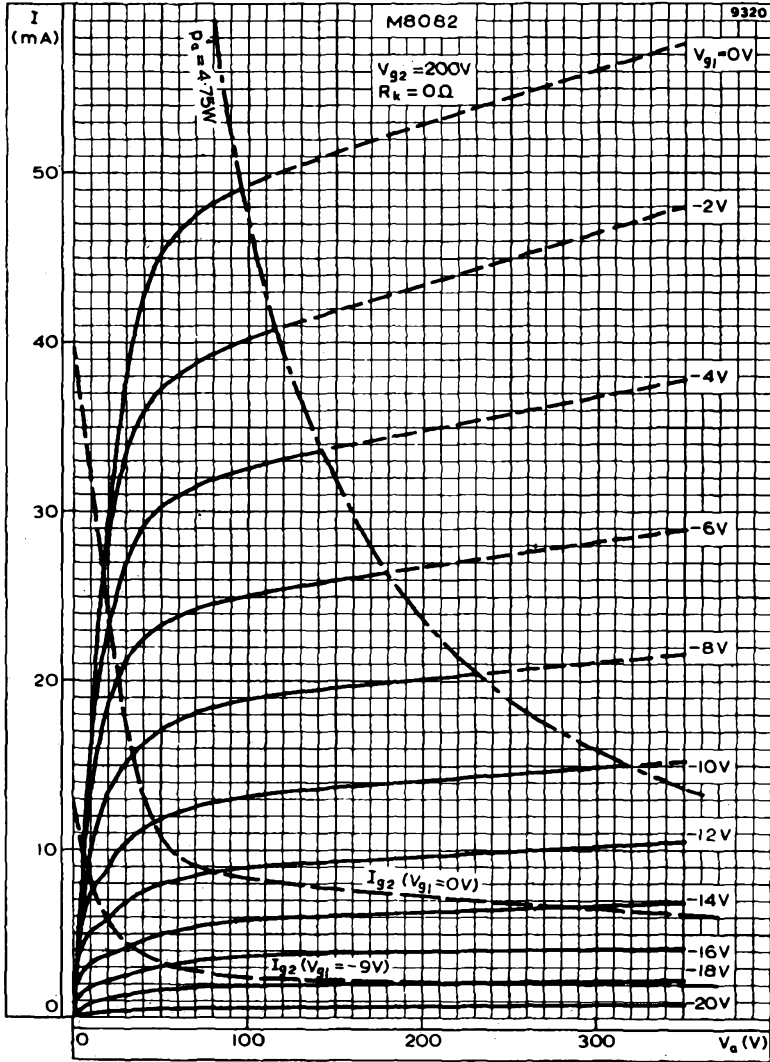

ANODE AND SCREEN-GRID CURRENTS PLOTTED AGAINST ANODE VOLTAGE WITH CONTROL-GRID VOLTAGE AS PARAMETER. $V_{g2} = 200V$



M8082

SPECIAL QUALITY OUTPUT
PENTODE

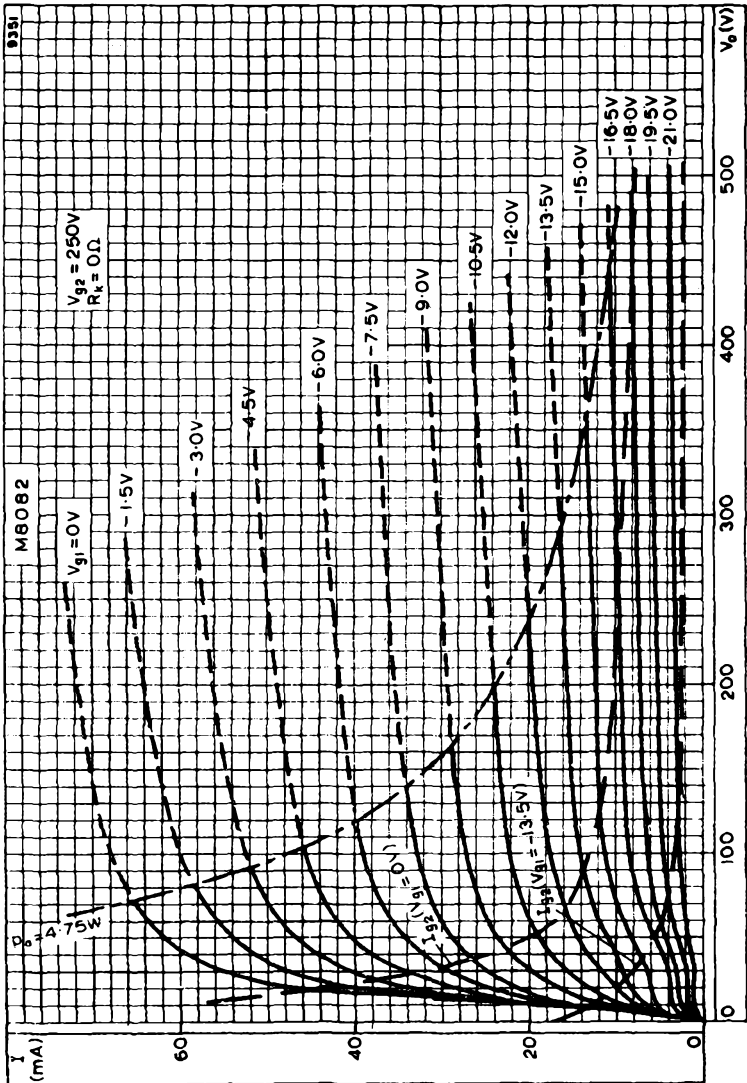

ANODE AND SCREEN-GRID CURRENTS PLOTTED AGAINST ANODE VOLTAGE WITH CONTROL-GRID VOLTAGE AS PARAMETER. $V_{g2} = 250V$



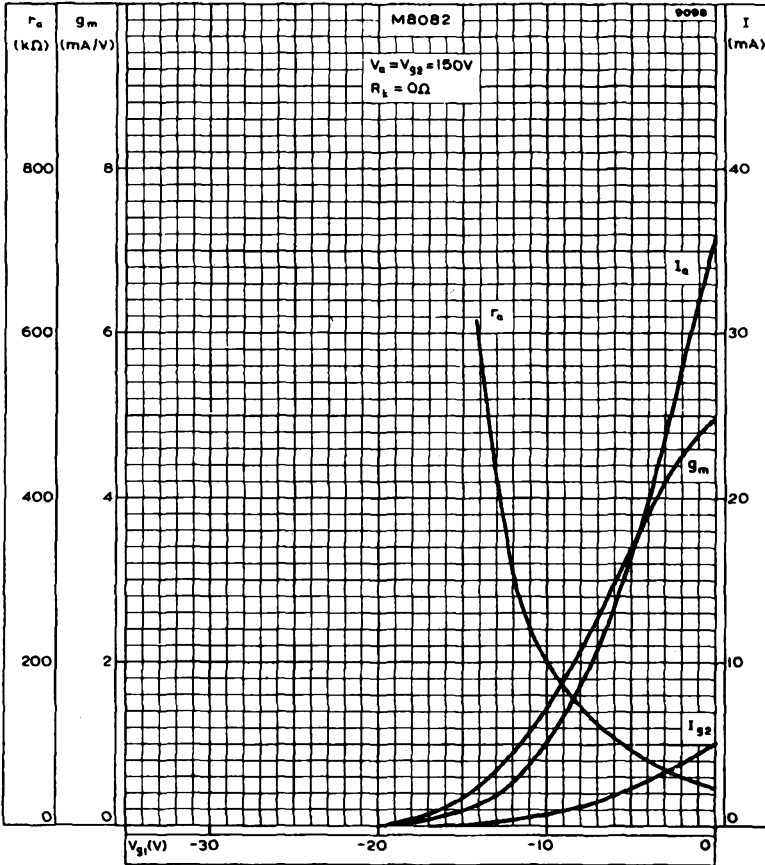

ANODE AND SCREEN-GRID CURRENTS, MUTUAL CONDUCTANCE AND ANODE IMPEDANCE PLOTTED AGAINST CONTROL-GRID VOLTAGE



M8082

SPECIAL QUALITY OUTPUT
PENTODE

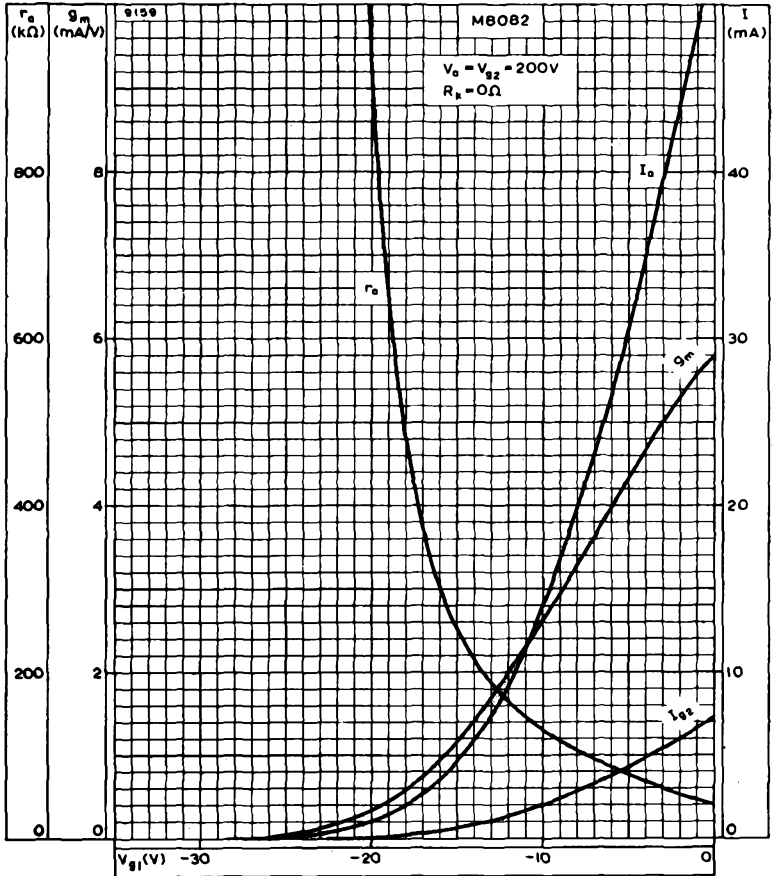

ANODE AND SCREEN-GRID CURRENTS, MUTUAL CONDUCTANCE AND ANODE IMPEDANCE PLOTTED AGAINST CONTROL-GRID VOLTAGE.

$$V_a = V_{g2} = 200V$$



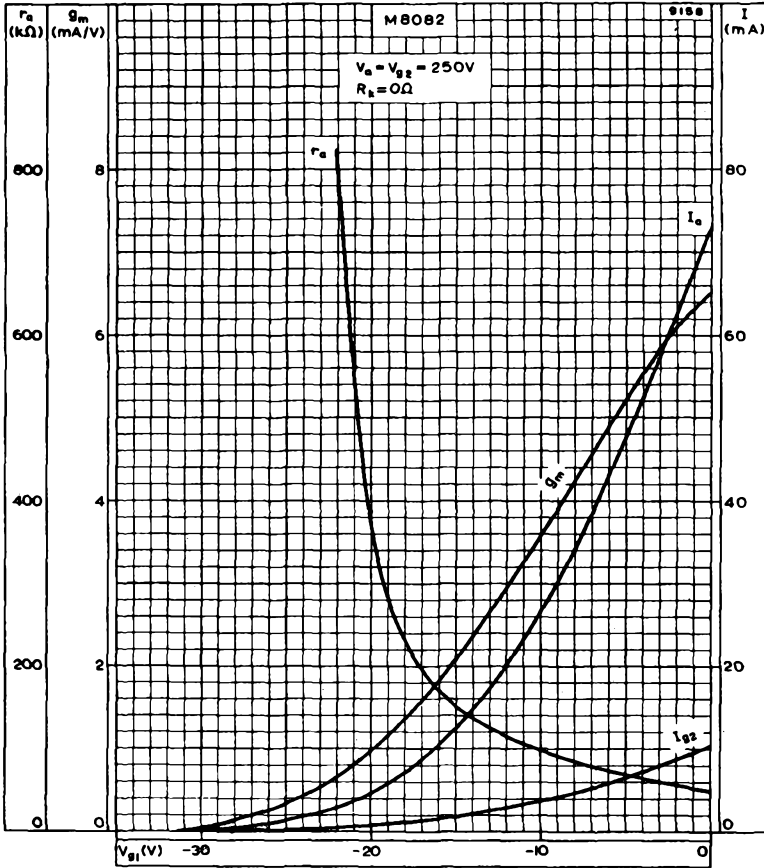

ANODE AND SCREEN-GRID CURRENTS, MUTUAL CONDUCTANCE AND ANODE IMPEDANCE PLOTTED AGAINST CONTROL-GRID VOLTAGE.
 $V_a = V_{g2} = 250V$



M8082

SPECIAL QUALITY OUTPUT
PENTODE

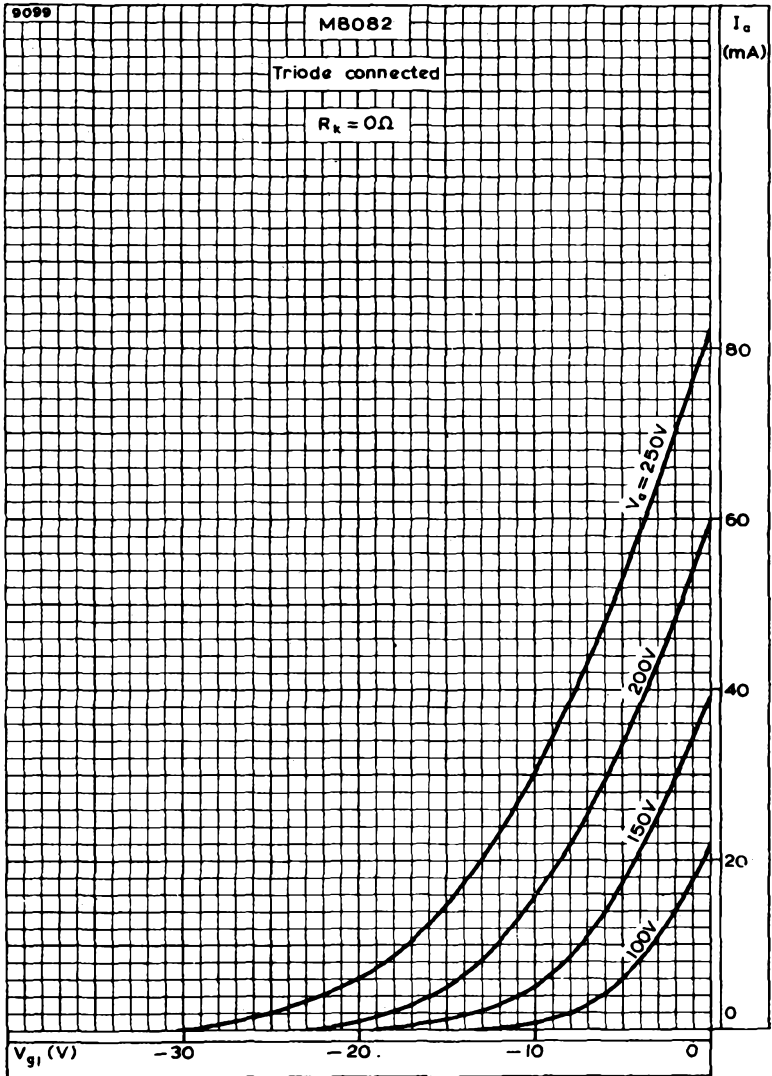

ANODE CURRENT PLOTTED AGAINST CONTROL-GRID VOLTAGE WITH ANODE VOLTAGE AS PARAMETER, WHEN TRIODE CONNECTED



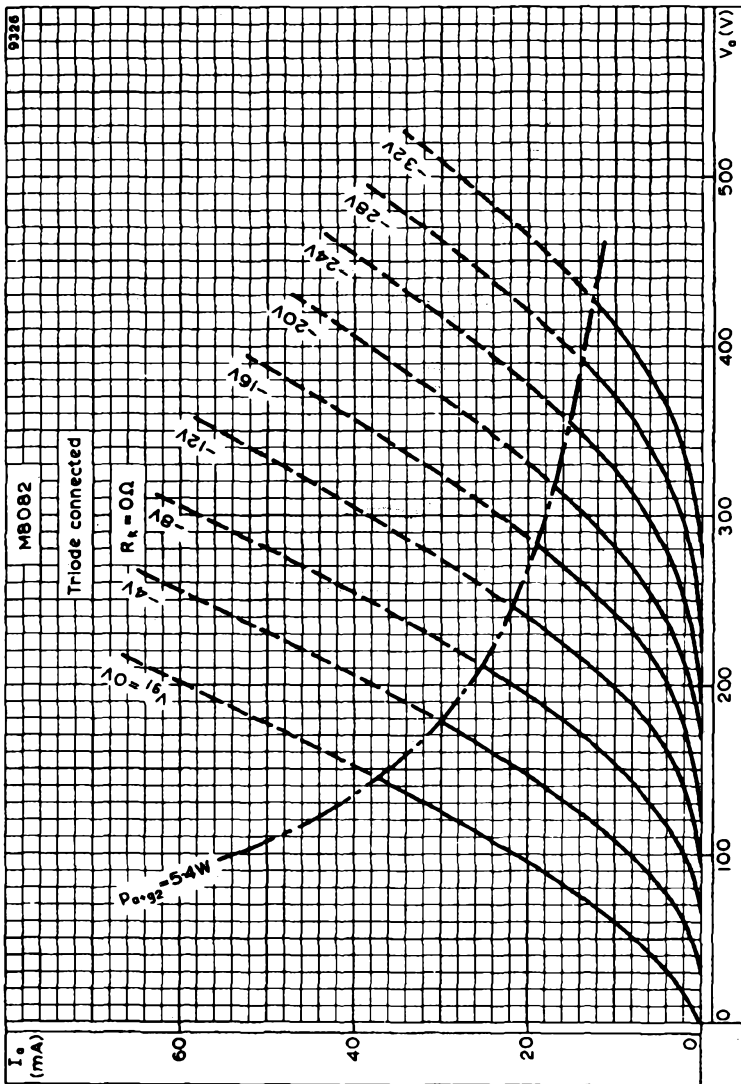

ANODE CURRENT PLOTTED AGAINST ANODE VOLTAGE WITH CONTROL-GRID VOLTAGE AS PARAMETER, WHEN TRIODE CONNECTED





SPECIAL QUALITY R.F. PENTODE

M8083

Special quality r.f. pentode for use in equipment where mechanical vibration and shocks are unavoidable and where statistically controlled major electrical characteristics are required.

This data should be read in conjunction with the GENERAL NOTES – SPECIAL QUALITY VALVES which precede this section of the handbook, and the index numbers are used to indicate where reference should be made to a specific note.

HEATER

V_h^1	6.3	V
I_h	300	mA

MOUNTING POSITION

Any

CAPACITANCES² (measured with an external shield)

C_{in}	7.1	pF
C_{out}	3.4	pF
C_{a-g1}	<10	mpF

CHARACTERISTICS³

V_a	250	V
V_{g3}	0	V
V_{g2}	250	V
I_a	10	mA
I_{g2}	2.6	mA
V_{F1}	-2.0	V
g_m	7.6	mA/V
r_a	>500	k Ω
μ_{g1-g2}	70	
R_k	0	Ω

LIMITING VALUES⁴ (absolute ratings)

$V_{a(b)}$ max.	550	V
V_a max.	300	V
p_a max.	3.0	W
$V_{g2(b)}$ max.	450	V ←
V_{g2} max.	300	V
p_{g2} max.	900	mW
$-V_{g1}$ max.	55	V
I_k max.	16.5	mA
R_{g1-k} max.	500	k Ω ←
V_{h-k} max.	150	V
Maximum acceleration (continuous operation)	2.5	g
Maximum shock (short duration)	500	g
T_{bulb} max.	200	°C

TEST CONDITIONS (unless otherwise specified)

V_h (V)	V_{a-e} (V)	V_{g3-k} (V)	V_{g2-e} (V)
6.3	250	0	250

TESTS

A.Q.L.⁵

(%)

GROUP A

Insulation

a-rest, g_2 -rest measured at -300V }
 g_1 -rest measured at -100V }

0.25

Reverse control-grid current

R_{g1} max. = 500k Ω

0.25

GROUP B

Heater current

0.65

Heater to cathode leakage current

V_{h-k} = 100V cathode negative

0.65

V_{h-k} = 100V cathode positive

{ 0.65
—

Anode current

{ 0.65
—

Screen-grid current

{ 0.65
—

Mutual conductance

{ 0.65
—

Group quality level¹⁰

1.0





V_{g1-e} (V)	R_k (Ω)		R_{g1} (Ω)	C_k (μF)	
0	160		0	1000	
Individuals ⁶			Lot average ⁷		Lot standard deviation ⁸
Bogey ⁹	Min.	Max.	Min.	Max.	Max.
—	100	—	—	—	— M Ω
—	—	0.5	—	—	— μA
—	275	325	—	—	— mA
—	—	10	—	—	— μA
—	—	10	—	—	— μA
—	—	—	—	2.0	— μA
9.85	7.5	12.2	—	—	— mA
—	—	—	8.7	11	0.91 mA
2.6	1.8	3.4	—	—	— mA
—	—	—	—	3.0	— mA
7.6	6.0	9.25	—	—	— mA/V
—	—	—	6.81	8.43	0.63 mA/V
—	—	—	—	—	—

M8083

SPECIAL QUALITY R.F. PENTODE

GROUP C

Anode current. $V_{g1-e} = -8.0V$	2.5	—	—	100	—	—	—	μA
Reverse control-grid current. $V_{g1-e} = -50V$	2.5	—	—	1.0	—	—	—	μA
Change in mutual conductance. $V_b = 5.7V$	2.5	—	—	15	—	—	—	%
Reverse control-grid current. $V_b = 6.9V$, $V_{a-e} = 300V$, $V_{g2-e} = 300V$, $R_k = 250\Omega$	2.5	—	—	1.0	—	—	—	μA
Microphonic noise at the anode at 50c/s and 2.0g min. peak acceleration. $V_b = 250V$, $R_a = 2k\Omega$, $R_k = 0\Omega$, $V_{g1} = -2V$	2.5	—	—	15	—	—	—	mV (r.m.s.)
Group quality level ¹⁰	6.5	—	—	—	—	—	—	—

GROUP D

Glass strain test ^{11A} . No applied voltages	6.5	—	—	—	—	—	—	—
Base strain test ¹² . No applied voltages	6.5	—	—	—	—	—	—	—
Capacitances (shielded). No applied voltages	6.5	—	—	—	—	—	—	—
C_{in}	—	—	6.5	8.7	—	—	—	pF
C_{out}	—	—	2.75	3.75	—	—	—	pF
C_{a-g1}	—	—	—	10	—	—	—	mpF
Grid 3 cut-off voltage $V_{g1-e} = -3.5V$, $I_a = 50\mu A$	6.5	—	-70	-120	—	—	—	V
Amplification factor (μ_{g1-g2})	—	—	60	89	—	—	—	—





TESTS	A.Q.L. ⁵
GROUP E	(%)
Fatigue¹⁴	
$V_h = 6.9V$, 1 minute on 3 minutes off. No other voltages applied, 5g min. peak acceleration, $f = 170c/s$, for 33 hours in each of 3 mutually perpendicular planes	
Post fatigue tests	
Heater to cathode leakage current. $V_{h-k} = \pm 100V$	2.5
Reverse control-grid current. $R_{g1} \text{ max} = 500k\Omega$	2.5
Mutual conductance	2.5
Microphonic noise as in group C	2.5
Sub-group quality level ¹⁰	4.0
Shock¹⁵	
No applied voltages, 500g	
Post shock tests	
Heater to cathode leakage current. $V_{h-k} = \pm 100V$	2.5
Reverse control-grid current. $R_{g1} \text{ max.} = 500k\Omega$	2.5
Mutual conductance	2.5
Microphonic noise as in group C	2.5
Sub-group quality level ¹⁰	4.0



<i>Individuals⁶</i>			<i>Lot average⁷</i>		<i>Lot standard deviation⁸</i>	
<i>Bogey⁹</i>	<i>Min.</i>	<i>Max.</i>	<i>Min.</i>	<i>Max.</i>	<i>Max.</i>	
—	—	20	—	—	—	μA
—	—	1.0	—	—	—	μA
—	5.5	9.25	—	—	—	mA/V
—	—	25	—	—	—	mV
—	—	—	—	—	—	(r.m.s.)
—	—	20	—	—	—	μA
—	—	1.0	—	—	—	μA
—	5.5	9.25	—	—	—	mA/V
—	—	25	—	—	—	mV
—	—	—	—	—	—	(r.m.s.)

M8083

SPECIAL QUALITY R.F. PENTODE

GROUP F

Stability life test¹⁴

Running conditions. $R_{g1} = 100k\Omega \pm 20\%$,
 $R_k = 180\Omega \pm 10\%$, $V_{h-k} = 100V$ (cathode
negative)

Stability life test end point

Change in mutual conductance after 1 hour 1.0

Intermittent life test

Sub-group (a)

Inoperatives¹⁸

Heater current

Heater to cathode leakage current. $V_{h-k} = \pm 100V$..

Reverse control-grid current. $R_{g1} \text{ max} = 500k\Omega$..

Mutual conductance

Average change in mutual conductance

Sub-group (b)

Anode current

Insulation as in group A

Group quality level¹⁰



SPECIAL QUALITY R.F. PENTODE

M8083

	10				%
		A.Q.L. ⁵ (%)	Min.	Max.	
.. {	500 hours	2.5	—	—	
.. }	1000 hours	4.0	—	—	
..	500 hours	2.5	275	325	mA
.. {	500 hours	2.5	—	20	μA
.. }	1000 hours	4.0	—	20	μA
.. {	500 hours	2.5	—	0.75	μA
.. }	1000 hours	4.0	—	1.0	μA
.. {	500 hours	2.5	5.2	9.25	mA/V
.. }	1000 hours	4.0	4.9	9.25	mA/V
..	500 hours	—	—	10	%
.. {	500 hours	4.0	6.8	12.2	mA
.. }	1000 hours	6.5	5.25	—	mA
.. {	500 hours	4.0	50	—	MΩ
.. }	1000 hours	6.5	30	—	MΩ
.. {	500 hours	6.5	—	—	
.. }	1000 hours	10	—	—	



M8083

SPECIAL QUALITY R.F. PENTODE

GROUP G

Valves are held for 28 days and retested for
Inoperatives¹⁶

Reverse control-grid current.

$R_{g1max} = 500k\Omega$

A.Q.L. ⁵ (%)	Min.	Max.
0.5	—	—
0.5	—	0.75 μA

3594

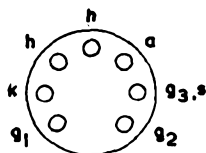
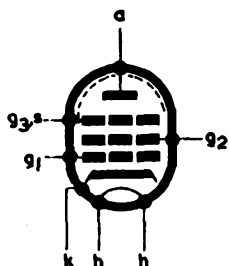

B7G Base

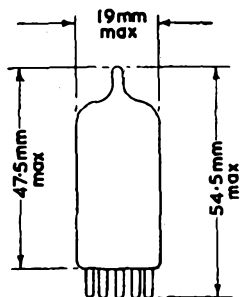

The bulb and base dimensions of this valve are in accordance with BS448, Section B7G



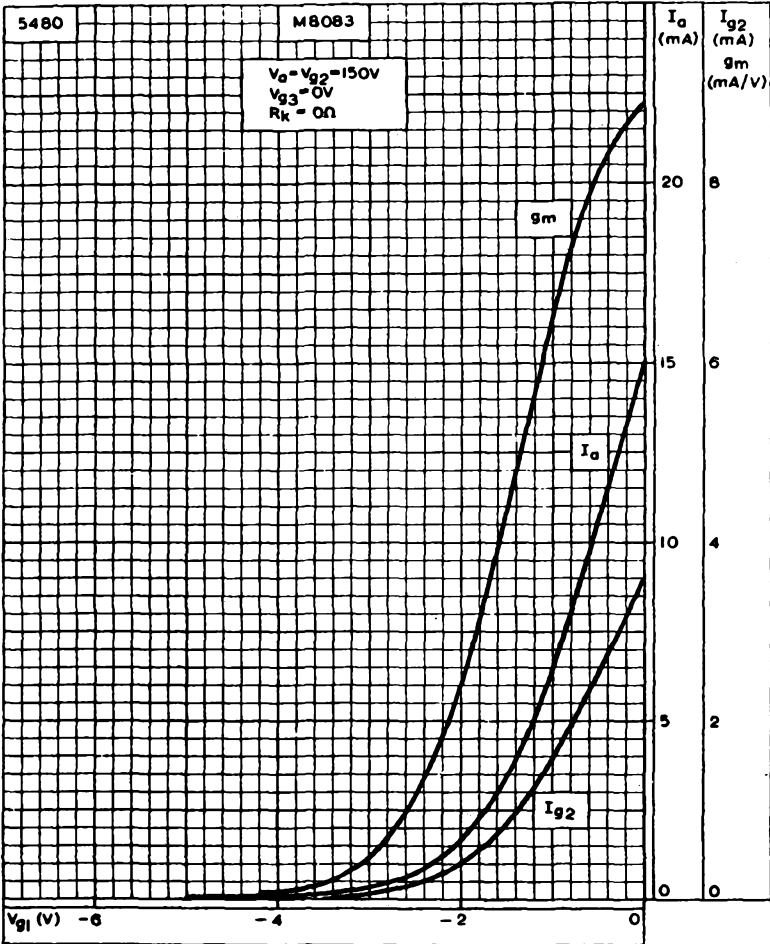

ANODE CURRENT, SCREEN-GRID CURRENT AND MUTUAL CONDUCTANCE PLOTTED AGAINST CONTROL-GRID VOLTAGE. $V_a = V_{g2} = 150V$



M8083

SPECIAL QUALITY R.F. PENTODE

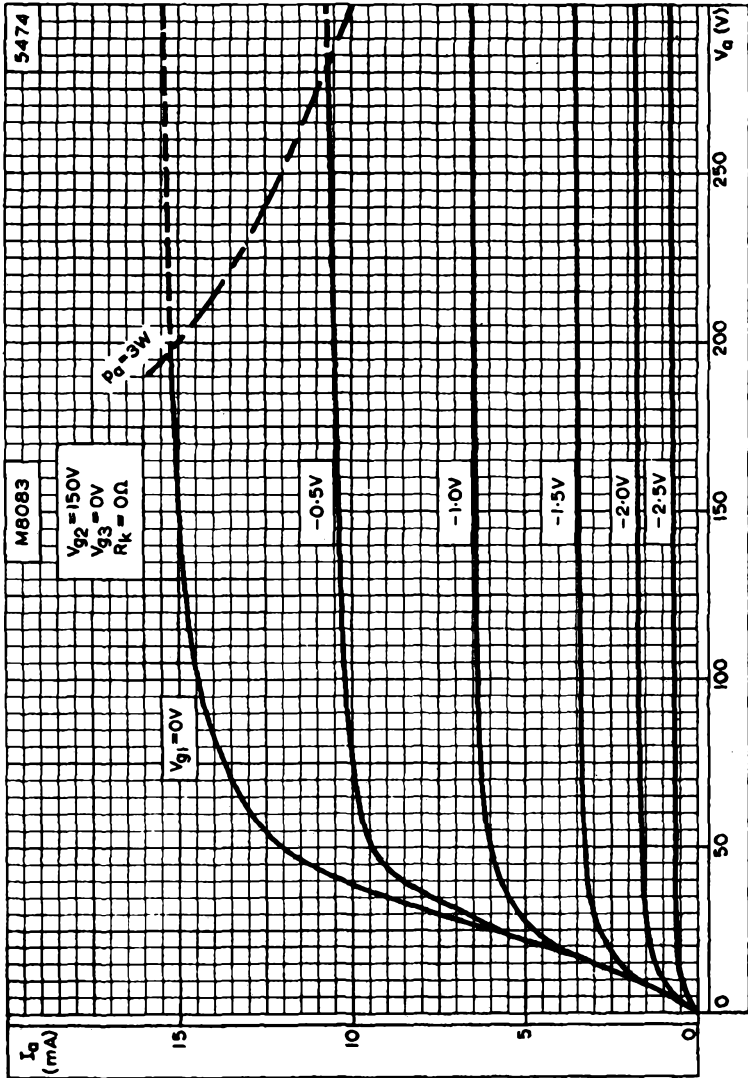

ANODE CURRENT PLOTTED AGAINST ANODE VOLTAGE WITH CONTROL-GRID VOLTAGE AS PARAMETER. $V_{g2} = 150V$



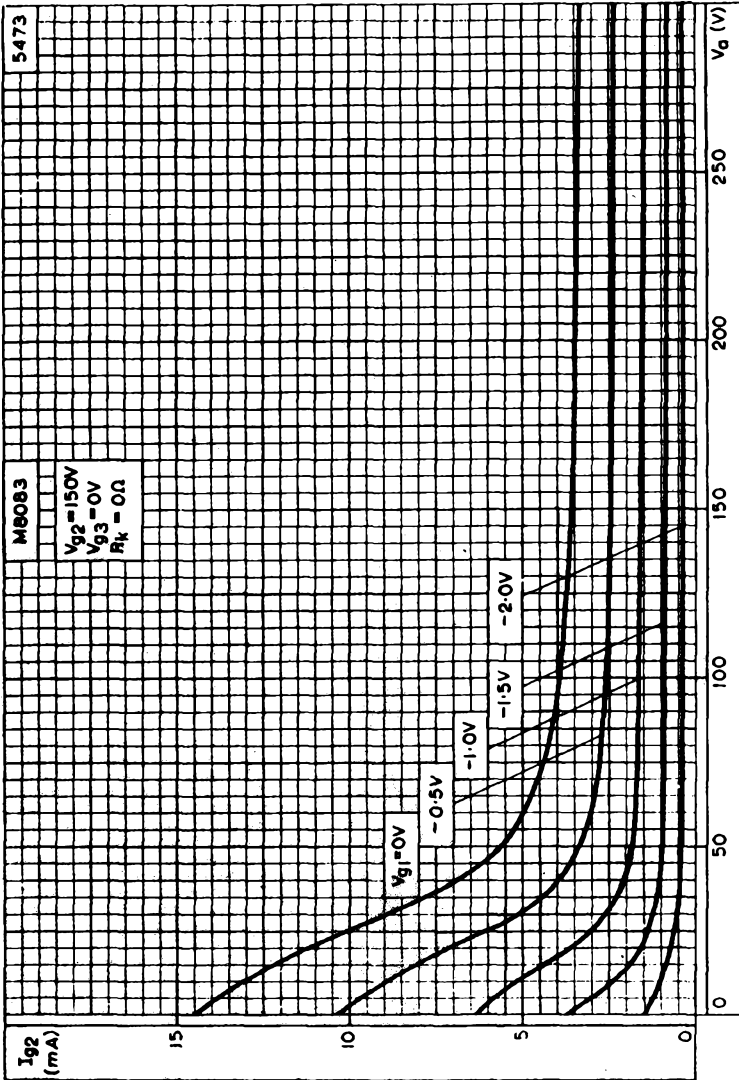

SCREEN-GRID CURRENT PLOTTED AGAINST ANODE VOLTAGE WITH CONTROL-GRID VOLTAGE AS PARAMETER. $V_{g2} = 150V$



M8083

SPECIAL QUALITY R.F. PENTODE

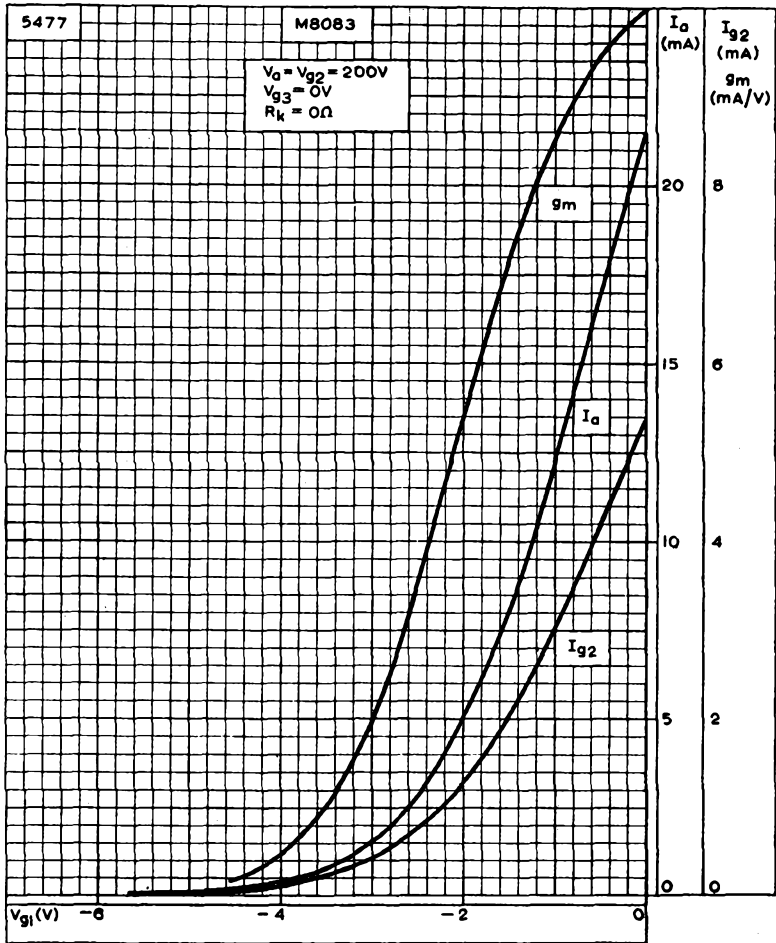

ANODE CURRENT, SCREEN-GRID CURRENT AND MUTUAL CONDUCTANCE PLOTTED AGAINST CONTROL-GRID VOLTAGE. $V_a = V_{g2} = 200V$



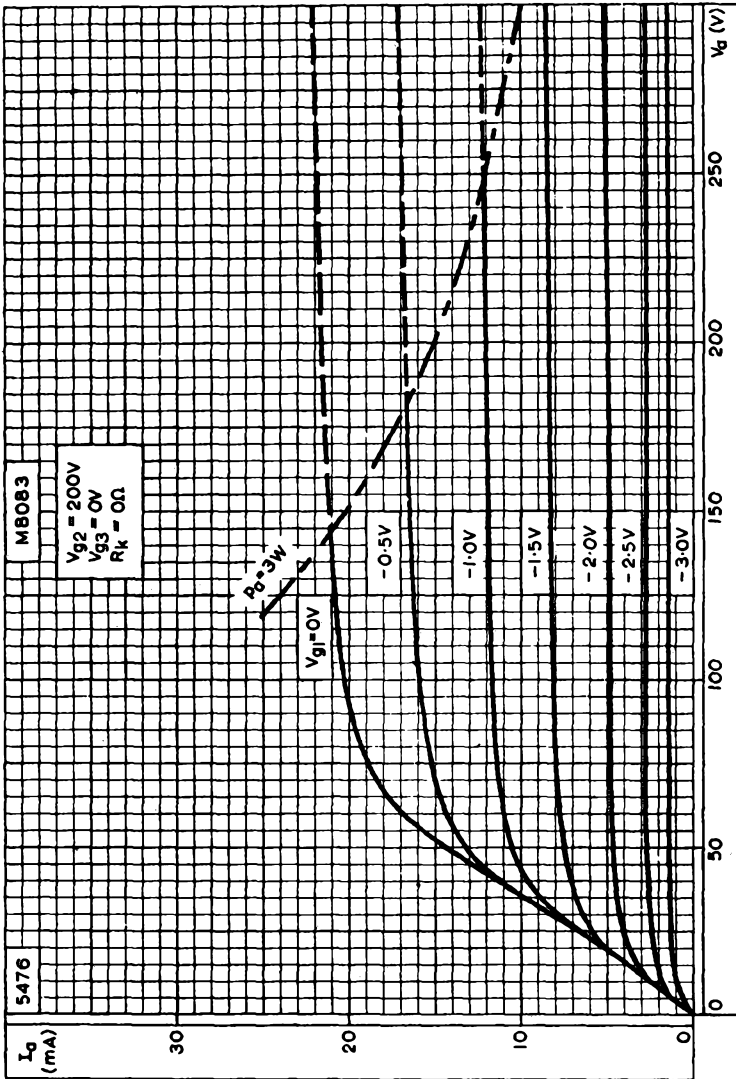

ANODE CURRENT PLOTTED AGAINST ANODE VOLTAGE WITH CONTROL-GRID VOLTAGE AS PARAMETER. $V_{g2} = 200V$



M8083

SPECIAL QUALITY R.F. PENTODE

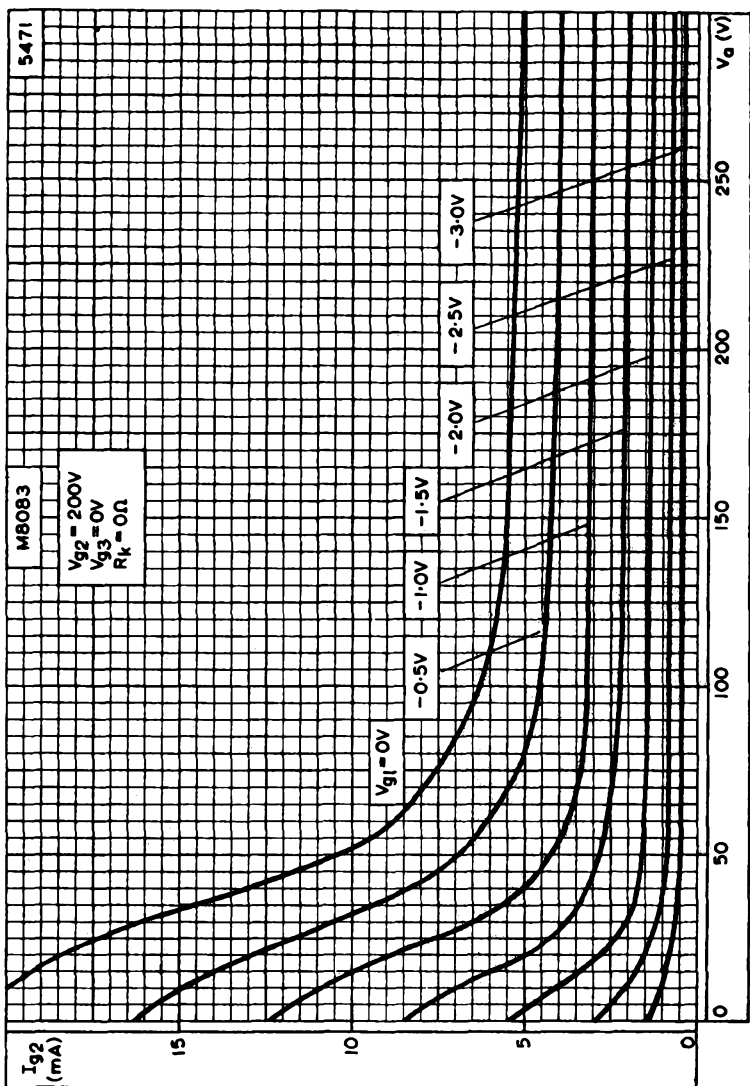

SCREEN-GRID CURRENT PLOTTED AGAINST ANODE VOLTAGE WITH CONTROL-GRID VOLTAGE AS PARAMETER. $V_{g2} = 200V$



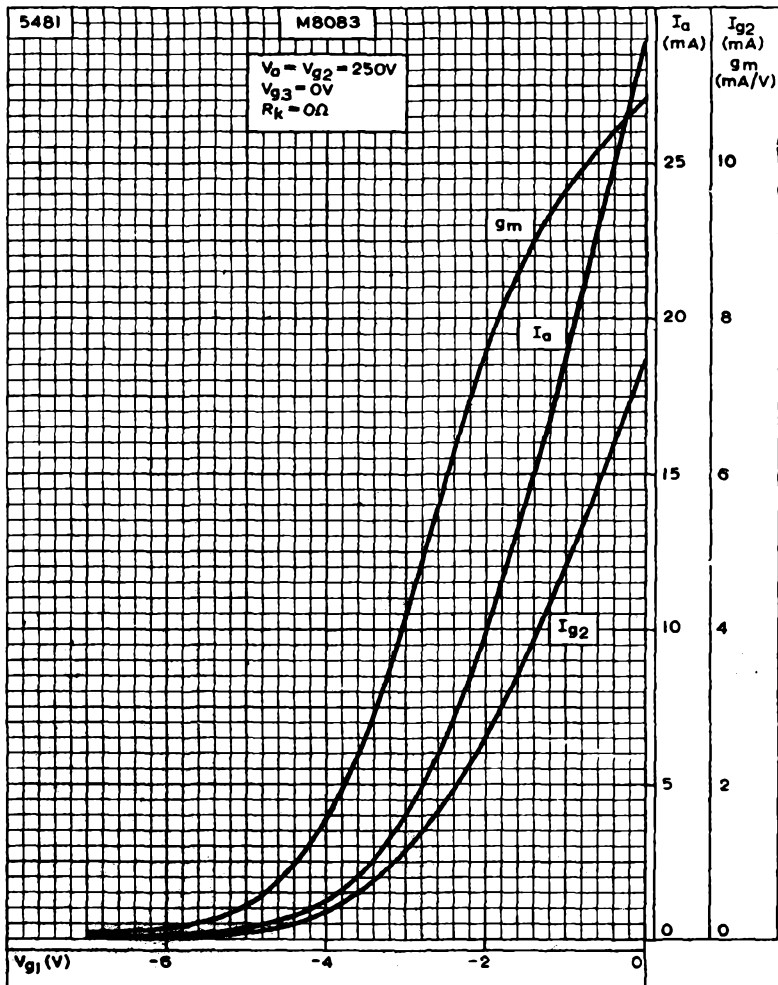

ANODE CURRENT, SCREEN-GRID CURRENT AND MUTUAL CONDUCTANCE PLOTTED AGAINST CONTROL-GRID VOLTAGE. $V_a = V_{g2} = 250V$



M8083

SPECIAL QUALITY R.F. PENTODE

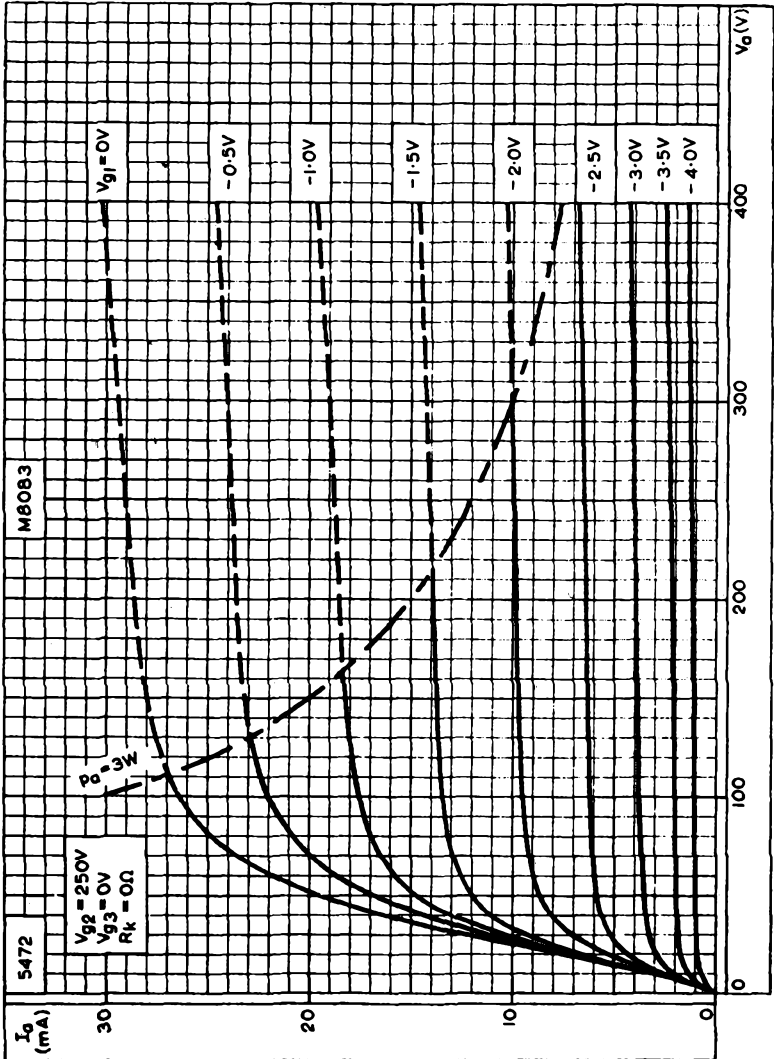

ANODE CURRENT PLOTTED AGAINST ANODE VOLTAGE WITH CONTROL-GRID VOLTAGE AS PARAMETER. $V_{g2} = 250V$



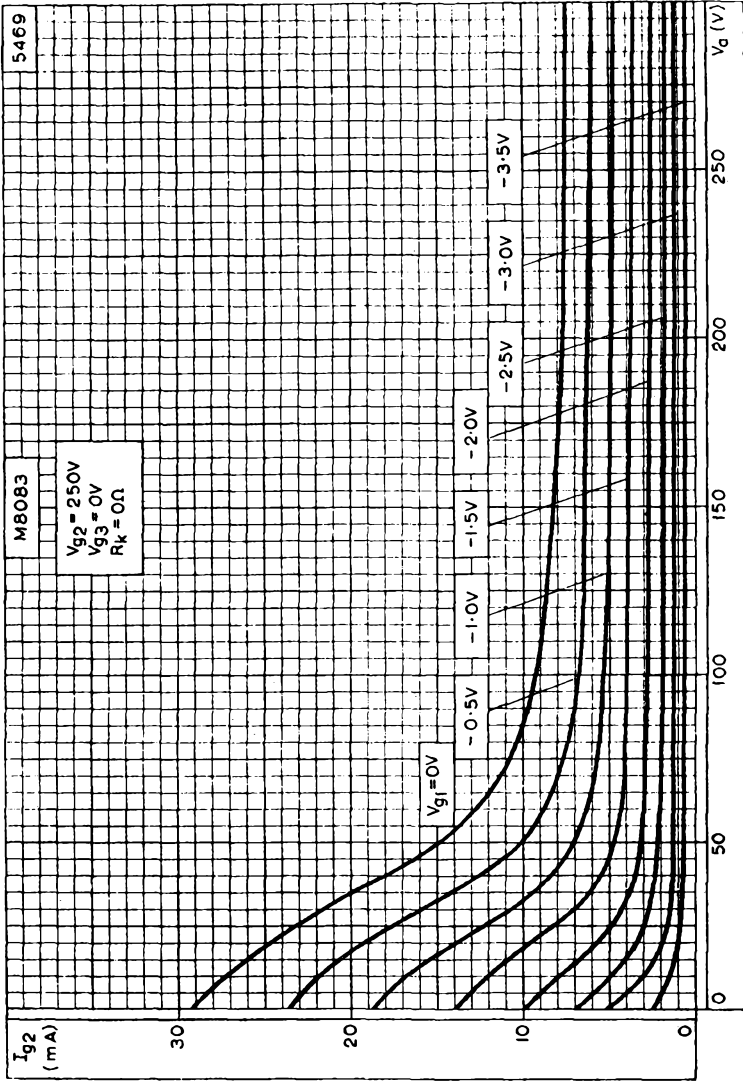

SCREEN-GRID CURRENT PLOTTED AGAINST ANODE VOLTAGE WITH CONTROL-GRID VOLTAGE AS PARAMETER. $V_{g2} = 250V$



M8083

SPECIAL QUALITY R.F. PENTODE

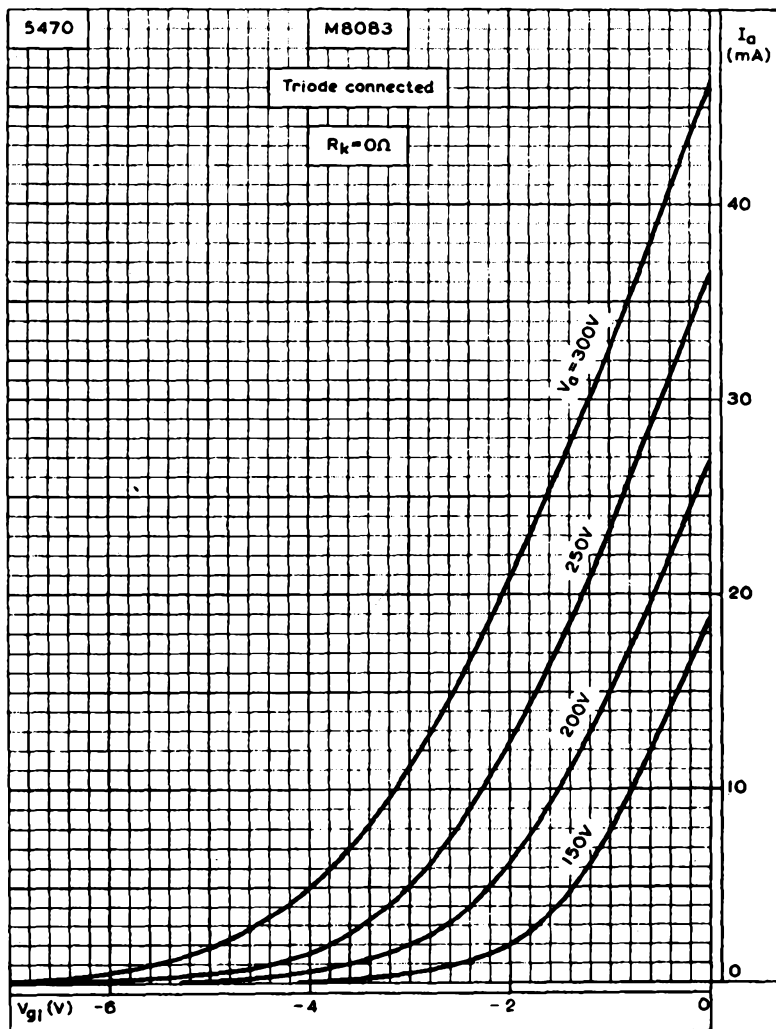

ANODE CURRENT PLOTTED AGAINST CONTROL-GRID VOLTAGE WITH ANODE VOLTAGE AS PARAMETER, WHEN TRIODE CONNECTED



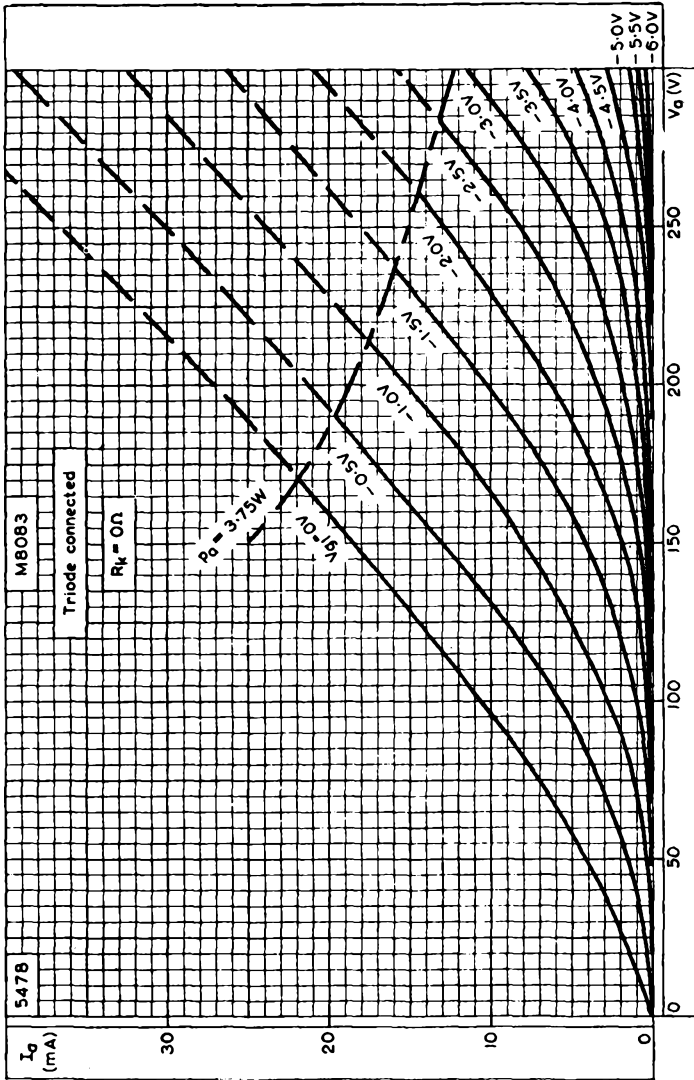

ANODE CURRENT PLOTTED AGAINST ANODE VOLTAGE WITH CONTROL-GRID VOLTAGE AS PARAMETER, WHEN TRIODE CONNECTED



M8083

SPECIAL QUALITY R.F. PENTODE

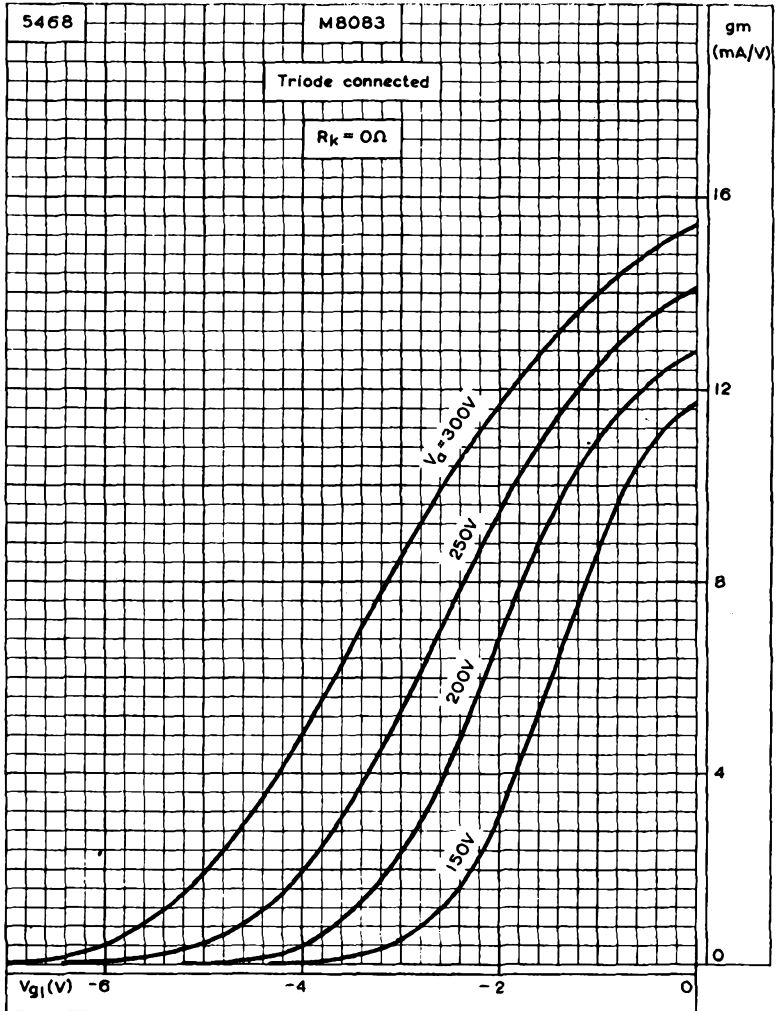

MUTUAL CONDUCTANCE PLOTTED AGAINST CONTROL-GRID VOLTAGE WITH ANODE VOLTAGE AS PARAMETER, WHEN TRIODE CONNECTED



SPECIAL QUALITY V.H.F. PENTODE**M8100**

Special quality low noise, high slope r.f. pentode for use in equipment where mechanical vibration and shocks are unavoidable and where statistically controlled major electrical characteristics are required.

This data should be read in conjunction with GENERAL NOTES - SPECIAL QUALITY VALVES which precede this section of the handbook, and the index numbers are used to indicate where reference should be made to a specific note.

HEATER

V_{h1}	6.3	V
I_h	175	mA

CAPACITANCES² (measured with an external shield)

C_{a-g1}	<20	mpF
C_{jn}	4.0	pF
C_{out}	3.1	pF

CHARACTERISTICS³

V_a	120	180	V
V_{g2}	120	120	V
I_b	7.5	7.7	mA
I_{g2}	2.5	2.4	mA
V_{g1}	-2.0	-2.0	V
g_m	5.0	5.1	mA/V
r_a	250	400	k Ω
μ_{g1-g2}	35	35	
R_k	0	0	Ω

ABSOLUTE MAXIMUM RATINGS⁴

f max.	400	Mc/s
$V_{a(b)}$ max.	400	V
V_a max.	200	V
p_a max.	1.65	W
$V_{g2(b)}$ max.	310	V
V_{g2} max.	155	V
p_{g2} max.	550	mW
$-V_{k1}$ max.	55	V
I_{g1} max.	4.0	mA
R_{g1-k} max.	3.0	M Ω
I_k max.	20	mA
V_{h-k} max.	130	V
Maximum acceleration (continuous operation)	2.5	g
Maximum shock (short duration)	500	g
T_{bulb} max.	165	$^{\circ}$ C



TEST CONDITIONS (unless otherwise specified)

V_h (V)	V_a (V)	V_{g2} (V)	V_{g1} (V)	R_k (Ω)
6.3	120	120	-2.0	0

TESTSA.Q.L.⁵

(%)

GROUP A

Insulation

a-rest, g_2 -rest measured at -300V

0.25

 g_1 -rest measured at -100V

0.25

Reverse grid current

 R_{g1} max. = 500k Ω

0.25

GROUP B

Heater current

0.65

Heater to cathode leakage current

0.65

 V_{h-k} = 100V (cathode negative)

—

 V_{h-k} = 100V (cathode positive)

—

Anode current

0.65

Screen-grid current

0.65

Mutual conductance

0.65

Group quality level¹⁰

1.0





$$V_{h-k}$$

$$\frac{(V)}{0}$$

Individuals ⁶			Lot average ⁷		Lot standard deviation ⁸	
Bogey ⁹	Min.	Max.	Min.	Max.	Max.	
—	100	—	—	—	—	MΩ
—	100	—	—	—	—	MΩ
—	—	0.1	—	—	—	μA
—	160	190	—	—	—	mA
—	—	—	—	—	—	—
—	—	10	—	—	—	μA
—	—	10	—	—	—	μA
7.5	5.0	11	—	—	—	mA
—	—	—	6.5	8.5	0.87	mA
2.5	0.8	4.0	—	—	—	mA
—	—	—	1.8	3.2	0.52	mA
5.0	4.0	6.25	—	—	—	mA/V
—	—	—	4.525	5.475	0.357	mA/V
—	—	—	—	—	—	—

M8100

SPECIAL QUALITY V.H.F. PENTODE

GROUP C

Anode current. $V_{g1} = -10V$	2.5
Anode current. $V_{g1} = -5.5V$	2.5
Change in mutual conductance. $V_h = 5.7V$	2.5
Reverse grid current. $V_h = 7.0V$, $R_{g1} = 100k\Omega$	2.5
Microphonic noise at the anode at 50c/s and 2.0g min. peak acceleration, $V_b = 135V$, $R_b = 2k\Omega$, $R_{g2} = 10k\Omega$, $C_{g2} = 2\mu F$, $R_{g1} = 100k\Omega$	2.5
Group quality level ¹⁰	6.5



GROUP D

Glass strain test ^{11A} . No applied voltages	6.5
Base strain test ¹² . No applied voltages	6.5
Capacitances ² (shielded). No applied voltages	6.5
C_{in}	—
C_{out}	—
C_{a-g1}	—
Noise factor	4.0

SPECIAL QUALITY V.H.F. PENTODE

M8100

—	—	200	—	—	—	μA
—	5.0	—	—	—	—	μA
—	—	15	—	—	—	%
—	—	0.5	—	—	—	μA
—	—	45	—	—	—	mV (r.m.s.)
—	—	—	—	—	—	
—	—	—	—	—	—	
—	—	—	—	—	—	
—	3.4	4.6	—	—	—	pF
—	2.45	3.25	—	—	—	pF
—	—	20	—	—	—	mpF
—	—	2.5	—	—	—	dB



TESTS

A.Q.L

GROUP E

(%)

Fatigue¹⁴

$V_h = 6.3V$, 1 minute on 3 minutes off. No other voltages applied, 5g min. peak acceleration, $f = 170c/s$, for 33 hours in each of 3 mutually perpendicular planes.

Post fatigue tests

Heater to cathode leakage current.

$V_{h-k} = \pm 100V$ 2.5

Reverse grid current.

R_{g1} max. = 500k Ω 2.5

Mutual conductance 2.5

Microphonic noise as in group C 2.5

Sub-group quality level¹⁰ 6.5

Shock¹⁵

No applied voltages, 500g

Post shock tests

Heater to cathode leakage current.

$V_{h-k} = \pm 100V$ 2.5

Reverse grid current.

R_{g1} max. = 500k Ω 2.5

Mutual conductance 2.5

Microphonic noise as in group C 2.5

Sub-group quality level¹⁰ 6.5

GROUP F

Stability life test¹⁴

Running conditions. $V_a = 150V$, $V_{g2} = 125V$,
 $R_{g1} = 100k\Omega$, $R_k = 130\Omega$, $V_{h-k} = 135V$
(cathode negative).



Stability life test end points

Change in mutual conductance after 1 hour 1.0

Intermittent life test

Running conditions. $V_a = 150V$, $V_{g2} = 125V$,
 $R_{g1} = 100k\Omega$, $R_k = 130\Omega$, $V_{h-k} = 135V$
(cathode negative).

Intermittent life test end points

Sub-group (a)

Inoperatives¹⁸

Heater current

Heater to cathode leakage current. $V_{h-k} = \pm 100V$

Reverse grid current. R_{g1} max. = $500k\Omega$

Mutual conductance

Average change in mutual conductance

Sub-group (b)

Anode current

Insulation as in group A

Noise factor

Group quality level¹⁰

GROUP G

Valves are held for 28 days and retested for
Inoperatives¹⁸

Reverse grid current. R_{g1} max. = $500k\Omega$



SPECIAL QUALITY V.H.F. PENTODE

M8100

	10				%
		A.Q.L. ⁵ (%)	Min.	Max.	
{ 500 hours		2.5	—	—	
{ 1000 hours		4.0	—	—	
{ 500 hours		2.5	160	190	mA
{ 1000 hours		4.0	160	190	mA
{ 500 hours		2.5	—	10	μA
{ 1000 hours		4.0	—	10	μA
{ 500 hours		2.5	—	0.1	μA
{ 1000 hours		4.0	—	0.1	μA
{ 500 hours		2.5	3.75	6.25	mA/V
{ 1000 hours		4.0	3.5	6.25	mA/V
{ 500 hours		—	—	15	%
{ 500 hours		4.0	4.5	11	mA
{ 1000 hours		6.5	4.0	11	mA
{ 500 hours		4.0	50	—	MΩ
{ 1000 hours		6.5	30	—	MΩ
{ 500 hours		4.0	—	2.7	dB
{ 1000 hours		6.5	—	2.8	dB
{ 500 hours		6.5	—	—	
{ 1000 hours		10	—	—	
		0.5	—	—	
		0.5	—	0.15	μA



M8100

SPECIAL QUALITY V.H.F. PENTODE

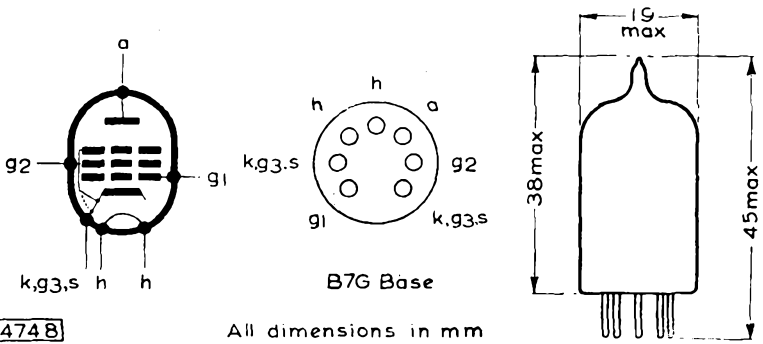

4748

All dimensions in mm

The bulb and base dimensions of this valve are in accordance with BS448, Section B7G



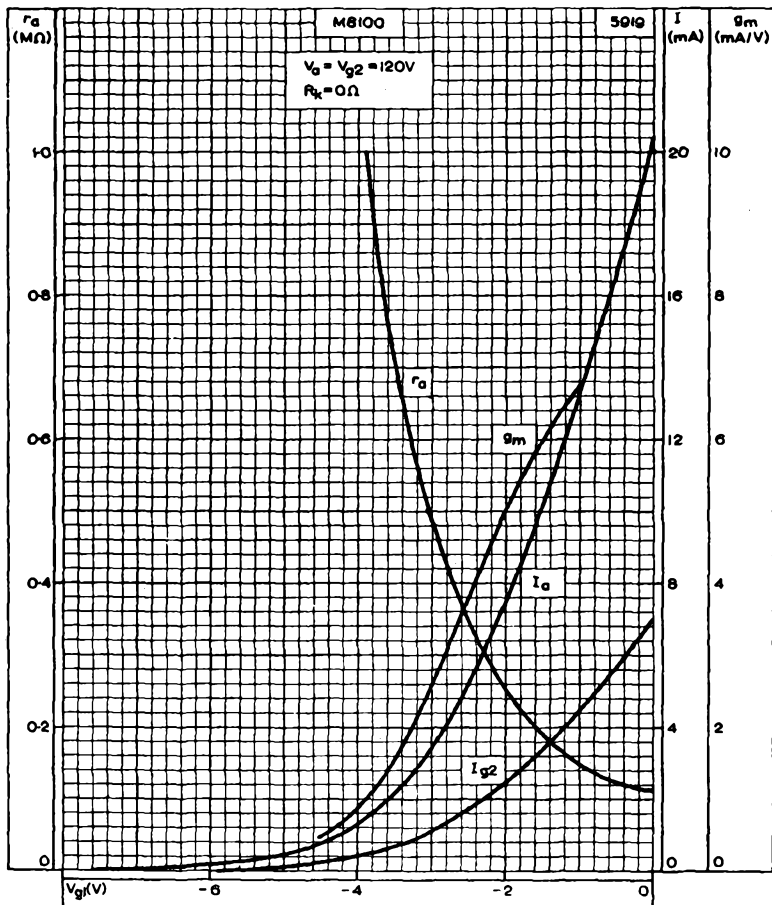

ANODE CURRENT, SCREEN-GRID CURRENT, MUTUAL CONDUCTANCE AND ANODE IMPEDANCE PLOTTED AGAINST CONTROL-GRID VOLTAGE.
 $V_a = 120V$



M8100

SPECIAL QUALITY V.H.F. PENTODE

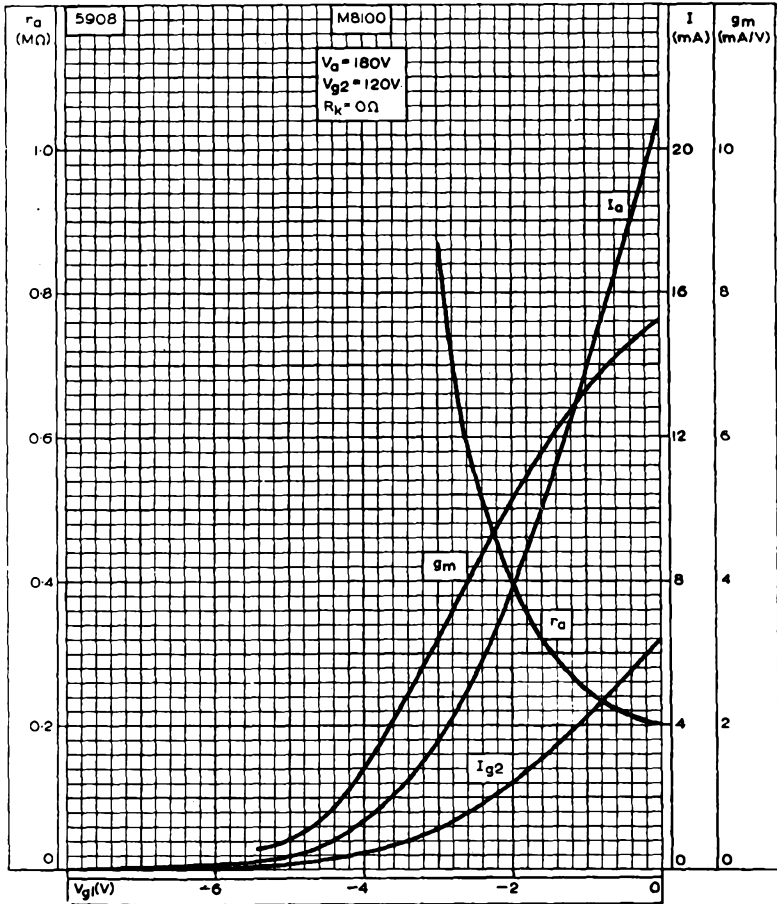

ANODE CURRENT, SCREEN-GRID CURRENT, MUTUAL CONDUCTANCE AND ANODE IMPEDANCE PLOTTED AGAINST CONTROL-GRID VOLTAGE.
 $V_a = 180V$



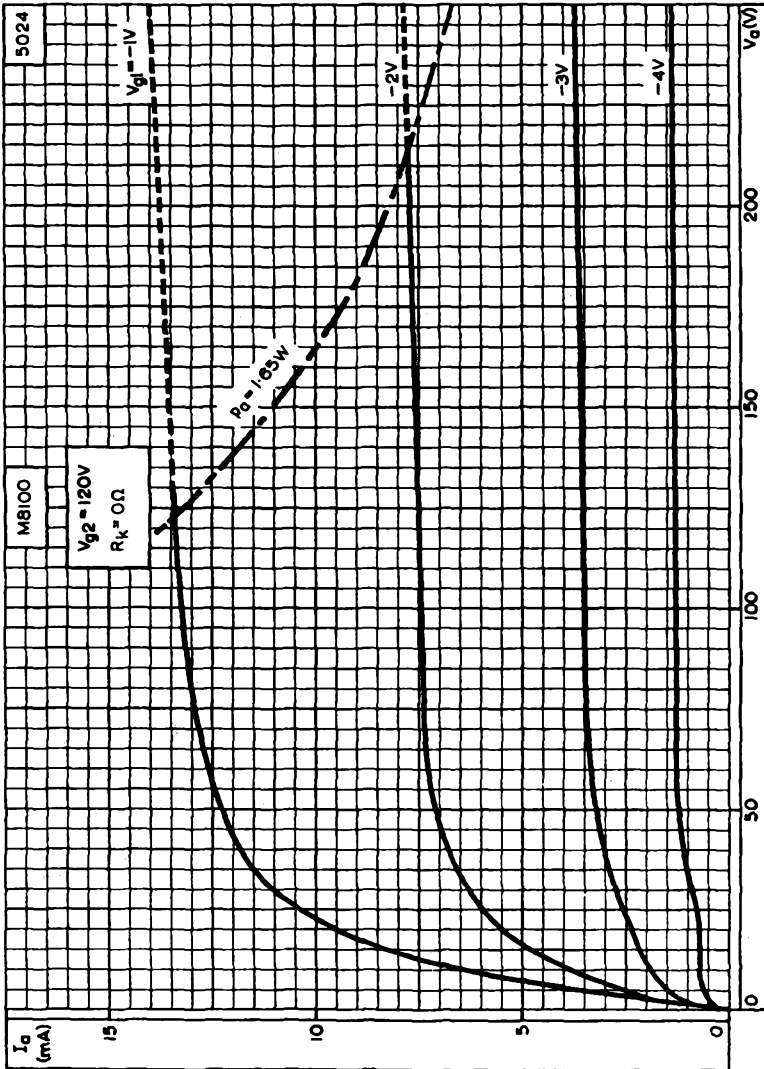

ANODE CURRENT PLOTTED AGAINST ANODE VOLTAGE WITH CONTROL-GRID VOLTAGE AS PARAMETER.



M8100

SPECIAL QUALITY V.H.F. PENTODE

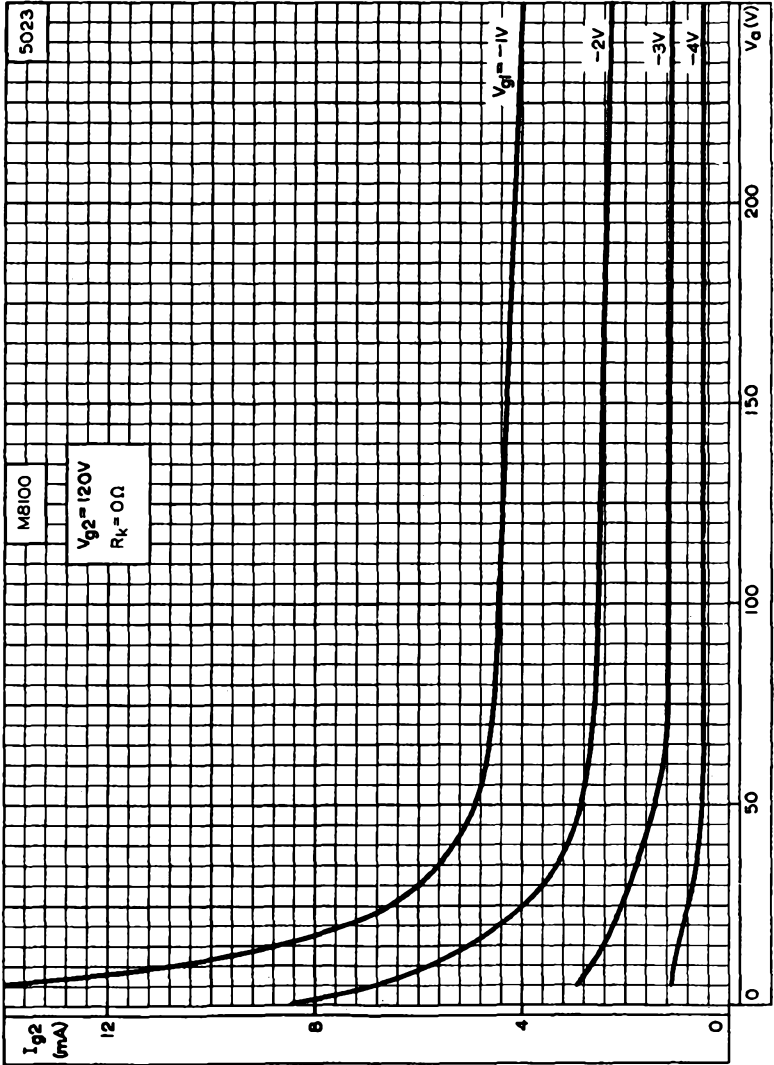

SCREEN-GRID CURRENT PLOTTED AGAINST ANODE VOLTAGE WITH CONTROL-GRID VOLTAGE AS PARAMETER.



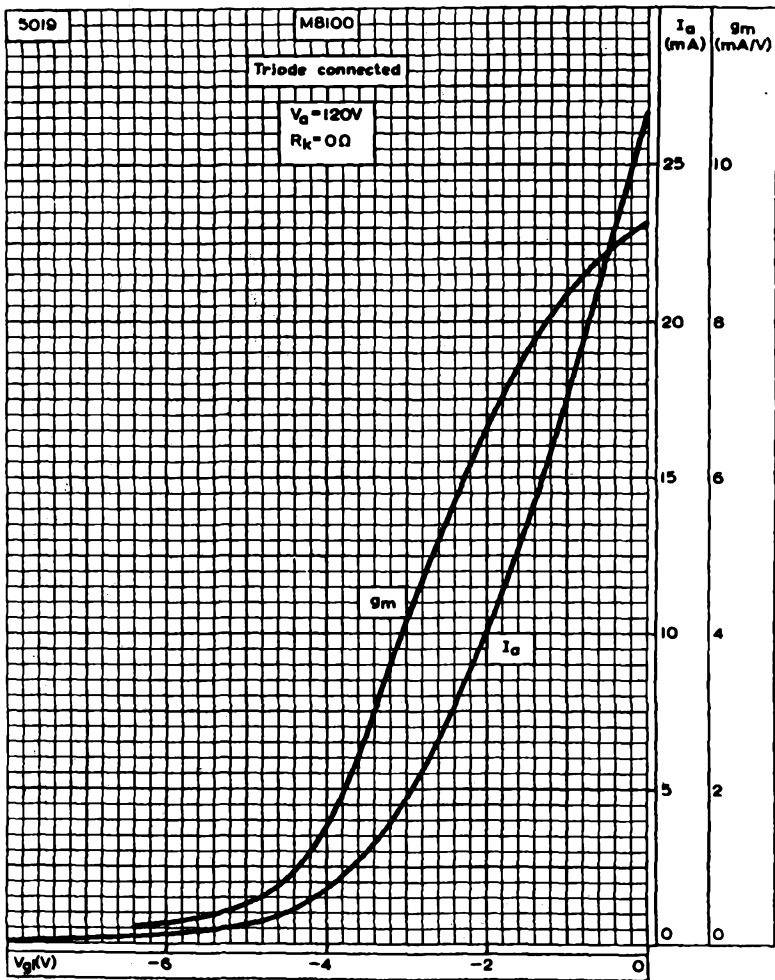

ANODE CURRENT AND MUTUAL CONDUCTANCE PLOTTED AGAINST CONTROL-GRID VOLTAGE, WHEN TRIODE CONNECTED.



M8100

SPECIAL QUALITY V.H.F. PENTODE

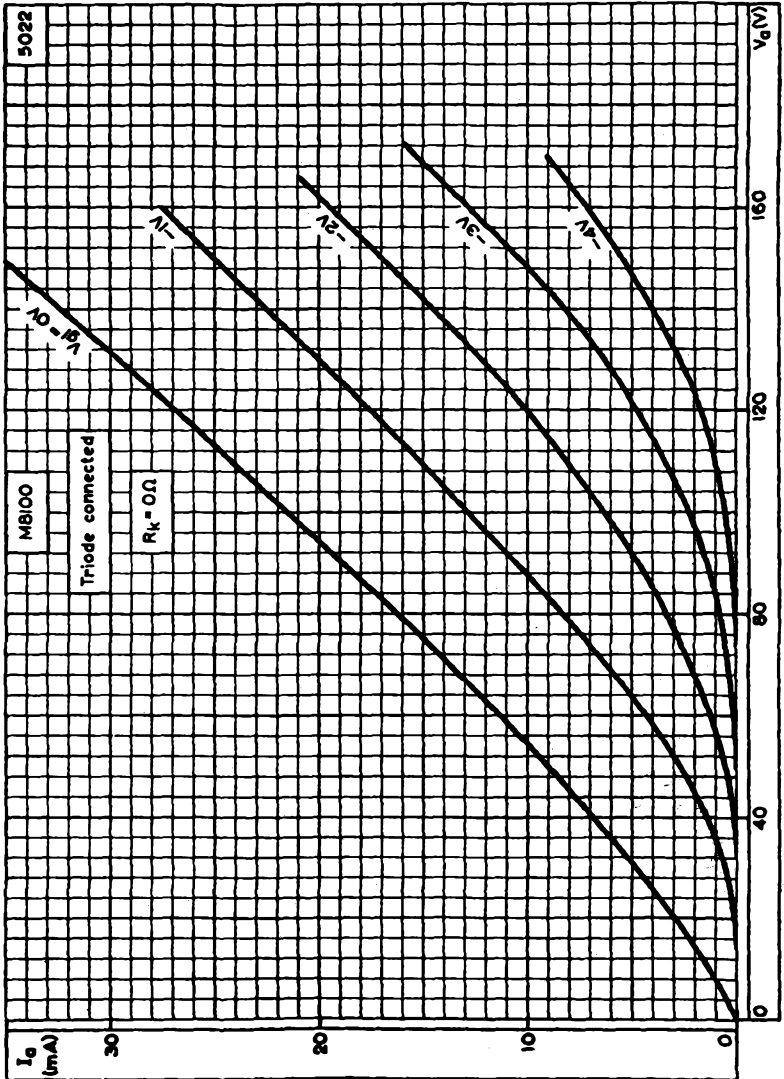

ANODE CURRENT PLOTTED AGAINST ANODE VOLTAGE WITH CONTROL-GRID VOLTAGE AS PARAMETER, WHEN TRIODE CONNECTED.



SPECIAL QUALITY DOUBLE TRIODE

M8136

Special quality low μ double triode for use in equipment where mechanical vibration and shocks are unavoidable and where statistically controlled major electrical characteristics are required.

This data should be read in conjunction with the GENERAL NOTES – SPECIAL QUALITY VALVES which precede this section of the handbook, and the index numbers are used to indicate where reference should be made to a specific note.

HEATER

The heater is centre-tapped and the two sections may be operated in series or in parallel with one another.

Series V_h applied between pins 4 and 5
 Parallel V_h applied between pin 9 and pins 4 and 5 connected together

	Series	Parallel	
V_h^1	12.6	6.3	V
I_h	150	300	mA

MOUNTING POSITION

Any

CAPACITANCES² (measured without an external shield)

* C_{a-g}	1.5	pF
* C_{1b}	1.6	pF
C_{out}	550	mpF
C_{out}	450	mpF

*Each section

CHARACTERISTICS³ (each section)

V_a	250	V
I_a	10.5	mA
V_g	-8.5	V
g_m	2.2	mA/V
r_a	7.7	k Ω
μ	17	
R_k	0	Ω

LIMITING VALUES⁴ (absolute ratings) each section

V_a max.	330	V
p_a max.	3.0	W
I_k max.	20	mA
$-V_g$ max.	110	V
* $-V_g$ (pulse) max.	200	V
V_{h-k} max.	200	V
Maximum acceleration (continuous operation)	2.5	g
Maximum shock (short duration)	500	g
T_{bulb} max.	200	$^{\circ}C$

* $t_p = 800\mu s$, duty factor (max.) = 0.05

TEST CONDITIONS (unless otherwise specified)

V_h	V_a	V_g	R_k	V_{h-k}
(V)	(V)	(V)	(Ω)	(V)
12.6	250	-8.5	0	0

TESTS

A.Q.L.⁵

(%)

GROUP A

Insulation

a-rest measured at -300V

0.25

g-rest measured at -100V

0.25

Reverse grid current

R_g max. = 500k Ω

0.25

GROUP B

Heater current

0.65

Heater to cathode leakage current

0.65

$V_{h-k} = 100V$ (cathode negative)

—

$V_{h-k} = 100V$ (cathode positive)

—

Anode current

0.65

—

Mutual conductance

0.65

—

Group quality level¹⁰

1.0





M8136

SPECIAL QUALITY DOUBLE TRIODE

Bogey ⁹	Individuals ⁶		Lot average ⁷		Lot standard deviation ⁸		
	Min.	Max.	Min.	Max.	Max.		
—	100	—	—	—	—	MΩ	
—	100	—	—	—	—	MΩ	
—	—	0.5	—	—	—	μA	
—	138	162	—	—	—	mA	
—	—	—	—	—	—	—	
—	—	10	—	2.0	—	μA	
—	—	10	—	2.0	—	μA	
10.5	6.5	14.5	—	—	—	mA	
—	—	—	9.0	12	1.22	mA	
2.2	1.75	2.65	—	—	—	mA/V	
—	—	—	2.0	2.4	0.157	mA/V	
—	—	—	—	—	—	—	

GROUP C

Anode current.

$V_g = -25V$ 2.5

$V_g = -18V$ 2.5

Anode current difference between sections 2.5

Change in mutual conductance. $V_h = 11.4V$ 2.5

Reverse grid current.

$V_h = 14V$, $R_g \text{ max.} = 500k\Omega$ 2.5

Microphonic noise at the anode at 50c/s
and 2.5g min. peak acceleration, $V_b = 250V$,

$R_a = 2k\Omega$, $R_k = 410\Omega$, $V_{g-e} = 0V$,

$C_k = 1000\mu F$. Both sections connected
in parallel 2.5

Group quality level ¹⁰ 6.5

GROUP D

Glass strain test^{11A}. No applied voltages 6.5

Base strain test¹². No applied voltages 6.5

Capacitances² (unshielded). No applied voltages 6.5

* C_{a-g} —

* C_{in} —

C_{out} —

C_{out}^* —

*Each section

Mutual conductance. $V_a = 100V$, $V_g = 0V$ } 6.5

Amplification factor } 6.5



SPECIAL QUALITY DOUBLE TRIODE

M8136

—	—	20	—	—	—	μA
—	5.0	—	—	—	—	μA
—	—	3.5	—	—	—	mA
—	—	15	—	—	—	%
—	—	1.5	—	—	—	μA
—	—	100	—	—	—	mV
—	—	—	—	—	—	(r.m.s.)
—	—	—	—	—	—	
—	—	—	—	—	—	
—	—	—	—	—	—	
—	1.1	1.9	—	—	—	pF
—	1.2	2.0	—	—	—	pF
—	300	700	—	—	—	mpF
—	300	600	—	—	—	mpF
3.25	2.5	4.0	—	—	—	mA/V
17	15.5	18.5	2.85	3.65	0.31	mA/V
—	—	—	16.2	17.8	0.63	



TESTS

GROUP E

*Fatigue*¹⁴

$V_h = 14V$, 1 minute on 3 minutes off.
No other voltages applied, 5g min. peak
acceleration, $f = 170c/s$ for 33 hours in
each of 3 mutually perpendicular planes.

Post fatigue tests

Heater to cathode leakage current.

$$V_{h-k} = \pm 100V$$

Reverse grid current.

$$R_g \text{ max.} = 500k\Omega$$

Mutual conductance

Microphonic noise as in group C

Sub-group quality level¹⁰

*Shock*¹⁵

No applied voltages, 500g

Post shock tests

Heater to cathode leakage current.

$$V_{h-k} = \pm 100V$$

Reverse grid current.

$$R_g \text{ max.} = 500k\Omega$$

Mutual conductance

Microphonic noise as in group C

Sub-group quality level¹⁰





A.Q.L. ⁵ (%)	Individuals ⁶			Lot average ⁷		Lot standard deviation ⁸
	Bogey ⁹	Min.	Max.	Min.	Max.	Max.
2.5	—	—	30	—	—	— μ A
2.5	—	—	1.5	—	—	— μ A
2.5	—	1.6	—	—	—	— mA/V
2.5	—	—	150	—	—	— mV
6.5	—	—	—	—	—	— (r.m.s.)
2.5	—	—	30	—	—	— μ A
2.5	—	—	1.5	—	—	— μ A
2.5	—	1.6	—	—	—	— mA/V
2.5	—	—	150	—	—	— mV
6.5	—	—	—	—	—	— (r.m.s.)

M8136

SPECIAL QUALITY DOUBLE TRIODE

GROUP F

*Stability life test*¹⁴

Running conditions. $R_g = 500k\Omega$,
 $V_{h-k} = 175V$ (cathode negative)

Stability life test end point

Change in mutual conductance after 1 hour 1.0

Intermittent life test

Running conditions, $R_g = 500k\Omega$
 $V_{h-k} = 175V$ (cathode negative)

Intermittent life test end points

Sub-group (a)

Inoperatives¹⁶

Heater current

Heater to cathode leakage current. $V_{h-k} = \pm 100V$..

Reverse grid current. R_g max. = $500k\Omega$

Mutual conductance

Average change in mutual conductance

Sub-group (b)

Anode current

Insulation as in group A

Group quality level¹⁰



SPECIAL QUALITY DOUBLE TRIODE

M8136

	10				%
		A.Q.L. ⁵ (%)	Min.	Max.	
..	{	500 hours	2.5	—	—
..		1000 hours	4.0	—	—
..		500 hours	2.5	138	162 mA
..	{	500 hours	2.5	—	20 μ A
..		1000 hours	4.0	—	20 μ A
..	{	500 hours	2.5	—	0.5 μ A
..		1000 hours	4.0	—	0.5 μ A
..	{	500 hours	2.5	1.6	2.65 mA/V
..		1000 hours	4.0	1.5	2.65 mA/V
..		500 hours	—	—	15 %
..	{	500 hours	4.0	5.5	14.5 mA
..		1000 hours	6.5	5.0	14.5 mA
..	{	500 hours	4.0	50	— $M\Omega$
..		1000 hours	6.5	30	— $M\Omega$
..	{	500 hours	6.5	—	—
..		1000 hours	10	—	—



M8136

SPECIAL QUALITY DOUBLE TRIODE

GROUP G

	A.Q.L. ⁵ (%)	Min.	Max.
Valves are held for 28 days and retested for Inoperatives ¹⁶	0.5	—	—
Reverse grid current. R_g max. = 500k Ω	0.5	—	0.5 μ A

2678

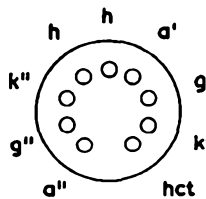
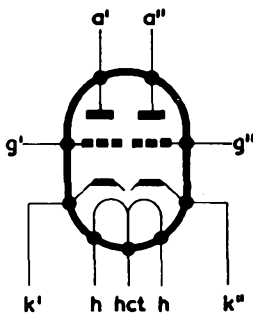

B9A Base

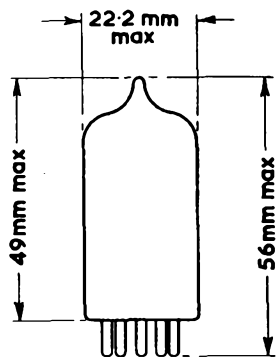

The bulb and base dimensions of this valve are in accordance with BS448, Section B9A



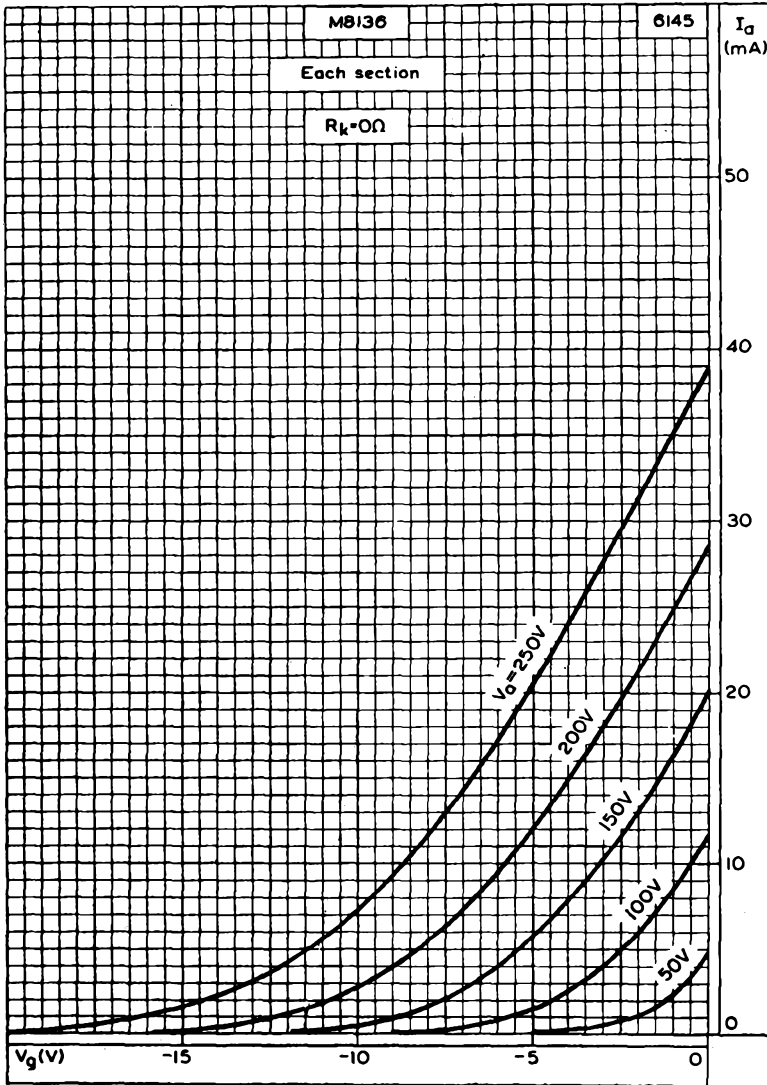

ANODE CURRENT PLOTTED AGAINST GRID VOLTAGE WITH ANODE VOLTAGE AS PARAMETER



M8136

SPECIAL QUALITY DOUBLE TRIODE

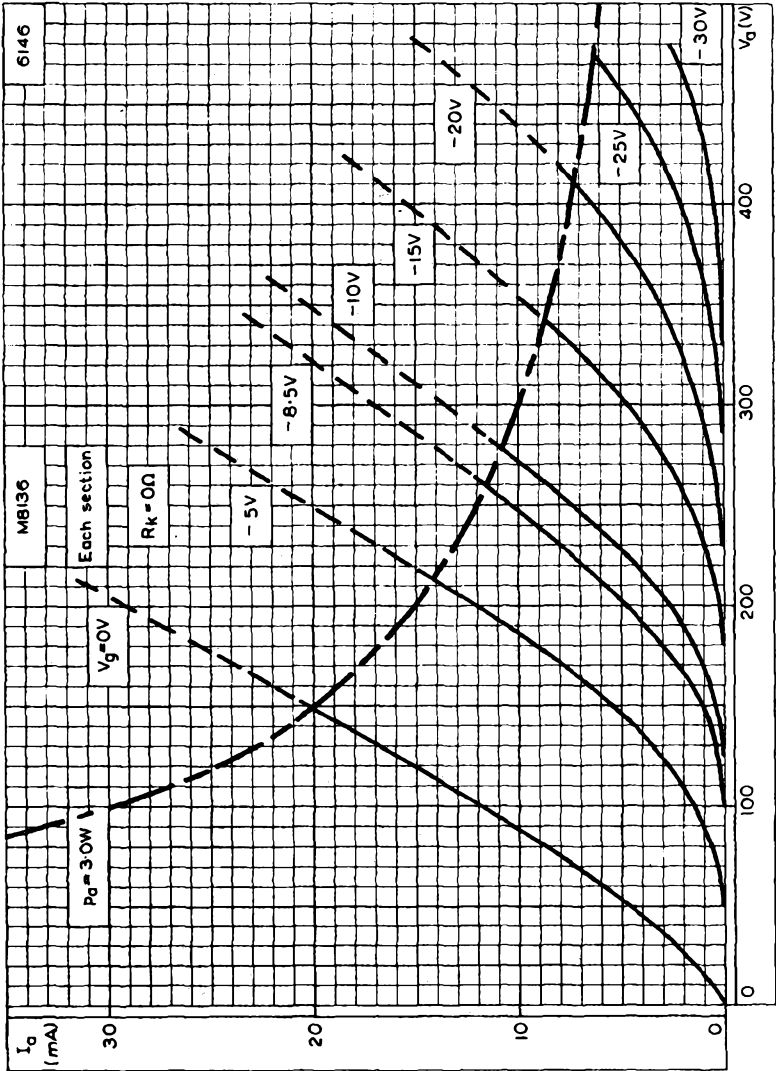

ANODE CURRENT PLOTTED AGAINST ANODE VOLTAGE WITH GRID VOLTAGE AS PARAMETER



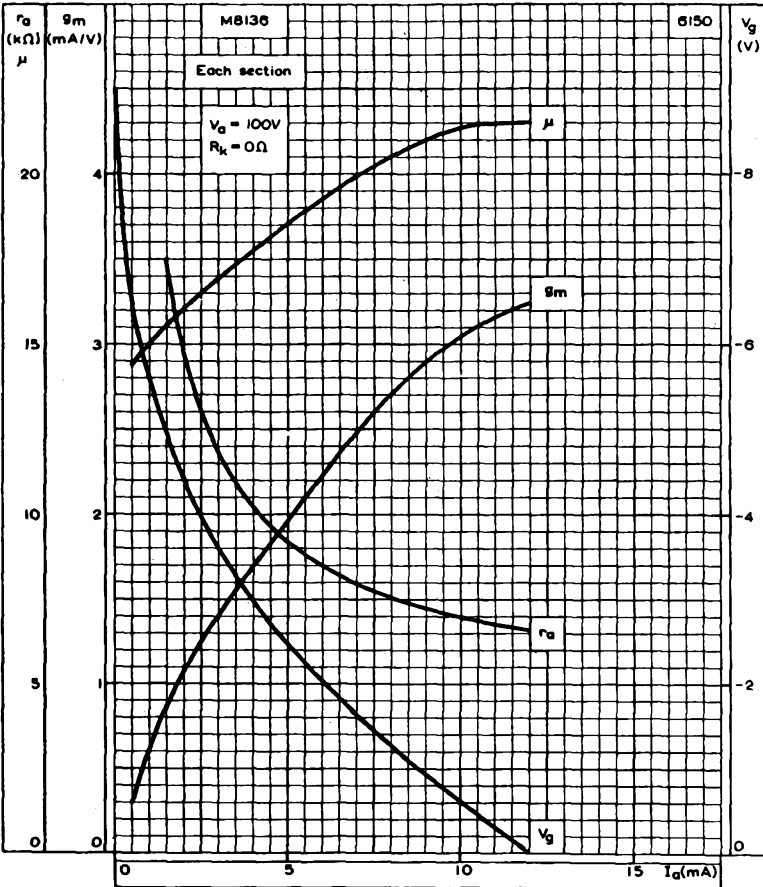

ANODE IMPEDANCE, AMPLIFICATION FACTOR, MUTUAL CONDUCTANCE AND GRID VOLTAGE PLOTTED AGAINST ANODE CURRENT. $V_a = 100V$



M8136

SPECIAL QUALITY DOUBLE TRIODE

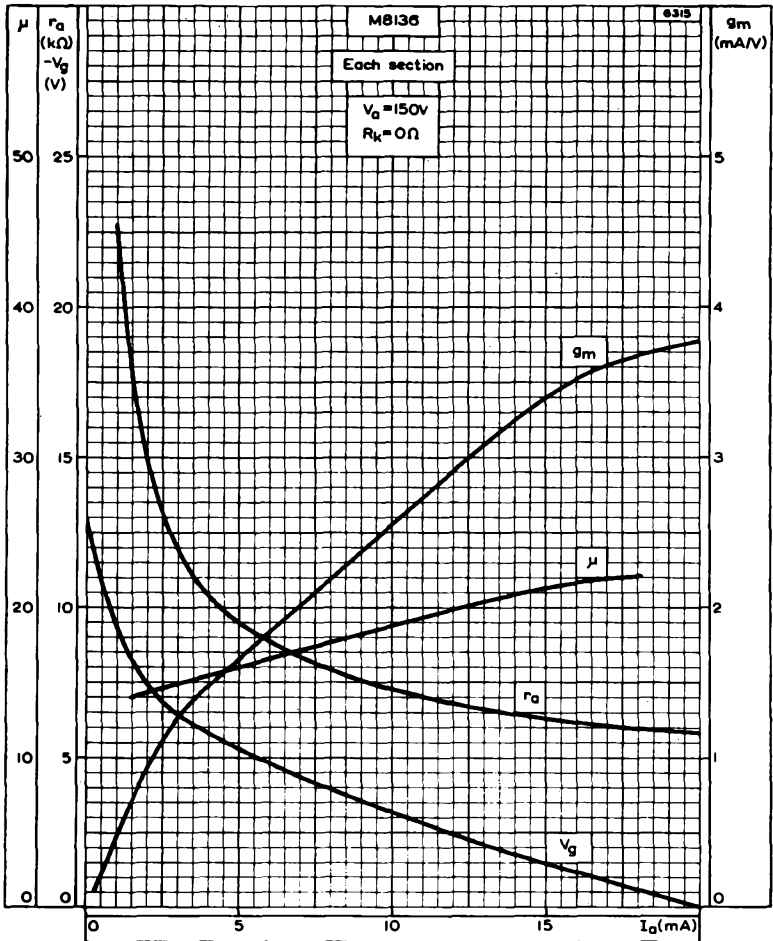

ANODE IMPEDANCE, AMPLIFICATION FACTOR, MUTUAL CONDUCTANCE AND GRID VOLTAGE PLOTTED AGAINST ANODE CURRENT. $V_a = 150V$



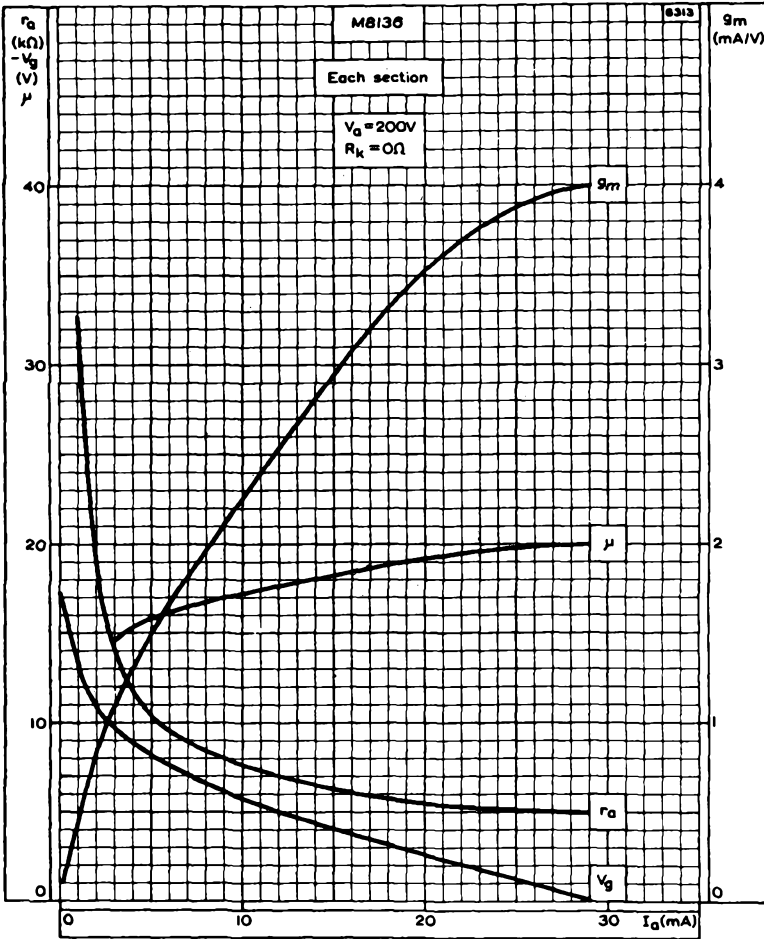

ANODE IMPEDANCE, AMPLIFICATION FACTOR, MUTUAL CONDUCTANCE AND GRID VOLTAGE PLOTTED AGAINST ANODE CURRENT. $V_d = 200V$



M8136

SPECIAL QUALITY DOUBLE TRIODE

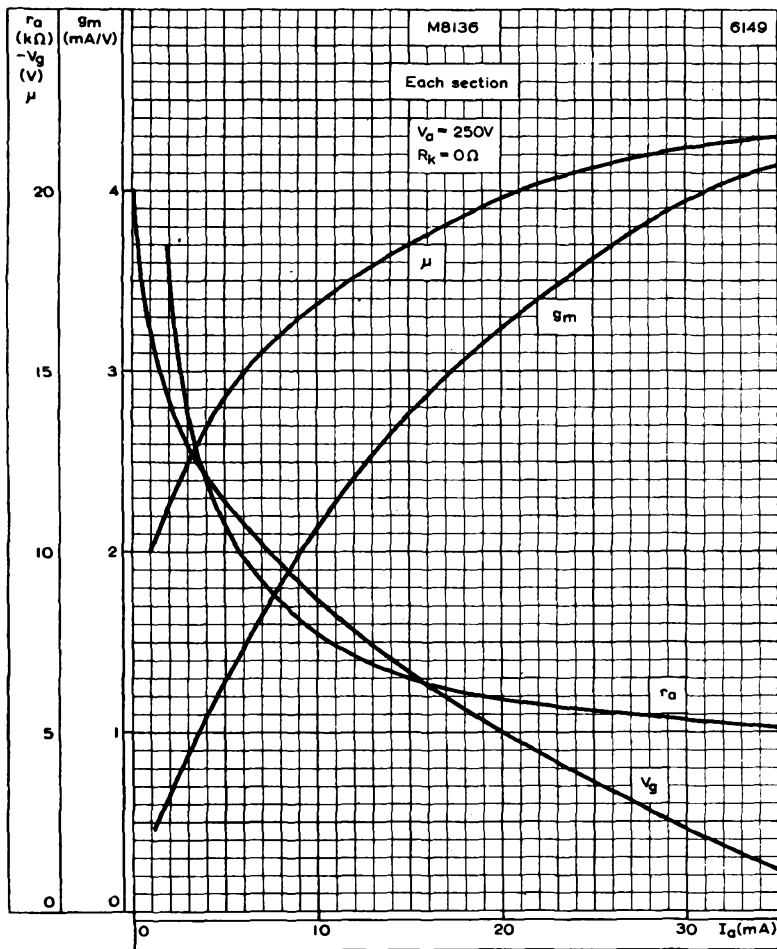

ANODE IMPEDANCE, AMPLIFICATION FACTOR, MUTUAL CONDUCTANCE AND GRID VOLTAGE PLOTTED AGAINST ANODE CURRENT. $V_a = 250V$



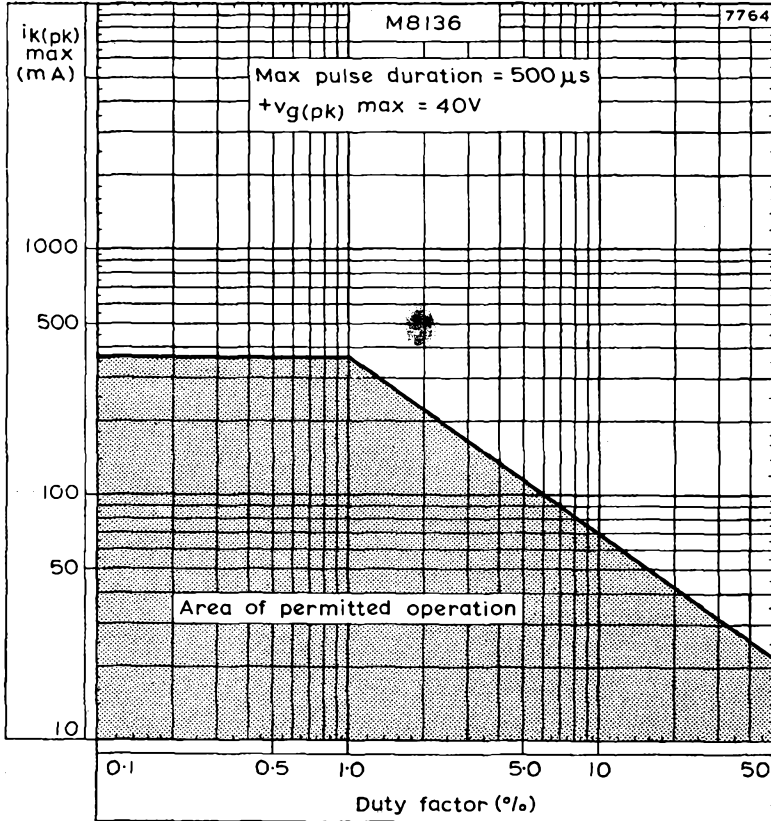

PULSE RATING CHART



M8136

SPECIAL QUALITY DOUBLE TRIODE

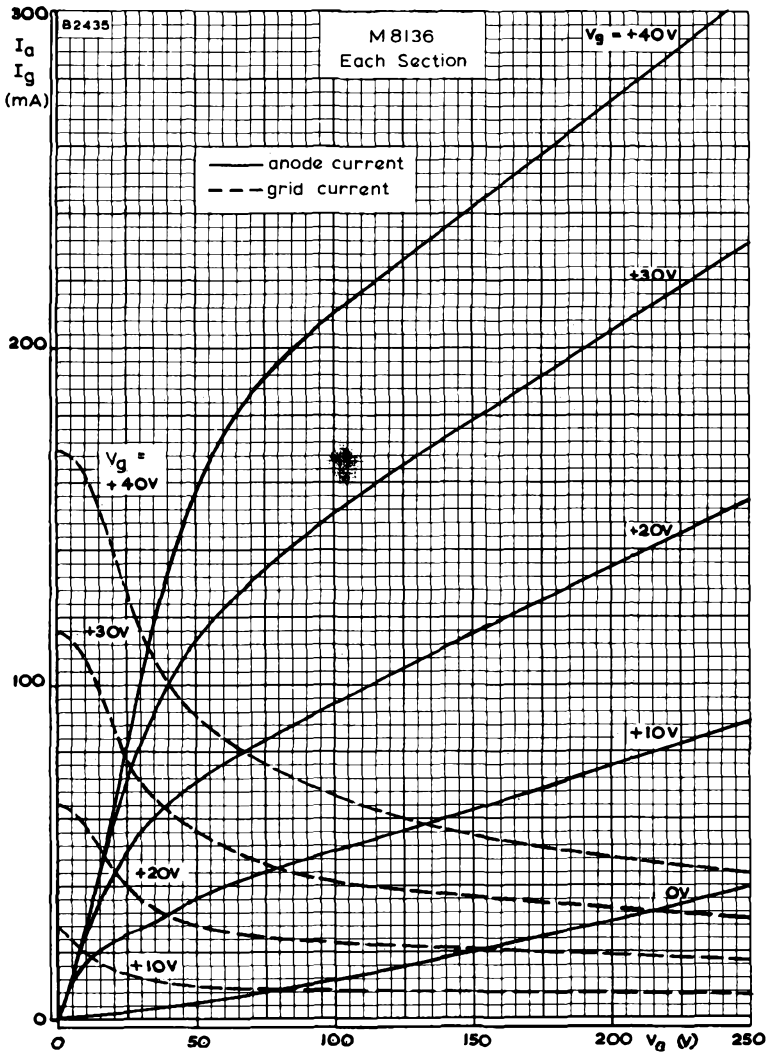

ANODE AND GRID CURRENTS PLOTTED AGAINST ANODE VOLTAGE WITH POSITIVE GRID VOLTAGE AS PARAMETER



SPECIAL QUALITY DOUBLE TRIODE

M8137

Special quality high- μ double triode for use in equipment where mechanical vibration and shocks are unavoidable and where statistically controlled major electrical characteristics are required.

This data should be read in conjunction with GENERAL NOTES—SPECIAL QUALITY VALVES which precede this section of the handbook, and the index numbers are used to indicate where reference should be made to a specific note.

HEATER

The heater is centre-tapped and the two sections may be operated in series or in parallel with one another.

Series

V_h applied between pins 4 and 5

Parallel

V_h applied between pin 9 and pins 4 and 5 connected together.

	Series	Parallel	
V_{h1}	12.6	6.3	V
I_h	150	300	mA

CAPACITANCES² (measured without an external shield)

* C_{a-g}	1.7	pF
* C_{fn}	1.6	pF
$C_{out'}$	520	mpF
$C_{out''}$	400	mpF

*Each section

CHARACTERISTICS³ (each section)

V_a	250	V
I_a	1.25	mA
V_g	-2.0	V
g_m	1.6	mA/V
μ	90	
r_a	56	k Ω
R_k	0	Ω

LIMITING VALUES⁴ (absolute ratings) each section

$V_{a(b)}$ max.	550	V
V_a max.	330	V
p_a max.	1.1	W
I_k max.	20	mA
$-V_g$ max.	55	V
* $-V_{g(pulse)}$ max.	200	V
R_{g-k} max. (cathode bias)	2.2	M Ω
R_{g-k} max. (fixed bias)	1.0	M Ω
V_{h-k} max.	200	V
Maximum acceleration (continuous operation)	2.5	g
Maximum shock (short duration)	500	
T_{bulb} max.	200	$^{\circ}C$

* $t_p = 800\mu s$, Duty factor (max.) = 0.05

TEST CONDITIONS (unless otherwise specified)

V_h (V)	V_a (V)	V_g (V)	R_k (Ω)	V_{h-k} (V)
12.6	250	-2.0	0	0

TESTS

A.Q.L.⁸

(%)

GROUP A

Insulation

a-rest, measured at -300V

0.25

g-rest, measured at -100V

0.25

Reverse grid current. R_g max. = 500k Ω

0.25

GROUP B

Heater current

0.65

Heater to cathode leakage current

V_{h-k} = 100V (cathode negative)

—

V_{h-k} = 100V (cathode positive)

—

Anode current

{ 0.65
—

Mutual conductance

{ 0.65
—

Anode current V_g = -4.0V

0.65

Group quality level¹⁰

1.0





M8137

SPECIAL QUALITY DOUBLE TRIODE

Bogey ⁹	Individuals ⁶		Lot average ⁷		Lot standard deviation ⁸		
	Min.	Max.	Min.	Max.	Max.		
—	100	—	—	—	—	MΩ	
—	100	—	—	—	—	MΩ	
—	—	0.5	—	—	—	μA	
—	138	162	—	—	—	mA	
—	—	10	—	2.0	—	μA	
—	—	10	—	2.0	—	μA	
1.25	0.75	1.75	—	—	—	mA	
—	—	—	1.0	1.5	0.19	mA	
1.6	1.25	2.05	—	—	—	mA/V	
—	—	—	1.425	1.775	0.136	mA/V	
—	—	35	—	—	—	μA	
—	—	—	—	—	—		

GROUP C

Anode current difference between sections	2.5
Change in mutual conductance. $V_{H} = 11.4V$	2.5
Microphonic noise at the anode at 50c/s and 2g min. peak acceleration, $V_b = 250V$, $R_a = 2k\Omega$, $R_k = 1.5k\Omega$, $C_k = 1000\mu F$, $V_{g-e} = 0V$, both sections connected in parallel	2.5
Group quality level ¹⁰	6.5



GROUP D

Glass strain test ^{11A} . No applied voltages	6.5
Base strain test ¹² . No applied voltages	6.5
Capacitances (unshielded). No applied voltages	6.5
C_{in}	—
$C_{out'}$	—
$C_{out''}$	—
C_{a-g}	—
Amplification factor	6.5
Grid emission $V_{H} = 14V$, $R_g = 500k\Omega$	6.5

SPECIAL QUALITY DOUBLE TRIODE

M8137

—	—	600	—	—	—	μA
—	—	15	—	—	—	%
—	—	25	—	—	—	mV (r.m.s.)
—	—	—	—	—	—	
—	—	—	—	—	—	
—	—	—	—	—	—	
—	—	—	—	—	—	pF
—	1.2	2.0	—	—	—	mpF
—	220	700	—	—	—	mpF
—	180	600	—	—	—	pF
—	1.27	2.12	—	—	—	
—	75	115	—	—	—	
—	—	1.5	—	—	—	μA



TESTS

GROUP E

*Fatigue*¹⁴

$V_h = 14V$, 1 minute on 3 minutes off. No other voltages applied, 5g min. peak acceleration. $f = 170c/s$ for 33 hours in each of 3 mutually perpendicular planes

Post fatigue tests

Heater to cathode leakage current.

$$V_{h-k} = \pm 100V$$

Reverse grid current. R_g max. = 500k Ω

Microphonic noise as in group C

Sub-group quality level¹⁰

*Shock*¹⁵

No applied voltages, 500g

Post shock tests

Heater to cathode leakage current.

$$V_{h-k} = \pm 100V$$

Reverse grid current. R_g max. = 500k Ω

Microphonic noise as in group C

Sub-group quality level¹⁰

GROUP F

*Stability life test*¹⁴

Running conditions. $R_g = 500k\Omega$,
 $V_{h-k} = 135V$ (cathode negative)





M8137

SPECIAL QUALITY DOUBLE TRIODE

A.Q.L. ⁵ (%)	Individuals ⁶			Lot average ⁷		Lot standard deviation ⁸	
	Bogey ⁹	Min.	Max.	Min.	Max.	Max.	
2.5	—	—	30	—	—	—	μA μA mV (r.m.s.)
2.5	—	—	1.5	—	—	—	
2.5	—	—	40	—	—	—	
6.5	—	—	—	—	—	—	
2.5	—	—	30	—	—	—	μA μA mV (r.m.s.)
2.5	—	—	1.5	—	—	—	
2.5	—	—	40	—	—	—	
6.5	—	—	—	—	—	—	

Stability life test end points

Change in mutual conductance after 1 hour 1.0

Intermittent life test

Running conditions $R_g = 500k\Omega$,
 $V_{h-k} = 135V$ (cathode negative)

Intermittent life test end points

Sub-group (a)

Inoperatives¹⁶

Heater current

Heater to cathode leakage. $V_{h-k} = \pm 100V$

Reverse grid current. R_g max. = $500k\Omega$

Mutual conductance

Average change in mutual conductance

Sub-group (b)

Anode current

Insulation as in group A

Group quality level¹⁰



SPECIAL QUALITY DOUBLE TRIODE

M8137

	10				%
		A.Q.L. ⁵ (%)	Min.	Max.	
.. {	500 hours	2.5	—	—	
.. }	1000 hours	4.0	—	—	
..	500 hours	2.5	138	162	mA
.. {	500 hours	2.5	—	20	μA
.. }	1000 hours	4.0	—	20	μA
.. {	500 hours	2.5	—	0.5	μA
.. }	1000 hours	4.0	—	0.5	μA
.. {	500 hours	2.5	1.15	2.05	mA/V
.. }	1000 hours	4.0	1.12	2.05	mA/V
..	500 hours	—	—	15	%
.. {	500 hours	4.0	0.65	1.75	mA
.. }	1000 hours	6.5	0.6	1.75	mA
.. {	500 hours	4.0	50	—	MΩ
.. }	1000 hours	6.5	30	—	MΩ
.. {	500 hours	6.5	—	—	
.. }	1000 hours	10	—	—	



M8137 SPECIAL QUALITY DOUBLE TRIODE

GROUP G

Valves are held for 28 days and retested for inoperatives¹⁶

Reverse grid current. R_g max. = 500k Ω

A.Q.L. ⁵ (%)	Min.	Max.
	0.5	—
	0.5	0.5 μ A

2678

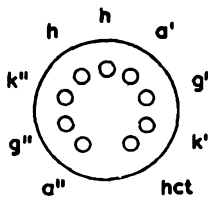
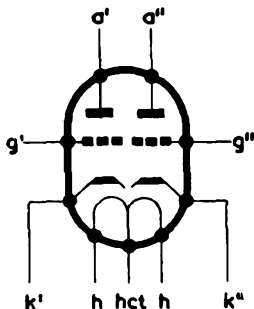

B9A Base

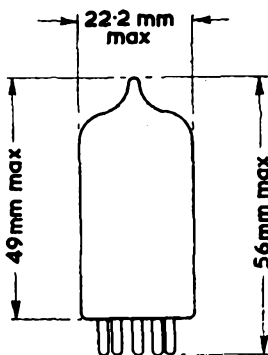

The bulb and base dimensions of this valve are in accordance with BS448, Section B9A



SPECIAL QUALITY DOUBLE TRIODE M8137

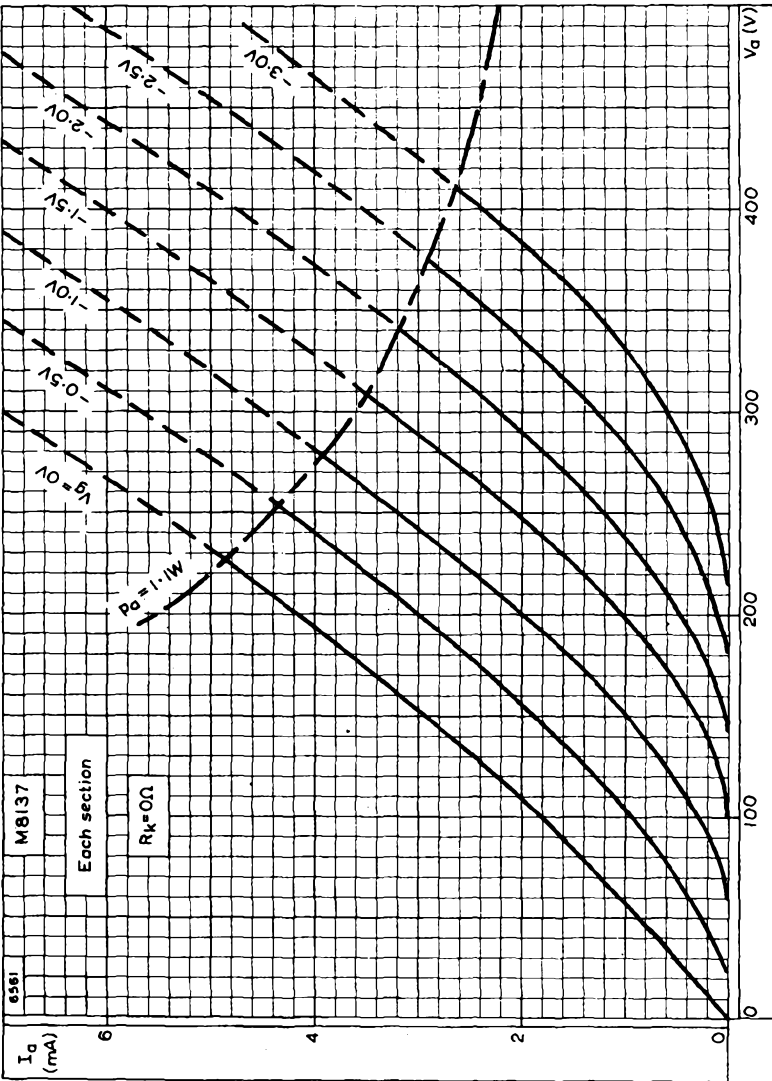

ANODE CURRENT PLOTTED AGAINST ANODE VOLTAGE WITH GRID VOLTAGE AS PARAMETER



M8137 SPECIAL QUALITY DOUBLE TRIODE

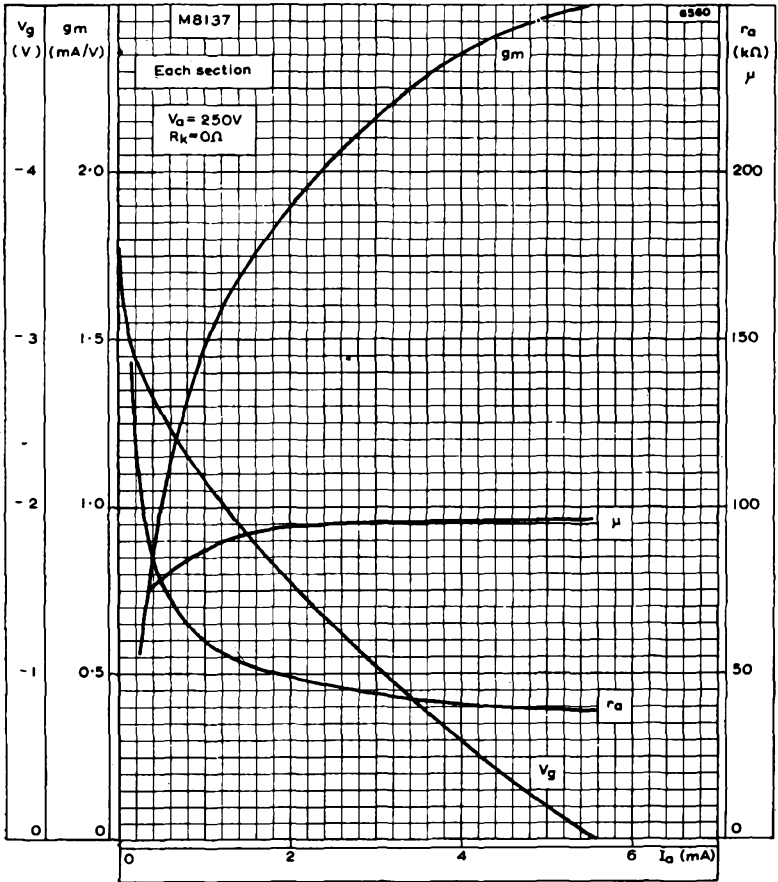

AMPLIFICATION FACTOR, MUTUAL CONDUCTANCE, ANODE IMPEDANCE AND GRID VOLTAGE PLOTTED AGAINST ANODE CURRENT



SPECIAL QUALITY VARIABLE-MU R.F. PENTODE

M8161

Special quality variable-mu r.f. pentode for use in equipment where mechanical vibration and shocks are unavoidable and where statistically controlled major electrical characteristics are required.

This data should be read in conjunction with GENERAL NOTES—SPECIAL QUALITY VALVES which precede this section of the handbook, and the index numbers are used to indicate where reference should be made to a specific note.

HEATER

V_h^1	6.3	V
I_h	200	mA

MOUNTING POSITION

Any

CAPACITANCES²

	Unshielded	Shielded	
C_{in}	4.8	5.0	pF
C_{out}	6.3	6.5	pF
C_{a-g1}	<15	<10	mpF
C_{h-k}	2.3	2.3	pF

CHARACTERISTICS³

V_a	200	V
V_{g2}	200	V
V_{g3}	0	V
I_a	8.25	mA
I_{g2}	2.1	mA
V_{g1}	-2.5	V
g_m	2.45	mA/V
r_a	900	k Ω
μ_{g1-g2}	30	
R_k	0	Ω
V_{g1} (for 100 : 1 reduction in g_m)	-27	V

ABSOLUTE MAXIMUM RATINGS⁴

$V_{a(b)}$ max.	500	V
V_a max.	300	V
p_a max.	3.0	W
$V_{g2(b)}$ max.	300	V
V_{g2} max.	300	V
p_{g2} max.	700	mW
$-V_g$ max.	55	V
I_k max.	14	mA
R_{g1-k} max. (cathode bias)	500	k Ω
R_{g1-k} max. (fixed bias)	100	k Ω
V_{h-k} max.	150	V
Maximum fatigue (continuous operation)	2.5	g
Maximum shock (short duration)	500	g
T_{bulb} max.	200	$^{\circ}$ C

TEST CONDITIONS (unless otherwise specified)

V_h	V_a	V_{g3}	V_{g2}	V_{g1}
(V)	(V)	(V)	(V)	(V)
6.3	200	0	200	-2.5

TESTS

	A.Q.L. ⁵
GROUP A	(%)
Insulation	
a-rest, g_2 -rest, g_3 -rest measured at -300V	0.25
g_1 -rest measured at -100V	0.25
Reverse grid current	
R_{g1} max. = 500k Ω	0.25
GROUP B	
Heater current	0.65
Heater-to-cathode leakage current	
$V_{h-k} = 100V$ cathode positive } cathode negative }	0.65
$V_{h-k} = 100V$ cathode positive	—
Anode current	{ 0.65 —
Screen-grid current	{ 0.65 —
Mutual conductance	{ 0.65 —
Group quality level ¹⁰	1.0





M8161

SPECIAL QUALITY VARIABLE-MU
R.F. PENTODE

R_k
(Ω)
= 0

V_{h-k}
(V)
0

Individuals ⁶			Lot average ⁷		Lot standard deviation ⁸	
Bogey ⁹	Min.	Max.	Min.	Max.	Max.	
—	100	—	—	—	—	M Ω
—	100	—	—	—	—	M Ω
—	—	0.5	—	—	—	μ A
—	184	216	—	—	—	mA
—	—	10	—	—	—	μ A
—	—	—	—	3.0	—	μ A
8.25	6.0	10.5	—	—	—	mA
—	—	—	7.6	8.9	0.77	mA
—	1.2	3.0	—	—	—	mA
—	—	—	—	2.4	—	mA
2.45	1.8	3.1	—	—	—	mA/V
—	—	—	2.25	2.65	0.23	mA/V
—	—	—	—	—	—	—

GROUP C

Mutual conductance. $V_{g1} = -26V$	2.5	—	4.0	60	—	—	—	$\mu A/V$
Reverse grid current. $V_{g1} = -50V$	2.5	—	—	1.0	—	—	—	μA
Change in mutual conductance. $V_h = 5.7V$	2.5	—	—	15	—	—	—	%
Reverse grid current. $V_h = 6.9V$, $V_{a-c} = 300V$, $V_{g2-e} = 200V$, $R_k = 240\Omega$	2.5	—	—	1.0	—	—	—	μA
Microphonic noise at the anode at 50c/s and 2.5g min. peak acceleration, $V_{a(b)} = 200V$, $R_a = 2.0k\Omega$	2.5	—	—	15	—	—	—	mV (r.m.s.)
Group quality level ¹⁰	6.5	—	—	—	—	—	—	—

GROUP D

Glass strain test ^{11A} . No applied voltages	6.5	—	—	—	—	—	—	—
Base strain test ¹² . No applied voltages	6.5	—	—	—	—	—	—	—
Capacitances ² (shielded). No applied voltages	6.5	—	—	—	—	—	—	—
C_{in}	—	—	3.8	5.2	—	—	—	pF
C_{out}	—	—	5.0	7.4	—	—	—	pF
C_{a-g1}	—	—	—	10	—	—	—	mpF
Grid 3 cut-off voltage. $V_{g1} = -7.0V$, $I_a = 50\mu A$	6.5	—	-55	-125	—	—	—	V
Amplification factor (μ_{g1-g2})	6.5	—	23	39	—	—	—	—



TESTS

GROUP E

*Fatigue*¹⁴

$V_h = 6.9V$, 1 minute on 3 minutes off. No other voltages applied, 5g min. peak acceleration, $f = 170 \pm 5c/s$ for 33 hours in each of 3 mutually perpendicular planes.

Post fatigue tests

Heater-to-cathode leakage current.

$$V_{h-k} = \pm 100V$$

Reverse grid current.

$$R_{g1} \text{ max.} = 500k\Omega$$

Mutual conductance

Microphonic noise as in group C

*Shock*¹⁵

No applied voltages, 500g

Post shock tests

Heater-to-cathode leakage current.

$$V_{h-k} = \pm 100V$$

Reverse grid current.

$$R_{g1} \text{ max.} = 500k\Omega$$

Mutual conductance

Microphonic noise as in group C





Q.L. ⁵ (%)	Individuals ⁶			Lot average ⁷		Lot standard deviation ⁸
	Bogey ⁹	Min.	Max.	Min.	Max.	Max.
.5	—	—	20	—	—	— μ A
.5	—	—	1.0	—	—	— μ A
.5	—	1.6	3.1	—	—	— mA/V
.5	—	—	25	—	—	— mV (r.m.s.)
.5	—	—	20	—	—	— μ A
.5	—	—	1.0	—	—	— μ A
.5	—	1.6	3.1	—	—	— mA/V
.5	—	—	25	—	—	— mV (r.m.s.)

M8161

SPECIAL QUALITY VARIABLE-MU
R.F. PENTODE

GROUP F

Stability life test¹⁴

Running conditions. $R_{g1} = 100k\Omega$,
 $V_a = 250V$, $V_{h-k} = 135V$ (cathode negative), $R_k = 160\Omega$, $V_{g1-e} = 0V$

Stability life test end point

Change in mutual conductance after 1 hour 1.0

Intermittent life test

Running conditions. $R_{g1} = 100k\Omega$,
 $V_a = 250V$, $V_{h-k} = 135V$ (cathode negative), $R_k = 160\Omega$

Intermittent life test end points

Sub-group (a)

Inoperatives ¹⁶
Heater current
Heater-to-cathode leakage current. $V_{h-k} = \pm 100V$
Reverse grid current. $R_{g1} \text{ max.} = 500k\Omega$
Mutual conductance
Average change in mutual conductance

Sub-group (b)

Insulation as in group A
Group quality level ¹⁰



**SPECIAL QUALITY VARIABLE-MU
R.F. PENTODE**

M8161

	10				%
		A.Q.L. ⁵ (%)	Min.	Max.	
.. { 500 hours		2.5	—	—	
.. { 1000 hours		4.0	—	—	
.. 500 hours		2.5	184	216	mA
.. { 500 hours		2.5	—	20	μA
.. { 1000 hours		4.0	—	30	μA
.. { 500 hours		2.5	—	0.75	μA
.. { 1000 hours		4.0	—	1.0	μA
.. { 500 hours		2.5	1.6	3.1	mA/V
.. { 1000 hours		4.0	1.5	3.1	mA/V
.. 500 hours		—	—	15	%
.. { 500 hours		4.0	50	—	MΩ
.. { 1000 hours		6.5	30	—	MΩ
.. { 500 hours		6.5	—	—	
.. { 1000 hours		10	—	—	



M8161

SPECIAL QUALITY VARIABLE-MU
R.F. PENTODE

GROUP G

Valves are held for 28 days and
retested for

Inoperatives¹⁶

Reverse grid current.
 R_{g1} max. = 500k Ω

A.Q.L. ⁵ (%)	Min.	Max.	
0.5	—	—	
0.5	—	0.75	μ A

3594

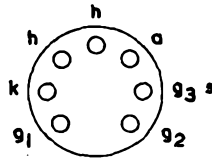
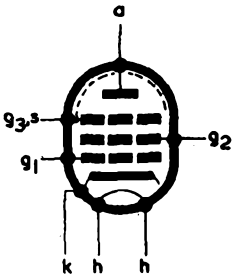

B7G Base

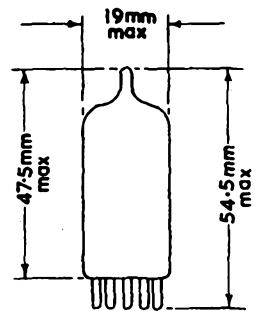

The bulb and base dimensions of this valve are in accordance with BS448
Section B7G





ANODE CURRENT PLOTTED AGAINST ANODE VOLTAGE WITH CONTROL-GRID VOLTAGE AS PARAMETER. $V_{g2} = 200V$.



M8161

SPECIAL QUALITY VARIABLE-MU
R.F. PENTODE

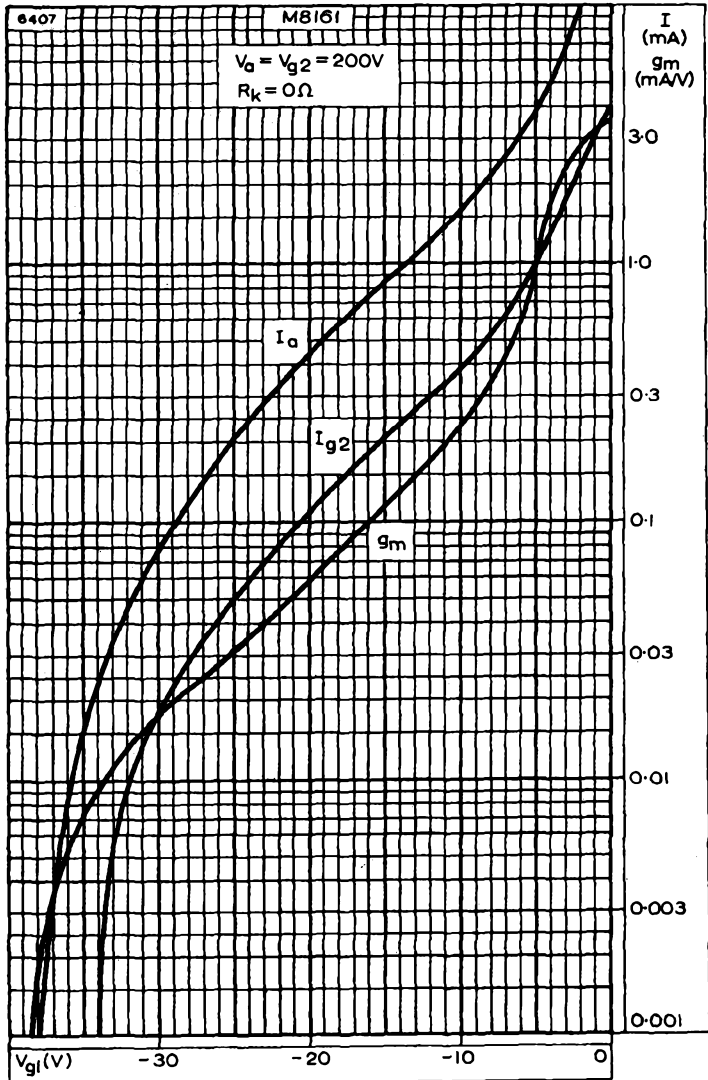

ANODE CURRENT, SCREEN-GRID CURRENT AND MUTUAL CONDUCTANCE PLOTTED AGAINST CONTROL-GRID VOLTAGE. $V_a = V_{g2} = 200V$.



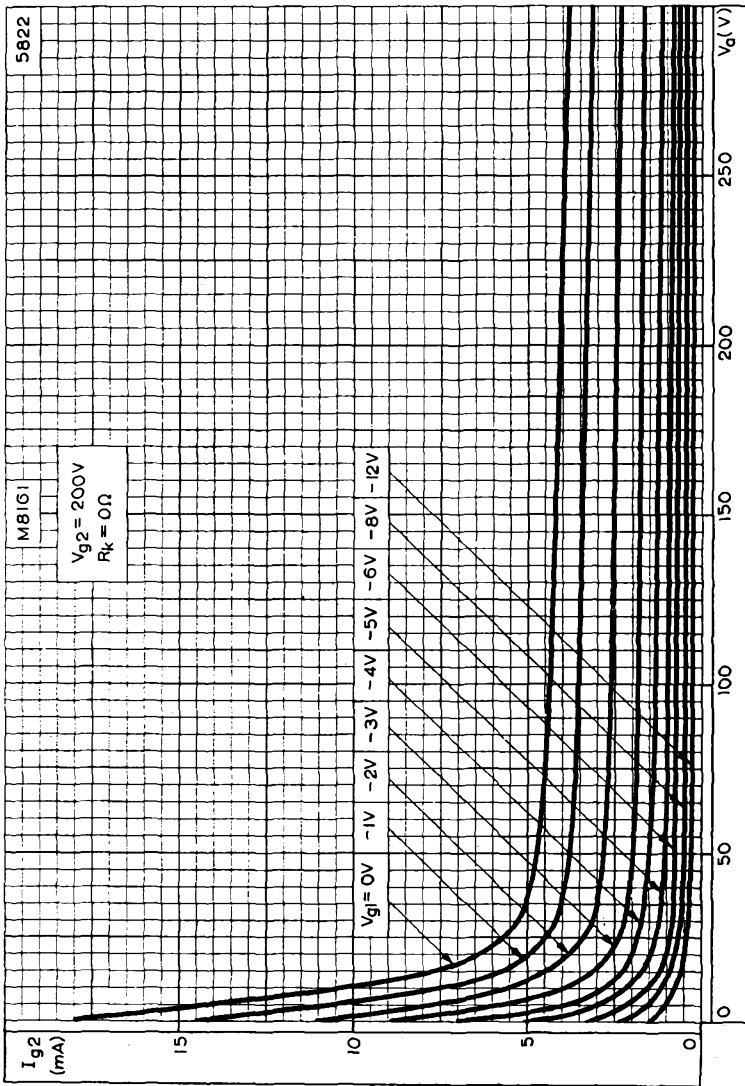

SCREEN-GRID CURRENT PLOTTED AGAINST ANODE VOLTAGE WITH CONTROL-GRID VOLTAGE AS PARAMETER. $V_{g2} = 200V$



M8161

SPECIAL QUALITY VARIABLE-MU
R.F. PENTODE

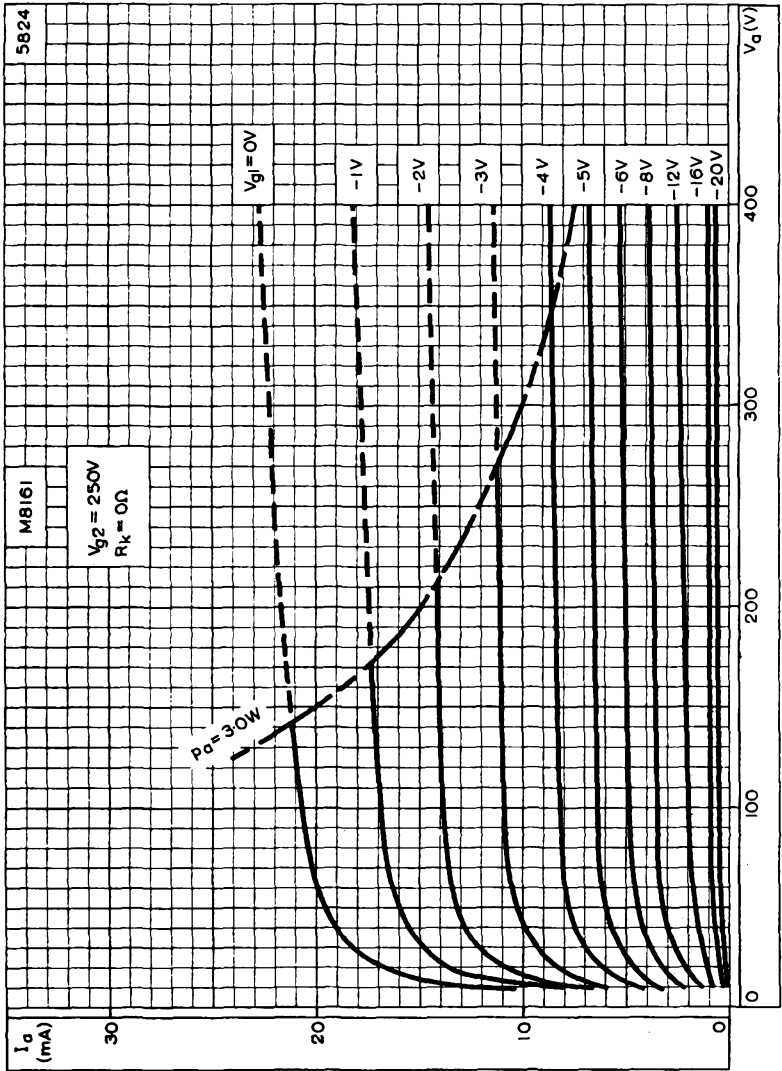

ANODE CURRENT PLOTTED AGAINST ANODE VOLTAGE WITH CONTROL-GRID VOLTAGE AS PARAMETER. $V_{g2} = 250V$



SPECIAL QUALITY VARIABLE-MU
R.F. PENTODE

M8161

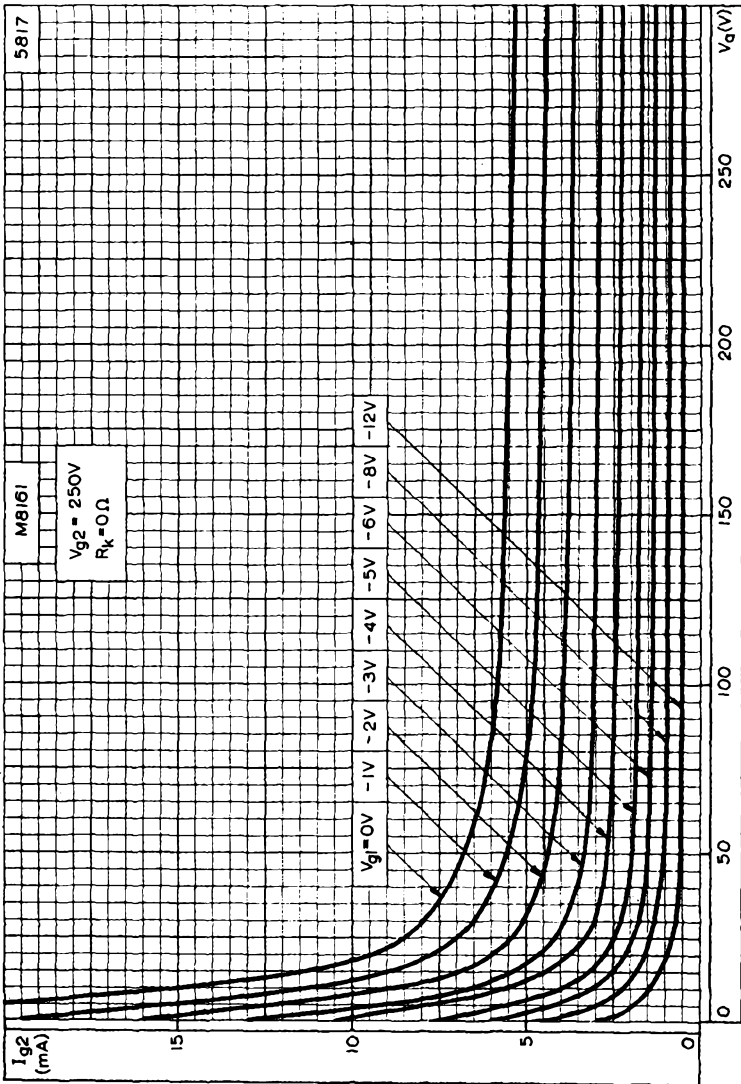

SCREEN-GRID CURRENT PLOTTED AGAINST ANODE VOLTAGE WITH CONTROL-GRID VOLTAGE AS PARAMETER. $V_{g2} = 250V$



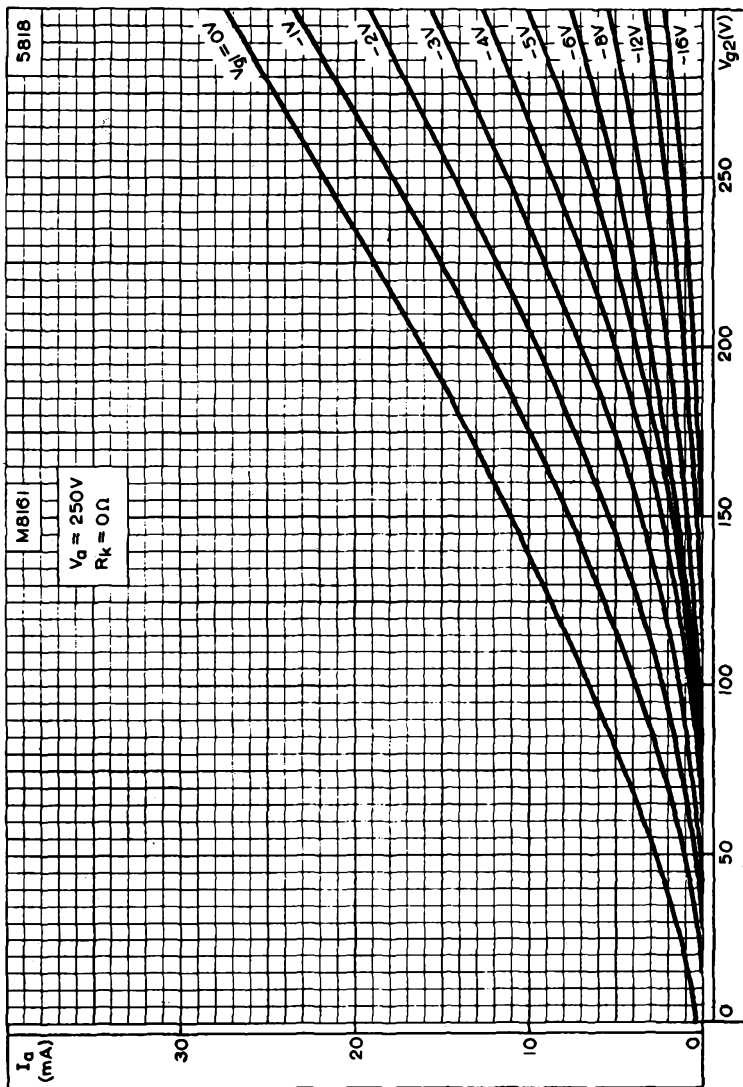

ANODE CURRENT PLOTTED AGAINST SCREEN-GRID VOLTAGE WITH CONTROL-GRID VOLTAGE AS PARAMETER. $V_{g3} = 250V$

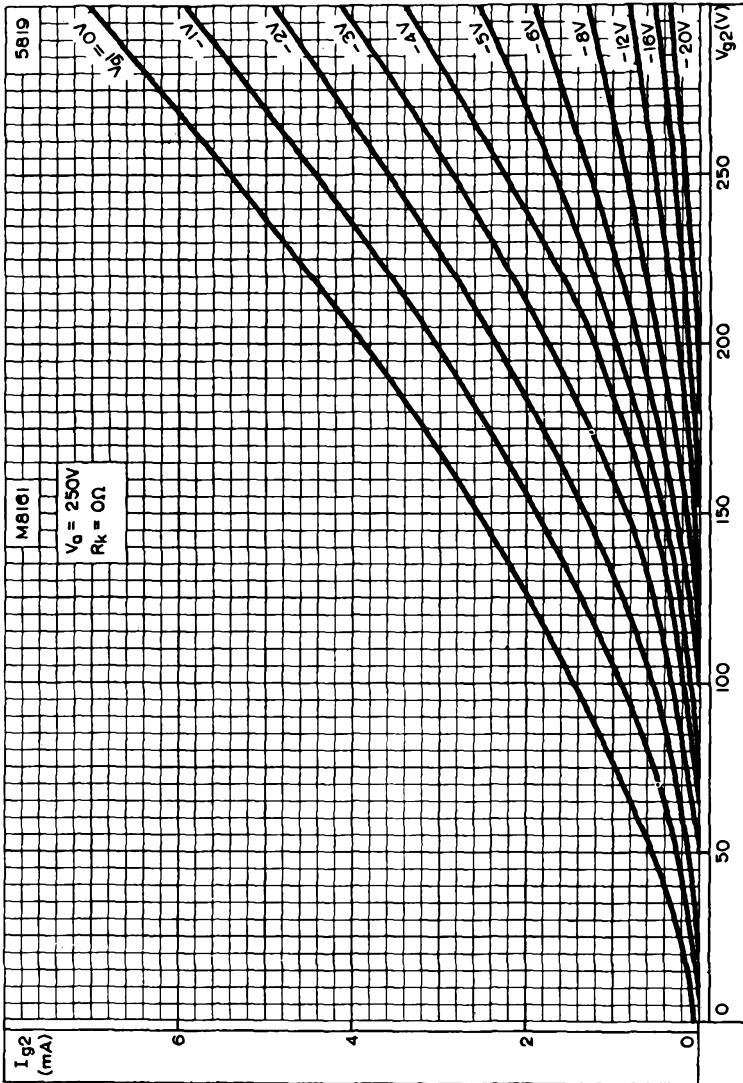

SCREEN-GRID CURRENT PLOTTED AGAINST SCREEN-GRID VOLTAGE WITH CONTROL-GRID VOLTAGE AS PARAMETER. $V_{g0} = 250V$



M8161

SPECIAL QUALITY VARIABLE-MU
R.F. PENTODE

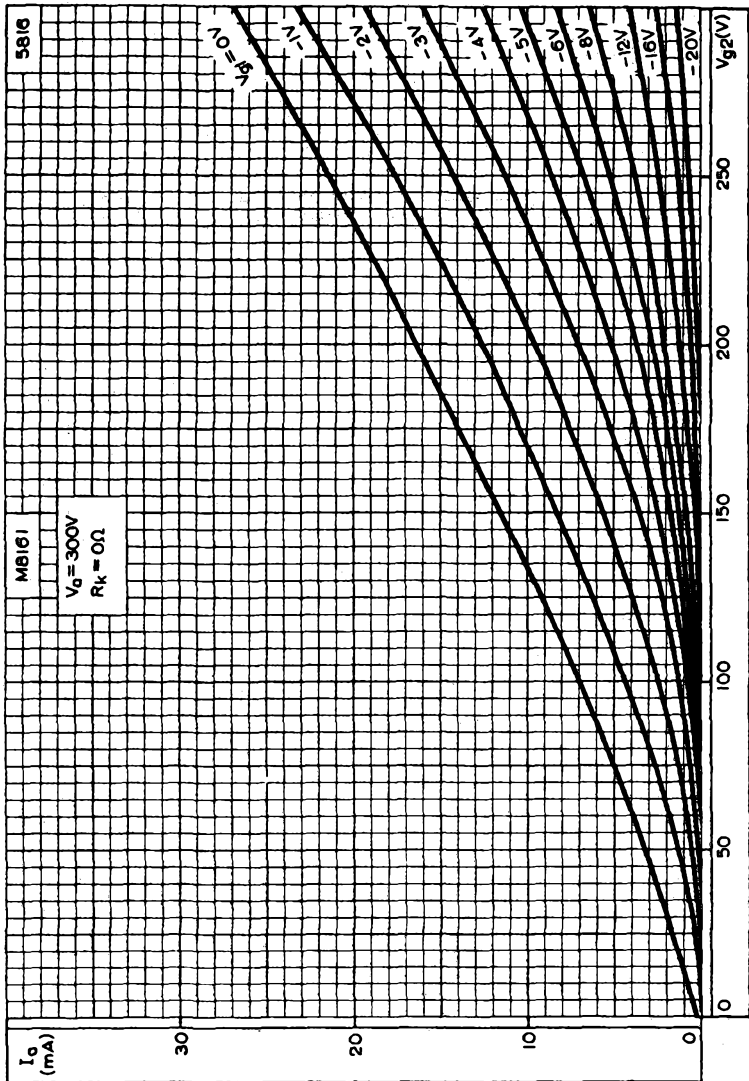

ANODE CURRENT PLOTTED AGAINST SCREEN-GRID VOLTAGE WITH CONTROL-GRID VOLTAGE AS PARAMETER. $V_a = 300V$



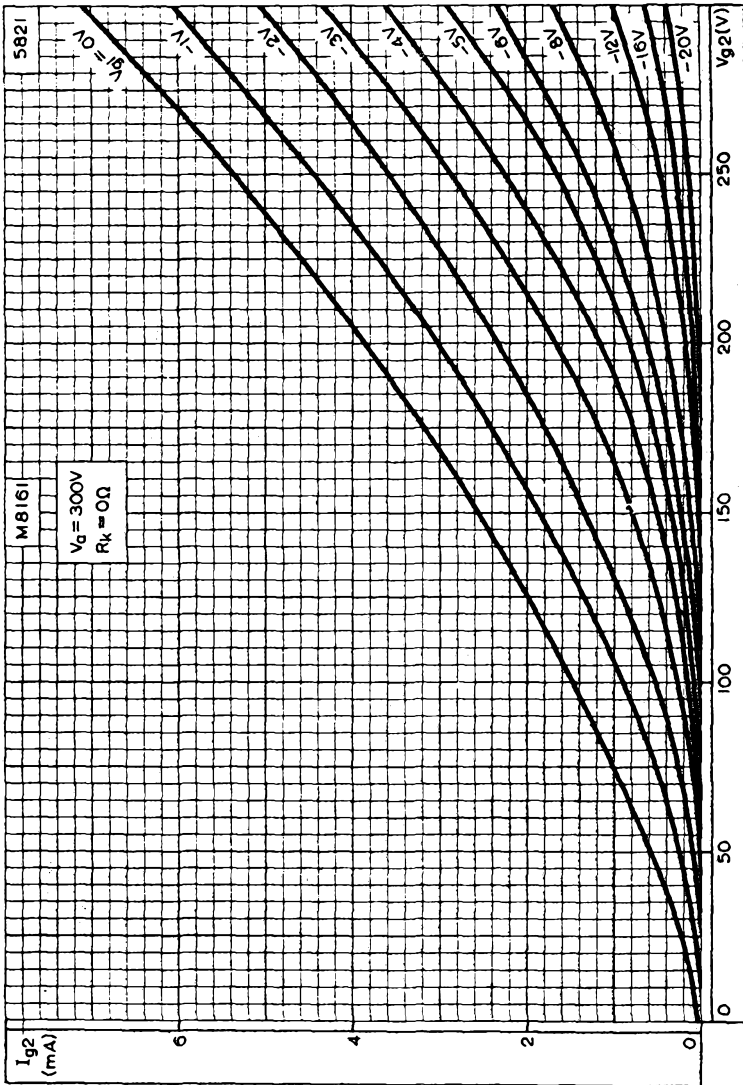

SCREEN-GRID CURRENT PLOTTED AGAINST SCREEN-GRID VOLTAGE WITH CONTROL-GRID VOLTAGE AS PARAMETER. $V_a = 300V$



M8161

SPECIAL QUALITY VARIABLE-MU
R.F. PENTODE

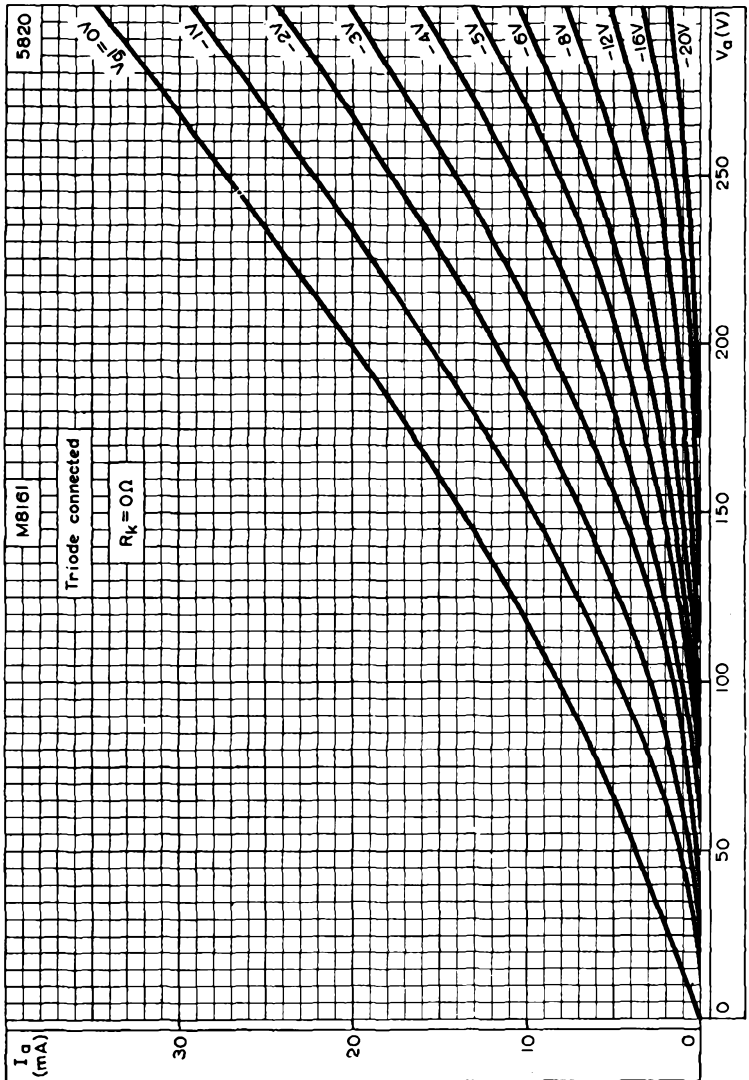

ANODE CURRENT PLOTTED AGAINST ANODE VOLTAGE WITH CONTROL GRID VOLTAGE AS PARAMETER, WHEN TRIODE CONNECTED



SPECIAL QUALITY PENTODE

M8196

Special quality dual control pentode for use in equipment where mechanical vibration and shocks are unavoidable and where statistically controlled major electrical characteristics are required.

This data should be read in conjunction with the GENERAL NOTES—SPECIAL QUALITY VALVES which precede this section of the handbook, and the index numbers are used to indicate where reference should be made to a specific note.

HEATER

V_h^{1}	6.3	V
I_h	175	mA

MOUNTING POSITION

Any

CAPACITANCES² (measured with an external shield)

C_{a-g1}	<20	mpF
C_{in}	4.2	pF
C_{out}	3.2	pF

CHARACTERISTICS³

V_a	120	120	V
V_{g2}	120	120	V
V_{g3}	-3.0	0	V
I_a	3.5	5.1	mA
I_{g2}	4.8	3.5	mA
V_{g1}	-2.0	-2.0	V
$g_m(g1-a)$	2.0	3.2	mA/V
$g_m(g3-a)$	660	450	$\mu A/V$
r_a	—	150	k Ω
$V_{g1}(I_a = 100\mu A)$	—	<-7.5	V
$V_{g3}(I_a = 20\mu A)$	-10	<-15	V
R_k	0	0	Ω

ABSOLUTE MAXIMUM RATINGS

$V_{a(b)}$ max.	400	V
V_a max.	200	V
V_{g3} max.	30	V
$-V_{g3}$ max.	55	V
$V_{g2(b)}$ max.	310	V
V_{g2} max.	155	V
p_a max.	1.65	W
p_{g2} max.	550	mW
R_{g1-k} max.	4.0	M Ω
I_k max.	20	mA
V_{h-k} max.	100	V
Maximum acceleration (continuous operation)	2.5	g
Maximum shock (short duration)	450	g
T_{bulb} max.	165	$^{\circ}C$





TEST CONDITIONS (unless otherwise specified)

V_b	V_a	V_{g3}	V_{g2}	V_{g1}	R_k	V_{b-k}
(V)	(V)	(V)	(V)	(V)	(Ω)	(V)
6.3	120	0	120	-2.0	0	0

TESTS	A.Q.L. ⁵	Individuals ⁶			Lot average ⁷		Lot standard deviation ⁸		
	(%)	Bogey ⁹	Min.	Max.	Min.	Max.	Max.		
GROUP A									
Heater current	{ 0.65	175	160	190	—	—	—	mA	
Heater-to-cathode leakage current	{ —	—	—	—	168	182	4.87	mA	
$V_{h-k} = \pm 100V$	0.65	—	—	10	—	—	—	μA	
Reverse grid current, $R_{g1} = 100k\Omega$	0.65	—	0	0.1	—	—	—	μA	
Anode current	{ 0.65	5.2	2.5	9.0	—	—	—	mA	
	{ —	—	—	—	4.2	6.2	0.8	mA	
Mutual conductance	{ 0.65	3.2	2.5	4.5	—	—	—	mA/V	
	{ —	—	—	—	2.9	3.5	0.26	mA/V	
Sub-group quality level ¹⁰	1.0	—	—	—	—	—	—		
Inoperatives ¹⁶	0.4	—	—	—	—	—	—		
GROUP B									
Insulation									
a-rest, measured at -300V	} 2.5 {	—	100	—	—	—	—	M Ω	
g_1 -rest, measured at -100V		—	100	—	—	—	—	M Ω	
g_3 -rest, measured at -300V		—	100	—	—	—	—	M Ω	



M8196
SPECIAL QUALITY PENTODE

Anode current									
$V_{g1} = -3V, V_{g3} = -10V$	2.5	—	—	200	—	—	—	μA	
$V_{g1} = -3V, V_{g3} = -6V$	2.5	—	5.0	—	—	—	—	μA	
$V_{g1} = -8V$	2.5	—	—	200	—	—	—	μA	
$V_{g1} = -6V$	2.5	—	5.0	—	—	—	—	μA	
Screen-grid current	2.5	—	1.5	5.5	—	—	—	mA	
Change in mutual conductance, $V_h = 5.7V$	2.5	—	—	15	—	—	—	%	
Reverse grid current									
$V_h = 7.5V, V_{g1} = -10V, R_{g1} = 100k\Omega$	2.5	—	0	1.0	—	—	—	μA	
†R.F. noise at anode, $V_{g1} = 0V, R_k = 200\Omega$, $V_{sig} = 15mV, C_k = 0.2\mu F$	2.5	—	—	—	—	—	—		
Vibration, 2.5g min. peak acceleration, $f = 50c/s, R_a = 10k\Omega$	6.5	—	—	150	—	—	—	mV	
Mutual conductance (g_{3-a}), $V_{g3} = -3V$	6.5	—	0.35	1.05	—	—	—	mA/V	
Mutual conductance (g_{1-a}), $V_{g3} = -5V$	6.5	—	0.7	1.7	—	—	—	mA/V	
Capacitances ² (shielded). No applied voltages									
C_{in}	—	—	3.5	4.5	—	—	—	pF	
C_{out}	—	—	2.6	3.4	—	—	—	pF	
C_{a-g1}	—	—	—	20	—	—	—	mpF	
Low pressure voltage breakdown									
Pressure = 55 ± 5 mm Hg	6.5	—	—	—	—	—	—		
Voltage = $500V_{r.m.s.}$. No other applied voltages.									
Microphonic noise at the anode at 50c/s, 15g min. peak acceleration, $V_{a(b)} =$ $V_{g2(b)} = 200V, R_a = 100k\Omega, R_{g2} = 500k\Omega$, $C_{g2} = 2\mu F, V_{g1} = 0V, R_k = 1k\Omega$, $C_k = 1000\mu F, V_{g(sig)} = 175mV$		2.5	—	—	—	—	—	—	
†The valve is tapped with a specified hammer and the output observed on a meter of specified dynamic response.									



TESTS

GROUP C

Base strain test¹²

Glass strain test^{11B}. No applied voltages

*Fatigue*¹⁴

$V_h = 6.3V$. No other voltage applied.
2.5g min. peak acceleration, fixed frequency
 $f = 25c/s$ min. 60c/s max. for 32 hours in
each of 3 mutually perpendicular planes.

Post fatigue tests

Heater-to-cathode leakage current

$$V_{h-k} = \pm 100V$$

Mutual conductance

Reverse grid current, $R_{g1} = 100k\Omega$

Vibration as in group B

Sub-group quality level¹⁰

*Shock*¹⁵

$V_{h-k} = 100V$, No other applied
voltages, 500g.

Post shock tests

Heater-to-cathode leakage current

$$V_{h-k} = \pm 100V$$

Mutual conductance

Reverse grid current, $R_{g1} = 100k\Omega$

Vibration as in group B





Q.L. ⁵ (%)	Individuals ⁶			Lot average ⁷		Lot standard deviation ⁸	
	Bogey ⁹	Min.	Max.	Min.	Max.	Max.	
—	—	—	—	—	—	—	
2.5	—	—	—	—	—	—	
—	—	—	30	—	—	—	μA
—	—	2.2	—	—	—	—	mA/V
—	—	0	0.4	—	—	—	μA
—	—	—	300	—	—	—	mV
6.5	—	—	—	—	—	—	
—	—	—	30	—	—	—	μA
—	—	2.2	—	—	—	—	mA/V
—	—	0	0.4	—	—	—	μA
—	—	—	300	—	—	—	mV

M8196

SPECIAL QUALITY PENTODE

GROUP D

Heater cycling life test

$V_h = 7.5V$ 1 minute on 4 minutes off

$V_{h-k} = 135V$. No other applied voltages

Heater cycling life test end point

Heater to cathode leakage current

$V_{h-k} = \pm 100V$

Stability life test¹⁴

Running conditions. $R_{g1} = 100k\Omega$,
 $R_k = 130\Omega$, $V_{a-e} = 180V$, $V_{g2-e} = 125V$,
 $V_{g1-e} = 0V$, $V_{h-k} = 135V$, $T_{ambient} =$
 Room temperature.

Stability life test end points

Change in mutual conductance after 1 hour 1.0

Intermittent life test

Running conditions. $R_{g1} = 100k\Omega$,
 $R_k = 130\Omega$, $V_{a-e} = 180V$, $V_{g2-e} = 125V$,
 $V_{g1-e} = 0V$, $V_{h-k} = 135V$, $T_{bulb \text{ min.}} =$
 $165^\circ C$.

Intermittent life test end points

Inoperatives ⁶
Heater current
Heater-to-cathode leakage current $V_{h-k} = \pm 100V$
Reverse grid current, $R_{g1} = 100k\Omega$
Change in mutual conductance (individuals)
Change in mutual conductance, $V_h = 5.7V$
Insulation as in group B
Average change in mutual conductance
Sub-group quality level ¹⁰



SPECIAL QUALITY PENTODE

M8196

— — 20 — — — μ A

— — 10 — — — %

	A.Q.L. ⁵ (%)	Min.	Max.	
.. { 500 hours	—	—	—	
.. { 1000 hours	—	—	—	
.. { 500 hours	4.0	160	190	mA
.. { 1000 hours	6.5	160	190	mA
.. { 500 hours	4.0	—	10	μ A
.. { 1000 hours	6.5	—	10	μ A
.. { 500 hours	4.0	0	0.1	μ A
.. { 1000 hours	6.5	0	0.1	μ A
.. { 500 hours	4.0	—	20	%
.. { 1000 hours	6.5	—	25	%
.. { 500 hours	6.5	—	15	%
.. { 500 hours	6.5	50	—	M Ω
.. { 500 hours	—	—	15	%
.. { 500 hours	10	—	—	
.. { 1000 hours	15	—	—	



M8196

SPECIAL QUALITY PENTODE

4491

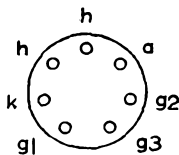
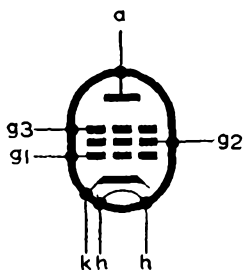

B7G Base

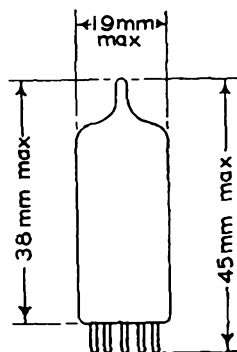

The bulb and base dimensions of this valve are in accordance with BS448, Section B7G.



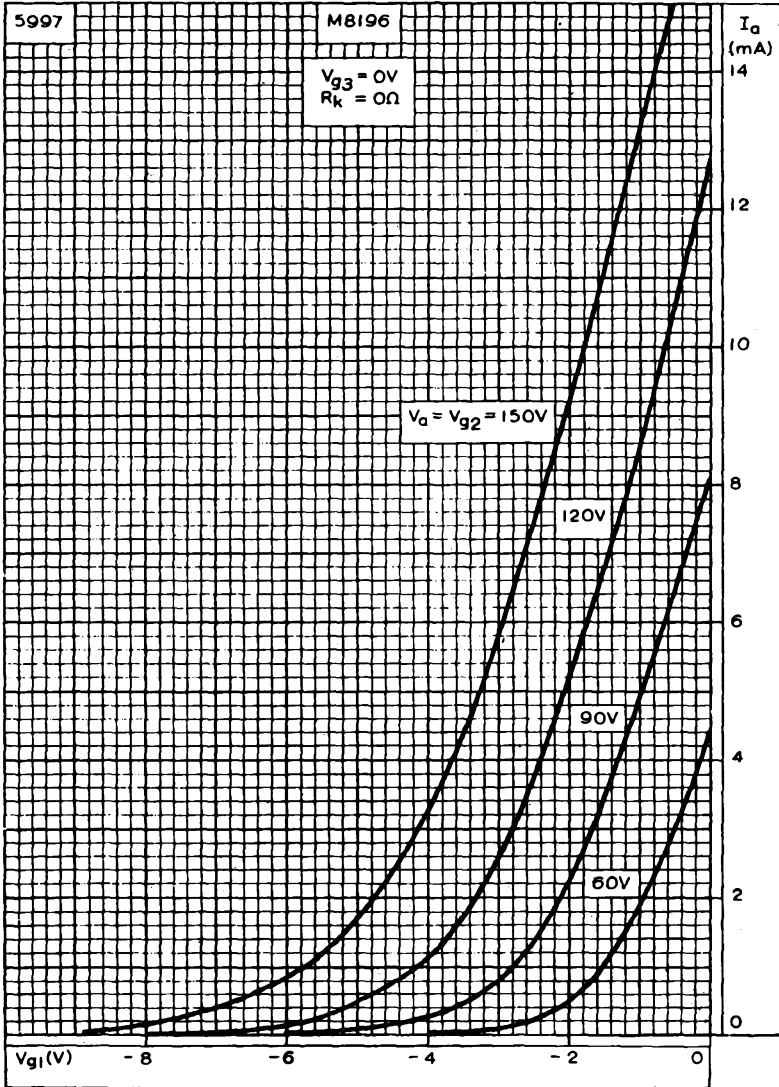

ANODE CURRENT PLOTTED AGAINST CONTROL-GRID VOLTAGE WITH ANODE AND SCREEN-GRID VOLTAGES AS PARAMETER



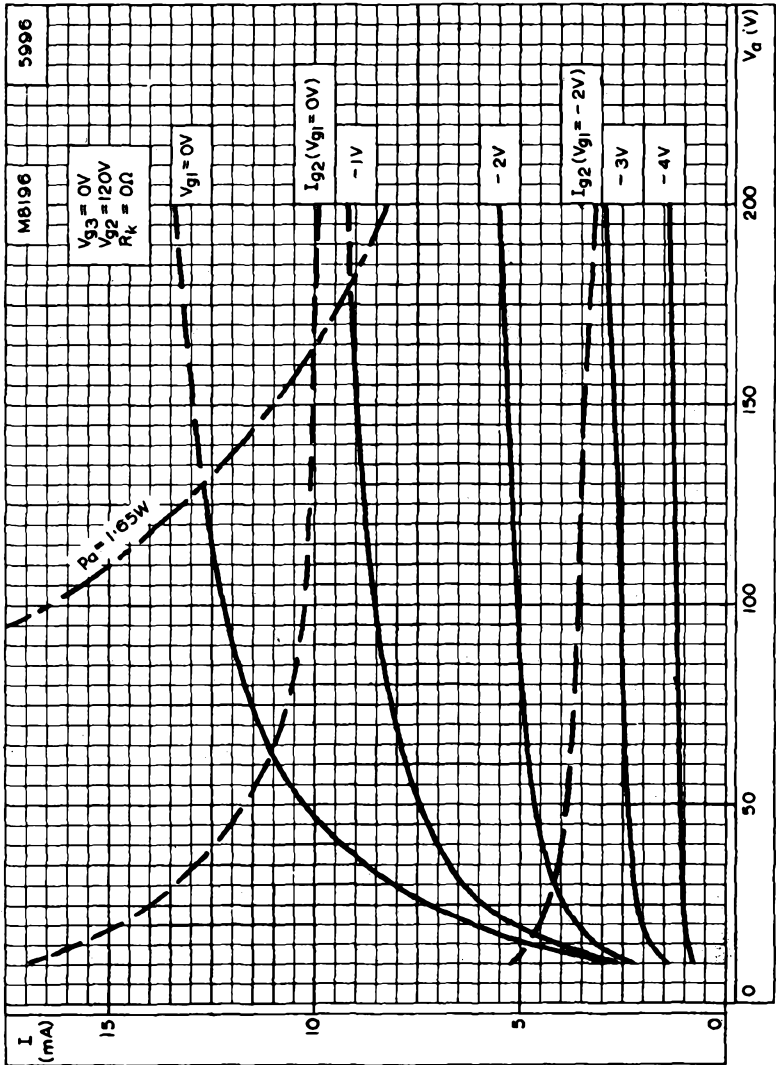

ANODE AND SCREEN-GRID CURRENTS PLOTTED AGAINST ANODE VOLTAGE WITH CONTROL-GRID VOLTAGE AS PARAMETER

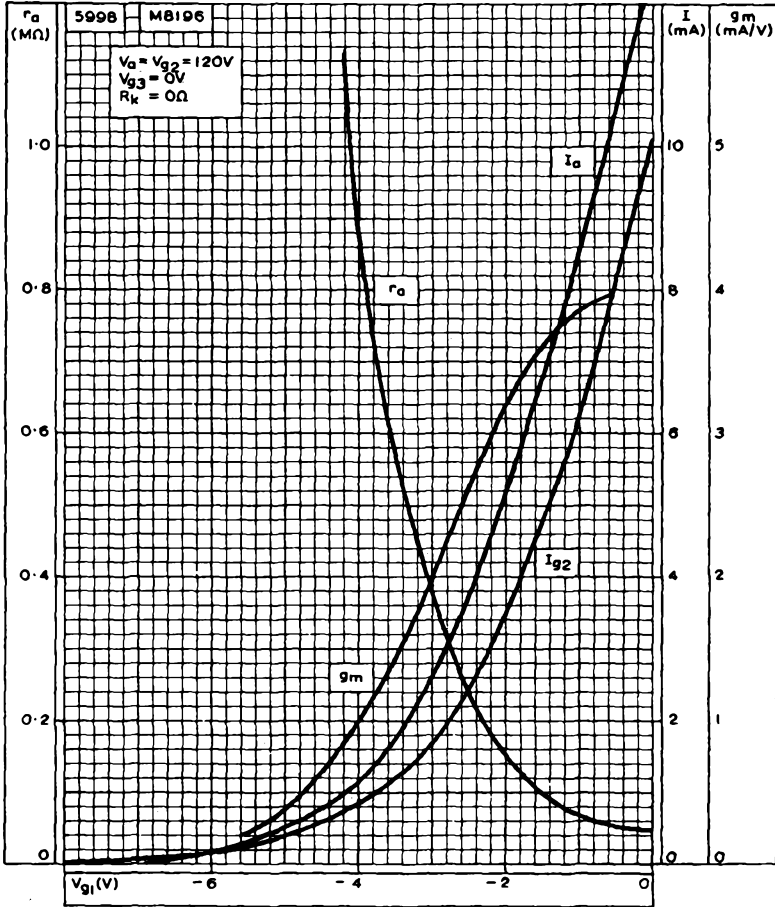

ANODE AND SCREEN-GRID CURRENTS, MUTUAL CONDUCTANCE AND ANODE IMPEDANCE PLOTTED AGAINST CONTROL-GRID VOLTAGE



M8196

SPECIAL QUALITY PENTODE

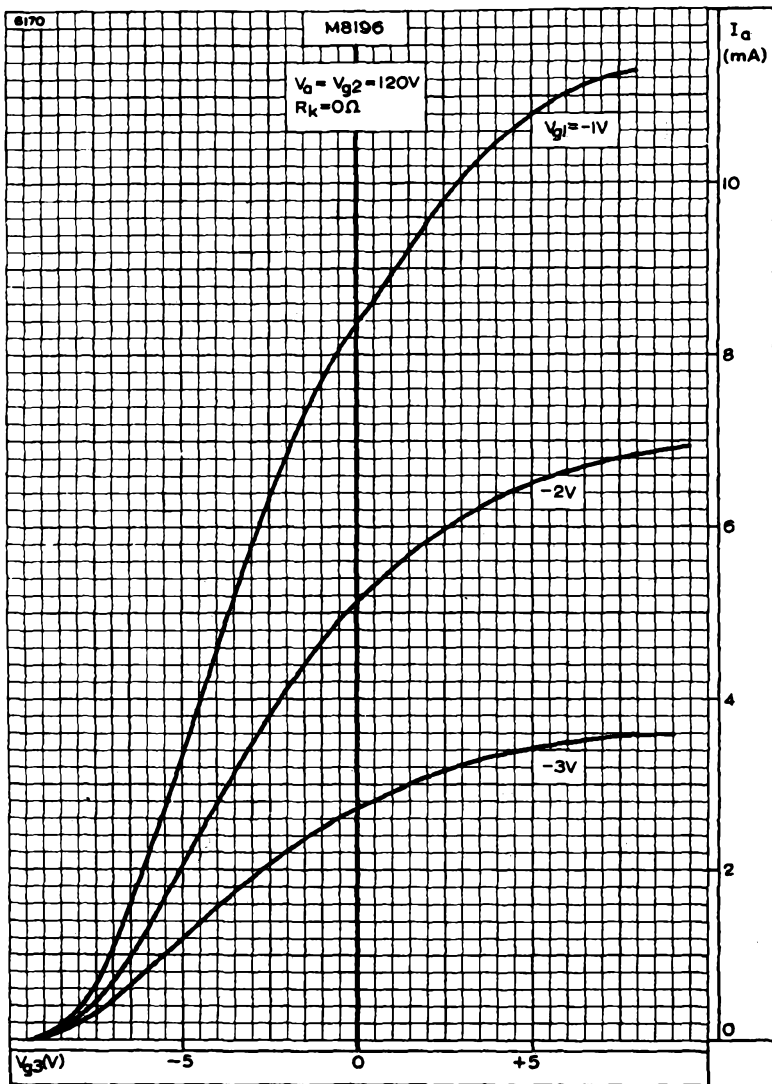

ANODE CURRENT PLOTTED AGAINST SUPPRESSOR-GRID VOLTAGE WITH CONTROL-GRID VOLTAGE AS PARAMETER



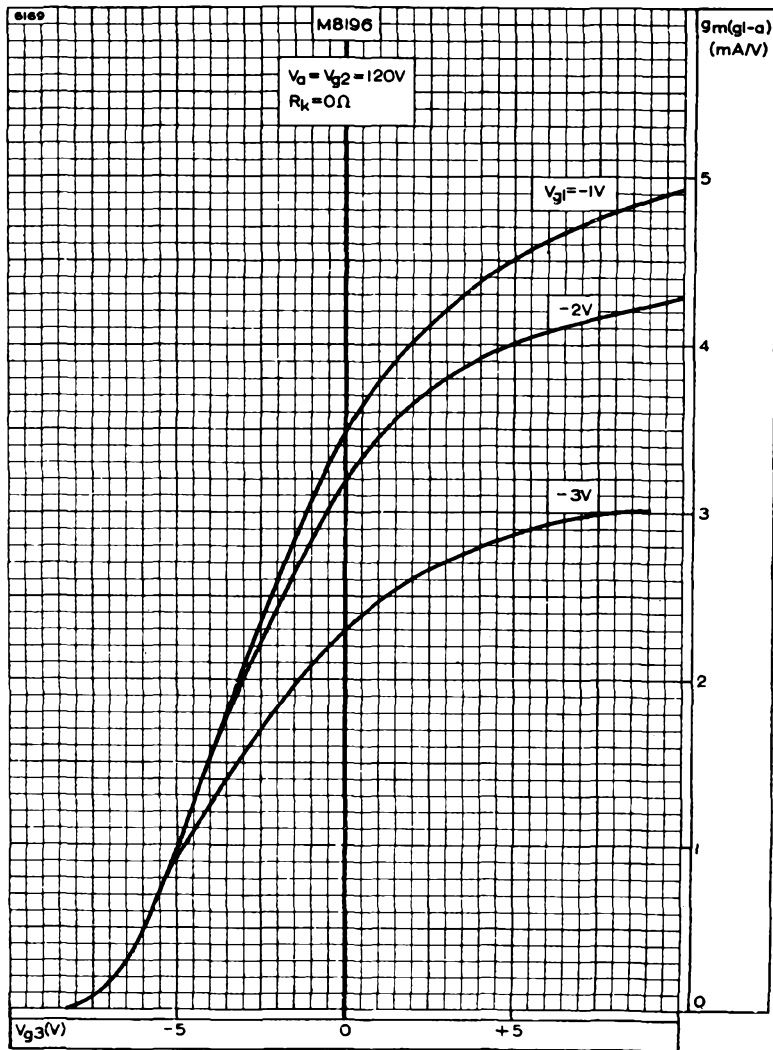

MUTUAL CONDUCTANCE (g_{1-a}) PLOTTED AGAINST SUPPRESSOR-GRID VOLTAGE WITH CONTROL-GRID VOLTAGE AS PARAMETER



M8196

SPECIAL QUALITY PENTODE

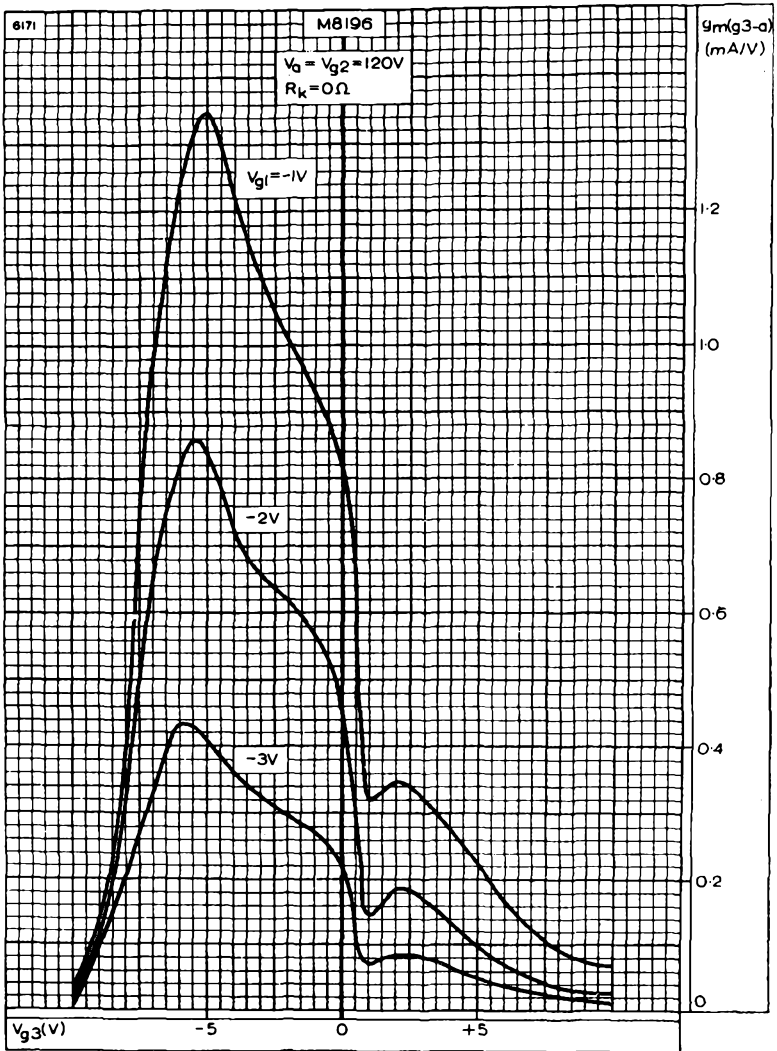

MUTUAL CONDUCTANCE (g_{3-a}) PLOTTED AGAINST SUPPRESSOR-GRID VOLTAGE WITH CONTROL-GRID VOLTAGE AS PARAMETER



ABRIDGED DATA FOR EARLIER TYPES





ABRIDGED DATA FOR EARLIER TYPES

BOOK 2 PART 1—RECEIVING VALVES AND TELEVISION PICTURE TUBES

Abridged data only are given in these tables.

Full data for these types are available on request.

Monochrome picture tubes

Type No.	Description
A44-120W	Export types. Characteristics for these types are identical with types having /R suffix except for omission of the ring trap. Pin No. 5 is omitted.
A50-120W	
A61-120W	

Double diode (separate cathodes)

Type No.	V_h (V)	I_h (mA)	P.I.V. max (V)	I_a (mA)	$i_{a(pk)}$ max (mA)	Base
EB91	6.3	300	420	†9.0	†54	B7G

†Each section

Triode

Type No.	V_h (V)	I_h (mA)	V_a (V)	V_g (V)	I_a (mA)	g_m (mA/V)	μ	Base
PC900	4.0	300	135	-1.0	11.5	14.5	72	B7G

Double triodes

Type No.	V_h (V)	I_h (mA)	V_a (V)	V_g (V)	I_a (mA)	g_m (mA/V)	μ	Base
*E90CC	6.3	400	100	-2.1	8.5	6.0	27	B7G
*E180CC	{ 6.3 12.6	{ 400 200	150	-1.85	8.5	6.4	46	B9A
*E182CC	{ 6.3 12.6	{ 640 320	120	-2.0	36	15	24	B9A
ECC85	6.3	435	250	-2.3	10	5.9	57	B9A
UCC85	26	100	170	-1.5	10.	6.2	50	B9A

*Special quality type



H.F. pentodes

Type No.	V_h (V)	I_h (mA)	V_a (V)	V_{g2} (V)	V_{g1} (V)	I_a (mA)	I_{g2} (mA)	g_m (mA/V)	Base
*E80F	6.3	300	250	100	-2.0	3.0	0.65	1.85	B9A
EF91	6.3	300	250	250	-2.0	10	25	7.6	B7G

*Special quality type

Double diode h.f. pentodes

Type No.	V_h (V)	I_h (mA)	V_a (V)	V_{g2} (V)	V_{g1} (V)	I_a (mA)	I_{g2} (mA)	g_m (mA/V)	Base
EBF89	6.3	300	250	100	-2.0	9.0	2.7	3.8	B9A
UBF89	19	100	200	100	-1.5	11	3.3	4.5	B9A

Triode h.f. pentodes

Type No.	V_h (V)	I_h (mA)		V_a (V)	V_{g2} (V)	V_{g1} (V)	I_a (mA)	I_{g2} (mA)	g_m (mA/V)	μ	Base
PCF80	9.0	300	triode	100	—	-2.0	14	—	5.0	20	B9A
			pentode	170	170	-2.0	10	2.8	6.2	—	
PCF86	8.0	300	triode	100	—	-3.0	14	—	5.7	17	B9A
			pentode	170	150	-1.2	10	3.3	12	—	
PCF801	8.5	300	triode	100	—	-3.0	15	—	9.0	20	B9A
			†pentode	170	160	-1.4	10	3.0	11	—	
PCF806	8.0	300	triode	100	—	-3.0	14	—	5.5	17	B9A
			pentode	170	150	-1.2	10	3.3	12	—	

† Variable- μ

Low noise audio pentode

Type No.	V_h (V)	I_h (mA)	V_a (V)	V_{g2} (V)	V_{g1} (V)	I_a (mA)	I_{g2} (mA)	g_m (mA/V)	Base
EF86	6.3	200	250	140	-2.0	3.0	0.6	2.0	B9A

Power pentodes

Type No.	V_h (V)	I_h (A)	V_a (V)	V_{g2} (V)	V_{g1} (V)	I_a (mA)	I_{g2} (mA)	g_m (mA/V)	Base
*E130L	6.3	1.7	250	150	-15.5	100	4.0	27.5	Octal
EL34	6.3	1.5	250	250	-12.2	100	15	11	Octal
EL84	6.3	0.76	250	250	-7.3	48	5.5	11.3	B9A
†EL822	6.3	0.75	250	250	-7.0	42.5	4.8	12.5	B9A
UL84	45	0.1	170	170	-12.5	70	5.0	10	B9A

*Special quality type

†Video output pentode

Triode i.f. pentodes

Type No.	V_h (V)	I_h (mA)	V_a (V)	V_{g2} (V)	V_{g1} (V)	I_a (mA)	I_{g2} (mA)	g_m (mA/V)	μ	Base	
ECL80	6.3	300	triode	100	—	-2.3	4.0	—	1.4	17.5	B9A
			pentode	200	200	-8.0	17.5	3.3	3.3	—	
ECL82	6.3	780	triode	100	—	0	3.5	—	2.5	70	B9A
			pentode	250	250	-22.5	28	5.7	5.0	—	
PCL82	16	300	triode	100	—	0	3.5	—	2.2	70	B9A
			pentode	170	170	-11.5	41	9.0	7.5	—	
UCL82	50	100	triode	100	—	0	3.5	—	2.5	70	B9A
			pentode	200	200	-16	35	7.0	6.4	—	

Triode heptodes

Type No.	V_h (V)	I_h (mA)	V_a (V)	$V_{g2,g4}$ (V)	V_{g1} (V)	V_{g3} (V)	I_a (mA)	$I_{g2,g4}$ (mA)	g_m (mA/V)	μ	Base	
ECH81	6.3	300	triode	100	—	0	—	13.5	—	3.7	22	B9A
			heptode	160	100	-0.5	0	11	7.0	4.5	—	
PCH200	8.5	300	triode	100	—	-1.0	—	9.0	—	8.8	50	B10B
			heptode	14	14	0	0	1.5	1.3	—	—	
UCH81	19	100	triode	100	—	0	—	13.5	—	3.7	22	B9A
			heptode	160	90	-0.5	0	9.8	6.1	4.3	—	

Half-wave rectifier

Type No.	V_h (V)	I_h (mA)	$V_{in(r.m.s.)}$ (V)	$I_{outmax.}$ (mA)	$C_{max.}$ (μ F)	$R_{limin.}$ (Ω)	Base
UY85	38	100	250	110	100	100	B9A

Full-wave rectifiers

Type No.	V _h (V)	I _h (A)	V _{IN(r.m.s.)} (V)	I _{outmax.} (mA)	C _{max.} (μF)	R _{limin.} (Ω)	Base
EZ81	6.3	1.0	2 × 350	160	50	†230	B9A
GZ34	5.0	1.9	2 × 450	250	60	†150	Octal

†Each anode

E.H.T. rectifiers (pulsed)

Type No.	V _h (V)	I _h (mA)	P.I.V.max. (kV)	i _{a(pk)} max. (mA)	I _{outmax.} (μA)	C _{max.} (pF)	Base
DY86/DY87	1.4	550	22	40	500	2000	B9A
EY51	6.3	90	17	80	350	5000	wires
EY86/EY87	6.3	90	22	40	800	2000	B9A



INDEX

INDEX TO BOOK 2, PART 1

RECEIVING VALVES AND TELEVISION PICTURE TUBES

Type No.	Section	Type No.	Section
A28-14W	•	E180F	F
A31-120W	C	E182CC	G*
A31-410W	C	E186F	•
A44-120W	G*	E188CC	•
A44-120W/R	C	E280F	•
A47-14W	•	E288CC	•
A47-26W	•	E810F	F
A47-26W/R	•	EA52	E
A49-11X	replaced by	EB91	G*
A49-120X	A49-120X	EBF80	•
A50-120W	G*	EBF89	G*
A50-120W/R	C	EC86	•
A56-120X	B	EC88	•
A56-140X	B	ECC81	E
A59-15W	•	ECC82	E
A59-23W	•	ECC83	E
A59-23W/R	•	ECC84	•
A61-120W	G*	ECC85	G*
A61-120W/R	C	ECC86	•
A63-11X	replaced by	ECC88	•
A63-120X	A63-120X	ECC189	•
A66-120X	•	ECC2000	•
A66-120X	B	ECF80	•
A66-140X	B	ECH81	G*
DM70	•	ECH83	•
DM160	F	ECH84	•
DY86	G*	ECL80	G*
DY87	G*	ECL82	G*
DY802	E	ECL83	•
E55L	F	ECL86	•
E80CC	•	EF80	E
E80CF	•	EF83	•
E80F	G*	EF85	•
E80L	•	EF86	G*
E83F	•	EF89	•
E88C	•	EF91	G*
E88CC	F	EF92	•
E90CC	G*	EF95	•
E92CC	•	EF183	E
E130L	G*	EF184	E
E180CC	G*		

* Not recommended for the design of new equipment.
Full data for these types are available on request.

Type No.	Section	Type No.	Section
EL34	G*	PCL85	see PCL805
EL81	.	PCL86	E
EL84	G*	PCL805	E
EL86	.	PD500	.
EL91	.	PFL200	E
EL360	.	PL36	.
EL821	.	PL81	.
EL822	G*	PL81A	.
EM84	.	PL82	.
EY51	G*	PL83	.
EY84	.	PL84	.
EY87	G*	PL500	replaced by PL504
EZ80	.		E
EZ81	G*	PL504	replaced by PL509
GY501	.	PL505	E
GZ34	G*	PL508	E
M8080	F		
M8081	F	PL509	E
M8082	F	PL802	E
M8083	F	PY33	.
		PY81/PY800	see PY800
M8091	.	PY82	.
M8096	.		
M8100	F	PY88	E
M8136	F	PY500	replaced by PY500A
M8137	F		E
M8161	F	PY500A	E
M8162	.	PY800	E
M8196	F	UABC80	.
PC86	.	UBF89	G*
PC88	.	UCC85	G*
		UCH81	G*
PC97	.	UCL82	G*
PC900	G*	UCL83	.
PCC84	.		
PCC85	.	UF89	.
PCC89	.	UL84	G*
		UY85	G*
PCC189	.	6AS6	E
PCF80	G*	6080	.
PCF86	G*		
PCF801	G*		
PCF802	E		
PCF806	G*		
PCH200	G*		
PCL82	G*		
PCL83	.		
PCL84	E		

* Not recommended for the design of new equipment.
Full data for these types are available on request.

RECEIVING VALVES, TELEVISION PICTURE TUBES

CONTENTS

 **SELECTION GUIDE (see coloured pages)**

 **A GENERAL SECTION—TV PICTURE TUBES**

 **B COLOUR PICTURE TUBES**

 **C MONOCHROME PICTURE TUBES**

 **D GENERAL SECTION—RECEIVING VALVES**

 **E RECEIVING VALVES**

 **F SPECIAL QUALITY RECEIVING VALVES**

 **G ABRIDGED DATA FOR EARLIER TYPES**

 **INDEX**

Mullard Limited
Mullard House, Torrington Place, London, WC1E 7HD

Printed in England

TP1421