

BROADCAST TRANSMITTER

BTA-1L

Power $\left. \begin{array}{l} 1000 \\ 500/1000 \\ 500 \\ 250/1000 \\ 250/500 \end{array} \right\}$ **WATTS**



INSTRUCTION BOOK

WARNING

THE VOLTAGES EMPLOYED IN THIS EQUIPMENT ARE SUFFICIENTLY HIGH TO ENDANGER HUMAN LIFE AND EVERY REASONABLE PRECAUTION HAS BEEN OBSERVED IN DESIGN TO SAFEGUARD THE OPERATING PERSONNEL. AN IMPORTANT PART OF THE PROTECTIVE SYSTEM IS THE SERIES OF DOOR INTERLOCK SWITCHES AND ANY TAMPERING WITH THESE SWITCHES SHOULD BE PROHIBITED. THE POWER SHOULD BE REMOVED COMPLETELY BEFORE CHANGING TUBES OR MAKING INTERNAL ADJUSTMENTS.

FIRST AID IN CASE OF ELECTRIC SHOCK

1. PROTECT YOURSELF with dry insulating material.
2. BREAK THE CIRCUIT by opening the power switch or by pulling the victim free of the live conductor.

DON'T TOUCH VICTIM WITH YOUR BARE HANDS until the circuit is broken.

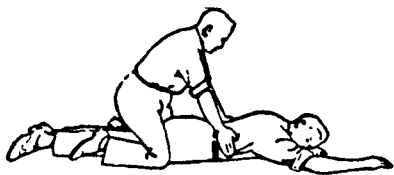

(A)

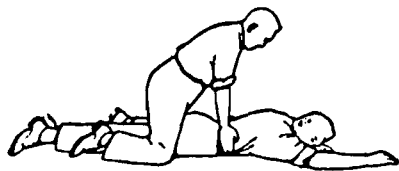

(B)

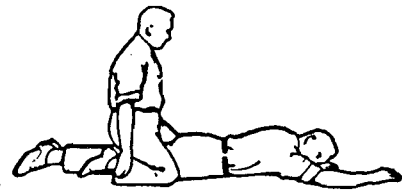

(C)

3. LAY PATIENT ON STOMACH, one arm extended, the other arm bent at elbow. Turn face outward resting on hand or forearm.
4. REMOVE FALSE TEETH, TOBACCO OR GUM from patient's mouth.
5. KNEEL STRADDLING PATIENT'S THIGHS. See (A).
6. PLACE PALMS OF YOUR HANDS ON PATIENT'S BACK with little fingers just touching the lowest ribs.
7. WITH ARMS STRAIGHT, SWING FORWARD gradually bringing the weight of your body to bear upon the patient. See (B).
8. SWING BACKWARD IMMEDIATELY to relieve the pressure. See (C).
9. AFTER TWO SECONDS, SWING FORWARD AGAIN. Repeat twelve to fifteen times per minute.
10. WHILE ARTIFICIAL RESPIRATION IS CONTINUED, HAVE SOMEONE ELSE:
 - (a) Loosen patient's clothing.
 - (b) Send for doctor.
 - (c) Keep patient warm.
11. IF PATIENT STOPS BREATHING, CONTINUE ARTIFICIAL RESPIRATION. Four hours or more may be required.
12. DO NOT GIVE LIQUIDS UNTIL PATIENT IS CONSCIOUS.

SUPPLEMENT AND ERRATA
-
INSTRUCTION BOOK
FOR
ETA-1L BROADCAST TRANSMITTER

Disposition: To be inserted in IB-30118

The following additions and changes should be made in the instruction book text, parts list, and photographs for the Type ETA-1L Broadcast Transmitter (IB-30118).

Page 19 - Under "Maintenance," supplement the notes on inductors as follows:

It is imperative that inductors (rotary coils) 1L5, 1L7, 1L9, 1L10, and 1L11 be kept clean at all times. This involves not only the removal of all dirt and dust but also cleaning of the electrical contact surfaces where oxidation may be present.

Deposits of dirt on the inductor slide shaft and wheel assembly will create a high-resistance joint which may cause heating and resultant damage to the spring and wheel contacts. It is particularly important that the slide shaft be kept clean and smooth. Use a clean, fine brush or a hand blower to remove all loose material. If a film or cake of dirt has formed, remove with a clean, soft cloth dipped in carbon tetrachloride. It is unnecessary to use a lubricant of any kind on the slide shaft or wheel assembly.

The ceramic coil form should also be treated as described in the preceding paragraph. If foreign deposits are present on the form between coil turns, clean with a cloth dipped in carbon tetrachloride.

To maintain the proper contact between the coil and slider, it is necessary to keep the coil contact surfaces clean. If a hand blower or a clean cloth dipped in carbon tetrachloride does not clean the surface properly, polish with crocus cloth applied lightly to avoid removal of the plating. **NEVER USE SANDPAPER NOR EMERY CLOTH FOR THIS PURPOSE.**

(over)

RADIO CORPORATION OF AMERICA
ENGINEERING PRODUCTS DEPARTMENT
Camden, New Jersey, U.S.A.

Printed in U.S.A.

IB-30118-a
11-20-46

Page 22 - Parts List, left-hand column. Change value of capacitor 2C17 to ".0008 mfd."

Page 27 - Figure 7, photograph. Change symbol designations as follows:

2X1 should be 2L13.

2X2 should be 2L14.

2X3 should be 2L15.

2X4 should be 2L16.

Page 28 - Figure 8, photograph. Change symbol designations as follows:

2L6 should be 2L5, 2L12.

2L5, 2L12 should be 2L6.

BROADCAST TRANSMITTING EQUIPMENT

TYPE BTA-1L

MI-7186-B

MI-7187-B

INSTRUCTIONS

**Manufactured by
RADIO CORPORATION OF AMERICA
ENGINEERING PRODUCTS DEPARTMENT**

Camden, New Jersey, U. S. A.

IB-30118
6-14-46

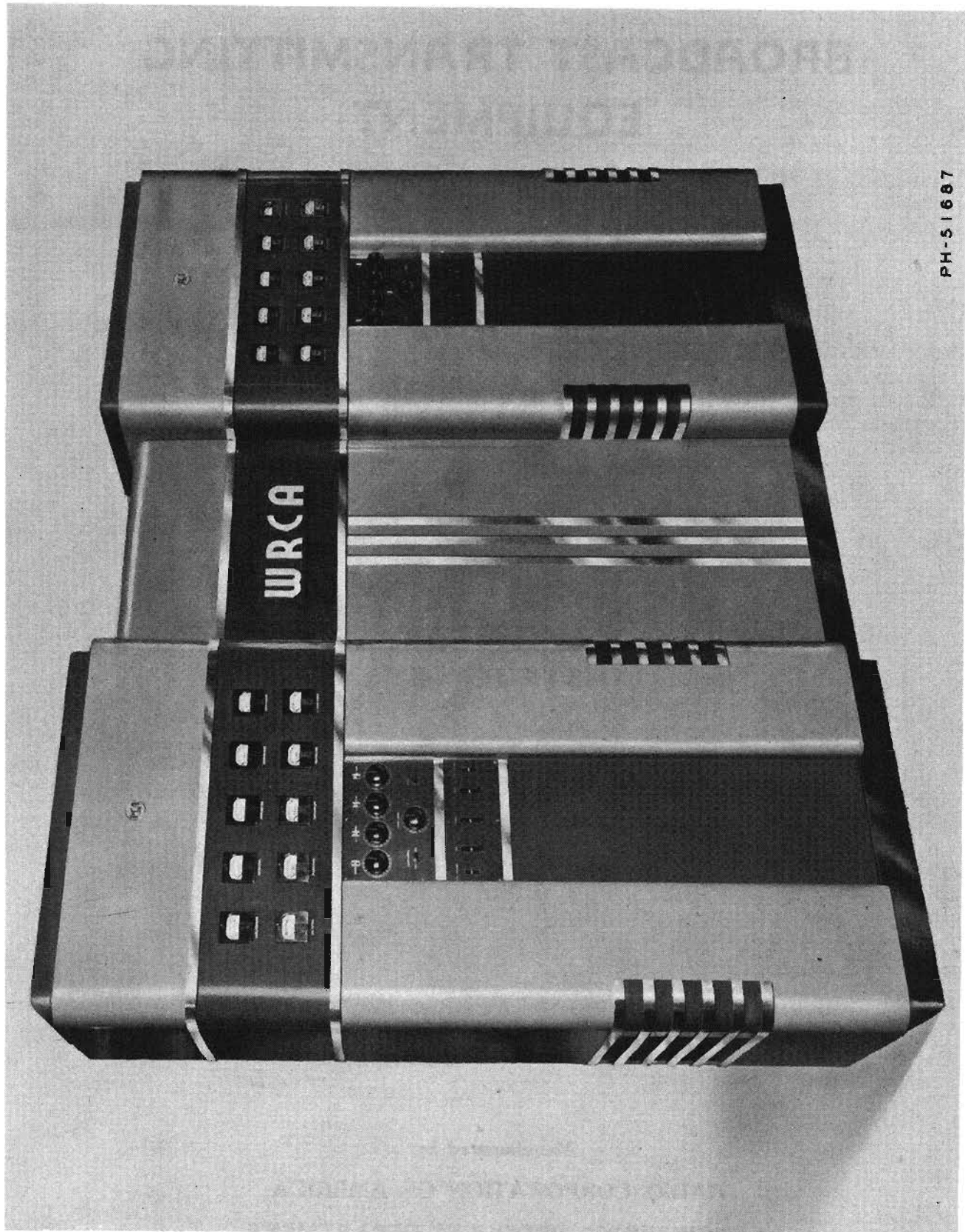

Figure 1—Type BTA-1L Transmitter (Front View)

TABLE OF CONTENTS

Title	Page
SAFETY	Inside Front Cover
TECHNICAL SUMMARY	4
Electrical Characteristics	4
Tube Complement	4
Mechanical Specifications	4
EQUIPMENT	5
DESCRIPTION	5
Construction	5
Circuit Design	6
INSTALLATION	7
Location	7
Assembly	8
Wiring	9
Preliminary Adjustments	10
Tuning	12
Modulator Adjustments	16
Typical Meter Readings	17
OPERATION	18
MAINTENANCE	19
REPLACEMENT PARTS LIST	20

ILLUSTRATIONS

Figure	Title	Page
1	Type BTA-1L Transmitter (Front View)	2
2	Equipment Output Circuit (K-8856608)	15
3	Output Test Circuit (K-863128)	16
4	Transmitter (Front View)	24
5	Exciter Chassis (Rear View)	25
6	Exciter Chassis (Rear View)	26
7	Center Panel (Rear View)	27
8	Amplifier-Modulator Chassis (Rear View)	28
9	Overall Schematic (TT-618413)	29, 30
10	Transmitter Control Circuits (Simplified Schematic, M-426824)	31
11	Exciter Connections (WW-303933)	33, 34
12	Crystal Oscillator Connections (M-429907)	35
13	Center Panel Connections (TT-618412)	37, 38
14	Amplifier-Modulator Connections (WW-303951)	39, 40
15	External Connections (T-618409)	41, 42
16	BTA-250L Connection Changes (P-722508)	43
17	BTA-250L Cabinet Changes (P-714505)	44
18	BTA-1L Transmitter Outline (T-611822)	45
19	Exciter IPA Neutralizing and Buffer Controls (Graph, Dial Setting vs. Frequency, S-853809)	46
20	Exciter IPA Tank and Grid Coupling Controls (Graph, Dial Setting vs. Frequency, S-852919)	47
21	Exciter PA Grid Tank Coil (Graph, Active Turns vs. Frequency, S-852920)	48
22	Output Network Impedance (Graph, Antenna Resistance vs. Network Impedance, S-853830)	49
23	Output Network Reactance (Graph, Carrier Frequency vs. Inductance and Capacity, S-853832)	50
24	Output Network Inductance (Graph, Inductance vs. Turns 2L9 or 2L10, S-853831)	51

TECHNICAL SUMMARY

ELECTRICAL CHARACTERISTICS

Frequency Range	540 to 1600 kc
Frequency Stability	±10 cycles
Carrier Shift	Less than 5 per cent from 0 to 100 per cent modulation (50 to 7500 cycles)
R-F Harmonics	Less than 0.05 per cent
Power Outputs (20 to 250 ohms unbalanced load)	250/500, 250/1000, 500/1000, 500, 1000 watts
Output Circuits	Usual antenna, or 70- to 600-ohm transmission line
Type of Modulation	High level, class B
A-F Input Level	
At 100 per cent modulation (sine wave)	+11 dbm
At average program level	+3 vu
A-F Response	Within ±1.5 db from 30 to 10,000 cycles
A-F Distortion	Less than 3 per cent r-m-s from 50 to 7500 cycles
Noise Level	60 db below 100 per cent modulation level
Main Power Supply	220 to 240 volts, 50/60 cycles, single phase
Permissible Line Voltage Variation	±5 per cent
Power Consumption at 1000 watts r-f output	(at 100 per cent modulation) approx. 5700 watts
	(at average program level) approx. 4500 watts
Power Consumption at 500 watts r-f output	(at 100 per cent modulation) approx. 4900 watts
	(at average program level) approx. 3700 watts
Power Consumption at 250 watts r-f output	(at 100 per cent modulation) approx. 4450 watts
	(at average program level) approx. 3350 watts
Crystal Heater Power Supply	115 volts, 50/60 cycles, single phase
Power Consumption	30 watts

TUBE COMPLEMENT

Exciter—Amplifier Unit "250-L" (MI-7320)

Crystal Oscillator	1 RCA-807
Buffer	1 RCA-828
Intermediate Power-Amplifier	1 RCA-810
First Audio	2 RCA-6J7
Second Audio	2 RCA-828
Main Rectifier	2 RCA-8008
Bias Rectifier	1 RCA-5Y3-GT

Power-Amplifier Unit (MI-7318)

Power-Amplifier	2 RCA-833-A
Modulator	2 RCA-833-A
Bias Rectifier	2 RCA-866-A/866
Main Rectifier	4 RCA-8008

MECHANICAL SPECIFICATIONS

Number of Cabinets	3
Type of Construction	Vertical Chassis
Floor Area	14.5 sq. ft.

Dimensions (overall)

Width	108 ³ / ₄ inches
Height (including lead-in bushings)	84 ⁷ / ₈ inches
Depth	20 ¹ / ₈ inches
Depth (including rear door swing)	38 ⁷ / ₈ inches

Weight (net)

Exciter-Amplifier Unit	1360 pounds
Power Amplifier-Modulator Unit	1000 pounds
Power Equipment Unit	1050 pounds
Total Floor Load	3410 pounds

EQUIPMENT

This RCA Type BTA-1L Broadcast Transmitting Equipment is identified by the Stock Number MI-7186-B and is comprised of the following items:

Quantity	Item	Stock No.
1	Type BTA-250L Exciter	MI-7281-B
1	Type BTA-1L Power-Amplifier Unit	MI-7185-A
1	Type BTA-1L Power Equipment Section	MI-7284-A
2	Type TMV-129B Crystal Unit Complete with Crystal	MI-7467
1	Power Change Equipment (supplied only if 250/500, 250/1000 or 500/1000 watt operation is desired)	MI-7188-A
2 Sets	RCA Tubes (See "TUBE COMPLEMENT")	
	Exciter Unit	MI-7320
	PA-Mod. Unit	MI-7318
2	Instruction Books	IB-30118
1	Touch-up kit	MI-7443
1	Set Miscellaneous hardware	MI-7474
1	RF output meter (Specify scale)	MI-7157-B
1	Set call letters (Optional)	26910-1

The RCA Type BTA-1L Amplifier Equipment (for use with BTA-250L Transmitter already installed) is identified by the Stock Number MI-7187-B, which is comprised of the following items:

Quantity	Item	Stock No.
1	Type BTA-1L Power-Amplifier Unit	MI-7185-A
1	Type BTA-1L Power Equipment Section	MI-7284-A
1	Conversion Kit (to convert Type BTA-250L Transmitter for use as an Exciter)	MI-7280-A
1	Power Change Equipment (supplied only if 250/500, 250/1000 or 500/1000 watt operation is desired)	MI-7188
2 Sets	RCA Tubes for BTA-1L Power Amplifier-Modulator and BTA-1L Power Equipment Section. (See "TUBE COMPLEMENT")	
2	Instruction Books	IB-30118
1	R-F Output Meter (Specify scale)	MI-7157-B

DESCRIPTION

This transmitter will provide reliable, high fidelity operation at any frequency between 540 and 1600 kc with negligible distortion and low carrier noise. It is very easily installed, requiring only the connection of external wiring and the bolting of cabinets together. When the Type BTA-1L Amplifier equipment is being added to an existing BTA-250L installation, several minor alterations are required to convert the BTA-250L Transmitter into an exciter for the Type BTA-1L Transmitter. A conversion kit is supplied with the equipment to facilitate the changeover. These changes have been made at the factory on the complete Type BTA-1L Transmitter. The equipment requires a single-phase power supply of 230 volts, 50/60 cycles. The transmitter will deliver rated power into a 70- to 600-ohm transmission line or into any type of antenna normally used with broadcast

transmitters. Convenient terminals are provided for supplying energy to operate modulation and frequency monitors, and a monitoring amplifier.

The transmitter as normally supplied is wired for operation only at its full rated power output of 1000 watts or only at a lower output of 500 watts. If it is desired to operate the equipment at 250/500, 250/1000 or 500/1000 watts, this may be accomplished by using the power change equipment kit listed under "EQUIPMENT." This kit may be added to the transmitter at any time.

CONSTRUCTION—The cabinet enclosures are designed to produce a unified and distinctive appearance as shown by the frontispiece illustration, Figure 1. All necessary controls are grouped conveniently on illuminated panels. Adjustments are facilitated by the liberal provision of meters,

which are mounted at eye level on hinged panels located just above the controls.

Access to the rear of each meter panel is obtained by first operating the release handle, which is reached through a chassis hand-hole from the rear, and then by swinging the panel forward. The panel is held in its raised position by stay joints. The handle which operates the panel-catches operates, in addition, a high voltage interlock switch.

All transmitter components are mounted on vertical type chassis and each is readily accessible from the rear through full-length doors. The opening of these doors operates high-voltage interlock switches. In making repairs and replacements it is necessary to remove the chassis. The edges of all wire holes are rounded, and the holes are of sufficient size to permit wires to be removed or replaced easily should this ever be necessary. Sufficient lengths of wire are provided to permit easy removal of the terminal boards and high voltage terminals. Shields are placed behind the high-voltage terminal bushings to protect them against accidental short circuits. The bushings may be removed and the wires "fished in" if necessary.

The equipment is mounted in three cabinets, shown in Figure 4 as the "BTA-250L EXCITER," the center unit, and the "BTA-1L AMPLIFIER." The "BTA-250L EXCITER" includes the crystal oscillator, the low-power audio and radio-frequency stages, and their power supplies. The center unit contains the heavy power and modulation transformers. The "BTA-1L AMPLIFIER" cabinet contains the power-amplifier stage, components of the modulator stage, and their power supplies.

CIRCUIT DESIGN—A schematic diagram for the complete transmitter is given in Figure 9 and the location of the various meters and controls is indicated in Figure 4. It will be noticed from Figure 9 that the circuit is divided into two sections, one labeled "TYPE BTA-250L EXCITER" and the other "TYPE BTA-1L AMPLIFIER." The various items of the first section are designated by code numbers prefixed by the number "1"; the items of the second section have code numbers prefixed by the number "2." The various sub-divisions of the "BTA-250L" section will be referred to in the following discussion as: oscillator; buffer; intermediate power-amplifier; first audio stage; second audio stage; second audio bias rectifier; exciter plate-voltage rectifier. The sub-divisions of the "BTA-1L" section consist of the power-amplifier, modulator, modulator bias rectifier and power-amplifier plate-voltage rectifier.

The names of the switches and controls on the BTA-250L panel are, in some cases, the same as those on the BTA-1L panel. To avoid confusion, references to controls located on the BTA-250L panel will include the control name, preceded by

the word "exciter" or by "BTA-250L." Similarly, names of the BTA-1L panel controls will be preceded by the word "amplifier" or by "BTA-1L."

Radio-Frequency Circuits—Excellent frequency stability is attained by the use of a low temperature-coefficient crystal installed in a temperature-controlled chamber, and connected across the control grid circuit of the RCA-807 oscillator tube. Vernier frequency control is obtained by an adjustment of capacitor |C| which is connected in parallel with the crystal.

Two stages of r-f amplification follow the oscillator stage. The first, or buffer, stage uses an RCA-828 tube and the second, the intermediate power-amplifier, uses an RCA-810 tube. The power-amplifier stage includes two RCA-833-A tubes, connected in a push-pull circuit.

The power-amplifier is inductively coupled to the antenna or transmission line through a "T" section filter, which effectively reduces radio-frequency harmonics.

Audio-Frequency Circuits—The audio-frequency amplifier consists of two stages of push-pull amplification, the first containing two RCA-6J7 tubes and the second two RCA-828 tubes operated Class "A." The modulator contains two RCA-833-A tubes.

The use of negative feedback around the three a-f stages results in an extremely low order of distortion. The entire audio system is designed in such a manner that it is inherently stable.

A 6-db pad (1A8), is connected across the primary side of the input transformer to the first stage of audio amplification. This serves two purposes: (1) it presents a 600-ohm impedance to any audio frequency supplied to the input terminals, and (2) it provides a 6-db gain in noise level over that which would be present if no such pad were included between the speech amplifier output and the transmitter audio input. If it becomes desirable, for any reason (such as insufficient audio level at the output of the line amplifiers), this pad may be eliminated from the circuit without any serious consequent change in the performance of the transmitter.

Control Circuits—The control circuits provide convenient operation and adequate protection to the tubes and other components. No fuses are used except in the crystal heater circuit, protection elsewhere being afforded by magnetic or thermal circuit breakers.

When the main "LINE" breaker (2S1) is open, all power is removed from the transmitter. However, voltage is still present in the connections between the power input terminals and this breaker, and power is still applied to the crystal heating circuit. When this breaker and 1S1 are closed, the panel illuminating lamps (2A1 and 1A7) are lighted. The "FILAMENT" lamp of the BTA-1L

panel is also lighted when the "LINE" switch (2S1) is closed. The "FILAMENT" breakers (1S2 and 2S2) protect all filament circuits and in addition, serve as filament switches. When these breakers are closed, and 2S1 and 1S1 are closed, filament power is available to all tubes. Under this condition, a buzz in the transmitter should be heard.

This buzz originates at the holding coils of the "PLATE" breakers (1S3, 2S3), and is an indication that the electrodes of the time delay relay (1E4) have not yet "closed." The "PLATE" breakers cannot be closed until this time delay relay which protects the rectifier tube filaments, has operated.

The time delay relay (1E4) is a plunger type, mercury-filled unit. A glass tube, containing two electrodes, is partially filled with mercury, on which floats an iron plunger. The tube is encircled by a solenoid, which is so positioned that, when energized, it pulls the iron plunger down. The mercury displaced by the plunger rises and contacts the electrodes, thus closing that circuit. The velocity of rise of the mercury, or "delay," is controlled by the rate of gas seepage through the porous wall of a gas chamber. For this relay the design is such that an interval of about 30 seconds elapses before the electrode circuit is closed. The circuit is opened, however, about 2 seconds after the relay coil is de-energized.

When the time delay relay contacts are closed, the coil of the auxiliary relay (1E5) is energized. This latter relay de-energizes the holding coils of the "PLATE" breakers (1S3, 2S3), permitting these breakers to be closed (by operation of the front panel levers), and thus allowing application of the plate voltages. The 2 second opening time of relay (1E4) serves to prevent breakers (1S3, 2S3), from opening in case of a momentary power failure. In order to accomplish this, relay (1E5) operates considerably faster than breakers (1S3, 2S3).

Seven interlock switches (1S4, 1S8, 1S9, 2S5, 2S6, 2S7, 2S8) are connected in series with the primary power circuits of the plate transformers. The "PLATE" indicator lamps (1A4 and 2A2), located on the control panels, are connected directly across the primary terminals of the plate transformers. These lamps are illuminated when the transformers are energized.

Power Supply Circuits—A full-wave rectifier con-

taining two RCA-8008 tubes supplies plate voltage for the oscillator, buffer, and intermediate power-amplifier, and for the first and second stages of audio amplification. Bias voltage for the second audio stage is supplied by a rectifier using an RCA-5Y3-GT tube. A full-wave, bridge-type rectifier employing four RCA-8008 tubes supplies plate power for the power-amplifier and modulator. Modulator bias is provided by a rectifier using two RCA-866A/866 tubes.

Power reduction may be obtained by means of the resistors which are connected, in series with the high-voltage plate supply of the power-amplifier and by changing the connections to the taps on the plate transformer (2T7). The wiring diagram, Figure 14, shows the connections which are required for different power operating conditions. For 500/1000-watt operation, the resistors 2R26 to 2R33 are combined to total 2050 ohms (maximum). For 250/1000-watt operation, these resistors are combined to total 4600 ohms (maximum). For 250/500-watt operation, the plate voltage is reduced by means of the taps on the plate transformer, and the change is obtained with the resistors combined to total 2050 ohms. One of these power change resistors is variable in order that adjustments may be made as required for a specific installation. When the power change is desired, these resistors may be inserted and removed from the circuit by means of a relay (2E1), which is operated by the "POWER CHANGE" switch (1S7), located on the control panel of the exciter unit. When the transmitter is to be operated only at 500 watts, the plate voltage may be reduced by means of the taps on the plate transformer. In this case the relay, resistors and switch are not employed. When the modulator is operated at reduced plate voltage, such as in 500 and 250/500-watt operation, it will be necessary to change wires numbered 43 and 44 (Figure 14) from taps 1 and 2 on the modulator bias transformer (2T5) to taps 4 and 5.

Monitoring Provisions—Terminals 15C and 16C are provided for connection of an audio-frequency monitor. A maximum level of approximately +10 vu is available. A jack is provided in the buffer stage for connection of the frequency monitor. Another jack is provided in the power-amplifier for connecting the modulation monitor. An extra plug is supplied to permit connection of a cathode ray oscillograph for sampling the r-f voltages.

INSTALLATION

LOCATION—The location of the transmitter should be carefully selected and provision made for external connections before the unit is set in place. Reference to the outline drawing, Figure 18, and the interconnection diagram, Figure 15,

will facilitate this preliminary work. It is of the utmost importance that the transmitter frame be securely grounded by short connections. For this purpose a 2 or 3 inch copper strip is recommended. There should be adequate circulation of

air to prevent the room temperature from ever exceeding 113° F. under the most severe conditions. Ample working space should be allowed at the rear as well as at the front of the unit. A generous allowance of space around the transmitter will not only facilitate inspection and servicing but will also improve the general appearance of the installation.

ASSEMBLY—The entire transmitter is delivered to the station site as completely assembled and wired as is consistent with safe transportation. Items such as tubes, crystals, etc., are grouped for safe and convenient handling in transportation. On the exciter unit, the low-power audio shield, the control panel illuminating lamp, and the glass for the control panel illuminating lamp are removed and packed in a separate case. The audio shield should be mounted by simply pushing the spring fasteners into the holes provided. The panel illuminating lamp and glass should be mounted behind the meter panel door. The Transtat Line Voltage Control (2T2), the Power Amplifier Tank Inductor (2L7), the Harmonic Tank Inductors (2L9 and 2L10), the Harmonic Tank Capacitors (2C15, 2C16, 2C17), the panel lamp, the panel lamp glass, and bushings for the transmission line connectors are removed and packed separately. In mounting the Transtat, place the coupling damper in the coupling assembly connecting the panel control to the Transtat. The coupling damper is packed with the Transtat unit. The coupling should be so connected that when the slider bar is at the bottom of the Transtat, the counter indicates 000. In use, the counter should not be run beyond the range bounded by 000 and 020, otherwise the calibration will be lost, since the control and counter can be turned past the point where the slider bar reaches the limit of its travel. The Power Amplifier Tank Inductor should be coupled to the panel control shaft by means of the tapered pin. The tapered pin is taped to the inductor for shipping. The rotor should be at right angles to the stator when the counter indicates 000. After these units are mounted in the amplifier unit, all controls should work freely without binding. The photographs and drawings included at the rear of this book will be found of great assistance in reassembling those components which are disassembled for safe transportation.

The transmitter units are mounted on wooden skids and packed front down in strong wooden boxes. After the boxes have been removed, the units should be set in an upright position and moved near the final location. They should then be blocked up in such a manner that the bolts under the unit which fasten the skids to the frame may be removed. When these bolts have been removed, the blocks should be removed and the units slid from the skids into place.

NOTE—If the amplifier equipment is being added

to an existing Type BTA-250L Transmitter, it will be necessary to cut the trim strips and drill several holes to permit mounting the enclosure between the exciter and power-amplifier units. These operations are not necessary on the complete transmitter. Figure 17 gives complete information as to size and location of the necessary holes. A special padded tool is supplied in the miscellaneous hardware kit (MI-7281-A) for cutting the trim strips. Using a straight edge, mark the proper cutting points on each trim strip as indicated in Figure 17. Next remove the accessible nuts that hold the strips in place and slip the wedge-shaped tool under the strip to the indicated cutting point previously marked. A slot in the tool is then used to guide the hack saw blade in cutting the strip. The curved portion of the strip should then be pulled back in place by replacing the washers and nut on the remaining stud.

The BTA-250L exciter unit is provided with chassis hand holes beneath the transformers 1T5 and 1T3 to permit the complete removal of trim strips for cutting. The nuts holding the two upper strips may, of course, be removed by opening the meter panel door. Use of the tool, however, is very simple, and may be preferred. After cutting, the end of each strip should be given an application of lacquer to prevent its rusting.

The center unit panel should be bolted to the exciter cabinet. Note that the center unit horizontal trim strips are about $\frac{1}{8}$ inch longer than necessary. The excess should be cut off as necessary to allow proper fitting to the exciter cabinet. The amplifier cabinet should then be moved into its proper location and bolted to the center panel. The vertical trim strips should then be adjusted to the edge of each cabinet. Reference to Figures 17 and 18 may facilitate the understanding of these operations. The station call letters should be installed at this time. Milled edges are provided on the two strips to hold the letters in place. These milled edges fit into milled slots in the top and bottom edges of the letters. The slots are milled off center, and the thicker of the two slot walls should be placed behind the trim strips so that when the nuts which hold the trim strips in place are tightened, the letters will be held rigidly in place. The letters should be properly spaced before these nuts are tightened.

The center cabinet should now be moved into the space between the two end cabinets and set so that its rear edges are flush with the other two cabinets. The strips which are supplied to bridge the gaps between cabinets should then be placed in position. It is necessary to drill and tap holes in the exciter and the amplifier cabinets so that the strips will fit the individual installation. These strips should be used as templates for locating the holes. Instead of tapping the exciter and amplifier cabinet holes, the holes may be drilled large enough to pass the screws, which should then be held in place by nuts.

WIRING—The interconnection diagram, Figure 15, supplies sufficient information to enable the selection of the proper conduits and wire sizes required in any particular installation. The conduits should be terminated so as to clear the bottom plate in the transmitter, in order that the wires may be brought through the wire holes and fanned out in such a manner that the cover plates may be screwed in place when the connections have been completed. The outline drawing, Figure 18, contains dimensions for locating and terminating the conduits under the transmitter units. All connections between units should be made as indicated in Figure 15. The two r-f leads to the grids of the power-amplifier tube, and the four a-f leads to and from the modulator driver transformer (2T1) should be run through the holes provided (V, V₁, W, W₁, X, X₁, Y and Y₁) as shown. The rest of the connections between units may be run through the center cabinet, and should enter the exciter and amplifier cabinets through the rectangular holes near the base.

NOTE—If the Type BTA-1L Amplifier is being added to an existing Type BTA-250L Transmitter installation, it will be necessary to make a few connection changes to convert the BTA-250L Transmitter into a BTA-250L exciter. These changes are described in the following fifteen paragraphs, and are shown on Figure 16. The necessary connectors and parts are supplied in the kit of conversion parts.

1. Mount the resistor capacitor boards, M-428-765-501 and 502, in the first audio stage, utilizing 1C31 and 1C32 mountings, and make connections as shown in Figure 16. The solid lines in Figure 16 indicate connections to be added and the dash-dot lines indicate connections to be removed. The schematic diagram, Figure 9, may be of assistance in making the correct connections.
2. Open the BTA-250L meter panel door. Remove the plate leads 39 and 40 at the insulated bushings, 5D and 6D (refer to Figure 11). Tape the ends of these leads, first with varnished cloth tape and then with friction tape. Then lace these two leads into the left wire cable in order to keep them clear of other equipment and to preserve a neat appearance.
3. Mount the "R-F OUTPUT" ammeter (1M7) in the meter panel and connect meter terminals "H," and "+" to bushings 1D and 2D, respectively. Then connect the unmarked terminal to bushing 3D with the 26/0.10, 300-volt insulation black wire supplied.
4. Remove the 500-ohm bias bleeder resistor (1R48) from the bias supply chassis. Replace it with the 2000-ohm, 10-watt resistor supplied.
5. Remove the 270-mmfd capacitors (1C45, 1C46) from the terminal boards adjacent to the first audio stage tubes (RCA-6J7) and replace them with the 1200-mmfd capacitors supplied.

6. Remove the 5600-ohm resistor (1R45) from the terminal board adjacent to the audio input transformer (1T8) and replace it with the 2200-ohm resistor supplied.

7. Remove the 220,000-ohm resistors (1R43 and 1R44) from the terminal boards adjacent to the first audio stage tubes (RCA-6J7) and replace them with the 68,000-ohm resistors supplied.

8. Disconnect the wires connecting the plates of the second audio tubes (RCA-828) to the top of the BTA-250L feedback ladder (at capacitors 1C33 and 1C36). These are the wires numbered 134 and 136 in Figure 11.

9. Disconnect and remove the twisted pair connecting the BTA-250L feedback ladder (at capacitors 1C78 and 1C79) to terminals 5 and 6 of the audio input transformer (1T8). These are the wires numbered 48 and 49 in Figure 11.

10. Connect a shielded twisted pair (supplied with MI-7280-A) from terminals 19B and 20B (terminal board B) to terminals 5 and 6 of the audio input transformer (1T8). Ground the shield of this cable at the terminal board.

11. Remove the 4000-ohm power-amplifier grid resistor (1R17), which is mounted beneath the amplifier shelf, and replace it with the 5000-ohm resistor supplied.

12. Remove the grid and plate connectors at V6. Only one of the power-amplifier tubes (RCA-810) is used for the exciter. These connectors are shown as part 13 on Figure 11.

13. Remove the wire (number 228, Figure 11) connecting reactors 1L16 and 1L17, and replace it with the 2000-ohm, 10-watt resistor supplied. The reactors are mounted on the rectifier tube shelf.

14. Connect terminals 8 and 9 of the modulation transformer 2T1 (located on the center unit chassis) to the insulated bushings 5D and 6D by means of the low-capacity cable supplied for this purpose.

15. The necessary wiring changes in the power-amplifier tank and coupling circuits are shown in detail in Figure 16. This figure shows the capacitors and associated connections required for the 750-kc to 1000-kc band. The capacitors required for other operating frequencies should be determined from the "CAPACITOR AND P-A TANK TAPS CHART." It will be noticed (from Figure 16) that it is necessary to relocate some capacitors when the Type BTA-250L Transmitter is employed as an exciter. Remove the capacitor ground straps on the capacitors mounted beneath items 1L9, 1L10, and 1L11 as indicated. Remove the connections numbered 4, 14, 15 and 16 on Figure 11 (and shown dash-dot on Figure 16). Add the ten connectors shown as solid lines in Figure 16. These connectors are supplied cut to length in the conversion kit (MI-7280-A). The schematic

diagram, Figure 9, will provide a check on the connections, although the particular capacitors used in each position will depend on the frequency of operation as previously explained. Radio-frequency in-put leads to the power-amplifier should be connected to 1L10 and 1L11 as shown in Figure 15.

Each transmitter-unit frame should be thoroughly bonded to the station ground with copper strip (about 2 inches in width).

Terminals are located at the top of the amplifier unit to provide for connecting the amplifier to the antenna and ground or to an open-wire transmission line. Three-eighths-inch copper tubing is generally used for these leads to the transmitter house wall bushings.

When a concentric transmission line is to be employed, it is generally desirable to bring it into the amplifier unit through the bottom; a knockout is provided in the bottom plate of the amplifier for this purpose. This knockout should be removed before the unit is set in an upright position, otherwise it will be necessary to remove the conduit cover plate and reach in under the base plate in order to perform this operation. Then, when the transmitter unit is set in place, the concentric line may be passed up through an opening in the floor. This opening in the floor should be provided before the transmitter is set in place. The line should be terminated at a point slightly above the chassis, and the center conductor connected to the output terminal of the harmonic tank coil (2L10). The outer conductor should be grounded and fastened to the chassis at some point near its upper end.

When the transmitter is to feed an antenna directly, the antenna current meter is supplied mounted on an insulated panel section, which is located directly behind the window in the dummy meter case on the front panel. The thermocouple is mounted behind the chassis. When the transmitter is to feed a transmission line, and the RCA Type BPA-1 (MI-7423-A) antenna tuner has been purchased, a remote metering kit (MI-19404-A) is supplied in place of the antenna current meter just mentioned. The meter from this kit may be installed directly in place of the dummy meter case, on the front panel. The insulated meter-mounting plate and the associated insulators may be removed, and the 10-ohm adjustable resistor which is supplied for calibrating the meter, can then be installed on the chassis. Two tapped holes are provided for this purpose just below the harmonic tank inductor, 2L9. Connection should then be made as indicated on the wiring diagram, Figure 14.

The 115-volt (nominal) power supply for the crystal heaters should be obtained from an external source, since power must be supplied continuously to the heaters in order that the crystal may be maintained at the proper operating temperature.

WARNING—Operation of this equipment involves the use of high voltages, which are dangerous to human life. The operating personnel must at all times observe all safety regulations. Do not change tubes or make adjustments inside the equipment while the plate voltage is being applied. Do not tamper with the door interlocks. Before proceeding with the adjustments of the transmitter, read the safety notice on the inside front cover of this book.

PRELIMINARY ADJUSTMENTS—All breakers should be opened before power is applied to the transmitter. It should be noticed that when the exciter "P.A. OVERLOAD" and "MOD. OVERLOAD" breakers, and the BTA-1L "MOD. OVERLOAD" breaker (1S5, 1S6 and 2S9 respectively) are open and high voltage is applied to the transmitter, the cathodes of the associated tubes are at a high potential with respect to ground.

Refer to the "CAPACITOR AND P.A. TANK TAPS CHART" and connect the proper capacitors and taps in the various tank circuits. These circuits are normally adjusted for 1000 kc when shipped. Since some capacitors will have been re-located in BTA-250L exciters which have been converted from BTA-250L transmitters, it would be well to refer to the stock numbers and capacity values given in the parts list located at the rear of this book, if any difficulty is experienced. A sufficient number of links and connectors are provided to enable the connecting of any capacitor combination required.

Check the primary tap connections on all transformers. Those in the exciter should be made to the 110-volt tap, with the exception of the plate transformer (1T5), which should be set on the 120-volt tap, so that the rated plate dissipation of the tubes and the capacity of the transformer will not be exceeded. The primary connections in the amplifier should be made to the 230-volt tap.

Insert all tubes in their proper sockets.

CAUTION—Do not connect the plate caps of the 6 RCA-8008 rectifier tubes. Be sure that the plate caps of the RCA-828 tubes ARE connected.

Close the exciter and amplifier "LINE" breakers. The panel illuminating lamps (1A7, 2A1) should light and the "LINE VOLTAGE" meters (1M12, 2M11) should indicate. Adjust the variable transformer (2T2) until the meter 2M11 indicates 230 volts. Check all filament voltages. Adjust the controls 1R23, 1R27 and 1R28 (located on the back of the rectifier chassis) if variation of filament voltages in the exciter unit is necessary. All filament voltages should be brought to within 2 per cent of their rated value.

A total of about 95 volts should be available across the exciter bias-rectifier output. This voltage may be measured across 1C61. Set the po-

CAPACITOR AND P-A TANK TAPS CHART—Frequency (kc)

Coil	Capacitor Schematic Symbol	540-650	650-750	750-850	850-1000	1000-1050	1050-1250	1250-1350	1350-1500	1500-1600
Buffer 1L5.....	—	A	A	B	B	B	C	C	C	C
IPA Neutralizing 1L7.....	—	D	D	E	E	E	F	E	F	F
IPA Plate Tank 1L9.....	1C _B	G	G	G	H	H	H	I	I	I
PA Grid Coupling 1L10...	1C _C	J	J	J	K	K	K	L	L	L
PA Grid Tank 1L11.....	1C _A	M	M	N	N	P	P	Q	Q	R
PA Plate Tank 2L6.....	2C _D 2C _E	S	T	T	T	U	U	U	V	V
Tank Coil 2L7. Approx. No. of Turns NOT Used	—	0 to 5	0 to 10	0 to 10	0 to 10	6 to 12	6 to 12	6 to 12	10 to 12	10 to 12

NOTE—The letters in the above chart are to be interpreted as follows:

A. Connect 1C18 and 1C19 in parallel; connect 1C17 in parallel with 1C27; the combination in series with 1C18, and 1C19. 1C19 and 1C18 are connected from intermediate power amplifier grid to 1C16.

B. Connect 1C18 and 1C19 in parallel; connect 1C17 in series with the combination (1C18 and 1C19 are connected from intermediate power amplifier grid to 1C16).

C. Connect 1C17, 1C18 and 1C19 in series (connect 1C19 to 1C16; connect junction of 1C19 and 1C18 to intermediate power amplifier grid.)

D. Connect 1C20, 1C21 and 1C42 in parallel.

E. Connect 1C20 and 1C42 in parallel.

F. Connect 1C20 and 1C42 in parallel; connect 1C121 in series with this combination.

G. Connect 1C54 and 1C57 in series.

H. Use only 1C48.

I. Use only 1C49.

J. Connect 1C52 and 1C53 in parallel.

K. Use only 1C52.

L. Connect 1C52 and 1C53 in series.

M. Connect 1C48 and 1C51 in parallel.

N. Connect 1C49 and 1C50 in parallel.

P. Connect 1C49 and 1C51 in parallel.

Q. Connect 1C50 and 1C51 in parallel.

R. Connect 1C50 and 1C51 in parallel; connect 1C48 in series with the combination.

S. Connect 2C10 and 2C12 in parallel for 2C_D; connect 2C11 and 2C13 in parallel for 2C_E.

T. Use 2C12 for 2C_D, and 2C13 for 2C_E.

U. Use 2C10 for 2C_D, and 2C11 for 2C_E.

V. Connect 2C10 and 2C12 in series for 2C_D; connect 2C11 and 2C13 in series for 2C_E.

tentiometers (1R22 and 1R54), which are located on the back of the BTA-250L rectifier shelf, fully clockwise to provide maximum 2nd audio amplifier bias voltage.

Allow the filament voltages to remain on. Insert the crystal holders in their proper sockets. Make certain that fuses (F₁, F₂) are installed in the fuse holders and then connect terminals 17B and 18B to a 115-volt power supply line. The crystal holders should reach their operating temperature (approximately 60° C., 104° F.) in about 30 minutes. Do not proceed further with any adjustments requiring the application of plate voltage during this period, since the rectifier tubes should have filament voltage applied for approximately this length of time before the plate voltage is applied.

NOTE—When an RCA-8008 tube is first placed in service, it should be operated for at least 15 minutes with the normal filament voltage, but without plate voltage applied, in order to properly distribute the mercury within the tube. This procedure need not be repeated unless during subsequent handling, the mercury is spattered on the filament or plate.

CAUTION—During all tuning adjustments, it is essential that the BTA-250L "MODULATOR OVERLOAD" and BTA-1L "MODULATOR OVERLOAD" breakers (1S6 and 2S9) be kept open. Since the audio system will oscillate violently if the feed-back connections happen to be reversed, the plate voltage must not be applied to the audio tubes until after the feed-back polarity has been checked. The check will be described later in this instruction book.

TUNING—The crystal oscillator utilizes an RCA-807 tube with the crystal connected in the control grid circuit. Tuning is accomplished by means of a tapped coil in the plate circuit; each tap covering a certain frequency range as follows:

Band Coverage (kc)	Tap No.
540- 700	1
700-1000	2
1000-1300	3
1300-1600	4

Taps 5, 6, 7 and 8, which cover frequencies from 1600 to 3000 kc, are not used with the BTA-1L.

The proper tap in the oscillator plate circuit (see Figure 9) should be connected before plate voltage is applied. If the oscillator should be sluggish in starting, the tap listed for the next higher frequency band should be employed.

Preliminary tuning adjustments should be made for the exciter. The "BUFFER" (1L5) and "P.A. NEUT." (1L7) panel controls should be adjusted as indicated by the curves in Figure 19. Set the BTA-250L "P.A. PLATE" knob (on the exciter control panel) as indicated by the curves in Figure 20 and adjust the "COUPLING" control for minimum coupling.

After the 30 minute "aging" interval has elapsed, connect the plate connectors to the 2 RCA-8008 mercury-vapor rectifier tubes in the exciter unit. The exciter "PLATE" breaker (1S3) may then be closed, thus applying plate voltage to the high-voltage rectifier. The control circuits should then be checked to see that all elements operate properly as previously described. The "PLATE" breakers should be checked to determine that the holding coil functions properly during the thirty-second warm-up periods, and the operation of the auxiliary relay (1E5), should be checked thoroughly. Each of the rear doors should be opened separately while plate voltage is applied to the rectifier. Opening either door should remove the plate voltage. The meter panels should then be opened to check the operation of the meter panel interlock switches. It should not be possible to ap-

TABULATION OF CONTROLS

EXCITER (BTA-250L)		AMPLIFIER (BTA-1L)	
Panel Designation	Symbol No.	Panel Designation	Symbol No.
BUFFER	1L5	P.A. PLATE	2L6
P.A. NEUT.	1L7	MODULATOR BIAS, LEFT ...	2R16
P.A. PLATE	1L9	MODULATOR BIAS, RIGHT..	2R17
POWER OUTPUT	1R15	LINE VOLTAGE	2T2
LOADING	1L10	POWER OUTPUT	2L7
*NONE	1L11		
POWER CHANGE	1S7	MOD. OVERLOAD	2S9
MOD. OVERLOAD	1S6	LINE	2S1
LINE	1S1	FILAMENT	2S2
FILAMENT	1S2	PLATE	2S3
PLATE	1S3	P.A. OVERLOAD	2S4
P.A. OVERLOAD	1S5		

* 1L11 is controlled by means of the knob at the rear of this inductor. It is accessible from the rear of the chassis after the rear doors have been opened. This control is referred to as "p-a grid tank coil."

ply plate voltage to the rectifier while either meter panel is open.

This check should be repeated immediately after plate voltage has been applied to the BTA-1L rectifier.

When plate voltage is applied, three milliammeters should indicate current. They are, the "OSCILLATOR PLATE" (1M1); the "1ST AUDIO PLATE" (1M9); and the "BUFFER PLATE" (1M2) meters. The indications on these meters should correspond to those given in the chart of "TYPICAL METER READINGS," located in the back of this book.

The "1ST AUDIO PLATE" meter should at first indicate approximately 2.5 ma. When plate voltage is later applied to the modulator stage, the plate current of this stage will change to that listed in the chart of "TYPICAL METER READINGS." Measurement of plate current and plate voltages on the first a-f stage serves as a good check on these circuit elements. The plate voltages to this stage should be read with a high resistance voltmeter, i.e., one having a resistance of at least 1000 ohms per volt.

The oscillator may be checked for oscillation by removing the crystal holder from its socket. When this is done, the oscillator plate current should increase.

The buffer stage may be tuned by means of the control marked "BUFFER" (1L5). It should be adjusted to the point which produces maximum grid current (on meter 1M4) in the intermediate power-amplifier tube. Minimum plate current in the buffer tube should be obtained at approximately the same point. When adjustments are made in the intermediate power-amplifier stage, it may be necessary to readjust the "BUFFER" tuning. It will be noted that the tank capacitors are arranged to form a capacitance voltage-divider in such a manner that when the values designated are used, proper excitation is supplied to the intermediate power-amplifier grid. Links are provided for capacitor connections in all exciter circuits in order that connections may be readily changed.

Excitation for a frequency monitor is obtained from the potentiometer (1R14), which is connected across a capacitor in the ground side of the buffer-tank circuit. This potentiometer is provided in order that the excitation may be adjusted as required. After the frequency monitor has been adjusted, the frequency of the oscillator should be adjusted to zero beat with the monitor by means of the vernier capacitor (1C1) which is connected across the crystal. A screwdriver slot in a bakelite shaft, accessible from the rear of the oscillator unit, is provided for this adjustment. The spare crystal should also be checked against the frequency monitor by inserting it in the socket provided in the oscillator unit. The setting of

capacitor 1C1 will probably be different for each of the two crystals.

A shunt is connected across the intermediate power-amplifier plate-tank meter thermocouple (1M8). This shunt should be removed during the neutralizing adjustment and then replaced. The shunt gives the meter a multiplying factor of approximately 1.6. After the transmitter has been completely adjusted and is operating at normal load, the shunt may be removed if the product of the meter indication and this factor (1.6) is less than 3 amperes.

The intermediate power-amplifier should first be neutralized. Disconnect the two leads connecting the "LOADING" inductor, 1L10, at the point designated as "A" in Figure 16 and bolt them together. Then remove plate voltage from the intermediate power-amplifier by opening the plate lead at some point in the circuit, such as the plate terminal on the exciter modulation transformer (1T6). Close the BTA-250L "P.A. OVERLOAD" breaker (1S5). Then, apply plate voltage to the rest of the exciter and tune the intermediate power-amplifier to resonance by means of the BTA-250L control marked "PLATE."

The approximate setting for this control may be obtained from the intermediate power-amplifier tuning chart, Figure 20. Resonance will be indicated by maximum current on the BTA-250L "OUTPUT CURRENT" meter (1M7) and on the BTA-250L "POWER AMP. GRID" meter (1M4). The intermediate power-amplifier neutralizing control (1L7) should now be adjusted to the point where minimum currents are indicated for the intermediate power-amplifier plate tank and intermediate power amplifier grid circuits. As the neutralizing control is varied, it will be found necessary to readjust the buffer and intermediate power-amplifier plate-tank tuning.

If a noticeable peak on 1M7 and 1M4 is not obtained when tuning over the range of the plate tank inductor ("P.A. PLATE"), the setting of the neutralizing tank coil ("P.A. NEUT.") is probably near the neutralizing point and it should be changed.

Remove the plate voltage; reconnect the plate voltage lead of the intermediate power-amplifier; turn the "POWER OUTPUT" control (1R15) fully counterclockwise; reapply plate voltage and adjust the BTA-250L "P.A. PLATE" control for minimum plate current as indicated by the BTA-250L "POWER AMP. PLATE" current meter (1M3).

The two leads to 1L10, previously disconnected, should be replaced and coils 1L10 and 1L11 should be adjusted in accordance with the data of the tuning charts, Figures 20 and 21. Apply plate power to the r-f stages in the exciter and adjust the exciter "LOADING" control to the point that provides maximum power-amplifier grid currents.

The grid circuit, consisting of "LOADING" coil 1L10, coil 1L11 and the grid tuning capacitor 1CA which is connected across these two coils, should now be tuned to parallel resonance. As this circuit is tuned, it may be found necessary to readjust the BTA-250L "P.A. PLATE" coil (1L9).

If the p-a grid currents are found to be unbalanced when the grid circuit is first tuned to resonance, balance may be obtained by rotating the p-a grid tank coil (1L11) a few turns and then readjusting the "LOADING" control to obtain the proper grid currents (see table: "TYPICAL METER READINGS").

When the proper loading has been obtained, assuming that the BTA-250L "P.A. PLATE" coil (1L9) has been adjusted for minimum intermediate power-amplifier plate current, the intermediate power-amplifier should then be adjusted for maximum efficiency. This condition does not occur at the point of minimum plate current. It is obtained by making the plate-tank circuit slightly capacitive and then adjusting the BTA-250L "LOADING" inductor for the proper output. A few such adjustments may be required to arrive at the point of maximum efficiency.

It is possible to adjust the grid circuit in a manner such that the grids of the power-amplifier are excited in parallel. If the "LOADING" coil (1L10) is tuned to parallel resonance with the grid coupling capacitor and if there is sufficient reactance in the p-a grid tank coil (1L11), one power-amplifier tube (2V1) will be excited directly and the other tube (2V2) will be excited practically in phase through the p-a grid tuning capacitor (1CA). If this improper adjustment should be obtained, only a slight dip will result when the p-a plate tank coil (2L6) is tuned through resonance. Under this condition, when the p-a grid currents are balanced, changing the setting of 1L11 will have little effect on this balance, i.e., changing the inductance of 1L11 will not unbalance the p-a grid currents.

The transmitter, as shipped from the factory, has capacitor 1C58 (which is connected between the low potential terminal of coil 1L10 and ground) short-circuited by means of a link. This link should be removed when the transmitter is operated at a frequency between 540 and 850 kilocycles. When the transmitter is operated at a frequency between 1050 and 1600 kilocycles, capacitors 1C55 and 1C56 should be connected in series between the low potential terminal of 1L10 and ground. This introduces a capacitive reactance at this point in the p-a grid tank circuit and prevents a parasitic condition from existing in the intermediate power amplifier stage in these two bands. No reactance is required at this point during operation in the frequency band between 700 and 1050 kilocycles.

Power-Amplifier Tuning—Initial tuning of the power-amplifier should be performed with only a

portion of the normal plate voltage applied. This may be effected by shifting the lead connected to terminal "2900" on the secondary side of the plate transformer (2T7) to tap "1450." After the circuits have been tuned to resonance, the lead should be returned to the "2900" tap.

The magnitude of the d-c voltage available from the power supply varies, depending upon the transformer secondary taps connected, as follows:

Secondary Terminals Used	Approximate Rectified Voltage (d-c)
0 and 2900.....	2650
0 and 2050.....	1870
0 and 1450.....	1325
2050 and 2900.....	780

The number of turns on the tank coil (2L7) should be adjusted as specified in the "CAPACITOR AND P-A TANK TAPS CHART." At the lower broadcast frequencies, only a few end turns normally will be shorted out of the circuit. If only one or two turns are left unused, they should be "opened" (instead of shorted) by detaching the end turn from its terminal post (inside the coil form) at each end of the coil assembly. The tuning coil (2L6) should be set in its mid-position until the proper taps are found, in order to permit tuning through resonance. The plate tank capacitors, 2C10-11-12-13 should be connected as indicated in the "CAPACITOR AND P-A TANK TAPS CHART," utilizing the connectors supplied with MI-7185A. The output coupling coil 2L7 should be tapped for the assigned frequency as indicated in the chart on page 11. The 833A PA tubes should draw equal plate currents but unbalance may be caused by a slight inequality of capacitance between $2C_D$ and C_E . For a final balance adjustment, vary the taps on each side of 2L7 until the plate currents in the tubes are equalized at resonance. The total number of active turns should remain the same.

Neutralization is unnecessary since fixed neutralizing capacitors are employed.

The plate caps should now be attached to the four RCA-8008 rectifier tubes of the power-amplifier supply.

Close the "PLATE" and "PLATE OVERLOAD" breakers (2S3 and 2S4, respectively) and with the coupling coil set for least coupling, tune for resonance as indicated by a minimum plate current indication on the "P.A. PLATE TOTAL" meter (2M5). With minimum coupling to the antenna, the plate current of the final amplifier tubes should be low since the tubes are unloaded.

Output Circuit—The input of the "T" network must be capacitive to compensate for the inductive reactance of the rotor of 2L7; approximately —J100 ohms at 1000 kc. The resistive component of the "T" network input is approximately

105 ohms at 1000 kc. It is necessary to adjust the "T" network to match this input impedance and the output load impedance. Electrically, the "T" network consists of a low-pass filter in which the series arms (2L9, 2L10) are inductive and the parallel section (2C15-2C17), is capacitive. The equivalent circuit is illustrated in Figure 2. The portion of each coil to be utilized and the selection of the coupling capacitor (2C15-2C17) will depend upon the resistance and reactance of the antenna or characteristic impedance of the transmission line, and on the operating frequency.

The shunt capacity of the "T" network should be of a value which will result in an appreciable number of turns being used on 2L9 and 2L10 to provide harmonic suppression.

Approximate adjustment of the "T" network may be accomplished by varying turns on 2L9 and 2L10 to obtain maximum PA loading and R-F output with the rotor of 2L7 at approximately 45° coupling.

With the "T" network properly adjusted, PA plate tuning will change very little with change in position of the 2L7 rotor.

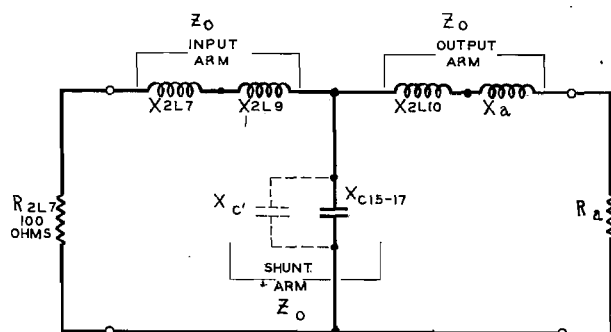

Figure 2—Equivalent Output Circuit (K-8856608)

- Z_0 Characteristic impedance of "T" network (and the impedance of each network arm for 90° phase shift.)
- R_{2L7} 100 ohms } Impedance of
- X_{2L7} + j 100 ohms } 2L7 rotor.
- X_{2L9} Reactance of inductance 2L9.
- X_{2L10} Reactance of inductance 2L10.
- X_a Antenna reactance.
- R_a Antenna resistance.
- X_{C15-17} Reactance of C15 to C17 combination.
- $X_{C'}$ Reactance necessary in shunt arm to conjugate unwanted reactance in other two arms.

The correct values of capacitance and inductance for the output network may be determined by means of Figures 22, 23, and 24.

Knowing the antenna resistance R in ohms, the impedance of the "T" network may be found from Figure 22, where each arm of the "T" is equal to Z_0 . It should be noted that Z_0 is composed of two separate reactances in some instances. Thus: Z_0 of the input arm is the sum of the reactances of 2L7 (+ j 100 ohms, a constant) and 2L9; the value of Z_0 for the output arm is the sum of the reactance of 2L10 and the reactance of the antenna or transmission line; and the reactance of the shunt arm is equal to Z_0 , lowered by any additional reactance necessary to conjugate the reactance in the other arms.

Having determined the value of Z_0 , the inductance of 2L9 and 2L10 in microhenries and the capacitance of the C15 to C17 combination in microfarads may be found by use of Figure 23. The desired C15 to C17 combination may be selected from the following table, using the nearest value to that wanted.

Capacity (mmfd)	Combination
A 5300.....	2C15, 2C16 and 2C17 in parallel.
B 4500.....	2C15 and 2C16 in parallel—2C17 is not used.
C 3800.....	2C15 and 2C17 in parallel—2C16 is not used.
D 3000.....	2C15 alone—2C16 and 2C17 are not used.
E 2300.....	2C16 and 2C17 in parallel—2C15 is not used.
F 1500.....	2C16 alone—2C15 and 2C17 are not used.
G 1000.....	2C15 and 2C16 in series—2C17 is not used.
H 800.....	2C17 alone—2C15 and 2C16 are not used.
I 630.....	2C15 and 2C17 in series—2C16 is not used.
J 520.....	2C16 and 2C17 in series—2C15 is not used.
K 445.....	2C15, 2C16 and 2C17 in series.

The final step is the use of Figure 24 to ascertain the necessary number of turns for 2L9 and 2L10.

The values of capacitance and inductance determined as above should be applied to the network and final adjustments made with the aid of an r-f bridge connected to the input of the network. If a bridge is not available, the following substitution method may be used in adjusting the input resistance of the network to 105-j100 ohms, and the output to the impedance of the antenna or transmission line.

Referring to Figure 3, the coil, L , should be loosely coupled to a low-power source of radio frequency. Only sufficient power to afford a readable deflection on the thermo-galvanometer, G , is necessary. It is desirable that the test circuit be shielded and wired in such a manner that stray capacities are reduced to a minimum. The test resistor, R , should be a non-inductive, 100-ohm

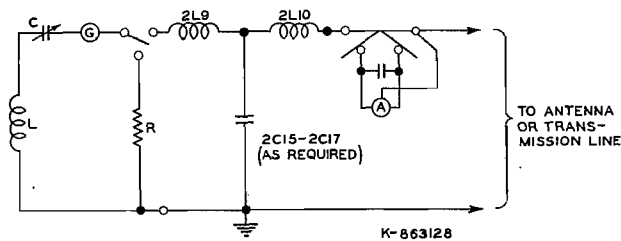

Figure 3—Output Test Circuit (K-863128)

resistor capable of dissipating about five watts. The calculated value of shunt capacitance should be connected in the circuit and adjustments made as follows:

First, throw the switch to the resistor position and adjust capacitor C for maximum current indication. Note the capacitor dial and current readings. If the maximum current indication is too low for accurate observation, increase the coupling slightly.

Shift the switch to the network position and vary the taps of inductor 2L10 until a point is found at which the galvanometer reading is the same as that previously observed when capacitor C was tuned for maximum indication.

When this adjustment has been completed, adjust the taps of 2L9 to a point which gives maximum current indication for the setting of capacitor C used with the switch in the resistance position. Finally, repeat the procedure again and make slight adjustments of 2L9 and 2L10 as required.

A value of X_0 slightly smaller than that calculated must be used to "tune out" the coupling coil inductance. This value can best be determined by inserting a low range r-f ammeter in the input arm of the network, and with very loose coupling and the lowest plate voltage applied, reducing the inductance of 2L9 until the maximum current point is reached.

When the output circuit has been properly adjusted, full plate voltage may be applied and the coupling adjusted for the normal power output as indicated by the antenna ammeter. When the transmitter is to be operated at two output powers, all adjustments should be made at the higher power.

When the antenna network has been properly adjusted, the exciter "POWER OUTPUT" control (1R15) should be rotated until the amplifier grid current meters indicate their recommended value. The grid currents of the two power-amplifier tubes should be balanced, but if not, a slight adjustment of inductors 1L10 and 1L11 will bring them into balance. Check all r-f stage meter readings against the "TYPICAL METER READINGS" table and make whatever adjustments are necessary.

The power output of the final amplifier may be varied by means of the BTA-1L "POWER OUTPUT" control (2L7) if, for any reason, the antenna resistance varies and changes the transmitter load.

When the proper loading has been obtained, assuming that the BTA-1L "P.A. PLATE" variable inductor (2L6) has been adjusted for minimum power-amplifier plate current, the power-amplifier should be adjusted for maximum efficiency. This condition does not occur at the point of minimum plate current. It is obtained by making the plate-tank circuit slightly capacitive and then adjusting the coupling for the proper output. Since there are four positions of the coupling coil (2L7) that give the same degree of coupling, each of these positions should be tried. It may be found that, with the grid currents of the power-amplifier tubes balanced, the plate currents may be slightly unbalanced. This unbalance will usually vary with each of the four positions of the coupling coil. The position which gives the maximum efficiency will usually result in the best balance. It may be necessary then to unbalance the location of the taps on the two sides of the power-amplifier tank coil (2L6) slightly in order to completely balance the power-amplifier tubes.

A cathode resistor is provided in the cathode circuit of each power output tube in order to keep the plate currents of these tubes within the maximum rated value when plate voltage is applied in the absence of excitation. These resistors (2R3, 2R4) are provided with taps. The BTA-250L "PLATE" breaker should be opened and the BTA-1L "PLATE" breakers should be closed, thus applying plate voltage to the power-amplifier tubes with no excitation at the grids. The tap to be used is that which inserts sufficient resistance in the cathode circuits to keep the power dissipation of each tube just under 300 watts. Plate voltage and current for each tube are indicated by the panel meters.

A pickup coil (2L8), which supplies excitation to the modulation indicator, is coupled to the PA plate tank coil. It may be necessary to remove turns from 2L8 to obtain sufficient excitation for the modulation indicator. This adjustment is rather critical and turns should be removed from the coil one at a time. While the adjustment is being made, the coil should be in the position for maximum coupling. After maximum output is obtained, the coupling may be adjusted to the desired value by rotating 2L8 on its mounting.

MODULATOR ADJUSTMENTS—When the r-f stages have been correctly adjusted for normal operation, close the second audio stage plate breaker, BTA-250L "MOD. OVERLOAD" (1S6). (Be sure that the modulator breaker BTA-1L "MOD. OVERLOAD" (2S9) is open before

closing 1S6. Leave breaker 2S9 open during this adjustment.) The tubes should not draw plate current with the grid bias potentiometer set as previously indicated. These potentiometers (1R22 and 1R54) should now be adjusted so that the sum of the plate and screen-grid currents (which is what is actually indicated on the plate current meters) for each of the second audio stage tubes is 80 milliamperes. The designations "LEFT" and "RIGHT" on the meters refer to the tubes as viewed from the front of the transmitter. Taps are provided on the bleeder resistors (1R62 and 1R63), in order that the screen and suppressor voltages of the tubes may be changed when necessary.

CAUTION—Open 1S6 before proceeding.

Inspect the safety gaps on the primary of 2T4. These gaps should have a spacing of 0.050 inch and should always be kept well polished. Next, the grid bias of the modulator tubes should be set by closing the "MOD. OVERLOAD" breaker 2S9 (be sure 1S6 is open before closing 2S9) and adjusting the "MODULATOR BIAS" potentiometers 2R16 and 2R17 for plate current as indicated in the table of "TYPICAL METER READINGS." Approximately 90 volts should be available across the modulator bias rectifier bleeder (2R18). This voltage may be measured across capacitor 2C20 or 2C21.

Since the inverse feed-back is connected externally between the two units, it is quite possible that the polarity of this feed-back has been re-

versed in these connections. It is necessary to check this as follows: Reduce the plate voltage on the modulators by moving the tap connection on the plate transformer (2T7) from tap "2900" to tap "1450." Turn on the transmitter, but do not close the two "MOD. OVERLOAD" breakers (1S6 and 2S9). Next, close the BTA-250L "MOD. OVERLOAD" breaker. Then, observing the modulator plate current meters, close the modulator breaker (2S9). If the indicated modulator plate current is low (between 0 and 50 ma per tube) then the feed-back polarity is correct. However, if the indicated plate current is high (150-300 ma per tube) then the audio system is oscillating, and the feed-back polarity must be reversed. To do this, reverse the twisted pair going to terminals 19 and 20 on terminal board "B" in the exciter unit. Then recheck for oscillation by turning on the transmitter and closing the audio overload breakers. The plate current should no longer rise excessively. Restore the plate voltage to normal value. With correct feed-back polarity, there should be no appreciable change in the no-signal value of the modulator plate current when the BTA-250L "MOD. OVERLOAD" breaker is opened and closed. If necessary, readjust the bias controls for the drivers (RCA-828) and modulators (RCA-833-A) for the correct static (unmodulated) plate currents as indicated in the table "TYPICAL METER READINGS." (When the transmitter is set up for straight 500-watt operation, it is not necessary to further reduce the plate voltage when checking the feed-back polarity.)

**TYPICAL METER READINGS
EXCITER**

Line Voltage 110 Volts

Tube	E_p (volts)	I_p (ma)	E_g (volts)	I_g (ma)	E_{sg} (volts)	E_{sup} (volts)
Crystal Oscillator.....	220	27-29				
Buffer.....	1250	60-70			210	60
Intermediate Power-Amplifier.....	1500	180-205		45-60		
1st Audio.....	220	*7-8			160	
2nd Audio.....	780	80-100	-73		690	65
(per tube).....					670-690	

Plate Tank (Output) Current—2.0 to 4.5 amperes

* This value includes screen current.

TYPICAL METER READINGS AMPLIFIER

Line Voltage 230 Volts					
Tube	1000 Watts	500 Watts Power Change Panel	500 Watts Straight	250 Watts Power Change Panel (250/500)	250 Watts Power Change Panel (250/500)
Grid Current (ma per tube).....	95	1000	100	100	100
Amplifier Plate Current (ma total)..	550	403	403	286	286
Amplifier Plate Voltage (volts)....	2450	1770	1770	1250	1250
*Modulator Plate Voltage (volts)...	2550	2600	1850	1850	2600
Modulator Plate Current (ma) (100 per cent modulation).....	210	160	185	115	100
Modulator Plate Current (ma) 0 per cent modulation.....	50	50	45	48	50
*Modulator Grid Voltage (volts)...	61	61	40	40	61

* Must be measured with an external meter.

OPERATION

After the transmitter has been tuned to the operating frequency and the other adjustments just described have been completed, the equipment is ready for operation. In normal use, with the transmitter shut down, the following breakers should be in their closed position: 1S1, 1S2, 1S5, 1S6, 2S2, 2S4 and 2S9.

To Place the Transmitter in Operation—The following operations should be performed, in the order listed:

1. Close the BTA-1L "LINE" breaker.
2. After the time delay relay has operated, close the BTA-250L "PLATE" breaker.

3. Close the BTA-1L "PLATE" breaker.
4. Adjust the BTA-1L "LINE VOLTAGE" control for 230 volts.
5. Adjust the "POWER OUTPUT" control, if necessary, for correct antenna current.

To Shut Down the Transmitter—The following operations should be performed in the order listed:

1. Open the BTA-1L "PLATE" breaker.
2. Open the BTA-250L "PLATE" breaker.
3. Open the BTA-1L "LINE" breaker.

MAINTENANCE

With ordinary care, little attention will be required to keep this transmitter operating at maximum efficiency. The adoption of a regular inspection schedule will assist in maintaining efficiency and in addition will minimize the possibility of program interruption. The table which follows may be used as a guide to the establishment of a regular maintenance schedule.

General	<ul style="list-style-type: none"> —Keep all equipment free from dust. Use a small electric hand blower, if available. —Inspect and tighten all r-f and ground connections, and connections to terminal boards, transformers, interlocks, etc.
Meter Readings	—All meter readings should be recorded and checked against previous readings to disclose abnormal operation. Refer to typical readings on pages 17 and 18.
Interlocks	—Clean contacts with carbon tetrachloride or crocus cloth (never sandpaper nor emery cloth). Apply a thin coating of petroleum jelly afterward.
Inductors	<ul style="list-style-type: none"> —Inspect and clean contact between sliders and turns of 1L5, 1L7, 1L9, 1L10, 1L11, and 2L6. Use carbon tetrachloride applied with a soft brush. To clean wire, use crocus cloth (never sandpaper nor emery cloth) lightly to avoid removal of plating. Poor contact will create heat, damaging spring and wheel contacts. —Check coil end-terminals for tightness. —Check condition of end-contact springs and rotors.
Rheostats	<ul style="list-style-type: none"> —Inspect rheostat contact arms to insure proper pressure and shaft tightness. Correct as necessary. —Rotate rheostats 1R23, 1R27, and 1R28 to remove any oxide coating between contact arm and wire. If oxidation is still evident, clean wire with crocus cloth to avoid shortened tube life.

Transtat	<ul style="list-style-type: none"> —Inspect and clean Transtat commutator with carbon tetrachloride or crocus cloth. —Inspect brushes for good contact. Coat sparingly with light film of petroleum jelly.
Resistors	<ul style="list-style-type: none"> —Inspect power resistors for signs of aging, cracked enamel, or discoloration—all indicative of possible future trouble. —At six months' intervals, using an accurate ohm-meter, check the resistance of feedback ladder resistors 2R37 through 2R44. Replace any resistor deviating more than 10% from rated value.
Tubes	<ul style="list-style-type: none"> —Inspect each tube immediately upon receipt for possible damage during transit. —Keep a log of tube life to anticipate eventual tube failure. —Inspect and clean filament contacts on all tube sockets, particularly rectifiers, to avoid possible reduced tube life. —Before replacement, properly "age" all rectifier tubes as described under "Preliminary Adjustments." —Age all spare rectifier tubes before storing. If not subsequently jarred and if stored in an upright position, initial warm-up period may be reduced to approximately one minute. —It is recommended that transmitting tube spares be operated once a month, for a minimum of eight hours, to minimize the possibility of tubes becoming "soft" or gassy.
Relays	—Clean contacts with carbon tetrachloride, or crocus cloth if necessary.
Spare Crystal	—Check periodically to insure operation when required.
External Surfaces	—Apply matching lacquers, furnished with equipment, to restore original finish of marred spots.

REPLACEMENT PARTS LIST

When ordering replacement parts, please give Symbol, Description, and Stock Number of each item ordered.

The part which will be supplied against an order for a replacement item may not be an exact dupli-

cate of the original part, however, it will be a satisfactory replacement, differing only in minor mechanical or electrical characteristics. Such differences will in no way impair the operation of the equipment.

EXCITER (MI-7281-B)

Symbol No.	DESCRIPTION	Stock No.
1A4	Lamp, plate indicator...	23216
1A7	Lamp, control panel, illumination, 40 watt....	47044
1A8	Attenuator, audio input, 6 db.	19651
1C1	Capacitor, crystal tuning, 4.5-20 mmfd.	16890
1C2, 1C3	Capacitor, bypass, .01 mfd	
1C4	Capacitor, output coupling, 47 mmfd.	50358
1C5	Capacitor, filter, .002 mfd.	50359
1C12, 1C13	Capacitor, buffer filament bypass, 10,000 mmfd..	69857
1C14	Capacitor, buffer screen bypass, same as C12	
1C15	Capacitor, buffer plate bypass, 20,000 mmfd....	69862
1C16	Capacitor, freq. monitor bypass, 10,000 mmfd..	52410
1C17	Capacitor, buffer plate tank, 620 mmfd.....	52411
1C18, 1C19	Capacitor, buffer plate tank, 300 mmfd.....	52412
1C20	Capacitor, neutralizing tank, 100 mmfd.....	69863
1C21, 1C24	Capacitor, neutralizing tank, 200 mmfd.....	69864
1C22, 1C23	Capacitor, P.A. filament bypass, 3900 mmfd...	52413
1C25	Capacitor, P.A. plate blocking, 5100 mmfd..	52414
1C26	Capacitor, P.A. plate bypass, 1000 mmfd....	52415
1C27	Capacitor, buffer plate tank, 100 mmfd.....	52417
1C28, 1C29	Capacitor, crystal heater bypass, .01 mfd.....	69857
1C30	Capacitor, meter bypass, 0.01 mfd.	62055
1C31, 1C32	Capacitor, modulator blocking, 0.25 mfd. ...	15943
1C33, 1C36	Capacitor, feedback divider, 620 mmfd....	52416
1C34, 1C35	Capacitor, feedback divider, 30,000 mmfd..	50787
1C37	Capacitor, P.A. filament bypass, 3900 mmfd...	52413
1C39, 1C40	Capacitor, high voltage filter, 12 mfd., 2000 v.	19178
1C41	Capacitor, low-power audio filter, 2 mfd., 1000 volts	19652
1C42	Capacitor, neutralizing tank, 100 mmfd.....	69863
1C43	Capacitor, P.A. filament bypass, 3900 mmfd....	52413
1C44	Capacitor, thermostat bypass, 5100 mmfd....	52418
1C45, 1C46	Capacitor, 270 mmfd....	65401
1C48	Capacitor, P.A. tank, 390 mmfd.	52419
1C49	Capacitor, P.A. tank, 200 mmfd.	52413

Symbol No.	DESCRIPTION	Stock No.
1C50	Capacitor, P.A. tank, 150 mmfd.	69865
1C51	Capacitor, P.A. tank, 100 mmfd.	69863
1C52	Capacitor, line matching, 1000 mmfd.	52415
1C53	Capacitor, line matching, 1500 mmfd.	52420
1C54	Capacitor, line matching, 2000 mmfd.	52421
1C55	Capacitor, antenna matching, same as C52.	
1C56	Capacitor, antenna matching, same as C53.	
1C57	Capacitor, antenna matching, same as C54	
1C58	Capacitor, antenna matching 3000 mmfd..	52422
1C59	Capacitor, filter, 8 mfd., 1000 volts d-c.....	19341
1C60, 1C61	Capacitor, bias rectifier filter, 4 mfd., 600 volts	19464
1C62	Capacitor, monitor blocking, .5 mfd., 600 volts.	60029
1C63	Capacitor, line matching, 1000 mmfd.	52415
1C64	Capacitor, power output control bypass, 1 mfd., 600 volts d-c	19465
1C65	Capacitor, P.A. grid resistor bypass, 30,000 mmfd.	52423
1C68	Capacitor, neutralizing series, 150 mmfd....	69865
1C69, 1C70, 1C71, 1C72	Capacitor, modulator filament bypass, 3900 mmfd.	52413
1C73, 1C74	Capacitor, feedback divider, 620 mmfd. ...	52416
1C76	Capacitor, suppressor bypass, 10,000 mmfd..	52410
1C80	Capacitor, l.f. compensation, 20,000 mmfd....	69674
1C84, 1C85	Capacitor, compensating, 390 mmfd.	52424
1C86	Capacitor, compensating, .001 mfd.	52415
1E4	Relay, plate time relay; coil, 115 volts, 50/60 cycle	48197
1E5	Relay, time interlock, D.P.D.T., 115 volts, 50/60 cycle	46117
1F1, 1F2	Fuse, crystal heater, 1 ampere	19335
1J1	Plug, power, 8-prong...	47317
1J2	Socket, oscillator	19656
1J3, 1J4	Connector, male	19568
1L1	Inductor, oscillator plate tank	50360
1L5	Inductor, buffer plate tank	50491
1L6	Inductor, P.A. grid choke	16892

Symbol No.	DESCRIPTION	Stock No.
IL7	Inductor, neutralizing tank	50491
IL8	Inductor, P.A. plate choke	19185
IL9	Inductor, P.A. plate tank.	50492
IL10	Inductor, P.A. loading..	50493
IL11	Inductor, transmission line series, same as L10	
IL12	Inductor, low-pass filter, 0.10 H	17906
IL13	Inductor, modulation monitor, pick-up	19337
IL14	Reactor, high voltage filter	16928
IL15	Reactor, high voltage filter	19201
IL16, IL17	Reactor, bias rectifier filter	19343
IM1	Milliammeter, oscillator plate, 0-50 ma. d-c...	19188
IM2	Milliammeter, buffer plate, 0-250 ma. d-c..	19189
IM3	Milliammeter, P.A. plate, 0-500 ma. d-c.....	19193
IM4	Milliammeter, P.A. grid, same as M2	
IM5	Voltmeter, P.A. plate, 0-2 kv. d-c, 1000 ohms per volt, complete with external multiplier (R36)	19190
IM9	Milliammeter, 1st Audio plate, 0-10 ma. d-c...	44514
IM10, IM11	Milliammeter, modulator plate, same as M2....	19189
IM12	Voltmeter, line voltage, 0-150 volts, a-c.....	19194
IPI, IP2	Connector, female	19569
IR1	Resistor, grid leak, 150,000 ohms, 1 watt.	31895
IR2	Resistor, cathode, 680 ohms, 2 watts	38325
IR12	Resistor, buffer grid, 22,000 ohms, 2 watts..	19081
IR13	Resistor, buffer series, 100 ohms, 2 watts....	14162
IR14	Potentiometer, frequency monitor, 1000 ohms..	19203
IR15	Rheostat, power output control, 750 ohms....	19204
IR16	Resistor, audio monitor, 10 ohms	19658
IR17	Resistor, P.A. grid, 4000 ohms	43140
IR18, IR19	Resistor, parasitic suppressor, 68 ohms, 1 watt	52213
IR22	Potentiometer, bias bleeder, 5000 ohms...	19206
IR23	Rheostat, r-f filament control, 10 ohms.....	17290
IR24	Resistor, overload coil, 33 ohms, 1 watt	52293
IR26	Resistor, overload coil, 56 ohms, 2 watts	52230
IR27	Rheostat, audio filament control, 15 ohms	19209
IR28	Rheostat, rectifier filament control, 10 ohms, same as IR23.....	17290
IR29, IR30	Resistor, grid load, 33,000 ohms, 1 watt..	60291
IR32	Resistor, first audio bleeder, 39,000 ohms, 1 watt	45420

Symbol No.	DESCRIPTION	Stock No.
IR33, IR34, IR35	Resistor, first audio screen dropping, 27,000 ohms, 2 watts	44213
IR36	Resistor, multiplier, part of IM5	
IR41, IR42	Resistor, 0.10 megohms, 2 watts	28738
IR43, IR44	Resistor, modulator grid, 0.22 megohm, 1 watt..	43018
IR45	Resistor, first audio cathode, 5600 ohms, 2 watts	51777
IR46, IR47	Resistor, P.A. cathode, 50 ohms	19659
IR48	Resistor, bias bleeder, 5000 ohms, 10 watts..	
IR54	Potentiometer, bias bleeder, 5000 ohms...	19206
IR64	Resistor, l.p. audio bleeder, 80,000 ohms, taps at 34,000—38,000—42,000 ohms	43311
IR65, IR66	Resistor, modulator grid suppressor, 10 ohms, 2 watts	43008
IR72, IR73, IR77, IR78	Resistor, feedback divider, 2.2 megohms, 2 watts..	46350
IR74, IR76	Resistor, feedback divider, 3900 ohms, 1 watt....	45420
IR75	Resistor, feedback divider, 22,000 ohms, 2 watts..	19206
IR79, IR80	Resistor, voltage divider, 1000 ohms, taps at 200 and 400 ohms	46118
IR81	Resistor, voltage divider, 800 ohms	19210
IR82, IR83	Resistor, voltage divider, 1000 ohms	19870
IR84	Resistor, 800 ohms, tap at 240 ohms	46119
IR85	Resistor, 65,000 ohms, taps at 25,000 ohms, 40,000 ohms, section rated at 100 watts....	52242
IR86, IR87	Resistor, compensating, 27,000 ohms, 4 watts..	
IS1	Switch, breaker line, 30 amps	19195
IS2	Switch, breaker filament, 5 amps.	19196
IS3	Switch breaker plate, 20 amps.	19339
IS4, IS8, IS9	Switch, door interlock...	18110
IS5, IS6	Switch, breaker, P.A. plate	19338
IS7	Switch, power change ...	20790
IT1	Transformer, audio filament	19197
IT3	Transformer, r-f filament	19199
IT4	Transformer, rectifier filament	19200
IT5	Transformer, rectifier plate	19336
IT6	Transformer, modulation.	15516
IT7	Transformer, bias rectifier plate	19342
IT8	Transformer, audio input.	46109
IX1	Socket, tube	18724
IX2	Socket, crystal unit....	16889
IX3	Socket, 6 contact, square.	
IX4, IX10, IX11	Socket, buffer	18724
IX5, IX6	Socket, P.A., 4 contact, lock-in type	45684

Symbol No.	DESCRIPTION	Stock No.
1X7	Socket, bias rectifier	31319
1X8, 1X9	Socket, first audio	18007
1X12, 1X13	Socket, rectifier	44765
1X14, 1X15	Socket, fuse	19334
1X16	Socket, plate indicator lamp	19026
1X17	Socket, control panel, illuminating lamp	50506
	MISCELLANEOUS	
	Mercury Unit, 3 section closing, 2 section opening	44688

Symbol No.	DESCRIPTION	Stock No.
	Coil, mercury unit, 115 volts, 50/60 cycle	50504
	Counter, less coupling and gear	50508
	Jewel, pilot lamp, red, with nut	32805
	Relay, time interlock, D.P.D.T., 115 volts . . .	46117
	Spring, tension, for 1L5, 1L7	50495
	Universal Joint, for gear bracket and knob shaft assemblies	47190

POWER AMPLIFIER

2A1	Lamp, control panel illuminating, 40 watts, 230 volts	43416
2A2, 2A3	Lamp, plate indicator	23216
2C4, 2C5, 2C6, 2C7, 2C8, 2C9	Capacitor, P.A. filament by-pass, 10,000 mmfd.	69857
	Capacitor, P.A. neutralizing, 7 mmfd.	UC-3272
2C10, 2C11	Capacitor, P.A. plate tank, .0002 mfd.	UC-3357
2C12, 2C13	Capacitor, P.A. plate tank, .0003 mfd.	UC-3355
2C14	Capacitor, P.A. plate by-pass, 200 mfd.	69864
2C15	Capacitor, harmonic tank, .003 mfd.	UC-3341
2C16	Capacitor, harmonic tank, .0015 mfd.	UC-3392
2C17	Capacitor, harmonic tank, .008 mfd.	UC-3346
2C20, 2C21	Capacitor, modulator, bias by-pass, 20 mfd. . .	43441
2C27	Capacitor, bias filter, 50 mfd.	68755
2C31, 2C32, 2C33, 2C34	Capacitor, modulator filament by-pass, 3900 mmfd.	52413
2C39 to 2C46	Capacitor, 2,000 mmfd. . .	50359
2C49, 2C50	Same as 2C20	
2J1	Connector, single-contact female	19569
2L1, 2L2	Inductor, P.A. grid choke	17270
2L5	Inductor, P.A. plate choke	17271
2L6	Inductor, P.A. plate tank, variable	50505
2L7	Inductor, P.A. tank	17310
2L8	Inductor, modulation monitor pick-up	17273
2L9, 2L10	Inductor, harmonic tank.	16984
2L12	Same as 2L5	
2L17, 2L18	Reactor, bias filter	43124
2M1, 2M2	Milliammeter, P.A. grid current, left, 0-250 ma d-c	19189
2M3, 2M4	Milliammeter, P.A. plate current, left, 0-500 ma d-c	19193
2M5	Ammeter, P.A. plate current, total, 0-1 amp. d-c	19469
2M6	Voltmeter, P.A. plate, 0-3 kv d-c. Resistance 1,000 ohms per volt complete with external multiplier (2R48) . . .	43629
2M9, 2M10	Same as 2M3	
2M11	Voltmeter, line voltage, 0-300 volts a-c.	43419

2P1	Connector, single-contact male	19568
2R1, 2R2	Resistor, P.A. grid, 4,000 ohms, 150 watts	44306
2R3, 2R4	Resistor, P.A. cathode, 450 ohms, nine equally spaced taps	17282
2R5, 2R6	Resistor, P.A. parasitic suppressor	17530
2R7, 2R8, 2R9	Resistor, H.V. bleeder, 16,000 ohms	43422
2R16, 2R17	Rheostat, modulator bias, 64 ohms, 25 watts	43424
2R18	Resistor, modulator bias, 100 ohms	43457
2R19	Rheostat, audio monitor control, 10 ohms, 25 watts	17290
2R20, 2R21	Resistor, plate indicator lamp dropping, 2500 ohms, 25 watts	43425
2R22	Resistor, P.A. overload coil parallel, 25 ohms, 25 watts	44078
2R24	Resistor, r-f driver load, 10,000 ohms, 120 watts	44080
2R25	Same as 2R22	
2R37 to 2R44	Resistor, 2.2 meg., 2 watts	46350
2R45, 2R46	Resistor, 47,000 ohms, 2 watts	44211
2S1	Switch, line	43426
2S2	Breaker, filament, 230 volts	43427
2S3	Breaker, plate circuit . . .	43951
2S4	Breaker, P.A. plate, 115 volts	44081
2S6, 2S7, 2S8	Switch, door interlock, 30 amps., 250 volts . .	18110
2S9	Breaker, modulator cathode	43442
2T2	Transformer, line voltage adjusting	43431
2T3	Transformer, modulator filament	43433
2T5, 2T6	Transformer, bias rectifier plate	43435
2T8, 2T9	Transformer, H.V. rectifier filament	43437
2T10	Transformer, bias rectifier filament	43439
2X1 to 2X4	Socket, P.A.	50368
2X5, 2X6	Socket, bias rectifier	45685
2S7 to 2X11	Socket, control panel lamp	50506
2X12, 2X13	Socket, filament indicator lamp	19026

Symbol No.	DESCRIPTION	Stock No.
	MISCELLANEOUS	
	Coil form	50526
	Counter, less coupling and gear	50508
	Gasket, vellutex washer for P.A. socket	50509
	Jewel, pilot lamp, red, with nut	32805

Symbol No.	DESCRIPTION	Stock No.
	Jewel, pilot lamp, green, with nut	14552
	Knob, tuning control....	17269
	Support, coil end.....	50488
	Spring, tension	50495
	Wheel (large sliding wheel mounts on shafts)	50496
	Wheel, small contact (2 used)	50525

POWER EQUIPMENT UNIT

2C22	Capacitor, audio monitor blocking, 2 mfd., 5,000 volts d-c	17881
2C23, 2C24, 2C25	Capacitor, H.V. filter, 4 mfd., 3,000 volts d-c.	18044
2C26	Same as 2C22	
2C35, 2C36	Capacitor, 1 mfd., 1,500 volts, d-c	44309
2L13	Reactor, modulation	17307
2L14, 2L15	Reactor, H.V. filter	17308
2L16	Reactor, H.V. filter shunt	43440
2R23	Resistor, A.F. driver plate series, 4,000 ohms, 200 watts	44307

2R34, 2R35	Resistor, A.F. driver load, 4,000 ohms, 25 watts..	44308
2R36	Resistor, A.F. driver hf compensating, 2,000 ohms, 95 watts	19526
2R47	Resistor, 2,000 ohms, tapped at 1,000, 1,200, 1,400, 1,600 and 1,800 ohms	45766
2S5	Switch, door interlock...	18110
2T1	Transformer, driver	44310
2T4	Transformer, output	17301
2T7	Transformer, H.V. rectifier plate	17304

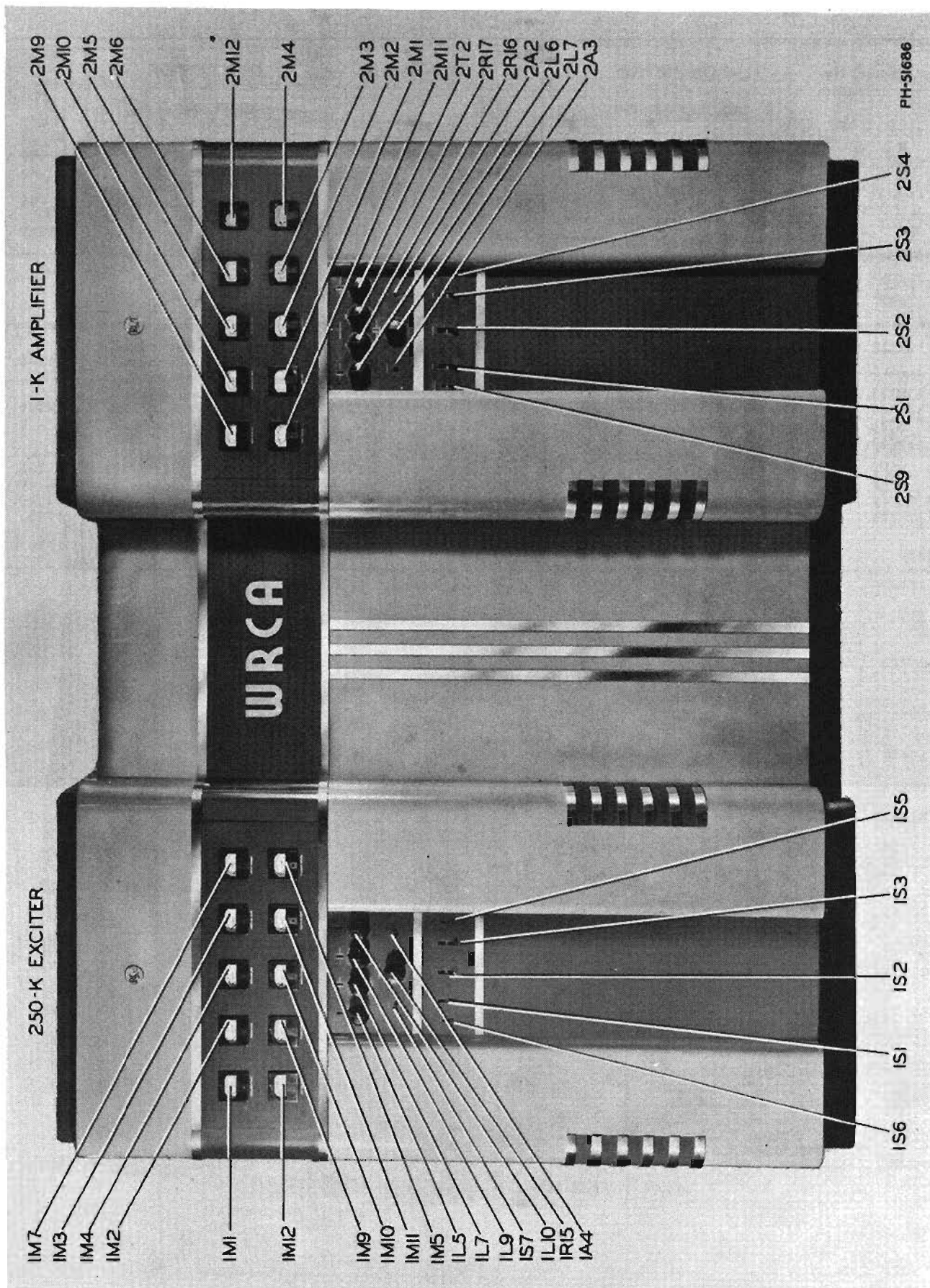
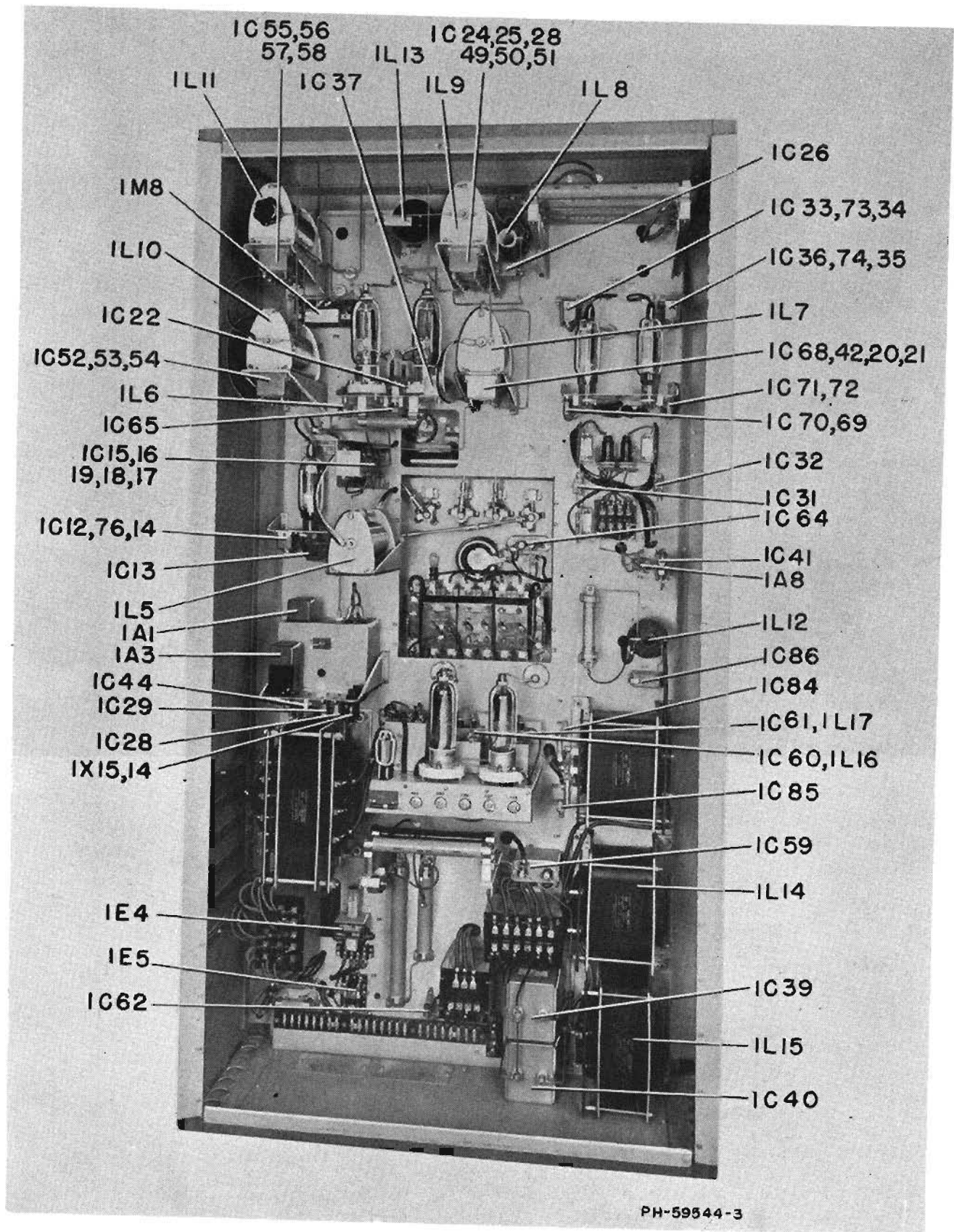
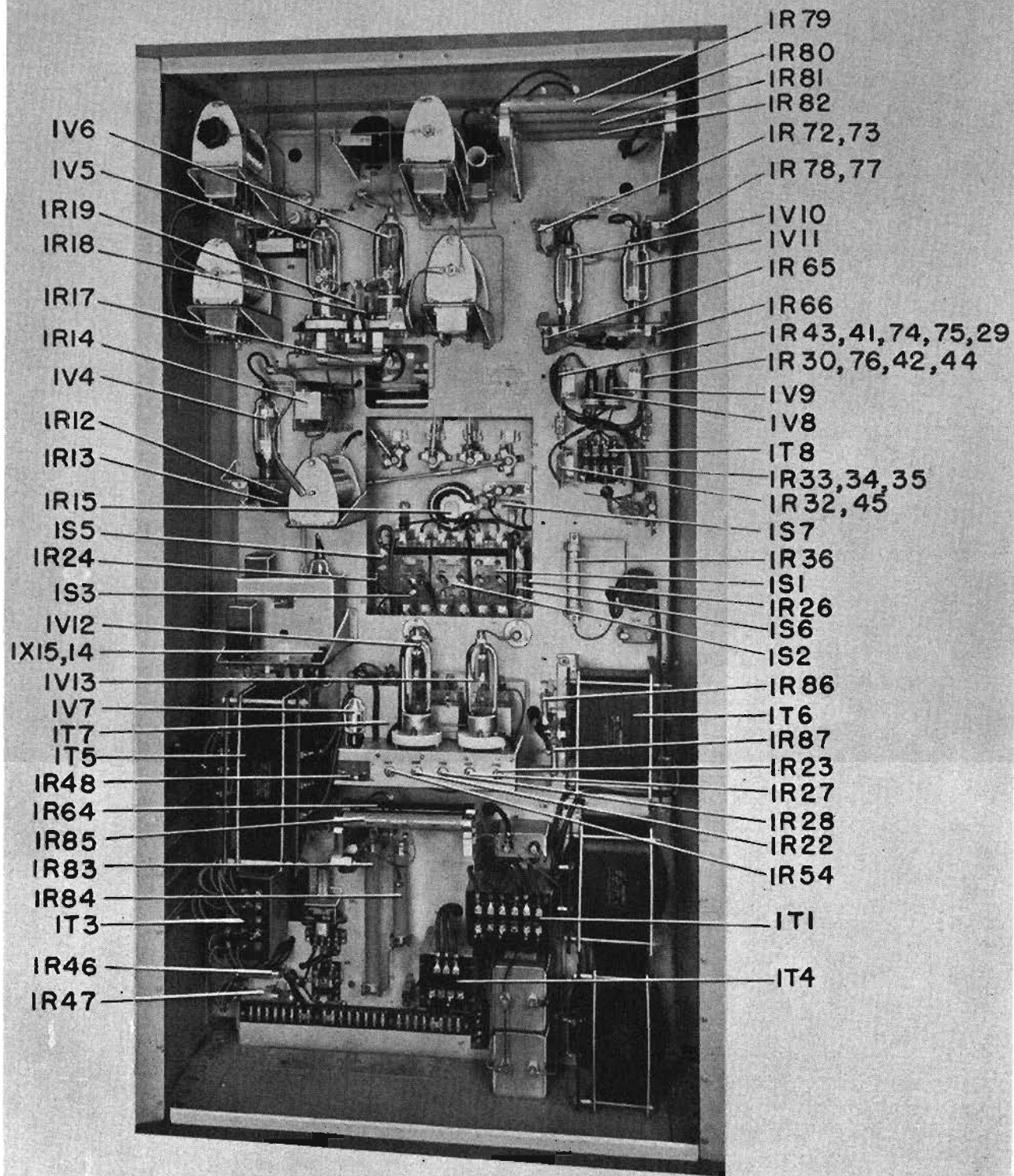

Figure 4—Transmitter (Front View)



PH-59544-3

Figure 5—Exciter Chassis (Rear View)



PH-59544-4

Figure 6—Exciter Chassis (Rear View)

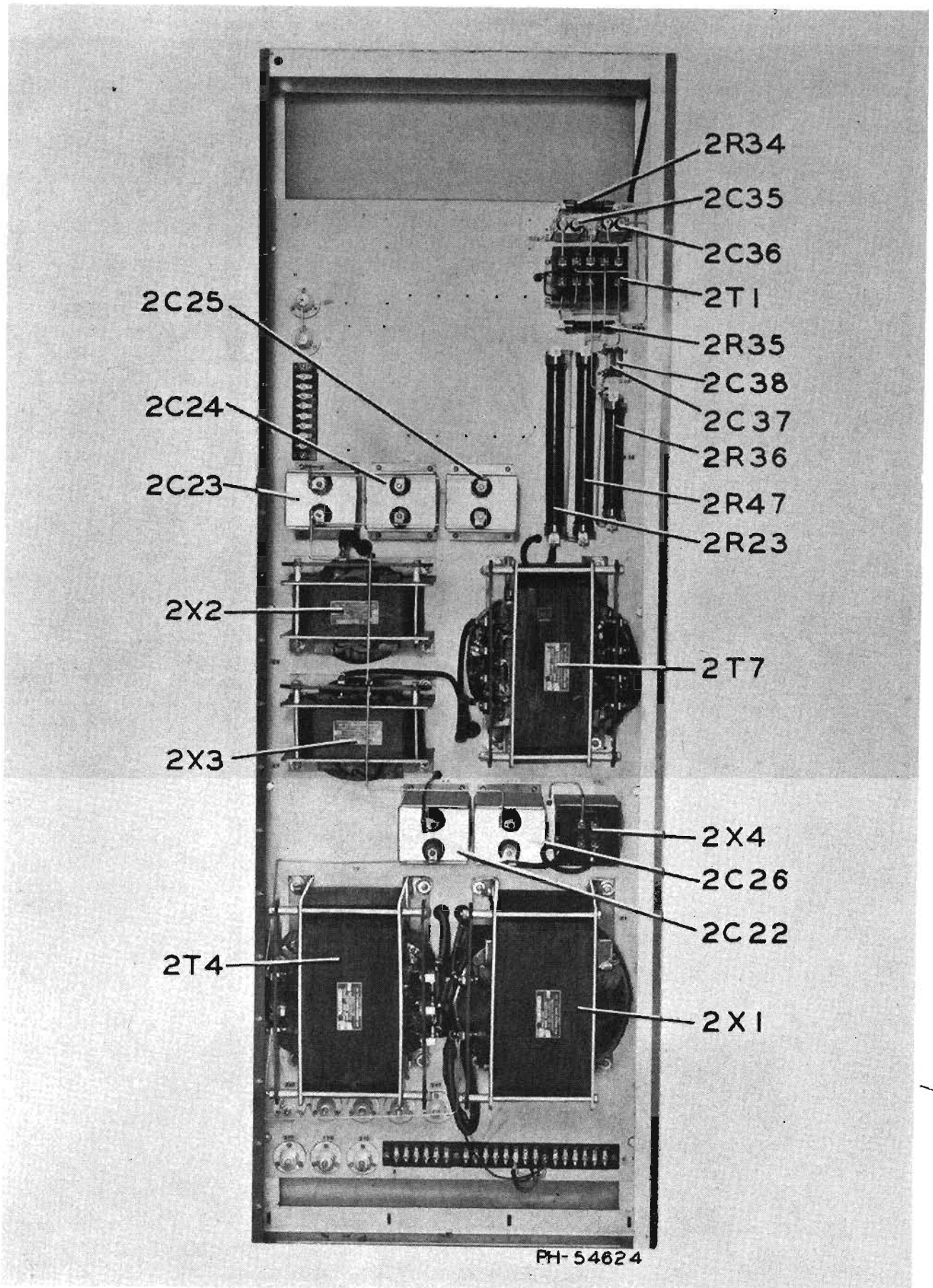

Figure 7—Center Panel (Rear View)

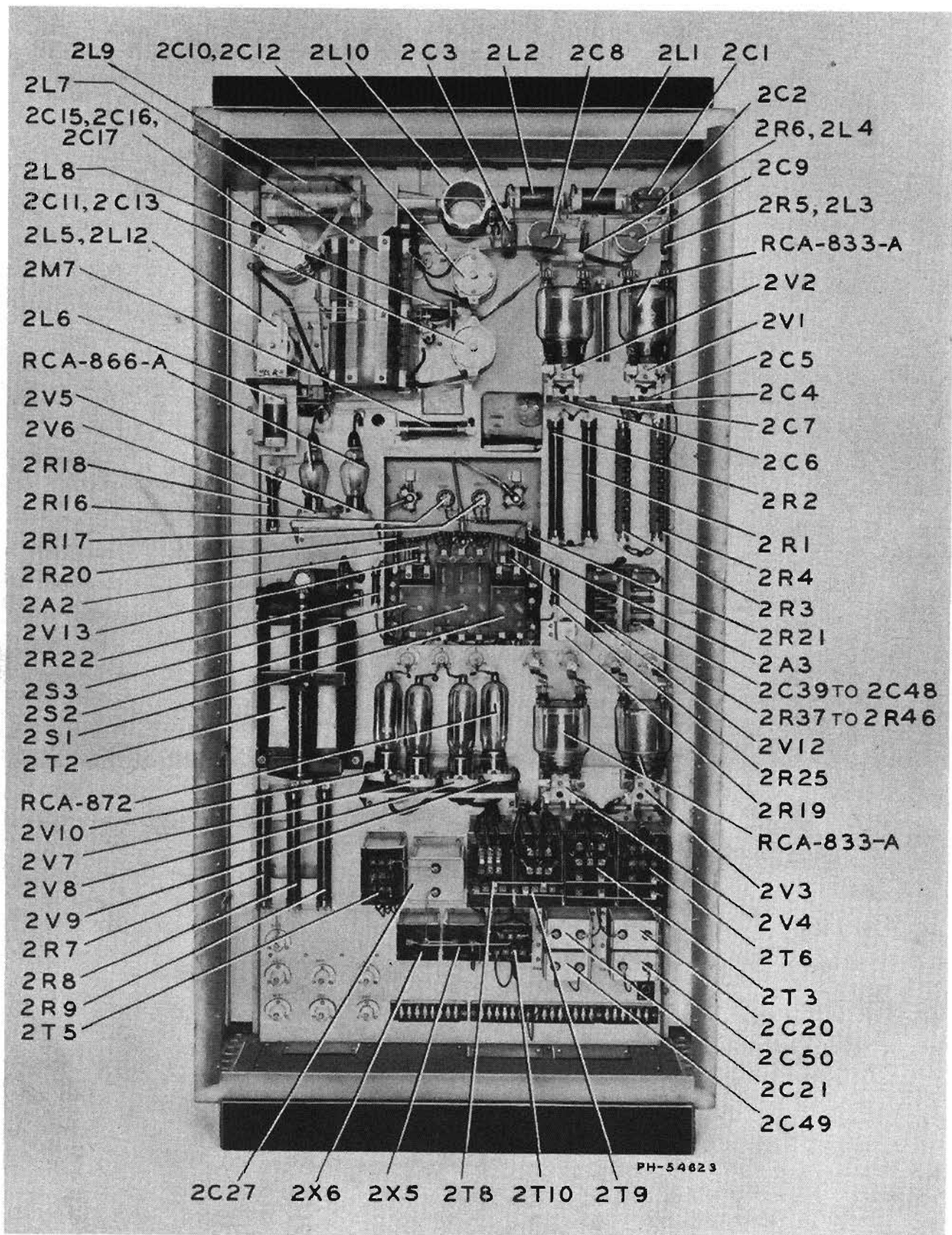

Figure 8—Amplifier-Modulator Chassis (Rear View)

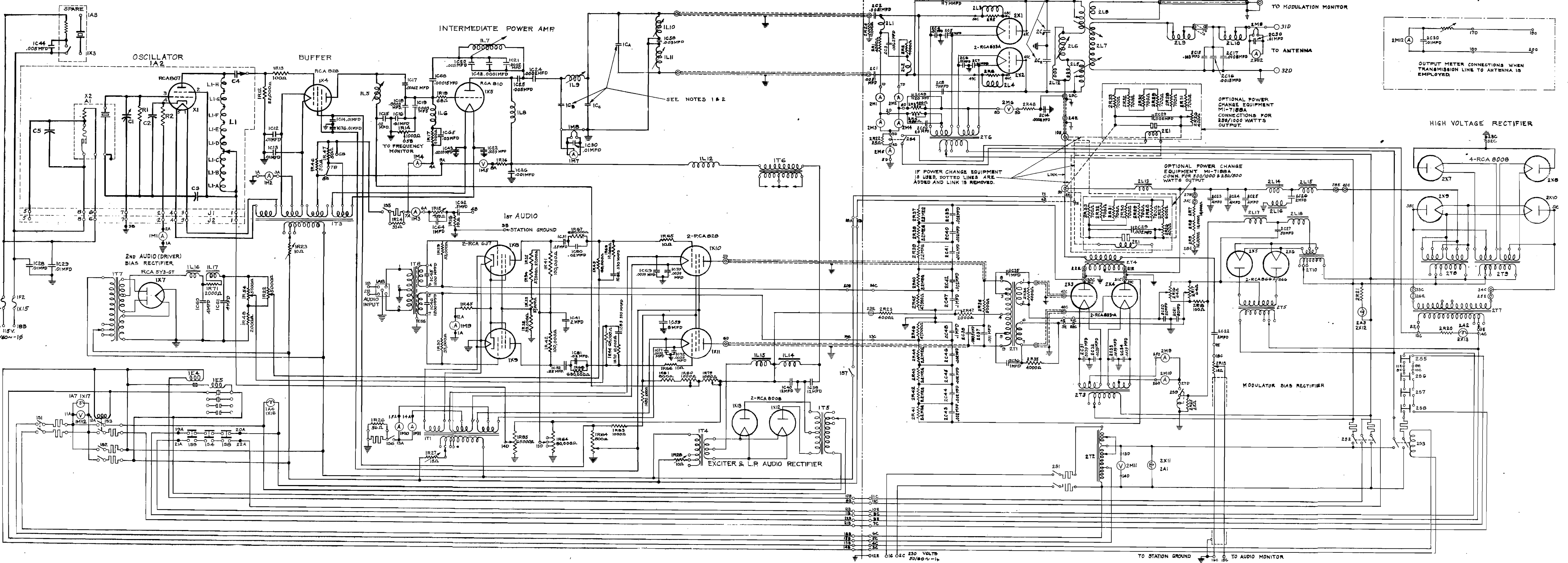

Figure 9—Overall Schematic (TT-618413)

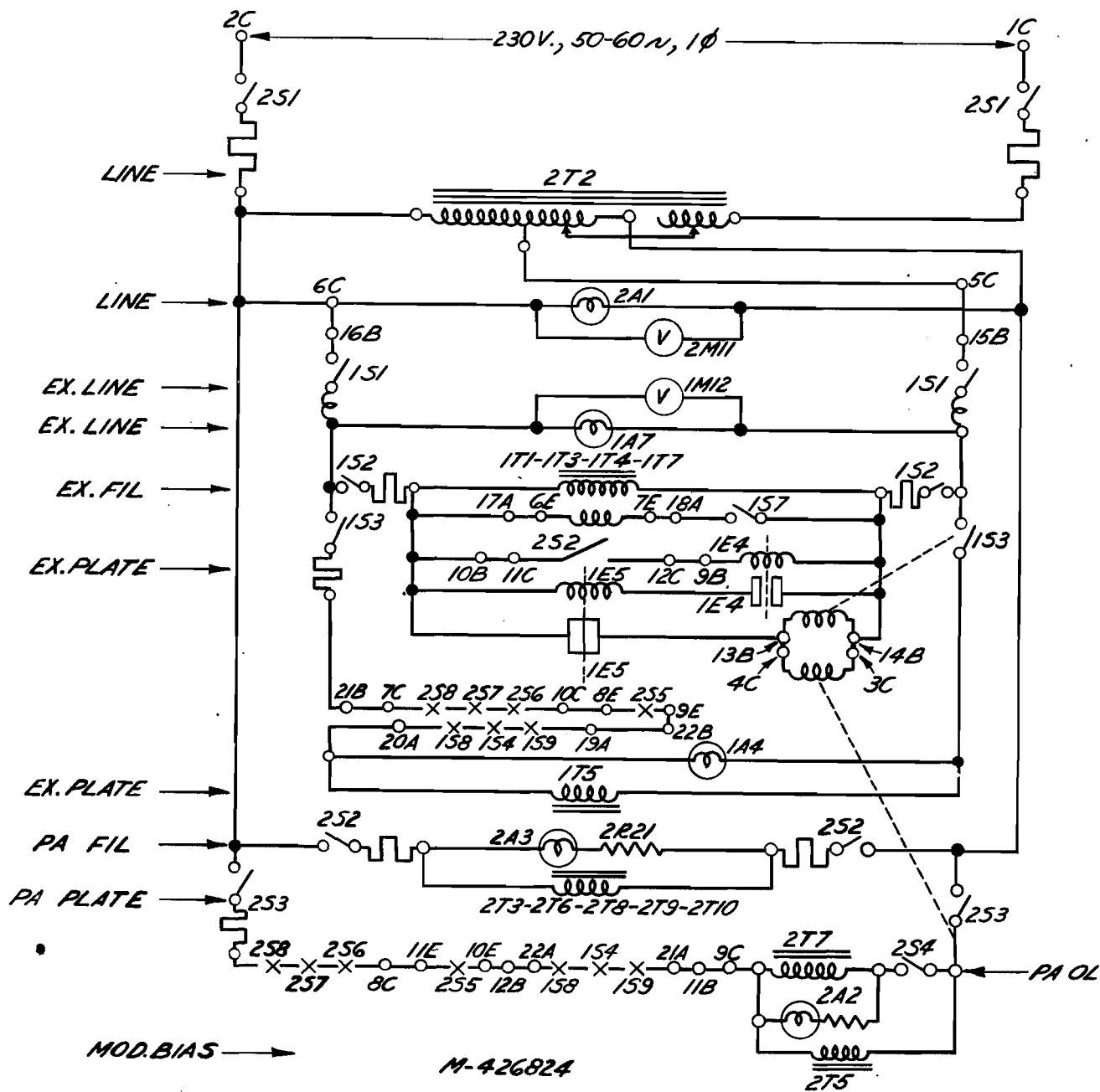

Figure 10—Transmitter Control Circuits (Simplified Schematic, M-426824)

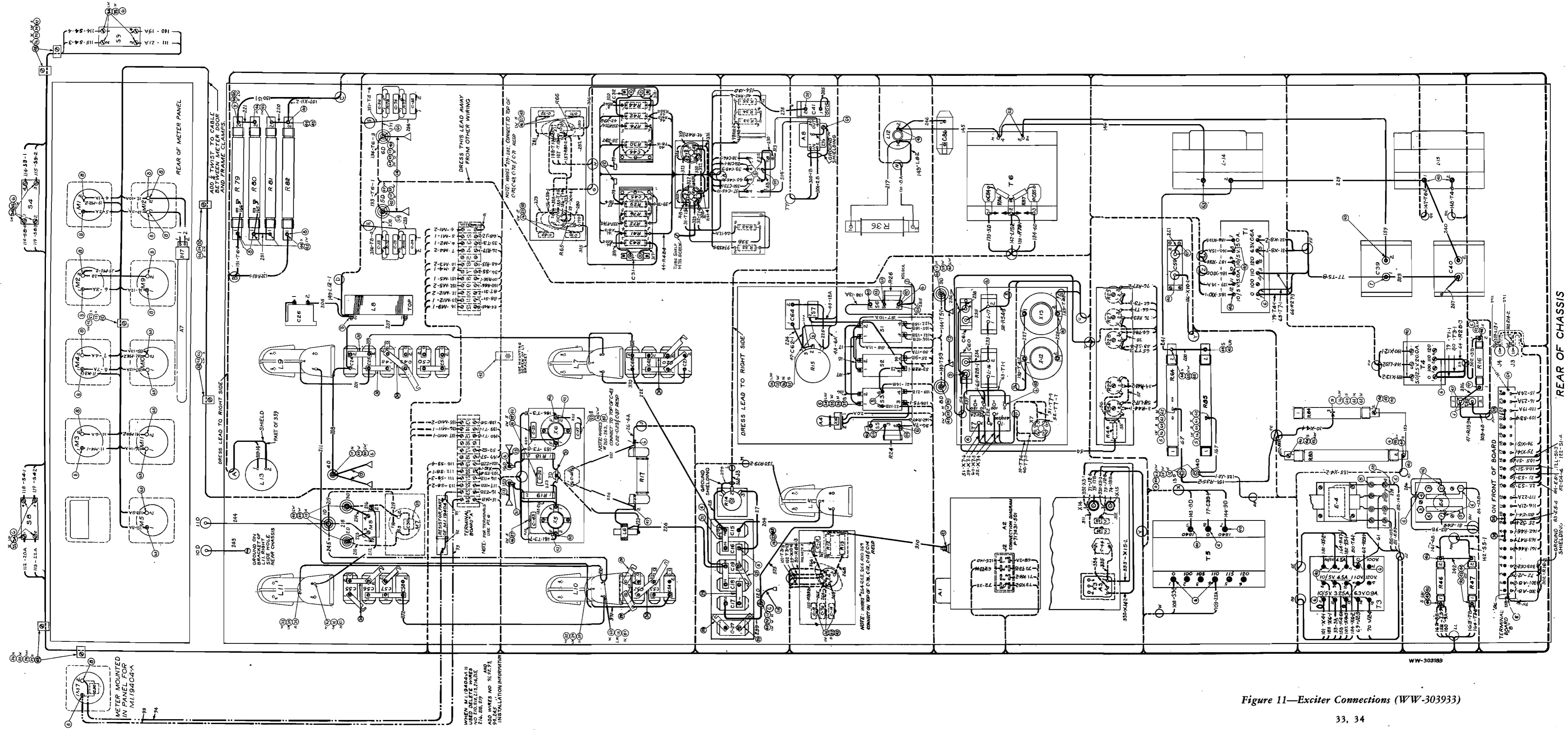
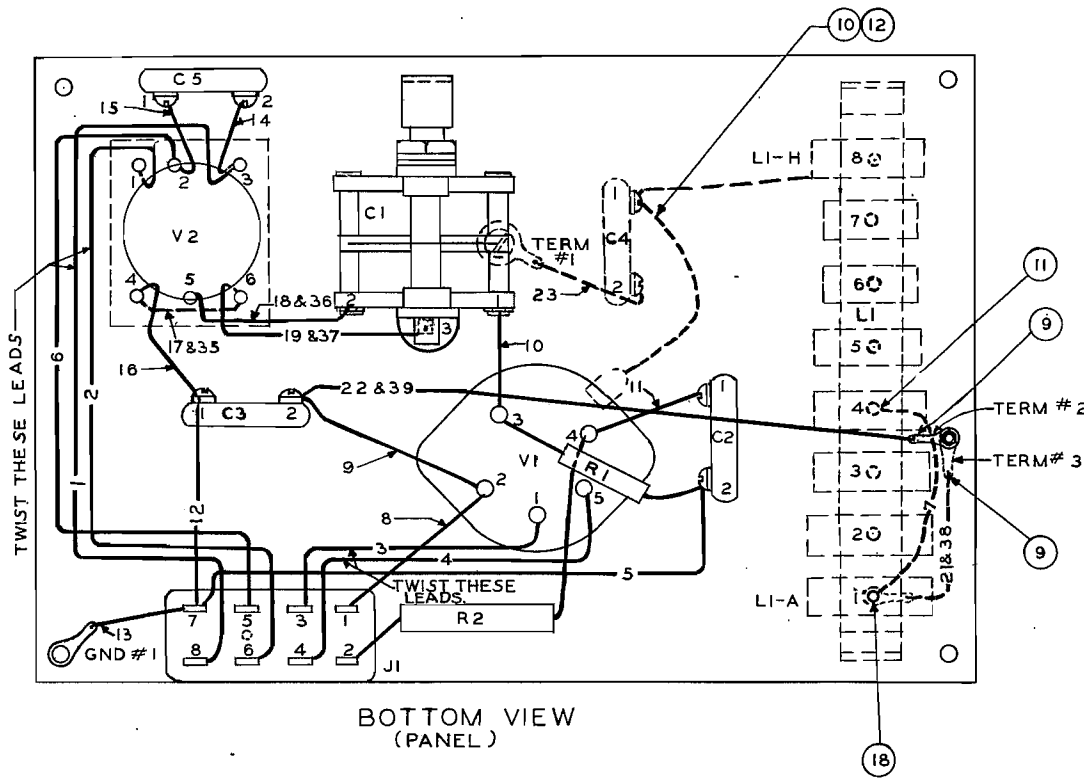

Figure 11—Exciter Connections (WW-303933)

Figure 12—Crystal Oscillator Connections (M-429907)



WIRE TABLE		
PART N ^o SEE K-884577	DESCRIPTION	WIRE NUMBER
5	PS 533-22 10/.010 VARN.CLOTH BRAID COVERED 300V. BLACK	1 TO 7 INCL.
6	PS 538 16/.010 VARN. CAMBRIC BRAID COVERED 600V. BLK.	
7	PS. 105 .0641 DIA. TINNED COPPER WIRE	8 TO 19 INCL. 21 TO 23 INCL.
8	PS 50 .066 I.D. VARN. TUBING. BLACK	35 TO 39 INCL.

NOTE #1:- NUMBERS INSERTED IN WIRES INDICATE S WIRE NUMBER. A NUMBER PRECEDED BY A LETTER INDICATES AN ELEC. ITEM THUS V-1 NUMBERS IN CIRCLES REFER TO PARTS ON WIRING M./L.

NOTE #2:- CUT LEADS TO LENGTH STRIP & TIN TO SUIT. DRESS LEADS AS INDICATED. SOLDER CONNECTIONS USING P-13. MARK SCHEMATIC ITEM NUMBERS ON OR NEAR RESPECTIVE PARTS USING BLACK OR WHITE LACQUER OF CONTRASTING COLOR

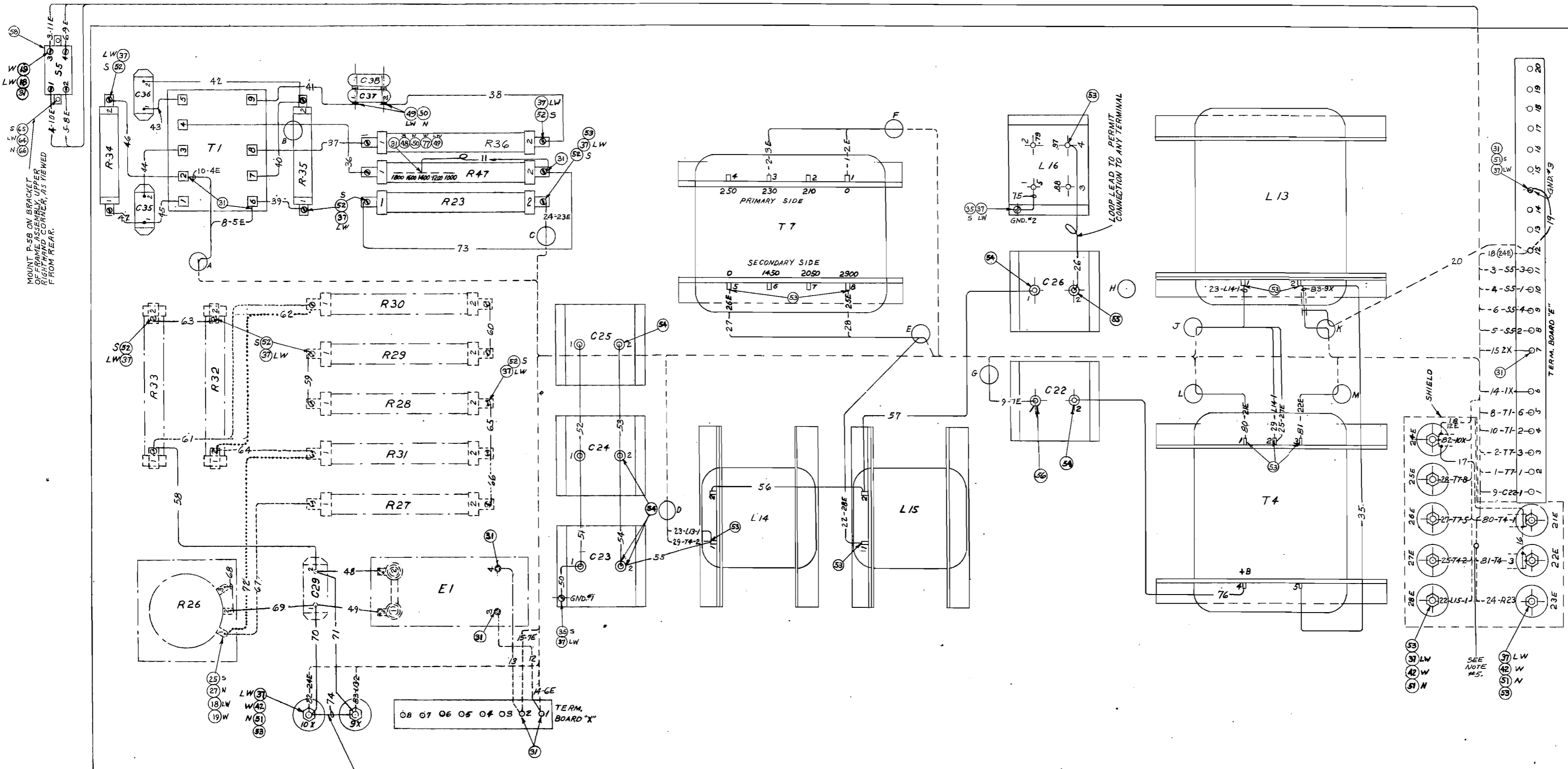

WIRE TABLE		
PART NO. SEE	DESCRIPTION	WIRE NUMBER
68	PS 533-9 26/010 V.C. B.C. 300 V BLACK	8 TO 20
69	PS 533-23 63/010 V.C. B.C. 300 V BLACK	1 TO 6
70	PS 538 26/010 V.C. B.C. 3000 V BLACK	22 TO 29
71	PS 105 .128 DIA. TINNED COPPER WIRE	35 TO 76
72	COAXIAL CABLE K-99211-2	80 TO 83

NOTE#1-CODING AT ENDS OF WIRES INDICATE WIRE NUMBER AND DESTINATION OF WIRE RESPECTIVELY, WHERE ONLY ONE NUMBER IS GIVEN WIRE NUMBER IS INTENDED, A LETTER PRECEDING A NUMBER, AS B0A-1, INDICATES AN ELECTRICAL ITEM, A NUMBER FOLLOWED BY A LETTER INDICATES A TERMINAL NUMBER SUCH AS 21E

FOR POWER CHANGE EQUIPMENT REMOVE LEAD #74 FOR 250/1000 WATT OPERATION CONNECT LEADS NUMBERED 12, 13, 48, 49, 58 TO 61 AND 63 TO 71 INCL. AS SHOWN

----- 250/500/1000 WATT
 250/1000 WATT

FOR 500/1000 AND 250/500 WATT OPERATION CONNECT LEADS NUMBERED 12, 13, 48, 49, 58 TO 61 AND 63 TO 71 INCL. AS SHOWN RESISTORS, RELAY AND CAPACITOR (C29) ARE PART OF MI-7188A

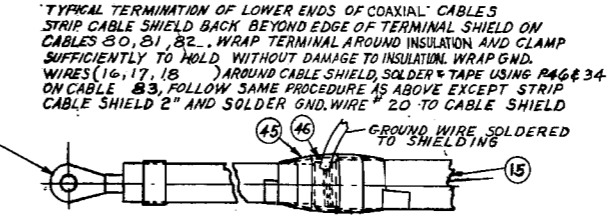
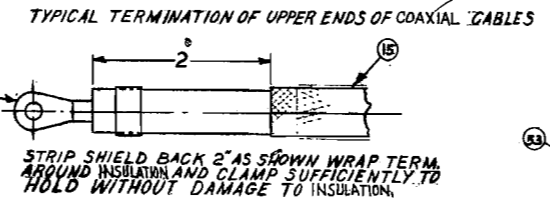
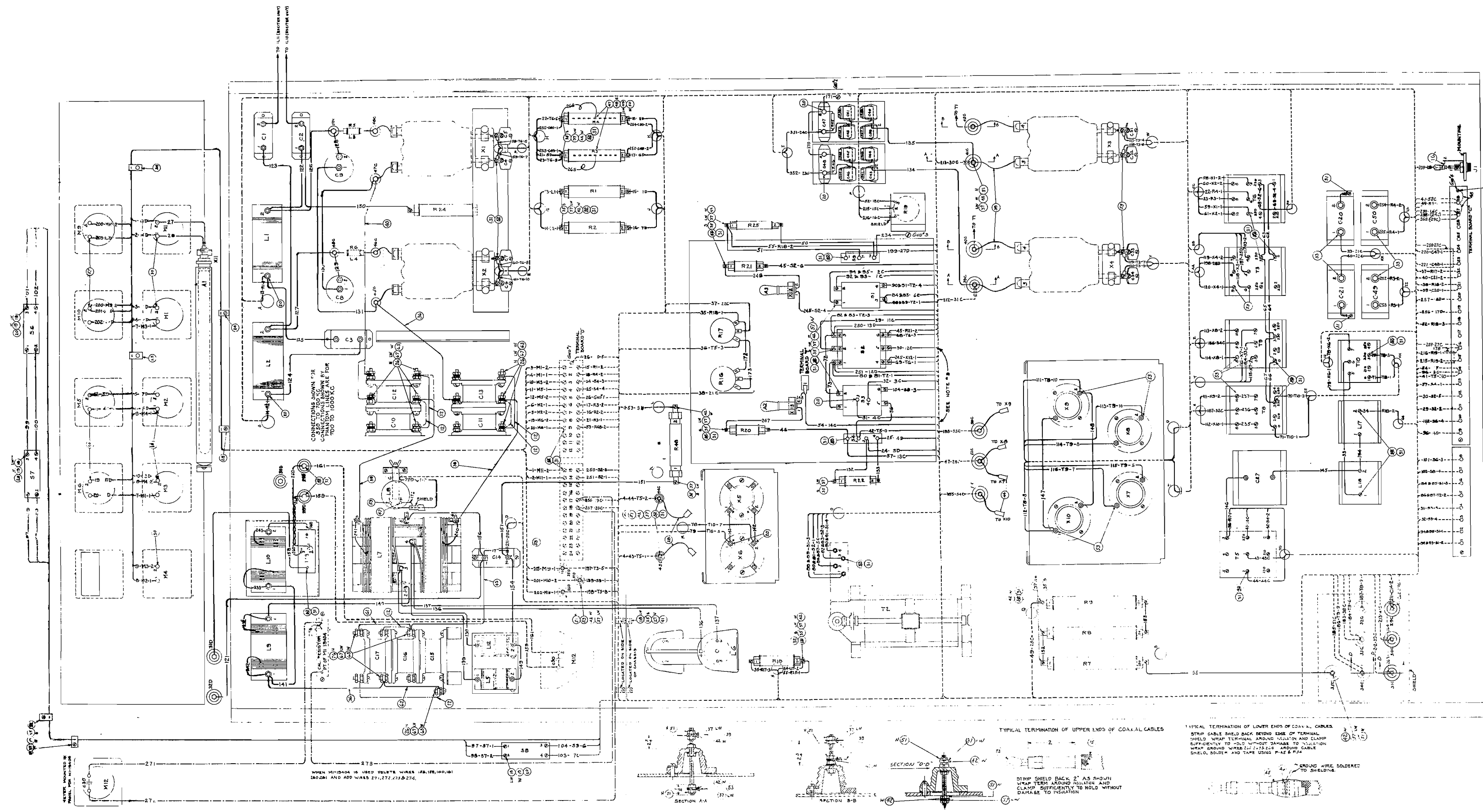

Figure 13—Center Panel Connections (TT-618412)



WIRE TABLE		
PART NO.	DESCRIPTION	WIRE NUMBERS
6	PS 230-8 24/010 V.C.B.C. 300 V. BLACK	1-57, 250-260
7	PS 230-13 24/010 V.C.B.C. 300 V. BLACK	56-73, 78-104
8	PS 230 26/010 V.C.B.C. 300 V. BLACK	188-187, 197-203
9	PS 230 24/010 V.C.B.C. 300 V. BLACK	111-120
10	PS 105 COPPER WIRE TINNED 0.030 DIA.	148-173
11	PS 105 COPPER WIRE TINNED .120 DIA.	71-101
12	PS 21 COPPER STRIP SOFT .015 THICK .125 WIDE FINISH: 100% 2 CONDUCTORS ALUMINUM WIRE, 24/010 V.C.B.C. 300 V. BLACK MIL. 100	132, 137, 240-243 216 (SEE NOTE #1)
13	PS 21 COPPER STRIP SOFT .015 THICK .125 WIDE FINISH: 100% 2 CONDUCTORS ALUMINUM WIRE, 24/010 V.C.B.C. 300 V. BLACK MIL. 100	215, 216
14	PS 21 COPPER STRIP SOFT .015 THICK .125 WIDE FINISH: 100% 2 CONDUCTORS ALUMINUM WIRE, 24/010 V.C.B.C. 300 V. BLACK MIL. 100	222
15	AXIAL CABLE .025 DIA. .004 DIA. THIN COPPER WIRE	211-214
16	AXIAL CABLE .025 DIA. .004 DIA. THIN COPPER WIRE	200
17	AXIAL CABLE .025 DIA. .004 DIA. THIN COPPER WIRE	.75-174

NOTE #1: EACH WIRE IS IDENTIFIED BY A SYMBOL NUMBER; AS AN EXAMPLE, WIRE 2 & 19-58 NUMBER (2) IDENTIFY THE WIRE IN THE WIRE TABLE, THE MOUNTING LETTER AND NUMBER (19) IDENTIFY THE ELECTRICAL PART TO WHICH THE OPPOSITE END OF THE WIRE IS ATTACHED, ON THE LETTER IDENTIFY THE PART AS TERMINAL, O THE LAST NUMBER, 2 OR 19 INDICATES THE NUMBER OF THE TERMINAL FROM THE WIRE IS ATTACHED, WHERE ONLY ONE NUMBER IS GIVEN, WIRE NUMBER IS INTENDED.

WHEN MINIDAG IS USED DELETE WIRES 12A, 12B, 12C, 12D, 12E AND ADD WIRES 27, 272, 273 & 274.

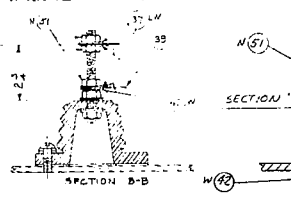
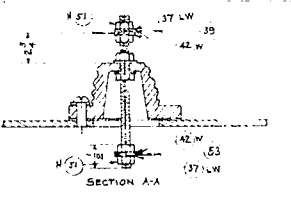

TYPICAL TERMINATION OF UPPER ENDS OF COAXIAL CABLES

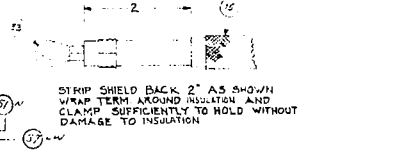

TYPICAL TERMINATION OF LOWER ENDS OF COAXIAL CABLES

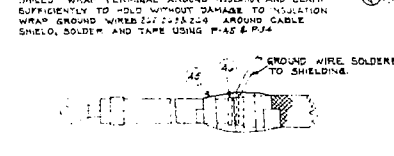
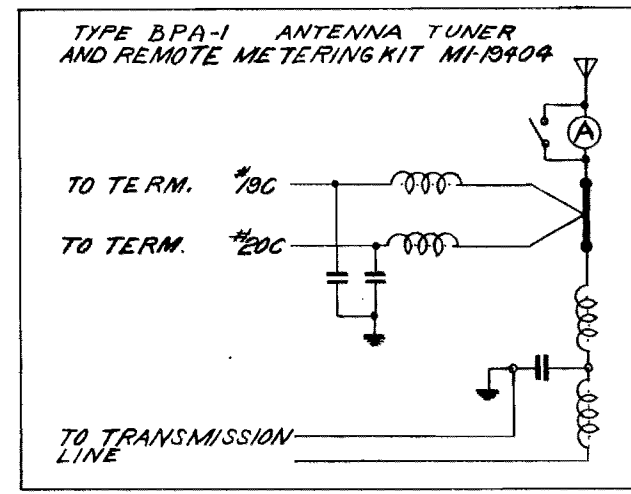
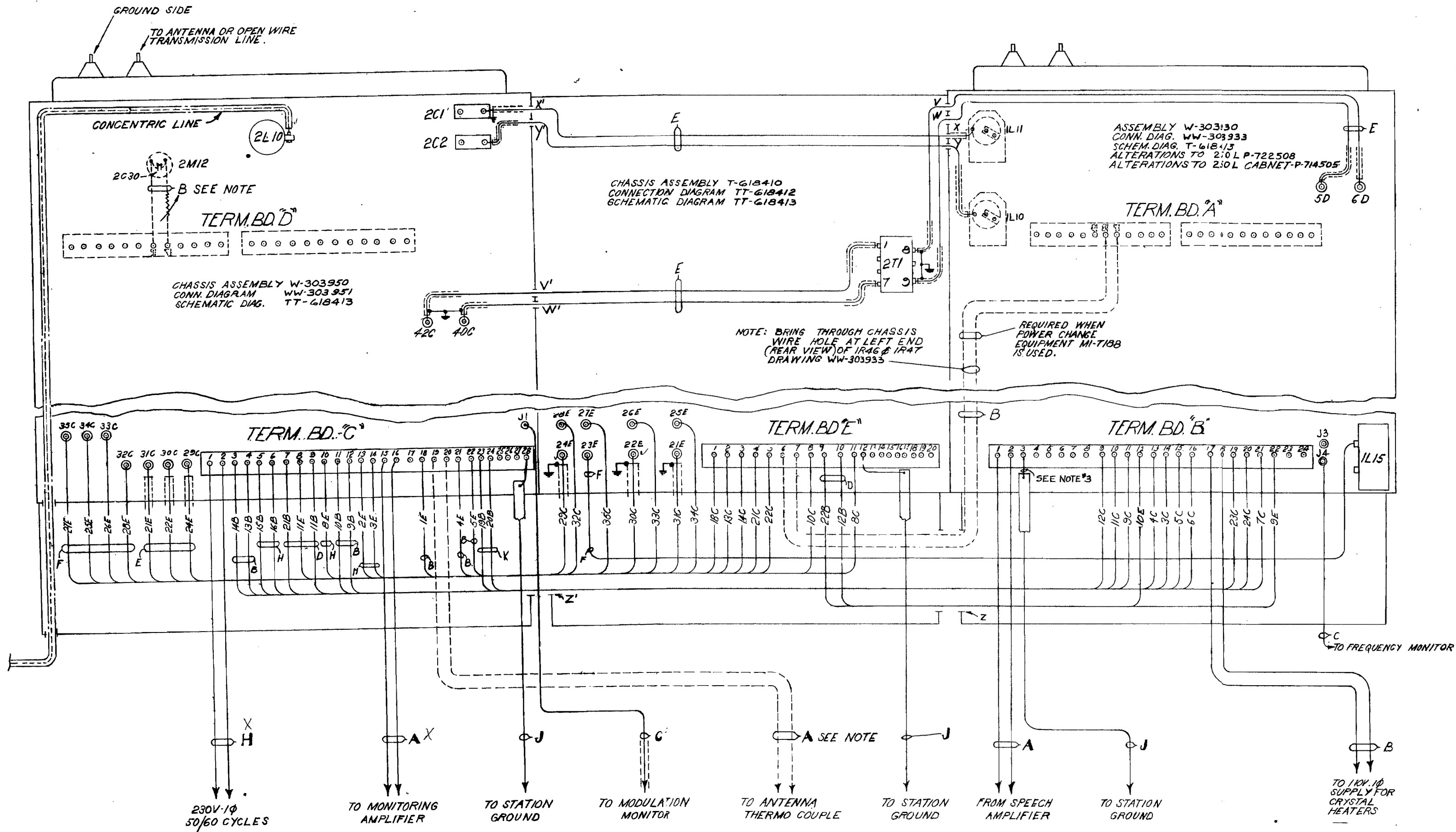

Figure 14—Amplifier-Modulator Connections (WV-303951)



WIRE SIZES

A	#19 AWG TWISTED PAIR LEAD COVERED
B	#14 AWG VARNISHED CAMBRIC-600V.
C	RG-8/U CONCENTRIC CABLE
D	#12 AWG VARNISHED CAMBRIC 600-V
E	RG-59/U CONCENTRIC CABLE
F	#14 AWG VARNISHED CAMBRIC 3000V
H	#8 AWG VARNISHED CAMBRIC 600V
J	.032x2 WIDE COPPER STRAP
K	MI-7P80-3F TWISTED PAIR SHIELDED

LEAD COVERED CABLE MAY BE USED

Figure 16—BT-A-250L Connection Changes (P-722508)

43

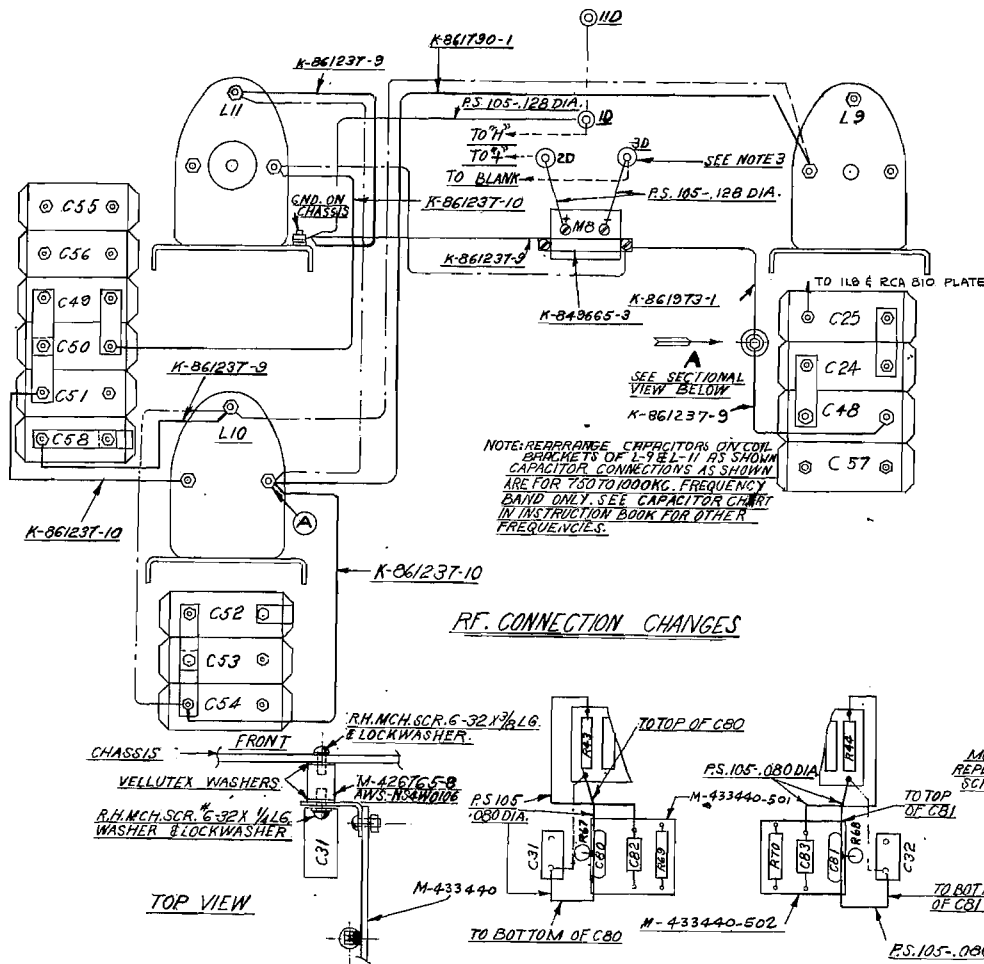

RF. CONNECTION CHANGES

TYPICAL MOUNTING OF RESISTOR CAPACITOR BOARDS M-433440-501 & 502

CONNECTIONS OF CAPACITOR RESISTOR BOARDS M-433440-501 & 502

NOTE #1: MOUNT RESISTOR-CAPACITOR BOARDS M-433440-501 & 502 AND MAKE CONNECTIONS AS SHOWN. LINES SHOWN FULL INDICATE CONNECTIONS TO BE ADDED, DASH DOT LINES INDICATE CONNECTIONS TO BE REMOVED.

NOTE #2: REMOVE WIRES 183 AND 184 (TO T6) FROM BUSHING 5D AND 6D DRG-WW-303933 AND TAPE FREE ENDS WITH VARNISHED CAMBRIC AND FRICTION TAPE, THEN LACE IN LEFTHAND WIRE CABLE.

NOTE #3: MOUNT M7 IN METER PANEL & CONNECT METER TERMINALS 1ANDZ AND BLANK TO BUSHINGS 1D-2D AND 3D RESPECTIVELY WITH FS. 533 26/1010, 300 VOLT BLACK WIRE, LACE TO METER PANEL CABLE. SUPPLIED AS MI-7280A ITEM 3G.

NOTE #4: REMOVE SCH. ITEM #R4B AND REPLACE WITH ONE RESISTOR SUPPLIED AS MI-7280A ITEM 2G.

NOTE #4A: INTERCHANGE PHYSICAL LOCATIONS OF C24 & C25. RECONNECT AS PER SCHEM. TT-618413.

NOTE #5: REMOVE SCH. ITEMS C45 AND C46 AND SUBSTITUTE CAPACITORS SUPPLIED AS MI-7280A ITEM 2C

NOTE #6: REMOVE SCH. ITEM R45 AND SUBSTITUTE RESISTOR SUPPLIED AS MI-7280A ITEM 2F.

NOTE #7: REMOVE SCH. ITEMS R43 & R44 & SUBSTITUTE RESISTORS SUPPLIED AS MI-7280A ITEM 2E.

NOTE #8: DISCONNECT WIRES FROM PLATES OF 82B AUDIO TUBES TO 250K FEED BACK LADDER, WIRE NOS. 270 & 271, WW-303933.

NOTE #9: DISCONNECT & TAPE TWISTED PAIR FROM 250K FEED BACK LADDER TO TERMINALS 3E6 OF INPUT TRANSFORMER (T8) WIRE NOS. 350 & 351.

NOTE #9A: REMOVE JUMPER BETWEEN C45, R29 & R76. ALSO REMOVE JUMPER BETWEEN C46, R30 & R74.

NOTE #10: CONNECT TWISTED PAIR FROM TERMINALS 19B & 20B TO TERMINALS 3E6 OF T8 USE TWISTED PAIR SUPPLIED AS MI-7280A ITEM 3F GROUND SHIELD AT TERMINAL BOARD USING MI-7280A ITEM 3G.

NOTE #11: REMOVE SCH. ITEM R17 AND SUBSTITUTE RESISTOR SUPPLIED AS MI-7280-A ITEM 2D

NOTE #12: REMOVE GRID & PLATE CONNECTOR FOR X6 (TWO OF PTS. 13 ON WW-303933).

NOTE #13: REMOVE WIRE #233 (DRG. WW-303933 BETWEEN SCHEMATIC ITEMS L10 & L11) AND REPLACE WITH ONE RESISTOR R-71 SUPPLIED AS MI-7280A ITEM 2G.

NOTE #14: RELOCATE CAPACITORS LINKS AND GROUND STRAPS AS SHOWN. (EXTRA LINKS AND GROUND STRAPS TO BE SHIPPED WITH EQUIPMENT.)

NOTE #15: PAINT OUT SCHEMATIC ITEM NUMBERS C48, C49, C50, C51, C54 & C57 LOCATED ON BRACKETS WHICH SUPPORT SCHEMATIC ITEMS L9, L10 & L11, USING SILVER GRAY LAQUER (FINISH #572.) AND APPLY IDENTICAL STENCILS ON RESPECTIVE CAPACITORS.

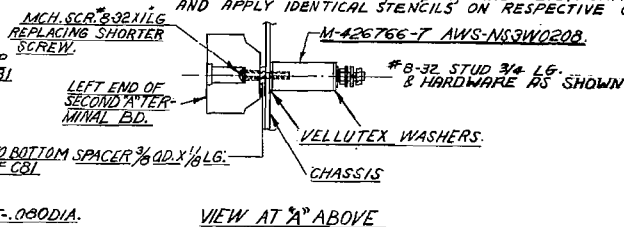

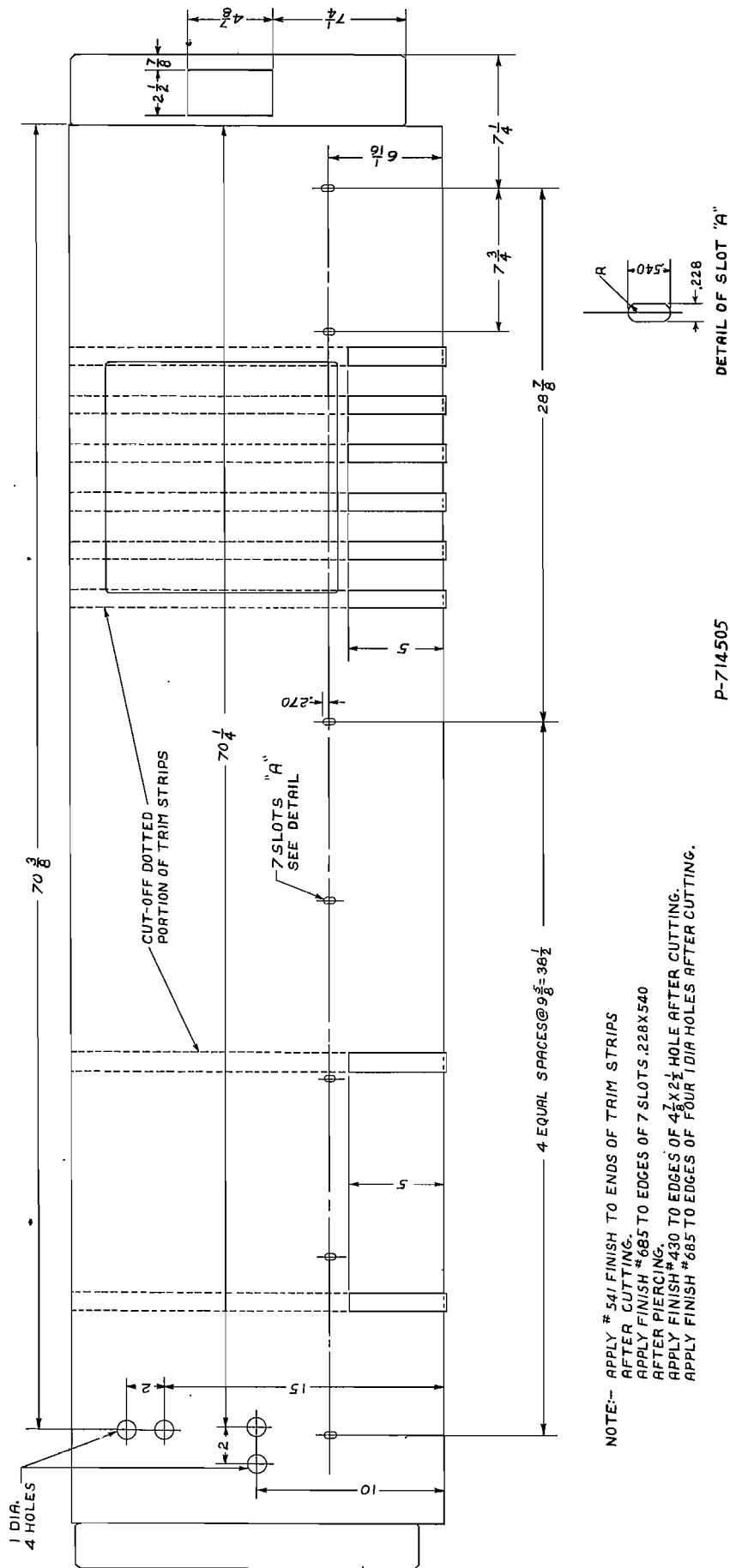

NOTE:— APPLY # 541 FINISH TO ENDS OF TRIM STRIPS
 AFTER CUTTING.
 APPLY FINISH # 685 TO EDGES OF 7 SLOTS. 228X540
 AFTER PIERCING.
 APPLY FINISH # 430 TO EDGES OF 4 1/8 X 2 1/2 HOLE AFTER CUTTING.
 APPLY FINISH # 685 TO EDGES OF FOUR 1 DIA HOLES AFTER CUTTING.

P-714505

DETAIL OF SLOT 'A'

Figure 17—BTA-250L Cabinet Changes (P-714505)

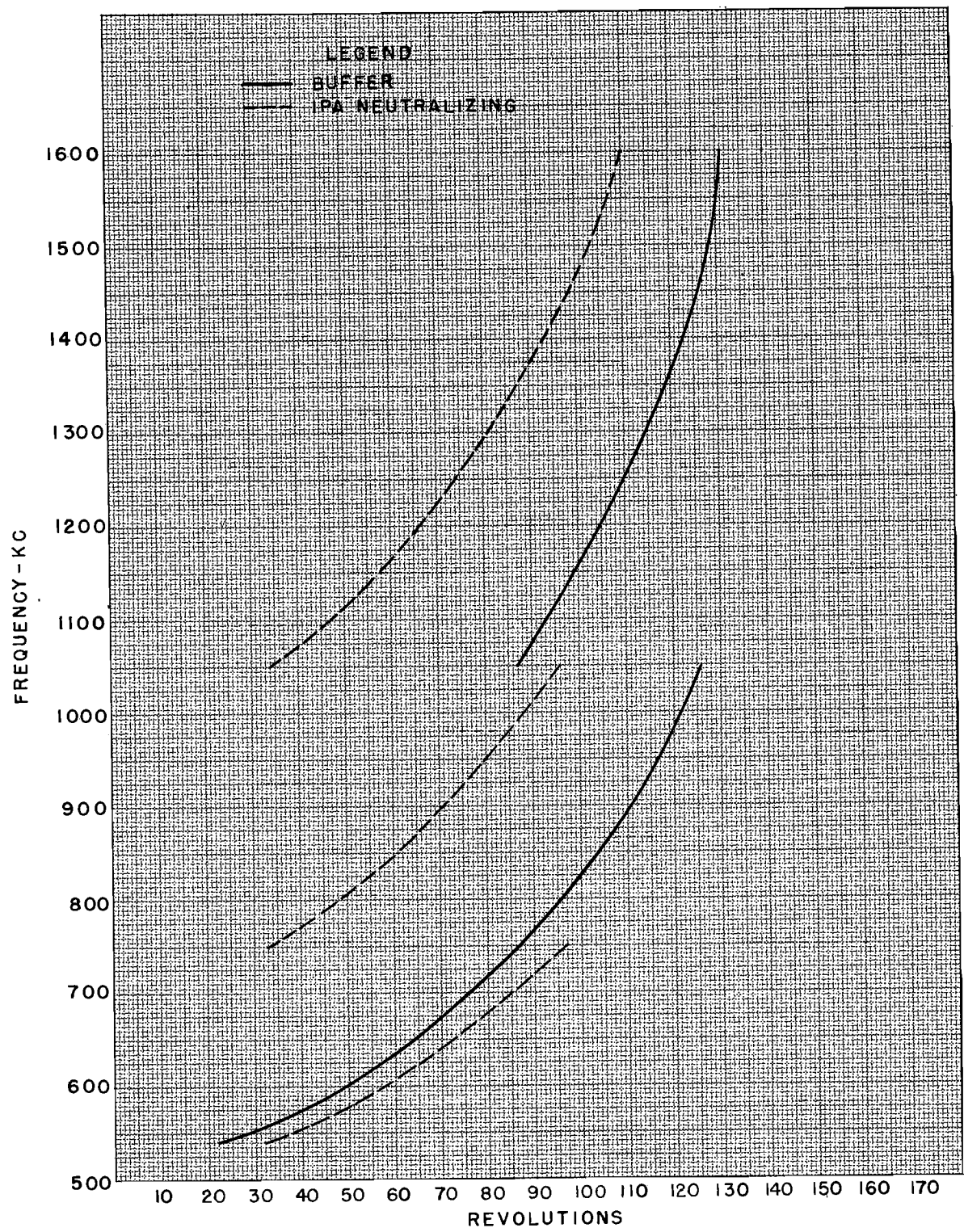

TUNING CHART BTA-250L TRANSMITTER

*Figure 19—Exciter IPA Neutralizing and Buffer Controls
 (Graph, Dial Setting vs. Frequency, S-853809)*

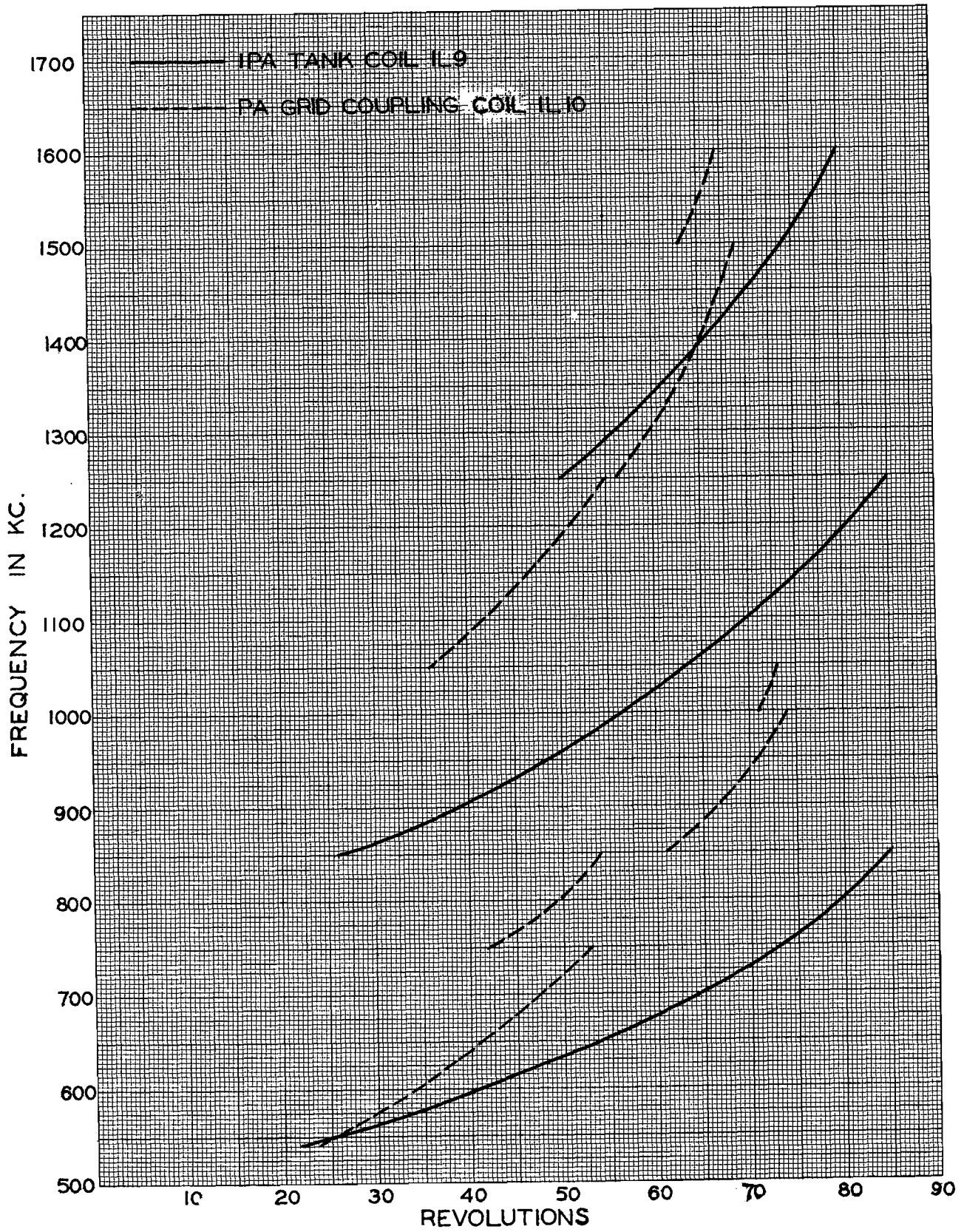
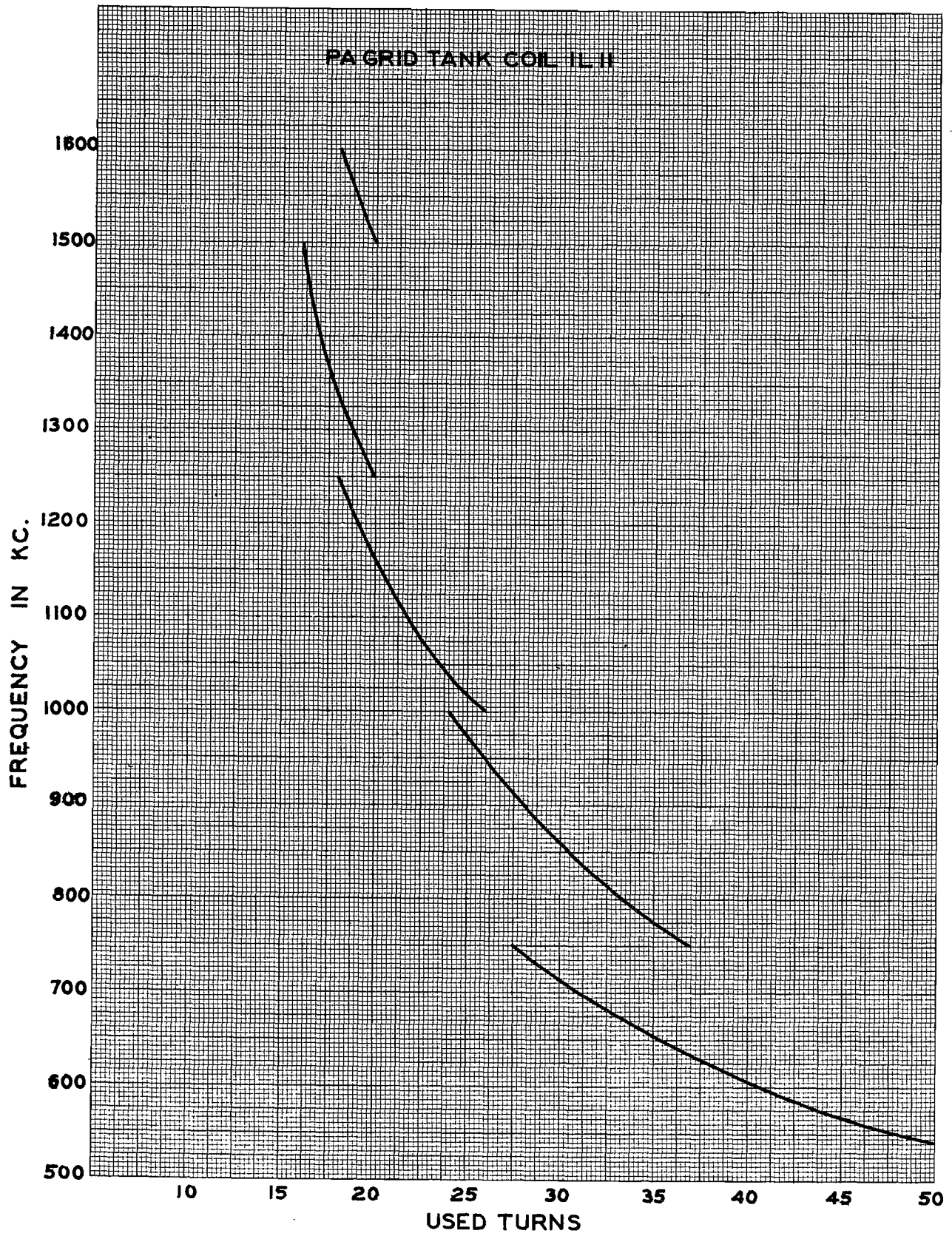

Figure 20—IPA Tank and Grid Coupling Controls
 (Graph, Dial Setting vs. Frequency, S-852919)



*Figure 21—Exciter PA Grid Tank Coil
(Graph, Active Turns vs. Frequency, S-852920)*

BTA-1L BROADCAST TRANSMITTER

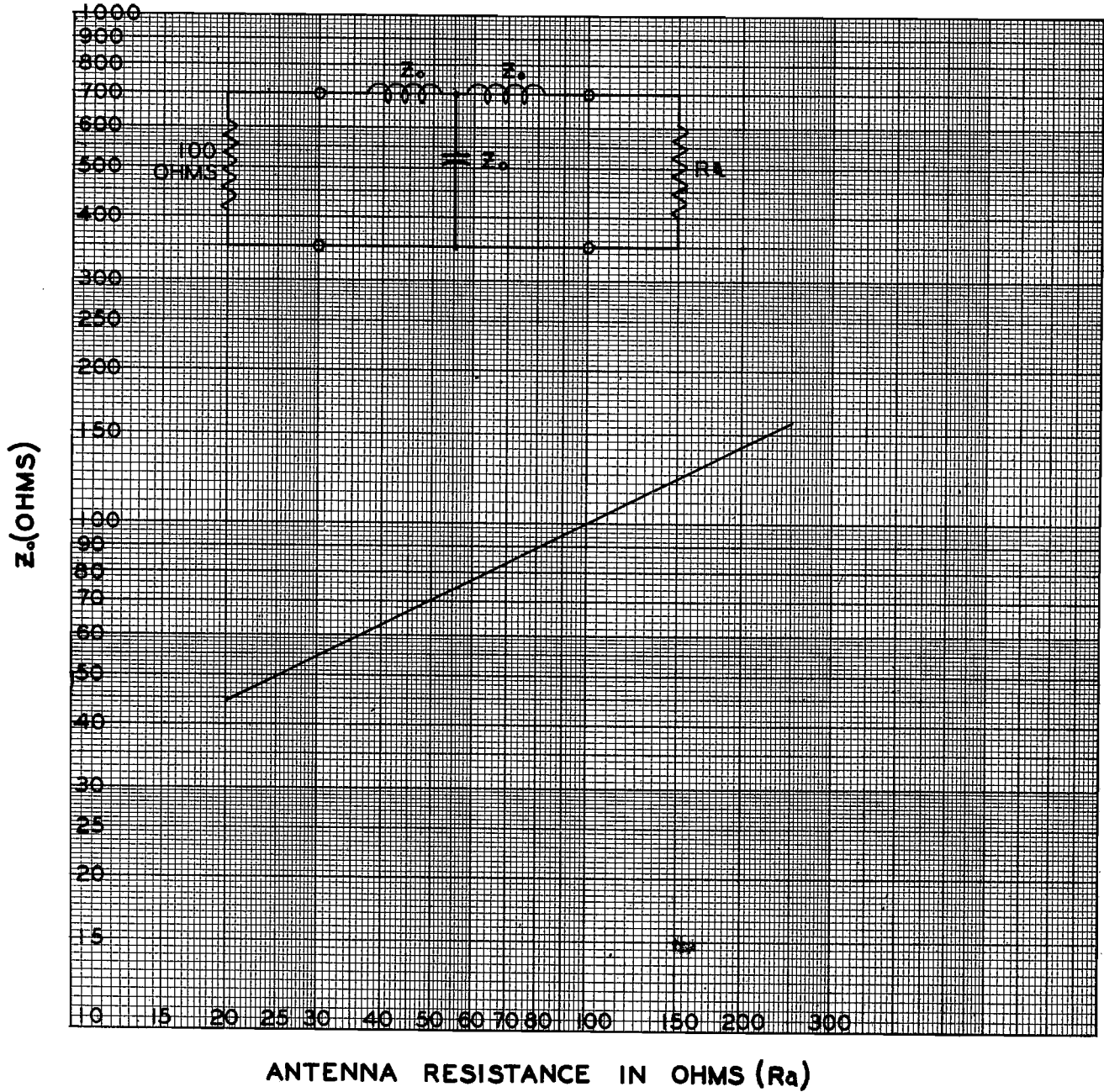

Figure 22—Output Network Impedance
(Graph, Antenna Resistance vs. Network Impedance, S-853830)

BTA-IL BROADCAST TRANSMITTER

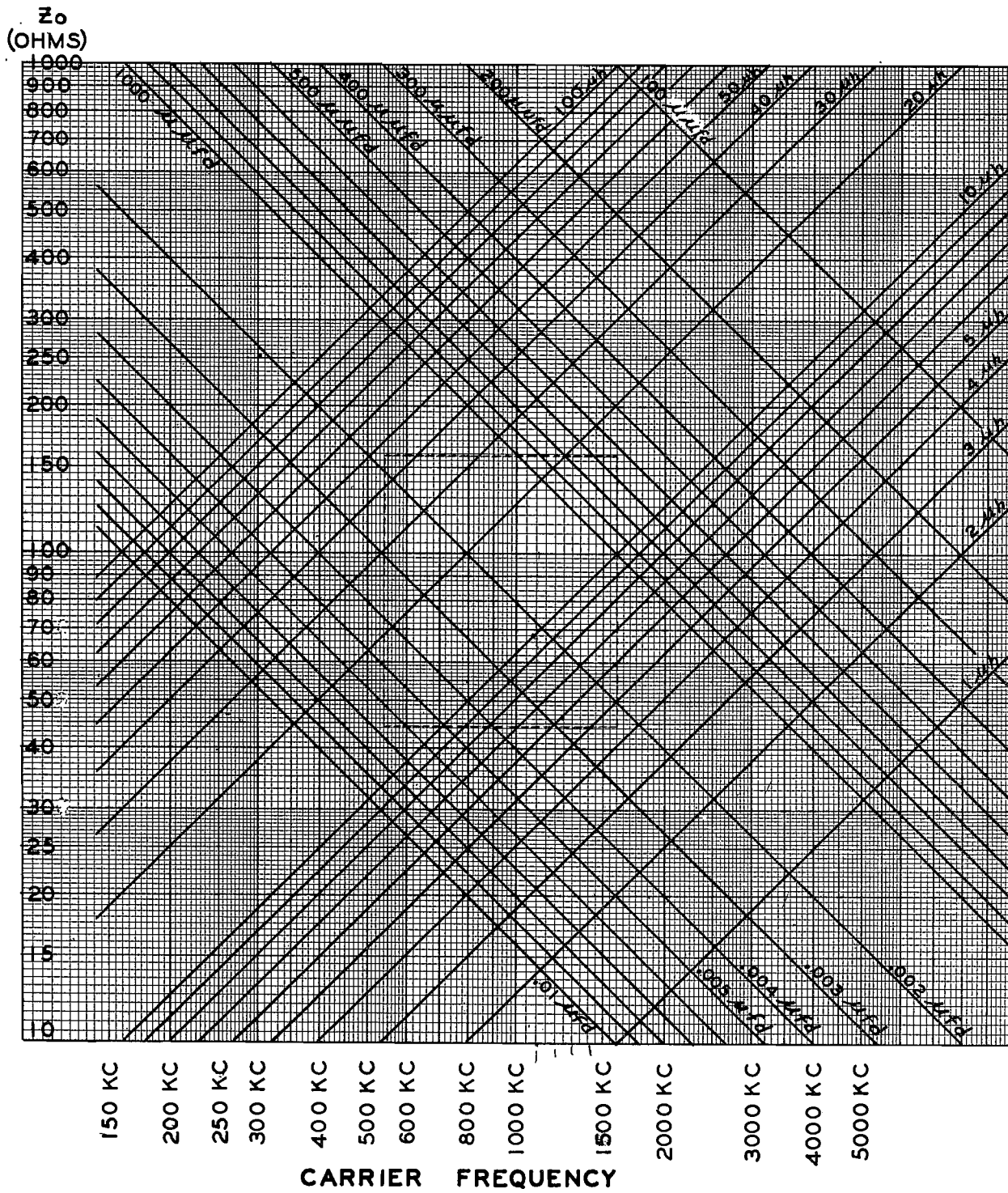

Figure 23—Output Network Reactance
(Graph, Carrier Frequency vs. Inductance and Capacity, S-853832)

BTA-1L BROADCAST TRANSMITTER

NUMBER
OF TURNS
(2L9
OR 2L10)

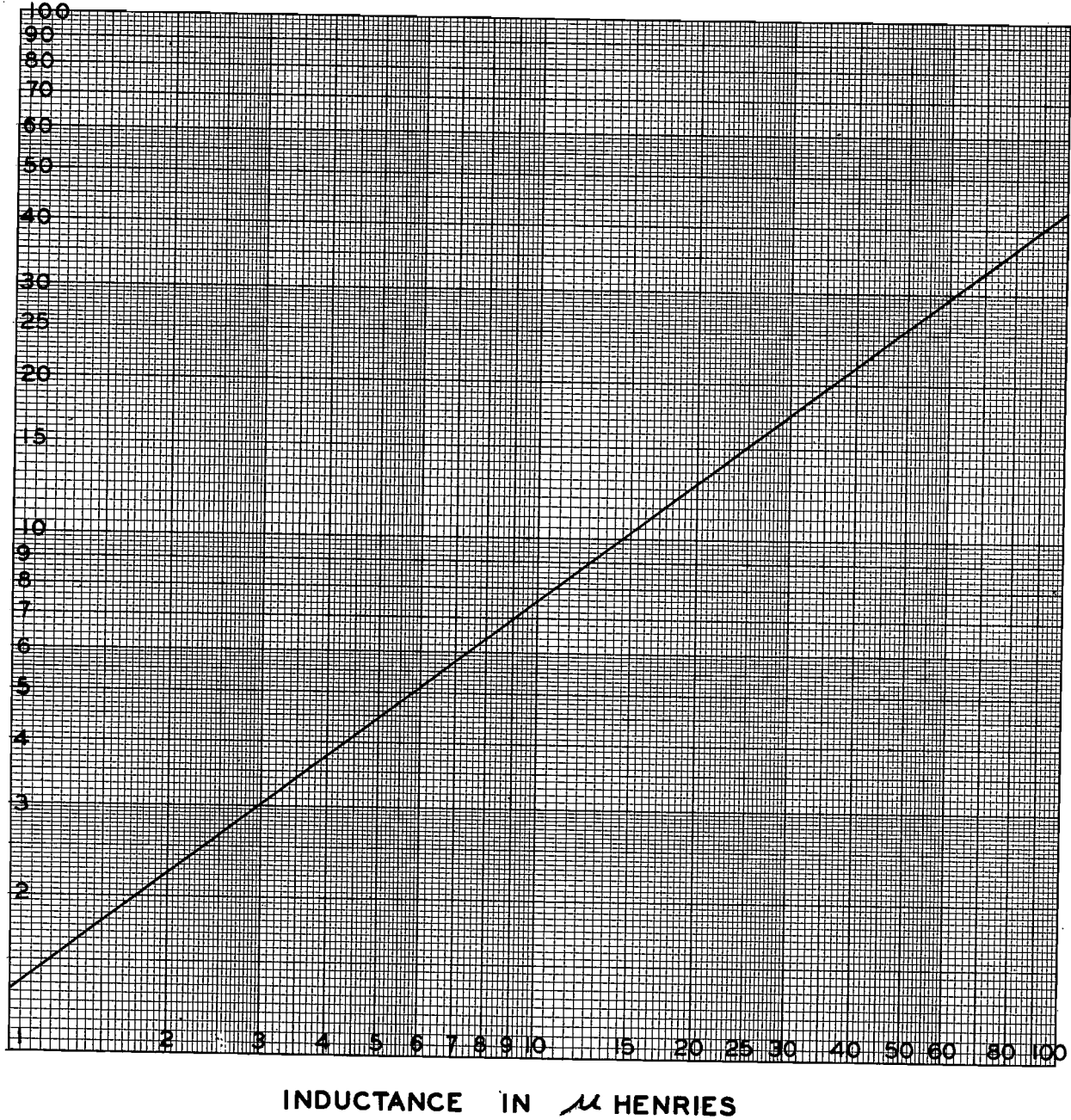

Figure 24—Output Network Inductance
(Graph, Inductance vs. Turns 2L9 or 2L10, S-853831)



Manufactured by
RADIO CORPORATION OF AMERICA
Engineering Products Department
CAMDEN, NEW JERSEY, U. S. A.

BROADCAST TRANSMITTER

BTA-1L

Power $\left. \begin{array}{l} 1000 \\ 500/1000 \\ 500 \\ 250/1000 \\ 250/500 \end{array} \right\} \text{WATTS}$



INSTRUCTION BOOK