

TECHNICAL
BULLETIN



NEW ALL-METAL RADIO TUBES

RCA RADIOTRON DIVISION
RCA MANUFACTURING CO., INC.

FOREWORD

THIS BOOKLET describes the technical features of the new RCA All-Metal Radio Tubes. These new tubes, designed by the General Electric Company and manufactured by RCA Manufacturing Company, are unique in their structural design. Perhaps the most important deviation from previous manufacturing practice is the use of a metal shell which serves as a vacuum-tight container and also as an almost perfect electrostatic shield.

Metal-bulb radio tubes have been made practical by the recent great advancements in welding procedure brought about by the use of electronic tubes to provide accurate control of welding operations. In these new metal tubes, vacuum-tight welds requiring a current flow of as much as 75000 amperes, are made to a precise fraction of a second.

Another important factor in the design of these tubes is the use of Fernico metal, a new alloy which seals readily to certain special kinds of glass. The use of Fernico eyelets and glass-bead seals, as illustrated in the frontispiece cut-away drawing, permits of many advantageous innovations in tube assembly. Some of these are: (1) elimination of need for the usual glass-stem structure, (2) reduction in overall length without reducing size of electrode structure, (3) small distance between mount and base with resultant rigidity of the mount, and (4) short and direct connection of each electrode to its pin terminal.

Further features of these new metal tubes are the very low grid-plate capacitance due to almost perfect shielding of the metal shell, the strong mechanical joint between header and base, as well as between cap and metal shell, and the use of the new octal base which because of its self-aligning design can be easily and quickly inserted in its socket.

Because of the octal base and general differences in electrical characteristics, these new metal tubes are not directly interchangeable with RCA glass-tube types.

Commercial Engineering Section
RCA RADIOTRON DIVISION
RCA MANUFACTURING COMPANY, INC.

Copyright 1935
by
RCA MANUFACTURING CO., INC.

The license extended to the purchaser of tubes appears in the License Notice accompanying them. Information contained herein is furnished without assuming any obligations.



- ① SOLDER
- ② CAP INSULATOR
- ③ ROLLED LOCK
- ④ CAP SUPPORT
- ⑤ GRID LEAD SHIELD
- ⑥ CONTROL GRID
- ⑦ SCREEN
- ⑧ SUPPRESSOR
- ⑨ INSULATING SPACER
- ⑩ PLATE
- ⑪ MOUNT SUPPORT
- ⑫ SUPPORT COLLAR
- ⑬ GETTER TAB
- ⑭ GLASS BEAD SEAL
- ⑮ FERNICO EYELET
- ⑯ LEAD WIRE
- ⑰ CRIMPED LOCK
- ⑱ ALIGNING KEY
- ⑲ PINCHED SEAL
- ⑳ ALIGNING PLUG

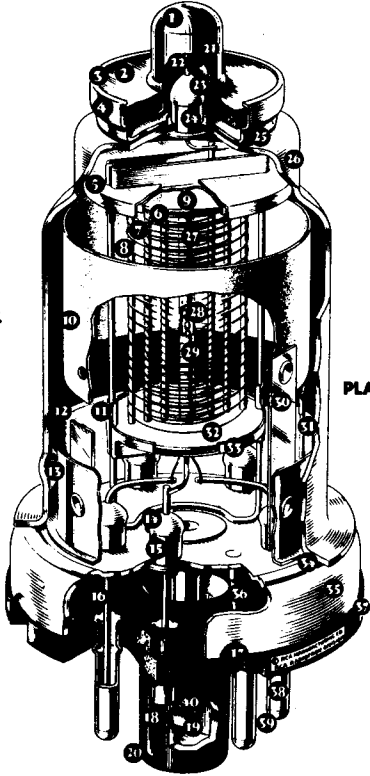

- GRID CAP ⑳
- GRID LEAD WIRE ㉑
- GLASS BEAD SEAL ㉒
- FERNICO EYELET ㉓
- BRAZED WELD ㉔
- VACUUM-TIGHT STEEL SHELL ㉕
- CATHODE ㉖
- HELICAL HEATER ㉗
- CATHODE COATING ㉘
- PLATE INSULATING SUPPORT ㉙
- PLATE LEAD CONNECTION ㉚
- INSULATING SPACER ㉛
- SPACER SHIELD ㉜
- SHELL TO HEADER SEAL WELD ㉝
- HEADER ㉞
- SHELL CONNECTION ㉟
- OCTAL BASE ㊱
- BASE PIN ㊲
- SOLDER ㊳
- EXHAUST TUBE ㊴

INTERNAL STRUCTURE OF AN ALL-METAL RADIO TUBE





RCA-5Z4

Full-Wave High-Vacuum Rectifier

The 5Z4 is a full-wave rectifying tube of the metal type intended for use in d-c power-supply devices which operate from the a-c supply line.

TENTATIVE CHARACTERISTICS

HEATER VOLTAGE	5.0	Volts
HEATER CURRENT	2.0	Amperes
A-C PLATE VOLTAGE PER PLATE (RMS)	400 <i>max.</i>	Volts
PEAK INVERSE VOLTAGE	1100 <i>max.</i>	Volts
D-C OUTPUT CURRENT	125 <i>max.</i>	Milliamperes
MAXIMUM OVERALL LENGTH	5-1/8"	
MAXIMUM DIAMETER	1-5/16"	
BASE	Small Octal 5-Pin	

INSTALLATION

The *base* pins of the 5Z4 fit the five-contact octal-base socket for this pin arrangement (or the universal eight-contact socket) which should be installed to hold the tube in a vertical position with the base down. Provision should be made for free circulation of air around the tube since it becomes quite hot during operation.

The *heater* of the 5Z4 is designed to operate from the a-c line through a step-down transformer. The voltage applied to the heater should be the rated value of 5.0 volts under operating conditions and average line voltage.

APPLICATION

As a *full-wave rectifier*, the 5Z4 may be operated with condenser-input or choke-input filter under conditions not to exceed the ratings given under CHARACTERISTICS.

As a *half-wave rectifier*, two 5Z4's may be operated in a full-wave circuit with reasonable serviceability to deliver more d-c output current than can be obtained from one tube. For this use, the plates of each 5Z4 are tied together at the socket. The allowable voltage and load conditions per tube are the same as for full-wave service.

The *filter* may be of either the condenser-input or choke-input type. If an input condenser is used, consideration must be given to the instantaneous peak value of the a-c input voltage. The peak value is about 1.4 times the RMS value as measured by most a-c voltmeters. Filter condensers, therefore, especially the input condenser, should have a rating high enough to withstand the instantaneous peak value, if breakdown is to be avoided. When the input-choke method is used, the available d-c output voltage will be somewhat lower than

for the input-condenser method for a given a-c plate voltage. However, improved regulation, together with lower peak current, will be obtained.

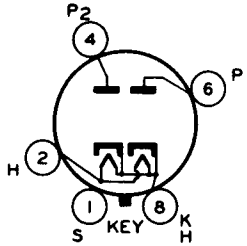

BOTTOM VIEW

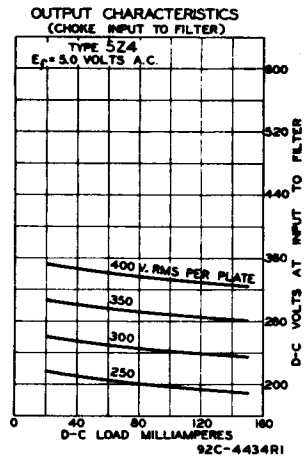
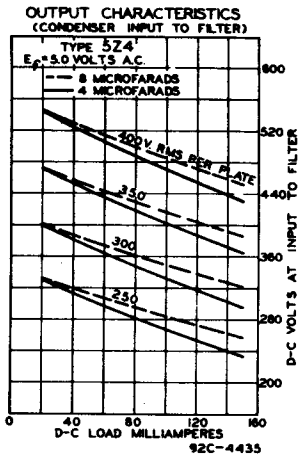

Cunningham
Radiotron

RCA-6A8

Pentagrid Converter

The 6A8 is a multi-electrode vacuum tube of the metal type designed to perform simultaneously the functions of a mixer (first detector) tube and of an oscillator tube in superheterodyne circuits. Through the use of this type, the independent control of each function is made possible within a single tube.

TENTATIVE CHARACTERISTICS

HEATER VOLTAGE (A.C. or D.C.)	6.3	Volts
HEATER CURRENT	0.3	Ampere
DIRECT INTERELECTRODE CAPACITANCES (Approx.):*		
Grid No.4 to Plate	0.03	μμf
Grid No.4 to Grid No.2	0.1	μμf
Grid No.4 to Grid No.1	0.09	μμf
Grid No.1 to Grid No.2	0.8	μμf
Grid No.4 to All Other Electrodes (R-F Input)	12.5	μμf
Grid No.2 to All Other Electrodes (Osc. Output)	5	μμf
Grid No.1 to All Other Electrodes (Osc. Input)	6.5	μμf
Plate to All Other Electrodes (Mixer Output)	12.5	μμf
MAXIMUM OVERALL LENGTH	3-1/8"	
MAXIMUM DIAMETER	1-5/16"	
CAP	Miniature	
BASE	Small Octal 8-Pin	

* With shell connected to cathode.

As Frequency Converter

PLATE VOLTAGE	250 max.		Volts
SCREEN (Grids No.3 and No.5) VOLTAGE	100 max.		Volts
ANODE-GRID (Grid No.2) VOLTAGE	200 max.		Volts
ANODE-GRID (Grid No.2) SUPPLY VOLTAGE **	250 max.		Volts
CONTROL GRID (Grid No.4) VOLTAGE	-3 min.		Volts
TOTAL CATHODE CURRENT	14 max. Milliampere		
TYPICAL OPERATION:			
Plate Voltage	100	250	Volts
Screen Voltage	50	100	Volts
Anode-Grid Voltage	100	250**	Volts
Control Grid Voltage (Minimum)	-1.5	-3	Volts
Oscillator Grid (Grid No.1) Resistor	50000	50000	Ohms
Plate Current	1.2	3.3	Milliamperes
Screen Current	1.5	3.2	Milliamperes
Anode-Grid Current	1.6	4.0	Milliamperes
Oscillator Grid Current	0.25	0.5	Milliamperes

** When the Anode-Grid Supply voltage exceeds 200 volts, it should be applied through a 20000-ohm voltage-dropping resistor.

Conversion Conductance	350	500	Micromhos
Control Grid Voltage for Conver. Cond. of 2 Micromhos (Approx.)	-20	-45	Volts

INSTALLATION

The base pins of the 6A8 fit the eight-contact octal-base socket, which may be installed to hold the tube in any position.

The heater of the 6A8 is designed to operate on either d.c. or a.c. For operation on a.c. with a transformer, the winding which supplies the heater circuit should operate the heater at its recommended value for full-load operating conditions at average line voltage. For service in automobile receivers, the heater terminals of the 6A8 should be connected directly across a 6-volt battery. In receivers that employ a series-heater connection, the heater of the 6A8 may be operated in series with the heater of other types having a 0.3-ampere rating. The current in the heater circuit should be adjusted to 0.3 ampere for the normal supply-line voltage.

The cathode of the 6A8, when operated from a transformer, should preferably be connected directly to the electrical mid-point of the heater circuit. When it is operated in receivers employing a 6-volt storage battery for the heater supply, the cathode circuit is tied in either directly or through bias resistors to the negative side of the d-c plate supply which is furnished either by the d-c power line or the a-c line through a rectifier. In circuits where the cathode is not directly connected to the heater, the potential difference between them should be kept as low as possible. If the use of a large resistor is necessary between the heater and cathode of the 6A8 in some circuit designs, it should be by-passed by a suitable filter network or objectionable hum may develop.

APPLICATION

As a frequency converter in superheterodyne circuits, the 6A8 can supply the local oscillator frequency and at the same time mix it with radio-input frequency to provide the desired intermediate frequency. For this service, design information is given under CHARACTERISTICS.

For the oscillator circuit, the coils may be constructed according to conventional design, since the tube is not particularly critical. The supply voltage applied to the anode-grid No.2 should not exceed the maximum value of 250 volts. In fact, from a performance standpoint, a lower value is to be preferred, because it will be adequate to provide for optimum translation gain. Under no condition of adjustment should the cathode current exceed a recommended maximum value of 14 milliamperes.

The bias voltage applied to grid No.4 can be varied from -3 volts to cut-off to control the translation gain of the tube. With lower screen voltages, the cut-off point is less remote. The extended cut-off feature of this tube in combination with the similar

characteristic of super-control tubes can be utilized advantageously to adjust receiver sensitivity.

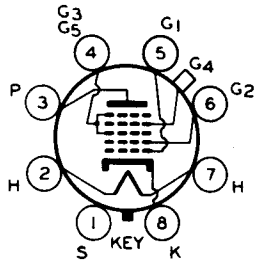

BOTTOM VIEW

Cunningham
Radiotron

 RCA-6C5

Detector Amplifier Triode

The 6C5 is a three-electrode tube of the metal type recommended for use as a detector, amplifier, or oscillator. This tube has a high mutual conductance together with a comparatively high amplification factor.

TENTATIVE CHARACTERISTICS

HEATER VOLTAGE (A.C. or D.C.)	6.3	Volts
HEATER CURRENT	0.3	Ampere
PLATE VOLTAGE	250 <i>max.</i>	Volts
GRID VOLTAGE °	-8	Volts
PLATE CURRENT	8	Milliamperes
PLATE RESISTANCE	10000	Ohms
AMPLIFICATION FACTOR	20	
MUTUAL CONDUCTANCE	2000	Micromhos
GRID-PLATE CAPACITANCE *	1.8	μf
GRID-CATHODE CAPACITANCE *	4	μf
PLATE-CATHODE CAPACITANCE *	13	μf
MAXIMUM OVERALL LENGTH		2-5/8"
MAXIMUM DIAMETER		1-5/16"
BASE		Small Octal 6-Pin

° If a grid-coupling resistor is used, its maximum value should not exceed 1.0 megohm.

* With shell connected to cathode.

INSTALLATION

The base pins of the 6C5 fit the six-contact octal-base socket (or the universal eight-contact socket) which may be installed to hold the tube in any position.

For heater operation and cathode connection, refer to INSTALLATION for type 6A8.

APPLICATION

As an amplifier, the 6C5 is applicable to radio-frequency or audio-frequency circuits. Recommended operating conditions for service using transformer coupling are given under CHARACTERISTICS. For circuits utilizing resistance coupling, typical operating conditions are as follows:

PLATE-SUPPLY VOLTAGE	250	Volts
GRID-BIAS VOLTAGE (Approx.)	-5	Volts
PLATE LOAD RESISTOR	50000 to 100000	Ohms
PLATE CURRENT	1 to 2	Milliamperes
VOLTAGE AMPLIFICATION	14	
VOLTAGE OUTPUT (5% second harmonic)	42	Volts (RMS)

As a detector, the 6C5 may be of the grid-leak and condenser or grid-bias type. The plate voltage for the grid leak and condenser method should be 45 to 100 volts. A grid leak from 0.1 to 1.0 megohm with a grid condenser of 0.00005 to 0.0005 μf is satisfactory. For the grid-bias method of detection, a plate-supply voltage of 250 volts may be used together with a negative grid-bias voltage of approximately 17 volts. The plate current should be adjusted to 0.2 milliampere with no input signal voltage. The grid-bias voltage may be supplied from the voltage drop in a resistor between cathode and ground.

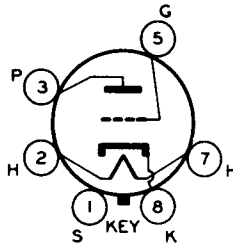

BOTTOM VIEW

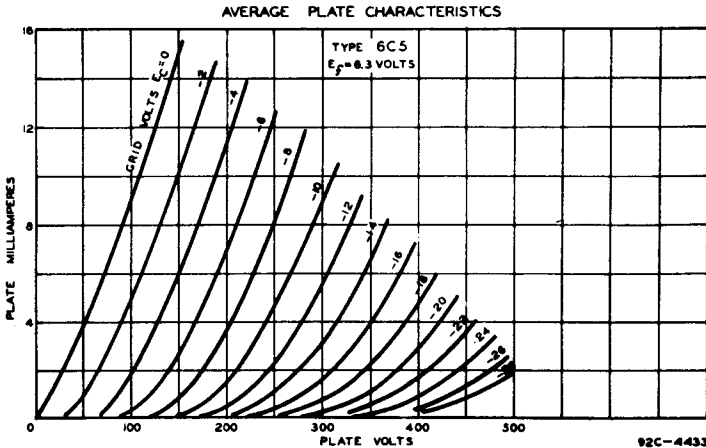



RCA-6F5

High-Mu Triode

The 6F5 is a high-mu triode of the metal type. It is particularly suitable for use in resistance-coupled amplifier circuits.

TENTATIVE CHARACTERISTICS

HEATER VOLTAGE (A.C. or D.C.)	6.3	Volts
HEATER CURRENT	0.3	Ampere
PLATE VOLTAGE	250 <i>max.</i>	Volts
GRID VOLTAGE	-2	Volts
PLATE CURRENT	0.9	Milliampere
PLATE RESISTANCE	66000	Ohms
AMPLIFICATION FACTOR	100	
MUTUAL CONDUCTANCE	1500	Micromhos
GRID-PLATE CAPACITANCE *	2	μf
GRID-CATHODE CAPACITANCE *	6	μf
PLATE-CATHODE CAPACITANCE *	12	μf
MAXIMUM OVERALL LENGTH	3-1/8"	
MAXIMUM DIAMETER	1-5/16"	
CAP	Miniature	
BASE	Small Octal 5-Pin	

* With shell connected to cathode.

INSTALLATION

The base pins of the 6F5 fit the five-contact octal-base socket for this pin arrangement (or the universal eight-contact socket) which may be mounted to hold the tube in any position.

For heater operation and cathode connection, refer to INSTALLATION for type 6A8.

APPLICATION

As an amplifier in resistance-coupled a-f circuits, the 6F5 may be operated under the following conditions:

PLATE-SUPPLY VOLTAGE	250	250	Volts
GRID-BIAS VOLTAGE	-1.3	-1.3	Volts
PLATE LOAD RESISTOR	0.25 to 1.0	0.25 to 1.0	Megohm
GRID RESISTOR **	0.25	0.5	Megohm
PLATE CURRENT	0.2 to 0.4	0.2 to 0.4	Milliampere
VOLTAGE AMPLIFICATION	52 to 56	51 to 60	
VOLTAGE OUTPUT	11 to 20	14.5 to 25.5	Volts (RMS)

** For the following amplifier tube.

When a 6F5 is used to amplify the output of the 6H6 diode, it

is recommended that fixed grid bias be employed. Diode-biasing of the 6F5 is not suitable because of the probability of plate-current cut-off, even with relatively small signal voltages applied to the diode circuit.

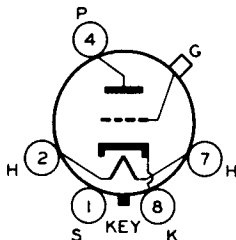

BOTTOM VIEW

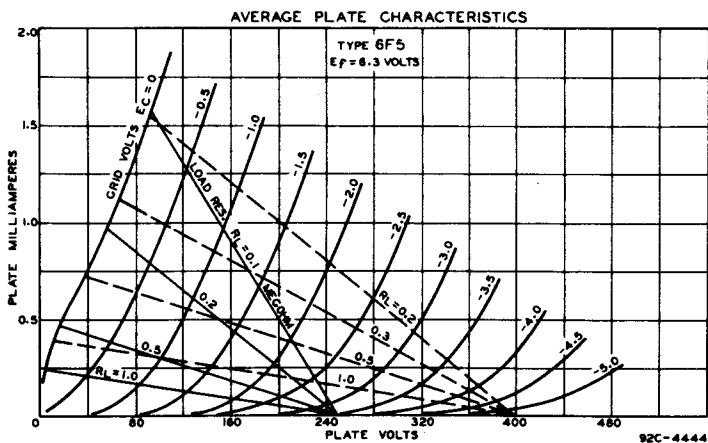

Cunningham
Radiotron

 RCA-6F6

Power Amplifier Pentode

The 6F6 is a heater-cathode power-amplifier pentode of the metal type for use in the audio-output stage of a-c receivers. It is capable of giving large power output with a relatively small input voltage. Because of the heater-cathode construction, a uniformly low hum-level is attainable in power-amplifier design.

TENTATIVE CHARACTERISTICS

HEATER VOLTAGE (A.C. or D.C.)	6.3	Volts
HEATER CURRENT	0.7	Volts
MAXIMUM OVERALL LENGTH	3-1/4"	
MAXIMUM DIAMETER	1-5/16"	
BASE	Small Octal 7-Pin	

Single-Tube Class A Amplifier

	<u>Pentode Connection</u>		<u>Triode Connection</u>		
			Screen tied to plate		
PLATE VOLTAGE	250	315 max.	250 max.		Volts
SCREEN VOLTAGE	250	315 max.	-		Volts
GRID VOLTAGE	-16.5	-22	-20		Volts
PLATE CURRENT	34	42	31		Milliamperes
SCREEN CURRENT	6.5	8	-		Milliamperes
PLATE RESISTANCE	8000 ^o	7500 ^o	2600		Ohms
AMPLIFICATION FACTOR	200 ^o	200 ^o	7		
MUTUAL CONDUCTANCE	2500	2650	2700		Micromhos
LOAD RESISTANCE	7000	7000	4000		Ohms
TOTAL HARMONIC DISTORTION	7	7	5		Per cent
POWER OUTPUT	3	5	0.85		Watts

Under the above maximum voltage conditions, transformer or impedance input-coupling devices are recommended. If resistance-coupling is used, refer to last paragraph of APPLICATION.

^o Approximate.

Push-Pull Class AB Amplifier (Pentode Connection)

	<u>Fixed-Bias</u>	<u>Self-Bias</u>	
PLATE VOLTAGE	375 max.	375 max.	Volts
SCREEN VOLTAGE	250 max.	250 max.	Volts
GRID VOLTAGE	-26 min.	-	Volts
SELF-BIAS RESISTOR	-	340 min.	Ohms
ZERO-SIGNAL PLATE CUR. (Per tube)	17	27	Milliamperes
ZERO-SIGNAL SCREEN CUR. (Per tube)	2.5	4	Milliamperes
LOAD RESISTANCE (Per tube)	2500	2500	Ohms
EFFECTIVE LOAD RESISTANCE (Plate-to-plate)	10000	10000	Ohms
TOTAL HARMONIC DISTORTION	5	5	Per cent
POWER OUTPUT (2 tubes)	19 approx.*	19 approx.*	Watts

Under the above maximum voltage conditions, transformer or impedance input-coupling devices must be used.

* With one triode-connected 6F6 as driver operated at plate volts of 250, grid volts of -20, and with a minimum plate load of approximately 10000 ohms: input transformer ratio, primary to one-half secondary, is 3.32. The plate, screen and grid supply have negligible resistance.

With one triode-connected 6F6 as driver operated at plate volts of 250, grid volts of -20, and with a minimum plate load of approximately 10000 ohms: input transformer ratio, primary to one-half secondary, is 2.5. The plate and screen supply have negligible resistance. The value given for the self-bias resistor is determined for a minimum grid bias of -21 volts.

Push-Pull Class AB Amplifier (Triode Connection)

	Screen tied to plate		
	<u>Fixed-Bias</u>	<u>Self-Bias</u>	
PLATE VOLTAGE	350 max.	350 max.	Volts
GRID VOLTAGE	-38	-	Volts
SELF-BIAS RESISTOR	-	730 min.	Ohms
ZERO-SIGNAL PLATE CURRENT (Per tube)	22.5	25	Milliamperes
LOAD RESISTANCE (Per tube)	1500	2500	Ohms
EFFECTIVE LOAD RESISTANCE (Plate-to-plate)	6000	10000	Ohms
TOTAL HARMONIC DISTORTION	7	7	Per cent
POWER OUTPUT (2 tubes)	18 approx. ⁰	14 approx. ⁰	Watts

Under the above maximum voltage conditions, transformer or impedance input-coupling devices must be used.

⁰ With one triode-connected 6F6 as driver operated at plate volts of 250, grid volts of -20, and with a minimum plate load of approximately 10000 ohms: input transformer ratio, primary to one-half secondary, is 1.67. The plate and grid supply have negligible resistance.

⁰ With one triode-connected 6F6 as driver operated at plate volts of 250, grid volts of -20, and with a minimum plate load of approximately 10000 ohms: input transformer ratio, primary to one-half secondary, is 1.29. The plate supply has negligible resistance. The value given for the self-bias resistor is determined for a minimum grid bias of -36.5 volts.

INSTALLATION

The base pins of the 6F6 fit the seven-contact octal-base socket (or the universal eight-contact socket) which may be installed to hold the tube in any position.

The heater is designed to operate at 6.3 volts. The transformer supplying this voltage should be designed to operate the heater at this recommended value for full-load operating conditions at average line voltage.

The cathode should preferably be connected directly to a mid-tap on the heater winding or to a center-tapped resistor across the heater winding. If this practice is not followed, the potential difference between heater and cathode should be kept as low as possible.

APPLICATION

As a Class A power-amplifier pentode, the 6F6 may be used either singly or in push-pull. Recommended operating conditions are given

under CHARACTERISTICS. If a single 6F6 is operated at a plate voltage of 250 volts, the self-bias resistor should have a value of approximately 410 ohms; at 315 volts, 440 ohms. For two tubes in the same stage, the value of the self-bias resistor should be approximately one-half that for a single tube.

As a *Class A power-amplifier triode*, the 6F6 may be used either singly or in push-pull. For this service the screen is connected to the plate. Recommended operating conditions are given under CHARACTERISTICS. If a single 6F6 is operated as a Class A triode at a plate voltage of 250 volts, the self-bias resistor should have a value of approximately 650 ohms. For two tubes in the same stage, the value of the self-bias resistor should be approximately one-half that for a single stage.

As a *Class AB power-amplifier triode or pentode*, the 6F6 should be operated as shown under the CHARACTERISTICS. The values shown cover operation with fixed-bias and with self-bias, and have been determined on the basis of some grid-current flow during the most positive swing of the input signal and of cancellation of second-harmonic distortion by virtue of the push-pull circuit.

Self-bias resistors should be shunted by a filter network to avoid degeneration at the low audio-frequencies. The filter network may be omitted for push-pull Class A pentode and Class A triode service.

The type of input coupling used should not introduce too much resistance in the grid circuit. Transformer- or impedance-coupling devices are recommended. When the grid circuit has a resistance not higher than 0.05 megohm, fixed bias may be used; for higher values, self-bias is required. With self-bias, the grid circuit may have a resistance as high as, but not greater than, 0.5 megohm provided the heater voltage is not allowed to rise more than 10% above rated value under any condition of operation.

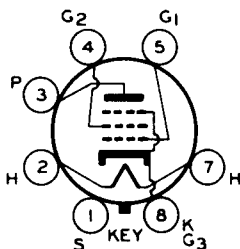

BOTTOM VIEW

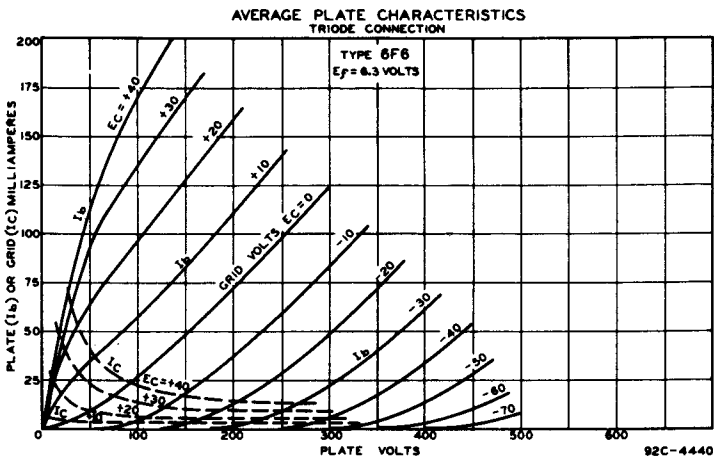
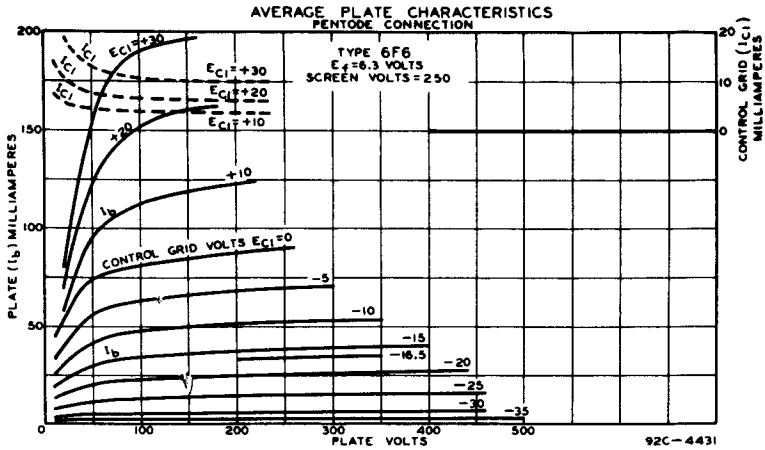

Cunningham
Radiotron

RCA-6H6

Twin Diode

The 6H6 is a heater-cathode type of metal tube combining two diodes in one shell. Each diode has its own separate cathode and corresponding base pin. This arrangement offers flexibility in the design of circuits employing the 6H6 for detection, for low-voltage low-current rectification, or for automatic volume control.

TENTATIVE CHARACTERISTICS

HEATER VOLTAGE (A.C. or D.C.)	6.3	Volts
HEATER CURRENT	0.3	Ampere
PLATE No.1 to PLATE No.2 CAPACITANCE *	0.02 max.	μ f
A-C PLATE VOLTAGE PER PLATE (RMS)	100 max.	Volts
D-C OUTPUT CURRENT	2 max.	Milliamperes
MAXIMUM OVERALL LENGTH	1-5/8"	
MAXIMUM DIAMETER	1-5/16"	
BASE	Small Octal 7-Pin	

* With shell connected to cathode.

INSTALLATION

The base pins of the 6H6 fit the seven-contact octal-base socket (or the universal eight-contact socket) which may be installed to hold the tube in any position.

For heater operation and cathode connection, refer to INSTALLATION for type 6A8.

APPLICATION

For detection, the diodes may be utilized in a full-wave circuit or in a half-wave circuit. In the latter case, one plate only, or the two plates in parallel, may be employed. The use of the half-wave arrangement will provide approximately twice the rectified voltage as compared with the full-wave arrangement.

For automatic-volume control, the 6H6 may be used in circuits similar to those employed for any of the duplex-diode types of tubes. The only difference is that the 6H6 is more adaptable due to the fact that each diode has its own separate cathode.

Since the diodes by themselves do not provide any amplification, it is usually necessary to provide gain by means of a supplementary tube. Types such as the 6C5, 6F5, 6J7, and 6K7 are very suitable for this purpose. Their use in combination with the 6H6 is similar to that of the amplifier sections of duplex-diode triode or pentode types, such as the 76, 75, 6C6, and 6D6. The amplifier sections of these types have somewhat the same characteristics as the 6C5, 6F5, 6J7, and 6K7, respectively.

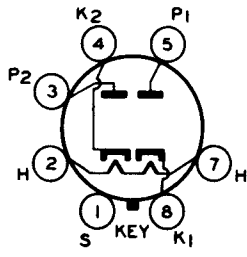

BOTTOM VIEW

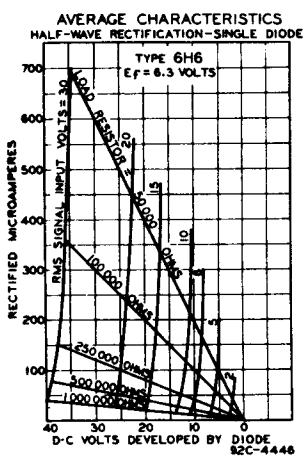



RCA-6J7

Triple-Grid Detector Amplifier

The 6J7 is a triple-grid type of metal tube recommended especially for service as a biased detector in radio receivers designed for its characteristics. In such service, this tube is capable of delivering a large audio-frequency output voltage with relatively small input voltage. Other applications of the 6J7 include its use as a high-gain amplifier tube.

TENTATIVE CHARACTERISTICS

HEATER VOLTAGE (A.C. or D.C.)	6.3	Volts
HEATER CURRENT	0.3	Ampere
PLATE VOLTAGE	100	250 max. Volts
SCREEN (Grid No.2) VOLTAGE	100	100** Volts
GRID (Grid No.1) VOLTAGE	-3	-3 Volts
SUPPRESSOR (Grid No.3)	Connected to cathode at socket	
PLATE CURRENT	2	2 Milliamperes
SCREEN CURRENT	0.5	0.5 Milliampere
PLATE RESISTANCE	1.0	Greater than 1.5 Megohms
AMPLIFICATION FACTOR	1185	Greater than 1500
MUTUAL CONDUCTANCE	1185	1225 Micromhos
GRID VOLTAGE (Approx.)#	-7	-7 Volts
GRID-PLATE CAPACITANCE °		0.005 max. μf
INPUT CAPACITANCE °		7 μf
OUTPUT CAPACITANCE °		12 μf
MAXIMUM OVERALL LENGTH		3-1/8"
MAXIMUM DIAMETER		1-5/16"
CAP		Miniature
BASE		Small Octal 7-Pin

* If a grid-coupling resistor is used, its maximum value should not exceed 1.0 megohm.

** Maximum Screen Volts = 125.

For cathode current cut-off.

° With shell connected to cathode.

INSTALLATION

The base pins of the 6J7 fit the seven-contact octal-base socket (or the universal eight-contact socket) which may be installed to hold the tube in any position.

For heater operation and cathode connection, refer to INSTALLATION for type 6A8.

The screen voltage may be obtained from a potentiometer or bleeder circuit across the B-supply source. Due to the screen-current characteristics of the 6J7, a resistor in series with the high-voltage supply may be employed for obtaining the screen voltage, pro-

vided the cathode-resistor method of bias control is used. This method, however, is not recommended if the high-voltage B-supply exceeds 250 volts.

APPLICATION

As a *biased detector*, the 6J7 can deliver a large audio-frequency output voltage of good quality with a fairly small radio-frequency signal input. Typical recommended conditions for the 6J7 as a biased detector are as follows:

PLATE SUPPLY *	250	250	250	250	Volts
SCREEN VOLTAGE	50	33	100	100	Volts
GRID VOLTAGE	-2	-1.7	-3.9	-4.3	Volts
CATHODE RESISTOR	3000	8000	4000	10000	Ohms
SUPPRESSOR	Connected to cathode at socket				
CATHODE CUR. (Zero signal)	0.65	0.21	0.97	0.43	Milliamperes
PLATE RESISTOR	0.25	0.50	0.25	0.50	Megohm
BLOCKING CONDENSER	0.03	0.03	0.03	0.03	μ f
GRID RESISTOR #	0.25	0.25	0.25	0.25	Megohm
R-F SIGNAL (RMS) **	1.18	1.21	1.38	1.37	Volts

* Voltage at plate will be PLATE-SUPPLY voltage less voltage drop in plate resistor caused by plate current.

For the following amplifier tube.

** With these signal voltages modulated 20%, the voltage output under each set of operating conditions is 17 peak volts at the grid of the following amplifier, a value sufficient to insure full audio output from a type 6F6 at 250 volts on plate.

Detector bias may be obtained from a bleeder circuit, from a resistor in the cathode circuit, or from a partial self-biasing circuit. The cathode-resistor method permits of higher output at low percentage modulation, since the input signal may be increased almost in inverse proportion to the modulation without resulting in objectionable distortion.

As an *audio-frequency pentode* in resistance-coupled circuits, the 6J7 may be operated as shown in the tables on page 150 of the RC-12 Manual for the types 57, 77, and 6C6.

As a *radio-frequency amplifier pentode*, the 6J7 may be used particularly in applications where the r-f signal applied to the grid is relatively low, that is, of the order of a few volts. In such cases either screen or control-grid voltage (or both) may be varied to control the receiver volume. When larger signals are involved, a super-control amplifier tube should be employed to prevent the occurrence of excessive cross-modulation and modulation-distortion. Recommended operating conditions for amplifier service are given under CHARACTERISTICS.

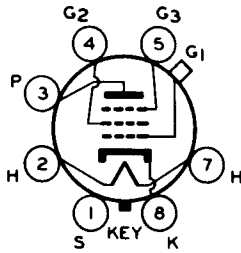

BOTTOM VIEW

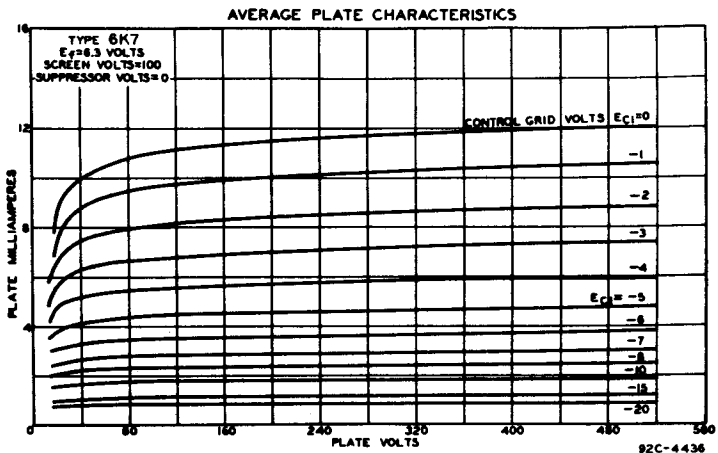
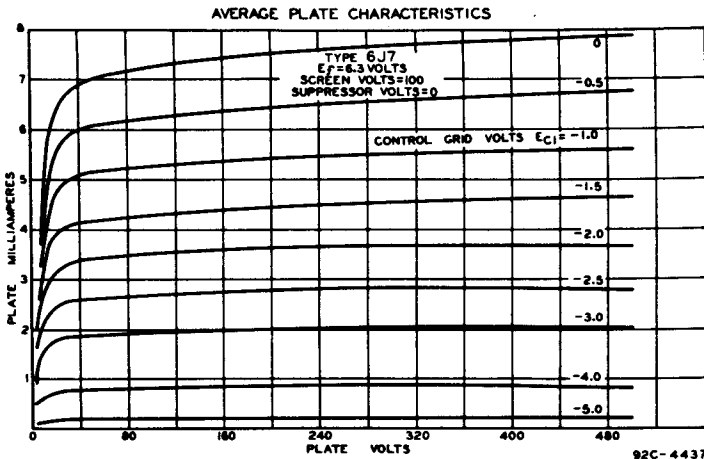



Triple-Grid Super-Control Amplifier

The 6K7 is a triple-grid super-control amplifier tube of the metal type recommended for service in the radio-frequency and intermediate-frequency stages of radio receivers designed for its characteristics. The ability of this tube to handle unusual signal voltages without cross-modulation and modulation distortion makes it adaptable to the r-f and i-f stages of receivers employing automatic volume control.

TENTATIVE CHARACTERISTICS

HEATER VOLTAGE (A.C. or D.C.)				6.3	Volts
HEATER CURRENT				0.3	Ampere
PLATE VOLTAGE	90	180	250 _{max.}	250 _{max.}	Volts
SCREEN (Grid No.2) VOLTAGE	90	75	100	125 _{max.}	Volts
GRID (Grid No.1) VOLT. (Min.)	-3	-3	-3	-3	Volts
SUPPRESSOR (Grid No.3)	Connected to cathode at socket				
PLATE CURRENT	5.4	4.0	7.0	10.5	Milliamperes
SCREEN CURRENT	1.3	1.0	1.7	2.6	Milliamperes
PLATE RESISTANCE	0.315	1.0	0.8	0.6	Megohm
AMPLIFICATION FACTOR	400	1100	1160	990	
MUTUAL CONDUCTANCE	1275	1100	1450	1650	Micromhos
GRID VOLTAGE *	-38.5	-32.5	-42.5	-52.5	Volts
GRID-PLATE CAPACITANCE °				0.005 _{max.}	μf
INPUT CAPACITANCE °				7	μf
OUTPUT CAPACITANCE °				12	μf
MAXIMUM OVERALL LENGTH				3-1/8"	
MAXIMUM DIAMETER				1-5/16"	
CAP				Miniature	
BASE				Small Octal 7-Pin	

* For mutual conductance = 2 micromhos.

° With shell connected to cathode.

INSTALLATION

The base pins of the 6K7 fit the seven-contact octal-base socket (or the universal eight-contact socket) which may be installed to hold the tube in any position.

For heater operation and cathode connection, refer to INSTALLATION for type 6A8.

Control-grid bias variation will be found effective in changing the volume of the receiver. In order to obtain adequate volume control, an available grid-bias voltage of approximately 50 volts will be required. The exact value will depend upon the circuit design and operating conditions. This voltage may be obtained, depending

on the receiver requirements, from a potentiometer across a fixed supply voltage or by the use of a variable self-bias resistor in the cathode circuit.

The screen voltage may be obtained from a potentiometer or bleeder circuit across the B-supply source. Due to the screen current characteristics of the 6K7, a resistor in series with the high-voltage supply may be employed for obtaining the screen voltage provided the cathode-resistor method of bias control is used. This method, however, is not recommended if the high-voltage B-supply exceeds 250 volts. Furthermore, it should be noted that the use of a resistor in the screen circuit will have an effect on the change in plate resistance with variation in suppressor voltage in case the suppressor is utilized for control purposes.

The suppressor may be connected directly to the cathode or it may be made negative with respect to the cathode. For the latter condition, the suppressor voltage may be obtained from a potentiometer or bleeder circuit for manual volume- and selectivity-control, or from the drop in a resistor in the plate circuit of the automatic volume-control tube.

APPLICATION

As a *radio-frequency amplifier*, the 6K7 is especially applicable to radio receiver design because of its ability to reduce cross-modulation effects, its remote "cut-off" feature, and its flexible adaptability to circuit combinations and to receiver design. Recommended conditions for the 6K7 as an amplifier are given under CHARACTERISTICS.

To realize the maximum benefit of the long "cut-off" feature of this tube, it is necessary to apply a variable grid bias and to maintain the screen at a constant potential with respect to the cathode. Good results, however, may be obtained by using a variable cathode resistance. Such a resistance, of course, reduces the screen potential by the amount that the bias is increased and thus hastens the "cut-off". Therefore, the ability of the tube to handle large signals is somewhat impaired. This effect may be nullified by means of a series resistor in the screen circuit.

The use of series resistors for obtaining satisfactory control of screen voltage in the case of four-electrode tubes is usually impossible because of secondary emission phenomena. In the 6K7, however, the suppressor practically removes these effects and it is therefore possible to obtain satisfactorily the screen voltage from the plate supply or from some high intermediate voltage providing these sources do not exceed 250 volts. With this method, the screen-to-cathode voltage will fall off very little from minimum to maximum value of cathode-control resistor. In some cases, it may actually rise. This rise of screen-to-cathode voltage above the normal maximum value is allowable because the screen and the plate current are reduced simultaneously by a sufficient amount to prevent damage to the tube. It should be recognized in general that the series-resis-

tor method of obtaining screen voltage from a higher voltage supply necessitates the use of the variable cathode-resistor method of controlling volume. When screen and control-grid voltage are obtained in this manner, the remote "cut-off" advantage of the 6K7 may be fully realized.

As a mixer in superheterodyne circuits, the 6K7 may be used to advantage. It is capable of producing, under the proper conditions of grid and local oscillator voltage, a gain in the mixer stage of about one-third that which can be obtained in an intermediate-frequency amplifier stage. In addition, this gain can be controlled as in the case of the radio-frequency amplifier by varying the grid bias either from a separate supply or from a variable resistor in the cathode circuit. This is a particularly desirable feature in receivers employing automatic volume-control, because it enables a much lower threshold input to be received without loss of amplification and permits the reception of high input voltages without loss of control. Recommended conditions for the 6K7 as a superheterodyne mixer follow: Plate voltage, 250 volts; screen voltage, 100 volts; suppressor connected to cathode at socket; and grid-bias voltage, -10 volts approximate (with 7-volt oscillator peak swing).

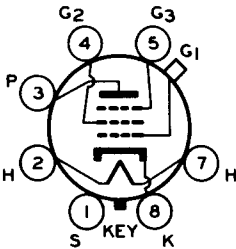

BOTTOM VIEW



RCA-6L7

Pentagrid Mixer Amplifier

The 6L7 is a multi-electrode vacuum tube of the metal type designed with two separate control grids shielded from each other. This design permits each control grid to act independently on the electron stream. This tube, therefore, is especially useful as a mixer in superheterodyne circuits having a separate oscillator stage, as well as in other applications where dual control, is desirable in a single stage. The design of the tube is such that coupling effects between oscillator and signal circuits are made very small. This feature enables the 6L7 to give high gain in high-frequency circuits.

TENTATIVE CHARACTERISTICS

HEATER VOLTAGE (A.C. or D.C.)	6.3	Volts
HEATER CURRENT	0.3	Ampere
DIRECT INTERELECTRODE CAPACITANCES: *		
Grid No.1 to Grid No.3	0.12	$\mu\mu\text{f}$
Grid No.1 to Plate	0.0005 max.	$\mu\mu\text{f}$
Grid No.3 to Plate	0.25	$\mu\mu\text{f}$
Grid No.1 to All Other Electrodes	8.5	$\mu\mu\text{f}$
Grid No.3 to All Other Electrodes	11.5	$\mu\mu\text{f}$
Plate to All Other Electrodes	12.5	$\mu\mu\text{f}$
MAXIMUM OVERALL LENGTH	3-1/8"	
MAXIMUM DIAMETER	1-5/16"	
CAP	Miniature	
BASE	Small Octal 7-Pin.	

As Mixer

PLATE VOLTAGE	250 max.	Volts
SCREEN (Grids No.2 and No.4) VOLTAGE	150 max.	Volts
TYPICAL OPERATION:		
Heater Voltage	6.3	6.3 Volts
Plate Voltage	250	250 # Volts
Screen Voltage	100	150 # Volts
Signal-Grid (Grid No.1) Voltage	-3	-6 min. # Volts
Oscillator-Grid (Grid No.3) Voltage**	-10	-15 Volts
Peak Oscillator Voltage		
Applied to Grid No.3 (Minimum)	12	18 Volts
Plate Current	2.4	3.3 Milliampere
Screen Current	6.2	8.3 Milliampere
Plate Resistance	Greater than 1	Megohm
Conversion Conductance	350	350 Micromhos
Signal-Grid (Grid No.1) Voltage		
for Conver. Cond. of 5 Micromhos	-30	-45 Volts

** The d-c resistance in oscillator-grid-No.3 circuit should be limited to 50000 ohms.

Recommended values for all-wave receivers.

* With shell connected to cathode.

As Amplifier

HEATER VOLTAGE	6.3	Volts
PLATE VOLTAGE	250 <i>max.</i>	Volts
SCREEN (Grids No.2 and No.4) VOLTAGE	100 <i>max.</i>	Volts
CONTROL GRID (Grid No.1) VOLTAGE	-3 <i>min.</i>	Volts
CONTROL GRID (Grid No.3) VOLTAGE	-3	Volts
PLATE CURRENT	5.3	Milliamperes
SCREEN CURRENT	5.5	Milliamperes
PLATE RESISTANCE	0.8	Megohm
MUTUAL CONDUCTANCE	1100	Micromhos
MUT. COND. { -15 volts bias on Grid No.1 } { -15 volts bias on Grid No.3 }	. 5	Micromhos

INSTALLATION

The base pins of the 6L7 fit the standard seven-contact octal-base socket (or the universal eight-contact socket) which may be installed to hold the tube in any position.

For heater operation and cathode connection, refer to INSTALLATION for type 6A8.

APPLICATION

As a mixer in superheterodyne circuits, the 6L7 can mix the input from an external oscillator with the radio-input frequency to provide the desired intermediate frequency. For this service, design information is given under CHARACTERISTICS.

As a radio-frequency or intermediate-frequency amplifier, the 6L7 should be operated as shown under CHARACTERISTICS. In general, properly designed radio-frequency transformers are preferable to interstage coupling impedances, especially in cases where a high-impedance B-supply may cause oscillation below radio frequencies. The fact that the grid No.1-plate capacitance of the 6L7 is extremely small is advantageous in circuits where high attenuation is required.

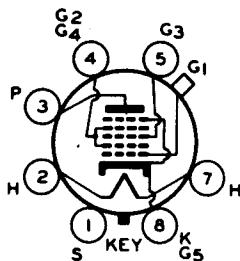

BOTTOM VIEW

AVERAGE CHARACTERISTICS FOR TYPE 6L7

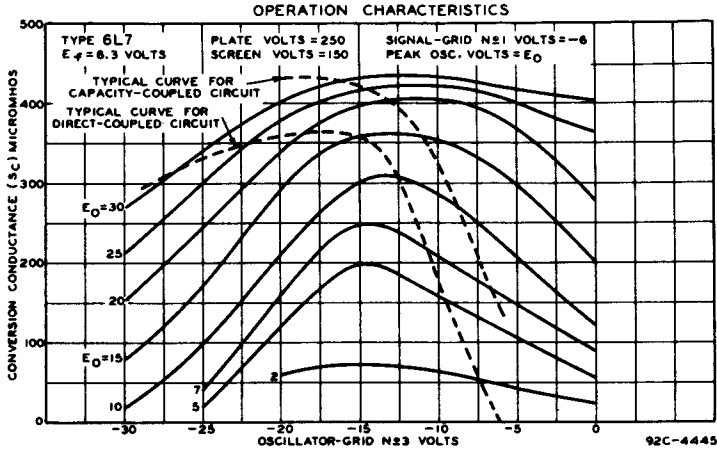
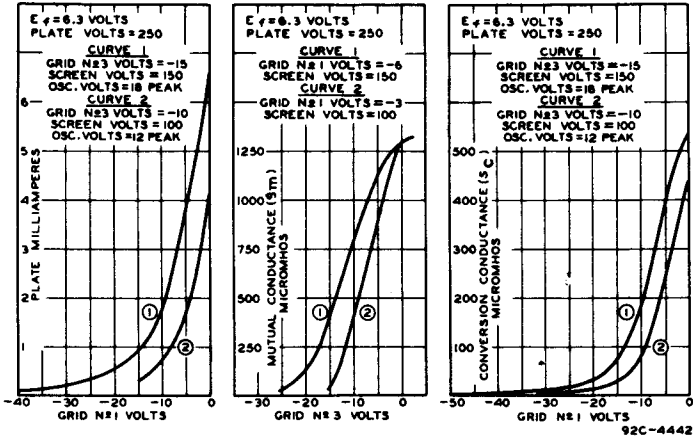

PIN NUMBERING OF OCTAL BASES

Octal bases, unlike previous base designs, are suitable for use with a universal socket. This fact makes it possible to set up a universal numbering system which is believed to offer advantages in simplicity. In this new system, numbers are assigned to each of the eight possible pin positions. Numbering starts from the shell connection which is always the first pin to the left of the locating key when the base is viewed from the bottom with the key toward the observer. Numbering is clockwise on the basis of possible pin positions. Thus, the pin numbers for a 6-pin base are 1, 2, 3, 5, 7, and 8.

The following table and chart show pin positions, pin numbers and pin arrangement for each of the RCA All-Metal Tubes.

TUBE TYPE	PIN POSITIONS AND NUMBERS							
	1	2	3	4	5	6	7	8
5Z4	S	H	-	P ₂	-	P ₁	-	K & H
6A8	S	H	P	G ₃ & G ₅	G ₁	G ₂	H	K
6C5	S	H	P	-	G	-	H	K
6F5	S	H	-	P	-	-	H	K
6F6	S	H	P	G ₂	G ₁	-	H	K & G ₃
6H6	S	H	P ₂	K ₂	P ₁	-	H	K ₁
6J7	S	H	P	G ₂	G ₃	-	H	K
6K7	S	H	P	G ₂	G ₃	-	H	K
6L7	S	H	P	G ₂ & G ₄	G ₃	-	H	K & G ₅

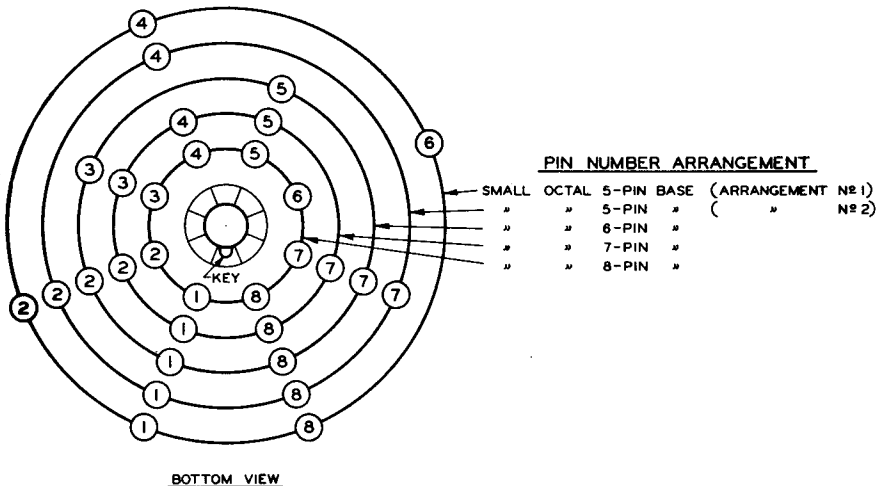

BASES AND DIMENSIONS

SMALL OCTAL 8-PIN BASE

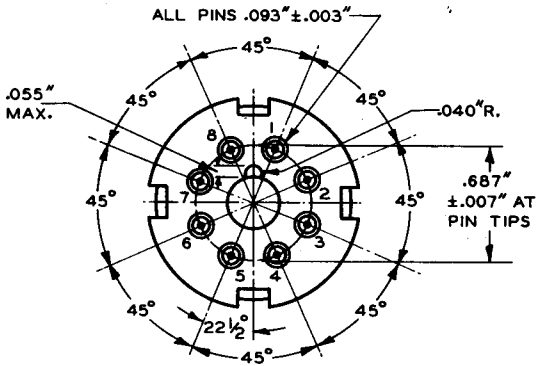
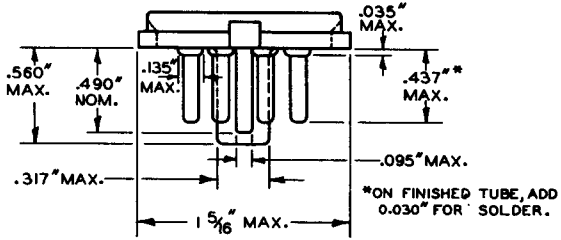

BOTTOM VIEW OF BASE

SMALL OCTAL 7-PIN BASE
AS ABOVE, OMITTING PIN N° 6

SMALL OCTAL 6-PIN BASE
AS ABOVE, OMITTING PINS N° 4 & 6

SMALL OCTAL 5-PIN BASES
ARRANGEMENT N° 1 - AS ABOVE, OMITTING PINS N° 3, 5 & 7
ARRANGEMENT N° 2 - AS ABOVE, OMITTING PINS N° 3, 5 & 6

MINIATURE CAP

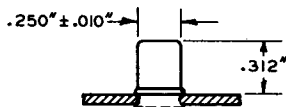

OUTLINE DIMENSIONS FOR ALL-METAL TUBES

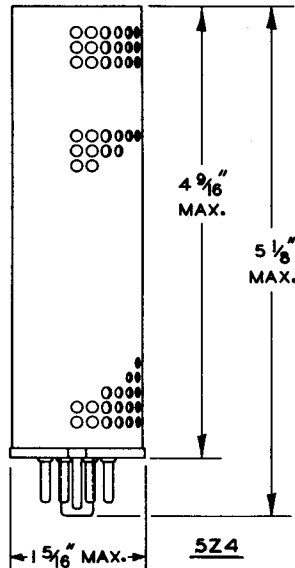
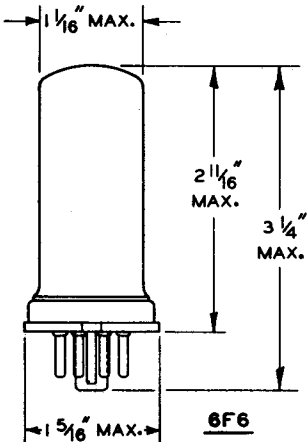
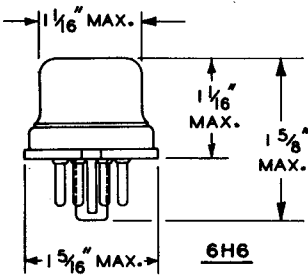
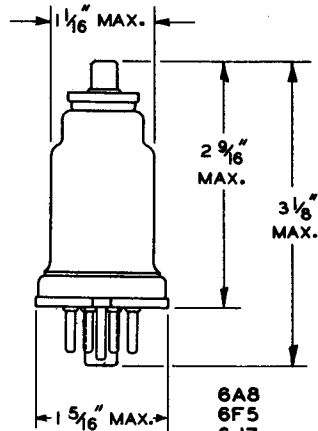
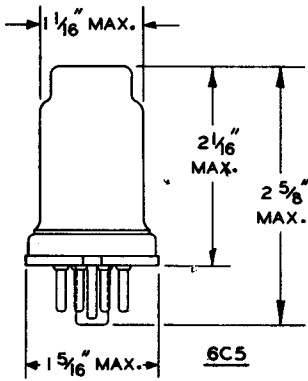

850

607



500
 100
 200
 300
 400
 500
 600
 700
 800
 900
 1000
 1100
 1200
 1300
 1400
 1500
 1600
 1700
 1800
 1900
 2000
 2100
 2200
 2300
 2400
 2500
 2600
 2700
 2800
 2900
 3000
 3100
 3200
 3300
 3400
 3500
 3600
 3700
 3800
 3900
 4000
 4100
 4200
 4300
 4400
 4500
 4600
 4700
 4800
 4900
 5000
 5100
 5200
 5300
 5400
 5500
 5600
 5700
 5800
 5900
 6000
 6100
 6200
 6300
 6400
 6500
 6600
 6700
 6800
 6900
 7000
 7100
 7200
 7300
 7400
 7500
 7600
 7700
 7800
 7900
 8000
 8100
 8200
 8300
 8400
 8500
 8600
 8700
 8800
 8900
 9000
 9100
 9200
 9300
 9400
 9500
 9600
 9700
 9800
 9900
 10000