



TV CAMERAS • LENSES • MOUNTS • LIGHTING EQUIPMENT



TELEVISION
camera
EQUIPMENT

**TELEVISION
CAMERA EQUIPMENT
CATALOG**



THE MOST TRUSTED NAME IN TELEVISION

ABOUT THIS CATALOG

This catalog provides information on RCA Television Camera Equipment. Other RCA Broadcast Equipment Catalogs supply information on TV Film, TV Tape, Terminal and Switching, and Audio equipment; also on AM, FM, VHF, and UHF TV transmitters, antennas, and transmission line.

The information contained in this catalog is intended to serve as a buying guide for the user. Complete specifications and ordering information are supplied. Readers who desire more information or individual bulletins on particular equipment items are invited to write to their RCA Broadcast Representative.

OTHER RCA TECHNICAL PRODUCTS

RCA also manufactures many other electronic products, including: two-way radio and microwave relay communications equipment; optical and magnetic film recording equipment; sound systems of all types; 16mm projectors and magnetic recorders; industrial inspection and automation equipment; scientific instruments, such as the electron microscope; closed-circuit television systems; and many types of custom-built equipment for industry, the military, educational and medical services. Information describing these products may be obtained from RCA Sales Offices in the United States and Canada or internationally from local RCA Distributors or RCA International Division.

PRICES

Domestic prices of the equipment shown in this catalog are provided in a separate price list. Equipments are identified by type and MI (Master Item) numbers which are used to identify apparatus on invoices and packing slips. International prices for the various equipment items shown in this catalog are available from RCA Distributors or RCA International Division.

HOW TO ORDER

The RCA Television Camera Equipment shown in this catalog is sold through RCA Broadcast Representatives, who are familiar with broadcast equipment and related problems. These RCA Representatives are located in convenient offices throughout the United States. Domestic orders for equipment, or requests for additional information, should be directed to the nearest RCA Sales Office. International Readers are invited to contact their local RCA Distributor or the RCA International Division Office.

Contents

	Page
TK-42 Transistorized Color Camera	5
TK-60B 4½" Image Orthicon TV Camera	15
TK-33 Transistorized Field Camera	23
TK-1C Monoscope Camera	27
Lenses	29
Pedestals and Mounts	42
Interphone Equipment	51
TV Cables, Plugs and Connectors	55
Lighting Equipment	59
Mobile Units	71
Index	83

Transistorized Live Color Camera, Type TK-42

- Separate Monochrome (luminance) Channel
- Bu It-In Zoom Lens
- Stabilized Circuitry
- Standard Transistorized Modules
- Low Profile Styling



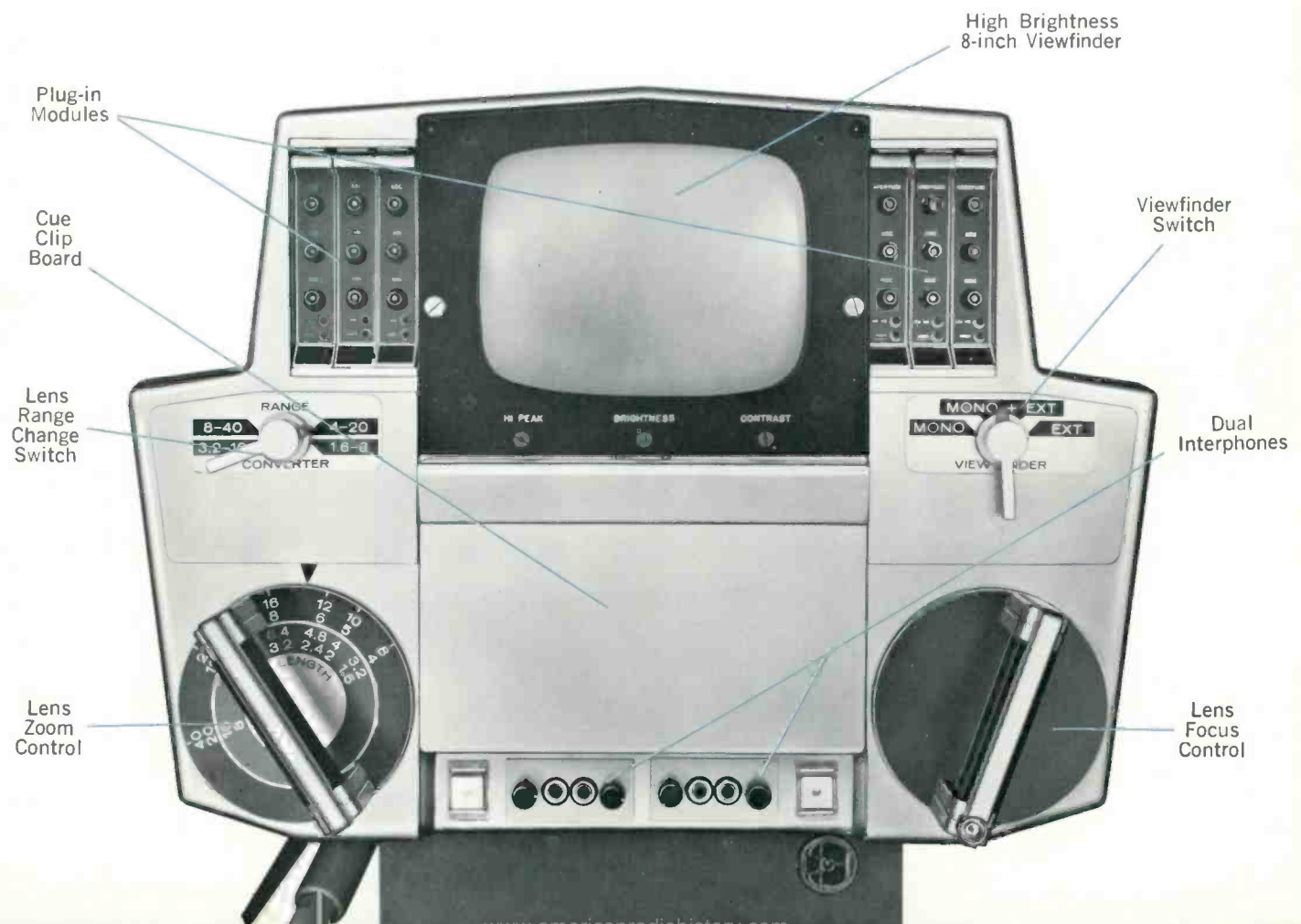

Transistorized Live Color Camera, Type TK-42

The RCA transistorized color camera, Type TK-42, represents an entirely new concept in color camera design and establishes a new high standard in color picture quality. A 4½-inch Image Orthicon Tube in a separate luminance channel lends "snap" to the color picture and results in monochrome picture quality comparative to that of the finest black-and-white cameras. Three 1-inch vidicon tubes provide chrominance information for color pictures of the highest fidelity.

The TK-42 Camera features a new, low profile design which places the viewfinder near the center line of the taking lens. This keeps the camera operating height at minimum at all times and places the viewfinder at or near eye level for the operator. The entire rack mounted portion of the camera chain including the power supply occupies less than 25 inches of rack space.

The compact, simplified camera control panel may be either rack mounted or console mounted in a single 20-inch console housing.

Advanced, solid state circuitry provides excellent performance and reliability with extremely low heat dissipation. The total power requirement of the camera chain excluding monitors is less than 750 watts. The camera and rack mounted auxiliary equipment employ modular design throughout. Standard modules are plug-in, rugged, and easy to maintain.

The TK-42 line color camera is new in entirety, thoroughly engineered to produce the best obtainable monochrome and color pictures with the least effort. This camera brings for the first time to color television a degree of simplicity and convenience of operating previously associated only with monochrome cameras.

Description

Separate, High Resolution Luminance Channel

The new TK-42 Color Camera utilizes four pickup tubes; one 4½-inch image orthicon to develop a separate wideband luminance signal and three electrostatically focused 1-inch vidicons to develop the chrominance signals. This is a new concept to produce both color and monochrome video signals of highest quality. The separate luminance channel provides two very important advantages over earlier three-tube cameras. First, the output signal of the TK-42 Color Camera when viewed on a monochrome receiver or monitor is equivalent in resolution, grayscale and overall quality to that obtained from the finest black and

white cameras. Second, the high resolution luminance component of the colorplexed video signal enhances the grayscale and resolution of the color picture.

Fully Transistorized

Transistors and other solid state components are utilized throughout the TK-42 Camera system to perform all circuit functions. The only exceptions are the four pickup tubes, viewfinder kinescope, high voltage rectifier, and the tubes used in the picture and waveform monitors. Solid state circuitry provides long term reliability, reduced maintenance and a consistently high level of performance. Transistorization has made possible a major reduction in power consumption, rack space re-

quirements, weight, and physical size of the auxiliary equipment and of the overall TK-42 Camera chain.

Built-in Zoom Lens System

Built into the camera is an extremely versatile, high quality zoom lens system. The basic lens and an accessory wide angle adaptor cover the entire range of focal length from 1.6 inches (40mm) to 40 inches. The superior optical quality and wide range of focal length of the system do away with the need for a conventional lens turret and assortment of lenses. In addition, the single lens system eliminates the problem of color matching between lenses of various focal lengths on a single turret.



SEPARATE LUMINANCE CHANNEL lends "snap" to the color pictures derived from RCA's TK-42 Transistorized Live Color Camera. Shown above is a 4½-inch Image Orthicon Tube that provides monochrome picture quality equivalent to that of the finest black-and-white cameras.

The built-in lens and wide angle adaptor will handle virtually any requirement for either studio or field operation—with the added advantage of an infinitely variable range of focal length to "frame" any scene precisely within the desired field of view.

Convenient Zoom and Focus Control

Camera Zoom and focus are controlled by two "D" handles located at the lower left and lower right corners at the rear of the camera respectively. These handles may be used to pan, tilt and dolly the camera. A wide angle adaptor is used on the camera for operation at focal lengths from 1.6 inches to 16 inches (40 to 400 mm) in two ranges; 1.6 to 8 inches and 3.2 to 16 inches. Selection between the two zoom ranges is made smoothly by means of a lever at the rear of the camera. The zoom range may be changed while the camera is on-air without need to re-focus optically. The wide angle adaptor is easily demounted

from the front of the camera for operation at focal lengths from 4 to 40 inches in two zoom ranges; 4 to 20 inches and 8 to 40 inches. The 1.6 to 16 inch range is normally ample for all in-studio operations. However, the full range of 1.6 to 40 inches is readily available for either studio or field applications.

Low Profile Camera

The TK-42 Camera has been carefully engineered to present an attractive, low profile for ease of handling and operation. The center of the viewfinder kinescope is less than 7 inches above the optical axis of the taking lens. As a result, the camera operating height is kept at a minimum at all times and the viewfinder is normally at or near eye level for the camera operator. A low center of gravity increases the mechanical stability when dollying or maneuvering the camera. Over-all size and weight have been minimized through the use of solid state circuitry and efficient mechanical packaging.

Plug-in Modular Construction

The circuits of the TK-42 Camera and rack mounted auxiliary equipment have been packaged in the form of plug-in modules for compactness, easy access for service and quick interchange of spares. The viewfinder is a separate unit and is mounted on a sliding track arrangement which may be pulled out for inspection and maintenance. The plug-in modules are serviced by removal and insertion in a module extender which plugs into the module space and permits servicing under operating conditions with normal voltages applied. Two full length side doors permit access to the modules within the camera and to all other components for alignment or service. Many of the module types used in the TK-42 Camera are the same as or similar to those of the RCA TK-33 Monochrome Live Camera, TK-22 Monochrome Film Camera and the TK-27 Color Film Camera. This minimizes the variety of circuitry with which technical personnel need be familiar.

Stabilized, Self-Compensating Circuitry

Stabilizing techniques have been used extensively throughout the camera chain to assure uniformly high performance over long periods of time. A unique cooling and heating system maintains optimum temperature of the chrominance pickup tubes at all times. Feedback stabilization circuitry is used to compensate for aging of components and for ambient temperature changes. Precise reference devices are used to maintain critical control voltages and currents at optimum value.

One Man Setup

Built-in calibration and alignment pulses are provided for ease and speed of normal alignment and setup procedures. In addition, the TK-42 has automatic black level control and self-adjusting cable timing. The colorplexing circuitry may be adjusted by utilizing the normal waveform and picture monitors, no special test equipment is required. The camera alignment and setup may be made by one man at the camera location using the camera viewfinder and special built-in test facilities.

Simplified Pulse System

Horizontal and vertical drive pulses are derived from sync and are generated internally within the camera. In addition, the timing of the camera chain output signal is compared with sync timing to produce a control signal which advances the drive signals at the camera and compensates automatically for delay in the camera cable. This technique also compensates for delay in the colorplexing circuits and does away with the need for delay of drive pulses to monochrome cameras operating synchronously in the same system. A substantial saving may thus be realized by eliminating pulse distribution amplifiers and delay lines from the station pulse system.

Also built into the camera auxiliary equipment is a color bar test signal generator, that provides standard full raster color bar signals of 0.7 or 1.0 volt level for adjustment of colorplexer circuitry. Space and circuitry is provided for installation of an I and Q module to provide an EIA standard color test signal. The only input signals required for the camera chain are sync, blanking, color subcarrier and burst flag signals.

GENERAL DESCRIPTION

The TK-42 Camera Head contains the optical system including zoom lens, four pickup tubes with associated deflection circuitry, video pre-amplifiers, an 8-inch transistorized viewfinder and DC regulator circuits. The rack mounted auxiliary equipment contains the power supply, colorplexing and signal processing circuits, cable equalizers and termination points for the camera and remote control cables.

The camera control panel is in two sections consisting of a remote control panel and a color control panel. Both panels may be mounted in a 20-inch camera control console or in a rack, occupying 7 inches of mounting height. The remote control panel contains all of the controls normally required by the operator including the sensitivity, black level, test, monitor, and automatic manual mode of black level and gain switches, gain controls and the lens cap switch. The color control panel contains controls for vernier regis-

tration, chrominance balance and chroma gain and includes switches for test functions and for waveform and picture monitor display selection.

The camera chain output signals include picture and waveform monitor feeds, two color video outputs and two monochrome video outputs. All outputs are available as either composite or non-composite signals and are sending-end terminated.

The camera is designed to operate on either 115 or 230 volts AC at 47 to 63 cycles. It will operate on either 60 field, 525 line scanning standards or 50 field, 625 line standards. The camera colorplexing circuit is supplied with appropriate filters for either the U. S. domestic color burst frequency standard (3.579545 mc) or for 4.4296875 mc, whichever is specified. If desired, the camera may be equipped with both filters for operation on either frequency standard on a switchable basis.

TK-42 Camera showing conveniently located set-up control panel.



Camera Unit Modules

CAMERA BACK

Proc

Processor clamps video and inserts gamma correction. Contains controls for manual and automatic black and automatic sensitivity. One used for each of four vidicon channels.

Video

Amplifies video from preamplifier and provides aperture compensation. One used for each of four vidicon channels.



CAMERA SIDE

Video

Amplifies video from preamplifier and provides aperture compensation. One used for each of four vidicon channels.

Proc

Processor clamps video and inserts gamma correction. Contains controls for manual and automatic black and automatic sensitivity. One used for each of four vidicon channels.

V Defl

Vertical deflection provides 4½-inch I.O. vertical deflection and drive signal to deflection amplifier. Provides pickup tube protection in case of scan-failure.

H Defl

Horizontal deflection provides 4½-inch I.O. horizontal deflection and drive signals to deflection amplifier. Provides pickup tube protection in case of scan-failure.

Defl Amp

Generates horizontal and vertical deflection for the three one-inch vidicons. Contains circuitry for blanking, high voltage and chroma "capping" for monochrome operational mode of the three vidicons.

Sync

Generates and distributes vertical gating, vertical drive, timing pulse and horizontal drive. Contains circuitry for automatic time delay compensation. Clips and amplifies sync for use in other modules.

Pulse

Generates white test pulse, black level pulse, horizontal drive stop pulse, gating pulses and

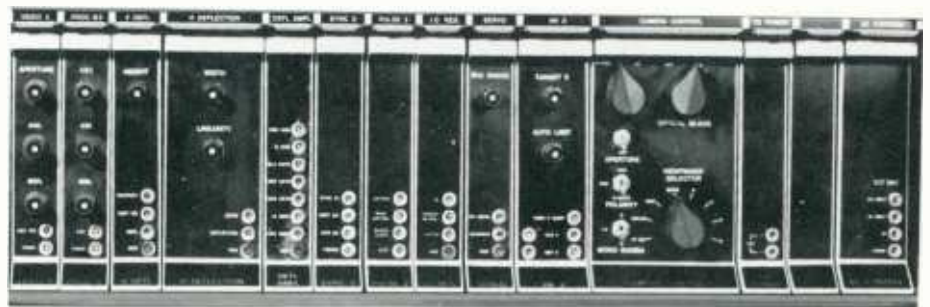

test pulses for use in setup, testing and automatic circuits.

IO Reg

Supplies precision regulated image orthicon focus current, focus voltage, beam current and +1300 and -650 voltages. Image orthicon blanking is also generated in this module.

Servo

Contains servo amplifiers for controlling the iris of the lens from either the camera control panel or remote control panel. The G-4 rock signal for alignment of the image orthicon is generated in this unit.

HV

High Voltage—Generates high voltage, DC filament voltage for the luminance channel vidicon and reference voltage to operate transistor de-

couplers. Vidicon blanking and target voltage ranges are set in this module.

Camera Control

Is a common control position with switching facilities for video polarity, aperture on/off, monochrome gamma, color gamma, viewfinder input sources, and automatic optical black mode of operation.

TE Power

Provides power and control for the thermal electric cooling or heating at the face of the vidicon tubes. The vidicon d.c. filament voltage is supplied by this module.

AC Control

Is a relay controlled distribution point of a-c power to lens-cap, on-air and preview tally lights, yoke heaters, blowers, iris drive, orbiter, and lapsed-time meter.

VIEWFINDER MODULES (not shown)

VF Video

Strips sync from composite video and distributes sync as required. Also provides video feed to kinescope.

VF Vert Defl

Provides vertical deflection for viewfinder kine-

scope. Size and linearity adjustments are also incorporated.

VF Horz Drive

Generates advanced horizontal drive signal for the high voltage from sync separator. A free-running oscillator provides for protection of high voltage if sync signal is lost.

VF Utility Module

Rectifies and regulates kinescope focus and screen voltage and provides filter for G-1 voltage of kinescope.

VF High Voltage

Develops horizontal deflection and regulated anode high voltage for kinescope—also focus and screen voltages for utility module.

Camera Auxiliary Modules

FRAME #1

Regen

Regenerates sync and blanking and generates clamp pulses. Contains part of circuitry for horizontal drive advance to compensate for cable and encoder delays.

Blanker

Adds final blanking to video. Contains multiple video output line driver with sending-end termination and has switchable sync addition to output video. Contains single line driver with sending-end termination which can be remotely switched to line, an external signal coming from a loop-through input or combination of line and external test signal.

Monitor

Contains line driver amplifier for feeds to the CRO and picture monitor. Regenerates blanking and clamp pulses and inserts system blanking on the RGB&M signals. Test switch is included to allow set-up of encoder using only CRO signal.

Det

Converts monochrome and color difference signals into receiver Rr, Br, and Gr signals. Non-additively mixes signals and switches between NAM white and black to form single NAM signal. (Similar to monochrome camera signal.) Individual NAM white and black signals are used in automatic white and automatic black control systems.

SC

Subcarrier—Supplies quadrature subcarrier to modulator and generates sampling bursts required by automatic carrier balance detectors.

Modulator

Modulates the I and Q color difference signals to produce chroma signal with automatic carrier balance. Generates gating signal to ungate blanker module during burst time. Provides color difference signals to detector module.

Driver

Band limits I and Q signals, inserts burst flag into I and Q signals for burst generation and feeds these signals to modulator. Amplifies M signal and drives M delay module. Inserts delay into I signal to match Q filter delay.

Matrix

Matrixes R, B and G signals into I and Q. Contains relays and amplifiers used in monitoring individual M, R, B and G signals and has provisions for tying chrominance signals together for white balance adjustment of encoder.

Bar Gen

Generates R, B and G pulses used to form standard non-split modulated color bar patterns of either 75% or 100% level as selected by switch on front panel.

Blank Module

Level

Detects NAM white and NAM black signals and forms DC voltages used in feedback loops for automatic white and automatic black level control. Provides gating required for automatic black operation of camera.

M Delay

Delays M signal to match Q filter delay.

Blank Modules

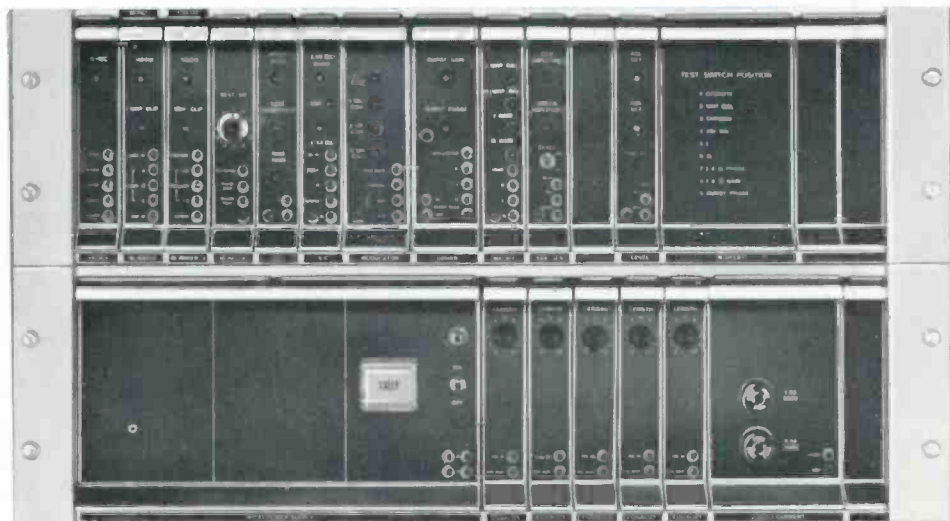

FRAME #2

WP-81

Develops regulated positive and negative low voltage DC for use in Camera Auxiliary.

(23456) Equalizers

Equalization networks and circuitry required to compensate for amplitude attenuation versus frequency characteristics of coaxial video cable is contained in this module. Correction is provided in increments of 100 feet for a maximum of 1000 feet of cable.

Focus Current

Develops a voltage which is supplied to the I.O. regulator and viewfinder.

Blank

FRAME #3

Power Regulators

Receives control voltage from power control and regulates the output of the d-c voltage supply.

DC Voltage Supply

In conjunction with the power regulators and power control modules, this unit provides two separate sources of precisely regulated plus and minus d-c voltages for the camera head. Overload and overvoltage protection is included.

Power Control

Senses power supply voltages in the camera head and supplies control voltages to the power regulator for maintaining correct output voltages.

FRAME #4

AC Regulator WP-85 (Optional)

Maintains the proper AC voltage at the camera head by sensing circuitry which adjust automatically the AC voltage input to the camera cable.

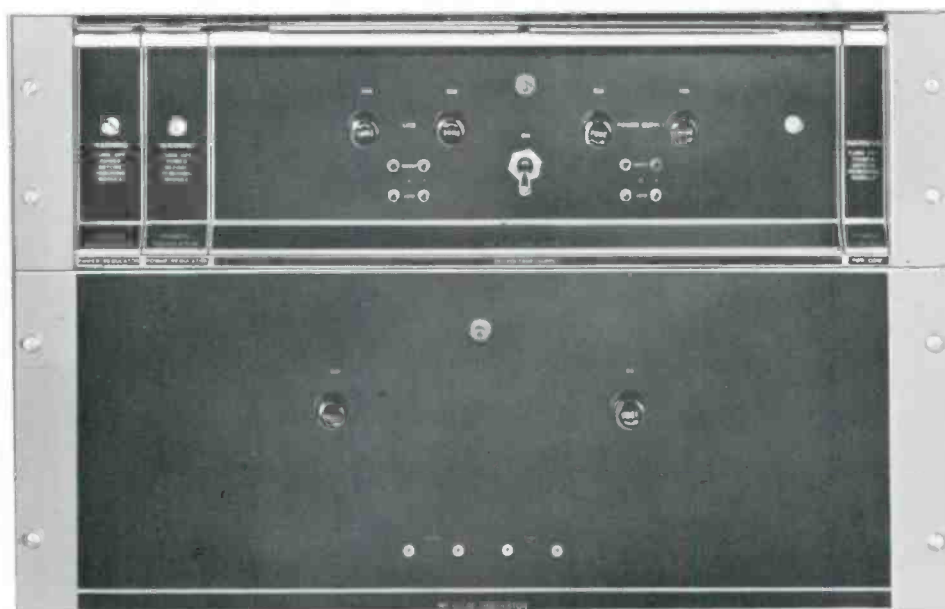

Controls and Functions

COLOR CONTROL PANEL

Bars

Connects color bars to colorplexer.

Monitor

Selects monitor display: color output, mono output, NAM, BRGM.

B, R, G, M

Selects outputs seen on monitor or CRO in BRGM position of monitor and CRO switches.

CRO

Selects display for CRO (same choice as on monitor switch).

Chroma

Varies white level in all color channels simultaneously, but not monochrome white level.

Mono

Disables color channels, provides mono signal without burst on all video outputs.

Chroma

Switch turns chroma, but not burst, off.

H Cent

Vernier horizontal centering.

V Cent

Vernier vertical centering.

White Balance

Varies white level of color channels individually.

Black Balance

Varies black level of color channels individually.

REMOTE CONTROL PANEL

Black Level

Selects manual or automatic black level control.

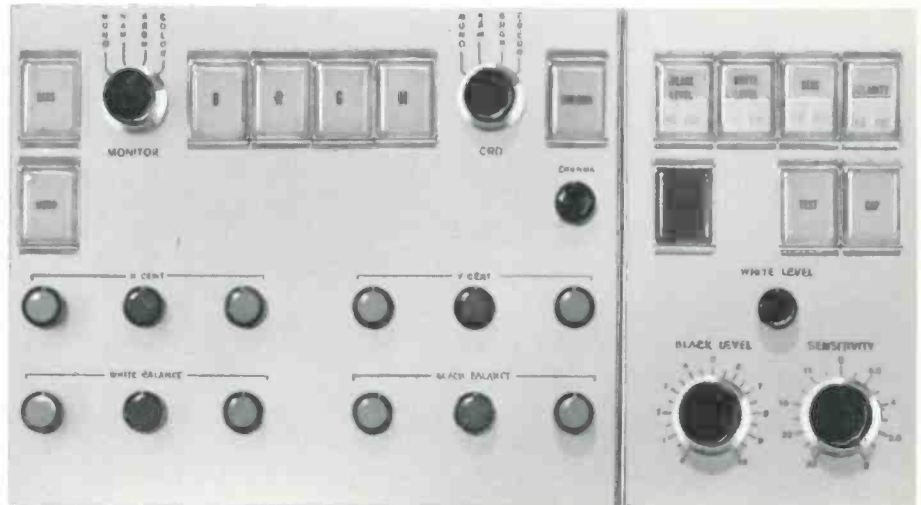

Control position for TK-42 Color Camera. Left is color control panel; right, remote control panel.

White Level

Selects manual or automatic white level control.

Sensitivity

Selects manual or automatic sensitivity control.

Polarity

Selects operation for positive or negative film.

Monitor

Used with studio switcher to connect camera chain output to console monitor.

Test

Energizes test pulses.

Cap

Electronically caps vidicon pickup tubes.

White Level

Controls white level reference pulse when switch is in manual, or sets level to which peak white is held when switch is in automatic.

Black Level

Controls black level reference pulse when switch is in manual, or sets level to which peak black is held when switch is in automatic.

Sensitivity

Controls vidicon sensitivity when switch is in manual, or sets level to which peak sensitivity is held when switch is in automatic.

FUNCTIONAL DIAGRAM

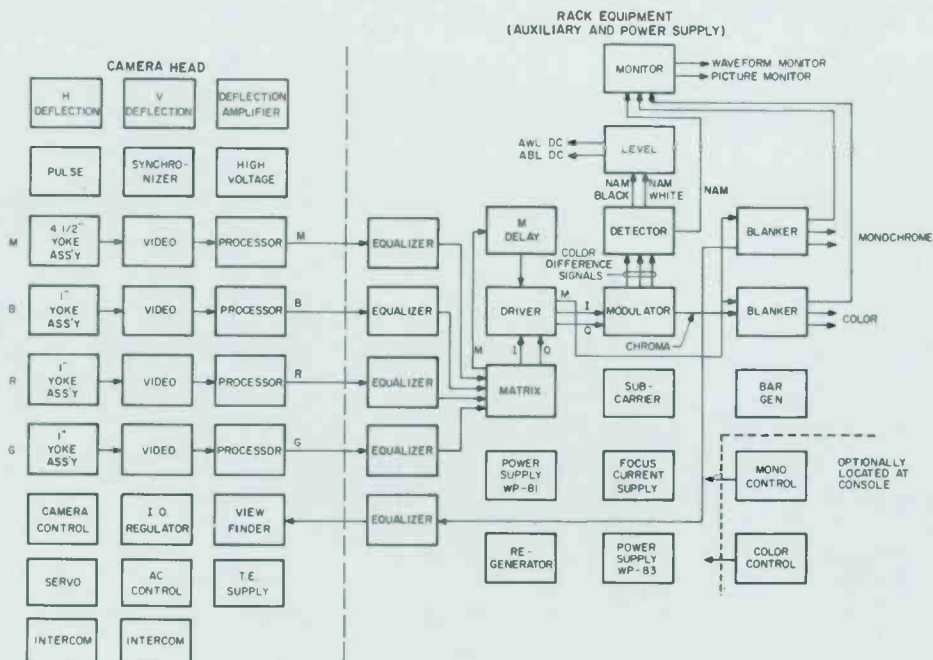

Specifications

General

Type of Reproduction.....Color and Monochrome
Scanning Standards.....Either 525 lines, 60 fields per sec.
or 625 lines, 50 fields per sec.
Viewfinder Display Size.....4½" x 6" (8" kinescope)
Viewfinder Brightness.....150 ft. Lamberts maximum
Maximum Length of Camera Cable:
Field Use.....Up to 2000 ft. (with optional AC Regulator
and In-Line Equalizer)
Studio Use.....Up to 1000 ft. (with optional AC Regulator)

Picture Quality

Limiting Horizontal Resolution,
Luminance Signal.....700 TV lines minimum in center
500 TV lines minimum in corners (image orthicon limiting)
Signal-to-noise Ratio,
Luminance Signal.....Nominal 36-38 db peak-to-peak
signal/RMS noise for bandwidth of 4.5 mc
Square Wave Tilt.....Maximum 2% for 60 cycle square wave

Blanking Signal Overshoots.....Not in excess of EIA
specifications
Overall Frequency Response:
With 100 ft. Camera Cable.....±0.5 db at 6 mc;
down not more than 3.0 db at 8 mc
With 1000 ft. Camera Cable.....±0.5 db at 6 mc;
down not more than 4.0 db at 8 mc
Total Geometric.....Any point within raster to be
within 2% of its true position
Orbiting.....Approximately circular path,
diameter 5.0% of picture height at 1 RPM

Operational

Remote Iris Control:
Elapsed Time to Cover Entire Range.....2 seconds max.
Accuracy of Setting.....Within ±0.25 lens stop
Gamma Correction,
Luminance Channel.....Switchable to three preset values:
0.5, 0.7 and 1.0
Aperture Correction.....Amplitude adjustable continuously
for 0 to +12.0 db
Camera Cable Equalization.....Adjustable in steps of 100 ft.
to a maximum of 1000 ft.

SIMPLICITY AND CONVENIENCE are cornerstones of new TK-42 Color Camera. Camera circuits are completely transistorized and take the form of standard plug-in modules, many of which can be interchanged with those of other cameras. Low-profile styling enhances maneuverability and ease of operation.

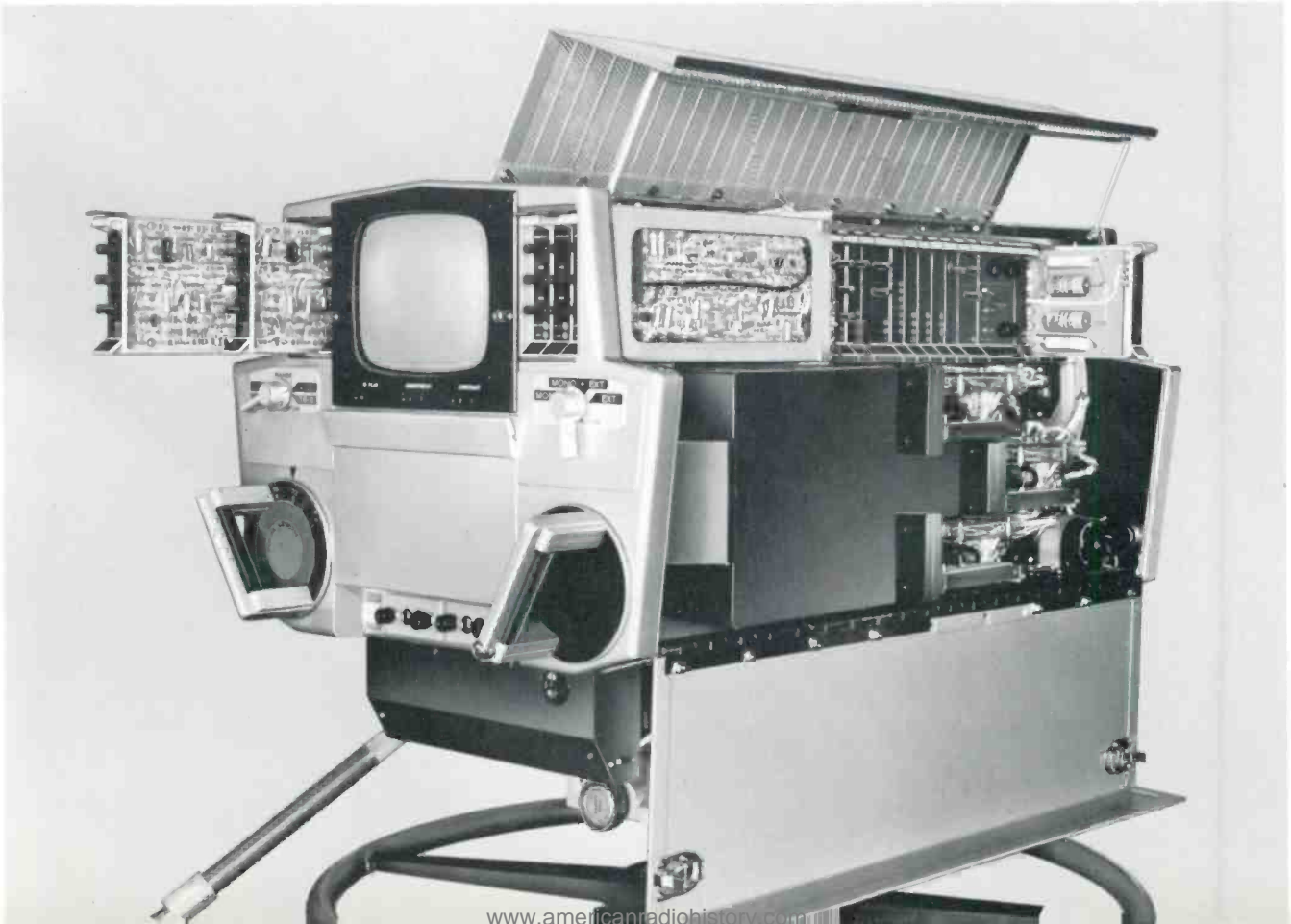

Specifications (Cont'd)

Electrical

Input Signals:

Sync, Blanking and Burst Flag Signals.....	4.0 ±0.5 volts, peak-to-peak negative ¹
Sub-Carrier.....	2.0 ±0.5 volts, peak-to-peak 3.579545 mc or 4.4296875 mc ²
Effects Signal to Viewfinder.....	0.7 volt nominal
Input Impedance	Bridging

Output Signals:

Program.....	2 Color, 2 monochrome, either 1.0 volt peak-to-peak composite or 0.7 volt peak-to-peak non-composite. One color output required for color monitor.
Monitoring.....	1 color and 1 monochrome for internal picture and waveform monitoring through system monitor selector switchers.

AC Power Input:

(camera and auxiliary but excluding monitors):

Line Voltage	
Field Use.....	90-130 volts or 180-260 volts (with optional AC Regulator)
Studio Use.....	113-125 volts or 226-250 volts (with 500 ft. max. camera cable)
Line Frequency.....	47-63 cycles per second
Power Consumption.....	750 watts approximately

¹ Pulse widths as specified by EIA RS-170. Terminals for signals are arranged for loop through connections.

² Choice of subcarrier frequency to be specified by customer.

Mechanical

Overall Dimensions:

	Wide	High	Long
Camera Case	22 ⁷ / ₈ "	16 ¹ / ₂ "	32 ¹ / ₂ "
	57.94 cm.	41.93 cm.	83.66 cm.
Total with wide angle lens adaptor and viewfinder hood.....	22 ⁷ / ₈ "	23 ¹ / ₄ "	45 ³ / ₈ "
	57.94 cm.	59.06 cm.	115.13 cm.
Auxiliary Assembly	19"	10 ¹ / ₂ "	16 ¹ / ₂ "
	48.3 cm.	26.6 cm.	42 cm.
Fan Assembly	19"	1 ³ / ₄ "	13"
	48.3 cm.	2.63 cm.	33 cm.
Power Supply WP-83	19"	5 ¹ / ₄ "	16 ¹ / ₂ "
	48.3 cm.	13.35 cm.	41.93 cm.
AC Regulator WP-85	19"	7"	13"
	48.3 cm.	17.8 cm.	33 cm.
Mounting Frame for Control Panels	19"	7"	
	48.3 cm.	17.7 cm.	
Remote Control Panel.....	4 ¹ / ₄ "	7"	8"
	11.4 cm.	17.7 cm.	20.1 cm.
Color Control Panel.....	8 ¹ / ₂ "	7"	8"
	21.5 cm.	17.7 cm.	20.1 cm.

Weight:

Camera and Viewfinder	280 lbs. (127 kg.)
Auxiliary Assembly	50 lbs. (22.7 kg.)
Fan Assembly	10 lbs. (4.53 kg.)
Power Supply, WP-83.....	40 lbs. (18.3 kg.)
AC Regulator, WP-85.....	35 lbs. (15.9 kg.)
Remote Control Panel.....	3 lbs. (1.36 kg.)
Color Control Panel.....	6 lbs. (2.72 kg.)

Ordering Information

TK-42 Color Studio Camera Chain as follows:

Qty.	Description	MI Number
1	Color Camera and Viewfinder including lens range converter, less vidicons and image orthicons	MI-557212-A1
1	Auxiliary Unit	MI-557227-A1
	To provide Colorplexing, Signal Processing, Power, Monitor Feeds, Cable Equalization	
1	Auxiliary Fan Assembly	MI-556547
1	Auxiliary Power Supply, WP-83.....	MI-557229-A1
1	Remote Control Panel.....	MI-557203
1	Color Balance Control Panel.....	MI-557204
1	Blank Panel	MI-556530-1
1	Frame Assembly for Control Panels.....	MI-557306
1	Master Monitor Equipment including:	
	TO-4 Waveform Monitor.....	MI-556523
	Connector Plate Assembly for TO-4.....	MI-556525
	Front Panel for TO-4.....	MI-556524
	TM-19 8-Inch Professional Monitor.....	MI-556526
	Front Panel for TM-19.....	MI-556527
	Rack Mounting Shelf 10 ¹ / ₂ " High.....	MI-556528
1	Color Monitor, Type TM-27, 17".....	MI-40232-A

Qty.	Description	MI Number
1	Console Housing, 20" to include:	
	Base Section	MI-556531
	Single Turret	MI-556535
	Remote Control Section	MI-556534
	Base Front Edge Trim, 22"	MI-556544-1
	Horizontal Turret Trim, 22"	MI-556546-1
1	Camera Cable, 50-foot length.....	MI-557315-1
1	Color Cam Head.....	MI-557310
1	Pedestal, TD-9AC	MI-40861-A
1	Image Orthicon, 4 ¹ / ₂ " (4492)	MI-557337
1	Vidicon, 1", 4493	MI-557334
1	Vidicon, 1", 4494	MI-557335
1	Vidicon, 1", 4495	MI-557336

Accessories

AC Regulator, WP-85	MI-557230-A1
In-Line Equalizer	MI-557245
100 ft. Camera Cable.....	MI-557315-2
200 ft. Camera Cable.....	MI-557315-3
Module Extender	MI-557301
Module Extender (for preamplifier).....	MI-557319
Terminal Extracting Tool.....	MI-43226
Cable, (Bulk 52-conductor) for Control Panels.....	MI-13358
I and Q Color Bar Module.....	MI-556554
Adjustable Viewfinder Hood	MI-55720

4 1/2-Inch Image Orthicon TV Camera, Type TK-60B

- Improved 4 1/2-inch I.O. tube
- Simplified operating controls
- Fully integrated design



New Look Camera — Engineering Excellence For Years of Service

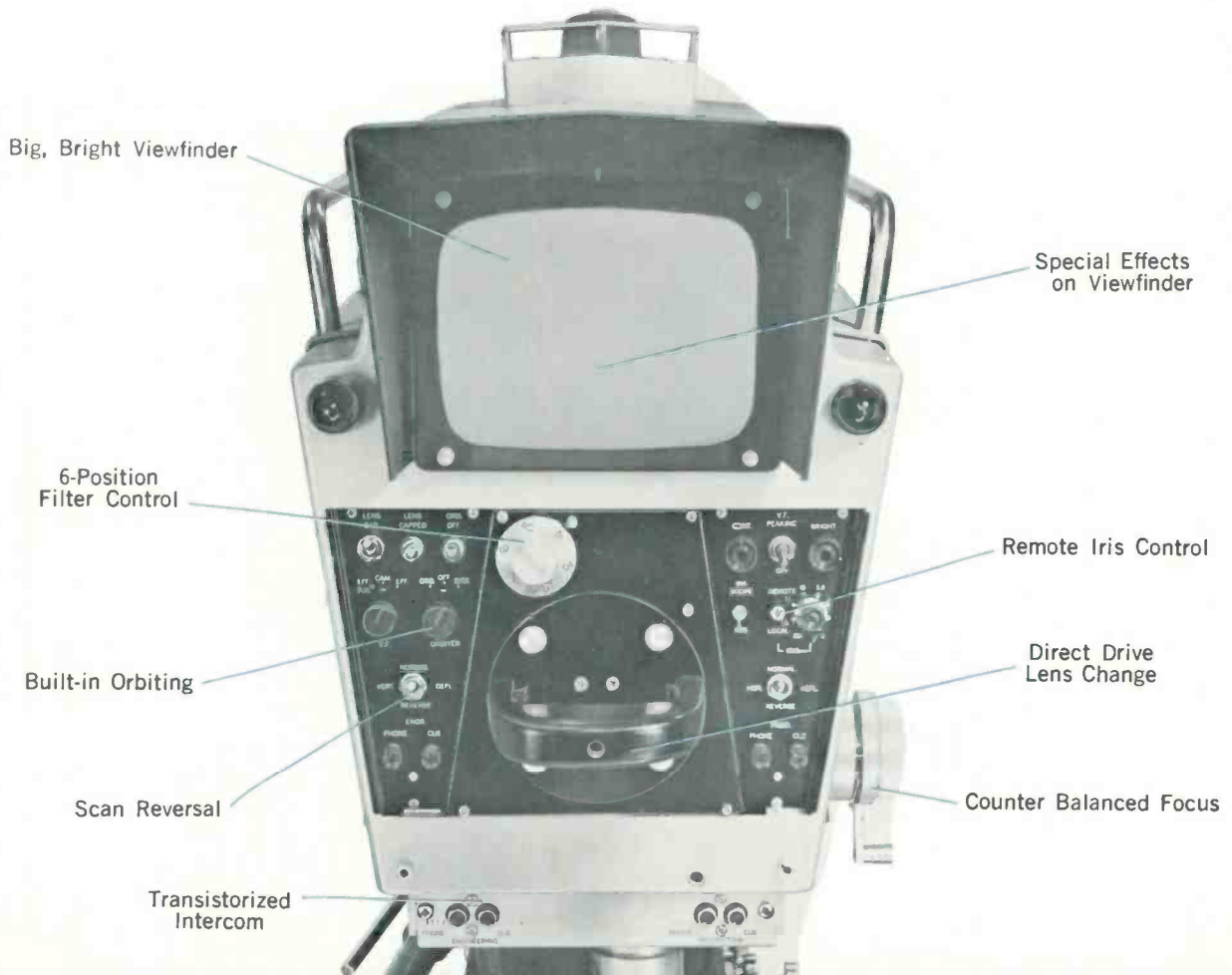
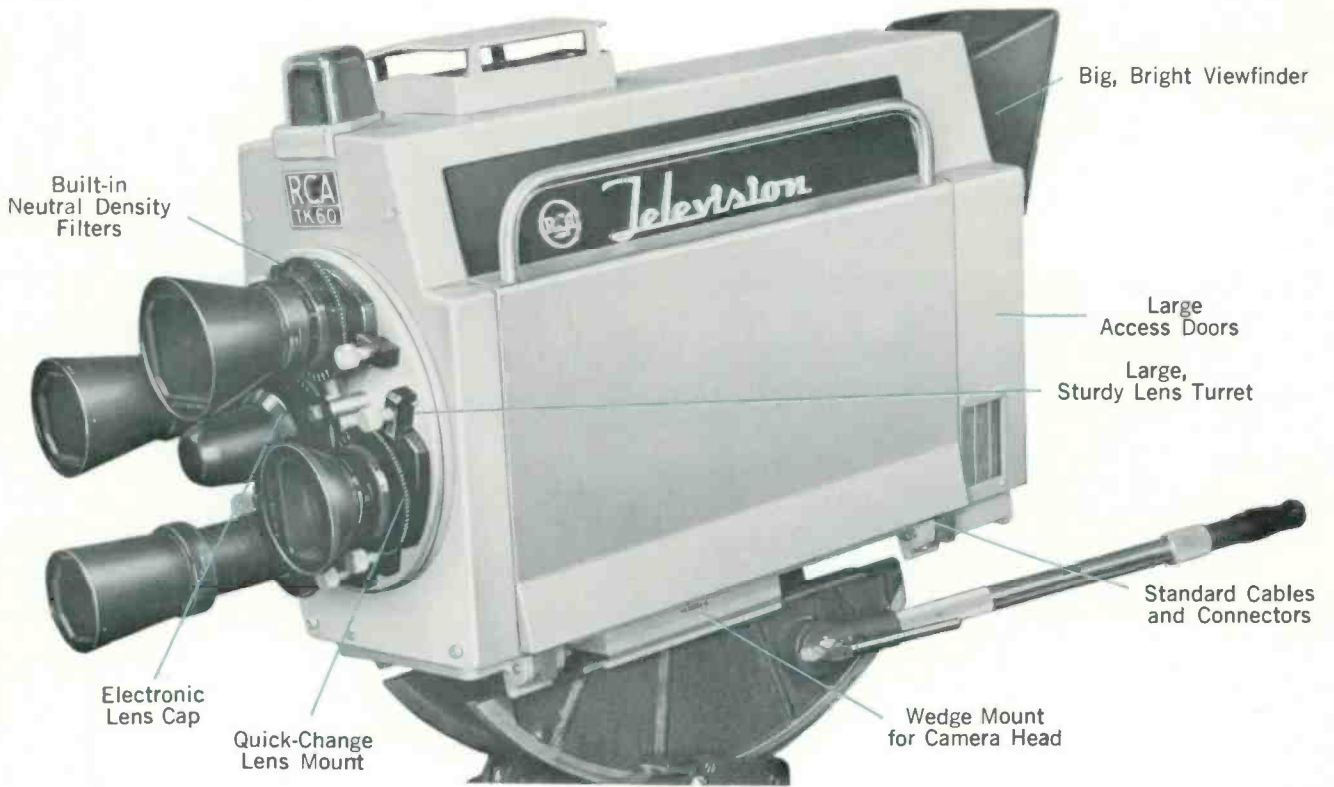

4½" Image Orthicon TV Camera, Type TK-60B

The RCA TK-60B Studio and Field Cameras are all new live monochrome camera chains featuring major advances in operational simplicity, stability and performance. The keystoneed "New Look" camera is identical in both studio and field chassis. It utilizes a 4½-inch image orthicon tube that provides a substantial improvement in resolution, signal-to-noise ratio and gray scale reproduction. These qualities result in pictures having the

faithfulness of detail and general high quality normally associated with fine photography.

Extensive use is made of stabilized circuitry in every part of the camera chain. As a result, a great improvement has been achieved in stability of operation, which has permitted in turn a major reduction in the number of operating controls and the amount of effort required for operation.

Description

RCA's TK-60 Monochrome Studio and Field Camera Chains include the RCA "New Look" features that provide remarkable improvement in picture quality and at the same time achieve far more simple and reliable equipment with inherent operating economy. Both field or studio version can be ordered to meet domestic or international operating standards.

Combined Camera-Viewfinder

The camera and viewfinder in the TK-60B are compacted in a single unit. The streamlined styling of the new housing with its keystone motif and new "space age" coloring lends a distinctive, pleasing and extremely functional appearance. All circuit functions within the camera have been segregated into three subchassis units and a setup control panel. The subchassis units consist of a video preamplifier, a deflection chassis and an auxiliary chassis.

Inside-Out Accessibility

Access to the inside of the camera is provided by two hinged side doors which open downward, forming convenient horizontal working surfaces during maintenance periods or are easily removed if desired. The video pre-amplifier is located in the lower lefthand side of the camera. The deflection and auxiliary chassis are mounted in opposite sides of the

camera by means of swing-out hinges which permit them to be raised for access to other parts of the camera assembly and for servicing. A control panel containing the camera setup controls is mounted toward the rear of the camera in the lower left side. The image orthicon and coil assembly are located on a movable focus carriage at the bottom of the camera.

Large, Bright Viewfinder

The viewfinder of the TK-60B features an 8½-inch rectangular kinescope which produces a large, bright picture display. Maximum usable highlight brightness is at least 150 foot-lamberts with a resolution capability of 600 lines. The viewfinder is normally fed by a signal from the output of the processor, permitting the cameraman to see a picture identical to that delivered to the studio output. This signal is sent over the camera cable and is equalized for flat response to the same degree as the output signal delivered by the camera.

Special Effects on Viewfinder

Provision is made to select remotely from the camera position an alternative signal feed through the camera cable. This feed may be used to show the cameraman a composite picture from an effects system when

the camera is being used as an input source for special effects. In addition, the input of the viewfinder may be connected locally to the output of the camera preamplifier to provide a quality check on the video signal as it leaves the camera.

Counter-Balanced Yoke Assembly

A unique arrangement has been provided to counterbalance the weight of the image orthicon focus and deflection coil assembly as it is moved backward and forward during optical focusing of the camera. As the camera is focused, this assembly is counterbalanced by the camera auxiliary subchassis which moves in a direction opposite to that of the coil assembly. In this way, the work required to move the focus mechanism is always minimum regardless of the angle-of-tilt of the camera. Furthermore, there is no tendency for the coil assembly to "slide down hill" when the camera is tilted.

Transistorized Intercom

Each TK-60B Camera Chain includes a self-contained intercom system with its own power supply. Two separate intercom circuits are provided, one of which has outlets in the camera, processor and remote control panel and may be operated independently from a built-in d-c power source in the camera or con-

ected to the existing station engineering intercom system. An outstanding feature is the provision of a built-in transistor amplifier and volume control at each point where a headset is plugged into the system. This provides a liberal reserve of intercom level at all times and permits each user to adjust the level to suit his own needs. Each station on the intercom system has back-loading to permit the bridging of a large number of stations without affecting sound level.

Large, Sturdy Lens Turret

The rugged, large diameter lens turret of the TK-60B camera provides mounting facilities for four lenses with remote iris control. The 1 $\frac{3}{4}$ -inch diameter turret provides liberal spacing between adjacent lenses, thus reducing optical interference. Rigid mechanical support and accurate optical alignment of the lenses are assured by rim support bearings at the edge of the turret, providing a solid mounting for heavy telephoto and zoom lenses. The turret shaft projects through the length of the camera and terminates in a handle at the rear, permitting change of turret position by a simple, direct rotating motion of the handle.

Built-in Remote Iris Control

Mechanical drive for remote control of iris adjustment is provided by an enclosed precision servo mechanism located at the center of the turret. A single gear engages the iris drive rings of the four lenses permitting simultaneous iris adjustment of all lenses mounted in the turret. The servo motor may be controlled either locally from the rear of the camera or remotely from the camera remote control panel. A slip-clutch guards against the possibility of damage to the lenses or drive mechanism due to jamming, and permits hand operation of iris adjustment at the front of the camera when desired.

Neutral Density Filter Holder

Immediately behind the lens turret is a disc containing six openings for the insertion of neutral density filters, any one of which may be introduced into the light path to compensate for major variations in light level. Selection of filters is provided by a control knob at the rear of the camera which rotates the disc

to the desired position. Detent stops located between filter positions permit use of the disc as an optical lens cap.

Easy-To-Service Features

When routine checking and repair of the TK-60B are needed, a number of self-testing circuits make the job easy. All significant circuits are wired to pin jacks for making either meter or oscilloscope measurements of signal and power supply voltages.

Test switches are provided in both the camera and processor for applying reduced filament voltage to one segment of the system at a time. Thus it is possible to obtain an indication of potential trouble and to isolate it to a particular area.

4 $\frac{1}{2}$ -Inch Image Orthicon Tube

The 4 $\frac{1}{2}$ -inch I.O. tube features wall-mesh and high quality dynode construction which assure uniform beam landing and freedom from shading and background non-uniformities of all kinds. Close tolerances held on electrical characteristics of the tube are a feature of special importance that permits the use of setup controls with restricted ranges in the TK-60B.

High Voltage and Focus Current Regulation

Close regulation of the voltages applied to the image orthicon and viewfinder is accomplished by using corona-discharge tubes to maintain highly accurate voltages. Current regulating circuits are employed in the processing amplifier to maintain the focus current within a maximum variation of 0.12 percent. Current reference is obtained from the drop in a resistor having a low temperature coefficient, and voltage reference is obtained from a highly stable zener diode.

Stabilization Techniques

To eliminate the need for constant resetting of bias controls during warm-up, beam current stabilization is provided in the TK-60B by the use of feedback between G2 and G1 of the image orthicon tube. This arrangement keeps the beam at the proper value for discharge of picture-whites and for minimum noise at all times.

A separate blower system is provided for temperature stabilization

of the image orthicon, consisting of a blower and a plenum chamber with two exhaust ducts. One duct maintains adequate cooling to the heater and cathode section, the other directs thermostatically controlled air to the image section of the image orthicon tube.

Current stabilization is used in amplifier tube circuits essentially throughout the TK-60B chain. Both temperature and aging effects which tend to cause a slump in cathode current are effectively counteracted where desirable by using a cathode resistor of high value with the grid returned to a positive voltage. Any change in emission characteristics of the tube will therefore result in only a small effective change in cathode current. Maximum use is made of feedback techniques in video output stages, deflection systems, and clamp circuits. Precision resistors with very low temperature coefficients are used in all critical circuits to minimize drift in voltage and current and to reduce camera warmup time. These are further aids in maintaining stable signal levels, linearity, and low differential gain.

Magnetic Shielding

Magnetic shielding is provided around the tube and its associated coils. It is possible to operate the camera in stray fields of intensities as high as 10 gauss without significant deterioration in picture quality.

Built-in Calibration Pulse

A control for adjusting gain of the signal multiplier in the image orthicon is included among the setup controls in the camera. A built-in calibration signal is provided for making proper preset adjustment of this control. The calibration signal consisting of a symmetrical square wave at scanning line frequency, is added by a switch to the picture signal at the input of the video pre-amplifier. The calibration signal is factory-adjusted to provide the normal level of 0.7 volts peak-to-peak at the output of the preamplifier.

Compact Control Panel

Essentially all of the setup controls in the TK-60B equipment are located in the camera where the viewfinder and a built-in calibration signal provide the measuring facilities required for setup adjustment, while only operating controls are

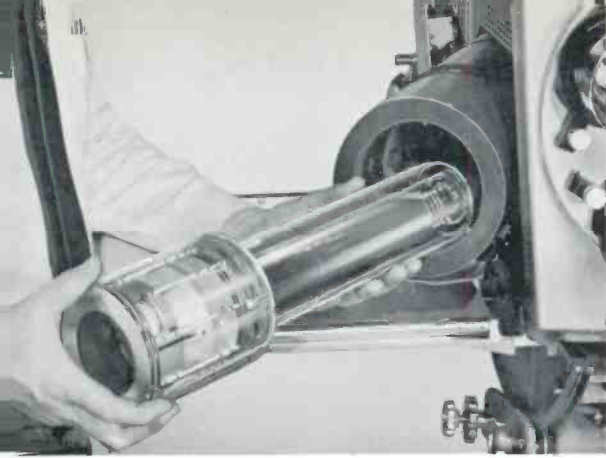

IMPROVED 4½-INCH I.O. TUBE—The heart of the TK-60B Camera is the RCA 4½-inch Image Orthicon, a newly designed tube made to the same high precision standards as color pickup tubes.

INSIDE-OUT ACCESSIBILITY—Complete access to all parts and components is made possible by swing-out design of the camera chassis. The yoke assembly is mounted on a swing-out pivot enabling the I.O. tube to glide out readily. Complete changeover can be accomplished in a few minutes.

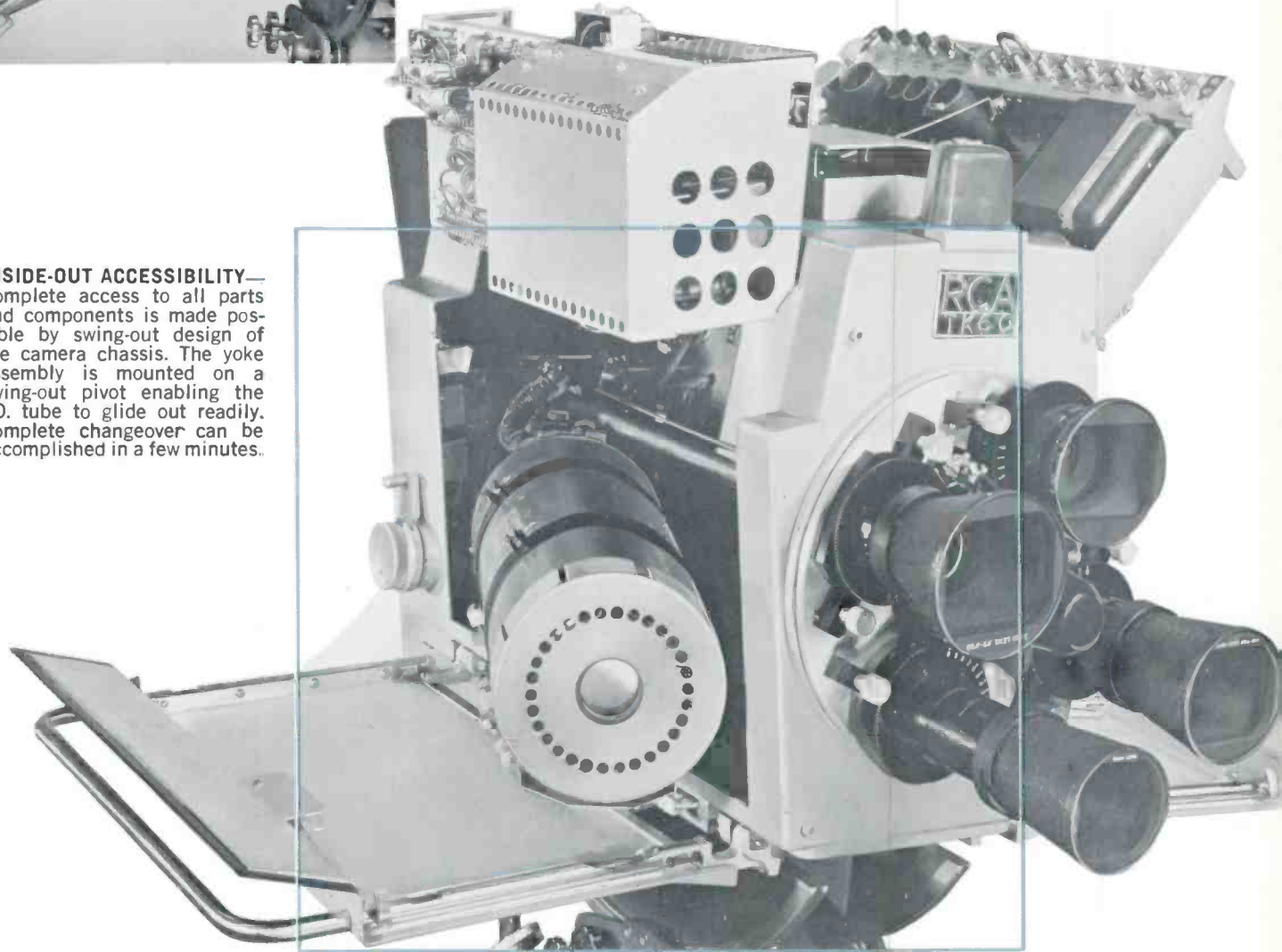

STANDARD CABLES AND CONNECTORS—The Camera Chain utilizes MI-94 type cable (now in use in stations throughout the country) making possible significant installation savings, particularly where cables are routed through conduits.

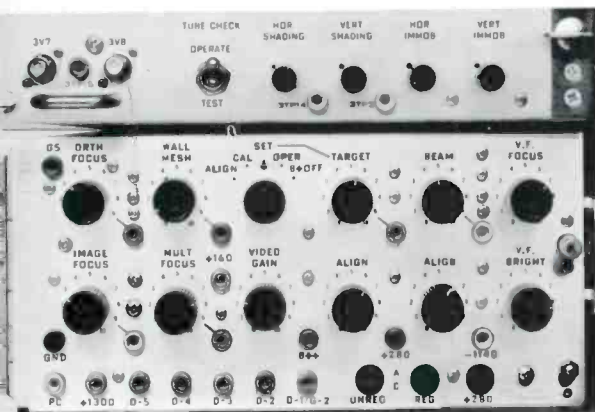

CENTRALIZED SET-UP CONTROLS—All set-up controls are located at the camera on a compact panel. Once set up, these controls require no further adjustment in normal day-to-day use. Pin jacks are also provided on the panel for routine checks. Liberal use of these test points is made throughout the camera chain.



placed at the camera control position. A previously adjusted camera may therefore be placed into service without need for adjusting setup controls at the camera or at the control position.

Setup functions at the camera include the usual adjustments for the image orthicon such as beam, beam alignment, target voltage, target calibration, orthicon focus, multiplier focus, and G6. A separate control for the wall-mesh electrode in the image orthicon tube is also located in the camera. Size and centering control (dual centering controls to accommodate reversal of scanning) and linearity adjustments are located on the deflection subchassis, while preset shading controls appear on the auxiliary subchassis.

Convenient Operating Controls

Operating controls which are located on the camera include turret handle, optical focusing control, and manual control for rotating the neutral density filter holder, and two switches for reversing directions of horizontal and vertical scanning, respectively. They are all conveniently located at or near the rear of the camera.

Remote Control Panel

The remote control panel contains the three operating controls of the TK-60B camera chain, consisting of the remote iris control, brightness and a contrast control. Two alternate versions of the remote control panel are available, identical in electrical function but designed to mount in either a standard rack or 13-inch console housing.

Built-in Electronic Lens Cap

A special new feature, of considerable convenience when the camera is left unattended, is an "electronic lens cap." It may be applied at any time by either the cameraman or the video operator. Tallies at both locations show when the camera has been capped. A switch cuts off the accelerating voltage in the image section of the pickup tube and applies a bias of about 4 volts to the target; thus the picture is effectively removed from the tube.

Built-in Image Orbiter

Electromagnetic image orbiting and immobilization, completely self-contained in the camera, are pro-

vided at a speed of 1 rpm. A switch at the back of the camera permits orbiting with or without image immobilization or turning the orbiting system off. In the "off" position, a red tally warns operator that the orbiter is not operating.

Processor

The processor is a rack-mounted unit containing all of the circuits for processing the signal delivered by the camera preamplifier and for providing three separate outputs to the signal switching and distribution system. It contains receptacles for the camera cable, power input to the camera chain, and intercom and remote control circuits. Also included are a 24-volt power supply and other components required for a self-contained intercom system. The improved signal-to-noise ratio obtainable with the new 4½-inch I.O. tube is sufficient to permit the use of considerable aperture and gamma correction to enhance the already improved detail response of the larger tube.

Accurate Cable Compensation

The processor also includes a tap switch for introducing video equalization to compensate for different lengths of camera cable. This switch provides increments in compensation corresponding to 100-foot increments in length up to a maximum of 1000 feet. The same switch assembly includes equalizing circuits for the coax used for viewfinder feed.

Semiconductor Power Supply

A Type WP-16B power supply, completely tubeless and with a current rating of 1.6 amperes at 280 volts, provides the necessary regulated power for the camera chain. Designed for minimum heat radiation and space consumption, it occupies only seven inches of rack space.

Self-Regulating Power Transformers

All power transformers in the camera, processor and the transistorized WP-16B regulated power supply are of the self-regulating type. They provide automatic compensation for the drop in a-c supply voltage to the camera over the camera cable up to a length of 1,000 feet. In addition, it gives assurance of stabilized heater voltages on all tubes and increases the stability and performance of the regulated d-c power supply.

Studio Camera Chain

The major units of the TK-60B Camera Chain consists of a combined camera-viewfinder, a processor, a type WP-16B Power Supply, a TM-6C master monitor, and a remote control panel. The camera chain is supplied complete with tubes including image orthicon, a set of three lenses, a 50-foot camera cable with connectors, a camera wedge mount and a 13-inch console housing for the master monitor and remote control panel. The processor and power supply are designed for mounting in a standard cabinet rack. A Cradle Head and one of the available tripods or pedestals should be ordered to support the camera.

TK-60B Field Camera Chain

The TK-60B Field Camera Chain is similar to the TK-60B Studio Camera equipment with the exception that the TK-60B is packaged for portable field applications. The major units of the TK-60B Field equipment consists of a combined camera-viewfinder, a field processor, a Type WP-16B power supply, a power supply field case, a TM-35 portable master monitor, and a remote control panel. The camera chain is supplied complete with tubes including image orthicon. A cradle head, Type TD-11A folding metal tripod, set of interconnecting cables, set of camera cables with connectors (50, 100 and 200 foot lengths), and a set of three lenses complete the camera chain.

The camera-viewfinder unit of the TK-60B Field Camera Chain is identical with that of the TK-60B Studio Camera equipment. The field processor is similar to the rack mounting processor with the exception that the field unit is housed in an attractive, portable field case and utilizes field type connectors mounted on a sub-panel at one end of the case. A similarly styled field case is supplied for the WP-16B power supply. The camera remote control panel fits into a space provided in the front of the TM-35 portable master monitor.

The TM-35 portable master monitor with remote control in place may be mounted on any convenient operating table. The field processor and WP-16B power supply may be mounted beneath the desk since neither unit contains operating controls.

Specifications

General Specifications

Type of Reproduction.....	Monochrome
Number of Scanning Lines.....	525 or 625
Frame Repetition Rate.....	30 or 25 per sec.
Field Repetition Rate.....	.60 or 50 per sec.
Line Repetition Rate.....	15,750 or 16,625 per sec.
Picture Signal.....	1.0 volts, peak-to-peak composite, nominal 1.4 volts, peak-to-peak composite, optional
Picture Polarity at Output.....	Black negative
Viewfinder Display Size.....	4½ x 6 inches (8" kinescope)
Viewfinder Brightness.....	150 foot Lamberts Max.
Impedance of Coaxial Transmission Line.....	.75 ohms
Maximum Length of Camera Cable.....	1000 feet

Picture Quality

Limiting Horizontal Resolution.....	700 TV lines minimum in center, 500 TV lines minimum in corners
Signal-to-Noise Ratio.....	Nominal 36—38 db peak-to-peak signal/RMS noise for bandwidth of 4.5 mc
Square Wave Tilt.....	Adjustable to zero at vertical rate
Blanking Signal Overshoots.....	Not in excess of EIA specifications
Overall Frequency Response:	
With 100 ft. Camera Cable.....	±½ db to 8 mc; down not more than 3 db at 10 mc
With 1000 ft. Camera Cable.....	±1 db to 8 mc; down not more than 4 db at 10 mc
Scanning Aspect Ratio.....	4 : 3
Scanning Linearity.....	Within ±1% normal
Overscan Amplitude.....	Horizontal 10%; Vertical 10%
Retrace Intervals.....	Horizontal 7.6 µsec.; Vertical 635 µsec.
Range of Centering Adjustment.....	Horizontal ±10%; Vertical ±20%
Orbiting.....	Approximately circular path 7% dia. of picture height at 1 RPM. With immobilization, motion in received picture not over 1%

Operational Specifications

Remote Iris Control.....	Elapsed time to cover entire range: 2.0 sec.; accuracy of setting: ±0.25 lens stop
Contrast Control.....	Range: 0% to 50% clipping of blacks
Electronics Lens Cap Control.....	Two-Way switch on remote control panel, operating in conjunction with similar switch on camera
Gamma Correction.....	Switchable to three preset values of 0.7, 0.8 and 1.0
Aperture Correction.....	Peaked at 6.0 mc; amplitude adjustable continuously from 0 to +13 db
Camera Cable Equalization ¹	Adjustable in steps of 100 ft. to a maximum of 1000 ft.

Electrical Specifications

Input:	
Horizontal Drive.....	4.0 ±0.5 volts, peak-to-peak negative ²
Vertical Drive.....	4.0 ±0.5 volts, peak-to-peak negative ²
EIA Blanking.....	4.0 ±0.5 volts, peak-to-peak negative ²
Effects Signal to Viewfinder.....	Video at 0.7 volt nominal, 1.0 volt nominal, black negative
Audio Cue Signal.....	Balanced into 60 ohms at 2W level
Output:	
Video No. 1, No. 2 and No. 3.....	Non-composite level either 0.7 or 1.0 volt, peak-to-peak black negative ³ (Sync may be added to any two outputs)
Isolation Between Any Two Non-composite Outputs.....	At least 46 db from 1 kc to 100 kc; At least 30 db from 10 cps to 10 mc

¹ Coaxial lines for preamplifier output and for viewfinder signal input are equalized simultaneously with identical compensating networks.

² Pulse widths as specified by EIA in RS-170. Terminals for signals are arranged for loop-through connections with isolating filters.

³ Circuits terminated at sending end and $Z_0 = 75$ ohms.

AC Power Input:	50 cycle 230 volt chain	60 cycle 115 volt chain
Line Frequency	50 cycles ±1 cycle	60 cycles ±1 cycle
Power Requirements (approx. total includ- ing master monitor and power supply.....)	1200 watts	1200 watts
DC Power Load (from WP-16B Power Supply)		
	Including TM-6C	Excluding TM-6C
Regulated, +280 V.....	1350 ma	900 ma
Unregulated, ±400 V.....	190 ma	190 ma
Centering Current, -4 V.....	1450 ma	1000 ma

Mechanical Specifications

	Overall Dimensions		
	Width	Height	Length/ Depth
Camera-Viewfinder (incl. hood, turret, iris drive and tally light)	15" 38 cm	22" 56 cm	36" 91.5 cm
Weight.....	150 lbs.—68 kg		
Camera-Viewfinder (case only).....	15" 38 cm	19½" 49.5 cm	26¼" 67 cm
Processor (Rack Mounting).....	19" 48 cm	15½" 39 cm	10" 25.5 cm
Weight.....	60 lbs.—27.2 kg		
Field Processor	8½" 21.5 cm	18½" 47 cm	23" 58.5 cm
Weight.....	70 lbs.—31.8 kg		
Remote Control Panel (TM-35 Mounting)	7¾" 20 cm	2¼" 5.5 cm	3½" 9 cm
Weight.....	1½ lbs.—.75 kg		
Remote Control Panel (Console Mounting)	11½" 28 cm	2-21/32" 5.5 cm	3½" 9 cm
WP-16B Power Supply (Rack Mounting)	19" 48 cm	7" 18 cm	13½" 34.5 cm
Weight.....	71 lbs.		
WP-16B Power Supply (Field Case)	8½" 21.5 cm	18½" 47 cm	27½" 70 cm
Weight.....	80 lbs.—36.25 kg		
TM-6C Master Monitor.....	13½" 34.5 cm	18" 46 cm	20" 51 cm
Weight.....	55 lbs.—25 kg		
TM-35 Portable Master Monitor....	8½" 21.5 cm	15¾" 40.5 cm	20¾" 52 cm
Weight.....	49 lbs.—22.7 kg		
Console Housing	12¼" 31 cm	44¼" 140 cm	46" 117 cm
Weight.....	75 lbs.—34 kg.		

OPTIONAL AND ACCESSORY EQUIPMENT

Cradle Head	MI-26203-A
Television Pedestal, Type TD-3A.....	MI-26036
TD-3A Counterweights (25 lbs.) required for TK-60.....	MI-26391
Console Well Adaptor for MI-26008 Remote Control Panel.....	MI-26252
Rack Adaptor for MI-26008 Remote Control Panel.....	MI-26254
Rack Adaptor for MI-26007 Remote Control Panel.....	MI-26887-2
Left Panel Assembly and Side Cover for Console Housing	MI-26788-1
Right Panel Assembly and Side Cover for Console Housing	MI-26788-2
Upper Left Side Cover Only.....	MI-26789-1
Upper Right Side Cover Only.....	MI-26789-2
Shock Mount for Processor.....	MI-26511-A6
Shock Mount for WP-16B.....	MI-26511-A5
Shock Mount for TM-35.....	MI-26511-A3
Spare Video Preamplifier for TK-60A Camera.....	MI-26006
Spare Remote Iris Drive Assembly for TK-60B Camera.....	MI-26019
Spare I.O. Yoke Assembly for TK-60B Camera.....	MI-26004

FULLY INTEGRATED DESIGN . . . A complete camera chain for studio or field pickup.

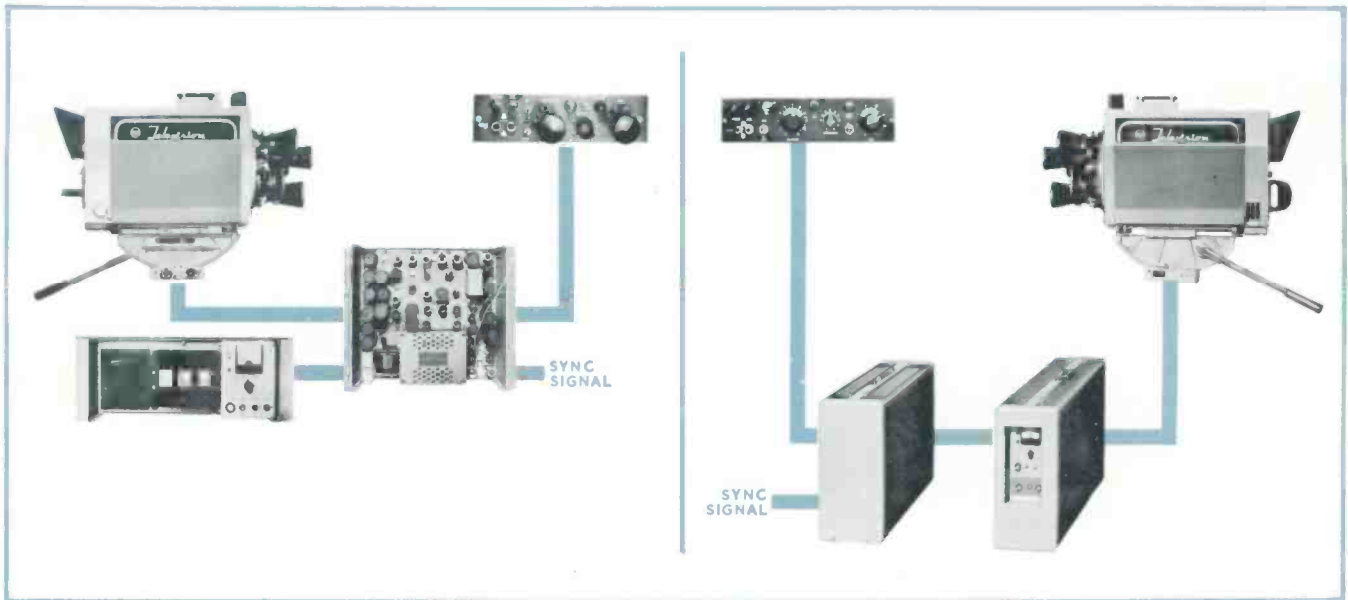

STUDIO CHAIN—Includes camera, processor chassis, transistorized power supply, master monitor and remote control panel.

FIELD CHAIN—Includes camera with suitcase-type master monitor, field processor and power supply in portable cases.

Ordering Information

The Type TK-60B 4½-inch I.O. TV Camera is available for operation on 525/625 line TV standard and 115 V., 60 cyc./230 V., 50 cyc.

Equipment Supplied

Type TK-60B Monochrome Studio Camera Chain including the following:

115 V., 60 Cycle Chain			230 V., 50 Cycle Chain		
Qty.	MI Number	Description	Qty.	MI Number	Description
1	26002-A	Camera Viewfinder	1	556002-A	Camera Viewfinder
1	26003-A	Processor	1	556003-A	Processor
1	26008	Remote Control Panel	1	26008	Remote Control Panel
1	26084-B	Power Supply, WP-16B	1	26094-B	Power Supply, WP-16B
1	26083-A	Centering Current Subchassis	1	26083-A	Centering Current Subchassis
1	26082-A	Unregulated High Voltage Subchassis	1	26082-A	Unregulated High Voltage Subchassis
1	26882-A3	Lens, 50mm, f/2.0	1	26882-A3	Lens, 50mm, f/2.0
1	26882-A4	Lens, 75mm, f/2.0	1	26882-A4	Lens, 75mm, f/2.0
1	26882-A5	Lens, 127mm, f/2.8	1	26882-A5	Lens, 127mm, f/2.8
1	26373	Viewfinder Hood	1	26373	Viewfinder Hood
1	26877-A	Image Orthicon, RCA 7295-B	1	26877-A	Image Orthicon, RCA 7295-B
1	26725-E5	Camera Cable, 50 feet	1	26725-E5	Camera Cable, 50 feet
1	26884-A	Wedge Mount	1	26884-A	Wedge Mount
1	26786	Console Housing, 13-inch	1	26786	Console Housing, 13-inch
1	26136-C	Master Monitor, TM-6C	1	N26136-C	Master Monitor, TM-6C
1	26579-B	Blower for TM-6C	1	556579-B	Blower for TM-6C
1	26667	CRO, RCA Type 5ABP1	1	26667	CRO, RCA Type 5ABP1
1	26655	Kinescope, RCA Type 10SP4	1	26655	Kinescope, RCA Type 10SP4

Type TK-60B Monochrome Field Camera Chain including the following:

115 V., 60 Cycle Chain			230 V., 50 Cycle Chain		
Qty.	MI Number	Description	Qty.	MI Number	Description
1	26002-A	Camera Viewfinder	1	556002-A	Camera Viewfinder
1	26009-A	Processor	1	556009-A	Processor
1	26007	Remote Control Panel	1	26007	Remote Control Panel
1	26084-B	Power Supply, WP-16B	1	26094-B	Power Supply, WP-16B
1	26083-A	Centering Current Subchassis	1	26083-A	Centering Current Subchassis
1	26082-A	Unregulated High Voltage Subchassis	1	26082-A	Unregulated High Voltage Subchassis
1	26216	Field Case for WP-16B	1	N26216	Field Case for WP-16B
1	26882-A3	Lens, 50mm, f/2.0	1	26882-A3	Lens, 50mm, f/2.0
1	26882-A4	Lens, 75mm, f/2.0	1	26882-A4	Lens, 75mm, f/2.0
1	26882-A5	Lens, 127mm, f/2.8	1	26882-A5	Lens, 127mm, f/2.8
1	26373	Viewfinder Hood	1	26373	Viewfinder Hood
1	26154	Portable Master Monitor, TM-35	1	556154	Portable Master Monitor, TM-35
1	26877-A	Image Orthicon, Type 7295-B	1	26877-A	Image Orthicon, Type 7295-B
1	26359	Set of Interconnecting Cables	1	26359	Set of Interconnecting Cables
1	26725-E5	Camera Cable, 50 feet	1	26725-E5	Camera Cable, 50 feet
1	26725-E6	Camera Cable, 100 feet	1	26725-E6	Camera Cable, 100 feet
1	26725-E7	Camera Cable, 200 feet	1	26725-E7	Camera Cable, 200 feet
1	26884-A	Wedge Mount	1	26884-A	Wedge Mount
1	26203-A	Cradle Head	1	26203-A	Cradle Head
1	26046	Tripod, Type TD-11	1	26046	Tripod, Type TD-11

Transistorized Field Camera, Type TK-33

- New 3-inch "Long Life Target" image orthicon
- Separate camera . . . detachable viewfinder . . . auxiliary equipment in two field cases
- Automatic operation . . . Standard plug-in interchangeable modules



Transistorized Field Camera, Type TK-33

The RCA TK-33 is a revolutionary new television camera employing electronic and mechanical advances that set entirely new high standards in picture quality, attention-free performance and long term dependability. Never before was a camera capable of higher quality studio pictures or

more ideally suited to field operation portability. Complete transistorization and premium modular design place the TK-33 truly in a class by itself, with no equal for rugged construction, light weight, small size and low power consumption.

Description

Easy Portability and Setup

The basic TK-33 system consists of the camera and viewfinder, which can be separated into two units for maximum transportability. Furthermore, two field cases house the camera auxiliary and power supply.

An important feature is the detachable viewfinder. This permits a size and weight reduction for convenience in transporting. At setup, the viewfinder is easily plugged into the camera and locked in place by quick release fasteners. A self-aligning connector makes all connections between the two units. Accepting composite monitoring signals, the viewfinder employs an 8-inch, high brightness (150 footlambert) kinescope. It contains the plug-in modules for video, sync, high voltage and deflection.

During operation, the camera auxiliary remains in the two field cases. One of these contains the modules for the main DC power supply, while the other field case houses the following modules: auxiliary DC power supply; image orthicon focus supply, equalizers for line and viewfinder; video; video output; blanking; and the remote control panel.

The camera, remote control panel and viewfinder all contain on-air tally indicators. Those for the camera are mounted on the front and top. The viewfinder also contains a preview tally indicator. Tallies for the viewfinder are mounted so that they are all within any type hood that may be used as a light shield.

New Long Life Camera Tube

The camera employs a new 3-inch image orthicon of exceptionally high sensitivity that permits focusing on bright, still scenes without the usual "burn in" or image retention found in today's image orthicon pickup

tubes. This feature, made possible by a unique target, completely eliminates any further need for an image orbiter or for continually moving the camera to prevent stationary scenes from "sticking" on the target. Other valuable features of the sturdy new pickup tube are longer life, constant gain and stable sensitivity throughout tube life.

Advanced Solid State Circuits

The completely transistorized circuits of the TK-33 are unmatched for their low power consumption, low heat dissipation and greater reliability. These solid state circuits are stable and free from microphonics. They also make possible plug-in modules that are more compact, have fewer components and are easier to service and repair. Some of the modules are interchangeable, increasing circuit familiarity and reducing spare requirements. All have built-in test jacks and are operable right in the frames, further simplifying maintenance.

One-Man Alignment and Test

Camera circuits are now arranged so that one man instead of two can set up and adjust the camera using pulse techniques. By simply depressing a switch, internally generated test pulses are sent through the system so that the operator can determine that the pickup tube and amplifiers are operating at proper levels. These pulses greatly simplify and speed up camera adjustment. Test pulses can be inserted at any time from the control panel for checks of stability.

Automatic Operation

New circuitry in the TK-33 provides many automatic features not found in previous live pickup cameras—features which reduce manual operation of the TK-33 camera to

basically one control: sensitivity, or lens iris control. Included are automatic controls for white level and black level, self-adjusting cable timing delay, and automatic DC power regulation.

Automatic Cable Compensation

The TK-33 camera automatically detects and compensates for any camera cable timing delays by advancing the horizontal pulses, assuring accurate timing regardless of the length of cable used. In other self-operating circuits of the TK-33, precise DC voltages are maintained in the camera by circuits that sense voltage changes and compensate for them by regulating the power supply output.

Simplified System

Drive signals for the image orthicon pickup tube originate in the camera itself so that the unit requires only sync and blanking signals from the sync generator. This simplifies system cabling.

Electronic Lens Cap

A feature of convenience to the operator when leaving the camera unattended is the electronic lens cap. As effective as a mechanical cap, the electronic cap may be applied either at the camera or at the control position. Tallies at both locations show when the camera has been capped. Capping is accomplished by a switch which cuts off the accelerating voltage in the image section of the pickup tube, and applies bias voltage to the target of the tube.

Universal Operating Standards

The TK-33 equipment is operable on both domestic and international TV and power line standards. Moreover, the camera is switchable between standards.

DETACHABLE VIEWFINDER with convenient carrying handle plugs into camera for ease of set-up.

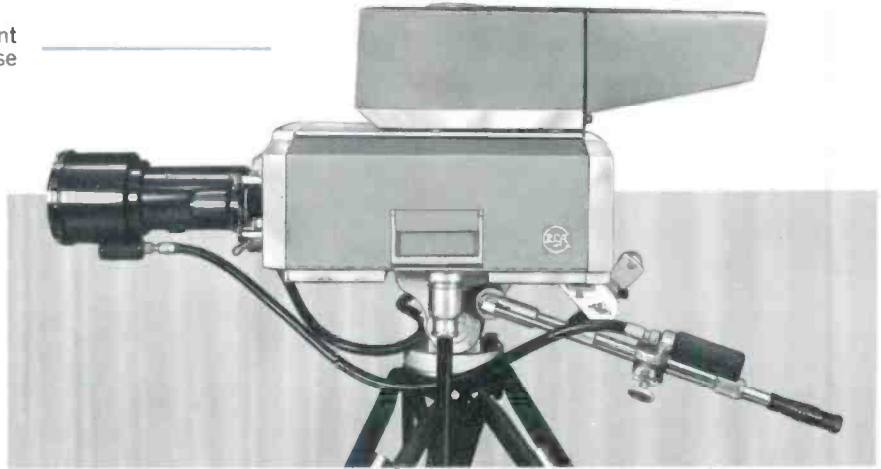

Compactness
Portability
Accessibility

SMALL SIZE CAMERA—Easily Portable, removable lens, accepts all TV-88 Lens mounts. Recessed carrying handles.

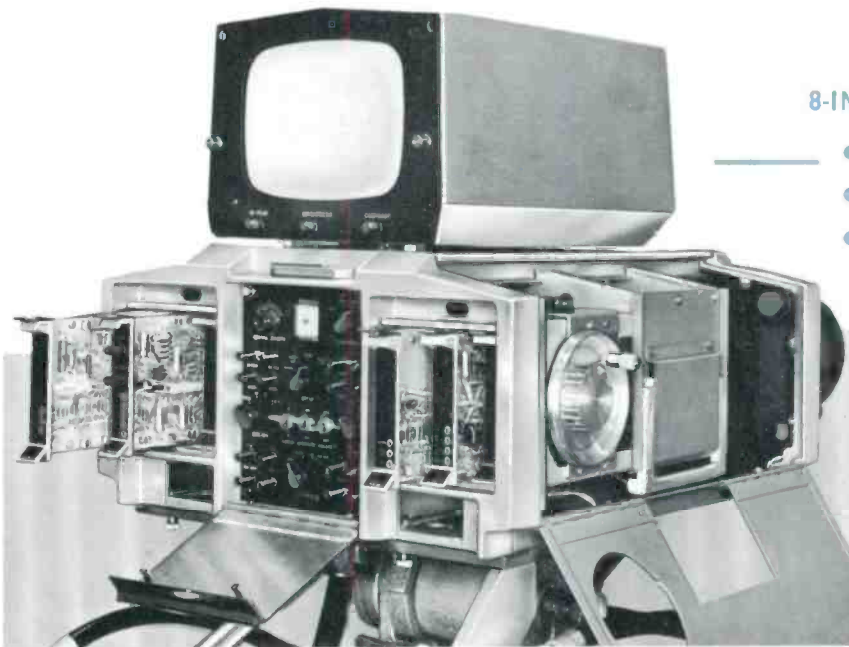

8-INCH VIEWFINDER

- High brightness kinescope
- On-Air and preview tally lights
- Removable viewfinder hood

FUNCTIONALLY STYLED CAMERA

- Recessed yoke focus control
- Centrally located set up panel
- Transistorized interphones

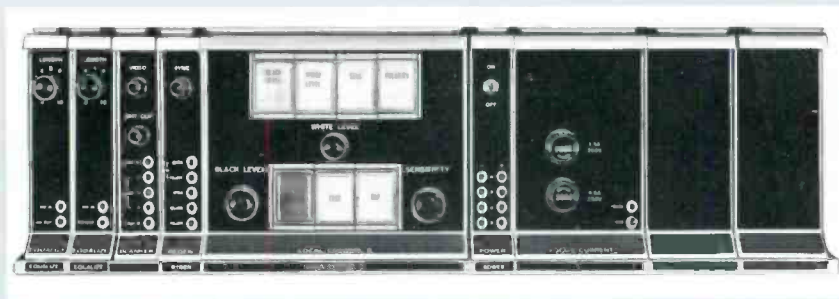

Camera Auxiliary

Two Portable Field Cases

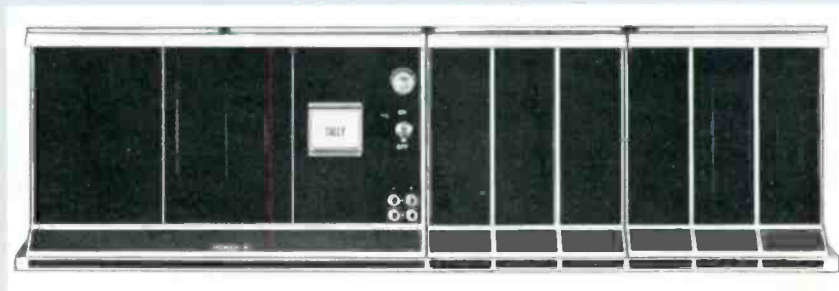

Camera Power Supply

Specifications

General

Type of Reproduction.....	Monochrome
Scanning Standards.....	Either 525 lines, 60 fields per sec. or 625 lines, 50 fields per sec.
Scanning Aspect Ratio.....	4:3
Lens Mounting.....	TV-88
Viewfinder Display Size.....	4½" x 6" (8" kinescope)
Viewfinder Brightness.....	150 footlamberts, maximum
Maximum Camera Cable Length.....	1,000 feet

Picture Quality

Limiting Horizontal Resolution.....	700 TV lines minimum in center (image orthicon limiting)
Signal-to-Noise.....	Nominal 30-33 db peak-to-peak signal/RMS for bandwidth of 4.5 mc
Square Wave Tilt.....	Not in excess of 2%
Blanking Signal Overshoots.....	Not in excess of EIA specifications
Overall Frequency Response: With 50 ft. Camera Cable.....	±0.5 db to 8 mc down no more than 3 db at 10 mc
Geometric Distortion (including Linearity).....	Within 2% of picture height

Operational

Remote Iris Control Elapsed Time to Cover Entire Range.....	2 seconds
Accuracy of Setting.....	Within ±0.25 lens stop
Black Level Control.....	Range: ±50% of video level

Electronic Lens Cap.....	Operated from either camera or remote control panel
Gamma Correction.....	Switchable to three preset positions; 0.5, 0.7 and 1.0. For negative video, two positions are pro- vided: 1.0 or 1.2
Aperture Correction.....	Peaked at 5.5 mc; amplitude adjustable continuously from 0 to +12 db
Cable Compensation.....	Manually adjustable video equal- ization in steps of 100 ft. to a maximum of 1000 ft. Auto- matic compensation of cable time delay and DC power to 1000 ft.

Electrical

Input Signals:	
Synchronizing.....	2-8 volts peak-to-peak, negative, bridging or terminated
Blanking.....	2-8 volts peak-to-peak, negative, bridging or terminated
Effects Signal to Viewfinder.....	1.0 volt composite, black negative, bridging 3000 ohms, 6 pf
Audio Cue Signal.....	Balance into 600 ohms at 2 watts level (maximum)
Tally Light Control On/Air Preview.....	24 volts DC
Output Signals:	
Video Output A, B and C.....	Video A & B—Either 0.7 or 1.0 volt peak-to-peak composite/non-composite, switchable as a pair; Video C—Composite/non-composite switchable 0.7 volt to 1.0 volt peak-to-peak
Isolation Between Outputs.....	At least 45 db at 3.6 mc
Output Impedance.....	75 ohms, sending end terminated
A.C. Power Input:	
Line Voltage.....	90-130 volts, or 180-260 volts
Line Frequency.....	47-63 cycles per second
Power Consumption.....	180 watts approximately

Mechanical

Dimensions (tentative)	Width	Height	Depth	Weight
Camera, less lens and viewfinder.....	18¾"	9¼"	24½"	60 lbs.
	46.3 cm	23.4 cm	62.2 cm	27.2 kg.
Viewfinder, less hood.....	10½"	8½"	15½"	22 lbs.
	26.6 cm	21.6 cm	39.4 cm	10.0 kg.
Auxiliary, without field case.....	19"	10½"	18½"	35 lbs.
	48.3 cm	26.6 cm	47.0 cm	15.9 kg.
Auxiliary, in field case.....	24"	15"	25"	50 lbs.
	61.0 cm	38.1 cm	63.5 cm	22.7 kg.
Power Supply, without case.....	19"	10½"	18½"	75 lbs.
	48.3 cm	26.6 cm	47.0 cm	34.0 kg.
Power Supply, with case.....	24"	15"	25"	90 lbs.
	61.0 cm	38.1 cm	63.5 cm	41.0 kg.

Ordering Information

TK-33, 3-Inch I.O. Camera—Basic Camera Equip-
ment and Accessories for Field and Studio Use.

MI Number	Description	Quantity	
		Field Camera	Studio Camera
557240-A1	TK-33 Camera, less Image Orthicon	1	1
557241-A1	Viewfinder, with kinescope.....	1	1
557242-A1	Auxiliary Unit.....	1	1
557243-A1	Power Supply.....	1	1
557797-B1	Local Control Panel.....	1	—
557796-B1	Local Indicator Panel.....	—	1
557203	Remote Control Panel.....	—	1
	Note: The above units comprise the basic camera equipment.		
557329	Image Orthicon, Type 7293A/L.....	1	1
557320	Viewfinder Hood, Adjustable.....	1	1
556523	TO-4 Waveform Monitor.....	1	1
556580	Field Case for Auxiliary.....	1	—
556580	Field Case for Power Supply.....	1	—

MI Number	Description	Quantity	
		Field Camera	Studio Camera
556581	Field Case for TO-4 Monitor.....	1	—
	TM-19/C Picture Monitor in fieldcase.....	1	—
557244	Set of Interconnect Cables.....	1	—
557331-1	Camera Cable, 50 ft.....	1	1
557331-2	Camera Cable, 100 ft.....	1	—
557331-3	Camera Cable, 200 ft.....	1	—
26205-C	Friction Head.....	1	—
26046-A	Tripod, TD-11B.....	1	—
557306	Mounting Frame for Control Panel	—	1
556524	Front Panel for TO-4.....	—	1
556525	Connector Assembly for TO-4.....	—	1
556526	Picture Monitor, TM-19N.....	—	1
556527	Front Panel for TM-19N.....	—	1
556528	Mounting Frame for TO-4/TM-19N	—	1
556531	Console Base Section, 20-inch.....	—	1
556534	Remote Control Section.....	—	1
556535	Single Height Turret.....	—	1
556544-1	Base Front Edge Trim, 22-inch.....	—	1
556546-1	Horizontal Turret Trim, 22-inch.....	—	1

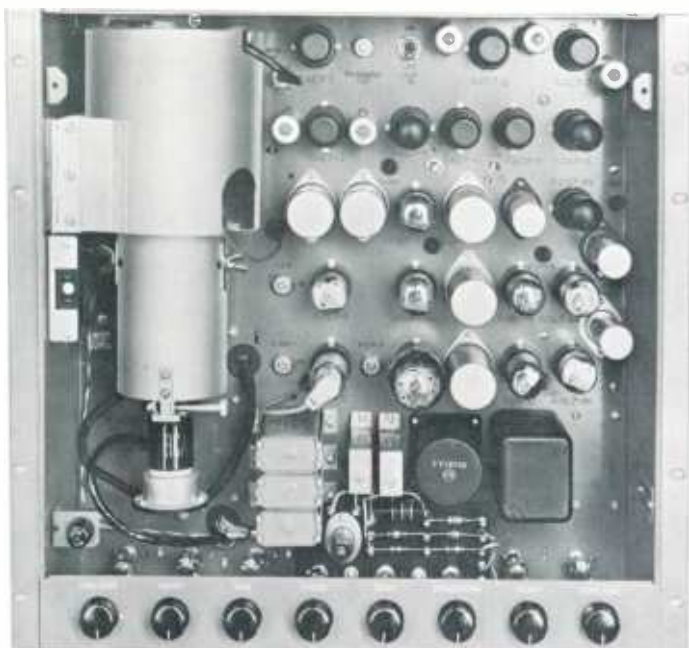

- Pattern shows scanning symmetry, vertical and horizontal resolution, shading, reproduction of isolated details, contrast and brightness
- Provision for remote control of gain and focus
- Auxiliary input for alignment purposes
- Built-in high voltage power supply
- Designed for standard rack mounting

Monoscope Camera, Type TK-1C

The Type TK-1C Monoscope Camera is a completely self-contained television camera which produces a video signal by scanning a picture pattern built into the monoscope pickup tube. The camera may be used as a convenient means of generating a television picture signal for video testing of television transmitting equipment, or for "test pattern" transmission during warm-up and stand-by periods. In the latter case, the station call letters may be made a part

of the pattern, thereby providing station identification. It may, likewise, be used in the television transmitting station as a readily available source of video signal, of high quality, to be used in place of the studio camera when making tests or adjustments on other units of the system. In the laboratory, factory, or service bench, the equipment may be used as a source of video signal to test or adjust television receivers, video amplifiers, and picture tubes.

Description

The TK-1C Monoscope Camera comprises the monoscope tube, the scanning generators, the video output amplifiers, and the high voltage power supply for the monoscope tube. This equipment is built on the familiar recessed "bath tub" type of chassis which fits into a standard 19-inch rack. All tubes and large components are located on the front of the chassis, while the wiring and smaller components are on the rear. The controls are grouped on a narrow control panel along the bottom of the chassis. When installed and in operation, the front is covered by a large cover plate which conceals everything but the control panel.

This cover plate is interlocked to protect operating personnel from the high voltages present in the equipment.

The monoscope tube in the TK-1C is mounted in a vertical position at the left of the chassis. The upper part of the tube is enclosed in a Mumetal shield. The magnetic deflecting coils are mounted within the shield, and are attached to it. By disconnecting the tube socket, anode, and signal leads, the whole assembly—tube, coils, and shield—may be swung outward. This arrangement allows quick tube change and conserves rack space.

The monoscope tube ordinarily used in the TK-1C is an RCA 2F21. This tube provides a standard test pattern which shows the following details of the quality of reproduction in a given television system: scanning symmetry, resolution in both vertical and horizontal directions, shading and reproduction of isolated details. In addition it provides a pattern to facilitate proper adjustment of contrast and brightness. Monoscope tube 1699 may be obtained with special pattern showing station call letter, monogram, or other subject matter of the customer's choice. Type 1699 tubes are available on a custom basis.

The Vertical Deflection Generator consists of four tubes and associated circuits. The first of these tubes amplifies the driving signal received from the synchronizing generator and generates a saw-tooth voltage wave which is amplified in the second, third, and fourth tubes. The output is applied to the magnetic deflecting coils of the monoscope tube. Negative feedback is employed to improve scanning linearity.

The Horizontal Deflection Generator includes three tubes and associated circuits. The first tube is the driving signal input amplifier and saw-tooth voltage generator; the second and third tubes amplify the out-

put wave and feed it to the horizontal deflecting coils of the monoscope tube.

The Blanking Amplifier is used to provide the proper level and polarity of the blanking pulses received from the synchronizing generator before these pulses are fed into the Video Amplifier for mixing with the video signal.

The Sync Amplifier is used to provide proper level and polarity of synchronizing pulses from the synchronizing generator. These pulses are fed into the video amplifier for mixing with the video signal.

The Video Amplifier includes six stages of video amplification — to-

gether with a clipper stage which is inserted between the fifth and sixth stages. The monoscope output signal is fed directly into the first stage of this amplifier, and the blanking signal is introduced in the output of the fifth stage (which contains both video and blanking signals) is fed to a clipper stage which adjusts the height of the blanking "pedestals." The clipper feeds an output stage which consists of two tubes having their grids tied in parallel, but with the plate circuits separate. This provides two separate outputs—one for picture output and one for monitoring purposes.

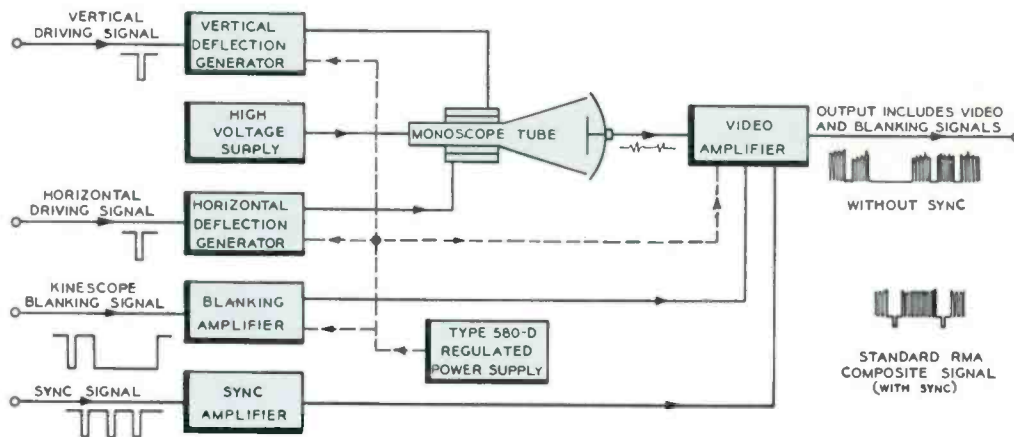

Block Diagram of TK-1C Monoscope Camera Circuit.

Specifications

Output Voltage.....	1.5 volts peak-to-peak
Output Impedance.....	75 ohms
Number of Scanning Lines.....	525 or 625
Field Repetition Rate.....	.60 or 50 per sec.
Line Repetition Rate.....	15,750 or 15,625 per sec.
Input Pulses Required:	
Blanking, Horizontal Drive and Vertical Drive	
(neg. polarity).....	3.5 to 5 volts

Resolution Capability.....At least 450 lines

Power Consumption:

AC Power.....	100 watts
280 volts, d-c.....	200 ma
-3 volts, d-c (centering).....	300 ma

Dimensions.....17½" high, 19" wide, 11" deep
(44.45 cm high, 48.26 cm wide, 27.94 cm deep)

Weight.....55 lbs. (25 kg)

Tube Complement:

6-6AC7, 3-6AG7, 3-6SL7GT, 1-6V6-GT, 1-6Y6-G,	
1-1B3-GT, 1-991, 1-2F21, 3-6SN7-GT	

Ordering Information

Monoscope Camera (less Monoscope Tube)	
For 115 Volts, 50/60 Hz.....	MI-26030-B
For 230 Volts, 50/60 Hz.....	MI-P26030-B
Monoscope Tube, 2F21.....	MI-26657

Accessories

Special Monoscope Tube.....	Type 1699
Power Supply, WP-16B	
For 60 Hz AC Operation.....	MI-26084-B
For 50 Hz AC Operation.....	MI-26094-B
WP-16B Centering Current Unit.....	MI-26083-B

- Geared iris ring may be operated by remote control servo drive motor
- Iris opening linear with respect to rotation of index ring
- Designed for 4½-inch image orthicon cameras



Ortal Fixed Focus Lenses

Description

The Ortal Fixed Focus Lenses are a series of optically superior type fixed focus lenses for use with RCA TK-60 and TK-33 4½-inch Image Orthicon TV cameras. In the design of the Taylor-Hobson Ortal range, the specialized requirements of television have been most fully taken into account. Each lens is shaped to transmit maximum possible information within the limits set by the television system.

TV Camera Design

The mechanical construction of the Ortal range of lenses, like the optical design, has been evolved specifically for TV camera requirements. Internal flare has been reduced to a minimum by the use of annular reisses and by matt blacking of all internal surfaces, together with the use of critically positioned baffles of suitable size. This is particularly advantageous because of the low frontal lighting often encountered

in the TV studio, coupled with the extremely high sensitivity of the Image Orthicon tube as compared with a photographic emulsion. The lenses are treated with anti-reflective coatings to assure optimum contrast in image formation and maximum transmission.

Interchangeability of Lenses

An important feature of the lens design is the iris diaphragm control mechanism which provides for complete interchangeability between lenses on camera turrets fitted with remote control of the lens diaphragm. This provision is independent of focal length or maximum aperture. The mechanism provides a linear relationship between the rotation of the index ring and the size of the diaphragm aperture; the f/scale is, therefore, absolutely linear between all stops. Overall rotation of the index ring, as well as rotation between marked aperture values, is

common to all lenses irrespective of focal length or maximum aperture.

Geared Iris Ring

When the lens is used on a camera turret incorporating iris-drive the index ring serves as the lens gear ring. The maximum torque required to drive the gear ring is 15 inch-ounces per lens, and the movement is smooth and free. The mechanism is totally enclosed within the lens iris barrel to prevent entrance of foreign matter which might cause deterioration of the movement. Good balance on the camera turret is achieved by maintaining a weight of 2½ pounds for each lens below 12½-inch focal length.

Quick-Change Lens Mount

The Ortal lenses feature a quick-change type TV-88 lens mount, which utilizes two captive screws to secure the lens in position. Only a half-turn of each clamp is required to insert or remove the lens from the camera turret.

Depth of Field: MI-26882-A2 f/2.8, 35mm (1.38-inch)

Distance Focused On (Feet)	f/2.8		f/5.6		f/8.0		f/11.0		f/16.0		f/22.0	
	ft.	in. to ft. in.	ft.	in. to ft. in.	ft.	in. to ft. in.	ft.	in. to ft. in.	ft.	in. to ft. in.	ft.	in. to ft. in.
INF.	22	7 inf.	11	4 inf.	8	0 inf.	5	10 inf.	4	1 inf.	3	0 inf.
15	9	1 43 6	6	7 inf.	5	4 inf.	4	4 inf.	3	3 inf.	2	7 inf.
8	6	0 12 2	4	10 25 4	4	1 inf.	3	6 inf.	2	8 inf.	2	4 inf.
5	4	2 6 3 1/2	3	7 8 6	3	2 12 3	2	10 28 1	2	5 inf.	1	10 inf.
4	3	5 1/2 4 9	3	0 5 11	2	9 7 5	2	6 11 2	2	3 72 3	1	10 inf.
3	2	8 1/4 3 4 1/4	2	5 1/2 3 11	2	3 4 6	2	1 5 6 1/2	1	10 9 4	1	7 1/2 56 9
2 1/2	2	3 1/2 2 9	2	1 1/2 3 1	2	0 3 5	1	10 4 2	1	8 5 6	1	6 10 5
1 1/2	1	5 1/4 1 7	1	4 1/4 1 8	1	6 1 9	1	3 1/4 1 10 1/4	1	2 1/4 2 1	1	1 1/4 2 5 1/2
1	0	11 3/4 1 1/4	0	11 1/2 1 3/4	0	11 1/4 1 1	0	11 1 1 1/4	0	10 1/2 1 2	0	10 1 3
.75	0	8 3/4 0 9 1/4	0	8 3/4 0 9 1/4	0	8 1/2 0 9 1/2	0	8 1/2 0 9 1/2	0	8 1/4 0 9 3/4	0	8 1/4 0 10 1/4

Depth of Field: MI-26882-A3 f/2.0, 50mm (2-inch)

Distance Focused On (Feet)	f/2.0		f/4.0		f/5.6		f/8.0		f/11.0		f/16.0		f/22.0	
	ft.	in. to ft. in.	ft.	in. to ft. in.	ft.	in. to ft. in.	ft.	in. to ft. in.	ft.	in. to ft. in.	ft.	in. to ft. in.	ft.	in. to ft. in.
INF.	65	8 1/2 inf.	32	11 inf.	23	6 3/4 inf.	16	6 1/2 inf.	12	3/4 inf.	8	4 inf.	6	1 1/4 inf.
25	18	2 1/4 39 11 1/4	14	3 3/4 100 4	12	2 3/4 inf.	10	3/4 inf.	8	2 3/4 inf.	6	4 inf.	4	11 3/4 inf.
15	12	3 1/2 19 3 3/4	10	5 27 1 1/4	9	3 1/4 40 1 1/4	7	11 3/4 inf.	6	9 1/2 inf.	5	5 1/2 inf.	3	7 inf.
8	7	2 9 1/2	6	6 10 4 3/4	6	3/4 11 10	5	6 14 11 1/4	4	11 22 3 1/4	4	2 1/4 inf.	4	5 1/4 inf.
5	4	8 5 4 1/2	4	4 3/4 5 9 3/4	4	2 1/4 6 2 1/2	3	11 6 11 1/4	3	7 1/2 8 1 3/4	3	2 3/4 11 5 3/4	2	10 1/4 22 10 1/4
4	3	9 1/2 4 2 3/4	3	7 1/4 4 5 3/4	3	5 3/4 4 8 3/4	3	3 1/2 5 1 1/2	3	1 5 8 3/4	2	9 3/4 7 1 3/4	2	6 1/4 10 3
3	2	10 3/4 3 1 1/2	2	9 1/2 3 3	2	8 1/2 3 4 1/2	2	7 1/4 3 6 3/4	2	5 3/4 3 10	2	3 1/2 4 4 3/4	2	1 1/2 5 4
2 1/2	2	5 2 7	2	4 1/4 2 8	2	3 1/2 2 9	2	2 3/4 2 10 1/4	2	1 3/4 3 1/4	2	0 3 4 1/4	1	10 1/2 3 10 1/4
2	1	11 1/2 2 1/2	1	11 2 1 1/4	1	10 1/2 2 1 3/4	1	110 2 2 1/2	1	9 1/4 2 3 3/4	1	8 1/4 2 5 3/4	1	7 1/4 2 8 3/4
1 1/2	1	5 3/4 1 6 1/4	1	5 1/2 1 6 3/4	1	5 1/4 1 7	1	5 1 7 1/4	1	4 1/2 1 7 3/4	1	4 1 8 3/4	1	3 1/2 1 10

Depth of Field: MI-26882-A4 f/2.0, 75mm (3-inch)

Distance Focused On (Feet)	f/2.0		f/4.0		f/5.6		f/8.0		f/11.0		f/16.0		f/22.0	
	ft.	in. to ft. in.	ft.	in. to ft. in.	ft.	in. to ft. in.	ft.	in. to ft. in.	ft.	in. to ft. in.	ft.	in. to ft. in.	ft.	in. to ft. in.
INF.	145	7 inf.	72	11 inf.	52	2 inf.	36	7 inf.	26	8 inf.	18	5 inf.	13	6 inf.
50	37	4 75 8	29	10 156 3	25	9 inf.	21	4 inf.	17	7 inf.	13	7 inf.	10	9 inf.
25	21	5 30 1	18	9 37 8	17	1 47 2	15	1 76 5	13	1 344 3	10	10 inf.	8	11 inf.
15	13	8 16 8	12	7 18 8	11	9 20 9	10	10 24 10	9	9 33 11	8	5 73 5	7	3 inf.
10	9	5 10 8	8	10 11 6	8	6 12 2	8	0 13 6	7	5 15 6	6	8 20 8	5	11 34 11
8	7	7 8 5	7	3 8 11	7	1 9 4	6	8 10 0	6	3 11 1	5	9 13 5	5	2 18 1
6	5	9 6 2	5	7 6 6	5	5 6 8	5	3 7 0	5	0 7 6	4	8 8 5	4	4 10 1
4	3	11 4 1	3	10 4 2	3	9 4 3	3	8 4 5	3	7 4 7	3	5 4 11	3	3 5 4
3	2	11 3 0	2	11 3 1	2	10 3 2	2	10 3 3	2	9 3 3	2	8 3 5	2	7 3 8
2	1	11 2 0	1	11 2 1	1	11 2 1	1	11 2 1	1	11 2 1	1	10 2 2	1	10 2 3

Depth of Field: MI-26882-A5 f/2.8, 127mm (5-inch)

Distance Focused On (Feet)	f/2.8		f/4.0		f/5.6		f/8.0		f/11.0		f/16.0		f/22.0	
	ft.	in. to ft. in.	ft.	in. to ft. in.	ft.	in. to ft. in.	ft.	in. to ft. in.	ft.	in. to ft. in.	ft.	in. to ft. in.	ft.	in. to ft. in.
INF.	297	3 inf.	208	2 inf.	148	10 inf.	104	4 inf.	76	0 inf.	52	4 inf.	38	3 inf.
100	75	1 150 0	67	10 191 1	60	2 300 10	51	5 inf.	43	6 inf.	34	8 inf.	27	11 inf.
50	42	11 59 10	40	6 65 4	37	8 74 6	34	1 94 6	30	5 142 2	25	11 917 6	22	0 inf.
25	23	2 27 1	22	5 28 3	21	7 29 9	20	4 32 5	19	1 36 7	17	2 46 4	15	5 68 7
15	14	4 15 9	14	1 16 1	13	9 16 6	13	3 17 4	12	8 18 4	11	11 20 5	11	1 23 9
10	9	8 10 4	9	7 10 5	9	5 10 7	9	3 10 11	9	0 11 4	8	7 12 1	8	2 13 1
8	7	10 8 2	7	9 8 3	7	8 8 4	7	6 8 7	7	4 8 9	7	1 9 2	6	10 9 9
6	5	11 6 1	5	10 6 2	5	10 6 2	5	9 6 4	5	8 6 5	5	6 6 7	5	4 6 11
5	4	11 5 1	4	11 5 1	4	10 5 1	4	10 5 2	4	10 5 3	4	8 5 5	4	7 5 7
4	3	11 4 1	3	11 4 0	3	11 4 3	3	11 4 1	3	10 4 2	3	10 4 3	3	9 4 4

Depth of Field: MI-26882-A6 f/4.0, 203mm (8-inch)

Distance Focused On (Feet)	f/4.0		f/5.6		f/8.0		f/11.0		f/16.0		f/22.0	
	ft.	in. to ft. in.	ft.	in. to ft. in.	ft.	in. to ft. in.	ft.	in. to ft. in.	ft.	in. to ft. in.	ft.	in. to ft. in.
INF.	541	3 inf.	386	10 inf.	271	1 inf.	197	5 inf.	136	0 inf.	99	2 inf.
150	117	11 206 6	108	7 243 2	97	2 331 9	85	10 610 4	71	11 inf.	60	4 inf.
75	66	2 88 8	62	2 92 5	59	2 102 8	54	10 119 3	48	11 163 3	43	4 294 2
50	46	0 54 10	44	6 57 0	42	7 60 9	40	4 66 1	37	1 77 5	33	10 97 8
30	28	7 31 7	28	0 32 4	27	3 33 5	26	4 34 11	24	11 37 9	23	6 41 10
25	24	0 26 1	23	7½ 26 7	23	1 27 3	23	5 28 3	21	5 30 5	20	4 32 6
20	19	4½ 20 8	19	1½ 20 11½	18	9½ 21 4¾	18	4½ 21 11½	17	3½ 23 0	17	0 24 4¾
15	14	8 15 4¼	14	6¼ 15 6	14	4 15 8¾	14	1¼ 16 ¼	13	3¾ 16 6½	13	3¾ 17 2½
12	11	9½ 12 2½	11	8½ 12 3¾	11	7¼ 12 5¼	11	5½ 12 7½	11	2½ 12 11	11	11¼ 13 3¾
9	8	10¾ 9 1¼	8	10¼ 9 1¾	8	9½ 9 2¾	8	8½ 9 3¾	8	7 9 5½	8	5¼ 9 7¾

Depth of Field: MI-26882-A7 f/4.0, 318mm (12½-inch)

Distance Focused On (Feet)	f/4.0		f/5.6		f/8.0		f/11.0		f/16.0		f/22.0		f/32.0	
	ft.	in. to ft. in.	ft.	in. to ft. in.	ft.	in. to ft. in.	ft.	in. to ft. in.	ft.	in. to ft. in.	ft.	in. to ft. in.	ft.	in. to ft. in.
INF.	1325	10 inf.	947	5 inf.	663	7 inf.	483	0 inf.	322	6 inf.	242	2 inf.	116	11 inf.
400	307	7 569 7	281	9 687 2	250	3 995 2	219	7 inf.	182	5 inf.	151	8 inf.	118	6 inf.
200	174	3 234 10	165	8 252 5	154	5 284 5	142	3 338 1	125	10 493 7	110	6 inf.	92	0 inf.
150	135	1 168 8	130	0 177 6	122	11 192 7	115	2 215 8	104	2 269 5	93	7 385 0	80	0 inf.
100	93	3 107 10	90	9 111 4	87	4 117 0	83	5 125 0	77	7 141 2	71	7 167 1	63	5 241 4
75	71	2 79 3	69	9 81 1	67	9 84 1	65	4 88 1	61	9 95 8	58	0 106 9	52	7 132 4
50	48	4 51 10	47	8 52 7	46	9 53 9	45	8 55 4	43	11 58 2	42	0 61 11	39	2 69 7
35	34	2 35 10	33	11 36 2	33	5 36 9	32	11 37 5	32	0 38 8	31	0 40 3	29	6 43 2
25	24	7 25 5	24	5 25 7	24	3 25 10	23	11 26 2	23	6 26 9	23	0 27 5	22	2 28 8
20	19	9 20 3	19	8 20 4	19	6 20 6	19	4 20 8	19	1 21 0	18	9 21 5	18	3 22 2

Depth of Field MI-26882-8 f/4.0, 406mm (16-inch)

Distance Focused On (Feet)	f/4.0		f/5.6		f/8.0		f/11.0		f/16.0		f/22.0		f/32.0	
	ft. in.	to ft. in.	ft. in.	to ft. in.	ft. in.	to ft. in.	ft. in.	to ft. in.	ft. in.	to ft. in.	ft. in.	to ft. in.	ft. in.	to ft. in.
INF.	2167 9	inf.	1548 11	inf.	1084 9	inf.	789 5	inf.	543 3	inf.	395 7	inf.	272 6	inf.
750	556 7	inf.	505 1	inf.	443 7	inf.	385 1	inf.	315 9	inf.	259 9	inf.	200 8	inf.
400	338 4	489 3	318 8	537 3	293 2	630 2	266 7	804 1	231 7	inf.	200 2	inf.	163 4	inf.
200	183 6	219 10	117 8	228 11	169 6	244 0	160 4	266 0	147 2	313 2	133 11	398 0	116 7	727 6
150	140 7	160 9	137 2	165 7	132 4	173 3	126 9	184 0	118 5	205 2	109 9	238 1	97 11	325 7
100	95 10	104 7	94 3	106 7	91 11	109 8	89 3	113 9	85 1	121 5	80 7	132 0	74 2	154 8
75	72 8	77 6	71 9	78 7	70 5	80 2	68 11	82 4	66 5	86 2	63 9	91 4	59 8	101 5
50	49 0	51 1	48 7	51 6	48 0	52 2	47 4	53 0	46 2	54 7	44 11	56 6	42 11	60 1
35	34 6	35 6	34 4	35 8	34 1	36 0	33 9	36 5	33 2	37 1	32 6	37 11	31 6	39 5
28	27 8	28 4	27 7	28 5	27 5	28 7	27 2	28 10	26 10	29 3	26 6	29 9	25 10	30 8

Depth of Field: MI-26882-9 f/5.6, 599mm (22-inch)

Distance Focused On (Feet)	f/5.6		f/8.0		f/11.0		f/16.0		f/22.0		f/32.0	
	ft. in.	to ft. in.	ft. in.	to ft. in.	ft. in.	to ft. in.	ft. in.	to ft. in.	ft. in.	to ft. in.	ft. in.	to ft. in.
INF.	2885 10	inf.	2020 11	inf.	1470 6	inf.	1011 10	inf.	736 7	inf.	507 3	inf.
750	597 5	inf.	549 2	inf.	498 11	inf.	433 0	inf.	373 9	inf.	304 7	inf.
400	351 8	462 5	334 6	496 0	315 4	545 6	287 11	654 7	260 8	861 8	225 3	inf.
275	252 2	303 11	243 4	317 11	233 1	337 5	217 10	375 10	202 0	435 5	180 3	592 4
200	187 6	214 4	182 7	221 2	176 10	230 4	168 0	247 5	158 6	271 7	144 11	324 8
150	142 11	157 10	140 1	161 5	136 9	166 2	131 5	174 10	125 8	186 5	117 1	209 8
100	96 11	103 4	95 7	104 10	94 1	106 9	91 7	110 2	88 10	114 6	84 6	122 8
80	78 0	82 1	77 3	83 0	76 3	84 2	74 8	86 3	72 10	88 10	70 0	93 7
60	58 11	61 1	58 6	61 7	57 11	62 3	57 0	63 4	56 0	64 8	54 4	67 1
50	49 3	50 9	49 0	51 1	48 7	51 6	48 0	52 3	47 3	53 1	46 1	54 8

Ordering Information

Stock Identification	Description	Lens Opening	Total Vertical Field Angle	Total Horizontal Field Angle
MI-26882-A1	28mm (1.1") Ortol Lens	f/2.0	60.5°	46.8°
MI-26882-A2	35mm (1.38") Ortol Lens	f/2.8	50°	38.6°
MI-26882-A3	50mm (2") Ortol Lens	f/2.0	34.6°	28.0°
MI-26882-A4	75mm (3") Ortol Lens	f/2.0	23.6°	19.2°
MI-26882-A5	127mm (5") Ortol Lens	f/2.8	14.2°	11.4°
MI-26882-A6	8" Ortol Lens	f/4.0	9.0°	7.2°
MI-26882-A7	12½" Ortol Lens	f/4.0	5.7°	4.5°
MI-26882-8	16" Ortol Lens	f/4.0	4.5°	3.6°
MI-26882-9	22" Ortol Lens	f/5.6	3.2°	2.6°



- Full range of focal length and speed to meet TV studio programming needs
- Color corrected for both color and monochrome television applications

Canon Fixed Focus Lenses

Description

Canon Fixed Focus Lenses are specially designed for high quality optical performance with 3-inch image orthicon cameras. The lenses are fixed-focused at infinity and are available with focal lengths from 35 to 600mm. When used with RCA

3-inch image orthicon cameras, focus adjustment is provided by means of the camera focus carriage.

Canon lenses feature high resolution which only superior optical design and workmanship can attain. Varied focal length and adjustable speed provide the high degree of

flexibility required for TV programming. All lenses mount directly in the four-lens turret of both monochrome and color 3-inch image orthicon cameras. They have a mechanical back length of 28.9mm and are supplied with a lens hood for protection from random reflections.

Specifications

Focal Length	Lens Opening	Aperture Dial Setting	Height	Angle of View		Diameter	Length		Weight		Ordering Information
				Width			Inches	MM	lbs.	kg.	
35mm	f/2.0	2, 2.8, 4, 5.6, 8, 11, 16, 22	39°	51°	64°	3.09	78.6	0.7	0.32	MI-26177-1	
50mm	f/1.8	1.8, 2, 2.8, 4, 5.6, 8, 11, 16, 22	28°	37°	46°06'	2.26	57.6	0.44	0.20	MI-26177-2	
85mm	f/1.9	1.9, 2.8, 4, 5.6, 8, 11, 16	17°	23°	29°	4.66	118.3	1.02	0.46	MI-26177-3	
135mm	f/3.5	3.5, 4, 5.6, 8, 11, 16, 22	11°	14°	18°	5.43	138.5	0.97	0.44	MI-26177-4	
200mm	f/3.5	3.5, 4, 5.6, 8, 11, 16, 22	7°	9°36'	12°	8.21	208.7	1.10	0.50	MI-26177-5	
300mm	f/4.0	4.0, 5.6, 8, 11, 16, 22	4°45'	6°24'	8°	13.3	338	3.52	1.60	MI-26177-6	
400mm	f/4.5	4.5, 5.6, 8, 11, 16, 22	3°40'	4°48'	6°	18.46	468	4.77	2.16	MI-26177-7	
600mm	f/5.6	5.6, 8, 11, 16, 22	2°24'	3°12'	4°	29	736	4.86	2.20	MI-26177-8	

Field Lenses for Color Studio Cameras

Description

The MI-40802 Series of Field Lenses function to redirect all of the light reaching the image plane from the objective lens so that it will enter the relay lens system of the color television camera and thus insure uniform illumination of the relayed image. The size of the primary image is not changed by the field lens.

The MI-40802 Field Lenses are designed to complement the television camera objective lenses and range in diopter power from 20 to 4.5 and are ground on a radius of 1.969 to 9.065 inches. The lens is made of spectacle crown glass of finest quality, precision centered and edged. Each is 1.812 inches in diam-

eter with 1/2mm beveled edge and is 1/2-inch thick at the central point. Both surfaces have a baked magnesium fluoride coating for minimum green reflection at normal incidence. Each field lens is set in a brass lens assembly consisting of a lens holder approximately 3 inches in diameter before knurling, with lens cap and a mask.

Ordering Information

Lens Assembly for 50mm objective lens (diopter power)MI-40802-A1

Lens Assembly for 85mm, 90mm and 135mm objective lens (diopter power 13.5).....MI-40802-A2

Lens Assembly for Electra Zoom and also 8 1/2 objective lens (diopter power 7).....MI-40802-A3

Lens Assembly for 13", 15", 17" and Berthiot Zoom objective lenses (diopter power 5.75).....MI-40802-A4

Lens Assembly for 25" objective lens (diopter power 4.5).....MI-40802-A5

Lens Assembly for 75mm objective lens (diopter power 6.5).....MI-40802-A6

Lens Assembly for 35mm objective lens (diopter power 24.7).....MI-40802-A7

Shock Mounts, MI-26511 Series

Description

Shock mounts are available for use with all RCA Field TV Camera Equipment. These mounts are designed to protect the camera chain from harmful shock and vibration during transportation and normal field usage. The MI-26511-A1 mounting bases are individually designed for use with Field Camera Controls,

Switchers, Power Supplies, Sync Generators, Processing Amplifiers, etc.

The chassis shock mountings are made of .063-inch stainless steel with Barry-type rubber mounts grounded to the frame by flexible strap or similar means. All steel fasteners and parts other than stainless steel are protectively plated with cadmium.

Two spring-loaded index pins grip the equipment through holes in the rear of the chassis, while lock down clamps bolt the equipment into place from the front so that the equipment is securely lashed down at all times.

Ordering Information

Stock Identification	Used With	Overall Length	Inside Width	Free Height*	Mountings	Loading	
MI-26511-A5	WP-16 Portable Power Supply in Field Case	28-29/32"	73.18 cm	9 1/16"	23.97 cm	1-13/32" 3.33 cm	4-rubber 13-31 lbs. 6-14 kg.
MI-26511-A6	TK-60 Field Processor	25-13/32"	64.29 cm	9 1/16"	23.97 cm	1-13/32" 3.33 cm	4-rubber 13-31 lbs. 6-14 kg.

*Free height from mounting surface to bottom equipment.

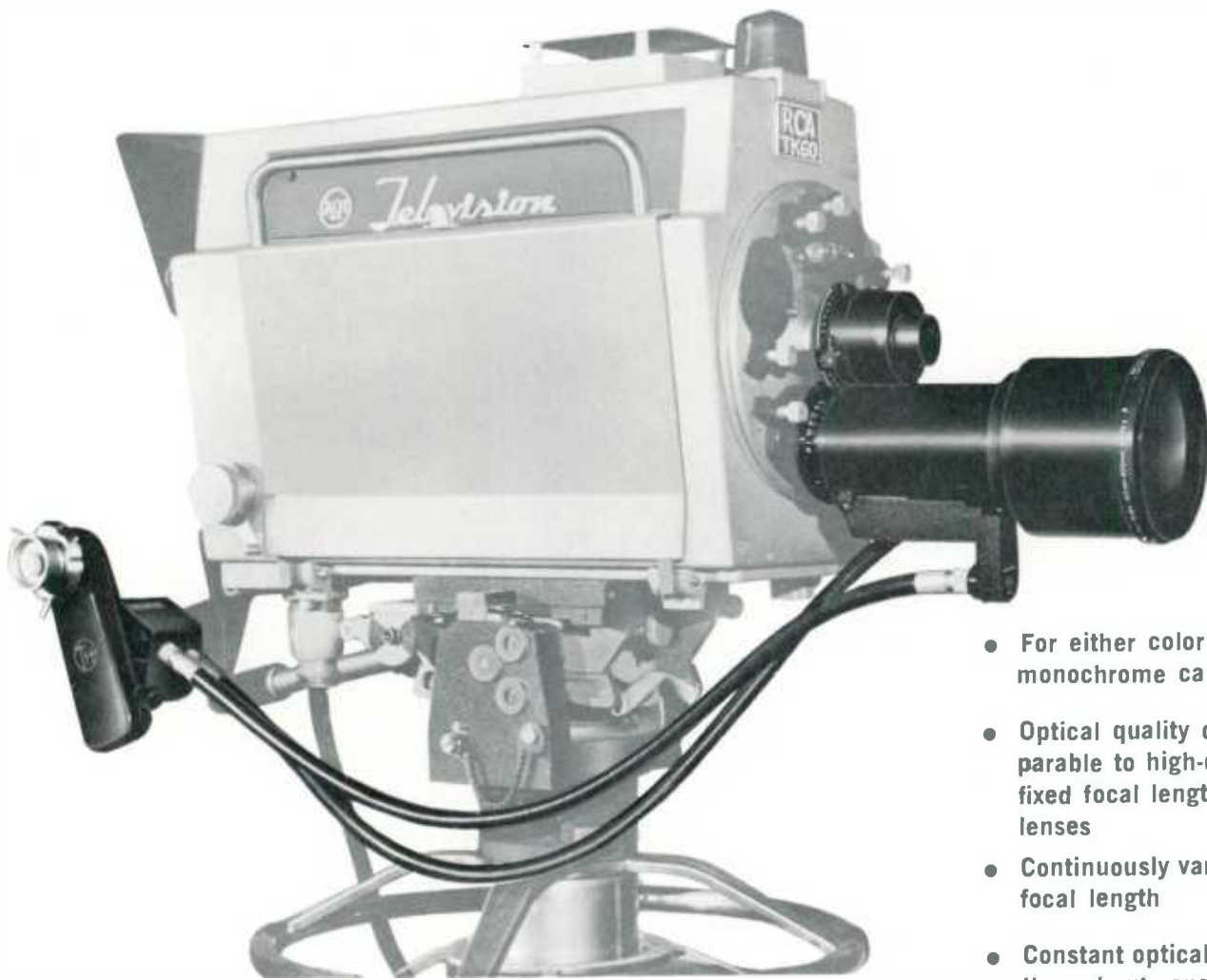

- For either color or monochrome cameras
- Optical quality comparable to high-quality fixed focal length lenses
- Continuously variable focal length
- Constant optical speed throughout range

Varotal Lenses

Description

The Studio Varotal V and Outdoor Varotal III are variable focal length lenses designed to cover the full range of focal lengths normally used for television programming. By eliminating the need to switch to a second camera for change of lens turret position, the Varotals provide means of producing a variation of close-up and distance "shots" with only one camera. The lenses enable observation of detailed processes without the loss of continuity entailed in changing lenses. In addition,

dramatic effects may be obtained by "zooming" from a distance shot to a close-up of one portion of the scene, or from a close-up view to a distance shot.

Outdoor Varotal III

The Outdoor Varotal III Lens has been designed for versatile use in studios or on remotes. It features a unique dual range change from 4 to 20 inches and from 8 to 40 inches by means of a small lever on the lens—without change of rear element or

loss of picture focus. High quality definition is achieved and the lens is fully color corrected and designed for use on both color or monochrome cameras. Minimum object distance for which the entire zoom range is available is twelve feet, and a close-up adaptor is available for reducing the minimum object distance to six feet.

The zoom and focus controls for the Varotal III are combined in a lever mechanism which mounts on

a bracket attached to the rear of the camera. The controls are mechanically coupled to the lens by means of a pair of flexible cables and a precision gearbox which is mounted on the lens. Zoom control is provided by rotation of the lever.

Focus control is provided by rotation of a knob mounted on the zoom control lever. The direction of rotation of the focus knob, with respect to focusing action, corresponds to that of the regular camera focus knob, for ease and familiarity of operation.

An adjustable friction brake is provided to vary the amount of pressure required to operate the zoom control in accordance with individual operator preference. This brake may also be used to lock the zoom control at any desired point within the zoom range.

Varotal V

The Varotal V is a new Zoom lens with a focal length range of 1.6 to

16 inches and a relative aperture of f/4.0 to f/22.0 throughout the zoom range. The focal length and optical speed of this lens make it suitable for both studio and outside broadcast use. The linear iris mechanism conforms to all requirements for adjustment by an iris motor drive system or manual operation.

The separate zoom and focus control of the lens are mechanically coupled to the lens by two separate flexible cables. The zoom mechanism is mounted on a bracket at the right rear of the camera, and a lever on this control adjusts the focal length of the lens. A knob is attached to this lever for adjustment of zoom friction and may be used to lock the iris at any point within the zoom range.

The zoom mechanism is a dual speed device which has two output couplings permitting a choice of zoom speeds by attaching the control cable to the desired output coupling. The focus control handle is attached to the camera pan and

tilt head handle at left rear of the camera and is coupled to the lens by a flexible cable. The Varotal V lens requires a field lens when used on a TK-41 Color Camera.

Three range extenders and a close-up adaptor are available as accessories for the Varotal V. The extenders change the range of the basic lens to 2.4 to 24 inches, f/6.0; 3.2 to 32 inches, f/8.0; and 4.8 to 48 inches, f/12.0. The close-up adaptor has a minimum object distance of three feet.

The Varotal III and V are mounted on the RCA TK-11, 31 and TK-14 monochrome TV Cameras by means of a special mounting plate which is readily installed in place of the standard camera turret. Either lens may be mounted directly on the TK-60 camera turret. Control cables and a suitable mounting bracket for the zoom and focus control mechanism are supplied with the lens. Ordering information should specify the type of RCA camera on which the lens is to be mounted.

Specifications

	Varotal III	Varotal V
Focal Length Range.....	4 to 20" and 8 to 40", range selected by lever	1.6 to 16"
Optical Speed	f/4.0 to f/45.0 f/8.0 to f/32.0	f/4.0 to f/22.0
Object Distance	12 feet to infinity	6 feet to infinity
Length (face of turret to end of lens).....	25¼"	17"
Approximate Weight:		
Basic Optional Unit.....	33 lbs. (68 lbs. in transit case)	15 lbs.
Control Lever and Cables	4 lbs.	5 lbs.

Accessories

	Varotal III	Varotal V
Range Extender 1.....	—	2.4 to 24" at f/6.0
Range Extender 2.....	—	3.2 to 32" at f/8.0
Range Extender 3.....	—	4.8 to 48" at f/12.0
Close-up Adaptor	Min. object distance 6 ft.	Min. object distance 3 ft.
Field Lens for RCA TK-41 Color Camera.....	MI-40802-A3	MI-40802-A3

Ordering Information

Varotal III.....	Order as Varotal III and specify RCA Type Camera
Varotal V.....	Order as Varotal V and specify RCA Type Camera



Angenieux Evershed

- Completely color balanced and corrected
- Single rod controls zoom and focus
- Self-supporting—no external bracing
- Maintains optical speed throughout zoom
- Fast conversion of zoom ranges

Television Zoomar Lenses

Description

Television Zoomar Lenses greatly facilitate programming by eliminating many problems of camera location and by reducing the number of cameras required to cover an event. Two Zoomar lenses are available to fit all RCA Image Orthicon Cameras for studio or field operation.

The Angenieux Evershed has a basic range of 35 to 350mm at a speed of $f/3.8$ and a transmission of $T/4.5$. It will zoom through its entire range at any object distance from 3 feet to infinity. The resolution and frequency response of the lens makes it the equal or superior of most fixed focus lenses.

The Angenieux Zoomar is a

small, lightweight lens that zooms from 1.6 to 16 inches at a speed of $f/5.0$. Its range of object distance is from 5 feet to infinity. The lens fits all I.O. cameras, color or monochrome, and normally requires no lens support. A preset focus control on the pan handle and a new fly-wheel zoom control provide easy operation. An interchangeable adaptor or new turret plate are required if this lens is to be mounted on RCA Type TK-10, 11, 30, 31 or 14 Cameras.

Both Zoomar lenses are designed for use with $4\frac{1}{2}$ -inch Image Orthicon cameras. An accessory interchangeable adaptor is available to

permit use of the lenses with 3-inch Image Orthicon TV cameras. All zoomars are color balanced and color corrected. The lenses are moderate in size and weight and are designed to mount directly on the camera lens turret. Zoom and focus control are provided by means of a rod which passes along or through the camera to the rear. Zoom adjustment is performed by moving the rod in or out, and focus is adjusted by rotating the same control rod. Both lenses have a geared iris ring for operation by the iris drive mechanism of an RCA TK-60 Camera. A series of converters for range extension are available for use with either type zoom lens to allow increased versatility.



Angenieux Zoomar

Specifications

	Angenieux Evershed Model 10X35B	Angenieux Zoomar Model 10X40C		Angenieux Evershed Model 10X35B	Angenieux Zoomar Model 10X40C
Zoom Range and Speed:			Mounting Provision, basic lens	Quick Change Mount for 4½" I.O. Cameras	Quick Change Mount for 4½" I.O. Cameras
Basic Lens	35 to 350mm, f/3.8	1.6 to 16", f/5.0	Method of Mounting to 3" I.O. Cameras	*Interchange- able Adaptor	*Interchange- able Adaptor
*With Converter #1	2.45 to 22.5", f/5.6	3 to 30", f/9.4	Length (basic lens, less converters)	17" (43.18 cm)	11" (29.94 cm)
*With Converter #2	3.6 to 26", f/8.0	—	Weight (basic lens only)	25 lbs. (11.25 kg)	11.5 lbs. (5.2 kg)
*With Converter #3	5.7 to 57", f/11.0	—			
Object Distance:					
Basic Lens	3 ft. to infinity	5 ft. to infinity			
Lens with All Converters	3 ft. to infinity	5 ft. to infinity			

* Not supplied with lens but available as accessories.

Ordering Information

Angenieux Evershed Lens.....Order as Model 10X35B and specify RCA Camera
 Angenieux Zoomar Lens.....Order as Model 10X40C and specify RCA Camera

EIA Television Test Charts offer a quick, convenient and reliable means of making live camera adjustments. By using these standard checks, telecasters have an accurate and objective method of evaluating picture quality of IO or Vidicon cameras.

Television Test Charts

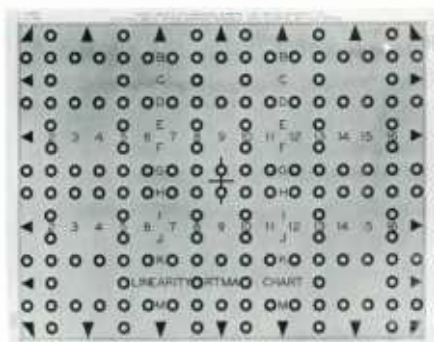

EIA Linearity Chart, MI-26822-1.

EIA Linearity Chart

The Linearity Chart, MI-26822-1, provides a standardized, precise method of measuring television scanning linearity. It is designed for use with an electrical grating generating test pattern which provides an accurate visual reference for comparison with the scanned image of the chart.

The chart has an aspect ratio of 3 by 4 and is designed to be scanned to its boundaries as indicated by the arrows. The pattern consists of circles arranged in 14 horizontal rows and 17 vertical rows. The inside diameter of each circle is equivalent to 2 per cent of picture height, and the outside diameter is equivalent to 4 per cent of picture height. A grating pattern from a source such as the TG-3 Synchronizing Generator is superimposed electrically upon the video signal produced by scanning the linearity chart. Observation of the relative position of each circle with respect to the grating bars thus permits measurement of scanning linearity within an accuracy of 1 per cent of picture height.

Ordering InformationMI-26822-1

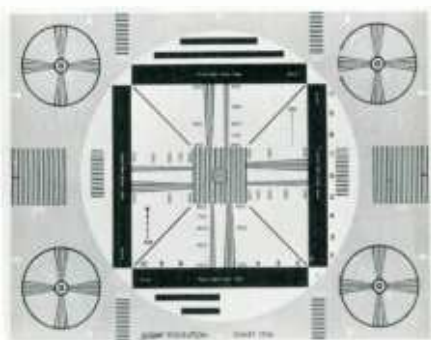

EIA Resolution Chart, MI-26822-2.

EIA Resolution Chart

The EIA Resolution Chart is designed to provide a standard reference for measuring resolution of television cameras and as an aid in testing for streaking, ringing, interlace, shading, scanning linearity, aspect ratio, and gray scale reproduction. The horizontal resolution obtained from many camera chains is often limited by the resolving capabilities of the camera tube and not by the bandwidth of the video amplifiers employed. Therefore, much useful information concerning the limiting resolution percentage response at various line numbers, and degradation of resolution with aging of camera tubes can be obtained from a test chart containing a high number of lines. Thus the horizontal and vertical wedges of the chart are arranged to permit resolution measurements from 200 to 800 lines. The reflection density of the various steps of the "paste on" gray scales supplied with the chart are very accurately maintained in the manufacturing process. Arranged in ten steps, the scales cover a contrast range of approximately 30 to 1. The steps are arranged in logarithmic decreasing

values of reflectance so that the difference in reflection density between adjacent steps is equal to 0.16.

Ordering InformationMI-26822-2

EIA Registration Chart

The EIA Registration Chart is used to adjust and check multiple color pickup devices for combined optical, mechanical and electrical registration, so that the output signals are in correct time relationship. The chart contains a ruled grid pattern to aid in adjusting height, width, rotation, skew, centering and linearity in each channel. The ruled grid pattern also serves to indicate any "S" distortion or bowing. The additional parallel lines about the edges are to allow for finer adjustments of the individual linearities in areas of the raster where the most difficulty is likely to occur in matching the time relationship of the scans.

The arrowheads pointing to the edges may be used for adjusting the amount of scan to a 3 by 4 aspect ratio. The circles are included to indicate readily that corresponding lines are being registered, and that

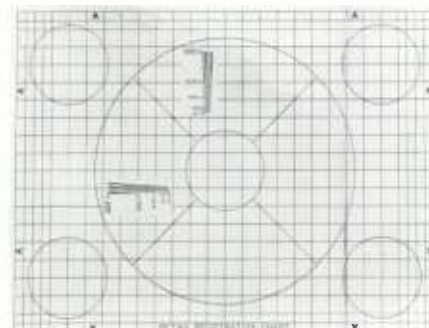

EIA Registration Chart, MI-26822-3.

centering of one channel is not displaced by one complete line with respect to the others. A horizontal and vertical resolution wedge is provided for fine adjustment of centering. The 45 degree radial lines will often indicate misregistration not easily detected from the ruled grid pattern.

Ordering InformationMI-26822-3

EIA Linear Reflectance Chart

The Linear Reflectance Chart provides a standard reference for the measurement and adjustment of the transfer characteristics of monochrome and color TV cameras. This chart has a pair of linear gray scales running in opposite directions placed a short distance apart on a uniform gray background. Nine chips ranging from white to black provide information on reflectance, Munsell value and reflection density. A reflectance of 60 per cent was chosen for the white chip, since it approximates the reflectance of the brightest object in the scene with present studio lighting practice. The contrast range of 20 to 1 was chosen because it has been found to cover the most useful "linear" luminance input range of an image orthicon when used for color reproduction. The crossed gray scales allow a distinction to be made readily between distortion due to poor transfer characteristics and those due to shading errors.

Ordering InformationMI-26822-4

EIA Logarithmic Reflectance Chart

The EIA Logarithmic Reflectance Chart provides a standard reference for the measurement and adjustment of the transfer characteristics of monochrome and color TV cameras. This chart consists of a pair of gray scales running in opposite directions placed a short distance apart on a uniform gray background. The reflectance values of the lightest and darkest chips are similar to those of the Linear Reflectance Chart. However, the nine chips of the logarithmic chart are scaled to provide equal percentage steps between reflectance values of consecutive chips. The logarithmic step pattern is of value in setting up monochrome TV cameras for optimum performance on the non-linear portion of the pickup tube transfer characteristic.

Ordering InformationMI-26822-5

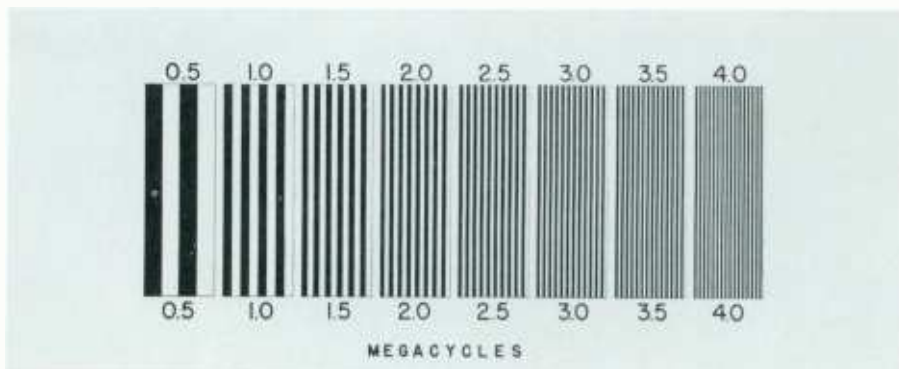

RCA Burst Chart

The RCA Burst Chart provides an accurate means of measuring the aperture response of a live TV camera system. The burst chart has 8 groups of alternate black and white bars. The number of black and white transitions in each group are such that when the chart is properly scan-

ned an indication of 0.5, 1.0, 1.5, 2.0, 2.5, 3.0, 3.5 and 4.0 megacycle response is obtained. The aperture response is a comparative evaluation in percentage of the response of the groups as measured on an oscilloscope.

Ordering InformationIB-31605

EIA Linear Reflectance Chart, MI-26822-4.

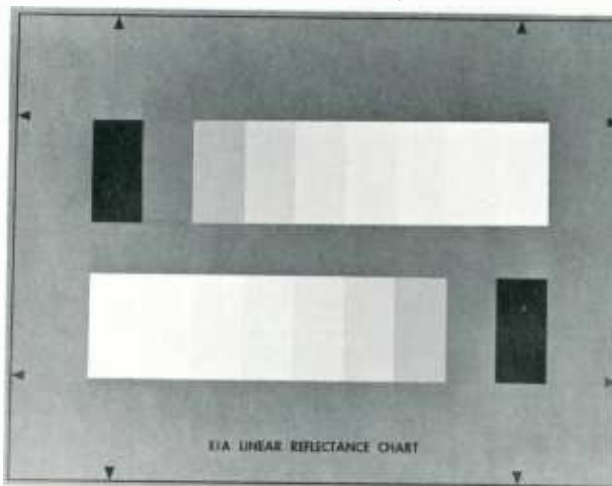

EIA Logarithmic Reflectance Chart, MI-26822-5.

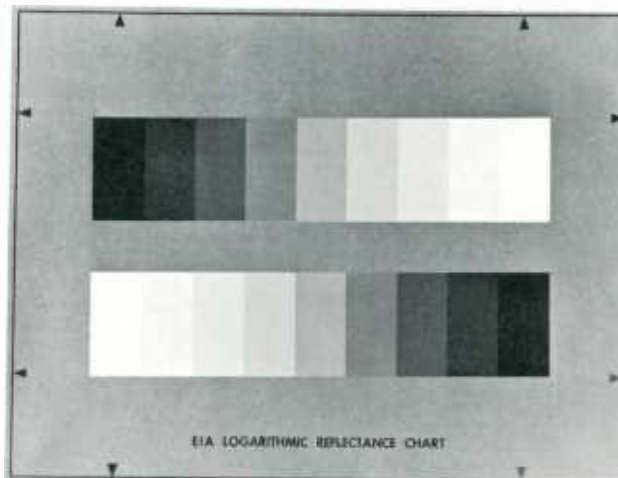



- Projects 2 by 2 inch test slides or captions directly upon photocathode of I.O. camera tube
- Precision 39mm focal length f/4.5 anastigmat coated lens
- Light intensity may be adjusted
- Standard double 2 by 2 inch slide holder aligned on camera turret
- Facilitates initial adjustment of cameras

Television Diascope

Description

The Watson Barnet Model 251 Diascope is a useful test or programing device intended to be mounted on the turret of an image orthicon television camera in place of the normal taking lens to project an image of a test pattern or caption from a 2-inch by 2-inch slide directly upon the photocathode of the camera tube. The camera and associated equipments may be adjusted or tested by projecting the appropriate test slide. The Diascope may also be used to program slides in emergencies or other situations where regular slide pickup facilities are not available.

The Diascope may be mounted on the turret of a 4½-inch I.O. live TV camera in place of one of the nor-

mal fixed focus lens. Projection is achieved by a precision 39mm focal length f/4.5 anastigmat lens with coated components designed to enlarge the 1.4 diagonal of the 2-inch by 2-inch slide picture area to fill the 1.6-inch diagonal of the photocathode surface. Lens performance is capable of projecting with good definition an opaque line .001 inch wide with .001 inch spaces.

The slides are inserted into a standard double 2 x 2 slide holder which is properly aligned by a locating pin on the camera turret that engages a slot in the Diascope mounting collar. By this means, orientation of the slide image is correct with respect to the photocathode.

The illumination system for the

slide comprises a 12 volt, 6 watt Mazda No. 209 lamp, a condensing lens and a ground glass screen. The light intensity may be adjusted by means of a rheostat mounted in the end of the Diascope. The mounting collar has two contacts for supplying voltage to the Diascope from a source within the camera.

The TK-60A/B camera turret has mating contacts for the Diascope and supplies power to the lamp from a variable 0 to 12 volt power source within the camera. The variable 0-12 volt power source is adjusted by the iris control knob at the camera or remote position provided the appropriate switch on the camera is placed in the "diascope" mode of operation.

Ordering Information

Watson Barnet Diascope.....Model 251



- Counterbalanced camera is easily raised or lowered
- Dual rubber-tired wheels for extra stability
- Drag clutch to suit individual requirements

Counterbalanced Camera Pedestal, Type TD-3

Description

The Counterbalanced Camera Pedestal, TD-3B, offers complete mobility for studio color and monochrome cameras. The Pedestal allows smooth, running dolly shots and raising and lowering of the camera while on the air. When used with Cradle Head, MI-26203-B it provides smooth horizontal and vertical panning. This heavy-duty pedestal gives a firm, stable mount to television cameras, resulting in more versatile operation and steadier pictures.

The Pedestal is quickly and easily moved in any direction by the cameraman. A steering wheel, which is directly below the camera at all heights, guides the three sets of dual wheels. Two types of steering are available:

- (1) Synchronous steering in which all wheels are locked parallel and turn simultaneously. This is best for tracking in a straight line.
- (2) Tricycle steering in which only the forward wheel turns with the steering wheel; the back wheels are locked parallel. This enables the Pedestal to be turned sharply in any direction.

Since the camera is carefully counterbalanced with adjustable weights, it may be raised or lowered simply by lifting or pushing on the steering wheel or camera. Additional camera weight such as large lenses, lights, etc., is easily compensated for by the use of additional weights to counter-

balance. A drag clutch is provided to suit individual requirements.

The Pedestal base is made of arc-welded steel; the center column of seamless steel tubing. It is finished in midnight blue; the trim and steering wheel of satin chrome.

Specifications

Overall Dimensions (not including Friction Head):	
Height (maximum).....	57" (144.78 cm)
Height (minimum).....	36" (91.44 cm)
Base Width (minimum).....	34½" (87.53 cm)
Load Capacity.....	225 lbs. (116 kg)
Net Weight.....	596 lbs. (270 kg)
Shipping Weight.....	750 lbs. (340 kg)

Accessories

Friction Head	MI-26205-B
Cradle Head	MI-26203-B
Cam Head	MI-557309
Counterweights for TD-3B (required for TK-60 Cameras).....	MI-26391

Ordering Information

TD-3B Pedestal, completely assembled, with lead counterweights stowed in base storage compartments.....MI-26036-A



- Motor driven lift mechanism provides new ease and smoothness of operation
- Height adjustable from 34 to 54 inches
- 1/3 h.p. drive mechanism shock mounted in sound proof casing
- Synchronous or tricycle steering offers complete mobility in small areas

Motor Driven Camera Pedestals, Type TD-9

Description

RCA Motor Driven Camera Pedestals are designed to provide convenient mounting with maximum maneuverability for TV cameras. Two models are available. The TD-9BC with large 34-inch steering wheel, is designed to mount color television cameras, and the TD-9BM, with 25-inch diameter steering wheel, is specified for monochrome and smaller type cameras. The pedestals are identical except for size of the steering wheel. The steering wheels are interchangeable so that one pedestal can be used for either color or monochrome cameras.

Pedestal height is controlled by a 1/3 h.p. motor which operates through a reduction gear and lifting cable. The entire drive mechanism is shock mounted and encased in a sound proof casing. The casing has three suit-case type catches which open for easy access to motor, relays, and associated control mechanism. The drive mechanism is operated by a single two-way (nominally off) control switch. The camera can be raised from lowest to highest position in 7 seconds. The direction is instantly reversible.

The pedestal has a ruggedly con-

structed re-inforced metal base which will pass through 35-inch doorways. The column is of seamless tubing, and a special column head casting permits accessibility to the tilt or cradle head mounting nut. The base

contains the a-c power socket and control cable connector. It rolls quietly on rubber-tired wheels. Adjustable cable guards are provided on each wheel to protect cables and other studio equipment.

Specification

Overall Dimensions (not including cradle head):

Height.....	53 3/4" (136.5 cm) max., 34 1/2" (87.63 cm) min.
Width and Depth (maximum at base).....	38 1/4" (97.26 cm)
Width and Depth (minimum at base).....	35" (88.9 cm)
Net Weight.....	365 lbs. (166 kg)
Shipping Weight.....	490 lbs. (222 kg)

Accessories

Friction Head	MI-26205-B
Cradle Head	MI-26203-B

Ordering Information

TD-9BC Pedestal (for Color TV Cameras):

115 volts, 60 cycles, 6 amps.....	MI-40861-A
230 volts, 50 cycles, 3 amps.....	MI-N40861-A

TD-9BM Pedestal (for monochrome TV Cameras):

115 volts, 60 cycles, 6 amps.....	MI-26038-A
230 volts, 50 cycles, 3 amps.....	MI-N26038-A

34" Diameter Steering Wheel
(supplied with TD-9BC)..... MI-40862

25" Diameter Steering Wheel
(supplied with TD-9BM)..... MI-26039

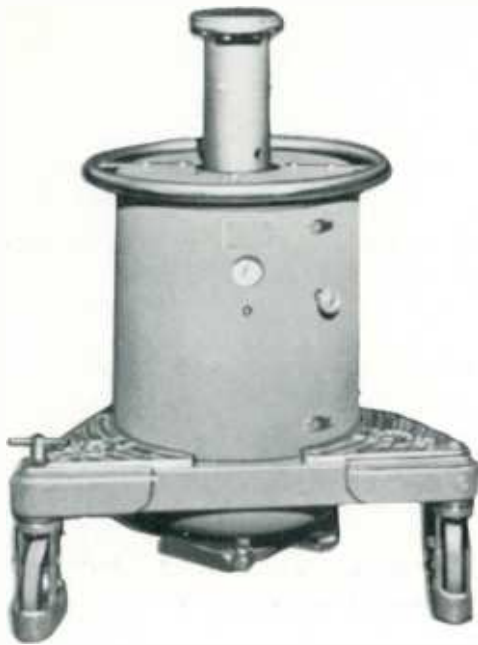

- Counter-balanced action—rotatable base
- Smooth effortless camera positioning in both vertical and horizontal planes
- Welded steel construction—light but strong

Pneumatic-Balance Camera Pedestals

Description

The PN6 and PN88 Series of Pneumatic-Balance Pedestals fill the need for a camera support that provides smooth, even motion in both the vertical and horizontal planes, and consequently allows the most flexible camera performance.

The Pneumatic-Balance Camera Pedestal incorporates a closed air system reservoir. The camera mount is on a piston which rides in a cylinder on a cushion of compressed air. An encircling reservoir provides the

storage space for excess air when the camera is at the lower heights. The spring-like effect of the compressed air on the piston results in a practically weightless camera load. Addition of air may be made through the use of an ordinary tire pump, a transfer bottle, or a compressor. Due to the fact that there is practically no loss in the closed air system, replenishment of the air supply in the pedestal is seldom needed. As camera load changes, the pressure in the system is readily compensated.

In addition to the counter-balanced action on the elevation adjust-

ment, the pedestal is easily moved about the studio. It is equipped with ball-bearing, rubber-tired wheels providing silent, smooth and effortless movement.

Models PN6-29B and PN88-33B/C are equipped with a solenoid operated brake mechanism to lock the pedestal at any desired height. The brake is released by operating a switch which is mounted on the handle of the camera cradle head. A large wheel base and larger diameter steering wheel make the PN88-33B/C Model especially suitable for color television cameras.

Specifications

Air Pressure Requirements, P.S.I.....	$\frac{1}{3}$ weight of camera load		
Base Position.....	Can be repositioned anywhere in 360° circle by lifting "T" handle on corner		
Wheels.....	6" on PN-6; dual 8" on PN-88, rubber tired, ball bearing with Alemite grease fittings		
	PN6-29	PN6-29B	PN88-33B/C
Net Weight	175 lbs. 79 kg	185 lbs. 84 kg	335 lbs. 142 kg
Shipping Weight	215 lbs. 98 kg	225 lbs. 102 kg	495 lbs. 225 kg
Height (excluding head) max.	50½" 128 cm	50½" 128 cm	51" 129.5 cm
Height (excluding head) min.	30½" 77.5 cm	30½" 77.5 cm	31" 78.7 cm
Wheel Base (center to center)	29" 73.7 cm	29" 73.7 cm	33" 83.9 cm
Base Width Max.....	34½" 87.6 cm	34½" 87.6 cm	43" 109.2 cm
Base Width Min.....	29¾" 75.6 cm	29¾" 75.6 cm	39" 97.1 cm

	PN6-29	PN6-29B	PN88-33B/C
Electric Column Brake.....	Available as kit	Included	Included
A-C Power Requirements*.....	None	117 v. 60 cps 0.75 amps	117 v. 60 cps 0.75 amps
		or 220 v. 50 Hz 0.75 amps	or 220 v. 50 Hz 0.75 amps

Accessories

Air Compressor	PN-100
Monochrome Cradle Head.....	MI-26203-A
Cam Head (Color or Monochrome).....	MI-557310

Ordering Information

Standard Pneumatic-Balance Camera Dolly.....	Model PN6-29
Pneumatic-Balance Camera Dolly with Brake....	Model PN6-29B
Pneumatic-Balance Color Camera Dolly with Brake.....	Model PN88-33B/C

* Specify A-C line voltage and frequency when ordering.



- Ideal for the small studio
- Choice of parallel or tricycle steering
- Easy, smooth dollying
- Height adjusts from 34 to 55 inches

Lightweight Camera Pedestal, Type TD-7

Description

The TD-7 Lightweight Camera Pedestal provides a firm, stable mount for lightweight TV studio cameras. The new pedestal is maneuverable and designed with the small type TV studio in mind. It accommodates friction, cradle or any other standard type heads for smooth horizontal panning and vertical tilting. Two models are available: The Type TD-7AO for use with 90 to 170-lb. studio cameras and the Type TD-7AV counterbalanced for lighter Vidicon cameras 60 to 90 lbs.

The TD-7 features two types of steering: parallel steering, in which the three wheels are locked parallel and turn together; and tricycle steering, in which all steering is done with the rear wheel, while the front wheels are locked in parallel. The former type is used for straight-line tracking in running dolly shots, while tricycle steering enables the pedestal to turn sharply in any direction or to rotate around its own axis. Changing from one type of steering to the other is accomplished

by simply lifting the steering wheel. By rotating the wheel 180 degrees, it can be used either as a tee handle or a semi-circular steering wheel. The camera pedestal is quickly and easily raised or lowered by turning

a hand wheel conveniently located on the side of the column. The center column and steering shaft are readily removed from the base for transporting the pedestal to field locations..

Specifications

Overall Dimensions (not including Head):

Height.....55" (139.7 cm) max., 34" (86.36 cm) min.

Width.....34" (86.36 cm) max., 30" (76.2 cm) min.

Net Weight.....140 lbs. (63.5 kg)

Shipping Weight.....200 lbs. (90.7 kg) approx.

Accessories

Friction HeadMI-26205-B

Cradle HeadMI-26203-B

Ordering Information

Type TD-7AO (Crank lift type
for 90-170 lb. Cameras).....MI-26044-A

Type TD-7AV (Crank lift type
for 60 to 90 lb. Cameras).....MI-26054



- Camera easily and rapidly raised with hydraulic lift
- Base legs adjustable to expand wheel spread
- Fully adjustable cable guards
- Large 8-inch diameter wheels for smooth dollying
- Swivel locks on wheels

Hydraulic Camera Pedestal, Type TD-10A

Description

The TD-10A Hydraulic Camera Pedestal, MI-26053-A, is an attractive chrome-trimmed mount designed for use with RCA TK-14, TK-15, and other monochrome television cameras. This sturdy pedestal is an economical choice for many studio and field applications.

The TD-10A offers greater convenience and utility than a combination tripod and dolly at a comparable price. Set up time is held to a minimum. Between camera shots the hydraulic lift allows height adjustments to be made easily and rapidly for operator preference; an important feature not easily accomplished with the tripod and dolly. Simple adjustments to the legs may be made to expand the wheel base. The large wheels provide smooth dolly shots.

The TD-10A pedestal meets the requirement for a camera mount that is easier to adjust in base width and height than the tripod-dolly combination, yet is more economical than pedestals which have the facil-

ity for providing smooth "on air" height adjustments.

The Type TD-10A Camera Pedestal features a hydraulic lift built into the lightweight center column to allow camera operator to easily raise the top of the pedestal to any

desired operating height between 35 to 60 inches from the floor. The camera is lowered by simply releasing the hydraulic valve. A three-position positive lock is provided at the pedestal base for a coarse adjustment of pedestal height.

Specifications

Overall Dimensions (not including head):

Height (maximum).....60" (152.43 cm)

Height (minimum).....35" (88.9 cm)

Base, not extended (minimum dimension).....32" (81.3 cm)

Base, extended (minimum dimension).....43" (109.2 cm)

Weight.....76 lbs. (34.5 kg)

Accessories

Friction HeadMI-26205-B

Cradle HeadMI-26203-B

Ordering Information

Type TD-10A Hydraulic Camera Pedestal.....MI-26053-A



- Light in weight—yet rugged in design
- Folds into compact, self-locking package for carrying
- Leg length calibration aids in accurate set-up
- Accessory dolly with large diameter 5-inch wheels

Metal Tripod, Type TD11-B

Description

The Type TD-11B tripod is designed to support (with cam and friction heads or cradle head MI-26203-B) all RCA color and monochrome television studio and field cameras. When used with television Tripod Dolly, Type TD-15B, it provides a maximum of convenience and mobility for dollying operations.

The Type TD-11B consists of an all-metal tripod structure of aluminum castings and tubular steel construction which provides a compact, lightweight, yet rugged design. It folds into a small-size unit which is easily portable.

In operation the TD-11B provides a "working-height" range of approximately 25 to 42 inches.

The lower tubular portion of each leg is easily adjusted and slides within a long-length bearing which is held to close tolerances. Thus, minimum play and maximum rigidity are assured throughout the working range. When tripod legs are adjusted for desired height, they may be

locked in position by means of hand-operated clamp screws. Calibration numbers are engraved on the lower legs to simplify leveling. The lower end of each leg is provided with

a self-aligning, universally-mounted casting which in one plane has a flat surface for use on level flooring—and in another plane has a steel spike for use on rough surfaces.

Specifications

Recommended Operating Heights:

Minimum.....	25 $\frac{5}{8}$ " (65 cm)
Maximum.....	42 $\frac{1}{2}$ " (108 cm)
Maximum Diameter at Feet (legs extended).....	70" (178 cm)
Dimensions (folded for transport):	
Overall Height (legs collapsed).....	31 $\frac{5}{8}$ " (80.33 cm)
Overall Diameter.....	10" (25.40 cm)
Net Weight.....	25 lbs. (11.5 kg.)

Accessories

Monochrome Camera Cradle Head.....	MI-26203-B
Tripod Dolly, Type TD-15B.....	MI-26042-B
Camera Friction Head.....	MI-26205-B
Cam Head for TK-60 Cameras.....	MI-557308
Cam Head for TK-42 Cameras.....	MI-557310

Ordering Information

Type TD-11B Metal Tripod.....	MI-26046-A
-------------------------------	------------



- Smooth dolly shots, field or studio
- Folds to compact package
- Easy tracking

Tripod Dolly, Type TD-15B

Description

The TD-15B Tripod Dolly is designed for use with the TD-11B Tripod fitted with television cameras. When tripods are used indoors, which is very often the case, use of the dolly precludes any possibility of marring the floor, and provides greater mobility for the tripod. Used in the field with reasonably flat terrain, the dolly makes it convenient and easy to change the position of the tripod.

Spring-Loaded Stop Feet

The TD-15B Dolly consists of a lightweight triangular-shaped steel structure supported on three swivel wheels, five inches in diameter. The finish is midnight blue. For convenience in transporting, the dolly folds into a package 8 by 14 by 29 inches. When extended and fastened to the tripod, it occupies a circular area 57 inches in diameter. The dolly is fastened firmly to the tripod by a clamp at each leg. Spring-loaded stop feet at each wheel serve to hold the tripod in a fixed position. Wheels may

be removed readily if such should be required.

Wheel Stops Aid Tracking

As each wheel is on a swivel, the course can be easily changed by merely pushing in the proper direction. Caster locking devices at each

wheel make it possible to lock two or all three wheels in a parallel position, enabling the dolly to track in a straight line for rolling dolly shots, closely simulating results obtained with more expensive studio type equipment.

Specifications

Dimensions (unfolded and extended):

Height (to mounting surface for tripod legs).....6" (15.24 cm)
 Diameter.....57" (1.48 m)

Folded for Transport:

Height.....8" (20.32 cm)
 Width.....14" (35.56 cm)
 Length.....29" (73.66 cm)

Net Weight.....25½ lbs. (11.5 kg.)

Ordering Information

Type TD-15B Tripod Dolly.....MI-26042-B

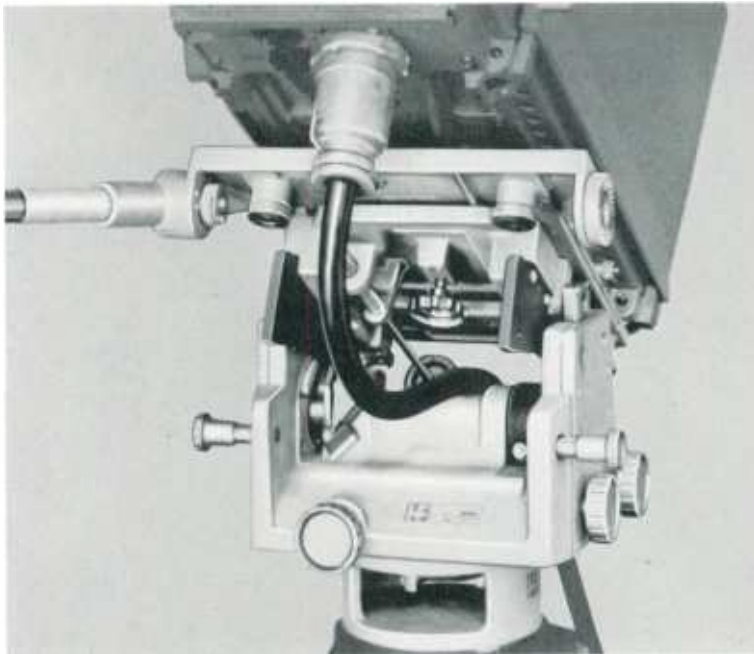

- Consistent balance throughout tilt range
- Greater tilt range
- Simplicity of adjustments
- Positive horizontal safety lock
- Sealed bearings—trouble free operation

Camera Cam Head

Description

A Cam Head, designed by Houston Fearless to operate with all RCA color or monochrome TV Cameras and fit on any standard pedestal or tripod, takes the work out of camera movement. Greater flexibility and adaptability as well as smooth finger-tip control of pan and tilt are made possible by the new camera positioning head. The Cam Head also features increased tilt range, simplicity of adjustments, positive horizontal safety lock, and simple trouble-free mechanical design.

The head makes use of a simple mechanical principle to provide finger-tip touch control of tilt positions. The camera is mounted so that the center of gravity of the camera is over the vertical center line of the head distributing the weight of the camera equally for balanced operation. Two identical cams, on either side of the head, are profiled so that as the camera is tilted up or down, the angular displacement of the cams counterbalances the weight of the camera in any position. The weight of the camera thus does all the

“work” of the movement—with the operator merely guiding the direction and limits of movement.

A separate cam profile has been developed for each RCA TV camera.

A color camera, for example, uses one set of cams while a lighter weight monochrome camera uses another. Cams are attached by means of four screws in the mounting yoke.

Specifications

Angle of Tilt.....	±50° from horizontal
Angle of Rotation.....	360°
Capacity.....	500 lbs. (225 kg.) max.
Dimensions (overall).....	20" long, 18" wide, 10" high (50.8 cm x 45.7 cm x 25.4 cm)
Weight.....	46 lbs. (20.9 kg.)

Ordering Information

Cam Heads Complete:	
Cam Head for TK-60 Cameras.....	MI-557308
Cam Head for TK-40/41 Cameras.....	MI-557309
Cam Head for TK-42 Cameras.....	MI-557310
Interchangeable Cams Only:	
Cams for TK-10/30, 11/31 and 14 Cameras.....	MI-557311-1*
Cams for TK-60 Camera.....	MI-557311-2
Cams for TK-40/41 Cameras.....	MI-557311-3
Cams for TK-42 Camera.....	MI-557311-4
Adaptor Plate:	
Adaptor Plate for Mounting TK-10/30, 11/31 and 14 Cameras.....	MI-557312*

* These two items are required for adapting the Cam Head for use with TK-10/30, 11/31 and TK-14 Cameras.

Camera Cradle Head

RCA MI-26203-A Cradle Head is specified for the Monochrome Image Orthicon Cameras. It fits all standard heavy duty pedestals, dollies, cranes, tripods or hi-hats, as well as the TD-7A Lightweight Camera Pedestal, and lightweight Mounting Adaptors.

The cradles provide a new balance and ease of camera operation.

When the camera is tilted up or down, the cradle rotates around a constant center of gravity, maintaining absolute balance at all times. There are no counterbalancing springs to get out of adjustment or to produce noise. Panning action is accomplished with the same ease as the tilt action due to precision ball bearing construction.

The heads have special flexibility for both studio or outdoor camera operation. The head tilts down 38 degrees and up 30 degrees. Stop blocks prevent the cradle from riding off the bearings at the extreme limits of travel. Drag adjustment is provided on the tilt. Brakes on the pan and tilt quickly lock the camera in a fixed position.

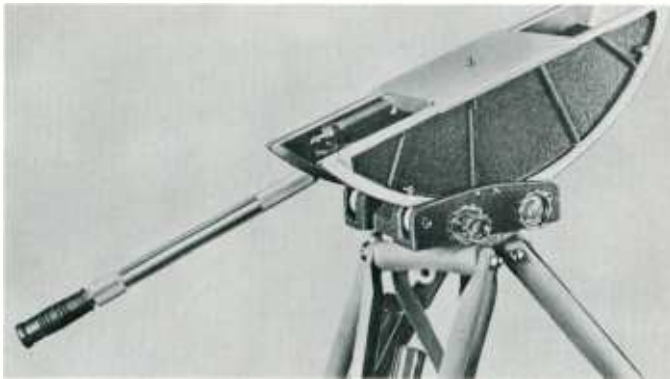

Specifications

Monochrome Cradle Head

Angle of Rotation.....	360°
Top Plate.....	6 $\frac{3}{4}$ " wide x 5" long (17.5 cm x 12.7 cm)
Height.....	7 $\frac{1}{4}$ " (18.4 cm)
Weight.....	26 lbs. (11.8 kg.)
Shipping Weight.....	45 lbs. (20.5 kg.)
Control Handle	Supplied

Ordering Information

Monochrome Camera Cradle Head.....	MI-26203-A
------------------------------------	------------

Camera Friction Head

The MI-26205-B, Friction Head, may be mounted on any of the RCA type pedestals or tripods by means of a single hand-operated wing nut, which is furnished with the Friction Head. The head is of rugged all-metal construction, in which all ma-

terials have been carefully selected for both field and studio use.

Rotation through 360 degrees in azimuth and ample tilt, up and down, are provided for operation with the RCA cameras. Extremely

smooth in operation, RCA Field and Studio Cameras when mounted on this unit are well balanced in any position of tilt, by means of specially designed counterbalance springs. Thus, a minimum of effort is required by the camera operator.



Specifications

Dimensions:	
Overall Height	8 $\frac{1}{4}$ "
Overall Length	8 $\frac{1}{2}$ "
Overall Width	13"
Weight (including panning handle).....	28 lbs. (approx.)
Angle of Rotation.....	360°
Finish	Midnight blue

Accessory

Hi-Hat Mounting Adaptor (6" high, 10 $\frac{1}{4}$ " mounting dia.).....	MI-26190-3A
---	-------------

Ordering Information

Camera Friction Head.....	MI-26205-B
---------------------------	------------

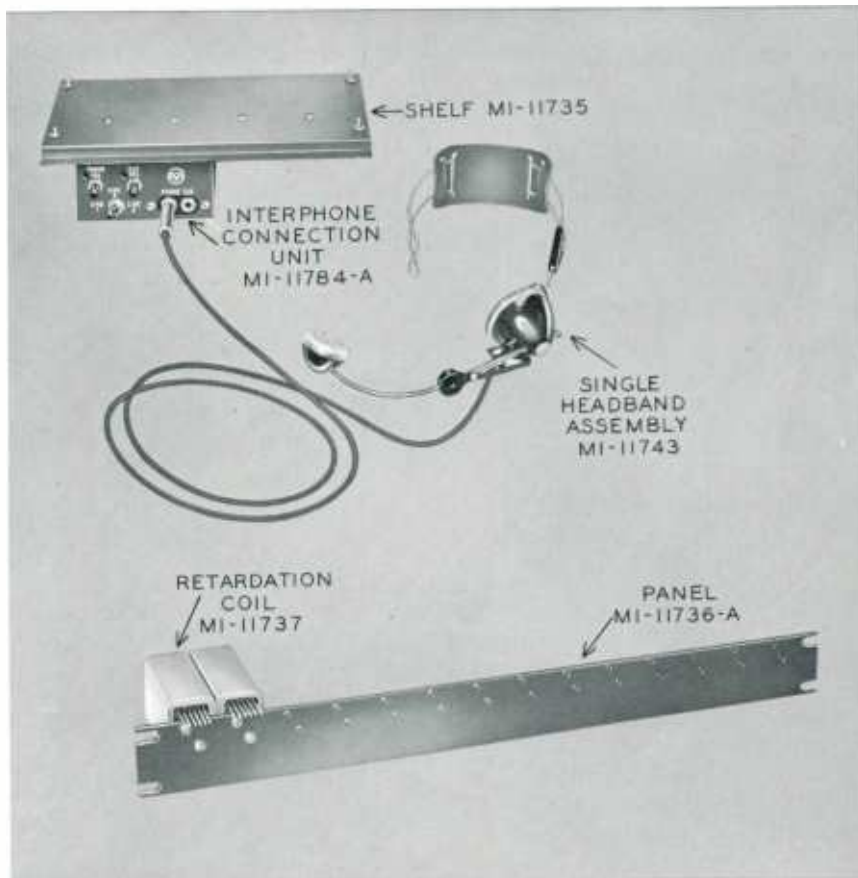

- Production intercom with studio personnel or remote line as desired
- Can mount to console, desk, or wall
- Compatible with RCA TV equipment
- Transistor amplifier or induction coil type interconnection units available
- Regulated power supply

Interphone Equipment

Description

RCA Interphone Equipment is designed to provide convenient line switching and headset connection facilities for a TV camera and studio communication system.

Heart of the RCA Interphone System is the Interphone Connection Unit. Two types of connection units are available. The MI-11784-A Transistor Interconnection Unit must be used with RCA TK-60 and other late model Cameras having transistorized intercommunication systems built into the camera. The MI-11734 Intercom Interconnection unit is designed for use with early RCA studio and field type cameras. The two interconnection units can not be intermixed in a system.

The MI-11784-A unit includes a single stage transistor amplifier, with

bridge rectifier and sidetone compensation network with level control to adjust volume. Each person on the talking bus can adjust the volume to suit his individual requirement. On the front is a three-way switch for selection of three intercom lines, and the separate volume controls for "phone" and "cue" adjustment. The box also contains two jacks to accommodate single or double headsets. A 9-pin and a 12-pin cable connector plug on the rear are used for external connection. The entire unit is housed in a box $4\frac{1}{8}$ inches wide, $2\frac{1}{2}$ inches high and $6\frac{3}{4}$ inches deep overall.

Operating power for the MI-11784-A interphone unit is derived from the common-battery interphone circuit to which the interphone unit

is connected. A bridge-rectifier is interposed in the line to the amplifier to maintain correct polarity at the amplifier regardless of the polarity of the interphone battery voltage. The sidetone compensation bridge is designed to hold the sidetone level to within 2 db of the received level for any number of connected stations up to 32.

The Transistor Interphone Connection Unit, MI-11784-A can replace the MI-11734 unit where it is designed to modernize the system since the unit physically replaces the MI-11734 Connection Unit and will operate with virtually all commercially available TV headsets using carbon microphones. The substitution can be made only if the camera is modified by substituting an MI-

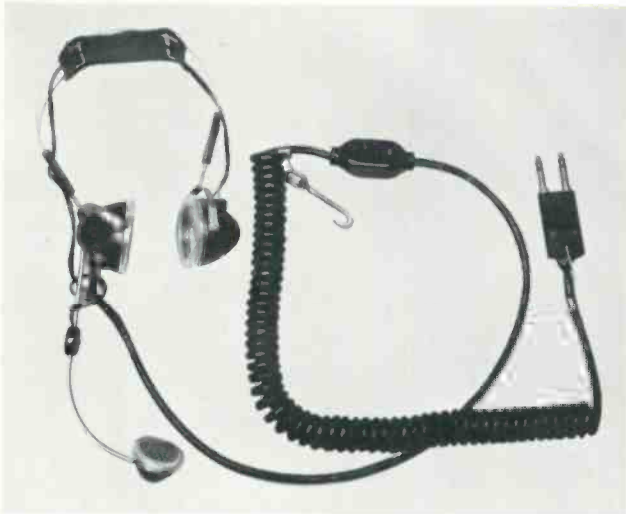

Double Headband Assembly, MI-11744



Transistor Interphone Unit, MI-11784-A

11757 Transistor Amplifier for the induction coil in the interphone circuit. Other circuit changes as outlined in the instruction book are also required.

The Interphone Connection Unit, MI-11734, consists of a simple circuit having an induction coil and capacitor to provide an anti-sidetone feature. The circuit is housed in a compact box having two phone jacks for use either with a single or double headset as required, and a two-position toggle switch for selecting a local circuit or a remote line. A cable plug is mounted in the rear. It is designed to work in early intercom systems employing induction coils throughout.

All other components of the Interphone System are designed for operation with either Interconnection Unit.

The Retardation Coil, MI-11737, permits simultaneous use of four carbon microphones such as one interphone connection unit and three camera headsets on a common battery or power supply. The coil permits a d-c power voltage to be imposed upon the two-wire telephone talking line. The MI-11737 is an audio frequency choke which isolates the power supply from the telephone line at voice frequencies.

The MI-11736-A Mounting Panel is recommended for mounting retardation coils. The panels have

standard mounting dimensions for use in the RCA BR-84 Series Racks.

The accessory, MI-11735 Shelf, is available for mounting the interphone connection units under the countertops of console housings on which switching units or camera controls are housed. The plate will accommodate one or two Interphone Connection Units.

Either a single or double headset identified as Single Headband Assembly, MI-11743 and Double Headband Assembly, MI-11744 can be used with RCA Interphone Equipment. One earphone unit of the double headband assembly is used for "cue" reception. Either type can be used in the same system.

Front and rear view of Induction Coil Interphone Unit, MI-11734

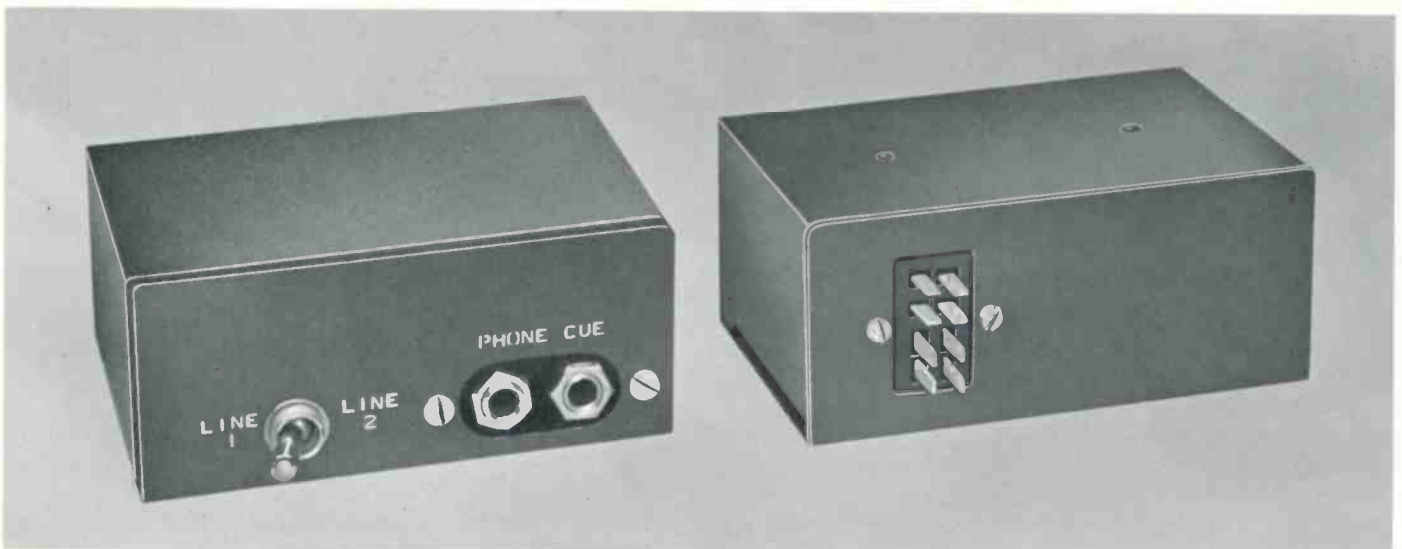

SCHEMATIC DIAGRAM FOR TRANSISTOR INTERPHONE SYSTEM

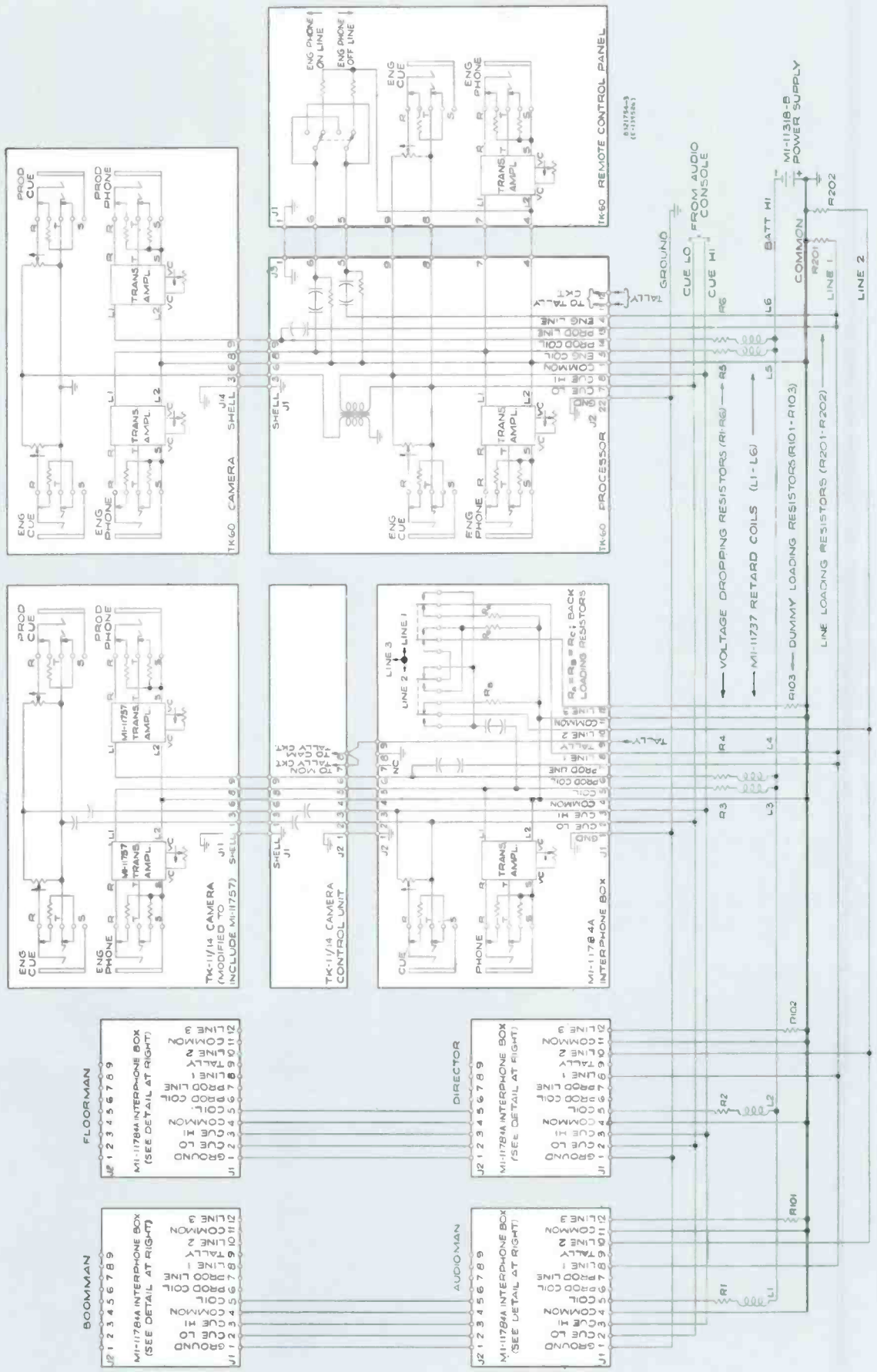

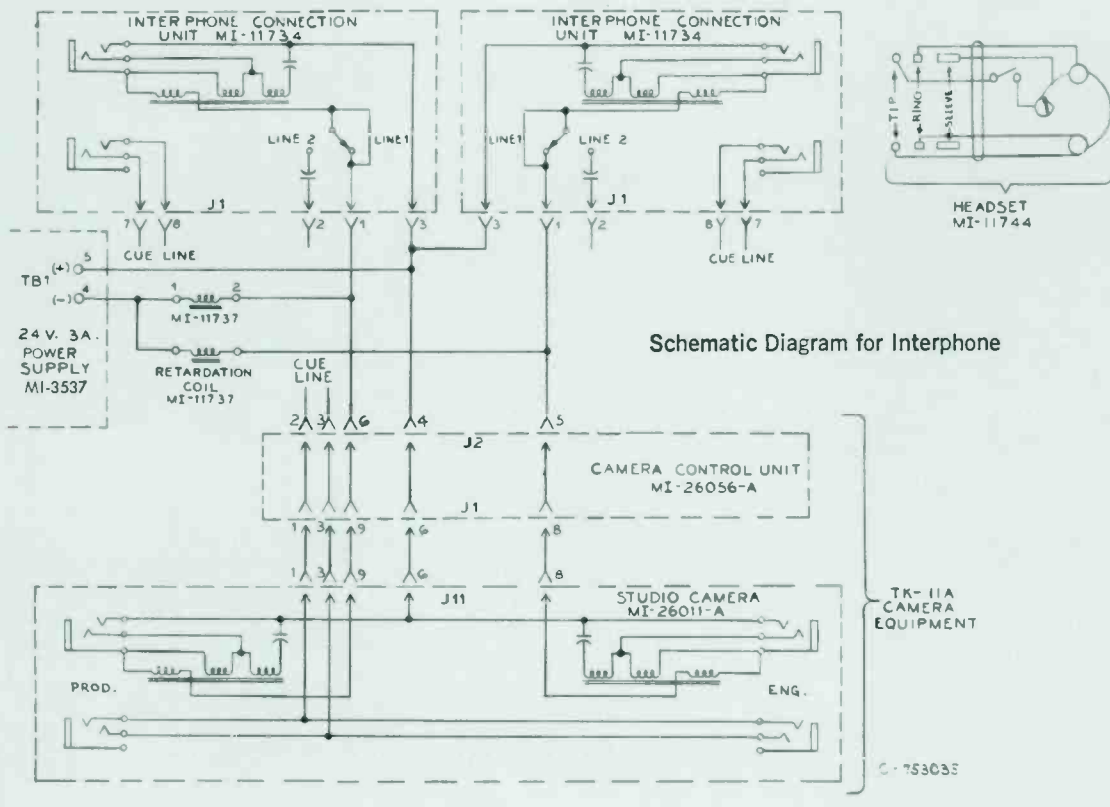

Specifications

Single or Double Headset

DC Resistance:	
Microphone Switch On.....	70 ohms approx.
Microphone Switch Off.....	Infinite
Inductance at 1000 Cycles:	
Microphone Switch On.....	70 millihenries approx.
Microphone Switch Off.....	245 millihenries

Weight:	
Single Headband Assembly.....	6 ozs. (less cord)
Double Headband Assembly.....	9 ozs. (less cord)

Transistor Interphone Connection Unit, MI-11784-A

Impedance.....	120 ohms
DC Voltage.....	8.5 volts (nominal)
DC Current.....	95 ma. (approx.)
Dimensions Overall.....	4 $\frac{5}{8}$ " wide, 2 $\frac{1}{2}$ " high, 6 $\frac{3}{4}$ " deep
Weight.....	3 lbs.

Interphone Connection Unit, MI-11734

Dimensions Overall.....	4 $\frac{5}{8}$ " wide, 2 $\frac{3}{8}$ " high, 4 $\frac{1}{4}$ " deep
Weight.....	1 lb., 11 ozs.

Retardation Coil, MI-11737

DC Resistance.....	165 ohms
Inductance.....	3.4 millihenries

Maximum Recommended Load Current.....	125 ma d-c
Dimensions Overall.....	1 $\frac{3}{8}$ " wide, 1-45/64" high, 4 $\frac{5}{8}$ " deep
Weight.....	16 ozs.

Power Supply, MI-3537

Input.....	115/230 volts \pm 10%, 50/60 cps
Output.....	Regulated 24 volts, 4 amps. d-c
Dimensions Overall.....	8 $\frac{3}{8}$ " wide, 4 $\frac{5}{8}$ " high, 11 $\frac{3}{8}$ " deep
Weight.....	25 lbs.

Power Supply

Input:	
MI-11318.....	100-130 volts, a-c, 60 cps, single phase, 144 watts
MI-591318.....	200-260 volts, a-c, 50 cps, single phase, 144 watts
Output.....	Regulated 24 volts, 6 amps, d-c
Dimensions Overall.....	19" wide, 5 $\frac{1}{4}$ " high, 9 $\frac{3}{4}$ " deep
Weight.....	25 lbs.

Mounting Shelf

Capacity.....	Mounts one or two Interphone Connection Units
Dimensions.....	11" long, 6 $\frac{3}{8}$ " wide
Weight.....	2 lbs. (approx.)

Retardation Coil Panel

Capacity.....	Mounts up to 14 retardation coils
Dimensions.....	19" wide, 1 $\frac{3}{4}$ " high
Weight.....	18 ozs.

Ordering Information

Transistor Interphone Connection.....	MI-11784-A
Interphone Connection Unit.....	MI-11734
Retardation Coil.....	MI-11737
Shelf for Mounting MI-11734.....	MI-11735
Panel (accommodating 14 Retardation Coils).....	MI-11736-A
Single Headband Assembly.....	MI-11743

Double Headband Assembly.....	MI-11744
Regulated Power Supply (24 volts, d-c, 4 amps) 110 volts, a-c.....	MI-3537
Regulated Power Supply (24 volts, d-c, 6 amps) 110 volts, a-c.....	MI-11318
Regulated Power Supply (24 volts, d-c, 6 amps) 220 volts, a-c.....	MI-591318
Transistor Amplifier (Replacement for Induction Coil).....	MI-11757

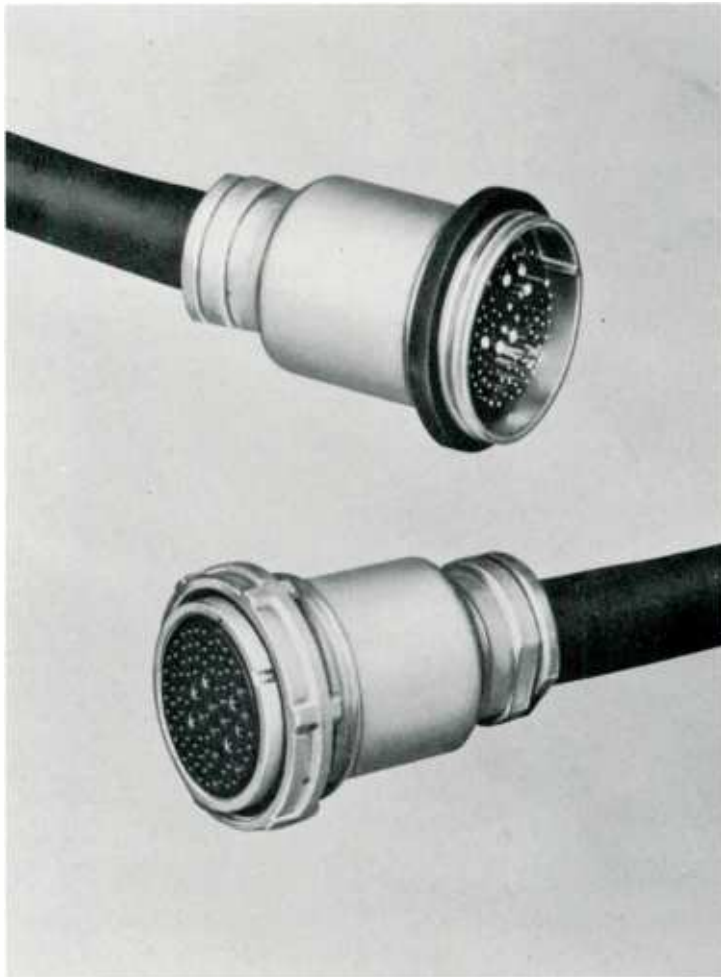

- Cable designs for every broadcast service—either studio or remote
- Exact replacements for cables and connectors supplied with RCA television equipment
- Connectors and bulk cable available separately or as wired cable assemblies
- Insulations with conservative voltage ratings and special shields employed

TV Cables, Plugs, Connectors

Description

RCA television cables, plugs and connectors are made available for inter-connecting the various components of television equipment—studio, control room and remote. Camera, power, pulse, intercom, coax transmission line and inter-connecting cables with companion connectors are available as individual items or in groups for use with various equipment systems.

The cables are generally designed for their particular application. The internal insulations and wire sizes are in many cases of special construction for specific purposes. The outer jackets of the cables will provide maximum durability and flexibility for the applications to which they are subjected. Specifications and ordering information are found on the following three pages.

Camera Cables

The multi-conductor, flexible camera cables listed here are supplied in convenient lengths complete with necessary male and female connectors. These cables facilitate making required inter-connections between cameras and camera controls. Conductors are stranded and covered with "color-coded" insulation. An inner shield of tinned copper braid is provided. Dust caps are provided where necessary. Outer coverings are of a durable neoprene compound.

Camera Cables and Plugs

Ordering Information	Description	Length
MI-26725-E5	25-Conductor, neoprene cover, with straight male and female connectors. With dustcaps.	50 feet
MI-26725-E6	Same as above except length.	100 feet
MI-26725-E7	Same as above except length.	200 feet
MI-26725-E9	25-conductor, neoprene cover, with 90° male and a straight female connector.	50 feet
MI-26725-E10	25-conductor, neoprene cover, with 90 degree female and a 90 degree male connector. With dustcaps.	50 feet
MI-40868-2	TK-41C Color Camera Cable. 82-conductor, single cable, vinyl covered flexible, straight male and female connectors.	50 feet
MI-40868-3	Same as above except length.	100 feet
MI-40868-4	Same as above except length.	200 feet
MI-557307	TK-27 Color Film Camera Interconnection cable, 52 conductor stranded, foil shielded, black vinyl jacket, straight male and female connectors.	50 feet
MI-557315-1	TK-42 Color Camera Cable. 79 conductor, single cable, flexible neoprene covered, straight male and female connectors.	50 feet
MI-557315-2	Same as above except length.	100 feet
MI-557315-3	Same as above except length.	200 feet
MI-557331-1	TK-33 Monochrome Camera Cable. 53 conductor, flexible neoprene covered, straight male and female connectors.	50 feet
MI-557331-2	Same as above except length.	100 feet
MI-557331-3	Same as above except length.	200 feet

Camera Cable Connectors and Accessories

The connectors described below include both the 90 degree and straight type for use in making up camera cables in any desired length, using bulk camera cable.

Ordering Information	Type	Description
MI-11719-A	Lacing Cord.	Black #6.
MI-26759-A21	Straight Male Camera Cable Connector.	24-contact for use as a cable termination.
MI-26759-A22	Straight Female Camera Cable Connector.	24-contact for use as a cable termination.
MI-26759-23	90° Female Camera Cable Connector.	24-contact for use as cable termination. Designed so cable enters connector at 90° to axis of contact pins.
MI-26759-24	90° Male Camera Cable Connector.	24-contact for use as cable termination. Designed so cable enters connector at 90° to axis of contact pins.
MI-26759-A41	Dustcap for male cable connector.	2 1/8" dia. x 1/2" deep, internal thread, with #10 chain and fastener.
MI-26759-A42	Dustcap for female cable connector.	2 1/8" dia. 1/8" deep, internal thread, with #10 chain and fastener.
MI-26759-45	Coaxial Termination. 75 ohm 1%.	Includes single contact coaxial connector plug, terminal assembly with a 1/2 watt, 75-ohm resistor.
MI-26759-48	Straight Female Connector, waterproof jacket.	24-contact for use as microwave cable termination.
MI-26759-49	Gasket for MI-26759-48.	Buna "N" rubber 1/4" square with knitted monel mesh bonded to rubber.
MI-40529-1	Male connector for TK-41C color camera cable.	82-contact, for use as cable termination.
MI-40529-2	Female connector for TK-41C color camera cable.	82-contact—same as above.
MI-40529-3	Male chassis connector.	82-contact, use with a color camera cable connector.
MI-40529-4	Female chassis connector.	Same as above.
MI-557316-1	Male cable connector for TK-33 monochrome camera cable.	53-contact for cable end termination.
MI-557316-2	Female cable connector for TK-33 monochrome camera cable.	53-contact for cable end termination.
MI-557316-3	Male chassis connector, 53-contact.	For use with 53-contact cable connector MI-557316-2.
MI-557316-4	Female chassis connector, 53-contact.	For use with 53-contact cable connector MI-557316-1.
MI-557321-1	Male cable connector for TK-42 color camera cable.	79-contact, for cable end termination.
MI-557321-2	Female cable connector for TK-42 color camera cable.	79-contact for cable end termination.
MI-557321-3	Male chassis connector, 79-contact.	For use with 79-contact cable connector MI-557321-2.
MI-557321-4	Female chassis connector, 79-contact.	For use with 79-contact cable connector MI-557321-1.

Sets of Interconnection Cables

The cables listed below are supplied in groups in accordance with the requirements of the indicated video equipment systems.

MI-26359, Interconnecting Cables for TK-60 Field Camera Chain

Includes:

- 2 MI-26759-58 10 ft., 3-cond., Power Cable with Plugs and Covers
- 1 MI-26759-9 7 ft., 7-cond., Pulse Cable with Plugs and Covers
- 2 MI-26759-46 10 ft., 12-cond., Power Cable with Plugs
- 4 MI-26759-12 7 ft., Transmission Line Cable with Plugs and Covers
- 1 MI-26759-59 10 ft., Transmission Line Cable with Plugs and Covers
- 1 MI-26759-60 7 ft., 19-cond., Remote Cable with Plugs and Covers
- 1 MI-26759-61 10 ft., 9-cond., Interphone Cable with Plugs and Covers

MI-43201, Interconnecting Cables for TK-14 Field Camera Chain

Includes:

- 1 MI-26759-2 10 ft., 2-cond., Power Cable with Plugs and Dustcaps
- 1 MI-26759-9 7 ft., 8-cond., Pulse Cable with Plugs and Dustcaps
- 1 MI-26759-11 7 ft., 8-cond., Interphone Cable with Plugs and Dustcaps
- 1 MI-26759-12 7 ft., Transmission Cable with Plugs and Dustcaps
- 1 MI-26759-62 7 ft., 12-cond., Power Cable with Plugs and Dustcaps
- 1 MI-26759-64 7 ft., 15-cond., Power Cable with Plugs and Dustcaps
- 1 MI-26759-65 7 ft., 7-cond., Orbiter Cable with Plugs and Dustcaps

MI-26730, Interconnecting Cables for TK-31 Field Camera Equipment

Includes:

- 1 MI-26759-2 10 ft., 2-cond., Power Cable with Plugs and Dustcaps
- 1 MI-26759-7 6 ft., 12-cond., Power Cable with Plugs and Dustcaps
- 1 MI-26759-9 7 ft., 8-cond., Pulse Cable with Plugs and Dustcaps
- 1 MI-26759-11 7 ft., 8-cond., Interphone Cable with Plugs and Dustcaps
- 1 MI-26759-12 7 ft., Coaxial Transmission Cable with Plugs and Dustcaps

MI-26740-A, Interconnecting Cables and Fittings for TS-30E Field

Switching Equipment Includes:

- 1 MI-26759-2 10 ft., 2-cond., Power Cable with Plugs and Dustcaps
- 1 MI-26759-7 6 ft., 12-cond., Power Cable with Plugs and Dustcaps
- 1 MI-26759-13 25 ft., Coaxial Transmission Cable
- 1 MI-26759-15 100 ft., Coaxial Transmission Cable
- 1 MI-26759-18 Set of Coaxial Fittings

MI-26746, Interconnecting Cables for TK-11B and TK-14 Studio Camera

Control Includes:

- 1 MI-26759-6 34-inch, 12-cond., Power Cable with Plugs
- 1 MI-26759-14 64-inch, Coaxial Transmission Line Cable with Plugs

Pulse and Interphone Cables

Ordering Information	Description	Length
MI-26759-9	Pulse Cable—8-cond., neoprene covered, flexible with straight male and female Cannon type connectors and dustcaps.	7 feet
MI-26759-11	Interphone Cable—8-conductor, vinyl covered, flexible, with male and female Cannon type connectors and dustcaps.	7 feet
MI-26759-17	Pulse Termination for TG-12A Sync Generator.	
MI-26759-60	Remote Control Cable (TK-60 Process Amplifier to Control Panel) 19-conductor shielded, black vinyl jacket, flexible with Cannon type mole and female connectors and dustcaps.	7 feet
MI-26759-61	Interphone Cable—9-conductor, flexible, shielded, black vinyl jacket non-contaminating, with Cannon type male and female connectors and dustcaps.	10 feet

Coax Cable Assemblies

The coaxial transmission line cable assemblies are made available in several different convenient lengths as shown in the accompanying chart. All are durable, vinyl covered, flexible cables with inner conductor and outer shielded conductor.

Ordering Information	Description	Length
MI-26759-12	Coax Cable Assembly with 2 male plugs and dustcaps. Impedance, 75 ohms.	7 feet
MI-26759-13	Same as MI-26759-12.	25 feet
MI-26759-15	Coax Cable Assembly with 2 male plugs and dustcaps. Impedance, 75 ohms.	100 feet
MI-26759-59	Coax Cable Assembly with 2 male plugs and dustcaps. Impedance, 75 ohms.	10 feet
MI-26759-45	Termination, 75 ohms $\pm 1.0\%$.	

Power and Control Cables and Plugs

The cables and connectors described below are available for use as spare units or replacements for those supplied with RCA television studio equipment.

Ordering Information	Power Cable Description	Length
MI-26759-2	2-conductor, vinyl covered, flexible with mole plug and female Cannon type connector with dustcap.	10 feet
MI-26759-6	12-conductor, vinyl covered, flexible with male and female Jones type connectors.	34 inches
MI-26759-7	12-conductor, vinyl covered, flexible with mole and female Cannon type connectors and dustcaps.	6 feet
MI-26759-8	12-conductor, vinyl covered, flexible with male and female Jones type connectors.	6 feet
MI-26759-41	18-conductor, vinyl covered, flexible with mole and female Jones type connectors.	4 feet
MI-26759-42	12-conductor, vinyl covered, flexible with mole and female Jones type connectors.	5½ feet
MI-26759-46	12-conductor, vinyl covered, flexible with male and female connectors and dustcaps.	10 feet
MI-26759-57	8-conductor, vinyl covered, flexible with straight male and 90° female connector.	36 inches
MI-26759-58	3-conductor, heavy duty Cord type S, synthetic rubber insulation, with Cannon type female connector and Hubbell type 3-wire polarized armored cap (twist-lock).	10 feet
MI-26759-62	12-cond., vinyl covered, flexible with male and female connectors and dustcaps.	7 feet
MI-26759-64	15-cond., neoprene covered, flexible with male and female connectors and dustcaps.	7 feet
MI-26759-65	7-cond., rubber covered, flexible with male and female connectors and dustcaps.	7 feet

Bulk Cable and Accessories

The various cables described in the accompanying table are available to the broadcaster in bulk quantities for making TV interconnections in special or nonstandard lengths as desired.

Ordering Information	Type Cable	Approx. Diam.	Characteristics
MI-48	PULSE CABLE—8-cand., rubber covered, flexible, individual color coding.	0.75"	4 coax conductors of 72 ohms impedance and 4 cond. of #16 A.W.G. with insulation for 600 v d-c.
MI-74A	COAXIAL CABLE—Type RG-8/U, flexible, vinyl covered. Single inner conductor and outer shield conductor.	0.405"	Impedance 52 ± 2 ohms. Normal capacitance 30.5 MMF/ft.; max. operating voltage 4000 RMS.
MI-75	COAXIAL CABLE—Type RG-59A/U, flexible, vinyl covered. Single inner conductor and outer shield conductor.	0.242"	Impedance, 75 ohms. Normal capacitance 20.5 MMF/ft. max., operating voltage 2300 RMS.
MI-83A	COAXIAL CABLE—Type RG-11A/U, flexible, vinyl covered. Single inner conductor and outer shield conductor.	0.405"	Impedance, 75 ohms. Normal capacitance 20.5 MMF/ft., max. operating voltage 4000 RMS.
MI-94N	CAMERA CABLE—25-cand., neoprene-covered, flexible, color coded, shielded cable consisting of: 3 coaxial cond., 18 stranded, tinned copper cond., and 1 group of 4 tinned copper conductors.	0.83"	Coax cond., impedance 50 ohms ± 2 ohms, 18 cond. of #22 A.W.G. and 4 of #14 A.W.G. with insulation for 1000 v, RMS max.
MI-13318-A	COAXIAL CABLE—Type RG-58C/U, flexible, vinyl covered.	0.20"	Impedance 50 ohms. Insulation for 1900 v, RMS.
MI-13319	POWER CABLE—18-conductor, rubber-covered, flexible, shielded and individually color coded.	0.590"	16 cond. #22 A.W.G., 2 cond. #16 A.W.G. with insulation for 2500 v, RMS, 60 cycles.
MI-13320	3-V FILM CAMERA CABLE—33-conductor, flexible, rubber-covered, shielded and individually color coded.	0.75"	27 cond. #22 A.W.G., wire jacketed; 4 cond. #22 A.W.G., wire jacketed; and 2 wires, #22 A.W.G., same shielded.
MI-13321	DELAY CABLE—Type RG-65/U, flexible, shielded.	0.75"	Impedance 1000 ohms.
MI-13325	COAXIAL CABLE, flexible, double shielded, rubber cover.	0.305"	Impedance 74.99 ohms at 4 mc, normal capacitance 20 MMF/ft., max. voltage 4000 RMS.
MI-13333	POWER CABLE, 7-conductor, shielded, black rubber jacket.	0.360"	7 cond. #20 A.W.G., 600 v, RMS max.
MI-13341	POWER CABLE, 26-conductor, shielded, black vinyl jacket.	0.625"	5 cond. #16 A.W.G., twisted and shielded overall as a group, 3 pairs #22 A.W.G. each pair shielded, 15 cond. #22 A.W.G.
MI-13345-17	POWER CABLE—34-conductor, stranded, foil shielded, black vinyl jacket.	0.500"	34 cond. #22 A.W.G. in 17 twisted pairs, 600 V RMS maximum.

Ordering Information	Type Cable	Approx. Diam.	Characteristics
MI-13348	POWER CABLE—52-conductor, stranded foil shielded, black vinyl jacket.	0.600"	52 cond. #22 A.W.G., overall foil shielded, 600 V RMS maximum.
MI-13351	POWER CABLE—16 cond., shielded, stranded wire, black neoprene jacket.	0.593"	16 cond. #16 A.W.G., 600 v, RMS max.
MI-13356	TK-42 COLOR CAMERA CABLE—70 conductor, black neoprene jacket.	1.028"	60 cond. #22 A.W.G., 600 V RMS; 6 cond. #22 A.W.G., 1500 V RMS; 5 cond. #14 A.W.G., 600 V RMS; 2 cond. #10 A.W.G., 600 V RMS; 6 coaxial cables, RG-58C/U, 50 ohm impedance. (In addition 4 drain wires and overall woven shield.)
MI-13357	TK-33 MONOCHROME CAMERA CABLE—53-conductor, black neoprene jacket.		37 cond. #22 A.W.G., 600 V RMS; 6 cond. #22 A.W.G., 1500 V RMS; 5 cond. #14 A.W.G., 600 V RMS; 2 cond. #10 A.W.G., 600 V RMS; 3 coaxial cables, RG-58C/U 50 ohm impedance. (In addition 4 drain wires.)
MI-13358	POWER CABLE—52-cond., stranded, shielded, black vinyl jacket.	0.600"	52 cond. #22 A.W.G., 600 V RMS coaxially foil shielded into four groups of 4, 10, 16 and 22 conductors. (In addition 3 drain wires.)
MI-13380-2	POWER CABLE—2-conductor, flexible, shielded, black vinyl jacket, non-contaminating.	0.420"	2 cond. #14 A.W.G., 600 v, RMS max.
MI-13380-3	POWER CABLE—Same as above except 3 cond.	0.450"	Same as above except 3 cond.
MI-13380-4	POWER CABLE—Same as above except 4 cond.	0.480"	Same as above except 4 cond.
MI-13380-5	POWER CABLE—Same as above except 5 cond.	0.540"	Same as above except 5 cond.
MI-13380-6	POWER CABLE—Same as above except 6 cond.	0.610"	Same as above except 6 cond.
MI-13380-8	POWER CABLE—Same as above except 8 cond.	0.610"	3 cond. #14 A.W.G.; 5 cond. #18 A.W.G.; 600 v, RMS max.
MI-13380-12	POWER CABLE—Same as above except 12 conductors.	0.625"	12 cond. #18 A.W.G.; 600 v, RMS max.
MI-13394-N	TK-41C COLOR CAMERA CABLE—82 conductors, black neoprene jacket.	1.24"	67 cond. #22 A.W.G.; 3 cond. #16 A.W.G.; 4 cond. #14 A.W.G., 8 coaxial cables, Type RG-58C/U, 50 ohms impedance.
MI-40422-A	Crimping Tool (for use with MI-13325 Cable and MI-40423 fittings).		Crimps adaptor to PL-259 connector and sleeve to shield.
MI-40423	Fittings for adapting MI-13325 Cable to PL-259 Connector.		Consisting of 25 pieces each of inner and outer sleeving.



- Efficient, economical studio lighting for any type of TV studio
- Lighting equipment designed with maximum "flexibility" in mind
- All lighting fixtures designed for maximum reliability and safety
- Experienced lighting engineers available to help plan studio requirements
- Recommendations based on many successful stations in operation

Television Lighting Equipment

Description

RCA's complete line of Television Lighting Equipment offers maximum flexibility, efficiency and economy in meeting the programming needs of modern, up-to-date TV studios. Based on their wide experience with the great number of today's television stations, RCA engineers have carefully selected a representative line of equipment of leading lighting manufacturers such as Kliegl Bros. and Century Lighting Inc. Such equipment includes all the fixtures, accessories and wiring and control devices needed for a workable and versatile studio lighting system.

RCA engineers are available to help plan TV lighting systems—whether it be for a "workshop-type"

of studio, TV theatre studio, or a "repetitive programming" studio. RCA also will plan lighting in accordance with any studio's architectural properties, degrees of flexibility desired, and as general program material dictates.

"Present-Day" TV Lighting

With the greater trend to color telecasts, proper studio lighting is occupying the attention of station designers. Rule-of-thumb lighting requirements have been drastically revised, and with the introduction of new close-spaced image orthicon tubes the philosophy of lighting has changed.

In general, the use of color has increased the amount of lighting con-

sidered desirable in the modern studio. This requirement can be satisfied by any one or by a combination of methods—by employing new quartz lighting, by raising the wattage of existing fixtures, by the addition of more fixtures of the same type and wattage (especially desirable in low-ceiling studios of 12 to 14 feet), or by adding higher wattage fixtures. Another approach may utilize the use of the new improved high sensitivity image orthicon tubes which greatly reduces the color lighting requirements.

Ideal Lighting

Excellent color pictures, like monochrome, require evenly lighted scenes. In order to secure such pic-

ture quality, light beams should overlap to cover acting areas with an even distribution of light. A typical flat lighting requirement for monochrome can be taken as about 100 foot candles, while typical flat lighting for color requirements will range from 150 foot candles for use with highly sensitive I.O. tubes to 300 to 400 foot candles with less sensitive I.O. tubes. Forty watts per square foot is generally suggested for 200 foot candles of lighting.

Lighting Effects

The more sensitive I.O. tubes have accounted for greater use of special or "trick" lighting effects. In black-and-white telecasting dimmer lighting fixtures are used chiefly for adjusting the contrast between front, back and side lighting and also for effects lighting to create silhouettes, transitions, and so forth. They can be equally useful in color telecasting, but in color, subject lighting is rarely dimmed except for unusual dramatic effect. However, dimmers can be used on background and base lights to show changes in the time of day, complement the action or mood, change background color, cut down scenery requirements, and to make smooth transitions from one scene to another.

In the studio, lighting fixtures are mounted from a fixed cross hatched gridwork, or if the ceiling height permits, on counterbalanced pipe battens or rope, chain, and wire cable suspended battens. Together with the pantographs, complete versatility is obtained with a minimum of labor and delay in rehearsal time. Any size of scenery may, therefore, be accommodated, and the front fill lights may be adjusted easily to approximately the recommended camera level.

Control Boards

More complex switching and dimming will require control boards. Outlet load selection by means of patch plugs or rotary selector switches greatly improve the safety and efficiency of lighting control. Electronic dimming has now taken its place in the lighting field to simplify the control functions. Because they control large studio currents with small control voltages, the electronic console may be located in the studio control room near the video operator.

Check List

In planning a TV lighting system, a great many factors must be kept in mind by the TV station engineer and the TV systems engineer as well. Listed here as a convenient check list are some of the objectives of the TV studio designer.

Requirements of Studio Lighting Techniques

Every television lighting system

should be capable of providing the following functions. RCA has selected and makes available its line of Lighting Equipment to satisfy the various requirements set forth here:

1. Base or General Lighting.
2. Modeling Lighting.
3. Back Lighting.
4. Effects Lighting.

Lighting Plan Check List

1. To provide a safe and rapid means of energizing the lighting fixtures:
 - a. By minimum lengths and number of time consuming portable cables.
 - b. By initially installing ample carrying capacity of wiring, control devices and feeders, additional costly electrical construction in an operating studio can be eliminated.
2. To specify equipment that is reliable and can be easily installed.
 - a. To assure dependable operation.
 - b. To keep maintenance and time consuming improvisation to a minimum.
 - c. To obtain the most favorable casualty, compensation, and fire insurance rates.
3. Fixtures should be specified that are:
 - a. Light weight for easy handling, yet durable to withstand the handling.
 - b. Easily adjusted, repositioned, and focused.
 - c. Safely constructed and wired.
 - d. The number and type of fixtures should be adequate to prevent the use of lamps of higher wattage than the units are designed for.
 - e. Equipment should include a variety of accessories specifically made for the fixtures. These are barn doors, diffuser frames, etc. This is to prevent the use of improvised 'wired on' gadgets that may drop off or cause damage.
 - f. Provide maximum light output per dollar invested.

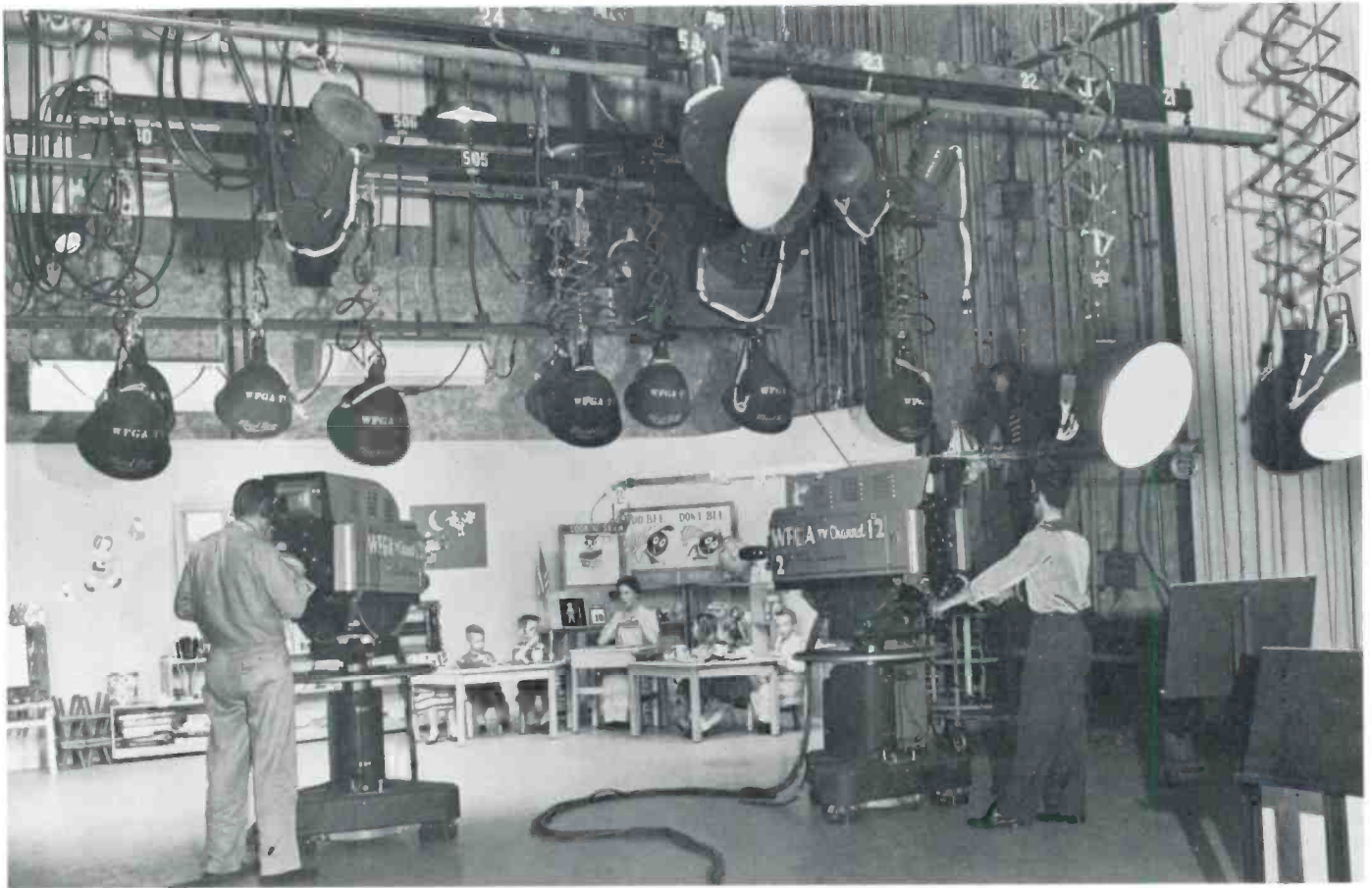

Basic Lighting

Base lighting is that uniform, wide angle illumination which covers the whole scene to be televised and is defined as uniform, diffuse illumination, approaching a shadowless condition, sufficient for a television picture of technical acceptability, and which may be supplemented by other lighting. The minimum level is limited to a value which will produce an acceptable signal-to-noise ratio with the studio camera used. The actual value of incident light required is also determined by the depth of field and normally ranges from 6 to 120 foot-candles for average lens stops for monochrome and 100 to 400 foot-candles for color. Productions may require even greater variations than this, and for our plans, we will specify 80 foot-candles for an average interior for monochrome and 240 foot-candles for color. This base or general light can be provided by incandescent floods (scoops), or long range scoops (for long distance throws). Base light-

ing can also be obtained by using the Fresnel spot lights at flood position.

Modeling Lighting

Modeling light is directional light at an angle to the camera axis which develops forms in the scene. Shadows are then produced, and give an illusion of depth to the subject. This can be obtained by unbalanced base light without destroying the illusion of the space effect. More generally, however, Fresnel lens spotlights provided with diffusers and barn doors can effectively create the form and enhance the appearance of the scene. The intensity of this lighting should be 20 to 30 percent greater than the base light in the scene.

Back Lighting

The purpose of back lighting is to separate the actors from the background. This is obtained by using spotlights at the rear of the set, directed from above. The level of this

backlight should approach an intensity of 50 percent greater than that of the base light, and should be applied with caution since light should never enter the television camera lens.

Effects Lighting

Effects lighting is specialized lighting which injects reality to the televised scene. Such effects as clouds, snow, rain, lightning, firelight, can be obtained by rear projection or by simple silhouettes in front of a light source. Many types of lighting equipment are available for special beam patterns which project light or shadows through windows, open doors or fireplaces. The background projector has been used more recently. It can project a simulated background which may be stationary as produced from a slide or moving objects from motion picture film. For proper picture quality, the highlights thus projected should be equal to or at least half of those of the live scene highlights.

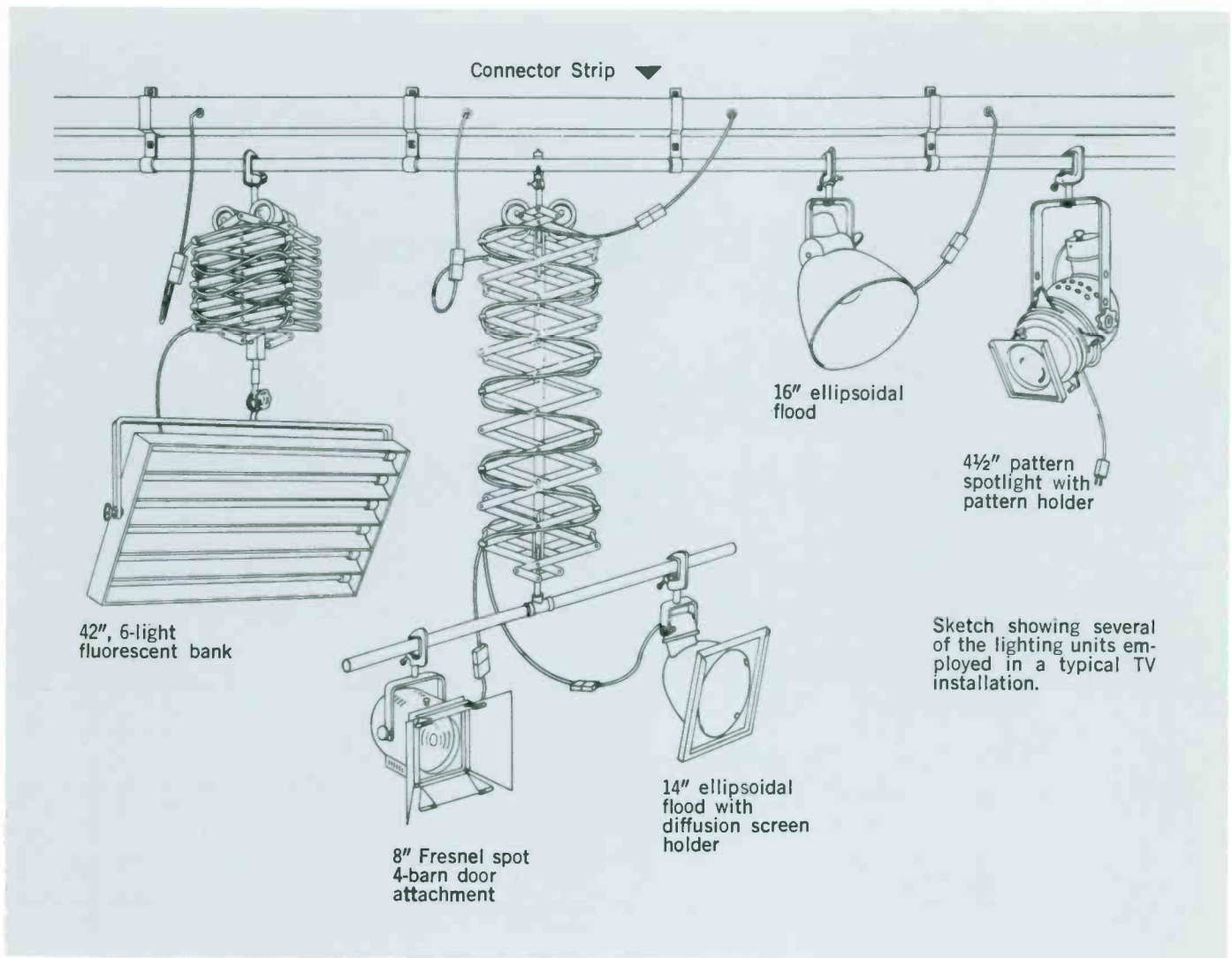

The proper combination of these various functions of light can give the illusion of three dimensions to the television picture and impart the desired artistic results. Complete flexibility in all phases of the lighting system is necessary to satisfy the techniques of present day television.

Lighting Application Tools

Unobstructed flexibility of camera and mike boom is required on the studio floor; therefore, the lighting is done from overhead. The means of supporting the lighting fixtures is facilitated by the application tools—viz., grid-work and pantographs.

The ceiling height of 14 to 18 feet prompts the use of a primary-secondary type of grid structure using a 1 1/4-inch black iron pipe. The pri-

mary grid is installed as close to the ceiling as possible—allowing clearance for raceways, ducts, and sprinklers. From this permanent group of parallel pipes is suspended a secondary grid. The secondary pipes are suspended by means of double "C" clamps or chain from the primary pipes and are perpendicular to them. The criss-cross network formed should be on 6- to 8-foot centers to insure adequate facilities for suspension of fixtures. The secondary pipes allow flexibility, as they make it convenient to reposition a fixture at any point on the scene required. Normally, the resulting grid is spaced 12 to 14 feet from the studio floor. From this grid the fixtures can be hung directly, or through pantograph hangers.

Pantographs Add Flexibility

Pantographs permit raising and lowering of lighting fixtures and when used with crossarms can support a number of fixtures. Current pantographs can support weights up to 60 pounds and allow for a vertical travel from 8 1/2 to 12 1/2 feet at maximum extensions. A number of pantographs supported from the grid have a great advantage for rapid vertical adjustment. Their most important use in the studio is the support of base lights which, for best pictures, should be approximately 8 feet from the floor.

For studios of ceiling heights above 16 feet a counter-weighted type of grid-work is recommended. This type of grid is described in Plan #3.

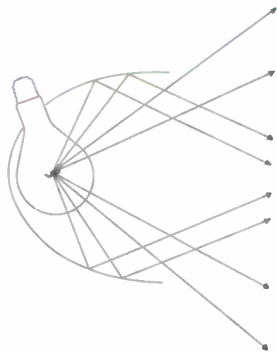

THE SCOOP: These 18-inch diameter, 750 to 2,000 watt wide angle, versatile floodlights provide efficient, soft, diffuse beam. Use with base and fill lights. Included are yoke, C-clamp and pin-connector. Also available are diffusers, cinemoid holder and pantographs.

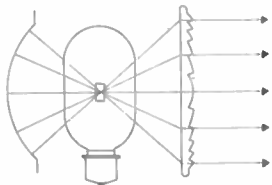

THE FRESNEL SPOT: This soft edge efficient spotlight is the single most valuable lighting instrument for TV usage. Spots rated 3-inch—150 watt, 6-inch—750 watt, 8-inch—2,000 watt, 12-inch—2,000 watt, 16-inch—5,000 watt, or 20-inch—10,000 watt provide variable beam spread in a smooth even field. Use with high and low key lighting, controlled fill lighting, or specials. Each spot includes yoke, C-clamp, pin-connector. Also available are barn doors, "pole-op," rectangular beam lenses, "cookies," and "lite lifts."

FOLLOW SPOTS: This is a useful specialized instrument available from 750 watts up to 5,000 watts. They provide a finely controlled beam of light with a hard-edge, and are recommended for use with follow spot, accent on star performer and special effects lights. They are provided with stand, yoke, iris, pin-connector and color booms, spread lenses and color wheels are available.

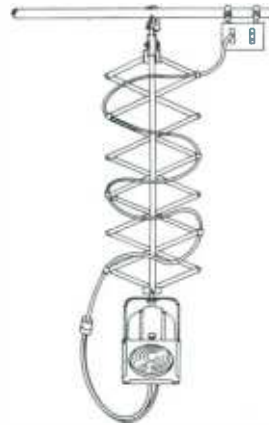

THE LIGHT-LIFT OR PANTOGRAPH: Negator springs permit automatic counter balance and height adjustment of these lighting fixtures. Light-Lifts are available for 12-15 pounds, 18-22 pounds, 26-30 pounds, 0-24 pounds, and 0-60 pound loads in either 7-foot or 12-foot extensions. They are used to quickly change the height or angle of a lamp, soften shadow when used with a fill-light scoop, or correct a shadow angle when used with a key-light fresnel.

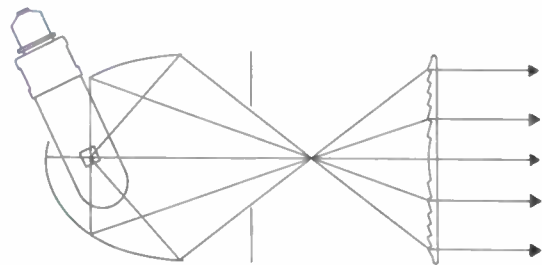

THE PATTERN PROJECTOR: This specialized unit is a controlled beam hard edge spotlight employing an ellipsoidal reflector and stepped or plano convex lens system. Available are 6-inch—750 watt, 8-inch—750 watt, 8-inch—2,000 watt, 8-inch—3,000 watt, 12-inch—5,000 watt units. They provide a clearly defined hard-edge beam. Gobos produce varied patterns on backgrounds. They can also be used with slash lights. The projectors include yoke, C-clamp and pin-connector. Also available are patterns, variable lenses and iris.

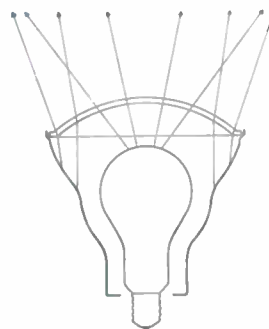

THE STRIP LIGHT: A series of lamps are set in designed reflectors in an approved wire-way for efficient easy handling. Lamps, 6, 8 or 12 inches on center can be specified. These are used for background lighting, eye lighting, etc. Included are reflectors, trunnions, leads and connectors. Color filters, roundels, cinemoid and clamps are useful accessories.

THE REAR SCREEN PROJECTOR: The rear screen projector has a one-to-one beam spread ratio and units of 2,000 watt, 2,100 watt 60 volt, 3,000 and 5,000 watt are available. They can be used as front or rear screen projectors. Each unit includes a stand and standard lens. Accessories available are automatic slide changers and super wide angle lens system.

Wiring and Control Devices

Mounted to the secondary pipes are the connector strips, each with 5 outlets. These outlets are pigtailed of 3- or 4-foot cables with female stage connectors attached. A total of one ceiling outlet for every 20 square feet of working studio space should be provided in the studio.

From each connector strip, a 12-conductor cable brings the branch circuits directly, or through 4 by 4-inch duct to the studio lighting control. The control board is located on the studio floor so that the operator can view the scene or the control room for cues, and has sufficient switches and dimmers for the accurate and noiseless control of each outlet.

The switchboard should contain a master switch to make possible blackouts and control of everything but worklights. The power is fed to individually fused and switchable outgoing 20 amp. circuits—one for each ceiling outlet. With the addition of a dimmer board, even greater flexibility is obtained. Dimming makes possible special effects, transitions, and control of overall light level.

Electrical Power Requirements

Practical considerations have limited the studio lighting system to a-c operation. The total a-c power service recommended for the switchboard input is 30 to 40 watts per square foot of working studio space from a 3-phase 4-wire, 60-cycle system. In addition to this, a special floor outlet box is recommended. This outlet in the middle of the scenic studio area should have a 60-amp. female outlet and 3-pole switch to provide power for special high current equipment such as an electric range in the kitchen set.

The wiring system of this studio should have, in addition, outlets and connectors of suitable uniformity to make possible complete interchangeability of cable, outlets, or instrument. An equipment ground, carried throughout the system, insures the safety of all personnel.

Lighting Sources

The scoop is a practical source to be considered for use in the TV

studio. Several of these units on each scene can provide easily the desired wide angle base light. This light level will vary with the mood of the scene to be televised. When mounted on the pantograph hanger, they can be adjusted with the result that their beam strikes the scene at an angle no greater than 20 degrees and, with diffuser frames, give the proper breakup of the harsh light.

A number of Fresnel spotlights can provide the key and modeling light for the scenes. These units, together with suitable barn doors, can provide the proper, narrow-angled light to supply form for the scene. Their level should contribute a 20 to 30 percent increase in intensity above the average base lighting.

These spotlights can provide backlight of 50 percent greater intensity than the base light. The purpose of backlight is to separate the main actors from the background scenery.

Four Practical Equipment Plans

Obviously, each TV studio must be considered on the basis of its own size and the programming to be accomplished. However, included here are floor plans and equipment lists for four station plans. These plans will perhaps cover a majority of the applications met in actual practice.

The RCA plans recommend use of the "Quartz Iodine" or "Quartz Halogen" lamps for "New Look" stations. These lamps, which are rapidly replacing the old type incandescent fixtures, maintain a constant lumen output throughout life due to the iodine re-cycling feature of the lamp. The re-cycling also prevents lamp blackening and thus maintains constant Kelvin temperature to the last hour of tube life.

In monochrome applications, the savings due to the longer life of the quartz lamps will overshadow the higher initial cost. In addition, when going to color, it is only necessary to install larger wattage quartz lamps in the basic fixtures. These 3200 degree K series lamps for the color studio provide from two to four times the light output with only a 25 percent drop in lamp life. This means a corresponding reduction in the customary allotment in power and air conditioning.

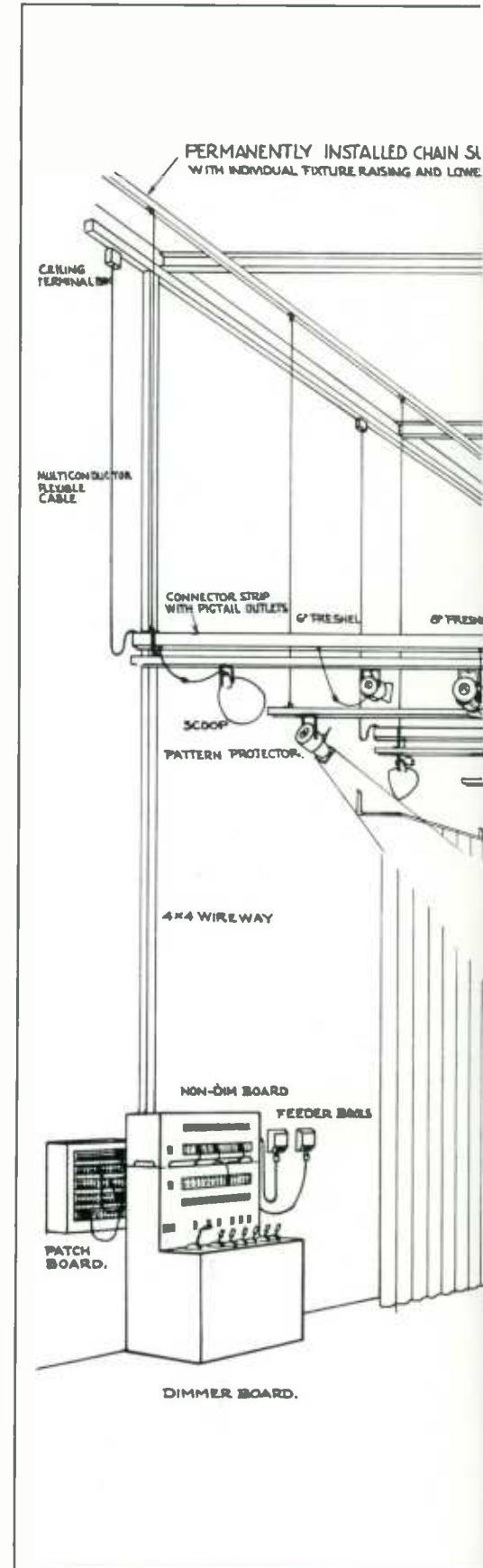

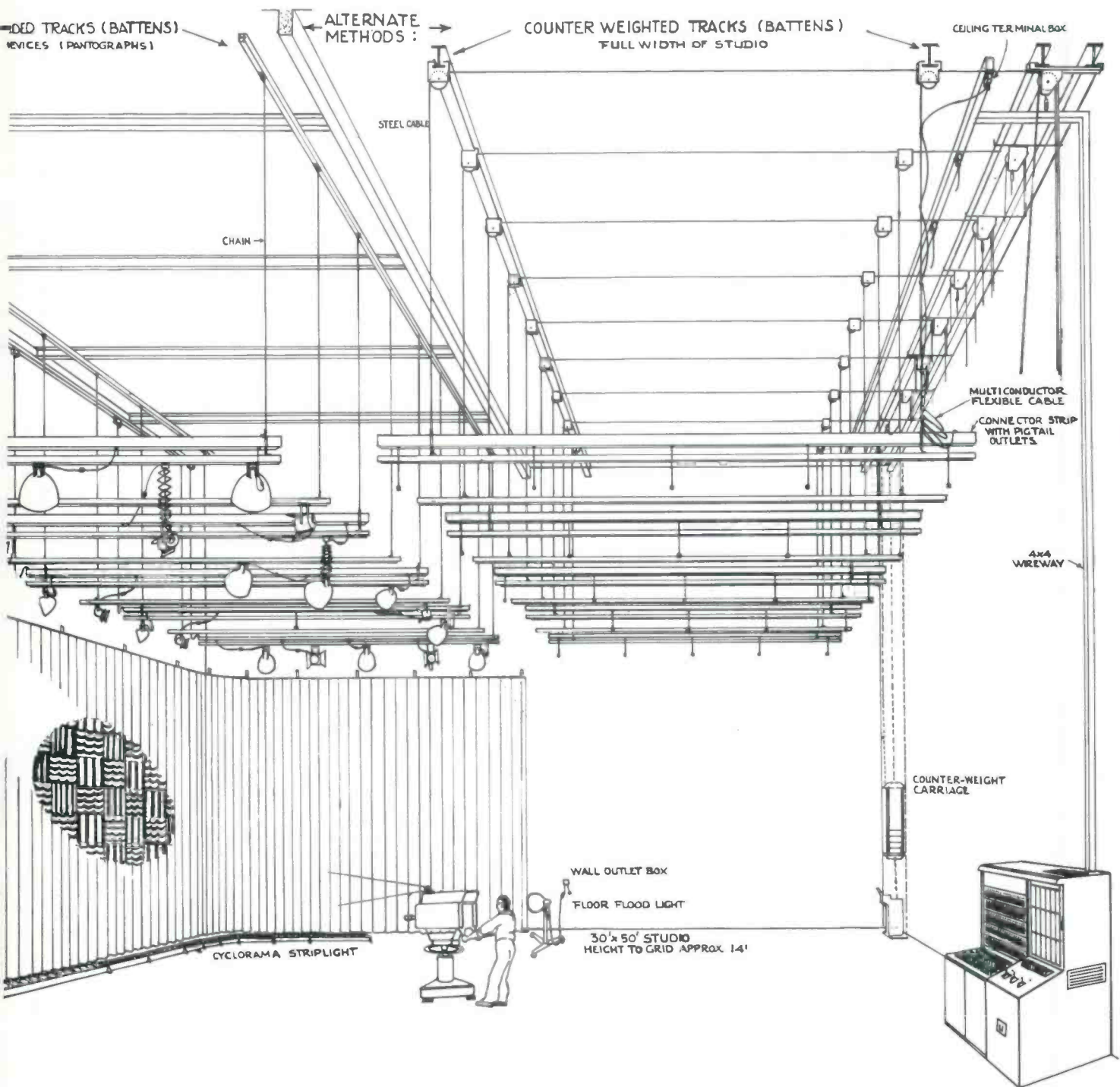

Sketch showing details of variety of lighting fixtures and methods of suspension.

PA 32 TYP/SCR COMPOSITE
SAF.PATCH & SCR DIMMER BOARD

Lighting Equipment Plan #1

In this plan, the studio will undoubtedly be used for repetitive type of programming. Local, unrehearsed shows such as panel discussions, interviews, local spots, kitchen shows or demonstrations will be predominant. Although the studio is a small 18 by 25-foot unit, it can accommodate a permanent kitchen set and an office scene. Space is also available for displaying the sponsor's products and advertising placards.

The lighting system for such a studio has previously been described from the standpoint of application tools, wiring and control devices, and sources. The equipment required for TV Studio Plan #1 is listed below.

Plan #1 Equipment List

Portable Lighting Equipment Complement for a Semi-Permanent Studio (18' x 25', Two Scene)

Quantity B & W* Color*	Description	Stock Reference Century	Kliegl
FIXTURES (each with 3-wire, 3-pole connectors)			
4	7 Baby Quartz Scoop, 500W	1313G	3450
4	7 Large Quartz Scoop, 1000W	1321G	3451
2	2 3" Fresnel Camera-light, 100/150W.....	523QG	44N3TVB
4	7 6" Quartz Fresnel Spotlight, 400/650W	520QG	3507
4	7 8" Quartz Fresnel Spotlight, 1000W.....	573G	3525D
1	2 Quartz Follow Spot with Iris, 1000W.....	1572G	1357/8/1
1	2 Quartz Pattern Projector with Pattern Holder, 1000W.....	1578G	1357P/6
ACCESSORIES			
4	7 Diffuser/Color Frame for Baby Scoop.....	3225	577
4	7 Diffuser/Color Frame for Large Scoop.....	3226	581
1	1 Roll of Spun Glass Diffuser	SGD	S-85
1	1 4-Way Barn Door for 3" Cameralight.....	2579	10803A
2	4 2-Way Barn Door for 6" Fresnel	2570	1106
1	2 4-Way Barn Door for 6" Fresnel.....	2580	1106A
2	4 2-Way Barn Door for 8" Fresnel.....	2571	1081
1	2 Set of Patterns for Projection	2067	1097TV
3	3 Roller Caster Floor Stands	3216	1421
5	8 Lightweight Pantograph Hangers.....	3281	111TV
5	8 Short Extension Cables for above.....	18RCCG	10E955G
3	3 Medium Extension Cables for Stands.....	25RCCG	25E955G

Quantity B & W* Color*	Description	Stock Reference Century	Kliegl
WIRING AND LIGHTING CONTROL DEVICES (3-wire system)			
2	4 Portable Connector Strip with 25 ft. cable and 5 outlets and load end boxes....	6315/5-20GP	2440TVG/25
2	4 Portable Connector Strip, with 35 ft. cable and 5 outlets and load end boxes....	6320/5-20GP	2440TVG/35
1	0 Portable Solid State Electronic Switch Dimmer and Distribution Panel with 18 20 Amp. outlets, 6-3 kw Silicon Rectifier Dimmers, and a 1-scene control console	S65310	6R64/3/18
0	1 Portable Solid State Electronic Switch Dimmer and Distribution Panel with 36 20 Amp. outlets, 6-6 kw Silicon Rectifier Dimmers, and a 1-scene control console	S65311	6R64/6/36

* If Vidicon Cameras are used, the quantities listed in the color column should be chosen.

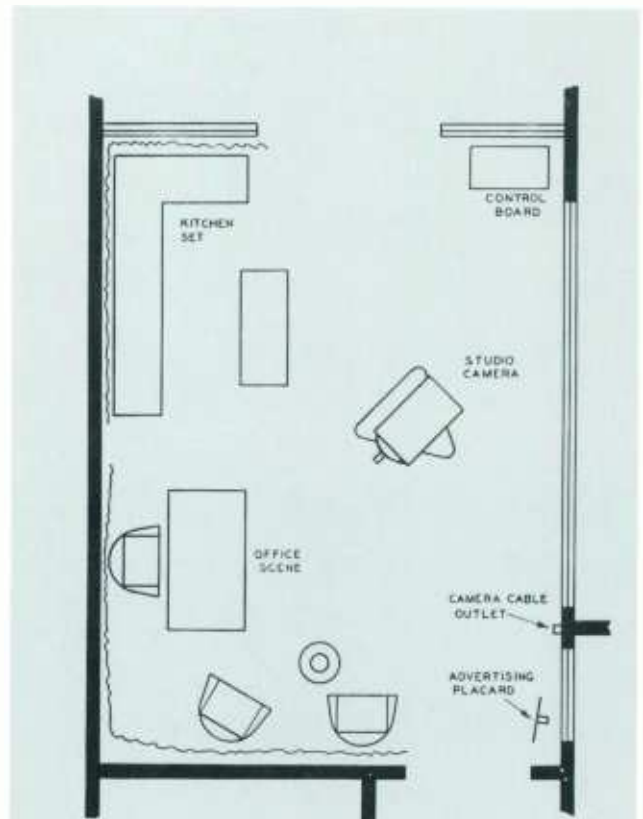

Sketch showing studio scenic arrangement for Plan #1.

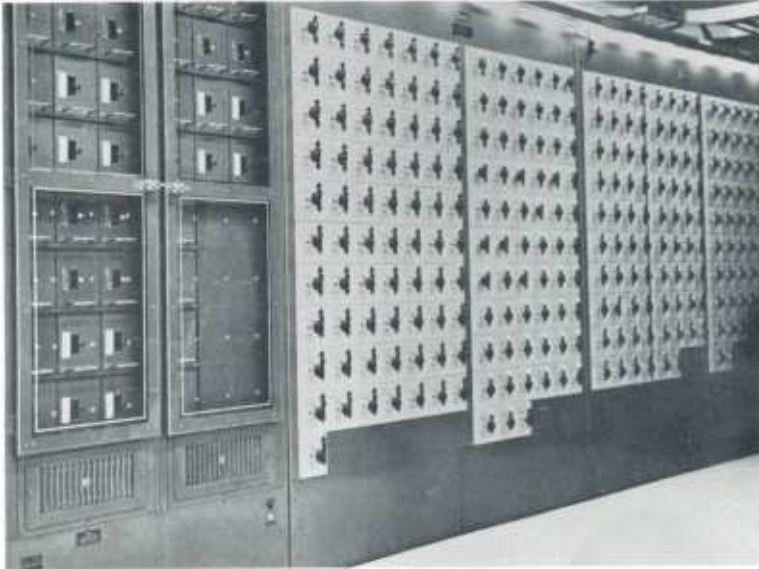

View of a composite solid state dimmer and rotary load selector bank which combine to provide efficient and precise control of lighting for a four studio TV complex.

Custom combination auto-transformer board and patch panel where all the lighting load circuits terminate in "Saf-T-Plugs." The dimmers control female receptacles in the patch section. Fast easy selection and grouping of lighting loads is achieved in this low-cost assembly.

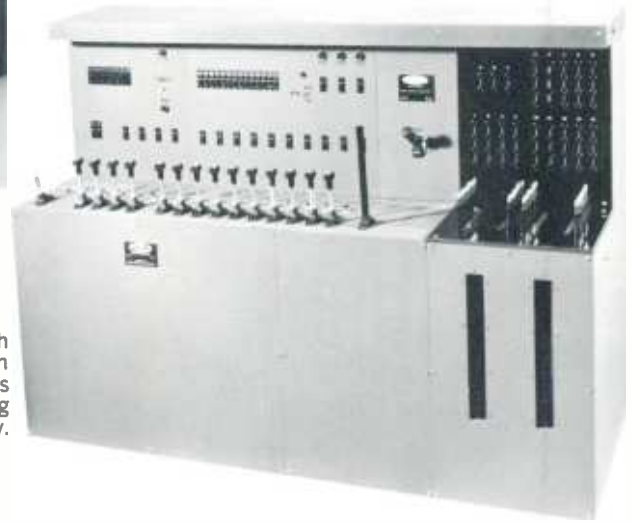

Lighting Equipment Plan #2

The studio of Plan #2 might be classified as a general utility or "workshop" type of studio. Unlike the Plan #1 studio, it is capable of handling somewhat more complex programming involving more frequent setup changes. Dramatic, planned, or restricted sequence programs will originate from this (22 by 34 by 14 to 18-foot high) studio.

To fulfill the requirements of present and future programming, the lighting arrangement for this studio must be as flexible as possible. A criss-cross pipe grid on 6-foot centers and spaced 12 to 14 feet from the floor is used. With such a network and spacing, it is always easy to relocate a fixture on a desired point in a scene. Besides the fixtures themselves, the grid also supports the connector strips and pantograph hangers. Since the latter brings the fixtures within arm's reach, they facilitate the adjustment of fixtures

with a minimum amount of time and effort on the part of electricians or other production personnel.

Safety and flexibility in the studio wiring system is assured by the use of six connector strips. Each has five pigtail female outlets and is fed from a terminal box on a 4-inch duct through rubber cable. Spaced uniformly on the secondary pipes, they provide 30 ceiling outlets or approximately one outlet for every 30 square feet of studio space. Five other double outlet circuits are provided 1 to 2 feet from the floor on the walls. The adequate branch circuits available at the switchboard make it possible to always find a convenient outlet in the studio. A uniform type of connector throughout the lighting system is suggested to permit interchangeability.

All ceiling and floor outlets are wired to the switchboard where they are switchable or dimmable either

collectively or individually, by a patchboard where each outlet is provided with a counterbalanced, retractable cord and male plug. They are patched into the desired bank of grouped female jacks, and, in turn, can be energized by breaker switches. The patching feature makes it possible to group all the fixtures associated with a particular scene to one master and dimmer. Lastly, the studio light control must be capable of supplying 25 KW of fused power or almost 30 watts per square foot of studio floor space.

From an engineering standpoint, the lighting sources must provide the proper quality and quantity of light needed to produce a good TV picture. Practically, it has been found that incandescents or a combination of fluorescents and incandescents can provide the quality of light to insure proper tonal rendition for monochrome cameras. Fluorescents cannot

be mixed with incandescents for color cameras because of their wide difference in effective color temperature. The quantity of light reflected from the TV scene must be sufficient to allow the camera to produce a picture of acceptable signal-to-noise ratio. The average lighting level is 100 foot-candles for monochrome, but it is recommended that sufficient sources be available to produce about 400 foot-candles of incident light in order that there be proper flexibility in control and lens stops for future color productions.

Plan #2 Equipment List

TV Lighting Equipment Complement for a Permanent Studio (approx. 22' x 34' x 14' Ceiling)

Quantity B & W* Color*	Description	Stock Reference Century	Kliegl
FIXTURES (each with 3-wire, 3-pole connectors)			
3	5 Baby Quartz Scoop, 500W	1313G	3450
9	15 Large Quartz Scoop, 1000W	1321G	3451
2	2 3" Fresnel Cameralight, 100/150W	523QG	44N3TVB
5	8 6" Quartz Fresnel Spotlight 400/650W.....	520QG	3507
12	20 8" Quartz Fresnel Spotlight, 1000W.....	573G	3525D
2	3 Quartz Follow Spot with Iris, 1000W.....	1572G	1357/8/1
2	3 Quartz Pattern Projector with Pattern Holder, 1000W.....	1578G	1357P/6
ACCESSORIES			
3	5 Diffuser/Color Frame for Baby Scoop.....	3225	577
9	15 Diffuser/Color Frame for Large Scoop.....	3226	581
1	1 Roll of Spun Glass Diffuser	SGD	S-85
2	2 4-Way Barn Doors for 3" Cameralight.....	2579	10803A
3	3 2-Way Barn Doors for 6" Fresnel.....	2570	1106
1	2 4-Way Barn Doors for 6" Fresnel.....	2580	1106A
3	5 2-Way Barn Doors for 8" Fresnel.....	2571	1081
3	5 4-Way Barn Doors for 8" Fresnel.....	2581	1081A
2	3 Set of Patterns for Projection	2067	1097TV
4	4 Roller Caster Floor Stands	3216	1421
4	6 Lightweight Pantomograph Hangers.....	3281	111TV
6	8 Medium Weight.....	3283	112TV
10	14 Short Extension Cables for above.....	18RCCG	10E955G
4	4 Medium Extension Cables for Stands.....	25RCCG	25E955G

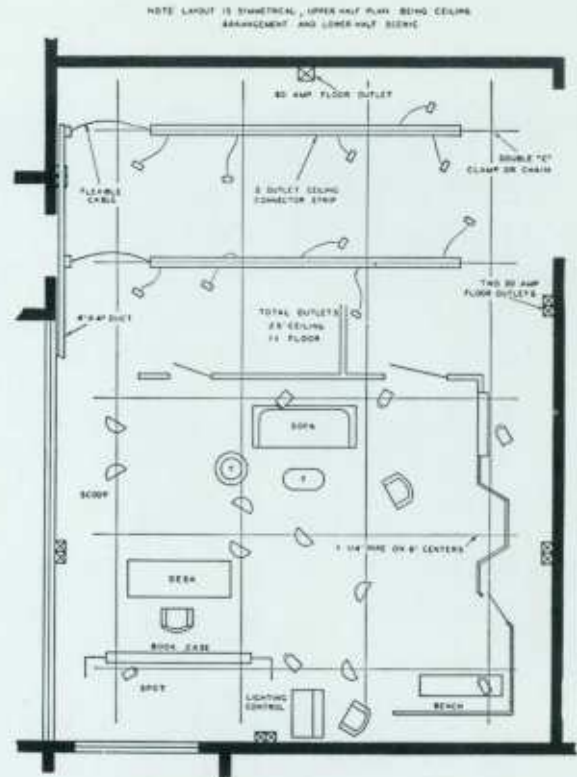

Sketch showing the studio lighting arrangement for Plan #2.

Quantity B & W* Color*	Description	Stock Reference Century	Kliegl
WIRING AND LIGHTING CONTROL DEVICES			
6	10 Connector Strips each 15 ft. long with 5-20 Amp. pigtail outlets and 20 ft. of feed cable.....	6315/5-20GP	619G/15/5/20F
2	2 Wall Outlet Boxes each with 2-20 Amp. pigtail outlets.....	3018/2-20GP	2433G/2
0	2 Wall Outlet Boxes each with 2-50 Amp. Pigtail Outlets.....	3018/2-50GP	2433G/2/1X
1	1 Wall Receptacle 60 Amp. 3-Phase.....	3018/1-60GP	4957G/GB
1	0 Solid State Electronic Switch, Dimmer, and Load Selection Board with 34-20 Amp. outlets, 6-3 kw Silicon Rectifier Dimmers, 6-3 kw Non-Dims, 1-100 Amp. 3-pole Main Breaker and a 2-scene Preset Console	S65312	HP34/6R64/3
0	1 Solid State Electronic Switch Dimmer and Load Selection Board with 54-20 Amp. and 4-50 Amp. outlets, 9-3 kw Silicon Rectifier Dimmers, 6-3 kw Non-Dims, 3-6 kw Non-Dims, 1-200 Amp. 3-pole Main Breaker, and a 2-scene Preset Console	S65313	HP54/9R64/3

* If Vidicon Cameras are used, the quantities listed in the color column should be chosen.

Lighting Equipment Plan #3

The television studio of Plan #3 is similar to Plan #2, except that this plan can accommodate two more scenes. In using a higher ceiling in a larger studio, a counter-weighted batten is employed as shown in the sketch at left. Plan #3 studio is 30 by 50 feet and can also be classified as a workshop type of studio. Lighting equipment is listed below.

Plan #3 Equipment List

TV Lighting Equipment Complement for a Permanent Studio (approx. 30' x 50' x 27' Ceiling)

Quantity B & W* Color*	Description	Stock Reference Century	Kliegl
FIXTURES (each with 3-wire, 3-pole connectors)			
4	6 Baby Quartz Scoops, 500W	1313G	3450
16	26 Large Quartz Scoops, 1000W	1321G	3451
3	3 3" Fresnel Camera-light, 100/150W.....	523QG	44N3TVB
8	13 6" Quartz Fresnel Spot-light, 400/650W.....	520QG	3507
16	26 8" Quartz Fresnel Spot-light, 1000W.....	573G	3525D
2	4 12" Quartz Fresnel Spotlight, 2000W.....	575G	3527
2	0 Four Light Quartz Cyclo-rama Strip-lights, 4-500W	454	3500F
0	4 Eight Light Quartz Cyclo-rama Strip-lights, 8-500W	466	3501F
3	0 Quartz Ellipsoidal Spot with Iris, 400-650W.....	1216	1340/1
0	4 Quartz Ellipsoidal Spot with Iris, 1000W.....	1572	1357/6/1
3	4 Quartz Pattern Projector with Pattern Holder, 1000W.....	1578	1357P/6
1	1 Quartz Follow Spot with Iris, 1000W.....	1572	1357/8/1

Quantity B & W* Color*	Description	Stock Reference Century	Kliegl
ACCESSORIES			
4	6 Diffuser/Color Frames for Baby Scoop.....	3225	577
16	26 Diffuser/Color Frames for Large Scoop.....	3226	581
1	1 Roll of Spun Glass Diffuser	SGD	S-85
3	3 4-Way Barn Door for 3" Camerelight.....	2579	10803A
3	4 2-Way Barn Door for 6" Fresnel.....	2570	1106
1	2 4-Way Barn Door for 6" Fresnel.....	2580	1106A
6	9 2-Way Barn Door for 8" Fresnel.....	2571	1081
2	4 4-Way Barn Door for 8" Fresnel.....	2581	1081A
1	2 2-Way Barn Door for 12" Fresnel.....	2583	1082
2	3 Set of Patterns for Projection.....	2067	1097TV
4	4 Roller Caster Floor Stands	3216	1421
6	8 Lightweight Pantomograph Hangers.....	3281	111TV
6	8 Medium Weight Pantomograph Hangers.....	3283	112TV
12	16 Short Extension Cables	18RCCG	10E955G
4	4 Medium Extension Cables	25RCCG	25E955G

WIRING AND LIGHTING CONTROL DEVICES

14	24 Connector Strips each 15 ft. long with 5-20 Amp. pigtail outlets, and 20 ft. of feed cable.....	6315/5-20	619G/15/5/20F
4	4 Wall Outlet Boxes each with 2-20 Amp. pigtail outlets.....	3018/2-20GP	2433G/2
0	4 Wall Outlet Boxes each with 2-50 Amp. pigtail outlets.....	3018/2-50GP	2433G/2X
1	1 Wall Receptacle 60 amp., 3-phase.....	3018/1-60GP	4957G/FB
1	0 Solid State Electronic Switch, Dimmer and Load Selection Board with 78-20 Amp. outlets, 12-3 kw Silicon Rectifier Dimmers, 6-6 kw Non-Dims, 1-200 Amp. 3-pole Main Breaker, and a 2-scene Preset Console	S65314	HP78/12R64/3
0	1 Solid State Electronic Switch, Dimmer and Load Selection Board with 120-20 Amp. and 8-50 Amp. Outlets, 12-6 kw Silicon Rectifier Dimmers, 6-6 kw Non-Dims, 1-300 Amp. 3-pole Main Breaker, and a 2-scene Preset Console.....	S65315	HP128/12R64/6

* If Vidicon Cameras are used, the quantities listed in the color column should be chosen.

Lighting Equipment Plan #4

The studio of Plan #4 offers greater versatility than that of the previous plans described. It will originate a variety of dramatic shows and commercial sequences. Having a 40 by 60 foot working space, it requires approximately 100 branch circuits. Branch circuits may be grouped as scenery requires by means of a patch or rotary selector board. They, in turn, are switched and dimmed at the control board.

Plan #4 Equipment List

TV Lighting Equipment Complement for a Permanent Studio (approx. 40' x 60' x 27' Ceiling)

Quantity B & W* Color*	Description	Century	Stock Reference Kliegl
FIXTURES (each with 3-wire, 3-pole connectors)			
4	6 Baby Quartz Scoops, 500W	1313G	3450
26	40 Large Quartz Scoops, 1000W	1321G	3451
4	4 3" Fresnel Cameralight 100/150W	523QG	44N3TVB
10	16 6" Quartz Fresnel Spotlight, 400/650W.....	520QG	3507
25	42 8" Quartz Fresnel Spotlight, 1000W.....	573G	3525D
3	5 12" Quartz Fresnel Spotlight, 2000W.....	575G	3527
4	0 Four Light Quartz Cyclorama Striplight, 4-500W	454	3500F
0	6 Eight Light Quartz Cyclorama Striplight, 8-500W	466	3501F
3	0 Quartz Ellipsoidal Spot with Iris, 400/650W....	1216	1340/1
0	4 Quartz Ellipsoidal Spot with Iris, 1000W.....	1572	1357/6/1
4	4 Quartz Pattern Projector with Pattern Holder, 1000W.....	1578	1357P/6

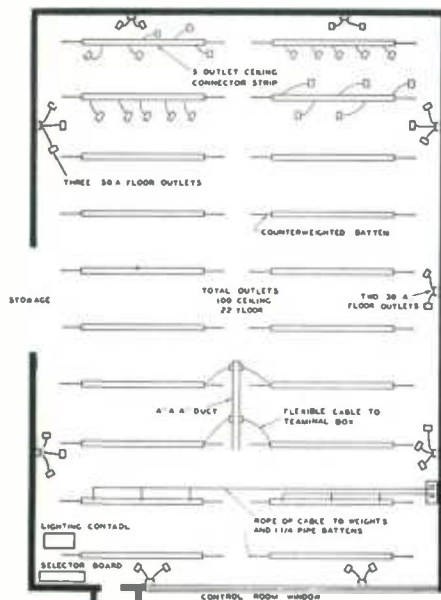

Plan #4 lighting arrangement.

Quantity B & W* Color*	Description	Century	Stock Reference Kliegl
2	2 Quartz Follow Spot with Iris, 1000W.....	1572	1357/8/1
4	6 Diffuser/Color Frame for Baby Scoop.....	3225	577
26	40 Diffuser/Color Frame for Large Scoop.....	3226	581
2	2 Roll of Spun Glass Diffuser	SGD	S-85
4	4 4-Way Barn Door for 3" Cameralight.....	2579	10803A
3	5 2-Way Barn Door for 6" Fresnel.....	2570	1106
2	3 4-Way Barn Door for 6" Fresnel.....	2580	1106A
8	14 2-Way Barn Door for 8" Fresnel.....	2571	1081
5	7 4-Way Barn Door for 8" Fresnel.....	2581	1081A
2	4 2-Way Barn Door for 12" Fresnel.....	2583	1082
3	3 Set of Patterns for Projection	2067	1097TV
4	4 Roller Caster Floor Stands	3216	1421
12	12 Lightweight Pantograph Hangers.....	3281	111TV
8	10 Medium Weight Pantograph Hangers.....	3283	112TV
20	22 Short Extension Cables	18RCCG	10E955G
4	4 Medium Extension Cables	25RCCG	25E955G
WIRING AND LIGHTING CONTROL DEVICES			
20	34 Connector Strips each 15 ft. long with 5-20 Amp. pigtail outlets, and 20 ft. of feed cable	6315/5-20GP	619G/15/5/20F
5	5 Wall Outlet Boxes each with 2-20 Amp. pigtail outlets.....	3018/2-20GP	2433G/2
0	5 Wall Outlet Boxes each with 2-50 Amp. pigtail outlets.....	3018/2-50GP	2433G/2X
2	2 Wall Receptacles, 60 60 Amp., 3 phase.....	3018/1-60GP	4957G/FB
1	0 Solid State Electronic Switch, Dimmer and Load Selection Board with 110-20 Amp. outlets, 6-3 kw and 6-6 kw Silicon Rectifier Dimmers, 7-6 kw Non-Dims, 1-250 Amp. 3-pole Main Breaker, and a 2-scene Pre-set Console.....	S65316	HP110/6/3R64
0	1 Solid State Electronic Switch, Dimmer and Load Selection Board with 180-20 Amp. and 10-50 Amp. Outlets, 10-3 kw and 10-6 kw Silicon Rectifier Dimmers, 10-6 kw Non-Dims, 1-400 Amp. 3-pole Main Breaker, and a 2-scene Pre-set Console.....	S65317	HP180/10/3R64

* If Vidicon Cameras are used, the quantities listed in the color column should be chosen.



- Choice of standard truck, bus or trailer chassis
- Custom designed for any requirement—monochrome or color live pickup, tape production, film and program transmission
- All equipment installed and system tested, ready for use

Custom TV Mobile Units

Description

Since the early days of television, mobile units—a station's studio-on-wheels—have broadened the scope of TV programming, added dynamic impact to sponsor's commercials, and proved an effective public relations medium. It is impossible to bring all events, sponsors, and environment to the studio door, but with a complete mobile production facility it is possible to drive to the scene to be tele-

vised. Whether the TV coverage problem is a sporting event, emergency news item, parade, convention or remote pickup of a sponsor product, a mobile unit is ready at all times.

The mobile unit can incorporate multiple camera chains, or many variations of other equipments including switching, tape, film and

microwave facilities. As such, it can be used in conjunction with broadcast studio facilities thereby permitting color or monochrome pickup and tape playback from existing facilities.

In producing commercials these same facilities can be transported to the sponsor's plant, or anywhere to capture the product story as it is

used. In educational and other closed circuit applications the mobile unit adds another dimension of efficiency—that of obtaining the highest degree of equipment utilization.

An attractively styled mobile unit is an excellent promotional asset. The unit can reflect the image that the station or agency wishes to set in the community. Combined with the many functional features of interior design and adequate drive-power "to get you there," the RCA Television Mobile Units offer the utmost in flexibility and efficiency.

RCA Television Mobile Units are custom built vehicles designed to meet specific customer requirements including road conditions, environment and equipment layout needs. Because of local restrictions in length, height and weight of a vehicle, it is important to design a mobile unit to meet the laws where it is to be licensed. When a unit is to be used interstate or intercounty then a compromise may be required in order that the unit can travel freely. Road conditions will determine the horsepower, suspension, and other features affecting roadability. For example, mountain roads require large horsepower engines and transmissions while bumpy, off-highway driving may require air suspension

instead of springs. In addition, the temperature and humidity expected to be encountered will determine the heating and cooling required inside the unit.

Twenty years of experience by RCA in the design and construction of color and monochrome TV mobile equipment are reflected in the RCA series of custom trucks, buses, and trailers. Each is specially engineered to provide the facilities required, whether it be for originating, recording or playing back of TV programs and commercials. Each unit is carefully engineered for efficient space utilization, operator comfort, and easy access to equipment. There is ample operating area for the operating and maintenance personnel. Complete underside storage space is provided in order that each equipment can be quickly unloaded. Everything to assure smooth production and program versatility, including central control, is designed into the equipment.

RCA Mobile Units are provided with standard truck, bus or trailer chassis and custom bodies. Standard brand chassis assure engine maintenance and spare parts anywhere on the road. Custom bodies offer many advantages including wider body, no wheel boxes, better visibility, full

size cab, firm door fits, versatile styling, underside storage compartments and recessed door handles and locks. Fiberglass front end, special 2-inch insulation, acoustical perforated steel walls and ceiling, custom interior lighting, reinforced floors and roof, rear bumper formed into step, and many other custom extras can also be provided. They have the design advantage of stronger construction and longer life.

RCA offers the following mobile equipment groupings: a series of TJ-70 Trucks, a series of TJ-80 Buses, and a series of TJ-90 Semi-Trailers. All mobile units are custom designed for the broadcast station which depends heavily on its remote pickup programs. They are engineered to meet the demands of the most rugged road tests. Interiors are designed to provide the utmost in comfort and convenience, whether the installations be simple or elaborate. Mobile units facilitate the origination of either elaborate or simple remote programs with minimum set-up time and provisions for up to four complete color or monochrome camera chains as well as video switching, audio and monitoring equipment. TV Tape and other specialized facilities can also be included in the RCA studios-on-wheels.

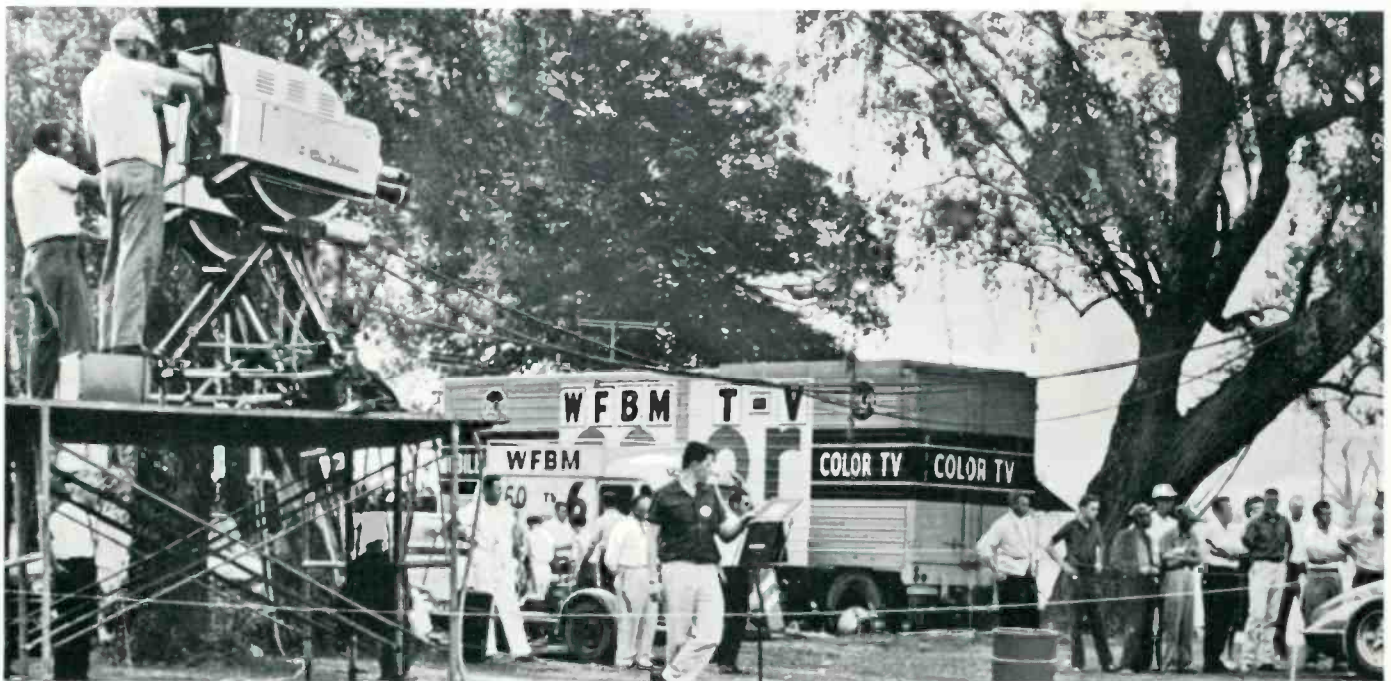

An excellent promotional asset, the broadcaster's studio-on-wheels is the most effective means of covering community events. Above, Station WFBM-TV uses trailer to color telecast the 500 Festival Golf Tourney.

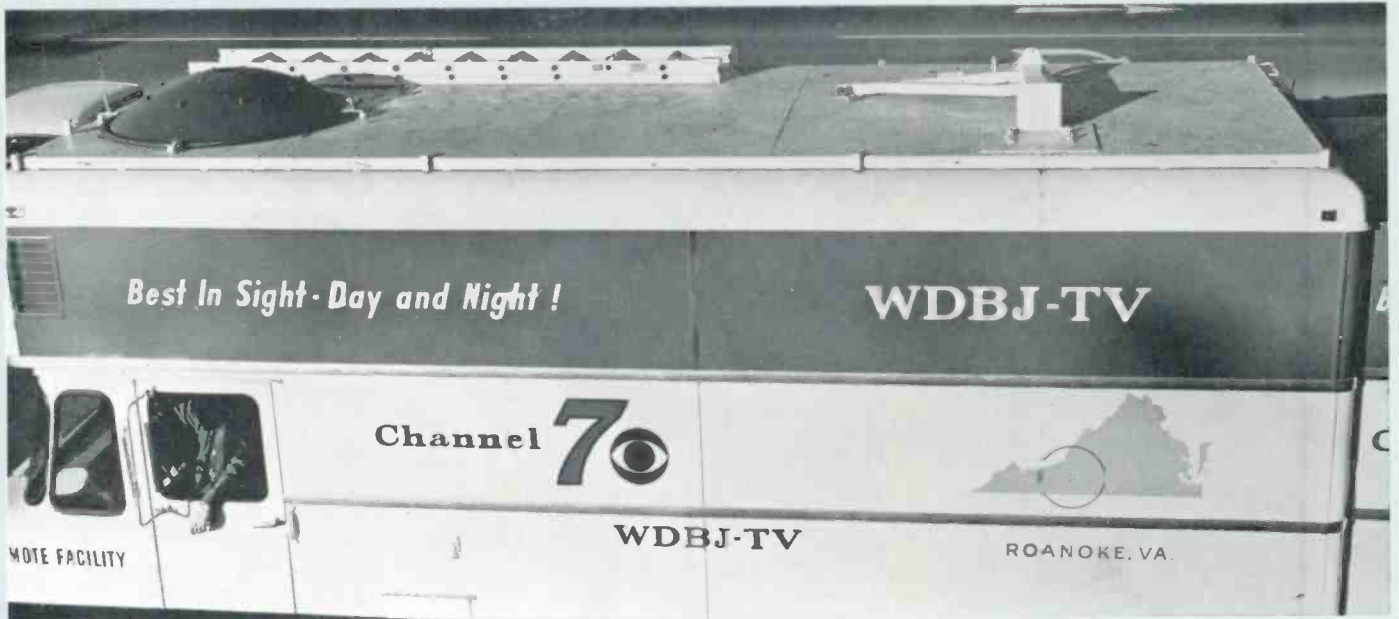

Select Features

RCA mobile units reflect years of experience in design and construction. From re-inforced roofs that afford vantage point for use of field camera chains to curbside storage compartments, custom truck above is engineered for efficient space utilization. The interiors of mobile units are divided in distinct operating areas with ample space for the driver, audio and tape center, switching operator and monitoring and control position. As shown below, operator comfort and easy access to equipment are prime considerations for both field case mounted equipments and permanent mounted philosophy.



TJ-70 Mobile Truck Series

The Type TJ-70 series of mobile units is characterized by the fact that the cab doors are located to the rear of the front wheels. Normally the operating cab is an integral part of the body and the usable area behind the driver's seat is the basis for defining the TJ-70 series. It is also possible to order a van or box-body type in which the cab and the operating studio portion are two distinct compartments on the same truck frame.

The smallest of the TJ-70 series is the TJ-71 Mobile Truck providing 10-feet of usable space behind the driver's seat. A typical complement of equipment which can be installed in this unit includes two image orthicon field camera chains,

a set of monitors, switching and terminal equipment, one TR-5 Tape Recorder, one BN-16 audio mixer. This represents a minimum system for a remote tape-recorded broadcast. Operationally, the audio, video and switching functions are provided on a single custom desk. The body design provides two large underside storage compartments, a mounting plate for tape recorder, and 10 by 7-foot roof platform.

The Type TJ-72 Mobile Trucks provide 16-feet of usable space behind the driver's seat. This larger unit allows room for more cameras, space for separate audio and switcher desks, and tape recorder/playback equipment. A typical complement of equipment would include up to four

image orthicon field camera chains, a set of monitor, switching and terminal equipment, a TR-4 TV Tape Recorder/Playback unit, and a Type BC-9A Audio Console. This body allows a 16 by 7 foot roof deck, built-in video and audio-switcher desks, underside storage compartments and mounting plate for tape recorder/reproducer.

The TJ-73, with 20-feet of usable space behind the driver's seat, can be tailored to fit the desires of the station or tape producer who may require the following equipments: up to four Image Orthicon camera chains; a set of monitor, switching and terminal equipments; one Type TR-22 Tape Recorder; one film island; and a Type BC-8A Audio Console.



Typical of the RCA Mobile Truck is the TJ-70 pictured. Maximum equipment storage space underside, balanced weight distribution, and air conditioning with cooling and heating units are design considerations. Featured is a fiberglass front with curved windshields and the central air conditioner mounted above the cab.



Shown is a typical video production desk with trays for field camera control units on the formica top and a forced air cooled compartment underside for field power supplies.



Typical interior of a TJ-70 series unit which has a video control desk in front, switcher and video desks in the middle and a TR-5 Tape Recorder at the rear. Shown is the view from the BC-8A Audio Console overlooking the three 14-inch production monitors, three 8-inch cameras, monitors and video control wedge with space for four CRO's in field cases.

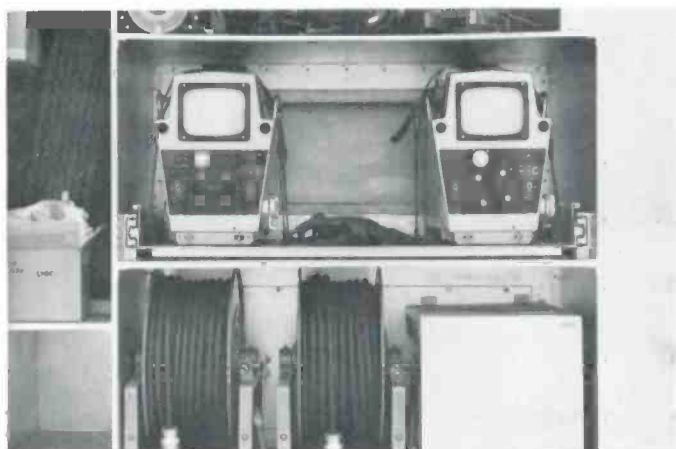

This Mobile Unit has provisions for transporting three field camera chains in easily accessible rear storage compartment. Shown above are camera tripods and dollies, a slider tray for three TK-60 Cameras, two cable reels, and storage space for a spare tire and regulator transformer.

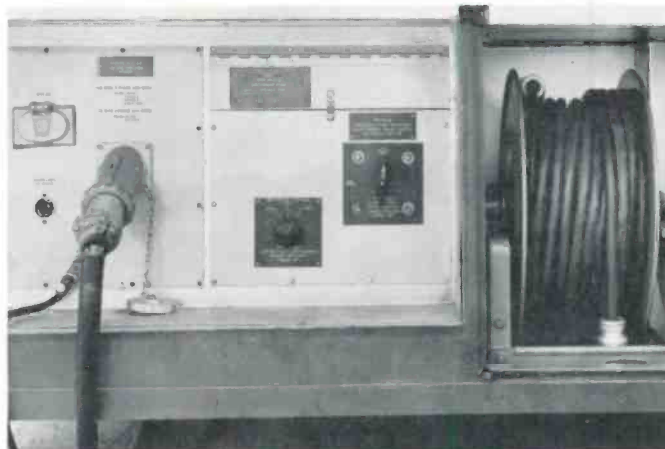

Rear curbside compartment showing power cable entrance panel, power selector panel, and power cable reel. Power selector panel contains 3 phase to single phase copper cross bar system behind hinged panel, a booster transformer cut-in switch for the air conditioner load, and a voltage tap selector switch for the isolation transformer.

Specifications

	TJ-71	TJ-72	TJ-73
Chassis	Standard truck, spring suspended with heavy duty shocks	Standard truck, spring suspended with heavy duty shocks	Standard truck, spring suspended with heavy duty shocks
Tires	7:50 x 20, 8 ply	8:25 x 20, 10 ply	9:00 x 20, 10 ply
Engine	300 cu. in., 6 cylinder, gasoline	345 cu. in., 8 cylinder, gasoline	354 cu. in., diesel
GWW	15,000 lbs.	20,000 lbs.	23,000 lbs.
Outside Dimensions:			
Length	16' 9"	21'	27' 6"
Width	8'	8'	8'
Height	10' 6"	11' 6"	11' 6"
Inside Dimensions (Usable):			
Length	10'	16'	20'
Width	7' 6"	7' 6"	7' 6"
Height	6' 4"	6' 6"	6' 6"
Body	Custom built with 10 ft. by 7 ft. roof platform, built-in production desk, two underside storage compartments, and mounting plate for tape recorder.	Custom built with 16 ft. by 7 ft. roof deck, built-in video, audio and switcher desks, underside storage compartments, and mounting plate for tape recorder.	Custom built with 16 ft. by 7 ft. roof deck, built-in video, audio and switcher desks, underside storage compartments and floor plates for film and tape equipments.

TJ-80 Mobile Bus Series

The TJ-80 Series of mobile units differs from the TJ-70 series in that the cab door is located forward of the front wheels. In addition to providing more usable space behind the driver's seat for the same overall length of vehicle, the bus series affords greater load carrying capability, sharper turning radius and better maneuverability. Buses with either forward or rear mounted engine can be specified. The overall length of the bus from bumper to bumper is the basis for defining the TJ-80 series.

The interior of the bus is divided in distinct operating areas, with ample space for the driver, audio and tape center, switching operator, and monitoring and control position. The rear of the mobile unit is given over to rack equipment, and the storage closets and cubicles. Double doors at the rear provide access to air coolers and generators. The unit has perforated steel walls and ceiling, and 2-inch insulation with aluminum foil moisture barrier. It is completely air conditioned.

The custom body is susceptible to numerous design changes to meet custom installations requirements. Doors can be single or double type, steps portable or retractable, a wide choice of floorings, custom duct work throughout, custom lighting, trim, reinforced roof platform, special window and windshield glass, paint body of exterior and interior and trim to suit station preference, with many other minor details designed to provide the utmost in efficiency, safety and reliability.

The TJ-81 is a 30-foot bus capable of accommodating two color camera chains, a set of monitors and terminal equipment, a colorized Type TR-4 TV Tape Recorder, one TS-40 vertical internal switcher and a

RCA Mobile units are completely air conditioned by means of efficient central type units. Shown is a rear mounted 17-ton cooling and 9-KW heating unit. Other standard equipment includes three heavy-duty tapped isolation power transformers and three transistor controlled voltage regulators.

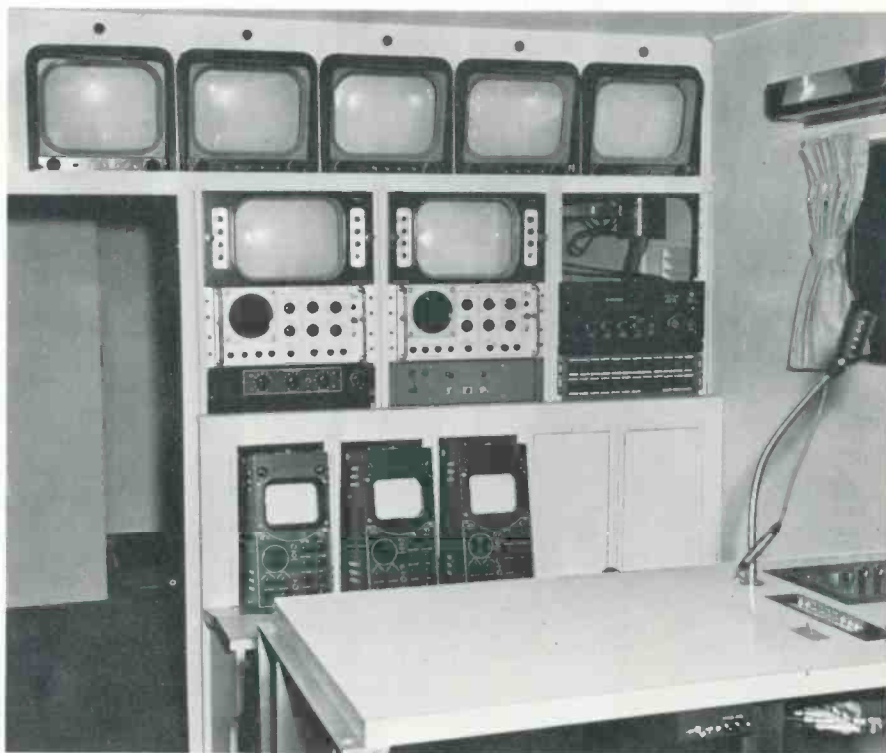

TJ-80 Mobile Bus showing distinct operating areas with ample space for the driver, audio and tape center, switching operator, and monitoring and control positions.

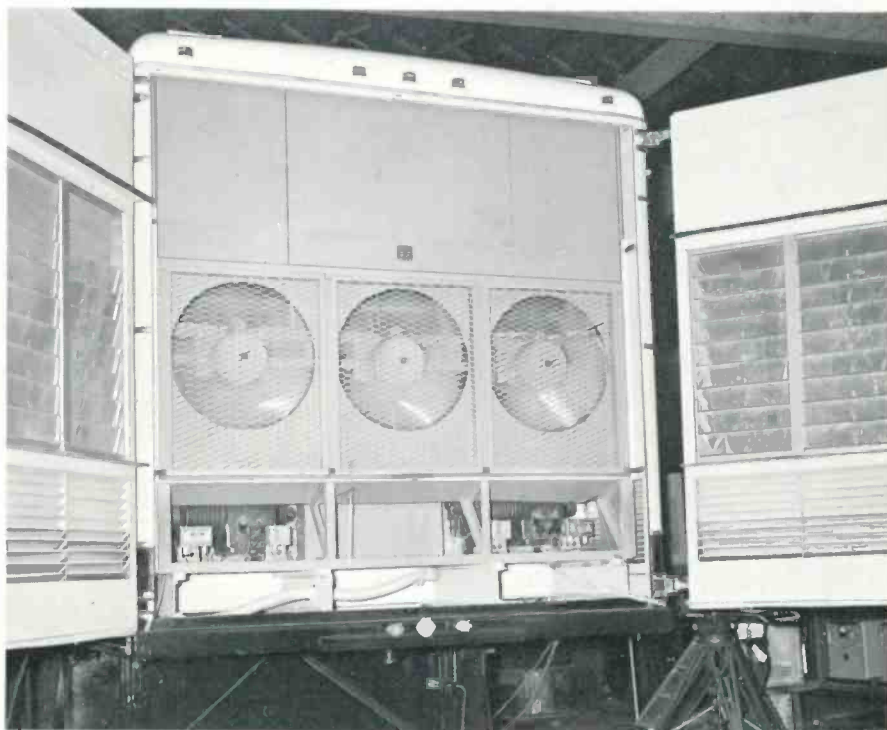

Artist's conception of typical 35-foot bus for monochrome camera production system including front to rear: custom audio desk, custom switching desk, video position for five field camera controls, custom monitor frame and two equipment rack assemblies.

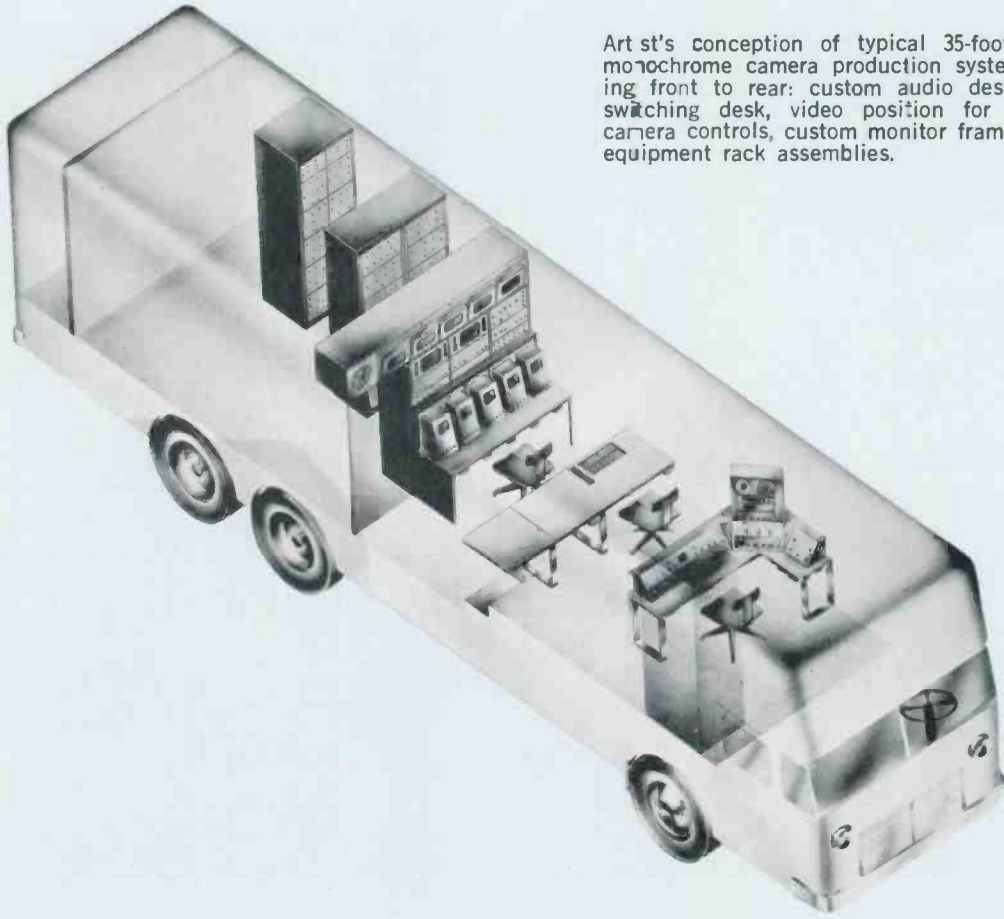

Distinctive RCA air bag suspension system which provides air-smooth riding, automatic leveling and longer equipment life. Bellows shown are optional with any RCA custom mobile truck, bus or trailer.

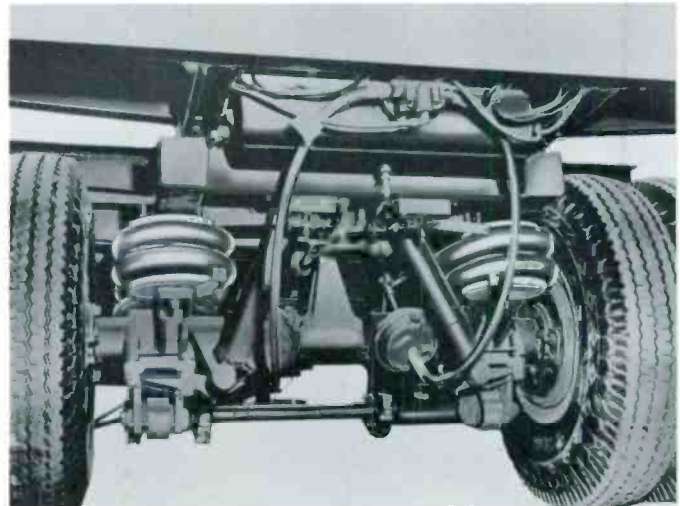

TJ-80 Mobile Bus Series (cont'd)

BC-7A Audio Console. A 20 by 7 foot roof deck is provided as well as ample storage cabinets, underside storage, and special camera storage facilities.

The 35-foot TJ-82 Mobile Bus is an ideal unit for transporting a complete monochrome camera production system. It can also be used for color TV Field operation. This unit consists essentially of a standard commercially available bus chassis which is modified for tandem rear axles upon which is constructed a custom body, attractively styled and well engineered for practical application of remote television pickups. This Mobile Unit serves as a studio always ready to move when needed and ready for operation in a minimum of time. Space is provided for all essential equipment needed for the pickup of a remote television program. Such equipment includes cameras, synchronizing generator, switching facilities, power supplies, and a means for relaying the picture and sound information back to the station.



The TJ-80 series is susceptible to numerous custom installation requirements. However, ample storage especially designed for safe equipment transportation is prime consideration in all units. In this unit a motor generator was also mounted in the lower rear of the bus.



Interior view of typical bus showing switching console overlooking the equipment frame and color video position in the operating compartment.



An RCA custom bus design illustrating maximum utilization of all available space for equipment storage.

Specifications

Chassis	TJ-81 Standard bus modified for tandem rear axles with air suspension heavy duty front shocks, power steering, air brakes, and dual 30 gallon gasoline tank.	TJ-82 Standard bus modified for tandem rear axles with air suspension, heavy duty front shocks, power steering, air brakes, and dual 30 gallon gasoline tank.
Tires	9:00 x 20, 12 ply	10:00 x 20, on 7.50 V rims
Engine	500 cu. in. V8, gasoline	—
GVW	30,000 lbs.	—
Outside Dimensions:		
Length	30'	35'
Width	8'	8'
Height	12'	12' 6"
Inside Dimensions (Usable):		
Length	27' 6"	31' 6"
Width	7' 6"	7' 6"
Height	6' 8"	7'
Body	Custom built with 20 by 7 foot roof deck, maximum under truck storage, custom desks and storage cabinets and special camera storage facilities.	Custom built with built-in power frame, video control equipment frame, storage compartments at rear production and audio decks, windows to customer specifications, roof deck, and complete underside storage area.

TJ-90 Mobile Trailer Series

A trailer offers many advantages over bus or truck. Most significant is the fact that a trailer provides 5 to 8 feet more inside length for the same overall length. RCA trailers provide about 60 percent more cubic storage space than a truck or bus with a forward mounted engine, and 80 percent more than a bus with a pancake engine underneath. Furthermore, a tractor to pull the trailer to a new site can be rented instead of made a part of the capital investment. If a tractor is provided, it becomes an ideal place to mount the motor generator, since it can then be driven a distance away from the trailer to reduce noise.

The TJ-90 Series of Trailers includes: the Type TJ-91 a 30-foot articulated van; the Type TJ-92, a 35-foot articulated van; and the TJ-93, a 40-foot articulated van. In common with other RCA mobile units, the studio trailer is designed from the chassis up specifically for color television mobile use. The trailer consists of a standard chassis with custom body built to be structurally sound and equipped for TV production requirements. The diamond steel roof is reinforced to permit its use as a camera mounting platform when on location. The outside walls are smooth, there are no wheel boxes, and the front is square with rounded corners. Typical facilities include king pin trailer hitch, air brakes, wire trench under floor, ceiling tie bars for equipment support, heavy-duty linoleum floor covering, insulated walls and ceiling, installed interior lighting system, special access doors, curbside door ladder, built-in power controls, and compartmentalized construction to house each unit of TV equipment.

The Mobile Trailer is completely air conditioned. Tapped isolation power transformers and transistor controlled voltage regulators are included. Recessed, covered power connectors are provided for connection of the trailer to commercial power sources.



Standard 35-foot trailers with custom body built to be structurally sound and equipped for TV production requirements offer maximum mobile facilities. TJ-90 design includes king pin trailer hitch, air brakes, under floor wiring trench, ceiling tie bars for equipment support, heavy-duty floor covering, insulated walls and ceiling, special access doors, curbside door ladder, compartmentalized construction to house each unit of TV equipment and many other plus features.

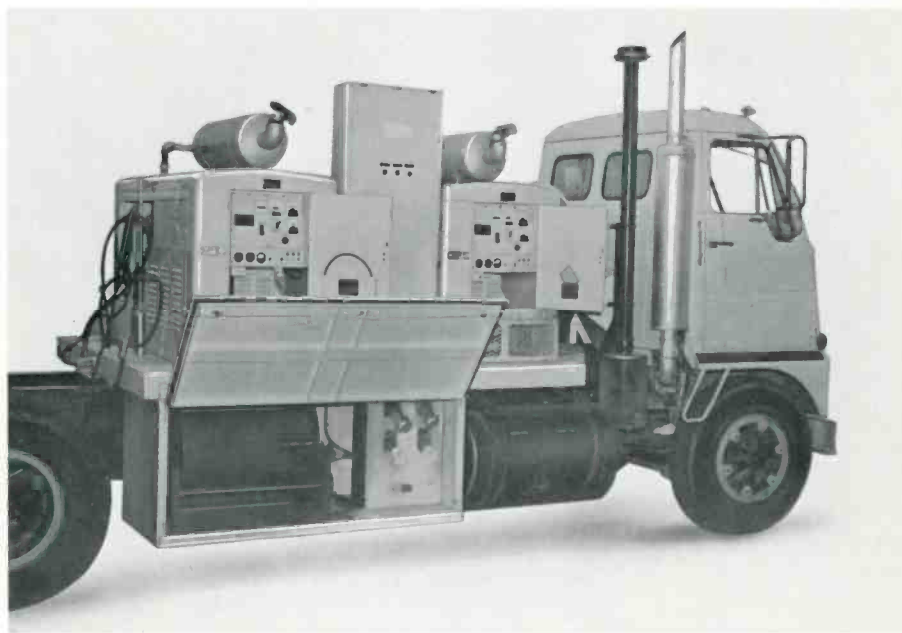

Tractor with dual 45 KW motor generators and automatic switch-over panel custom mounted. Note underside compartment provided for a power cable reel and power cable entrance panel.

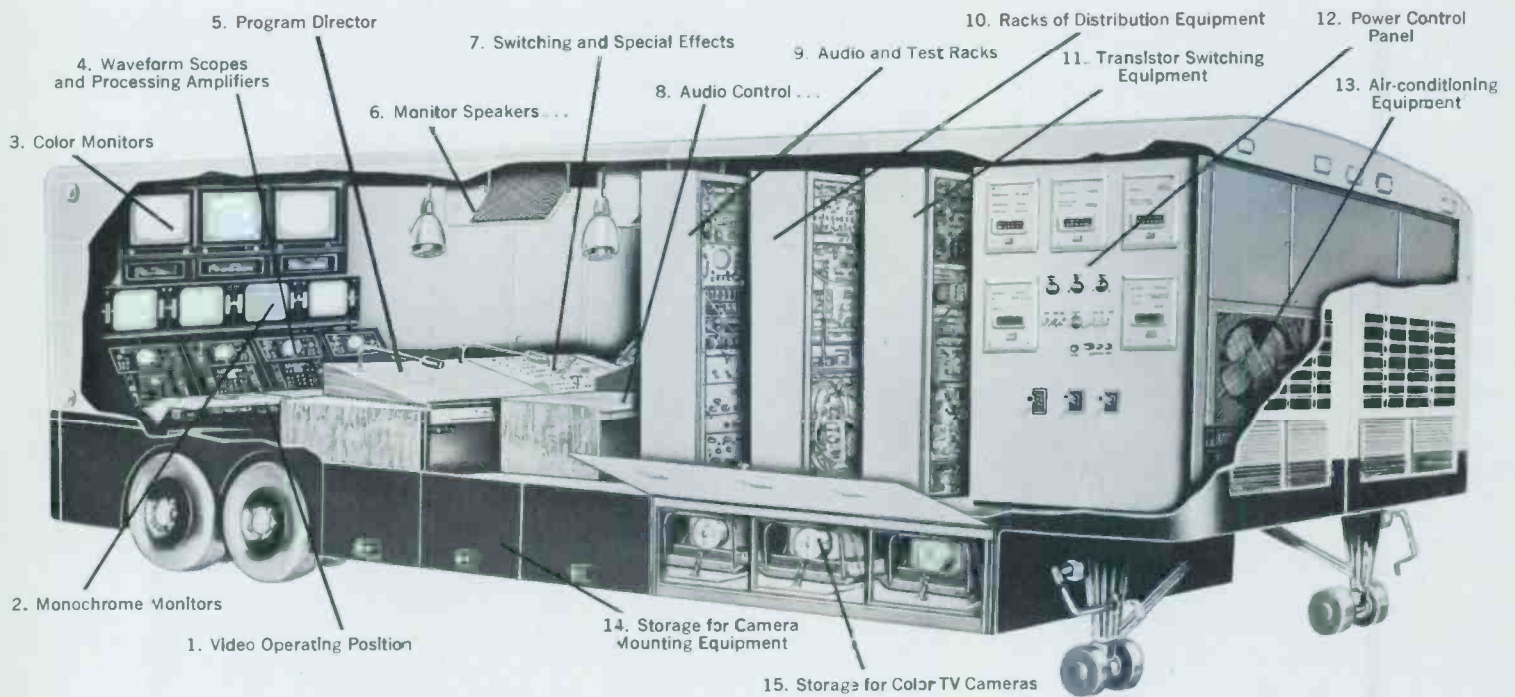

Color Mobile Trailer such as this TJ-92 unit is the largest of RCA custom designed studios-on-wheels.

Specifications

	TJ-91	TJ-92	TJ-93
Chassis	Custom semi-trailer chassis with single axle, air suspended 30-foot with two speed, individually controlled landing gear.	Custom semi-trailer chassis with tandem axle, air suspended 35-foot with two speed, individually controlled landing gear.	Custom semi-trailer chassis with tandem axle, air suspended 40-foot with two speed, individually controlled landing gear.
Tires	10:00 x 20, 12 ply	10:00 x 20, 12 ply	10:00 x 20, 12 ply
GVW	36,000 lbs.	50,000 lbs.	50,000 lbs.
Outside Dimensions:			
Length	30'	35'	40'
Width	7' 11½"	7' 11½"	7' 11½"
Height	12' 6"	12' 6"	12' 6"
Inside Dimensions:			
Length	29'	34'	39'
Width	7' 6"	7' 6"	7' 6"
Height	7' 2"	7' 2"	7' 2"
Body	Custom built with roof platform, winch, built-in audio desk and switching desk, and complete underside storage compartments.		

Summary

All RCA mobile units of TJ-70, TJ-80 or TJ-90 vintage are custom designed to provide the following:

Air conditioning—both heating and cooling to meet expected environment. RCA units also include special control features to minimize power line surges and provide low noise.

Custom Air Duct System—assures cool air where it is needed.

Power Isolation Transformers—complete with taps to accommodate varying voltage sources.

Voltage Regulators—incorporate transistorized automatic control.

Power Control Panel—built-in with switchable meters.

Fire Extinguishers.

Set of Power Cables and Connectors installed.

Power Entrance panel.

All TV Equipment Installed, wired and tested as a system prior to delivery to the customer.

Custom lettering and body finishes painted to customer specifications.

RCA's Engineering experience can be applied to your mobile problem and a design tailored to fit your needs. Our engineers and functional designers will work closely with your staff to develop maximum utility and practical layout with a minimum investment.

Optional features available in truck, bus or trailer are:

Expansible Sides—permits sides to open out to enlarge operating and maintenance area when at standstill.

Air Suspension—50 percent better ride. Automatic leveling provided.

Motor Generator—built in or on trailer type (See trailer photo).

Air Conditioning—complete cooling, heating and humidity control.

Ordering Information

When requesting information on Custom Mobile Units refer to the following designations:

TJ-70 Series Trucks (Front doors to rear of front wheels)

TJ-71	10 ft. Usable space behind driver seat
TJ-72	16 ft. Usable space behind driver seat
TJ-73	20 ft. Usable space behind driver seat

TJ-80 Series Buses (Front door forward of front wheels)

TJ-81	30 ft. Overall Length
TJ-82	35 ft. Overall Length

TJ-90 Series Trailers (Requires Tractor for motive power)

TJ-91	30 ft. Overall length less tractor
TJ-92	35 ft. Overall length less tractor
TJ-93	40 ft. Overall length less tractor

Index

	MI No.	Page
AC Voltage Regulator for TK-42 Cameras.....	557230-A1	14
Adaptors:		
Close-up (for Varotal Lenses).....	—	36
Coaxial (set of 25 for use with MI-13325).....	40423	58
Console Well (for use with control panels).....	26252	21, 54
Rack (for use with control panels).....	26254	21, 54
Wedge Mount (for TK-60 Cameras).....	26884-A	22
Adjustable Viewfinder Hood, for TK-33/42 Cameras.....	557320	14
Air Compressor for PN-6 Series Pneumatic Pedestals.....	PN-100	44
Amplifier, Transistor Type (replacement for Interphone Induction Coil).....	11757	54
Bulk Cable	—	58
Burst Pattern Chart.....	IB-31605	40
Cable (Bulk):		
Pulse, 8 conductor 4-75 ohm coax, 4 #16.....	48	58
Coax, 52 ohm Vinyl jacket (RG-8/U).....	74A	58
Coax, 75 ohm Vinyl jacket (RG-59A/U).....	75	58
Coax, 75 ohm Vinyl jacket (RG-11A/U).....	83A	58
For Monochrome Camera, Neoprene jacket.....	94N	58
Coax, 50 ohm Vinyl jacket (RG-58/U).....	13318-A	58
18 Conductor; 2 #16, 16 #22.....	13319	58
33 Conductor (for TK-26 Camera Control).....	13320	58
Delay, 1000 ohm impedance (RG-65/U).....	13321	58
Coax, 75 ohm, double shielded.....	13325	58
7 Conductor, #20, rubber jacket.....	13333	58
26 Conductor, Vinyl jacket.....	13341	58
34 Conductor, #22, Vinyl jacket.....	13345-17	58
52 Conductor, #22, Vinyl jacket.....	13348	58
16 Conductor, #16 shielded Neoprene jacket.....	13351	58
79 Conductor (for TK-42 Camera).....	13356	58
53 Conductor (for TK-33 Camera).....	13357	58
52 Conductor, #22, Vinyl jacket.....	13358	58
2 Conductor, #14, Vinyl jacket.....	13380-2	58
3 Conductor, #14, Vinyl jacket.....	13380-3	58
4 Conductor, #14, Vinyl jacket.....	13380-4	58
5 Conductor, #14, Vinyl jacket.....	13380-5	58
6 Conductor, #14, Vinyl jacket.....	13380-6	58
8 Conductor, #14, Vinyl jacket.....	13380-8	58
12 Conductor, #14, Vinyl jacket.....	13380-12	58
82 Conductor (for TK-41C Camera).....	13394-N	58
Cable (Camera):		
TK-26 Camera Control, 33 conductor, 50 ft.....	40831-1	56
TK-27 Color Film Camera, 50 ft.....	557307	56
TK-33 Camera, 50 ft.....	557331-1	56
TK-33 Camera, 100 ft.....	557331-2	56
TK-33 Camera, 200 ft.....	557331-3	56
TK-41C Single Color, 50 ft.....	40868-2	56
TK-41C Single Color, 100 ft.....	40868-3	56
TK-41C Single Color, 200 ft.....	40868-4	56
TK-42 Camera, 50 ft.....	557315-1	56
TK-42 Camera, 100 ft.....	557315-2	56
TK-42 Camera, 200 ft.....	557315-3	56

	MI No.	Page
TK-60 Camera, straight connectors, 50 ft.....	26725-E5	56
TK-60 Camera, straight connectors, 100 ft.....	26725-E6	56
TK-60 Camera, straight connectors, 200 ft.....	26725-E7	56
TK-60 Camera, straight female and 90° male connectors, 50 ft.....	26725-E9	56
TK-60 Camera, 90° connectors, 50 ft.....	26725-E10	56
Cable (Coax Assemblies):		
Coax Cable with 2 male plugs and dustcaps, 75 ohms, 7 ft.....	26759-12	57
Coax Cable with 2 male plugs and dustcaps, 75 ohms, 25 ft.....	26759-13	57
Coax Cable with 2 male plugs and dustcaps, 75 ohms, 100 ft.....	26759-15	57
Coax Cable with 2 male plugs and dustcaps, 75 ohms, 10 ft.....	26759-59	57
Cable (Interconnecting Sets):		
For TK-11/14 Studio Camera Control.....	26746	57
For TK-14 Field Camera Chain.....	43201	57
For TS-30E Field Switching Equipment.....	26740-A	57
For TK-31 Field Camera Chain.....	26730	57
For TK-33 Field Camera Chain.....	557244	57
For TK-60 Field Camera Chain.....	26359	57
Cable (Power and Control):		
Power Cable (10 ft., 2 cond. with plugs).....	26759-2	57
Power Cable (34 ft., 12 cond. with plugs).....	26759-6	57
Power Cable (6 ft., 12 cond. with Cannon Plugs).....	26759-7	57
Power Cable (6 ft., 12 cond. with Jones Plugs).....	26759-8	57
Pulse Cable (7 ft., 8 cond. with Cannon Plugs).....	26759-9	57
Interphone Cable (7 ft., 8 cond. with Cannon Plugs).....	26759-11	57
Power Cable (4 ft., 18 cond. with Jones Plugs).....	26759-41	57
Power Cable (5½ ft., 12 cond. with Jones Plugs).....	26759-42	57
Power Cable (10 ft., 12 cond. with plugs).....	26759-46	57
Control Cable (3 ft., 8 cond. with straight male and 90° female connectors).....	26759-57	57
Power Cable (10 ft., 3 cond. with plugs).....	26759-58	57
Transmission Line Cable (10 ft. with plugs).....	26759-59	57
Control Cable (7 ft. with plugs).....	26759-60	57
Interphone Cable (10 ft. with plugs).....	26759-61	57
Power Cable (7 ft., 12 cond. with plugs).....	26759-62	57
Power Cable (7 ft., 15 cond. with plugs).....	26759-64	57
Orbitor Cable (7 ft., 7 cond. with plugs).....	26759-65	57
Cable Accessories:		
Straight Male Cable Connector.....	26759-A21	57
Straight Female Cable Connector.....	26759-A22	57
90° Female Cable Connector.....	26759-23	57
90° Male Cable Connector.....	26759-24	57
Dust Cap for Male Cable Connector.....	26759-A41	57
Dust Cap for Female Cable Connector.....	26759-A42	57
Coax Termination, 1%, 75 ohms.....	26759-45	57
TK-41C Male Color Cable Connector (82 cond.).....	40529-1	57
TK-41C Female Color Cable Connector (82 cond.).....	40529-2	57
TK-41C Female Chassis Connector (82 cond.).....	40529-4	57
TK-41C Male Chassis Connector (82 cond.).....	40529-3	57
TK-33 Male Cable Connector.....	557316-1	57
TK-33 Female Cable Connector.....	557316-2	57
TK-33 Male Chassis Connector.....	557316-3	57
TK-33 Female Chassis Connector.....	557316-4	57
TK-42 Male Cable Connector.....	557321-1	57
TK-42 Female Cable Connector.....	557321-2	57
TK-42 Male Chassis Connector.....	557321-3	57
TK-42 Female Chassis Connector.....	557321-4	57
Crimping Tool for MI-40423.....	40422-A	58

	MI No.	Page
Adaptor, Coax. (Set of 25 for use with MI-13325 Dual Shielded Coax.).....	40423	58
Straight Female Connector, waterproof, 24 cond.....	26759-48	56
Gasket (for MI-26759-48).....	26759-59	56
Cameras:		
Type TK-33 Transistorized Monochrome.....		23-26
Type TK-42 Transistorized Color.....		5-14
Type TK-60 4½-Inch Orthicon Field and Studio Chain.....		15-22
Type TK-1 Monoscope.....		27-28
Cam:		
For TK-10/30, 11/31 and 14 Cameras.....	557311-1	50
For TK-40/41 Cameras.....	557311-3	50
For TK-42 Cameras.....	557311-4	50
For TK-60 Cameras.....	557311-2	50
Cam Head (Complete):		
For TK-40/41 Cameras.....	557309	50
For TK-42 Cameras.....	557310	50
For TK-60 Cameras.....	557308	50
Centering Current Unit (for WP-16B Power Supply).....	26083-B	28
Chart:		
EIA Linearity	26822-1	39
EIA Resolution	26822-2	39
EIA Registration	26822-3	39-40
EIA Linear Reflectance.....	26822-4	40
EIA Logarithmic Reflectance.....	26822-5	40
RCA Burst Pattern.....	IB-31605	40
Close-Up Adaptor for Varotal Lenses.....		36
Color TV Camera, Type TK-42.....		5-14
Color Field Lenses.....		34
Compressor, Air (for PN-6 Series Pneumatic Pedestals).....	PN-100	44
Connection Unit, Transistor Interphone.....	11784-A	54
Connectors (Cable Accessories).....		55-58
Console Adaptor (for Control Panels).....	26252	21, 54
Cord, Lacing—Black #6.....	11719-A	56
Counterweights for TD-3 Pedestal (Required for TK-60 Cameras).....	26391	42
Cover:		
Upper Left Side (for console housing).....	26789-1	21
Upper Right Side (for console housing).....	26789-2	21
Control Panels:		
TK-60 Remote to mount in TM-35.....	26007	22
TK-60 Remote to mount in older consoles.....	26008	22
TK-60 Remote to mount in "New Look" consoles.....	557220	22
Cradle Head, Midnight Blue (for monochrome cameras).....	26203-B	50
Diascope, Watson Barnet.....	Model 251	41
Dolly, Folding Tripod (Midnight Blue) Type TD-15B.....	26042-B	48
Equalizer, TK-42 In-Line Cable.....	557245	14
Extracting Tool, Terminal.....	43226	14
Field Lenses		34
Field Processor (for TK-60B Series).....	556009-B	22
Friction Head, Midnight Blue.....	26205-B	50

	MI No.	Page
Headset:		
Single	11743	54
Double	11754	54
Hood:		
Adjustable Viewfinder for TK-33/42.....	557320	14
TK-60 Viewfinder	26373	22
I & Q Color Bar Module.....	556554	14
I.O. Yoke Assembly (spare for TK-60 Cameras).....	26004-A	21
In-Line Cable Equalizer (for TK-42 Camera).....	557245	14
Intercom Key Switch Panel Assembly.....	11754	54
Interphone Equipment:		
Interphone Connection Unit.....	11734	54
Shelf (for Interphone Connection Unit).....	11735	54
Panel (accommodating up to 14 Retardation Coils).....	11736	54
Retardation Coil	11737	54
Single Headset	11743	54
Double Headset	11744	54
Intercom Key Switch Panel Assembly.....	11754	54
Switch	11755-2	54
Switch Housing Assembly.....	11756	54
Transistor Amplifier (Replacement for Induction Coil).....	11757	54
Transistor Interphone Connection Unit.....	11784-A	54
Console Adaptor (for MI-11754).....	26252	54
Rack Adaptor (for MI-11754).....	26254	54
Iris Drive Assembly, Remote (spare, for TK-60B Cameras).....	26019	21
Lacing Cord, Black #6.....	11719-A	56
Lens:		
Angenieux Evershed Zoomar: 35 to 350mm, f/3.8.....	Model 10 x 35	38
Angenieux Zoomar: 40 to 400mm, f/5.0.....	Model 10 x 40C	38
Angenieux Range Converter: 3 to 30 Inches, f/9.4.....		38
Angenieux Evershed Range Converter #1; 2.25 to 22.5 Inches, f/5.6.....		38
Angenieux Evershed Range Converter #2; 3.6 to 36 Inches, f/8.0.....		38
Angenieux Evershed Range Converter #3; 5.7 to 57 Inches, f/11.....		38
Cannon: 35mm, f/2.0.....	26177-1	34
Cannon: 50mm, f/1.8.....	26177-2	34
Cannon: 85mm, f/1.9.....	26177-3	34
Cannon: 135mm, f/3.5.....	26177-4	34
Cannon: 8-inch, 200mm, f/3.5.....	26177-5	34
Cannon: 12-inch, 300mm, f/4.0.....	26177-6	34
Cannon: 16-inch, 400mm, f/4.5.....	26177-7	34
Cannon: 24-inch, 600mm, f/5.6.....	26177-8	34
Color Field: 20.0 Diopter, for 50mm.....	40802-A1	34
Color Field: 13.5 Diopter, for 90 and 135mm.....	40802-A2	34
Color Field: 7.0 Diopter, for 8½-inch.....	40802-A3	34
Color Field: 5.75 Diopter, for 13-, 15- and 17-inch Berthiot B-4, and Studio Zoomar.....	40802-A4	34
Color Field: 4.5 Diopter, for 25-inch.....	40802-A5	34
Color Field: 16.5 Diopter, for 75mm.....	40802-A6	34
Color Field: 24.7 Diopter, for 35mm.....	40802-A7	34
Ortal: 1.10-inch, 28mm, f/2.0.....	26882-A1	32
Ortal: 1.38-inch, 35mm, f/2.8.....	26882-A2	32
Ortal: 2.0-inch, 50mm, f/2.0.....	26882-A3	32
Ortal: 3.0-inch, 75mm, f/2.0.....	26882-A4	32
Ortal: 5.0-inch, 127mm, f/2.8.....	26882-A5	32
Ortal: 8.0-inch, 203mm, f/4.0.....	26882-A6	32
Ortal: 12.5-inch, 317mm, f/4.0.....	26882-A7	32

	MI No.	Page
Ortal: 16-inch, 406mm, f/4.0.....	26882-8	32
Ortal: 22-inch, 559mm, f/5.6.....	26882-9	32
Varotal Studio: 1.6 to 16-inch Zoom (Specify RCA Camera).....	Varotal V	36
Varotal Outdoor: 4 to 20-inch or 8 to 40-inch Zoom (Specify RCA Camera)	Varotal III	36
Lighting Equipment for TV Studios.....		59-70
Linear Reflectance Chart.....	26822-4	40
Linearity Chart	26822-1	39
Logarithmic Reflectance Chart.....	26822-5	40
Mobile Units:		
TJ-70 Series	Custom	74-75
TJ-80 Series	Custom	76-79
TJ-90 Series	Custom	80-82
Module, I & Q Color Bar for TK-42.....	556554	14
Panel:		
Mounting for 14 Retardation Coils.....	11736-A	54
Intercom Key Switch Assembly.....	11754	54
Pedestals:		
Type TD-3 Counterbalanced.....	26036-A	42
Type TD-7AO Lightweight (90-170 lb. Cameras).....	26044-A	45
Type TD-7AV Lightweight (60-90 lb. Cameras).....	26054	45
Type TD-9BC Motor Driven, 115 V., 60 Hz, 6 amps. (Color Cameras).....	40861-A	43
Type TD-9BC Motor Driven, 230 V., 50 Hz, 3 amps. (Color Cameras).....	N40861-A	43
Type TD-9BM Motor Driven, 115 V., 60 Hz, 6 amps. (Monochrome Cameras)	26038-A	43
Type TD-9BM Motor Driven, 230 V., 50 Hz, 3 amps. (Monochrome Cameras)	N26038-A	43
Type PN6-29 Pneumatic-Balance.....	PN6-29	44
Type PN6-29B Pneumatic Balance with Brake.....	PN6-29B	44
Type PN88-33B/C Pneumatic-Balance Heavy Duty with Brake.....	PN88-33B/C	44
Type TD-10A Hydraulic Camera.....	26053-A	46
Type TD-11B Metal Tripod (Midnight Blue).....	26046-A	47
Type TD-15B Folding Tripod Dolly (Midnight Blue).....	26042-B	48
Plate Adaptor Mounting (For TK-10/30, 11/31 & 14 Cameras).....	557312	50
Plugs (Cable Accessories).....		55-58
Preamplifier Video (spare for TK-60A Camera).....	26019	21
Processor:		
TK-60B Rack Mounting.....	556003-B	22
TK-60B Field	556009-B	22
Power Supply:		
Type WP-16B, 60 Hz.....	26084-B	28
Type WP-16B, 50 Hz.....	26094-B	28
Rack Adaptor:		
For Intercom Key Switch Panel Assembly.....	26254	54
For Remote Control Panel MI-26007.....	26887-2	21
For Remote Control Panel MI-26008.....	26254	21
Range Extenders:		
#1: 2.4 to 24-inch at f/6.0 (for Varotal V Lens).....		36
#2: 3.2 to 32-inch at f/8.0 (for Varotal V Lens).....		36
#3: 4.8 to 48-inch at f/12.0 (for Varotal V Lens).....		36
Reflectance Chart, Linear.....	26822-4	40
Reflectance Chart, Logarithmic.....	26822-5	40
Registration Chart	26822-3	40
Regulator, AC Voltage (for TK-42 Camera).....	557230-A1	14

	MI No.	Page
Remote Control Panels:		
TK-60B (Console Mounting).....	26008	22
TK-60B ("New Look" Console Mounting).....	557220	22
TK-60B (TM-35 Mounting).....	26007	22
Remote Iris Drive Assembly (spare for TK-60B).....	26019	21
Resolution Chart	26822-2	40
Retardation Coil (Interphone Equipment).....	11737	54
Shelf (for Interphone Connection Unit).....	11735	54
Shock Mounts:		
For TK-60B Camera Processor.....	26511-A6	21
For TM-35 Monitor.....	26511-A3	21
For WP-16B Power Supply.....	26511-A5	21
Side Cover:		
Upper Left for Console.....	26789-1	21
Upper Right for Console.....	26789-2	21
Steering Wheel:		
25-inch Diameter (supplied with TD-9BM Camera Pedestal).....	26039	43
34-inch Diameter (supplied with TD-9BC Camera Pedestal).....	40862	43
Studio Lighting Equipment.....		59-70
Switch (Interphone Equipment).....	11755-2	54
Switch Housing Assembly (Interphone Equipment).....	11756	54
Terminal Extracting Tool.....	43226	14
Tripod, Type TD-11B (Midnight Blue).....	26046-A	47
Tripod Dolly, Type TD-15B (Midnight Blue Folding).....	26042-B	48
Tubes:		
1699 Special Monoscope.....	Type 1699	28
2F21 Monoscope	26657	28
Video Preamplifier (spare for TK-60 Cameras).....	26006-A	21
Viewfinder Hood (for TK-60 Cameras).....	26373	22
Voltage Regulator, Type WO-85 (for TK-42 Cameras).....	557230-A1	14
Wedge Mount Adaptor (for TK-60 Cameras).....	26884-A	22
Yoke Assembly (spare for TK-60 Cameras).....	26004-A	21



The Most Trusted Name in Television

RADIO CORPORATION OF AMERICA

BROADCAST AND COMMUNICATIONS PRODUCTS DIVISION, CAMDEN, N.J. 08102 • RCA INTERNATIONAL DIVISION, CENTRAL & TERMINAL AVENUES, CLARK, N. J. 07066