

88T 2 1 1968

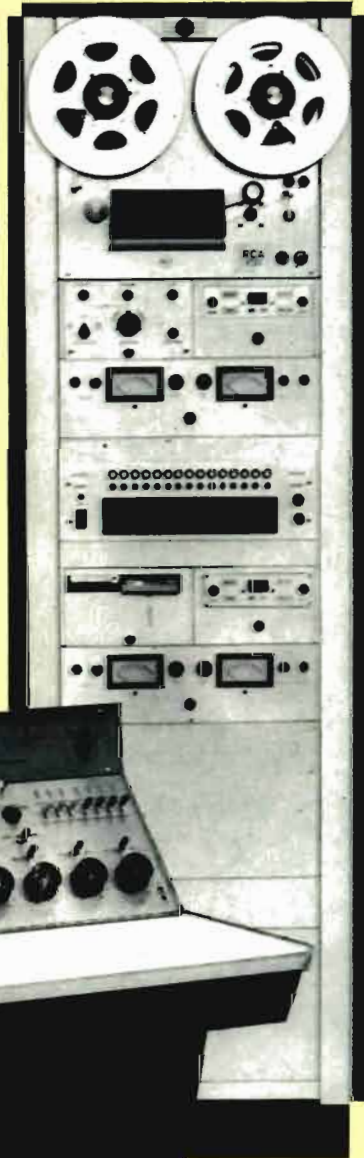

MICROPHONES • CONSOLES • RECORDERS • SPEAKERS



BROADCAST
audio
EQUIPMENT

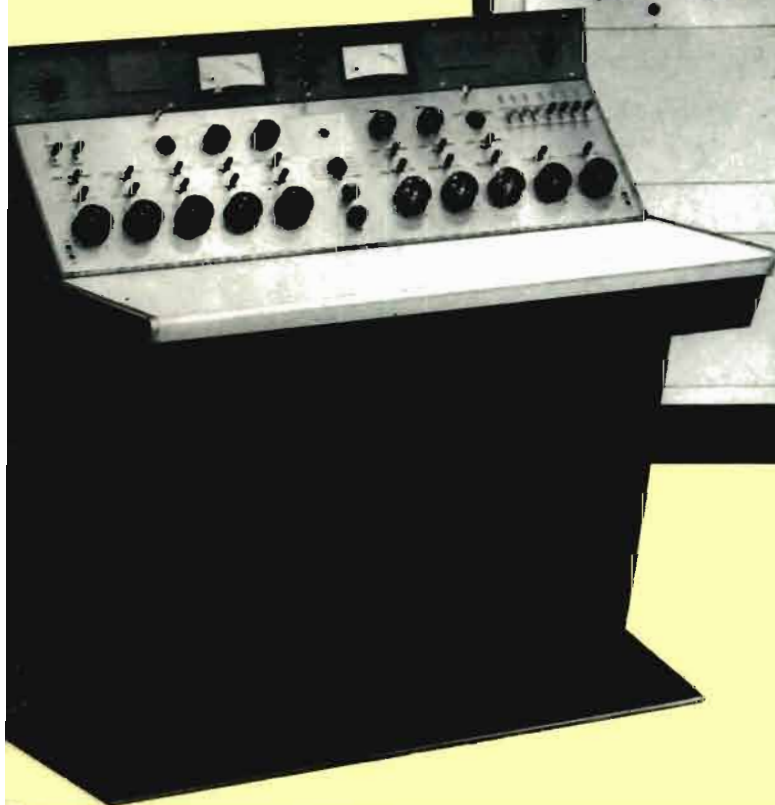

AUDIO EQUIPMENT CATALOG

MICS ~~DOE 19~~ 10, 19

Handphone 2 comp 57



THE MOST TRUSTED NAME IN ELECTRONICS

ABOUT THIS CATALOG

This catalog provides information on RCA Audio Equipment. Other RCA Broadcast Equipment Catalogs supply information on TV Film, TV Tape, TV Cameras, and Terminal and Switching equipment; also on AM, FM, VHF, and UHF TV transmitters, antennas, and transmission line.

The information contained in this catalog is intended to serve as a buying guide for the user. Complete specifications and ordering information are supplied. Readers who desire more information or individual bulletins on particular equipment items are invited to write to their RCA Broadcast Representative.

OTHER RCA TECHNICAL PRODUCTS

RCA also manufactures many other electronic products, including: two-way radio and microwave relay communications equipment; optical and magnetic film recording equipment; sound systems of all types; 16mm projectors and magnetic recorders; industrial inspection and automation equipment; scientific instruments, such as the electron microscope; closed-circuit television systems; and many types of custom-built equipment for industry, the military, educational and medical services. Information describing these products may be obtained from RCA Sales Offices in the United States and Canada or internationally from local RCA Distributors or RCA International Division.

PRICES

Domestic prices of the equipment shown in this catalog are provided in a separate price list. Equipments are identified by type and MI (Master Item) numbers which are used to identify apparatus on invoices and packing slips. International prices for the various equipment items shown in this catalog are available from RCA Distributors or RCA International Division.

HOW TO ORDER

The RCA Audio Equipment shown in this catalog is sold through RCA Broadcast Representatives, who are familiar with broadcast equipment and related problems. These RCA Representatives are located in convenient offices throughout the United States. Domestic orders for equipment, or requests for additional information, should be directed to the nearest RCA Sales Office. International Readers are invited to contact their local RCA Distributor or the RCA International Division Office.

Contents

	Page
Microphones	5
Consoles	27
Custom Audio Equipment	43
Amplifiers	47
Power Supplies	77
Racks & Accessories	81
Turntables	101
Tape Recording Equipment	105
Speakers	123
Test Equipment	132
Index	141

RCA Microphones

Description

General Information

The excellence of RCA microphones is the result of continued effort on the part of engineering and production personnel to produce a superior product. Out of this work have come the several types of broadcast microphones listed in the catalog. There is considerable overlap in the applications of the various types, but each does possess certain attributes which make it particularly well suited to some specific applications. These have been noted for each microphone in the catalog in order to assist in the selection of the microphone best suited for the intended application.

High Quality Broadcast and Television Microphones

Broadcast-type microphones such as the Types BK-1A, BK-5B, BK-6B, BK-11A, BK-12A and 77DX, all have certain common performance criteria which make them especially suited to this application. They have smooth frequency-response characteristics over the audio range, low distortion, high output levels, well-shielded output transformers to prevent hum pickup, and where necessary, are shock mounted to reduce the pickup of low frequency building rumble. Performance features which are unique to each particular type are listed and the applications discussed in the catalog.

Public Address Microphones for Broadcast Use

Public Address Microphones such as the SK-30, SK-31, SK-39, SK-45B, and SK-46, have been designed as economy microphones. In general, frequency range and sensitivity have been sacrificed to some extent in order to gain ruggedness and lower cost. The response limitations should be borne in mind when these microphones are used in broadcast applications.

Unloaded Transformer Input

RCA Broadcast Microphones are designed to work into a microphone preamplifier whose input transformer is unloaded. Under this condition of operation the voltage appearing at the input of the first amplifier stage results in a gain in signal-to-noise ratio between 3 and 6 dB as compared with a matched resistance load. The exact value will depend on whether the major source of thermal noise is in the microphone amplifier or in the microphone.

Microphone Resistance Loading

Microphones in which the moving system is highly damped will in general have their frequency response characteristics little changed by electrical loading. The BK-1A and BK-6B are examples of this.

Microphones which show output impedance variations with respect to frequency will have their response characteristics adversely affected by resistance loading. The Type BK-5B, and 77-DX (in the bi-directional and uni-directional positions) are typical examples. Resistance loading of these microphones will generally result in a loss in low frequency response.

150 Ohms vs. 250 Ohms

When microphones are connected to unloaded input transformers, impedance matching is not a consideration and the effects of connecting microphones with an output impedance of 250 Ohms to a microphone amplifier designed to operate from a 150 Ohm source and vice versa will usually be of small consequence. The effect on the level is shown in the tabulation below.

Mic. Output Impedance ↓	Level Change dB	
	250	0
150	-2.2	0
Amp. Input Designation →	250	150

In addition there will be some change in the overall response-frequency characteristic of the system below 100 Hz and above 5000 Hz, the magnitude depending on the connection and the design of both the microphone and the amplifier input transformer. Variations in response with the usual broadcast quality microphone amplifiers will in most cases not exceed ± 2 dB.

When microphones are connected to a resistance load the following changes in level will result when the output is referred to a matched condition.

Mic. Output Impedance ↓	Level Change dB	
	250	0
150	+2.0	0
Load Impedance →	250	150

Microphones Shipped Less Plug

RCA microphones are supplied less the plug for connection to the wall outlet or amplifier system. This is done to allow the user to select any desired plug. As a convenience, popular types of Cannon plugs are catalogued and they may be ordered as an accessory if desired.*

Microphone Mounting

RCA has standardized on the rugged 1/2-inch pipe thread for broadcast microphone mounting. This size thread makes it easy to add microphone stand extensions, booms, etc., for they may be easily made up locally from standard 1/2-inch pipe and fittings. Stands listed for use with microphones having 5/8"-27 thread will accommodate RCA Broadcast Microphones by the addition of an adapter.

* Microphones are shipped connected for 250 Ohms since in normal usage an improved signal to noise ratio results when connected to a 150 Ohm preamplifier input.

Effective Output Level

When a microphone is connected to an unloaded input transformer its power output cannot be expressed in dBm because no appreciable power is delivered by the microphone. The logical approach to the problem is to arrive at some level figure which, when combined with the conventionally measured amplifier gain, will give the correct output level for the combination. This figure is listed in the catalog for each microphone and is called the Effective Output Level. It differs from the EIA standard rating G_M in the value of sound pressure and source impedance. The EIA rating computation is based on a source impedance of 150 Ohms for all microphones having output impedances between 75 and 300 Ohms, and on a sound pressure of 0.0002 dynes per square centimeter.

The Effective Output Level calculation is based on the nominal microphone impedance and on a sound pressure of 10 dynes/cm².

The EIA standard defines the system rating (G_M) of a microphone as the ratio in decibels relative to 0.001 Watt per 0.0002 dynes per square centimeter of the maximum electric power available from the microphone to the square of the undisturbed sound field pressure in a plane progressive wave at the microphone position. Expressed mathematically:

$$G_M = (20 \log_{10} \frac{E}{P} - 10 \log_{10} R_{MR}) - 50 \text{ dB.}$$

where E = the open circuit voltage of the microphone

P = the undisturbed sound field pressure

R_{MR} = the microphone rating impedance

Electrical reference level = .001 Watt

Sound pressure = .0002 dynes/sq. cm.

While this may look complex the application is simple. For all practical purposes the output level of the microphone is obtained by adding to G_M , the sound pressure level relative to 0.0002 dynes per square centimeter. The sound pressure level of the program material can be measured with any of the several available sound level meters.

Hum Pickup Level

An arbitrary standard 60 Hz AC field of 10⁻³ gauss has been established as a reference. It is fairly representative of fields measured at typical microphone locations in broadcast studios. The hum level is referred to .001 Watt and is calculated in the same fashion as the Effective Output Level, using as the output voltage the voltage produced by the standard field.

Chart Showing Microphone Applications, Chief Characteristics and Recommended Mounts

Type No.	Use ³	Directional Characteristic	Effective Output Level ¹ and G_M ⁴	Output Impedance Ohms	Frequency Response Hz	Max. Hum Pick-up Level ²	Finish	Stand
77-DX	Program Announce	Poly-directional	-53 dBm G_M -147 dB	30/150 250	30-20,000	-128 dBm	Satin Chrome & TV Gray	Boom, Desk, Floor
BK-1A	Program Announce	Semi- and Non-directional	-52 dBm G_M -146 dB	30/150 250	50-15,000	-102 dBm	Satin Chrome & TV Gray	Hand, Desk, Floor
BK-5B	Program Announce	Uniaxial	-57 dBm G_M -151 dB	30/150 250	30-20,000	-128 dBm	TV Gray	Boom, Desk, Floor
BK-6B	"Off-Mike" Speech	Semi-directional	-65 dBm G_M -159 dB	30/150 250	60-15,000	-112 dBm	TV Gray	Microphone Lonyord
BK-11A	Program Announce	Bi-directional	-56 dBm G_M -150 dB	30/150 250	20-20,000	-130 dBm	Stainless Steel & TV Gray	Desk, Floor
BK-12A	Program Announce	Non-directional	-60 dBm G_M -154 dB	30/250	60-18,000	-120 dBm	Bronze epoxy & matte gold	Lovalier, Clip, Hand
BN-10A	Remote Program	Semi-directional	+6VU	600	80-12,000	-112 dBm	TV Gray	Hand
KU-3A	Program Announce	Uni-directional	-51 dBm G_M -145 dB	30/150 250	30-15,000	-122 dBm	Two-Tone Umber Gray	Boom, Desk, Floor
SK-30	Public Address Paging	Omni-directional	-55 dBm G_M -149 dB	30/250	50-14,000	-115 dBm	Midnight Blue	Desk, Floor
SK-31	Public Address Paging	Omni-directional	-57 dBm below 1V/ dyne/cm ²	30,000	50-14,000	-90 dBm	Midnight Blue	Desk, Floor
SK-39A	Close Up Announce	Semi-directional	-54 dBm G_M -148 dB	250	70-10,000	-105 dBm	Two-Tone Umber Gray	Desk, Floor
SK-45B	Intercom & Talkback	Semi-directional	-56 dBm G_M -150 dB	200/15,000	70-12,000	-106 dBm -88 dB below 1 Volt	TV Gray	Desk, Floor
SK-46	Radio & TV Announce	Bi-directional	-58 dBm G_M -150 dB	200/15,000	40-15,000	-115 dBm -98 dB below 1 Volt	Satin Chrome & TV Gray	Desk, Floor

¹ Reference level 0.001 Watt, sound pressure 10 dynes per square centimeter. This corresponds to a rating by the EIA system at a sound pressure level of 94 dB.

² Level referred to a hum field of 10⁻³ gauss.

³ For details refer to description of each particular type.

⁴ G_M = (EIA rating).

⁵ Also available in TV Gray as MI-11006-C.



- High quality reproduction with greater sensitivity over entire audio frequency range
- Frequency range—30 to 20,000 Hz
- Styled for either radio or TV applications
- Choice of directional pattern to control ratio of direct-to-reverberant sound pickup
- Three-position voice-music switch allows selection of best operating characteristic
- Efficient shock mounting

Polydirectional Microphone, Type 77-DX

Description

The RCA Type 77-DX Polydirectional Microphone provides a choice of directional patterns in its use in sound systems, broadcast and recording studios. Two models are available. The MI-4045-F finished in satin chrome and a low-gloss umber gray enamel is intended for AM or FM stations, while the MI-11006-C microphone is intended for television use and is therefore completely finished in a low-gloss umber-gray enamel which eliminates glaring reflections. Both instruments are high-fidelity microphones of the ribbon type which may easily be adjusted to obtain a variety of directional patterns.

As a uni-directional microphone the 77-DX has a wide pick-up angle on front which may be used to advantage as a general program and announce studio microphone and for television boom operation. It is recommended for use on programs where it is desirable to cover a large area with a single microphone, on programs where studio acoustics are more live than optimum, and pro-

grams where it is desirable to eliminate audience noise originating behind the microphone. The 77-DX can also serve as a bi-directional instrument on programs where the players are grouped around the microphone or are seated on opposite sides of a table. In the non-directional position, the microphone is excellent for announce work.

The RCA Type 77-DX Polydirectional Microphone operates as a uni-directional, bi-directional or non-directional instrument by positioning of a shutter to secure various areas of opening. The moving element is a thin corrugated metallic ribbon clamped at the ends and suspended in the air gap of a magnetic circuit consisting of an Alnico V permanent magnet and pole pieces. One side of the ribbon is open and the other is connected by means of a tube to a folded acoustically damped pipe contained in the center section of the microphone.

The tube connecting the back of the ribbon to the labyrinth is slot-

ted directly behind the ribbon and fitted with the shutter which controls the directional properties of the microphone. When the opening is completely closed, the microphone operates as a non-directional pressure microphone: at the wide-open position the instrument becomes bi-directional. With the proper size opening the pattern becomes a cardioid by virtue of the phase shift which occurs. Openings smaller or larger than this critical size produce directional patterns with various sized rear lobes. Different amounts of low-frequency attenuation are obtained by a reactor shunting the output.

The shutter opening is operated by turning a slotted shaft which is brought out flush with the rear of the windscreen.

The shutter position is indicated on a plate mounted on the screen and marked "U", "N" and "B". Three additional markings "L-1", "L-2", and "L-3" are used as reference points for other directional patterns which may be obtained. The

bottom portion of the microphone contains an impedance matching transformer and switch for selecting response characteristics for voice or music. The switch shaft is slotted and accessible through a hole in the bottom of the lower shell. The

77-DX has very low sensitivity to magnetic hum.

The 77-DX will mount on any stand having a 1/2-inch pipe thread. Other stands will require a suitable adaptor. The microphone is cushion-mounted, and a fork mounting is

provided so that the instrument may be fitted to the desired position. The microphone is connected for an output impedance of 250 Ohms at the factory, but it may be adjusted for an output impedance of 30 or 150 Ohms.

Specifications

Directional Characteristics	Adjustable, 6 positions (see curve)		
Frequency Response	30-20,000 Hz		
Response Compensation	3 position voice-music switch		
Output Impedance	250 Ohms, may be changed to 30 or 150 Ohms		
Output Level (1000 Hz):			
	Bi-	Uni-	Non-
	Directional	Directional	Directional
Effective (10 dynes/cm ²)..	-50 dBm	-53 dBm	-56 dBm
EIA-G _m	-144 dB	-147 dB	-150 dB
Hum Pick-up (.001 gauss, 60 Hz)	-128 dBm (max.)		
Dimensions (overall)	11 1/2" long, 3 3/4" wide, 2 1/2" deep (8.29 x 9.5 x 6.4 cm)		
Weight (less cable)	3 lbs. (1.4 kg.)		
Cable (MI-43-D, 3 conductor, shielded)	30 ft., no plug		
Mounting	Cushion mount, 1/2" pipe thread		

Accessories:

Spare Zipper Bag for 77DX	#99H0102
Boom Mounting	Mole Richardson Type H-2

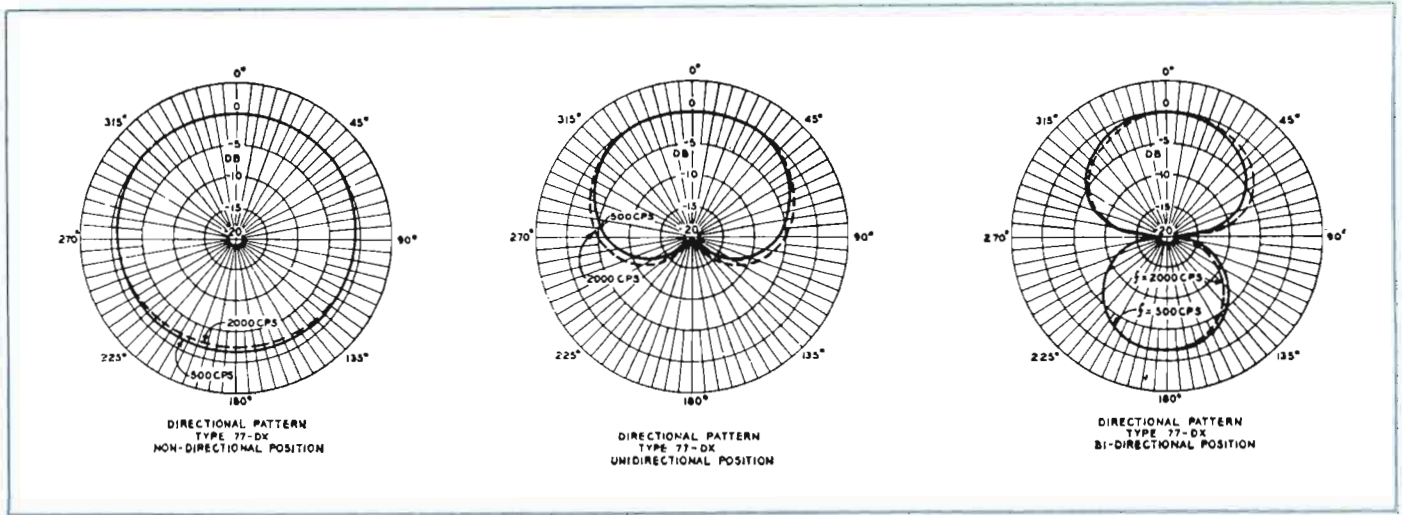
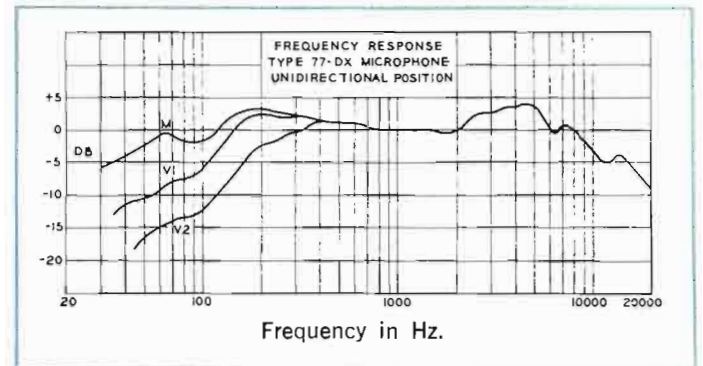

Ordering Information

Type 77-DX Polydirectional Microphone
in protective cloth bag:
Satin Chrome FinishMI-4045-F
Low Luster Gray FinishMI-11006-C



- Wide range—50 to 15,000 Hz response
- Smooth response over essential range
- Removable from base for hand use or mounting on floor stand
- Ideal for remote pickups — insensitive to wind and mechanical vibrations
- Frequency characteristic independent of source distance

Pressure Microphone, Type BK-1A

Description

The high-fidelity BK-1A Pressure Microphone is designed for use in AM, FM and TV broadcast stations, recording studios, and for public address. Its construction makes it particularly well suited for remote

pickups where, if used in the open air, the modern design practically eliminates the effect of air currents. The BK-1A features a smooth response and frequency range of 50 to 15,000 Hz.

The BK-1A is an omni-directional microphone when mounted verti-

cally. A semi-directional characteristic is obtained when horizontally mounted, in which case the BK-1A is essentially non-directional for frequencies below 2000 Hz. The higher frequencies are attenuated more as the angle with the perpendicular to the diaphragm increases.

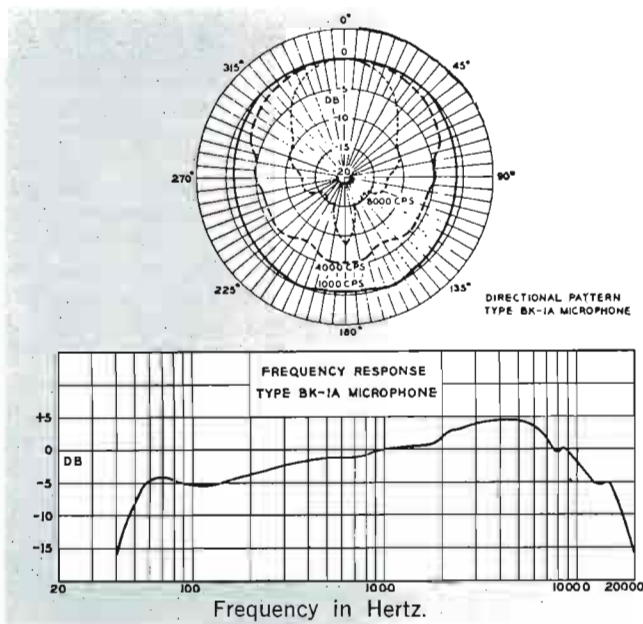

Specifications

Directional Characteristics	Semi-Directional (horizontal) Omni-Directional (vertical)
Frequency Response	50 to 15,000 Hz (see curve)
Output Impedance	30/150/250 (250 as shipped)
Output Level (1000 Hz):	
a. Effective (10 dynes/cm ²)	-52 dBm
b. EIA—G _m	-146 dB
Hum Pickup (.001 gauss, 60 Hz)	-102 dBm (max.)
Cable (attached)	30 ft., 3 conductor shielded, without connector
Mounting	Ball and socket, 1/2" pipe thread
Dimensions (overall)	7 3/4" long, 1 7/8" diameter (20 x 4.8 cm)
Weight	18 ounces; (.51 kg.) less cable
Finish	Low luster gray and satin chrome

Ordering Information

Type BK-1A Pressure Microphone	MI-11007
Desk Stand, Type KS-11A	MI-11008

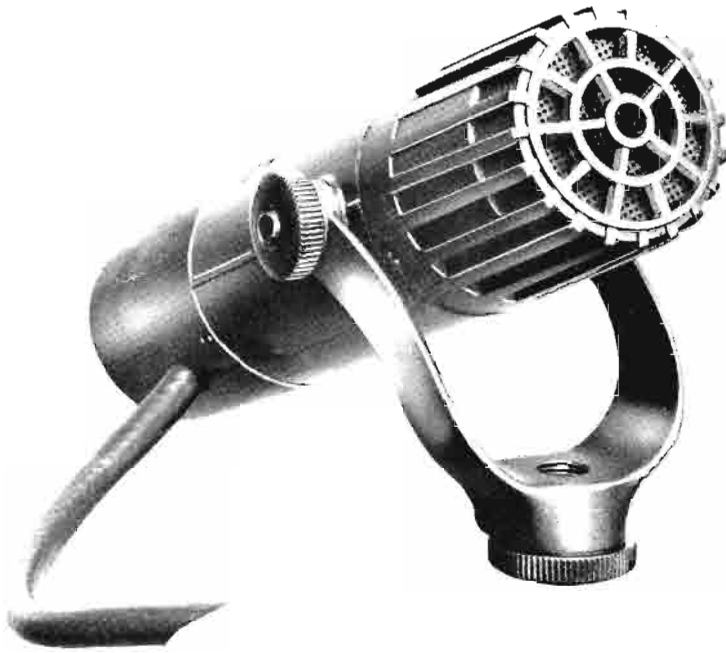

- Frequency range—30 to 20,000 Hz
- Improved unidirectional characteristic with wide pickup angle on front
- Three position voice-music switch allows selection of most desirable operating characteristic

Uniaxial Microphone, Type BK-5B

Description

The RCA Type BK-5B Uniaxial Microphone is a dependable, high-quality ribbon instrument possessing an improved unidirectional characteristic. It is designed for broadcast, public address, and recording applications. The microphone has a frequency response that is essentially uniform from 30 to 20,000 Hz. Its excellent response and frequency range, combined with its unexcelled cardioid directional characteristic make it ideal for reproducing both speech and music.

The microphone has been especially engineered with the television studio in mind. Since maximum sensitivity lies on the major mechanical axis, it is a one axis, or uniaxial type microphone. This directional characteristic simplifies microphone and camera placement problems. Incorporated in the unit is a blast filter

which effectively reduces damage to the microphone from gun blasts and other violent noises. In addition, the small size, light weight, unobtrusive yet attractive TV gray finish and appearance render it especially suitable for television, but it is also admirably suited to general broadcasting and high-fidelity sound systems.

The Type BK-5B Microphone is a unidirectional microphone in which the moving element is a thin corrugated metallic ribbon clamped under light tension to cause it to vibrate at its own resonant frequency. The ribbon is placed between the pole pieces of a magnetic circuit. One side of the ribbon is open to the atmosphere and the other opens on an acoustical labyrinth which has phase-shift openings giving the instrument its improved unidirection-

al characteristics. The labyrinth of the microphone houses an impedance matching transformer and switch for selecting response characteristics for voice or music.

A unique feature of the BK-5B is a blast filter consisting of two separate cloth layers supported by perforated metal screens. The filters effectively reduce damage to the microphone from gun blasts and other loud noises encountered in broadcast programming. In addition, the transformer is exceptionally well shielded against stray magnetic fields and can perform satisfactorily in high hum fields. As further protection for the sensitive vibrating ribbon a wind screen is available for use with the instrument. Its use is recommended if the instrument is to be used outdoors.

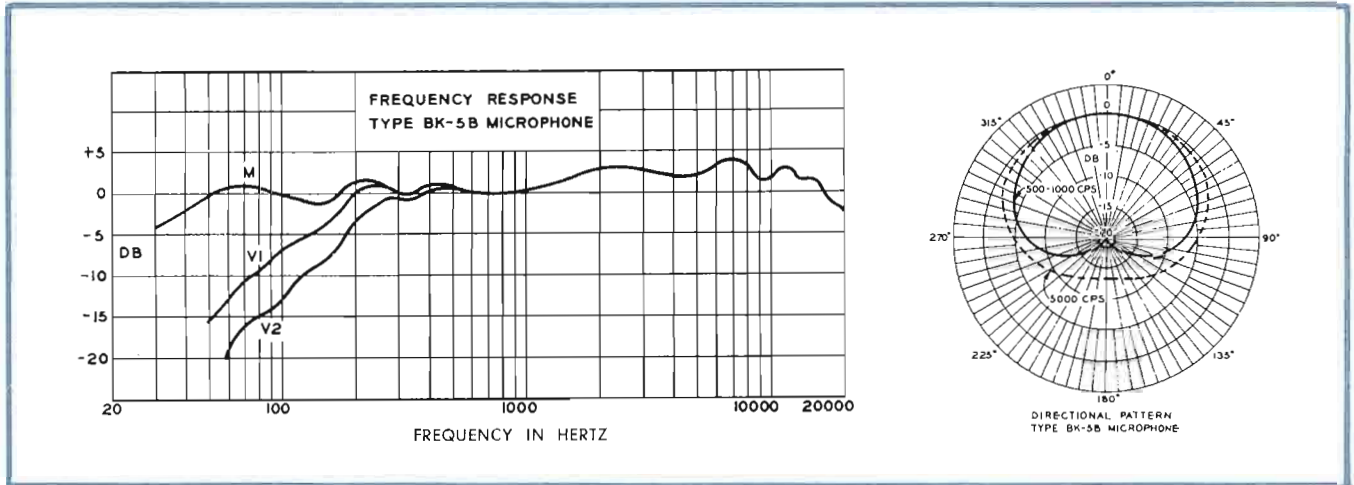

The integration of the blast filter, acoustic phase-shift network and especially designed connector to couple the ribbon to the labyrinth is responsible for the unique uniaxial characteristic of the BK-5B, and uniform frequency response over the entire aural spectrum. The microphone is supported on a cushion mounting which has a 1/2-inch internal pipe thread to fit RCA desk or floor stands. An improved shock mount based on panel meter mounts designed for military use is incorporated in the optional Boom Unit. This new mount isolates the microphones effectively from vibration and shock transmitted by the boom. There are no rubber band mountings to wear out. A 30-foot flexible cable, of high tensile strength is supplied with the microphone.

BK-5B Microphone shown with Wind Screen, MI-11011; and Boom Unit, MI-11012.



Specifications

Directional CharacteristicUniaxial
(improved cardioid pattern)
 Frequency Response30-20,000 Hz (see curve)
 Response Compensation3 position, voice-music switch
 Output Impedance250 Ohms, may be changed
 to 30 or 150 Ohms
 Effective Output Level at 1000 Hz
 Sound Pressure 10 dynes/cm²-57 dBm
 EIA Rating (G_m) (150 Ohm connection)-151 dB
 Hum Pickup Level (.001 gauss, 60 Hz)-128 dBm (max.)

Cable Attached3-conductor, shielded, 30 feet, no plug
 Dimensions (overall)7" long, 1 3/4" dia. (18 x 4.5 cm)
 Weight1 lb., 11 ozs. (less cable) (.76 kg.)
 FinishLow luster gray enamel
 MountingCushion mount, 1/2" pipe thread (female)

Accessories

Boom Mount (1/8-inch fitting)MI-11012
 Wind ScreenMI-11011
 Desk Stand, Type 91-DMI-4092-G

Ordering Information

Type BK-5B Uniaxial MicrophoneMI-11010-A



- Excellent speech balance when talking "off-mike"
- Easily concealed in man's hand . . . in clothing . . . on TV settings
- Clip type lanyard for ease of looping about neck
- Wide-range frequency response 60 to 15,000 Hz

Miniature Dynamic Microphone, Type BK-6B

Description

The Miniature Dynamic Microphone, Type BK-6B is especially designed for correct speech balance when used in television broadcasting interviews and public address applications. The frequency response and directional characteristics are engineered to complement human speech so that the microphone has excellent balance when the performer is talking "off mike."

The BK-6B may be worn by the performer; its small bulk and neutral color make it inconspicuous. The lightweight and flexible cable permit free, unhampered movement of the performers. It may be wholly concealed in a man's hand during an interview, or it may easily be concealed on a set. The styling blends readily with any props, and is pleasing where it is exposed to direct view. It is best used, suspended from

the neck, resting on the chest, where it attenuates the low pitched chest sounds while at the same time it points straight up toward the lips, the position in which it is most sensitive to the sibilant sounds that would normally be lost.

The BK-6B microphone has a frequency response from 60 to 15,000 Hz. A special internal acoustic resonator is employed to support the response to lower frequencies and a damped resonator placed in front of the diaphragm reduces high frequency emphasis while extending the upper frequency limit. The result is a pleasing balance for speech when the microphone is used "off mike," or worn on the person. The special plastic diaphragm and coil assembly, output transformer and terminal board and bracket assembly are housed in a

rugged and practically weather-proof case. The entire microphone is only 2 9/16 inches long and 15/16-inch in diameter and weighs but 2.3 ounces, less the cable.

The cable, especially designed for the BK-6B unit, has unusual flexibility combined with long life under conditions of severe abuse. High tensile alloy conductors provide high flexibility and long life. The semi-conducting wrap shield is overlaid with a light metallic braid. The conducting wrap ensures complete electrostatic shielding and the light, metallic braid keeps the series resistance of the shield low without making the cable excessively stiff. The external jacket gives a tough, neutral colored, protective covering to the cable. A lanyard is furnished for mounting the microphone conveniently about the neck.

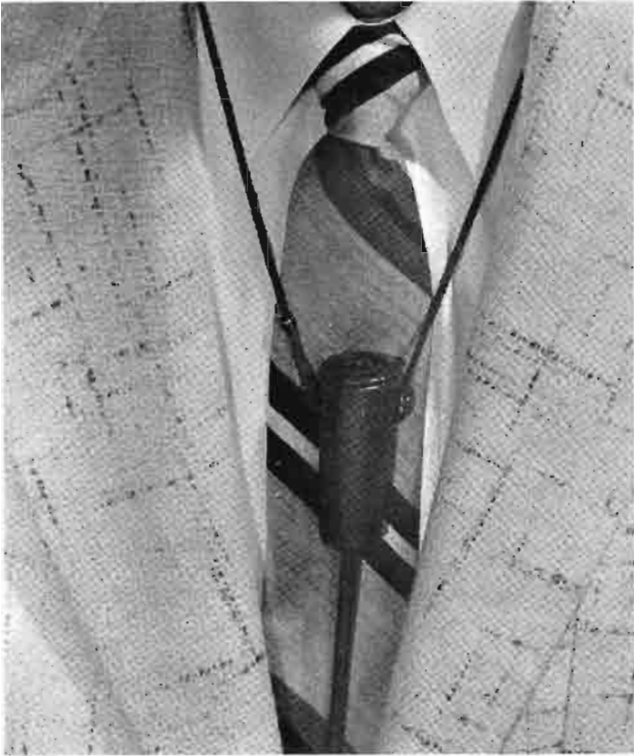

BK-6B Microphone used as a "necktie" mike. May be positioned beneath the necktie or exposed.

Specifications

Directional Characteristics	Semi-directional
Frequency Response	60-15,000 Hz shaped for lavalier use (See Curve)
Output Impedance	30/150/250 Ohms (250 as shipped)
Output Level (1000 Hz):	
Effective (10 dynes/cm ²)	-65 dBm
EIA-G _m	-159 dB
Hum Sensitivity (.001 gauss, 60 Hz)	-112 dBm (max.)
Cable (Attached)	30 ft., two conductor shielded, highly flexible, brown PVC jacket, no plug
Mounting	Removable lanyard supplied for suspending about neck
Dimensions	2 3/16" long x 15/16" diameter (6.5 cm x 2.4 cm)
Weight (less cable)	2.3 ozs., (65 grams)
Finish	Low luster gray

Accessories

Microphone Holder, Clamp Type	MI-12086
Microphone Stand Adaptor Kit (for gooseneck)	MI-11073
13" Flexible Microphone Stand	MI-11745
19" Flexible Microphone Stand	MI-11746

Ordering Information

Type BK-6B Miniature Dynamic MicrophoneMI-11017-A

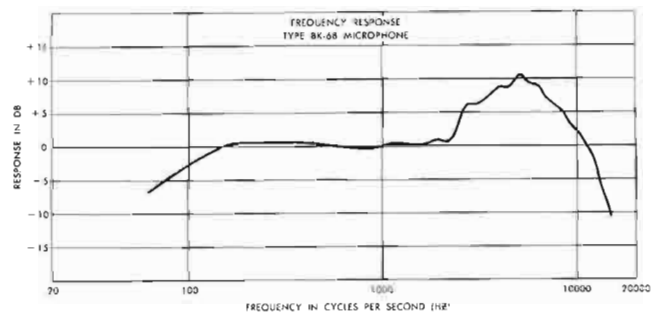
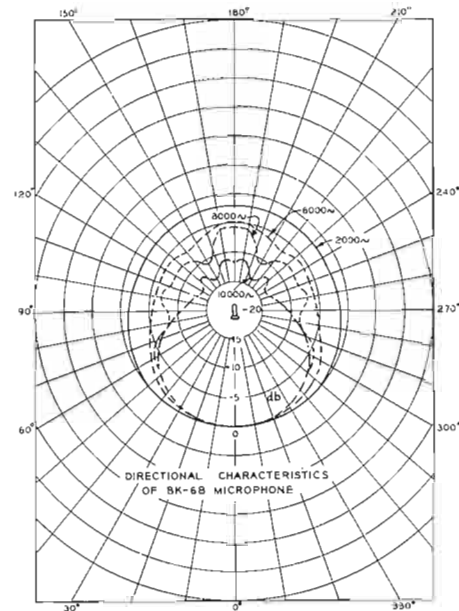



- Exceptionally smooth frequency response
- No loss in quality with off axis pickup
- Reduced pickup of reflected sound
- Three position, voice-music switch

Velocity Microphone, Type BK-11A

Description

The BK-11A is intended primarily for AM, FM and TV studio use where a microphone capable of highest quality reproduction is desired.

It is a dependable bi-directional microphone free of the effects of cavity resonance, diaphragm resonance and pressure doubling. The BK-11A is well shielded against stray magnetic fields and can perform satisfactorily in high hum fields. Acoustically designed sturdy stain-

less steel screens protect the microphone from mechanical injury. Internal shock and vibration isolation is provided between the case and the element. The microphone is supported by a swivel mounting which permits a 45 degree forward or backward tilt.

Specifications

Directional Characteristics	Bi-directional
Frequency Response	20 to 20,000 Hz
Response Compensation	3 position voice-music switch
Output Impedance	30/150/250 Ohms (250 as shipped)
Output Level (1000 Hz):	
Effective (10 dynes/cm ²)	-56 dBm
EIA-G _{III}	-150 dB
Hum Pickup Level (.001 gauss, 60 Hz)	-130 dBm (max.)
Cable Attached	30 ft. 3 conductor, shielded, brown neoprene jacket
Mounting	Swivel mount 1/2" pipe thread
Dimensions (overall)	8" long, 2 7/8" wide, 2 3/8" deep (20 x 7.3 x 6 cm)
Weight (less cable)	2 lbs. (.9 kg.)
Finish	Low luster gray and stainless steel

Accessories

Desk Stand, Type KS-11A	MI-11008
Desk Stand, Type 91-D	MI-4092-G
Collapsible Floor Stand, Type CS-1	MI-11021-1

Ordering Information

Type BK-11A Velocity Microphone	MI-11019
---------------------------------------	----------

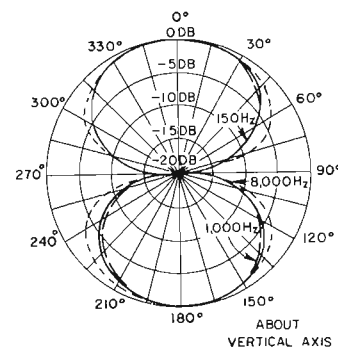
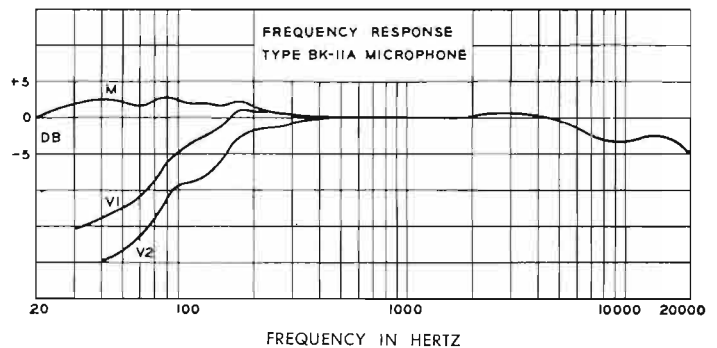

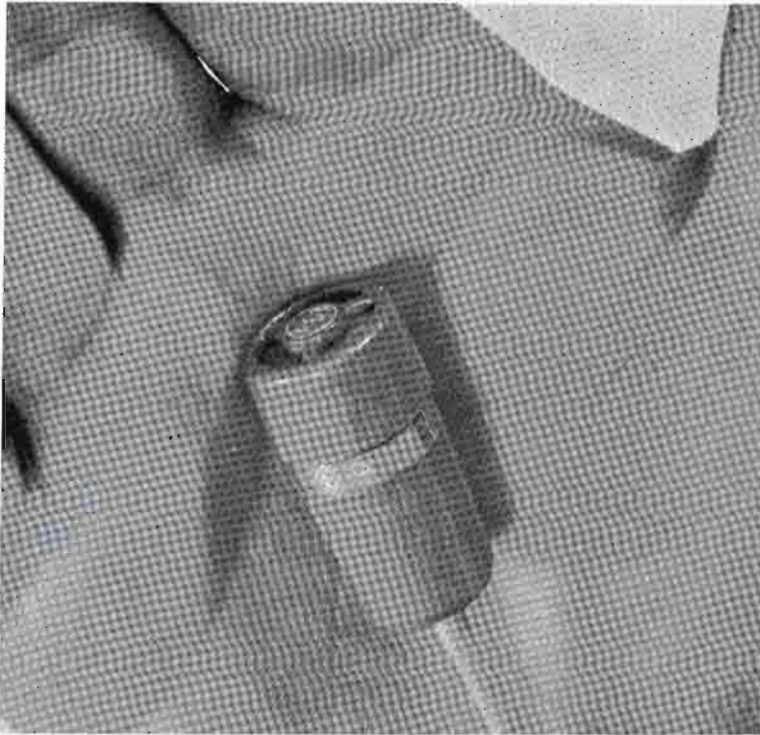

- **Lightweight subminiature design**
- **Easily concealed**
- **Non-directional pickup**
- **Improved efficiency**
- **Withstands rough usage**
- **Cartridge replacement eliminates factory repair**

Subminiature Dynamic Microphone, Type BK-12A

Description

The BK-12A Subminiature Dynamic Microphone is RCA's "New Look" in very small, extra lightweight mikes with excellent speech balance for use in television and public address applications. The BK-12's small bulk and neutral color make it inconspicuous when worn around the neck on a lanyard, clipped to the clothing, or concealed in the hand. Due to its small size, the BK-12A is essentially non-directional to 6,000 Hertz, thus ordinary errors in orientation are inconsequential.

The 20-gram mike has a wide range frequency response of 60 to 18,000 Hz which has been tailored for proper speech balance. Other notable features include a line impedance voice coil that permits use with 30 to 250 Ohm unloaded inputs

without changing the microphone's impedance. Through elimination of the output transformer, magnetic hum sensitivity is lower than comparable microphones that employ a voice coil to line matching transformer. The micron-mesh acoustical filter provides dirt and moisture protection as well as an excellent appearance. Through careful design and the availability of improved magnetic materials, an extremely high acoustical to electrical power efficiency has been achieved in the BK-12A despite its small diaphragm area.

Due to its small size and lightweight, the BK-12A is adequately supported by the tie clip holder which fastens equally well to shirt

front or lapel. A lavalier holder is also supplied for suspending the microphone around the neck. The bracelet clasp on this accessory is extremely easy for women to use. Also supplied is a cable clip which attaches the cable to clothing to isolate noise and strain. All accessories are gold plated to present a pleasing, jewelry-like appearance.

The user need never send the BK-12A back for factory repairs. A complete replacement cartridge can be installed in a few minutes. The cable is also easily replaced. Since the microphone is designed to withstand repeated drops and the cable is made of long-flex life cadmium copper, indefinitely long service can be expected with normal use.

Specifications

Output ImpedanceLow—for use with 30 to 250 Ohm unloaded inputs
 Frequency Response.....60 to 18,000 Hz, shaped for lavalier use (see curve)
 Direction CharacteristicsNon-directional
 Output Level (1000 Hz):
 Effective (10 dynes/cm²)-60 dBm (150 Ohms)
 EIA—G_M-154 dB (150 Ohms)
 Effective Output Level @ 1000 Hz-60 dBm (150 Ohms) referred to a sound pressure of 10 dynes/cm²
 EIA Sensitivity Rating-159 dB (150 Ohms)
 Output Voltage (open circuit)75 mV/d/cm²
 Hum Pickup (0.001 gauss, 60 Hz)-120 dBm max.
 Cable (attached).....30 ft. 2-conductor shielded, highly flexible, beige PVC jacket
 Mounting.....Lavalier and tie clip holders supplied
 Overall Dimensions3/4" dia. (2.0 cm) x 1 1/2" (3.8 cm) long
 Weight0.71 oz. (20 grams) less cable
 Finish.....Bronze epoxy and matte gold

Accessory

Cable, Two-Conductor, MiniatureMI-13373



BK-12B Microphone (actual size) with clip mounting.

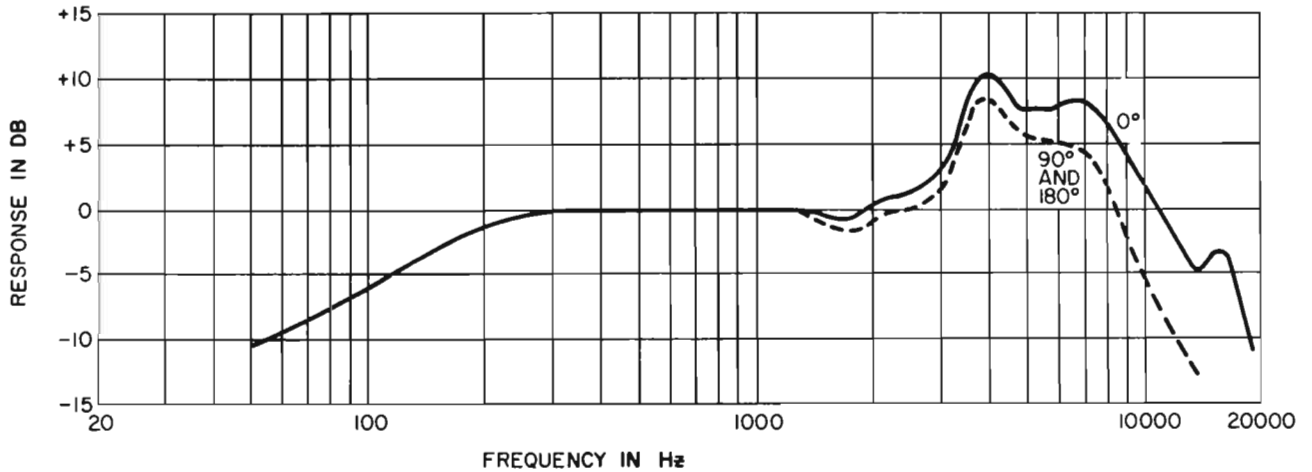

3322148

Ordering Information

Type BK-12A Subminiature Dynamic Microphone, complete with accessory Lavalier Holder, Tie Clip Holder and Cable Clip.....MI-11024



- Combines miniature microphone and transistor remote amplifier in convenient hand-held package
- Speech output level of +6 V.U. sufficient to feed phone lines direct
- Self-powered by small mercury battery
- Plug-in earphone for checking performance and receiving "cue" over phone line
- Wide-range frequency response

Microphone-Amplifier, Type BN-10A

Description

The RCA Type BN-10A comprises a single channel remote amplifier to which has been added a miniature dynamic microphone to produce a compact microphone/remote amplifier easily held in one hand. The unit weighs less than a pound and is completely self-contained including its transistor amplifier and battery power supply. The +6 V.U. output of the microphone/amplifier is more than adequate for feeding telephone lines.

The BN-10A affords broadcasters a lightweight unit capable of handling single microphone remotes without the use of large remote amplifiers. The BN-10A is ideal for interviews, sports announcements, on-floor convention reports, and other remote broadcast uses. A built-in earphone jack makes it easy to hear telephone line cues as well as monitor the BN-10A output.

The microphone used in BN-10A equipments is RCA's Type BK-6B personal microphone designed for correct speech balance. The BK-6B has a frequency response of 80 to 12,000 Hz and it has semi-directional

characteristics. The microphone chamber is completely sealed and isolated from the amplifier section to assure optimum performance of the microphone.

The built-in amplifier employs transistors. The circuit is designed for very low battery drain thus securing about 50 hours of service from the single E-134 mercury battery which is easily inserted in the BN-10A. The distortion of the amplifier is less than 2 percent for normal output. The amplifier itself has

a frequency response of ± 1.5 dB from 50 to 15,000 Hz,

A 30-foot line cord for connection to the phone line is supplied as well as a lightweight earphone. The earphone plugs into the base of the BN-10A. The battery is automatically turned on whenever the line cord is plugged into the BN-10A. The body of the BN-10A is finished in a low luster gray enamel. A convenient carrying case which accommodates microphone/amplifier, cord and earphone is also supplied with the BN-10A.

Specifications

Frequency Response (System)	80-12,000 Hz
Distortion	2% maximum
Output Level (for normal speech)	+6 V.U.
Load Impedance	600 Ohms
Line Cord	30 ft. flexible, with cannon plug
Overall Dimensions	11 $\frac{3}{4}$ " long by 1 $\frac{1}{8}$ " dia. 29.84 cm long by 2.86 cm dia.
Weight	14 oz. (0.4 kg.)
Finish	Low luster gray
Battery	Eveready E-134

Ordering Information

Type BN-10A Microphone/Amplifier complete with 1 cord and plug, 1 E-134 battery, 1 carrying case, and 1 EarphoneMI-11023-A



- Higher output—6 dB or more
- More uniform response
- Rugged and time tested
- Single ribbon element
- No power supply required

Unidirectional Microphone, Type KU-3A

Description

The RCA KU-3A Unidirectional Microphone, for years the standard of quality comparison in the major motion picture industry, is proving popular with TV broadcasters in live studio programs especially where boom operation or a suspension microphone is indicated. The frequency response and output is very uniform over the normal front pickup angle of 90 degrees permitting broader tolerances in microphone handling on booms.

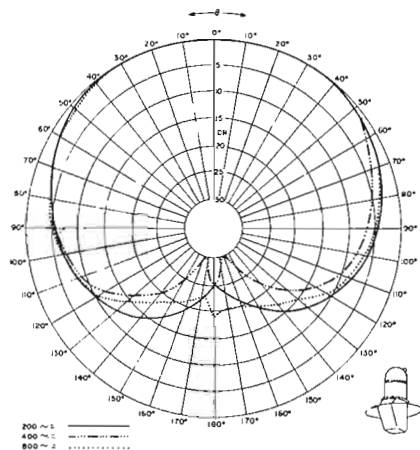

Horizontal Pattern of MI-10001-C Microphone.

Specifications

Output Impedance30, 150 or 250 Ohms
 (connected for 250 Ohms when shipped)
 Load ImpedanceOpen circuit (unterminated transformer)
 Effective Output Level at 1000 Hz
 (10 dynes/cm² input)-49 dBm at 30 Ohms,
 -51 dBm at 150 and 250 Ohms
 Frequency ResponseSee diagram
 Directional Characteristics30-15,000 Hz (See diagram)
 External Connection12" long cable "pigtail" without plug
 FinishFlat two-tone umber gray
 DimensionsLength 8", width 3", depth 3½"
 (20.32 cm, 7.62 cm, 8.89 cm)
 Weight (less suspension mounting)2 lbs. 13 ozs. (1.25 kg.)

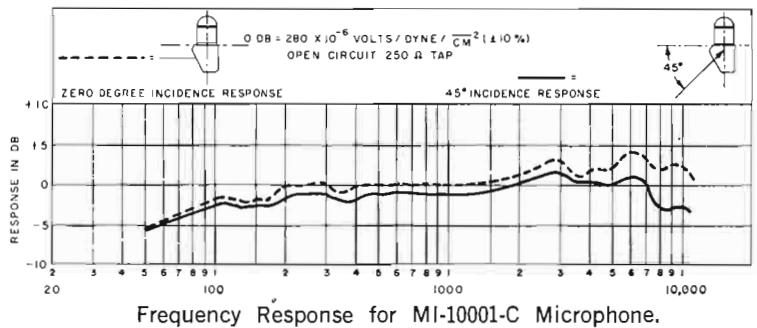

Ordering Information

KU-3A Unidirectional Microphone, complete with Voice/Music switch, cable pigtail, and resilient mountingMI-10001-C



- Frequency response — 50 to 14,000 Hz
- Lightweight — small size — attractively styled
- Available as a high impedance (SK-31) or low impedance (SK-30) microphone
- Designed for use as a hand-held, stand-mounted or gooseneck-mounted microphone
- Excellent for close-talking applications

Dynamic Microphone, Types SK-30/31

Description

The RCA SK-30 and SK-31 Dynamic Microphones are general purpose units with a broad range of applications. They are excellent for public address and paging use. These two microphones have been designed and constructed for dependable performance and rugged service. They are relatively insensitive to mechanical shock and wind disturbances.

The SK-30 and SK-31 Dynamic

Microphones are essentially identical in every respect except that the SK-30 is a low impedance unit, and the SK-31 is a high impedance version. Frequency response of both units is exceptionally wide, 50 to 14,000 Hz. Both units have a non-directional pick-up pattern which tends to become uni-directional at high frequencies. Best results can be had by speaking directly into the mike.

Housed in an attractive, rugged zinc alloy case, the SK-30 and SK-31 microphones may be hand held or mounted in a variety of ways. By removing the threaded end cap, the microphones may be gooseneck-mounted for use on lecterns. A Swivel Adapter, MI-11032, available as an accessory, permits the microphones to be mounted on any standard floor or desk stand.

Specifications

Directional Characteristics	Omni-directional
Frequency Response	50 to 14,000 Hz
Output Impedance:	
SK-30.....	Low—for use with 30 to 250 Ohm unloaded inputs
SK-31	30,000 Ohms
Output Level (1000 Hz):	
SK-30 (150 Ohm system)	
Effective (10 dynes/cm ²)	-55 dBm
E.I.A.—G _m	-149 dB
SK-31	-57 dB below 1V/dyne/cm ²

Hum Sensitivity (.001 gauss 60 Hz):	
SK-30	-115 dBm
SK-31	90 dB relative to 1 Volt
Cable (attached):	
SK-30	2 conductor shielded cable, black plastic jacket
SK-31	Single conductor shielded cable, black plastic jacket
Mounting	May be hand held or mounted on a gooseneck by removing end cap. Mounts on stand with swivel adapter
Dimensions	1.5" diameter by 4.5" long (3.8 cm, 11.39 cm)
Weight	8 ounces (140 gr)
Finish	Midnight blue

Accessories

Swivel Mounting Adapter (5/8"—27 female thread)	MI-11032
---	----------

Ordering Information

Type SK-30 Dynamic Microphone (Low Impedance)	MI-11030-1
Type SK-31 Dynamic Microphone (High Impedance)	MI-11031-1



- Modern streamlined appearance
- Excellent for close talking application
- May be used outdoors — minimum response from wind
- Unaffected by temperature or humidity
- Alnico V magnet — high sensitivity with light weight

Aerodynamic Microphone, Type SK-39A

Description

The Type SK-39A Aerodynamic Microphone has excellent response for close talking announce purposes. Its light weight and small size make it ideal for remote pickup and mobile use. It is used for paging and announcing in areas of high noise level because its rising high frequency characteristic gives excellent intelligibility. This feature is espe-

cially useful in home recording and amateur applications. Another application for which this unit is especially suited, is for use of an individual soloist, where a second microphone, usually a velocity type, is used to pick up the musical accompaniment. Either a floor stand or a desk stand may be used as a mounting or it may be fitted with a handle

for use in sports announce work.

The SK-39A has been designed and constructed for dependable performance and rugged service. It is relatively insensitive to mechanical shock and wind disturbances and will withstand nominal exposure to moisture or rain because of its plastic diaphragm.

Specifications

Directional Characteristics	Semi-Directional
Frequency Response	70 to 10,000 Hz (see curve)
Output Impedance	250 Ohms
Output Level (1000 Hz):	
SK-39A;	
Effective (10 dynes/cm ²)	-54 dBm
EIA-G _m	-148 dB
Hum Pickup (.001 gauss, 60 Hz)	-105 dBm
Cable (attached)	25 ft., 2 conductor, shielded
Mounting	5/8" - 27 thread
Dimensions (overall)	2 7/8" dia., 2 3/4" long, 3 1/4" high (7.3 x 7 x 8.2 cm)
Weight	1 lb. (.45 kg.) less cable

Finish	Light and dark gray
Grill Cloth Identification	Black

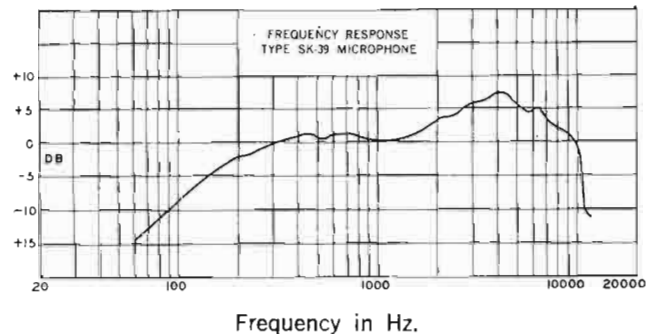

Ordering Information

Type SK-39A Aerodynamic MicrophoneMI-12039-A



- Frequency response—70 to 12,000 Hz
- Rugged construction
- High or low impedance
- Excellent for announce work
- Swivel mounting

Pressure Microphone, Type SK-45B

Description

The Type SK-45B Pressure Microphone is excellent for paging and public address work indoors or outdoors where a rugged, light weight microphone with good response to

voice and music is required. It is admirably adapted to commercial and industrial sound installations and also suitable as a "close-talk" mike.

A swivel arrangement allows tilting of the head forward or back

through an arc of approximately 45 degrees each side of the vertical position. New streamlined design, rugged construction and attractive baked TV gray enamel finish makes this microphone a welcome addition to any installation.

Specifications

Directional Characteristics	Semi-Directional
Frequency Response	70 to 12,000 Hz (see curve)
Output Impedance	200/15,000 Ohms (200 as shipped)
Output Level (1000 Hz)	
a. 200 Ohms	
Effective (10 dynes/cm ²)	-56 dBm
EIA—G _m	-150 dB
b. 15,000 Ohms	
-58 dB below 1 Volt/dyne/cm ²	
Hum Pickup (.001 gauss, 60 Hz)	
a. 200 Ohms	-106 dBm
b. 15,000 Ohms	-88 dB below 1 Volt
Cable (attached)	25 ft., 2 conductor shielded, no plug
Mounting	Swivel mount, 5/8"—27 thread
Dimensions (overall)	5 1/2" high, 1 5/8" wide, 2" deep (14 x 4.1 x 5.1 cm)
Weight (less cable)	1 lb. (.45 kg.)
Finish	Satin chrome and low luster gray

Ordering Information

Type SK-45B Microphone and CableMI-12045-B

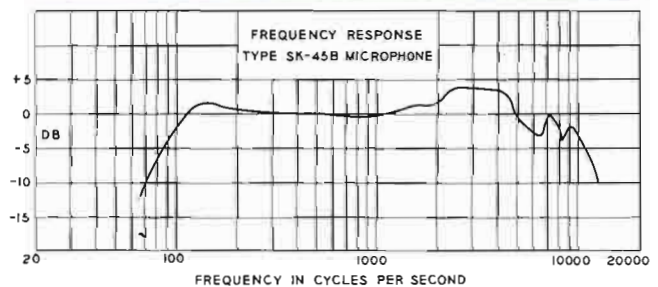
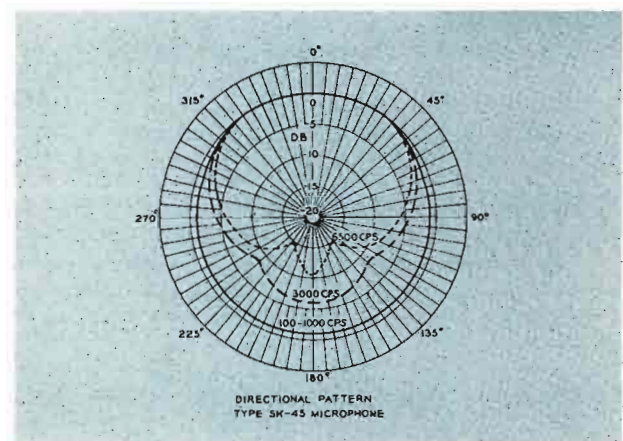



- Bi-directional characteristics over wide frequency range—40 to 15,000 Hz
- Adjustable for high or low impedance
- TV gray and satin chrome finish
- Swivel mounting

Velocity Microphone, Type SK-46

Description

The RCA Type SK-46 Velocity Microphone is useful for announcing, AM, FM and TV studio or control room announcing, public address, and night club applications. Its excellent response, directional characteristics and small size makes it a valuable and versatile instrument where quality sound reproduction is desired. The directional characteristics reduce unwanted acoustical background noise, reflections and feedback. This makes the microphone appropriate for "on stage", announce booth and general indoor programs. The microphone is not recommended for outdoor use because of its relative sensitivity to wind.

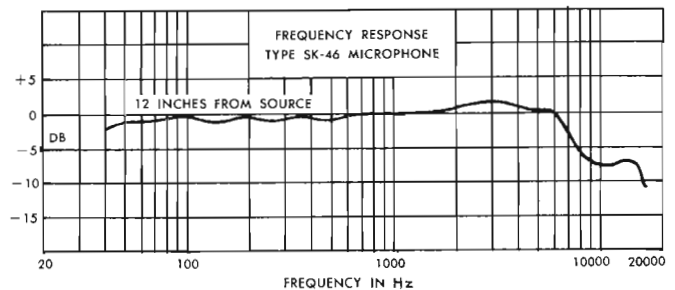
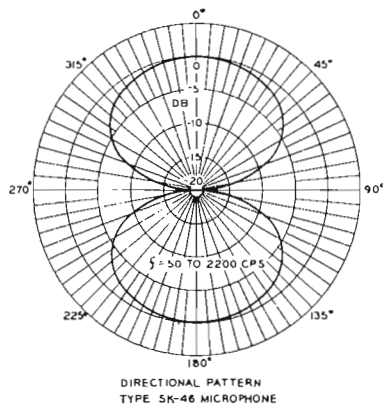

Specifications

Directional CharacteristicsBi-directional
Frequency Range40 to 15,000 Hz (See Curve)
Output Impedance200 Ohms/15,000 Ohms (200 as shipped)
Effective Output Level at 1000 Hz/second:	
Low Impedance-58 dBm, EIA G _m -150 dB
High Impedance-60 dB below 1 volt/dyne/cm ²
Hum Pickup (.001 gauss, 60 Hz):	
Low Impedance (200 Ohms)-115 dBm
High Impedance (15,000 Ohms)-98 dB below 1 Volt
Cable (attached)25 feet, 2 conductor shielded, no plug
MountingSwivel mount, 5/8"-27 thread
Height5 1/8" (13 cm)
Width1 29/32" (4.9 cm)
Depth1 3/8" (3.5 cm)
FinishSatin chromium and low luster gray
Weight (less cable)13 ounces

Ordering Information

Type SK-46 Velocity Microphone and CableMI-12046



Microphone Floor Stands.

- Rugged construction
- Attractive appearance
- Easy to assemble or take apart
- Compact and convenient for portability

Microphone Desk Stands.

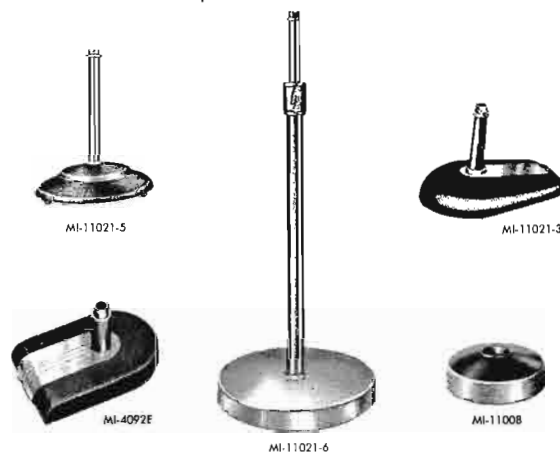

Microphone Stands and Accessories

MICROPHONE DESK STANDS

Type No.	Mounting	Base Dimension	Height	Weight	Finish	Ordering Information
91-D	1/2" Pipe Thread	4 1/2" by 6 5/8"	3/4" to 1 3/4"	4 lbs. (1.8 kg.)	Umber Gray Chrome Trim	MI-4092-G
KS-11A	1/2" Pipe Thread	4 3/8" diameter	—	1 1/2 lbs. (.68 kg.)	Dull Umber Gray	MI-11008
DS-10	5/8"—27 Fixture Thread	—	—	1 1/2 lbs. (.68 kg.)	Dull Gray Chrome Trim	MI-11021-3
DS-5	5/8"—27 Fixture Thread	6" diameter	4"	2 lbs. (.91 kg.)	Gun Metal Shrivel Finish	MI-11021-5
TS-6	5/8"—27 Fixture Thread	8" diameter	14 1/2" to 26"	6 lbs. (2.7 kg.)	Chrome	MI-11021-6

MICROPHONE FLOOR STANDS

Type No.	Mounting	Base Diameter	Height	Weight	Finish	Ordering Information
90-A	1/2" Pipe Thread 5/8"—27 Fixture Thread	12 3/4" diameter	44" to 74"	33 lbs. (15 kg.)	Chrome	MI-4090-A
CS-1	5/8"—27 Fixture Thread	Collapsible	23" to 62"	5 lbs. (2.3 kg.)	Chrome and Cadmium	MI-11021-1
MS-25	5/8"—27 Fixture Thread	17"	38" to 67"	22 lbs. (10 kg.)	Chrome and Gray	MI-11021-7
MS-20	5/8"—27 Fixture Thread	12"	37" to 66"	15 lbs. (6.8 kg.)	Chrome and Gray	MI-11021-8

MICROPHONE BOOMS WITH STANDS OR PERAMBULATOR

DESCRIPTION

RCA Microphone Boom Stands and Perambulator afford proper microphone placement for programs where the best microphone position cannot be reached with conventional stands. The perambulator is designed to noiselessly follow the sound, or move from one source of sound to another in broadcast or television studios. Boom length and counter balance overhang are easily adjustable.

KS-3B MICROPHONE BOOM & STAND

Height of StandAdjustable from 5' 3" to 8' 10"
 Horizontal Arm Adjustment
 (with overhang to rear)5' 4" to 8' 1"
 Microphone MountingStandard 1/2" pipe thread
 5/8"-27 fixture thread with adaptor removed
 Weight (unpacked)67 lbs. (30.4 kg.)
 FinishSatin stainless steel and low luster gray
Ordering InformationMI-11056

BS-36 FLOATING ACTION BOOM & STAND

Height of StandAdjustable from 4' to 6'
 Boom Length62" (an additional 31" extension may
 be added if a lightweight mike is used)
 Microphone Mounting5/8"-27 Fixture Thread
 Base Diameter17"
 Weight Shipping36 lbs. (16 kg.)
 FinishChrome plated with base of polished chrome
 and gun metal
Ordering InformationMI-11021-2

MI-11070 MICROPHONE BOOM & STAND

Height of StandAdjustable from 4' to 8'
 Horizontal Arm AdjustmentTelescope 6' 10" to 18'
 Microphone MountingShockproof rubber mount
 with 1/2" pipe thread
 Microphone AdjustmentRear handwheel
 Weight (approx.)70 lbs. (32 kg.)
 FinishSatin, stainless steel and gray
Ordering InformationMI-11070

MI-26574 MICROPHONE BOOM & PERAMBULATOR

Dimensions:
 Maximum Height (with boom pedestal elevated)9' 5"
 Height (with pedestal lowered)6' 5"
 Length of Boom:
 Extended17'
 Retracted7' 4 1/2"
 Weight:
 Boom (with gunning device
 and counterweights)102 lbs. (46.5 kg.)
 Perambulator421 lbs. (190 kg.)



Microphone Booms, Stands, Perambulators.

Accessory Equipment

Standard Clamp Type Holders
 (Mole Richardson)Type H-1 to H-7

Ordering Information

Boom and Perambulator (complete)MI-26574
 Boom OnlyMI-26574-1
 Perambulator OnlyMI-26574-2



ADJUSTABLE MICROPHONE SUPPORT ARMS

Type M-2-MD-U—Has 12-inch upright to raise bottom joint of arm to level of top of console. Screw attachment base for horizontal surface. Extreme extension 33 inches. Male stud 5/8"-27 thread. Shipping weight 9 lbs. (4.1 kg.)

Ordering InformationMI-11020-1

Type M-2-MC Two-arm type similar to MI-11020-1 with clamp base attachment for thickness up to 2 1/8 inches. Extreme extension 33 inches. Shipping weight 7 lbs. (3.2 kg.)

Ordering InformationMI-11020-2

Type M-3MW Three arm type for wall mounting three feet above working level, male stud 5/8"-27 thread. Extreme extension 33 inches. Shipping Weight 9 lbs. (4.1 kg.)

Ordering InformationMI-11020-4

BK-6B MICROPHONE HOLDER

Use...To mount BK-6B Microphone to floor or flexible stands
 Size2 5/8" long x 1 1/8" dia.
 Weight—Holder2 oz. (57 g.)

Ordering Information

BK-6B Microphone Holder, 5/8"—27 threadMI-12086



MI-12086

MICROPHONE STAND ADAPTOR KIT

Weight8 oz. (230 g.)

Ordering Information

BK-6B Microphone Stand Adaptor Kit (Consisting of stand adaptor flange, 3 tapping screws, microphone adaptor, 2 machine screws and rubber gasket)MI-11073



MI-11073

CABLE HOOK

UseFits all microphones
 Weight15 oz. (425 g.)
 FinishPolished Chrome
 Fits Stands 7/8" to 1 1/4" in diameter
 AttachmentOne screw

Ordering Information

Cable HookMI-11099-B



MI-11099-B

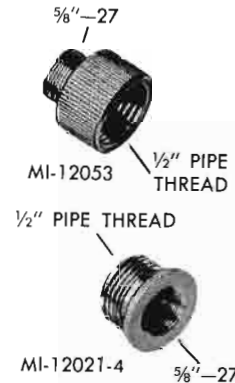

MI-12053 1/2" PIPE THREAD

1/2" PIPE THREAD

MI-12021-4 5/8"—27

MICROPHONE ADAPTORS

Stand Thread	Microphone Thread	Ordering Information
1/2" pipe thread	5/8"—27	MI-12053
5/8"—27	1/2" pipe thread	MI-11021-4
5/8"—27	1/8" pipe thread	MI-6229

GOOSENECK STANDS

Ordering Information

13" Flexible Stand, chrome finish, 5/8"—27 thread, wt. 1 lb. (.45 kg.)MI-11745
 19" Flexible Stand, chrome finish, 5/8"—27 thread, wt. 1 1/2 lbs. (.68 kg.)MI-11746
 6" Stand Bracket Clamp, 5/8"—27 threadMI-11747



MI-11746

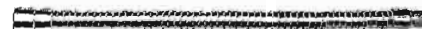

MI-11745

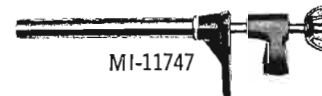

MI-11747

Microphone Accessories.

MICROPHONE CABLES

RCA microphone cables are of rugged construction and are jacketed with a neoprene compound to insure long life. They are especially designed for broadcast service either studio or remote.

LOW IMPEDANCE CABLE, MI-43-D

UseCable for low impedance microphone circuits
 TypeThree conductor, twisted
 ConductorsCadmium copper, stranded, equivalent to #20 AWG
 InsulationSpecial rubber compound
 Shield...Semiconducting wrapped and braided tinned copper (Complete coverage without loss in flexibility)
 Outer CoveringBrown neoprene compound
 Overall Diameter0.300

Ordering Information

Specify length in 100-foot multiplesMI-43-D

HEAVY DUTY CABLE, MI-13307-A

TypeTwo conductor, twisted
 ConductorsStranded, equivalent to #16 AWG
 InsulationSpecial rubber compound
 ShieldTinned copper. Complete coverage without loss in flexibility
 Outer CoveringBlack neoprene compound
 Overall Diameter0.300

Ordering Information

Specify length in 100-foot multiplesMI-13307-A

LIGHTWEIGHT CABLE, MI-13322-B or C

TypeTwo conductor, twisted
 ConductorsStranded cadmium copper, equivalent to #24 AWG
 InsulationPolyethylene
 Shield...Semiconducting wrapped and braided tinned copper (Complete coverage with greater flexibility)
 Outer CoveringPYC
 Overall Diameter0.215 plastic

Ordering Information

Specify length in 100-foot multiplesMI-13322-B or C

Type "XLR"

Microphone Receptacle (Male)
MI-11087-B



Microphone Plug (Female)
MI-11090-A



Microphone Receptacle (Female)
MI-11088-B



Microphone Plug (Male)
MI-11089-A



Type "UA"



Microphone Plug
MI-11062



Receptacle
MI-11063



Cord Connector
MI-11061



Wall Receptacle
MI-4624-A

Type "P"



Microphone Plug
MI-4630-B



Cord Connector
MI-4620-B

MICROPHONE PLUGS AND RECEPTACLES

RCA microphones are sold without plugs in order that the purchaser may use any type desired. Three series of Cannon plugs which meet requirements for reliability and ruggedness are stocked. These include the "UA" series of plugs which have been designed as a result of EIA recommendations, the "P" Type Connectors and the "XLR" matched family of small 3-contact connectors.

The "UA" connectors have gold-plated contacts for low-loss and noise-free operation. Flat top construction provides positive polarization. All have thumb action latch-lock for quick insertion and firm engagement and a 1 $\frac{3}{4}$ -inch rubber sleeve for cord protection.

The "P" connectors are the original connectors for audio circuits and accommodate wires up to No. 10. The "P" connectors have a 15 ampere contact capacity. The Cannon connectors "XLR" type plugs and receptacles are miniature connectors favored by many users.

SPECIFICATIONS

Description	Cannon Stock No.	Ordering Information
Female Plug for Microphone Extension Cable (mates with UA-3-12).....	UA-3-11	MI-11061
Male Plug for Microphone Cable (mates with UA-3-11 and UA-3-13)	UA-3-12	MI-11062
Flush Mounting Receptacle (mates with UA-3-12)	UA-3-13	MI-11063
Male Plug for Microphone Cords	P3-CG-12S	MI-4630-B
Wall Receptacle for Above Plug	P3-35	MI-4624-A
Note: The MI-4624-A Receptacle will fit a standard AC outlet box.		
Extension Cord—Female Connector..	P3-CG-11S	MI-4620-B
Microphone Receptacle, Female	XLR-3-31	MI-11088-B
Microphone Receptacle, Male	XLR-3-32	MI-11087-B
Microphone Plug, Female	XLR-3-11C	MI-11090-A
Microphone Plug, Male	XLR-3-12C	MI-11089-A



- Complete high-fidelity audio system designed for dual channel operation
- Compact self-contained
- Solid state design
- Provision for optional second VU meter
- Built-in cue monitor and intercom amplifier completely independent of program circuits
- Optional BCM-2A Auxiliary Mixer

Studio Console, Type BC-8A

Description

Possessing great flexibility and featuring simplified operation, the BC-8A Studio Console provides a high-fidelity audio input system for AM, FM and TV broadcast stations. Designed for operating convenience and ease of servicing, the Console offers two channel mixing and switching with monitoring facilities, plus dependable plug-in transistor amplifiers, low impedance mixing circuits, self-contained power supply and built-in cue/intercom amplifier. Provisions are included for

installation of a second VU meter so that simultaneous, visual monitoring of both program channels may be accomplished if desired.

Field installation of a third program channel is possible. This is useful for pre-testing microphone circuits for quality and level before switching to TV program or preview channels.

Plug-In Unitized Construction

Plug-in unitized construction is

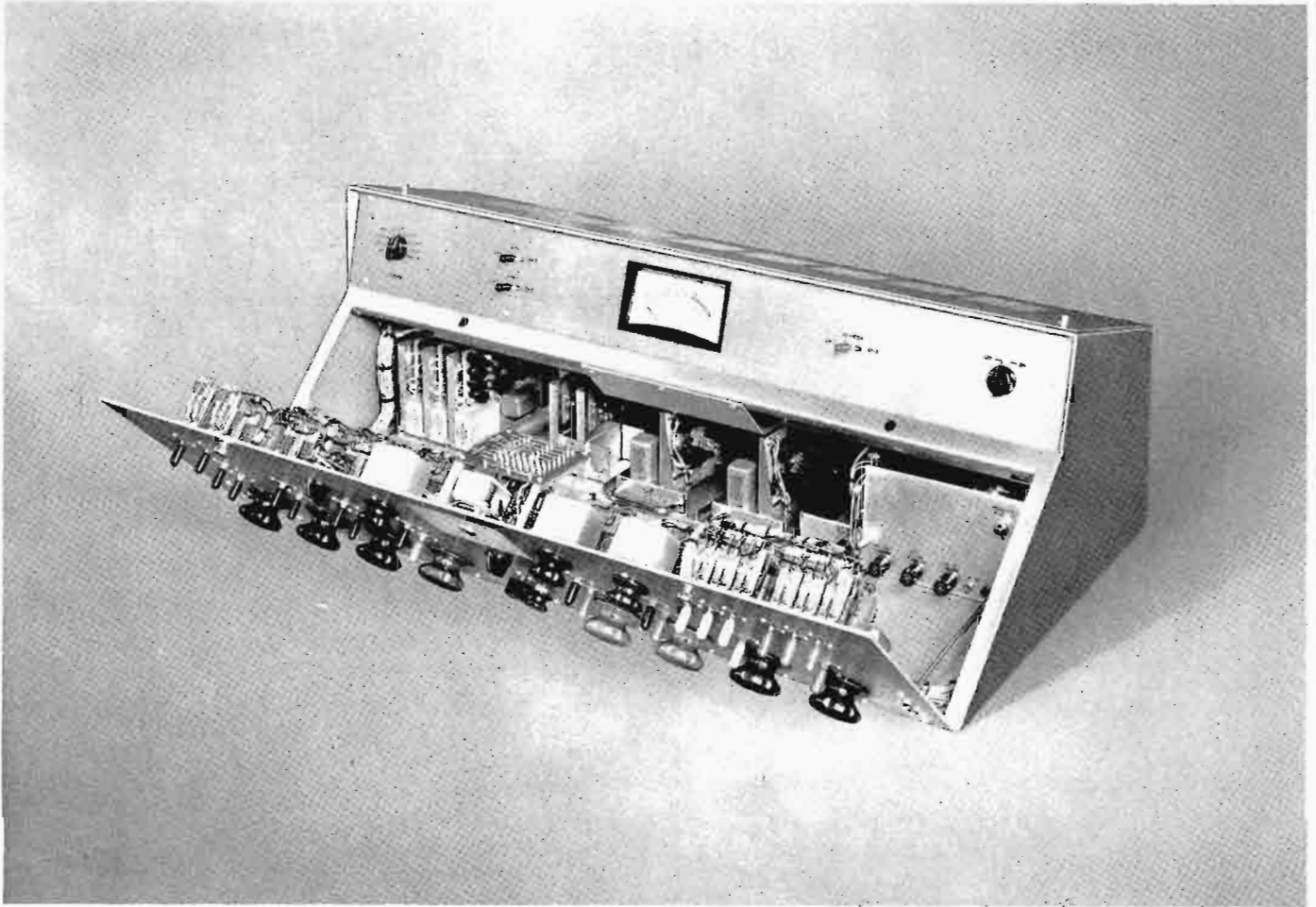

BC-8A with front panel lowered to show internal plug-in modules, pre-amplifiers, high-level isolation units, program amplifiers, cue amplifier and power supply.

the key to the flexibility of the BC-8A. The basic console consists of a wired housing including all operating controls, three dust-protected speaker muting relays, one VU meter, with provisions for adding an optional second VU meter, and guide assemblies for accepting plug-in transistor modules. These comprise three preamplifiers, two program amplifiers, one cue/intercom amplifier, one monitor amplifier, one power supply, and two high level isolation units. Plug-in units used are identical with those of the BC-7A Console and BCM-2B Auxiliary Mixer.

8 Low Impedance Mixers With Cue Positions

The BC-8A Studio Console contains a total of eight mixer positions; three low level, each switchable to one of three inputs; three high level, each switchable to one of three inputs; and two line level, each switchable to one of three inputs. All amplifier inputs and outputs are brought out to terminal connections within the console, so that wiring to external jack fields may be easily accomplished.

Ease of Operation

All switching, mixing, and operational controls are contained on the main control panel and are grouped

and color coded for fast identification. The double slope front panel, pleasing functional design, large illuminated VU meter and completely uncluttered control panel highlight the simplicity and beauty of the unit. The finish of the main control panel is anodized, brushed aluminum, while the housing and upper panel are finished in a harmonizing blue color. The console is intended for flat desk top mounting. The BCM-2B Auxiliary Mixer may be used with the BC-8A to increase the number of available mixers by five. Convenient terminals are provided in the BC-8A to extend the mixer bus to the BCM-2B.

FUNCTIONAL DRAWING OF THE BC-8A STUDIO CONSOLETTA

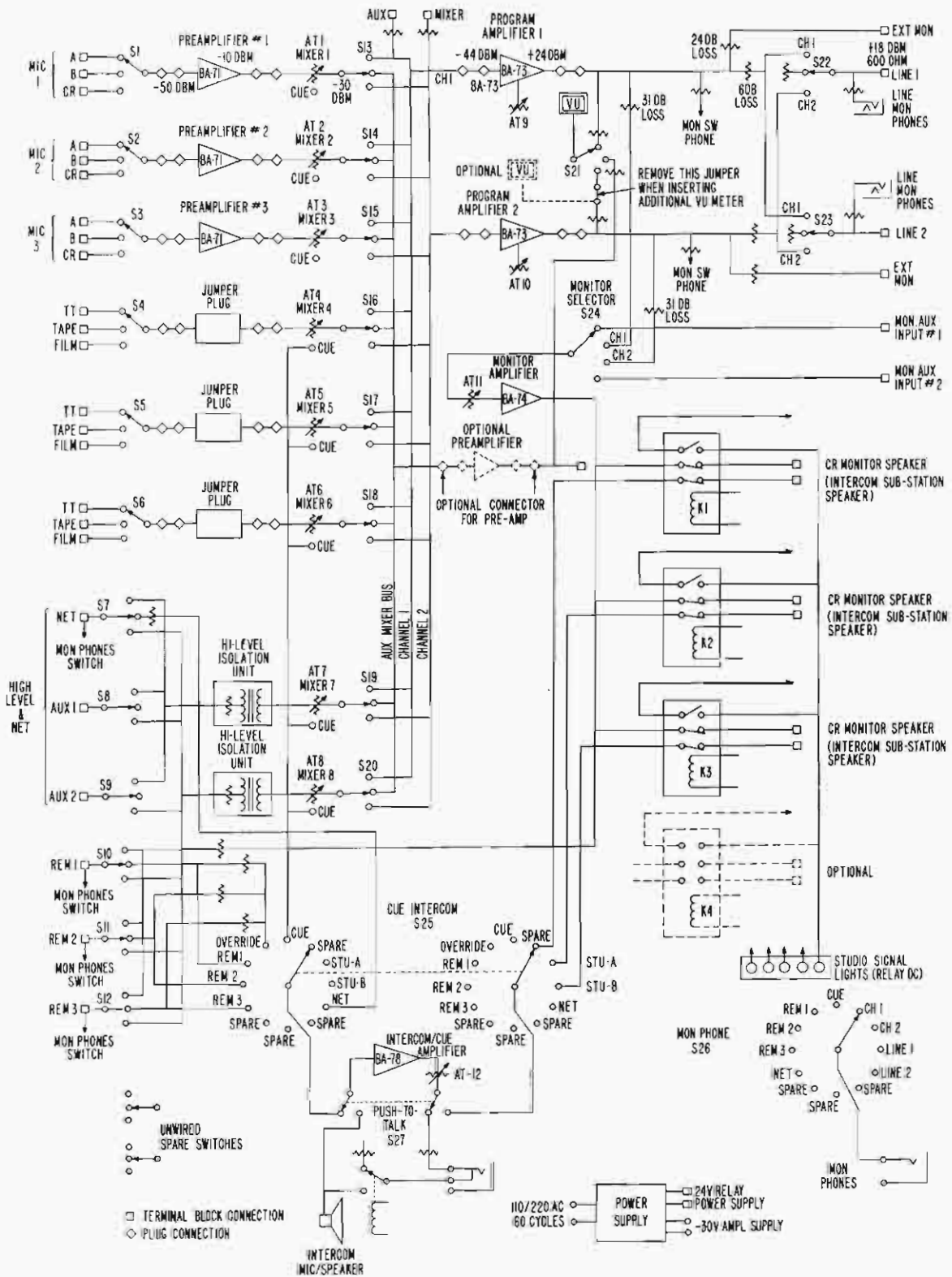

Specifications

Mixers8 (selectable by lever key to either program channel)

Inputs:

- 9 Microphones switchable to 3 preamplifiers
- 9 Turntable, tape or film, switchable to 3 high level mixers
- 3 Network or high level, each switchable to Mixer No. 7 or No. 8
- 3 Remote lines, switchable to mixer No. 8, intercom, and program cue

Plug-in Components:

- 3 Plug-in transistor preamplifiers (with provisions for 3 additional accessory preamplifiers)
- 2 Plug-in transistor program amplifiers with individual master gain controls
- 1 Plug-in transistor cue/intercom amplifier
- 1 Plug-in transistor monitor amplifier with provisions for a second accessory monitor bus
- 1 Plug-in transistor power supply
- 2 High level isolation units

Outputs:

- 2 Program lines (either channel may feed either or both lines)
- 2 External monitor (one for each channel)
- 3 Speakers

Source Impedance:

- Microphones37.5/150/600 Ohms
- Net and Remote Lines600 Ohms balanced
- Turntables, tape and film600 Ohms unbalanced (may be balanced by use of MI-11665 high level isolation units)

Load Impedance:

- Line600 Ohms balanced from 6 dB pad
- Speaker16 Ohms
- HeadphoneHigh Impedance

Input Level:

- Microphone Inputs (maximum)-22 dBm
- Turntable Input (maximum)+18 dBm
- Net or Remote Line (maximum)+18 dBm

Gain:

- Microphone Input to Program Line105 dB (can be increased to 111 dB)
- Turntable or Remote Line to Program Line64 dB

Frequency Response±1.5 dB, 30 to 15,000 Hz

Distortion:

- Program Channel.....Less than .5%, 50-15,000 Hz; less than .75% at 30 Hz
- Monitor Amplifier.....Less than 1%, 50-15,000 Hz

Signal-to-Noise Ratio:

- Microphone to Program Line (68 dB gain, +18 dBm output)68 dB

Dimensions (overall).....34¾" wide, 12½" high, 20" deep (88.26 cm, 31.75 cm, 50.8 cm)

Weight.....Approximately 125 lbs. (57.7 kg) (with plug-in units)

Finish.....Blue, brushed aluminum panel, color coded controls

Power Requirements.....115/230 V, 50-60 Hz, 120 Watt maximum

BA-71B PREAMPLIFIER, MI-11658-A

Power Requirements30 V, 45 mA (each) from BX-71A

Maximum Ambient Temperature.....55°C (131°F)

Mounting.....Plug-in for BC-8A Console
Dimensions Overall.....13¾" wide, 45¾" high, 75¾" long (deep) (3.49 cm, 11.75 cm, 19.37 cm)

Weight.....2¼ lbs. (1 kg)

BA-73B PROGRAM AMPLIFIER, MI-11659-A

Power Requirements30 V, 300 mA (each) from BX-71A
Ambient Temperature.....55°C (131°F)

Mounting.....Plug-in for BC-8A Console
Dimensions Overall.....3¾" wide, 45¾" high, 9" long (deep) (9.52 cm, 11.75 cm, 22.86 cm)

Weight.....4 lbs. (1.8 kg)

BA-74B MONITOR AMPLIFIER, MI-11661-A

Power Requirements100-130 V, AC, 50/60 Hz, 30 Watts (with taps for 105, 115 and 125 Volts)

Ambient Temperature.....50°C (131°F)
Mounting.....Plug-in for BC-8A Console
Dimensions Overall.....5" wide, 45¾" high, 97¾" long (deep) (12.7 cm, 11.75 cm, 25.08 cm)

Weight.....11 lbs. (5 kg)

BA-78B CUE/INTERCOM AMPLIFIER, MI-11662-A

Power Requirements115/230 V, AC, 50/60 Hz
3-5 Watts full program, 2 Watts standby
8 Watts max. sine wave output
Maximum Ambient Temperature.....50°C (131°F)

Dimensions Overall.....3" wide, 45¾" high, 87¾" long (deep) (7.62 cm, 11.75 cm, 21.27 cm)

Weight.....3 lbs. (1.36 kg)

BX-71A POWER SUPPLY, MI-11663-A

Power Requirements100-130, or 200-260 V, AC, 50/60 Hz (with taps at 105, 115, 125, 210, 230 and 250 V)

Power Output-30 V at 1 Amp., regulated; 24 V at .56 Amp., unregulated; 6 V AC at 1.5 Amp.

Regulation.....0.35% no load to full load
Ripple.....0.15 mV max. on 30 V supply

Fuse1.5 and 1 Ampere, slo-blow
Mounting.....Plug-in for BC-8A Console

Dimensions Overall.....7½" wide, 45¾" high, 87¾" long (deep) (19.05 cm, 11.75 cm, 22.54 cm)

Weight.....14 lbs. (6.35 kg)

Accessories

Auxiliary Mixer Housing, Type BCM-2B (less all plug-in modules)	MI-11656-A
On-Air Light Relay	MI-11702-A
Warning Lights	MI-11706-Series
Film Changeover Relay	MI-11729
Clock, Sessions Studio Type, 13½" Diameter	MI-11758
Indicating Glasses for MI-11706 Series	MI-11718-1 to 6
Custom Indicating Glasses for MI-11706 Series	Custom
BC-8A Studio Console Housing only, less plug-in modules	MI-11667-A
Headphone, Single 9K Ohms Impedance with plug	MI-11749
Headphone, Double, 24K Ohms Impedance with plug	MI-11750
Type BA-71C Preamplifier (less guide assembly)	MI-11658-B
Type BA-73B Program Amplifier (less guide assembly)	MI-11659-A
Type BA-74B Monitor Amplifier (less guide assembly)	MI-11661-B
Type BA-78B Cue/Intercom Amplifier (less guide assembly)	MI-11662-A
Type BX-71A Power Supply (less guide assembly)	MI-11663-A

Ordering Information

BC-8A Studio Console, complete.....ES-11167-A



- Unmatched flexibility
- Ease of operation
- Solid State design
- Utmost reliability

Dual-Channel Audio Console, Type BC-7A

Description

The BC-7A Dual Channel Audio Console is a completely self-contained unit providing the broadcaster with both stereo or monaural mixing, switching, and monitoring facilities, plus dependable plug-in transistor amplifiers, low impedance mixing circuits, self-contained power supply and built-in cue/intercom amplifier. Provisions are included for installation of optional AGC meters so the gain reduction of an external amplifier may be observed while controlling program gain.

Stereo/Dual Channel Operation

The BC-7A is normally supplied with five preamplifiers, two program amplifiers, one cue/intercom amplifier and one monitor amplifier. With an additional preamplifier and a second monitor amplifier, complete stereo monitoring is available. For stereo broadcasting the program

master gain controls of the BC-7A are ganged together as are the monitor gain controls by placing the mode switch in the stereo position. A unique, smooth action, dual mixer control is used in all stereo positions.

Ten Preselected Program Inputs

The BC-7A console contains a total of ten mixer positions; five low level, each switchable to one of three inputs; three high level, each switchable to one of three inputs; and two line level, of which one is switchable to three, the other to four inputs. All amplifier inputs and outputs are brought out to terminal connections within the console, so that wiring to jack fields may easily be accomplished.

Functional Design

The BC-7A Dual Channel Console is designed not only for

greater operating convenience and ease of servicing, but for aesthetic value as well. The double slope front panel, pleasing functional design, large illuminated VU meters and uncluttered control panel highlight the simplicity and beauty of the unit. The finish of the main control panel is anodized, brushed aluminum while the housing and upper panel is finished in harmonizing blue color. The console is intended for flat top desk mounting.

Compact Control Arrangement

All switching, mixing, and operational controls are contained on the main control panel and are grouped and color coded for fast identification thus minimizing operator error. Permanent panel designations are etched in black whereas designations which are most subject to change, depending on individual

BC-7A with front panel lowered to show internal plug-in units, including left to right, preamplifiers, high-level isolation units, program amplifiers, cue amplifier and power supply.

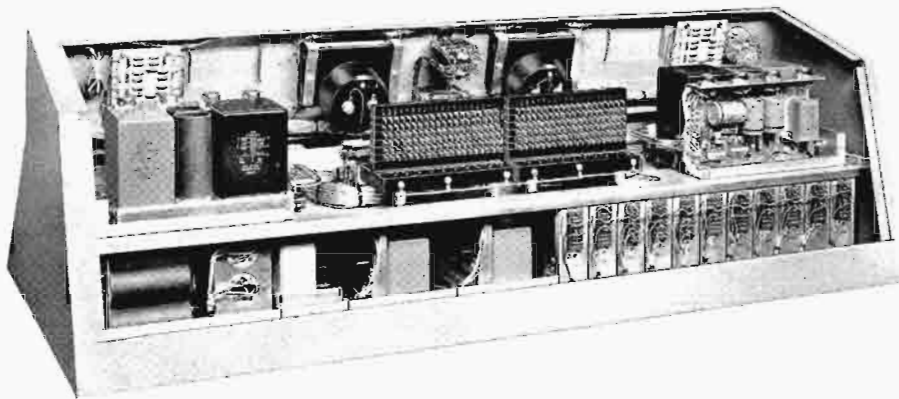
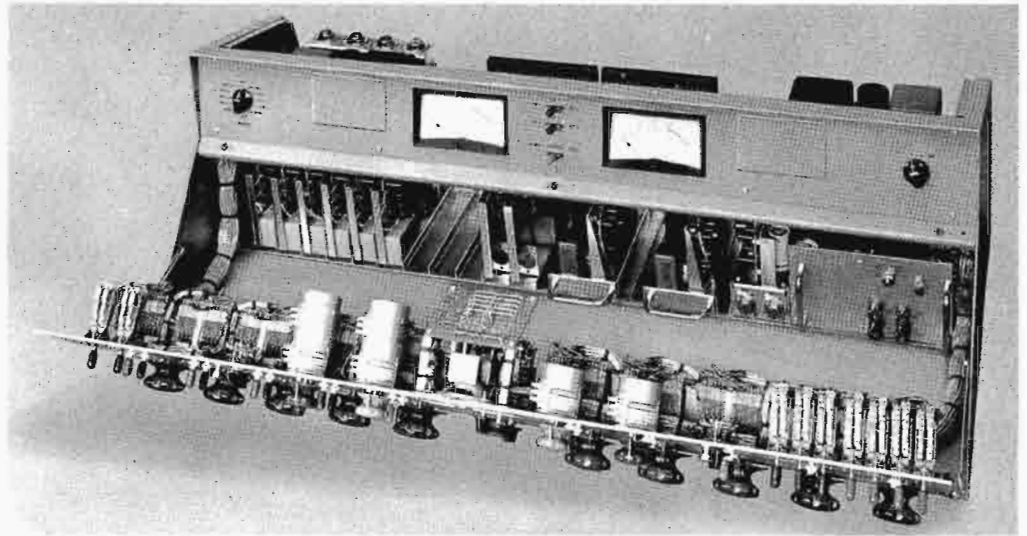

Rear of BC-7A with cover removed showing plug-in monitoring amplifiers and accessibility to external plug-in connection terminals.

needs, are left blank. Uniform panel depressions, provided at these locations, accept a wide assortment of pressure sensitive labels supplied with each unit. The labels provide a neat, permanent appearance to the console, yet can easily be changed when necessary.

Unitized Construction

Plug-in, unitized construction is the key to the flexibility of the BC-7A to meet the varying needs of TV and AM broadcasters as well as recording studio applications. Six plug-in unit types are used in the BC-7A: the preamplifier, program amplifier, monitor amplifier, cue/intercom amplifier, power supply and high level isolation unit.

Optional AGC Meters

The basic console consists of a wired housing including all operating controls, five dust-protected speaker muting relays, two VU

meters, with provisions for adding two optional gain reduction meters, and guide assemblies for accepting plug-in units.

All Solder Input Connectors

One feature of the design is the availability of the input and output circuits on terminals. This facilitates wiring to external sound effects equipment, compensating networks or jack panels. Another feature is the muting relay strapping panel, conveniently located behind the main control panel at the top, center. Any of the five muting relays may be controlled by any combination of source selection lever keys associated with mixers 1 thru 8.

Self-Contained Power Supply

The power supply provides operating power for up to ten preamplifiers, two program amplifiers, five speaker muting relays as well as reserve power for operation of five

additional optional warning light relays. The ten Watt monitor amplifier and the cue/intercom amplifier contain their own power supply.

Mixing Facilities

Each of the ten, low impedance mixing positions will accept one of three plug-in units: the preamplifier for low level sources; the high level isolation unit for balanced high level sources or a simple jumper plug for direct unbalanced input to the mixer. The standard console housing is supplied with dual attenuators in mixer positions 5, 6, 7 and 8.

Auxiliary Mixer

The BCM-2B Auxiliary Mixer is designed as a companion piece to increase the number of available mixers by 5. One or more of the BCM-2B Auxiliary Mixer Units may be added. Convenient terminals are provided in the BC-7A console to extend the mixer bus to the BCM-2B.

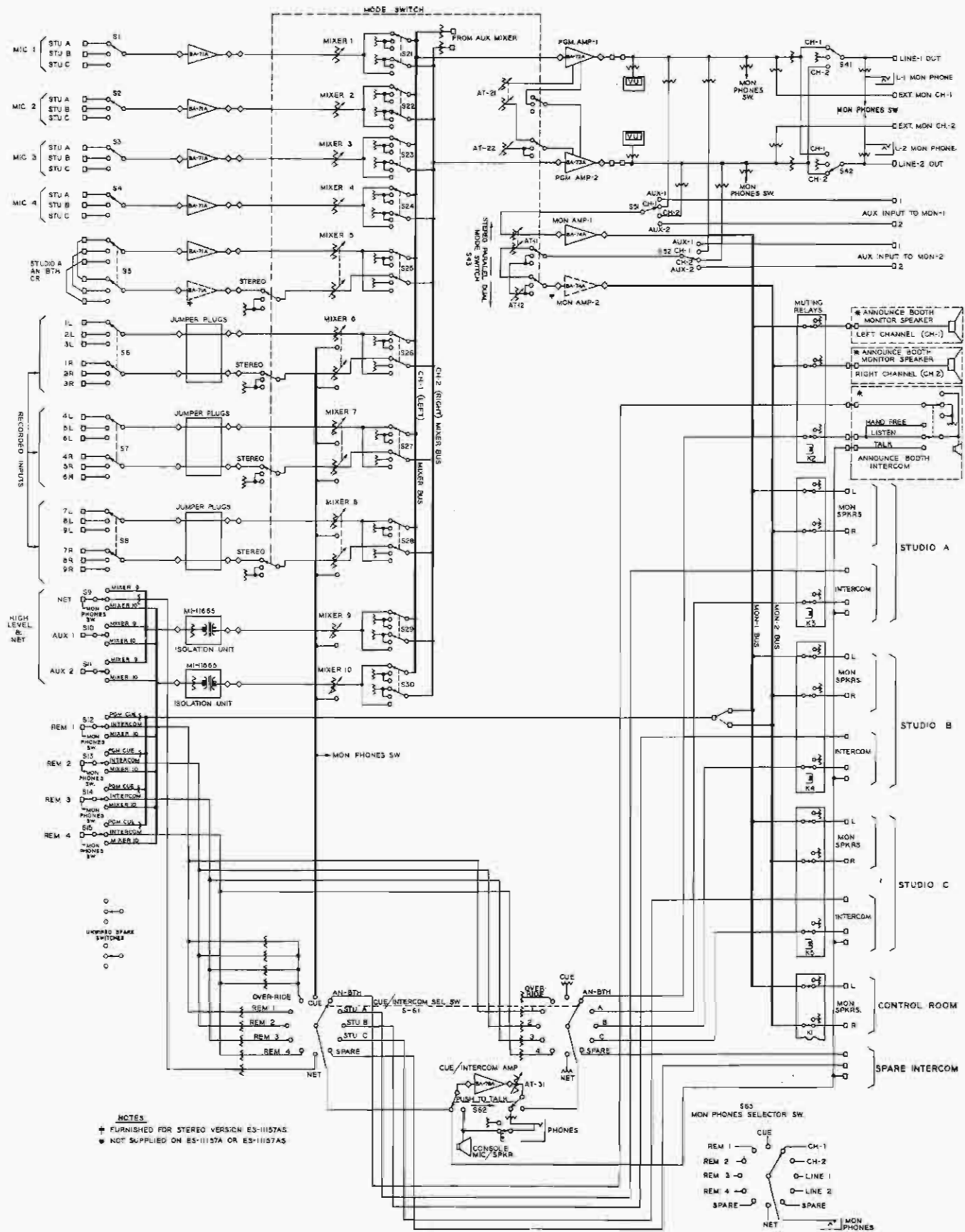

Simplified functional drawing of the BC-7A Dual Channel Audio Console.

Specifications

Mixers:

- 10 Selectable by lever key to either program channel.

Inputs:

- 15 Microphones switchable to five preamplifiers (microphone on mixer 5 may be split to feed both channels for stereo operation by addition of accessory preamplifier).
- 9 Turntable, tape or film, switchable to three high level mixers. (All three may be stereo operated.)
- 3 Network or high level, each switchable to either mixer No. 9 or mixer No. 10.
- 4 Remote lines, switchable to mixer No. 10, intercom, and program cue.
- 2 Spare monitor positions each channel.

Amplifiers:

- 5 Plug-in transistor preamplifiers (with provisions for five additional accessory preamplifiers).
- 2 Plug-in transistor program amplifiers with individual master gain controls. (Gain controls, ganged for stereo.)
- 1 Plug-in transistor cue/intercom amplifier.
- 1 Plug-in transistor monitor amplifier. Provisions are included for a second accessory monitor amplifier. Gain controls ganged for stereo.

Outputs:

- 2 Program lines (either channel may feed either or both lines).
- 2 External monitors (one for each channel).
- 5 Speakers per channel (provisions for 10 speakers, two per location for stereo operation when using optional second monitoring amplifier).

Source Impedance:

Microphones	37.5/150/600 Ohms
Net and Remote Lines	600 Ohms
Turntables	600 Ohms
Tape	600 Ohms
Film	600 Ohms

Load Impedance:

Line	600 Ohms
Speaker	16 Ohms
Headphone	High Impedance

Output Level:

Program Channel	+18 dBm after 6 dBm isolation pad (each channel)
Monitor Amplifier	+40 dBm

Input Level:

Microphone Inputs (maximum)	-22 dBm
Turntable Input (maximum)	+18 dBm
Net or Remote Line (maximum)	+18 dBm

Gain:

Microphone Input to Program Line	105 dB
can be increased to 111 dB	
Turntable or Remote Line to Program Line	64 dB
Frequency Response	±1.5 dB, 30 to 15,000 Hz

Distortion:

Program Channel.....	Less than .5%, 50-15,000 Hz
	Less than .75%, 30 Hz
Monitor Amplifier.....	Less than 1%, 50-15,000 Hz

Signal to Noise Ratio:

Microphone to Program Line (68 dB gain, +18 dBm output)	68 dB
---	-------

Dimensions.....39¼" wide, 12½" high, 20" deep (99.7 cm, 31.75 cm, 50.8 cm)

Accessories

Auxiliary Mixer Housing, Type BCM-2B (less all plug-in modules)	MI-11656-A
On-Air Light Relay.....	MI-11702-A
Warning Lights	MI-11706-Series
Simpson VU Meter	MI-53064
Type BA-71C Preamplifier (less guide assembly)	MI-11658-B
Type BA-73B Program Amplifiers (less guide assembly)	MI-11659-A
Type BA-74B Monitor Amplifiers (less guide assembly)	MI-11661-B
Type BA-78B Cue/Intercom Amplifiers (less guide assembly)	MI-11662-B
Type BX-71A Power Supply (less guide assembly).....	MI-11663-A
VU Meter for BC-8A	#226033
Intercom Sub Station	MI-11452-A
Hook-up Wire, 2 Conductor, shielded pair, #28 Stranded, Vinyl Jacket (for BC-7/8)	MI-13395-1

Ordering Information

BC-7A Console Housing (less all plug-in modules)MI-11657-A

BC-7A Console Housing (for monaural programming)ES-11157-B
Including the following:

- 1 BC-7A Console HousingMI-11657-A
- 5 Preamplifiers, Type BA-71CMI-11658-A
- 2 Program Amplifiers, Type BA-73BMI-11659-A
- 1 Monitor Amplifier, Type BA-74BMI-11661-B
- 1 Cue/Intercom Amplifier, Type BA-78BMI-11662-B

- 2 High Level Isolation Units.....MI-11665
- 1 Power Supply, Type BX-71AMI-11663-A

BC-7A Console Housing (for stereo programming).....ES-11157-AS
Including the following:

- 1 BC-7A Console HousingMI-11657-A
- 6 Preamplifiers, Type BA-71CMI-11658-B
- 2 Program Amplifiers, Type BA-73BMI-11659-A
- 2 Monitor Amplifiers, Type BA-74BMI-11661-B
- 1 Cue/Intercom Amplifier, Type BA-78BMI-11662-B
- 2 High Level Isolation Units.....MI-11665
- 1 Power Supply, Type BX-71AMI-11663-A



- Solid State design
- Pushbutton selection of high level sources
- Self-contained relay switching permits remote operation
- Plug-in modules interchangeable with other consolettes
- Built-in intercom

Audio Console, Type BC-9A

Description

The BC-9A is a monaural consolette which has just been added to the RCA family of transistorized audio mixing equipments. This compact consolette packs a lot of versatility and convenience. Multiple pushbuttons permit easy selection of high level sources (such as tape recorders, cartridge tape, turntable, etc.) to each of two mixer controls. The BC-9A may be operated remotely, since the sources are switched by self-contained relays. Two additional mixers are provided for use with microphones.

The modular plug-in amplifiers and power supply used in the BC-9A are identical with those incorporated in several other RCA audio consolettes (BC-19A, BC-7A, BC-8A). The advantages of this interchangeability are obvious.

Communications between control room and studio or remote locations is facilitated by the intercom facilities built into the BC-9A.

Specifications

Mixers	4 mono
Inputs:	
Low Level (Microphone).....	6
High Level.....	14 (7 to each of 2 mixers)
Outputs:	
Program	1
Audition	1
Monitor Speaker Relays	3
Source Impedances:	
Microphones	37.5/150/600 Ohms
Turntables/Tape	600 Ohms
Input Levels:	
Microphone	-22 dBm maximum
Turntables/Tape/Remote	-10 dBm
Maximum Gain	105 dB
Frequency Response	±1.5 dB 30-15,000 Hz
Distortion:	
Program Channel	Less than .5% 50-15,000 Hz
Monitor Amplifier	Less than .75% 30 Hz
Signal-to-Noise Ratio	68 dB
Dimensions.....	19½" wide, 12½" high, 24" deep

Accessory

Relay Switchers Printed Circuit Board	MI-11795
---	----------

Ordering Information

Type BC-9A Monaural Consolette.....	ES-11153-A
consisting of:	
3 Type BA-71C Preamplifiers	MI-11658-B
1 Type BA-73B Program Amplifier	MI-11659-A
1 Type BA-74B Monitor Amplifier	MI-11661-B
1 Type BX-71A Power Supply.....	MI-11663-A
1 Type BA-78B Cue Amplifier	MI-11662-B
1 High Level Isolation Unit.....	MI-11665
1 Console Housing	MI-11670-A

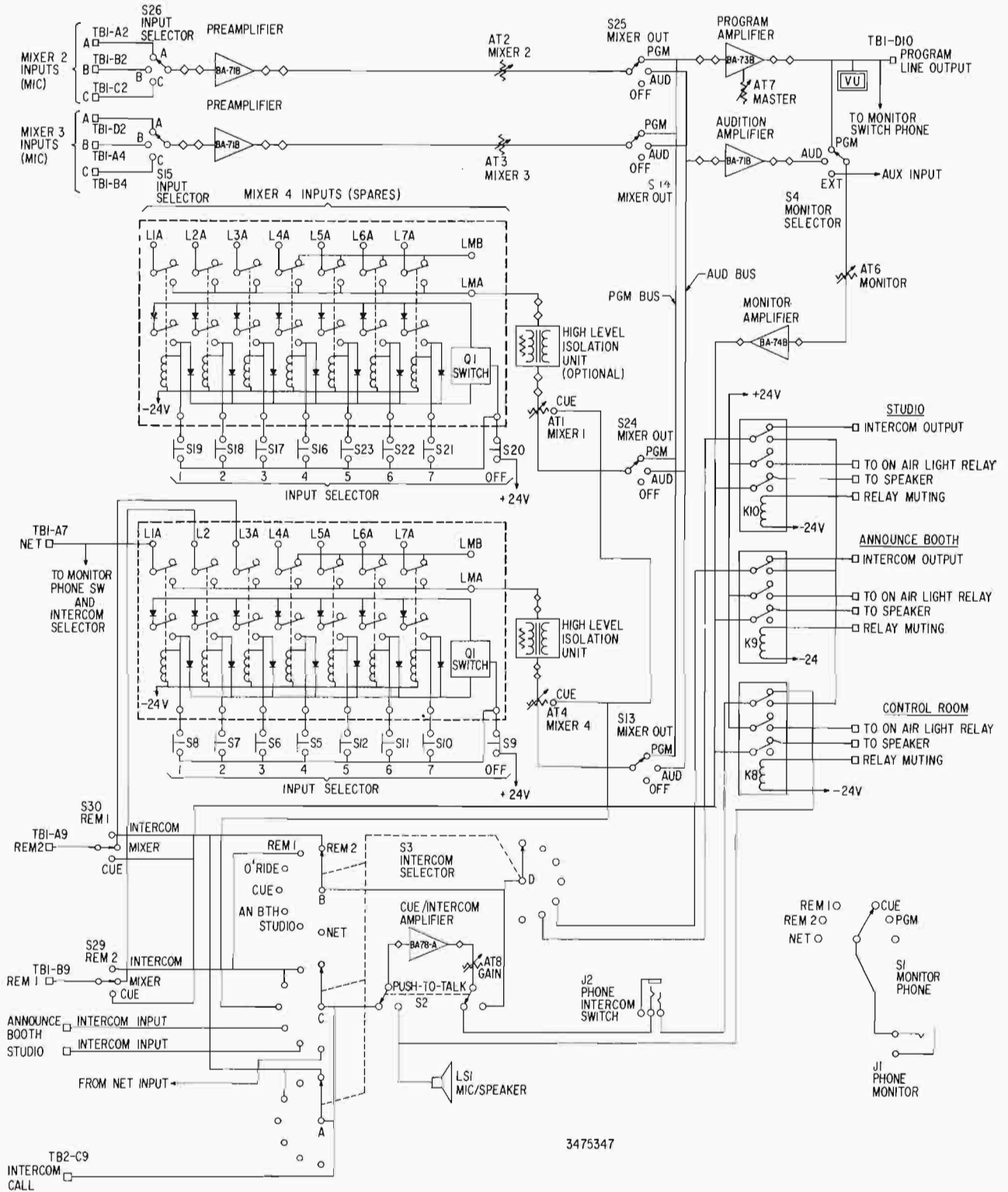

Functional Diagram



- Solid State design
- Pushbutton selection of high level sources
- Self-contained relay switching permits remote operation
- Plug-in modules interchangeable with other consolettes
- Built-in intercom

Stereo Console, Type BC-19A

Description

The BC-19A stereo console is a new addition to the growing RCA line of transistorized audio mixing equipments. It is a compact package which offers ample versatility and performance features.

Multiple pushbuttons permit easy selection of high level sources (such as tape recorders, cartridge tape, turntable, etc.) to each of two stereo mixer controls. Self-contained relays switch the sources, permitting remote operation of the BC-19A. Two additional stereo mixers are provided for use with microphones.

Interchangeability is another feature of the BC-19A. The modular plug-in amplifiers and power supply used in this unit are identical with those incorporated in several other RCA audio consolettes, including the BC-7A, BC-8A, BC-9A. Intercom facilities built into the BC-19A facilitate communications between control room and studio or remote locations.

For applications where stereo operation is not required, this versatile consolette can be used to provide two program channels and a separate intercom channel.

Specifications

Mixers	4 stereo
Inputs:	
Low Level (Microphone).....	2 stereo
High Level.....	14 stereo (7 to each of 2 mixers)
Outputs:	
Program.....	2 mono, 1 stereo
Monitor Speaker Relays.....	2
Source Impedances:	
Microphones	37.5/150/600 Ohms
Turntables/Tape	600 Ohms
Input Levels:	
Microphone	-22 dBm maximum
Turntables/Tape/Remote	-10 dBm
Maximum Gain	105 dB
Frequency Response	±1.5 dB 30-15,000 Hz
Distortion:	
Program Channel	Less than .5% 50-15,000 Hz
Monitor Amplifier	Less than 1% 50-15,000 Hz
Signal-to-Noise Ratio	68 dB
Dimensions.....	19½" wide, 12½" high, 24" deep

Accessories

Microphone Input Selector Switch	MI-11796
Relay Switcher Printed Circuit Board	MI-11795

Ordering Information

Type BC-19A Stereo Consolette.....	ES-11154-A
consisting of:	
3 Type BA-71C Preampifiers	MI-11658-B
2 Type BA-73B Program Amplifiers	MI-11659-A
2 Type BA-74B Monitor Amplifiers	MI-11661-B
1 Type BX-71-A Power Supply.....	MI-11663-A
1 Type BA-78B Cue Amplifier	MI-11662-B
1 High Level Isolation Unit.....	MI-11665
1 Console Housing	MI-11671-A

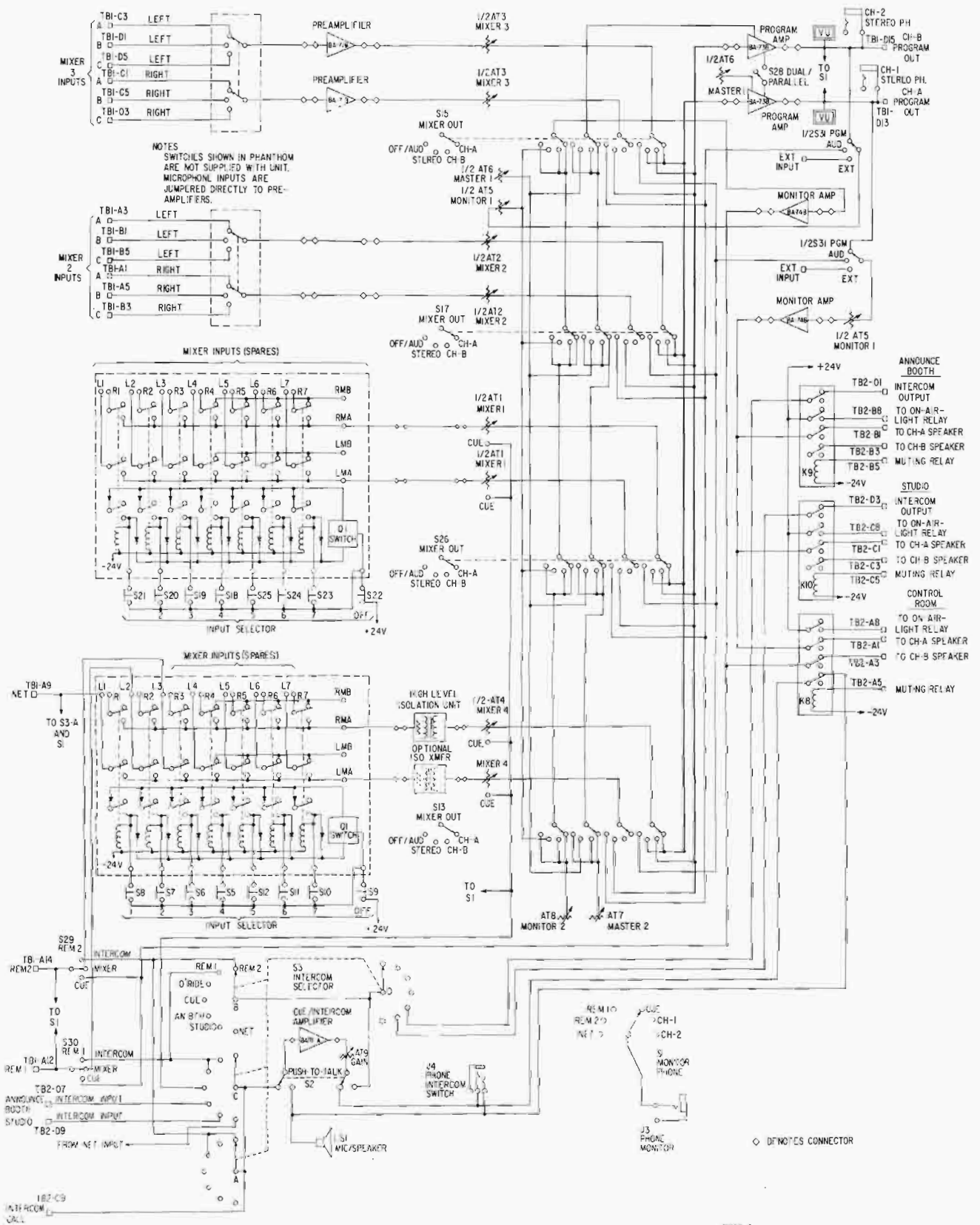

Functional Diagram

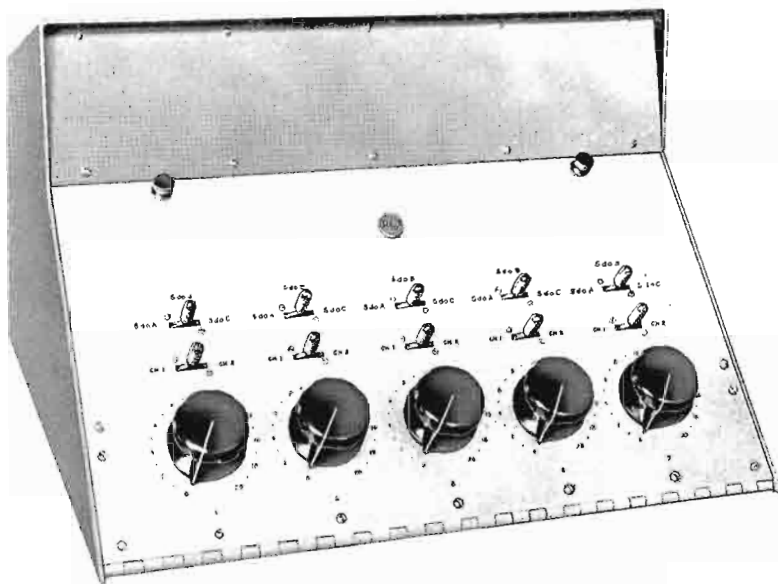

- Supplements facilities of stereo or monaural consolettes
- Provides 5 mixing channels with 15 additional input sources
- Matches RCA consolettes in design and styling
- Plug-in modules offer choice of low-level or hi-level input to each mixer
- Low impedance high level mixers
- Plug-in modules are interchangeable with other RCA consolettes

Auxiliary Mixer Consolette, Type BCM-2B

Description

The BCM-2B Auxiliary Consolette is designed to supplement the BC-7A Dual-Channel/Stereo and BC-8A Consoles by providing five additional mixing channels and 15 inputs available on selector switches. Two units may be paralleled to increase the capacity to 10 mixers and 30 source inputs. The console is styled to match the BC-7, 8, 9 and 19 Series Consolettes and is designed so that each mixer channel accepts a preamplifier, high level isolation unit or straight thru jumper plug, to accommodate a wide choice of input levels.

By use of BA-71 Preamplifiers as booster amplifiers, the 600 Ohm outputs of the auxiliary console may be bridged into the console's main mixer busses through terminals provided; or the BCM-2B may be fed into one of the high level inputs of the main console to provide a sub-master. Substitution of high level isolation units in place of booster amplifiers enables the auxiliary mixer outputs to be fed into microphone inputs of the BC-7, 8, 9 and 19 Consolettes. The gain is such that the same fader settings may be used on both BCM-2B and the console faders for equivalent levels.

The consolette has provision for its own self-contained power supply, and will supply an output level of

up to +18 dBm, and may be strapped for a maximum gain of up to 77 dB (65 dB nominal). The console has ample panel space for additional equipment or controls including extra space on the main panel plus a 4½ by 19-inch panel and a spare shelf for housing additional equipment such as the BA-70 Series of plug-in amplifiers, isolation transformers, relays, compensators, equalizers, special effects filters or other special apparatus. These features make it possible to use the BCM-2B in many special custom sound applications. The consolette has normal through terminals for convenient access to components in the system and there are spare terminals on the main terminal board for special use.

Console Controls

All operational controls are contained on the main control panel and are functionally grouped for fast identification and operating ease. Permanent panel designations are etched in black, whereas designations which are most subject to change, depending on individual needs, are left blank. Uniform panel depressions, provided at these locations, accept a wide assortment of pressure sensitive metal labels supplied with each unit. The labels provide a neat, permanent appearance to the consolette, yet can easily be changed.

Five faders or mixers are equally spaced across the main panel. Immediately above each fader is a FADER DELEGATION SWITCH (a three position lever key with a BLACK handle). Above each fader is also a SOURCE SELECTOR SWITCH (a three position lever key with a RED handle). Thus each switch is located above the mixer with which it is associated. Throwing a fader delegation switch to the left connects it to the LEFT (CH-1) mixer bus; throwing it to the right connects it to the RIGHT (CH-2) mixer bus. The center is an off position. Each of the five input selector keys permits selection of one of three inputs, thus the BCM-2B Auxiliary Consolette makes available 15 sources. Two BCM-2B Auxiliary Mixer Consolettes can be used with any BC-7 consolette to obtain a total of 61 sources available on switches and with any BC-8A consolette to provide a total of 54 switchable inputs.

Dual Channel Facilities

Three-position fader delegation keys and two mixer busses provide facilities suitable for dual channel operation (either stereo; program-audition; or two independent channels). The mixer delegation keys are pre-wired for stereo mixers so that any mixer can be conveniently replaced by a dual (stereo) mixer available from stock. Extra contacts are

provided on the input selector switches so that, if desired, any input selector switch may be custom wired to simultaneously select both LEFT and RIGHT channels of a stereo source (i.e., stereo microphone, stereo tape, or stereo turntable). Terminals are provided on the main terminal block for a "RIGHT" input adjacent to the normal "LEFT" input.

Control Circuit Patch Board

A muting relay strapping panel is conveniently located behind the main control panel and appears in the center front in a horizontal posi-

tion when the main panel is hinged open. All terminals are functionally identified so that any of the console muting relays may be controlled by any combination of source selection lever keys.

Power Supply

The Auxiliary BCM-2B has provision for its own self-contained plug-in power supply. It can be operated from the power supply in the main console provided no more than nine preamplifiers (including preamplifiers in the consolette) are powered at any of one time to the

two program amplifiers located in the consolette.

The BCM-2B is intended for flat top desk mounting. The double slope front panel, pleasing functional design and simplicity of layout offer flexibility, great convenience and ease of operation. The finish of the main control panel is anodized brushed aluminum, while the housing and upper panel is finished in a harmonizing baked shadow blue enamel. The front panel hinges forward and the rear cover can be removed by latches.

Specifications

- Mixers5 low-impedance high-level
- Amplifiers:
 - Preamplifiers5 Type BA-17
 - Booster Amplifiers2 Type BA-71
 - Power Supply1 Type BX-71
- Microphone Inputs...15—3 to each channel (any channel may have high level inputs if isolation units are used in place of preamplifiers)
- Source Impedance (Preamplifier Input) ...37.5/150/600 Ohms
- Input Impedance (Preamplifier Input)Unloaded input transformer
- Load Impedance150/600 Ohms
- Outputs
 - (from booster or isolation units) ...2—each 150/600 Ohms
- Gain (with controls set for max.)65 dB nominal, may be strapped for up to 77 dB
- Maximum Output+18 dBm
- Frequency Response±1 dB 30-15,000 Hz
- DistortionLess than .5%, 50-15,000 Hz
- Signal-to-Noise Ratio:
 - Microphone to BC-7A Program Line Out (68 dB gain +18 dB output)At least 68 dB
- Dimensions Overall.....19½" wide by 12 ½" high by 20" deep (49.53 cm, 31.75 cm, 50.8 cm)
- WeightApprox. 45 lbs., (20.5 kg.) (no plug-in units)
- Power Supply—Approx. 14 lbs., (6.35 kg.) Preamplifiers—Each Approx. 3 lbs. (1.36 kg.)

Accessories

- High Level Isolation UnitES-11665
- Power Supply, BX-71AMI-11663-A
- Preamplifier, Type BA-71CMI-11658-B

Functional Block Diagram

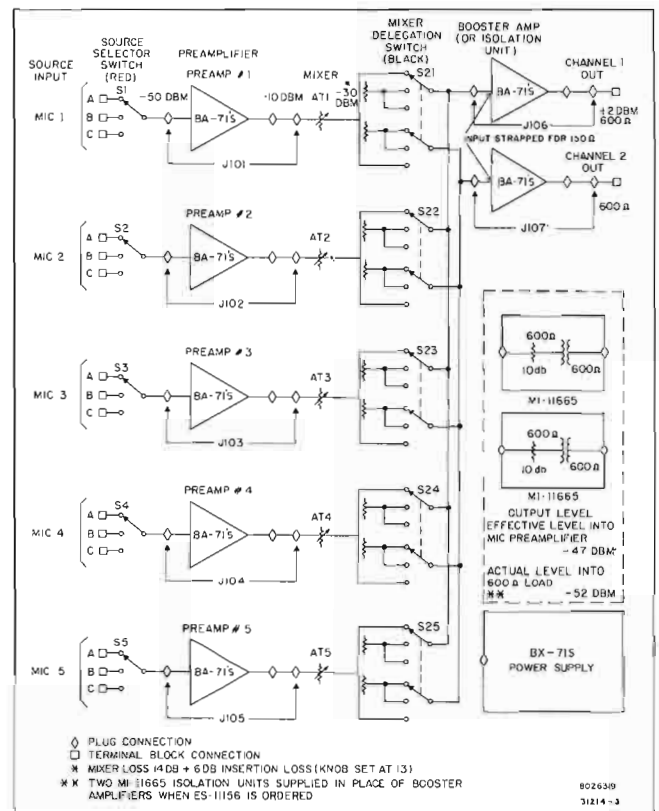

Ordering Information

- BCM-2B Consolette Housing (less all plug-in units) MI-11656-A
- BCM-2B Auxiliary Mixing Consolette (for Mixer Bus Bridging)ES-11155
- Including the following:
 - 1 BCM-2B Consolette HousingMI-11656-A
 - 7 Preamplifiers, Type BA-71CMI-11658-A
 - 2 Booster Amplifiers, Type BA-71CMI-11658-B
 - 1 Power Supply, Type BX-71AMI-11663-A

- BCM-2B Auxiliary Mixing Consolette (for Mixer Input)ES-11156-A
- Including the following:
 - 1 BCM-2B Consolette HousingMI-11656-A
 - 5 Preamplifiers, Type BA-71CMI-11658-B
 - 2 Isolation UnitsMI-11665
 - 1 Power Supply, Type BX-71AMI-11663-A

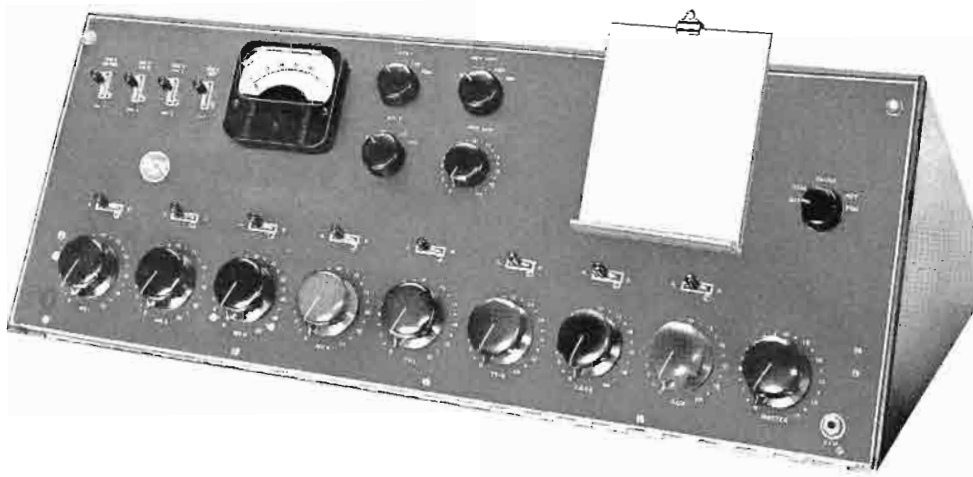

- Complete high-fidelity speech input system
- Headphone selection of network, remote, and program line
- Compact modular construction
- Easy operation

Standard Audio Console, Type BC-3C

Description

The RCA Type BC-3C Standard Audio Console is a compact, self-contained, high-fidelity speech-input system providing audio amplification, switching, control and monitoring facilities essential to the operation of medium size radio or television broadcast stations. This model incorporates eight mixer positions, which control thirteen inputs. The console is sufficiently flexible to accommodate two studios, announce booth, control room, transcription turntables and auxiliary input circuitry.

Convenient Operating Controls

The Type BC-3C Standard Audio Console is a convenient audio control equipment mounted in a smartly styled housing of all-metal construction. A hinged front panel and removable cover provide access to tubes, switches, gain controls and

other interior components. An etched panel contains all operating controls, an illuminated volume indicator calibrated in VU's, and a rack designed to hold script. The mixer controls are assigned so as to offer the greatest flexibility and operating ease.

Facilities for 13 Inputs

The BC-3C will handle thirteen separate inputs with provisions for simultaneously mixing of any eight inputs. There is provision for feeding program cue or talkback to remote lines. Headset switching is provided for network, program and remote line monitoring. Cue positions are incorporated on high level and turntable mixers. A separate audition channel is provided for maximum flexibility. The monitoring amplifier may be switched from the cue position, program line, audi-

tion bus, or external input. The output of an off-air receiver or modulation monitor can be connected to this external position. All inputs are terminated when the switches are in the off position.

Entirely Self-Contained

The BC-3C is of modular construction with etched wiring on durable glass-epoxy sub-assemblies. It has self-contained amplifiers and power supply. Three amplifiers are utilized in the design plus monitoring and booster equipment. Recommended operating practice is for the inclusion of separate BA-26 pre-amplifiers mounted in each turntable cabinet. The control circuits include two 24 Volt relays for control room and studio speaker muting. The muting relays may be used to actuate "on air" light relays when such accessories are used.

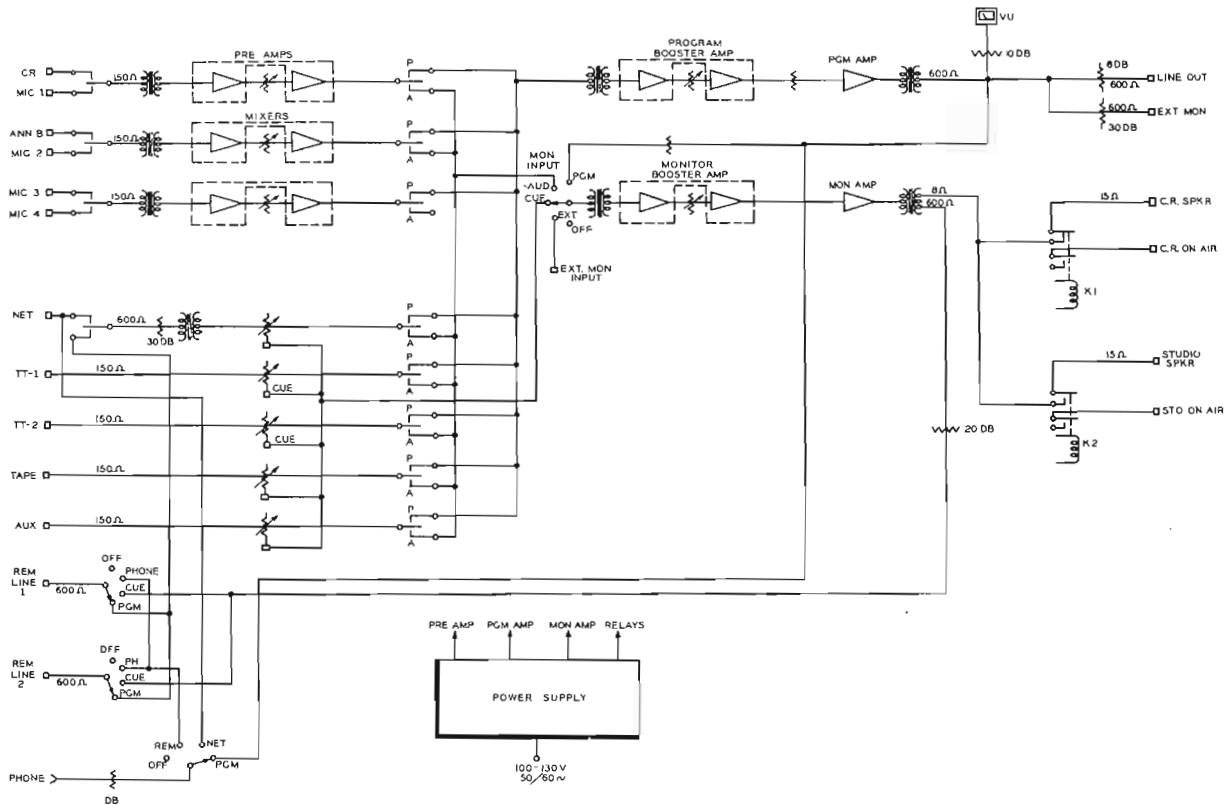

Simplified block diagram of the BC-3 Standard Console.

Specifications

Inputs:

- 6 Microphones (4 Studio, 1 Control Room and 1 Announce Booth)37.5/150/600 Ohms
- 2 Turntable, 1 Tape, and 1 Auxiliary Inputs150 Ohms
- 2 Remote Lines, 1 Network and 1 External Monitor 600 Ohms

Outputs:

- 1 Program Line & 2 Remote Lines Cue600 Ohms +18dBm
- 2 Monitor Speakers 16 Ohms 3 W each
- 1 External Monitor600 Ohms -6 dBm
- 1 Turntable Cue150 Ohms 1 V rms

Gain:

- Microphone to Program Line108 dB
- Network or Remote to Program Line 32 dB
- Turntable, Tape or Auxiliary to Program Line 64 dB
- Microphone to Audition Speaker124 dB
- Microphone to Program Speaker144 dB
- Microphone to External Monitor 84 dB
- Microphone to Remote Line (Cue)106 dB
- Network to Audition Speaker 48 dB
- Network to Program Speaker 68 dB

Frequency Response:

- Program ± 1.5 dB30-15,000 Hz
- Monitor ± 2.5 dB30-15,000 Hz

Harmonic Distortion:

Program 18 dBm Output1% at 30 Hz; .75% at 50 Hz; 0.5% at 100-15,000 Hz

Monitor 6 W Total1.5% at 50-10,000 Hz

Signal to Noise Ratio:

Program Channel, Mixer and Master Gain controls set for 68 dB Gain68 dB below 18 dBm output

Tube Complement:

2—6V6-GT, 2—12AU7, 2—12AX7, 1—5R4GY, 5—12AY7, 5—MI-11299 (selected 12AY7)

Power Requirements100-130 Volts AC, 50/60 Hz, 155 Watts

Dimensions33" wide, 11¼" high, 21¼" deep (83.82 cm, 28.58 cm, 53.98 cm)

Weight88 lbs. (36.9 kg.)

Accessories

- Tube KitMI-11486-A
- On-Air Light RelayMI-11702-A
- Warning LightsMI-11706-Series
- BA-26B Equalized PreampifierMI-11436-C
- Announce Booth Speaker RelayMI-11748
- Selected 12AY7 TubeMI-11299
- Cue Type Fader for BC-3C High Level Inputs#94136
- Film Changeover RelayMI-11729

Ordering Information

- BC-3C Standard Console (less tubes)MI-11641-A
- BC-3C Standard Console (complete with tubes)ES-11103-A

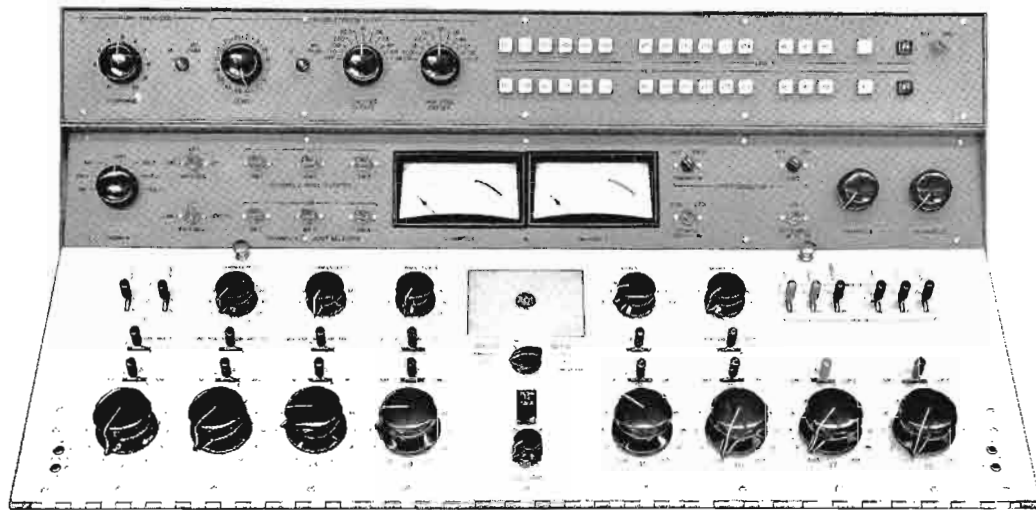

- Designs for Exact Customer Requirements
- Reduced operating expense
- Extensive Custom Engineering Service available for consultation
- Instant "fool-proof" switching
- Custom designs provide means for complete automation later, if desired
- Increased station prestige with clients
- Increased operating efficiency
- Possibilities for new business . . . More programs handled

Custom Audio Equipment

Description

In addition to a comprehensive line of standard studio control equipment, RCA specializes in custom designing and building complete speech-input systems to meet individual needs of stations and networks. Our engineers have worked closely with the nation's leading broadcast engineers in the design, production and installation of many custom equipments, a few of which are pictured on these pages. Studio-control systems such as these are tailor-made, combining just the right facilities for

the control of program operations and the reproduction of high-fidelity sound.

Since no two broadcast stations have exactly the same operating requirements, equipment needs will differ for each installation, ranging from special equipment for small and medium-size stations to more complex systems for the largest installation. In planning new installations, this "Custom-built" equipment service is available to every AM, FM,

or Television station, and it includes the services of an entire RCA engineering staff. Broadcast station engineers, in some cases, may wish to lay out and design the system themselves, complete with specifications. In these instances, RCA will provide specifically built units or modify standard equipment to meet these specifications. On the other hand, where stations desire, RCA engineers will study station requirements, make overall and detailed layouts, and draw up specifications for equipment needed.

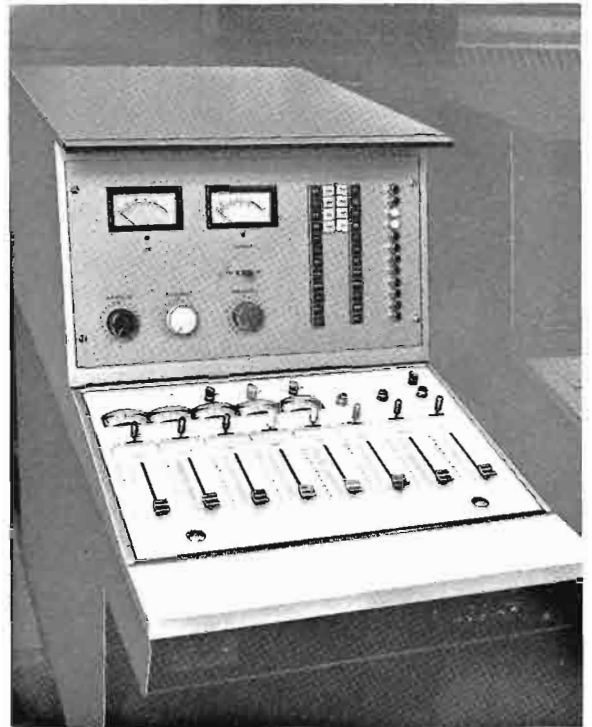
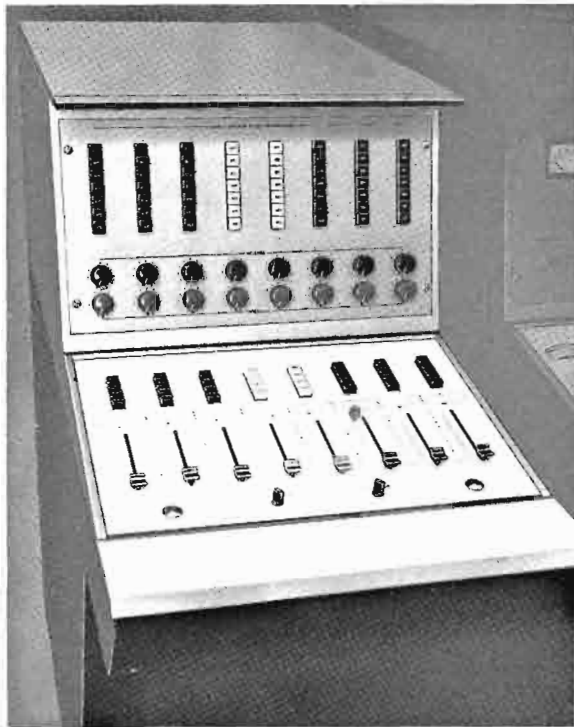

Three console housings designed for in-line installation will offer Station KRON complete studio audio facilities. Shown at left is eight-channel microphone mixer with three sub-mixing channels. Up to six microphones per channel can be selected. Note the vertical type faders, convenient bus selectors, and reverberation and equalizer controls. The second section is an eight-channel master mixer featuring latest RCA remote AGC meters and BA-40 series amplifiers.

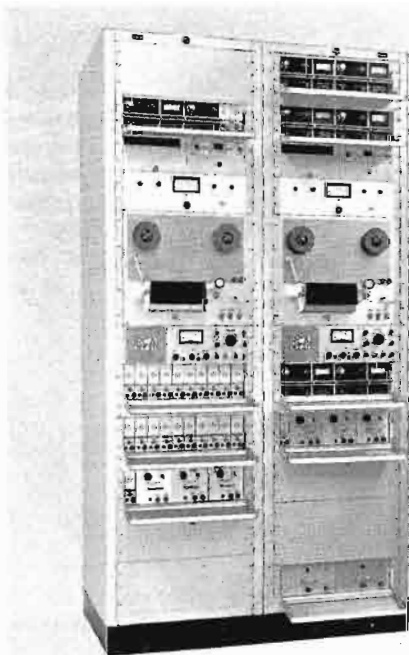

Two of the many racks of Audio Equipment for Station KRON are seen here, they contain cartridge and reel tape audio recorders, latest style BA-40 series amplifiers, and other solid-state audio components.

Audio console for KRON's operation center showing custom facilities designed to occupy RCA "New Look" console housings. Mixing and monitoring facilities and voice operated controls for two microphones are among the modern convenient facilities offered.



The record mixer and monitoring facilities offering control for two cartridge tape, two reel type tape machines and two turntables are contained in the third console. Solid state DC circuits and voice operated relays are highlighted in the equipment.

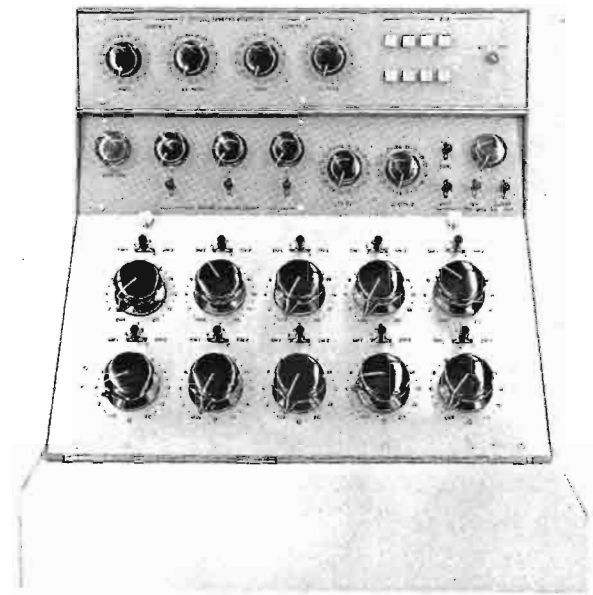

Custom-built ten-input mixer for Station WCAU designed for three-channel output. An accessory panel has been included to provide special utility and switching controls. This panel has been built into a special housing which is mounted on top of basic console form.

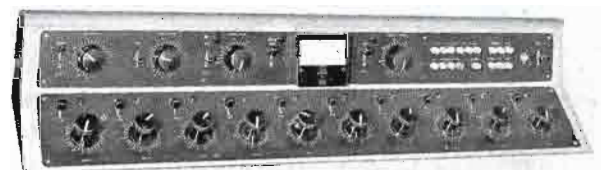
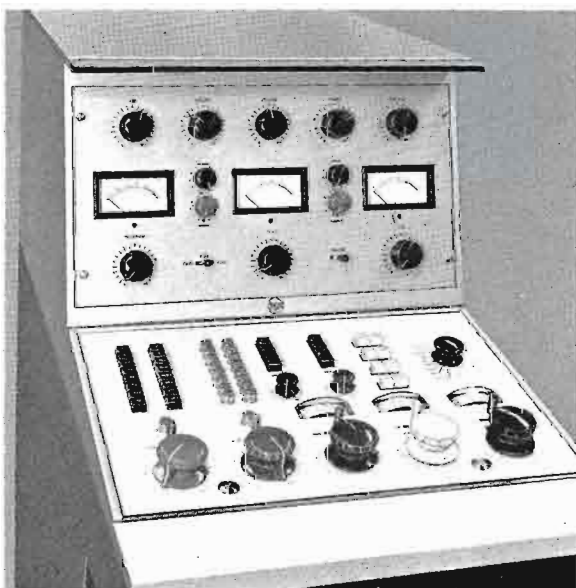

Custom audio control console designed and built for Station KHJ's television studio. It includes complete mixing and cueing facilities for five microphones and an announce microphone, two turntables, one remote and three utility inputs.

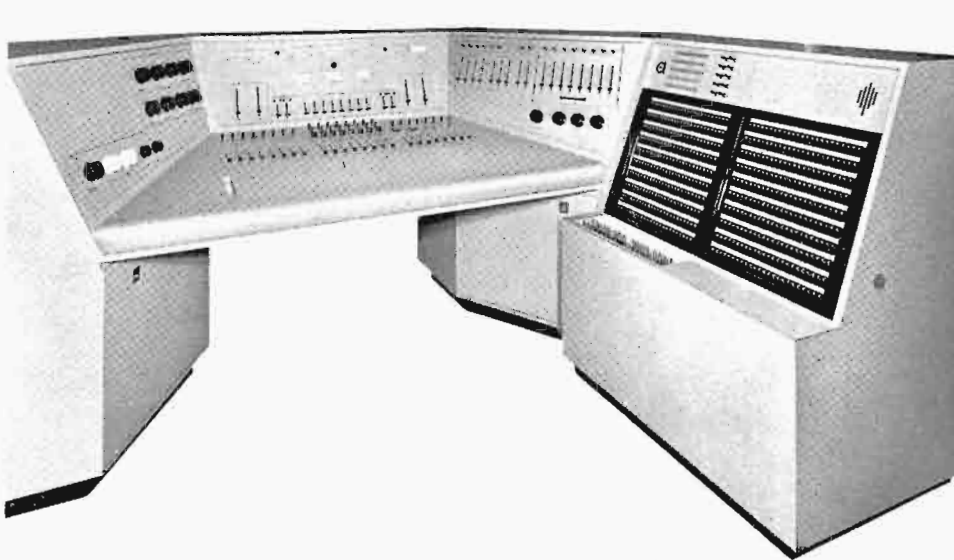

One of five custom master control consoles designed and built by RCA for the American Broadcasting Corporation. The console features solid state circuitry, sound effects controls, sub-mixers, equalizers, echo effects, monitor controls, unitized construction for complete accessibility. The left side of the console contains effects filters, space for another mixer module. In the center is the echo control, sub-master equalizers, VU meters. The desk portion contains mixing faders and submaster controls. To the right the console has monitor, and sound reinforcement controls and mixer module, below are four monitor selector knobs. Additional right wing housing is the patching wing unit.

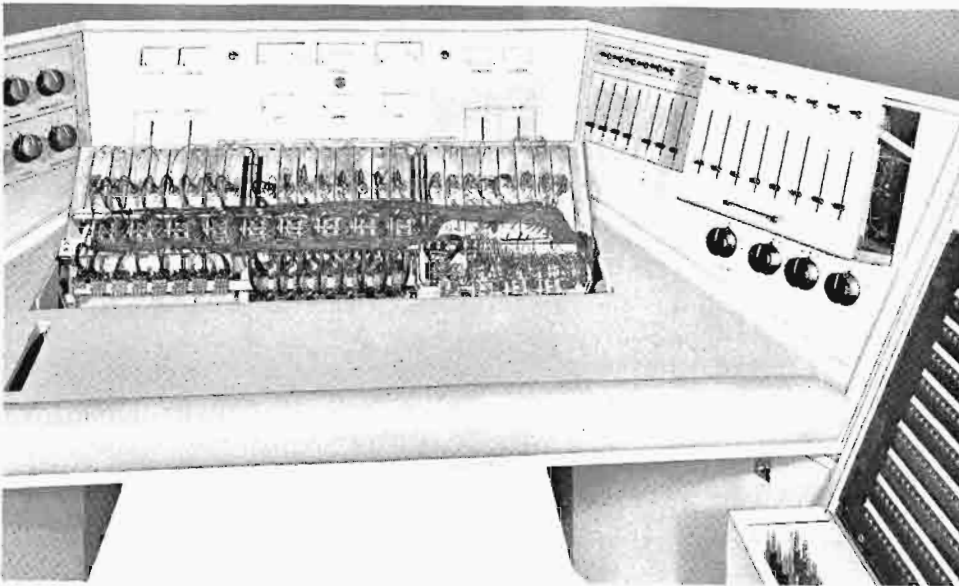

Desk top flipped over showing vertical faders, switches, and controls.

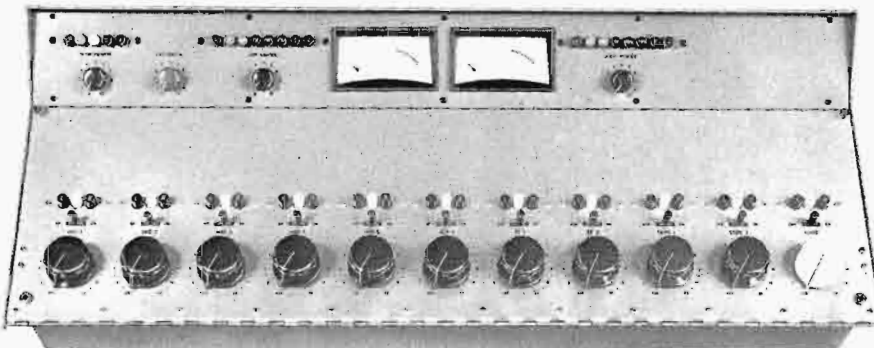

Custom three-channel audio control console shown is designed to match the three-channel master control shown on previous page. The eleven simultaneous mixers on this console and twenty-two on the master console offer exceptional flexibility for an AM-FM station.

Summary of RCA Broadcast Amplifiers

Type	Usage	Max. Gain dB	Max. Input dBm	Max. Output dBm	Source Impedance Ohms	Load Impedance in Ohms	Power Requirements	Type Mounting
BA-43	Program, Line, & Isolation Amp.	40 Low 56 High	-22/-28	-18	37.5/150/600	150/600	117/234 V. AC 50/60 Hz 3.5 W	Shelf 1/10
BA-43/45	AGC Program Amp.	80 dB below verge of compression	—	—	150/600	150/600	117/234 V. AC 50/60 Hz 10 W	Shelf 2/10
BA-43/46	Limiting Amp.	90 dB	—	—	150/600	150/600	117/234 V. AC 50/60 Hz 100 W	Shelf 2/10
BA-71C	Preamplifier	40 Low 46 High	-22 Low, -28 High	-18	37.5/150/600	150/600	30 V. DC at 45 mA	Console or Shelf 1/10
*	Isolation Amp. with MI-11278-E/F Bridging Gain Control	3 Low 9 High	30	+18	1,000	150/600	Use BX-71A Power Supply	Console or Shelf 1/10
BA-73B	Program Amp, Line Amp, Isolation Amp, Monitor Amp.	Matching 70 High, 55 Low, Bridging 33 High, 18 Low	Matching -20 Bridging +18	+30	150/600	150/600	30 V. DC at 300 mA Use BX-71A Power Supply	Console or Shelf 1/3 inc. BX-71A
BA-74B	Monitoring Amp. Recording Amp.	63	-23	-140 (10 W)	37.5/150/600	4/8/16/150/600	115/230 V. AC 50/60 Hz 30 W	Console or Shelf 1/3
BA-78A	Cue/Intercom Amp. with AGC	90	-30	+30	50/150	50/8	115/230 V. AC 50/60 Hz 8 W at max. output	Console or Shelf 1/6
	Preamplifier	90 Low 46 High	-22/-28	+18	37.5/150/600	150/600	117/234 V. AC 50/60 Hz 3.5 W	Shelf 1/10
BA-31C	Isolation Amp. with MI-11278-E/F Bridging Gain Control	3 Low 9 High	30	-18	10,000	150/600	117/234 V. AC 50/60 Hz 3.5 W	Shelf 1/10
BA-33B	Program Amp, Line Amp, Isolation Amp.	Matching 70 High, 55 Low, Bridging 33 High, 18 Low	Matching -20 Bridging +18	-30	150/600	150/600	100-130 V. AC 50/60 Hz 20 W	Shelf 3/10
BA-34C	Monitoring Amp. Recording Amp.	104	-30	+40 (10 W)	37.5/150/600	4/8/16/150/600	100-130 V. AC 50/60 Hz 25 W at Rated Output	Shelf 3/10
BA-26B	Equalized Turntable Preamplifier (Mono.)	—	—	-5	—	150/600	115/230 V. AC 50/60 Hz 1 W	Turntable Cabinet
BA-36A	Equalized Turntable Preamplifier (Stereo)	—	—	-5	—	150/600	100-130 V. AC 50/60 Hz 1 W	Turntable Cabinet
BA-8A	Cue Amplifier	53	Matching -24 Bridging +9	+30 (1 W)	Matching 150/600 Bridging 10,000	3.2	117/235 V. AC 50/60 Hz 13 W	Table or Rack
BN-7A	Remote Portable Amplifier	90	—	+18	150/250 37.5/150 using MI-11776 Input Transformer	600	117/235 V. AC 50/60 Hz, 5 W or battery	Portable Case
BN-16B/C	Remote Portable Amplifier	90	-40	+18	37.5/150-250	150/600	117/235 V. AC 50/60 Hz, 5 W. or battery	Portable Case
BN-26	Portable Remote Amp.	95	-20 (Microphone)	+24 after isolation	600/150	600/150	117/234 V. AC 50/60 Hz or battery	Portable Case or Rack
SN-10	Mixer Preamp.	80	—	+10	150/600	600	117/235 V. AC 50/60 Hz, 5 W	Shelf
SA-1000	Bridging Power Amp.	59.5	0.53 V.	100 W	—	3.2/8/16	120/130 V. AC 50/60 Hz 228 W max.	Chassis or Rack
SA-1004	Mixer Power Amp.	123	2.2 mV	100 W	—	3.2/8/16	120/130 V. AC 50/60 Hz 228 W max.	Chassis or Rack
SA-202	Power Mixer Amp.	118 (Mike) B2 (Auxiliary)	1.8 mV (Mike) 1.3 V. (Auxiliary)	20 W	—	4/8/16	117 V. AC 60 Hz, 90 W	Chassis or Rack
MI-9289-B	Bridging Power Amp.	69/79	.23 V. (with 240 W input pad) .007 V. less pad	240 W	—	3.57/7.15/ 28.6/114.3	105/115/225 V. AC, 60 Hz, 440 V. max.	Hinge Mtg. in Rack or Cabinet

Gain and level references in RCA Amplifier Catalogs are defined as follows: dB—refers to gain; dBm—sine wave power measurement referred to 1 mW; VU—refers to average program level as read on a standard VU meter. This value is subject to considerable variation from dBm but is generally considered 10 dB below peaks. All amplifiers are solid state except the following: SA-1000, SA-1004, SA-202, and MI-9289-B.

* Used with BA-43 Program Amplifier.

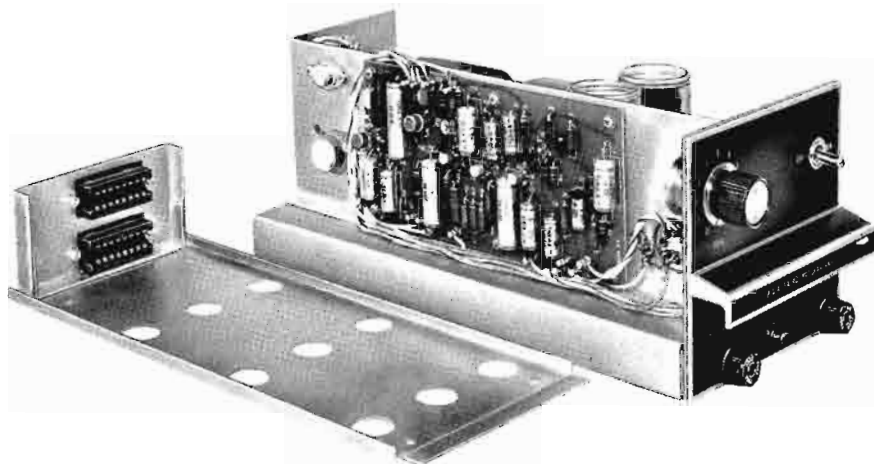

- Silicon transistor design and etched wiring provide uniform performance
- Extended frequency response and power bandwidth
- Ambient temperature range -20 to $+75^{\circ}\text{C}$
- Self-contained regulated power supply
- Plug-in chassis for shelf mounting

Program Amplifier, Type BA-43

Description

The BA-43 is a Wide Band Program Amplifier designed for broadcast service by itself or in conjunction with auxiliary BA-45 AGC and BA-46 Limiter units. New circuitry, featuring silicon transistors, provide the advantages of small, compact design, uniform performance, reduced power consumption and long-life expectancy for the amplifier. The high gain and low distortion of the unit make it an ideal choice for use as a program or line amplifier, bridging amplifier or as an isolation unit.

The BA-43 features improved performance, especially in the areas

of bandwidth, noise and temperature stability, due largely to the use of silicon transistors. The improved amplifier circuit consists of an unloaded input transformer and a three-stage negative feedback pre-amplifier followed by a continuously variable gain control that is adjustable from the front panel. This control varies the signal into a negative feedback output amplifier employing five transistors. This amplifier, in turn, drives a multi-impedance output transformer. Levels as high as $+30$ dBm (1 Watt) can be supplied at the output. The

self-contained power supply consists of a full-wave rectifier, filter and transistor voltage regulator to assure uniform performance.

The BA-43 Program Amplifier is a plug-in type, reflecting the RCA "New Look" panel styling and handle. It is designed for mounting on the BR-22 Mounting Shelf. Mating sockets and a guide assembly are provided with each amplifier for this purpose. The shelf permits convenient removal for servicing or interchanging units. Up to three BA-43 amplifiers can be accommodated on the mounting shelf.

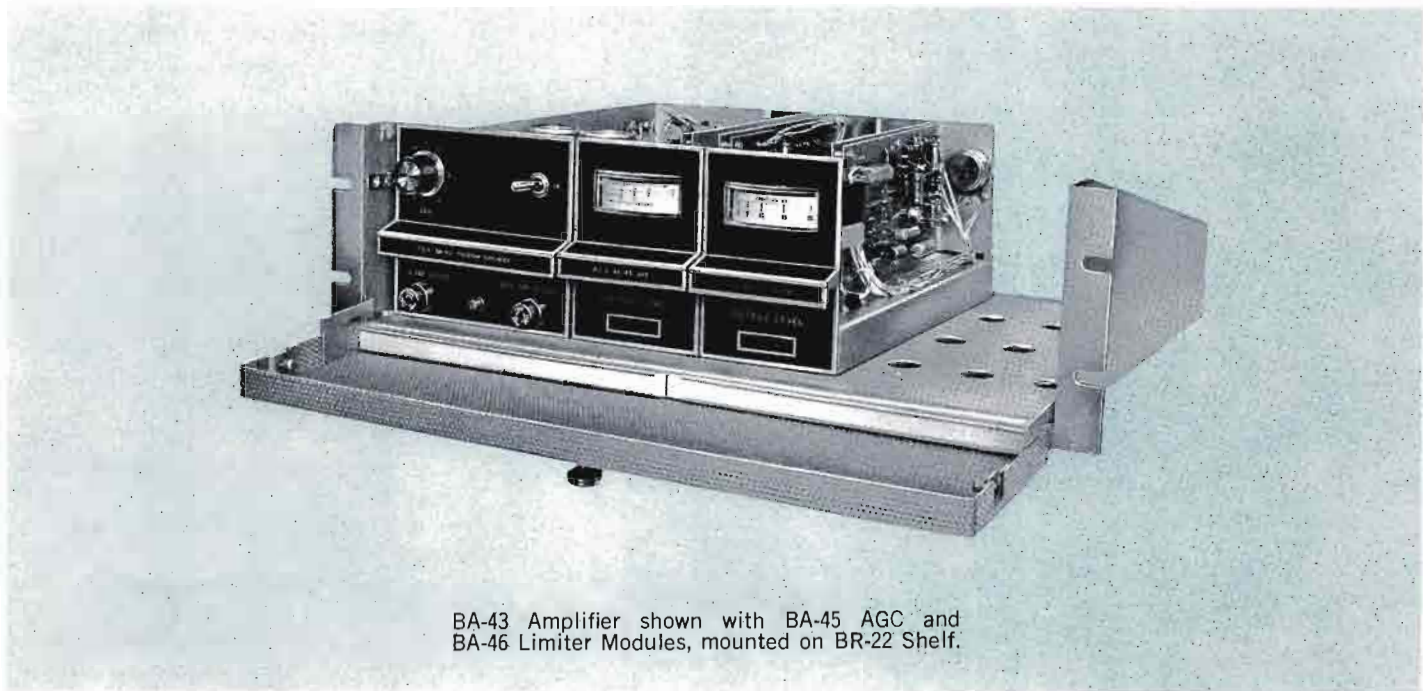

BA-43 Amplifier shown with BA-45 AGC and BA-46 Limiter Modules, mounted on BR-22 Shelf.

Specifications

Source Impedance600 Ohms, balanced when shipped,
may be reconnected for 150 Ohm balanced or unbalanced
source

Input Impedance:

 Matching600/150 Ohms

 Bridging20,000 Ohms

Load Impedance600/150 Ohms

Maximum Input Level:

 Matching-17 dBm

 Bridging+13 dBm

Frequency Response Referred to
1000 Hz+0, -3/4 dB, 20-20,000 Hz

Maximum Output Level+30 dBm

Harmonic Distortion0.5% rms max. at +30 dBm output,
25-20,000 Hz

Matching Gain (Max.)76 ± 1/2 dB (Loaded),
82 ± 1/2 dB (Unloaded)

Bridging Gain (Max.)46 ± 1 dB (Loaded),
52 ± 1 dB (Unloaded)

Ambient Temperature Range-20°C to +75°C
(-4°F to +167°F)

Noise Level:

 Input-126 dBm (20-20,000 Hz)

 Output-44 dBm (20-20,000 Hz)

Power Requirements115 Volts, AC, 50/60 Hz, 10 Watts
(transformer taps at 105, 115 and 125-V primary connected
in parallel); 230 Volts, AC, 50/60 Hz, 10 Watts (trans-
former taps at 210, 230 and 250 V, primary connected
in series)

Fuses2 Amps SB (Power Line);
.4 Amps SB (B+ Line)

Overall Dimensions4 21/32" high, 5" wide, 11 3/8" deep
(11.8 cm, 12.7 cm, 28.4 cm)

Weight9 1/2 lbs. (4.3 kg.)

MountingPlug-in on BR-22C Shelf, (requires 3/10 of shelf)

Accessories:

BR-22C Mounting ShelfMI-11597-B

Spare Guide Assembly (with receptacles)MI-11593-1

BA-45 Automatic Gain Control UnitMI-11455

BA-46 Limiter AmplifierMI-11456

Ordering Information

BA-43 Program Amplifier (includes transistors,
diodes and chassis guide assembly
with receptacles)MI-11454



- Wide adjustable AGC action
- Low distortion
- Input and output controls
- Provision for remote meter
- Step output attenuator

AGC Program Amplifier, Type BA-43/45

Description

The BA-43/45 Automatic-Gain-Controlled Program Amplifier is designed to control automatically variations in audio program level. The amplifier is capable of maintaining a nearly constant average output level over wide variations in input level, since it provides expansion of low-level signals as well as compression of high level signals. This arrangement allows more compression to be used without audible "gain pumping" or background "swishing" sounds.

The new AGC Program Amplifier

consists of the BA-45 Automatic Gain Control Unit used in conjunction with the BA-43 Program Amplifier from which it derives its power and signals. It can be used in program or preamplifier channels and has provision for stereo. The amplifier may be used with an external bias source for remote gain control or automatic fading, permitting unattended remote operation. Other uses include microwave input audio control, and automatic fader control.

The BA-43/45 is a compact, tran-

sistorized and modularized amplifier mounted on a plug-in chassis for easy maintenance and replacement. Two BA-43/45 equipments can be mounted on the Type BR-22 Shelf. An edgewise-mounted meter on the front panel permits monitoring the amount of AGC action. Other controls, located on the front panel of the BA-43 include; a Power Off-On Switch, Gain control knob, and two plug-in fuses. Mounted on the BA-45 panel is a control to adjust the output level to match following equipment.

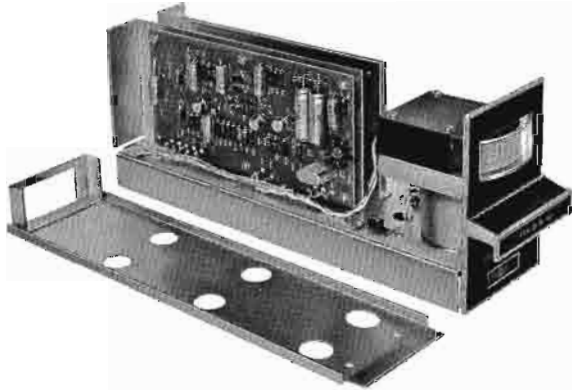

BA-45 Automatic Gain Control Amplifier with Guide Assembly.

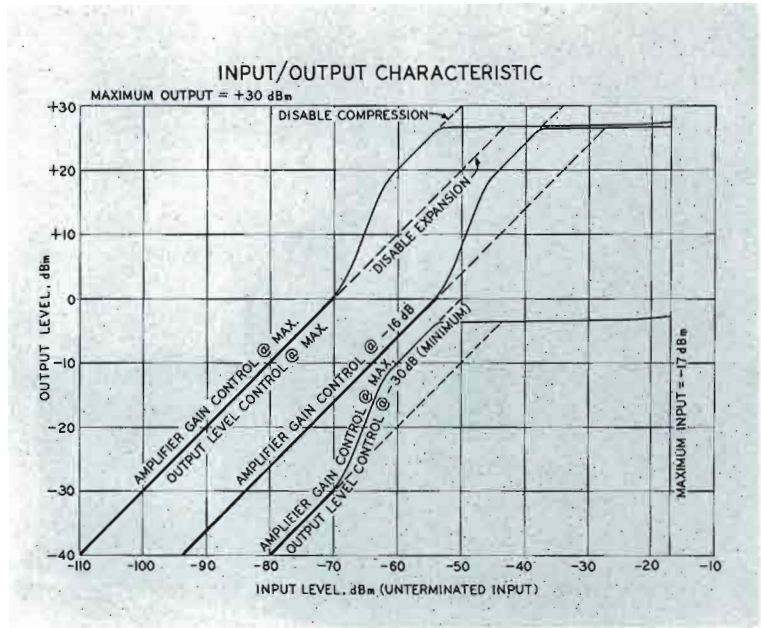

Specifications

Source Impedance ... 600/150 Ohms (Balanced or unbalanced)
 Input Impedance 6000/1500 Ohms
 Load Impedance 600/150 Ohms
 Frequency Response ... +0 to -3/4 dB at any operating level,
 20-20,000 Hz, 1000 Hz reference
 Operating Levels See curve

	Input, dBm	Output dBm
Verge of Expansion	-70 (adj.)	0 (adj.)
Verge of Compression	-54 (adj.)	+26 (adj.)
Maximum Rated	-17	+26.5
Maximum Uncontrolled	-17	+32
Expansion/Compression Range	+10/-20 dB Control	
Gain, Maximum below Verge of Compression	.80 dB unloaded	
Compression Ratio	20 dB into 0.5 dB	
Time Constants:	Attack	Recovery
Expansion	4 sec.	6 sec.
Compression	15 ms	3 sec.
Uncontrolled	2 μs	2 μs

Harmonic Distortion (Total RMS) Less than 0.6%,
 25 to 20,000 Hz

Noise Level (20 to 20,000 Hz):
 Input -125 dBm
 Output -55 dBm

Gain Controls:
 Input Continuous
 Output 15 steps, 2 dB per step, 30 dB total
 Power Requirements 115/230 V, 50/60 Hz, 10 Watts
 Ambient Temperature Range -20°C to +55°C
 (-4°F to 131°F)

Dimensions (BA-45 only) ... 4-21/32" high, 3 5/16" wide, 1 11/16" deep
 (11.8 cm, 8.4 cm, 28.4 cm)

Panel Finish ... Black background with aluminum epoxy trim
 Weight 3 3/4 lbs. (1.7 kg.)

Accessory

BR-22 Mounting Shelf MI-11597-B

Ordering Information

BA-43 Program Amplifier
 complete with guide assembly and receptacle MI-11454*
 BA-45 AGC Amplifier complete with guide assembly,
 receptacle and connecting cable MI-11455

* Refer to catalog page B.1417 for BA-43 Program Amplifier specifications.



- Fast limiting action (200 microseconds)
- All silicon transistors
- Low distortion
- Separate input and output controls
- Provision for remote metering
- Plug-in shelf mounting

Limiting Amplifier, Type BA-43/46

Description

The BA-43/46 Limiting Amplifier provides economical and extremely fast abrupt limiting action in speech input channels of FM, AM broadcast and TV sound transmitters. It serves as an automatic means of limiting the audio signal peaks to a certain pre-determined level thereby preventing overmodulation or overloading with its consequent distortion and adjacent channel interference.

Use of the BA-43/46 permits more effective use of transmitter power by

allowing the system to be operated at near maximum output. It raises the average percentage modulation level several decibels without appreciably increasing the harmonic distortion.

The limiting characteristics of the BA-43/46 also readily adapt it for use in recording application. Here, it prevents overmodulation of the recording medium on heavy passages of music or speech and permits marked improvement in the signal to noise ratio.

The limiting amplifier is comprised of the BA-43 Program Amplifier and the BA-46 Limiter module which derives its power and signals from the program amplifier. Both modules are completely transistorized and designed for shelf mounting in the Type BR-22 Mounting Shelf. Two equipments can be accommodated in the BR-22. The BA-46 Limiter has an edge mounted meter for measuring gain reduction, etc.

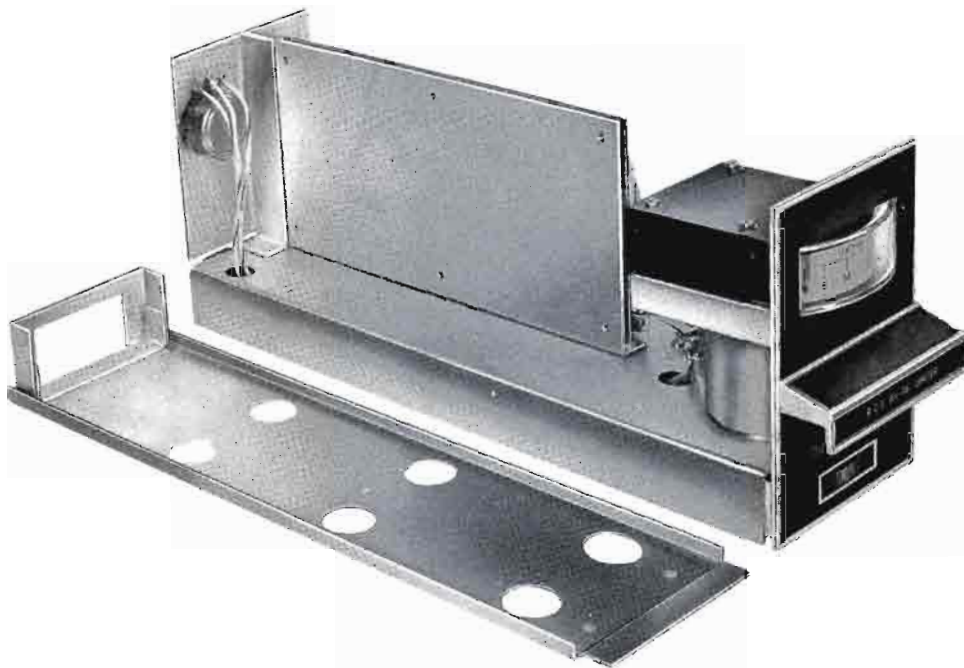

The BA-46 Limiter Amplifier, MI-11456 shown with the guide assembly ready for mounting in the BR-22 Mounting Shelf. The amplifier prevents over-modulation of the system on heavy passages of music or speech.

Specifications

Source Impedance600/150 Ohms (balanced or unbalanced)
 Input Impedance6000/1500 Ohms
 Load Impedance600/150 Ohms
 Frequency Response+0 to -3/4 dB any operating level
 from 20 to 20,000 Hz, 1000 Hz reference
 Operating Levels:

	Input, dBm	Output, dBm
Verge of Limiting	-60 (adj.)	+30 (adj.)
Maximum Rated	-17	+30 (adj.)
Maximum Uncontrolled	-17	+32 (adj.)

Gain, Maximum 90 dB
 Gain Controls:
 InputContinuous
 Output15 steps, 2 dB per step, 30 dB total
 Noise Level:
 Input-125 dBm, 20 to 20,000 Hz
 Output.....-35 dBm, 20 to 20,000 Hz
 Harmonic Distortion (Total RMS slow
 action at 20 dB of limiting)Less than 0.75%, 25-20,000 Hz
 Below Limiting vergeLess than 0.50%, 25-20,000 Hz

Limiting Characteristic (Max. limited output)+30 dBm
 Compression ratio above verge of limiting20 dB into .5 dB
 Time Constants:

	Attack	Recovery
Uncontrolled	2 μ s	2 μ s
Limiting, Fast Action	200 μ s	0.4 sec.
Limiting, Slow Action	200 μ s	3 sec.

Power Requirements115/230 V, 50/60 Hz, 100 Watts
 Ambient Temperature Range-20°C to +55°C
 (-4°F to +131°F)
 Dimensions (BA-46 Only) .4-21/32" high, 3 3/16" wide, 1 13/16" deep
 (11.8 cm, 8.4 cm, 28.4 cm)
 Weight3 3/4 lbs. (1.7 kg.)
 Panel FinishBlack background with silver accents
 MountingPlug-in on BR-22C Shelf
 (BA-46 requires 2/10 of shelf)

Accessories

BR-22C Mounting ShelfMI-11597-B
 Spare Guide Assembly (with receptacles)MI-11593-2
 Remote Limiting Meter#237431

Ordering Information

BA-43 Program AmplifierMI-11454
 BA-46 Limiter AmplifierMI-11456
 (Each complete with guide assemblies, receptacles and connecting cable.)

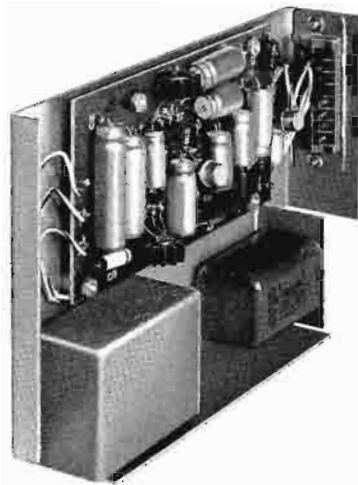

- Compact design—solid state circuitry
- Extremely low noise
- Minimum distortion
- Full range frequency response
- Companion program amplifier and power supply
- Convenient plug-in design

Consolette Preamplifier, Type BA-71C

Description

The BA-71C is one of a series of transistorized amplifiers especially designed for use in consolettes or custom built audio systems. The BA-71C may be plugged directly in RCA consolettes such as the BC-7, BC-8, BC-9, BC-19 and BCM-2A and other types designed for its use or it may be used in custom audio applications when plugged into Accessory

Guide Assembly MI-11759-1. The Guide Assembly with mating receptacle may be attached to a BR-22 shelf or mounted in any enclosure used in custom construction.

The BA-71C is designed primarily as a microphone preamplifier, but may also be used as an isolation or bridging amplifier with the addition of an externally mounted MI-11278-E or F volume control. The transistor circuitry is identical to the BA-31C preamplifier except

that it does not contain a built in power supply. A single BX-71A power supply is used to meet the power requirements of up to 22 BA-71C preamplifiers.

The use of transistors results in long life, low maintenance, and freedom from microphonics. The high output level reduces the likelihood of overloading due to occasional high microphone levels. Negative feedback is used to stabilize gain and reduce distortion to a very low level.

Specifications

Source Impedance	37.5 Ohm unbalanced; 50/600 Ohm balanced or unbalanced
Input Impedance:	
Matching (unloaded input transformer)	Connected when shipped for 150 Ohms. May be reconnected for 37.5 or 600 Ohms.
Bridging (using external bridging control)	20,000 Ohms
Maximum Input Level:	
Matching	-22 dBm low gain strapping -28 dBm high gain strapping
Gain:	
Matching	40 dB \pm 1 dB low gain (as shipped) 46 dB \pm 1 dB high gain strapping
Bridging	3 dB low gain, 9 dB high gain strapping
Frequency Response	Better than \pm 1 dB from 30 to 15,000 Hz (referred to 1000 Hz)
Rated Output Level and Distortion	Total rms harmonic distortion at +18 dBm output less than 0.5% from 30 to 15,000 Hz
Hum and Noise Level	(20 Hz to 20 kHz weighted) -127 dBm referred to input; -81 dBm referred to output; 99 dB max. signal to noise ref. to +18 dBm
Power Requirements	30 Volts, 45 ma from BX-71A
Transistor Complement:	
1	2N404, 3—2N2270

Maximum Ambient Temperature	55°C (131°F)
Finish	Cadmium plate with clear chromate dip
Mounting	Plug-in for BC-7, BC-8, BC-9 and BC-19 Console; Up to 10 Preamplifiers can be mounted on BR-22 shelf equipped with MI-11759-1 Guide Assemblies
Dimensions Overall	7 $\frac{5}{8}$ " long, 4 $\frac{5}{8}$ " high, 1 $\frac{3}{8}$ " wide (19.37 cm, 11.75 cm, 3.59 cm)
Weight	2 $\frac{1}{4}$ lb. (1 kg.)

Accessories

Guide Assembly for	
BA-71C Transistor Preamplifier	MI-11759-1
Bridging Gain Control Kit:	
With Screw-driver Adjustment	MI-11278-F
With Knob Adjustment	MI-11278-E
BR-22 Mounting Shelf for Rack Mounting	MI-11597-B
Spare Transistor and Diode Kit	MI-11786-6
Power Supply, Type BX-71	MI-11663-A

Ordering Information

BA-71C Consolette Preamplifier with transistors in place, less Guide Assembly	MI-11658-B
BA-71C Consolette Preamplifier complete with transistors and Guide Assembly	ES-11158-B



- High gain, low distortion
- Ideal for custom applications
- Very low noise level, -122 dBm
- Frequency response better than ± 1 dB, 30 to 15,000 Hz

Consolette Program Amplifier, Type BA-73B

Description

The BA-73B Program Amplifier is designed for use as a high-quality booster or program amplifier. There is provision for adding an external volume control which may be used as a master fader. Input and output transformers provide circuit isolation.

The BA-73B is one of a series of transistor amplifiers designed to

plug-in directly into RCA consolettes. Accessory Guide Assembly, MI-11759-2 with mating receptacles permits the BA-73B to be mounted in a BR-22 Shelf or any enclosure used in custom construction. Up to three Program Amplifiers as well as one BA-71B Consolette Preamplifier can be accommodated on the BR-22 Shelf. Power for the amplifier is supplied by the Type BX-71A Power Supply. Up to three amplifiers may be operated by one BX-71 supply.

The BA-73B Amplifier incorporates full transistor curcuitry providing the advantages of small, compact design, uniform performance, reduced power consumption and long life expectancy for the amplifier. The high gain and low distortion of the unit make it an ideal choice for any audio system. Etched wiring boards are used and all circuitry and components are readily accessible.

Specifications

Source Impedance.....150/600 Ohms, balanced or unbalanced
 Input Impedance:
 MatchingInput transformer unloaded, with impedance higher than source impedance. Connected when shipped for 600 Ohms; may be reconnected for 150 Ohms
 Load ImpedanceConnected for 600 Ohms when shipped; may be changed to 150 Ohms
 Maximum Input Level:
 Unloaded Input -30 dBm
 Loaded Input -24 dBm
 Frequency ResponseBetter than ± 1 dB, 30 to 15,000 Hz (referred to 1000 Hz)
 Rated Output Level $+24$ dBm
 Harmonic Distortion.....Less than 0.5% rms $+24$ dBm output, 50 to 15,000 Hz. Less than 0.25% at 1 kHz, 24 dBm output
 Gain:
 Unloaded Input 92 ± 1 dB
 Matching Input 86 ± 1 dB
 Noise Level -122 dBm referred to the unloaded input

Power Requirements30 Volts, 300 ma drain from BX-71A
 Transistor Complement (supplied in place):
 4—2N220, 2—2N270, 1—2N526, 2—2N1905
 Ambient Temperature 55°C (131°F)
 Overall Dimensions9" long, $3\frac{3}{4}$ " wide, $4\frac{5}{8}$ " high (22.86 cm, 9.52 cm, 11.75 cm)
 Weight4 lbs. (1.8 kg.)
 FinishCadmium plate with clear chromate dip

Accessories

Shelf Guide Assembly for BA-73B AmplifierMI-11759-2
 BR-22C Mounting ShelfMI-11597-B
 Step Attenuator (external)MI-11751-5
 BX-71B Transistor Power SupplyMI-11663-A
 Spare Transistor and Diode KitMI-11786-5

Ordering Information

Type BA-73B Consolette Program Amplifier with transistors in place and less Guide Assembly.....MI-11659-A
 Type BA-73B Consolette Program Amplifier and Guide AssemblyES-11159-A

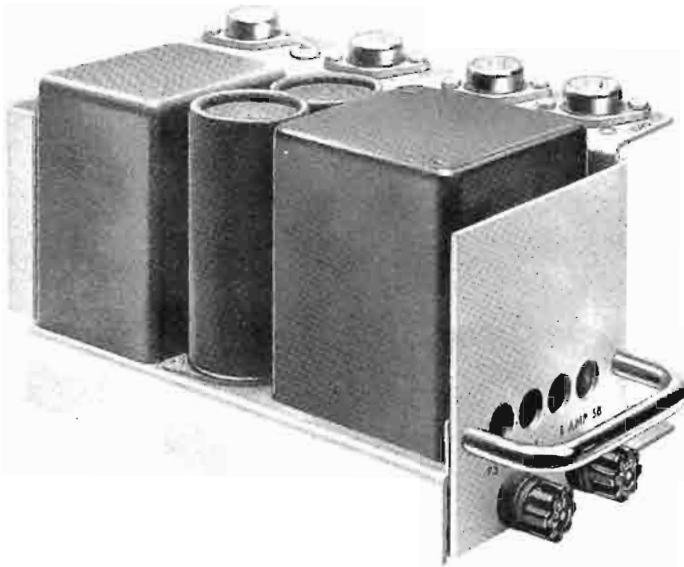

- Solid state circuitry
- Self-contained power supply
- 10 Watt output—very low distortion
- Small, compact, with low heat dissipation
- Plug-in guide assembly with mating plugs

Consolette Monitor Amplifier, Type BA-74B

Description

The BA-74B Consolette Monitor Amplifier is designed for monitoring, audition and "talk back" applications. This high fidelity amplifier has 65 dB gain and delivers a full 10 Watts of audio power output. It may also be used as a program or a line amplifier.

The BA-74B is one of a series of matched transistorized plug-in amplifiers specifically designed for console and custom applications. It can be plugged into the BC-7, BC-8 or other consoles or installed on the BR-22 mounting shelf with the aid of Accessory Mounting Guide, MI-11759-3. Three BA-74B Amplifiers may be mounted on one shelf. Its

small size makes it very useful in many custom applications.

The circuit design of the Monitor Amplifier is simple and straightforward. All circuit functions are accomplished by 8 transistors and two

diodes. The use of solid state components provides a number of advantages including: small, compact design, greatly reduced power consumption and trouble-free, long-life expectancy for the amplifier.

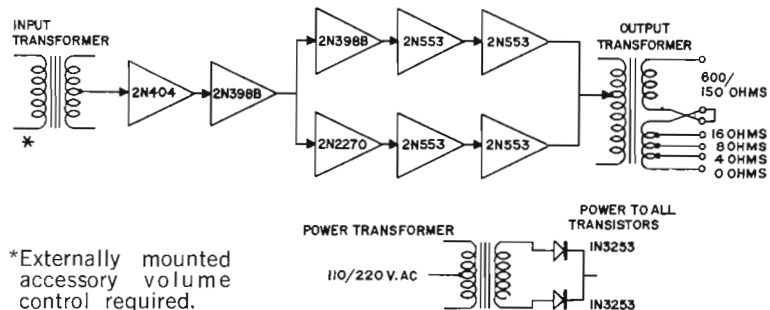

*Externally mounted accessory volume control required.

Specifications

Source Impedance	600/150 Ohms
Input Impedance	Unloaded input transformer, high in comparison to source impedance
Load Impedance	4/8/16/150/600 Ohms
Maximum Input Level	-23 ±2 dBm
Maximum Gain:	
Loaded Input	65 ±2 dB
Unloaded Input	71 ±2 dB
Frequency Response	+0, -2 dB 30-15,000 Hz 4, 8 and 16 Ohms
+0, -2 dB 30-10,000 Hz, +0, -3 dB 10,000 to 15,000 Hz	
150 and 600 Ohms	
Maximum Output Level	10 Watts (40 dBm)
Harmonic Distortion	Less than 1% 50-15,000 Hz at 10 Watt output level
Noise Level	-47 dBm maximum, -50 dBm typical
Power Requirements	115/230 V, AC 50/60 Hz, 30 Watts, (with taps for 105, 115, 125 or 210, 230 and 250 Volts)
Transistor and Diode Complement (supplied in place):	
2—1N3253, 4—2N553, 2—N398B, 1—2N2270, 1—2N404	
Ambient Temperature	55°C (131°F) max.

Mounting	On guide strip provided with BC-7 and BC-8 console or using Guide Assembly MI-11759-3 for installation on BR-22 mounting shelf
Finish	Cadmium plate with clear chromate dip
Dimensions Overall	9 7/8" long, 5" wide, 4 5/8" high (25.08 cm, 12.70 cm, 11.75 cm)
Weight	11 lbs. (4.99 kg.)

Accessories

Shelf Guide Assembly for BA-74B Monitor Amplifier	MI-11759-3
BR-22 Mounting Shelf (mounts 3 BA-74B's)	MI-11597-B
Bridging Volume Control:	
With Screwdriver Adjustment (externally mounted)	MI-11278-F
With Knob Adjustment (externally mounted)	MI-11278-E
Transistor and Diode Kit	MI-11786-2

Ordering Information

Type BA-74B Consolette Monitor Amplifier, less Guide Assembly	MI-11661-B
Type BA-74B Consolette Monitor Amplifier with Guide Assembly	ES-11161-A

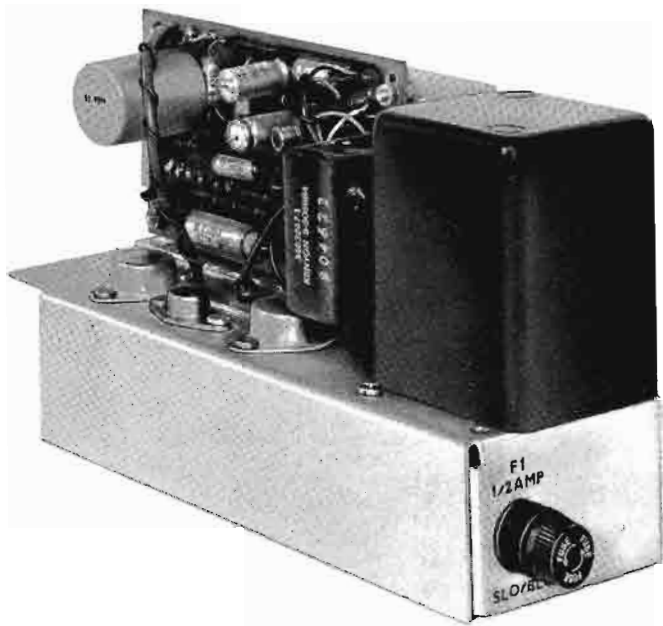

- Automatic Gain Control
- Self-contained regulated power supply
- High gain—full output with mic level input
- One Watt (+30 dBm) output with AGC
- Seven Watts output without AGC

Transistor Cue/Intercom Amplifier, Type BA-78B

Description

The Type BA-78B Cue/Intercom Amplifier is a compact chassis-mounted equipment featuring solid state circuitry, automatic gain control and self contained power supply. It is designed specifically for plug-in use with the RCA Broadcast transistor consolettes, for intercom and cueing purposes. However,

it may also be shelf mounted by use of accessory guide assembly, MI-11759-5.

The principal feature of the BA-78B is its ability to maintain essentially constant output for a wide variation of input level. Automatic gain control action is maintained over a 25 dB range. Output level changes are limited to approximately 1 dB for each 5 dB input change over the operating range. The BA-78B amplifier is nominally a 1 Watt

amplifier but has an output capability of 7 Watts with AGC disconnected.

The BA-78B has a self-contained power supply with taps for 117 or 234 Volts 50-60 Hz operation making it easily adaptable to general applications independent of the consolettes. Its relatively high power and high quality output makes it useful with loudspeakers for applications where a communication channel with AGC is specified.

Specifications

Power Required	117/234 Volts, AC, 50/60 Hz 10 Watts, no signal, 17.8 Watts max. output
Source Impedance	50-150 Ohms
Input Impedance	115 Ohms; below AGC threshold
Load Impedance	50 Ohms floating, 8 Ohms unbalanced
Effective Input Level.....	-70 dBm for verge of AGC action -45 dBm handled by AGC action
Output Level	Nominally set at 1 Watt average (+30 dBm) by AGC action (7 Watts max. with AGC disconnected, 100 Hz to 20 kHz)
AGC Action	Approx. 1 dB change in output level for each 5 dB change in input level throughout operating range of 25 dB
Gain	100 dB with no gain reduction 80 dB with max. gain reduction
Frequency Response	±1 dB, 100 to 20,000 Hz, within 2.5 dB at 50 Hz

Distortion	5% at 7 Watts output, 100 to 20,000 Hz, with AGC out; 3% at 1 Watt output with 10 dB AGC action, 35 Hz to 20 kHz
Noise Level	At least 60 dB below max. output (with no gain reduction)
Dimensions Overall	4 5/8" high, 3" wide, 8 3/8" deep (11.75 cm, 7.62 cm, 21.27 cm)
Weight	4.75 lbs. approx. (2.16 kg.)
Temperature Range	-10 to +131°F
Finish	Cadmium plate

Accessories

Guide Assembly for BA-78B Cue Amplifier	MI-11759-5
Type BR-22C Mounting Shelf	MI-11597-B
Transistor and Diode Kit	MI-11786-1

Ordering Information

Type BA-78B Cue Amplifier, less Guide Assembly....	MI-11662-B
Type BA-78B Cue Amplifier and Guide Assembly....	ES-11162-B

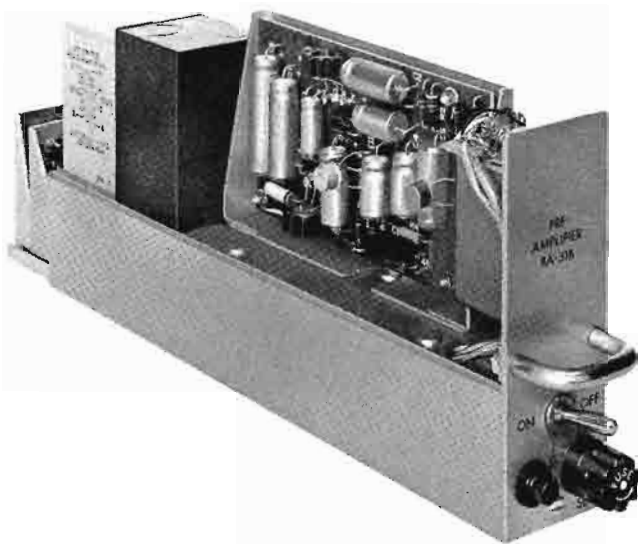

- Excellent frequency response
- Transistor design
- Self-contained power supply
- High gain, low noise circuitry
- Plug-in chassis for shelf mounting

Preamplifier and Isolation Amplifier, Type BA-31C

Description

The BA-31C Preamplifier is a small, compact unit featuring solid state circuitry and is intended for use as a microphone preamplifier, turntable preamplifier or booster amplifier. With the addition of the MI-11278-E or F volume control kit, which mounts external to the amplifier, the BA-31C is provided with a 20,000 Ohm input and may be

used as a bridging or isolation amplifier.

Cool operation, achieved by low power dissipation, makes possible a trouble-free long-life expectancy for this amplifier. Noise level and distortion have been reduced to a very low value through proper circuit design and the use of stabilized feedback. Transistor selection to produce low noise is not required in the BA-31C. The amplifier is a plug-in type chassis and is sup-

plied complete with guide assembly that is designed for mounting on a BR-22 Shelf.

The BA-31C circuit consists of an unloaded input transformer, a two-stage negative feedback amplifier, and a four-transistor output amplifier. The output amplifier drives a transformer which can be strapped for 150 or 600 Ohm loads. The power transformer isolates the amplifier from the power line, and an additional transistor in the power supply reduces ripple.

Specifications

Source Impedance37.5 Ohm unbalanced; 150/600 Ohm balanced or unbalanced

Input Impedance
 MatchingUnloaded transformer high in comparison with source impedance

Bridging200,00 Ohms (using external bridging control)

Load Impedance600 Ohms when shipped; may be changed to 150 Ohms

Maximum Input Level—Matching-22 dBm low gain
 -28 dBm high gain strapping

Maximum Input Level—Bridging30 dBm

Gain:
 Matching40 \pm 1 dB low gain (as shipped)
 46 \pm 1 dB high gain strapping

Bridging3 dB low gain, 9 dB high gain strapping

Frequency Response....Better than \pm 1 dB from 30 to 15,000 Hz (referred to 1000 Hz)

Rated Output Level and DistortionTotal rms harmonic distortion at +18 dBm output less than 0.5% from 30 to 15,000 Hz

Hum and Noise Level(20 Hz to 20 kHz weighted)
 -127 dBm referred to input; -81 dBm referred to output;
 99 dBm max. signal to noise reference to +18 dBm

Maximum Ambient Temperature55°C (131°F)

Transistor and Diode Complement
 1—2N404, 4—2N2270, 2—1N3253

Fuse1/16 amp. 3AG Slow-Blow

Power Requirements115/230 Volts, AC, 50/60 Hz, 3.5 Watts (with taps for 105, 115, 125 Volts or 210, 230 and 250 Volts)

Overall Dimensions4-21/32" high, 1 5/8" wide, 13 1/2" deep (11.79 cm, 4.13 cm, 34.29 cm)

Weight3 1/2 lbs. (1.5 kg.)

FinishAluminum Epoxy

MountingPlug-in mounting on BR-22 Mounting Shelf requires 1/10 of the shelf

Accessories

Bridging Gain Control Kit
 With Screw-driver AdjustmentMI-11278-F
 With Knob AdjustmentMI-11278-E

BR-22 Mounting Shelf for Rack MountingMI-11597-B

Spare Transistor and Diode KitMI-11786-7

Spare Guide Assembly (with receptacles)MI-11594-1

Ordering Information

BA-31C Preamplifier (includes transistors and diodes)MI-11444-C

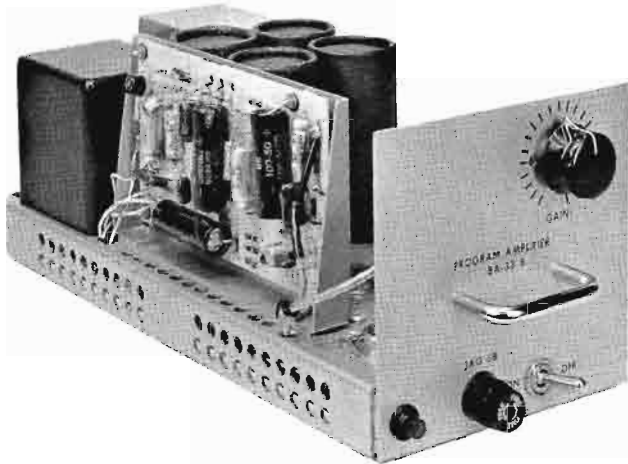

- Transistor circuit design and etched wiring provide uniform performance
- Self-contained power supply
- Excellent frequency response
- Front panel gain control
- Plug-in chassis for shelf mounting

Program Amplifier, Type BA-33B

Description

The BA-33B is a high-fidelity Program Amplifier designed for broadcast service. It incorporates solid state circuitry providing the advantages of small, compact design, uniform performance, reduced power consumption and long-life expectancy for the amplifier. The high gain and low distortion of the unit make it an ideal choice for use as a program or line amplifier, bridging amplifier or as an isolation amplifier.

The BA-33B is a plug-in type designed for use with the BR-22 Mount-

ing Shelf. This shelf permits quick, easy removal for servicing or interchanging units. Three BA-33B Program Amplifiers as well as one BA-31C Transistor Preamplifier can be accommodated on the mounting shelf. All connections are made through plugs at the back of the amplifier. The mating sockets and guide assembly are supplied with the amplifier. Etched wiring boards are used and the circuitry and all components are readily accessible.

The amplifier circuit consists of an unloaded input transformer and a two-stage negative feedback pream-

plifier, followed by a continuously variable gain control that is adjustable from the front panel. The control connects to a negative feedback output amplifier employing five transistors. The output amplifier, in turn, drives an output transformer. Levels as high as +30 dBm (1 Watt) can be supplied at the output. The self-contained power supply consists of a full-wave bridge rectifier and a three-section filter to assure low ripple. A strap is provided for either 55 or 70 dB of maximum gain. The unit is shipped strapped for 70 dB gain. A bridging pad is built into the amplifier.

Specifications

Source Impedance	600 Ohms, balanced when shipped; may be re-connected for 150 Ohm balanced or unbalanced
Input Impedance	
Matching	600/150 Ohms
Bridging	20,000 Ohms
Load Impedance	600/150 Ohms
Maximum Input Level	
Matching	-20 dBm
Bridging	+18 dBm
Frequency Response	
Referred to 1000 Hz	Less than ±1 dB, 30 to 15,000 Hz
Maximum Output Level	+30 dBm
Harmonic Distortion	0.5% rms max. at 30 dBm output, 30 to 15,000 Hz
Matching Gain	
High Gain Connection	70 ±1 dB loaded; 76 ±1 dB unloaded
Low Gain Connection	55 ±1 dB loaded; 61 ±1 dB unloaded
Bridging Gain	
High Gain Connection	33 ±2 dB
Low Gain Connection	18 ±2 dB
Maximum Ambient Temperature	55°C (131°F)

Noise Level at Output

High Gain	47 dBm max., 30 to 15,000 Hz		
Low Gain	-62 dBm max., 30 to 15,000 Hz		
Transistor and Diode Complement			
2—2N2270	2—2N526	3—2N553	4—1N3253
Power Requirement	117 Volts, AC, 50/60 Hz, 20 Watts (transformer taps at 105, 115 and 125 V primary connected in parallel on T-103)		
	230 Volts, AC, 50/60 Hz, 20 Watts (transformer taps at 210, 230 and 250 V, primary connected in series on T-103)		
Fuse	3/8 Amp 3AG Slow-Blow		
Overall Dimensions	4 ² / ₃₂ " high, 5" wide, 13" deep (11.8 cm high, 12.7 cm wide, 33 cm deep)		
Weight	10 lbs. (4.5 kg)		
Mounting	Plug-in on BR-22 Shelf, (requires 3/10 the shelf)		

Ordering Information

BA-33B Program Amplifier (includes transistors and diodes)	MI-11446-A
BR-22C Mounting Shelf	MI-11597-B
Step Attenuator (20 steps, 2 dB per step, 5000 Ohm)	MI-11751-5
Spare Kit of Transistors and Diodes	MI-11781-B
Spare Guide Assembly (with receptacles)	MI-11594-2

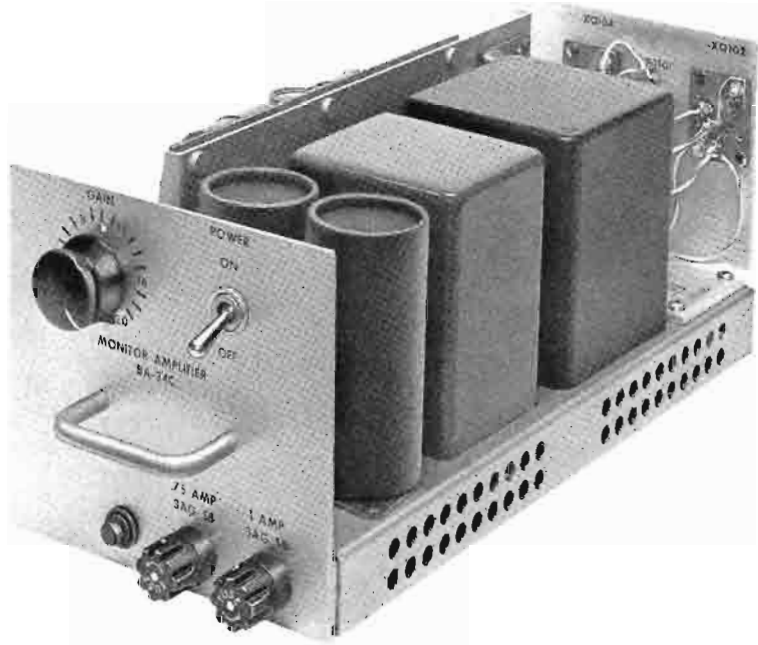

- Completely transistorized
- Self-contained power supply
- High-gain—will accept microphone input level
- 10 Watt output with very low distortion
- Plug-in chassis for shelf mounting

Monitoring Amplifier, Type BA-34C

Description

The BA-34C Monitor Amplifier is a high fidelity amplifier, having 104 dB gain and delivering a full 10 watts of audio power output. It is particularly designed for monitoring, audition, recording and "talk-back" applications. It may also be used as a program or a line amplifier for emergency use. It is ideal for playback of transcriptions and will operate an LC-1B speaker directly from the output of an equalized cartridge. The BA-34C is small in size and is designed for convenient plug-in installation in the BR-22 mounting shelf using the guide assembly supplied with the amplifier.

Low Power Consumption

The use of transistors throughout the BA-34C provides a number of

advantages including: small, compact design, low heat dissipation, greatly reduced power consumption and trouble-free, long-life expectancy for the amplifier. The circuit design of the Monitoring Amplifier is simple and straightforward. All circuit functions are accomplished by ten transistors, and two diodes which are used in the self-contained DC power supply.

Circuit Features

The BA-34C consists of two basic amplifiers, the first a two-stage preamplifier which connects through a gain-control to the input of a multistage power amplifier. The input preamplifier, having an unloaded input transformer can be connected for 37.5, 150 or 600 Ohm

sources. A bridging volume control or the self-contained bridging pad may be used for high level inputs. Negative feedback stabilizes the gain of the two-transistor preamplifier.

Following the preamplifier are two low-level stages, followed by a dual transistor phase splitter, dual transistor driver, and dual class "B" output transistors which are in series with the driver. A thermistor adjusts the idling current of the output stage to compensate for temperature changes. Isolated taps on the output transformer match 4, 8, 16, 150 and 600 Ohm balanced loads. By using three separate feed-back paths, the distortion drops to a low level. Long life silicon diodes are used in self-con-

tained power supply. Two fuses serve to protect the transistors and rectifiers from damage by an accidental short-circuit.

Convenient Controls

All controls are located on the front panel including the interstage

gain control knob, a power ON-OFF toggle switch, indicator lamp, and two fuses—one a 3/4 amp. AC line fuse, the other a 1 amp. DC fuse. The entire amplifier is mounted on a plug-in type chassis. Connections to the BA-34C are made through

two 8-prong blue ribbon connectors at the back of the amplifier which plugs into a socket supplied with the mounting assembly. All input connections are made through one plug, the output and a-c power through the other.

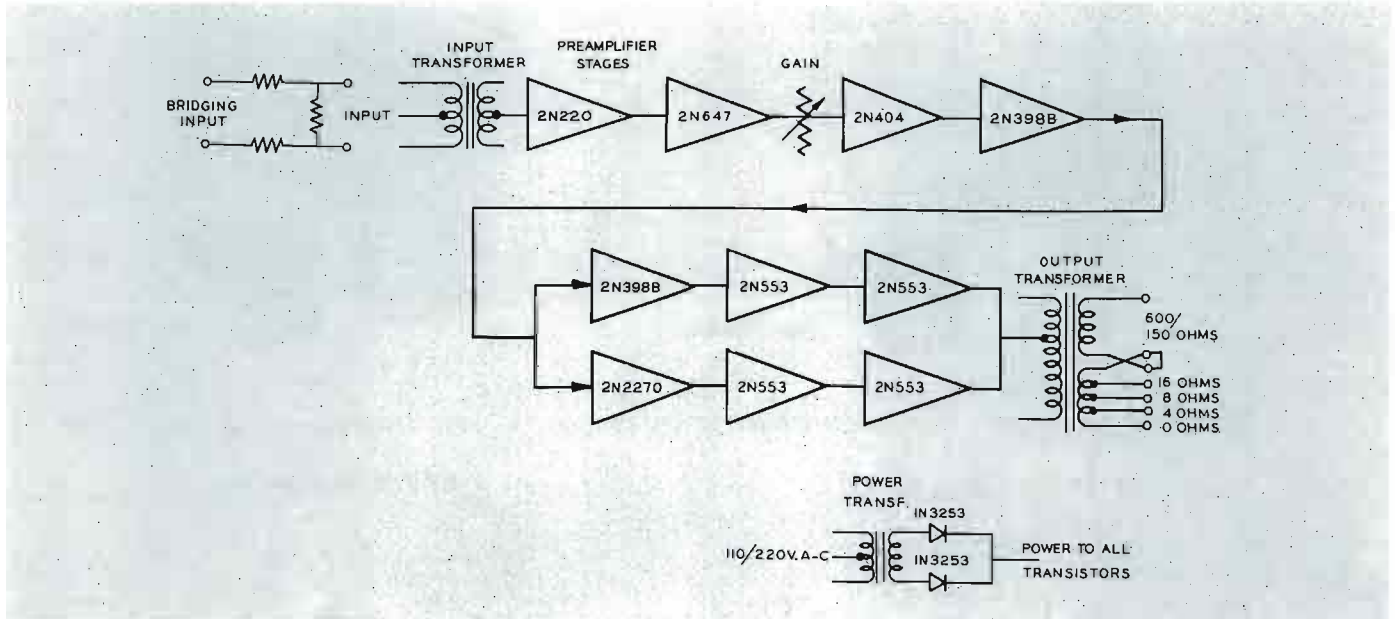

Specifications

Power Required117 Volts, AC, 50/60 Hz.
Taps at 105, 115 and 125 Volts primary (connected in parallel on T-103). 230 Volts, AC, 50/60 Hz. Taps at 210, 230 and 250 Volts (primary connected in series on T-103). 30 Watts at rated output, 10 Watts (approx.) at normal speaker volume.

Source Impedance...150-Ohm balanced source when shipped: may be reconnected to operate from a 600 Ohm balanced or unbalanced, or a 37.5 Ohm unbalanced source.

Input Impedance:
MatchingUnloaded input transformer, input impedance higher than source impedance for all frequencies from 30 to 15,000 Hz.
Bridging50,000 Ohms

Load Impedance4/8/16/150/600 Ohms balanced

Maximum Input Level:
Matching-30 dBm
Bridging+20 dBm

Maximum Gain:
Matching103 dB, ±2 dB
Bridging53 dB, ±2 dB

Average Power Output10 Watts (40 dBm) max.

Frequency Response±2 dB 30-15,000 Hz
Noise Level
(with 15 kHz bandwidth)-120 dBm referred to input
-17 dBm at output at 103 dB gain
Harmonic DistortionAt 10 Watt output (40 dBm)
and -30 dBm input less than 1%, 50 to 15,000 Hz
Ambient Temperature55°C max. (131° F)
Fuses0.75 amp 3AG (AC)
1.0 amp 3AG (DC)

Transistor and Diode Complement:
1-2N404, 1-2N467, 2-1N3253, 1-2N220, 4-2N553,
2-2N398B, 1-2N2270

Dimensions, Overall...13 1/8" (33.3 cm) long, 5" (12.7 cm) wide,
4-31/32" (12 cm) high

Weight11 3/4 lbs. (5.33 kg.)

MountingPlug-in mounting on BR-22 Mounting shelf,
requires 3/10 of space, three amplifiers may be mounted
on each shelf

Accessories

BR-22 Mounting Shelf (mounts 3 BA-34's)MI-11597-B
Bridging Volume ControlMI-11278-E/F
Spare Kit of Transistors and DiodesMI-11782-B
Spare Guide AssemblyMI-11594-3

Ordering Information

BA-34C Monitoring Amplifier
(includes transistors and diodes)MI-11437-C

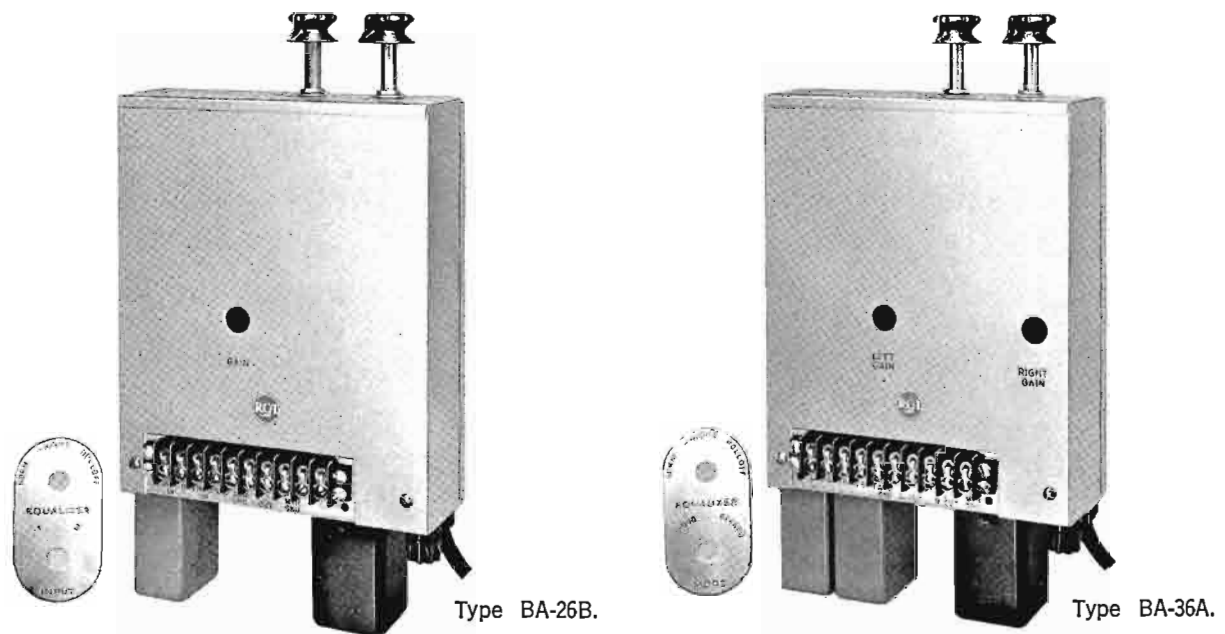

- Wide dynamic range
- Self-contained power supply
- Low distortion—High output level
- Level setting control
- NAB/RIAA response

Pickup Equalizer-Preamplifier, Type BA-26B/36A

Description

The Type BA-26B Monophonic and Type BA-36A Stereo Pickup Equalizer-Preamplifiers are designed to provide correct equalization for reproduction of records and transcriptions. Both models are designed for use with transcription turntables, such as RCA BQ-51's, where they can be mounted inside the turntable cabinet. They are especially recommended for use with the MI-11865 Pickup mounted in either the RCA MI-11894-B or MI-11895-A Tone Arm.

All New Design

Both BA-26B and BA-36A equipments employ RCA low-noise type transistors in a four-stage amplifier utilizing selective feedback to achieve NAB/RIAA equalizing curve. The self-contained AC power supply

utilizing silicon rectifiers provides trouble-free operation. The etched wiring assemblies are mounted inside the chassis while the output and power transformers and two control switches are mounted at the ends of the chassis. A convenient slip-on cover is provided to allow easy access to component parts and transistors. The equalizers have a terminal board for making input and output connections. A six-foot, 3-wire, AC cord with plug is attached to the equipment. This enables the unit to be properly grounded to the AC system ground and produces the maximum possible signal-to-noise ratio. NAB/RIAA or flat response is chosen by strapping. The flat response, achieved by a strap change on the circuit board, is useful for test.

Simplified Controls

Simplified controls are featured in the BA-26B and BA-36A. Two control knobs and a dial plate with necessary mounting hardware are supplied with each unit. One control is a three-position filter switch which provides for normal equalization, high frequency de-emphasis and high frequency cut-off. The second switch on the BA-26B selects either of two tone arms. The ability to select either of two tone arms is especially desirable in playing older transcriptions and 78 rpm records as well as new high-fidelity monophonic transcriptions. With two MI-11895-A tone arms and MI-11865 cartridges mounted on a BQ-51B Turntable, one with a 1 mil stylus and the other with a 2.5 mil stylus any record or transcription may be played quickly

and easily by simply selecting the proper tone arm. The second control knob is used to switch from stereo to mono modes of play.

Adjustable Gain Control

A built-in screwdriver-adjust, gain control allows the gain of the BA-26B to be set to exact requirements. The gain control is accessible through a hole in the removable side panel of the housing. Two similar screwdriver controls are provided in the BA-36A to balance the right and

left channel gains of the dual amplifiers.

Designed For Long Life

The Pickup Equalizer-Preamplifiers are designed for long life. The RCA Type 2N220 low-noise transistor is used in the input stage followed by three Type 2N404 transistors to provide the required gain and output capabilities. Type 1N3193 silicon rectifiers are used in the AC power supply. The unit exhibits complete freedom from

microphonics. An output transformer is employed to provide either balanced or unbalanced output impedance of 150 and 600 Ohms. Two such transformers are used in the BA-36A stereo equipment. Etched wiring boards are utilized to provide stable trouble-free operation of the unit. Selective feedback within the amplifier eliminates the need for inductances to accomplish low-frequency equalization. This eliminates the possibility of hum pick up by the inductance.

Specifications

Performance*

Power Requirements...3 taps 105/115/125 Volts, AC, 50/60 Hz

Power Consumption:

BA-26B 1/2 Watt
BA-36A 1 Watt

Frequency Response:

NAB/RIAA Meets NAB Specifications
Flat ±0.5 dB 20 to 20,000 Hz

Hum and Noise Level -78 dBm max. (30 to 15,000 Hz);
(5 microvolts equivalent 1000 Hz signal at input) (600 Ohm
input termination NAB/RIAA strapping, gain as shipped)

Inputs:

BA-26B Either of two, selected by input switch
BA-36A Monophonic or stereo mode
selected by input switch

Input Impedance:

BA-26B 24,000 Ohms shunted by approximately 100 pf
(for MI-11865 cartridge, monophonic connection) Up to
60,000 Ohms by changing shunt resistor.

BA-36A 47,000 Ohms shunted by approximately 100 pf
(for MI-11865 cartridge, stereophonic connection) Up to
60,000 Ohms by changing shunt resistor.

Output Impedance 150/600 ohms (600 ohms as shipped)

Load Impedance 150/600 Ohms

Sensitivity at 1000 Hz:

BA-26B 5.5 cm/sec. (lateral) for -20 dBm output level
(with any magnetic cartridge and gain adjusted as per
instructions)

BA-36A 3.9 cm/sec. (45°) for -20 dBm output level
5.5 cm/sec. (lateral) for -20 dBm output level (with any
magnetic cartridge and gain, Left and Right adjusted)
per instructions

Input Voltage for -20 dBm Output

Level (1000 Hz) 0.016 V to .013 V (approx.)
.004 V (as shipped)

Output Level:

Program -20 VU (average record)
Maximum -5 dBm

Distortion:

At -20 dBm Output Level:
Intermodulation Less than 1%
(40/4000 Hz or 400/4000 Hz 4:1)
Harmonic Less than 0.25% (30 to 15,000 Hz)

At -5 dBm Output Level:
Intermodulation Less than 4%
Harmonic Less than 1%

High Frequency Compensation 0, -3.5, or -10 dB at
10,000 Hz by means of Equalizer switch

Crosstalk between Channels (BA-36A) Below noise level,
30 to 15,000 Hz

Transistor and Rectifier Complement:

BA-26B: 1-2N220, 3-2N404, 1-1N3193
BA-36A: 2-2N220, 6-2N404, 2-1N3193

Mechanical

Dimensions (overall) 10 3/4" long, 6 5/8" wide, 2 1/2" deep
(27.3 cm, 16.83 cm, 6.35 cm)

Weight:

BA-26B 4 lbs. 10 ozs. (2.1 kg.)
BA-36A 5 lbs. 4 ozs. (2.38 kg.)

Accessories

Transistor and Rectifier Kit for BA-26B MI-11779-B

Transistor and Rectifier Kit for BA-36A MI-11783

* Specifications of the BA-26B and BA-36A are identical unless otherwise indicated.

Ordering Information

BA-26B Pickup Equalizer-Preamplifier (monophonic)
including transistors and rectifier MI-11436-C
BA-36A Pickup Equalizer-Preamplifier (stereophonic)
including transistors and rectifiers MI-11441-B



- Frequency response peaked for high intelligibility
- Input selector switch for ten inputs
- Speaker muting provisions
- Panel available for rack mounting

Transistor Cue Amplifier, Type BA-8B

Description

The RCA Type BA-8B Transistor Cue Amplifier is a compact, low-cost monitoring amplifier designed to provide high intelligibility whether used as a remote line, turntable cue or remote amplifier monitor. It provides an ideal monitor in the announce lounge, program director's office, news rooms, executive office, TV studio prop area, etc. Muting provisions are included in the amplifier so that when the unit is used in the control room or any location where a microphone will also be used, the muting terminals on the rear terminal board may be connected to a set of normally closed contacts on an external muting relay. The completely encased amplifier and loudspeaker may be placed on the console or desk near the operator.

Although the BA-8B is attractively styled for table-top installation, an aluminum epoxy mounting panel, MI-11449-A, is also available for rack mounting. The front panel of the BA-8B contains the volume and input selector switch controls plus a neon on-off indicator. A perforated metal grill serves as a protector for the 3 by 5-inch speaker.

Up to ten inputs may be selected by the self-contained input selector switch. Connections to the amplifier are made at a

rear terminal board where a plastic cable clamp is also provided for holding cables neatly in place. The number one input is wired for bridging a 600 Ohm line, the other nine are matching inputs, but may be made bridging inputs by customer installation of the proper resistor network within the unit.

Specifications

Power Requirements	117/235 Volt AC, 50/60 Hz, single phase, 13 Watts
Frequency Response.....	Compensated for high intelligibility
Number of Inputs.....	9 matching, 1 bridging
Input Impedance:	
Matching	600 Ohms when shipped; may be connected for 150 Ohms
Bridging	10,000 Ohms
Input Level:	
Matching	-23 dBm \pm 2 dBm, minimum for +30 dBm (1 Watt) output
Bridging	+8 dBm \pm 2 dBm, minimum for +30 dBm (1 Watt) output
Gain	53 dBm (approx.)
Maximum Output Level	+30 dBm (1 Watt)
Distortion.....	Less than 2% (measured with 1 Watt output at 1 kHz)
Muting Provision.....	Strapping on rear terminals marked MUTE
Loudspeaker Impedance	3.2 Ohms
Loudspeaker Dimensions.....	3 by 5 inches elliptical, permanent magnet
Transistor and Diode Complement:	
1-2N109, 1-2N404, 1-2N652, 1-2N456, 1-1N2069	
Dimensions (Overall).....	7 $\frac{1}{4}$ " wide, 3 $\frac{1}{2}$ " high, 8 $\frac{1}{8}$ " deep (18.42 cm, 8.89 cm, 20.48 cm)
Weight.....	6 $\frac{1}{2}$ lbs. (2.95 kg)
Finish.....	Midnight blue, etched aluminum panel

Ordering Information

BA-8B Transistor Cue Amplifier (includes transistors)	MI-11450-A
Accessory Rack Mounting (Shelf accommodates one BA-8B)	MI-11449-A



- Low-cost—high quality performance
- Self-contained AC and battery supply
- Compact, portable case with tilt-rest cover
- Optional plug-in input transformers
- Separate PA gain control

Two-Channel Remote Amplifier, Type BN-7A

Description

The Type BN-7A Portable Remote Amplifier, MI-11451-A, is designed for broadcast use, providing two separate input channels that can be operated either balanced or unbalanced. Transistors and germanium diodes are employed throughout. The BN-7A is completely self-contained for AC or battery operation. For operating convenience, a pull-out chassis housing the batteries is removable from the front panel. A separate PA gain control is provided. Excellent frequency response and low harmonic distortion assure high quality performance.

The BN-7A Amplifier is styled for operating convenience. All amplifier components, controls, batteries and

AC power supply are mounted on a one piece chassis easily removable from the portable carrying case. This ruggedly-constructed steel case, is provided with a soft leather handle and finished in midnight blue. The cover can be removed easily for quick set-up of the equipment. Special hinges permit the cover to be detached, reversed and used as a special tilt-rest for the amplifier case in applications where inclined positioning of the control panel is desired.

Located on the front panel are all operating functions including an illuminated VU meter, two mixer controls, the master control, phone jack, PA gain control, and power switch. For ease of servicing, the

amplifier chassis may be withdrawn from the case thereby exposing all components.

Mercury cell batteries are self-contained in a convenient battery storage chamber located on a pull-out chassis accessible from the front panel. A rear cut-out in the case provides easy accessibility to the AC power connector, fuse holder, microphone connectors and the output connections. Clips are provided in the cover of the carrying case for securing the 8-foot AC power cord when not in use. The PA gain control bridges the output at the amplifier and allows the operator to conveniently control the level fed to external PA equipment.

Specifications

Input ConnectorType XL
 Inputs2 microphones
 (both may be used simultaneously) 150/250 Ohms
 unbalanced, 37.5/150 Ohms balanced when using MI-11776
 Input Transformer
 Output (balanced output 600/150 Ohms) (shipped connected
 for 600 Ohms)+18 dBm (6 dBm isolation provided)
 Gain92.5 dB \pm 2 dB (150 Ohm source on 150 Ohm input
 to 600 Ohm load)
 Frequency Response \pm 2 dB from 30-15,000 Hz
 Harmonic Distortion (+18 dBm output mixer
 and master controls set for 68 dB gain)Less than 1.5%
 50-100 Hz; less than 1% 100-15,000 Hz
 Noise Level Referred to Input-118 dBm
 Meter3" VU illuminated
 Power Requirements:
 AC Power117/235 Volts, 50/60 Hz, 5 Watts
 DC Power6 batteries required (not supplied)
 5—PR Mallory Type TR135R 6.5 Volts,
 1—RCA VS036, D size, flashlight cell, 1.5 Volts.

Transistor and Diode Complement:
 2—2N220, 2—2N404, 1—2N274, 1—2N1090, 3—2N270, 2—1N91
 Dimensions (overall)5½" high, 14½" wide, 10½" deep
 (13.97 cm, 36.83 cm, 26.67 cm)
 Weight15 lbs. approx. (6.8 kg.)
 FinishMidnight blue case and silver gray panel

Accessories

Input Transformer (37.5/150 Ohms)MI-11776
 Spare Transistor and Diode Kit for BN-7AMI-11785
 Step Type Attenuator for BN-7A Master ControlsMI-11751-3
 Step Type Attenuator for BN-7A Fader ControlsMI-11751-4

Ordering Information

BN-7A Portable Two-Channel Remote Amplifier including
 transistors and diodes but less batteriesMI-11451-A

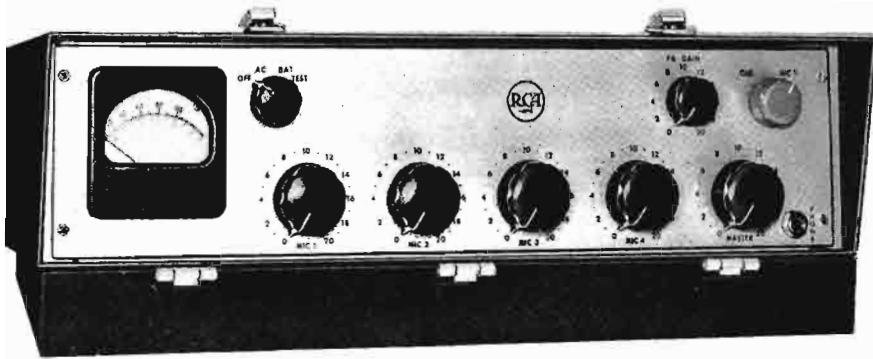

- Completely Transistorized
- High Level Mixing
- Full 8 VU Output to Line
- Self-Contained AC and Battery Power Supplies

Four-Channel Remote Amplifier, Type BN-16B/C

Description

The Type BN-16B/C Portable Remote Amplifier is a four-channel transistor amplifier especially designed for remote broadcast use. Its small size and low power dissipation makes it equally useful in other applications requiring additional or auxiliary mixing facilities. AC or battery operation is available at the flip of a switch. Ten, single type silicon transistors employed in the amplifier contribute materially to its dependability and excellent performance characteristics. Four separate balanced input channels are provided as well as cueing, monitoring and mixer bus paralleling facilities.

Self-Contained AC and Battery Power Supplies

The BN-16B/C is completely self-contained for 115 or 230-Volt, 50 or 60 Hz power line or battery operation. Other features include microphone input transformers for all channels, earphone monitoring and line cueing facilities and a PA gain control. Up to eight microphones may be mixed by paralleling the

mixer busses of two BN-16 amplifiers by means of receptacles made available for this purpose. This arrangement also provides a dual line feed and dual PA feed.

Simplified Controls—8 VU Output to Line

All controls are located on the front panel including an illuminated VU meter, power switch, PA gain control, cue switch, four mixer controls, the master control, and monitoring phone jack. The VU meter is used to monitor the output level and to test the battery voltage. Five long-life mercury batteries may be used as a battery power supply for the BN-16B. A separate type D, dry cell battery will provide illumination for the VU meter. The generous power output capability of the amplifier allows a full +8 VU delivered to the line after the 6 dB line isolation pad.

Functional Styling

The amplifier is a functionally styled unit in which an etched wir-

ing board including amplifier components and transistors, controls, batteries and alternate AC power supply are all contained in a portable carrying case. The steel case, finished in midnite blue, is provided with a soft leather handle. An 8-foot power cord is clipped inside the cover of the carrying case. The cover is easily removed from the hinges and may be used as a tilt-rest for the amplifier. A recess in the bottom of the case protects the AC power connector, fuse holder, microphone connectors, mixer bus receptacle and line binding posts. A weather-proof canvas carrying case, MI-11377-A is available as an accessory.

High Level Mixing

High level mixing on all four channels is afforded by the BN-16 Amplifier as shown in the block diagram. Each channel follows a similar path through its corresponding transformer, transistor and attenuator to the gain stage except that Microphone 1 input is fed through the CUE-Mic 1 switch. When this

switch is operated in the CUE position the telephone line from the output of the amplifier is connected to the microphone 1 input. Cue signals from the studio are then amplified through the BN-16B to the headphones. A pad in the cue circuit reduces the cue signal to proper preamplifier input level.

PA Gain Control

The PA gain control bridges the output of the amplifier and allows the operator to conveniently control the level fed to external PA equipment. Five convenient binding posts are mounted on the rear panel of the amplifier. Two are used for feeding the PA equipment, two for line output, and one for ground.

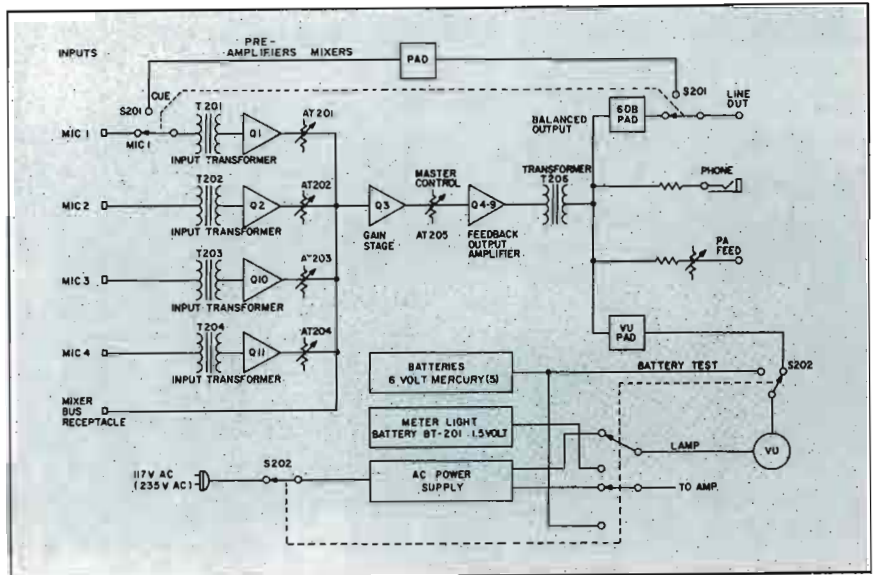

Specifications

Power Required:

- AC Power117 Volts/235 Volts, 50-60 Hz, 5 Watts
- DC Power5—Mallory TR-135R, 6.5 Volt (not supplied)
1—RCA VS 306, 1.5 Volt, D Size (not supplied)

Inputs:

- 4 Microphone Inputs 37.5/150-250 Ohms, balanced transformer (as shipped, strapped for 150-250 Ohms)
- 1 Mixer Bus receptacle (permits paralleling mixer buses of two BN-16 Amplifiers)

Output Level+18 dBm at 600/150 Ohms, balanced (6 dB isolation provided) (as shipped, strapped for 600 Ohms)

PA Feed Output-7 dBm maximum, 600 Ohms balanced, with adjustable attenuator

Gain90 dB \pm 2 dB

Frequency Response \pm 1 dB from 30 to 15,000 Hz

Harmonic DistortionLess than 1% with +18 dBm output master at step 14 and mixer control set for 68 dB gain

Noise Level-120 dBm referred to input; equivalent to 70 dB S/N with -50 dB input and +18 dBm output 30 to 15,000 Hz

Input Connections.....Type XLR (space available to mount P type or UA type connectors in place of the XLR type)

Transistor and Diode Complement:

- 10—2N2270, 1—2N398A, 2—1N3253

Dimensions Overall18½" wide, 5½" high, 10½" deep (46.99 cm wide, 14.3 cm high, 26.7 cm deep)

Weight.....20.5 lbs. (9.2 kg), less batteries

Accessories

- Step Type Attenuator for Master Control.....MI-11751-3
- Step Type Attenuator for Mixer Controls.....MI-11751-4
- Weather-proof Canvas Carrying Case.....MI-11377-A
- XLR-4-12C Cable Connector (for combining two units, 2 requiredStock Number 219546
- XLR-3-12C Input Cable Connector.....MI-11089-A
- Transistor and Diode KitMI-11498

Ordering Information

- BN-16B Four-Channel Portable Remote Amplifier, complete with transformers, XLR Type connectors (less batteries)MI-11221-D
- BN-16C Four-Channel Portable Remote Amplifier with Step Attenuators, and UA Type Connectors (less batteries)MI-11453-A



- Provisions for paralleling units
- Built-in 1000 Hz oscillator for setup
- Selectable inputs
- Full cue features
- Internal line and battery power supplies

Mixer Amplifier, Type BN-26

Description

The Type BN-26 Portable Remote Mixer-Amplifier is a four-channel transistor unit especially designed for broadcast use. Its small size and low power consumption make it equally useful in other applications requiring additional or auxiliary mixing facilities. Several amplifiers can be bridged together for increased flexibility.

The solid state design of the BN-26 materially contributes to its dependability and excellent performance characteristics. Four separate balanced/unbalanced input channels are provided as well as cueing, monitoring and provisions for mixer bus paralleling.

Simplified Styling

The remote amplifier is a functionally styled unit housed in an attractive portable carrying case. The Royalite, aluminum trimmed case finished in powder blue is provided with a convenient handle and mounting hardware for portable or rack-mounting applications. The cover can be reversed to serve as a tilt-rest for the amplifier.

Complete Accessibility

The case may be easily removed for complete access. When the front cover is closed on the mixer, for transport, the power is automatically turned off, thus preventing accidental battery drain. The chassis will accommodate either XLR type or VA type microphone connectors, without modification.

Front Panel Controls

BN-26 controls are located on the front panel including an illuminated VU meter. Controls include: the automatic power switch with indicator, PA gain control, Cue switches, four mixer controls, and master gain. The VU meter is used to monitor the output level and test the battery voltage. Monitor and Cue jacks, input and output jacks, as well as convenient binding posts are mounted on the rear panel of the BN-26.

Self-Contained AC/Battery Power

The BN-26 is completely self-contained for 117 or 234 Volt, 50 or 60 Hertz power line or battery operation.

A new feature is the provision that automatically switches from the AC source to internal battery operation if the AC power fails, with power failure indication. An 8-foot power cord is carried inside the cover of the carrying case for convenient AC power utilization. Long-life batteries may be used as an alternate power supply for the BN-26. Two Type D, dry cell batteries provide illumination for the VU meter.

Monitor and Cue Facilities

The BN-26 has microphone input transformers for all channels. Two models are available with carbon or step-type attenuators, as desired. Earphone monitoring, line and station cueing, and a PA gain control is also provided. Eight or more microphones may be mixed by paralleling the mixer buses of two or more BN-26's by means of receptacles and a bridging cable supplied for this purpose. This arrangement also provides a multiple line feed and multiple PA feed.



Rear view of portable BN-26 Mixer Amplifier showing convenient binding posts, Monitor and Cue Jacks as well as inputs and outputs.

Specifications

Mixer Channels

(Convenient push button selection, switchable inputs):

- Channel 1Microphone—High Level
- Channel 2Microphone—Internal Oscillator—
High Level
- Channel 3Microphone—Phono (RIAA Equalization)—
High Level
- Channel 4Microphone—Phono (RIAA Equalization)—
High Level

Microphone Inputs:

- Source Impedance600/150 Ohms
- Input Impedance1400 Ohms min. for 150 Ohm tap
- Max. Input Level-20 dBm

High Level Inputs:

- Source Impedance600 Ohms
- Input Impedance4400 Ohms
- Max. Input Level+10 dBm

Phono InputsRIAA Equalization; max. stylus velocity
35 cm sec. @ 1000 Hz

Internal OscillatorFrequency 1000 Hz

Frequency Reponse (with master set at 13, channel gain set
for 64 dB, 0 VU Level and a -50 dBm level into the micro-
phone input)+0, -0.5 dB, 20 Hz to 20 kHz

Distortion (with master set at 13, channel gain set for 64 dB,
0 VU Level and a -50 dBm level into the microphone
input)0.25% 20 Hz to 20 kHz

Output Level+24 dBm on AC; +18 dBm on battery
to 600 Ohm load after 6 dB isolation

Noise Level-125 dBm referred to input
Load Impedance600/150 Ohms (shipped connected
for 600 Ohms)

Gain95 dB

Power Requirements117/234 Volts AC 50/60 Hz or self-
contained battery pack of 18 Type C and 2 Type D

Connections:

- Microphone or High LevelXLR inputs (Provisions for
mounting UA connectors)
- High Level/Microphone250 dia. 2-circuit phone jack
- PA Feed, Phone LineBinding Posts
- BridgingPhono connectors, patch cord provided
for bridging connections

Controls4 mixer, 1 master, cue gain, PA feed, and cue
switching (selectable, channels 1, 2, 3, 4 and station cue)

AttenuatorsCarbon type or step attenuators
(see Ordering Information)

Finish:

- CaseLight Blue
- PanelBlack anodized, silver lettering
- Mounting ProvisionsMay be rack mounted,
hardware provided

Overall Dimensions:

- In Case19" wide, 4" high, 16¼" deep
(48.26 cm, 10.16 cm, 41.28 cm)
- Rack Mounted (out of case)19" wide, 3½" high,
13" deep, less plug (48.26 cm, 8.89 cm, 33.02 cm)
- Weight25 lbs. (11.34 kg.) less batteries

Ordering Information

- Type BN-26 Portable Remote Mixer-Amplifier
(with step-type attenuators)MI-11461
- Type BN-26 Portable Remote Mixer-Amplifier
(with carbon type attenuators)MI-11462



- Fully transistorized
- High and low level mixing
- Separate bass and treble controls for full boost and cut
- Plug-in transformers (combination input/output)
- Shelf or desk top mounting
- Self contained 115 V, AC Supply or external battery operated

Five-Channel Mixer Preamplifier, Type SN-10

Description

The SN-10 Mixer Preamplifier is a five-channel transistor amplifier especially designed for Professional Audio use. Its small size and low power requirement makes it equally useful in applications requiring additional or auxiliary mixing facilities. Four of the five channels are primarily intended for low level microphone mixing; the fifth channel is used for high level (+18 dBm) line mixing, with any of the mike inputs. All of the inputs provided may be used in either the unbalanced condition or with the use of accessory plug-in transformers, in the balanced condition.

Combination Input/Output Transformers and Separate Bass and Treble Controls

A single type input/output transformer provides matching and balancing for either the input or

output circuit/ Sockets are provided for plug-in operation with the accessory transformer. Separate bass and treble controls provide 30 dB ± 4 dB dynamic range from full boost to full cut, with flat response when set to mid range.

Simplified Controls

All controls are located on the front panel. These include an illuminated output meter calibrated in VU, cueing switch and headset jack, master gain control, tone controls, and individual mixer controls. The power output capability of the amplifier delivers +10 dBm to the line. A cueing switch is provided which allows insertion of earphones during program.

Functional Styling Includes Self-Contained AC Power Supply

The SN-10 is completely self-

contained for 115 or 230 Volt, 50 or 60 Hz power line, or external battery operation. Terminals are provided in the rear for the connection of an external DC supply. The unit is compact and functionally styled to allow installation of two units in one shelf, or desk top mounting. The input connections are made with XLR type connectors for microphone, and screw terminals for the high level input. The unbalanced inputs for high level, and unbalanced output of the amplifier, are made through RCA type phono jacks. The balanced output connection is made with screw-type terminals. The circuitry is contained on an etched wiring board. The steel case is finished in midnight blue and the amplifier is provided with a 6 foot power cord. The bottom of the case is provided with four rubber feet.

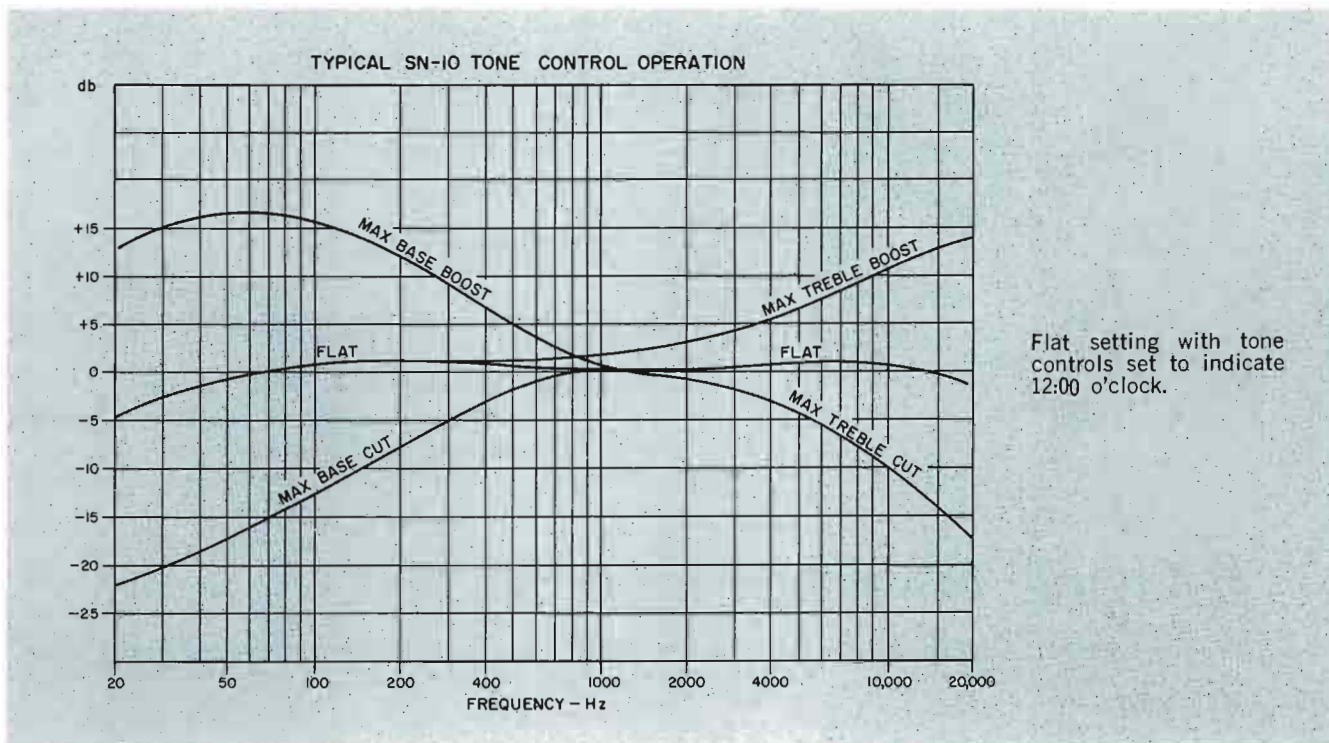

Specifications

Power Required;

AC Power 117 V/235 V, 50-60 Hz, 5 Watts
 External Battery 32 V DC @ 36 ma

Input Connectors;

Microphone Type XLR
 Balanced Line Screw Type
 Unbalanced Line RCA Phono
 External DC Supply Screw Type

Output Connectors;

Balanced Line Screw Type
 Unbalanced Line RCA Phono
 Earphones Standard 1/4" Phone Jack

Input Impedances, Microphone and Line 600 Ohm
 or 10,000 Ohm balanced or unbalanced

Output Level +10 dBm, balanced or unbalanced

Gain (Microphone Input) 80 dB \pm 2 dB

Tone Control Operation; (See Graph)

Bass 15 dB \pm 2 dB boost and cut @ 50 Hz
 (30 dB dynamic range \pm 4 dB)
 Treble 15 dB \pm 2 dB boost and cut @ 10 kHz
 (30 dB dynamic range \pm 4 dB)
 Crossover Frequency 1000 Hz

Frequency Response:

Without input transformers \pm 1 dB, 20 to 20,000 Hz
 With input transformers \pm 1 1/2 dB, 50 to 20,000 Hz

Harmonic Distortion 1% maximum with -50 dB input,
 master gain control set to 3/4 CW and mike gain control
 set for +10 dBm output 1000 Hz

Noise Level -120 dBm referred to input

Transistor and Diode Complement;

7 Type 40233 1 Type 2N1415 1 Type 2N2868
 3 Type 1N3253 1 Type 1N4154

Dimensions - (Overall) 4 5/8" high, 8 1/2" wide, 1 1/4" deep
 (11.8 cm, 25.4 cm, 28.5 cm)

Weight 9 lbs. (4.03 kg.)

Accessories

BR-22C Mounting Shelf MI-11597-B
 XLR-3-12C Input Cable Connector MI-11089-A
 Combination Input/Output Transformer MI-9667

Ordering Information

Type SN-10 5-Channel Mixer Preamplifier, MI-38705

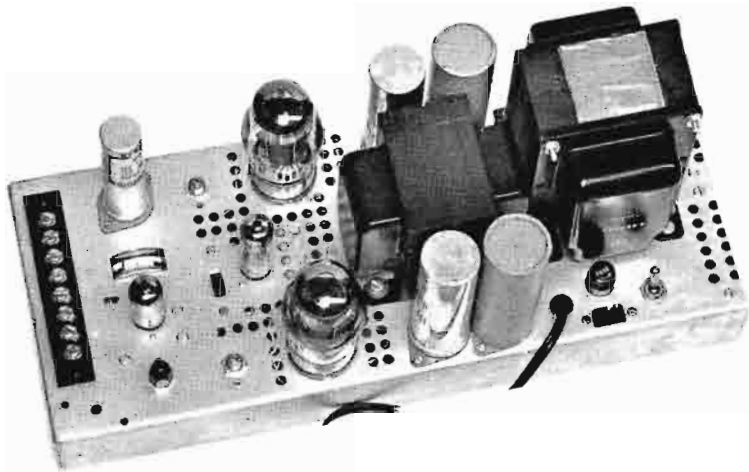

- Several amplifiers may be connected in parallel for higher power applications
- High operating efficiency
- Built for continuous duty at full power output
- Rugged power transformer operates on either 50 or 60 hertz and has a shield to reduce hum pick-up into nearby equipment

Bridging Amplifier, Type SA-1000

Description

Efficiency of operation and lower power consumption have been achieved in the SA-1000 amplifier through the use of solid state silicon rectifiers in the power supply rather than tube type rectifiers. The silicon rectifiers are used in a voltage doubler circuit to drive the screens of the RCA 6550 output tubes, thereby providing all of the advantages of a regulated screen supply.

The power amplifier section is composed of a phase inverter, driver tube and output tubes. The phase inverter has exceptional balance qualities which are independent of tube aging due to local feedback. The driver tube provides ample driving voltage to the output tubes throughout tube life.

For true high fidelity performance, the SA-1000 amplifier uses a specially

designed output transformer, with grain-oriented silicon steel laminations and bifilar winding techniques. This couples the 6550 tubes to the output load (speakers, line transformers, etc.). An overall negative-feedback loop provides low distortion, excellent output-voltage regulation and exceptionally flat frequency response. The amplifier is shipped with a high-frequency roll-off.

Specifications

Power Output:

Rated Power100 Watts at less than 2% THD
from 50 to 20,000 Hz, 110 Watts at less than 5% THD
from 50 to above 22,000 Hz

Maximum power output175 Watts at 400 Hz

Maximum instantaneous peak power238 Watts

Regulation1.5 dB no load to full load

GainBridging input to 50 ohm load 59½ dB

Input Terminal Voltage
(for rated output):Bridging input .53 V

Frequency ResponseBridging input Flat ±2 dB,
20 to 50,000 Hz

Output ConnectionsScrew terminals on terminal board

Output Voltage*	Output Tap	Load Impedance
12.5 Volts	1.6 ohm	For 3.2 ohm speakers
25 "	6.3 "	" 8 "
35 "	12.5 "	" 16 "
70 "	50 "	" "

Input Connections—Screw Terminals:Bridging
on Terminal Board

Signal to Noise RatioBridging Input 93 dB

Power ConsumptionAt no signal 90 Watts,
At rated output 228 Watts

*Normally used in constant voltage distribution systems.

Power Supply:

Voltage120/130 Volts AC taps

Frequency50/60 Hz

Fuse(1) 3 Amp, Slo-Blo

(1) Convenience outlet (4½ Amps. max.)

10 foot type SPT-2 power cord

Tube/Semiconductor Complement:

1—RCA Type 6EU7 2—RCA Type 1N3196 rectifier

1—RCA Type 12BH7-A 1—RCA Type 1N3194 rectifier

2—RCA Type 6550

Controls:

1—Input gain control

1—On-off toggle switch

1—Output tube bias switch and

2—bias adjustments for use with bias check meter

FinishChassis: Cadmium finish, with black lettering
for tube type numbers, etc.

Dimensions (overall):

Chassis6¾" high x 17" wide x 7" deep

(17.14 cm, 43.18 cm, 17.78 cm)

WeightNet, unpacked. 24 lbs. (10.9 kg.)

Shipping Weight30 lbs. approx. (13.6 kg.)

RCA Type SA-1000 Bridging Amplifier,
with tubes, less coverMI-38194

Rack Mounting ShelfMI-38195

Trim PanelMI-38100-8

Rack Mounting ("Swing-out" servicing)MI-38196

Bridging Input Transformer—10,000/100,000 ohmsMI-38703

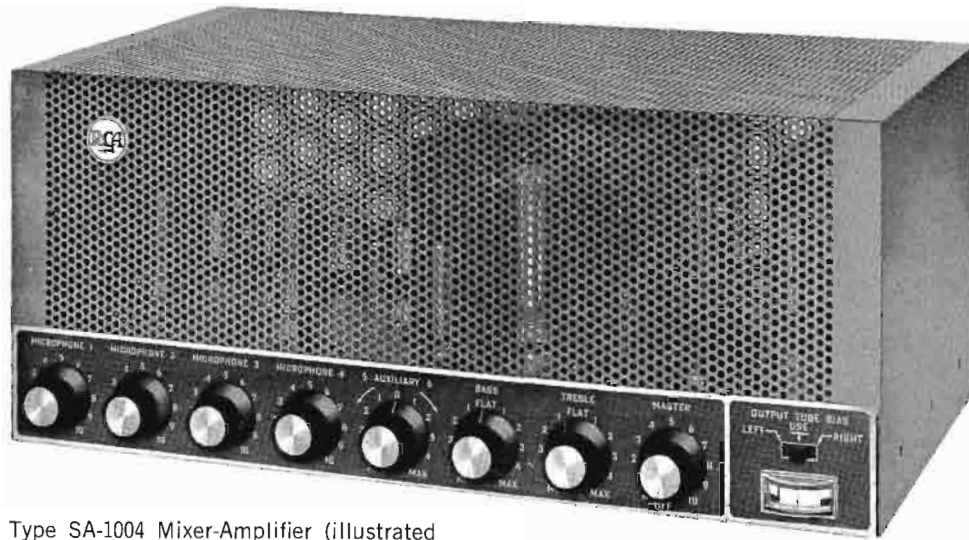

Type SA-1004 Mixer-Amplifier (illustrated with optional top cover, MI-38174)

Mixer Amplifier, Type SA-1004

Description

The Type SA-1004 is an unusual power amplifier; a completely new design from circuitry to chassis styling. It draws on RCA's nearly 40 years of experience in sound reproduction, but is decidedly not an extension of a previous design. For versatility, efficiency, durability and full-function performance, the SA-1004 is unmatched in its class. It may be used without reservation for voice or music reproduction, even in those critical applications where high fidelity response is essential.

Circuit Description

Efficiency of operation and lower power consumption have been achieved in the SA-1004 amplifier through the use of solid state silicon rectifiers in the power supply rather than tube type rectifiers. The silicon rectifiers are used in a voltage doubler circuit to drive the screens of the RCA 6550 output tubes, thereby providing all of the advantages of a regulated screen supply.

The power amplifier section is composed of a phase inverter, driver tube and output tubes. The phase inverter has exceptional balance qualities which are independent of tube aging due to local feedback. The driver tube provides ample driving voltage to the output tubes throughout tube life. The 6550 output tubes are ideally suited for this application, because of their ruggedness and power capability. With normal program material, these tubes operate in this circuit at only two-thirds of their maximum power ratings, resulting in life-extending lower component operating temperatures.

For true high fidelity performance, the SA-1004 amplifier uses a specially designed output transformer, with grain-oriented silicon steel laminations and bifilar winding techniques. This couples the 6550 tubes to the output load (speakers, line trans-

formers, etc.). An overall negative feedback loop provides low distortion, excellent output-voltage regulation and exceptionally flat frequency response.

For low-noise, non-microphonic operation, the preamplifier stages of the Mixer-Amplifier utilize type 6EU7 tubes which are factory built to provide these characteristics. Each of the preamplifier stages and the auxiliary inputs is mixed by the passive-resistance method to form a common signal channel; a type of mixing which provides superior performance.

The tone controls provide their boost and cut characteristics through changes in feedback. In this way, the entire tone control is enclosed by a heavy feedback loop, which results in lower distortion, noise, uniform gain, improved frequency response—all of the advantages that are inherent with negative feedback.

Specifications

Power Output:

Rated Power100 Watts at less than 2% THD
 from 50 to 20,000 Hz, 110 Watts at less than 5% THD
 from 50 to above 22,000 Hz
 Maximum power output160 Watts at 400 Hz
 Maximum instantaneous peak power240 Watts

Regulation1.5 dB no load to full load

Gain:

System switch set at:	"Special"	"Normal"
Microphones:	123 dB	113 dB
Auxiliary inputs:	88 dB	88 dB
Bridging input:	58 dB	58 dB

Input Terminal Voltage (for rated output)

System switch set at:	"Special"	"Normal"
Microphone inputs:	2.2 MV	7.0 MV
Auxiliary Inputs:	0.16 V	0.16 V
Bridging input:	.59 V	.59 V

Frequency Response:

Microphone Inputs $\pm 1\frac{1}{2}$ dB 25 to 20,000 Hz*
 Auxiliary Inputs ± 1 dB 25 to 20,000 Hz
 Bridging Input ± 1 dB 20 to 40,000 Hz

*Switch in "special" position, refer to figure for operation of tone controls.
 (Refer to frequency response curves for minimum performance under actual operating use.)

Output ConnectionsScrew terminals

Output Voltage*	Output Tap	Load Impedance
12.5 Volts	1.6 ohm	For 3.2 ohm speakers
25 "	6.3 "	" 8 "
35 "	12.5 "	" 16 "
70 "	50 "	" "

*Normally used in constant voltage distribution systems.

Input Connections:

MicrophoneSwitchcraft Type C3F (female)
 AuxiliaryTelephone jack
 BridgingPhono jack

Frequency Response Curve for MI-38191.

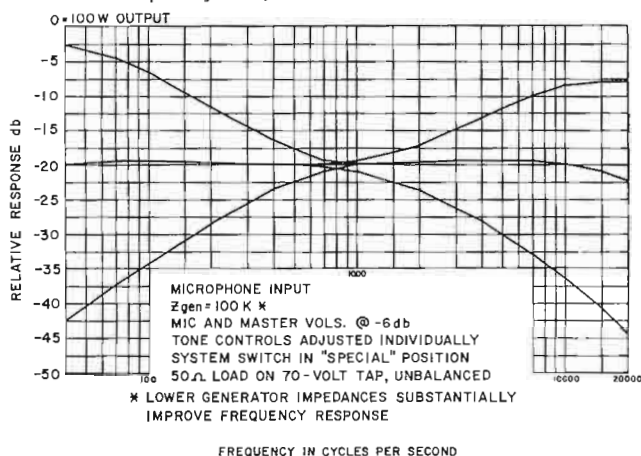

Signal to Noise Ratio:

Microphone Channels
 (Equiv. Input Noise = -126 dBm)53 dB
 Auxiliary Channels70 dB
 Bridging Input93 dB

Crosstalk RejectionGreater than 30 dB between
 2 adjacent channels; more than 50 dB on
 non-adjacent channels (measured at 20 kHz).

Power Consumption:

At no signal110 Watts
 At $\frac{1}{3}$ rated output171 Watts
 At rated output250 Watts

Power Supply:

Voltage120/130 volts AC
 Frequency50/60 Hz
 Fuse(1) 3 Amp, Slo-Blo
 (1) Convenience outlet (3- $\frac{1}{2}$ Amps. max.)
 9 foot type STP-2 power cord

Tube/Semiconductor Complement:

4—RCA Type 6EU7
 1—RCA Type 12BH7-A
 2—RCA Type 6550
 2—RCA Type 1N3196 rectifier
 1—RCA Type 1N3194 rectifier
 1—Type #159 Pilot Light

Controls:

4—Microphone gain controls
 1—Auxiliary dual gain control
 1—Master gain/on-off control
 1—Bass control, boost and cut
 1—Treble control, boost and cut
 1—System switch
 1—Output tube bias switch and
 2—bias adjustments for use with
 illuminated bias check meter.

Finish:

EscutcheonBrushed aluminum
 with black, epoxy-lacquer-covered lettering
 KnobsBlack, skirted, with spun aluminum inserts
 ChassisCadmium finish, with black lettering
 for tube type numbers, etc.

Dimensions:

Overall Chassis7" high x 17" wide x 10 $\frac{1}{8}$ " deep
 (17.78 cm, 43.18 cm, 25.72 cm)

Overall chassis with optional
 cover installed7 $\frac{1}{4}$ " high x 18 $\frac{7}{8}$ " wide x 10 $\frac{1}{8}$ " deep
 (18.42 cm, 47.94 cm, 25.72 cm)

WeightNet, unpacked, 30 lbs. (13.6 kg.)

Shipping Weight34 lbs. approx. (15.4 kg.)

Accessories

Top CoverMI-38174
 Rack Mounting ShelfMI-38195
 Trim PanelMI-38100-9
 Microphone Input TransformerMI-12399-A
 High Level Adapter PlugMI-38155

Ordering Information

RCA Type SA-1004 Mixer-Amplifier, with tubes, high im-
 pedance plug, less coverMI-38191

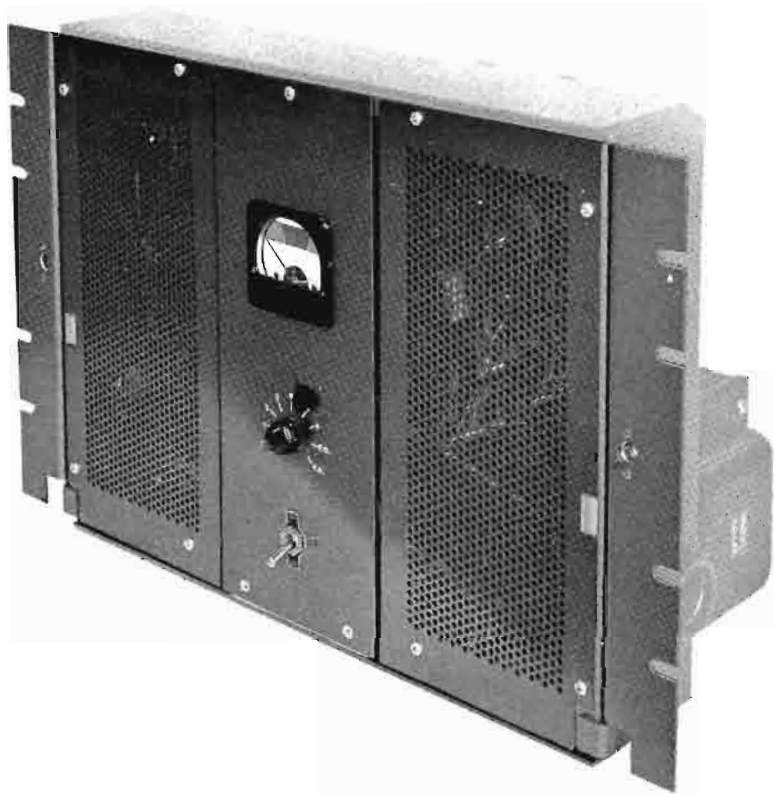

- High quality, low distortion, low noise level
- Excellent frequency response (20-20,000 Hertz)
- Three separate AC input taps
- Separate plate and filament transformers
- Combined voltage and VU meter
- Operates class AB with fixed bias
- Supplies plate and filament power for external loads

200-Watt Power Amplifier

Description

The MI-9289-B is a bridging type power amplifier using four type 6550 tubes in push-pull class AB₁ operation. Its exceptional frequency response and low distortion make it an ideal amplifier for wide range reproduction of music. One or more of these amplifiers can be used in a system. When more than one is used, the inputs can be paralleled and driven by the same source. With 16 decibels of inverse feedback, for frequency stabilization, it is capable of producing 200 Watts of clean audio power to any load.

The self-contained AC power rectifier unit operates from 105/-115/125 Volts, 60 Hertz source.

Power consumption of the amplifier is 168 Watts (no signal) and 440 Watts (maximum signal). The amplifier is equipped with screw type terminals assembled on 2 barrier terminal boards.

The frequency range is approximately flat from 20 to 20,000 Hertz with the high frequency end being down 1.5 dB at 20,000 Hertz. The amplifier has a 470 pF capacitor in the input circuit to provide the frequency response required for large outdoor (drive-in) theatre installations which drops the frequency at the high end approximately .4 of a dB at 1,000 Hertz.

The amplifier is designed for hinge-mounting in a standard 19-inch rack or cabinet. Because of this "tip out" feature, the amplifier can be serviced from the front.

A meter is supplied on a center panel with a selector switch which can be used to test the condition of the amplifier tubes.

The meter can also be used when the switch is in #7 position to indicate the power output (as a VU meter). When the amplifier is mounted in an open cabinet or rack an additional front cover is available. This front panel is held in place by two captive spring thumb screws.

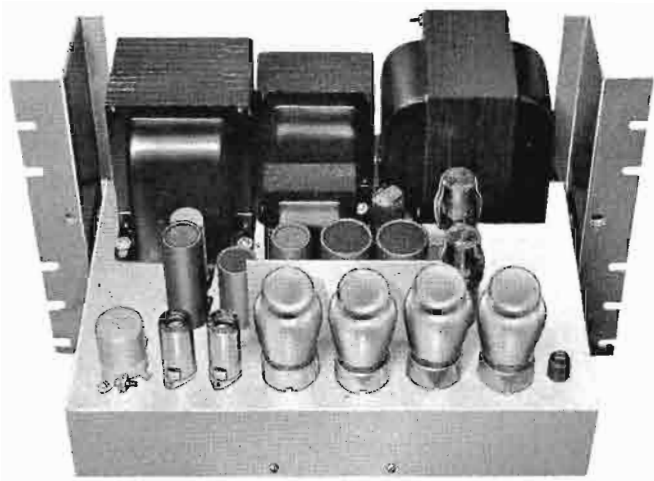

Hinge-mounted amplifier tipped forward for top-chassis inspection.

Specifications

Power Required:

Operating105/115/125 Volts, 60 Hz, 440 Watts
 Idling168 Watts

Power Output and Distortion:

Frequency Hz	Output at 5% Distortion	Distortion at 175 Watts (Rated Output)
40*	180 Watts	4.8%
100	190 Watts	3.7%
400	200 Watts	2.8%
1000*	200 Watts	2.0%
5000	200 Watts	2.7%
10,000*	190 Watts	3.6%

* Measurements not required by EIA standards
 Source Conditions 600 Ohms, with 0.23 Volt input
 Load Conditions 114.3 Ohm tap; 114.3 Ohm load

Power Input:
 No Output168 Watts
 175-Watts Output240 Watts
 Maximum Power Output240 Watts
 Peak Power Output412 Watts
 Gain at 1000 Hz69.0 or 79.0 dB measured from a 600 Ohm source to 114.3 Ohm load at 1000 Hz
 Frequency Response...20 to 20,000 Hz (refer to response curve)
 Feedback16 dB at 1000 Hz
 Noise Level:
 With reference to 1.0 mW-49.0 dBm
 Signal-to-Noise Ratio95 dB
 Input Impedance600 Ohms
 Input Voltage ...0.23 at 1000 Hz for full output with input pad
 0.07 at 1000 Hz for full output without pad
 Output Impedances3.57, 7.15, 28.6, 114.3 Ohms
 Output Voltage at 175 Watts25, 35.3, 70.7, 141 Volts
 Output Voltage Regulation1.8 dB—no load to full load
 Number of Stages3
 Tube Complement:
 1 RCA Type 12AY7, 1 RCA Type 6SN7GT, 2 RCA Type OD3,
 1 RCA Type 6L6GC, 4 Type 6550, 6 Diodes—750 MA—750 PIV,
 Selenium Rectifier—75 MA, 130 Volts
 Fuses:
 5 AmperesType 3AG, Slo-Blow
 Physical DimensionsWidth 15 $\frac{3}{8}$ " (39.7 cm) with rack mounting brackets extending to 19" (48.26 cm), Depth 8 $\frac{3}{4}$ " (21 cm), height 12" (30.48 cm) with front panel requiring 14" (35.56 cm) rack space
 Weight (unpacked)68 lbs. (31.1 kg.)
 FinishChassis finished light umber gray
 ConnectionsTwo screw type, barrier terminal boards

SPECIAL FEATURES:

- Power available for external loads:
 0.6 Amperes @ 6.3 Volts AC
 10 mA @ 250 Volts DC
 - Designed for 24 hour per day operation
 - VU meter to permit metering the tubes
- Checked as per EIA standards

Accessories

Relay (24 Volt DC)MI-38154-1
 Relay (117 Volt AC)MI-38153-1
 Panel for Rack or CabinetMI-9789-2

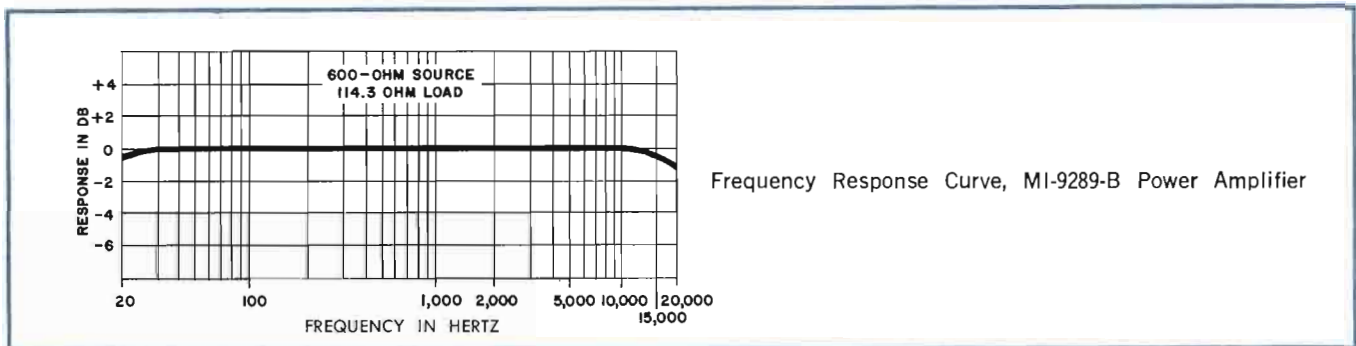

Frequency Response Curve, MI-9289-B Power Amplifier

Ordering Information

200-Watt Power Amplifier
 (including one set of tubes, in place)MI-9289-B



- Regulated DC output voltage
- Exceptionally low hum level
- Supplies power for 22 BA-71 Preamplifiers or 3 BA-73 Program Amplifiers
- 24 Volt relay supply and 6 Volt AC meter lamp supply provided

Console Power Supply, Type BX-71A

Description

The Type BX-71A Console Power Supply delivers a well regulated DC voltage for operation of the BA-70 Series preamplifiers and program amplifiers. As many as 22 BA-71's or 3 BA-73's or any combination of the amplifiers with total current requirement up to 1000 mA can be operated simultaneously by one BX-71. In addition, an unregulated 24 Volt supply can power various relays, such as "On-Air" light relays, etc. A 6 Volt AC meter light supply is also provided. Two outputs for the regulated -30 Volts DC are provided; one for preamplifiers, the other for program amplifiers, to achieve maximum decoupling.

The power supply is designed for use in plug-in type consolettes or it may be used in custom applications when plugged into an accessory Guide Assembly, MI-11759-4. One or two guide assemblies with mating receptacles may be attached to a Type BR-22 Shelf.

The power supply can be operated on any 115/230 Volt, 50/60 hertz AC line. Fuses, a DC voltage control, and two pin jacks for checking

the -30 Volt supply are located on the front panel.

The 30 Volt power supply consists of a full-wave bridge rectifier, capacitor-input filter, and a five-transistor regulator. Three zener

diodes supply a reference voltage which is compared with the output voltage. The output voltage is adjustable to maintain -30 Volts under varying loads up to 1,000 mA capacity.

Specifications

Power Requirements100 to 130, or 200 to 260 Volts, AC, 50/60 Hz, with taps at 105, 115, 125, 210, 230, and 250 Volts
Power Output-30 Volts at 1 amp., regulated; 24 Volts at .56 amp., unregulated, 6 Volt AC at 1.5 amp.
Regulation0.35% no load to full load
Ripple0.15 mV max. on 30 Volt supply
Fuse1.5 and 1 Ampere, slo-blow
Transistor & Diode Complement:	
	1-2N270, 2-2N456, 2-2N526, 1-2N1090, 6-1N3253, 2-1N751, 1-1N752
MountingPlug-in for consolettes; as ES-11163 can be mounted in BR-22 and requires 2/5 of shelf space
Dimensions Overall8 7/8" by 7 1/2" by 4 5/8" (22.54 cm, 19.05 cm, 11.75 cm)
Weight14 lbs. (6.35 kg.)
FinishCadmium plate with clear chromate dip

Accessories

Shelf Guide Assembly for BX-71A Power SupplyMI-11759-4
Type BR-22C Shelf (for 2 power supplies)MI-11597-B
Transistor and Diode Kit for BX-71AMI-11786-3

Ordering Information

Type BX-71A Console Power Supply less Guide AssemblyMI-11663-A
Type BX-71A Console Power Supply with Guide AssemblyES-11163



- 24 Volt, 6 Amp. DC output
- Constant DC voltage with variable loads
- Silicon diode rectifiers
- Low ripple voltage
- Self-regulating power transformer

Heavy Duty Regulated Power Supply

Description

The MI-11318-C Heavy Duty Regulated Power Supply provides up to 6 Amperes DC at 24 Volts to inductive, capacitive or resistive loads. This power supply therefore is widely used in audio and video relay switching systems, tally light circuits, and other equipments requiring a constant DC source with varying current loads. High reliability and low cost maintenance makes the RCA MI-11318-C Power Supply an excellent choice. By changing taps it will operate on either 117V, 50 Hz, 117V, 60 Hz, 234V, 50 Hz or 234V, 60 Hz.

Specifications

Input	117/234 V, 50/60 Hz
Output	6 Amperes, 24 Volts DC
Regulation.....	7.5% no load to full load, 2.5% 1/2 load to full load
Ripple Voltage	0.2 Volt RMS maximum
Ambient Temperature.....	65°C max.
Finish	Aluminum epoxy
Dimensions Overall.....	19" wide, 5 1/4" high, 9 3/4" deep (48.26 cm, 13.34 cm, 24.76 cm)
Weight.....	Approx. 25 lbs. (11.3 kg)

Ordering Information

110 Volt, 60 Hz Regulated Power SupplyMI-11318-C



- All solid state
- Very low ripple content
- Complete short circuit protection
- Convection cooling—no blowers
- Universal power standards
- 24 Volt, 4 Amp. DC output

Regulated Power Supply, Type PS-24

Description

The Type PS-24 Power Supply is a compact, efficient source of precisely regulated 24 Volts DC at 4 Amperes. Featuring the reliability of solid state design and dual overload protection, the PS-24 is ideal for relay switching systems, tally lights, solenoids, and for any transistorized audio or video units requiring a stable 24 Volt DC source.

Effective transistor regulating and hum-bucking feedback circuits reduce ripple content to a very low value making the PS-24 particularly suited to audio systems with low noise outputs. DC output terminals are "floating," and may be grounded, if desired, to meet a variety of requirements.

Bridge Rectifier Circuit

A bridge rectifier circuit employs four silicon diodes which feed the output through a high capacity

smoothing filter and the transistor series regulator circuit. Regulator components are mounted on a printed circuit board and comprise a zener reference source and four silicon transistors. Changes in voltage at the output terminals of the power supply due to variations in load or in power line voltage are confined to less than 3 percent. A transistor feedback circuit amplifies a portion of the output signal and feeds it to the regulators so as to oppose AC variations, reducing hum to a very small value.

Overload Protection

Diodes protect the transistors for short term overloads. Thus, direct short circuiting of the output can occur for limited durations without damage to the transistors and without disabling the power source by blowing a fuse in the DC circuits. Long term shorts will blow the DC

fuse. Another fuse in the primary of the power transformer protects the power supply from damage due to internal shorts.

Further hum reduction is effected by a special power transformer that is electrically and magnetically shielded against hum pickup. Primary taps on this transformer permit operating the PS-24 on either domestic or international AC power sources ranging from 105 to 250 Volts, 50/60 Hz.

Chassis Mounted Components

All components of the PS-24 are mounted on a small chassis. Transistors are heat sinked, and space and layout provides for efficient convection cooling eliminating any need for a blower. The unit occupies one-half of the space provided by a 5¼-inch high BR-22C Rack Mounting Shelf.

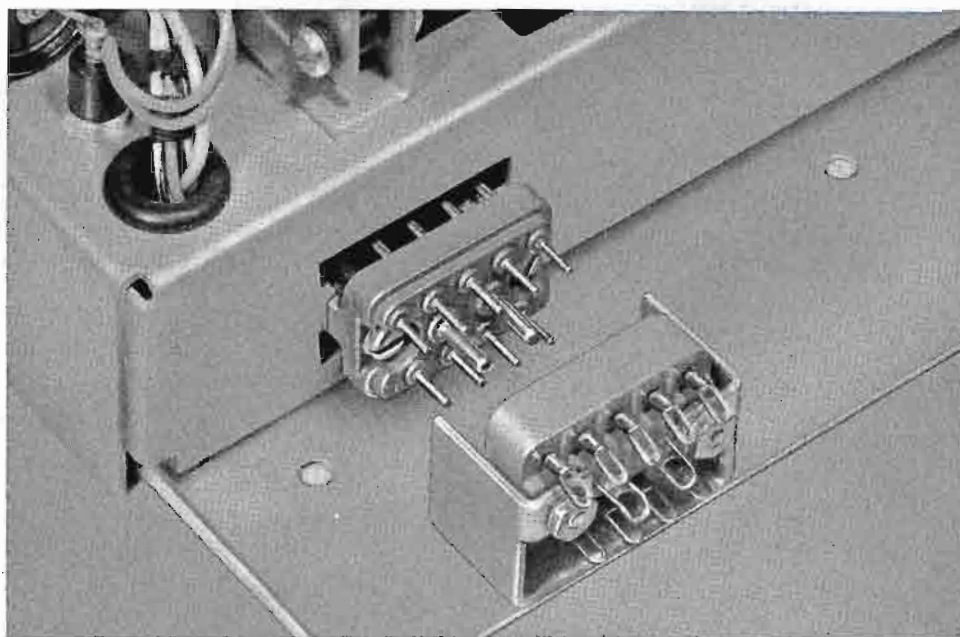

Connections to PS-24 are through mating connector on guide plate furnished with power supply.

Specifications

Output Voltage	24 Volts DC
Output Current	4.0 Amperes, max.
Regulation.....	Output voltage stable within $\pm 3\%$ over specified voltage input range and from no load to full load
Ripple	Less than 15 millivolts at full load, 60 Hz
Power Requirements	115/230 Volts, $\pm 10\%$, 50/60 Hz; 200 Watts
Fuses	2.0 A, Type 3 AG; 0.2 A, Type 8 AG
Ambient Temperatures.....	to 50°C (122°F)

Mechanical

Dimensions.....	8½" wide, 5" high, 13" deep (21.59 cm, 12.7 cm, 33.02 cm)
Weight	18 lbs. (8.2 kg.)
Mounting.....	Occupies one-half of BR-22C Shelf. PS-24 includes guide plate and mating power connector
Finish (front panel).....	Aluminum epoxy

Accessory

Type BR-22C Rack Mounting Shelf (5¼" high).....	MI-11597-A (Mounts two PS-24 Power Supplies)
---	--

Ordering Information

Type PS-24 Regulated Power Supply.....	MI-3537
--	---------

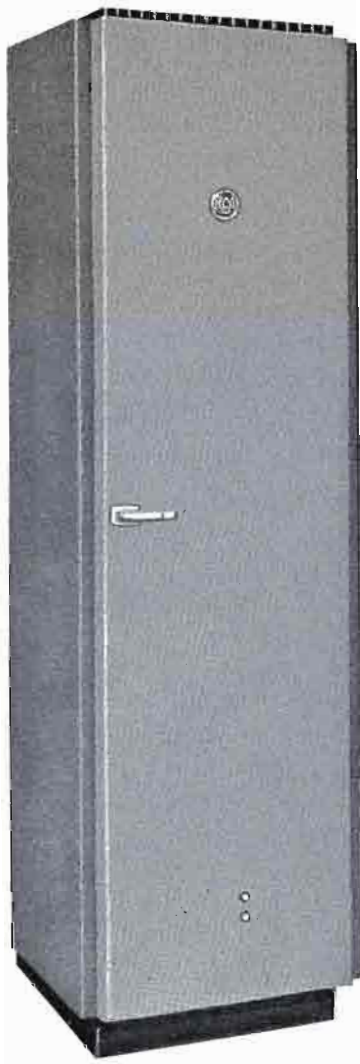

- Cabinets available in 77 or 84-inch height and 18 or 24-inch depth
- Total panel space 70 or 77 inches
- Drilled and tapped for standard 19-inch panels
- Wide variety of rack accessories available
- Accommodates the heaviest equipment encountered in studio use

Cabinet Racks, BR Series

Description

The RCA Type BR-84 and BR-77 Series of Cabinet Racks are designed for use in control rooms and similar installations. The cabinet rack provides mounting space for installing amplifiers, jack panels, switch panels, oscillators, measuring equipment, shelves, or other panel-mounted equipment of standard 19-inch width. The panels of the equipment may be mounted flush with the

frame or behind a hinged front door. A pair of terminal board mounting angles are provided for installing terminal block mounting brackets.

BR-84 Cabinet Racks have a shadow blue and midnight blue vinyl finish with an aluminum epoxy frame. The racks are finished in black enamel and are offered with 18 or 24-inch deep frames.

The front and rear doors are of the universal type, and may be hinged on either the right or left side. Solid or ventilated doors are available. When a front door is not used and panels are to be set flush with the frame, trim strips may be installed along the vertical frame angles to cover the frame angles and panel-mounting screws and give the rack a finished appearance.

SUMMARY OF CABINET RACKS AND COMPONENTS WITH ORDERING INFORMATION

	BR-84 Series			BR-77 Series	
Height:					
Frame	80" (203.2 cm)	80" (203.2 cm)	80" (203.2 cm)	73" (185.4 cm)	73" (185.4 cm)
Frame with base	84" (213.4 cm)	84" (213.4 cm)	84" (213.4 cm)	77" (195.6 cm)	77" (195.6 cm)
Frame with base and top	85" (215.9 cm)	85" (215.9 cm)	85" (215.9 cm)	78" (198.1 cm)	78" (198.1 cm)
Panel Mounting Area:					
Width	19" (48.26 cm)	19" (48.26 cm)	19" (48.26 cm)	19" (48.26 cm)	19" (48.26 cm)
Height	77" (195.6 cm)	77" (195.6 cm)	77" (195.6 cm)	70" (177.8 cm)	70" (177.8 cm)
Depth	18" (45.7 cm)	18" (45.7 cm)	24" (61.55 cm)	18" (45.7 cm)	24" (61.55 cm)
Color	2-Tone Umber Gray Enamel	2-Tone Blue Vinyl Alum. Epoxy Frame	2-Tone Blue Vinyl Alum. Epoxy Frame	2-Tone Blue Vinyl Alum. Epoxy Frame	2-Tone Blue Vinyl Alum. Epoxy Frame
Complete Cabinet Rack—includes basic cabinet rack, side covers, top cover, non-ventilated front door and ventilated rear door	ES-30951-A84	ES-36591-G84	ES-36591-N84	ES-36591-G77	ES-36591-N77
Cabinet Rack—Less front door	ES-30951-B84	ES-36591-H84	ES-36591-P84	ES-36591-H77	ES-36591-P77
Cabinet Rack—Less side panels	ES-30951-C84	ES-36591-J84	ES-36591-R84	ES-36591-J77	ES-36591-R77
Cabinet Rack—Less front door and side panels	ES-30951-D84	ES-36591-K84	ES-36591-S84	ES-36591-K77	ES-46591-S77
Cabinet Rack—Less front door, rear door and side panels	ES-30951-E84	ES-36591-L84	ES-36591-T84	ES-36591-L77	ES-36591-T77
Basic Cabinet Rack—includes base, panel mounting angles, terminal board mounting angles, hardware	MI-30951-F84	MI-36551-M84	MI-36551-U84	MI-36551-M77	MI-36551-U77
Door (ventilated) — includes handle, keeper, hinges, and assoc. hardware	MI-30535-G84	MI-36535-S84	MI-36535-S84	MI-36535-S77	MI-36535-S77
Door (non-ventilated)—includes same items as above	MI-30530-G84	MI-36530-S84	MI-36530-S84	MI-36530-S77	MI-36530-S77
Side Covers	MI-36542-G84	MI-36542-B84	MI-36541-B84	MI-36542-B77	MI-36541-B77
Top Cover (ventilated)	MI-30521-G1	MI-30521-B1	MI-36521-B1	MI-30521-B1	MI-36521-B1
Base (with electrical outlet)	MI-36511-1	MI-36511-1	MI-36511-2	MI-36511-1	MI-36511-2
Electrical shield for top and bottom sections	MI-30546-G28	MI-30546-A28	MI-36546-A28	MI-30546-A21	MI-36546-A21
Electrical shield for mid-section of rack	MI-30546-G21	MI-30546-A21	MI-36546-A21	MI-30546-A28	MI-36546-A28
Trim Strip Single	MI-30566-G84	MI-30566-A84	MI-30566-A84	MI-30566-A77	MI-30566-A77
Trim Strip Double	MI-30568-G84	MI-30568-A84	MI-30568-A84	MI-30568-A77	MI-30568-A77
Terminal Board Mounting Angles	MI-30527-G29	MI-30527-A29	MI-30527-A29	MI-30527-A29	MI-30527-A29
Panel Mounting Angles	MI-30526-G84	MI-30526-A84	MI-30526-A84	MI-30526-A77	MI-30526-A77
Terminal Board Bracket	MI-4570-A2	MI-4570-A2	MI-4570-A2	MI-4570-A2	MI-4570-A2



BR-84D



BR-84E with Accessories

Cabinet top view.

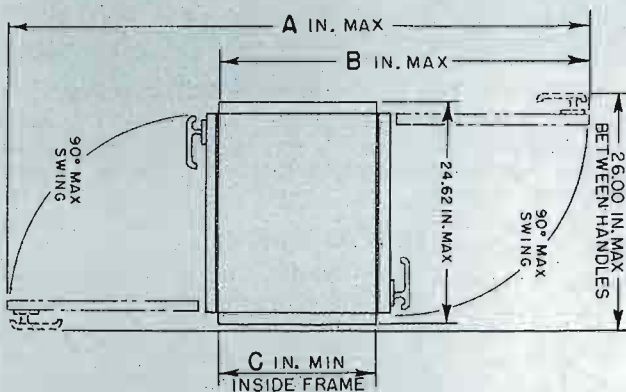

NOM CABINET DEPTH	A	B	C
18.00	64.00	41.00	17.82
24.00	70.00	47.00	23.82

Ordering Information

Finish	Steel	Alum.	Steel
Material	Umber Gray	Umber Gray	Alum. Epoxy
1¾" Blank Panel	MI-4590-A	MI-3090	MI-36547-1
3½" Blank Panel	MI-4591-B	MI-3091	MI-36547-2
5¼" Blank Panel	MI-4592-B	MI-3092	MI-36547-3
7" Blank Panel	MI-4593-A	MI-3093	MI-36547-4
8¾" Blank Panel	MI-4594-B	—	MI-36547-5
10½" Blank Panel	MI-4595-B	—	MI-36547-6
Power Terminal Block			MI-4568
Audio Terminal Block			MI-4569-A4
Terminal Board Bracket (umber gray)			MI-4570-A
Terminal Board Bracket (aluminum epoxy)			MI-4570-A2
Ground Bus Kit			MI-11728
Circuit Breaker Mounting Panel			MI-11792
Circuit Breaker, 2.5 A, 115/230 V			MI-26176-1
Circuit Breaker, 5 A, 115/230 V			MI-26176-2
Circuit Breaker, 10 A, 115/230 V			MI-26176-3
Circuit Breaker, 20 A, 115/230 V			MI-26176-4
Circuit Breaker, 40 A, 115/230 V			MI-26176-5

BR-22B/C Mounting Shelf

The BR-22 mounts in any 19-inch rack and occupies 5 1/4 inches of rack space. RCA plug-in amplifiers fit perfectly in this shelf. They are slipped into the shelf from the front. The receptacles fit in such a manner that a small amount of free movement is permitted in all directions. This eases the alignment of the plugs and receptacles when the amplifiers are pushed into position.

The opening in the front of the shelf is covered by a hinged panel, which may be opened to gain access to the amplifiers and any amplifier controls. The bottom of the shelf has ventilation holes.

The BR-22B/C Mounting Shelf is capable of mounting the following quantities of specific equipments:

10 BA-71A Preamplifiers or 10 BA-31B Preamplifiers

3 BA-73A Program Amplifiers or 3 BA-33B Program Amplifiers + 1 BA-31B Preamplifier

3 BA-74A Monitor Amplifiers or 3 BA-34C Monitor Amplifiers + 1 BA-31B

2 BA-25A AGC Program Amplifiers

5 BA-78A Cue/Intercom Amplifiers

2 BX-71A Power Supplies

3 BA-43 Program Amplifier

2 BA-48 50 Watt Monitor Amp.

5 BA-45 AGC Modules

5 BA-46 Limiter Modules

5 BA-47 Peak Clipper Hops.

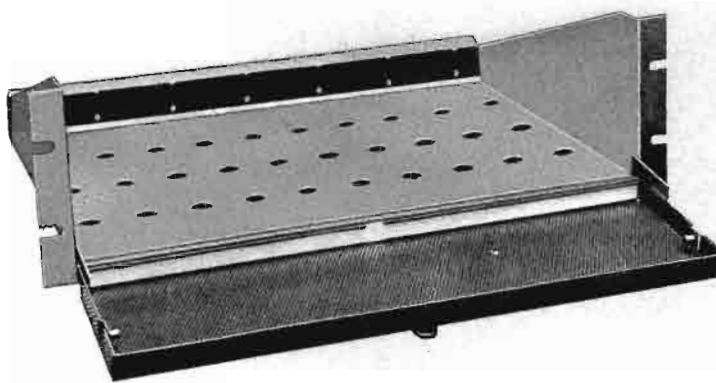

Specifications

Dimensions, Overall:

Width 19" (48.26 cm)
 Height 5-7/32" (13.26 cm)
 Depth 13 3/4" (33.66 cm)

Space for Mounting Equipment:

Width 17 1/8" (43.50 cm)
 Height 4 1/8" (11.89 cm)

Weight, Unpacked 10 lbs. (4.5 kg)

Ordering Information

BR-22B Mounting Shelf, Umber Gray Finish MI-11597-A

BR-22C Mounting Shelf, Aluminum Epoxy MI-11597-B

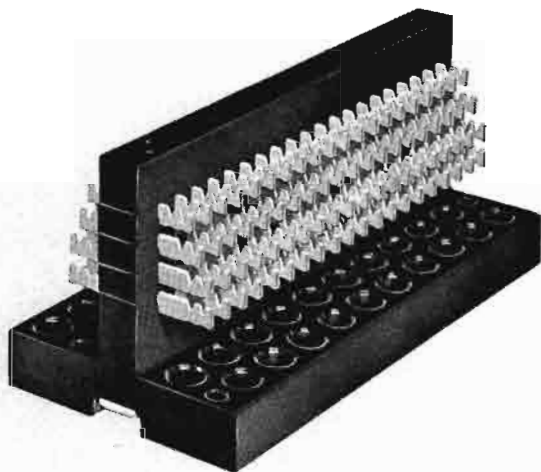

Audio Terminal Block MI-4569-A4.

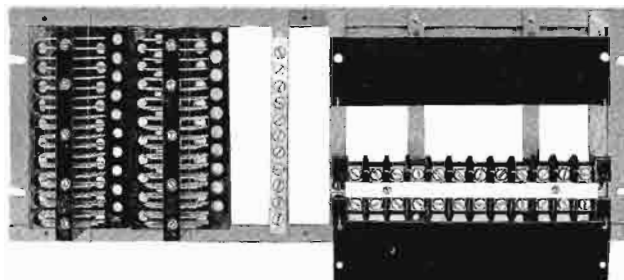

Terminal Board Bracket, MI-4570-A2, on which is assembled two MI-4569-4A Audio Terminal Blocks, one MI-11728 Ground Bus Kit and two MI-4568 Power Terminal Blocks (one shown with cover removed).



Ground Bus Kit, MI-11728.

Rack Accessories

A complete line of 19-inch blank panels is carried in stock for filling spaces on racks and cabinets not occupied by equipment panels. These blanks are also suitable for applications where equalizers, transformers, switches or other items must be panel mounted by the user. The stock of panels includes all standard widths from 1 3/4 inches to 10 1/2 inches. They are 3/16-inch sheet steel finished and notched to match standard racks.

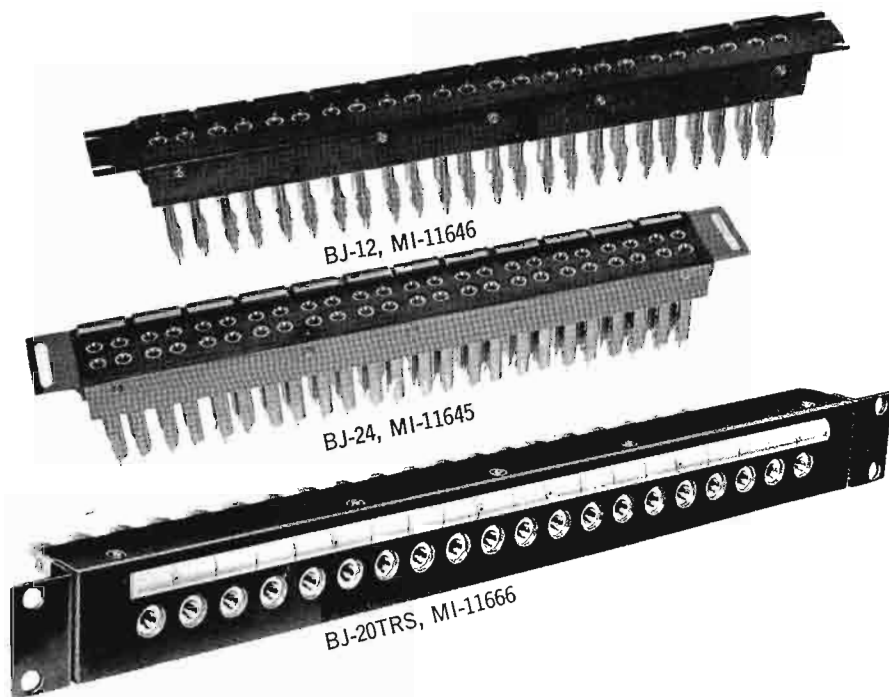

- Offset ground lugs—easy to wire
- Spacing of jack pairs prevents cross-circuit patching
- Bakelite strip reinforced to prevent warping or breakage

Jack Panels, Mats and Cords

Description

Jack Panels, with their associated patch cords, are used with broadcast speech input systems to improve the overall operating flexibility. In addition to providing a convenient termination for program and other wire telephone circuits, closed-circuit jacks may be connected to provide "patch cord" access to the input and output circuits of individual units of the audio system. When connected for this purpose, the regular circuits are continuous through the jacks until a patch cord is inserted to make an external connection. With properly connected jacks, patch cords may be freely used in emergencies or for test purposes to interchange or transfer telephone lines, amplifiers, mixers, microphones, or other equipment items.

The BJ-24 consists of two rows of twelve double jacks mounted on thick black bakelite and furnished with designation card holders. The BJ-12 is similar to the BJ-24 but has only one row of twelve double jacks.

The jack sleeves of the BJ-24 and BJ-12 are chromium plated. Tip-ring-sleeve jack panels are also available as MI-11666.

Jack Mats are available for covering 1 or 2 type BJ-24 Double Jack Strips.

RCA maintains a stock of patch cords for the convenience of broadcasting stations. The cord is shielded and uses two Type PJ-1 Plugs which are interchangeable with the W.E. Type 241-A Plug. A choice of black

or gray colored cord is available in three sizes. A two-foot black tip-ring-sleeve patch cord is also stocked.

Interconnection Cable

The majority of cables required to interconnect the various components of a broadcast audio assembly are of a special type and cannot be readily purchased from the local electrical dealer. In order to avoid unnecessary installation delays, RCA carries in stock the generally used special type cables.

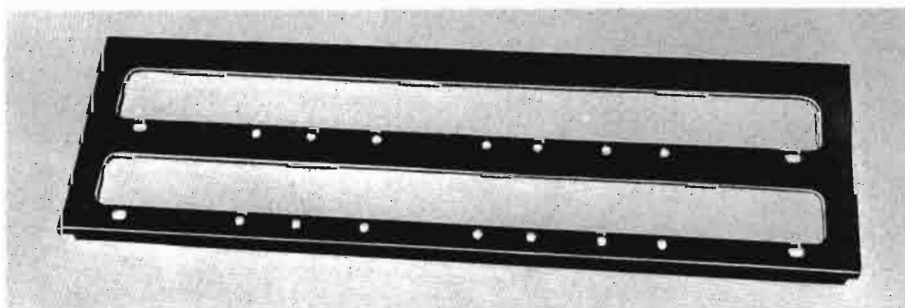

Double BJ-24 Jack Mat, MI-11647-2.

Specifications

Jack Panels	BJ-24	BJ-12	BJ-20TRS
Number of Jacks.....	24 pair	12 pair	20*
Dimensions	2½" x 19"	1¾" x 19"	1¾" x 19"
Weight (unpacked)	5½ lbs.	3 lbs.	3 lbs. (approx.)

Jack Mats

Dimensions (Overall):	
Single BJ-24 Jack Strip Mat.....	17⅞" x 3-5/32"
Double BJ-24 Jack Strip Mats.....	17⅞" x 5-7/32"

Patch Cord

Overall Length..... Available in two, four, or six foot lengths

* BJ-20TRS Jacks spaced ¾" on centers.

SOLID CONDUCTOR CABLE, MI-33

Use.....	General purpose Audio Transmission Line
Type.....	Shielded twisted pair, each conductor solid #20 tinned copper wire, with Vinyl resin insulation covered with lacquered rayon braid.
Shield.....	Tinned copper braid
Overall Diameter.....	Approximately .170"
Color Code.....	Red and black
Rating	300 volts

STRANDED CONDUCTOR CABLE, MI-34

Use.....	Recommended for audio circuits where extra flexibility is required
Type.....	Shielded; twisted pair, stranded, composed of 7—.010 tinned copper conductors equivalent to #22 AWG
Insulation.....	Vinyl resin insulated with lacquered rayon braid
Shield.....	Tinned copper braid
Overall Diameter.....	Approximately .166"
Color Code.....	Red and black
Rating	300 volts

STRANDED CONDUCTOR CABLE, MI-35

Use.....	Especially recommended for 110 volt supply and filament circuits
Type.....	Shielded; twisted pair, stranded, composed of 16—.010 tinned copper conductors equivalent to #18 AWG
Insulation.....	Vinyl resin insulated with lacquered rayon braid
Shield.....	Tinned copper braid

Overall Diameter.....	Approximately .236"
Color Code.....	Red and black
Rating	300 volts

SOLID CONDUCTOR CABLE, MI-13342-1

Use.....	General purpose Audio Transmission Line
Type.....	Shielded twisted pair, tinned copper drain wire each conductor #22 tinned copper wire, cabled, with black vinyl jacket
Insulation	Vinyl
Shield.....	Tinned copper braid
Overall Diameter.....	Approx. .200"
Color Code.....	Red and black
Rating	200 volts

STRANDED CONDUCTOR CABLE, MI-13342-2

Use.....	General purpose Audio Transmission Line
Type.....	Shielded pair, each conductor #22 AWG (16 x 34) tinned copper wire, cabled, tinned copper drain wire, with black vinyl jacket
Insulation	Vinyl insulated
Shield.....	Tinned copper braid
Overall Diameter.....	Approx. .200"
Color Code.....	Red and black
Rating	200 volts

STRANDED CONDUCTOR CABLE, MI-13342-4

Use.....	Miniature Broadcast Audio Cable
Type.....	Tinned copper, polypropylene insulated #22 AWG (7 x 30) conductors, cabled. Stranded tinned copper ground drain wire, combination foil, aluminum, mylar, shield paper wrap
Insulation Thickness008"
Jacket Thickness020"
Outside Diameter (O.D.).....	.135"
Color Coding.....	Black and red
Percent Shield Coverage.....	100%
Working Voltage.....	200 volts

CABLE LACING CORD, MI-11719

Lacing cord is available for general cable lacing and dressing uses. Cord is of strong material such as linen or nylon and thoroughly impregnated with a wax or paraffin. Supplied on spools.

Ordering Information

Type BJ-24 (RCA Standard) Jack Panel.....	MI-11645
Type BJ-12 (RCA Standard) Jack Panel.....	MI-11646
Single BJ-24 Jack Mat (for 1 BJ-24)	MI-11647-A1
Double BJ-24 Jack Mat (for 2 BJ-24)	MI-11647-A2
Type BJ-20TRS (Tip-Ring-Sleeve) Jack Panel.....	MI-11666
	Black Gray
Two-foot Patch Cord.....	MI-4652-B 4652-C2
Four-foot Patch Cord.....	MI-4652-4B 4652-C4
Six-foot Patch Cord.....	MI-4652-6B 4652-C6
Two-foot Tip-Ring-Sleeve Patch Cord.....	MI-4652-D2
*Solid Conductor Cable, #20 AWG.....	MI-33

*Stranded Conductor Cable, #22 AWG.....	MI-34
*Stranded Conductor Cable, #18 AWG.....	MI-35
*Solid Conductor Cable, #22 AWG.....	MI-13342-1
*Stranded Conductor Cable, #22 AWG.....	MI-13342-2
*Stranded Conductor Cable, #22 AWG.....	MI-13342-4
Cable Lacing Cord:	
Black Linen, No. 6 med., 4 ply, 580 yds/lb., 30 lb. strength.....	MI-11719-A
Natural Nylon, .085" x .016", 500 yds, 50 lb. strength.....	MI-11719-C
Natural Nylon, .090" x .0125", 500 yds, 50 lb. strength.....	MI-11719-D

* Order in 100 ft. multiples only.

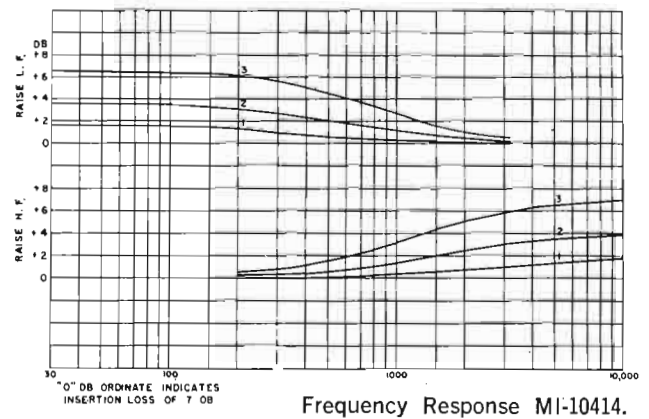
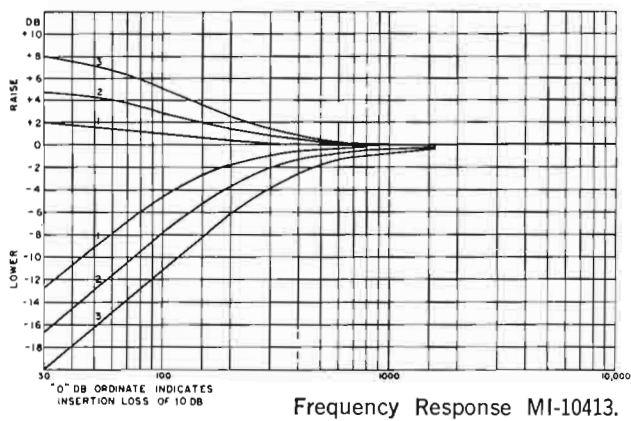

VU Meter Panel, Type BI-5B

The BI-5B Meter Panel employs the industry standardized VU Meter which embodies closely controlled electrical and dynamic characteristics combined with deliberate pointer action, moderate pointer speed, and small pointer overswing. It is intended as an audio level indicator for broadcasting, recording or wherever it is desired to read the level of one or more audio circuits with a rack mounting type of instrument.

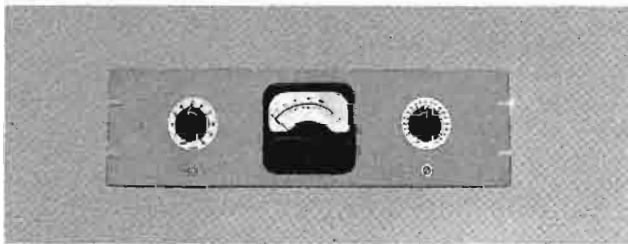

Specifications

Input Impedance (except on 1 mW step)	7500 Ohms
Attenuator Steps	1 mW position, +4 to +40 dB in 2 dB steps and off position
No. of lines that may be measured	1 to 10 inclusive
Mounting	Standard Cabinet Rack
Dimensions:	
Height	5¼" (13.39 cm)
Width	19" (48.26 cm)
Depth	3¾" (9.52 cm)
Finish	Light umber gray
Weight (unpacked)	7½ lbs. (3 kg.)

Ordering Information

BI-5B VU Meter PanelMI-11265-G

BE-21C Sound Effects Filter

The BE-21C furnishes a desirable means for producing a variety of special or unusual sound effects through control of the audio bandwidth of the transmitted program. It is especially useful in the production of dramatic plays for making programs sound "bassy" or "tinny" or for simulating the sound of telephone conversations, short wave radio communications or midget radios.

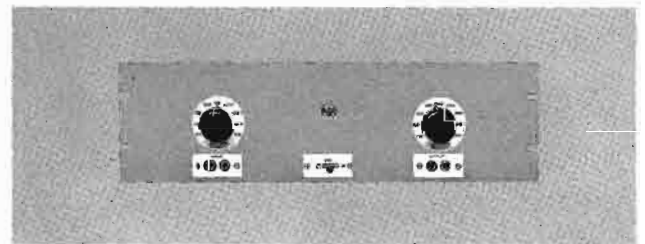

Specifications

Source Impedance (unbalanced)	600 Ohms
Load Impedance	600 Ohms
Input Level	-60 to +18 dBm
Output Level (maximum)	+18 dBm
Frequency Response	Variable
Insertion Loss	1 dB or less at frequencies remote from cut-off
Dimensions, overall	5¼" high, 19" wide, 5" deep (13.39 cm, 48.26 cm, 12.70 cm)
Weight (unpacked)	15 lbs. (6.8 kg.)
Finish	Light umber gray

Ordering Information

BE-21C Variable Sound Effects FilterMI-11723-A

VU Meter and Attenuators

A VU meter and attenuators are available as amplifier accessory equipment for indicating audio volume levels. Equipment is pictured at the right and may be ordered as follows:

Ordering Information

Simpson VU Meter	Stock #53064
Multiple Pad for calibrating the VU Meter to the desired reference level	Stock #19328
Zero Adjustment Pad	Stock #19327
The complete kit is pictured at the right.	

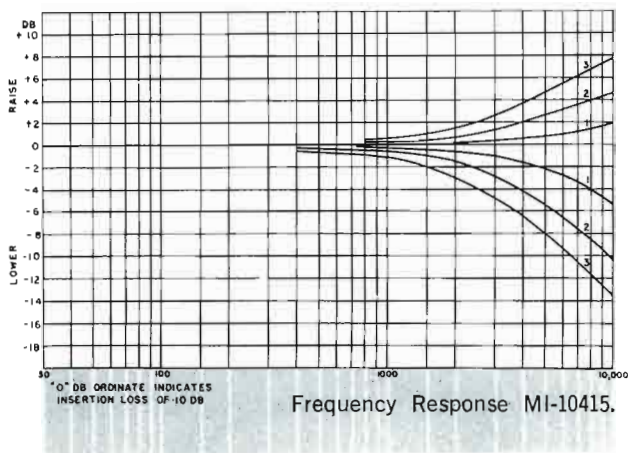

Pads and Networks

RCA offers a comprehensive selection of attenuator pads, bridging pads and dividing networks. The pads and networks are well constructed and insulated with precision wound resistors, assuring no internal reflection. The terminals are accessible and securely mounted with the connections stenciled in an appropriate place. The fixed balanced "H" type is available in four types, introducing losses of 6 dB, 10 dB, 20 dB or 40 dB. The dividing networks are available as tabulated specifications.



Specifications

Fixed Pads:

Balanced "H" Type, Input/Output impedance, 600 Ohms, insertion loss of:	
6 dB Pad	MI-4171-29
10 dB Pad	MI-4171-30
20 dB Pad	MI-4171-32
40 dB Pad	MI-4171-39

Dividing Networks:

Balanced 2-way, 600 Ohms, 6 dB insertion loss	MI-11704
Balanced 3-way, 600 Ohms, 9-5 dB insertion loss	MI-11704-A
Balanced 4-way, 600 Ohms, 12 dB insertion loss	MI-11704-B
Balanced 6-way, 600 Ohms, 10 dB insertion loss	MI-11704-D

Isolation Pad (Bridge Circuit):
Balanced, input impedance 600 Ohms to two 600 Ohm lines, isolation between lines about 45 dB, insertion loss 10 dBMI-11705

Line Equalizer, Type BE-2A

The RCA Type BE-2A Line Equalizer is designed to equalize the non-linear frequency characteristics of a non-loaded telephone line. It is suitable for 15,000 Hz FM circuits. The small, low-cost unit is recommended for use on lines which are permanently installed and continuously used such as studio-to-transmitter lines and remote lines.

The BE-2A Line Equalizer employs parallel resonant circuits and consists of a capacitor, a reactor, a series of resistors, and a rotary selector switch for selecting different resistance values. The resonant frequency of this circuit is just above the operating frequencies of associated equipment, so that the frequency characteristics of the equalizer below resonance are of interest. Examination of these characteristics (shown in the chart) reveals that the more resistance in series with inductor, the less the low-frequency attenuation of the equalizer.

Specifications

Source Impedance	150 or 600 Ohms
Equalization Frequency Limit	15,000 Hz
Insertion Loss (minimum at 1000 cycles)	7 dB
Equalization Range (see attenuation characteristic curve)	1 to 40 dB
Mounting	Single hole
Dimensions	2 7/8" wide, 2 1/2" high, 3 3/8" deep (7.30 cm, 6.35 cm, 8.57 cm)
Weight	1 1/4 lbs. (.57 kg.)
Finish	Cadmium plate

Accessories

Line Transformer	MI-11713
------------------	----------

Ordering Information

BE-2A Line Equalizer	MI-11752
----------------------	----------

Frequency characteristic of Type BE-2A Line Equalizer.

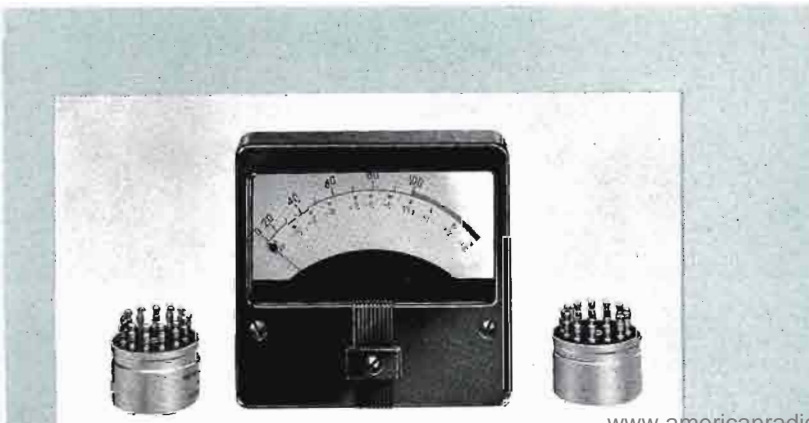
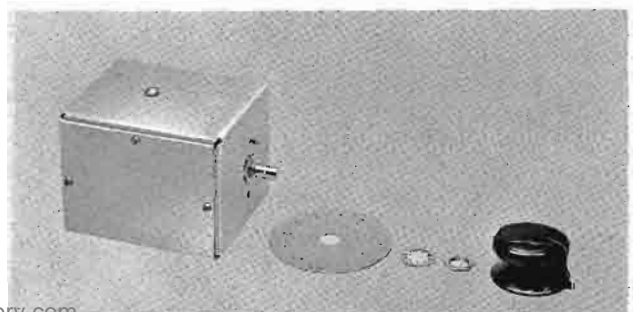
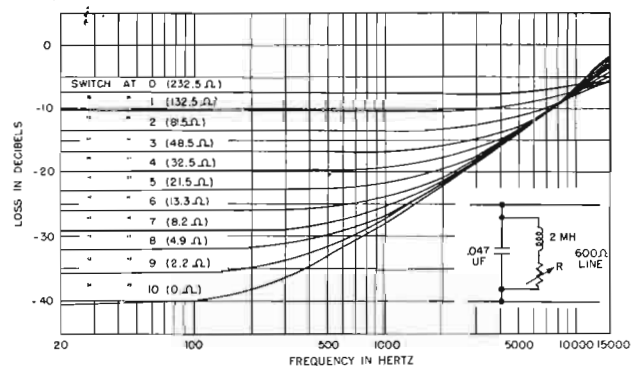

Line and Bridging Transformers and Controls

Specifications

Transformers

Frequency Response $\frac{1}{2}$ dB, 20 to 20,000 Hz

Primary Impedances

MI-11791-A/11712 Bridging Transformer20,000 Ohms

MI-11713 Line Transformer150/600 Ohms

Secondary Impedances

MI-11791-A/11712 Bridging Transformer150/600 Ohms

MI-11713 Line Transformer150/600 Ohms

Distortion Loss:

MI-11791-ANot greater than 0.5% at 30 Hz for level of 32 Volts across a 600 Ohm source

MI-11712Not greater than 0.5% at 30 Hz for level of 45 Volts across a 600 Ohm source

MI-11713Not greater than 0.8% at 30 Hz for level of 7.5 Volts across a 600 Ohm source

Insertion Loss:

MI-11791-A/11712Not more than 19 dB at 1000 Hz

MI-11713600 Ohm source to 600 Ohm load: 1 dB max. at 1000 Hz; 150 Ohm source to 150 Ohm load: 2 dB max. at 1000 Hz

Overall Dimensions:

MI-11791-A $2\frac{1}{4}$ " x $1-23/32$ " x $1-7/32$ "

MI-11712/117134" x $2-11/32$ " x $1\frac{7}{8}$ "

Weight:

MI-11791-A $1\frac{1}{2}$ lbs.

MI-11712/117132 lbs. 14 ozs.

Volume Controls

Input Impedances20,000/10,000 Ohms

Output Impedances600/150 Ohms

Insertion Loss $32/24$ dB

Maximum Input Level+40 dBm

Overall Dimensions:

Length:

MI-11278-E $2\frac{1}{16}$ "

MI-11278-F $2\frac{3}{16}$ "

Diameter $1\frac{3}{8}$ "

Weight $4\frac{1}{2}$ ozs.



MI-11712/3

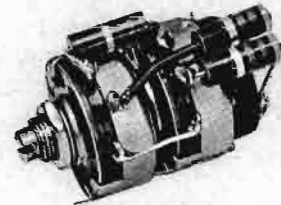

MI-11278-F

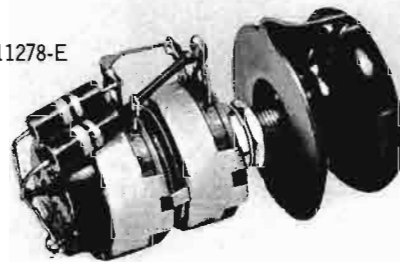

MI-11278-E

Ordering Information

Bridging Transformer (Bracket Mounting)	MI-11791-A
Bridging Transformer (Base Mounting)	MI-11712
Line Transformer	MI-11713
Volume Control (Panel Mounting, with knob)	MI-11278-E
Volume Control (Chassis Mounting, with screw-driver adjustment)	MI-11278-F

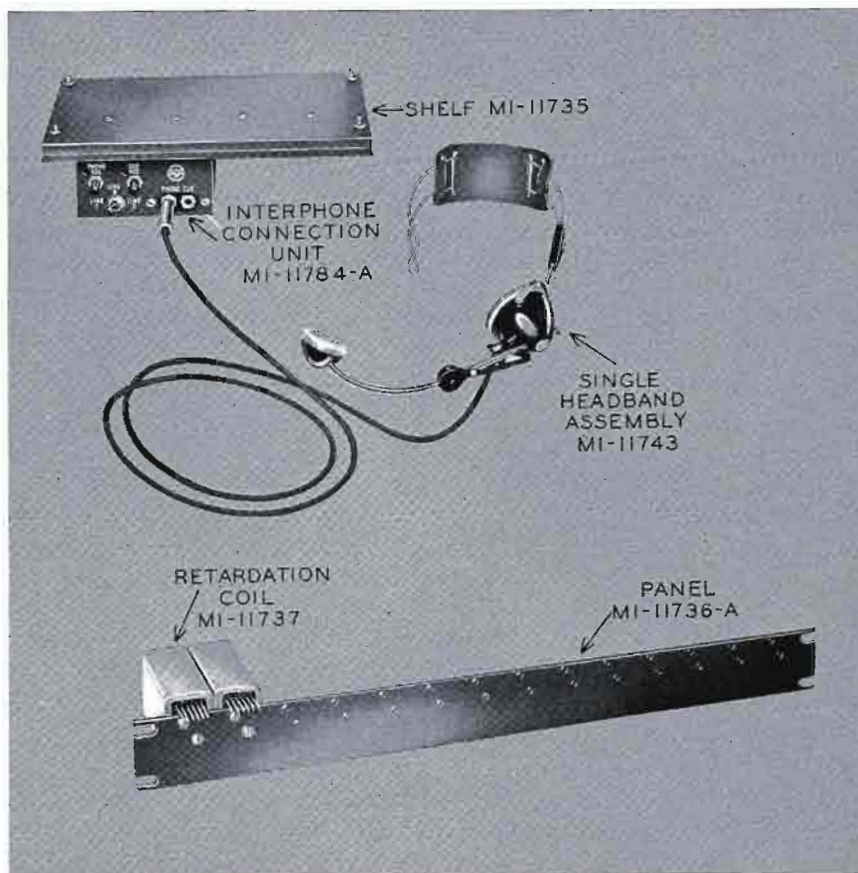

- Production intercom with studio personnel or remote line as desired
- Can mount to console, desk, or wall
- Compatible with RCA TV equipment
- Transistor amplifier or induction coil type interconnection units available
- Regulated power supply

Interphone Equipment

Description

RCA Interphone Equipment is designed to provide convenient line switching and headset connection facilities for a TV camera and studio communication system.

Heart of the RCA Interphone System is the Interphone Connection Unit. Two types of connection units are available. The MI-11784-A Transistor Interconnection Unit must be used with RCA TK-60 and other late model Cameras having transistorized intercommunication systems built into the camera. The MI-11734 Intercom Interconnection unit is designed for use with early RCA studio and field type cameras. The two interconnection units can not be intermixed in a system.

The MI-11784-A unit includes a single stage transistor amplifier, with

bridge rectifier and sidetone compensation network with level control to adjust volume. Each person on the talking bus can adjust the volume to suit his individual requirement. On the front is a three-way switch for selection of three intercom lines, and the separate volume controls for "phone" and "cue" adjustment. The box also contains two jacks to accommodate single or double headsets. A 9-pin and a 12-pin cable connector plug on the rear are used for external connection. The entire unit is housed in a box $4\frac{5}{8}$ inches wide, $2\frac{1}{2}$ inches high and $6\frac{3}{4}$ inches deep overall.

Operating power for the MI-11784-A interphone unit is derived from the common-battery interphone circuit to which the interphone unit

is connected. A bridge-rectifier is interposed in the line to the amplifier to maintain correct polarity at the amplifier regardless of the polarity of the interphone battery voltage. The sidetone compensation bridge is designed to hold the sidetone level to within 2 db of the received level for any number of connected stations up to 32.

The Transistor Interphone Connection Unit, MI-11784-A can replace the MI-11734 unit where it is designed to modernize the system since the unit physically replaces the MI-11734 Connection Unit and will operate with virtually all commercially available TV headsets using carbon microphones. The substitution can be made only if the camera is modified by substituting an MI-



Double Headband Assembly, MI-11744



Transistor Interphone Unit, MI-11784-A

11757 Transistor Amplifier for the induction coil in the interphone circuit. Other circuit changes as outlined in the instruction book are also required.

The Interphone Connection Unit, MI-11734, consists of a simple circuit having an induction coil and capacitor to provide an anti-sidetone feature. The circuit is housed in a compact box having two phone jacks for use either with a single or double headset as required, and a two-position toggle switch for selecting a local circuit or a remote line. A cable plug is mounted in the rear. It is designed to work in early intercom systems employing induction coils throughout.

All other components of the Interphone System are designed for operation with either Interconnection Unit.

The Retardation Coil, MI-11737, permits simultaneous use of four carbon microphones such as one interphone connection unit and three camera headsets on a common battery or power supply. The coil permits a d-c power voltage to be imposed upon the two-wire telephone talking line. The MI-11737 is an audio frequency choke which isolates the power supply from the telephone line at voice frequencies.

The MI-11736-A Mounting Panel is recommended for mounting retardation coils. The panels have

standard mounting dimensions for use in the RCA BR-84 Series Racks.

The accessory, MI-11735 Shelf, is available for mounting the interphone connection units under the countertops of console housings on which switching units or camera controls are housed. The plate will accommodate one or two Interphone Connection Units.

Either a single or double headset identified as Single Headband Assembly, MI-11743 and Double Headband Assembly, MI-11744 can be used with RCA Interphone Equipment. One earphone unit of the double headband assembly is used for "cue" reception. Either type can be used in the same system.

Front and rear view of Induction Coil Interphone Unit, MI-11734

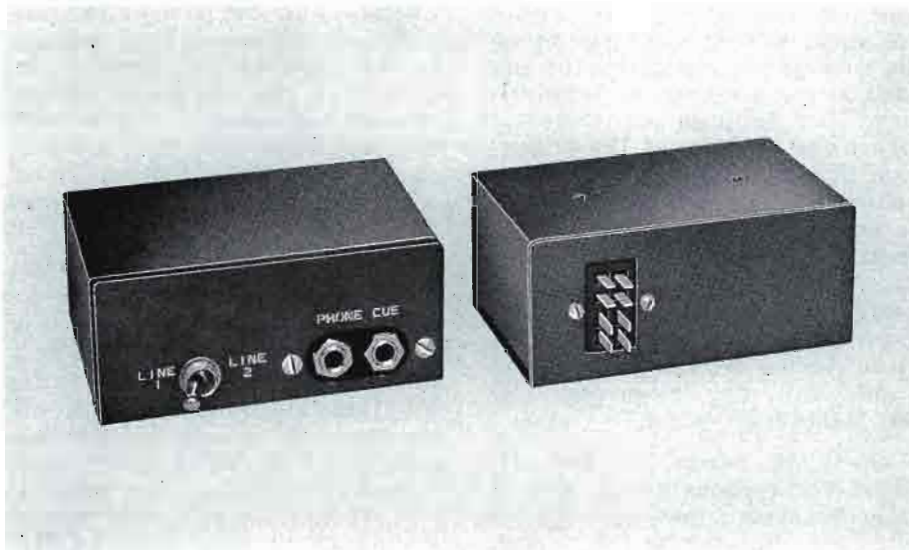

Transistor Amplifier, MI-11757

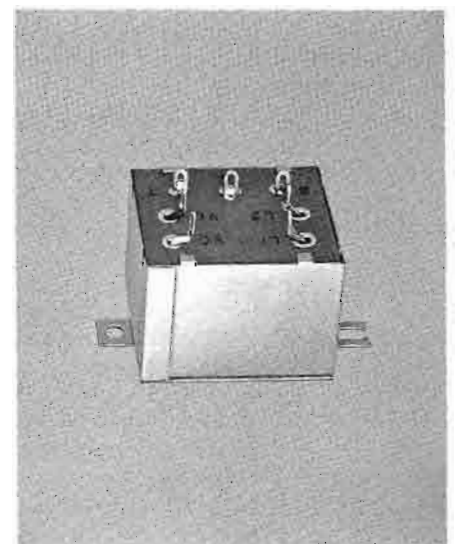

SCHEMATIC DIAGRAM FOR TRANSISTOR INTERPHONE SYSTEM

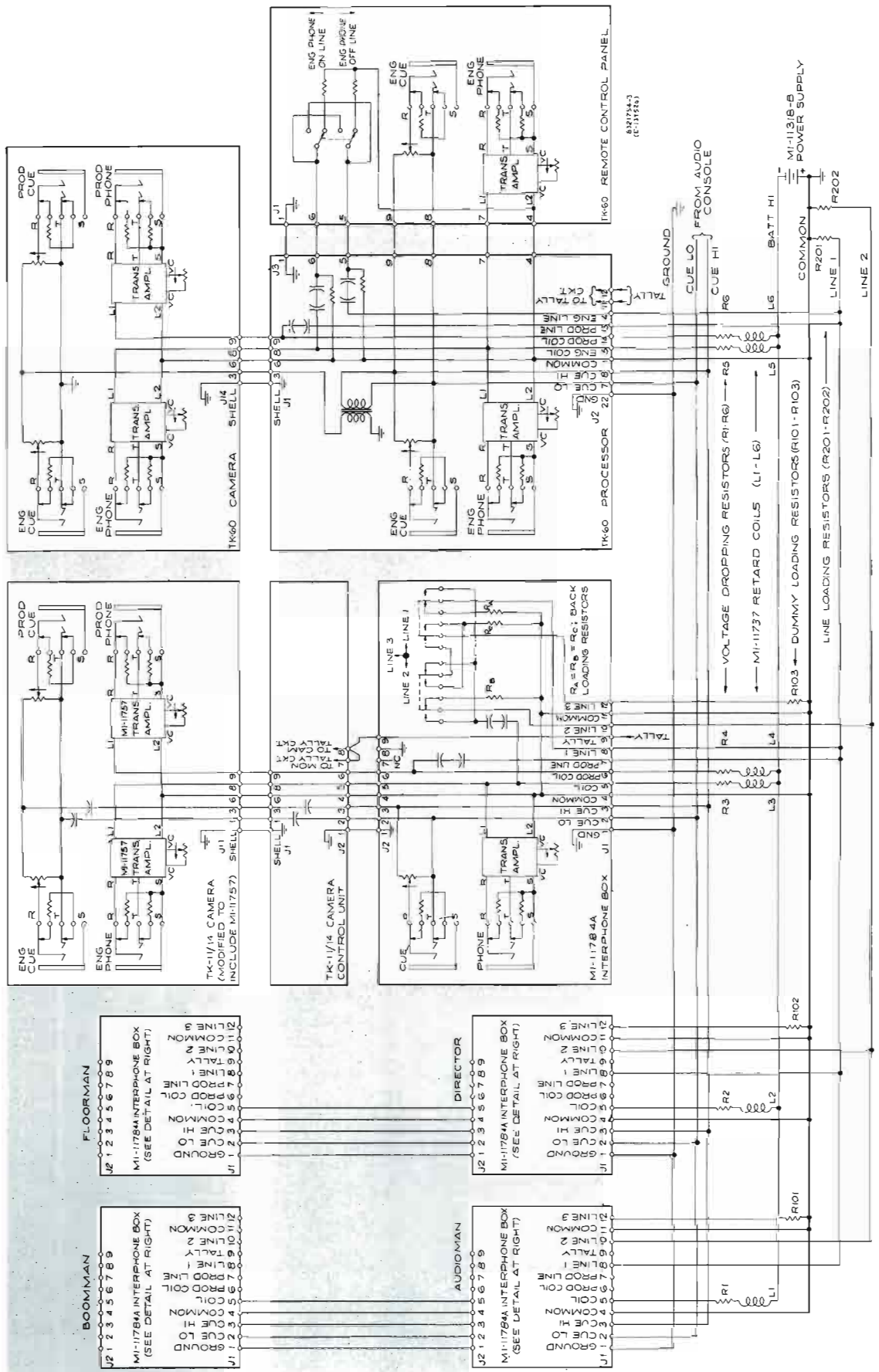

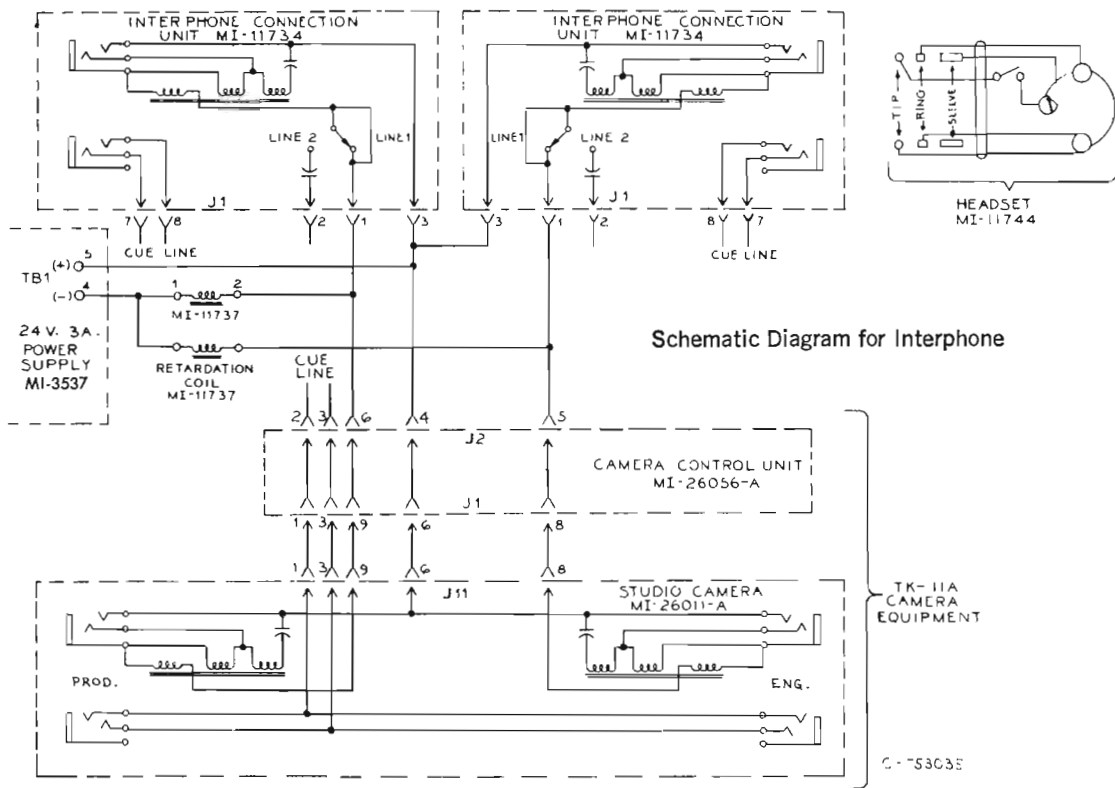

Schematic Diagram for Interphone

Specifications

Single or Double Headset

DC Resistance:
 Microphone Switch On70 Ohms approx.
 Microphone Switch Off.....Infinite
 Inductance at 1000 Hz:
 Microphone Switch On.....70 millihenries approx.
 Microphone Switch Off.....245 millihenries
 Weight:
 Single Headband Assembly.....6 ozs. (less cord)
 Double Headband Assembly.....9 ozs. (less cord)

Transistor Interphone Connection Unit, MI-11784-A

Impedance120 Ohms
 DC Voltage8.5 Volts (nominal)
 DC Current95 mA (approx.)
 Dimensions Overall.....4 $\frac{5}{8}$ " wide, 2 $\frac{1}{2}$ " high, 6 $\frac{3}{4}$ " deep
 Weight3 lbs.

Interphone Connection Unit, MI-11734

Dimensions Overall.....4 $\frac{5}{8}$ " wide, 2 $\frac{3}{8}$ " high, 4 $\frac{1}{4}$ " deep
 Weight1 lb., 11 ozs.

Transistor Amplifier, MI-11757

Dimensions Overall2 $\frac{1}{2}$ " wide, 1 $\frac{1}{2}$ " high, 1 $\frac{1}{2}$ " deep
 (6.35 cm, 3.81 cm, 3.81 cm)
 Weight6 oz. (170 grs.)

Retardation Coil, MI-11737

DC Resistance.....165 ohms
 Inductance3.4 millihenries
 Maximum Recommended Load Current125 mA DC
 Dimensions Overall.....1 $\frac{3}{8}$ " wide, 1-45/64" high, 4 $\frac{5}{8}$ " deep
 Weight16 ozs.

Power Supply, MI-3537

Input115/230 Volts \pm 10%, 50/60 Hz
 OutputRegulated 24 Volts, 4 Amps. DC
 Dimensions Overall.....8 $\frac{3}{8}$ " wide, 4 $\frac{5}{8}$ " high, 11 $\frac{3}{8}$ " deep
 Weight25 lbs.

Power Supply

Input:
 MI-11318-C .100-130 Volts, AC, 60 Hz, single phase, 144 Watts
 MI-591318 .200-260 Volts, AC, 50 Hz, single phase, 144 Watts
 OutputRegulated 24 Volts, 6 Amps. DC
 Dimensions Overall.....19" wide, 5 $\frac{1}{4}$ " high, 9 $\frac{3}{4}$ " deep
 Weight25 lbs.

Mounting Shelf

Capacity.....Mounts one or two Interphone Connection Units
 Dimensions.....11" long, 6 $\frac{3}{8}$ " wide
 Weight.....2 lbs. (approx.)

Retardation Coil Panel

Capacity.....Mounts up to 14 retardation coils
 Dimensions.....19" wide, 1 $\frac{3}{4}$ " high
 Weight18 ozs.

Ordering Information

Transistor Interphone Connection.....MI-11784-A
 Interphone Connection Unit.....MI-11734
 Retardation CoilMI-11737
 Shelf for Mounting MI-11734.....MI-11735
 Panel (accommodating 14 Retardation Coils).....MI-11736-A
 Single Headband Assembly.....MI-11743

Double Headband Assembly.....MI-11744
 Regulated Power Supply
 (24 Volts, DC, 4 Amps) 110 Volts, ACMI-3537
 Regulated Power Supply
 (24 Volts, DC, 6 Amps) 110 Volts, ACMI-11318-C
 Regulated Power Supply
 24 Volts, DC, 6 Amps) 220 Volts, ACMI-591318
 Transistor Interphone Amplifier
 (Replacement for Induction Coil).....MI-11757

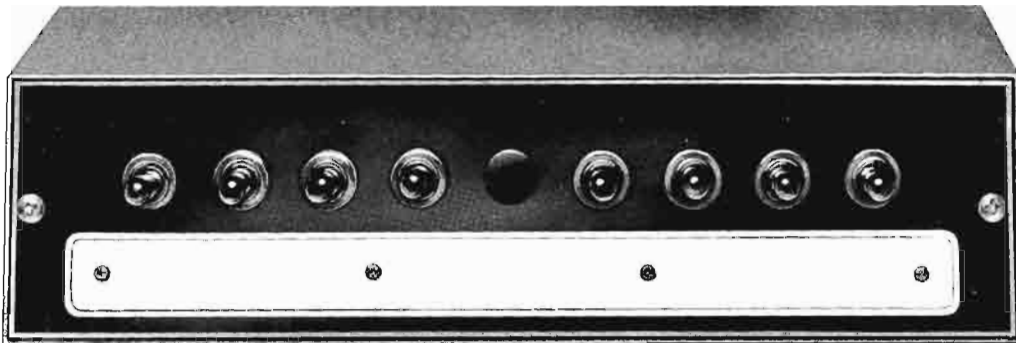

- Facilities for 9 switches
- Easily mounted at any convenient location
- Long-life palladium switch contacts
- Write-in designation strip

Switch Panel and Housing

Description

The Switch Panel and Housing Assembly provide an ideal and inexpensive means of augmenting any present switching installation. The compact Switch Housing Assembly, MI-11756, and removable Switch Panel, MI-11754, are designed to house up to nine manually operated Switches, MI-11755-2. The panel is styled to match RCA audio and TV studio equipment.

The Panel and Housing Assembly accommodates pilot lights and switches for special applications as well as the MI-11752-2 switches. The switching assembly may be used to provide switching of audio outputs and inputs for tape recorders, intercom equipment, remote lines, etc. It is designed for desk or shelf mounting, but may be mounted in a 13½-inch TV console housing by means of a Basic Mounting Panel, MI-26252 or in a 22-inch console

or standard rack by means of Rack Adaptor, MI-26254.

Simple and inexpensive manually-operated switching equipment is made available by RCA in the form of unassembled Switch Panel, MI-11754 to which may be assembled up to nine MI-11755-2 lever-type, low-capacity leaf switches, lights, or other type switches which mount in single 15/32-inch hole. The equipment is designed to fit in Switch Housing Assembly, MI-11756.

The switch panel is made of reverse etched aluminum with nine 15/32-inch holes for mounting. Dummy plugs are supplied for all mounting holes left blank. An erasable write-in designation strip is provided for proper identification of the switching facilities. The housing is of sturdy steel construction with removable back panel for

accessibility. The case has rubber feet which will not scar desk, table or shelf mounting area. The panel mounts in the case so as to provide a 15 degree sloping front for easier identification of the switching functions.

The MI-11755-2 switches are lever type low capacity leaf with 3 Form C contacts (single pole, double throw) on each side. The center position is neutral with one locking and one non-locking position. The construction of the key is such that the switch may be adjusted to be locking or non-locking in either position. The actuating lever has a nylon hub for long life, while all contacts are of long-life palladium. Switch contacts are rated 3 amperes, 120 Volts, AC non-inductive load. Two cable clamps provide secure fastening for all switch wiring installation to the front panel.

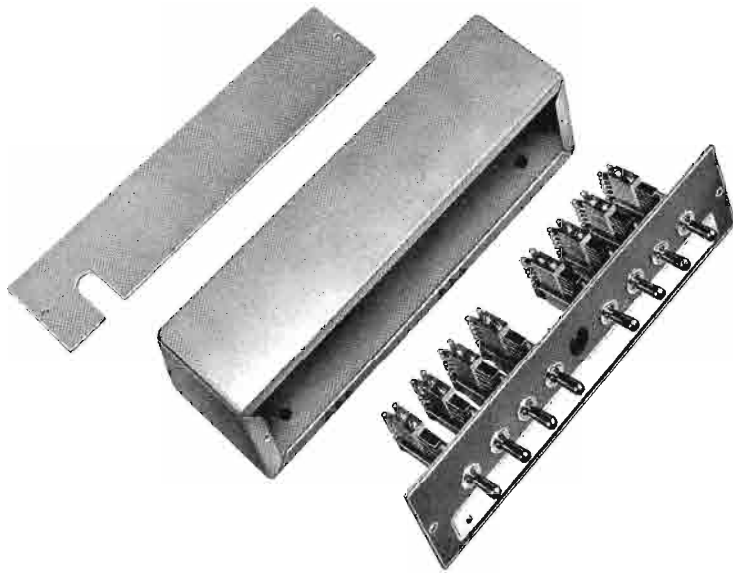

Shown above are:
Switch Housing Assembly, MI-11756; and Switch Panel,
MI-11754, containing eight MI-117522-2 Switches.

Detail drawing showing dimensions of single pole, double
throw, lever type switch, MI-11755-2, designed for use with
the MI-11756 Switch Housing Assembly and MI-11754 Panel.

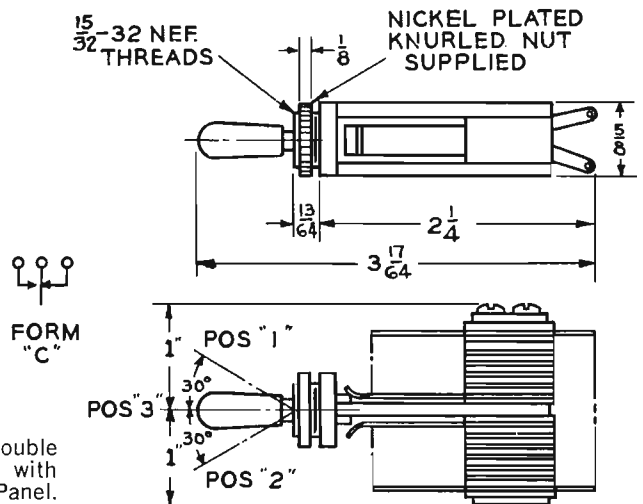

Specifications

Switch Contact Capacity Rating3 amps., 120 Volts AC,
non-inductive load
Finish Umber gray
Dimensions Overall:
Width11½" (29.21 cm)

Height2-3/5" (6.59 cm)
Depth (top)2¾" (6.98 cm)
Depth (bottom)3½" (8.89 cm)
Weight Approx. 5 lbs. (2.27 kg.)

Ordering Information

Switch Housing AssemblyMI-11756
Switch PanelMI-11754
Switch, 6 Form C, Single Pole, Double Throw,
Contacts (each)MI-11755-2
Basic Mounting Panel (for mounting MI-11754
in 13½" Console housing)MI-26252
Rack Adaptor (for mounting MI-11754
in 19" rack or 22" console)MI-26254

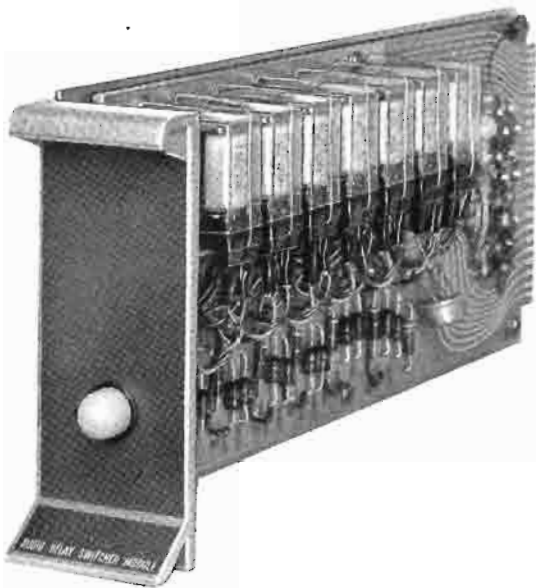

- "Custom" switcher for finest audio installations
- Solid state modules form unlimited switcher configurations
- Seven inputs, one output per module
- Plug-in, unitized construction
- Switching level 0 to +18 dBm in 600 Ohms

Audio Relay Switcher Module, MI-11787-A

Description

The Audio Relay Switcher Module is a primary component for use in custom relay switching systems. The basic module is a 7-input by 1-output switcher and offers the user a true building block in the development of unlimited audio switcher configurations.

Electronic Expansion

The MI-11787-A Module may be combined in numerous combinations to fit the needs of individual systems. A typical switcher (shown in the diagram) has 21 inputs each switchable to either or both of two outputs, such as preview and program bus. Such a switcher utilizes six modules mounted in an MI-557300 Standard Frame Assembly. Up to nine Audio Switcher Modules can be mounted in the frame to provide combinations such as the following: 2 modules for 14 x 1 or 7 x 2; 3 modules for 21 x 1 or 7 x 3; 4 modules for 28 x 1, 14 x 2 or 7 x 4; 5 modules for 35 x 1, or 7 x 5; 6 modules for 42 x 1, 21 x 2, 14 x 3 or 7 x 6; 7 modules for 49 x 1 or 7 x 7; 8 modules for 56 x 1, 28 x 2, 14 x 4 or 7 x 8;

9 modules for 63 x 1, 21 x 3 or 7 x 9. Systems beyond these configurations may be assembled by using additional frames and modules.

The use of standard plug-in modules greatly reduces the cost of custom-built switching systems, provides reliable performance and allows for future expansion requirements. The switcher may be controlled either by a custom-designed bank of individual push buttons or by pulses generated in automation or preset switching equipment.

DC Power Supply

A 24-Volt DC power source such as an MI-11316 or MI-11318 power supply is required. Two module connector units are available as accessory items, the MI-11790 connector assembly and the MI-11789 connector kit.

The MI-11790 consists of an assembly of three connectors wired for use with three relay modules in a 7 x 3 switcher configuration. The assembly, if desired, can be reconnected for a 21 x 1 switcher. All

audio, tally and control circuits are wired to an audio terminal block on the assembly. Also included are three transformer mounting plates and hardware for securing the MI-11790 to the rear of the MI-557300 frame assembly. Numerous MI-11790 connector assemblies may be cross-connected to obtain any desired switcher configuration.

Mounting Accessories

The MI-11789 mating connector kit includes one connector housing, solder type terminals, one transformer mounting plate, and all hardware required for securing the connector and mounting plate to the rear of the MI-557300 frame assembly. One MI-11789 connector kit is required when installing a single MI-11787-A relay module.

Gap Switching

The Audio Relay Switcher Module utilizes a transistor latch circuit. The circuit design and relay characteristics are chosen so that relay drop-out is faster than pickup, hence

gap switching is assured. Each Module contains a pilot light to indicate presence of control voltage and fuse continuity. The lamp is operated at reduced voltage for extended life.

Printed Circuitry

The latest printed circuitry techniques are employed including two-sided printed wiring on glass epoxy boards. The board contacts as well as the contacts of the mating receptacle are gold plated for maximum reliability. All audio circuits are wired with two conductor twisted pair cable, individually shielded and

insulated to minimize crosstalk as well as hum and noise pickup. Each module contains seven plug-in relays held in place by spring retaining clips. Each relay is equipped with gold contacts and a clear plastic dust cover to assure long life and quiet operation.

The MI-11787-A Switcher is designed for switching balanced audio circuits at levels of 0 dBm (up to +18 dBm) in 600 Ohms, or equivalent levels at other impedances. An external bridging transformer is normally used to provide 20,000 Ohms

impedance at the switcher cross-points, with a choice of either 150 or 600 Ohms output bus impedance. The MI-11791-A Bridging Transformer may be mounted on either the MI-11789 Connector Kit or MI-11790 Connector Assembly. Back loading of the input source is not required when using a bridging output, unless many outputs are simultaneously connected to one input. However, each relay crosspoint has "C" contacts, and the terminals are arranged so that back loading resistors may be conveniently installed if required.

Specifications

Input/Output Impedance.....	Dependent upon associated circuit (usually 600 or 150 Ohms)
Insertion Loss.....	Essentially zero in the module (Normal loss through external bridging transformer 20 dB)
Crosspoint Activation.....	Pulse or continuous voltage
Switching Level	0 to +18 dBm, 600 Ohms
Switching Time.....	Break before make approx. 5 milliseconds
Signal-to-Noise	Better than 60 dB; with 0 dBm, 600 Ohm input
Relay Contacts.....	Gold plated; 2 form C and 3 form A (each relay)
Maximum Length of Control Cable.....	300 ft. using #22 wire
Power Requirements	24 Volts, DC; 135 mA (including pilot lamp but excluding tally lamps)
Fuse	1/2 Amp, 3 AG
Pilot Lamp	#327

Dimensions (Overall).....	4 3/4" high, 1 1/8" wide, 13" deep (12 cm, 4.5 cm, 33 cm)
Weight.....	2 1/2 lbs. (1.13 kg)
Transistor and Diode Complement:	
	1—2N1183B, 14—1N2070, 1—1N746

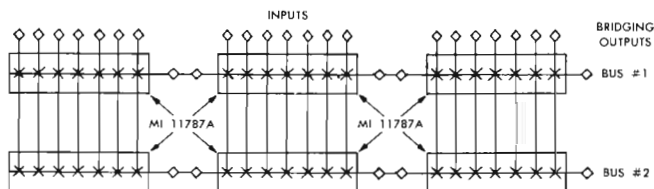

Accessories

Standard Frame Assembly (holds up to 9 Modules)	MI-557300
24 Volts DC Power Supply	MI-11318-C
Single Module Connector Unit	MI-11789
Multiple Connector Base	MI-11790
Bridging Transformer (mounts on MI-11790)	MI-11791-A

Ordering Information

Audio Relay Switcher ModuleMI-11787-A



- High impedance, ceramic type
- Lightweight for better comfort
- Comfortable ear cushions shield out noise
- Impact resistant
- Uses strong, flexible cadmium bronze cable

Headset, Type EDC-12

Description

Rugged, Comfortable Ceramic Headset

The EDC-12 is a lightweight high impedance headset with an extended frequency range. It uses sensitive ceramic elements which are resistant to impact, vibration, heat and humidity. The earphones are made of Implex and equipped with removable vinyl covered plastic foam ear cushions. Light in weight and shaped to fit snugly the EDC-12 Headset can be worn comfortably for extended periods of time. Earphones and cushions effectively seal out noise and actually improve frequency response. A four foot cable terminating in a telephone plug is provided. The cable is made of cadmium bronze, an exceptionally strong and flexible material, and is covered in vinyl.

Specifications

Type	Ceramic
Impedance	8000 Ohms @ 1000 Hz
Frequency Response	20-11,000 Hz \pm 5 dB
Input Voltage for 0.5% distortion at 1 kHz	14 Volts
Sound Level for 0.5% distortion at 1 kHz	113 dB
Sound Level at maximum operating level (7 Volts)	109 dB
Cord.....	Vinyl covered cadmium bronze cable, 4 ft. or 6 ft. long
Cord Termination206"/.250" diameter telephone plug (Specify when ordering)
Weight	11 oz. (312 gr.)

Ordering Information

Type EDC-12 Ceramic Headset, including cord and plug.....	MI-38029-2
Type EDC-12 Ceramic Headset, including cord and .250" plug	MI-11797-M

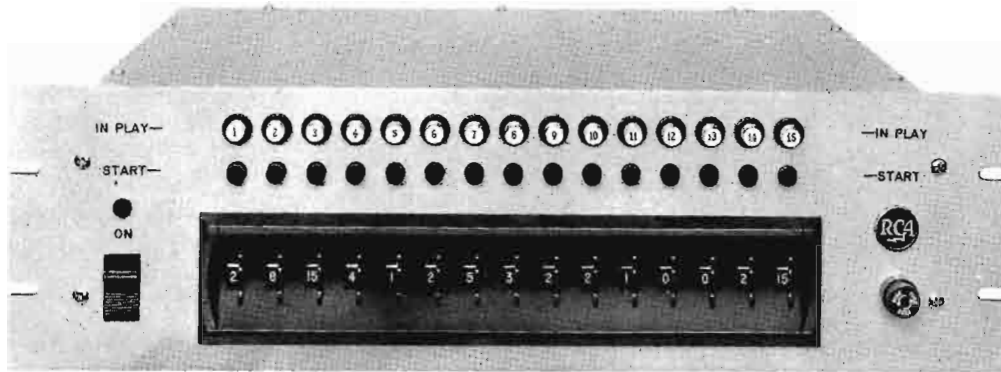

- Fifteen events, eighteen sources
- Solid state logic
- Plug-in relays used
- Quiet operation
- Provision for "skip" or "stop" events

Audio Tape Programmer, Type BCA-15A

Description

The Audio Tape Programmer, RCA Type BCA-15A, is designed to program fifteen events from any of 18 program sources. These sources can be derived from RCA Type RT-8, RT-17, RT-22 or RT-37 tape recorders. In addition, any source may be used if it can be started by a contact closure and provides a contact closure to signal the end of program material. Each of the 15 events is programmed by means of a thumbwheel switch which selects any of the 18 program sources. In addition, the switch permits an event to be skipped or the program sequence stopped. The program recycles to the first event upon completion of event 15.

The number of events may be increased easily by adding Audio Tape Programmer units either in series or as sub-programs to a particular event in a main program. Numbered lights indicate the event being played and a push button permits any particular event to be selected. Relays and solid state logic circuits are used to permit fast operation with so little noise that the BCA-15A may be used in announce positions with the microphones open.

Specifications

Events	15
Program Sources	18
Source Selector.....	Thumbwheel switch
Source Relay Switching	+24 Volts DC
Power	115/230 Volts, AC, 50/60 Hz, 6.25 Watts
Panel Size.....	5¼" high, 19" wide, 15⅝" deep (13.34 cm, 48.26 cm, 39.70 cm)
Weight.....	16 lbs. (7.25 kg.)
Terminals.....	Screw type barrier terminal strips

Ordering Information

Type BCA-15A Audio Tape Programmer.....MI-11365-A

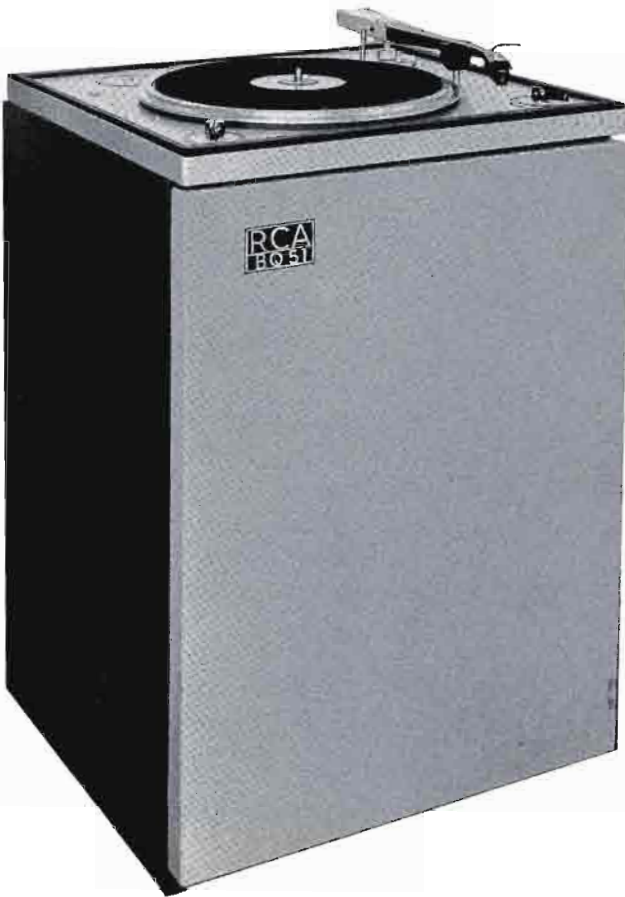

- Precision, 2-speed rim-drive mechanism for 33 $\frac{1}{3}$ and 45 rpm records
- Compact cabinet accepts BA-26/36 Equalizer Preamplifier
- Provision for mounting two tone arms for greater versatility
- Smooth and rapid starts

12-Inch Dual Speed Turntable, Type BQ-51B

Description

The RCA BQ-51B Dual Speed Turntable fulfills the broadcaster's need for a high-quality turntable mechanism to accommodate commercial disc recordings up to 12 inches in diameter at speeds of 33 $\frac{1}{3}$ and 45 r/min. The BQ-51B is available as a mechanism for mounting in custom-built arrangements. It may also be obtained as a complete assembly with a styled cabinet, MI-11809-A.

Space is provided on the top panel of the BQ-51B for mounting one or two standard low impedance, reluctance-type pickups that con-

form to EIA standards. The RCA 12-inch (MI-11894-A) or the RCA 16-inch (MI-11895-A) Tone Arm are recommended. Both arms accommodate the RCA Universal Pickup Cartridge, MI-11865 and associated styli, MI-11866 series, for playing stereo or monaural recordings.

The BQ-51B Dual Speed 12-inch Turntable is a 2-speed rim-drive mechanism, utilizing a hysteresis synchronous motor. It is available for 60 hertz or 50 hertz operation and a 2-position speed selector switch is provided on the turntable assembly. An "Off-On" selector control oper-

ates a mercury motor switch and simultaneously engages or disengages the rubber idler wheels. This feature relieves the idlers from pressure when set to the "Off" position.

The metal cabinet assembly, MI-11809-A of functional design, affords a simplified mounting for the drive assembly mechanism. A hinged door is located on the front of the cabinet to permit ready access to the interior. A sloped bracket is provided within the cabinet to mount the BA-36 Series Equalizer Preamplifier.

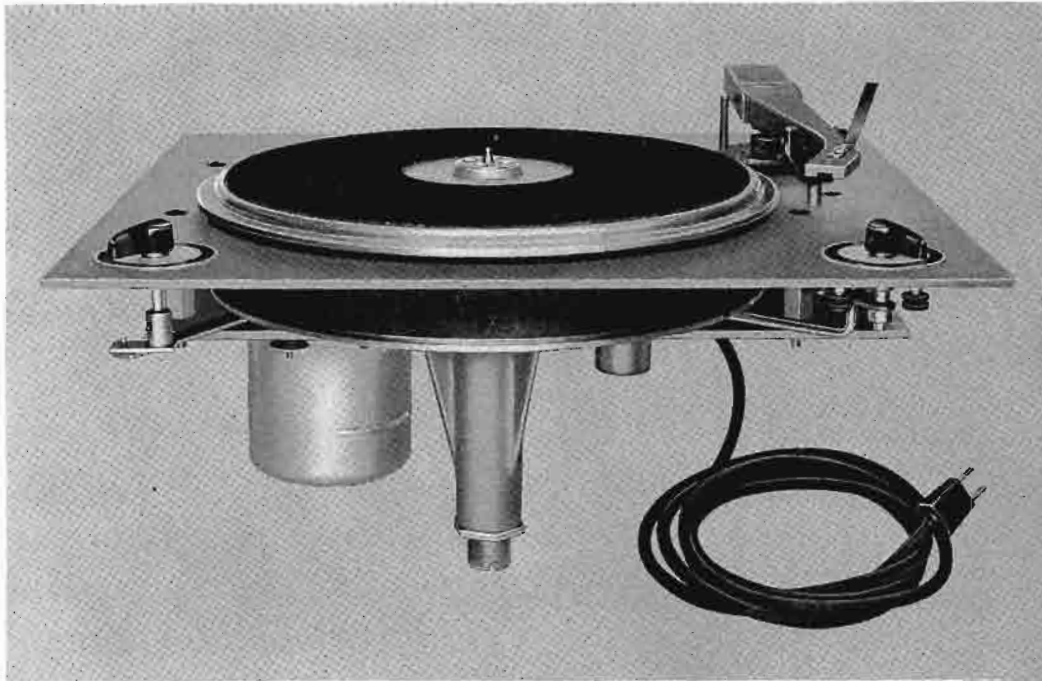

The BQ-51B turntable platter is a sturdy aluminum casting. The platter and spindle assembly is held in the main support casting by oilite bushings and the thrust is supported by a single ball at the bottom end of the spindle. A foam rubber belt on the outside rim of the platter eliminates resonance effects. The drive motor is mounted on a separate plate, supported by vibration mounts to eliminate rumble. A rubber cushioning frame reduces extraneous vibrations by isolating the motor board assembly from the mounting frame. All posts and shafts which provide bearings for cams and arms are assembled to a common plate to insure proper alignment.

Specifications

Turntable Speed	33 $\frac{1}{3}$ and 45 rpm \pm 0.3%
Rumble	40 dB down (ref. level 1.4 cm/s at 100 Hz)
Wow or Flutter:	
At 33 $\frac{1}{3}$ r/min.....	0.1% of mean speed
At 45 r/min.....	0.1% of mean speed
Motor.....	1/100 h.p., 1800 r/min. at 60 Hz or 1/125 h.p., 1500 r/min. at 50 Hz
Power Supply.....	105-125 V, 50/60 Hz single phase
Power Consumption.....	40 W
Power Cord.....	8 ft. long (2.44 m)
Turntable Diameter.....	12" (30.48 cm)
Hub and Spindle Diameter:	
Hub for 45 r/min. records.....	1.5" (4.31 cm)
Spindle for 33 $\frac{1}{3}$ records.....	0.2835" (72 mm)
Overall Dimensions:	
Turntable Drive Unit.....	22" wide, 18 $\frac{1}{16}$ " deep (55.9 cm x 45.9 cm)—height below top surface motor board, 9" (22.86 cm)—height above surface motor board, 1 $\frac{1}{2}$ " (3.81 cm)
Cabinet.....	23 $\frac{1}{16}$ " wide, 19 $\frac{1}{8}$ " deep and 29" high (58.6 cm x 46 cm x 73.66 cm)

Weight:	
Turntable Drive Unit.....	31 lbs. (14.06 kg)
Cabinet.....	47 lbs. (21.32 kg)
Finish.....	Shadow blue with aluminum trim

Accessories

Cabinet assembly to house turntable mechanism	MI-11809-A
12" Tone Arm (less pickup head)	MI-11894-B
16" Tone Arm (less pickup head).....	MI-11895-A
Universal Cartridge (less stylus).....	MI-11865
0.7 Mil Diamond Stylus (for use with Universal Cartridge).....	MI-11866-7
1.0 Mil Diamond Stylus (for use with Universal Cartridge).....	MI-11866-10
2.5 Mil Diamond Stylus (for use with Universal Cartridge).....	MI-11866-25
BA-26B Pickup Equalizer-Preamplifier	MI-11436-C
BA-36A Stereo Pickup Equalizer-Preamplifier	MI-11441-B
220 Volt Transformer Kit.....	MI-41605

Ordering Information

BQ-51B Dual Speed Turntable Mechanism for 60 hertz operation (less Cabinet, Tone Arm and Pickup Heads)	MI-11810-B
BQ-51B Dual Speed Turntable Mechanism for 50 hertz operation (less Cabinet, Tone Arm and Pickup Heads)	MI-11810-C



- Lightweight — minimum distortion
- Accurate stylus force adjustment
- Track properly at all times
- Plug-in pickup cartridges

Lightweight Tone Arms

Description

The RCA Lightweight 16 and 12-inch Tone Arms, MI-11895 and MI-11894-A, and the Universal Cartridge and Stylus are designed to fulfill the need for a high quality pickup combination for playing stereo and monaural fine-groove records as well as transcriptions and 78 RPM records. The tone arms are especially designed to operate with the RCA BQ-51B Turntable.

The advanced tone arm design incorporates a 3-terminal pickup socket, with free floating collets, to accept the plug-in MI-11865 Universal Cartridge. This smooth-action socket provides "Instant Cartridge Change" capability. Facilities for accepting pickups which mount on standard 1/2-inch mounting centers have also been included.

RCA Stylus Saver

Both models of the tone arm contain the RCA "Stylus Saver" adjustment which limits the vertical downward travel of the arm so that the cartridge stylus only engages the record groove and never reaches the top of the turntable, thus preventing accidental damage to the stylus,

should the arm be knocked off the edge of the record.

Design Features

By careful design, tone arm resonance is well outside the operating frequency range of the system. Distortion due to tracking error in the arm and pickup has been reduced to a minimum. The anti-friction vertical and lateral pivots and low mass allow the tone arms to track properly on warped and eccentric records.

The arms are hinged at the pivot center to allow easy access to the pickup and wiring on the underside. An adjustable counterweight controlled by an accessible thumb nut at the rear of the arm provides accurate stylus force adjustment.

Universal Pickup Cartridge

The RCA Universal Pickup Cartridge and Replaceable Stylus, MI-11865 and MI-11866 provide a fully compatible unit for reproducing stereophonic and monophonic phonograph records in broadcast studios. It utilizes the moving magnet system which makes possible superior performance and simplified stylus re-

placement. The MI-11865 cartridge is completely housed in a molded plastic case. The stylus MI-11866 may easily be removed and replaced without use of tools. This eliminates the need for ever sending the pick-up out for repairs.

The cartridge proper is a three terminal device. The center pin is common and the outside pins are the left and right stereo outputs. In stereo use the head is connected in the usual manner with the left output going to the left equalizer and the right output, to the right equalizer. In monophonic use, the left and right outputs are paralleled. The cartridge plugs into the MI-11894-B (12-inch) or MI-11895-A (16-inch) tone arms, or may be mounted on arms with standard 1/2-inch mounting centers. It features low distortion, and excellent frequency response and very good channel separation. The diamond stylus and low tracking force insure long life for both the stylus and recordings.

Plug-in stylus assemblies, readily identified by their color are available in three types as shown in table under specifications.

Specifications

Tone Arms

Tracking Error, 16-inch Record4° max.
 Pivot BearingsAnti-resonant bearings in vertical and horizontal planes
 Tone Arm Head ReceptacleQuick-lock, plug-in type
 Construction of ArmAluminum casting
 Length of Arm:
 MI-11895-A16¾"
 MI-11894-B12"
 Height of ArmAdjustable
 Weight (arm assembly, etc.):
 MI-11895-A2 lbs.
 MI-11894-B1½ lbs.
 Mounting:
 MI-11895-AApprox. 12" from spindle center
 MI-11894-BApprox. 8" from spindle center
 Leads3-conductor and shield

Universal Pickup Cartridge

Inductance400 mh
 DC Resistance280 Ohms
 Output Voltage at 1000 Hz, 5 cm/sec0.005 Volt
 Channel Separation20 dB min. @ 1000 Hz
 Recommended Load Impedance47,000 Ohms
 Number of Terminals3
 Dimensions (overall)1½" long, ¾" wide, 1/16" high
 Weight10.5 grams
 MountingPlug-in (standard EIA mounting centers)
 Recommended Stylus Force(see table)

Accessories

BA-36A Stereo Equalizer-PreamplifierMI-11441-B
 BA-26B Equalizer-PreamplifierMI-11436-C



MI Number	Stylus (Tip Radius)	Function	Tracking Force (grams)	Color
11866-7	0.7 mil	Stereo records	4	Black
11866-10	1.0 mil	45 RPM and LP records	4	Red
11866-25	2.5 mil	Transcription and 78 RPM records	8	Green

Ordering Information

16-Inch Tone Arm (less pickup head) includes assembly complete with tone arm rest and mounting hardwareMI-11895-A
 12-Inch Tone Arm Assembly (less pickup head) complete with tone arm rest and mounting hardwareMI-11894-B
 Pickup Cartridge (less stylus assembly)MI-11865
 Stylus Assembly 0.7 mil (black)MI-11866-7
 Stylus Assembly 1.0 mil (red)MI-11866-10
 Stylus Assembly 2.5 mil (green)MI-11866-25

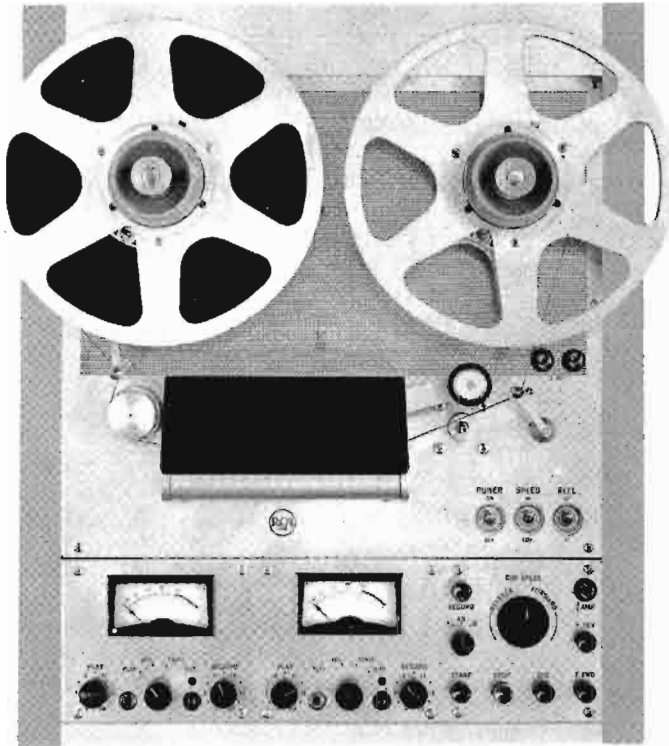

- Solid state design
- Monaural or stereo recording
- 7½ and 15 or 3¾ and 7½ IPS tape speed models
- Rack, console or portable mounting
- Plug-in record equalizer

Professional Audio Tape Recorder, Type RT-21B

Description

The RCA Type RT-21B Professional Tape recorder is designed to meet rigid specifications and requirements set forth by broadcast and studio engineers for magnetic monaural or stereo tape operations. Utmost flexibility is provided in this complete transistor design, permitting programs to be recorded with greater ease.

Solid state circuitry accounts for the low power consumption, cool operation and small size of the RT-21B. Improved circuitry allows a wide range of record input levels, high playback output levels, and facilitates stereo performance. A master bias oscillator system is employed. The oscillator, located in the control module, drives power amplifiers in each amplifier module—an important feature where synchronous bias voltage is required such as in the stereo model of the RT-21B.

The RT-21B basic recorder is supplied in two sections: a tape transport and a control panel which includes one amplifier. These components readily enable either a custom or standard installation to be made. The equipment is normally supplied for rack mounting. Console cabinet and portable carrying case are optional equipment.

Ease of Operation

The control panel of the RT-21B is divided into three sections. The center contains the monaural record/playback module, the left area contains provisions for a duplicate module (used for stereo recording) and the right side of the control panel contains operating controls in a convenient grouping. When recording in stereo it is possible to record both tracks simultaneously in a normal manner or either of the two half-tracks by means of the A/B selector switch.

Front Panel Controls

The record/playback modules are identical and are directly interchangeable. Front panel controls consist of the following: a record level control, playback level control, headset jack, bias adjustment and meter function selector to monitor, playback, record, bias and erase signals. A record indicator light is associated with each amplifier so that when recording in stereo it is possible to quickly ascertain whether normal stereo or half track recording mode is selected.

Continuously Variable Speed Control and Interlocked Record Operation

The operating controls consist of the following: variable cue speed and related cue delegate button, record, record delegate, start, stop, fast forward and fast reverse. The control panel features an interlocked record operation. This means that to place



Portable carrying case with stereophonic RT-21B system.

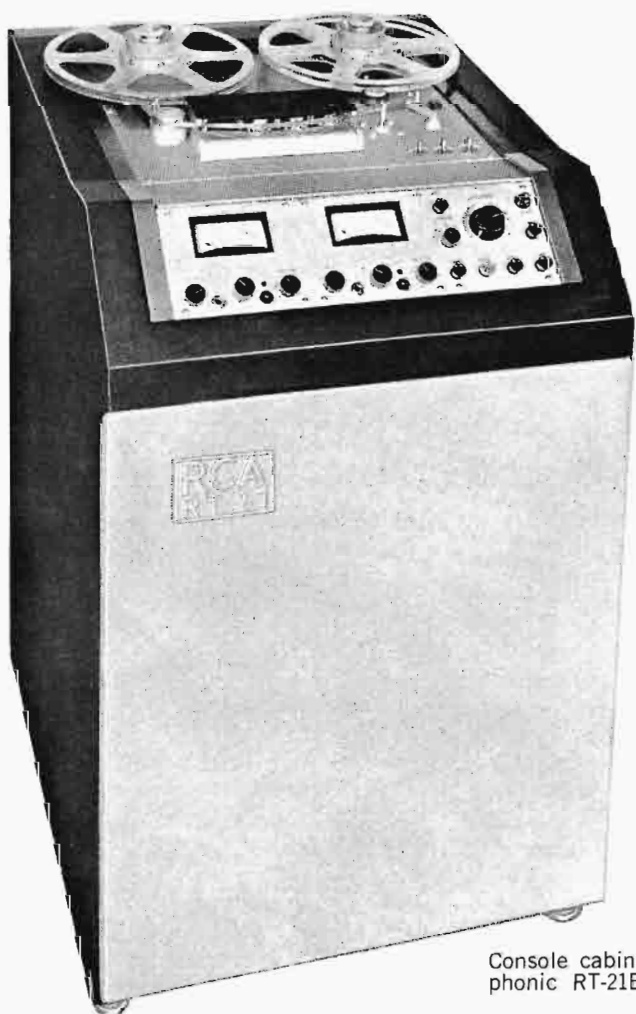

Console cabinet with stereophonic RT-21B system.

the machine in the record mode, the record button must first be depressed and then the start button to begin operation. This interlock feature may be defeated by simple internal strapping so that the record button may be depressed at any time for editing purposes, etc.

All controls are d-c relay operated. The necessary 24 volt d-c control voltages are generated within the recorder and are also available for remote control purposes.

Tape Transport

The RT-21B Tape Transport Panel accommodates either 10½-inch or 7-inch EIA reels. NAB 10½-inch reels and NAB hubs are available as accessory items. Proper tape tension for 10½ or 7-inch reels is provided by means of a toggle switch at the lower right of the panel. Also located in this same area are the main power on-off switch and a switch for selecting either high or low tape speeds. Proper tape equalization is automatically selected by the speed change switch. 7½/15 IPS and 3¾/7½ IPS models are available. Each RT-21B is supplied with the proper plug-in record equalizer depending upon speed and track width ordered.

Velocity Brake System

The smooth acting "Velocity sensing brake system" providing velvet smooth action is achieved in the RT-21B by use of large surface area brake hubs which are integral parts of the reel motors. A microswitch, controlled by the tape brake arm, cuts power to the capstan motor and releases the control relays when the arm is in the down position. This safety feature stops the transport mechanism in the event of tape breakage. Power to the electronics is not controlled by this switch.

Threading of tape is simple and can be done without removal or movement of the head cover.

DC Solenoid Operated Tape Lifters

These are employed to lift the tape away from all magnetic heads whenever the machine is in the fast forward or fast reverse mode of operation. When the cue mode is selected, tape is then lifted from all heads except the playback head. This permits the operator to listen to the audio as he jockeys the tape for final

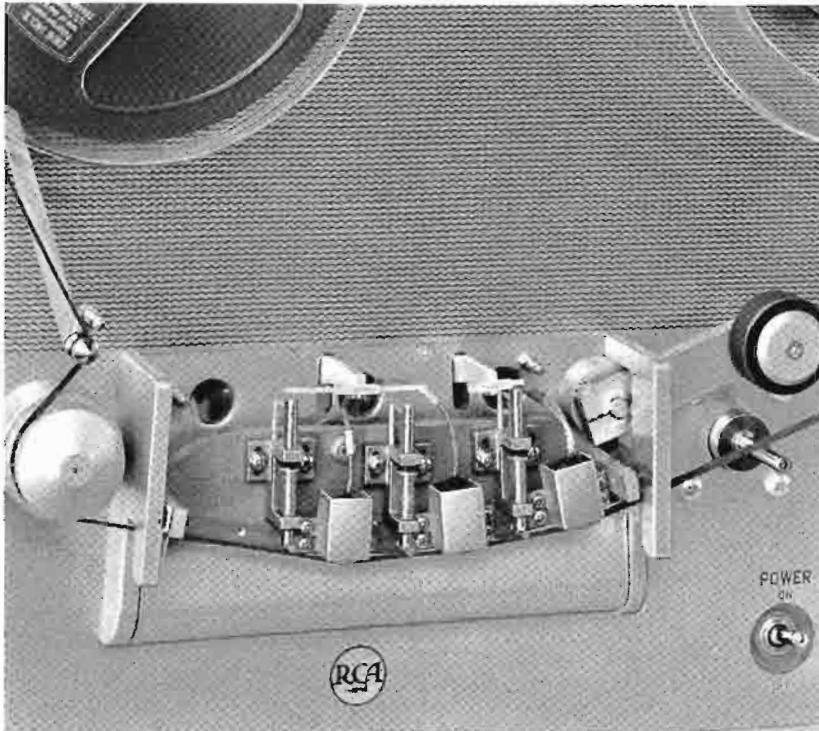

RT-21B Head Plate with cover removed to reveal magnetic heads. Note cut-out provision on left for optional fourth head kit for playing pre-recorded stereo tapes.

cueing via the continuously variable speed control.

Full Track or Dual Half-Track

A total of four magnetic head positions are available. The three heads normally supplied with the equipment provide full or dual half-track recording, erase and playback (depending on model ordered). An optional fourth head may be used for time delay broadcast and other special applications. A switchable dual quarter-track fourth head kit is available for playing pre-recorded stereo tapes. All azimuth head adjustments are available from the front panel by simply removing the snap-on protective cover.

Remote Control Panel

A Remote Control Panel for the RT-21B Tape Recorder is available as an optional equipment. The panel affords remote operation of all front panel operations except variable speed cue, including the A/B record facilities. The remote panel, however, has facilities for defeating the tape lifter on all heads, so that tape cueing can be accomplished by using the fast forward and fast reverse pushbuttons.

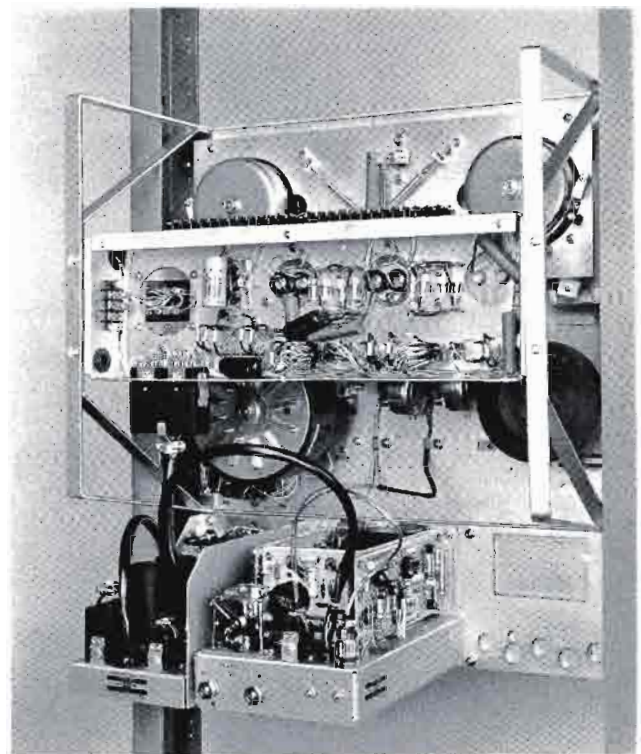
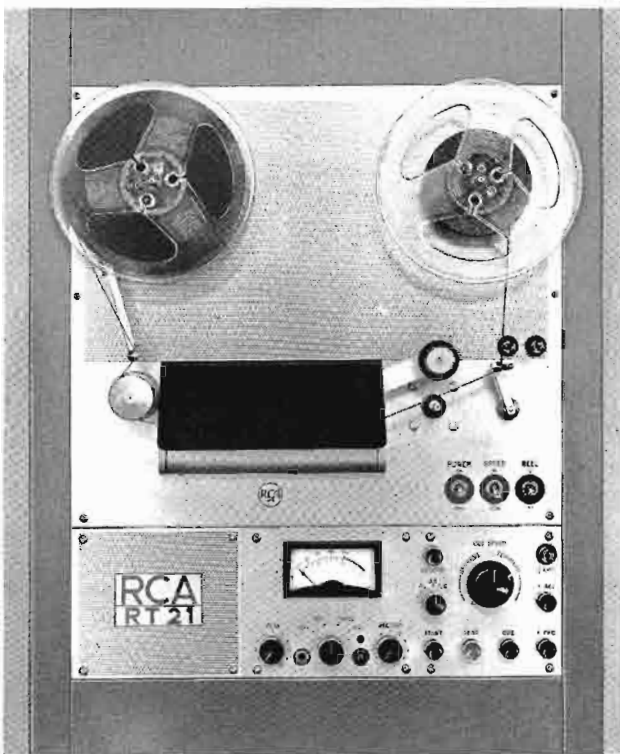

Front and rear views of RT-21B Tape Recorder showing tape transport at top, and control panel below. In rear view the modular control unit is shown at left and amplifier module in center. Space at right supports a second amplifier module for stereo tape operation.

Specifications

Tape Speed.....	7½ and 15 IPS, 3¾ and 7½ IPS	
Track Width.....	Full track or dual half (80 mil tracks)	
Frequency Response (Overall):		
15 IPS	50-15,000 Hz ±2 dB full or half track (within 4 dB at 30 Hz)	
7½ IPS	40-10,000 Hz ±2dB full or half track (within 4 dB at 30 Hz and 15,000 Hz)	
3¾ IPS	40-7,500 Hz ±2 dB half track (within 4 dB at 30 Hz)	
Signal-to-Noise Ratio:	Full Track	Half Track
15 IPS	60 dB	55 dB
7½ IPS	60 dB	55 dB
3¾ IPS		50 dB
Flutter and Wow	(Measured over a band of 0.5 to 250 Hz):	
15 IPS.....	0.1% rms	
7½ IPS.....	0.15% rms	
3¾ IPS.....	0.2% rms	
Starting Time.....	0.1 second full speed	
Stopping Time.....	2" of tape at 15 IPS	
Playback Timing Uniformity.....	±3 seconds in 30 minutes	
Rewind Time.....	Approximately 90 seconds for 2400 ft. on 10½" reel	
Tape	¼" wide	
Reels.....	7" and 10½" EIA (optional NAB hubs available)	
Amplifiers.....	Independent Record and Playback	
Record Input:		
Matching	150 Ohms, balanced, unloaded input transformer (may be strapped for 600 Ohms)	
Bridging	20,000 Ohms	
Record Input Level:		
Matching	-70 to -20 dBm	
Bridging	-30 to +20 dBm	
Playback Output	+18 dBm, maximum into 600 Ohms, balanced (normal program level of +8 VU)	
Distortion	Less than 1% of 0 VU recording level, 400 Hz (Distortion limited by tape only)	
Metering	3" illuminated VU meter reads record level, playback level, bias and erase current	
Monitoring.....	Phone jack provided to enable headphone monitoring of either the record input signal before or dur- ing recording, or the playback signal while recording or during playback. A function switch simultaneously trans- fers the VU meter and phone jack to either the record amplifier or playback amplifier output so that aural, as well as visual level comparisons may be made between the original program and the recorded program. The same switch also delegates the VU meter to read bias or erase current.	
Record Selector.....	Switch permits erasure and recording on either or both tracks of stereo machines	
Record Equalization.....	Plug-in equalizers (50 μs 7½/15 IPS) (80 μs 3¾ IPS)	
Bias.....	Screwdriver level adjustment on front panel. 80 kHz frequency. Independent of line voltage variations.	

Tape Lifters.....	Tape is removed from all heads, automatically during fast forward and fast reverse (tape lifters may be defeated from remote locations—see RE- MOTE CONTROL). Tape is removed from the erase and record heads when transport is in the cue mode of operation.	
Remote Control.....	Provisions included for use of an optional remote control panel. All control functions (ex- cept variable cue speed) including record selector may be remotely controlled. Remote panel includes control for tape lifter release (all heads) so that tape may be cued from a remote location.	
Power Supply.....	Self-contained. Supplies regulated 30 Volts for amplifiers and unregulated 24 Volts for relays	
Power Requirements	105-125 Volts, 50/60 Hz, single phase 115 Watts monaural, 135 Watts stereo	
Transistor and Diode Complement:		
Record Playback Amplifier	3—2N2270, 1—2N404, 3—1N3253, 5—2N526, 2—2N1183B, 8—2N270, 1—1N34A	
Control Panel Module	2—2N456, 2—N1183B, 1—2N270, 4—1N1763, 1—2N526, 4—1N3253, 1—1N1316	
Tape Transport	12—1N3253, 12—1N1763	
Dimensions (Overall):		
Tape Transport.....	19" wide, 15¾" high, 9" deep 48.26 cm, 40 cm, 22.86 cm	
Amplifier Control Panel.....	19" wide, 5¼" high, 9" deep 48.26 cm, 13.34 cm, 22.86 cm	
Rack Space.....	21" (55.34 cm) total—Monaural or Stereo	
Finish.....	Anodized aluminum overlay	
Approximate Weight.....	75 lbs. (34 kg) monaural, 83 lbs. (37.65 kg) stereo	

Optional and Accessory Equipment

NAB Reel Hubs for RT-21B Recorders.....	ES-41919
Consisting of:	
2 Reel Hubs.....	MI-41604
1 Empty 10½" Reel.....	MI-11932-2
Remote Control Panel for RT-21B Equipment.....	MI-141301-A
RT-21B Record/Playback Amplifier Module.....	MI-141351-A
Portable Carrying Case for RT-21A/B.....	MI-141302-A
Console Cabinet for RT-21B.....	MI-141303-A
Switchable 4th Head Kit (Dual ¼ track) for RT-21A/B	MI-41602-A
Bulk Magnetic Tape Eraser.....	MI-11992
Auto. Transformer Kit (110/220 Volts, 50/60 hertz)	MI-41605

Ordering Information

	115 V. 60 hertz	115 V. 50 hertz
Type RT-21B Professional Tape Re- corder Full Track, 3¾" and 7½" IPS, less NAB hubs.....	ES-41920-B	ES-41909-B
Type RT-21B Professional Tape Re- corder, Dual Half Track, 3¾" and 7½" IPS, less NAB hubs.....	ES-41921-B	ES-41911-B
Type RT-21B Stereo Professional Tape Recorder, Dual Half Track, 3¾" and 7½" IPS, less NAB hubs	ES-41921-BS	ES-41911-BS

	115 V. 60 hertz	115 V. 50 hertz
Type RT-21B Professional Tape Re- corder, Full Track, 7½" and 15" IPS, less NAB hubs.....	ES-41930-B	ES-41910-B
Type RT-21B Professional Tape Re- corder, Dual Half Track, 7½" and 15" IPS, less NAB hubs.....	ES-41931-B	ES-41912-B
Type RT-21B Stereo Professional Tape Recorder, Dual Half Track, 7½" and 15" IPS, less NAB hubs	ES-41931-BS	ES-41912-BS

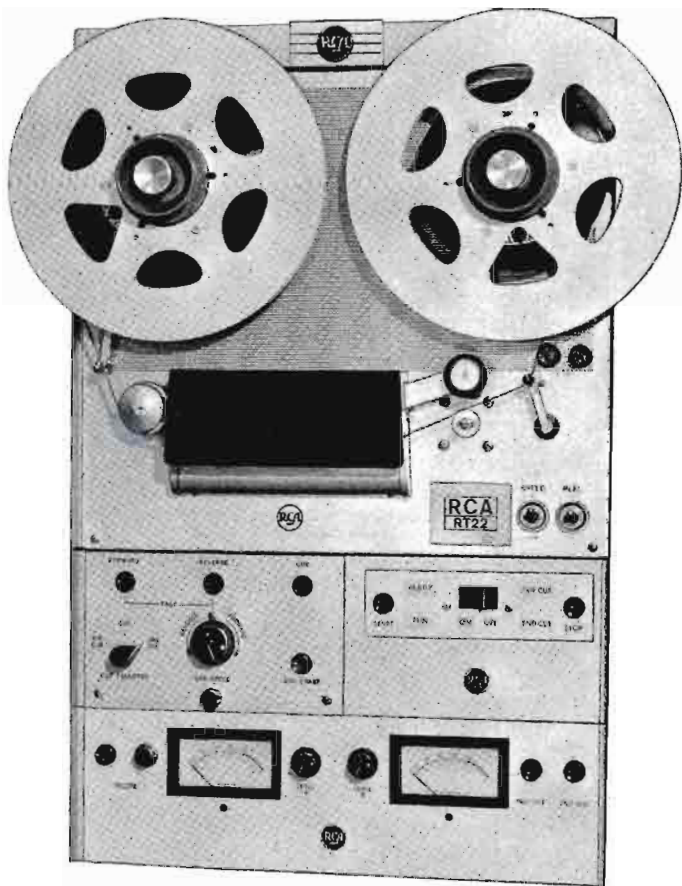

Automatic Stereo Tape Recorder

- Automatic record/playback in stereo or monaural models
- Solid state circuitry
- Variable speed tape cueing
- Remote control provisions
- Plug-in circuit modules

Automatic Tape Recorder, Type RT-22A

Description

The RT-22A Automatic Tape Recorder is a reel-to-reel tape handling mechanism combined with the electronics and cueing facilities normally found only in cartridge tape equipment. The equipment is designed to meet rigid specifications and requirements set forth by broadcast and studio engineers for magnetic monaural or stereo tape operations.

The RT-22A is available as a playback only or complete record/playback system in stereo or monaural models. The record/playback systems are supplied with a standard BA-37A Stereo or BA-17A Monaural Record Amplifier. All units are designed for rack mounting and feature solid state and plug-in modular circuits.

The tape transport is basically the same high quality mechanism used in the RT-21B series of tape recorders, featuring a heavy duty hysteresis synchronous capstan motor, integrated reel motor and brake hub, solenoid operated tape lifters, smooth action brake system, four (4) head positions and the capability of accepting reel sizes up to 10½ inches. The RT-22A is equipped with separate erase, record, and playback heads plus a fourth cue track erase head.

The amplifier and control panel for the automatic tape recorder houses the playback amplifier; power supply; cue, end cue and trip cue amplifiers; as well as the control relays and circuitry. Front panel controls include start, stop, fast forward,

fast reverse, cue speed, cue (mode selection), cue selection (tone) and cue (tone) erase.

Cue Tone Automatically Recorded

At start of the recording operation a 1000 Hz stop cue tone is automatically recorded on the tape. During playback the stop cue is used to stop the transport mechanism, leaving the recorded program material in a pre-cued condition.

Two Trip Cue Frequencies

A 150 Hz, end of message tone is automatically recorded at the termination of the recording operation. Upon playback, this tone activates a relay whose contacts may be used to start the next device in an automation system. The automatic record feature of the end-of-message tone

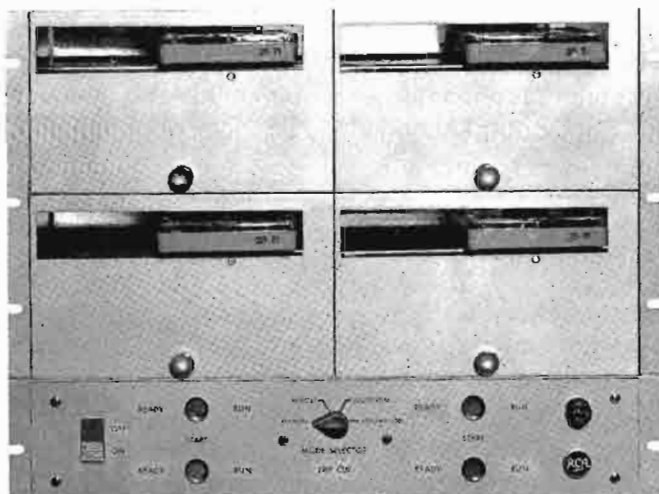

- Facilitates Continuous Programming
- Any one of four Cartridges Available for Immediate Playback
- Four Modes of Operation: Manual, Remote, Sequential, Automation
- Plug-in Relays and Circuit Breaker
- Heavy Duty Tape Transports
- Self-Contained Relay Power Supply

Multicartridge Tape System, Type RT-8A

Description

The RCA Type RT-8A Multiple Cartridge Tape System (either monaural or stereo) is a single compact unit designed for instant playback of four pre-recorded tape cartridges singly or in random sequence. A mode selection switch allows four modes of operation: manually, remotely, sequentially, or by pulses supplied from an automation system. The RT-8A meets all NAB standards and plays either of the three NAB size of cartridge, with playback time varying from a few seconds to 31 minutes.

The RT-8A Multicartridge is available for use with cartridges recorded on the RT-7A/B cartridge tape units. An alternate model is designed for operation with cartridges recorded on the RT-17 tape cartridge unit. There is also an RT-8A designed for stereo operation, available with stereo transports and dual program amplifiers.

Tandem Operation

The RT-8A Multicartridge playback units may be connected in tandem to give systems of 4-8-12-16 or more units in an operating system.

Use of multiple RT-8A units could provide enough cartridge storage capacity to give continuous broadcast programming for long time periods.

The Multicartridge system consists primarily of four independent, roll-out tape transports, plug-in transistor circuit boards and control relays, a mode selector switch and separate start switches for each of the tape transports. These are housed in a rack-mounting cabinet. Adequate ventilation has been provided in the design of chassis and cabinet to allow two or more RT-8A's to be stack mounted in a standard rack.

Tape Transport

The rugged 10-pound tape transport is identical to those used in the Monaural RT-17A or Stereo RT-37A Single Cartridge Playback Units. The drive system for the transport consists of a heavy duty, hysteresis, synchronous motor, coupled by "O" ring belts to a precision-ground capstan and flywheel assembly. The mechanism meets latest NAB standards (tape speed $7\frac{1}{2}$ IPS with a speed accuracy of ± 0.4 percent; machine tape pulling force, minimum $1\frac{1}{2}$

pounds; flutter not to exceed 0.2 percent RMS.)

Fast, Quiet Operation

Insertion of a cartridge cocks the RT-8A mechanical system by swinging the pressure roller up to within a fraction of an inch of the capstan, assuring fast starts and quiet operation upon playback. Mechanical release of the cartridge is accomplished by merely lifting up the edge of the cartridge before removing it from the slot in the transport. All electrical connections to the transport are made through two, quick disconnect cable connectors, one for power and the other for the heads.

Relays

A set of six plug-in relays is associated with each individual transport system. They control the ready, start, run and play control functions of the transport as well as the cue and trip (end of message cue) functions. A mute relay and an audio switch relay are the two final relays in the system. The former mutes the audio output during initial starting of the playback process to prevent operational noises entering pro-

gram circuits; the audio switch relay provides automatic audio switching to a single program channel when two or more RT-8A's are connected in tandem. The relays are protected from dirt and dust by individual plastic covers. Each is rigidly held in place by an overall metal cover.

Relay Power Supply

The RT-8A is completely self-contained including a 24 Volt power supply for relay operation. Tally lamps indicate cartridge "ready" and "run". An individual cue and trip cue circuit board is associated with each tape transport. A common output audio amplifier is provided with each RT-8A.

Four Position Mode Switch

A four position mode switch selects the play mode desired. These are as follows:

- a. Manual—The operator can select the cartridge play sequence by operating "start" buttons on the RT-8A Control Panel. The deck that has been placed in operation will run until it is automatically "cued up." The second or following deck must be started manually.
- b. Remote Control—This is basically the same as manual. It allows for manual control from a remote position. Custom remote "trip cue" delegation panels may also be employed to vary cartridge sequence.
- c. Sequential—Any deck may be used to start a sequence. The sequence continues automatically within the RT-8A thru as many decks as there are cartridges inserted. The play se-

quence may be started locally or remotely.

- d. Automation—This mode permits external pulses to activate individual cartridge decks and "trip cue" pulses from the active deck to start the next device in the automation system. When the mode switch is in automation all manual control is removed.

Random Trip Cue

The MI-11973-2 8000-Hz Random Trip Cue Board is an optional accessory. Random Trip Cue tones must be recorded in an RT-17/37 system during preparation of a cartridge. A "random trip cue" may be used to activate a slide projector or other device during play of a cartridge.

Specifications

Frequency Response	±2 dB 50 to 12,000 Hz
	±4 dB 50 to 15,000 Hz
Distortion.....	2% or less at normal recording level
Signal-to-noise Ratio:	
Monaural	45 dB at standard NAB reference level
	(53 dB below 3% total harmonic distortion)
Stereo	42 dB at standard NAB reference level
	(50 dB below 3% total harmonic distortion)
Crosstalk, Cue Tone to Program Channel:	
Monaural	Better than 55 dB
Stereo	Better than 50 dB
Wow and Flutter.....	Less than 0.2% RMS
Tape Speed.....	7.5 IPS
Power	115/230 V, AC, *50/60 Hz, single phase
Playing Time.....	1 second to 31 minutes
	in 3 basic cartridge sizes
Cueing Accuracy.....	Within 0.1 second
Starting Time.....	0.05 second or less
Output Level	+18 dBm, 150/600 Ohms, balanced

Finish	Aluminum Epoxy
Dimensions	19" wide, 17½" high, 16¾" deep
	(48.25 cm, 44.45 cm, 42.52 cm)
Weight:	
Chassis, less decks.....	112 lbs. (50.8 kg.)
Chassis including four 10 lb. decks.....	152 lbs. (68.9 kg.)
Cartridge Transports.....	4 plug-in type
Mounting.....	Standard Relay Rack

Accessories

Remote Control Panel (Four Position Start)	MI-11968-1
150-Hz End-of-Message Cue Board	MI-11973-1
8,000-Hz Random Trip Cue Board (for use only	
with ES-11169 and MI-11961-AS Systems only).....	MI-11973-2
18,000-Hz Trip Cue Board	MI-11973-3
Playback Amplifier	MI-11974-4
Power Supply	MI-11974-1
50-Hz Modification Kit (4 required)	MI-11494
Remote Control Panel (Record)	MI-11968-2
Preamplifier Kit	
(Provides four low level outputs)	MI-11369

* By use of MI-11494 Conversion Kits

Ordering Information

RT-8A Mono Multicartridge Tape System (for use with RT-7 Pre-Recorded Cartridges)ES-11168

Consisting of:

- 1 RT-8A Multicartridge Unit including 4 mono transports, but less trip cue board.....MI-11961-A
- 4 18,000-Hz Trip Cue Circuit BoardMI-11973-3

RT-8A Mono Multicartridge Tape System (for use with RT-17 Pre-Recorded Cartridges)ES-11169

Consisting of:

- 1 RT-8A Multicartridge Unit including 4 mono transports, but less random cue and end-of-message cue boards.....MI-11961-A
- 4 150-Hz End-of-Message Cue BoardsMI-11973-1

RT-8A Stereo Multicartridge Tape System (for use with RT-37 Pre-Recorded Cartridges)MI-11961-AS

Including 4 stereo transports and 4—150-Hz end-of-message cue boards for use with RT-37/BA-37 recorded cartridges

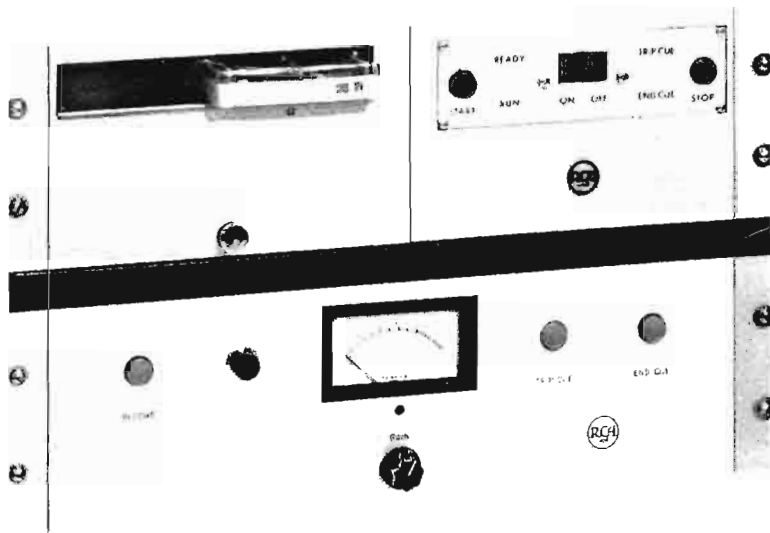

- Monaural Program Record and Playback
- Pull-out Tape Transport
- Separate Record and Playback Heads
- Plug-in Circuit Boards
- Three Cue Frequencies
- Silicon Transistors

Cartridge Tape Recorder, Type RT-17A

Description

RCA Deluxe Cartridge Tape Recorders are ideal studio equipments for recording program material that is later available for instant selection and playback. The Monaural Type RT-17A with its automatic, silent operation, compact modern styling, and high quality reproduction adds a new realism to broadcast material from "quickie" spot announcements to complete programs.

With tape cartridges, cueing and threading of tape is unnecessary. The desired cartridge is selected, placed in the playback unit until "on air" time when it is instantly available for playback at the touch of the start button. Remote control permits program record or playback from any desired location. Through a trip cue tone which may be placed anywhere on the tape, the RT-17A can automatically trigger slide projectors, or other equipment capable of being remotely started. The end-of-message cue is used to instantly start RT-17's tape recorders, or other program units on completion of a message.

Compact, Modern Styling

The RT-17A Monaural Tape Cartridge System consists of two separate units, the RT-17A Playback

Unit and the BA-17A Cartridge Recorder. Both units are designed for standard rack or console mounting and require but $5\frac{1}{4}$ inches of rack space. Remote control panels, tape cartridges, cabinet stands, cartridge storage racks, eac. are optional accessories.

30 Minute Continuous Play

The RT-17A Playback Unit reproduces tape cartridges varying in length from 40 seconds to 31 minutes. Delayed broadcast, spot announcement campaigns, production aids, themes, station breaks—all can be handled by the unit with a minimum of effort.

Transistor Circuitry

Compact transistor design is displayed in the Deluxe Cartridge Tape System. Plug-in circuit boards and plug-in power supply circuit board together with the new roll-out transport mechanism permit quick access to the equipment for easy service. The 24-volt control relays are plug-in types.

The Playback Unit consists of tape deck, power supply, playback amplifier and cue circuitry all designed for continuous use, economical power consumption, and reliable operation.

The unit is housed in a shielded chassis with functional front panel of heavy gage aluminum. The panel contains the slot for insertion of the tape cartridge, an ON-OFF switch, and all operating controls.

Simplicity of Operation

The Cartridge playback unit is ready to go at the flick of a button. A red pilot light shows when the equipment is on. After insertion of the cartridge, an amber ready light located beside the start button will light. Upon depressing the start button, the tape will run and a green run light will show. At the end of the tape run the equipment will automatically stop, the green run light will go out and the amber light again appear. Indicator lights show presence of trip cue and end of message cues.

Three Cue Frequencies

Three cue frequencies—stop cue—end of message cue—and trip cue—are provided in the RT-17A. The tape may be stopped at any time by pressing the stop button. Relays control the start and stop functions of the unit through impulses generated by a cue tone control circuit. These cue tone bursts are

inserted automatically each time the tape is started during recording so that taped announcements always are properly recued and ready for reuse. A special feature is the use of two additional cue circuits which are independent of the cue-tone circuit. This feature allows the broadcaster to record the second, or "end of message" cue tone, immediately at the conclusion of the program material. It is used to "trigger" start following program devices or automation systems. The third, or trip-cue tone, may be recorded at any time. This tone, when reproduced during playback, can be used to activate associated program devices such as TV slide projectors with split-second accuracy.

Individual Record Level Controls

The BA-17A Record Amplifier is similar to the RT-17A Playback Unit in chassis construction and appear-

ance to provide an integrated appearance. The front panel contains the RECORD button and red supervisory light to indicate the recording mode. Cut buttons grouped at the right of the panel by themselves minimize accidental operation.

Microphone and Bridging Inputs

The BA-17 Amplifier has sufficient gain to permit microphone recording and a bridging pad may be connected for recording at line level. The record amplifier, bias and cue oscillators are mounted on glass epoxy laminate plug-in boards which can easily be removed for servicing. The unit is designed and shielded to minimize pick-up of hum and r-f fields. The recorder connects to the playback with a light, flexible cable and plug arrangement. Operating voltage for the amplifier are supplied by the Playback Unit. Operation at 115 or 230 Volts is optional.

Continuous Playback

Careful consideration has been given to prevention of accidental recording. The recorder must be intentionally placed in the record mode before a recording can be made, and drops out of the mode whenever a tape is stopped. Convenient terminals are available for addition of a "stop cue" defeat switch that would permit start-stop recording of a series of separate messages. This will eliminate the intervening stop cues so as to permit continuous playback. Operation of the record button during playback will not accidentally place the system in the record mode.

Record-Playback Heads

Separate playback and record heads permit simultaneous playback or monitoring while recording. The RT-17 system employs two track heads for program and cue.

Specifications

Frequency Response	±2 dB 50-12,000 Hz at 7½ ips ±4 dB 50-15,000 Hz at 7½ ips
Distortion.....	Less than 2% at normal recording level
Signal-to-Noise Ratio	45 dB at standard NAB Reference level
Cross Talk Between Channels	Better than 55 dB
Wow and Flutter.....	Less than 0.2% RMS
Bias Frequency	75 kHz
Tape Speed.....	7.5 ips ±0.4%
Equalization	NAB
Playback Time.....	1 second to 31 minutes in 3 basic cartridge sizes
Cueing Accuracy.....	Within 0.1 second
Starting Time	0.05 second or less
Output Level	+18 dBm, 150/600 Ohms, balanced
Recording Input Level	Microphone -70 dBm (minimum) Matching -20 dBm (maximum) Bridging ±18 dBm (maximum)
Input Impedance.....	Unloaded input transformer for 37/150/250 Ohm microphones, or 20,000 Ohm bridging input
Cue Signal	1 kHz automatically recorded at start of recording
Auxiliary Cue Signals:	
End of Message	150 Hz tone may be recorded manually or automatically
Trip Cue	8 kHz may be recorded at any time
Meters.....	Two 3" illuminated, rectangular VU
Indicator Lights:	
RT-17A.....	"Ready," "Run," "Trip Cue," and "End Cue"
BA-17A	"Record"

Heads.....	Two tracks, separate record and playback heads permit simultaneous monitoring while recording		
Transistor and Diode Complement:			
RT-17A.....	17—2N2270,	1—2N301,	4—1N4140, 1—1N721A, 4—1N3253
BA-17A.....	11—2N2270,	4—1N34A,	6—1N3253
Power Requirements	115/230 Volts, AC, 60 Hz		
Power Consumption	Record, 80 Watts; Playback, 69 Watts; Ready, 54 Watts; Standby, 8 Watts		
Ambient Temperature.....	55°C max.		
Finish.....	Silver Gray epoxy		
Dimensions (overall):			
	Wide	High	Deep
RT-17A	19"	5¼"	16¼"
	48.26 cm	13.34 cm	41.28 cm
BA-17A	19"	5¼"	11½"
	48.26 cm	13.34 cm	29.53 cm
Weight:			
RT-17A.....	52 lbs. (23.59 kg.)		
BA-17A.....	25 lbs. (11.34 kg.)		

Accessories

Power Supply Board	MI-11974-1
End Cue, Trip Cue Board	MI-11974-2
Cue Amplifier Board	MI-11974-3
Playback Amplifier Board	MI-11974-4
Bias and Cue Tone Board	MI-11974-5
Record Amplifier Board	MI-11974-6
Module Extender (Set of 4)	MI-11495
Module Extender (Set of 2)	MI-11496
Spare Tape Deck with Play Head	MI-11363
Remote Control Panel—Record	MI-11968-2
Stereo Head	MI-11975

Ordering Information

Other RT-17 System Components and spares including remote control panels, console cabinets, cartridges and cartridge storage racks, etc. are described in RCA Catalog B.1725.

RT-17A Cartridge Playback Unit (Monaural).....	MI-11965-A
BA-17A Cartridge Recorder (Monaural).....	MI-11966-A

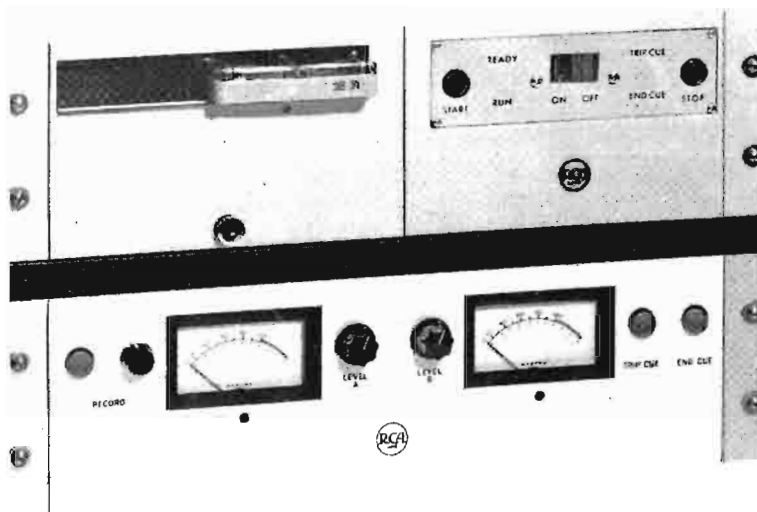

- Stereo Program Record and Playback
- Pull-out Tape Transport
- Separate Record and Playback Heads
- Plug-in Circuit Boards
- Three Cue Frequencies
- Silicon Transistors

Stereo Cartridge Tape Recorder, Type RT-37A

Description

RCA Deluxe Cartridge Tape Recorders are ideal studio equipments for recording program material that is later available for instant selection and playback. The Stereo Type RT-37A with its automatic, silent operation, compact modern styling, and high quality reproduction adds that third dimension to broadcast material from "quickie" spot announcements to complete programs.

With tape cartridges, cueing and threading of tape is unnecessary. The desired cartridge is selected, placed in the playback unit until "on air" time when it is instantly available for playback at the touch of the start button. Remote control permits program record or playback from any desired location. Through a trip cue tone which may be placed anywhere on the tape, the RT-37A can automatically trigger slide projectors, or other equipment capable of being remotely started. The end of message cue is used to instantly start RT-37's, tape recorders, or other program units on completion of a message.

Compact, Modern Styling

The RT-37A Stereo Tape Cartridge System consist of two separate units, the RT-37A Playback Unit

and the BA-37A Cartridge Recorder. Both units are designed for standard rack or console mounting and require but 5¼ inches of rack space. Remote control panels, tape cartridges, cartridge storage racks, etc. are optional accessories.

30 Minute Continuous Play

The RT-37A Playback Unit reproduces tape cartridges loaded with lubricated tape varying in length from 40 seconds to 31 minutes. Delayed broadcast, spot announcement campaigns, production aids, themes, station breaks—all can be handled by the unit with a minimum of effort.

Transistor Circuitry

Compact transistor design is displayed in the Deluxe Cartridge Tape System. The Playback unit consists of tape deck, power supply, playback amplifier and cue circuitry all designed for continuous use, economical power consumption, and reliable operation. The unit is housed in a shielded chassis with functional front panel of heavy gage aluminum. The panel contains the slot for insertion of the tape cartridge, an ON-OFF switch, and all operating controls.

Simplicity of Operation

The Cartridge playback unit is ready to go at the flick of a button. A red pilot light shows when the equipment is on. After insertion of the cartridge, an amber ready light located beside the start button will light. Upon depressing the start button, the tape will run and a green run light will show. At the end of the tape run the equipment will automatically stop, the green run light will go out and the amber light again appear. Indicator lights show presence of trip cue and end of message cues.

Three Cue Frequencies

Three cue frequencies—stop cue—end of message cue—and trip cue—are provided in the RT-37A. The tape may be stopped at any time by pressing the stop button. Relays control the start and stop functions of the unit through impluses generated by a cue tone control circuit. These cue tone bursts are inserted automatically each time the tape is started during recording so that taped announcements always are properly recued and ready for reuse. A special feature is the use of two additional cue circuits which are independent of the cue-tone circuit. This feature allows the broad-

caster to record the second, or "end of message" cue tone, immediately at the conclusion of the program material. It is used to "trigger" start following program devices or automation systems. The third, or trip-cue tone, may be recorded at any time. This tone, when reproduced during playback, can be used to activate associated program devices such as TV siled projectors with split-second accuracy.

Individual Record Level Controls

The BA-37A Record Amplifier is similar to the RT-37A Playback Unit in chassis construction and appearance to provide an integrated appearance. The front panel contains the RECORD button and red supervisory light to indicate the recording mode. The BA-37 Stereo Record Amplifiers have individual gain controls for level balancing and two front panel illuminated meters to monitor both channels simultaneously. Cue buttons grouped at the

right of the panel by themselves minimize accidental operation.

Microphone and Bridging Inputs

The BA-17 Amplifier has sufficient gain to permit microphone recording and a bridging pad may be connected for recording at line level. The record amplifier, bias and cue oscillators are mounted on glass epoxy laminate plug-in boards which can easily be removed for servicing. The unit is designed and shielded to minimize pick-up of hum and r-f fields. The recorder connects to the playback with a light, flexible cable and plug arrangement. Operating voltage for the amplifier are supplied by the Playback Unit. Operation at 115 or 230 Volts is optional. The Stereo Amplifier has two microphone inputs for each channel with provision for monitoring the tone and bias levels. The dual circuitry of record amplifiers, bias and cue oscillators are mounted on three plug-in boards.

Continuous Playback

Careful consideration has been given to prevention of accidental recording. The recorder must be intentionally placed in the record mode before a recording can be made, and drops out of the mode whenever a tape is stopped. Convenient terminals are available for addition of a "stop cue" defeat switch that would permit start-stop recording of a series of separate messages. This will eliminate the intervening stop cues so as to permit continuous playback. Operation of the record button during playback will not accidentally place the system in the record mode.

Record-Playback Heads

Separate playback and record heads permit simultaneous playback or monitoring while recording. The RT-37 system has three track heads for stereo operation in which two tracks are used for program and one track for cue signals.

Specifications

Frequency Response	±2 dB 50-12,000 Hz at 7½ ips ±4 dB 50-15,000 Hz at 7½ ips
Distortion.....	Less than 2% at normal recording level
Signal-to-Noise Ratio	42 dB at NAB Standard Reference Level
Cross Talk Between Channels	Better than 50 dB
Wow and Flutter.....	Less than 0.2% RMS
Bias Frequency	75 kHz
Tape Speed.....	7.5 ips ±0.4%
Equalization	NAB
Playback Time.....	1 second to 31 minutes in 3 basic cartridge sizes
Cueing Accuracy.....	Within 0.1 second
Starting Time.....	0.05 second or less
Output Level	+18 dBm, 150/600 Ohms, normally +8 vμ
Recording Input Level	Microphone -70 dBm (minimum) Matching -20 dBm (maximum) Bridging +18 dBm (maximum)
Input Impedance.....	Unloaded input transformer for 37/150/250 Ohm microphones, or 20,000 Ohm bridging input
Transistor and Diode Complement:	
RT-37A.....	22—2N2270, 1—2N301, 4—1N4140, 1—1N721A, 4—1N3253
BA-37A.....	4—1N34A, 6—1N3253, 17—2N2270
Cue Signal	1 kHz automatically recorded at start of recording
Auxiliary Cue Signals:	
End of Message	150 Hz tone may be recorded manually or automatically
Trip Cue	8 kHz may be recorded at any time
Meters.....	Two 3" illuminated, rectangular VU

Indicator Lights:			
RT-37A.....	"Ready," "Run," "Trip Cue," and "End Cue"		
BA-37A	"Record"		
Heads.....	Three track, separate record and playback heads permit simultaneous monitoring while recording		
Power Requirements	115/230 Volts, AC, 60 Hz (50 Hz optional by use of MI-11494 Conversion Kit)		
Power Consumption	Record, 80 Watts; Playback, 69 Watts; Ready, 54 Watts, Standby, 8 Watts		
Finish.....	Silver Gray epoxy		
Ambient Temperature.....	55°C max.		
Dimensions (overall):	Wide	High	Deep
RT-37A	19"	5¼"	16¼"
	48.26 cm	13.34 cm	41.28 cm
BA-37A	19"	5¼"	11⅝"
	48.26 cm	13.34 cm	29.53 cm
Weight:			
RT-37A.....			52 lbs. (23.59 kg.)
BA-37A.....			25 lbs. (11.34 kg.)

Accessories

Power Supply Board	MI-11974-1
End Cue, Trip Cue Board	MI-11974-2
Cue Amplifier Board	MI-11974-3
Playback Amplifier Board	MI-11974-4
Bias and Cue Tone Board	MI-11974-5
Record Amplifier Board	MI-11974-6
50-Hertz Conversion Kit	MI-11494
Remote Control Panel—4 Playbacks	MI-11968-1
Remote Control Panel—Record	MI-11968-2
Stereo Head	MI-11975

Ordering Information

Other RT-37 System Components and spares including remote control panels, console cabinets, cartridges and cartridge storage racks, etc. are described in RCA Catalog B.1725.

RT-37A Cartridge Playback Unit (Stereo).....	MI-11962-A
BA-37A Cartridge Recorder (Stereo).....	MI-11963-A

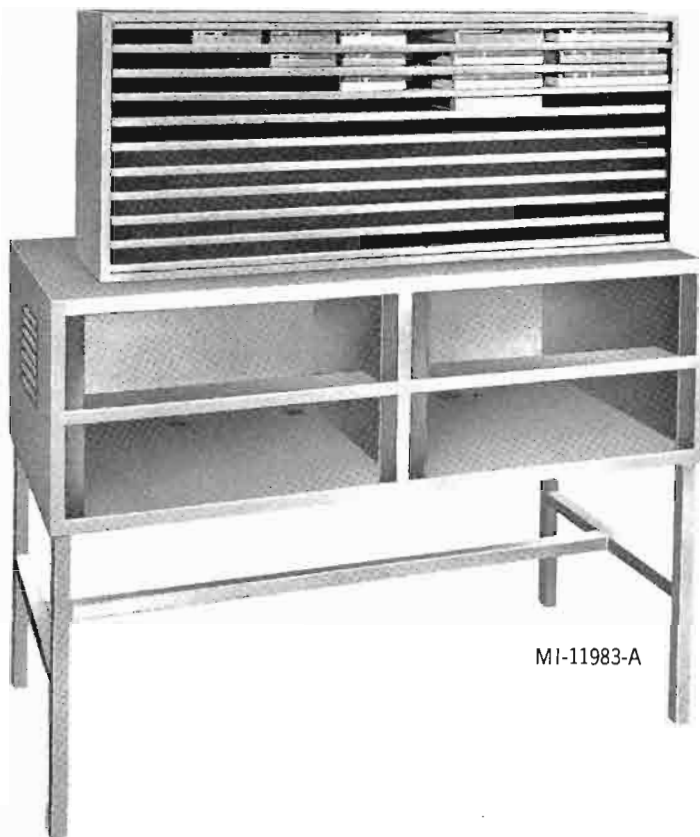

MI-11985-A

MI-11983-A

Four-unit Console (MI-11983-A) with Tape Cartridge Storage Cabinet (MI-11985-A) mounted above.

- Choice of attractively styled consoles for two or four Playback or Record amplifier units
- Matching storage cabinet with large tape cartridge capacity
- Affords ease of identification and efficient handling of cartridges
- Flexible mounting system meets varying studio space requirements
- Provisions for mounting automatic switcher, standard audio panels and other equipment

Cartridge Tape Accessories

Description

RCA Tape Cartridge Consoles provide mountings at a convenient operating level for the RT-7/17/37 Tape Cartridge Playback Units and the BA-7/17/37 Tape Cartridge Record Amplifiers. MI-11984-A is a two-unit console designed to mount two playback units, or one playback unit and one record amplifier. MI-11983-A Console is a four-unit cabinet to mount four playback or one record amplifier and three playback units with suf-

ficient space at the rear to mount an RT-7 Audio Automatic Switcher, MI-11982. A Tape Cartridge Storage Cabinet, MI-11985-A, provides ten shelves 1½ inches high to accommodate the 300 series of tape cartridges.

The consoles are sturdily constructed of metal with a midnight blue finish. Holes in the cabinet accommodate interconnection cables and louvers afford ventilation. Pro-

TECTIVE screens, attached to the rear frames also provide ventilation.

Cabinet MI-11985-A is set up to store 80 small, 300 Series tape cartridges. The storage cabinet may be placed on top of the consoles. Two cabinets can be accommodated if placed back-to-back. Mounting feet have been provided so that the cabinet may be placed on the floor underneath the MI-11983-A Console. There is room for two storage cabinets, one on each side of the cross bar.

Tape Cartridge Consoles

SPECIFICATIONS

	2 Unit Console MI-11984-A	4 Unit Console MI-11983-A	Storage Cabinet MI-11985-A
Construction	Metal	Metal	Metal
Finish	Midnight blue	Midnight blue	Midnight blue
Legs	17" long, 43.18 cm removable	17" long, 43.18 cm removable	—
Dimensions (overall)			
Width	20 $\frac{3}{4}$ " 52.71 cm	40 $\frac{3}{4}$ " 103.51 cm	35 $\frac{7}{8}$ " 91.12 cm
Depth	19 $\frac{5}{16}$ " 50.32 cm	19 $\frac{5}{16}$ " 50.32 cm	9" 22.86 cm
Height (less legs)	13" 33.02 cm	13" 33.02 cm	16" 40.64 cm
Height (with legs)	30" 76.20 cm	30" 76.20 cm	—
Weight (approximate)	25 lbs. 11.34 kg.	40 lbs. 18.14 kg.	30 lbs. 13.61 kg.

Ordering Information

Console Cabinet for two Playback or one Playback and one Record Amplifier Units complete with legs and mounting hardwareMI-11984-A



Convenient two-unit Console, MI-11984-A, for mounting one Tape Cartridge Playback Unit and one Record Amplifier or two Playback Units.

Console Cabinet for four Playback or three Playback and one Record Amplifier Units complete with legs, crossbar, and mounting hardwareMI-11983-A
Cartridge Storage Cabinet with dividers and spacer boards set up to store 80 small, 300 series tape cartridgesMI-11985-A

RT-7 Audio Automatic Switcher

Audio Automatic Switcher, MI-11982, is an important unit in RCA's Cartridge Tape System affording a means to switch up to four RT-7 outputs to one console input. The switchers may be connected in tandem to service multiple playback units when desired.

SPECIFICATIONS

Operation Sequential
Power Requirement...110/220 Volts, AC, 50/60 Hz, single phase
Line Cord and Plug56" long
Fuse1, slo-blo, rated 0.3 Amps
Diode1 Type 1N1763
Dimensions (overall)3 $\frac{1}{4}$ " high, 13" wide, 2 $\frac{1}{4}$ " deep
(8.26 cm, 33.02 cm, 6.83 cm)
Weight4 lbs. (1.8 kg.)

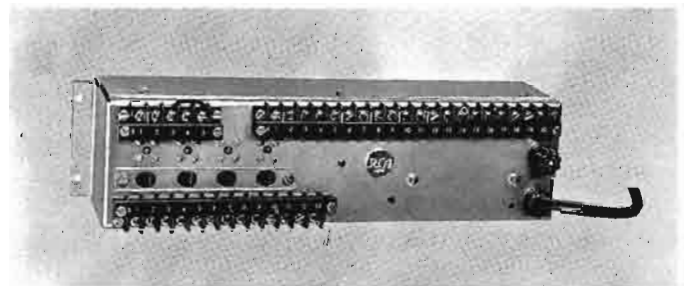

MI-11982 Audio Automatic Switcher.

Ordering Information

Audio Automatic Switcher complete with line cord and plugMI-11982

RT-7 Remote Control Panels

Remote Control Panel, MI-11977 provides a convenient means for remotely controlling from one to four RT-7 Cartridge Tape Playback Units. Through a rear terminal board connections may easily be made directly to the playback units. Four red pushbuttons on an alu-

minum panel labelled "START," control up to four units.

Remote control of the BA-7 Record Amplifier in the RT-7 Cartridge Tape System is provided by Remote Control Panel, MI-11979. Operational functions of the BA-7 can

be transferred to the remote control panel with its four pushbutton controls—START, RECORD, STOP, AND TRIP-CUE. The panel is identical in size and styling with the remote control panel for the RT-7 Playback Unit.

MI-11977

MI-11979

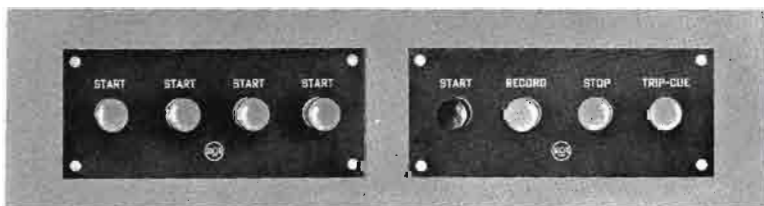

SPECIFICATIONS

Dimensions (overall)2 $\frac{1}{2}$ " high, 6" wide, 2 $\frac{1}{4}$ " deep
(8.89 cm, 15.24 cm, 7.14 cm)
Weight $\frac{1}{2}$ lb. (0.25 kg.)
FinishDark umber gray

Ordering Information

Remote Control Panel for RT-7 Playback Unit CompleteMI-11977
Remote Control Panel for BA-7 Record Amplifier.....MI-11979

Cartridge Tape Head Degausser

The Cartridge Tape Head Degausser, MI-11995, is designed to facilitate demagnetizing of record-playback and erase heads of cartridge tape units. The unit is housed in a lightweight hand-grip case. It has a 1 $\frac{3}{8}$ -inch demagnetizing tip that can be conveniently inserted in the slot of the tape cartridge housings. A momentary-contact ON-OFF pushbutton safety switch energizes the unit.

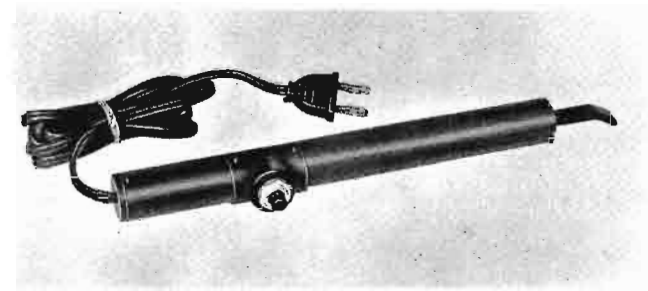

Long Probe Degausser, MI-11995.

SPECIFICATIONS

Power Requirements.....117 Volts, AC, 50/60 Hz, single phase
 SwitchMomentary contact, rating 8 Amps.
 Line Cord5 ft. long (1.52 m)
 FinishBlack

Dimensions Overall9 $\frac{7}{8}$ " long, $\frac{7}{8}$ " diameter
 (25.08 cm, 2.22 cm)
 Weight9 oz. (0.25 kg.)

Ordering Information

Cartridge Tape Head Degausser (117 V. AC)MI-11995
 Cartridge Tape Head Degausser (230 V. AC)MI-11996

Tape Cartridges and Tape Head Cleaner

Cartridges, blank or tape loaded, for use with the RCA Tape Cartridge System are made available in varying sizes and with convenient playing time ranging from 40 seconds to more than a half hour. Cartridge cases are plastic with clear top and RCA Light Gray base. Car-

tridges are loaded with RCA Type 10-MCG-16 single coated lubricated tape, and wound for continuous-loop operation with the RT-7, RT-17, and RT-37 Playback Units. Special tape lengths are available on special order.

The Cartridge Tape Head Cleaner, MI-11998, facilitates frequent head cleaning. The head cleaner contains a cotton belt (or tape) which is assembled in an empty 1200 series cartridge. By the application of a solvent such as denatured alcohol on the belt and then by inserting the cartridge into the unit and allowing it to run for a few seconds, the heads can be given a frequent cleaning. A set of twelve cleaning belts can be reordered as MI-11999.

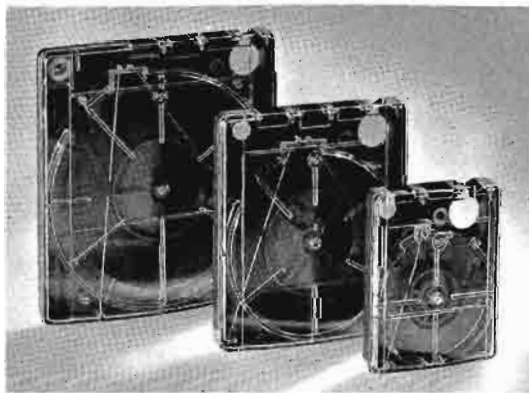

Series 1200, 600 and 300 (large, medium and small) RCA Tape Cartridges.

Ordering Information

Bulk lubricated audio tape,
 7" reel, 1600 ft., RCA Type 10-MCG-16MI-11986-A
 Azimuth alignment calibration tape (with 15,000 Hz tone
 and frequency response test tape (with voice identified
 test frequencies) supplied in a single 300 Series
 CartridgeMI-11993-3
 Cartridge Tape Head Cleaner
 (including 12 belts)MI-11998
 Pack 12 Cleaning BeltsMI-11999

Specifications and Ordering Information for Tape Cartridges

Stock Identification	Cartridge Series	Playing Time	Size Overall	Unit Weight	Packaged	MI Total Weight
MI-11988-B1	300	40 secs.	4" w x 5 $\frac{1}{8}$ " d x $\frac{7}{8}$ " h	3 oz.	6/box/MI	1 $\frac{1}{4}$ lbs.
MI-11988-B2	300	70 secs.	4" w x 5 $\frac{1}{8}$ " d x $\frac{7}{8}$ " h	3 $\frac{1}{2}$ oz.	6/box/MI	1 $\frac{1}{2}$ lbs.
MI-11988-B11	300	2 $\frac{1}{2}$ min.	4" w x 5 $\frac{1}{8}$ " d x $\frac{7}{8}$ " h	4 oz.	6/box/MI	1 $\frac{3}{4}$ lbs.
MI-11988-B3	300	3 $\frac{1}{2}$ min.	4" w x 5 $\frac{1}{8}$ " d x $\frac{7}{8}$ " h	4 oz.	6/box/MI	1 $\frac{3}{4}$ lbs.
MI-11988-B4	300	5 $\frac{1}{2}$ min.	4" w x 5 $\frac{1}{8}$ " d x $\frac{7}{8}$ " h	4 $\frac{1}{2}$ oz.	6/box/MI	2 lbs.
MI-11988-B5	300	10 $\frac{1}{2}$ min.	4" w x 5 $\frac{1}{8}$ " d x $\frac{7}{8}$ " h	5 $\frac{1}{2}$ oz.	6/box/MI	2 $\frac{1}{4}$ lbs.
MI-11988-B6	600	16 min.	6" w x 7" d x $\frac{7}{8}$ " h	10 oz.	2/box/MI	1 $\frac{1}{2}$ lbs.
MI-11988-B7	1200	31 min.	7 $\frac{5}{8}$ " w x 8 $\frac{3}{8}$ " d x $\frac{7}{8}$ " h	13 oz.	2/box/MI	2 lbs.
MI-11988-B8	300	blank	4" w x 5 $\frac{1}{8}$ " d x $\frac{7}{8}$ " h	2 $\frac{3}{4}$ oz.	6/box/MI	1 $\frac{1}{8}$ lbs.
MI-11988-B9	600	blank	6" w x 7" d x $\frac{7}{8}$ " h	3 oz.	6/box/MI	1 $\frac{1}{4}$ lbs.
MI-11988-B10	1200	blank	7 $\frac{5}{8}$ " w x 8 $\frac{3}{8}$ " d x $\frac{7}{8}$ " h	4 oz.	2/box/MI	10 oz.

Cartridge Tape Bulk Eraser

Bulk Eraser, MI-11992, affords complete erasure of any 1/4-inch recorded reel of tape or tape cartridge. The eraser will demagnetize record-playback and erase heads, thus eliminating distortion and tape background noise problems.

The bulk eraser is housed in a plastic, hand-grip case measuring only 4 7/8 inches in diameter and 4 3/4 inches high overall. A momentary-contact, ON-OFF pushbutton safety switch prevents current being applied when not in use. To operate, simply plug into any AC outlet and hold over the reel of tape, energize, then rotate the eraser around the tape for several seconds. Slowly withdraw the eraser from the tape to arms length before releasing on-off pushbutton.



MI-11992

SPECIFICATIONS

Power Consumption	100-130 Volts, 50/60 Hz, AC single phase, 8.5 Amps
Switch	Momentary contact rating 15 Amp AC inductive
Line Cord	8 ft. long (2.44 m)
Dimensions (including handle)	4 7/8" dia. by 4 3/4" high (12.38 cm dia. by 12.06 cm high)
Weight	4 lbs. approx. (1.8 kg.)

Ordering Information

Bulk Eraser complete in plastic, hand-grip type case, furnished with 8-foot (2.44 m) line cord, molded rubber plugMI-11992

Automatic Magnetic Tape Eraser

The RCA Automatic Magnetic Tape Eraser is a self-contained unit mounted in a metal cabinet of table height requiring a floor space about 22 inches square. The unit is designed to erase full reels of magnetic film or tape and will accommodate up to 15-inch reels.

Audio and video signals are

erased down to the noise level of the magnetic medium in an automatic 18 second cycle. The erase cycle is fully automatic and controlled by a motor-operated mechanism. Once the reel of tape is placed on the carriage and pushed into the operating position the erase cycle is set in motion without

manual operation of any controls.

The use of an air core coil eliminates the possibility of "erasure spokes" so common in erasing with an iron core coil. Power factor correction with the air core coil provides a very high field strength from a nominal 12 Ampere 220 Volt input.



ES-29976

SPECIFICATIONS

Capacity	6 rolls of 1/4" tape, or 3 rolls of 1/2" tape; or 2 rolls of 16mm film, 1 roll of 35mm film; or 1 roll of (2") TV tape
Roll or Reel Size	Up to 2" height and 15" diameter
Erase Cycle	18 seconds automatically controlled
Erase Coil	Air Core Type (approx. 600 gauss)
Degree of Erasure	Reduces a fully modulated signal to the noise level of the magnetic medium
Power Requirements	Approximately 12 Amperes—220/115 Volts, 3 wire, 1 phase, 60 Hz
Dimensions	22" long, 21 5/8" wide, 37 1/4" high (55.88 cm, 54.93 cm, 94.62 cm)
Weight	235 lbs. (106.5 kg.)

Ordering Information

Automatic Magnetic Tape Eraser, 60 Hertz (Audio) ES-29976
 Automatic Magnetic Tape Eraser, 50 Hertz (Audio) ES-29978
 Automatic Magnetic Tape Eraser, (Video) 60 Hertz ES-29975
 Automatic Magnetic Tape Eraser, (Video) 50 Hertz ES-29977



- Convenient means of pre-recording
- For reel and cartridge tape
- For recording, editing, re-recording
- Separate microphone and program mixers
- Illuminated pushbutton selection of audio sources

Custom Tape Production System

Description

With the new RCA Custom Tape Production System you can record, edit or re-record anything from spot announcements to complete broadcast programs with a minimum of set-up time. You free overtaxed existing audio facilities for broadcasting with this convenient programming center.

The Tape Production System is designed to provide the utmost flexibility and convenience in meeting programming demands of present-day broadcasting. At locations apart from on-air facilities this transistorized audio production center permits program and production personnel to prepare or edit reel or cartridge tapes without interference or interruption to

on-air programming. The system is ideal for transferring material from disc or tape to cartridge tape. Live announce inserts may be added or superimposed as desired.

The versatility of the system is such that numerous day-to-day and emergency operations can be performed without disruption to regular broadcast facilities. For example, the system can be used to record network, remote, or special programs for later on-air use. Program personnel can prepare complete programs for later use. Spot announcements can be sequentially recorded on tape for use with radio automation systems. Records and tapes may be auditioned through the system (without neces-

sarily re-recording) by non-technical personnel. The RCA Custom Tape Production System may also be used to originate programs for on-air or other uses thereby providing added program originating facilities for the station.

The RCA custom equipment is supplied as a complete production system and includes an RCA Type RT-7D/BA-7B Cartridge Tape System, RCA Type RT-21B Professional Audio Tape Recorder, all necessary amplifiers, 24-Volt power supply and a custom control panel. The completely-wired system is housed in two 60-inch cabinets and includes a Formica-covered desk top, shelf mounted 29½-inches above the base. Suggested external

equipment items (supplied separately as accessories) include a loudspeaker and cabinet, transcription turntable with equalizing preamplifier, and a microphone. All connections to external equipment, AC power, and circuits to and from the master control are made to convenient receptacles which are

accessible through the rear cabinet doors.

The centralized custom control panel includes a VU meter, microphone switch and mixer, interlocked five-position input selector switch and mixer, headphone jack, and monitor volume control. These facilities permit pushbutton mixing

of a microphone with one of three other program sources and recording the result on either cartridge or reel tape recorder. The cabinets are 59 $\frac{5}{8}$ inches high, 44 inches wide and 21 $\frac{1}{8}$ inches deep at the base or 40 inches deep overall. The cabinet and desk weigh approximately 500 pounds, or 675 pounds including equipment in place.

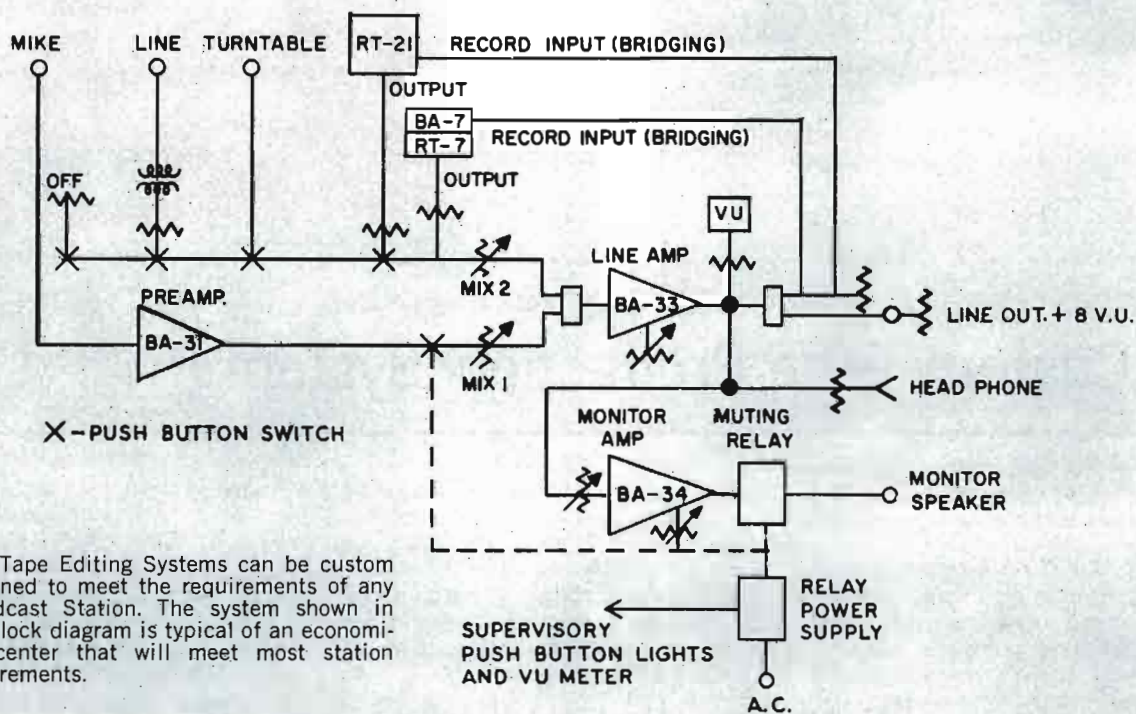



- Excellent frequency response, 25-16,000 Hz
- Low cone resonance
- Ideal for monitoring AM, FM and television programs
- Wide angle sound radiation of all frequencies

Duo-Cone Speaker Mechanism, Type LC-1B

Description

The LC-1B is a "Broadcast Quality" loudspeaker with low distortion, wide angle distribution, and extended frequency range. It is specifically designed for use in recording studios, executive offices, reception rooms, sponsors' booths, control rooms or other locations that warrant the finest sound possible. This speaker gives wide range smooth response from 25 to 16,000 hertz with low harmonic distortion and with very uniform distribution over a 120 degree angle.

High-Compliance Duo-Cone

The LC-1B Loudspeaker is a high-compliance duo-cone speaker providing excellent response over a wide angle. The two coaxial cones are direct radiators and are driven by separate voice coils. An electrical filter consisting of a 4 μ F capacitor and the inductance of the low-frequency voice coil delivers the low frequencies to the large outer cone

and the high frequencies to the small inner cone. The filter (or crossover network) reduces the response of the low-frequency unit above 1600 hertz and that of the high-frequency unit below 1600 Hz.

Alnico V Magnets

Other features of the construction are: a sturdy die-cast aluminum frame; separate Alnico V magnets in a non-welded structure for high and low frequencies; a high-frequency voice coil wound with aluminum wire to get full high-frequency range. A specially treated fabric cone suspension allows a low, 22 hertz cone resonance and extended low frequency response. The high frequency diaphragm is mounted co-axially with the low frequency diaphragm and the two conical surfaces are in line. This minimizes out of phase components in the cross-over range. Smooth response is also obtained by the shallow angle

of the diaphragm, and flange mounting which places the face of the diaphragm practically flush with the face of the baffle.

New Construction Features

A feature of construction is the use of acoustical domes—largely responsible for smooth response. The series of domes placed on the speaker's large cone breaks up the unit's symmetry and eliminates the interference normally characteristic of the symmetrical shape without sacrifice of either highs or lows.

The LC-1B is designed for use either in the Olson Floor Cabinet MI-11415-A or Wall Mount Speaker Housing, MI-11406-A-1B. The floor cabinet, functionally styled in satin walnut finish, is especially designed to reduce variations in frequency response due to diffraction effects. It also provides maximum low frequency response. The wall housing provides excellent performance.

Specifications

LC-1B Duo-Cone Speaker

Impedance (nominal)15 Ohms
 Frequency Response (see curve)25 to 16,000 Hz
 Directional CharacteristicSee graph
 Sensitivity at 1000 Hz94.5 dB
 (measured with 1 Watt signal at 4 ft.)
 Power Handling Capacity20 Watts of program material
 Resonance22 Hz (in an infinite baffle)
 Magnetic AssemblyTwo Alnico V magnets
 (in a non-welded structure)

Dimensions:

Diameter (cone)15 $\frac{5}{8}$ " (39.6 cm)
 Diameter (bolt fixing circle)16 $\frac{1}{4}$ " (43.31 cm)
 Diameter (overall frame)17" (43.2 cm)
 Depth7 $\frac{1}{8}$ " (18.9 cm)
 Weight (unpacked)21 lbs. (9.5 kg.)

LS-1A Wall Housing

Mounting30° or 60° angle
 Dimensions:
 Height (max.)21 $\frac{3}{4}$ " (55.26 cm)
 Width (overall)37 $\frac{1}{2}$ " (95.25 cm)
 Depth (max.)17 $\frac{1}{8}$ " (43.5 cm)
 Weight45 lbs. (20.4 kg.)

LS-11A Floor Cabinet

Dimensions (Exterior):

Height (including 4-inch legs)44" (111.8 cm)
 Width28 $\frac{1}{2}$ " (72.4 cm)
 Depth16" (40.6 cm)
 FinishSatin Walnut
 Weight64 lbs: (27.2 kg.)

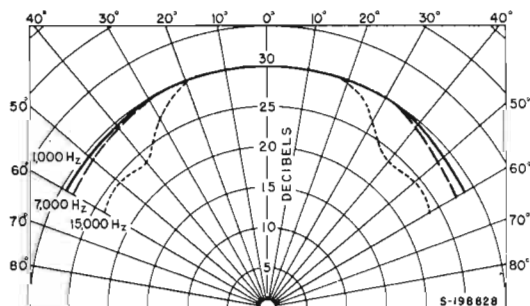
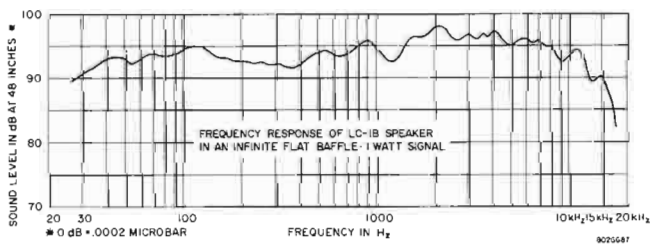

Rear view of LC-1B Duo-Cone Speaker Mechanism MI-11411-B.

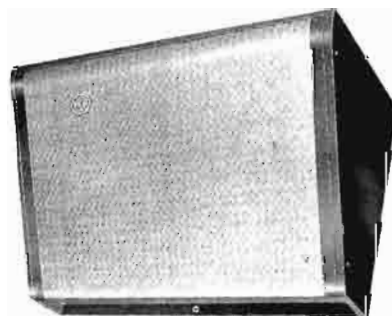

LS-1A Wall Speaker Housing MI-11406-B.



LS-11A Olson Floor Cabinet, MI-11415-A.

Ordering Information

LC-1B 15-inch Duo-Cone Speaker MechanismMI-11411-B
 LS-1A Wall Speaker Housing
 (Midnight Blue finish)MI-11406-B
 LS-11A Olson Floor Cabinet for LC-1BMI-11415-A

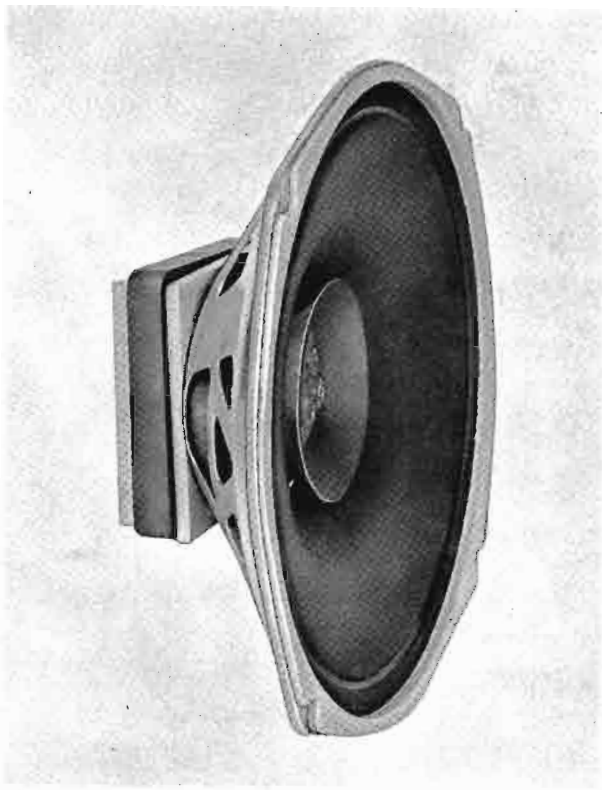

- High sensitivity
- Smooth frequency response 50 to 18,000 Hz
- Balanced listening characteristic
- Indox (ceramic) permanent magnet
- Excellent power handling capability
- Curvilinear cone plus a mechanically coupled high frequency cone

Dioplex 8-Inch Speaker, Type SL-8C

Description

The SL-8C High Fidelity Dioplex 8-inch cone type loudspeaker should be specified where smooth, uniform response and natural reproduction of voice and music are desired. This 8-inch loudspeaker may be used with any standard 8-inch baffle, but it is recommended that for quality reproduction a minimum enclosure size of 2½ cubic feet be used.

The smooth frequency response of the SL-8C Speaker is the result of extensive research by Dr. H. F. Olson and his associates at the Acoustical Laboratories of the David Sarnoff Research Center. A special shape has been used for the curvilinear cone, and, in addition, the material for the cone has received particular attention. These two factors play important roles in giving a broad pattern to the speaker. A further refinement is the damping ring in the outer suspension of the cone which provides optimum acoustical imped-

ance to eliminate effectively standing waves in the suspension cone. This gives improved efficiency at the bass end and relatively smooth response at the high end of the spectrum.

The mechanically coupled high frequency cone extends the smooth high frequency response well out beyond the normal listening range of the average listener.

Specifications

Frequency Response	50 to 18,000 Hz
Power Handling Capacity	10 Watts
Magnet Material and Weight	Indox 10 ounces
Input Impedance	8 Ohms
Overall Diameter	8¾ inches (21 cm)
Depth	3¾ inches (8.0 cm)
Weight	2¾ pounds (1.64 kg)
Axial Sensitivity at 4 ft. 1 Watt, see curve	92 dB
Cone Resonance (6½ cubic ft. cabinet)	74 Hz
Mounting Data (EIA).....	4 equally spaced slots on a 7⅝" bolt circle
Flux Density.....	9000 gauss

Ordering Information

Type SL-8C Dioplex Eight-Inch Speaker.....MI-38311-B

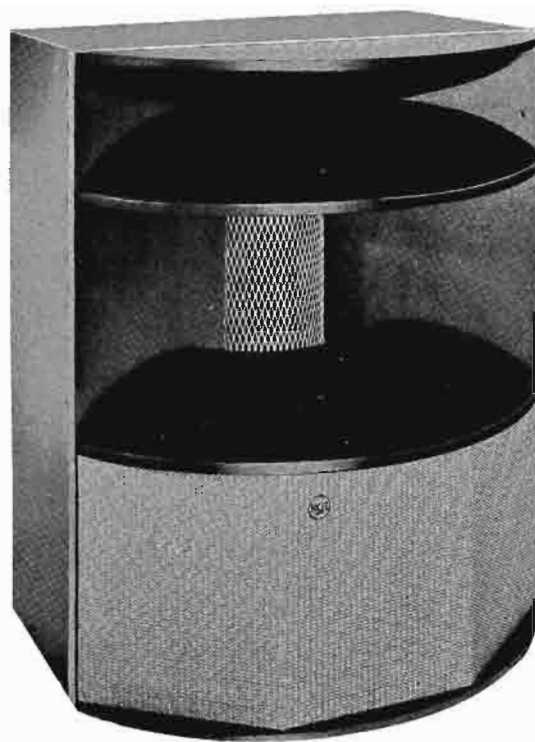

- Excellent frequency response—35 to 22,000 Hz
- 50 watts program input
- Wide angle sound radiation of all frequencies
- Matching H.F. and L.F. wavefront
- 500 hertz crossover

Auditorium Loudspeaker, Type LC-9A

Description

The LC-9A Loudspeaker system is designed for applications where high acoustical level, wide dispersion angle, and extended frequency response are required. The frequency range is covered by separate low and high frequency horns with a crossover point at 500 Hz. A feature of the LC-9A is the particular care with which the high and low frequency horns have been designed to provide matched acoustical wavefronts for smooth response over the entire frequency range at all listening angles.

Specifications

Power Input	35 Watts
Frequency Response	50 Hz to 16 kHz
High Frequency:	
Horn	120° horizontal, 45° vertical dispersion
Driver	16 Ohms, 1¾" V.C.
Low Frequency:	
Horn	120° horizontal, 45° vertical dispersion
Driver	16 Ohms, 15" speaker
Dividing Network	16 Ohms, 500 Hz crossover frequency, 12 dB per octave
Overall Size	44" high, 36" wide, 27½" deep (16¾" deep less flair) 111.76 cm, 91.44 cm, 68.90 cm (42.54 cm less flair)
Weight.....	175 lbs. (79.4 kg.)
Finish.....	Shadow blue and midnight blue

Ordering Information

Type LC-9A Studio LoudspeakerES-11423



- Smooth response from 500 to 15,000 Hz
- Aluminum voice coil and diaphragm
- High intensity permanent magnet
- Heavy duty construction

High Frequency Speaker Mechanism, MI-11419

Description

The MI-11419 High Frequency Speaker Mechanism is designed for professional audio use as a component in auditorium/studio type loudspeaker systems. Throat adaptor MI-9575 may be used to couple it to RCA Radial Horns such as MI-9594 (60 degrees) or MI-9595 (90 degrees). It may be used with other horns

having a suitable throat acoustic impedance and cross-over network.

The H.F. speaker mechanism attaches to the MI-9573 throat by means of two 1/4—20 threaded studs 2 1/4 inches apart. The throat is 2 5/8 inches front to back and adapts the H.F. speaker mechanism to the radial horn.



Throat Adaptor, MI-9575

Specifications

Nominal Voice Coil Impedance	16 Ohms
Crossover Frequency	500 Hz
Power Handling Capacity	40 Watts of program material when used in system with a suitable horn and cross-over network
Frequency Response	500 to 15,000 Hz
Gap Flux Density	16,500 gauss
Voice Coil Diameter	1 3/4" (4.45 cm)
Horn Throat Diameter	1" (2.54 cm)

Overall Diameter	4 1/2" (11.47 cm)
Overall Depth	3 7/8" (8.84 cm)
Mounting	Two 1/4—20 threaded studs, 2 1/4" apart
Shipping Weight	10 lbs. (4.54 kg.)

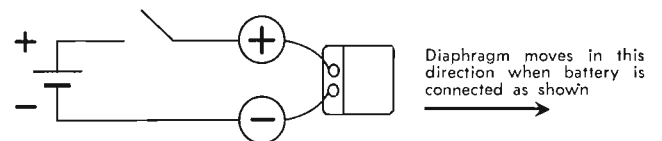

Ordering Information

High Frequency Speaker Mechanism.....MI-11419

ACCESSORIES

Throat (for use with RCA Horns MI-9594 or MI-9595).....	MI-9573
60° Radial Horn	MI-9594
90° Radial Horn	MI-9595
Diaphragm Assembly (Replacement).....	#234776

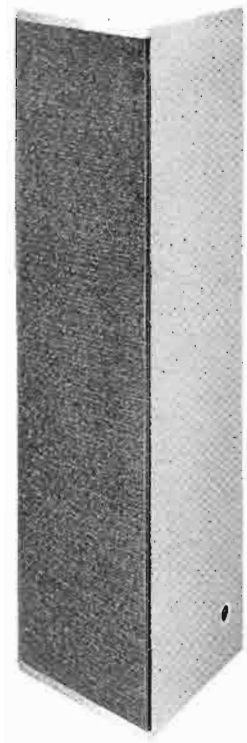

- Wide horizontal dispersion—narrow vertical dispersion—ideal for problem areas
- Excellent frequency response provided by five 8-inch speakers
- 25 Watt power rating
- High sensitivity . . . acoustically balanced
- Nominal impedance 8 Ohms

Dioplex Line Speaker System

Description

The Dioplex Line Speaker System, MI-38351-A, is used to provide uniform, full range sound coverage in studios, auditoriums, arenas, exhibition halls, and large indoor and outdoor areas which present acoustical problems. It provides an excellent degree of intelligibility where high reverberation problems are encountered with the use of conventional speaker systems.

The Dioplex Line Speaker System consists of five Type SL-58 8-inch Speakers (MI-38304-A) mounted vertically in a line, in a specifically designed and acoustically treated cabinet. The result of the "in line" combination is a concentration of sound into a fan shaped beam which can be directed into areas where sound coverage is desired while min-

imizing radiation to undesirable reflecting surfaces, thus providing high quality reproduction relatively free of harmful reverberation. The high directivity in the vertical direction is also useful in reducing feedback. Side-tapered baffles allow a number of cabinets to be mounted in a cluster over the proscenium arch. Wall mounting brackets are provided for the speaker system.

Specifications

Frequency Response of System	80 to 16,000 Hz	Size of Baffle	Front 12½" (31.75 cm), Rear 5¾" wide (14.6 cm), 13" deep (33 cm), 45½" high (115.6 cm)
Number of Loudspeakers	5—MI-38304-A	Vertical Plane Dispersion	25°/35°
Matching Impedance	8 Ohms	Horizontal Plane Dispersion	120°
Connection	Terminal block	Weight of System (Net)	25 lbs. (11.3 kg.)

Ordering Information

Dioplex Line Speaker SystemMI-38351-A



MI-12399-A



MI-12377-D

- Extended frequency response ± 1 dB from 20-20,000 Hz
- Bifilar wound primary
- Extremely low hum pickup
- Double mumetal shielded
- Core oriented especially for use in RCA amplifiers
- Plug-in and permanently fixed types

Input Transformers

Description

These transformers are used to couple a balanced low level source to a single grid. The MI-12377-D and MI-12399-A are designed for use with any microphone having a 150 to 300 Ohm impedance. The core is oriented in a fixed position which further reduces hum pickup when the transformers are used in all RCA amplifiers. The MI-12377-D can be easily rotated to also accomplish

minimum hum pickup when used in any amplifier.

These small input transformers have a balanced center tapped primary and a 50,000 Ohm unbalanced secondary enclosed in two concentric mumetal cases. Extensive tests have shown that the double shielding results in a reduction of induced hum voltage of more than 10 dB at flux densities from 2 to 20 gauss, compared to input transformers

using a single shield. The MI-12399-A transformer is easily mounted in an RCA amplifier chassis by means of a nine pin plug-in socket, and replaces the high impedance plugs shipped with larger RCA amplifiers. The MI-12377-D can be attached to the chassis by means of a bracket riveted or bolted to the chassis. This bracket permits rotating the transformer to the lowest point of hum pick-up. Lead length is six inches.

Specifications

Primary Impedance	Full winding: 250 Ohms
	Each half, to center tap: 62.5 Ohms
Secondary Impedance	50,000 Ohms
Primary Unbalance	Less than 0.8% from 10 to 100,000 Hz
Typical Response	Within ± 1 dB, 20 to 20,000 Hz, terminated in 500,000 Ohms (See Curve)
Distortion	Less than 1% maximum at rated operating level (much less at microphone levels)
Recommended Maximum Operating Level	-5 dBm
Diameter	1 1/8"
Height:	
MI-12399-A	2 1/16"
MI-12377-D	1 1/16"
Weight:	
MI-12399-A	4 oz. (115 grams)
MI-12377-D	3 1/2 oz. (100 grams)
Mounting:	
MI-12399-A	9 Pin Socket
MI-12377-D	Bracket 1 1/16" on centers

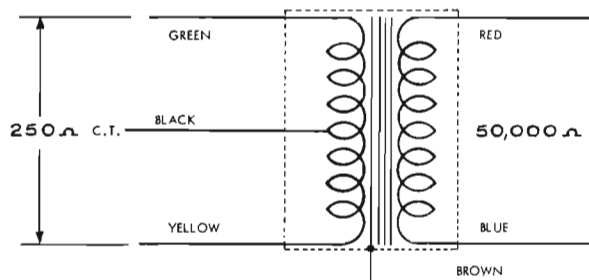
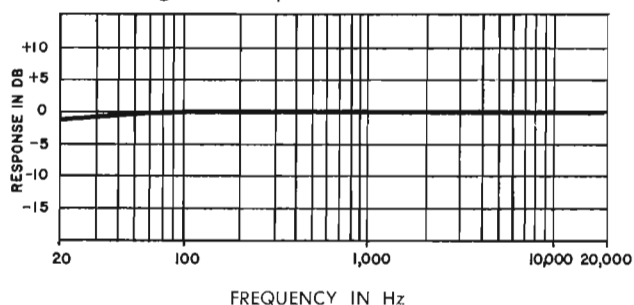

Diagram of Input Transformers



Ordering Information

Input Transformer (250/50K), 9-Pin SocketMI-12399-A
 Input Transformer (250/50K), Bracket MountingMI-12377-D



- Direct reading eliminates lengthy calculations
- Measures signals from noise to line levels
- Generates signals ranging from mike to line level
- Self-contained low distortion oscillator

Transmission Measuring Set, Type 452A

Description

The Transmission Measuring Set, Model 452A, is a simplified, accurate and direct-reading instrument designed for the use in the following applications: audio gain measurements; direct audio voltage and level measurement; signal to noise ratio; frequency response measurements; and low distortion signal source for distortion measurements. The unit combines both measuring and generating devices into one compact and easily mounted instrument.

With the 452A, the engineer no longer is required to spend considerable time in complicated calculations, but merely turns a switch and automatically obtains a reading of the output level and measurement of the return signal. The precision AC voltmeter incorporated in the

452A permits direct measurements of all levels from noise to line. The 452A has a continuously variable oscillator that permits the analysis and correction of unwanted "peaks" and "holes" in the response of a transmission system.

Output Circuitry

The output section of the instrument consists of a continuously variable oscillator that delivers +20 dBm into a precision decade attenuator followed by a repeat coil. A panel switch permits instantaneous strapping of the repeat coil to match loads of 50, 150, 250 or 600 Ohms, all balanced. The frequency range of the instrument so used is 15 Hz—50 kHz. A panel switch permits the repeat coils to be by-passed in which case the frequency range is 10 Hz

to 100 kHz into a 600 Ohm unbalanced load. The positions of the decade attenuator in dBm are +20, +10, 0, -10, -20, -30, -40, -50, -60, and "No Signal." A Fine Output Control permits adjustment of signal output to any point between these settings. When the "Meter Reads" switch is in the "Output Level" position, the output is read automatically on the meter. The meter reading is simply added to the reading of the decade attenuator. No correction factor for impedance setting is required.

Input Circuitry

The Input section consists of an amplifier AC voltmeter which is accurate over the range of 10 Hz—100kHz. An input repeat coil is switch strapped for matching or

bridging circuits of 50, 150, 250, or 600 Ohms balanced or unbalanced. A fifth position on this Input Impedance Selector connects the set's input terminals directly to the voltmeter, by-passing the repeat coil. With the repeat coil in the circuit, the meter range is 15 Hz—50 kHz.

With the repeat coil out of the circuit, the meter range is 10 Hz—100 kHz, and the instrument input impedance is 10 megohms unbalanced. The meter range switch is a decade attenuator of twelve positions marked —60, —50, —40, —30, —20, —10, 0, +10 +20, +30,

+40 and +50 dBm. Levels of above +20 dBm may only be read with the repeat coil out of the circuit ("high impedance" position). Because a linear meter movement is used, levels as low as —80 dBm may be read directly.

Specifications

Generator:

Frequency Range;	
600 Ohms unbalanced	10 Hz—100 kHz
50, 150, 250 and 600 Ohms balanced	15 Hz—50 kHz
Frequency Accuracy	±1% (±1 Hz)
Output Level Accuracy;	
600 Ohms unbalanced	±¼ dB 10 Hz—100 kHz
150 and 600 Ohms balanced	±¼ dB 15 Hz—15 kHz
50 and 250 Ohms	±½ dB 15 Hz—50 kHz
	Relative
Output Impedance Accuracy;	
600 Ohms unbalanced	±5% 10 Hz—100 kHz
150 and 600 Ohms balanced	±5% 30 Hz—15 kHz
50 and 250 Ohms balanced	Relative
Distortion	0.1% max. 30 Hz—15 kHz up to +10 dBm output
Noise	80 dB below full output
Output Level Range	Continuously variable from +20 dBm to —75 dBm

Level-Meter:

Calibration Accuracy;	
Unbalanced (10 MegOhms)	±¼ dB 10 Hz—100 kHz
150, 600 Ohms balanced	±¼ dB 15 Hz—15 kHz
50, 250 Ohms balanced	±½ dB 15 Hz—50 kHz
	Relative
Input Impedance Accuracy (Matching);	
150, 600 Ohms balanced	±5% 30 Hz—15 kHz
50, 250 Ohms balanced	Relative
Input Impedance (Bridging)	Above 10 Kilohms at 1 kHz
Meter Scales	0-1 and 0-3 Volts; —12 to +2 dBm
Meter Ranges in dBm (10 dB per step):	
50, 150, 250, and 600 Ohms	—60 dBm to +20 dBm
High Impedance	—60 dBm to +50 dBm
Meter Residual Noise	35 dBm below full scale
Power Requirements	115/230 Volts AC, 50 Hz to 400 Hz, 70 Watts
Dimensions Overall	19" wide, 7" high, 10" deep (48.26 cm., 17.78 cm., 25.40 cm.)
Weight	27 lbs. (12.25 kg.)
Ordering Information	
Model 452A Waveforms Transmission Measuring Set	MI-11351

Audio Sweep Generator, 610/620 Series



610B



620A

- Logarithmic sweep for automatic frequency response plotting
- 20 Hz to 20 kHz sweep width
- 1 to 100 seconds sweep speed
- Can be remotely programmed

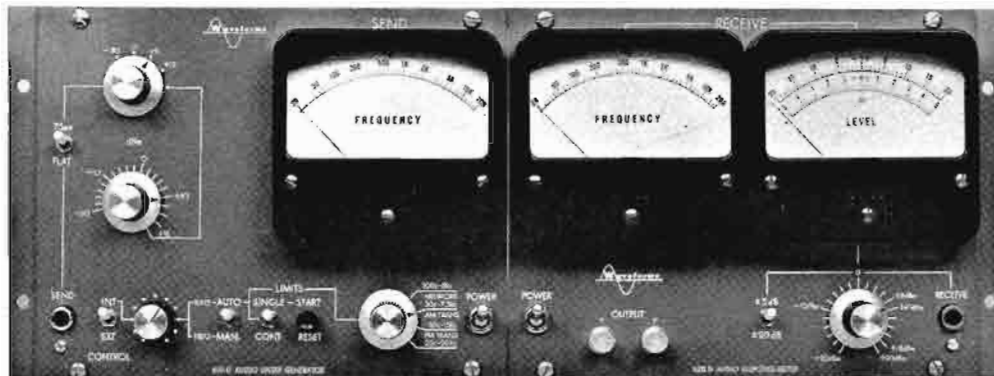

610D

620D

Description

Waveforms 610 Series of all new Sweep Generators are designed for fast, accurate testing of amplifiers, transducers, equalizers, attenuators, filters, recording systems, transmission lines, etc. The Series 610 solid-state miniature modules are logarithmic voltage controlled oscillators with built-in ramp generators that provide frequency sweep. Generator output is extremely flat for all waveforms—sine, square and triangular.

Features and controls permit generator operation in the widest number of test situations. Sweep rate is continuously variable. Sweep may be one-shot (starting on command) or continuous. In addition, sweep may be re-cycled before completion. Frequency may be controlled externally or manually. A DC output proportional to the logarithm of frequency is brought to front panel binding posts. During retrace, output is blanked out. Output frequency is read on an edge-wise meter.

Several sweep generators may be specified. The 610B is the basic instrument for the vast majority of test applications with a sweep width of 20 Hz to 20 kHz. The 610C sweep width is 5 Hz to 5 kHz. Extras in the 610D include fixed send levels of +18 dBm, +8 dBm, and 0 dBm and -50 dBm, in addition to a continu-

ous Attenuator. The proper sweep width for the measurement job is switch selected: AM transmitters 30 Hz to 7.5 kHz; FM and TV transmitters 30 Hz to 15 kHz; intercity networks 100 Hz to 5 kHz, and for general service work 20 Hz to 20 kHz. A 75 microsecond de-emphasis network may be switched in when working with FM and TV transmitters. The frequency meter is a 4-inch rectangular meter with a logarithmic frequency scale.

Logarithmic AC Volt and Frequency Meter

The 620 Series Frequency Response Meters are also solid state and contain two instruments: a logarithmic frequency meter and a logarithmic voltmeter. Both meters operate from 0.01 Volt (-40 dBm) to 100 Volts (+40 dBm). Audio (20 Hz to 20 kHz) models and vibration study (5 Hz to 5 kHz) models are standard. The 620D model includes a 4-inch rectangular frequency meter and calibration of the voltmeter ranging control at +18 dBm, +8 dBm, 0 dBm, and -20 dBm and is designed for use with the 610D sweep generator.

Frequency on the 620B and 620C Models is read on an edge-wise meter with a logarithmic scale. Voltage level is read on the 4-inch

rectangular meter with logarithmic scale. Full scale deflection sensitivities of ± 2 dB and ± 20 dB may be switch selected. A calibrated potentiometer is employed to move the 0 dB point anywhere between 0.1 Volt (-20 dBm) and 10 Volts (+20 dBm). The meter also has a voltage scale.

DC outputs proportional to the logarithm of both frequency and voltage are brought to front panel BNC connectors. These outputs, fed to scopes or X-Y recorders, may be used to draw log/log frequency response curves.

Automatic Frequency Response Plotting System

The Waveforms automatic frequency response plotting system unites two modules: the series 610 Sweep Generator and the series 620 Frequency Response Meter.

Operation is automatic and all electronic. No physical connection between Generator and Response Meter is required. Markers are unnecessary. The system may be used with X-Y Recorders to automatically draw log/log response curves.

This automatic system affords faster testing, greater accuracy, absence of human error, and detection of peaks and holes often missed in point-to-point spot frequency checks.

Specifications

	610B	610C	610D
610 Sweep Generator;			
Sweep width	20 Hz to 20 kHz	5 Hz to 5 kHz	20 Hz to 20 kHz 30 Hz to 7.5 kHz 30 Hz to 15 kHz 100 Hz to 5 kHz
Sweep speed range	1—100 sec.	1—10 min.	6—120 sec.
Sweep characteristic	log	log	log
Sweep modes	Manual and free-running, one shot external triggering		
Analog DC output	1 V per octave	1 V per octave	1 V per octave
External programming voltage	1 V per octave	1 V per octave	1 V per octave
Maximum output level	+10 dBm into 600 Ohms	5 V into hi Z	+18 dBm into 600 Ohms
Output Impedance	600 Ohms un-balanced	600 Ohms un-balanced	600 Ohms un-balanced
Flatness	±0.25 dB	±0.25 dB	±0.25 dB
Attenuation range (cont.)	80 dB	20 dB	20 dB
Fixed output levels	None	None	+18, +8, 0, -50 dBm
Sine, square and triangular waveform	Yes	Yes	Yes
Harmonic distortion (1 kHz)	1% max.	1% max.	1% max.
Size	6" x 4¼" x 10" (15.24 cm., 10.8 cm., 17.78 cm.)	6" x 4¼" x 10" (15.24 cm., 10.8 cm., 17.78 cm.)	6" x 8½" x 10" (15.24 cm., 21.59 cm., 17.78 cm.)
Weight	6 lbs. (2.7 kg.)	6 lbs. (2.7 kg.)	8 lbs. (3.6 kg.)
Power (all models)	115/230 V ±10%, 50 to 400 Hz, 10 Watts		

	620B	620C	620D
620 Frequency Response Meter;			
Voltmeter;			
Frequency Range	20 Hz to 20 kHz	5 Hz to 5 kHz	20 Hz to 20 kHz
Meter Size (all models)	3"	3"	4"
Meter Scales	-20-0- +20 dB -2-0- +2 dB +2 V	-20-0- +20 dB -2-0- +2 dB +2 V	-20-0- +20 dB -5-0- +5 dB +2 V
Analog DC output	-2-0- +2 V	-2-0- +2 V	-2-0- +2 V
Meter ranges;			
As Voltmeter (B & C only)	0.01-1V; 0.1-10 V; 1-100 V		
As Response Meter*	±20 and ±2 dB	±20 and ±2 dB	±20 and ±5 dB
Flatness	±1% (±0.1 dB)	±1% (±0.1 dB)	±1% (±0.1 dB)
Input Impedance	100 kilohms	100 kilohms	100 kilohms
Frequency Meter;			
Frequency range	20 Hz to 20 kHz	5 Hz to 5 kHz	20 Hz to 20 kHz
Meter type	3" edge-wise linear movement with log scales	Same as voltmeter	
Analog DC output	1 V per octave	1 V per octave	1 V per octave
Mechanical;			
Size	6" x 4¼" x 10" (15.24 cm, 10.8 cm, 15.24 cm)	6" x 4¼" x 10" (15.24 cm, 10.8 cm, 15.24 cm)	6" x 8½" x 10" (15.24 cm, 21.59 cm, 15.24 cm)
Weight	6 lbs. (2.7 kg.)	6 lbs. (2.7 kg.)	8 lbs. (3.6 kg.)
Power (all models)	115/230 V ±10%, 50 to 400 Hz, 10 Watts		

* 0 dB may be moved continuously between 0.1 V (-20 dBm) and 10 V (+20 dBm).

Ordering Information

Sweep Generator	Model 610B
Sweep Generator	Model 610C
Sweep Generator	Model 610D
Frequency Response Meter	Model 620B
Frequency Reponse Meter	Model 620C
Frequency Response Meter	Model 620D

Distortion Measuring Sets, Types 456A/B

Description

The Waveforms' Model 456 Distortion Measuring Set is a simple passive instrument for three types of measurement: harmonic distortion, frequency and impedance. It is basically a switch tuned filter set, and may be used with a VTVM or an oscilloscope. The audio model (456A) includes the 8 frequencies used in reporting FCC Proof of Performance. The video model (456B)

includes 7 evenly spaced frequencies between 50 kHz and 5 MHz.

Operation is fast and simple. The frequency to be analyzed is switch selected. A calibrate/measure switch permits by-pass of the filter for instant signal amplitude measurement on the scope or VTVM. Return of the calibrate/measure switch to "measure," inserts the filter which rejects the signal fundamental. The scope or VTVM sensitivity controls

are adjusted to measure the distortion. Scope presentation can be either with its own time base or with Lissajous patterns. Lissajous patterns are particularly useful in analyzing distortion.

Due to the high frequency accuracy of the filters the 456 may be used to check oscillator frequency calibration in the field. Impedance measurement may be made quite simply.



Specifications

	456A	456B
Frequencies	50, 100, 400 Hz 1 k, 5 k, 7.5 kHz 10 k, 15 kHz	40, 100, 250, 500, 1,000 2,500, 5,000 kHz
Fundamental re-jection	Infinite	Infinite
Attenuation of 2nd harmonic	1 dB max.	1 dB max.
Frequency accuracy of notch	±2% +5 Hz	±1%
Connectors (binding post)	input, output	_____
Connectors (BNC)	_____	input, direct output & compensated output
Input Impedance	600 Ohms/150 Ohms, High Z	50, 75, 93 Ohms, High Z
Maximum signal input	+20 dBm	+20 dBm
Size	6" high, 4¼" wide, 6" deep (15.24 cm, 10.8 cm, 15.24 cm)	6" high, 4¼" wide, 6" deep (15.24 cm, 10.8 cm, 15.24 cm)
Weight	4 lbs. (1.8 kg.)	4 lbs. (1.8 kg.)

Ordering Information

Distortion Measuring Set (For Audio) Model 456A
 Distortion Measuring Set (For Video Baseband).. Model 456B

Attenuator Set, Model 454A

Description

Waveforms' Model 454A Attenuator Set is a simple, non-electronic, portable instrument which will convert any oscillator into a complete accurate signal generator. A decade attenuator permits selection of levels from -95 dBm up to the full capability of the oscillator. (+10 dBm in the case of the Waveforms' Model 510C, or +20 dBm used with Waveforms' Model 410B.) The attenuator has a switch permitting the unit to be matched to any of four impedances.



Specifications

Input	Any oscillator (balanced or unbalanced)
Output	-95 dBm to +15 dBm (depending on power capability of the oscillator)
Output Reading Accuracy	±¼ dB, 30-15,000 Hz; ±½ dB, 15-50,000 Hz
Output Impedance Accuracy	±5%, 30-15,000 Hz
Impedance Settings	37.5, 150, 250, and 600 Ohms, balanced or unbalanced regardless of input
Meter	Direct reading in dBm
Styling	Portable carrying case or panel mounting

Overall Dimensions:	
Portable Model 454A	7½" high, 6" wide, 5" deep (19.05 cm, 15.24 cm, 12.70 cm)
Rack Model 454A-R	7" high, 19" wide, 5" deep (17.78 cm, 48.26 cm, 12.70 cm)
Weight	5¾ lbs. approx. (2.6 kg.)

Ordering Information

Waveforms' Inc. Attenuator Box
 in portable carrying case Model 454A
 Waveforms' Inc. Attenuator Box
 in rack mounting panel Model 454A-R

General Purpose Oscillators, Models 401B/403A

- 10 Hz to 100 kHz
- 0.1 percent distortion
- +22 dBm output
- Step attenuator



Description

The Model 401B is a general purpose Audio Oscillator featuring +22 dBm power capability and an output attenuator. It has extended frequency range of 10 Hz to 100 kHz, with constant output ± 1 dB and calibration accuracy of +3 percent (± 1 percent on special order). The stability is $\pm \frac{1}{2}$ percent with temperature and line voltage and maximum output is 20 Volts open circuit or 10 Volts into 600 Ohms (+22 dBm). Distortion is less than 1/10 percent. A step attenuator and logarithmic output control cali-

brated approximately in Volts, for levels down to 0.1 millivolt is provided. Source impedance 600 Ohms unbalanced. Power 115/230 Volts, ± 10 percent, 50-400 Hz. Weight is 12 pounds.

The Model 403A Oscillator is identical to the Model 401B Oscillator except that square wave output is provided as well as sine wave. Selection is by front panel switch.

The square wave is symmetrical about ground and at full output is 20 Volts peak-to-peak into a high impedance, and 10 Volts into 600 Ohms. Both waveforms pass through the attenuation system. Square wave rise is 1 μ sec.

Square waves are useful for bench checking of amplifier feedback stability, transient response, and tendency toward ringing.

Ordering Information

Waveforms' Inc. Audio Oscillator	Model 401B
Waveforms' Inc.	
Sine and Square Wave Oscillator	Model 403A

Amplifier-Voltmeter, Model 520A

- 10 Hz to 2 MHz
- 1.0 millivolt full scale
- 12 ranges to 300 Volts



Description

The Model 520A is a stable, general purpose AC voltmeter, null indicator, and decade amplifier, featuring high input impedance for negligible circuit loading, full-wave average rectifier for minimum waveform error, and extremely low pick-up from stray fields and power line.

The meter range extends from 1.0 millivolt full scale to 300 Volts, permitting measurements to 100 microVolts and useful indications at still

lower levels; -60 to +50 dBm full scale in 10 dBm ranges. Its accuracy is ± 3 percent, 20Hz to 1 MHz; or ± 5 percent 10 Hz to 2 MHz and stability is ± 1 percent with line voltage from 105-130 Volts. The input impedance is 10 megOhms shunted by 24 mmf; and amplifier gain is 1000. The meter is protected against overload. The equipment weighs 6 lbs. The voltmeter consumes 40 Watts, 50-400 Hz, 115/230 Volts ± 10 percent.

Ordering Information

Waveforms' Inc. Amplifier-Voltmeter	Model 520A
---	------------

Index

	Catalog References		MI No.
	Page	Sheet	
Adaptor:			
Console (For Interphone Key Switch Panel Assembly)	96	B.1510	26252
Hi Level (For SA-1004)	74	B.1474	38155
Rack (For Interphone Key Switch Panel Assembly)	96	B.1510	26254
Swivel Mounting (For SK-30/31 Microphones)	19	B.1027	11032
Adaptor Kit (For BK-6B Mike Stand)	21	B.1030	11073
Adjustable Microphone Arm:			
Clamp Mount, O.C. White M-2-MD-U	24	B.1030	11020-1
Screw Mount, O.C. White M-2-MC	24	B.1030	11020-2
Wall Mount, O.C. White, M-2MW	24	B.1030	11020-4
AGC Program Amplifier, Type BA-45A/43A	50	B.1519	11455/11454
Alignment Tape, Azimuth (15,000 Hz Tone, Full Track)	119	B.1725	11993-2
Amplifiers, Audio			
BA-8B Cue (includes transistors)	47	B.1400	—
BA-26B Equalizer-Preamplifier (Mono) with transistors	64	B.1402	11450-A
BA-31C Preamplifier and Guide Assembly	64	B.1414	11436-C
BA-31C Preamplifier and Guide Assembly	58	B.1406	11444-C
BA-33B Program and Guide Assembly	59	B.1408	11446-A
BA-34C Monitor (10 Watt) and Guide Assembly	60	B.1410	11437-C
BA-36A Equalizer-Preamplifier (Stereo) with transistors	62	B.1414	11441-B
BA-43 Program	48	B.1417	11454
BA-45 AGC Module	50	B.1419	11455
BA-46 Limiter Module	52	B.1429	11456
BA-71C Console Preamplifier and Guide Assembly	54	B.1420	ES-11158-B
BA-71C Console Preamplifier (less Guide Assembly)	54	B.1420	11658-B
BA-73B Console Program with Guide Assembly	55	B.1421	ES-11159-A
BA-73B Console Program (less Guide Assembly)	55	B.1421	11659-A
BA-74B Console Monitor with Guide Assembly	56	B.1422	ES-11161-A
BA-74B Console Monitor (less Guide Assembly)	56	B.1422	11661-B
BA-78B Cue with Guide Assembly	57	B.1423	ES-11162-B
BA-78B Cue (less Guide Assembly)	57	B.1423	11662-B
Interphone (Replacement for Induction Coil)	94	B.1137	11757
Amplifiers, Power:			
SA-1000 100-Watt Bridging	72	B.1470	38194
SA-1004 100-Watt (Four input)	73	B.1474	38191
Bridging, 200-Watts	75	B.1480	9289-B
Amplifiers, Remote:			
BN-7A Two-Channel	65	B.1435	11451-A
BN-16B Portable Remote (XLR Type 1 Connectors)	66	B.1438	11221-D
BN-16C Portable Remote (UA Type Connectors and Step Attenuators) ...	66	B.1439	11453-A
SN-10 Five Channel Mixer Preamplifier	70	B.1472	38705
Amplifier Module:			
RT-21B Record/Playback	108	B.1704	141351-A
Amplifier Voltmeter, Waveforms Inc.	138	B.1915	520-A
Announce Booth Speaker Relay (For BC-6A/3B/5A)	42	B.1102	11748
Attenuator:			
Step (For BA-33B/73B)	55	B.1421	11751-5
Step (For BN-7A/16 Master Controls)	65	B.1435	11751-3
Step (For BN-7A/16 Fader Controls)	65	B.1435	11751-4

AUDIO EQUIPMENT

	Catalog References		MI No.
	Page	Sheet	
Attenuator Set, Waveforms Inc.	136	B.1915	454-A
Audio Automatic Switcher (For RT-7 Series)	118	B.1725	11982
Audio Oscillator:			
Waveforms Inc.	138	B.1915	401-B
Waveforms Inc.	137	B.1915	510-C
Audio Relay Switcher Module	97	B.1512	11787-A
Audio Sweep Generator, Waveforms Inc.	133	B.1915	610/620 Series
Audio Tape Programmer, Type BCA-15A	100	B.1756	11365-A
Audio Terminal Block	83	B.1500	4569-A4
Auditorium Loudspeaker, Type LC-9A	127	B.1810	11423
Automatic Transformer Kit 110/220 V, 50/60 Hz	102	B.1610	41605
Azimuth Alignment Tape 15,000 Hz Tone, Full Track	119	B.1725	11993-2
Belts, Spare Pack of 12 for Cleaner Cartridge	119	B.1725	11999
Blocks:			
Audio Terminal	83	B.1500	4569-A4
Power	83	B.1500	4568
Board, Printed Circuit:			
RT-17B Power Supply	114	B.1736	11974-1
RT-17B End Cue, Trip Cue	114	B.1736	11974-2
RT-17B Cue Amplifier	114	B.1736	11974-3
RT-17B Playback Amplifier	114	B.1736	11974-4
RT-17B Bias and Cue Tone	114	B.1736	11974-5
RT-17B Record Amplifier	114	B.1736	11974-6
Boom:			
Floating Action, Type BS-36	24	B.1030	11021-2
Microphone Boom and Perambulator	24	B.1030	26574
Microphone Boom less Perambulator	24	B.1030	26574-1
Microphone Boom and Stand	24	B.1030	11070
Boom Mount:			
For BK-5B	11	B.1018	11012
Mole Richardson Type (For 77DX)	24	B.1009	H-2
Bridging Amplifier:			
100 Watt, Type SA-1000	72	B.1470	38194
200 Watts	75	B.1480	9289-B
Bulk Cartridge Tape Eraser	120	B.1725	11992
Bracket, Terminal Board	83	B.1500	4570-A2
Cabinet:			
Audio Tape (Mounts 2 Cartridge Record/Playback Units)	117	B.1725	11984-A
Audio Tape (Mounts 4 Cartridge Record/Playback Units)	117	B.1725	11983-A
Floor (For LC-1B Loudspeaker)	124	B.1804	11415-A
Floor (For BQ-51B Turntable)	102	B.1610	11809-A
Storage (For Audio Tape Cartridges)	117	B.1725	11985-A

AUDIO EQUIPMENT

	Catalog References		MI No.
	Page	Sheet	
Cabinet Rack:			
Complete;			
BR-84A 84 x 18" Umber Gray	82	B.1500	ES-30951-A84
BR-84G 84 x 18" Blue & Aluminum Epoxy	82	B.1500	ES-36591-G84
BR-77G 77 x 18" Blue & Aluminum Epoxy	82	B.1500	ES-36591-G77
BR-84N 84 x 24" Blue & Aluminum Epoxy	82	B.1500	ES-36591-N84
BR-77N 77 x 24" Blue & Aluminum Epoxy	82	B.1500	ES36591-N77
Less Front Door;			
BR-84B 84 x 18" Umber Gray	82	B.1500	ES-30951-B84
BR-84H 84 x 18" Blue & Aluminum Epoxy	82	B.1500	ES-36591-H84
BR-77H 77 x 18" Blue & Aluminum Epoxy	82	B.1500	ES-36591-H77
BR-84P 84 x 24" Blue & Aluminum Epoxy	82	B.1500	ES-36591-P84
BR-77P 77 x 24" Blue & Aluminum Epoxy	82	B.1500	ES-36591-P77
Less Side Panels;			
BR-84C 84 x 18" Umber Gray	82	B.1500	ES-30951-C84
BR-84J 84 x 18" Blue & Aluminum Epoxy	82	B.1500	ES-36591-J84
BR-77J 77 x 18" Blue & Aluminum Epoxy	82	B.1500	ES-36591-J77
BR-84R 84 x 24" Blue & Aluminum Epoxy	82	B.1500	ES-36591-R84
BR-77R 77 x 24" Blue & Aluminum Epoxy	82	B.1500	ES-36591-R77
Rear Panel Only;			
BR-84D 74 x 18" Umber Gray	82	B.1500	ES-30951-D84
BR-84K 84 x 18" Blue & Aluminum Epoxy	82	B.1500	ES-36591-K84
BR-77K 77 x 18" Blue & Aluminum Epoxy	82	B.1500	ES-36591-K77
BR-84S 84 x 24" Blue & Aluminum Epoxy	82	B.1500	ES-36591-S84
BR-77S 77 x 24" Blue & Aluminum Epoxy	82	B.1500	ES-36591-S77
With Base Only;			
BR-84F 84 x 18" Umber Gray	82	B.1500	ES-30951-F84
BR-84M 84 x 18" Blue & Aluminum Epoxy	82	B.1500	ES-46551-M84
BR-77M 77 x 18" Blue & Aluminum Epoxy	82	B.1500	ES-36551-M77
BR-84U 84 x 24" Blue & Aluminum Epoxy	82	B.1500	ES-46551-U84
BR-77U 77 x 24" Blue & Aluminum Epoxy	82	B.1500	ES-36551-U77
With Top Cover and Base Only;			
BR-84E 84 x 18" Umber Gray	82	B.1500	ES-30951-E84
BR-84L 84 x 18" Blue & Aluminum Epoxy	82	B.1500	ES-36591-L84
BR-77L 77 x 18" Blue & Aluminum Epoxy	82	B.1500	ES-36591-L77
BR-84T 84 x 24" Blue & Aluminum Epoxy	82	B.1500	ES-36591-T84
BR-77T 77 x 24" Blue & Aluminum Epoxy	82	B.1500	ES-36591-T77
Cable Connector (XLR-4-12C Female Plug)	67	B.1438	#219546
Cable, Microphone:			
Three Conductor	25	B.1030	43-D
Two Conductor	25	B.1030	13307-A
Two Conductor, Small Diameter	25	B.1030	13322-B/C
Two Conductor, Miniature (For BK-12A)	16	B.1025	13373
Shielded Pair #20 AWG Solid	86	B.1503	33
Shielded Pair, #22 AWG Stranded	86	B.1508	34
Shielded Pair, #18 AWG Stranded	86	B.1508	35
Cable Hook (For Microphone Stands)	25	B.1030	11099-B
Carrying Case, Canvas (For BN-16)	67	B.1438	11377-A
Carrying Case, Portable (For RT-21A/B)	108	B.1704	141302-A

AUDIO EQUIPMENT

	Catalog References		MI No.
	Page	Sheet	
Cartridge:			
Tape Eraser	120	B.1725	11992
Head Cleaner (Incl. 12 belts)	119	B.1725	11998
Freq. Response Test of RT-17/37	119	B.1725	11993-3
Tape:			
Blank 300 Series (6/Box/MI)	119	B.1725	11988-B8
Blank 600 Series (6/Box/MI)	119	B.1725	11988-B9
Blank 1200 Series (2/Box/MI)	119	B.1725	11988-B10
40 Second Series (6/Box/MI)	119	B.1725	11988-B1
70 Second Series (6/Box/MI)	119	B.1725	11988-B2
2.5 Minute Series (6/Box/MI)	119	B.1725	11988-B11
3.5 Minute Series (6/Box/MI)	119	B.1725	11988-B3
5.5 Minute Series (6/Box/MI)	119	B.1725	11988-B4
10.5 Minute Series (6/Box/MI)	119	B.1725	11988-B5
16 Minute Series (2/Box/MI)	119	B.1725	11988-B6
31 Minute Series (2/Box/MI)	119	B.1725	11988-B7
Transcription:			
Universal Stereo/Mono	104	B.1613	11865
Case, Canvas Carrying (For BN-16B)	67	B.1438	11377-A
Change Over Relay, Film (For Consoles)	30	B.1118	11729
Circuit Breaker:			
2.5A, 115/230V	83	B.1500	26176-1
5.0A, 115/230V	83	B.1500	26176-2
10A, 115/230V	83	B.1500	26176-3
20A, 115/230V	83	B.1500	26176-4
40A, 115/230V	83	B.1500	26176-5
Circuit Breaker Mounting Panel	83	B.1500	11792
Clock, Sessions Studio Type 13½ inch Diameter	30	B.1118	11758
Coil, Retardation (For Interphone Systems)	94	B.1137	11737
Column Speaker	130	B.1826	38351-A
Compensator:			
Variable Audio (Low Frequency)	87	B.1509	10413
Variable Audio (Mid Frequency)	87	B.1509	10414
Variable Audio (High Frequency)	87	B.1509	10415
Connection Unit:			
For Interphone System	94	B.1137	11734
Transistor (For Interphone Systems)	94	B.1137	11784-A
Connector Base, Multiple (For use with MI-11787-A)	98	B.1512	11790
Connector Unit, Single Module (For use with MI-11787-A)	98	B.1512	11789
Console Adaptor (For MI-11754 Key Switch Panel Assembly)	96	B.1510	26252
Console Cabinet (For RT-21A/B)	108	B.1704	141303-A
Consolette:			
BC-3C Standard Audio	41	B.1102	ES-11103-A
BC-3C Standard Audio, less tubes	41	B.1102	11641-A
BC-7A Dual-Channel Stereo	31	B.1115	ES-11157-AS

AUDIO EQUIPMENT

	Catalog References		MI No.
	Page	Sheet	
Consolette: (Continued)			
BC-7A Dual-Channel Mono	31	B.1115	ES-11157-A
BC-7A Dual-Channel, Housing only—less plug-in modules	31	B.1115	11657-A
BC-8A Studio Dual-Channel Mono	27	B.1118	ES-11167-A
BC-8A Studio Dual-Channel, Housing only—less plug-in modules	27	B.1118	11667-A
BC-9A Audio Mono	35	B.1119	ES-11153-A
BC-9A Audio, Housing only—less plug-in modules	35	B.1119	11670-A
BC-19A Stereo	37	B.1129	ES-11154-A
BC-19A Stereo, Housing only—less plug-in modules	37	B.1129	11671-A
BCM-2B Auxiliary Mixer (For Mixer Bus Bridging)	39	B.1131	ES-11155
BCM-2B Auxiliary Mixer, Housing only—less plug-in modules	39	B.1131	11656-A
BCM-2B Auxiliary Mixer (For Connection to Mike input)	39	B.1131	ES-11156-A
Control:			
Chassis Mounting, Volume	90	B.1509	11278-F
Panel Mounting, Volume	90	B.1509	11278-E
Cue Amplifier:			
BA-8B (with transistors)	64	B.1402	11450-A
BA-78B (with Guide Assembly)	57	B.1423	ES-11162-A
BA-78B (less Guide Assembly)	57	B.1423	11662-A
Cue Board:			
150 Hz End of Message (For RT-8)	112	B.1732	11973-1
8,000 Hz Trip (For RT-8)	112	B.1732	11973-2
18,000 Hz Trip (For RT-8)	112	B.1732	11973-3
End Cue, Trip (For RT-17B)	114	B.1736	11974-2
Cue Type Fader:			
For BC-3C High Level Inputs	42	B.1102	#94136
Custom Audio Equipment	43	B.1200	CB
Custom Tape Production System	121	B.1799	CH
Degausser:			
Cartridge Tape Head (117 Volts, AC)	119	B.1725	11995
Cartridge Tape Head (230 Volts, AC)	119	B.1725	11996
Diamond:			
0.7 mil (For Universal Cartridge)	104	B.1613	11866-7
1.0 mil (For Universal Cartridge)	104	B.1613	11866-10
2.5 mil (For Universal Cartridge)	104	B.1613	11866-25
Diaphragm Assembly (Replacement for Speaker Assembly 11419)	129	B.1823	#234776
Dioplex Line Speaker Assembly	130	B.1826	38351
Distortion Measuring Set	135	B.1915	456-A/B
Door:			
Non-Ventilated (For Cabinet Racks);			
84" Umber Gray	82	B.1500	30530-G84
84" Shadow Blue	82	B.1500	36530-S84
77" Shadow Blue	82	B.1500	36530-S77
Ventilated (For Cabinet Racks);			
84" Umber Gray	82	B.1500	30535-G84
84" Shadow Blue	82	B.1500	36535-S84
77" Shadow Blue	82	B.1500	36535-S77

AUDIO EQUIPMENT

	Catalog References		MI No.
	Page	Sheet	
Electrical Shield:			
For Cabinet Center Section;			
84 x 18" Umber Gray	82	B.1500	30546-G21
84 x 18" Aluminum Epoxy	82	B.1500	30546-A21
84 x 24" Aluminum Epoxy	82	B.1500	36546-A21
77 x 18" Aluminum Epoxy	82	B.1500	30546-A28
77 x 24" Aluminum Epoxy	82	B.1500	36546-A28
For Cabinet Top and Bottom Sections;			
84 x 18" Umber Gray	82	B.1500	30546-G28
84 x 18" Aluminum Epoxy	82	B.1500	30546-A28
84 x 24" Aluminum Epoxy	82	B.1500	36546-A28
77 x 18" Aluminum Epoxy	82	B.1500	30546-A21
77 x 24" Aluminum Epoxy	82	B.1500	36546-A21
Equalizer:			
BE-2A Line	89	B.1509	11752
Equalizer-Preamplifier:			
BA-26B Mono	62	B.1414	11436-C
BA-36A Stereo	62	B.1414	11441-B
Eraser:			
Automatic Magnetic Tape, 60 Hz (Audio)	120	B.1725	ES-29976
Cartridge Tape	120	B.1725	11992
Extender:			
Module, set of four (For RT-17B)	114	B.1736	11495
Module, set of two (For RT-17B)	114	B.1736	11496
Extended Range Oscillator, Waveforms Inc.	137	B.1915	510C
Fader:			
Cue Type, High Level Inputs (For BC-3C)	42	B.1102	94136
50 Hz Modification Kit	114	B.1736	11494
Film Change Over Relay	30	B.1118	11729
Filter, Sound Effects, Type BE-21C	88	B.1509	11723-A
Flexible Microphone Stand:			
6-Inch with bracket clamp	25	B.1030	11747
13-Inch	25	B.1030	11745
19-Inch	25	B.1030	11746
Frequency Response Cartridge Tape (For Test of RT-7A/B)	119	B.1725	11993-1
Generator:			
WA-44C Sine/Square Wave, Waveforms Inc.	138	B.1915	403A
Audio Sweep, Waveforms Inc.	133	B.1915	610/620 Series
Glass:			
Indicating (For MI-11706 Series)	30	B.1118	11718-1 to 6
Custom Indicating (For MI-11706 Series)	30	B.1118	Custom
Ground Bus Kit	83	B.1500	11728
Guide Assembly:			
For BA-31C	58	B.1406	11594-1
For BA-33B	59	B.1408	11594-2
For BA-34C	61	B.1410	11594-3
For BA-43	49	B.1417	11593-1

AUDIO EQUIPMENT

	Catalog References		MI No.
	Page	Sheet	
Guide Assembly: (Continued)			
For BA-46	53	B.1429	11593-2
For BA-71B and High Level Isolation Unit	54	B.1420	11759-1
For BA-73B	55	B.1421	11759-2
For BA-74B	56	B.1422	11759-3
For BA-78A	57	B.1423	11759-5
For BX-71A	77	B.1442	11759-4
Head Cleaner Cartridge	119	B.1725	11998
Head Degausser (For Cartridge Tape Units) 117/230V, AC	119	B.1725	11995/11996
Head Kit, Switchable 4th Head—Dual ¼ Track (For RT-21B)	108	B.1704	41602-A
Headphone:			
Single, 9K Ohms Impedance, with plug (For all Consolettes)	30	B.1118	11749
Double, 24K Ohms Impedance, with plug (For all Consolettes)	30	B.1118	11750
Headset:			
Single (For Interphone System)	94	B.1137	11743
Double (For Interphone System)	94	B.1137	11744
Ceramic, Including Cord and .206 Plug	99	B.1140	38029-2
Ceramic, Including Cord and .250 Plug	99	B.1140	11797-M
Holder (For BK-6B Microphone)	25	B.1030	12086
Hook, Cable	25	B.1030	11099-B
Horn:			
60° Radial	129	B.1823	9594
90° Radial	129	B.1823	9595
Housing Assembly (For RT-21 Remote Control Panel)	108	B.1704	141308
Input Amplifier, 100-Watt, Type SA-1004	74	B.1474	38191
Input Transformer:			
Pin Socket, 250/50 K	131	B.1892	12399-A
Bracket Mounting, 250/50 K	131	B.1892	12377-D
37.5/150 Ohms (For BN-7A)	65	B.1435	11776
Intercom Sub Station (For BC-7/8/9/19)	34	B.1115	11452-A
Interphone Equipment:			
Connection Unit	94	B.1137	11734
Transistor Connection Unit	94	B.1137	11784-A
Transistor Amplifier (Replacement for Induction Coil)	94	B.1137	11757
Key Switch Panel Assembly	96	B.1510	11754
Switch	96	B.1510	11755-2
Switch Housing Assembly	96	B.1510	11756
Console Adaptor (For MJ-11754 Panel Assembly)	96	B.1510	26252
Rack Adaptor (For MI-11754)	96	B.1510	26254
Shelf	94	B.1137	11735
Panel	94	B.1137	11736-A
Retardation Coil	94	B.1137	11737
Headset, Single	94	B.1137	11743
Headset, Double	94	B.1137	11744
Isolation Unit:			
High Level (For BCM-2B and BC-7/8/9/19)	40	B.1131	11665
High Level with Guide Assembly (For BCM-2B, BC-7/8/9/19)	40	B.1131	ES-11165

AUDIO EQUIPMENT

	Catalog References		MI No.
	Page	Sheet	
Jack Panel:			
Double, Type BJ-24	86	B.1508	11645
Single, Type BJ-12	86	B.1508	11646
Tip-Ring-Sleeve, Type BJ-20TRS	86	B.1508	11666
Lacing Cord #6	86	B.1508	11719-A
Lacing Tape:			
Natural Color Nylon, 600 yds	86	B.1508	11719-C
Natural Color Nylon, 500 yds. Fungus Proof	86	B.1508	11719-D
Light Relay (For all Consolettes except 76 series)	42	B.1102	11702-A
Lights, Studio Warning	34	B.1115	ES-11706-Series
Limiter Module, Type BA-46A	53	B.1429	11456-A
Limiting Amplifier, BA-43/46	52	B.1429	11454/11456
Line Equalizer, Type BE-2A	89	B.1509	11752
Loudspeakers:			
LC-1B	123	B.1804	11411-B
LC-9A	127	B.1810	ES-11423
SL-8C	125	B.1800	38311-B
SL-12B	126	B.1808	38315-A
Lubricated Tape, 1700 ft. on 7" reel	119	B.1725	11986-A
Mat:			
Aluminum Epoxy for Single Jack Panel	86	B.1508	11647-A1
Aluminum Epoxy for Double Jack Panel	86	B.1508	11647-A2
Meter:			
Remote Limiting (For BA-43/46)	53	B.1429	#237431
Gain Reduction for BC-7 (For BA-25 Only)	34	B.1115	#6H0107
Simpson VU	88	B.1509	#53064
VU (For BC-7/BC-8)	34	B.1115	#226033
Meter Panel, Type BI-5B	88	B.1509	11265-G
Microphones	5	B.1000	—
Aerodynamic, Type SK-39	20	B.1026	12039-A
Dynamic Low Impedance, Type SK-30	19	B.1027	11030-1
Dynamic High Impedance, Type SK-31	19	B.1027	11031-1
Microphone/Amplifier, Type BN-10A	17	B.1436	11023-A
Miniature Dynamic, Type BK-6B	12	B.1019	11017-A
Pressure, Type BK-1A	9	B.1012	11007
Pressure, Type SK-45B	21	B.1028	12045-B
Polydirectional, Type 77DX	7	B.1009	4045-F
Polydirectional, Low Lustre Gray, Type 77DX	7	B.1009	11006-C
Subminiature Dynamic, Type BK-12A	15	B.1025	11024
Uniaxial, TV Low Lustre Gray, Type BK-5B	10	B.1018	11010-A
Uni-Directional with Hanger, Type KU-3A	18	R.1051	10001-C
Velocity, Type BK-11A	14	B.1024	11019
Velocity, with cable, Type SK-46	22	B.1029	12046
Microphone/Amplifier, Type BN-10A	17	B.1436	11023-A
Microphone Adaptors:			
½" Pipe Thread to ⅝"—27	25	B.1030	12053
⅝"—27 Stand to ½" Mike Thread	25	B.1030	11021-4
Swivel ⅝"—27 (For SK-30/31 Microphones)	19	B.1027	11032

AUDIO EQUIPMENT

	Catalog References		MI No.
	Page	Sheet	
Microphone Arm:			
Adjustable, Clamp Mount, O.C. White M-2-MC	24	B.1030	11020-2
Adjustable, Screw Mount, O.C. White M-2-MD-U	24	B.1030	11020-1
Adjustable, Wall Mount, O.C. White M-2MW	24	B.1030	11020-4
Microphone Holder:			
Clamp and Stud Type, Mole Richardson	24	B.1030	H-1 to H-7
For BK-6B	25	B.1030	12086
Microphone Input Selector Switch, 3 position (For BC-19A)	38	B.1129	11796
Microphone Plugs and Receptacles:			
Extension Cord Connector, Female, Type P3-CG-11S	26	B.1030	4620-B
Microphone Plug, Male, Type XLR-3-12C	26	B.1030	11089-A
Microphone Plug, Female, Type XLR-3-11C	26	B.1030	11090-A
Microphone Receptacle, Male, Type XLR-3-32	26	B.1030	11087-B
Microphone Receptacle, Female, Type XLR-3-31	26	B.1030	11088-B
Microphone Cord Plug, Cannon Type UA-3-11 (Mates with UA-2-12)	26	B.1030	11061
Microphone Cord Plug, Cannon Type UA-3-12 (Mates with UA-2-11 and UA-3-13)	26	B.1030	11062
Receptacle, Cannon Type UA-3-13 (Mates with UA-3-12)	26	B.1030	11063
Microphone Stands:			
Adjustable Banquet, Type TS-6	23	B.1030	11021-6
Adjustable Floor, Type MS-20	23	B.1030	11021-8
Boom, Atlas Model BS-36	24	B.1030	11021-2
Boom, Type KS-3B	24	B.1030	11056
Boom, Century Model	24	B.1030	11070
Collapsible, Atlas Model CS-1	23	B.1030	11021-1
Desk, Type DS-5 (For SK Type Microphones)	23	B.1030	11021-5
Desk, Type KS-11A (For BK-1 and BK-11 Microphones)	23	B.1030	11008
Desk, Type DS-10 (For SK Series Microphones)	23	B.1030	11021-3
Desk, Midnight Blue, Type 91D	23	B.1030	4092-G
Deluxe Program, Type 90-A (For BK-1/5/77DX Mikes)	23	B.1030	4090-A
Flexible 13-Inch	25	B.1030	11745
Flexible 19-Inch	25	B.1030	11746
Flexible 6-Inch with Bracket Clamp	25	B.1030	11747
Floor, Type MS-25	23	B.1030	11021-7
Microphone Stand Adaptor Kit (For BK-6B)	24	B.1030	11073
Module Extender:			
Set of Two (For RT-17B)	114	B.1736	11496
Set of Four (For RT-17B)	114	B.1736	11495
Module Frame (Holds up to 9 Modules)	98	B.1512	557300
Monitor Amplifier:			
BA-34C 10-Watt (with Guide Assembly)	61	B.1410	11437-C
BA-74B (with Guide Assembly)	56	B.1422	ES-11161-A
BA-74B (less Guide Assembly)	56	B.1422	11661-B
Mounting, Swing-out Rack for SA-1000	72	B.1470	38196
Mounting Shelf:			
Aluminum Epoxy, Type BR-22C	84	B.1500	11597-B
Umber Gray, Type BR-22B	84	B.1500	11597-A
Oscillator:			
Audio (Waveforms Inc.)	138	B.1913	401B
Extended Range (Waveforms Inc.)	137	B.1915	510C
Power (Waveforms Inc.)	139	B.1915	512
Sine and Square Wave (Waveforms Inc.)	138	B.1915	403A

AUDIO EQUIPMENT

	Catalog References		MI No.
	Page	Sheet	
Pads:			
Bridge (One Input to 2 Lines)	89	B.1509	11705
Dividing (Balanced 2-Way)	89	B.1509	11704
Dividing (Balanced 3-Way)	89	B.1509	11704-A
Dividing (Balanced 4-Way)	89	B.1509	11704-B
Dividing (Balanced 6-Way)	89	B.1509	11704-D
Fixed 6 dB (Balanced)	89	B.1509	4171-29
Fixed 10 dB (Balanced)	89	B.1509	4171-30
Fixed 20 dB (Balanced)	89	B.1509	4171-32
Fixed 40 dB (Balanced)	89	B.1509	4171-39
Multiple (For Calibrating VU Meter)	88	B.1509	#19328
Zero Adjustment	88	B.1509	#19327
Panels:			
Blank;			
1¾" Aluminum Epoxy	83	B.1500	36547-1
1¾" Aluminum, Umber Gray	83	B.1500	3090
1¾" Umber Gray	83	B.1500	4590-A
3½" Aluminum Epoxy	83	B.1500	36547-2
3½" Aluminum, Umber Gray	83	B.1500	3091
3½" Umber Gray	83	B.1500	4591-B
5¼" Aluminum Epoxy	83	B.1500	36547-3
5¼" Aluminum, Umber Gray	83	B.1500	3092
5¼" Umber Gray	83	B.1500	4592-B
7" Aluminum Epoxy	83	B.1500	36547-4
7" Aluminum, Umber Gray	83	B.1500	3093
7" Umber Gray	83	B.1500	4593-A
8¾" Aluminum Epoxy	83	B.1500	36547-5
8¾" Umber Gray	83	B.1500	4594-B
10½" Aluminum Epoxy	83	B.1500	36547-6
10½" Umber Gray	83	B.1500	4595-B
Circuit Breaker Mounting	83	B.1500	11792
For Interphone Equipment;			
For Interphone Key Switch Assembly	94	B.1510	11754
For Interphone Equipment	94	B.1137	11736-A
Meter, Type BI-5B	88	B.1509	11265-G
Rack or Cabinet (For 200-Watt Power Amplifier)	76	B.1480	9789-2
Rack Mounting (For BA-8A)	64	B.1402	11449-A
Remote Control;			
For RT-7 Functions	118	B.1725	11979
With 4 Start Buttons (For RT-7)	118	B.1725	11977
4-Position Start	112	B.1732	11968-1
4-Playbacks (For RT-17B)	114	B.1736	11968-1
Record (For RT-8/17B)	112	B.1732	11958-2
For RT-21B	108	B.1704	141301-A
Trim;			
For SA-1000	72	B.1470	38100-8
For SA-1004	74	B.1474	38100-9
Panel Mounting Angles:			
84" Set of two, Umber Gray	82	B.1500	30526-G84
84" Set of two, Aluminum Epoxy	82	B.1500	30526-A84
77" Set of two, Aluminum Epoxy	82	B.1500	30526-A77
79" Set of two, Aluminum Epoxy	82	B.1500	30527-A29

AUDIO EQUIPMENT

	Catalog References		MI No.
	Page	Sheet	
Patch Cord:			
Black Shield (2-foot)	86	B.1508	4652-B2
Black Shield (4-foot)	86	B.1508	4652-B4
Black Shield (6-foot)	86	B.1508	4652-B6
Gray Shield (2-foot)	86	B.1508	4652-C2
Gray Shield (4-foot)	86	B.1508	4652-C4
Gray Shield (6-foot)	86	B.1508	4652-C6
Tip, Ring, Sleeve (2-foot)	86	B.1508	4652-D2
Perambulator and Microphone Boom	24	B.1030	26574
Perambulator, less Boom	24	B.1030	26574-2
Plugs:			
Male Cable, Type P3-CG-12S (For Mike Cords)	26	B.1030	4630-B
Microphone Cord, Cannon UA-3-11	26	B.1030	11061
Microphone Cord, Cannon UA-3-12	26	B.1030	11062
Microphone, Female, Type XLR-3-11C	26	B.1030	11090-A
Microphone, Male, Type XLR-3-12C	26	B.1030	11089-A
Power Blocks	84	B.1500	4568-A4
Power Oscillator (Waveforms Inc.)	139	B.1915	512
Power Supply:			
BX-71A Console Transistor, with Guide Assembly	77	B.1442	ES-11163
BX-71A Console Transistor, less Guide Assembly	77	B.1442	11663-A
Panel-Mounted Relay (24-Volt, 6A DC)	78	B.1445	11318-C
Relay Supply (24-Volt, 4A DC)	79	PTV.1580	3537
Power Supply Board (For Cartridge Tape Recorders)	112	B.1732	11974-1
Preamplifier:			
BA-31C (with Guide Assembly)	58	B.1406	11444-B
BA-71C (with Guide Assembly)	54	B.1420	ES-11158-A
BA-71C (less Guide Assembly)	54	B.1420	11658-A
Preamplifier Kit (Provides Four Low-Level Outputs for RT-8A)	112	B.1732	11369
Program Amplifier:			
BA-33B (with Guide Assembly)	59	B.1408	11446-A
BA-43	48	B.1417	11454
BA-73B (with Guide Assembly)	55	B.1421	ES-11159-A
BA-73B (less Guide Assembly)	55	B.1421	11659-A
Programmer:			
Audio Tape, Type BCA-15A	100	B.1756	11365-A
Rack Adaptor (For MI-11754 Key Switch Panel Assembly)	96	B.1510	26254
Receptacle:			
Cannon, Type UA-3-13	26	B.1030	11063
Microphone, Female, Type XLR-3-31	26	B.1030	11088-B
Microphone, Male, Type XLR-3-32	26	B.1030	11087-B
Wall, Female, Type P3-35	26	B.1030	4624-A
Record/Playback Amplifier Module (For RT-21B)	108	B.1704	141351-A
Recording Equalizer:			
Low Frequency	87	B.1509	10413
Mid Frequency	87	B.1509	10414
High Frequency	87	B.1509	10415

AUDIO EQUIPMENT

	Catalog References		MI No.
	Page	Sheet	
Reel Hubs, NAB Type (For RT-21B)	108	B.1704	ES-41919
Reel, Empty 10½" O.D. (For RT-21 Recorder)	108	B.1704	11932-2
Relay:			
Announce Booth Speaker (For BC-7)	42	B.1102	11748
Film Change Over	30	B.1118	11729
Signal Light (For all Consolettes except 76 series)	30	B.1118	11702-A
Relay Switcher Module (Audio)	97	B.1512	11787-A
Remote Amplifier:			
Two-Channel, Type BN-7A	65	B.1435	11451
Portable Blue Case, Type BN-16B	67	B.1438	11221-D
Portable Blue Case with UA Type Connectors	67	B.1438	11453-A
Remote Control Panel:			
Start, Record, Stop Trip Cue, RT-7	118	B.1725	11979
4-Position Start (For Audio Tape Recorders)	112	B.1732	11968-1
RT-7A *Start Buttons	118	B.1725	11977
Record (For Audio Tape Recorders)	112	B.1732	11968-2
RT-21B Record	108	B.1704	141301-A
Retardation Coil (Interphone Equipment)	94	B.1137	11737
Shelf:			
Mounting (For Interphone Equipment)	94	B.1137	11735
Mounting (For BA-8B)	64	B.1402	11449-A
Rack Mounting (For SA-1000/SA-1004)	72	B.1470	38195
Side Panel for Cabinet Racks:			
84" Umber Gray	82	B.1500	36542-G84
84" Midnight Blue	82	B.1500	36542-B84
77" Midnight Blue	82	B.1500	36542-B77
84" Midnight Blue for deep cabinet	82	B.1500	36541-B84
77" Midnight Blue for deep cabinet	82	B.1500	36541-B77
Signal Light Relay (For all Consolettes except 76 series)	30	B.1118	11702-A
Signs (Studio Warning Lights):			
"On Air"	30	B.1118	ES-11706-1
"Rehearsal"	30	B.1118	ES-11706-2
"Audition"	30	B.1118	ES-11706-3
"Standby"	30	B.1118	ES-11706-4
"Silence"	30	B.1118	ES-11706-5
"Recording"	30	B.1118	ES-11706-6
Simpson VU Meter	30	B.1118	53064
Sine/Square Wave Generator (Waveforms Inc.)	138	B.1915	403A
Sound Effects Filter, Type BE-21C	88	B.1509	11723-A
Speaker, Column	130	B.1826	38351-A
Speaker Mechanism:			
LC-1B Duo-Cone	124	B.1804	11411-B
High Frequency	128	B.1822	9584-A
High Frequency	129	B.1823	11419
Speaker Relay, Announce Booth (For BC-3C)	42	B.1102	11748

AUDIO EQUIPMENT

	Catalog References		MI No.
	Page	Sheet	
Step Attenuator:			
For BA-33B/73B	55	B.1421	11751-5
For BN-7A/16B Master Controls	65	B.1435	11751-3
For BN-7A/16B Fader Controls	65	B.1435	11751-4
Studio Warning Lights	34	B.1115	ES-11705-Series
Switch Housing Assembly (For Interphone Equipment)	95	B.1510	11756
Switch, Interphone	96	B.1510	11755-2
Switch, 3-Position Microphone Input Selector (For BC-19A)	38	B.1129	11796
Switcher:			
Audio Automatic	118	B.1725	11982
Audio Relay Module	97	B.1512	11787-A
Swivel Adaptor 5/8"—27 (For SK-30/31 Microphones)	19	B.1027	11032
Tape:			
Azimuth Alignment (15,000 Hz Tone, Full Track)	119	B.1725	11993-3
Bulk Lubricated (1700-ft. on 7" Reel)	119	B.1725	11986-A
Tape Cartridges:			
40 Second Series (6/Box/MI)	119	B.1725	11988-B1
70 Second Series (6/Box/MI)	119	B.1725	11988-B2
2.5 Minute Series (6/Box/MI)	119	B.1725	11988-B11
3.5 Minute Series (6/Box/MI)	119	B.1725	11988-B3
5.5 Minute Series (6/Box/MI)	119	B.1725	11988-B4
10.5 Minute Series (6/Box/MI)	119	B.1725	11988-B5
16 Minute Series (2/Box/MI)	119	B.1725	11988-B6
31 Minute Series (2/Box/MI)	119	B.1725	11988-B7
Blank 300 Series (6/Box/MI)	119	B.1725	11988-A8
Blank 600 Series (6/Box/MI)	119	B.1725	11988-A9
Blank 1200 Series (2/Box/MI)	119	B.1725	11988-A10
Tape Deck, Spare:			
For RT-17B with Play Head	114	B.1736	11363
For RT-37B with Play Head	114	B.1736	11362
Tape Eraser:			
Automatic Magnetic, 60 Hz (Audio)	120	B.1725	ES-29976
Automatic Magnetic, 50 Hz (Audio)	120	B.1725	ES-29978
Automatic Magnetic, 60 Hz (Video)	120	B.1725	ES-29975
Automatic Magnetic, 50 Hz (Video)	120	B.1725	ES-29977
Tape Programmer, Audio Type BCA-15A	100	B.1756	11365-A
Tape Recorders:			
RT-8A Mono Multicartridge System for use with RT-7	111	B.1732	ES-11168
RT-8A Mono Multicartridge System for use with RT-17	111	B.1732	ES-11169
RT-8A Stereo Multicartridge System for use with RT-37	111	B.1732	11961-AS
RT-17B Stereo Cartridge Tape Playback	113	B.1736	11965-A
BA-17B Mono Cartridge Tape Recorder	113	B.1736	11966-A
RT-21B Full Track 3 3/4" and 7 1/2" IPS	105	B.1704	ES-41920-B
RT-21B Dual Half Track, 3 3/4" and 7 1/2" IPS	105	B.1704	ES-41921-B
RT-21B Stereo Dual Half Track, 3 3/4" and 7 1/2" IPS	105	B.1704	ES-41921-BS
RT-21B Full Track, 7 1/2" and 15" IPS	105	B.1704	ES-41930-B
RT-21B Dual Half Track 7 1/2" and 15" IPS	105	B.1704	ES-41931-B
RT-21B Stereo Dual Half Track, 7 1/2" and 15" IPS	105	B.1704	ES-41931-BS

AUDIO EQUIPMENT

	Catalog References		MI No.
	Page	Sheet	
Tape Recorders: (Continued)			
RT-22A Automatic Mono Tape Playback, 3¾" and 7½" IPS	109	B.1706	ES-41924-A
RT-22A Automatic Mono Tape Recorder, 3¾" and 7½" IPS	109	B.1706	ES-41925-A
RT-22A Automatic Stereo Tape Playback, 3¾" and 7½" IPS	109	B.1706	ES-41926-A
RT-22A Automatic Stereo Tape Recorder, 3¾" and 7½" IPS	109	B.1706	ES-41927-A
RT-37A Cartridge Stereo Playback Unit	116	B.1738	11962-A
RT-37A Cartridge Stereo Recorder	116	B.1738	11963-A
Terminal Board Bracket:			
Aluminum Epoxy	84	B.1500	4570-A2
Umber Gray	84	B.1500	4570-A
Terminal Board Mounting Angles:			
Set of 2 (For Umber Gray Cabinets)	82	B.1500	30527-G29
Set of 2 (For Aluminum Epoxy Cabinets)	82	B.1500	30527-A29
Throat (For use with Horns, MI-9594/9595)	129	B.1823	9573
Tone Arm:			
Lightweight 12" (Wired for Stereo)	103	B.1613	11894-B
Lightweight 16" (Wired for Stereo)	103	B.1613	11895-A
Top Cover:			
For SA-1004 Amplifier	74	B.1474	38174
Ventilated Midnight Blue (For 18" deep Cabinets)	82	B.1500	30521-B1
Ventilated Midnight Blue (For 24" deep Cabinets)	82	B.1500	36521-B1
Ventilated Umber Gray (For 18" deep Cabinets)	82	B.1500	30521-G1
Transformers:			
Balancing (Waveforms Inc.)	102	B.1913	T11
Bridging	90	B.1509	11712
Bridging for use with Switcher	90	B.1509	11791-A
Bridging Input (10,000/100,000 Ohms)	72	B.1470	38703
Combination Input/Output	71	B.1472	9667
Input (250/50K)	131	B.1892	12377-D
Input (250/50K)	131	B.1892	12399-A
Input for BN-7A	65	B.1435	11776
Line	90	B.1509	11713
Matching (135/600 Ohms Balanced Operation)	137	B.1915	T-11
220 Volt Kit	102	B.1610	41605
Transistor and Diode Kits:			
For BA-26B	63	B.1414	11779-B
For BA-31C	58	B.1406	11786-7
For BA-33B	59	B.1408	11781-B
For BA-34C	61	B.1410	11782-B
For BA-36A	63	B.1414	11783
For BA-71C	54	B.1420	11786-6
For BA-73B	55	B.1421	11786-5
For BA-74	56	B.1422	11786-2
For BA-78B	57	B.1423	11786-1
For BN-7A	65	B.1435	11785
For BN-16B/C	67	B.1438	11498
For BX-71A	77	B.1442	11786-3
Transmission Measuring Set (Waveforms Inc.)	132	B.1915	452A
Trim Strip:			
Double for Cabinet Racks:			
84" Umber Gray	82	B.1500	30568-G84
84" Aluminum Epoxy	82	B.1500	30568-A84
77" Aluminum Epoxy	82	B.1500	30568-A77

AUDIO EQUIPMENT

	Catalog References		MI No.
	Page	Sheet	
Trim Strip: (Continued)			
Single for Cabinet Racks;			
84" Umber Gray	82	B.1500	30566-G84
84" Aluminum Epoxy	82	B.1500	30566-A84
77" Aluminum Epoxy	82	B.1500	30566-A77
Tube, Selected Type 12AY7	42	B.1102	11299
Turntable, Type BQ-51B, 2-Speed, 12"	101	B.1610	11810-B
Voltmeter and Amplifier (Waveforms Inc.)	138	B.1915	520A
Volume Control:			
Chassis Mounting Bridging	90	B.1509	11278-F
Panel Mounting Bridging	90	B.1509	11278-E
VU Meter:			
Simpson	88	B.1509	#53064
For BC-7/BC-8	34	B.1115	#226033
VU Meter Panel, Type BI-5B	88	B.1509	11265-G
Wall Housing, LS-1A Loudspeaker	124	B.1804	11406-A
Windscreen, For BK-5	11	B.1018	11011
Wire:			
Belden Type 8437 #22 AWG Solid, 2 Conductor, shielded, Vinyl jacket ...	86	B.1508	13342-1
Belden Type 8441 #22 AWG Stranded, shielded, Vinyl jacket	86	B.1508	13342-2
Belden Type 8451 #22 AWG Stranded, shielded, Vinyl jacket	86	B.1508	13342-4
BC-7/8 Hook-Up Wire, 2 conductor, shielded pair, #28 Stranded, Vinyl jacket	34	B.1115	13395-1
Zero Adjustment Pad	88	B.1509	#19327
Zipper Bag, Spare for 77-DX Microphone	8	B.1009	#99HO102



The Most Trusted Name in Electronics

RADIO CORPORATION OF AMERICA

BROADCAST AND COMMUNICATIONS PRODUCTS DIVISION, CAMDEN, N. J. 08102 • RCA INTERNATIONAL DIVISION, CENTRAL and TERMINAL AVENUES, CLARK, NEW JERSEY, U.S.A. 07066

TRADEMARK(S) REGISTERED (MARCA(S) REGISTRADA(S))