

rust corporation of america

rust corporation of america

Sal Fulchino, President and Treasurer

HOME OFFICE:

195 Massachusetts Avenue
Cambridge 39, Massachusetts

Telephone: Area Code 617
864-9150
864-9151
864-9152

SALES DEPARTMENT

John L. Wyman, Jr.
Vice President of Marketing and Sales

David A. Shaw
Sales Representative

John W. Beck
Sales Engineer

CUSTOMER SERVICE

B. T. Newman
Assistant to the President

Fast, around-the-clock, field service is available to owners of **RUST** Broadcast Equipment. For service on **RUST** Equipment, which is essential for continued, on-the-air operation of the station, contact the **RUST** Home Office, Area Code 617, Telephone: 864-9150.

WESTERN REGIONAL OFFICE

2921 South 104th Street
Omaha, Nebraska

Telephone: Area Code 402
393-4747

Mr. Bill L. Dunbar
Western Regional Manager

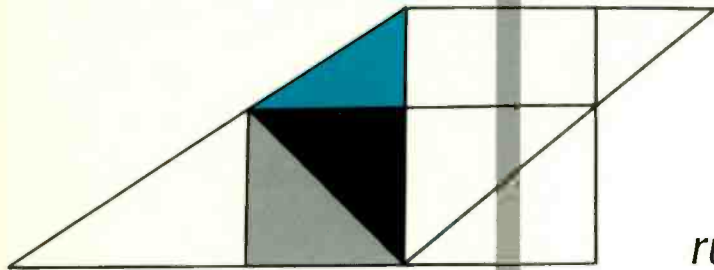

rust corporation of america

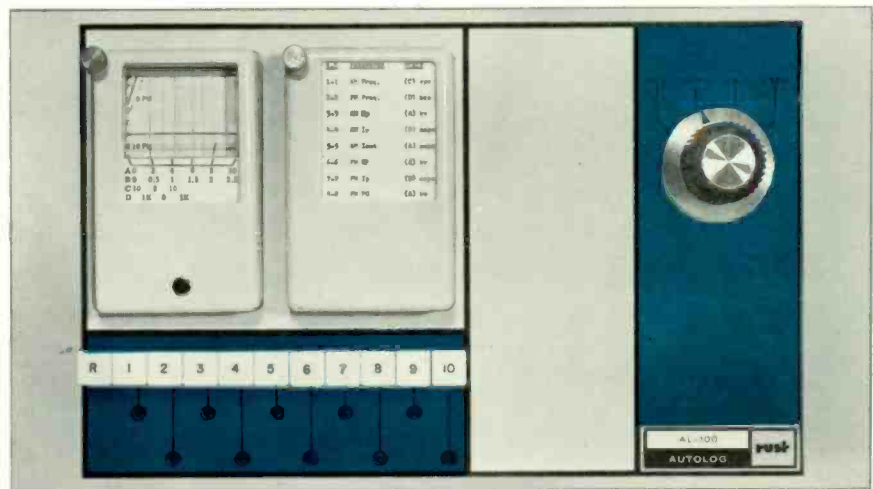

THE AL-100

... the most significant advance in automatic logging equipment for AM, FM and TV stations since the introduction of the original AUTOLOG.

CHECK THESE EXCLUSIVE FEATURES:

ONLY THE RUST AL-100 eliminates "chicken tracks". The new AL-100 employs Rust's unique continuous line recording for immediate and easy readings. Time previously spent deciphering and analyzing "chicken tracks" can now be spent more productively. Serious variations from the standard are immediately evident with continuous line recording.

ONLY THE RUST AL-100 provides ten parameter readings for complete coverage and flexibility for AM, FM & TV stations. This unique unit will log any combination of AM, FM or TV installations.

ONLY THE RUST AL-100 gives you the greatest degree of simplicity and economy of operation. No special log books or storage devices are needed. The AL-100 uses only six chart rolls a year. Save over \$50/year in logging material alone.

ONLY THE RUST AL-100 provides maximum dependability and accuracy through the use of magnetic alarm meter movements with separate upper and lower limit relays.

RUST



rust corporation of america

AND LOOK WHAT ELSE RUST GIVES YOU:

With the AL-100 you can calibrate with the chart paper in place. Fully automatic operation lets your engineer or announcer attend to more important duties. Standard sized 19" unit is completely self-contained.

Best of all, the price is competitive with any other logging system. And with their being obsolete, the AL-100 is the only logical choice.

SPECIFICATIONS:

Parameters: 10 on a single chart
Type of recording: Straight line, using linear axis
Actual Chart Width: Standard 2.3"
Chart Speed: 1/2"/hour
Chart Recorder Accuracy: 1% of full scale
Power requirements: 115 Volts AC, 60 Cycles, 1 Ampere
Input Range: 10 MV to 10 Volts
Input Impedance: 1 megohm
DC Offset — 2 positions
Physical Dimensions: 10 1/2" x 19" x 11" Standard Rack Mounting
Weight: 21 lbs.

RUST 
corporation of america

Eastern Division
195 Mass. Avenue
Cambridge, Mass.
[617] 864-9150

Washington, D.C.
John Andre
13205 May Court
Silver Spring, Md.
[301] 942-5156

Western Division
2921 South 104th St.
Omaha, Nebraska
[402] 393-4747

RUST FM STEREO TRANSMITTERS • AUTOLOG • RUST REMOTE CONTROL

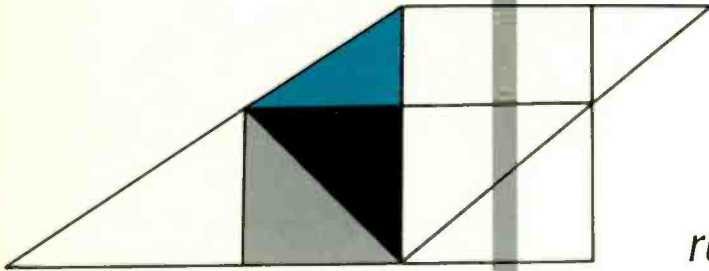

rust corporation of america

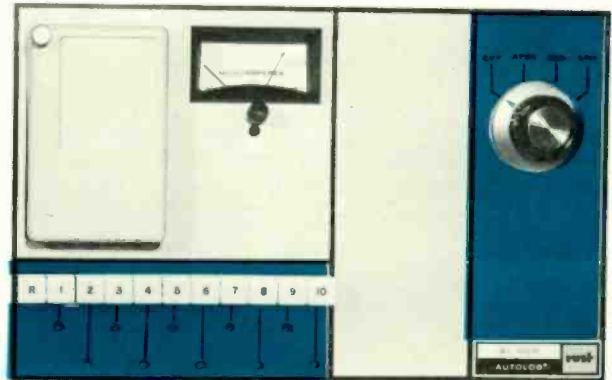
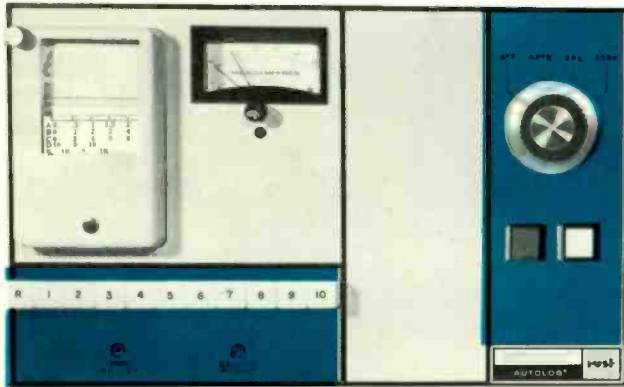

THE AL-100R

... the most advanced system ever designed for remote transmitter logging. The AL-100R is compatible with all DC metering remote control systems, and will do everything the AL-100 does locally.

CHECK THESE EXCLUSIVE FEATURES:

Easy to read continuous line recordings for immediate charting on the RUST AUTOLOG. Valuable time is saved, and any serious variations from the preset standard are obvious.

Ten parameter readings with an automatic calibration check at the end of each cycle to insure accuracy.

Aural alarm provisions for immediate notification when a defect occurs. The AL-100R locks in on the defective parameter to give you fast identification.

A full two months' logging on a single roll of standard size recording paper. You save as much as \$50 per year on paper alone.

Utilizes existing telephone remote control lines.

Ultimate dependability, ease of operation, and accuracy.

RUST

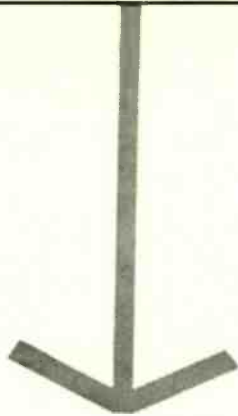

rust corporation of america

The AL-100R is designed to be used by stations operating transmitter equipment from a distant control point through the use of any remote control equipment that utilizes DC metering over a single metallic pair of wires. The system consists of two basic units: the 100C at the remote control location, and the 100T at the transmitter site.

The parameter sampling to be logged and alarmed is fed to one of the ten (10) inputs of the 100T unit at the transmitter site. The output of the 100T is connected to the control point through the station's existing remote control system by introducing this information to one of the remote control system's metering positions. When the remote control system is set to read this particular position, the 100T unit output is connected to the 100C input at the control location. It is usually possible for the 100T to share the remote control samplers.

The readings are fed to the 100C by the AUTOLOG 100T through the station's existing remote control system and displayed on the chart recorder by the RUST AUTOLOG synchronous system so as to appear as continuous lines which will vary in direct proportion to any parameter variation in the equipment being logged. In addition to displaying the reading on the chart recorder, the parameter is also indicated on a meter mounted on the panel beside the chart recorder.

The AL-100R system is designed to have continuous alarming of required or desired parameters at the transmitter site. When a parameter exceeds its preset upper or lower limit setting, the system is so designed as to stop sequencing on the defective position and indicate on the 100C at the control point which position has varied beyond the desired value. In addition, contacts for an aural alarm are incorporated in the 100C for instant notification that a variation beyond the desired has occurred.

SPECIFICATIONS:

100C (Control Location Unit)

Parameters: 10 on a single chart
Type of recording: Continuous line, using linear axis
Chart width: Standard 2.3 inches
Chart speed: $\frac{1}{2}$ " / hour (other selected speeds available)
Power requirements: 115 volts AC, 60 CPS, 1.5 amperes
Physical dimensions: $10\frac{1}{2}$ " x 19" x 11"
Weight: 25 lbs.
System requirement: Single metallic pair of wires up to 5000 ohms loop resistance.

100T (Transmitter Location Unit)

Inputs: 10 (one megohm)
Input range: 10mv to 10 volts
DC offsets: 2 positions
Power requirements: 115 volts AC, 60 CPS, 1.5 amperes
Physical dimensions: $10\frac{1}{2}$ " x 19" x 11"
Weight: 30 lbs.
System requirement: Single metallic pair of wires up to 5000 ohms loop resistance.

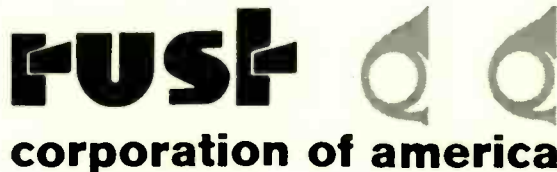

Eastern Division
195 Mass. Avenue
Cambridge, Mass.
(617) 864-9150

Washington, D.C.
13205 May Court
Silver Spring, Md.
(301) 942-5156

Western Division
2921 South 104th St.
Omaha, Nebraska
(402) 393-4747

RUST FM STEREO TRANSMITTERS • AUTOLOG • RUST REMOTE CONTROL

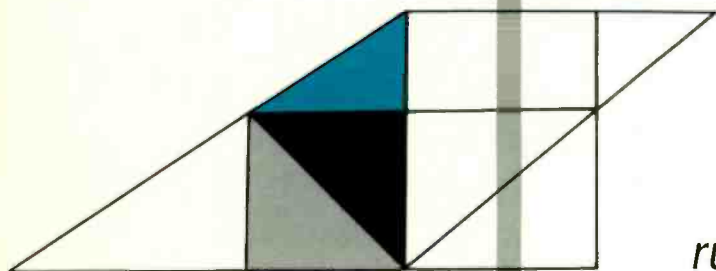

rust corporation of america

15 KW FM STEREO TRANSMITTER

AT LAST . . . a powerful 15 KW FM Stereo Broadcast Transmitter that is field proven for stereo/multiplex or monaural operation and delivers the superior sound discriminating listeners are demanding. Built to the highest quality standards the RUST 15 KW sounds better because it is better. Beginning with the FME exciter through the 1 KW driver and ending with the 15 KW amplifier, RUST engineers have designed a system incorporating the proper balance of quality and economy. Exciting listening, inexpensive operation and modern functional styling are outstanding features of the new RUST 15 KW FM Stereo Broadcast Transmitter.



CHECK THESE EXCLUSIVE FEATURES:

STEREO DESIGN—RUST Transmitters have been designed for multiplex operation since 1956. The RUST type FME multiplex exciter, field proven to be the most reliable exciter available, has been in continuous multiplex operation longer than any other stereo model.

SOLID STATE POWER SUPPLIES—The most modern solid state components are used throughout. Up-to-date and proven for cooler, more efficient operation.

MODERN COMPACT UNIT—The RUST 15 KW Transmitter requires less than 12 square feet of floor space, the same space previous 5 KW models occupied. This slim line styling will complement existing station equipment.

BUILT-IN REMOTE CONTROL METERING SAMPLERS—RUST samplers proven since 1954 mean accurate metering.

LONGER TUBE LIFE—Conservatively operated final tubes result in lower station replacement cost savings and longer tube life.

RUST

rust corporation of america

THE RUST 15 KW ALSO PROVIDES:

- Solid State Power Supply
- Crystal - control, with provisions for a spare crystal to be switched in immediately.
- Plug in pre-emphasis network.
- Five year guarantee exciter power supply.

SPECIFICATIONS

Frequency Range	88-108 mc
Power Output	15 KW
Output Impedance	Nominal 50 ohms
Frequency Deviation	(100% modulation) \pm 75 KC
Modulation Capability	\pm 100 KC
Carrier Frequency Stability	Better than 1000 cps
Audio Input Impedance	600/150 ohms
Audio Input Level for 100% modulation at 400 cps	+10 \pm 2 dbm (with standard pre-emphasis network as provided with the equipment)
Audio Frequency Response	(50-15,000 cps) \pm 1 db
Harmonic Distortion	Less than 1.0% 50-15,000 cycles
FM Noise Level (Reference Signal 400 cps Modulation 100%)	Exceeds -65 db as measured with a standard 75 μ sec de-emphasis and a 15 KC low pass filter
AM Noise Level	Exceeds -60 db referred to carrier amplitude
Power Line Requirements	220 V 80 A 3 Phase and 115 V 15 A 1 Phase
Dimensions	84" high x 60" wide x 28" deep

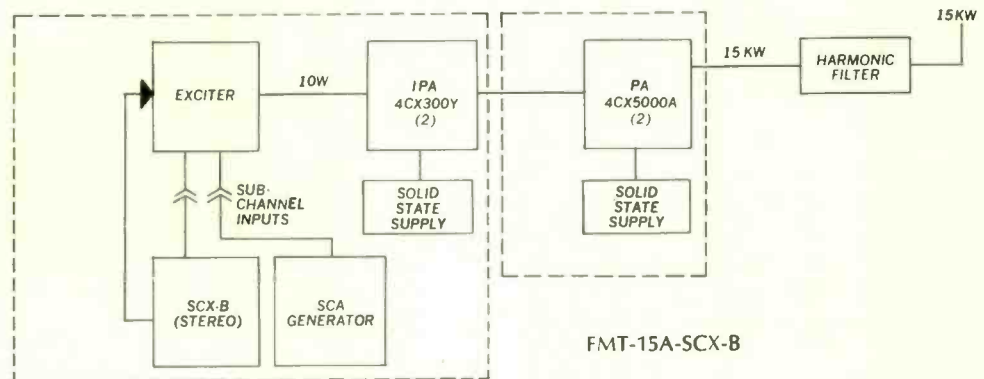

When purchased for FM Stere-O use, order Type.FMT-15A-SCX-B; when purchased for FM Mono use, order FMT-15A .. either way the same fine transmitter.



Eastern Division	Washington, D.C.	Western Division
195 Mass. Avenue	13205 May Court	2921 South 104th St.
Cambridge, Mass.	Silver Spring, Md.	Omaha, Nebraska
[617] 864-9150	[301] 942-5156	[402] 393-4747

RUST FM STEREO TRANSMITTERS • AUTOLOG • RUST REMOTE CONTROL

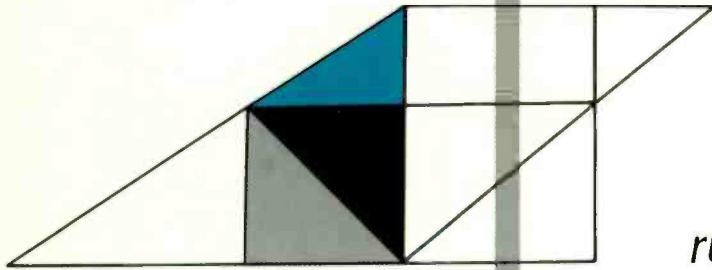

rust corporation of america

5 KW FM STEREO TRANSMITTER

The new Rust 5 KW FM Stereo Broadcast Transmitter is the thoroughbred of 5 KW Transmitters. A result of Rust's continuing design advances, the 5 KW delivers a stereo sound so superior, it will excite even the most discriminating listeners.

Not only does this transmitter deliver the ultimate in stereo sound, it is also the most economical, practical and attractive 5 KW ever developed.



CHECK THESE EXCLUSIVE FEATURES

The Rust 5 KW's modern, compact, slim line design requires the smallest floor space of any 5 KW transmitter.

The Rust 5 KW is the easiest and most economical 5 KW transmitter to operate and maintain. Operating controls, crystals and meters are conveniently located on the front of the equipment.

The Rust 5 KW is equipped with Rust's Model FME Exciter; field-proven to be the most reliable and trouble free exciter available.

The Rust 5 KW uses the lowest cost final tube and its 100% tube replacement cost is the lowest.

The Rust 5 KW is designed for remote control and is equipped with provisions to insert stereo multiplex and background music multiplex subchannel generators.

The Rust 5 KW undergoes a thorough test on the stations assigned frequency to assure maximum reliability and trouble free operation.

RUST



rust corporation of america

THE RUST 5 KW ALSO PROVIDES:

- Solid State Power Supply
- Crystal - control, with provisions for a spare crystal to be switched in immediately.
- Plug in pre-emphasis network.
- Five year guarantee exciter power supply.

SPECIFICATIONS

Frequency Range	88-108 mc
Power Output	5 KW
Output Impedance	Nominal 50 ohms
Frequency Deviation	(100% modulation) \pm 75 KC
Modulation Capability	\pm 100 KC
Carrier Frequency Stability	Better than 1000 cps
Audio Input Impedance	600/150 ohms
Audio Input Level for 100% modulation at 400 cps	+10 \pm 2 dbm (with standard pre-emphasis network as provided with the equipment)
Audio Frequency Response	(50-15,000 cps) \pm 1 db
Harmonic Distortion	Less than 1.0% 50-15,000 cycles
FM Noise Level (Reference Signal 400 cps Modulation 100%)	Exceeds -65 db as measured with a standard 75 μ sec de-emphasis and a 15 KC low pass filter
AM Noise Level	Exceeds -60 db referred to carrier amplitude
Power Input	7.6 KVA
Power Line Requirements	220 V 30 A 3 Phase and 115 V 15 A 1 Phase
Dimensions	84" high x 48" wide x 28" deep

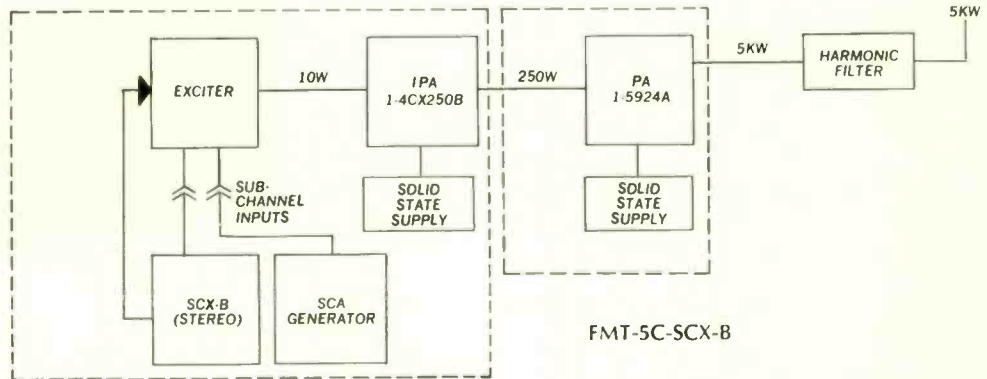

When purchased for FM Stere-O use, order Type FMT-5C-SCX-B; when purchased for FM Mono use, order FMT-5C . . . either way the same fine transmitter.



Eastern Division	Washington, D.C.	Western Division
195 Mass. Avenue	13205 May Court	2921 South 104th St.
Cambridge, Mass.	Silver Spring, Md.	Omaha, Nebraska
[617] 864-9150	[301] 942-5156	[402] 393-4747

RUST FM STEREO TRANSMITTERS • AUTOLOG • RUST REMOTE CONTROL

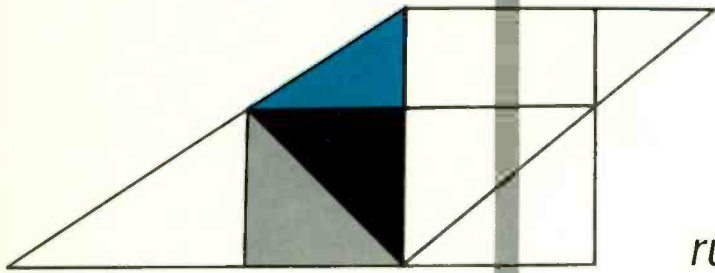

rust corporation of america

1 KW FM STEREO TRANSMITTER

Now, a completely self-contained 1 KW FM stereo transmitter from Rust Corporation. This slim line 1000 watt automated transmitter occupies less than five square feet! Utilizing the world-famous FME type multiplex exciter, that's been time-tested, and stereo proved to be *the* exciter design, Rust's 1 KW FM presents a clear, undistorted sound that listeners tune to, and stay with . . . rugged solid state power supplies, using the highest quality components, keep the signal strong, the transmitter cool, reducing maintenance costs. Even final tubes last longer, due to conservative operation. Here at last is a 1 KW FM stereo transmitter including all the wanted features broadcasters have needed for years.



EXCLUSIVE RUST FEATURES:

AUTOLOG OPTION: Easy to operate . . . easy to remote with the famous Rust Autolog, automatic transmitter logging system.

CLOSET SIZE: The Rust 1 KW FM stereo transmitter is just 23 inches wide and 28 inches deep . . . takes less than five square feet of floor space and compliments all equipment with its slim line cabinet styling.

PROOF OF PERFORMANCE: Rust's FME type exciter has been in continuous broadcast use longer than any competitive model. It's the standard of excellence in the industry.

MODERN POWER SUPPLIES: The most up-to-date solid state components are used in a perfect balance of quality and economy.

RUST

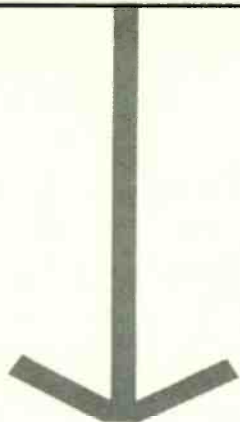

rust corporation of america

SPECIFICATIONS

Frequency Range	88-108 mc
Power Output	1000 watts
Output Impedance	Nominal 50 ohms
Frequency Deviation	(100% Modulation) ± 75 kc
Carrier Frequency Stability	± 1000 cps
Audio Input Impedance	600/150 ohms
Audio Input Level	100% Modulation at 400 cps $+10 \pm 2$ dbm (with standard pre-emphasis network as supplied with the equipment)
Audio Frequency Response	(50-15,000 cps) ± 1 db
Harmonic Distortion	Harmonics up to 30 kc do not exceed the following values at 25%, 50% and 100% modulation: 1.3% at 50-100 cps; 0.8% at 100-7500 cps; 1.3% at 7500-15000 cps.
FM Noise Level	(Reference Signal 400 cps Modulated 100%) Better than -65 db as measured with standard 75 micro-second de-emphasis and a 15 kc low-pass filter.
AM Noise Level	Exceeds -50 db referred to carrier amplitude.
Power Input	Approximately 3.0 KW
Power Line	208/230 single phase 50/60 cps and 110 VAC single phase 50/60 cps.
Dimensions	84" high x 23" wide x 28" deep.

FMT-5C-SCX-B

When purchased for FM Stere-O use, order Type FMT-5C-SCX-B; when purchased for FM Mono use, order FMT-5C . . . either way the same fine transmitter.



corporation of america

Eastern Division	Washington, D.C.	Western Division
195 Mass. Avenue	13205 May Court	2921 South 104th St.
Cambridge, Mass.	Silver Spring, Md.	Omaha, Nebraska
[617] 864-9150	[301] 942-5156	[402] 393-4747

RUST FM STEREO TRANSMITTERS • AUTOLOG • RUST REMOTE CONTROL

FM STEREO- O EXCITER

FEATURES

- *Stere-O, Monaural, SCA Design*
- *Built-in Metering*
- *Crystal-Controlled*
- *Compatible with Existing Transmitters*

GENERAL

The GEL STEREO/SCA basic Exciter FME-10A-SCX-B* is a time tested, field proven Exciter that has been in operation in radio stations from coast to coast for a number of years. GEL has found it unnecessary to develop a new exciter for stereo. The basic exciter design developed for SCA operation has proven to be excellent for stereo as well. This exciter has been extensively used to modernize old transmitters and to increase station revenue by transmission of background music and/or stereo. The basic FME Exciter can be supplied to modernize any existing transmitter.

TECHNICAL DESCRIPTION

The GEL time tested, field proven, Model FME-10A Mono and FME-10A-SCX-B Stereo Exciter is a frequency-division system which permits the integration of a main channel and one or two subchannels into an allocated FM channel. This equipment can be used with any existing type of frequency-modulation broadcast transmitter operating in the 88 to 108-megacycle band. Salient features of the General Electronic's system include improved multiplex Stereo and SCA performance by the virtual elimination of interchannel crosstalk and spurious output signals. Tuning is designed to be non-critical and adjustments to be stable in order to permit unattended operation in remote locations. These features are obtained through the utilization of complete radio-frequency shielding

*When purchased for FM Stereo use, order Model FME-10A-SCX-B; when purchased for FM Mono use, order Model FME-10A...either way the same fine exciter.

FM Stere-O
Exciter



of all components and the application of advanced circuitry techniques. The only external connections required for the FME system are made to the existing FM transmitter, the main and sub-channel audio input equipments, and a 110-volt, 60-cps, single-phase primary power source.

The operating voltages for the Multiplex Exciter are provided by the Power Supply, Lambda Model C481M-670; the operating voltages for each Sub-channel Generator are provided by individual Power Supplies, Lambda Model C281M-670, for SCA operation and Lambda Model 28M for stereo operation.

The FME-10A Exciter is mounted on four panels; namely, a main channel audio unit, an oscillator-modulator unit, a frequency-multiplier unit, and a main-channel output unit.

A vertical-chassis type of layout is utilized throughout the FME exciter system. Components are mounted directly on the main panel in order to provide ready accessibility of circuitry and tubes for signal tracing and equipment maintenance. All operating controls, tubes, crystals, and other components requiring periodic testing are conveniently located on the front of the panels. Inter-unit connections are made via terminal strips or r-f connectors readily available on the rear of the panels.

SPECIFICATIONS

Output Frequency Range	- Full Frequency Type FME-10A, - 1/2 Frequency Type FME-1D, - 1/3 Frequency Type FME-1B, - 1/6 Frequency Type FME-1E. Exact frequency dependent on FM transmitter and customer requirements.	Audio Frequency Response	- ± 1 db between 50 and 15,000 cps referred to 1000 cps. standard.
RF Output Connector	- Type "N".	Harmonic Distortion	- Harmonics up to 30 kc not to exceed the following values at 25%, 50% and 100% modulation; 1.3% at 50-100 cps; 0.8% at 100 - 7500 cps; 1.3% at 7500 -15,000 cps.
Power Output	- 10 w nominal.	FM Noise Level	- (Reference signal 400 cps modulation 100%) Better than -65 db as measured with standard 75-micro second de-emphasis and a 15-kc low-pass filter.
Output Impedance	- Nominal 50 ohms.	AM Noise Level	- Better than -50 db referred to carrier amplitude.
Frequency Deviation	- ± 75 kc for 100% modulation at carrier output frequency; capable of ± 100 kc.	Power Input	- 105 -125 v ac; 480 w max. (For power supply specifications, see C481M Data Sheet).
Carrier Frequency Stab.	- ± 1000 cps at carrier output frequency.	Power Supply & Audio Input	- Barrier-type terminal strips.
Audio Input Impedance	- 600 or 150 ohm balanced or unbalanced line.		
Audio Input Level	- $\pm 10 \pm 2$ dbm for 100% modulation at 400 cps. (with standard 75-micro second pre-emphasis network as supplied with the equipment.)		

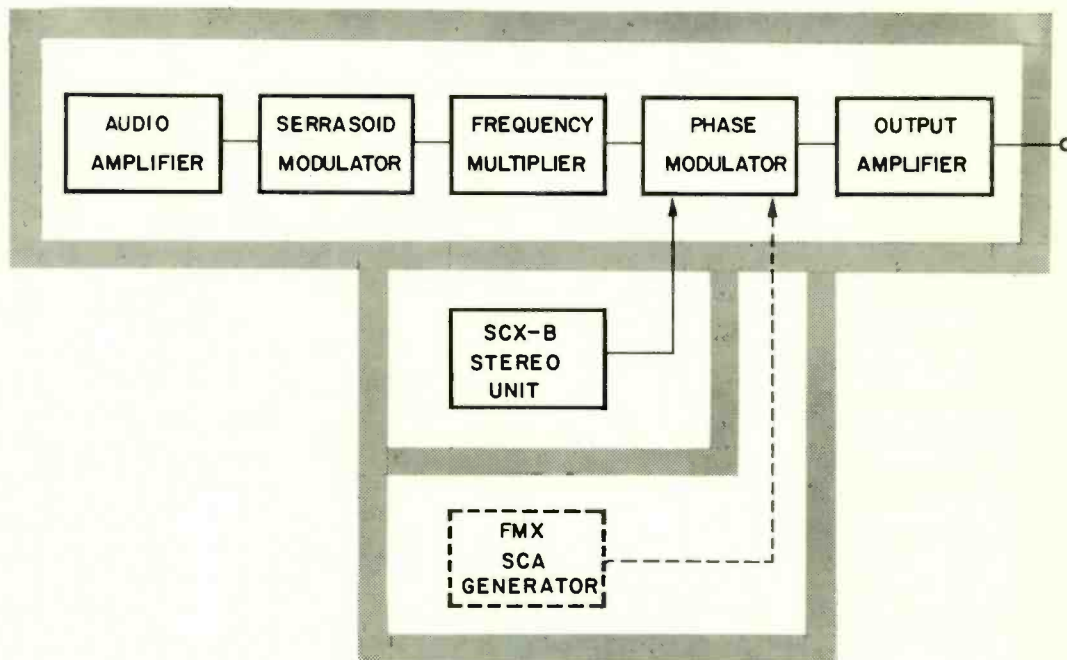

FME-10A-SCX-B STEREO EXCITER

FM SCA MULTIPLEX GENERATOR

GEL TYPE FMX

FEATURES

- Field-Proven Service
- Crystal-Controlled
- All Electronic Muting
- Built-in Metering

GENERAL

The GEL SCA Sub-Channel Generator is the original quality multiplex unit for successful broadcasting of two programs on one F.M. channel. The GEL equipment has been in service from coast to coast, without modification, longer than that of any present day FM transmitter manufacturer. Yet, because of its advanced design, this generator has remained modern and consistent with the present state of the broadcasting art.

The GEL Type FMX SCA Generator has "built-in" all of the factors necessary and desirable for efficient money making SCA operation. Complete metering is self-contained. A simple turn of a front panel knob presents on the front panel mounted meter the condition of any amplifying circuit. The system is crystal controlled with provisions for a spare crystal if so desired. A Lambda long service power supply furnishes the required voltages while operating at only one-half rated output.

In addition, to insure long, trouble-free programming no electrolytic capacitors are used.

To assist in proper silencing of field receivers between selections, an all-electronic muting system was designed into the system.

TECHNICAL DESCRIPTION

A vertical-chassis type of layout is utilized throughout the FMX multiplex system. Components are mounted directly on the main panel in order to provide ready accessibility of circuitry and tubes for signal tracing and equipment maintenance. All oper-

ating controls, tubes, crystals, and other components requiring periodic testing are conveniently located on the front of the panels. Inter-unit connections are made via terminal strips or r-f connectors readily available on the rear of the panels.

The FMX sub-channel generator is mounted on four panels: a sub-channel audio input unit, an oscillator-modulator unit, a frequency-multiplier unit, and a sub-channel output unit. Tuning is designed to be non-critical and adjustments to be stable in order to permit unattended operation in remote locations. These features are obtained through the utilization of complete radio-frequency shielding of all components and the application of advanced circuitry techniques.

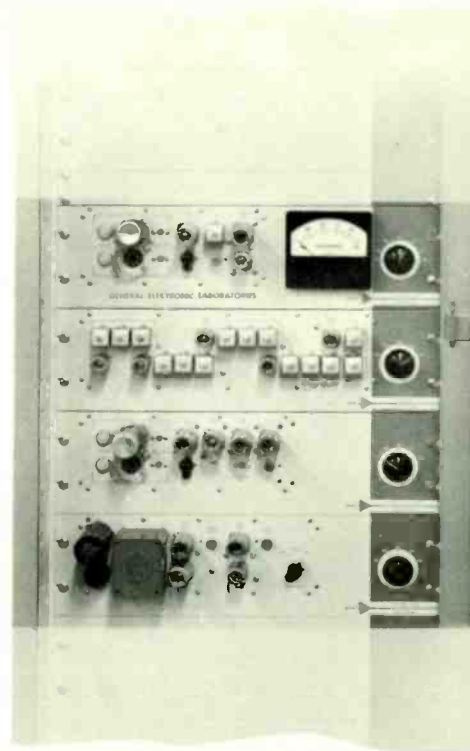

FMX Sub-Channel Generator

SPECIFICATIONS

Output Frequency Range: 30-70 kc.
Output Level: 0-2 volt.
Frequency Deviation: ± 7.5 kc for 100% modulation; modulation capabilities to 12.5 kc.
Carrier Frequency Stability: ± 1000 cps.
Audio Input Impedance: 600 or 150 ohm balanced or unbalanced line.
Audio Input Level: $+10 \pm 2$ dbm for 100% modulation at 400 cps (with standard 75-microsecond pre-emphasis network as supplied with the equipment).
Audio Frequency Response: ± 2 db between 100 and 7500 cps for output frequency below 40 kc; ± 2 db between 100 and 15,000 cps for output frequency above 40 kc.

Harmonic Distortion: All harmonics to 15 kc shall not exceed 2% for signals 100 - 7500 cps for output frequencies below 40 kc; all harmonics to 30 kc shall not exceed 2% for signals 100 - 15,000 cps for output frequencies above 40 kc.
FM Noise Level: -60 db referred to normal deviation as measured with standard de-emphasis circuit and 15-kc low-pass filter.
AM Noise Level: -50 db referred to carrier amplitude.
Automatic Muting: The output is removed in absence of audio input signal. The muting time is adjustable.
Power Input: 105 - 125 v ac; 330 w max. (For power supply specifications, see C281M Data Sheet.)
Subcarrier Output Connector: Type BNC
Power Supply and Audio Input: Barrier-type terminal strips.

FMX MULTIPLEX SYSTEM SUB-CHANNEL GENERATOR

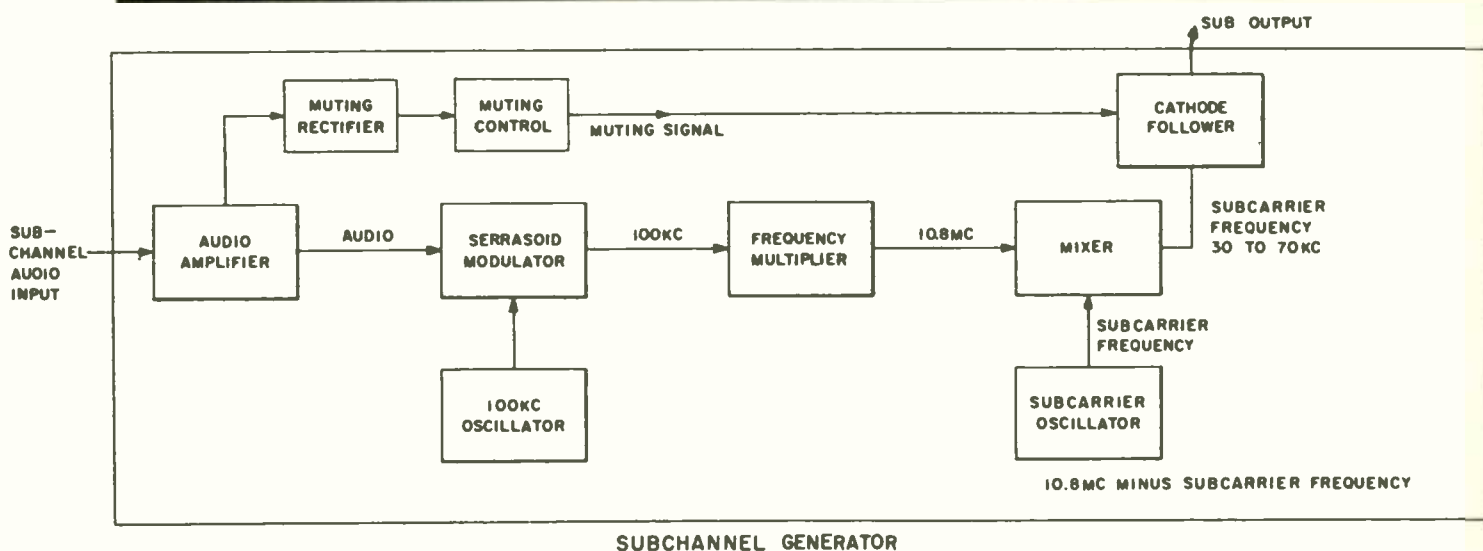

GO STEREO QUICKLY, EASILY AND RELIABLY

with a

GEL STEREO SUBCHANNEL GENERATOR

MODEL SCX-B

- Easy Installation by Station Personnel
- Remotely Switched from Monaural to Stereo
- Straight Forward Circuit Design
- Pre-Tested and Tuned at Factory

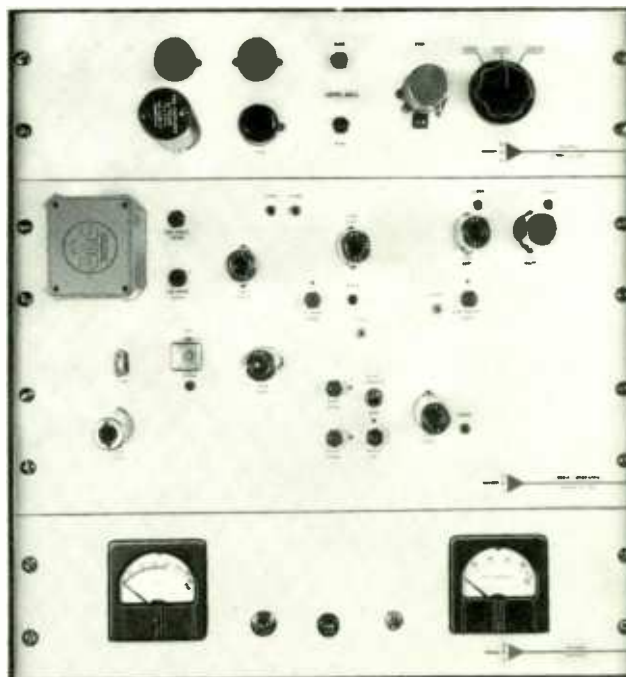

Stereo Generator

Monaural FM stations can go Stereo and earn greater Stereo income with a tested, ultra-reliable GEL Stereo Generator. The GEL unit is easy to install and can be set up by a station's regular technical personnel.

The GEL Stereo Generator will open up what many stations are finding to be a rich area for added income, Stereo Broadcasting. And the GEL Stereo unit has build-in relay and terminals to allow switching from monaural to stereo from a remote point. Station users of the unit have reported that FM Stereo and background music work perfectly together.

Although some stations using GEL equipment have gone Stereo within 24 hours, even a normal change-over will only require two to three nights. If the station is already equipped with a GEL exciter a minimum of modifications are needed. The technical personnel of the station can transfer the RF connections, power connections and audio lines. For stations equipped

with different makes of exciters, the GEL unit can be readily adapted.

In designing the stereo generator, GEL engineers incorporated the same straight-forward circuit approach used on other GEL broadcasting equipment, avoiding the use of transistors as amplifiers. Only high quality components were used which had been field-tested on GEL products over the past three years. The use of proven, precision components throughout the entire unit also minimizes the number of variable adjustments which a station engineer would have to make.

All GEL Stereo Units are pre-tested and tuned at the factory to 38KC. The Lambda power supply carries a five year guarantee. Power consumption is low.

The design of GEL's Stereo Generator also eliminates the need for heavy stocking of a great number of tubes. Exclusive of the power supply, the only tube types used are 12AT7, and 5879.

DESCRIPTION

The GEL Stereo Subchannel System is patterned after the field-proven, successful GEL FM System. Physically, the Stereo Generator is mounted on one 5-1/4" and one 10-1/2" standard 19-inch panel. Primary power is derived from one 5-1/4" high Lambda power supply. The complete system, including power supply, can be provided in a steel cabinet 83" high. When installed in an existing GEL transmitter-exciter cabinet, the additional cabinet is not required.

The vertical chassis layout with components mounted directly on the main panel provides ready accessibility of circuitry and tubes for signal tracing and equipment maintenance.

As with all other GEL broadcast products, the new Stereo System exceeds specifications necessary for high-fidelity broadcasting.

SPECIFICATIONS

Audio Input:	
Left & Right Signal	600 ohm, balanced or unbalanced, +10 ±2 dbm for 100% modulation at 400 cycles with standard 75 micro-second pre-emphasis networks as supplied. (100% includes 10% of 19 Kc Pilot)
Frequency Response	50-15,000 cps ±1 db
Distortion	Less than 1.3%, 50-100 cps Less than 0.8%, 100-7500 cps Less than 1.3%, 7500-15,000 cps
Physical Size	Two 5-1/4" panels One 10-1/2" panel 21 inches Overall

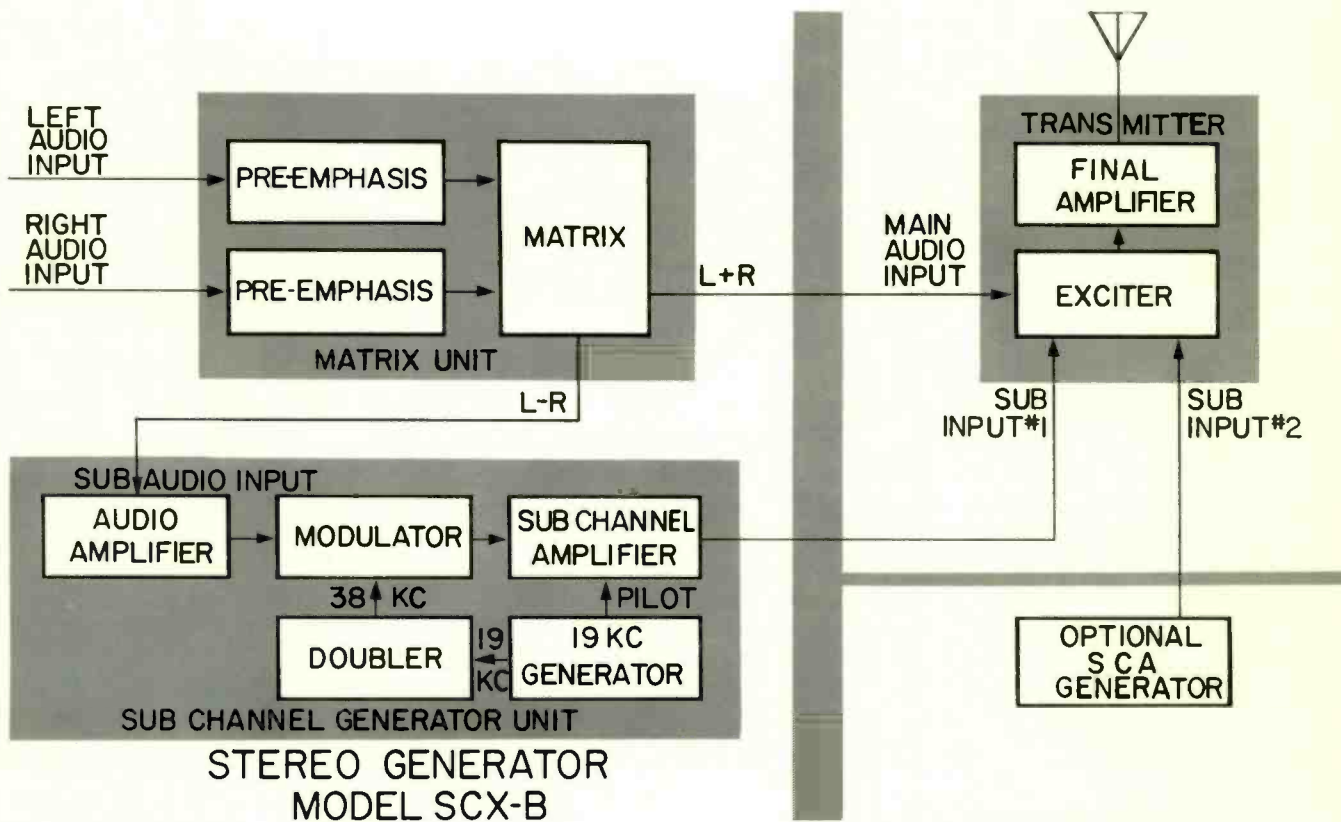

Block Diagram, FM Stereo Generator, Model SCX-B

CAPACITY TO MEET ANY REQUIREMENT

series F — economy system

The Rust Model F Remote Control System has been developed to meet the need for an economical but high grade and reliable system to serve the requirements of many single-transmitter installations. It uses an improved self-correcting 10-function stepping system.

SPECIFICATIONS

OF UNIT

Location	To be rack mounted at control point.
Size	19" x 8 $\frac{3}{4}$ " x 8" deep.
Panel	Umber gray — 8 $\frac{3}{4}$ " x 19" — RETMA slotting.
Power Source	100-130 volts 60 cycle A.C. — 20 watts.
Meters	Plate Voltage 0-2000/4000. Plate MA 0-500/1000. Ant. Amps. 0-5/20 (also "Twr Lts" & "CAL"). Frequency Deviation (100-0-100 μ A). Modulation Percentage (600 μ A F.S.).
Metering Capacity	Ten different readings plus CAL reading.
Control Capacity	Ten two-direction control functions plus fail safe circuit.
Panel Controls	Main transmitter & remote control power switch. Push button for CAL reading. Knob to set CAL reading. Raise-lower switch. Function selector knob.

1F UNIT

Location	To be rack mounted adjacent to transmitter.
Size	19" x 8 $\frac{3}{4}$ " x 7 $\frac{1}{4}$ " deep.
Panel	8 $\frac{3}{4}$ " x 19" — RETMA slotting.
Power Source	100-130 volts 60 cycle A.C. — 10 watts.
Accessories Supplied	Four pole double throw monitor switch assembly.
Control Switch	Panel switch controls fail-safe circuit to disable remote control and locally switch transmitter "on" or "off".
Telephone Lines	Two separate "signal circuit" pairs plus ground return. Max. DC loop resistance 4000 ohms.

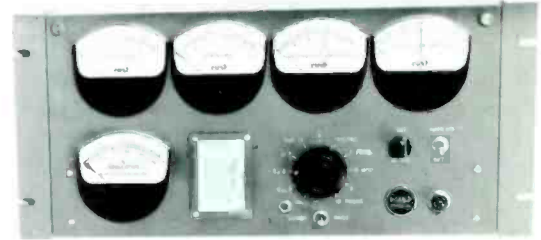

OF

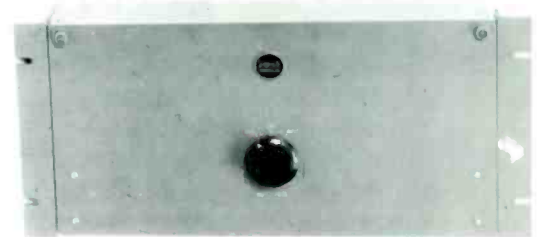

1F

series S — space saver system

The Rust Model S-2 Special Remote Control System has been developed to meet the need for remotely controlling a transmitter from a nearby control point to which it may be connected with multi-wire cable. This provides simultaneous reading of all meters and independent operation of all control functions with a minimum of complicated equipment. Uses standard Rust Metering and Control units at the transmitter.

UNIT SPECIFICATIONS

Location:	Installed in relay rack at control point.
Size:	19" wide x 7" deep.
Panel Color:	Off white.
Power Requirements:	115 volts, 60 cycles, 25 watts.
Controls:	Filament on-off. Plate on-off. Raise-lower output. 2 spare push buttons.
Indicators:	Meters: 0-150/300V A.C. Line voltage. 0-2/4KV D.C. Plate volts. 0-500/1000 Ma D.C. Plate current. 0-5/20 Amp A.C. antenna current. Frequency deviation. Percent modulation.
Line Required:	21 conductor #18 cable (stocked for your convenience.)

no vacuum tubes, oscillators, critical adjustments or tuned circuits

RUST REMOTE CONTROL SYSTEMS

SECTION

2

Rust line

of

Remote Control

and

Automatic Logging

Equipment

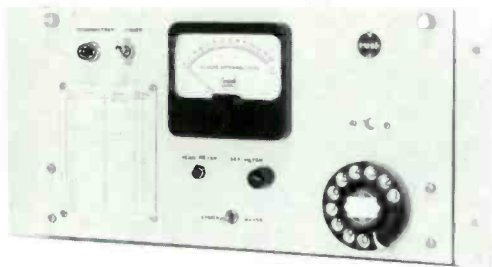

series C — fully flexible deluxe system

10 CONTROL FUNCTIONS Provides maximum control for one-transmitter stations where a high order of flexibility is desired. Used with a standard complement of accessory units to provide up to 9 meter readings and 10 two-direction control functions.

FEATURES

A D.C. system designed on proven dial telephone principles. Operates without vacuum tubes, amplifiers, oscillators or tuned circuits.

Lowest telephone line rental and lowest power consumption.

Full accessibility with drop-down front panels.

Adaptable to any transmitter at minimum cost.

Provision for checking metering circuit calibration at control point.

SPECIFICATIONS

Control Unit — OC — 19" x 7" x 7½" deep.

Transmitter Unit — 1C — 19" x 8¾" x 7½" deep.

Power, each unit — 100-130 volts 50/60 cycles, 25 VA or less.

Function indication — By individual numbered pilot light indicators.

Panels — Standard RETMA rack slotting, umber gray.

Supplied — 25' plug-in transmitter interconnecting cables. 2 instruction manuals.

Individual interconnection diagram prepared for each customer.

Telephone line — Two inexpensive signal circuit lines required; max. D.C. loop resistance 4000 ohms.

34 Factory Wired 25' Cable Assembly Included With Each 5 Functions Ordered With C or D Systems.

series D — extra capacity system

24 CONTROL FUNCTIONS Designed for those stations needing the utmost in system capacity, flexibility and reliability. For use with standard accessories to provide up to 24 meter readings and 25 two-direction control functions. Recommended for larger stations with more than one transmitter or other situations requiring a large capacity system.

FEATURES

A D.C. system designed on proven dial telephone principles. Operates without vacuum tubes, amplifiers, oscillators or tuned circuits.

Lowest telephone line rental and lowest power consumption.

Fully accessible with drop down panels.

Reserve capacity for future needs built into basic units.

Adaptable to any transmitter at minimum cost.

Provision for checking metering circuit calibration at control point.

SPECIFICATIONS

Control Unit — OD 19" x 8¾" x 8½" deep.

Transmitter Unit — 1D 19" x 10½" x 8½" deep.

Power — each unit 100-130 volts 50/60 cycles, 25 VA or less.

Function Indication By illuminated drum mounted on stepper.

Panels Standard RETMA rack slotting, umber gray.

Supplied 25' plug in transmitter interconnecting cables.

2 instruction manuals. Individual interconnection diagram prepared for each customer

Telephone Line Two inexpensive signal circuit lines required; max. D.C. loop resistance 4000 ohms.

hundreds of satisfied customers vouch for **RUST** systems

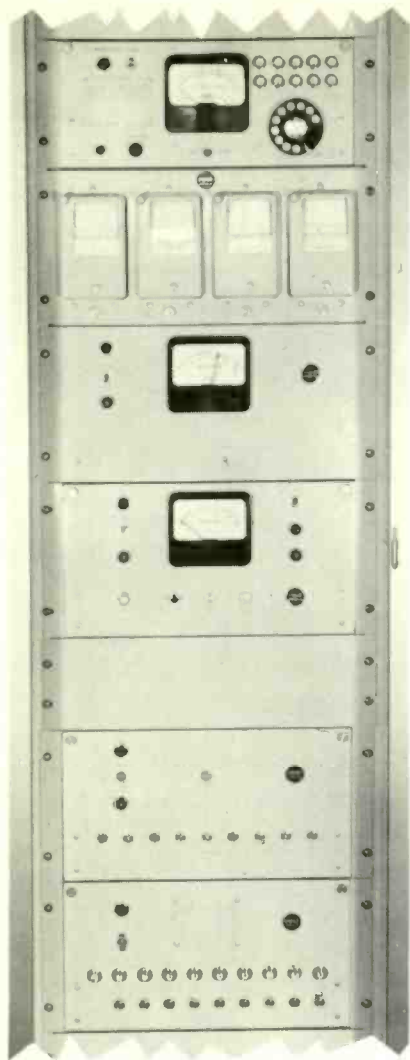

AUTOLOGTM

REPLACES MANUAL READINGS

for any AM, FM or TV Transmitter

Remote or Local Installation

AUTOLOG

is a low-cost automatic

4 Business Advantages for Specifying Autolog

Autolog maintains a constant record of AM, FM, or TV Broadcast Transmitters. Installation of Autolog produces four immediate business advantages:

1 The transmitter log is accurate and meets FCC rules and regulations. With accurate records and the Autolog alarm system to warn of erratic transmitter operation, **the threat of citation is removed.**

2 All personnel are free to concentrate on main duties — particularly important in peak load work situations. Relieved of technical responsibilities, announcers can concentrate on the main purpose of your station . . . **error-free production of programs and the convincing delivery of commercials resulting in contract renewals.**

3 The accurate technical records provide realistic data which is of great help to engineers in producing an **optimal money-saving preventative maintenance program.**

4 Man-hour time savings of Autolog (not counting more efficient business use of technical and non-technical personnel) **will pay for itself.**

Autolog is automation in an economical modular design. Autolog is designed to grow with your station without fear of obsolescing equipment. The parameter coverage of the standard Autolog may be expanded from the basic chart records to as many as nine different parameter chart records. The expansion can take place with no change in equipment except for the addition of more recorders and limit alarm meters, as desired.

There is an Autolog system available for every local or remote operated station, directional or non-directional.

AUTOLOG IS EASY TO INSTALL: Each Autolog is supplied with simple installation instructions and the circuit "samplers" required for your particular transmitter. A complete sampler installation takes only a few hours.

AUTOLOG IS INEXPENSIVE: Starting with the three-parameter format, Autolog grows with your station. It is not necessary to purchase unused measuring facilities.

WHAT IS AUTOLOG

Autolog is a low-cost, modular automatic operating log chart recording system that can be incorporated in stations that are either remote or local-controlled. Autolog measures specified transmitter electrical characteristics and records them on easy-to-read charts.

In the event that the transmitter should deviate beyond required or desired limits, Autolog alarms will alert station personnel (in the standard Autolog system). The alarms remain "ON" until the deviation has been corrected, and the alarm reset.

- Parameter change period
- Calibration signal from transmitter Autolog equipment
- Parameter recording period
- Calibration signal from studio Autolog equipment
- Zero calibration period

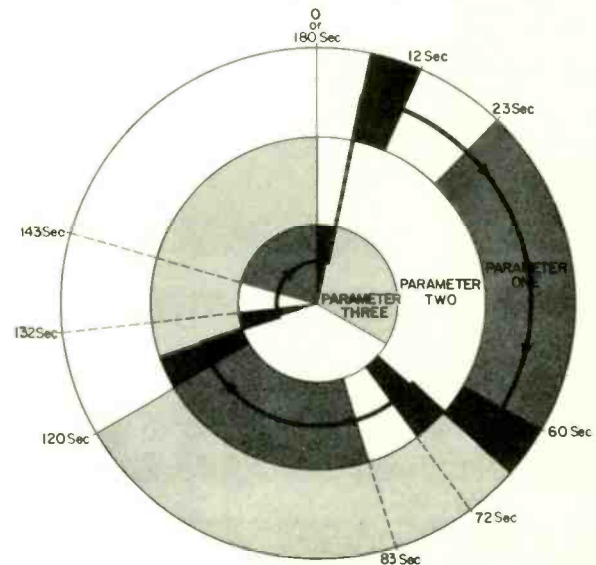

TYPICAL THREE-PARAMETER AUTOLOG SEQUENCE

Full-time monitoring of a remote system is divided into overlapping periods. Three concentric rings represent the cycles of parameters 1, 2 and 3 (outside in) respectively. Total three-parameter sequence takes one minute, three sequences occur each three minutes for continuous 24-hour coverage. For stations with requirements of more than three parameters, the timing will increase one minute for each parameter added to a maximum of nine minutes per cycle.

Full-scale calibrating periods occur before and after the recording of each parameter reading. The purpose of this is to localize the source of an improper reading.

For example, if parameter reading shifts, transmitter trouble is indicated. If parameter reading and remote calibration marks shift together, telephone line trouble is indicated. Finally, if transmitter parameter and local calibration marks shift together, the trouble will usually be found in the studio.

Logging system for recording transmitter operation.

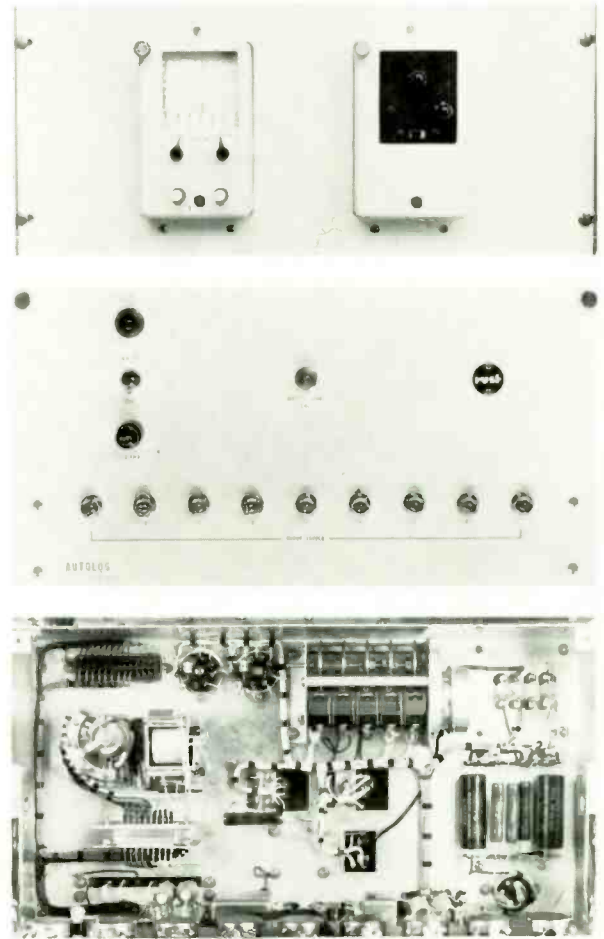
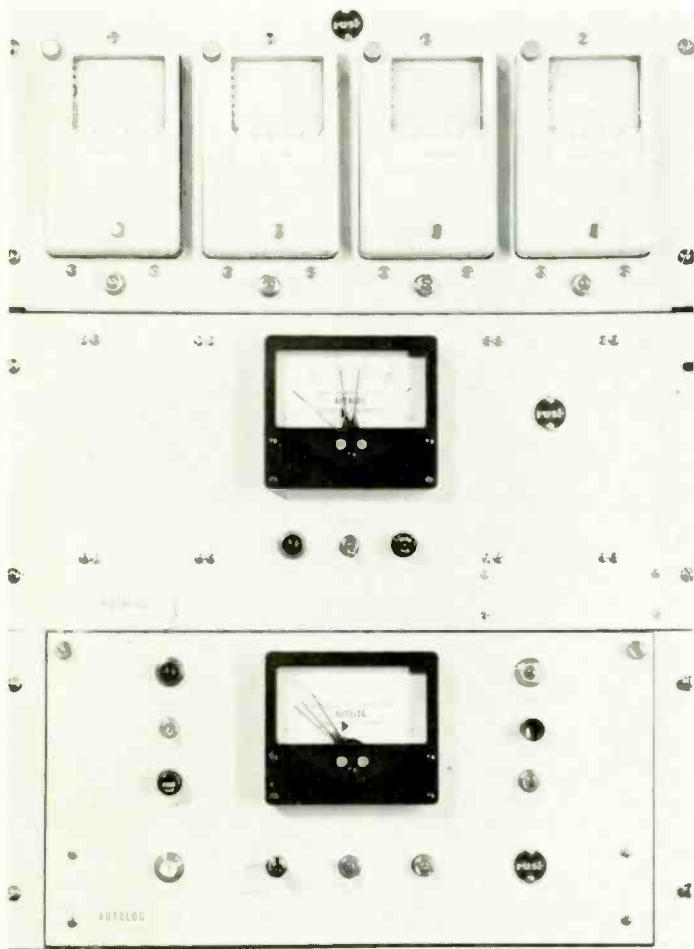

THREE-PARAMETER STUDIO EQUIPMENT PLUS FREQUENCY MONITOR RECORDER AND TRANSMITTER UNITS

Studio Equipment (left) includes recorders; control, power and calibration circuits; and facilities for interconnection of various units. In addition there is a "no-signal" alarm plus one parameter alarm. Frequency Chart Recorder, (top right) shares rack with Studio Autolog or station

Frequency Monitor. Transmitter Unit, (middle right), for remote control stations, contains sequence timing and synchronizing circuits and facilities to connect various transmitter samplers to telephone line pair. Autolog unit (bottom right), uses vertical

rack with Studio Autolog or station for maximum accessibility. Components and wiring are exposed for easy inspection. All relays are enclosed. Stepping switches are pre-wired plug-in units. Potentiometers and switches normally used in operation are front-panel mounted for convenience.

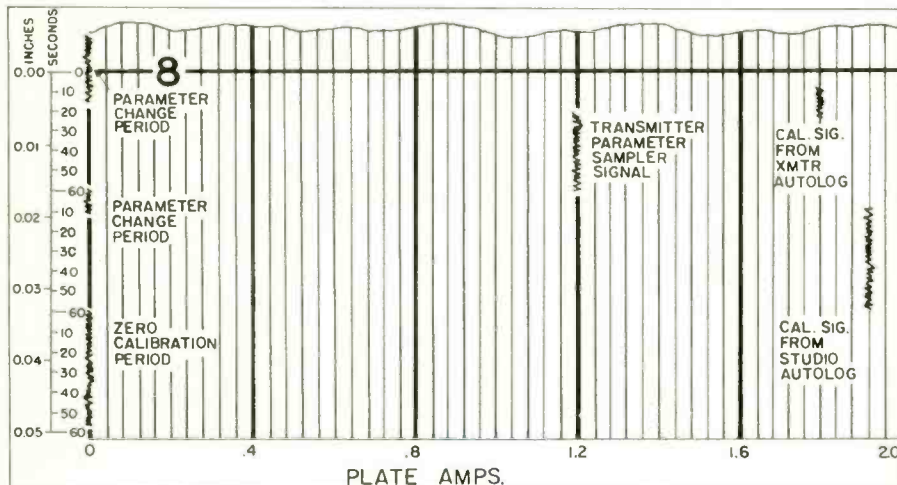
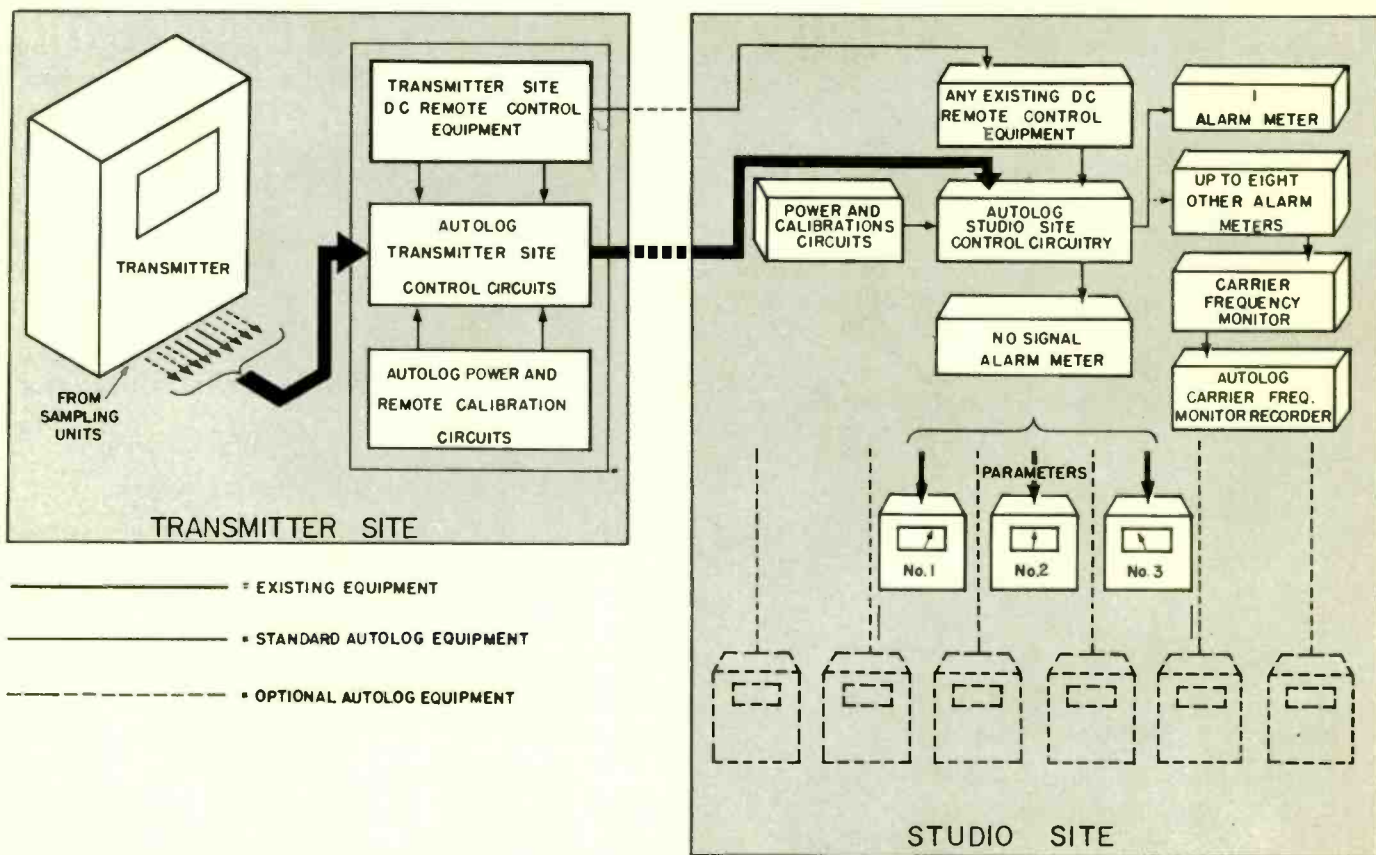

PLATE CURRENT AUTOLOG CHART

One cycle illustrates how recorder pointer makes an impression on chart paper every two seconds, producing trains of marks to indicate parameter levels. Lengths of trains and cycle schedule (see Typical Autolog Sequence) identify calibration and parameter trains. In this example, normal plate current is 1.2 amperes. Time scale is indicated on the extreme left. Chart has a 24-hour schedule printed on 31-day roll. Sign-in, sign-out, date and other notations are made directly on chart with pencil or pen.

Chart has at least 40 vertical divisions (according to application), each a millimeter wide. Operating parameters are identified by appropriate scales.



REMOTE CONTROL AUTOLOG SYSTEM shows up to nine transmitter parameters connected to Autolog Transmitter Equipment. The basic Autolog system monitors three

parameters: plate voltage, plate current and antenna current (for FM, "Kilowatts out"). In operating Autolog with a conventional DC remote control system, the telephone

control pair is not disturbed. This insures that the fail-safe circuitry is unimpaired. Only the telephone metering pair is used. Synchronization of the transmitter unit is con-

trolled by DC pulses from the studio equipment. Local station installations require considerably less equipment.

AUTOLOG SYSTEM MODULE CHART

Description	Model Designation	Local Station	Remote Control Station
Studio Recorder Panel	3-CR	yes	yes
Studio Interconnection Unit	CCR-9A	no	yes
Studio Control Unit	CCR-9B	no	yes
Frequency Monitor Recorder	FCRA-141B	depends on application	
Transmitter Unit	TCR-9	no	yes

Every recorder on the Autolog matches the accuracy requirement of the transmitter meter it represents. The circuits are simple and dependable . . . the result of **rust** long experience in the design and manufacture of self-operating equipment across the broad electronic communications industry. Autolog . . . another quality product of **rust**.

