

Bradley

B R O A D C A S T



1 9 9 1



Bradley BROADCAST

8101 CESSNA AVENUE • GAITHERSBURG, MD 20879
800-732-7665 • 301-948-0650 • FAX: 301-330-7198

Sales Office Hours 9:00 AM to 7:00 PM Eastern Time, Monday through Friday
Business Office Hours 9:00 AM to 5:30 PM Eastern Time, Monday through Friday

We are pleased to send you our ninth annual catalog of professional broadcast and audio equipment.

Our professional staff is dedicated to helping you select the right products to solve your problems. They are supported by Bradley's sophisticated and accurate order fulfillment system. And Bradley has the industry's best reputation for after sale support.

Sincere thanks to our many loyal customers. If you have not called upon us in the past, we invite you to select Bradley Broadcast... where service and engineering make the difference.



Art Reed
General Manager



Neil Glassman
Sales Manager



Bill Ashley



Matt Laur



Craig Klein



Les Fleming



Steve Alexander

CONTENTS

DIGITAL AUDIO	1-7
Workstations, Satellite Equipment, Digital Recorders, CD Players	
CONSOLES	8-16
Broadcast, Production, Utility Mixers	
TAPE RECORDERS	16-32
Reel-to-Reel, Automation, Cassette, Cart Machines, Compact Multitrack, Tape, Recording Supplies	
AUDIO PROCESSING	33-41
Equalizers, Dynamics Controllers, Effects Processors	
AUDIO INTERFACE	42-55
Audio Interface, Distribution Amps, Routing Switchers, Patch Panels, Connectors and Adapters, Wire and Cable, Test Equipment	
TELEPHONE INTERFACE	56-60
Hybrids, Teleconferencing, Couplers, Delays, Voice Announcers	
INTERCOM	60-61
Intercom Equipment, IFB	
TURNTABLES	62-63
Turntables, Bases, Tone Arms, Cartridges, Phono Preamps	
FURNISHINGS	64-73
Clocks, Timers, Power Outlets, Media Storage, Warning Lights, Equipment Racks and Hardware, Studio Furniture, Accessories,	
MONITORING	74-84
Headphones, Power Amps, Speakers, Powered Monitors, Signal Monitors, Metering, Tuners and Receivers	
MICROPHONES	85-96
Microphones, Mic Stands, Mic Accessories, Preamps, Processors, Wireless Mics	
FIELD PRODUCTION	96-107
Mixers, Frequency Extenders, Portable Tape Recorders, Microphones, Headsets, Cases	
SOUND REINFORCEMENT	108-112
Sound Systems, Mixers, Power Amps, Speakers, Accessories	
RF EQUIPMENT	113-124
Transmitters, Processing, Remote Control, Monitoring, STL, RPU, Antennas, Accessories	
CREDIT APPLICATION	125
ORDER FORM	126
PRICING AND ORDERING INFORMATION	127
PRODUCT INDEX	128
MANUFACTURER INDEX	129

Bradley's Sales Professionals

Dyaxis Digital Audio Production System

Dyaxis sets the standard for performance, power, and economy throughout the professional audio industries. With the high speed Dyaxis Digital Audio Production System you can record and play back up to twelve hours of 16 bit stereo digital audio, freely edit any of the material to the resolution of a single sample, and mix an unlimited number of high-quality digital tracks. The unique Dyaxis 2+2 system provides two channels of recording with up to four simultaneous channels of playback and/or overdubbing.

A modular design approach, with differing amounts of audio storage and a variety of options, allows you to select the building blocks you need for your application. The Audio Processor forms the heart of Dyaxis, and connects to an Apple Macintosh computer which serves as the controller. Custom MacMix software (supplied with Dyaxis) is the industry's most mature recording, mixing, crossfading, and processing package. MacMix lets you record audio material to the Mass Storage System of hard disk drives at user-selectable sampling frequencies. The resultant sound files can be viewed on the Macintosh screen and all recording, playback, and editing tasks are accomplished using a mouse and familiar point-and-click menus. All sound sources can be cut and pasted relative to one another for full creative control within the digital domain. All editing is non-destructive so you are free to experiment.

Direct digital inputs and outputs include AES/EBU, SDIF-2, S/PDIF, Sony PCM-601, and Yamaha Stereo. Analog I/O is also provided. On-line

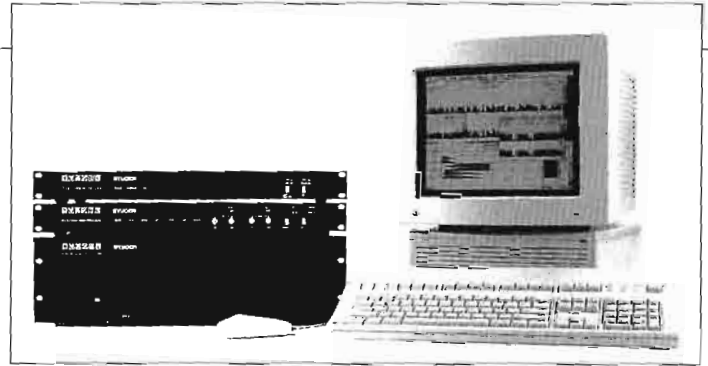

Digital Signal Processing offers digital equalization, dynamic level and pan control, on-screen metering, time compression/expansion, and sample frequency conversion. For MIDI and SMPTE time code synchronizing, the optional MIDI Time Code Interface adds a SMPTE time code reader to the Macintosh and enables digital audio to be locked to video, film, or automation systems. The sophisticated System Synchronizer adds full featured time code read/write capabilities, including VITC (vertical-interval time code), LTC, film tach, absolute lock and synchronous time code generation, in addition to locking to external clock-sync sources. Complete Dyaxis Digital Audio Production Systems, not including the Apple Macintosh, start at \$11,495.00.

Comstream Satellite Equipment

More radio program distributors are selecting ComStream satellite equipment. The reason is that ComStream's innovative digital audio compression techniques yield CD quality audio while using less satellite bandwidth than other methods. The use of new technologies also makes this equipment very affordable.

Additionally, ComStream's Ku-band equipment is ideal for point-to-point transmissions such as remote broadcasts. Satellite time is simple and economical to lease, and an easily transported ComStream earth station can allow your broadcasts to originate from virtually anywhere. Some station groups are even purchasing systems to share so that costs are even lower.

Stereo transmission at 256kbps specs at 20Hz to 15kHz, $\pm 0.05\text{dB}$, with less than 0.05% distortion @ 1kHz, greater than 85dB signal to noise @ 1kHz, and greater than 90dB of dynamic range. The multi-rate terminals allow you to select mono or stereo configurations at either 7.5kHz or 15kHz bandwidths.

Complete duplex earth stations and both portable and fixed receive-only terminals are offered with several antenna options. Contact your Bradley professional today for details. ComStream digital audio satellite transmission equipment is another way in which Bradley will help you go digital in the 1990's.

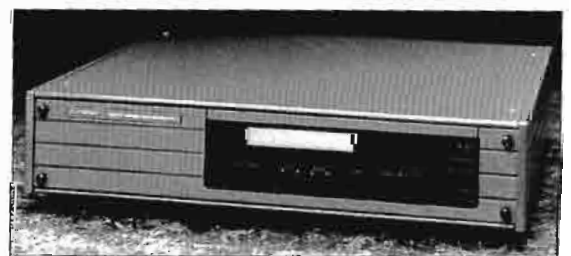

BRADLEY BROADCAST CATALOG 1991

Toll Free: 800-732-7665 • MD & DC: 301-948-0650 • FAX: 301-330-7198 • Bradley Broadcast

Sony TCD-D10PRO Portable DAT Recorder

Now you have no excuse for field recordings to be analog. Weighing less than five pounds, the Sony TCD-D10PRO boasts both the incredible audio performance of DAT and a remarkably rugged transport. The TCD-D10PRO achieves the full frequency response, low noise, and immeasurable wow and flutter of DAT in a compact package that is easy to use. Four direct drive motors enhance reliability and provide great stability in extended use.

Mic/line inputs are balanced XLR, and a level attenuator, low cut filter, and peak limiter can be used with the mic inputs. A digital input/output connector and supplied cables permit digital transfer in the AES/EBU format at 44.1kHz. The index and search features allow high speed search of your selections, and a wide variety of status information is available on the LCD front panel display.

Bradley and Sony pack the TCD-D10PRO with two rechargeable battery packs, a battery recharger, an AC power supply, a pistol-grip type remote control, a carrying case with strap, and a complete service manual. Optional accessories enable DC operation and use of extended time battery packs. For less than the price of open reel analog, your Bradley professional can deliver digital to you today.



TCD-D10PRO
60SOTCDD10PRO
MFR LIST
\$2900.00

Accessory:
Spare rechargeable battery
60SONP22H
MFR LIST **\$49.00**

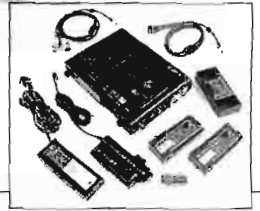

Call Bradley for a current price quotation.

Panasonic SV-255 Portable DAT Recorder

In the recent past, an audio recorder with 88dB S/N ratio, THD less than 0.05%, and a frequency response of 10Hz to 22kHz within 1.5dB would cost over \$10,000 and weigh 100 pounds. Today, the miracle of DAT recording provides this performance level for one-third the price, in a unit weighing 3.2 pounds, and with battery power! The SV-255 uses a lead-acid battery to provide 2.2 hours record time on an 8 hour charge. Inputs are mic/line, via XLR, with switchable attenuator and limiter. Automatic track numbering is provided, with search speed 60 times normal playback speed. Its LCD display shows track number in play, tape counter/program step, next track number, and audio level meters with peak hold indication. The End Search feature automatically finds the last recorded position on a tape. A coaxial digital output and cable are also provided.

Panasonic's MASH digital encoding system has a sample rate of 3MHz, and mic inputs and other analog circuitry are designed for best performance. The unit is packaged with battery, combination recharger/AC adapter, carrying case with strap, and digital output cable.



SV-255
60PASV255
MFR LIST **\$2700.00**

Accessory:
Spare Battery
60PASHDTB250 MFR LIST **\$60.00**

Call Bradley for a current price quotation.

Sony PCM-2000 Portable DAT Recorder

Whether you're gathering sound for video or audio-only applications, the PCM-2000 has more to offer than any other portable DAT recorder. Compact and lightweight, the microprocessor controlled, four motor transport will keep tape motion rock stable. One of the DAT format's spare longitudinal tracks is used to record SMPTE/EBU time code with the optional time code interface. Audio inputs are balanced, through XLR connectors, and can be switched between line level (+4dBm) and mic level (-50dBm to -70dBm). A switchable 48V/12V phantom power supply will power condenser mics. The unit will operate from external AC or via standard Sony NP-1A battery (same as Betacam recorders) which will support approximately two hours of use. All of this weighs in at only eight pounds with the battery!

PCM-2000 60S0PCM2000 MFR LIST **\$5000.00**

Accessories:

Time Code Interface 60SOBVG200 MFR LIST **\$2500.00**

Battery 60SONP1A MFR LIST **\$85.00**

Call Bradley for a current price quotation.



Tascam DA-30 DAT Recorder

The front panel of the DA-30 is as familiar as the face of an old friend. When you see and hear it perform, you'll wonder where it has been your whole life.

The DA-30 is an affordable, full function DAT recorder that combines outstanding audio performance with famous Tascam reliability. The A/D converters employ 64 times oversampling Delta Sigma modulation, and 18 bit, 8 times oversampling D/A converters are used. Recording is offered at 48kHz and 44.1kHz sampling frequencies.

Features include 150 millisecond cue increments, AES/EBU digital input/output, start ID positioning, and both +4dBm and -10dBV analog inputs and outputs. The provided wired remote control allows control of all DA-30 functions, and includes numeric keys for direct search and playback programming. The clean layout and clearly marked controls make operation of the DA-30 a breeze.



DA-30
60TEDA30 MFR LIST \$1499.00
Call Bradley for a current price quotation.

Panasonic SV-3700 DAT Recorder

Panasonic's third generation DAT recorder features high performance "one bit" A/D converters and four precision D/A converters. These advanced technologies produce improved performance and linearity. Instrumentation quality analog circuitry and specially developed digital components also ensure the utmost quality. Analog inputs and outputs are balanced XLR, and digital I/O is in both the professional AES/EBU and consumer S/PDIF-2 formats. Recording is offered at 48kHz, 44.1kHz, and 32kHz.

The SV-3700 has a shuttle wheel for accurate cueing. The high speed transport, with up to 400 times speed, can access any point on a two hour tape in 30 seconds or less. The comprehensive front panel display can show error correction rates for assessing tape quality. The SV-3700 is built on a massive die-cast chassis that ensures stability. Rack mount included.



SV-3700
60PASV3700 MFR LIST \$1599.00
Call Bradley for a current price quotation.

Fostex D-20 DAT Recorder with Time Code

The Fostex D-20 is the first DAT recorder with synchronizer control via SMPTE time code, Sony BVU emulation, instant punch-in/punch-out, and variable speed operation. With the D-20, you can post-stripe time code on an existing DAT tape recorded on any DAT machine. You can record stereo audio and time code on the D-20 and play that tape on any other DAT with complete compatibility. The synchronizer port allows interface with all popular synchronizer systems, and there is an RS-422 port for serial control. There's an External Sync input for composite video, Word Sync input and output capabilities, and DAT Sync for locking two D-20's together with no phase shift.

The D-20 software emulates Sony BVU-950 and BVU-2000/3000 video tape recorders so that it is guaranteed to work with a wide range of popular video editors. The D-20 uses two pairs of heads (one for recording and the other for playback) enabling off the tape monitoring. Balanced analog and AES/EBU digital inputs and outputs are provided.



D-20
60FOD20 MFR LIST \$8000.00

Accessory:

8320 Remote Control provides expanded functions and operations to the D-20.

60FO8320 MFR LIST \$800.00

Call Bradley for a current price quotation.

DAT Accessories

Digital Audio Tape

Length	Panasonic #	Price	Maxell #	Price
46 Minutes	61PARTR46P	\$6.80	61MXR46DM	\$7.30
60 Minutes	61PARTR60P	7.80	61MXR60DM	8.50
90 Minutes	61PARTR90P	9.40	61MXR90DM	10.20
120 Minutes	61PARTR120P	11.15	61MXR120DM	11.90

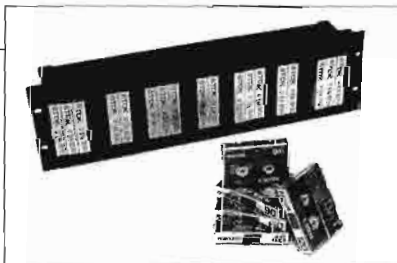

Maxell DAT Head Cleaning Tape
61MXRCL \$13.25

Rack Mount Digital Audio Tape Holder
This three rack space unit stores up to 27 tapes.
61MADAT \$50.00



Technics SV-DA10 DAT Recorder

Digital recording is now available to even the smallest facility. Technics' SV-DA10 uses MASH A/D and D/A converter technology to offer DAT quality at a new low price. The shuttle search dial makes it possible to cue and review from 1/2 to 15 times normal tape speed while monitoring the audio.

The recorder has a digital fade-in and fade-out feature that is valuable for assembling programs from digital sources. The post recording utilities include writing end markers, start ID's, program numbers, and skip ID's. Outputs are -10dBV and an IHF-to-Pro interface (found in our Audio Interface section) is recommended when the SV-DA10 is used in a professional installation. A wireless remote control is included.

Whether you use it in your studio or your living room, the SV-DA10 will let you take full advantage of DAT's great sound and convenience.



SV-DA10
60TCSVDA10
MFR LIST
\$995.00

Accessory:
Rack Mount Shelf
61MATCSVDA10 MFR LIST **\$134.00**
Call Bradley for a current price quotation.

360 Systems DCR-1000 DigiCart Digital Recorder

The DigiCart combines the convenience of an ordinary cart machine with the quality of 16 bit digital audio. It uses a unique, removable Digital Audio Disk that can store up to 10 minutes of 15kHz stereo. The 2000th play sounds just as great as the first. Each disk can store several spots or songs. Optional internal and external hard disk storage allows hours of recordings to be instantly accessed. A large cue knob makes it easy to dial up any selection, and the large display window shows the cut's name and run time. You can even cue the next cut while the machine is in use! DigiCart is automation ready, as it can be controlled from an external computer.

Standard cart machine features, such as three cue tones and full remote control capabilities, are incorporated. Inputs and outputs are on balanced XLR connectors. The DigiCart produces ruler flat response with absolute phase accuracy. Recording bandwidths of 20kHz, 15kHz, and 10kHz, as well as mono and stereo tracking, can be combined on a single disk. You can choose the format that provides the highest fidelity and maximum playing time for your format. Audio specifications include bandwidth from 10Hz to 20kHz, ±5dB, 92dB dynamic range, and THD+N of 0.005% @ +26dBu.

DCR-1000 DigiCart 60THDCR1000 MFR LIST **\$3995.00**

Also available:
Internal and external hard drives from 20MB to 1.2GB. DigiCart allows connection of up to one optional internal drive and five external drives allowing stereo audio storage maximum of between 18 and 55 hours depending on bandwidth selected.



Accessories:
Digital Audio Disks (10 pack) 60THDAD10 MFR LIST **\$400.00**
Digital Audio Disks (50 pack) 60THDAD50 MFR LIST **\$1750.00**
Call Bradley for a current price quotation.

Numark CD6020 Dual CD System

Designed for live mixing, the CD6020 is divided into two rack-mountable pieces. The transport/CPU contains two independent CD transports, while the remote control panel has all transport functions. Track-to-track access is fast, and, when you use the Beat Sync and Integrate functions, fades and segues are automatic. Each transport has a slider controlled ±8% varispeed and extra large Stop/Start buttons. Eight times oversampling and 18 bit D/A converters are used for high quality sound reproduction.

CD6020
60NUCD6020
MFR LIST **\$1995.00**

Call Bradley for a current price quotation.



Tascam CD-301 CD Player

For professional quality and features on a budget, the CD-301 is an excellent choice. Tascam's ZD "Zero Distortion" circuitry and 18 bit, quadruple oversampling D/A converters assure excellent sound reproduction. Analog outputs are on balanced XLR connectors, and rack mount ears are standard. Front panel controls are limited to the basics, with full programming available with the included, wired remote control. A special link function allows one unit to start another for sequence play. The single play feature stops the unit at the end of the selected track. For quality and value, the CD-301 is tough to beat.

CD-301
60TECD301
MFR LIST **\$549.00**

Call Bradley for a current price quotation.



Denon DN-950FA & DN-970FA CD Cart Players

Denon CD players are industrial strength with audiophile quality. CD's are stored in special cartridges that protect them from scratches, dust, and fingerprints. To play, simply load the cartridge into your Denon. No fidgeting with jewel boxes and no damaged CD's. Dual D/A converters and a 4 times oversampling digital filter ensure distortion free sound.

The DN-950FA CD Cart Player, as its name implies, is as easy to operate as a broadcast cart machine. The front panel allows you to make selections using a rotary dial, select single track or continuous play, and audition the beginning of a track. Autocue to the first audio of a selection is available, and the LED display shows track number and time elapsed or remaining. An EOM signal (dry contact) can be used to give the operator a warning signal between 5 and 35 seconds before the selection ends. Outputs are XLR balanced with level adjustable from -20dBm to +10dBm, a 2% fixed speed increase can be internally jumpered, and full remote control capabilities are offered.

Denon's latest is the DN-970FA for production use. Features include ±10% varispeed with real time display; 3 separate A-B loops within a disc; and AES/EBU digital output. The Search Mode uses the track select knob to allow fast forward and fast reverse through a disc. Cueing can be as tight as 1/75th of a second.

DN-950FA	60DEDN950FA	MFR LIST	\$1499.00
DN-970FA	60DEDN970FA	MFR LIST	\$2599.00



Accessories:

Cartridges for CD Cart Players	60DEACD5B	MFR LIST	\$5.30
Lens Cleaning Cartridge	60DEAMC9	MFR LIST	\$19.95
Single rack shelf for DN-950FA	61MA950S	MFR LIST	\$110.00
Dual rack shelf for DN-950FA	61MA950D	MFR LIST	\$148.00
Single rack shelf for DN-970FA	61MA970S	MFR LIST	\$110.00
Dual rack shelf for DN-970FA	61MA970D	MFR LIST	\$148.00

Also available:

Your Bradley professional can provide additional labels and screws for CD cartridges, as well as replacement optical assemblies and alignment kits for players.

Call Bradley for a current price quotation.

Tascam CD-401 CD Player

Let's face it, consumer audio in a broadcast world just won't do. Tascam's CD-401 gives you broadcast features at a "consumer" price. This unit is rack mounting with XLR balanced and phono unbalanced analog outputs, as well as SP/DIF format digital outputs. The CD-401 comes standard with a fader start port. Technical specifications are broadcast standard with 18 bit, 4 times oversampling, a precision 3 beam pick-up for accurate tracking, and Tascam's ZD "Zero Distortion" circuitry for a truly clean sound. Now is the time to step up to a Tascam CD-401 and enter the world of broadcast gear without contracting sticker shock.

CD-401	60TECD401	MFR LIST	\$799.00
---------------	-----------	----------	-----------------

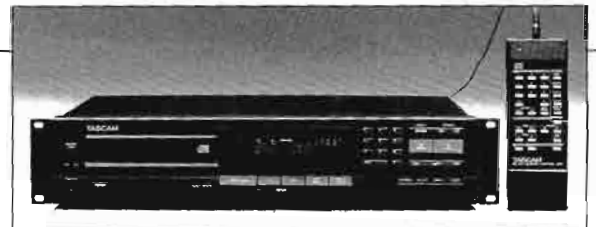

Accessory:

Wired remote control.	61TERC401	MFR LIST	\$75.00
------------------------------	-----------	----------	----------------

Call Bradley for a current price quotation.

Tascam CD-701 CD Player and RC-701 Control Unit

The CD-701 CD Player and the RC-701 Control Unit form a powerful CD reproduction system that responds to the requirements of all audio production professionals. The CD-701 has been designed for heavy use and the most precise, natural CD sound available. The front panel controls are uncluttered. The loading tray has a convenient thumb slot and is rugged enough to be pushed shut by your meanest jock. A unique disc clamping system ensures precise disc rotation and faultless tracking. The unit may be programmed to autocue to the beginning of audio and to automatically stop at the end of a single track. Innovative "ZD" circuitry, 4 times oversampling, and 16 bit D/A converters achieve impeccable sound.

For multiple machine operation, the RC-701 control unit is designed to turn up to four CD-701 players into a complete production workstation. The RC-701 includes pitch control (±6% in 0.1% steps) and a frame accurate cueing wheel for precise location of any point within a track. The program function allows you to set up 4 selections to play sequentially. The optional BU-1 RAM buffer, when used with the RC-701, reduces start-up time from 0.3 seconds to zero. An optional RS-232 interface allows computer control for automation systems.

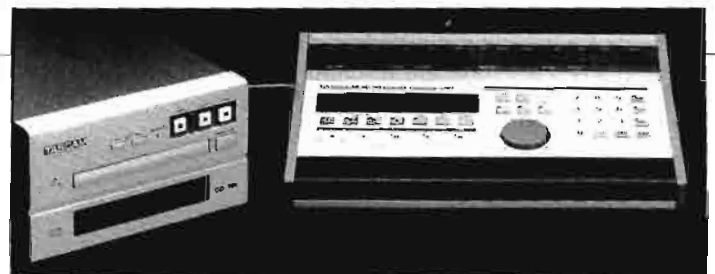

CD-701	60TECD701	MFR LIST	\$2199.00
RC-701	60TERC701	MFR LIST	\$1249.00

Accessories:

Ram buffer	61TEBU1	MFR LIST	\$399.00
Basic remote control	61TERC7	MFR LIST	\$199.00
Rack mount kit for CD-701	61TERM701	MFR LIST	\$225.00

Call Bradley for a current price quotation.



Technics SL-P1300 CD Player

Technics' top of the line professional CD player puts you in complete control. To find any point on a disc quickly, the SL-P1300 has a two speed search dial letting the operator "spin" the disc to the desired point. Slow speed gives one second of program time per rotation, while fast speed gives 30 seconds per turn. Once a selection is cued, you may preview the cue point for accuracy without losing that cue point. In the autocue mode, the SL-P1300 does the work for you by positioning the pickup at the start of the first note of the track, ready to begin play instantly at your command.

The SL-P1300 incorporates 4 digital-to-analog converters, 18 bit resolution with 8 times oversampling, and twin Class AA analog circuitry. Other features include $\pm 8\%$ continuously adjustable pitch control on a long throw fader, comprehensive track selection and programming facilities, and an easy to read multi-function display. Programmable music scan lets you preview the first few seconds of each song on a disc. "Play," "stop," and "pause" functions may be controlled via a hardwire rear connector.

SL-P1300
60TCSLP1300
MFR LIST
\$1800.00



Also available:
SL-P1200 CD Player
Dual D/A converters, 2 x oversampling, and only unbalanced outputs.
60TCSLP1200 MFR LIST **\$1500.00**
Call Bradley for a current price quotation.

Technics SL-PS50 & SL-PS70 CD Players

These are the latest, top of the line front loading units from Technics. Both feature MASH (Multi-Stage Noise Shaping) digital to analog converters for most accurate sound reproduction. The SL-PS50 uses 4 DAC's, while the SL-PS70 takes advantage of 8 DAC's and acclaimed Class AA analog stages. Both units have a rugged, center mounted transport and a floating isolation design to protect against the effects of vibration. Features include auto cue to the beginning of any track's audio, headphone jack with volume control, large display with track and index information, and wireless remote control.

SL-PS50	60TCSLPS50	MFR LIST	\$329.00
SL-PS70	60TCSLPS70	MFR LIST	\$449.00

Accessories:
Rack mount shelf
for SL-PS50
61MATCSLPS50 **\$78.00**
Rack mount shelf
for SL-PS70
61MATCSLPS70 **\$78.00**



Call Bradley for a current price quotation.

Technics SL-PG100 & SL-PG300 CD Players

Technics' MASH technology is now available in these moderately priced units. The SL-PG100 and SL-PG300 have a digital servo system for faster access and improved focusing. Both units feature a 4 DAC design with 4 times oversampling, 18-bit resolution, and a digital filter. The linear motor used in these players provides remarkably accurate and responsive tracking of the disc. Auto cue is provided. The SL-PG300 has the added features of a front panel headphone jack with level control, a wireless remote control, and 10 key direct access.

SL-PG100	60TCSLPG100	MFR LIST	\$179.00
SL-PG300	60TCSLPG300	MFR LIST	\$199.00

Accessories:
Rack mount shelf
for SL-PG100
61MATCSLPG100 **\$78.00**
Rack mount shelf
for SL-PG300
61MATCSLPG300 **\$78.00**



Call Bradley for a current price quotation.

Technics SL-PC33 CD Changer

This front loading, rotary 5 disc CD changer allows you to play all discs in sequence, program only the songs you want from each disc, play songs randomly, or play only one disc. The front loading design allows you to change a disc, even when there is a disc playing. The SL-PC33 is ideal for background music, as a backup program source, or for partying in your basement.

SL-PC33	60TCSLPC33	MFR LIST	\$299.00
----------------	------------	----------	-----------------

Call Bradley for a current price quotation.



DIGITAL AUDIO

Bradley Broadcast • 8101 Cessna Avenue • Gaithersburg, Maryland 20879

CD Accessories

ATI Disc-Patcher

This unidirectional level and impedance interface is a popular choice for connecting a consumer compact disc player to a professional (600 ohm balanced, +4dBm) system. True transformer balanced, isolated, and protected outputs provide greater rejection of common mode interference, which is particularly important in high RF environments. The Disc-Patcher's offers 102dB dynamic range, flat (± 0.25 dB 20Hz to 20kHz) frequency response, and low 0.005% THD. A convenient Velcro mount is supplied.

60AIDP100 MFR LIST \$219.00

Accessory:

Rack Kit Holds one or two Disc-Patchers.

60AI20273 MFR LIST \$25.00

Call Bradley for a current price quotation.

Excalibur CD-1 & CD-2 Interface Amps

On everyone's list of the ten worst nuisances is interfacing semi-pro, IHF (-10dBV) to your professional (+4dBm) equipment. Excalibur eases the pain with the CD-1 which amplifies a single stereo source and CD-2 which handles two stereo sources. Input is via phono jack and the barrier strip output may be adjusted to levels up to +22dBm. Frequency response is 10Hz to 25kHz ± 0.25 dB; THD is <0.006% and noise is >90dB below 4dBm. Guaranteed to work in the strongest RF fields.

CD-1 60EXCD1 \$99.00

CD-2 60EXCD2 \$165.00

CD Jewel Boxes

These high quality replacement boxes are delivered quickly and at a great low price.

60EMJB 78¢

Purchase 25 or more for only 66¢ each

Denon Audio Technical CD

The 99 tracks on this CD include spot and sweep frequency tones and a variety of other signals to allow you to evaluate the THD, channel separation, and other playback characteristics of your CD player and other audio components in your facility.

60DETCDC \$25.00

Discwasher CD Cleaner

The computer designed gear drive system ensures true radial cleaning of the compact disc. The CD-1 cleaning fluid is specially formulated to safely remove debris from the compact disc.

61DICDC \$15.00

Accessories:

CD-1 Cleaning Fluid Refill 61DICD1 \$3.95

CD Cleaner Replacement Pads 61DJCDP \$4.95



Discwasher CD Lens Cleaner

This disc-shaped cleaner uses a dual wet/dry action to ensure thorough lens cleaning.

61DICDL2 \$23.50

Intraclean CD-121 CD Cleaning System

If the microscopic data encoded into a compact disc becomes soiled, the disc may not play properly. The CD-121 cleans discs using the radial movement (straight lines from the center out to the edge) recommended by disc manufacturers. The rotating cleaning mechanism, combined with the specially formulated cleaning fluid, can help to ensure long life for your valuable disc library.

60ICCD121 \$24.95

Accessories:

Package of three replacement pads

60ICCD122 \$9.95

Additional 1.5 ounce bottle CD-103 cleaning fluid

60ICCD103 \$4.95

Discwasher CD Polish

Removes minor scratches and blemishes from CD surfaces. The package includes CD-1 cleaner, CD-2 polish, 6 applicator swabs and 4 polishing wipes.

61DICD2 \$12.95

Rack Mount CD Holder

This holder allows up to 40 compact discs to be stored in 4 rack spaces. The discs stand vertically and protrude 3/8" for easy access. Partitions prevent discs from falling over, and open design permits storage of multiple disc sets. 61MACDSH \$53.00

Nigel B. CD Drawer

This 4 rack unit high drawer holds 69 CD's. Discs are angled for easy viewing of the titles. This space saver is great for keeping your production library close at hand.

60NBCDD \$148.00

Henry TwinMatch

Henry knows you use more than one CD player, so he designed the TwinMatch to interface two consumer CD players into your professional level studio. Output level is up to +26dBm. Frequency response is DC to 20kHz ± 0.25 dB; THD is 0.008% at any level; and noise is 85dB below +4dBm. The metal chassis is RF proof, and every unit includes famous Henry reliability.

60HETM MFR LIST \$195.00

Call Bradley for a current price quotation.

Benchmark IHF-to-Pro Interfaces

When interfacing a consumer CD player, no one offers more options of higher quality than Benchmark. DOA (Differential Output Amplifiers) offers 26dB of gain, THD @2kHz of 0.0008%, 120dB dynamic range, and excellent RF immunity. The DOA-1 and DOA-3 modules require a bipolar power supply from ± 9 to ± 22 VDC. The DOA-3 module is AC coupled so that its gain pot can be removed. The DOA-2 uses single + power from +12 to +44VDC. The IFA series amplifiers offer the same performance in a connectorized chassis.

DOA module with XLR connector

60BMDOAX MFR LIST \$55.00

DOA module without connector

60BMDOANC MFR LIST \$48.00

IFA-3 Stereo IHF-to-Pro interface

60BMIFA3 MFR LIST \$165.00

IFA-5 Dual stereo IHF-to-Pro interface

60BMIFA5 MFR LIST \$250.00

Power Supply for IFA interfaces.

Handles up to 10 devices.

60BMP51 MFR LIST \$30.00

Call Bradley for a current price quotation.

DIGITAL AUDIO

ATI Vanguard Console

The Vanguard series is a most popular choice for broadcasters seeking a well built, but reasonably priced console. The audio is VCA controlled for clean, reliable performance. Nearly all switching control functions on the Vanguard are handled by membrane switches, which are ideal since they are raised, silent, and employ tactile feedback. The control legends have 5 color graphics behind a tough, polycarbonate overlay. The front panel hinges for quick access to the plug-in amplifier modules and punch block audio connections. The standard console versions include dual VU meters (switchable between the program and audition outputs), internal cue and headphone amps, two mic preamps, and two muted monitor feeds.

Eight channel consoles have twelve inputs, while the twelve channel console has twenty four inputs. A variety of options allows you to customize the Vanguard for your studio. Call today for details on why the Vanguard is so highly recommended by those who use it.

8 channel, rotary pots	60AIBC8DSR	MFR LIST	\$3395.00
8 channel, linear faders	60AIBC8DSL	MFR LIST	\$3395.00
12 channel, linear faders	60AIBC12DSL	MFR LIST	\$4995.00

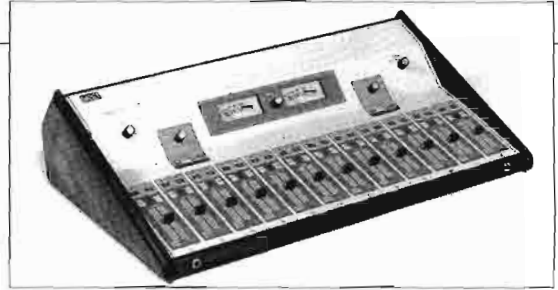

Accessories:

Additional dual mic preamp	60AIMIC	MFR LIST	\$150.00
Dual 5 x 1 input expanders	60AIEXP	MFR LIST	\$275.00
Relay option for on air lights	60AIRLY	MFR LIST	\$125.00
4 channel start/stop switches	60AISSS	MFR LIST	\$125.00
2 stereo LED bar-graph meters	60AIBGD	MFR LIST	\$350.00
Spares and maintenance kit	60AISCK	MFR LIST	\$125.00

Call Bradley for a current price quotation.

Broadcast Electronics Rotary Consoles

Broadcast Electronics offers two fine lines of rotary pot consoles. The 150A Series uses high reliability, sealed potentiometers and the 250A Series uses easy to maintain step attenuators. Both feature cue on detent. Modular plug-in electronics provide low distortion and flat response. Each channel accepts two inputs and is field adjustable for mic or line level. Monitor, headphone, and cue amplifiers ensure full monitoring capability. Front panel graphics are under a laminated overlay for years of durability. Both series are available in 5, 8, and 10 channel models, in mono or stereo. These BE consoles provide economy, extensive operational flexibility, and excellent audio performance. Prices listed are for stereo boards. Please call for mono console prices and information on accessories.

Also Available:

Broadcast Electronics offers the 350A series of 10 channel linear fader consoles. For smaller operations, BE also has four pot boards in desk top and rack mount configurations.

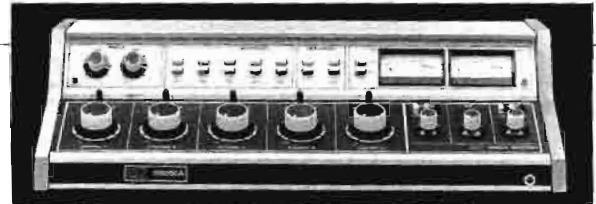

5 Mixer, 150A Series	60BR5S150	MFR LIST	\$3150.00
8 Mixer, 150A Series	60BR8S150	MFR LIST	\$3850.00
10 Mixer, 150A Series	60BR10S150	MFR LIST	\$5450.00
5 Mixer, 250A Series	60BR5S250	MFR LIST	\$3950.00
8 Mixer, 250A Series	60BR8S250	MFR LIST	\$5050.00
10 Mixer, 250A Series	60BR10S250	MFR LIST	\$6150.00

Call Bradley for a current price quotation.

LPB Signature III Console

The Signature series is by far the most popular LPB console. It combines modern circuitry with classic battleship type construction and the best RF immunity. The Series III boasts THD of .05%, dynamic range of 98dB, channel separation of 65dB, and a high isolation cue amp design. LED status indicators on each input channel, switchable metering, and a headphone amplifier with front-panel jack are only a few of the user oriented features. The Series III has nearly indestructible roller-cam telephone type key switches and high quality step attenuators as standard equipment. Three position preselect keys are provided for each fader, with silver contacts rated for 250,000 operations. All models have two stereo outputs, and muting and tally are programmable for up to three studios. While the traditional design may not look high tech, the layout is extremely user friendly and allows plenty of desk space for copy, carts, and coffee.

Also available:

LPB Citation 10 mixer stereo console with Penny & Giles linear faders.

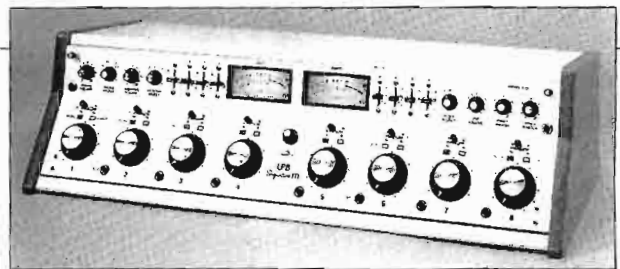

S-10 6 Mixer	60LPS10	MFR LIST	\$4195.00
S-13 8 Mixer	60LPS13	MFR LIST	\$4995.00
S-20 10 Mixer	60LPS20	MFR LIST	\$5895.00
S-24 12 Mixer	60LPS24	MFR LIST	\$6895.00

Call Bradley for a current price quotation.



BE Mix Trak 90 Console

Selecting your on-air console is one of the toughest purchasing decisions your station will make. On-air programmers want an easy to use console loaded with convenience features. Engineers demand a console that will be easy to install and maintain. Everyone wants a board that sounds great and provides a good value.

Introducing the Broadcast Electronics Mix Trak 90. This modular console was engineered for radio by people who know radio. All modules are 2" wide providing a cleaner, less cluttered console. All controls are easily reached by the operator. With nearly two dozen input and auxiliary modules from which to choose, you can build the exact console to meet your on-air needs.

VCA's are used for all audio controls and separate speech and music program busses allow you to process each type of source individually. In addition to the program and audition busses, there are three auxiliary busses assigned by internal jumpers for setting up multiple mix-minus sends. All input modules include dual inputs with "break before make" switching, input overload indicators, and flexible ribbon extender cables for maintenance. Mic input modules include a switchable pan pot and line input modules allow operation with stereo, mono, left only, and right only sources.

Automatic source sequencing allows the operator to pre-program an entire block. The various sources are armed from the input modules, and the EOM of each source triggers the next event. This leaves your operators more time for the creative tasks.

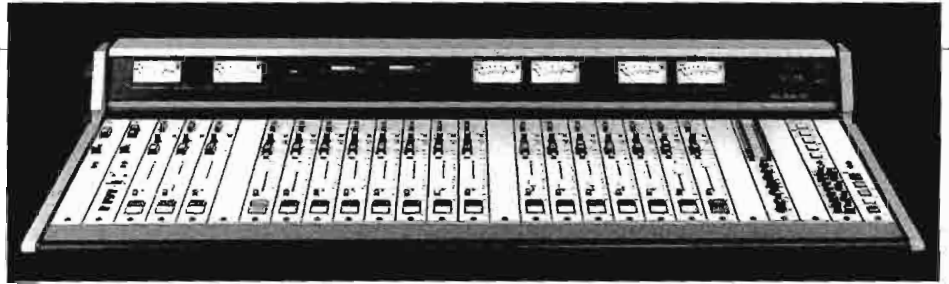

The Mix Trak 90 also includes a full meter bridge, a comprehensive control room monitor module, monitor dimming when cue is engaged, a time of day clock, and an event timer with control module. Optional modules include a studio monitor, input expanders, derived mono outputs, and remote switching for cart and reel-to-reel decks. A spare power supply with automatic changeover is also available.

The polycarbonate overlays, Penny & Giles long throw faders, Hall effect On/Off switches, and highest quality components throughout insure your Mix Trak 90 will serve you for many years. Mainframe sizes are available for 12, 18, and 21 input modules. Fully configured consoles start at about \$15,000. Call today and have your Bradley professional give you all the details on the Mix Trak 90 ... the console that will take you into the next century.

Audioarts A-50 Console

The A-50 achieves a level of reliability and value never before offered at this price point. It accomplishes this by combining the most requested features and the latest in high performance audio components. The console is available in two mainframe sizes. Both include four meters, event timer, control room and studio monitor modules, and headphone and cue amps. The 12 fader frame can be ordered with all 12 modules or it can be short loaded with only 8 modules. The 18 fader version adds a time of day clock to the meter bridge.

Each input module allows selection between two inputs. A dual mic preamp is included so any input may accept mic or line level. Additional mic preamps are optionally available. Full machine control functions, channel logic, and monitor muting are dip switch selected on each module. The A-50 has one mono and two stereo outputs.

Audio performance is spectacular. Dynamic range, noise, distortion, and slew rate specifications all combine to make the A-50 a perfect match for your digital sources. Construction features include Penny & Giles faders, socket mounted IC's, external heavy-duty power supply, and full and accurate documentation. The A-50 sits on your table top, so no cut-out is required.

A-50 8 Fader	60WSA508	MFR LIST	\$4495.00
A-50 12 Fader	60WSA5012	MFR LIST	\$6495.00
A-50 18 Fader	60WSA5018	MFR LIST	\$8895.00



Accessories:

Additional dual microphone preamp.

60WSMC2 MFR LIST **\$275.00**

Full function tape machine remote control.

60WSFF1 MFR LIST **\$195.00**

Start/stop remote control for 3 devices.

60WSSS3 MFR LIST **\$195.00**

Six source preselector.

60WSLS50 MFR LIST **\$250.00**

Custom stamping of OFF buttons for source identification.

60WSHS50 MFR LIST **\$7.50**

Colored fader. Select from black, blue, green, gray, orange, red, or yellow. Standard fader is white.

60WSCF50XX MFR LIST **\$5.50**

Call Bradley for a current price quotation.

Selecting a console is one of the most important decisions you'll make. Get the expert advice you need from Bradley Broadcast.

Logitek Stereorack Console

The Stereorack is a full featured, dual buss stereo console in a standard 19 inch rack mount. Each of the six stereo input channels has a two position input preselect, and a pan/balance control concentric with the channel fader. The faders themselves are heavy duty conductive plastic type with a standard cue detent position. The channel select buttons are high reliability Hall-effect push-buttons. Seven internal mic preamps are hard wire assignable on the rear panel, and each output buss has its own stereo, four output distribution amplifier. Two separate headphone systems each have independent 5 x 1 source switching, and the talent headphone system provides for separate IFB-style interrupts for up to three different headsets. The Stereorack is very system friendly, providing logic for the remote starting of machines and for accepting remotely generated channel commands.

The unique Logitek "swap" key can automatically interchange all selected program and audition assignments. This handy feature is indispensable for sports and election coverage because it allows for presetting and salvo switching of an entire mix. In addition, an internal virtual mono mix minus buss allows the Stereorack to handle telephone talk applications without tying up the audition

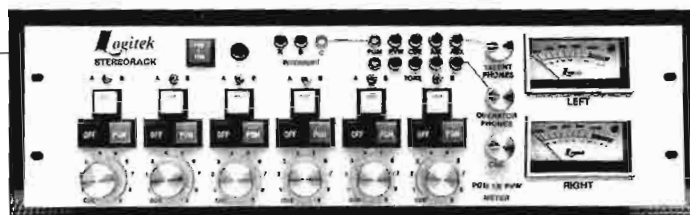

buss. Connections are made with wire clamping terminal blocks, except for logic connections, which are on 37 pin D connectors. Noise is down at least 76dB from a +4dBm reference, with over 18dB of headroom and THD under 0.05%.

Logitek Stereorack 60LTSR MFR LIST \$4950.00

Also available:

Audiorack - A monaural version of the Stereorack offering the same features.
60LTAR MFR LIST \$3600.00

Call Bradley for a current price quotation.

Logitek TR2 Console

Logitek has shrunk a 12 fader, 36 input console to fit a standard 19" rack without shrinking features or performance. The TR2 mixer frame is only 5 rack units high, and the detachable meter bridge/power supply unit is only 2 rack units.

The fully modular approach to the TR2 makes it easy to get just the console you need. Three types of input modules and a 10 input preselector are offered. Each of the two main stereo busses feeds two stereo and a summed mono output. Additional mono busses are derived from each stereo buss for mix-minus and IFB applications. A third stereo buss is available for cueing. Two separate stereo monitor drivers are provided. Machine control and tally outputs are provided for each input, and plug-on screw terminal blocks make installation quick and easy.

TR2 Mainframe 60LTTR2 MFR LIST \$2600.00

Modules - Select 12.

TRI-3 input module with 2 stereo line inputs and one mono mic input with phantom power. 60LTTRI3 MFR LIST \$525.00

TRI-M input module with single mic input with phantom power and pan pot. 60LTTRIM MFR LIST \$525.00

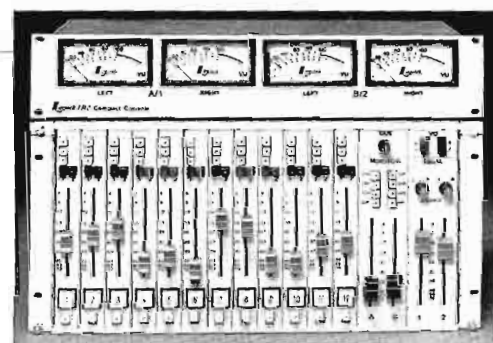

Call Bradley for a current price quotation.

TRI-L input module with single stereo line input with left only, right only, stereo, or mono assignment selection.

60LTTRIL MFR LIST \$525.00

TRI-P ten source preselector. 60LTTRIP MFR LIST \$525.00

Blank panel. 60LTPRIB MFR LIST \$20.00

Yamaha MC02 Series Mixers

The Yamaha MC02 Series mixers are among our most popular mixers. These professional quality, exceptionally compact consoles are available in 8, 12, and 16 channel versions. Controls are bright, easy to read and understand, and allow for quick set up and on-the-fly operation. Each channel provides an accurate fader, pre-fader cue switch, three band EQ with sweepable mid-range, three auxiliary/effects sends, and input gain controls. Phantom power is available and each channel has a send/return insert jack for external processing. The electronically balanced mic/line inputs are available on both XLR and 1/4" TRS connectors. The stereo outputs are balanced, +4dBm, XLR. The master section controls the main stereo outputs, headphone monitor selection, the auxiliary/effects busses, the talkback functions, and switchable metering. Yamaha has put it all together in these slim, attractive, and rugged mixers, which are ideal for small studios, remote trucks, and PA systems.

Call Bradley for a current price quotation.



MC802 8 inputs 60YAMC802 MFR LIST \$825.00
MC1202 12 inputs 60YAMC1202 MFR LIST \$1095.00
MC1602 16 inputs 60YAMC1602 MFR LIST \$1295.00



Soundcraft 200 Delta Consoles

If you're seeking a console with virtues such as flexibility, sonic purity, and value you will find the Soundcraft 200 Delta to be a true virtuoso. The molded chassis and armrest give the 8, 16, 24, and 32 input position mainframes great looks and tremendous durability. The 200 Delta is also available in an 8 input position rack mounting frame.

This console's flexibility is evidenced by its four input modules. The Standard Input has an input attenuator for microphone and line level inputs, 48V phantom power, 3 band EQ with sweepable midrange, six auxiliary sends, and a very clean 100mm fader. The Deluxe Input Module contains the same features with the addition of a phase reversal switch, a high-pass filter, and sweepable high-mid and low-mid EQ. The Stereo Input Module handles two stereo line inputs and features an input attenuator, A/B input selector, mono sum and phase reversal switches, and the EQ features found on the Standard Input. The Channel On switch may be used to remotely start an external source. Also available is a Dual Line Input which handles two mono line level sources with identical controls for both signals including input attenuator, the 3 band EQ as found on the Standard Module, 4 auxiliary sends, a pan pot, and a rotary gain pot.

The Group Module features 2 mono returns with 2 band EQ and a bar graph meter. You can choose to incorporate up to 4 Group Modules or you may use the four group slots on the mainframe to increase the number of console input modules. THD, crosstalk, and noise floor specs on the 200 Delta are so good, it is the recommended console for direct recording to DAT. All inputs are electronically balanced.

Mainframes prices:

8 input mainframe	60SFPW1112	MFR LIST	\$1830.00
8 input rack mnt mainframe	60SFPW1113	MFR LIST	\$1830.00
16 input mainframe	60SFPW1114	MFR LIST	\$2470.00
24 input mainframe	60SFPW1115	MFR LIST	\$3050.00
32 input mainframe	60SFPW1116	MFR LIST	\$3880.00

Modules:

Standard mono input	60SFPS9268	MFR LIST	\$140.00
Dual mono line input	60SFPS9269	MFR LIST	\$270.00
Deluxe mono input	60SFPS9270	MFR LIST	\$215.00
Stereo input	60SFPS9271	MFR LIST	\$340.00
Blank panel	60SFPS9288	MFR LIST	\$40.00

Subgroup modules. Select up to four or use slots for additional inputs. Blank panels must be placed in unused slots.

60SFPS9273	MFR LIST	\$185.00
------------	----------	-----------------



Also available:

Delta 8

This new version of the Delta console is designed for 16 track recording. It offers 8 groups, 16 returns, 2 two track tape returns, and an alternate speaker output selector. The Delta 8 comes in 20, 28, and 36 input mainframe sizes, each with 6 auxiliaries. Standard, stereo, and dual line input modules are available.

200 B/VE

The 200B/VE offers Soundcraft quality in a console that operates under the control of a video editor. Two types of mono input modules (one with standard four band EQ, the other with sweepable high-mid and low-mid EQ bands) are video editor controllable via the high quality VCA system in the signal path. A short throw auxiliary fader adjacent to each input fader allows the user to determine the extent the editor will attenuate that channel's signal. Stereo input modules are also available.

The master module contains four subgroup outputs along with the main stereo output and the four auxiliary masters. An eight channel monitor section allows you to monitor both the subgroups and an eight track tape recorder. Interfacing with virtually any type of editor is possible via the VSA24 serial interface adapter. Talkback facilities, and special monitor controls and status indicators address the special needs of the video control room.

Call Bradley for a current price quotation.

Yamaha MC04 Series Mixers

Let Bradley and Yamaha set your creativity and budget free with the MC04 mixing consoles. Select from 12, 16, or 24 input versions feeding eight mixing busses (4 program group, 2 echo, and 2 foldback) in turn feeding a stereo master buss. Balanced XLR connectors are on all primary inputs and outputs. Insert patch points are provided on all input channels as well as on the groups. Input channels are equipped with cue buttons and channel on/off switches, as well as 3 band EQ with sweepable midrange, pan, 20dB input pad, and variable input gain control.

The MC04 Series is recommended for sound reinforcement, live-to-tape recording, and production room use. When your application requires versatility, the MC04 Series consoles provide the answer.

Call Bradley for a current price quotation.



MC1204	12 Channel	60YAMC1204	MFR LIST	\$2495.00
MC1604	16 Channel	60YAMC1604	MFR LIST	\$2995.00
MC2404	24 Channel	60YAMC2404	MFR LIST	\$3995.00



Soundcraft Series 6000 Consoles

With the widespread use of digital recorders and processors, your console may be your only major piece of analog equipment. The Soundcraft Series 6000 of recording and production consoles is designed to meet this challenge.

The Series 6000 is a full 16 or 24 buss console. Mainframe sizes are from 16 inputs through 44 inputs. Many sizes can be fitted with a patchbay. Each input module has six auxiliary sends and Soundcraft's renowned EQ with sweepable midrange. Stereo line input modules, an essential feature for many production houses, are available. Among the advanced features are both PFL and true Solo-in-Place, a low crosstalk routing matrix, silent electronic muting, and a programmable mute buss. The consoles provide 16 or 24 groups, each of which can be configured as a full subgroup with dedicated effects returns. Each group's monitor section has a two band EQ, two auxiliary sends, and PFL.

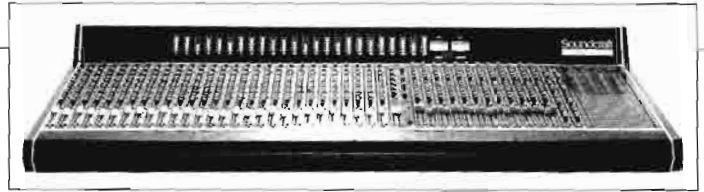

The design of the Series 6000 incorporates clear color coding and smooth, high quality controls that makes these consoles easy to read and accurate to adjust. Due to the wide range of options and modular construction, your Series 6000 can be custom configured. Manufacturer's suggested list prices range from \$16,000 to \$50,000 depending on your requirements. Your Bradley professional is trained to help you design a Series 6000 console that will improve the quality and efficiency of your operation.

ElectroVoice BK 42 Series Mixers

These live mixing and sound reinforcement boards have been updated to provide even more professional features and quality at a budget price. Versions are available with 12, 16, and 24 inputs, and in an 8 input rack mount model. Each input accepts a balanced mic input (with 48V phantom power) and a balanced 1/4" TRS line input. Trim pots, three-band EQ with sweepable midrange, plus effects/reverb buss, monitor send, and pre/post fader auxiliary sends are provided on each channel. A humbucking ground design and 100mm low glide faders are just two of the many improvements in this latest version.

The output section provides left, right, main (mono sum), and monitor outputs. The BK series features a straightforward layout for ease of operation, with useful touches like a front panel BNC for a console light, switchable LED metering, headphone amp with gain control, and sub inputs on all channels and on the left/right output buss. A great value from a trusted name in electronics.

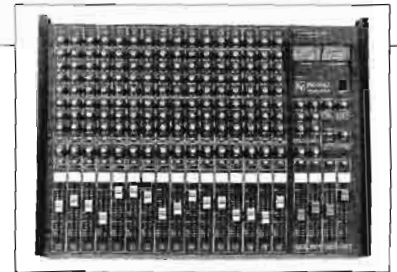

Call Bradley for a current price quotation.

8 input, rack mount	60ELBK842	MFR LIST	\$1000.00
12 input	60ELBK1242	MFR LIST	\$1209.00
16 input	60ELBK1642	MFR LIST	\$1459.00
24 input	60ELBK2442	MFR LIST	\$2000.00

Tascam M3500 Console

The M3500 is loaded with features that can help you produce a superior recording. All configurations have 8 group busses and an in-line monitor system that allows hassle-free connection to recorders having up to 24 inputs. In addition to versatile, easy to follow monitor signal routing, the in-line monitor format means that each input channel actually has two signal paths so that input capacity is effectively doubled. Main, monitor, and effects return inputs are all equipped with linear faders for precise level setting.

Available in 24 and 32 channel frame sizes, the M3500 features 4 fully assignable effects returns with mute and solo switches; 8 bar graph meters with select switches for group/tape return monitoring plus 2 VU meters on the stereo outputs; talkback facility; insertion points on each stereo and group buss; and +4dBm balanced XLR stereo outputs and two track inputs. The optional meter bridge provides dedicated meters for tape return inputs, channel inputs, and aux outputs. Each standard input channel features XLR mic input, -10dBV line input, -10dBV tape input, direct out, four band EQ with two sweepable mid bands and high pass filter, 6 aux sends with 4 send level controls, PFL or stereo in-place solo facilities, and mute switches for channel, monitor and Aux 5 and 6. The M3500/24ST features 24 standard inputs and 8 dual line stereo inputs. Stereo inputs are similar to standard inputs, but with a three band EQ.

Also available:

M3700 automated console based on M3500 configurations. Your Bradley professional can provide all the details.



M3500/24 24 mono inputs	60TEM350024	MFR LIST	\$7499.00
M3500/24ST 24 mono/8 stereo inputs	60TEM350024ST	MFR LIST	\$9499.00
M3500/32 32 mono inputs	60TEM350032	MFR LIST	\$8499.00
Accessories:			
24 channel meter bridge	61TEMU3524	MFR LIST	\$750.00
32 channel meter bridge	61TEMU3532	MFR LIST	\$1000.00
Pedestal for M3500/24	61TECS3524	MFR LIST	\$1000.00
Pedestal for M3500/24ST & M3500/32	61TECS3532	MFR LIST	\$1150.00

Call Bradley for a current price quotation.



Ramsa WR-133 Mixer

The attractive and functional briefcase styling of the WR-133 makes this mixer an excellent "road" unit and high quality audio makes it equally at home in the studio. This 8 x 2 mixer provides mic or line inputs on each channel, and has RIAA phono preamps to allow two turntables to be connected via inputs 1 through 4. Each input section features dual band shelving EQ, monitor and effects send, pan pot, and peak LED. The output section has a mono output, master effects and monitor output controls, plus stereo record outputs via XLR, 1/4" TRS, and phono jacks.

Ramsa WR-133
 60PAWR133 MFR LIST \$1290.00
Accessory: Rack Mount Kit
 60PAWRQ51 MFR LIST \$87.00
 Call Bradley for a current price quotation.



Yamaha MR Series Console

For recording, production, and light duty sound reinforcement, the economical MR series offers exceptional value. Constructed and featured similar to the MC02 series, the MR consoles add four subgroup mixing busses to the main stereo buss. Additional features on these models include a tape input phono jack on each input channel. The three auxiliary sends can tap into the mic/line input, the tape return input, or both inputs for multitrack recording work. Metering is provided for all busses. Phono jack outputs parallel the balanced XLR outputs on all busses for compatibility with nearly any piece of gear.

MR842 8 inputs	60YAMR842	MFR LIST	\$1295.00
MR1242 12 inputs	60YAMR1242	MFR LIST	\$1595.00
MR1642 16 inputs	60YAMR1642	MFR LIST	\$1795.00



Call Bradley for a current price quotation.

Ramsa WR-8616 Console

No matter how well designed a console is, or how good its specs are, most consoles have drawbacks of some type for each user. You can have your console custom built (expensive), you can modify an existing console (and take your chances), or you can get the Ramsa WR-8616. Its mainframe, combined with a variety of modules, allows this console to be tailored for either production or recording applications. Choose any combination of up to 16 mono mic/line or stereo line inputs. Two types of groups modules allow for four basic subgroups, plus tape monitoring for up to 16 channels. Comprehensive metering, and monitor and oscillator/talkback modules are included with the mainframe.

WR-8616 Mainframe	60PAWR8616	MFR LIST	\$5530.00
Input Modules - Select any combination of 16.			
Mono mic/line	60PAWU8101	MFR LIST	\$280.00
Stereo line	60PAWU8106	MFR LIST	\$310.00
Blank panel	60PAWU8091	MFR LIST	\$45.00

Group modules - Select four.
 Each tape monitor module adds 4 channels of monitoring.

Basic group	60PAWU8107	MFR LIST	\$190.00
Tape monitor/group	60PAWU8102	MFR LIST	\$275.00

Call Bradley for a current price quotation.



Mackie Designs CR-1604 Mixer

This 16 input, stereo output mixer offers flexible installation choices and excellent audio performance. When rack mounting the CR-1604, the connector panel rotates to place connectors at the rear of the console and to save space. The connectors can also rotate to the top of the console for tabletop installation. The unity gain design and center detent controls keep noise low and headroom high. Channels 1 through 6 have XLR mic inputs with phantom power, and all channels have a three band EQ and 6 aux sends. Other features include 4 stereo effects returns, stereo "in-place" solo system, precision sealed rotary pots, and an alternate stereo mix output.

CR-1604	60MDCR1604	MFR LIST	\$1099.00
----------------	------------	----------	------------------

Accessory:
Mic Input Expander
 Adds mic input capabilities to all 16 inputs.
 60MDXLR10
 MFR LIST \$349.00



Call Bradley for a current price quotation.



Tascam M-200 Series Mixers

All M-200 models provide four program busses, each with its own pan and fader, and a stereo buss also with separate faders. The M-208 and M-216 provide 8 tape inputs with corresponding switches in the channel strips so that an 8 track recorder can be permanently connected for playback monitoring. The M-224 has the same provision for a 16 track recorder. Each input strip provides input pad and trim, channel insert, 3 band EQ, effects and foldback level controls, and a pre-fader listen switch. The master section includes four meters, switching matrices for the monitor and meters, and a mono sum switch for the stereo buss.

M-208 8 inputs	60TEM208	MFR LIST	\$1199.00
M-216 16 inputs	60TEM216	MFR LIST	\$1849.00
M-224 24 inputs	60TEM224	MFR LIST	\$2599.00

Accessory:
Rack Mount Kit
 For M-208
 61TERM208
 MFR LIST **\$65.00**

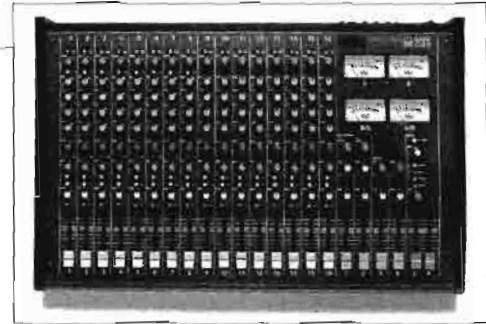

Call Bradley for a current price quotation.

Tascam M2500 Mixer

These compact boards are designed for 8 track recording and electronic music production. In-line monitoring effectively doubles the number of available inputs at mix down. Features include phantom power, 100mm faders, 4 aux busses and 6 effects returns, three band EQ on input channels, and talkback mic. MIDI mute automation provides muting of complete monitoring section and individual inputs. The M2500 provides excellent value for the smaller facility.

M2516 16 inputs	60TE2516	MFR LIST	\$2999.00
M2524 24 inputs	60TE2524	MFR LIST	\$3999.00

Call Bradley for a current price quotation.

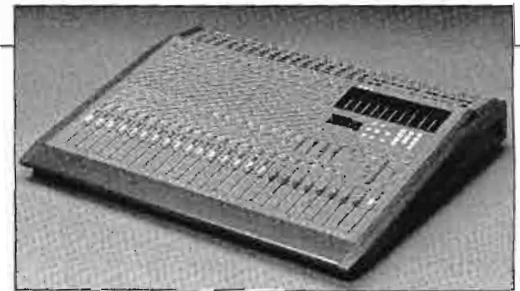

DOD Mixers

The DOD 820 (8 channel) and 1220 (12 channel) stereo mixers set a new standard in compactness, while maintaining studio quality sound reproduction. Each channel has a 1/4" TS line input, two band EQ, monitor send, effects send, pan, and LED overload and level indicators. Inputs on XL and RM models have XLR mic inputs with phantom power. Bandwidth is 10Hz to 22kHz, +0/-1dB; THD+Noise is less than 0.05%, 20Hz to 22kHz; and crosstalk is better than -65dB for adjacent channels and for left and right masters.

Tabletop models have connectors mounted on top of chassis, while the rack mounted versions have the connectors mounted on the rear. With six versions from which to choose, there is a DOD mixer perfect for your application.

1220 12 channel line level table top.	60DO1220	MFR LIST	\$599.00
1220XL 12 channel mic/line table top.	60DO1220XL	MFR LIST	\$669.00
1220RM 12 channel mic/line rack mnt.	60DO1220RM	MFR LIST	\$699.00

Call Bradley for a current price quotation.

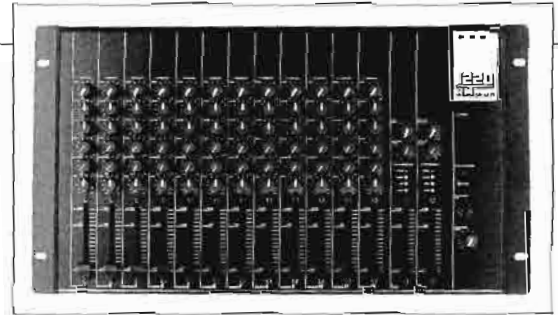

820 8 channel line level only table top.	60DO820	MFR LIST	\$399.00
820XL 8 channel mic/line table top.	60DO820XL	MFR LIST	\$469.00
820RM 8 channel mic line rack mnt.	60DO820RM	MFR LIST	\$499.00

Tascam M-106 Mixer

The M-106's six input channels each have mic and line inputs. Four channels have RIAA phono inputs to accommodate two stereo turntables. The M-106 has four main mixing busses and two independent monaural auxiliary busses. Each input channel has a 30dB mic attenuator, 44dB input trim control, and 2 band EQ. The monitor section allows you to monitor the four busses separately, either as stereo pairs or as a mono sum of either pair. Uses phono and 1/4" TS connections.

M-106	60TEM106	MFR LIST	\$699.00
Accessory: Rack Mount Kit	61TERM106	MFR LIST	\$55.00

Call Bradley for a current price quotation.



Yamaha MV422 Mixer

The Yamaha MV422 is a compact, rack mounted multi-source mixer for A/V, industrial screening rooms, nightclub entertainment, and other applications. In only four rack spaces, the MV422 provides four mono inputs, two stereo inputs, an adjustable BBD echo, crossfading between stereo sources, and a master output with metering. Each stereo channel can select from four stereo sources including one with a built-in phono preamp. Video signals can be routed through stereo channel two. The Auto-Mute switch has fully adjustable source attenuation, hold time, and release time. The monitor section allows cueing from any combination of

the input sources.

MV422
60YAMV422
MFR LIST \$795.00



Call Bradley for a current price quotation.

Yamaha M-406 Mixer

The M-406 is a rack mounting, 6 x 2 mixer with superior specifications, XLR inputs and outputs, and plenty of useful features. Each channel has a six position input attenuator, three band EQ, send control, and pan pot. Dual illuminated VU meters show left and right output with right meter and phones switchable to monitor the send/echo channel. With low noise (-95dBm) and +24dBm output capability, the M-406 fills the bill for high quality in a small space.

M-406
60YAM406
MFR LIST \$1295.00

Call Bradley for a current price quotation.



Yamaha MV802 Mixer

The Yamaha MV802 is a versatile eight input, stereo output rack mounting mixer. All eight inputs have a 20dB pad for handling a broad range of signal levels, and the first two channels also offer mic level inputs. The MV802 has two aux busses, stereo LED ladder meters, a headphone output with gain control, and a switch that engages a stereo VCA for use with foot pedals or other outboard devices to control the overall gain of the stereo buss. Inputs are 1/4" TS phone jacks and outputs appear on both 1/4" TS and XLR. Maximum output is +20dBm at 0.2% THD, 20Hz to 20kHz. Residual noise output is greater than 90dB below +4dBm at the stereo buss, and frequency response is +1dB, -1.5dB from 20Hz to 20kHz at +4dBm output. As a multitrack monitor mixer or production sub-mixer

for expanding a short console, the MV-802 is a workhorse.

MV802 60YAMV802 MFR LIST \$475.00

Call Bradley for a current price quotation.



Rane SM-26 Splitter Mixer

This Rane mixer is compact and versatile. It functions as a 6x2 mixer, a 2x6 splitter/DA, or a 6 channel buffer amp. The unique circuit design allows various combinations of splits and mixes to be performed simultaneously, via 1/4" TRS balanced inputs and 1/4" TRS floating outputs. Shorting input jacks determine whether a given input is fed to an individual output or to the main stereo buss. All inputs route to individual mono outputs via front panel level controls, and can be panned to the stereo buss. There is almost no limit to the routing applications you can devise with this economical device. It has justly earned its nickname "Swiss army mixer" for the variety of audio solutions it provides.

SM-26 60RNSM26 MFR LIST \$349.00

Call Bradley for a current price quotation.



Tascam M06ST Mixer

This 6x2, stereo input mixer is a popular choice for small video suites, recording, and PA applications. Channels 1 & 2 have mic and RIAA phono inputs, while channels 3-6 accept mic or line levels. Each stereo input channel has a trim control, high and low EQ, cue send, and balance control. The line inputs on channels 1 and 2 have phono preamps for direct connection of two turntables. Line inputs are on phono jacks, mic inputs are 1/4" TS, and outputs appear on both phono and TS connectors. The M06ST also features a headphone amp with two jacks.

M06ST 60TEM06ST MFR LIST \$499.00

Also available:
M06 mixer with mono inputs.
60TEM06 MFR LIST \$369.00

Call Bradley for a current price quotation.



Furman MM Series Mixers

The MM Series Mixers are straightforward, one rack space devices designed to work in a broad range of applications. Both the MM-4ABP (mono output) and the MM-8ABP (stereo output) have four mono inputs. Both units feature balanced microphone (XLR) and line (1/4" TS) inputs which can be used simultaneously on each channel, switchable 48V phantom power, an effects send which can be used for processing or as a separate mix bus, and a switchable bass roll-off filter. The MM-8ABP also has a pan control on each input. There are two Hi-Z auxiliary inputs and a headphone output with gain control. There are both balanced (XLR) and unbalanced (1/4" TS) outputs that can be used simultaneously for distribution purposes.

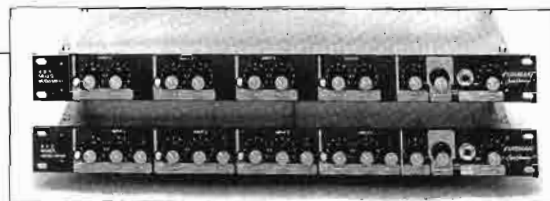

MM-4ABP mono output	60FUMM4ABP	MFR LIST	\$415.00
MM-8ABP stereo output	60FUMM8ABP	MFR LIST	\$475.00

Call Bradley for a current price quotation.

Benchmark IFA-10 Mixer

This compact 4 input, 4 output assignable mixer is suited for installations where superior audio performance is demanded. The noise floor of the IFA-10 is -104dBu at unity gain; THD is 0.0009% @ 2kHz; and the common mode input filters virtually eliminate RFI. Requires PS-1 power supply.

IFA-10	60BMIFA10	MFR LIST	\$350.00
---------------	-----------	----------	-----------------

Accessory:

PS-1 power supply for IFA interfaces. Handles up to 10 devices.

60BMPS1	MFR LIST	\$30.00
---------	----------	----------------

Also available:
MIA-4X4+ quad mic preamp mixes to a stereo line level output. See the full description in our Microphone section.

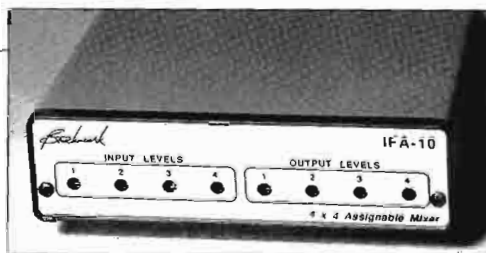

Call Bradley for a current price quotation.

See our Field Production Section for an expanded selection of portable, compact mixers.



Revox PR99 Reproducer

The PR99 reproducer features a die cast aluminum alloy chassis and head block, servo - controlled capstan motor, and contactless full logic switching. A single multipin connector carries all audio, status, and remote signals, or these signals may be accessed via parallel XLR and DIN connectors. Modular plug-in circuit boards, 25Hz tone detector, adjustable stop delay, convenient front panel controls, and a competitive price make the PR99 the automation advantage. Rack mount is standard.

Revox PR99 Reproducer	60REPR99R	MFR LIST	\$2795.00
------------------------------	-----------	----------	------------------

Call Bradley for a current price quotation.

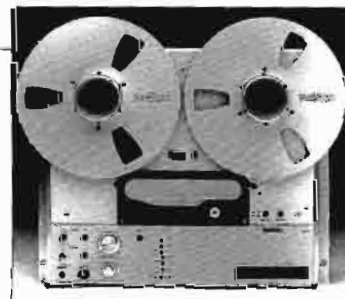

Otari ARS-1000 Reproducer

The ARS-1000 two speed reproducer is designed for reliability and continuous operation in broadcast automation. Its circuitry is on plug in boards, and its flip up head cover provides ready access to heads. Recessed front panel adjustments for level and head azimuth allow immediate adjustment of these parameters when changing tapes. The straight line tape path and interlocked transport controls ensure ease of operation and minimize tape damage. Includes 25Hz sensor with relay output.

Otari ARS-1000 Reproducer	60OTARS1000DC	MFR LIST	\$2250.00
----------------------------------	---------------	----------	------------------

Call Bradley for a current price quotation.

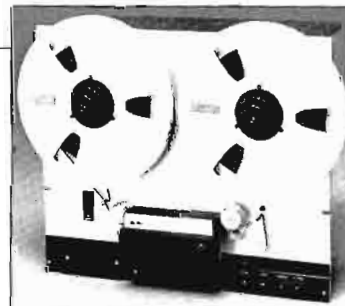

Revox C270 Series Recorders

The C270's deliver famous Studer sound and a wealth of useful features. C270 versions include two track, two track with center track time code, 1/4" four track, and 1/2" eight track. Common to all versions are constant tape tension on both supply and take up reels, DC servo capstan motor, real time counter, RS-232 serial port, Dolby HX Pro headroom extension, seamless and gapless punch in/punch out, and a +50%/-33% varispeed. Tape speeds of 3%, 7%, and 15ips are available on standard machines, with any pair selected and quickly changed in the field. Fully modular electronics, behind the hinged front panel, permit full access even when rack mounted and operating. The C274 and C278 have a code track system which, when activated, will record on the last audio track any two of the following: time, date, counter, or external code.

C270 Two track stereo	60REC270	<i>MFR LIST</i>	\$3995.00
C270TC Two track with center track time code	60REC270TC	<i>MFR LIST</i>	\$5995.00
C274 Four track	60REC274	<i>MFR LIST</i>	\$4995.00
C278 Eight track	60REC278	<i>MFR LIST</i>	\$5995.00

Call Bradley for a current price quotation.



Revox PR99 MKIII Recorder

Whether making master recordings or editing the news, the carefully designed electronics panel of the PR99 MKIII provides great operator convenience. The chassis and frame are solid aluminum alloy die castings for rigidity and alignment stability. Tape heads are mounted onto a precisely machined head block assembly, and electronics are modular for ease of access. The real time tape counter has a zero locator, single address locator, and the ability to play and rewind between two tape locations. The variable tape speed has a half octave range. This two track stereo machine includes complete editing facilities, balanced XLR inputs and outputs with calibrated/uncalibrated level adjustment, and a tape dump feature. Panel adjustments make reproduce level and high frequency EQ easy. Available with 15 and 7 1/2 ips or 7 1/2 and 3 1/2 ips speeds. The PR99 MKIII comes standard with 19" rack mount. For production or master control, the PR99 MKIII is an excellent choice.

Revox PR99	60REPR99	<i>MFR LIST</i>	\$3495.00
-------------------	----------	-----------------	------------------

Call Bradley for a current price quotation.



Revox Remote Controls and Accessories

Remote control for PR99 and B77.	60RERC	<i>MFR LIST</i>	\$175.00
Remote control for C270.	60RE34610	<i>MFR LIST</i>	\$245.00
Autolocator for all C270 versions.	60RE34630	<i>MFR LIST</i>	\$950.00
Serial to parallel remote control converter for the C270 two track.	60REC270SI	<i>MFR LIST</i>	\$184.00

Standard NAB 1/4" hub adapters. One pair.

60RE45001P *MFR LIST* **\$62.00**

Oversized metal NAB 1/4" hub adapters designed for ease of editing. One pair.

60RE45010P *MFR LIST* **\$138.00**

Call Bradley for a current price quotation.



Otari MX-50 Recorder

Otari tape recorders are known for their quality and value. The MX-50 uses current technologies to provide exceptional performance in an economical machine. Features include $\pm 7\%$ varispeed, 5 digit tape timer with search-to-zero and search-to-cue functions, standard record/reproduce level selection on input and output, and individual reel size compensation switching. The MX-50 is user selectable for 15 & 7 1/2 ips or 7 1/2 & 3 3/4 ips operation. Inputs and outputs are balanced XLR. An editing block is located immediately below the head stack for easy splicing, and there is a front panel headphone jack with volume control. The overall audio performance and features of the MX-50 rival many higher priced tape recorders.

Otari MX-50 600TMX50 MFR LIST \$2495.00

Call Bradley for a current price quotation.



Otari MX-5050 MarkIV Series Recorders

The new MarkIV Series is the premium edition of the Otari 5050 line of compact professional recorders. Three models are available: 1/4" two track, 1/2" four track, and 1/2" eight track. All three feature a servo controlled direct-drive capstan motor, dynamic braking, $\pm 20\%$ variable speed control in 0.01% steps, and selective reproduce for overdubbing. The mini-autolocator and tape timer functions of the MX5050B-III are incorporated into the MarkIV series. The four track and eight track models include gapless, seamless punch-in, punch-out; rehearse function; and automatic monitor switching.

Audio specifications are first class, and MarkIV machines are capable of being interfaced to synchronizers and editors when one track is used for time code information. Record set up adjustments can be made from the front panel, and a convenient built-in oscillator provides test tones for callibration. Active balanced transformerless XLR input and output connectors make installation easy.

MarkIV-2 2 track 600T5050MK42 MFR LIST \$4295.00
 MarkIV-4 4 track 600T5050MK44 MFR LIST \$5995.00
 MarkIV-8 8 track 600T5050MK48 MFR LIST \$6295.00

Call Bradley for a current price quotation.



Otari Accessories

Rack mount for MX-5050-BIII & MX-5050-BQIII.
 600TRK2B MFR LIST \$63.00

Rack mount for MX-50.
 600TZA5EK MFR LIST \$63.00

Rack mount for MX-55N.
 600TZB51A MFR LIST \$63.00

Metal roll around stand for all Otari recorders except MX-50 and MX-55 models. Specify model.
 600TZA52LXX MFR LIST \$368.00

Metal roll around stand for MX-50.
 600TZB51M MFR LIST \$368.00

Metal roll around stand with skirt for MX-55N.
 600TZB51D MFR LIST \$520.00

Metal roll around stand with skirt for MX-55NM & MX-55TM.
 600TZB51E MFR LIST \$520.00

PO100 side panels to hold the MX-5050B-III in a convenient slanted position. Wood composite covered with black vinyl.
 600PRPO100 MFR LIST \$89.95

Voice Edit Module for use with MX-50. Alters pitch of internal monitor output for improved intelligibility when listening at twice normal speed.
 600TZA5EL MFR LIST \$263.00

Voice Edit Module for use with MX-55 models.
 600TZA5CV MFR LIST \$263.00

Input and output transformers are available for the MX-50, MX-5050-BIII, and MarkIV-2. Contact Bradley for details.

NAB 1/4" hub adapter. One each.
 600TTW670 MFR LIST \$21.00

Clamps for small (7") reels. One pair.
 600TZA52Y MFR LIST \$40.00

Call Bradley for a current price quotation.



Otari MX-55 Series Recorders

The MX-55 series consists of three superior quality decks. The MX-55N has its electronics and transport in a compact upright unit that may be rack or console mounted. The MX-55NM, which has its electronics in an overbridge, adds Dolby HX Pro and gapless, seamless punch in/punch out to the available features. The MX-55TM, also an overbridge unit, adds center track SMPTE time code capabilities. All models feature a built-in 3 point locator with LED elapsed time counter; return-to-zero and repeat looping; $\pm 20\%$ varispeed; front panel record/reproduce alignment adjustments; and external synchronizer interface. Other standard features are built-in cue speaker, headphone amp with level control, 3 tone oscillator, mic/line mixing on each channel, and 3 speeds that are switch selectable in pairs.

Electronically, the MX-55's feature transformerless balanced inputs and outputs, 68dB or better S/N ratio at 7 $\frac{1}{2}$ or 15ips, and ± 2 dB frequency response from 20Hz to 18kHz at 7 $\frac{1}{2}$ ips. Individual reel size switches are provided, as well as an integral splicing block. The innovative operating approach incorporated into this machine must be seen and heard to be appreciated. All versions also come in high speed models, operating at 15 and 30ips, at additional cost.

MX-55N With integral electronics.

600TMX55 MFR LIST \$4295.00

MX-55NM With electronics overbridge.

600TMX55NM MFR LIST \$5495.00

MX-55TM With center track time code and overbridge.

600TMX55TM MFR LIST \$6495.00



Call Bradley for a current price quotation.

Otari MX-5050BIII Recorder

If you're an audio professional, odds are that you own an Otari MX-5050. New for 1991, the "BIII" two track is designed for superior frequency response, distortion, and signal-to-noise performance. A built-in mini-autolocator provides three one-touch cue point memories, zero search, and a repeat function. The tape timer display shows tape time in Hours/Minutes/Seconds, as well as tape speed in inches per second and percentage of tape speed. Capstan speed can be varied $\pm 20\%$ in 0.01% steps using the built-in pitch control.

The extremely rugged mechanical construction includes a 1/4" deckplate with cast aluminum side panels and steel support members. All circuit boards are designed to swing out or unplug for full service access. Microprocessor governed logic, motion sensing, and dynamic braking assure smooth tape handling. The four head design allows playback of both half and quarter track tapes. Other features include a built-in tone oscillator and external oscillator input, active balanced XLR inputs and outputs, headphone monitor, dump edit and lifter defeat modes, and mic/line mixing on each channel.

MX-5050BIII Recorder 600T5050B3 MFR LIST \$3295.00

Also available:

MX-5050BQIII Recorder

For those who need the versatility of a four channel recorder, but who want the economy of 1/4" tape, this is ideal. The "BQIII" features gapless, seamless, punch-in, punch out.

600T5050BQ3
MFR LIST \$5160.00

Call Bradley for a current price quotation.



Otari Remote Controls

CB-127 remote control for MX-50, all MX-55 versions, and all MX-5050 models except MarkIV-8. Includes record, play, stop, rewind, fast forward, and record indicator.
600TCB127 MFR LIST \$263.00

CB-119 autolocator for MarkIV and MX-55 series. The CB-119 has a six memory locator with single stroke store/locate capability. Also included are transport controls and head and tail guard memories.
600TCB119 MFR LIST \$1775.00

CB-114 remote control for Mark IV-8. Functions identical to CB-127.

600TCB114 MFR LIST \$242.00

CB-144 session controller for the MarkIV-8. Includes transport controls, channel status switching, tape timer readout, and zero return.

600TCB144 MFR LIST \$1249.00

Call Bradley for a current price quotation.

TAPE RECORDERS

Toll Free: 800-732-7665 • MD & DC: 301-948-0650 • FAX: 301-330-7198 • Bradley Broadcast



Fostex G-16 and G-24S Recorders

Fostex presents the first recorders with integrated synchronizer capabilities. The G-16 1/2" 16 track and G-24S 1" 24 track both offer a removable front control panel, making these the only recorders with a built-in remote control. When the optional 8330 card is plugged in, both machines will operate as a slave or master deck under SMPTE synchronization using the machine's own front panel controls. The 8330 further provides Sony BVU-650 and BVU-2000/3000 emulation for direct connection of a video editor and full transport control via MIDI.

Audio performance and tape handling are excellent. Both the G-16 and G-24S offer jog shuttle and spot erase functions, programmable meters, ±12% pitch control, and rack mount rails. Automation/synchronization features include 10 point memory, pre-roll, autolocate, auto play, auto return, zone limiting, and total memory access for verification or change. The G-16 uses Dolby C noise reduction, while the G-24S uses Dolby S for incomparable sound on 1" tape.

G-16	60FOG16	MFR LIST	\$8000.00
G-24S	60FOG24S	MFR LIST	\$14,500.00

Call Bradley for a current price quotation.

Accessories:
8330 Synchronizer/Emulation Card
 60FO8330
 MFR LIST
\$1000.00

Also available:
 Extension kits to allow remote operation from up to 10' from the transport. Contact your Bradley professional for details.



Fostex Time Code Synchronization Systems

As the worlds of audio and video draw closer, the tools that communicate between them must work better and faster. Fostex and Bradley present the tools for SMPTE time code reading and writing, window insertion, transport synchronization, and MIDI interaction. Available components include the 4030 Synchronizer and 4035 Controller which together handle up to four machines, the 4010 Time Code Generator/Reader, the 4011 Window Inserter, and the 4050

Time/Code MIDI Interface. Your Bradley professional is trained to help you configure a powerful synchronization system that will meet your requirements and budget.



Tascam MTS-1000 Synchronizer

The MTS-1000 is a powerful and versatile SMPTE time code based, two machine synchronizer and controller. In addition to basic tape transport control, it features record function selection; auto punch-in/punch-out with rehearsal, review, and post-roll functions; and a 20 point cue memory. The internal time code generator provides all standard formats and offers a jam synch function. The MTS-1000 connects directly with many Tascam models, and an interface is available for most synchronizer controllable ATR's and VTR's. The MTS-1000 provides flawless master/slave chase synchronization.

Full MIDI-to-SMPTE time code conversion/control capabilities and full sequential and data control of all of your MIDI devices are provided. This unique combination of MIDI and SMPTE time codes means that you can lock a multitrack deck to a video deck, while at the same time running a virtual MIDI sequencing system in sync with the rest of the system. Data entry is fast and easy via a rotary dial and numeric keypad.

MTS-1000	60TEMTS1000	MFR LIST	\$1999.00
-----------------	-------------	----------	------------------

Accessories:
Serial Interface Cable
 to connect TSR-8, MSR-16, and other current Tascam multitracks.
 60TEPW5MD MFR LIST **\$75.00**
Dual Serial-to-Parallel Convertor for interfacing other ATR's and VTR's.
 60TEIF1000 MFR LIST **\$800.00**

Call Bradley for a current price quotation.



Tascam Accessories

Rack mount kit for 30 series recorders.	61TERM300	MFR LIST	\$60.00
Remote control for 30 series recorders.	61TERC71	MFR LIST	\$90.00
Remote control for BR-20.	61TERC402	MFR LIST	\$175.00

Remote control for TSR-8.	61TERC408	MFR LIST	\$150.00
Remote control for MSR-16.	61TERC416	MFR LIST	\$349.00
NAB reel hub adapters. One pair.	61TETZ612B	MFR LIST	\$20.00

Call Bradley for a current price quotation.



Tascam BR-20 Recorders

The Tascam BR-20 sets a new standard in its class. This professional two track has both balanced +4dBm and -10dBV unbalanced inputs and outputs. All major calibration controls are accessed from the front panel. The transport has a precision tension servo control transport system for exceptionally smooth operation and editing. The rack mount kit is standard. The built-in autolocator features 3 cue points, zero return, and direct time location. Other features include $\pm 12\%$ pitch control, headphone monitoring, splicing block, dump edit and lifter defeat, and independent reel size selectors.

Also available is the BR-20T with center track time code. It uses Tascam's in-line head design and time code level optimization and waveform shaping for error-free synchronization. Gapless punch-in/punch-out and spot erase are also featured in the BR-20T.

BR-20	60TEBR20	MFR LIST	\$2399.00
BR-20T with center track time code	60TEBR20T	MFR LIST	\$2999.00

Call Bradley for a current price quotation.



Tascam Series 30 Recorders

All Tascam multitrack machines are designed "from the ground up" for maximum performance. Tascam designs and builds its own heads and matches them closely to their associated circuitry for improved performance. Series 30 recorders come in 2 and 4 channel versions and are designed for production needs at an economical price. Standard features include servo-controlled capstan motor with $\pm 12\%$ pitch control, full motion sensing with dynamic reel braking, 10% reel capacity, return-to-zero function, and dump/edit capability. Both versions are 7 1/2 & 15ips quarter inch format with NAB equalization. Phono inputs and outputs at -10dBV.

Model 32 two track.	60TE32	MFR LIST	\$1749.00
Model 34B four track.	60TE34B	MFR LIST	\$2119.00

Call Bradley for a current price quotation.



Tascam TSR-8 and MSR-16 Recorders

The TSR-8 eight track and MSR-16 sixteen track offer excellent sound, stability, and versatility. Their silent transports provide faultless tape handling of 1/2" tape at 15 ips. Tape motion is controlled by an 8 bit microcomputer for smooth, precise tape handling in any mode. The capstan motor speed is controlled by a quartz PLL servo system using the industry standard 9.6kHz reference for compatibility with most synchronizers. The TSR-8 and MSR-16 have precision real-time tape counters with two autolocate points and return to zero.

For clean, noise-free reproduction, these recorders feature dbx Type I noise reduction. In addition to manual, gapless punch in/out capability, they offer fully automated punch in/out with a rehearsal function. There's also a spot erase function that permits you to rotate the tape manually past a desired section, erasing it with no noises or clicks.

The TSR-8 and MSR-16 adapt easily to virtually any type of external control system via three different interfaces: a parallel input which allows direct interfacing to standard SMPTE/EBU time code based synchronizers; a serial port that can be used to connect to a variety of controllers, to a computer with an RS-232 interface, or to the Tascam MTS-1000 synchronizer; and a third connector for an optional remote control.

TSR-8
60TETSR8
MFR LIST
\$3499.00

MSR-16
60TEMMSR16
MFR LIST
\$7499.00

Call Bradley
for a current
price quotation.



Adams-Smith Zeta-Three Synchronizer

The Zeta-Three is designed to sync a slave machine to a master transport while generating MIDI, time code, and clock information. Provisions are made on the rear of the unit for the master and slave machines; time code input and output; various remote control schemes; MIDI IN, OUT, and THRU; auxiliary input and output for event controlling; and video in and out for time code window insertion.

The Zeta-Remote provides control of up to four Zeta-Three's, allows direct keypad entry of time positions, operates as a 100 point autolocator, does time code calculation functions, locates with tach information only, and maps tempo. Programmable "soft" keys simplify your routines. Also available are two special versions of the Zeta-Three: the Zeta-Three "em" with transport emulation capabilities, and the Zeta-Three "B" without front panel controls for operation from the Zeta-Remote. Your Bradley professional can assist you in developing a full system, including interconnect cables.



Zeta-Three	60ADZ3	MFR LIST	\$3345.00
Zeta-Remote	60ADZ3R	MFR LIST	\$1795.00

Call Bradley for a current price quotation.

ESE ES488 Time Code Generator/Reader

From ESE, one of the best known names in time, comes the ES488 microprocessor-based SMPTE Time Code Generator/Reader/Insertter. The ES488 has a large, highly visible LED display for time code data and will insert the time code reading into a video path for monitor display. The unit reads and writes both Time and User bits; works with both Drop Frame formats; has provision for user preset of hours, minutes, and seconds; reconstitutes the time code output when reading; accepts Color Frame Sync input; will perform Jam Sync; and completes error detection and correction. SMPTE code is sent and received on XLR connectors. Video (one input, two outputs) is on BNC's, and the ES488 will pass video even when powered down. The BNC Color Frame input accepts a negative-going TTL or

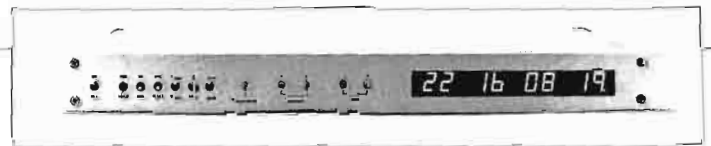

CMOS compatible pulse during the vertical interval of color field 1. The ES488 will serve as both a convenient window into the SMPTE stream and as an important striping and corrective tool.

ES488	60ES488	MFR LIST	\$1195.00
--------------	---------	----------	------------------

Call Bradley for a current price quotation.

Conex 25Hz Tone Generator

An essential automation accessory, the Conex CG-25A tone generator is used to record a 25Hz tone of predetermined length on either or both audio channels between selections. Length of tone may be user adjusted, or the manual switch may be used for any tone length. An adjustable silence interval, paired to an open-collector output, may be used to operate a muting circuit or stop the recorder for greater consistency.

CG-25A	60CNCG25	MFR LIST	\$420.00
Accessory:			
Rack mount kit.	60CNRMK	MFR LIST	\$27.00

Call Bradley for a current price quotation.



Zercom 25Hz Tone Processor

This unit provides all necessary functions to interface a reel-to-reel recorder with an automation or live-assist system. Each unit consists of two independent 25Hz decoders feeding two program amplifiers with 25Hz notch filters. Stop delay time is adjustable, and the processor provides normally open and normally closed relay outputs for the EOM command and stop command. Front panel LED's indicate sensing of the 25Hz tone.

60ZE25	MFR LIST	\$390.00
--------	----------	-----------------

Call Bradley for a current price quotation.



Tascam 424 Portastudio

The new 424 combines a 4 track cassette recorder and an 8 input mixer. The mixer has 4 mic/line (1/4" TS) inputs and 2 stereo (phono) line inputs. You can simultaneously record on any or all of the 4 recorder tracks. dbx noise reduction results in excellent performance. The recorder operates at three speeds and has $\pm 12\%$ pitch control. For electronic music production, you can mix up to 8 MIDI sources with the tape tracks. The familiar layout of the mixer and recorder controls makes the 424 easy to use.

424 60TE424 MFR LIST \$549.00



Call Bradley for a current price quotation.

Tascam 488 Portastudio

The 488 is a complete 8 track studio ideal for broadcast production and music composition. The 8 track recorder operates at 3 $\frac{3}{4}$ ips, has $\pm 12\%$ pitch control, uses dbx noise reduction, and allows recording of up to four tracks at once. Two autolocate functions are provided, as well as a mode which loops a tape segment between the two memory locations. The mixer section has 2 mono mic/line and 6 mono and 2 stereo line inputs (on 1/4" TS jacks) and 4 (phono) group outputs. The mono inputs have a two band EQ and the 488 has two effects sends. A mix feature allows recorder outputs to share a channel with an input to expand the number of sources available at mix down. At a great low price, the 488 takes away all of your excuses for not going multitrack.

488 60TE488 MFR LIST \$1599.00



Call Bradley for a current price quotation.

Tascam Porta 03 Ministudio

The Porta 03 is a 4 track, 2 input channel recorder that opens the world of multitrack to anyone who can operate a tape recorder. Two mixable inputs (1/4" TS) can be recorded onto any of the four tracks. Each track has independent gain and pan control for the stereo output. Standard cassettes can be played and recorded. The Porta 03 also includes switchable Dolby B noise reduction and a headphone jack.

Porta 03 60TEP03 MFR LIST \$329.00

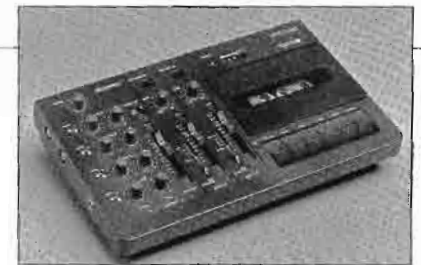

Call Bradley for a current price quotation.

Tascam 644 and 688 Midistudios

Tascam's 644 and 688 Midistudios put the multitrack cassette capabilities format into the professional production arena. With MIDI controlled automated mixer routing systems, the Midistudios are compact and easy to operate; perfect for audio and music production in small project studios and for commercial and industrial applications.

The 644 four track recorder operates at both 1 $\frac{1}{2}$ or 3 $\frac{3}{4}$ ips, while the 688 eight track recorder utilizes a staggered head design and runs only at 3 $\frac{3}{4}$ ips. Both offer professional dbx Type II noise reduction and an auto punch in/out function that allows gapless and noise-free inserts and edits. A rehearsal mode engages the punch in/out function without actually recording, and the transport includes a rotary shuttle control that provides cueing convenience and precision typical of open reel machines. Three autolocate functions are provided, as well as a mode which loops a tape segment between two memory locations.

The mixer section on the 644 has 16 mix positions and the 688's mixer section has 20 mix positions, each with independent gain, pan and effects controls. The mixers also have four effects returns, and there are two XLR mic inputs on the 644, eight on the 688. To simplify multitasking, Tascam designed the Midistudios' mixer settings to be stored as "scenes."

Up to 99 scenes can be stored and recalled, and its status can be viewed on an LCD display. The LED meter bridge is used to concurrently monitor recording levels and channel assignments.

644 60TE644 MFR LIST \$1499.00
688 60TE688 MFR LIST \$3229.00

Call Bradley for a current price quotation.



Professional Recording Tape and Accessories

Ampex Reel to Reel

Model	Item No.	Size	Reels/ Ctn.	Carton Price	Single Price
456	61AM456151111	1/4" x 1200' x 7"	10	\$ 78.40	\$ 9.40
456	61AM45617611T	1/4" x 2500' HUB	10	114.00	N/A
456	61AM456173111	1/4" x 2500' x 10 1/2"	10	208.10	24.98
456	61AM456273111	1/2" x 2500' x 10 1/2"	7	257.39	44.13
456	61AM456573111	1" x 2500' x 10 1/2"	5	289.60	N/A
456	61AM45697G111	2" x 2500' x 10 1/2"	2	275.70	N/A
406	61AM406151131	1/4" x 1200' x 7"	10	66.10	7.93
406	61AM40617613T	1/4" x 2500' HUB	10	91.80	N/A
406	61AM40617313J	1/4" x 2500' x 10 1/2"	10	170.00	20.40
407	61AM407151131	1/4" x 1800' x 7"	10	86.80	10.42
407	61AM40717613T	1/4" x 3600' HUB	10	146.50	N/A
407	61AM40717313J	1/4" x 3600' x 10 1/2"	10	230.60	27.67

Ampex Tape Types
456 Grand Master, 1.5 mil, Backcoated.
406 Mastering, 1.5 mil, Backcoated.
407 Mastering, 1.0 mil, Backcoated.

Also available:

Bradley offers the complete line of Ampex audio and videotape. Other audio formulations available by the case are 467 digital mastering tape, 478 low print tape for archiving, and economical 631 and 641 standard output tape.

Scotch Reel to Reel

Model	Item No.	Size	Reels/ Ctn.	Carton Price	Single Price
226	61SC226141200	1/4" x 1200' x 7"	12	\$ 93.36	\$ 9.60
226	61SC2261425H	1/4" x 2500' HUB	12	133.00	N/A
226	61SC226142500	1/4" x 2500' x 10 1/2"	12	243.00	25.00
226	61SC226122500	1/2" x 2500' x 10 1/2"	10	364.50	45.00
806	61SC806141200	1/4" x 1200' x 7"	12	81.60	8.40
806	61SC8061425H	1/4" x 2500' HUB	12	113.00	N/A
806	61SC806142500	1/4" x 2500' x 10 1/2"	12	204.12	21.00

Scotch Tape Types
226 Highest Headroom, Low Print-through, 1.5 mil, Backcoated.
806 Low Noise, High Output, 1.5 mil, Backcoated.

All tape is loaded on reels by the factory. 7" reels are plastic, 10 1/2" reels are metal. Other tape formulations and sizes are available. Due to their fragile packaging, hubs are available only in full cases.

Geneva AT-200B Cassette Alignment Tape

Cassette machines need periodic alignment just as reel and cart machines do. The AT-200B is an original master recording and conforms to IEC/NAB standards. Tests include 7 spot frequencies, 400hz Dolby calibration tone, pink noise and sweep tone for stereo phasing, and 3150Hz pilot tone for wow and flutter measurements. 61NOAT200B \$73.00



Rack Mount Cassette Holder

Has a capacity of 33 cassettes and is 3 rack spaces high. 61MACS \$50.00

MRL Test Tapes

Bradley offers the full line of MRL test tapes for all types of tape recorders. Spot frequency tapes are for overall frequency response checking. Fast sweep and pink/white noise tapes are used for frequency response or phasing verification. Most 1/4" test tapes for 7 1/2 and 15ips are \$57.00 and most 1/2" tapes at those speeds are \$118.00. Tapes can be ordered with NAB or IEC equalization; for 1/4", 1/2", 1", and 2" machines; for various operating levels; and for 3%, 7%, 15, and 30ips. Below is a selection of our most popular models. Your Bradley professional can help you select the right test tapes for your recorders.



1/4" Spot Frequency, 7 1/2 ips, 250nWb/m, NAB	60ML21T204	\$ 57.00
1/4" Spot Frequency, 15ips, 250nWb/m, NAB	60ML21J205	\$ 57.00
1/2" Spot Frequency, 15ips, 250nWb/m, IEC	60ML31J229	\$118.00

Rack Mount Tape Holder

A great way to keep tapes, LP's, and binders handy. 14" tall.
 61MALP \$105.00

Cassette Tapes

Bradley saves you money on the cassette tapes you need. Get the same low price on any quantity up to 100. When ordering 100 tapes of any mix, take an additional 10% off.

Model	Length	Item Number	Price
Maxell XLII	60 min	61MXXL2C60	2.17
Maxell XLII	90 min	61MXXL2C90	2.72
Maxell XLII	100 min	61MXXL2C100	2.99
Maxell MX	60 min	61MXMXC60	2.17
Maxell MX	90 min	61MXMXC90	2.72
Maxell MX	100 min	61MXMXC100	2.99
Scotch AVX	20 min	61SCAVX20	95¢
Scotch AVX	30 min	61SCAVX30	99¢
Scotch AVX	60 min	61SCAVX60	1.19
Scotch AVX	90 min	61SCAVX90	1.62
Scotch AVX	120 min	61SCAVX120	2.19

Tape Types
Maxell XLII - Type II, high bias for music recording.
Maxell MX - Type IV, metal formulation for critical recording.
Scotch AVX - Type I, normal bias for general recording.

Nigel B. Recorder Stand

New from Nigel B. is an incredibly sturdy, easily-moveable recorder stand. Heavy-duty construction and smooth rolling casters are the trademark of this fine stand. Plus, it's cost effective. Mounts units up to 19 rack spaces tall.

60NBPLRS \$275.00



Reel-to-Reel Tape Accessories

Scotch Splicing Tape For 1/4" Tape

#41 1.5mil acetate tape in white. This is a general use splice tape with a non-removable adhesive. 66 feet per roll. 61SC41 **\$3.15**

#67 1.0mil polyester tape in blue. The splice is extremely durable, but is removable. 100 feet per roll. 61SC67 **\$5.50**

#620 1.0mil polyester tape in white. This tape is recommended for high reliability and a permanent bond. 66 feet per roll. 61SC620 **\$4.75**

Call for pricing on larger format splicing tapes.

Scotch Leader Tape For 1/4" Tape

#20 2.5mil uncoated white paper, 7" reel, 1000 feet. 61SC2014 **\$7.15**

#61W 1.5mil white polyester with timing indications each 7½ and 15 inches. 7" reel, 1500 feet. 61SC61W **\$18.00**

#61Y 1.5mil yellow polyester with timing indications each 7½ and 15 inches. 7" reel, 1500 feet. 61SC61Y **\$18.00**

Call for pricing on larger format leader tapes.

Scotch Relabel Tape

Relabel tape covers old, messy labels on your tapes, reels, and boxes. Removes easily. In plastic dispenser, 3/4" x 700'. 61SCRLT **\$1.85**

Empty Reels

Price includes box.

1/4" x 7" plastic 60EMRB7 **\$1.59**
 1/4" x 10½" plastic 60EM10R **\$4.50**
 1/4" x 10½" metal 61SCRNB14 **\$18.75**
 1/4" x 10½" metal 61SCRNB12 **\$22.50**

Scotch RSD-1 Dispenser



This convenient 9½" x 6" desk-top device makes it easy to store and dispense your most used tape accessories. The RSD-1 comes complete with an assortment of seven leader, splicing, and labeling tapes, a brush for razor blade storage, a head cleaner container/ pump assembly, and 100 cotton swabs. 61SCRSD1 **\$165.00**

Editing Supplies

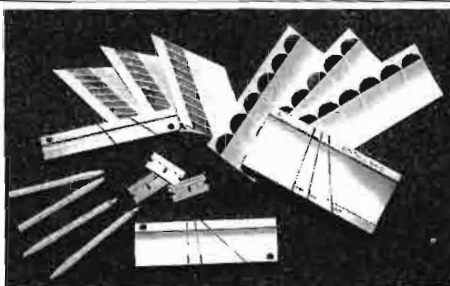

Edital pre-cut polyester splicing tabs make splicing recording tape easy.

200 1/4" tabs 61EDCX1 **\$11.70**
 200 1/2" tabs 61EDCX6 **\$18.00**
 200 1" tabs 61EDCX8 **\$25.00**
 200 cassette tabs 61EDCX3 **\$11.70**

Edital splicing blocks are precision machined anodized aluminum blocks that hold the tape firmly for fine quality splices. Provisions for multitrack and 45° cuts.

1/4" block 61EDS3 **\$28.50**
 1/4" block with 90° and 45° cuts 61EDS390 **\$28.50**

1/4" replacement block for Otari MX-5050B-II 61EDS30T **\$41.00**

1/2" block 61EDS35E **\$34.00**

1" block 61EDS4 **\$76.00**

2" block 61EDSA2 **\$143.00**

Cassette block 61EDS1S **\$26.75**

White grease pencils for marking recording tape. One dozen. 61EDWP1 **\$11.00**

100 single edged razor blades designed for professional splicing. 61EDRB1 **\$12.00**

Intraclean Head Care Products



S-711 Intraclean is the tape head, capstan, and pinch roller cleaning solution used by the top manufacturers. Formulated of halogenated hydrocarbons, S-711 removes the toughest oxide deposits. It contains no alcohol (which can dry out pinch rollers) and its controlled evaporation rate combines maximum cleaning power with fast drying.

Two ounce bottle 60ICS711 **\$5.90**
 Quart can 60ICS711Q **\$22.95**
 Gallon can 60ICS711G **\$42.00**

Bulk Tape Erasers



Audiolab TD-1B

This sturdy tabletop eraser completely erases any magnetic media up to 1/4" thickness on reel sizes up to 10½". Pushbutton switch prevents accidental burnout from leaving unit on, and an automatic thermal protector is included to prevent overheating. Eraser duty cycle is 1 minute on, 3 minutes off.

60AUTD1B MFR LIST **\$132.00**

Also available:

Audiolab TD-4 designed for heavy use. This unit erases up to 14" reels, 1" wide. Adjustable "on" cycle, cooling fan and automatic shut-off for trouble-free operation. Use for audio, video, computer, and cartridge tape.

60AUTD4 MFR LIST **\$895.00**

Audiolab TD-5 for 2" tape.

60AUTD5 MFR LIST **\$1295.00**

Call Bradley for a current price quotation.

Fidelipac 400

Dependable and attractive, this tabletop eraser is an excellent choice for 1/4" reel tape, cassettes, and cartridges.

60FP400 MFR LIST **\$125.00**

Call Bradley for a current price quotation.

Geneva PF-211

The powerful 60Hz magnetic field erases 1/4" reels, cassettes and cartridges. Burn-out resistant design. Case contoured to fit comfortably in the hand.

61NOPF211 **\$54.00**

Cotton cleaning swabs with 6" highly polished maple stick. The tip is tightly wound and mounted with solvent resistant glue to prevent unraveling.

100 swabs 60BBCS100 **\$2.85**
 1000 swabs 60BBCS1000 **\$16.95**

Pump dispenser makes it easy to keep a few ounces of S-711 handy and reduces the chances of spilling. A great way to take advantage of economical quarts and gallons.

60ICPD **\$16.00**

D-511 head demagnetizer reaches into the tightest spaces to remove residual magnetism. Plastic on probe will not damage sensitive head faces. Leaf switch activates with fingertip pressure. Use on reel-to-reel, cassette, and cartridge machines.

60ICD511 **\$19.95**

K-161 head care kit is a special package that includes the CD-511 demagnetizer, a two ounce bottle of S-711, and 100 cotton swabs. Convenience and economy.

60ICK161 **\$24.95**

Nakamichi MR-1 and MR-2 Cassette Recorders

The MR-1 and MR-2 are rich with the kind of innovations that have made Nakamichi a household word. Nakamichi's unique Asymmetrical Dual-Capstan system guides the tape past the tape heads with virtually inaudible scrape flutter and wow artifacts. In fact, the machine actually pushes the cassette's pressure pad away from the head and uses its two differently sized, different speed capstans to diffuse audibly resonant vibrations in the tape path. Coupled with ultra-clean electronics, this transport helps to create the famous Nakamichi 20Hz to 20kHz response ± 3 dB. Each of these professional decks sports features like transport pitch control, adjustable bias tune, 16 segment meters, Dolby B and C noise reduction, wired remote jack, and adjustable headphone amp.

The MR-1 has three fully independent heads, while the MR-2 has two heads. Inputs and outputs on the MR-1 are both balanced (XLR) and unbalanced (1/4" TS), with a convenient pair of balanced (1/4") inputs on the front panel. Audio connections on the MR-2 are unbalanced phono jacks, and its line level outputs are adjustable from -10 dBV to +4 dBm.



MR-1	60NKMR1	<i>MFR LIST</i>	\$995.00
MR-2	60NKMR2	<i>MFR LIST</i>	\$695.00

Accessory:

Wired remote control	60NKRM5	<i>MFR LIST</i>	\$50.00
-----------------------------	---------	-----------------	----------------

Call Bradley for a current price quotation.

Tascam 122 MKII Cassette Recorder

The 122 MKII deserves its title as a broadcast industry standard. Balanced inputs and outputs with XLR connectors, rack mount, 3 tape heads, and micro-processor control add up to professional construction. Dolby HX Pro circuitry and Dolby B and C noise reduction result in superior audio performance. Wow and flutter measure only 0.04% (NAB weighted) and frequency response is 25Hz to 20kHz, ± 3 dB with metal tape and 25Hz to 17kHz with normal tape. Channel separation exceeds 35dB at 1kHz. The real time tape counter is based upon a clock that reads actual record or play time elapsed. Other features include a multiplex filter to improve off air recordings, a two tone test oscillator, and $\pm 12\%$ pitch control.



122 MKII	60TE122MKII	<i>MFR LIST</i>	\$1099.00
-----------------	-------------	-----------------	------------------

Accessory:

Remote control	61TERC71	<i>MFR LIST</i>	\$90.00
-----------------------	----------	-----------------	----------------

Call Bradley for a current price quotation.

Tascam 112R Cassette Recorder

The 112R offers bidirectional, auto-reverse capabilities for professional applications requiring extended record and playback times. To achieve optimum reproduction quality, the tape head is a special 2 channel design that rotates 180° when the tape changes direction. A control system maintains constant tension throughout record or playback of the entire cassette, improving wow and flutter as well as distortion. A 16 pin connector allows remote control, plus multi-deck interfacing for a broad range of applications such as continuous record/play, duplication, or stop-activated deck switchover. The recorder also has pitch control, metal tape capability, Dolby B/C, counter with memory stop, and rack mount.



112R	60TE112R	<i>MFR LIST</i>	\$859.00
-------------	----------	-----------------	-----------------

Accessory:

Remote control	61TERC205K	<i>MFR LIST</i>	\$75.00
-----------------------	------------	-----------------	----------------

Call Bradley for a current price quotation.

Tascam 112 and 112B Cassette Recorders

These light duty, rack mount cassette recorders from Tascam incorporate features such as Dolby HX pro circuitry to enhance high frequency reproduction, $\pm 12\%$ pitch control, Dolby B/C, and metal tape capability. Selecting fast forward or rewind while in the pause mode allows audio to be monitored in fast wind for cueing or reviewing. The digital tape counter and return-to-zero function also assist in locating specific points on the tape. The 112B has XLR balanced inputs and outputs.



112	60TE112	<i>MFR LIST</i>	\$679.00
112B	60TE112B	<i>MFR LIST</i>	\$859.00

Accessory:

Remote control	61TERC71	<i>MFR LIST</i>	\$90.00
-----------------------	----------	-----------------	----------------

Call Bradley for a current price quotation.



Yamaha C-300 Cassette Recorder

The Yamaha C-300 offers every feature one could want in a professional cassette deck. The C-300's versatility starts with dbx, Dolby B and C noise reduction assuring compatibility with any other decks. Additionally, Dolby HX Pro Dynamic Bias monitors the signal level and automatically adjusts the bias for perfect recordings. The deck mounts in three standard rack spaces and offers balanced +4dBm inputs and outputs via XLR connectors (-10dBV phono connectors are also provided). What sets the C-300 apart is its sophisticated closed loop, dual capstan transport with separate motors for reel and capstan drive. It also automatically selects the tape type and indicates it on the display. The four digit linear tape counter and two color, twenty segment florescent level meters are remarkably easy to see at a glance, and optimum record levels are indicated for each tape and noise reduction type. Standard equipment includes a wired remote control for all transport functions. Let Bradley supply you with the cassette deck that combines rugged construction, full features, and great audio.



C-300 60YAC300 MFR LIST \$1095.00

Accessory:

Wireless remote control that adds several features including Random Play, Intro Scan, Record Time Remaining Indicator, and Music Search.

60YARSK12 MFR LIST \$35.00

Call Bradley for a current price quotation.

Dual Cassette Recorders

All of our dual cassette recorders have one deck that records and plays back and one deck that only plays back; normal and twice speed dubbing; Dolby B and C noise reduction; -10dBV inputs and outputs on phono jacks; auto tape selection; and metal tape capability.

The Teac W370C offers continuous playback from deck 2 to deck 1 and is an excellent choice for light duty dubbing. The Tascam 202WR has two auto-reversing transports with continuous playback capabilities. Built for studio use, recordings on the 202WR are enhanced by Dolby HX Pro. The front panel includes a headphone jack.

The Technics RS-TR265 can alternate between its two auto-reversing decks for continuous playback for up to 24 hours. Included are Dolby HX Pro headroom extension and a headphone jack. Play or record can be started when you use an external timer to power up the unit.

Teac W370C	60TEW370	MFR LIST	\$199.00
Tascam 202WR	60TE202WR	MFR LIST	\$329.00
Technics RS-TR265	60TCRSTR265	MFR LIST	\$249.00

Call Bradley for a current price quotation.

Note:

Rack mounting shelves are available for the Teac V285CHX and W370C, the Technics RS-TR265, and the Tascam 102, 103, and 202WR. Shelves are priced at only \$89.00 each; please specify model when ordering.



Tascam/Teac Cassette Recorders

Tascam 103 and 102 Cassette Recorders

These two decks offer Tascam quality at a moderate price. Both the three head 103 and two head 102 feature Dolby B and C noise reduction, Dolby HX Pro headroom extension, a tape counter with run time mode, and automatic tape type sensing. Operators will appreciate the uncluttered front panel with headphone jack and bias fine adjustment. Inputs and outputs are -10dBV on phono jacks. Who could ask for more than Tascam cassette quality on a budget?

103	60TE103	MFR LIST	\$449.00
102	60TE102	MFR LIST	\$299.00

Teac V285CHX Cassette Recorder

This cost effective deck offers both Dolby B and C noise reduction, as well as Dolby HX Pro headroom extension circuitry. A bias fine tuning control, metal tape capability, two color peak program level meters, and one touch recording make this a bargain at any price. Inputs and outputs are -10dBV on phono jacks.

V285CHX	60TEV285	MFR LIST	\$149.00
----------------	----------	----------	-----------------

Call Bradley for a current price quotation.



Technics RS-BR465 Auto-Reverse Cassette Recorder

The two motor drive of the RS-BR465 means fast reverse time and better deck reliability. Dolby B and C noise reductions and Dolby HX Pro headroom extension are all available. Other features include cue and review, auto tape type selector, bias fine adjustment, headphone jack, and MPX filter.

RS-BR465 60TCRSBR465 *MFR LIST* **\$229.00**

Call Bradley for a current price quotation.

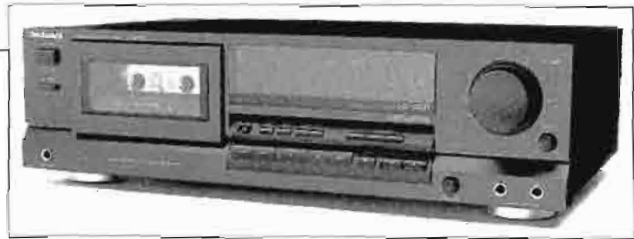

Tascam Cassette Duplicators

The T-2640 is a versatile and economical solution for situations where high capacity systems are just too expensive, but "dubbing decks" just won't do. An 8 to 1 duplication ratio is employed, with one pass duplication of any or all tracks. The master unit makes a single copy, and provides an onboard monitor amp and speaker, ±3% pitch control, master reproduce level metering and adjustment, and an automatic rewind function which the slaves can follow. Up to ten slaves, each creating two copies, can be connected to the master. The system can handle standard or chrome bias and EQ.

Master unit with single slave 60TET2640MS *MFR LIST* **\$2750.00**

Dual slave 60TET26402S *MFR LIST* **\$2500.00**

Call Bradley for a current price quotation.

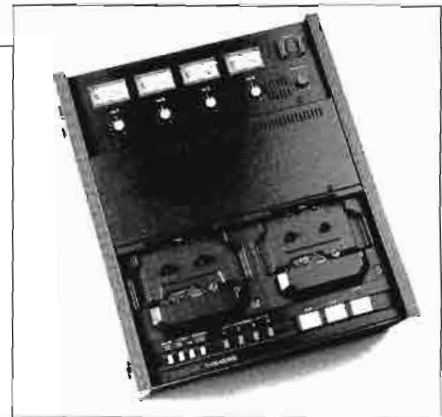

Toa BA-400 Four Cassette Deck

If your attention span outlasts the playback offered by a standard auto-reverse cassette machine, the BA-400 is for you. Using 90 minute cassettes, the BA-400's four transports will provide six hours of endless playback before repeating. The BA-400 will handle playback in one of two ways: each tape can be played, then reversed and played, followed by the next tape in line, or all four A sides can be played, followed by all four B sides. Each transport can be individually removed without interruption of the play cycle. Automatic gain control circuitry assures constant output level and the unit's monaural output is transformer isolated at 600 ohms. For foreground or background music systems, the BA-400 is a remarkably low priced solution.

BA-400 60TOBA400 *MFR LIST* **\$1329.00**

Accessories:

Rack mount kit 60TOYM003 *MFR LIST* **\$26.00**

Spare transport 60TOCU400 *MFR LIST* **\$204.00**

Call Bradley for a current price quotation.



Marantz Portable Cassette Recorders

These rugged and reliable recorders are described in full in our Field Production section.

PMD201 mono, two head 60MR201 **\$228.00**

PMD221 mono, three head 60MR221 **\$272.00**

PMD420 stereo, two head 60MR420 **\$354.00**

PMD430 stereo, three head 60MR430 **\$449.00**

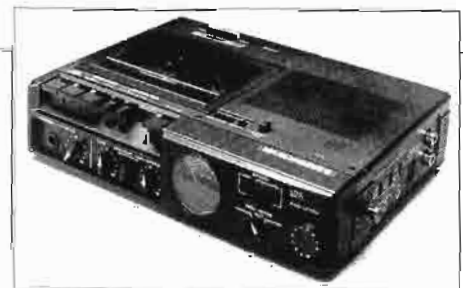

Broadcast Electronics Phase Trak 90 Cart Machines

The Phase Trak 90 provides features unavailable in any other machine. Its automatic phase correction circuit continually monitors and corrects playback phasing. Any cartridge will undergo this automatic correction, regardless of the machine on which it was originally recorded. Audio quality is excellent, with 80dB S/N ratio (using the included Dynaflex noise reduction) and 40Hz to 16kHz, ±2dB frequency response. Automatic level sensing of high/low record levels is provided on carts encoded with foil tabs. Non-repeat lockout and cart-not-cued lockout prevent operator errors, and automatic/manual fast forward provides rapid cueing. All machines come standard with four cue circuits including an FSK decoder which provides an RS-232 compatible data output for automatic logging applications.

Engineers will appreciate the "clean" function, which engages the pinch roller and activates the motor without a cart inserted by depressing STOP and START simultaneously. Modular construction provides easy access for servicing. An advanced cartridge guidance system, Phase Lok V head bracket, and DC servo motor provide exceptional tape handling characteristics. The innovative Phase Trak 90 record/play deck uses a microprocessor assisted automatic tape analysis system to evaluate a new tape and "learn" all of the bias, level, and EQ settings. These settings are then stored in memory for selection. Also included is a built in splice finder and eight frequency test oscillator. A digital timer is standard



on the recorder, synchronized to motor speed for accurate tape timing. An EOM tone can be used to freeze the timer for actual message timing. The timer is an option on the playback only deck.

Stereo playback	60BRPT90PS	MFR LIST	\$2750.00
Stereo record/playback	60BRPT90RPS	MFR LIST	\$4550.00

Note: Your Bradley professional can provide details on rack shelving, mono play units, and other optional accessories for the Phase Trak 90.

Call today for information and a current price quotation.

Broadcast Electronics Dura Trak 90A

Based upon the innovations of BE's Phase Trak 90, the Dura Trak 90A cart machines offer sparkling audio performance to meet your highest expectations. They give you all the features you need most: three cue tones, fast forward, cart-previously-played lockout, pressure roller cleaning mode, DC servo motor, and much more. From the ground up, reliability and ruggedness are built into these machines. Toroidal transformers and CMOS logic reduce heat dissipation, and provide superior noise performance and immunity. Hall-effect switches will operate flawlessly through thousands of operations. A low voltage, current regulated solenoid provides a full 1.25 pounds of tape pull while generating 66% less heat than other machine designs. The Dura Trak 90A gives you all of this at a most affordable price.

BE's attention to detail extends to the instruction manual; a well thought out, detailed, complete manual which includes circuit descriptions, troubleshooting guide, setup procedures, and more. Designed for broadcasting in the 90's, these machines will see you into the next century!



Mono playback only	60BRDT90P	MFR LIST	\$1750.00
Mono record/playback	60BRDT90RP	MFR LIST	\$2600.00
Stereo playback only	60BRDT90PS	MFR LIST	\$1900.00
Stereo record/playback	60BRDT90RPS	MFR LIST	\$2850.00

Call Bradley for a current price quotation.

Broadcast Electronics Splice Trak 90

For optimum performance in any system, every cart needs to be prepared before recording. The cart should be deep erased and the tape splice located and positioned before the start of audio. Employing dual erase heads, the Splice Trak 90 typically provides 85 to 90dB erase depth below the tape saturation point. Its solid state motor control slowly accelerates motor speed after pinch roller engagement for smooth tape handling. Erasure occurs at 27½ ips for quick operation. The splice detector locates splices by sensing minute differences in tape thickness, providing a more accurate method than optical locators. For cooler operation, the motor runs only when erasing and splice-locating are performed. Housed in the same rugged case as the Dura Trak 90 machines, the Splice Trak will complement any studio's appearance.

Splice Trak 90 60BRST90 MFR LIST **\$1150.00**

Call Bradley for a current price quotation.



Broadcast Electronics 2100C Series Cart Machines

The 2100C Series provides excellent economy and value. Standard features of the 2100C include wide band IC opamps with differentially balanced inputs and outputs, two cue tones (1kHz and 150Hz), direct drive transport, air damped solenoid, modular construction, and mono/stereo switching. The Phase Lok head block allows azimuth adjustment that is independent of height and zenith adjustment, a real time saver when aligning heads. Exclusive to the 2100C is a mono/stereo switching system, allowing monaural carts to be played through both channels of the stereo deck when a 150Hz tone is recorded at the beginning of the mono cart. Stereo record machines will also record mono cartridges by summing L+R onto the left channel, and recording a mono encode tone. These features are ideal for facilities where conversion to stereo is in the future. A special version of the 2100C includes a playback amplifier and front panel speaker, providing a self-contained unit for cartridge monitoring.

Note: Your Bradley professional can provide you with details on rack mounting accessories and other options for the full line of BE cart machines.

2100CP mono play.
60BR2100P MFR LIST \$1550.00

2100CRP mono record/play.
60BR2100RP MFR LIST \$2250.00

2100CPS stereo play.
60BR2100PS MFR LIST \$1650.00

2100CRPS stereo record/play.
60BR2100RPS MFR LIST \$2550.00

2100CPA mono play with amp and speaker.
60BR2100PA MFR LIST \$1800.00

Call Bradley for a current price quotation.

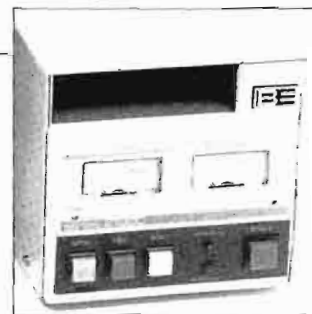

Broadcast Electronics Triple Deck Cart Machines

Broadcast Electronics offers the 5300C and 5400C series of three deck cart machines. Both models incorporate features such as non-repeat lockout, Phase Lok V head assembly for greater operational ease, and a toroidal power transformer for improved performance. Plug-in decks and electronics make servicing quick and easy, and sturdy mechanical construction assures consistent playback quality.

Four machine configurations are available: Mono or stereo, each with or without secondary and tertiary cue tones. Optional record decks for mono or stereo are available, allowing the bottom deck to record as well as play back. Audio outputs are transformer balanced 600 ohms, with up to +10dBm nominal output; record inputs are 50K balanced bridging, transformer coupled.

The 5300C series plays A, AA, and B size carts, and two units may be rack mounted side by side with optional rack shelving. The 5400C is a more compact package that fits three across in a rack but will not play B size carts.

5301C mono play, 1 tone	60BR5301	MFR LIST	\$3800.00
5302C mono play, 3 tones	60BR5302	MFR LIST	\$4000.00
5303C stereo play, 1 tone	60BR5303	MFR LIST	\$4300.00
5304C stereo play, 3 tones	60BR5304	MFR LIST	\$4500.00

5309C mono record amp, includes aux tones
60BR5309 MFR LIST \$1350.00

5310C stereo record amp, includes aux tones
60BR5310 MFR LIST \$1450.00

Accessory:
Audio switcher to automatically delegate audio from the deck that is playing.
60BR5W5F MFR LIST \$250.00

Note: Model 5400C machines have a manufacturer's list prices of \$100.00 higher than 5300C decks. Call for pricing on rack shelves and filler panels. The Model 5500C Five Deck is also available.

Call Bradley for a current price quotation.



Otari CTM-10 Cartridge Machines

The CTM-10 series is available in three packages. In addition to mono record/playback and stereo record/playback machines, a mono/stereo playback only unit with both types of playback heads is available. This latter unit can provide economy and allows easy upgrade from mono to stereo. Unique features include matrix stereo operation for improved, phase stable operation, Dolby HX Pro bias optimization circuitry, three tape speeds, varispeed, and front panel head azimuth adjustment. All units also include a four digit timer, optical splice finder, and a front panel headphone jack. The cue track may be assembled or altered independently of the audio (a real time saver). Also, SMPTE/EBU or FSK logging information may be independently recorded on the cue track for automated bookkeeping or use with synchronizers.

The outboard record module is the same for both mono and stereo use. The record unit includes a five tone test oscillator and standard record level switch. Active balanced inputs and cross-coupled outputs assure the finest recording quality, and separate low frequency reproduce EQ is provided to give full range response control. This feature packed series is compact too, allowing any combination of three machines to be rack mounted side by side. A full

complement of controls, status indicators, and audio/cue metering make these machines versatile and easy to use and maintain. Destined to be a broadcast standard, the CTM-10 is ready now for your station.

CTM-10M mono record/playback unit. Requires CTM-10R for record capabilities.	600CTM10M	MFR LIST	\$2445.00
CTM-10S stereo record/playback unit. Requires CTM-10R for record capabilities.	600CTM10S	MFR LIST	\$2695.00
CTM-10R record electronics.	600CTM10R	MFR LIST	\$1350.00
CTM-10P mono/stereo playback unit	600CTM10P	MFR LIST	\$2195.00

Call Bradley for a current price quotation.



Audi-Cord DL Series Cart Machines

These moderately priced cart machines offer a full range of features, including two cue tones, replay reminder system, manual or automatic output muting, and automatic motor shutoff. Record models provide bias and tone present indicators, automatic record/play meter switching, and front access tone editing. Engineers will appreciate the DL series modular design, plug-in circuit cards, and heavy-duty quality construction. Select single transport models or the exclusive "studio in a box" incorporating two record/play units on one chassis. Record units are also available with an integral timer, and tertiary (third) tone may be added to any deck at the factory or in the field.

Best of all, the DL series has a proven record of reliability. No wonder it's one of our best sellers.

Mono playback only	60ACDLPM	MFR LIST	\$920.00
Stereo playback only	60ACDLPS	MFR LIST	\$1000.00
Mono record/play	60ACDLRM	MFR LIST	\$1290.00
Mono record/play w/timer	60ACDLRM5	MFR LIST	\$1370.00
Stereo record/play	60ACDLRS	MFR LIST	\$1480.00

Call Bradley for a current price quotation.



Stereo record/play w/timer	60ACDLRS5	MFR LIST	\$1560.00
Dual mono record/play	60ACDLDM	MFR LIST	\$2270.00
Dual mono record/play w/timer	60ACDLDM5	MFR LIST	\$2350.00
Dual stereo record/play	60ACDLDS	MFR LIST	\$2630.00
Dual stereo record/play w/timer	60ACDLDS5	MFR LIST	\$2710.00

Accessories:

Tertiary tone record capability	60AC1840007	MFR LIST	\$55.00
Tertiary tone detection	60AC1840009	MFR LIST	\$35.00
Rack shelf assembly	60AC1850006	MFR LIST	\$62.50

Fidelipac Dynamax Cart Machines

The all new CTR90 has been designed to compliment the audiophile quality of today's sophisticated digital audio systems. Superior audio performance is achieved using non-encoding Dynamic Noise Reduction (DNR) on all units. Dolby HX Pro headroom extension circuitry is found on the recorders. Input and output circuitry are active balanced differential and direct coupling is utilized through all possible internal stages. Features include three cue tones and FSK compatibility, fast forward, real time timer, cleaning mode, and a self-aligning long life pinch roller. The recorder front panel has extended scale VU/PPM metering. A high torque DC capstan motor, regulated by sophisticated PPL control circuitry and a precision resolution tachometer, guarantees accurate speed at 3%, 7%, and 15ips. Inputs and outputs are on both XLR and "D" connectors. The CTR90 is designed for easy service and comes with a two year limited warranty.

The established CTR10 and CTR100 series remain available. The CTR10 has fast forward, three cue tones, and an audio switcher/mixer for using multiple machines on a single console input. The CTR100 decks offer the Cartscan optical sensor system which allows inter-mixing different types of carts and activation of external functions such as noise reduction. Other CTR100 standard features include a splice finder; ±30% varispeed; and a 12 tone test generator.

Call Bradley for details and a current price quotation.



CTR91 mono playback	60FPCTR91	MFR LIST	\$1895.00
CTR92 stereo playback	60FPCTR92	MFR LIST	\$2050.00
CTR93 mono record/ playback	60FPCTR93	MFR LIST	\$2790.00
CTR94 stereo record/ playback	60FPCTR94	MFR LIST	\$3050.00
CTR11 mono playback	60FPCTR11	MFR LIST	\$1795.00
CTR12 stereo playback	60FPCTR12	MFR LIST	\$1935.00
CTR13 mono record/ playback	60FPCTR13	MFR LIST	\$2640.00
CTR14 stereo record/ playback	60FPCTR14	MFR LIST	\$2890.00

Note: Dynamax accessories, including rack shelves, calibration tools, and MaxTrax heads, are available. Contact your Bradley professional for CTR100 pricing.

Fidelipac Triple Deck Cart Machines

The Dynamax CTR 30 triple deck has record electronics built into the bottom deck as standard equipment on every unit. The CTR 30 recorder/reproducer utilizes the same premium record and playback electronics as the CTR 10 and many of the same features. The included record electronics makes it possible to record one cartridge while simultaneously playing two others. Rugged, and compact enough to fit three across in a 19" rack.

Mono	60FPCTR33	MFR LIST	\$4250.00
Stereo	60FPCTR34	MFR LIST	\$4600.00



Call Bradley for a current price quotation.

Fidelipac ESD10 Cart Eraser and Splice Finder

Bulk erasing carts is about the last place where you'd expect to find a big research and development effort, but the Fidelipac crew decided that the old fashioned technique of using a huge erase coil under the deck of a splice finder just couldn't produce satisfactory results and could damage the tape pack of your carts. The ESD10 uses two dual gap high current erase heads for absolutely complete erasure of even the newest high coercivity tape formulations. Without the traditional "flux monster" erase coil, tape tension is totally unaffected by the erase process. You can even put the ESD10 right next to an on-air playback deck without worrying about stray flux causing hum on the air. Fidelipac's unique solenoid servo system uses the pinch roller itself to detect the splice, flawlessly, with no adjustments.



ESD10	60FPESD10	MFR LIST	\$1150.00
--------------	-----------	----------	------------------



Henry Fast Trac

Free your studio from dubbing duty. The Fast Trac is specially designed for dubbing from one source to another. The input lets you select from four sources and adjust level and balance. A tone oscillator provides 400Hz and 10kHz tones for system set up. External processing may be inserted, and recording mode (stereo, mono sum, left only, right only) is push button selectable. The monitoring section allows you to listen to your input or the tape monitor of either of two recorders. With the push of a button, you can also check mono sum for compatibility and phase error. There is even a front panel headphone jack.

Fast Trac's unique machine control system provides two timing adjustments for



each input. One sets an audio muting delay for the source. The other sets the start delay of the recorder or source machine. Once these timing circuits are set, a push of the Master Start button creates perfect dubs every time. Let your production studio produce, and use the Fast Trac for dubbing carts.

Fast Trac 60HEFT **MFR LIST \$1195.00**
Call Bradley for a current price quotation.

Cartridges

audiopak Cartridges



Three great lines of cartridges are available from audiopak. The A2, an industry standard, features precise tape guidance and bracing. It is a popular choice for monaural use and is very economical. The AA4 boasts Formula 615 lube tape, which provides superior magnetic properties in a high output, low noise tape. Tight quality control provides you with consistent performance, cart after cart. Also available is the AA3 cartridge, also suitable for stereo use. Factory loads are available in lengths up to 10½ minutes, and Bradley stocks empties, lube tape, and replacement parts for all audiopak cartridges. Call for pricing.

Fidelipac Cartridges

The Dynamax Cobalt Cartridge tops the Fidelipac line. The shell is constructed of high grade plastics for greater strength and accuracy, and the high output, low noise tape provides the extended head room necessary when carting CD's. The recently introduced Audiomax cart uses a high output tape formulation compatible with type AA4 carts. Mastercarts are available for those stereo applications requiring standard operating level, and the Model 300 is an economical choice for mono use. Standard lengths are from 20 seconds to 10½ minutes. Empties, bulk tape, replacement parts, and B and C size carts are also available. Call Bradley for current pricing.



Geneva PF710 Cartridge Zenith/Height Gauge

Provides three adjustment measurements with one gauge: zenith, track height, and tape guide position. Zenith adjustment accuracy exceeds NAB standard; height adjustment checks tape guide and track height to ±0.001" accuracy.

61NOPF710 **\$38.00**

ITC Cart II

Formerly called the Scotchcart II, the ITC Cart II delivers reel-to-reel performance and useful life up to three times greater than ordinary cartridges. Part of the reason is the 219 tape formulation based on high quality mastering tape with

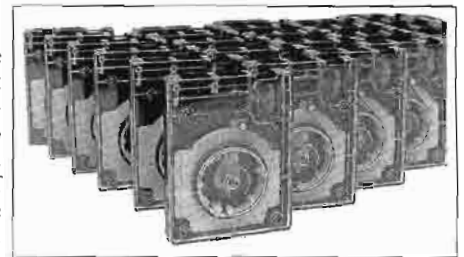

a special polished surface which nearly eliminates oxide shedding and reduces head and guide wear. Concave guides and no pressure pads mean accurate tape guidance, less wear on tape and equipment, and less phase jitter. The life extension can enable adjustment of tape tension on an occasional basis, permitting extended cart life and improved cart to cart consistency. Lengths up to 7½ minutes are available and 219 tape can be purchased on hubs. Call for pricing.

MRL Cartridge Test Tapes

Bradley and MRL team up to provide you with a comprehensive series of cartridge test tapes. We provide these tapes loaded into the audiopak, Fidelipac, or ITC shell that you use at your station to ensure accurate machine setup. The multi-frequency tape is the most widely used for reproduce gain, head azimuth, and frequency response calibration. Also available are single frequency tapes, fast and slow frequency sweeps, pink and white noise, and cue tone test tapes at the same price. A number of custom tapes are available, and all tapes can be provided unloaded. These full track master recordings, with cue track erased, are suitable for mono or stereo players. Specify 160nWb/m or 250nWb/m.



audiopak shell	60MLS211AP	\$74.00
ITC shell	60MLS211SC	\$74.00
Fidelipac 300 shell	60MLS211FP	\$74.00
Fidelipac Mastercart shell	60MLS211MC	\$74.00
Fidelipac Dynamax Cobalt shell	60MLS211DC	\$74.00
Unloaded	60MLS211	\$56.00

See our Furnishing section for our complete selection of cart storage racks.



Orban Paragraphic Equalizers

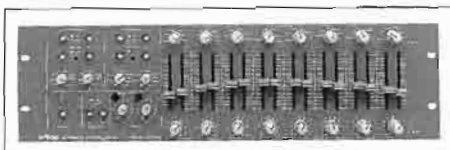

Think of these as tonal first aid kits. The Orban Paragraphics combine the operational ease of a graphic EQ while providing the substantial benefits of parametric units. The user may change the "Q" of each filter with graphic tuning changes. The flexibility of notching is available, plus excellent accuracy and specifications, giving the user the best of both EQ types in a single unit. Tunable low and high pass filters enable it to be used as an electronic crossover with separate output from the main EQ section. Active balanced input, unbalanced output. Connections are on both barrier strips and XLR connectors. Versions with output transformers are available at a slightly higher cost.

- 674A stereo 60OB674A MFR LIST \$1695.00
- 672A mono 60OB672A MFR LIST \$795.00

Call Bradley for a current price quotation.

Audio Logic Graphic Equalizers

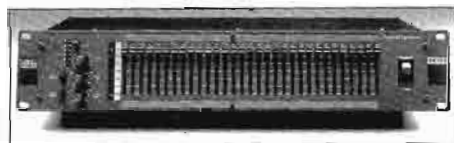

The Audio Logic graphic equalizers are straightforward, professionally oriented devices for studio, permanent installation, and reinforcement applications. The SC31 is a single channel 1/3 octave EQ that provides 12dB of cut and boost at 31 ISO centered bands from 20Hz to 20kHz. Unlike many other EQ's, the SC31 has both high pass and low pass continuously adjustable filters (20Hz to 200Hz and 3.5kHz to 22kHz respectively). The roll-off filters and the graphic section of the EQ can all be independently bypassed via front panel switches. For gain staging, the SC31 has a 12dB cut/boost level control and an LED headroom meter. In order to accommodate a variety of signal types, the input and output connectors are XLR, 1/4" TRS, and barrier strip. The unit's clean signal path boasts a signal to noise ratio of greater than 92dB, response of ±0.5dB, THD of 0.005% at +22dBm at 1kHz, and a maximum output level of +27dBm. The SC215 is a stereo 2/3 octave, 15 band version of the SC31 for stereo operation with a rougher curve.

- SC31 Mono 1/3 Octave EQ
60DOS31 MFR LIST \$550.00
- SC215 Stereo 2/3 Octave EQ
60DOS215 MFR LIST \$565.00

Call Bradley for a current price quotation.

Ashly Graphic Equalizers

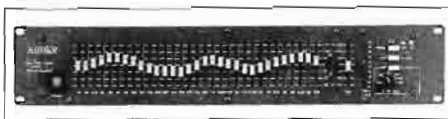

Ashly's graphic equalizers have set the standard by which all other designs are judged. They feature precision Wein-Bridge filters for accurate response and low distortion and a constant "Q" design with low ripple ensures constant bandwidth regardless of fader position. At the detented "flat" setting, the filters actually go off circuit, which electronically bypasses unused filters. The stereo 15 band provides 15dB cut/boost and switchable 40Hz low cut filter. The 31 band models give you a selectable 15dB or 6dB range, a switchable and tunable low cut filter, and 9 position LED level meters. Metal shaft faders with saddle knobs, peak LED meters, and balanced XLR and 1/4" unbalanced inputs and outputs round out additional features.

- GQ215 stereo 15 band
60ASGQ215 MFR LIST \$529.00
- GQ131 single channel 31 band
60ASGQ131 MFR LIST \$599.00
- GQ231 stereo 31 band
60ASGQ231 MFR LIST \$1099.00

Call Bradley for a current price quotation.

Rane GE27 & GE14 Graphic EQ's

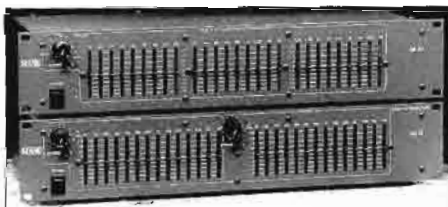

With many equalizers, when you increase the cut or boost you decrease the bandwidth. This can cause filter overlap, loss of resolution, and the need to readjust adjacent sliders. Rane's constant-Q bandpass filters in the GE27 1/3 octave and GE14 2/3 octave graphics eliminate these problems by providing constant bandwidth at all settings. 45mm sliders are accurately calibrated for 15dB cut/12dB boost, and Rane builds in subsonic and ultrasonic filters as well as complete RFI protection. Active balanced input; unbalanced, floating output.

- GE27 1/3 Octave 60RNGE27 MFR LIST \$499.00
- GE14 2/3 Octave 60RNGE14 MFR LIST \$499.00

Also available:

- GE30 30 band, 1/3 octave graphic EQ is capable of acting in either 15dB cut/12dB boost or 20dB cut mode. 50mm sliders.
60RNGE30 MFR LIST \$749.00

Call Bradley for a current price quotation.

DOD Graphic Equalizers



DOD's popular line of graphic equalizers are ruggedly built with simplicity in mind. They provide high quality 12dB cut/boost filters, gain control, a low cut filter, and headroom metering. All are two rack spaces high with both balanced XLR and balanced/unbalanced TRS phone jacks for inputs and outputs. If your budget is tight and standards high, a DOD graphic EQ is the right tool for the job.

- R815C mono 15 band 2/3 octave
60DOR815C MFR LIST \$214.95
- R830C stereo 15 band 2/3 octave
60DOR830C MFR LIST \$349.95
- R831C mono 31 band 1/3 octave
60DOR831C MFR LIST \$344.95
- R231C stereo 31 band 1/3 octave
60DOR231C MFR LIST \$599.95

Call Bradley for a current price quotation.

Rane Micro-Graphic Equalizers



These compact equalizers offer more features and quality than their single rack size might lead you to believe. The 30 band, 1/3 octave ME30 and dual 15 band, 1/3 octave ME15 have a range switch providing a choice of 6dB or 12dB cut/boost, Rane's constant-Q filter design, and many other professional features. Micro size, micro price, macro performance.

- ME30 60RNME30 MFR LIST \$359.00
- ME15 60RNME15 MFR LIST \$369.00

Call Bradley for a current price quotation.

Yamaha Q2031A Graphic EQ



The Q2031A is a highly sophisticated stereo 1/3 octave graphic equalizer. In only two rack spaces, Yamaha puts 31 filters on two channels, each of which also has a sweepable 12dB per octave high pass filter, a 6dB to 12dB cut/boost range switch, a filter bypass, a peak indicator, and channel gain control. Inputs and outputs are both balanced (XLR) and unbalanced (1/4" TS), and the Q2031A operates from -20dBV to +4dBm. Sockets for output transformers are included on the rear panel.

- Q2031A 60YAQ2031 MFR LIST \$695.00

Call Bradley for a current price quotation.



Rane PE 15 Parametric EQ



The five bands of the PE15 each have a four octave frequency sweep range and are individually adjustable for bandwidth from 1.5 octaves down to 0.03 octave. Fully symmetrical filter performance provides 20dB cut and 15dB boost for notch filter type operation. Both balanced and unbalanced inputs and outputs are provided via XLR and 1/4" TRS connectors. This unit flexes some real muscle and packs excellent specs into one rack space.

PE 15 60RNPE15 MFR LIST \$399.00

Also available:

SP 15 parametric EQ is identical in features to the PE15, but special components allow it to achieve a dynamic range of 120dB and THD less than 0.005% @+4dBm, 20Hz to 20kHz. The SP15 has tonal control and sonic transparency that is digital-ready.

SP 15 60RNSP15 MFR LIST \$599.00

Call Bradley for a current price quotation.

Orban 642B Parametric EQ



The Orban 642B parametric equalizer is designed to meet the digital era. In fact, its noise and distortion are better than 16 bit digital. In terms of musicality and power of control, the 642B allows for a wide scope of both creative and corrective EQ. Each channel has four bands of EQ with a maximum boost of 16dB and cut of 40dB. The two channels can be coupled to form a single channel, 8 band equalizer by simply switching to the Cascade mode. The constant "Q" design eliminates interaction between the controls and allows the 642B to be used as an infinite depth notch filter for feedback control or for removal of an undesirable coherent noise like AC hum. To simplify this notch capability, Orban has included a frequency vernier control which varies the center frequency by 10% for quickly tuning to an exact null. EQ in/out switches on each channel and each band simplify comparisons of selected equalization to flat response. The 642B has actively balanced inputs and outputs. Versions with transformer outputs are available at a slightly higher cost.

642B 60OB642B MFR LIST \$1295.00

Also available:

642B/SP limited frequency range unit is intended for speech processing, forensic work, and similar applications. Both bands 1 and 2 are tunable from 80Hz to 1.6kHz while bands 3 and 4 may be tuned from 315Hz to 6.3kHz.

642B/SP 60OB642BSP MFR LIST \$1395.00

Call Bradley for a current price quotation.

t.c. electronic TC 1128 Programmable EQ



The TC 1128 will make broadcasters and production houses sit up and take notice. This 28 band, 1/3 octave EQ has 100 user named memories. The built-in spectrum analyzer provides several references to assist in visualizing settings. Full MIDI capabilities are included, and units may be linked for stereo or multi-channel operation via MIDI link. The SMPTE option permits automatic change of settings at any of 250 time code addresses. These changes can be manually programmed or assigned "on the fly."

The filters provide 12dB boost and cut in 1dB steps or 6dB boost and cut in 0.5dB steps. The TC 1128 boasts a dynamic range greater than 100dB; response of 10Hz to 100kHz, +/-0.05dB; and THD <0.002% @1kHz, 0dBm. Inputs and outputs are balanced XLR, +22dBm maximum.

TC 1128 60TL1128 MFR LIST \$2839.00

Also Available:

TC 1128 w/SMPTE Option
60TL1128S MFR LIST \$3375.00

Call Bradley for a current price quotation.

Programmable Equalizers



When your productions require repeatable EQ settings on multiple channels, a programmable EQ can provide consistency and save you time. Orban's 764A boasts the audio quality of their advanced analog parametrics with a powerful digital control scheme. Units can be combined to handle up to 99 audio channels with 99 equalization settings. Units come with your choice of MIDI, RS-232, or RS-422 interface modules for remote control and automation.

Both Rane and DigiTech offer digitally controlled, analog graphic EQ's that are MIDI controllable. The Rane MPE series has a single channel, 28 band unit; a dual channel, 14 band unit; and a four channel, 7 band unit. DigiTech's MEQ displays the gain position of each filter on a large, front panel LED screen and uses a data wheel to set levels.

Programmable EQ's can make your job easier. Call Bradley today. One of our professionals will help you select the proper unit for your studio.

Bradley accepts Visa, MasterCard, and Discover.

Symetrix SX201 Parametric EQ



The SX201 is a high performance, studio quality parametric EQ/notch filter designed to handle both low level and line level inputs. Three parametric bands provide 30dB cut/15dB boost capability, and overlapping bands cover the entire audio range. Bandwidth is variable for each section from 0.05 to 3.3 octaves for notch filtering or tone shaping. Its balanced line input accepts -10dBV to +8dBm inputs, while its preamplified input accepts low level signals from synthesizers, guitars, or electronic drums. High headroom, active devices are used throughout the unit to deliver the best possible dynamic range. Separate balanced and unbalanced outputs are provided. The SX201 mounts in 1/2 rack width and is a single channel unit. Use two for stereo, or combine it with any other SX series unit for processing versatility.

SX201 60SYSX201 MFR LIST \$259.00

Accessory:

Rack mount kit for one or two SX series units.
60SYRM2 MFR LIST \$39.00

Call Bradley for a current price quotation.

Symetrix SX208 Stereo Compressor/Limiter



The SX208 is a true stereo dynamic range controller offering studio sonic performance and ease of operation at a very economical price. By eliminating redundant controls, the SX208 is a step ahead in usability and reliability. Attack and release times are program controlled. The front panel includes an input gain trim with LED input level indicator; a compression ratio control adjustable from 1:1 to 1:20; a fast/slow response time switch; an output gain control; and an LED gain reduction meter. The SX208 is built around a high performance VCA, enabling a dynamic range in excess of 100dB with typical distortion of less than 0.03%. Inputs and outputs are electronically balanced on 1/4" TRS connectors.

SX208 60SYSX208 MFR LIST \$299.00

Accessory:

Rack mount kit for one or two SX series units.
60SYRM2 MFR LIST \$39.00

Call Bradley for a current price quotation.



Symetrix SX206 Multi-Dynamics Processor



The SX206 really packs it in. This half rack width unit allows you to select one of five different operational modes from the front panel. Use the compressor/limiter to handle those annoying transients. Select the expander to help reduce noise, or punch in the gate to clean up that drum track. The duck mode is perfect for voice overs, and the slave mode is used to track a second SX206 for stereo operation. You can program the SX206 to "wake up" in the mode of your choosing. Input is 1/4" balanced and you have the choice of balanced or unbalanced 1/4" outputs. Add all of this up and you too will believe that good things really do come in small packages!

SX206 60SYSX206 MFR LIST \$329.00

Accessory:

Rack mount kit for one or two SX series units.

60SYRM2 MFR LIST \$39.00

Call Bradley for a current price quotation.

Symetrix 525 Dual Gated Compressor/Limiter



Versatile. That's the best way to describe the Symetrix 525. One rack space gives you two separate channels of gated compression/limiting, which can also be ganged for stereo operation. Utilizing its intelligent control circuitry, the 525 can adapt to whatever sound source you have. It handles quick signal transients as well as it handles slow or small transients. The compressor/limiter and expander/gate employ a soft knee curve to guarantee smooth processing. Input connections are 1/4" balanced while the outputs are 1/4" unbalanced, and side-chain insertion is standard to complete the 525's list of useful features. Whether in broadcast or music, studio or stage, you'll find the Symetrix 525 as versatile as your needs are varied.

525 60SY525 MFR LIST \$539.00

Call Bradley for a current price quotation.

Noise Gates

Noise gates are used to ride gain on multiple microphones, to attenuate music beds in the presence of voiceovers, to create special musical effects, and many other applications. Aphex, Drawmer, Ashly, Valley, and others make a variety of gates. Bradley can find one just right for your application.

ART MDC 2001 Dynamics Processor



The MDC 2001 multi-dynamics processor takes on many tasks that would require a small fortune to accomplish with separate units. A stereo compressor, limiter, de-esser, exciter, expander, and gate are all rolled into this exciting, yet cost effective box. Using a wide dynamic range, low distortion VCA, the processor works without "pumping," "breathing," or signal coloration. The MDC 2001 features individual isolated processing circuits, switchable input/output metering, balanced XLR and 1/4" TRS inputs/outputs, a switchable detector loop, and threshold activation LED's. This unit will be a welcome addition to your processing arsenal.

MDC 2001 60MX520 MFR LIST \$499.00

Call Bradley for a current price quotation.

UREI Compressor/Limiters

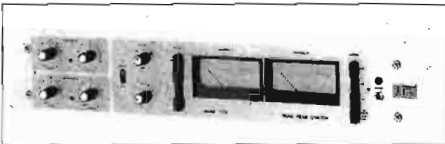

These classic gain control devices are valued throughout the world for their "musical" sound. The LA-4 limiter has a smooth RMS response and the compression ratio is user selectable from 2:1 to 20:1. Two units can be coupled for stereo operation.

The 1178 processor is designed to control absolute peak levels in program material without introducing stereo image shifting. Compression/limiting is push button selected in four steps from 4:1 to 20:1. FET circuitry permits severe limiting without added distortion. Also available is the 1176LN mono version.

LA-4 mono 60URLA4 MFR LIST \$690.00

1178 stereo 60UR1178 MFR LIST \$1290.00

1176LN mono 60UR1176LN MFR LIST \$790.00

Accessories:

Single rack mount for LA-4

60URSR21 MFR LIST \$40.00

Dual rack mount for LA-4

60URDR1 MFR LIST \$40.00

Call Bradley for a current price quotation.

Rane DC24 Dynamic Controller



The DC24 dynamic controller is a two channel compressor, limiter, expander/gate system with unique features. Separate controls for each of the three sections provide wide control range, free from control interaction. An internal crossover allows a single audio channel to be divided into two bands, processed separately, and re-combined into one channel. This crossover may also serve as a dividing network allowing all processing functions for each band. Inputs and outputs are XLR, active balanced, with RFI filtering provided. Individual channel hard wire bypass switches are also provided.

DC24 60RND24 MFR LIST \$549.00

Call Bradley for a current price quotation.

Ashly Compressor/Limiters



Ashly's compressor/limiters offer complete dynamic range control. They provide a variety of high quality features such as trigger circuit patch, variable threshold, variable ratio from 2:1 to infinite:1, variable attack and release, and LED's to indicate up to 20dB of gain reduction.

The CL52E provides two channels of clean, accurate gain reduction in one compact package. This unit can be used as either two independent peak limiter/compressors, or may be strapped for stereo tracking. Precise and independent adjustments make the CL52E ideal for such diverse applications as loudspeaker protection, broadcast limiting or compression, recording, tape to disc transfer, special effects, and more. The CL50E, a single channel version, is also available. Both units rack mount in a single space.

CL52E Dual channel

60ASCL52 MFR LIST \$499.00

CL50E Single channel

60ASCL50 MFR LIST \$299.00

Also Available:

CG85-E Gated Compressor Limiter, single channel.

60ASCG85 MFR LIST \$399.00

Call Bradley for a current price quotation.



Klark-Teknik DN500 Compressor/Limiter/Expander



Klark-Teknik is known for superior design and top quality performance. The two channel DN500 combines a variable knee compressor, independent limiter and clipper, plus a variable ratio expander gate for the ultimate in dynamic control. Front panel controls offer greater flexibility than similar products. The compressor may be operated in automatic or manual attack/release modes, and the expander section features variable ratio. The advanced VCA design yields frequency response of $\pm 0.5\text{dB}$ from 20Hz to 20kHz, distortion less than 0.03% (at +4dBm at 1kHz), and noise below -94dBm unweighted. Side chain inputs are provided for both the compressor and expander sections. Audio inputs are electronically balanced, outputs are low impedance unbalanced, and both are on XLR connectors. Transformer balanced outputs are available at extra cost.

DN500 60KTDN500 *MFR LIST* \$1195.00

Call Bradley for a current price quotation.

Symetrix 511A Noise Reduction



This two channel single ended noise reduction unit is great for a wide variety of audio clean-up jobs. Because the system requires no encoding, the 511A may be placed anywhere in the audio signal chain. How does it work? On high frequencies, when spectral content falls below the user set threshold, the corner frequency of the high frequency filter slides down, reducing bandwidth and the noise it contains. When high frequency content resumes, the filter widens response again. A downward expander reduces low frequency noise by increasing the dynamic range of the signal when below the threshold. As the input level decreases, the expander causes the output to fall by a greater amount, reducing accompanying noise. Applications include studio and remote recording, teleconferencing, public address, and music transcription. Direct coupled inputs and outputs readily connect to balanced or unbalanced equipment at +4dBm or -10dBV nominal levels.

511A 60SY511A *MFR LIST* \$599.00

Call Bradley for a current price quotation.

Crossovers

Modern high power sound systems demand rugged and clean sounding crossovers. Your Bradley professional can help you select the right crossover from Ashly, Rane, and other respected manufacturers. Call today.

Valley 800 Series

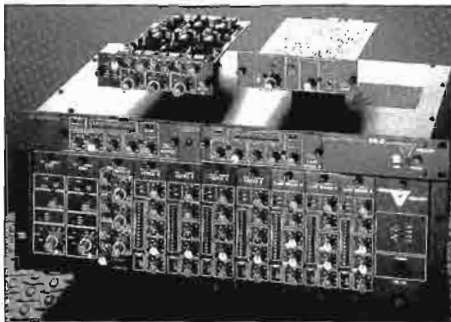

You can install any combination of ten 800 series signal processors in the PR-10A powered vertical card frame. The PR-2A horizontal rack frame holds one or two modules; a front panel switch links gain control voltages for stereo tracking.

PR-10A vertical frame
60VPPR10 *MFR LIST* \$759.00

PR-2A horizontal frame
60VPPR2 *MFR LIST* \$399.00

Modules:

Model 810 Kepex II keyable expander.
60VP810X *MFR LIST* \$499.00

Model 811 Gain Brain II compressor/limiter.
60VP811X *MFR LIST* \$499.00

Model 812 Maxi-Q three band equalizer.
60VP812X *MFR LIST* \$499.00

Model 815 Dynamic Sibilance Processor.
60VP815X *MFR LIST* \$499.00

Model 817 Commander compressor/expander.
60VP817X *MFR LIST* \$499.00

Blank panel 60VPPR800BP *MFR LIST* \$18.00

Note: Each module comes in both a vertical and horizontal version appropriate to the frame in which it is being used.

Call Bradley for a current price quotation.

dbx 160XT Compressor/Limiter



The Model 160XT provides the studio operator, broadcaster, or sound reinforcement specialist with performance and flexibility in a single space rack mount package. The 160XT is the only compressor/limiter that offers you the choice of OverEasy or hard-knee operation, regardless of compression ratio selected. It includes a precision dual display system with an expanded range for continuously monitoring gain reduction as well as input or output levels. Balanced inputs and outputs are on 1/4" TRS and XLR connectors.

160XT 60DB160X *MFR LIST* \$459.00

Call Bradley for a current price quotation.

dbx 166 Gated Compressor/Limiter



The dbx 166 dual channel processor provides a complete range of signal processing. Capable of stereo coupled or dual mono operation, the 166 uses dbx's OverEasy compression with adjustable threshold and ratio adjustable from 1:1 to infinity:1. The effective, easy to use noise gate has an adjustable threshold, fixed attack time, and switchable release rate. The intelligent clipper yields absolute peak limiting. Other features include side chain monitoring, rack mount, hard wire bypass, differential input, and unbalanced high impedance output.

166 60DB166 *MFR LIST* \$599.00

Call Bradley for a current price quotation.

CRL Dynafex Noise Reduction

The Dynafex DX-1 and DX-2 provide up to 30dB of noise reduction without the encode/decode process. Combining dynamic filtering and a unique downward expansion, these are highly effective single ended systems. Both units incorporate an adjustable brilliance feature to enhance upper harmonics. The DX-2, pictured, operates in either stereo or dual mono. The mono DX-1 features additional user control over the downward expansion parameters,

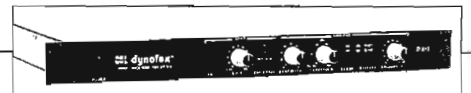

filter bandwidth control, and up to 40dB of output gain. 110dB dynamic range, 0.1% THD typical (ref. 400Hz), 20Hz to 20kHz $\pm 0.5\text{dB}$ response.

DX-1 mono 60CUDX1 *MFR LIST* \$720.00
DX-2 stereo 60CUDX2 *MFR LIST* \$820.00

Call Bradley for a current price quotation.



dbx 900 Series Modular Processors

When multiple channels of processing are required, the dbx 900 series offers quality, versatility, and value. Two powered frame sizes are available.

Frames:

F-900A three rack unit frame with nine active slots. Holds modules vertically. Audio connections are made by barrier strip terminals.

F-900A 60DB900 *MFR LIST* **\$759.00**

FS-900 single rack unit frame with two active slots. Holds modules horizontally. Audio connections are made with XLR connectors.

FS-900 60DBFS900 *MFR LIST* **\$399.00**

Modules:

902 De-esser operates independently of input level so there is no threshold to set. Controls govern the amount of gain reduction as well as the frequency above which excessive high frequency energy activates the circuit.

902 60DB902 *MFR LIST* **\$449.00**

903 Compressor/Limiter with legendary dbx OverEasy compression yields a gradual transition into compression ratios up to infinity:1 (beyond which there are negative ratios available for unusual dynamic reversal effects.) The unit is stereo strappable and includes threshold, ratio, and output controls as well as 10 segment LED gain reduction displays.

903 60DB903 *MFR LIST* **\$449.00**

904 Noise Gate provides smooth downward expansion (gating). Threshold and ratio controls, along with adjustable attack and release rates, permit a high degree of flexibility. The key mode allows gating of one audio source by another.

904 60DB904 *MFR LIST* **\$499.00**

905 Parametric Equalizer with three bands that are adjustable for up to 15dB boost or cut, Q (width), and center frequency. Each band also has a notch cut with an extremely narrow Q and suppression of greater than 50dB. High and low bands also have selectable shelving.

905 60DB905 *MFR LIST* **\$499.00**

911 Type-I has a single channel of simultaneous encode/decode noise reduction. Provides greater than 40dB of noise reduction when used with wide bandwidth media such as analog tape recorders operating at 15 ips.

911 60DB911 *MFR LIST* **\$239.00**

929 Single Ended Noise Reduction contains two channels to process sources that have a continuous, steady-state hiss floor beneath the desired audio. Each channel is controlled by a single quieting knob and can be stereo coupled. No encoding is required, and the 929 offers balanced inputs and outputs.

929 60DB929 *MFR LIST* **\$399.00**

933 Amplifier/Mixer can serve as either a one to three distribution amplifier or a three to one mixer. Each channel has a gain control with a range of -40dB to +20dB, and internal jumpers select balanced or unbalanced inputs and outputs.

933 60DB933 *MFR LIST* **\$349.00**

941A and 942A Type-II noise reduction modules provide more than 40dB of noise reduction for limited bandwidth media such as cart machines, telco lines, and videotape audio tracks. The 941A incorporates two channels of encoding and the 942A has two channels of decoding.

941A Encoder 60DB941 *MFR LIST* **\$259.00**

942A Decoder 60DB942 *MFR LIST* **\$269.00**

Blank panel covers one slot.

60DBBP *MFR LIST* **\$12.00**

Call Bradley for a current price quotation.

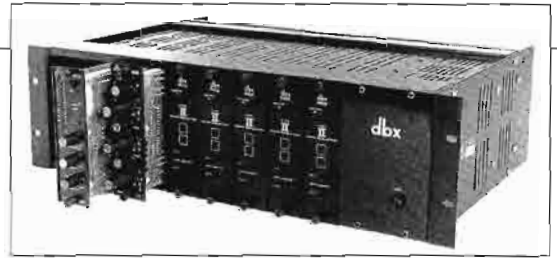

dbx Performer Series

These intelligent signal processors make clean, dynamic audio easier than ever. Each unit is one-half rack width and comes complete with hardware for mounting one or two units in a single rack space. The 140X and 150X have electronically balanced inputs and outputs on 1/4" TRS jacks, and are designed to operate at +4dBu. All other models have unbalanced (1/4" TS) inputs and outputs on their rear panels.

Call Bradley for a current price quotation.

140X and 150X Noise Reduction

Each of these half rack units provides two channels of encoding and two of decoding. The 140X uses dbx standard Type-II noise reduction. It is recommended for cart machines, VTR's, microwave links, land lines, and other media with limited high and low-end frequency response. The 150X, with Type-II noise reduction, is recommended for tape machines of flat response running at 15 ips or greater and other wide bandwidth media. Both units achieve 40dB or more of noise reduction.

140X 60DB140X *MFR LIST* **\$299.00**

150X 60DB150X *MFR LIST* **\$299.00**

163X Compressor/Limiter

Famous dbx OverEasy compression is controlled by a single slide control. An LED display indicates the amount of compression and two units may be strapped for stereo. The 163X can be strapped to a 463X noise gate to provide switch selectable stereo compression or stereo gating. Front panel 1/4" instrument input.

163X 60DB163X *MFR LIST* **\$149.00**

263X De-esser

A simple to use de-esser, the 263X features a single slider for adjusting sibilance reduction, plus a knob for sensitivity to specific sibilance frequencies and a push button for selecting bandwidth. Even if the input levels vary as much as 45dB, patented circuitry delivers the exact de-essing required. Front panel 1/4" mic input.

263X 60DB263X *MFR LIST* **\$149.00**

463X Noise Gate

The 463X has a slide control for setting the amount of OverEasy gating. There is also a knob for adjusting the gate threshold, an LED indicator of downward expansion, and a rear panel key input. It is stereo strappable. Front panel 1/4" instrument input.

463X 60DB463X *MFR LIST* **\$149.00**

563X Silencer

Employing dbx's single ended noise reduction technology, the 563X features single slider action for de-hissing. It is most effective on sources with a continuous, unchanging hiss floor. Stereo strappable. Front panel 1/4" instrument input.

563X 60DB563X *MFR LIST* **\$219.00**



Orban 275A Automatic Stereo Synthesizer



The complete, automatic answer for providing full time stereo output from mixed mono and stereo program material, such as TV stereo. The 275A is designed to be permanently placed in the station's stereo program line. It recognizes true stereo, allowing it to pass unaltered. It also recognizes dual or single channel mono, and automatically switches to synthesis mode via smooth cross-fade. In addition to the automatic mode, the 275A may be controlled by automation or sequencer, or manually set for full time synthesis or bypass modes. The unit also automatically detects and corrects out of phase audio, and provides single ended noise reduction of synthesized stereo audio. Synthesized audio may be selected for two bandwidth configurations, allowing spatial perspective to be matched to program material. To insure full compatibility with mono receivers, the sum of the synthesized outputs is identical to the mono input. Front panel functions are duplicated on an optional remote panel.

275A 60OB275A MFR LIST \$2400.00

Accessory:

Remote control 60OB275ARC MFR LIST \$295.00

Call Bradley for a current price quotation.

Orban 464A Co-operator



The Orban Co-operator provides transparent level control, compression, and high frequency limiting in a powerful, compact, and economical package. The Co-operator achieves transparent audio performance through the use of finely tuned control loops to eliminate dynamic distortions and a clean, Class A VCA to ensure negligible static distortion and noise. A defeatable silence gate effectively inhibits undesirable sudden gain increases. The high frequency limiter has six selectable curves (25 to 150µs) and is followed by a peak clipper for absolute peak protection. Gain compression recovery rate is switch selectable, and a faster compression rate is available for additional transient overshoot protection. Other features include stereo tracking or independent channel operation, LED bar graphs for both gain reduction and peak output level for each channel, balanced and floating inputs and outputs, and hard wire bypass. The Co-operator is ideal protection for broadcast, teleproduction, and recording studio operations, with controls that offer unprecedented flexibility and ease of operation.

464A 60OB464A MFR LIST \$1295.00

Call Bradley for a current price quotation.

Orban 290RX Adaptive Enhancement Processor



The 290RX provides three functions in one unit to restore openness, sparkle, and life to recorded materials. Orban's patented harmonic restoration circuitry recreates desirable even order harmonics without introducing graininess. Spectral restoration circuitry continuously analyzes the spectral density of the input signal, dynamically adding high frequency "air and shimmer" to dull, flat signals. A Spectral Restoration Level control allows the user to control the amount of restoration applied. To complement harmonic and spectral restoration, the RX also includes a single ended noise reduction system incorporating a downward expander and a sliding bandwidth control.

This powerful processor is indispensable for transferring records to tape with better than new sound, for dressing up synthesizer or sampler tracks, or pulling solo tracks out of the mud. Its two channels can be operated independently or as a stereo pair. Each channel provides separate LED metering to display gain reduction, peak headroom, and dynamic filter bandwidth.

290RX 600BRX MFR LIST \$1200.00

Call Bradley for a current price quotation.

Also Available From Orban:

245F Stereo Synthesizer creates a seductive pseudo-stereo effect from any mono source.

245F 60OB245F MFR LIST \$495.00

536A Dynamic Sibilance Controller is a two channel, line level de-esser offering constant de-essing over a 15dB input range without audible side effects.

536A 60OB536A MFR LIST \$695.00

222A Stereo Spatial Enhancer is described in detail in the RF Equipment section.

787A Programmable Mic Processor is described in detail in the Microphones section.

Acrylic security covers to protect your Orban and other rack mounted equipment from fiddling fingers or inquisitive eyes. Includes three sets of screws: thumbscrew, Phillips head, and hex socket head (with wrench). Specify clear, blue translucent, or opaque white.

One space 60OBACC11XX MFR LIST \$55.00

Two space 60OBACC12XX MFR LIST \$60.00

Three space 60OBACC13XX MFR LIST \$60.00

Four space 60OBACC14XX MFR LIST \$60.00

Call Bradley for a current price quotation.

Aphex Type C Aural Exciter



Aural Excitement is a process which restores audio intelligibility and clarity which are lost through repeated recording and dubbing. The Type C Aural Exciter restores detail and clarity to program material by regenerating normal musical overtones present in the original source material. The result is improved presence and apparent loudness without the disadvantages of compression or equalization. At this low price, Aural Excitement fits into any budget. This stereo unit has unbalanced 1/4" connectors and comes with rack mount.

Type C 60APTC MFR LIST \$299.00

Call Bradley for a current price quotation.

Orban Compressor/Limiters



Orban industry standard compressor/limiters utilize the highly successful 8100A FM Optimod circuitry to provide maximum transparency and natural sound, even with the controls set for maximum processing. Broadcast stations, studios, theaters, and sound reinforcement companies prove the quality of these units every day. The 424A stereo and 422A mono "Studio Optimods" are extremely versatile production tools, combining gated compression, limiting, and de-essing in one package. Due to advanced VCA circuitry, level control and de-essing are handled simultaneously, avoiding unwanted processing side effects.

The 414A stereo and 412A mono compressor/limiters offer compression and limiting at a more moderate price. Front panel controls include attack and release times, compression ratio, output attenuator, and both an input attenuator and threshold control. To further simplify their operation, the 414A and 412A maintain approximately constant peak output regardless of attack time and ratio settings. This feature makes readjustment of other operating controls unnecessary and prevents severe clipping in the VCA circuitry.

424A stereo 60OB424A MFR LIST \$1195.00

422A mono 60OB422A MFR LIST \$750.00

414A stereo 60OB414A MFR LIST \$895.00

412A mono 60OB412A MFR LIST \$595.00

Call Bradley for a current price quotation.



Aphex Compellor



The Compellor is one of the most effective gain riding devices available. Its name describes the three functions it performs: compression, leveling, and peak limiting. These three functions operate harmoniously, as the compressor and leveling sidechains are intelligent, program controlled, and interactive. The leveler provides a platform based on long term average audio levels. The compressor, operating from this platform, more readily handles short term gain changes. A process balance control varies the ratio of these two functions. A fast peak limiter follows, to catch any overshoots and hold them to an absolute peak value. A silence gate prevents gain pumping during slow fades by inhibiting release of gain reduction below a preset threshold.

An unusual Compellor feature is a stereo enhancer, which creates a wider stereo image by modulating the gain in each channel based on the difference information (L-R) derived from the inputs. This switchable effect is fully mono compatible. The Compellor is particularly well suited to recording applications, and is widely used as a first stage in broadcast processing. Its unique sound has been described as virtually transparent, while maintaining absolute peak protection and high average levels.

Compellor 60APCMP MFR LIST \$1195.00

Also available:

Monaural version of the Compellor.

60APMCMP MFR LIST \$795.00

Call Bradley for a current price quotation.

Aphex Expressor



Aphex is famous for their transparent dynamics processors. Now comes the Expressor, which allows you to compress and limit your audio to achieve just the right "sound" you seek. Add "punch" or "slap" or "squeeze" with the Expressor's wide control range. The exclusive SPR function adds bass range and power without adding bass level boost. The HFX high frequency expander compensates for dullness often associated with compression and limiting. Input and output circuitry are servo-balanced, and two units may be linked for stereo.

Expressor 60APEXP MFR LIST \$495.00

Call Bradley for a current price quotation.

Aphex Dominator II



The Model 720 Dominator II is a stereo, 3 band peak limiter designed to fit a wide range of audio applications. This latest version boasts a 104dB dynamic range, making it the ideal limiter for use with your digital sources and recorders. Through the use of multiband techniques and Aphex exclusive circuit designs, the audible side effects of the limiting action has been greatly reduced. This means that greater limiting depth is possible, resulting in higher loudness with maintained audio quality. The Dominator is free of hole punching, dullness, and most other sound deterioration normally associated with limiters. As a peak overshoot protection limiter, the Dominator is undetectable in line, while it absolutely prevents peak levels from exceeding a user set output level. Greater audio density, increased "punch," and other effects can be achieved.

Dominator II 60APDOM MFR LIST \$1350.00

Also available:

Model 723 Dominator II has pre-emphasis (either 50 or 75 usec) added before the limiters. A switchable de-emphasis circuit appears after the final limiter. The 723 is designed for use in broadcast, satellite, and transmission links.

723 Dominator II 60AP723 MFR LIST \$1495.00

Call Bradley for a current price quotation.

Aphex Type III Aural Exciter



The Type III is the latest generation, fully professional Aural Exciter loaded with powerful new processing features and improved circuitry. The dual channel Type III adds thrilling new dimensions to Aural Excitement. Noise and distortion are virtually eliminated in the Type III circuitry, while the new special features now make enhancement possible while actually reducing noise from noisy sources. Features new to the Type III include adjustable harmonics mixing, two modes of noise reduction, a Spectral Phase Refractor to compensate for phase smearing caused by the recording process, servo balanced input/output on XLR connectors, the new VCA 1001 chip, and a Null Fill control to let the user set the amount of de-emphasis that surrounds the excited band of frequencies for added presence. Like its predecessors, the Type III still allows front panel or remote control of a relay hard wire bypass, automatic balanced or unbalanced operation, stable and repeatable settings, and LED's indicating all switchable functions. To add sparkle, clarity, intelligibility, openness, and that extra "edge" to recorded or broadcast material, there is no excitement like the kind you'll get from an Aphex Aural Exciter.

Type III 60APIII MFR LIST \$995.00

Call Bradley for a current price quotation.

Eventide Ultra-Harmonizers



Each of the three available Ultra-Harmonizers has an array of pitch shift programs, such as Diatonic Shift which allows you to create musically correct harmony based on your input. The wealth of effects includes reverb programs plus effects such as chorus and flange. The H-3000 provides complete programmable MIDI control of all parameters.

The H-3000B features special presets designed with the broadcaster in mind. You can fly around in a helicopter and give traffic reports without ever leaving the ground. You can call in on a telephone or walkie-talkie without stepping outside. You can . . . well, you get the picture, and so will your listeners.

In addition to the broadcast presets, the H-3000B provides you with automatic stereo audio time compression and expansion. To shorten a spot, just tell the H-3000B how long your piece is, how long you want it to be, and which tape recorder you are using. It does the rest. This unique feature works with almost all frequency controlled reel-to-reel and cart machines.

The H-3000SE adds more delays, reverbs, filters and special effects. Unique SE algorithms are multi-band delays, vocoding, lush reverbs, smoother pitch shifting, an Instant Phaser, and the String Modeler

which adds subtle harmonic ambience.

For the musician or the studio on a budget, there is the H-3000S. It includes a bank of presets by noted guitarist Steve Vai. All models are designed for internal expansion with future hardware and software enhancements

H-3000B 60EVH3000B MFR LIST \$2995.00

H-3000SE 60EVH3000SE MFR LIST \$2995.00

H-3000S 60EVH3000 MFR LIST \$2495.00

Also available:

HS322 Sampler Board installs into any version H3000 with 11.35 seconds of stereo (23.71 seconds mono) of 16 bit, 44.1kHz sampling.

HS322 60EVHS322 MFR LIST \$995.00

BCONKIT adds H-3000B features to your H-3000SE create the ultimate production tool.

BCONKIT 60EVBCON MFR LIST \$600.00

Eventide and Bradley offer a complete set of software updates that enable you to install the features of any H-3000 model into any other.

Call Bradley for a current price quotation.



Yamaha SPX-1000 and SPX-900 Effects Processors

Professional specifications and great effects programs make these a potent pair of processing "Swiss Army Knives." Sophisticated digital reverberation and effects systems provide dozens of preset programs including natural reverberation and early reflections, delay and echo, pitch change and more. The preset programs can be edited, retitled and stored in multiple user defined memories. The SPX-1000 has stereo inputs; the SPX-900 has mono inputs. Both units have stereo outputs and switchable -20dBm and +4dBm line levels (unbalanced) on inputs and outputs. Multiple effects programs allow the SPX processors to provide up to 5 processes simultaneously. The sampling frequency of 44.1kHz and full frequency response from 20Hz to 20kHz result in exceptionally clean, transparent sound. Other features include individual two band parametric EQ and dynamic filter parameters on each effect, full MIDI implementation, and, on the SPX-1000, Yamaha format digital inputs and outputs. These units are among our best sellers because of their exceptional value.



SPX-1000 60YASPX1000 MFR LIST \$1595.00
SPX-900 60YASPX900 MFR LIST \$895.00

Call Bradley for a current price quotation.

Yamaha REV-5 Reverb/Effects Processor

The REV-5 offers rich natural stereo reverb that simulates the acoustic properties of virtually any environment. Improved circuitry provides full bandwidth in the effects channels for exceptionally clean, transparent sound and broader control range. Each effects program provides a 3 band digital EQ in addition to the front panel EQ. Thirty instantly available presets are incorporated in the REV-5, covering a wide variety of plate, spring, hall, and echo programs, as well as delay, ambience, stereo phasing, flanging, chorus, and tremolo effects. An additional 60 programs may be created by the user, stored in memory, and recalled at the touch of a button. The REV-5 also contains nine programs which contain a series of effects, effectively functioning as several REV-5 units in one.



REV-5 60YAREV5 MFR LIST \$1995.00

Call Bradley for a current price quotation.

ART Multiverb III

ART's Multiverb series has carved itself a niche in the effects-processor Hall-Of-Fame. The Multiverb III has over 50 effects, including sampling, stereo chorus and flanging, 21 delay types (with up to 2 full seconds of digital delay), stereo panning, pitch transposing, and 24 reverbs. Up to four effects may be used simultaneously and sequenced in the order of your choice. Full programmability, 200 memory locations, and Performance MIDI keep you in complete control of all parameters. Bandwidth of the Multiverb III is a full 20kHz. Connectors are 1/4" TS.

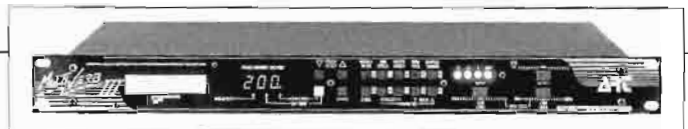

Multiverb III 60MX440 MFR LIST \$529.00

Call Bradley for a current price quotation.

Yamaha DDL3 Digital Delay Line

The new Yamaha DDL3 is a one-in, three-out high performance digital delay for sound reinforcement and other critical delay applications. Each of the three outputs is independently programmable with up to 1300 milliseconds on each. Delay can be adjusted in terms of time (in increments of 0.02ms), or for acoustic purposes, in terms of distance (in increments of 6.8mm or .27"). A digital domain filter system can work in one of three different modes: independent 3 band parametric EQ for each output, a 3 way frequency divider for the three outputs, or a two way divider plus a low pass filter. Complete settings can be stored in 15 memory locations, which can be recalled via the front panel MIDI, or contact closure. Audio specs include a dynamic range of over 100dB and THD less than 0.03% from 20Hz to 20kHz. Inputs and outputs are balanced at +4dBm. This unit is ideal for almost any application where an audio signal being sent to multiple destinations or devices must be synchronized or phase corrected.



DDL3 60YADDL3 MFR LIST \$1195.00

Call Bradley for a current price quotation.



Lexicon 300 Digital Effects System

Lexicon's 300 is one of the world's most versatile audio processors with positively breathtaking digital effects. Reverb elements are randomized, providing a lush reverberation field that substantially reduces coloration. The ambience algorithm enables you to quickly and accurately match a room environment or create a new one. Pitch shifting is precise and clean. When you are creating a digital or analog master, the 300's Stereo Mastering preset allows precision level, balance, and equalization control. Select from dozens of outstanding presets or create your own.

The 300 has a built-in time code reader. An event list can be created containing a time code value and a set-up number to automate processing changes in your film or video. In addition to balanced analog (XLR) inputs and outputs, the 300 supports consumer (S/PDIF) and professional (AES/EBU) digital formats via XLR, coaxial, and optical connections. Total control of all parameters can be accomplished with Lexicon's Dynamic MIDI.

Advanced 64 times oversampling, delta sigma A/D converters and 8 times over-



sampling D/A converters result in sonic purity. The 300 is an excellent choice for all types of audio production, digital mastering, and film and video post production.

300 60LE300 MFR LIST \$4795.00

Also available:

Lexicon PCM-70 includes a wide range of silky smooth reverbs, punchy delays, and a wealth of other effects that make it unique in its price range.

PCM-70 60LEPCM70 MFR LIST \$2295.00

Call Bradley for a current price quotation.

Lexicon LXP Effects Processors

LXP-1

The LXP-1 has 16 different reverb and delay oriented programs, with continuous control over pre-delay and decay on reverbs and recirculation and delay time on delays. Those same parameters can all be addressed through MIDI System Exclusive messages with a controller like the Lexicon MRC-1. Just like its big brother, the PCM-70, many of the LXP-1's parameters can be manipulated in real time through MIDI to create very expressive and dramatic effects. Signal inputs and outputs are stereo on 1/4" TS jacks. It may only be half a rack space wide, but it's 100% Lexicon.

LXP-5

The LXP-5's pallet of effects includes a wide variety of echoes, choruses, flangers, and three octave pitch shifters. These all have the typically lush and detailed sound characteristic of all Lexicon devices, and can be stacked up to five at a time. All effects parameters may be edited and stored from the front panel or manipulated via MIDI System Exclusive messages. Real time MIDI control over parameter values can let the LXP-5 perform many of the dynamic effects seen only in units costing several times as much. MIDI clock signals can even be used to tie delay times in with tempo and timing of synchronized material. When used with the Lexicon MRC-1 MIDI controller, the LXP-5 is easily and quickly maneuvered through its many modes of parameter editing. Signal inputs and outputs are stereo on 1/4" TS jacks. This great little processor could quickly become one of your favorites.

LXP-15

Lexicon designed the LXP-15 multi-effects processor to be extremely easy to operate, and they didn't sacrifice performance or breadth of effects to do it. Every



major function is accessed by a rotary selector switch, a soft adjustment knob, and a soft-key controlled LCD display. It's the type of straightforward approach that lets you put the unit to work within minutes of taking it out of the box. Lexicon's Dynamic MIDI provides the ultimate in remote control, and five inputs are provided for external switches to change parameters without MIDI.

The LXP-15 sounds as good as it feels. The palette of 128 preset effects includes pitch shift, stereo delay, gate, plate, Lexicon's renowned reverb, and many more. Up to 128 user presets may be stored. Connectors are 1/4" TS.



LXP-1 60LELXP1 MFR LIST \$549.00

LXP-5 60LELXP5 MFR LIST \$549.00

Accessory:

Rack shelf for up to two units.

60LEALXPR MFR LIST \$30.00

LXP-15 60LELXP15 MFR LIST \$1050.00

Call Bradley for a current price quotation.

Lexicon MRC-1 MIDI Controller

The MRC-1 from Lexicon is a powerful generic MIDI controller that is well suited to today's increasingly MIDI compatible studio. This device makes the programming and real time control of one or many MIDI devices both simple and more graceful. By transmitting program change commands and very comprehensive System Exclusive messages over any or several MIDI channels, the MRC-1 can serve as not just a remote control for your MIDI system, but as a precise and programmable editor for the software in those devices. Without repatching cables, you can switch channels on the MRC-1 and change the settings on any MIDI device in your studio. Even complex multiple device, multi-

channel global changes are easily whipped up on the fly. This unit's "soft" buttons and faders can be programmed to perform many tasks, and their labels and values appear on a large back lit LCD. Dual MIDI inputs and outputs allow a greater variety of devices to be put to work without the need for a MIDI patcher or combiner.

MRC-1 60LEMRC MFR LIST \$399.00

Call Bradley for a current price quotation.

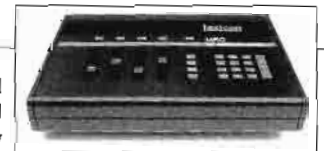

Aphex 124 Audio Level Interface

The Aphex 124 is designed to allow use of -10dBV consumer or semi-pro equipment with +4 or +8dBm professional audio systems. The 124 provides an extremely clean, reliable two way buffer so both systems can operate at maximum performance levels by matching impedances and operating levels. Inputs and outputs are transformerless for wide, flat frequency response and perfect square waves to preserve transients. Hum and noise rejection are very high, while the noise and distortion of the 124 are almost non-existent. A front panel switchable 600 ohm load allows for input line termination.

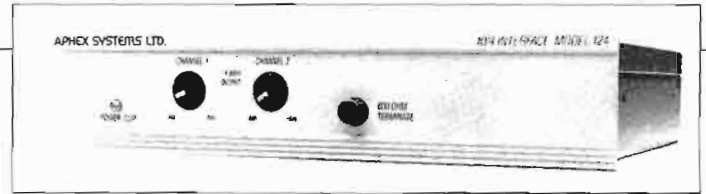

124 60AP124 MFR LIST **\$219.00**

Accessory:

Rack mount kit holds one or two units in a single rack space.
60AP44008 MFR LIST **\$24.95**

Call Bradley for a current price quotation.

ATI L-1000 Precision Dual Line Amp

The L-1000 provides 34dB of gain for solving numerous control room problems. Low noise, high impedance balanced input bridges +24dBm lines with 80dB hum rejection.

Transformer output 60AIL10001 MFR LIST **\$375.00**
Balanced differential outputs 60AIL10002 MFR LIST **\$355.00**

Call Bradley for a current price quotation

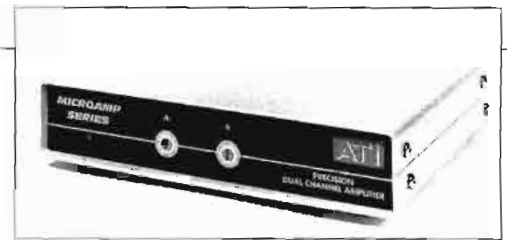

ATI Multiple Amplifier Arrays

These useful arrays have a wide variety of applications. They combine audio gain control, distribution, and mixing in a single rack space enclosure. They are available with four or eight channels of mic-to-line (up to 84dB) or line-to-line (up to 42dB) of amplification. Rear panel jumpers let you create combinations of distribution amplifiers, mono summing networks, or sum and difference networks. Use the amplifiers individually or in sets as a mic distribution amp; headphone amp; consumer, IHF level to 600 ohm, pro level interface; a press box; or a simple mixer. Excellent audio specifications make these arrays an exceptional value.

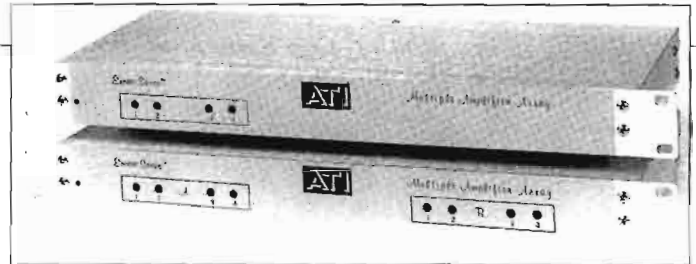

4 channel line amp, transformer outputs
60AIMLA4001 MFR LIST **\$475.00**
4 channel line amp, differential outputs
60AIMLA4002 MFR LIST **\$349.00**
8 channel line amp, transformer outputs
60AIMLA8001 MFR LIST **\$725.00**
8 channel line amp, differential outputs
60AIMLA8002 MFR LIST **\$549.00**

4 channel mic-to-line amp, transformer outputs
60AIMMA4001 MFR LIST **\$525.00**
4 channel mic-to-line amp, differential outputs
60AIMMA4002 MFR LIST **\$399.00**
8 channel mic-to-line amp, transformer outputs
60AIMMA8001 MFR LIST **\$795.00**
8 channel mic-to-line amp, differential outputs
60AIMMA8002 MFR LIST **\$599.00**

Call Bradley for a current price quotation.

ATI Matchmaker

Loading, distortion, hum loops, RF pickup, and high frequency roll off can be problems when interconnecting consumer (unbalanced, IHF) and professional (+4dBm) equipment. The Matchmaker solves these problems with less than 0.02% THD, 20Hz to 20kHz with +0/-0.25dB response, and over 98dB of dynamic range. Exceptional performance including its transformer balanced outputs.

Matchmaker 60AIMM100 MFR LIST **\$269.00**

Call Bradley for a current price quotation.

Accessory:

Rack panel
holds one or two units in a single rack space.
60AI20273 MFR LIST **\$25.00**

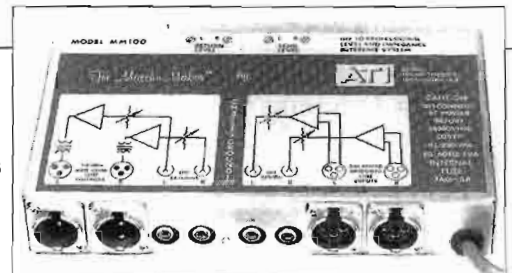

Excalibur IA-1 Interface Amplifier

The IA-1 is used to interface consumer type equipment to equipment requiring professional levels and impedances. This compact two way, stereo unit has excellent audio performance. Frequency response is $\pm 0.2\text{dB}$, DC to 25kHz; THD $< 0.006\%$; and noise $> 90\text{dB}$ below operating level. Barrier strips provide gas-tight connections on the balanced inputs and outputs, with phono jacks on the unbalanced I/O. Input and output levels are adjustable.

IA-1 60EXIA1 \$165.00

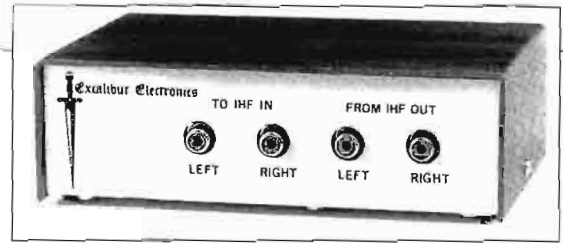

Henry LogiConverter

The LogiConverter is an interface unit that converts TTL/CMOS or "open collector" console outputs to momentary or maintained relay closures. All inputs are opto-isolated and outputs are SPDT relay contacts. Internal DIP switches program the unit to generate momentary or continuous closures. The LogiConverter will control up to four circuits and can provide start only or start/stop outputs from a single input signal.

LogiConverter 60HELC MFR LIST \$195.00



Call Bradley for a current price quotation

Henry Superrelay

Hundreds of engineers have built "little black boxes" of relays to tie up loose ends. Now Henry Engineering does it for you! Superrelay is for use in broadcast station control rooms, A/V systems, or any installation requiring multiple circuit control. It's ideal for controlling the various equipment functions that need to be switched when, for example, a control room mic is turned on.

Superrelay can be controlled by any external momentary or maintained switch, or by CMOS/TTL. It provides six double pole relays used for low-voltage and audio switching, and a switched AC output will directly power up to 300 watts of warning lights (without buzz, pops, or arcs) and make them flash using the built-in, defeatable flasher. Superrelay can also be connected to any dial-up telephone line

for control of equipment when the line rings. Keep an extra one handy for those emergency jobs.

Superrelay 60HESR MFR LIST \$225.00

Call Bradley for a current price quotation.



Henry Matchbox

This is the impedance and level matching device our customers ask for by name. The Matchbox is a four amplifier unit used to interconnect IHF standard (-10dBV) with professional broadcast standard (+4dBm) equipment. Full bi-directional stereo interface is provided. All circuitry is active and direct coupled. Excellent specifications, and convenient AC outlet is provided.

Matchbox 60HEMATCH MFR LIST \$195.00

Call Bradley for a current price quotation.



Oxmoor 4x4 Buffer Amplifier

Sometimes you need to "mix and match" your audio. The 4x4 is a four channel buffer/mixer/distribution amplifier that will let you do it easily. Any of the four inputs can be assigned to any (or all) of the four outputs. Independent mixing busses enable the signals to be mixed before or after the gain stages. All inputs and outputs are XLR and electronically balanced, with output transformers optional. Internal jumpers are used for configuration. Front panel controls provide $\pm 15\text{dB}$ of gain adjustment, and outputs can deliver +24dBm. Response is ruler flat, and the 4x4 has 100dB dynamic range, extremely low distortion, and 80dB of channel separation. The 4x4 can be one of the basic tools of your trade, one that can perform a number of functions flawlessly.



4x4 60OX4X4 MFR LIST \$560.00
4x4T w/output transformers 60OX4X4T MFR LIST \$720.00

Call Bradley for a current price quotation.

Radio Design Labs Stick-On Series

Each Stick-On is only 1/2" x 1 1/2" x 3" and can be attached anywhere with its adhesive backing. All products are designed to work in high RF environments and carry a 3 year limited warranty.

STA-1 Electronic Transformer Pair

A combined electronic line transformer and adjustable 20dB gain amplifier. There are two circuits in each unit for stereo operation. Typical applications include: balanced to unbalanced interface, unbalanced to balanced bridging amp, monaural combiner, stereo splitter, DC amplifier, and Hi-Z amplifier. Includes 24VDC supply.

STA-1 60RDSTA1 *MFR LIST* \$109.95

ST-DA3 Distribution Amplifier

This audio DA allows bridging of any line and driving either low or high impedance, balanced or unbalanced loads. Master gain adjustment provides up to 20dB of gain. Available as a single 1x3, or as a stereo or dual mono 2x6 sharing a single power supply.

ST-DA3 mono 1x3 60RDSTDA3 *MFR LIST* \$99.95

ST-DA3D stereo 2x6 60RDSTDA3D *MFR LIST* \$149.95

Also available:

STM-DA3 feeds one 150 ohm mic signal to three isolated inputs.

STM-DA3 60RDSTMDA3 *MFR LIST* \$109.95

STD-1 Divider/Combiner

A passive, four channel device where any channel may be an input or output. It may be used to branch a 600 ohm line to three inputs, combine stereo signals to a mono input, branch or combine 150 ohm mic signals, or divide a mono signal to apply stereo inputs. Insertion loss is 3dB, isolation between channels 3dB. Accepts maximum signal input of +28dBm at 600 ohms, +22dBV at 150 ohms.

For 150 ohms 60RDSTD1150 *MFR LIST* \$32.95

For 600 ohms 60RDSTD1600 *MFR LIST* \$32.95

For 10k ohms 60RDSTD10K *MFR LIST* \$32.95

STP-1 Attenuator

Useful for reducing input levels to improve headroom, feeding line level signals to a mic input, or lowering line levels to match your system's standard levels. Each STP-1 has two variable modified "H" pads providing up to 85dB attenuation. A 15 turn trim pot allows precise adjustment of levels.

STP-1 60RDSTP1 *MFR LIST* \$32.95

STA-3/STA-6 Power Amplifiers

Available in 3 or 6 watt RMS versions, these Stick-On amps feature a two input mixer combining the inputs equally. The STA-3 provides unbalanced 10k inputs; the STA-6 provides either unbalanced or balanced 10k bridging. Both units drive 8 ohm loads with THD 0.1%. Power supply included.

3 watts 60RDSTA3 *MFR LIST* \$79.95

6 watts 60RDSTA6 *MFR LIST* \$99.95

STM-1/STM-2 Microphone Preamplifiers

These mic preamplifiers provide 150/600 ohm balanced inputs with phantom power available, and two outputs, one 600 ohm balanced, the other 10k unbalanced. Both outputs may be used simultaneously. The STM-1 has a fixed gain of 50dB, while the STM-2 has a variable gain to 65dB. Specifications include 0.05% THD and response 50Hz to 30kHz, ±1dB.

STM-1 60RDSTM1 *MFR LIST* \$79.95

STM-2 60RDSTM2 *MFR LIST* \$109.95

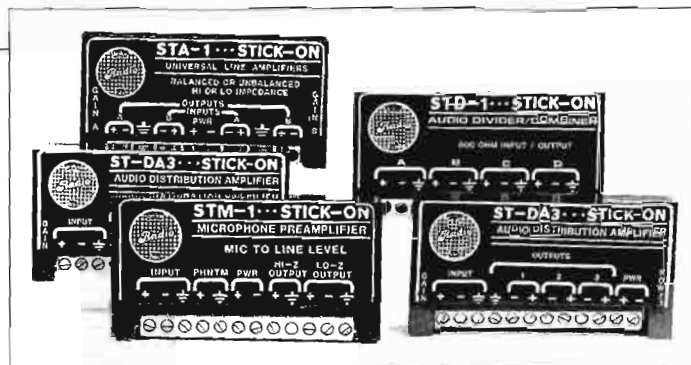

ST-GCA1 Gain Control Amplifier

The ST-GCA1 offers gain reduction (compression) for positive control of peak levels. The slow AGC makes a 20dB level adjustment in 8 seconds. Accepting nearly any input, this Stick-On has both balanced mic and balanced/unbalanced line outputs. THD+N <0.3%. Power supply included.

ST-GCA-1 60RDGCA1 *MFR LIST* \$89.95

ST-VCA1 Voltage Controlled Amplifier

This high quality VCA allows you to remotely control audio with a DC voltage. The built-in mic preamp allows any combination of mic or line level inputs and outputs. A standard 10k linear taper pot (not included) is used to control the audio level using a single pair wire. 24VDC power supply included.

ST-VCA1 60RDVCA1 *MFR LIST* \$84.95

ST-ACR Audio Controlled Relay

Control switching from any audio signal with the ST-ACR. The multiturn sensitivity adjustment covers the range from mic to line level (-40 to +10dBV) for reliable switching. Relay release can be adjusted from 1/2 to 5 seconds. Double-pole, double-throw switching contacts are provided. A "slave" terminal connects Stick-On logic controlled relays (see below) for additional contacts. Maximum switching power is 60W, 125VAC. Power supply included.

ST-ACR 60RDACR *MFR LIST* \$84.95

ST-LCR1/ST-LCR2 Logic Controlled Relays

Both of these units provide double-pole, double-throw switching contacts, open-collector outputs, and an LED indicator of relay closure. The ST-LCR1 provides momentary operation, with the relay remaining on when control signal is applied. The ST-LCR2 is used where pulses must alternately toggle on/off switching. Dual inputs accept control signals between 3.5 and 35VDC. Price includes power supply.

ST-LCR1 momentary action

60RDSTLCR1 *MFR LIST* \$55.95

ST-LCR2 alternate action

60RDSTLCR2 *MFR LIST* \$89.95

Accessory:

STR-19 Rack Mount Kit

Holds up to 12 Stick-Ons behind its 5 1/4" hinged panel.

STR-19 60RDSTR19 *MFR LIST* \$159.00

Bradley accepts Visa, Mastercard, and Discover



Benchmark Interface Modules

These modules are designed to transparently solve your audio interface problems. Amplifier modules boast as much as 200kHz bandwidth, >120dB dynamic range, and THD of 0.0008% @2kHz. Models that require bipolar (± 9 to ± 22 VDC) or single rail (+18 to +44VDC) powering do not include power supplies. AC coupled units may have their gain controls removed.

The DOA differential output amplifiers provide up to 26dB of gain when connecting a semi-pro or consumer (-10dBV) output to a professional (+4dBm) input. The DIA differential input amplifiers are used to retrofit an unbalanced, high impedance input for professional levels and impedance. Specify unity gain, -6dB, or -12dB when ordering DIA's. The MIA's are general purpose microphone preamplifiers available with 40dB or 54dB of gain. To create a zero loss mono sum without compromising stereo crosstalk, use the DOM differential output mixers. All of these interfaces come with an XLR connector; modules without connectors are available at a slightly lower cost.

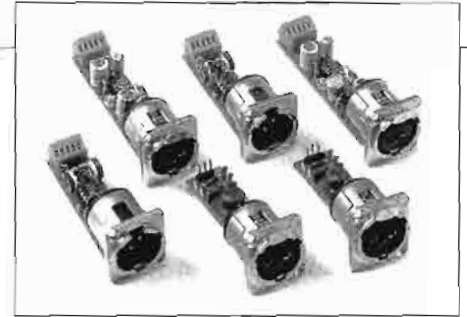

The HPA-1 stereo headphone amp can be used anywhere and will drive nearly any headphone. It includes a TRS connector and potentiometer. The CBO-1 current boost amplifier serves as a line driver for long cable runs.

The LMA-1 is designed to attenuate a balanced line level down to microphone level. The CMF-1 common mode input filter is a useful tool wherever RF interference may be a problem. The LMA-1 and CMF-1 are priced with XLR connectors; models without connectors may be ordered.

Model	Part Number	Description	Powering	MFR LIST
DOA-1	60BMDOA1	Differential output amp	Bipolar	\$55.00
DOA-2	60BMDOA2	Differential output amp	Single rail	55.00
DOA-3	60BMDOA3	Differential output amp; AC coupled	Bipolar	55.00
DIA-1	60BMDIA1XX	Differential input amp (0dB, -6dB, or -12dB)	Bipolar	55.00
DIA-2	60BMDIA2XX	Differential input amp (0dB, -6dB, or -12dB)	Single rail	55.00
MIA-1	60BMMIA1XX	Microphone preamp (40dB or 54dB gain)	Bipolar	55.00
MIA-2	60BMMIA2XX	Microphone preamp (40dB or 54dB gain)	Single rail	55.00

Model	Part Number	Description	Powering	MFR LIST
DOM-1	60BMDOM1	Differential output amp	Bipolar	55.00
DOM-3	60BMDOM3	Differential output amp; AC coupled	Bipolar	55.00
HPA-1	60BMHPA1	Stereo headphone amp	Bipolar	60.00
CBO-1	60BMCBO1	Current boost output amp with XLR	Bipolar	60.00
LMA-1	60BMLMA1	Line to mic level attenuator	Passive	30.00
CMF-1	60BMCMF1	Common mode filter	Passive	40.00

Call Bradley for a current price quotation.

Benchmark IFA Series

Highest sonic purity and outstanding RF immunity are only two of the reasons professionals choose Benchmark for their most critical applications.

All of the amps listed below have 200kHz bandwidth, >120dB dynamic range, and THD of 0.0008% @2kHz. Housings may be rack mounted three across in a single rack unit. Use the PS-1 power supply for a single amp, or the PS-11 for up to four units depending on their individual power requirements.

The IFA-1 Recorder Interface provides complete, two way interface of a stereo semi-pro or consumer (-10dBV) piece of equipment with your +4dBm system. The IFA-3 Output Amplifier provides two channels of one way, IHF-to-professional interface, while the IFA-5 offers four channels of the same function. The IFA-2 Mix Amplifier combines two balanced inputs to a single output, and has up to 20dB of available gain. The IFA-4 Line Amplifier offers 20dB of gain to a stereo signal.

IFA-1 Recorder Interface	60BMIFA1	MFR LIST	\$250.00
IFA-2 Mix Amp	60BMIFA2	MFR LIST	\$200.00
IFA-3 Dual Output Amp	60BMIFA3	MFR LIST	\$165.00
IFA-4 Dual Line Amp	60BMIFA4	MFR LIST	\$225.00
IFA-5 Quad Output Amp	60BMIFA5	MFR LIST	\$250.00

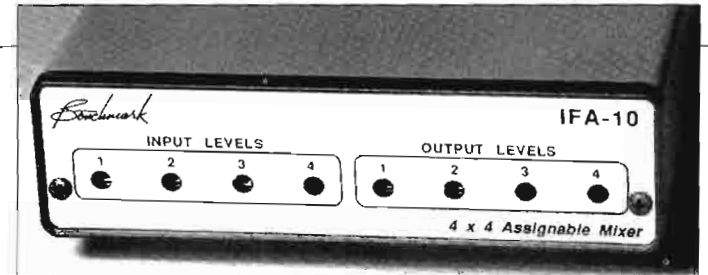

Accessories:

PS-1 Power supply	60BMPS1	MFR LIST	\$30.00
PS-11 Power supply	60BMPS11	MFR LIST	\$200.00
IFA-R Rack mount panel	60BMIFAR	MFR LIST	\$45.00

Call Bradley for a current price quotation.

Excalibur "H" Pads

Don't be a resistor twister! Excalibur's "H" pads are so inexpensive, home brewing is just not worthwhile. 1% metal film resistors assure accurate losses and low noise. A 6-32 threaded stud allows easy mounting. "H" pads are available in 6, 10, 20, and 50dB losses, and with a blank PC board for custom values. "T" pads have been discontinued, but are available at the same price as "H" pads while supplies last. **Minimum order: 10 pads of any mix.**

6dB 600 ohm	60EX6H	\$2.25
10dB 600 ohm	60EX10H	\$2.25
20dB 600 ohm	60EX20H	\$2.25
50dB 600 ohm in/150 ohm out	60EX50H	\$2.25
Blank pad	60EXBH	\$2.10



Whirlwind Accessory Boxes

(1) **Hot Box** active direct box offers advanced electronic circuitry that completely eliminates low-end saturation, produces wide bandwidth with no signal loss, and provides totally transparent, non-colored sound. Includes an LED "on" indicator, a +15dB, Flat, and -40dB switch, a ground-lift switch and can be powered by either two 9V batteries, or 48V phantom power.

Hot Box 61WHHB \$119.00



(2) **IMP 2** is a high quality passive direct box with a ground lift switch and bridged output.

IMP 2 61WHIMP2 \$34.00



(3) **Director** direct box combines road durability with great studio performance. Loading, distortion, and signal loss are eliminated by the TRHL-M transformer and custom circuitry. Mu-metal shielding is included for EM and RF isolation. With no need for a battery or external power, you avoid related problems.

Director 61WHDIR \$62.00



(4) **IMP Splitter** allows a single input to be split into two or three signals. Low impedance.

1x2 61WHMS2 \$45.00

1x3 61WHMS3 \$52.00



(5) **IMP Combiner** combines two low impedance signals into one low impedance output. Features phase reverse switch to match phase or to throw mics out of phase for special effects.

IMP Combiner 61WHCOMB \$48.00



(6) **Phase Reverse** is a handy "back pocket" adaptor for reversing phase on low impedance lines. XLR connectors.

Phase Reverse 61WHPR \$16.80

(7) **IMP Pads** provide fixed attenuation on low impedance lines. XLR connectors.

10dB pad 61WHPAD10 \$20.00

20dB pad 61WHPAD20 \$20.00

30dB pad 61WHPAD30 \$20.00

(8) **Lifter** is a handy in-line device for ground lift at pin-1 on an XLR line.

Lifter 61WHGL \$14.00



Logitek Audio Accessory System

This versatile rack system has found favor with many of our customers who desire efficient and orderly audio distribution installation. The mainframe provides space for an optional redundant power supply module. The Audio Accessory System fills a need in virtually every audio facility.

Mainframe with power supply holds up to ten modules and an optional redundant power supply. 60LTMASMF MFR LIST \$610.00

Redundant Power Supply 60LTMASPS MFR LIST \$265.00

Modules:

MAS-DA 1x6 distribution amp, fixed level outputs, active balanced. Front panel input gain control. 60LTMASDA MFR LIST \$225.00

MAS-ADJ 1x6 distribution amp with six adjustable outputs and front panel input gain control. 60LTMASADJ MFR LIST \$290.00

MAS-LA single channel line amp, Hi-Z balanced input, 600 ohm balanced output. 60LTMASLA MFR LIST \$200.00

MAS-AGC 1x6 distribution amp with AGC to compensate for input level changes. Front panel input gain control and AGC/standby switch. 60LTMASAGC MFR LIST \$320.00

MAS-VCA 1x5 distribution amp with input for remote gain control. 60LTMASVCA MFR LIST \$295.00

MAS-MKE two channel microphone preamp for feeding mics to any other module or other line level devices. 60LTMASMKE MFR LIST \$245.00

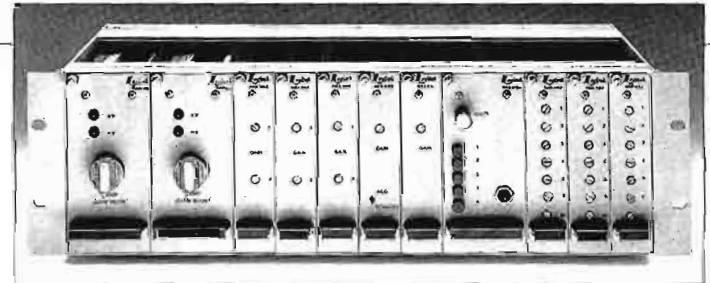

MAS-SCL stereo compressor/limiter module. 60LTMASSCL MFR LIST \$620.00

MAS-MON six watt monitor amp with five selectable line level inputs for monitoring various audio functions. Front panel gain control and input selector. Fills two mainframe positions. 60LTMASMON MFR LIST \$235.00

MAS-OSC two channel, three frequency oscillator module. 60LTMASOSC MFR LIST \$260.00

Blank panels: Available to cover either one or two module positions.
One space 60LTMASBKS MFR LIST \$32.00
Two spaces 60LTMASBKL MFR LIST \$35.00

Call Bradley for a current price quotation.



ATI DA10000 Modular Audio Distribution System

The ATI DA10000 offers flexibility to meet your audio distribution needs in one efficient package. Each 5 1/2" rack holds up to ten amplifier modules and dual redundant power supplies. Designed for maximum reliability and excellent audio.

Rack frame 60AIRM100 MFR LIST \$299.00

Modules:

DA100 basic 1x6 DA with active balanced outputs. Single level control for all outputs and a headphone monitor jack are on the front panel.

60AIDA100 MFR LIST \$250.00

MDA100 is similar to the DA100, and adds an LED bargraph meter and an alarm output that warns of a dead channel.

60AIMDA100 MFR LIST \$335.00

CDA100 adds a gated compressor to the MDA100.

60AICDA100 MFR LIST \$395.00

IDA100 is a 1x6 DA with independent adjustment of all outputs, master level control, and front panel headphone jack.

60AIDA100 MFR LIST \$385.00

MIDA100 is similar to the IDA100, and adds an LED bargraph meter.

60AIMIDA100 MFR LIST \$462.00

MIDA100-1RC is similar to the MIDA100, and adds VCA remote control capabilities.

60AIMIDA100RC MFR LIST \$495.00

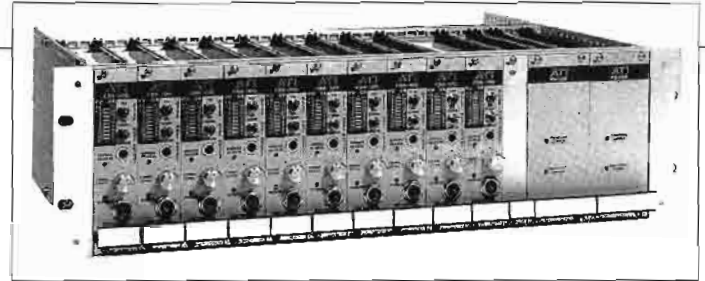

SDA200 stereo 1x4 DA with two inputs into eight active balanced outputs. Switch selection of stereo, L+R/L-R, left only, or right only outputs.

60AISDA200 MFR LIST \$XXX.00

SMDA200 is similar to the SDA200, and adds an LED bargraph meter.

60AISMDA200 MFR LIST \$XXX.00

PS100 power supply. Two may be installed in each frame.

60AIPS100 MFR LIST \$299.00

Blank panel for missing amp module 60AIBP1001 MFR LIST \$25.00

Blank panel for missing power supply 60AIBP1002 MFR LIST \$30.00

Call Bradley for a current price quotation.

ATI Microamp Distribution Amplifiers

These high quality amplifiers form a flexible distribution system by providing individual level adjustments for each output line. Full LED metering with switchable OVU calibration and a headphone amp, switchable to any output, are provided. A full complement of models include transformer or differential outputs at +22dBm, with +30dBm models available at additional cost.

Single 1x8 w/transformer outputs 60AIDA10081 MFR LIST \$895.00

Single 1x8 w/differential outputs 60AIDA10082 MFR LIST \$795.00

Call Bradley for a current price quotation.

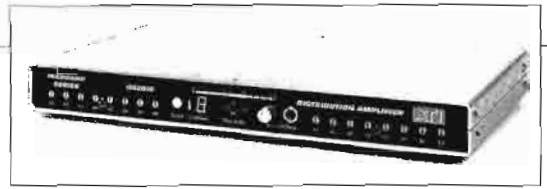

Dual 1x8 w/transformer outputs 60AIDA20161 MFR LIST \$1295.00

Dual 1x8 w/differential outputs 60AIDA20162 MFR LIST \$1045.00

ATI Encore Distribution Amps

Superior audio quality and practical configurations make these DA's from ATI our best sellers. Here is a no frills DA system available in either two or four sections of 1x4. You won't pay for extra outputs you won't use, and these DA's can be configured to grow with your needs. Paralleling inputs allows you to select 1x4, 1x8, 2x8, or 1x16 set-ups as your application requires. The front panel provides for adjustment of individual output amps and has clipping indicators for each output set. Outstanding RFI suppression. 13V/usec slew rate, 60dB CMRR at 60Hz, THD max 0.1%, SMPTE IMD max 0.05%, 30Hz to 20kHz ±0.25dB, S/N -75dB at 20dB gain (ref: +18 out).

Call Bradley for a current price quotation.



DA208 with two 1x4 sections. 60AIDA208 MFR LIST \$339.00

DA416 with four 1x4 sections. 60AIDA416 MFR LIST \$489.00

Aphex 120 Distribution Amplifier

The 120 high performance DA has one input, four outputs with individual, front panel level controls, and one unity gain direct output. The wide, flat frequency response (5Hz to 100kHz, +0, -0.5dB) allows the 120 to be used in the most critical applications, as well as distributing SMPTE time code if necessary. The 120 boasts THD 0.002% at +4dBm and hum and noise better than -90dBm at unity gain. XLR input and output connectors and maximum RF shielding make the 120 suitable for both studio and field use. Compact enough for 2 to fit side by side in the rack.

120 60AP120
MFR LIST \$279.00

Accessory:

Rack mount kit holds one or two units in a single rack space.

60AP44008 MFR LIST \$24.95

Call Bradley for a current price quotation.



Benchmark IFA-9 Distribution Amp

One of the side benefits of digital technologies is that analog keeps getting better. The Benchmark IFA-9 1x6 DA is designed for your very best analog. It has a noise floor of -104dBu at unity gain, typical THD of 0.0009% @2kHz, superior common mode rejection, input and output clipping levels of +27dBu, and virtual immunity from RF interference. The master gain control range of -10 to +20dB is complemented by individual output controls with a range of unity to -20dB. A bi-colored LED indicates signal presence and peak level. External power supply required. Connections are via a 25 pin "D" connector, making the IFA-9 appropriate for permanent installations.

IFA-9 60BMIFA9 MFR LIST \$270.00

Call Bradley for a current price quotation.

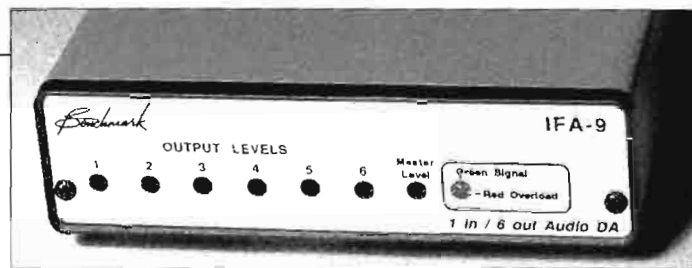

Accessories:

- PS-1 power supply for 1 unit 60BMPS1 MFR LIST \$30.00
- PS-11 power supply for 3 units 60BMPS11 MFR LIST \$200.00
- IFA-R rack panel holds three units 60BMIFAR MFR LIST \$45.00

Gentner Routing Distribution Amplifier

Here is an audio distribution amplifier with a versatile and unique structure. The RDA has eight inputs and twenty-eight outputs. Any input, or any combination of inputs, can be routed to any output. The RDA employs a specially designed input stage which ensures that input signals are delivered at optimum level. Selection of sources to each of the twenty-eight outputs is provided from the front panel via jumpers. Output level controls are provided for each channel. Active balanced outputs provide +4dBm into 600 ohms with 20dB headroom. Input range is -20dBm to +8dBm, balanced bridging. The rear panel connections are barrier strip screw terminals. With the RDA, you'll spend less time on installation, less effort in production, and less money on distribution equipment.



RDA 60GERDA MFR LIST \$1295.00

Call Bradley for a current price quotation.

Henry Engineering U.S.D.A. & MicroMixer

The Universal Summing and Distribution Amplifier has the unique ability to combine, as well as split, audio signals. The U.S.D.A. has two inputs (one stereo pair) and four outputs (two stereo pairs). While it can be used as a conventional 1x4 or 2x4 distribution amp, there is the added ability of either stereo input to be combined into dual mono without affecting the other output. Up to 20dB of gain is available, adjustable individually on each output.

The MicroMixer has four balanced inputs that can be individually assigned to its two balanced outputs. Used alone, or with the U.S.D.A., the MicroMixer is a high quality method of combining stereo to mono, creating mix-minus or monitor busses, and numerous other uses. Each unit's balanced outputs are isolated and will drive a 600 ohm load to +25dBm with less than 0.01% THD. The bridging inputs accept a wide range of both balanced and unbalanced sources.

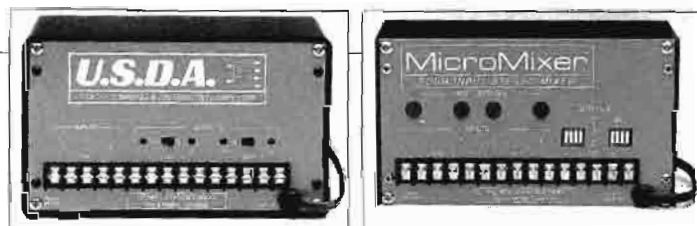

U.S.D.A. 60HEUSDA MFR LIST \$195.00
MicroMixer 60HEMM MFR LIST \$195.00

Call Bradley for a current price quotation.

Hedco TWS-200 Stereo Routing Switcher

The TWS-200 12x1 stereo audio switcher is just one example of Hedco quality and value. Four outputs are provided and the front (local control) panel can be extended to up to 300' from the main unit. This unit boasts input and output levels of up to +24dBm; frequency response of 20Hz to 20kHz, ±0.1dB; THD <0.02%; and S/N >90dB @ +24dBm. It can be coupled with a companion video switcher for audio-follow-video operation.

TWS-200 60HDTWS200 MFR LIST \$595.00

Call Bradley for a current price quotation.

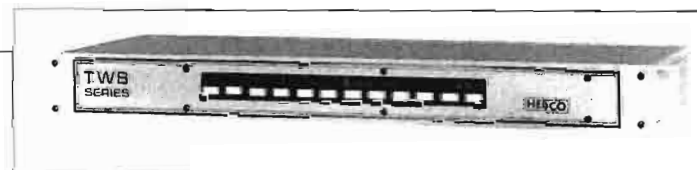

Also available:

Bradley offers the complete Hedco line of audio and video distribution and routing equipment. Regardless of the size or complexity of your project, we can provide the DA's and switchers to meet your needs.



360 Systems AM-16/B Routing Switcher

The AM-16/B Routing Switcher replaces the patch panels and cumbersome switchers in your facility with a compact, easy to use, and expandable system. The AM-16/B is field selected as either a 16 x 16 mono or an 8 x 8 stereo matrix. The companion AM-16/E slave unit operates in parallel to provide additional simultaneous inputs. Combine one master and one slave unit for 16 x 16 stereo operation. Additional slaves may be used for multi-channel applications or for custom matrices.

All inputs and outputs are electronically balanced, and both RS-422 and MIDI remote control facilities are provided. Front panel setups may be stored in any of 100 memory locations, allowing recall of individual patches or complex "salvos." The front panel includes single ended jacks with the input and output of two mono channels or one stereo pair, to serve as test points or for an emergency patch. Specifications are impeccable. Frequency response is $\pm 0.5\text{dB}$, 20Hz to 20kHz. Distortion is less than 0.008% THD+N, DC to 20kHz @ +22dBu. Signal to



noise is 105dB unweighted, and crosstalk is 99dB @ 1kHz and 83dB @ 20kHz, any channel to any other. CMRR is better than 55dB, DC to 20kHz.

The features and performance of the AM-16/B are typically found only in routing switchers costing much more. The AM-16/B can make your job easier at a very economical price.

AM-16/B Switcher	60TH16B	MFR LIST	\$1495.00
AM-16/E Expander	60TH16E	MFR LIST	\$995.00

Call Bradley for a current price quotation.

Conex AS-101 Routing Switcher

The AS-101 is a reasonably priced, high quality 10x1 stereo routing switcher. It is unique in that it can be programmed for "overlap" switching, which prevents the source from turning off until the trailing edge of the command strobe which turns on the new source. Input and output level controls are accessible from the front panel, and inputs may be individually switched for 10K bridging or 600 ohm terminating. Audio connections are via plug in screw clamp terminal blocks, and all audio paths are transformerless balanced. The control format is four level BCD plus strobe, ground, and 12VDC. Several control heads may be operated in parallel. An auxiliary rack mount chassis can accept option boards for relay based machine control, RS-232/422 interface, and a system controller board. The system board allows the AS-101 to function as a simple automation system when

controlled by an inexpensive personal computer.

AS-101 Switcher	
60CNAS101	
MFR LIST	\$895.00

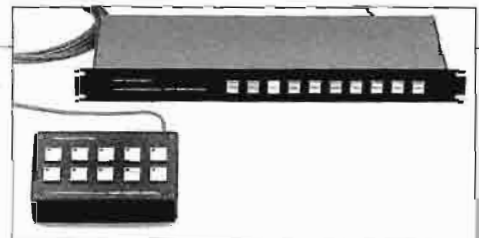

Accessory:

Single unit remote control	60CNAS401	MFR LIST	\$150.00
-----------------------------------	-----------	----------	-----------------

Call Bradley for a current price quotation.

Gentner Audio Program Switchers

The 10A 10x1 stereo and 20A 20x1 mono audio switchers are compact and reliable. They have simple, easy to use front panels with a "deselect" control which disconnects the switcher from all sources for stacking and matrixing. Routing is accomplished with sealed, socket mounted magnetically latching relays driven by a programmable logic array. This makes the switcher insensitive to line voltage glitches or failures. Since the audio path is passive, there is no significant degradation of audio crossing the matrix. Audio and control connections are via standard 25 pair "D" connector.

10A stereo	60GE10A	MFR LIST	\$899.00
20A mono	60GE20A	MFR LIST	\$899.00

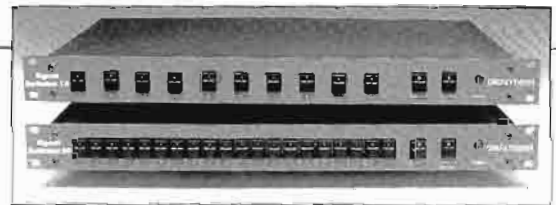

Accessories:

Multipair cables terminating in Flexiblocks or punchblocks are available to simplify installation.

60GEXXXX	MFR LIST	\$49.00
----------	----------	----------------

Call Bradley for a current price quotation.

Logitek Pre-10 And Mon-10 Switchers

Here are two unique items everyone needs. The Pre-10 is a passive 10x2 routing switcher available in mono with XLR connectors or stereo with barrier strip terminations. The Mon-10 is a stereo 10x1 passive switcher with wire-capture terminal blocks and front panel switching to look at Left, Right, L+R, or L-R and feed the selected signal to the VU meter and internal monitor amp. Meter sensitivity may be selected over a 50dB range in 10dB steps. The monitor amp feeds the front panel speaker, a front panel headphone jack and rear panel speaker connections.

Pre-10 mono	60LTPRE10	MFR LIST	\$495.00
Pre-10 stereo	60LTPRE10S	MFR LIST	\$540.00
Mon-10	60LTMON10	MFR LIST	\$845.00

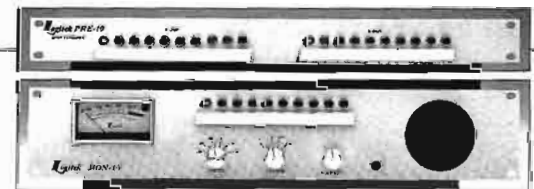

Also available:

MON-S/2 single input meter with monitor speaker designed for mounting in Tektronix type half-racks. 60LTMONS2 MFR LIST **\$730.00**

Call Bradley for a current price quotation.



Oxmoor Mixing Matrix Systems

In just one rack unit, Oxmoor has combined a mixer, routing switcher, and distribution amplifier. The RMX-44 has four inputs and four outputs, while the RMX-62 has six inputs and two outputs. Both have individual, ± 15 dB input adjustments and the ability to send any combination of inputs to any or all outputs. Using the rear panel remote control port, you can use simple switch closures to change the assignments. Frequency response is $+0/-0.3$ dB, 20Hz to 20kHz and distortion and noise are extremely low. Inputs and outputs are electronically balanced (output transformers optional) on XLR connectors. Inputs accept nominal levels from -10 to +8dBm, and maximum output is +24dBm. Use these for combining inputs for zone mixing, for simultaneous stereo and mono feeds from different sources, and numerous other applications.

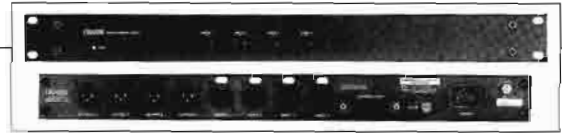

RMX-44	60OXRMX44	MFR LIST	\$920.00
RMX-44T w/transformer outputs	60OXRMX44T	MFR LIST	\$1000.00
RMX-62	60OXRMX62	MFR LIST	\$827.00
RMX-62T w/transformer outputs	60OXRMX62T	MFR LIST	\$867.00

Call Bradley for a current price quotation.

Gentner Versapatch Audio Patch Panels

Versapatch provides the convenience of a high quality, chassis enclosed patch bay with rear panel punch down termination. Each unit has wide designation strips, a rear strain relief bar for cable tie down, and the enclosure provides protection against dust and RFI. Select from Flexiblock or "66" punchblock termination. The Flexiblock permits a high density of connections in a small space and allows the use of stranded wire. A half normalled (i.e. top-row-bridging) version is available. The punchblock version has tip, ring, sleeve, and normals brought out to the punchblock for each jack. Best of all, delivery is fast.

Flexiblock termination normalled at bay	60GEVPAB	MFR LIST	\$659.00
Flexiblock termination normals brought out	60GEVPBO	MFR LIST	\$699.00

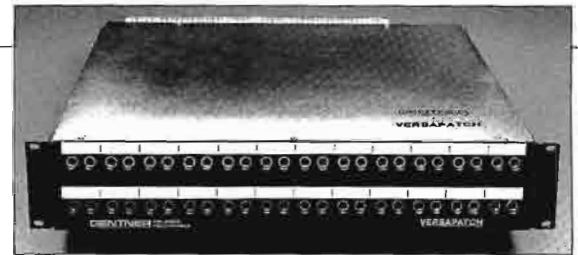

Flexiblock top-row-bridging	60GEVPTRB	MFR LIST	\$659.00
Punchblock termination normalled at bay	60GEVP66	MFR LIST	\$699.00

Call Bradley for a current price quotation.

Gentner Pre-Wired Audio Patch Panels

There is no reason to spend your valuable time wiring patch panels. Gentner and Bradley can provide pre-wired patch panels in virtually any configuration at very affordable prices, and with fast delivery. The examples below are our most frequently purchased models. Call your Bradley professional at 800-732-7665 for assistance in completing your installation on time and on budget.

Model 48DR-TRS-AB-XX has 48 quarter-inch tip-ring-sleeve jacks in two rows with stereo offset spacing, normalled at the bay, with your choice of Flexiblock, punchblock, or "Christmas Tree" termination. Price varies with termination selected and length of cable harness.

Model 48DR-TRS-BO-XX is similar to the above, except the normals brought out to the termination.

Model 48DR-TRS-TRB-XX is similar to the above, except the top row of this normalled bay is bridged to permit monitoring from the bay.

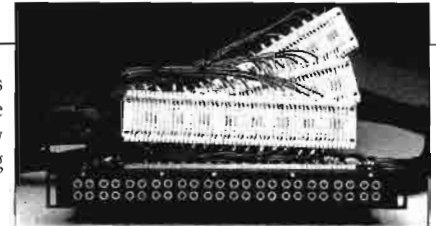

Other patch bays available include 52 quarter-inch jacks in two evenly spaced rows; 78 quarter-inch jacks in three evenly spaced rows; 96 bantam jacks in two offset rows; and single row bays of 24 or 26 quarter-inch jacks. Panels are also available unterminated, with barrier block termination, with EasyTerm or SuperPatch or with any other termination you provide. Cables are bundled to the left as viewed from the rear of the panel.

Gentner SuperPatch

SuperPatch assemblies provide you with a convenient and flexible rack mount termination for your wiring projects. All models have a fixed, rack mounted aluminum panel to make punchdown connections fast and easy. SuperPatch benefits include high wiring density, ample room for cable dressing, and low cost.

SuperPatch 1 uses one row of Flexiblocks. It has 160 terminals with 2 slots per terminal. Recommended for stranded or solid wire. 2 rack units high.

60GESP1	MFR LIST	\$109.00
---------	----------	-----------------

SuperPatch 2 is similar to above, but with 2 rows or Flexiblocks in 3 rack units.

60GESP2	MFR LIST	\$139.00
---------	----------	-----------------

SuperPatch 3 uses a S66B3-75 "66" block. It has 150 terminals with 2 slots per terminal. Recommended for solid wire. 3 rack units high.

60GESP3	MFR LIST	\$99.00
---------	----------	----------------

Call Bradley for a current price quotation.

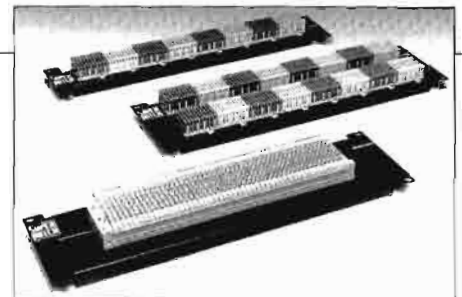

ADC Pro Patch MarkII

From every angle, the Pro Patch MarkII is designed to save you work and time. The front panel designation strips are neat and convenient. The rear panel QCP terminations afford fast, flexible, and reliable installation, and the cable support bar takes the strain off cables and terminations. Both front and back panels remove easily for service without taking the panel out of the rack. The fully enclosed chassis protects (and hides) the internal wiring.

The Standard Pro Patch is a 2x24 array of 1/4" jacks with even spacing. They are available in one or two rack space high chassis, with the two rack height version in 14" or 18" depths. The Stereo Pro Patch has the jacks grouped in pairs and is two rack spaces high. Bantam Pro Patches come as a single row, one rack space, 48 tie line bay and a dual row, two space bay with normals strapped at the jacks.

Also available:

Your Bradley professional can help you select from among the full line of ADC video products. These include Video Pro Patch MarkII, the C.A.P.S. Component Analog Patching System, video patch panels, and an RS-422 patching system. Ask about V.A.M.P., the Video Audio Modular Patchbay which allows you to mix video and audio patching in the same bay.

Call Bradley for a current price quotation.

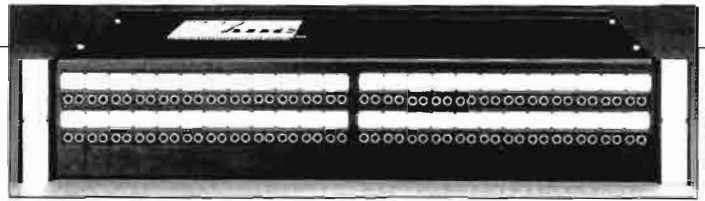

- Standard Pro Patch MarkII with normals brought out.
60ADPPAXXNO MFR LIST \$799.00
- Standard Pro Patch MarkII with normals strapped.
60ADPPAXXNS MFR LIST \$652.00
- Stereo Pro Patch MarkII with normals brought out.
60ADPPSXXXNO MFR LIST \$859.00
- Stereo Pro Patch MarkII with normals strapped.
60ADPPSXXXNS MFR LIST \$705.00
- Bantam Pro Patch MarkII, 48 tie line bay.
60ADPPB114 MFR LIST \$687.00
- Bantam Pro Patch MarkII with normals strapped.
60ADPPB314NS MFR LIST \$1111.00

ADC Ultra Patch Panels

Ultra Patches use ADC's QCP termination for gas tight connections using stranded or solid cable of 22, 24, or 26 gauge. The plastic module surrounding the split cylinder provides excellent strain relief and is color coded to save time and minimize errors. Wires can be easily removed from the QCP cylinder without special tools, and re-insertion can be performed at least 100 times. Panels listed bring normal connections out; panels for normalizing at the jackfield are also available.

- UP-3NMKII terminates a 48 point TRS patchbay.
60ADUP3NMKII MFR LIST \$144.00
- UP-96NMKII terminates a 96 point TRS patchbay.
60ADUP96NMKII MFR LIST \$242.00

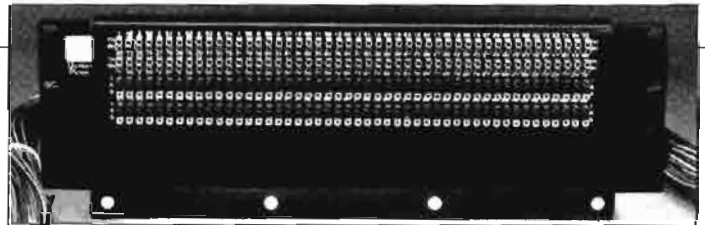

- QB-2 spring loaded impact tool. 60ADQB2 MFR LIST \$70.00
 - Replacement blade for QB-2. 60ADQ904 MFR LIST \$25.00
 - Manual punch tool for Ultra Patch. 60ADQ115 MFR LIST \$20.00
- Call Bradley for a current price quotation.

ADC BJF MarkII Pre-Wired Patchbays

ADC BJF MKII Patchbays are available in several convenient configurations. All feature top covers on the chassis to protect your jacks, removable front panel, and secure cabling and connections. Designation strips are included.

Price varies with configuration and harness length. Contact Bradley by phone or fax for complete details.

- BJF100 Series** has two rows of 24 1/4" jacks in a single rack height chassis. Available with normals brought out or strapped, with Ultra Patch termination or unterminated.
- BJF200 Series** is similar to above in a two rack space chassis with larger designation strips.
- BJF300 Series** has two rows of 48 bantam jacks in a single rack height chassis.

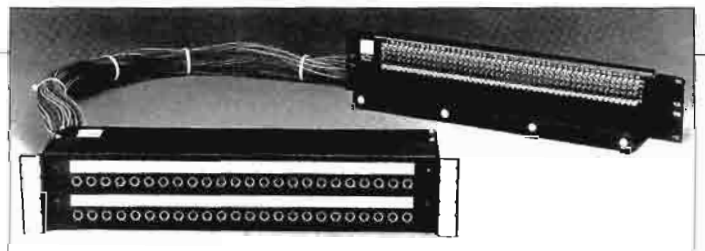

Also available:

Patch Kits are BJF MKII bays designed for the do-it-yourselfer. Each patch kit comes fully assembled, and Bradley can provide you with the cabling and terminations you'll need.

ADC I.C.O.N.

The Integrated Cable Organization Network is engineered for broadcast, production, recording, and professional audio applications. The I.C.O.N. is used as the central audio termination and distribution point. Both rack mount and wall

mount systems use ADC's QCP punch down contacts. Whether you are building a network hub or a single studio, I.C.O.N. is a system you should consider. Rack mounting video I.C.O.N. panels are also available.



Patch Panels and Accessories

Bradley is your one-stop source for patch panels, patch cords, punch blocks, and punch tools. These items can mean the difference between pain and pleasure when it comes to wiring and operating your facility. Let us make your job easier with the widest assortment of products from ADC, Gentner, and others.

ADC Longframe (1/4") Patch Panels

- PJ396** panel with 26 1/4" TRS jacks in one row. One rack space high.
 60ADPJ393 *MFR LIST* **\$99.58**
- PJ390** panel with 52 1/4" TRS jacks in two rows. One rack space high.
 60ADPJ390 *MFR LIST* **\$161.23**

ADC Bantam Patch Panel

- PJ739** panel with 96 bantam jacks in two rows. One rack space high.
 60ADPJ739 *MFR LIST* **\$239.96**

ADC Patch Cords

Pro Patch cords feature nickel plated plugs that are molded directly into the patch cord. They are available in red, green, blue, and black. Standard patch cords are available in any quantity.

Format	Length	Pro Patch Cord	Standard Cord
1/4" Single	24"	60ADXX2 \$24.95	60ADPJ82 \$18.92
1/4" Single	36"	60ADXX3 \$25.70	60ADPJ83 \$19.59
1/4" Single	48"	60ADXX4 \$26.45	60ADPJ84 \$20.35
1/4" Single	72"	60ADXX6 \$28.00	60ADPJ86 \$21.82
1/4" Dual	24"	60ADXX22 \$44.00	60ADPJ172 \$37.97
1/4" Dual	36"	60ADXX33 \$45.00	60ADPJ173 \$38.32
1/4" Dual	48"	60ADXX44 \$46.00	60ADPJ174 \$38.51
1/4" Dual	72"	60ADXX66 \$48.00	60ADPJ176 \$40.00
Bantam Single	24"	60ADXX2B \$21.95	60ADPJ714 \$10.71
Bantam Single	36"	60ADXX3B \$22.70	60ADPJ716 \$11.12
Bantam Single	48"	60ADXX4B \$23.45	60ADPJ718 \$11.52
Bantam Single	72"	60ADXX6B \$26.00	60ADPJ722 \$12.37
Bantam Dual	24"	60ADXX22B \$44.00	60ADPJ764 \$16.06
Bantam Dual	36"	60ADXX32B \$45.00	60ADPJ766 \$17.42
Bantam Dual	48"	60ADXX42B \$46.00	60ADPJ768 \$18.12
Bantam Dual	72"	60ADXX62B \$48.00	60ADPJ772 \$19.49

- ADC Patchcord Holder** hangs up to 75 cords vertically. Rack or wall mounted.
 60ADPPH *MFR LIST* **\$33.00**

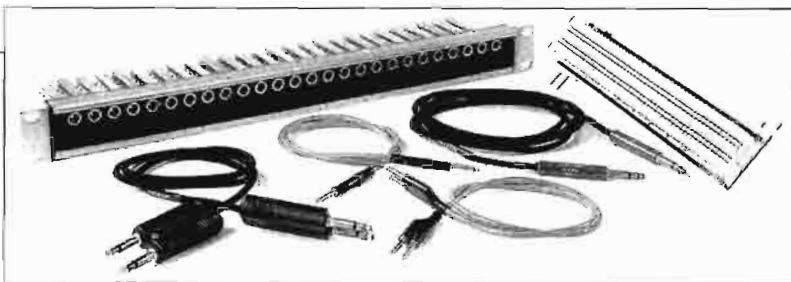

Gentner Flexiblocks and Accessories

Designed to accept 22 AWG stranded audio wire in common use among broadcasters and studios, as well as 24 AWG solid wire. Flexiblock is slightly smaller than a "66" block and accepts two wires per slot, allowing a greater wiring density in less space.

- FB-1 Flexiblock** with 100 terminals in two columns of 50, two connection slots per terminal.
 60GEFB100 *MFR LIST* **\$29.00**
- Mounting bracket** for FB-1.
 60GEFB89 *MFR LIST* **\$3.62**
- FB-10 Miniblock** with 20 terminals in two columns of 10, two connection slots per terminal.
 60GEFB10 *MFR LIST* **\$7.69**
- Bridging clips** for Flexiblocks, bag of 50.
 60GE576800004 *MFR LIST* **\$3.50**
- Flexitool punch tool** for Flexiblock.
 60GEFB714 *MFR LIST* **\$63.79**
- Replacement blade** for Flexitool.
 60GE652081002 *MFR LIST* **\$17.05**

Gentner "66" Punch Blocks and Accessories

This termination is a favorite among many professionals.

- S66B3-50** punch block with 50 terminals in two columns of 25, two connections per terminal.
 60GE66B350 *MFR LIST* **\$21.99**
- S66B3-75** punch block with 50 terminals in two columns of 25, three connections per terminal.
 60GE66B375 *MFR LIST* **\$21.99**
- Mounting bracket** for "66" blocks.
 60GE577066060 *MFR LIST* **\$5.16**
- Plastic cover** for "66" blocks.
 60GE577066006 *MFR LIST* **\$3.62**
- Bridging clips** for "66" blocks, bag of 50.
 60GE576800001 *MFR LIST* **\$3.50**
- Punch tool** for "66" blocks.
 60GED1714 *MFR LIST* **\$63.95**
- Replacement blade** for punch tool.
 60GE652001002 *MFR LIST* **\$17.05**

Call Bradley for a current price quotation.

Furman PB Series Patch Bays

Sturdily housed in a heavy gauge, one rack space steel chassis, the PB series patch fields come in three forty point configurations. All models are fully assembled with standard 1/4" phone jacks with either tip-sleeve (TS) or tip-ring-sleeve (TRS) front and rear, or with 1/4" TS in front and RCA-type phono jacks in the rear. Top to bottom normalization is standard on all models. A normal may be easily defeated by snipping a wire on that pair's circuit board. Don't spend unnecessary hours slaving over a "you-do-the-work" bay when Furman lets you "be normal" at a very reasonable price.

- TS back to TS front** 60FUPB40P *MFR LIST* **\$165.00**
- TRS back to TRS front** 60FUPB40T *MFR LIST* **\$180.00**
- Phono back to TS front** 60FUPB40R *MFR LIST* **\$155.00**

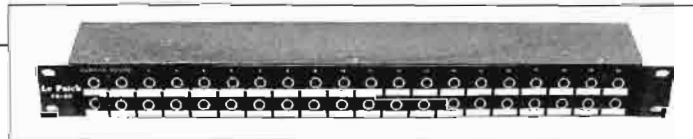

Accessories:

- Patch cords are 30" long and come in packs of 10.
- Patch-P 1/4" TS connectors** 60FUPATCHP *MFR LIST* **\$18.00**
- Patch-R phono connectors** 60FUPATCHR *MFR LIST* **\$18.00**
- Patch-T 1/4" TRS connectors** 60FUPATCHT *MFR LIST* **\$22.00**
- Call Bradley for a current price quotation.



Tascam Eight Channel Snakes

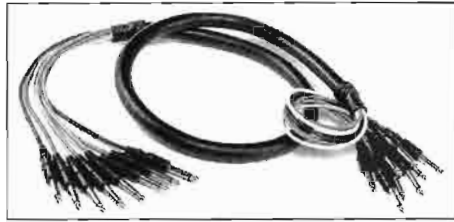

Why drive yourself crazy wiring your multi-track to your console? Tascam has done the work for you, and Bradley delivers these snakes quickly and at low prices. Eight circuits per snake.

Connectors	Length	Part #	Price
Male phono to male phono	5'	61TETC805R	\$30.00
Male phono to male phono	10'	61TETC810R	41.00
Male phono to male phono	20'	61TETC820R	63.00
Male 1/4" TS to male 1/4" TS	5'	61TETC805PP	39.00
Male 1/4" TS to male 1/4" TS	10'	61TETC810PP	50.00
Male 1/4" TS to male phono	5'	61TETC805RP	34.00
Male 1/4" TS to male phono	10'	61TETC810RP	45.00
Male XLR to female XLR	10'	61TETC810X	130.00
Male phono to female XLR	10'	61TETC810XR	95.00
Male phono to male XLR	10'	61TETC810XMR	99.00

Also available:

Whirlwind and ProCo fully professional multitrack wiring systems. Examples are described in our field production section. Call or fax for complete details on the custom snake you need.

Bradley Assembled Mic Cables



You need them, and Bradley's got them. Our own high quality mic cables, using Neutrik XLR connectors, come in 25' and 50' lengths.

25' cable	61WHMKS20	\$14.50
50' cable	61WHMKS50	\$22.00

Bradley Bulk Mic Cable

Our low impedance mic cable is rugged and reliable. Get as much as you want or as little as you need. 60AT8300 **34¢ per foot**

Gotham CT-1 Cable Ties



Reusable plastic tie great for keeping cables neatly hanked. Cables can also be hung. Packaged in a bag of 50. 61NECT1 **\$19.00**

Tascam Cables

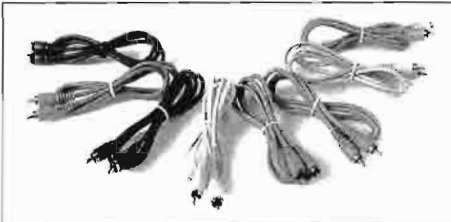

Pro Series Single Cables

With male phono (RCA) connectors.

Length	Part #	Price
5'	61TETC105	\$5.00
10'	61TETC110	7.20
20'	61TETC120	12.40

Pro Series Dual Cables

With male phono (RCA) connectors.

Length	Part #	Price
5'	61TETC205	\$9.70
10'	61TETC210	15.75
20'	61TETC220	26.00

Standard Series Cable Kits

Eight, single cables with phono connectors.

Length	Part #	Price
6"	61TETC70058	\$12.60
18"	61TETC70158	13.95
3'	61TETC7038	15.75
5'	61TETC7058	22.00
10'	61TETC7108	35.00

Tascam Insert Cables

One 1/4" TRS to two male phono connectors.

Length	Part #	Price
6.5'	61TEPW2Y	\$13.50
13'	61TEPW4Y	18.00

Bradley Cord-Lox Easy to Use ... Hard to Lose

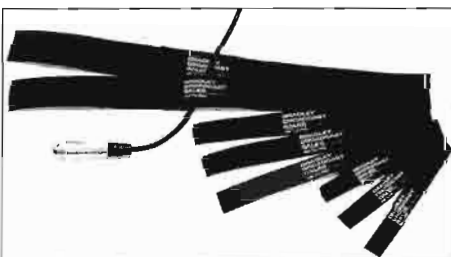

Three sizes delivered from stock. Black only.

3/4"x5" With cable holder closed at both sides. For most shorter cables.	60CL205C	\$1.12
1"x7" With cable holder closed at both sides. For medium cables.	60CL307C	\$1.20
1"x10" With cable holder closed at both sides. For most longer cables.	60CL310C	\$1.45

Custom imprinting and colors are available. Call your Bradley professional for details.

Canare Star Quad Mic Cable

What is Star Quad? It isn't simply a marketing gimmick. Rather, it is a cable design that has resulted from research into how interference signals are introduced into balanced mic and line level transmission cables. The Star Quad innovation is

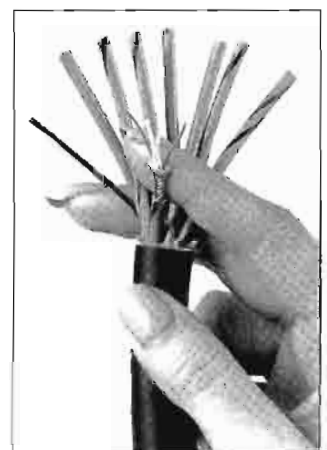

the introduction of an additional signal carrying pair which is tightly interwoven with the first. The result is much greater magnetic interference rejection.

Bulk Star Quad

per foot	60CAL4E6BK	39¢
500' reel	60CAL4E605XX	\$182.00
1000' reel	60CAL4E610XX	\$350.00

Black is the only color offered by the foot. Reels are available from stock in black, or in blue, brown, grey, green, orange, purple, red, white, and yellow by special order. Call for pricing on multipair cable with 2, 4, 8, 12, 16, and 24 pairs.

Canare Star Quad Assembled Mic Cables

5 feet	60CAEC005FBXX	\$16.00
15 feet	60CAEC015FBXX	\$20.00
25 feet	60CAEC025FBXX	\$24.50
50 feet	60CAEC050FBXX	\$35.00

Cables are made with Neutrik XLR connectors. Black is available from stock. Other colors are special order and are priced the same. Cable may be special ordered in any length. All special order cables have a minimum order of 10 cables in any mix of colors and lengths.

Cord-Lox Coil 'n Carry

This ingenious little device really helps out in organizing and transporting your large spools of cable. Webbing is wrapped around a doweled handle and attached to a wide Cord-Lox strap. Very handy.

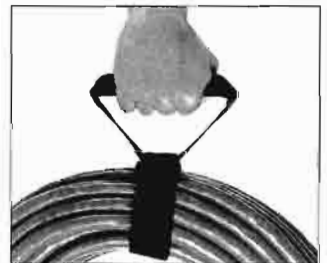

Coil 'n Carry	60CL419WHP	\$12.00
---------------	------------	---------

Wire and Cables

Bradley Broadcast can provide a complete selection of wire for your station or studio. We offer low prices and prompt delivery on custom connectorization of multiple pair cable. We've listed our best sellers below.

West Penn 291

Two conductor shielded cable with drain wire and foil shield. Signal conductors are 22 gauge stranded, and the drain conductor is 24 gauge stranded. Perfect for audio connections. Grey comes in 1000' lengths in the convenient to dispense EZ box.. Available on 1000' spools are black, blue, red, white, yellow, brown, green, violet, and orange.

60WP291XX \$85.00

West Penn 510

Two pair individually foil shielded cable with common drain wire and overall shield. Saves time when wiring stereo signals. 1000' reels.

60WP510 \$162.00

Whirlwind Multipair Cable

Each pair of this heavy duty cable is individually twisted and shielded and has its own drain wire. Sold in multiples of 50'. Price is for a 50' length.

6 pair	61WHW06PR	\$40.00
9 pair	61WHW09PR	\$60.00
12 pair	61WHW12PR	\$76.00
16 pair	61WHW16PR	\$99.00
20 pair	61WHW20PR	\$124.00
32 pair	61WHW32PR	\$195.00

Assembled Speaker Cables

50 feet of 16 gauge speaker wire with chrome plated plugs. 42ME500 \$15.95

Bulk Speaker Cable

Our heavy duty speaker cables have a black, polypropylene jacket. Minimum order is 50 feet.

14 ga, 2 conductor	61WHW14GA	32¢ per foot
12 ga, 2 conductor	61WHW12GA	48¢ per foot

Arcor ZIP Stereo Cable

This new cable makes wiring stereo audio a breeze. The outer jackets of the individual cables are bonded, but can be easily "zipped" apart for stripping. ZIP stereo is color coded red for channel one and green for channel two. Each conductor is two conductor, 22GA stranded with individual drain wires.



1000' foot spool 60AWD2202 \$195.00

Shrink Sleeving

Keep your installations neat with by shrink sleeving your stripped cable ends. Shrunken size is approximately half of original diameter. Available in black, red, blue, white, and clear. Minimum order is 50' of any one length and color. Other sizes available.

3/16" diameter, 1' long	61WHPT316	29¢
3/8" diameter, 1' long	61WHPT38	41¢

Switchcraft Connectors And Adapters



Connectors (Solder type)

Inline TS 1/4" phone M	61WHSW280	\$1.58
Inline TRS 1/4" phone M	61WHSW297	\$3.77
Inline 1/8" TS MINI M	61WHSW780	\$3.20
Inline Phono (RCA) M	61WHSW3502	\$1.05

Adapters (User assembly required)

1/8" TS F to 1/4" TS M	61WHSW364	\$5.05
XLR F to 1/4" TRS F	61WHSW383A	\$12.95
XLR M to 1/4" TRS F	61WHSW384A	\$11.90
XLR F to 1/4" TRS M	61WHSW386A	\$12.60
XLR M to 1/4" TRS M	61WHSW387A	\$11.30
XLR F to XLR F	61WHSW389	\$11.80
XLR M to XLR M	61WHSW390	\$9.85
XLR M to XLR F	61WHSWS3FM	\$9.85

M=Male, F=Female

Also see our full selection of Har-Ken adaptors in our Field Production Section.

Whirlwind XLR Connectors

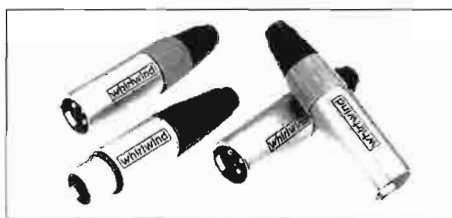

For inline applications, Whirlwind's "WI" series features one piece, die cast housings and 100% cable strain relief. Use with cable diameters from .11" to .31". Strain relief boots are black, with red, blue, and white available by special order. These may be the best XLR connectors available.

Male inline XLR	61WHWI3MXX	ea: \$2.25
Box of 100		\$180.00
Female inline XLR	61WHWI3FXX	ea: \$2.40
Box of 100		\$192.00

Neutrik Connectors



Bradley stocks the popular "X" series Neutrik. These connectors have only 4 parts. They have no set screw and crimping is not required during assembly. One piece unbreakable die cast housing, bellows-style polyurethane flex relief and chuck-type, snap on cable clamp provide secure strain relief. The standard "C" series is available only as right angle connectors that swivel at 45° intervals when assembled for maximum packing density. Other "C" series models have been discontinued. Both XLR types are available in nickel shell with silver contacts and black chrome shell with gold contacts.

3 Pin XLR

Type	Shell	Part#	Price
Female Cable	Nickel	61NT3FX	2.62
Female Cable	Black	61NT3FXB	3.82
Female Panel	Nickel	61NT3FP	2.65
Female Right Angle	Nickel	61NT3FRC	7.05
Male Cable	Nickel	61NT3MX	2.46
Male Cable	Black	61NT3MXB	3.26
Male Panel	Nickel	61NT3MP	2.53
Male Right Angle	Nickel	61NT3MRC	6.78

Other Neutrik Connectors

1/4" TS phone plug	61NTNP2C	\$2.47
1/4" TRS phone plug	61NTNP3C	\$3.66
1/4" TRS lockable chassis jack	61NTNJ3FP6C	\$5.25

Whirlwind Wall Mounting Plates

These stainless steel plates are designed to fit standard single or double gang electrical junction boxes. Mounting screws included.

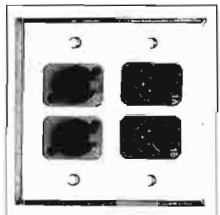

Plate	Connectors	Part #	Price
Single	One female XLR	61WHWP1FW	\$ 8.10
Single	One male XLR	61WHWP1MW	8.00
Single	One 1/4" TRS jack	61WHWP1QW	9.55
Single	Two female XLR's	61WHWP2FW	12.60
Single	Two male XLR's	61WHWP2MW	12.35
Single	Two 1/4" TRS jacks	61WHWP2QW	15.45
Double	Four female XLR's	61WHWP4FW	24.00
Double	Four male XLR's	61WHWP4MW	23.00
Double	Four 1/4" TRS jacks	61WHWP4QW	29.00



Audio Control Industrial SA3050A Real Time Analyzer

Until the Audio Control Industrial SA3050A real time spectrum analyzer came along you had to pay a ransom for a serious measurement grade RTA. In sound reinforcement applications, the SA3050A is used to acoustically test and adjust overall frequency response by using the supplied calibrated microphone and built-in pink noise generator. It can just as easily and accurately test frequency response of an electrical audio source like a tape recorder, telco program circuit, mixing console, or any other device via its balanced, bridging, wide input range line input. For critical, intra-circuit measurements there is a 1 megohm BNC input, also with a wide input level range.

The LED display simultaneously shows the amplitude of each of the 30 ISO third octave frequencies between 20Hz and 20kHz. Three response times allow analysis of transient, average, or integrated response. Results of acoustical or electrical response tests using the digital pink noise generator, whose response is flat to within 0.25dB, can be viewed instantly on this simultaneous 30 band display. An individual response curve can be frozen on the display, and the SA3050A can store up to six different frequency response curves in its internal memory.

An internal back-up battery maintains the contents of the memory for up to one year, even with the AC power disconnected. Acoustical noise spectral distribution and absolute sound pressure level measurements are also in a day's work for the SA3050A. No station, studio, sound reinforcement company, chief, or consulting engineer should be without the SA3050A real time analyzer, especially at this price. Available as a basic unit or loaded with both an internal, rechargeable battery with 5 hour life and a parallel printer interface for use with your printer.



Basic unit	60AOSA3050A	MFR LIST	\$995.00
Deluxe unit with rechargeable battery and printer interface (Printer not included.)	60AOSA3050AX	MFR LIST	\$1300.00
Accessories:			
RM-10 rack mount adapter requires 3 rack spaces (5.25").	60AORM10	MFR LIST	\$55.00
SC-10 soft carrying case with pocket for mic and cables.	60AOSC10	MFR LIST	\$59.00
AC-10 in line filter for "A" weighted measurements.	60AOAC10	MFR LIST	\$44.00

Call Bradley for a current price quotation.

RTS Model 927 Programmable Tone Generator

The 927 provides high audio quality tones and allows the user to program nine separate tone sequences with up to 27 different tones in each. Select from 29 frequencies between 20Hz and 20kHz; output level from -10dBm to +18dBm; channel routing; and duration from 20 milliseconds to continuous. Also provided are pink and white noise, two noise reduction signals, a phase checking positive peak clipped sine wave, and channel ID consisting of either "blips" or spoken voice. All programs are accessed by three front panel soft keys, and a rear panel connector enables remote selection of programs. A must for networks, the 927 is a valuable addition to any audio or video room.



927	60RT927	MFR LIST	\$1280.00
------------	---------	----------	-----------

Call Bradley for a current price quotation.

Fostex TT-15 Tone Generator

This is the hottest! Not much larger than a cigarette pack, the TT-15 oscillator is housed in a rugged metal casing. It includes push button selection of tones at 40Hz, 400Hz, 1kHz, 10kHz, and 15kHz, with distortion typically less than 0.02%. A 3 position attenuator provides output levels of 0dBV, -10dBV, and -30dBV with insignificant level shift when changing from a bridging load to a 150 ohm load. An internal 9V battery provides very reliable operation. A "must" for field and bench.



TT-15	60FOTT15	\$41.95
--------------	----------	---------

Whirlwind Cable Tester

With no buttons to push (except for a power-on switch) the Cable Tester provides a fast and easy way to determine the condition of your cables. In a convenient pocket sized package, the Cable Tester accepts all of the standard audio connectors and, through the intelligent use of LED's, gives you straight ahead information about the condition and phasing of your cables.

Cable Tester	61WHTR	\$53.00
---------------------	--------	---------

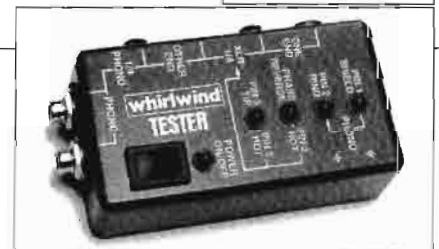

Gentner PeopleLink

PeopleLink is a completely new approach to broadcast telephone systems. With this one system, your talk show, on-air, contest, request line, and all other broadcast telephone requirements can be met. Each control panel can operate simultaneously and independently, with all system resources available to all studios.

The PeopleLink can handle up to 40 lines, and is compatible with any KSU. Multiple telephone hybrids in the system can be used by any control location, whether it is for morning drive or recording off-air news interviews. For contest calls, it will auto-answer, deliver a prerecorded message, and then put the winning caller at your fingertips. PeopleLink can accommodate up to four hold audio sources and each control panel can be tailored to individual requirements. Your custom applications can be stored and retrieved when needed at any control location. Once programmed, most functions are initiated with the touch of a single button.

PeopleLink is the complete, fully personalized phone system that can meet your needs today and is designed to easily grow with you. Your Bradley professional can provide you with details on a PeopleLink system for your facility.



Gentner TeleSwitch Call Director

Finally ... a simple telephone call director at an affordable price. Gentner's TeleSwitch is the logical solution to your basic telephone line selection needs. Up to five lines can be connected, placed on hold, and routed to your telephone hybrid. TeleSwitch operation is similar to a multi-line phone, so no training time is required. Connections are made with standard RJ-11C modular jacks. Connection to all popular hybrids is easy. Other features include a conferencing mode, a hold audio input, and a telephone set connection. TeleSwitch is compatible with almost any phone system. This one box solution will help you get more out of your call-in program segments.

Accessory:
Pre-wired cable to connect TeleSwitch to hybrid. Specify model of hybrid being used.
61GE830002XXX
MFR LIST \$24.95



TeleSwitch 60GETS MFR LIST \$995.00

Call Bradley for a current price quotation.

Gentner Digital Hybrid II

The Digital Hybrid II provides both improved caller and announcer audio, plus a full set of features which make studio connections simple and recording and on-air use a snap. Its all new hybrid provides excellent audio quality, employing a Motorola 16 bit DSP chip with 2 times oversampling. The Digital Hybrid II control circuitry provides a record button which, when depressed, activates a tape machine when the unit is toggled "on," and delivers a stop command when switched "off." The "cue" button, which can be remoted, selects the main or cue send audio to be applied to the hybrid input. Thus, when the cue input is connected to the announcer's mic preamp, ahead of program switching, the DH-2 can be used as a hands-free speaker phone. By removing the cue feature to the announce mic on/off switch, operation becomes fully automatic.

Both momentary and maintained closures are provided to readily interface to any recorder. Two outputs are provided: caller-only and caller/send mix. Dip switch selectable features include auto answer/disconnect, and automatic re-null which allows the DH-2 to be connected to a multi-line phone instrument and used as an on-air selection device. When no phone line is present, the DH-2 automatically mutes.



Digital Hybrid II 60GEDH2 MFR LIST \$1795.00

Also available:

SPH-5 is an analog version of the Digital Hybrid II. A new dual transformer hybrid system achieves consistent send-to-caller rejection. The SPH-5 provides all of the features of the DH-2. The SPH-5E adds the additional feature of phone line frequency extension which is used with a companion extender in the field.

SPH-5 60GESPH5 MFR LIST \$899.00
SPH-5E 60GESPH5E MFR LIST \$1329.00

Call Bradley for a current price quotation.

Gentner SPH-3A Telephone Hybrid

The SPH-3A is a basic, yet complete, hybrid telephone interface system which is ideal for newsrooms, production studios, or on-air telephone interviews. Its unique analog hybrid circuit is fairly insensitive to telco line impedance problems and typically provides a null on the order of 15 to 20dB. Main audio connections are XLR line level, with a standard RJ-11C jack for telco. Relative caller level, and the internal 2 watt studio monitor amp are controlled on the front panel. "Set-and-forget" trimmers are provided for telco send level and hybrid balance. The



SPH-3A can seize the line and close your phone system A-lead via the front panel toggle switch or the remote control jack.

SPH-3A 60GESPH3A MFR LIST \$599.00

Call Bradley for a current price quotation.



Gentner TC-100 Automatic Telephone Interface

In addition to functioning as a phone coupler and basic telephone hybrid, the TC-100 can automatically answer a line after a selectable ring count, and automatically disconnect upon standard line reversal signaling from the central office. Logic outputs are available for ring detect and off-hook conditions, and form-C relay contacts (momentary or continuous) actuate upon connection to the line. The coupler can also be manually placed on line with either a front panel switch or a remote contact closure. The built-in DTMF decoder card provides 100mA open collector outputs for all standard touch tones, including the extended tones



A, B, C, D. Additionally, the DTMF card can recognize dial-tone and disconnect if desired. The possibilities are limited only by your imagination.

TC-100 60GETC100RTT MFR LIST \$499.00
 Call Bradley for a current price quotation.

Gentner Hybrid Coupler and Auto Coupler

Gentner Hybrid Coupler

This compact unit provides an easy and inexpensive way to get audio on and off a phone line. The Hybrid Coupler connects directly to a phone line via a modular jack, and provides a loop-through to a telephone set. A three position front panel switch allows the Hybrid Coupler to seize the line, simply tap the circuit for insertion of send audio, or take receive audio off the phone line for recording. Its hybrid coil provides approximately 10dB of separation between send and receive audio, adjustable with a front panel trimmer. The coupler is a passive device requiring no external power.

Hybrid Coupler 60GEHC MFR LIST \$149.00

Gentner Auto Coupler

These units are auto-answer, auto-disconnect units allowing for simultaneous send and receive audio transmission upon connection. Balanced 600 ohm connec-



tions are provided for both send and receive audio, and a null trimmer pot maximizes isolation.

Upon loop drop, this version hangs up the phone line. A special "CP" version is used on phone lines where the telephone company does not provide the loop drop signal. The call progress decoder disconnects on dial tone, busy signal, recorder signal, or ringback. Units operate on 117VAC from a provided external power supply.

Auto Coupler 60GEAC MFR LIST \$269.00
Auto Coupler CP 60GEACCP MFR LIST \$299.00

Call Bradley for a current price quotation.

Henry Engineering MixMinus Plus

The MixMinus Plus is designed to add a "mix-minus" output to a broadcast console suitable for feeding to the send input of a telephone hybrid. One input of this unit is fed with the console output, the other takes hybrid receive audio. These two signals are subtracted using phase reversal to create a program mix, minus the receive audio. Initial null adjustment will provide 40dB rejection of the receive audio signal. The unique MixMinus Plus can expand the capabilities of your present console and make hybrid installation a breeze.

Mix Minus Plus 60HEMMP MFR LIST \$195.00

Call Bradley for a current price quotation.



Henry Telecart II

Many stations use cart machines to answer telephones and provide recorded messages. The Telecart II will work with virtually any cart machine, as no auxiliary tones or relays are needed. All cart machine connections are opto and relay isolated. Failsafe design prevents the line from being answered unless the cart is cued and ready to play. Also, if a caller hangs up before the entire message has played, the Telecart II will hold the line "busy" until the cart has re-cued. Then the line is released and a new call may be received. The audio circuit is transformer coupled to the phone line for isolation and protection. A-lead control is provided for use with key systems. A digital call counter registers up to 9,999 calls. A built-in power supply means no power is taken from the telephone line.

Telecart II 60HETC MFR LIST \$225.00

Call Bradley for a current price quotation.



Symetrix TI-101 Telephone Interface

The TI-101 yields more performance per dollar than any other system in its price class. The unit functions as a conventional fixed hybrid with dual-constant null adjustments to allow more precise nulling than the classic transformer hybrid. To enhance the performance of this basic design, input bandpass filtering and AGC protect your telco line and reduce nulling problems. Output AGC and front panel receive equalization can clean up even rotten feeds. Conferencing is



possible with two units and the front panel conference button. Throw that old QKT in the parts bin where it belongs!

TI-101 60SYT101 MFR LIST \$549.00
 Call Bradley for a current price quotation.

Symetrix Model 104A Broadcast Telephone System

The Model 104A provides a sophisticated system for routing up to four incoming telephone lines for talk shows and other telephone-to-air applications. The 104A connects directly to your telephone lines and, unlike other systems, requires no external phone system. The rack mount controller incorporates two hybrids permitting up to four callers on the air at one time. All system control is performed by the desk module, and the unit can support a second module for use by a call director or in another studio. Hybrids may be ordered as full duplex, half duplex, or a combination. Phone lines are seized, routed, and released by the desk module. LED indicators provide studio talent with complete status information. The hybrid section incorporates "caller override" ducking and gated AGC circuitry.

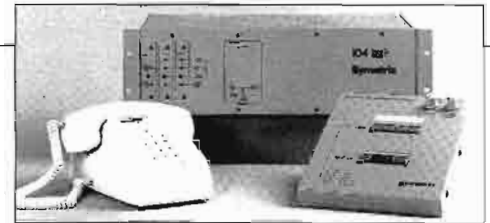

Call Bradley for a current price quotation.

104A 60SY104 MFR LIST \$2395.00
Accessory:
Extra control module 60SY104CTRL MFR LIST \$495.00

Symetrix SX203 Telephone Interface

The SX203 is a single line coupler that provides high quality audio transfer between telephone lines and professional audio equipment. With Symetrix's positive tracking, half-duplex control circuitry, the SX203 responds very naturally, yet does not require time consuming null balance. Just plug a telephone line into the rear panel modular jack, and it's ready to work. An extra modular jack is provided for a standard telephone desk set, so calls may be originated. Even the most inexperienced user always gets great results, as only four control functions are required. Provided are separate controls for the caller level and the host level, and two push button switches to route the caller to either the desk set or to the SX203's balanced audio output.

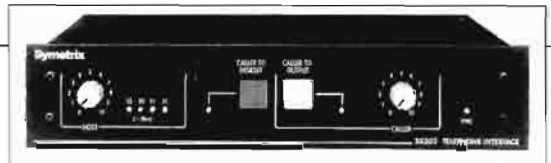

Call Bradley for a current price quotation.

SX203 60SYSX203 MFR LIST \$389.00
Accessory:
 Rack mount kit for one or two SX series units. 60SYRM2 MFR LIST \$39.00

Eventide BD941/BD942 Broadcast Delays

Even stations with only occasional live talk show programming can afford a reliable Eventide obscenity delay. The mono BD941 and stereo BD942 are full 20 kHz bandwidth. When a "no-no" is uttered, simply hit the Delete button on the front panel or via a remote closure. This control both bypasses the delay line and closes a relay contact to start your filler material. The mono delays are available in 6 and 12 second versions, and the stereo units offer 3 or 6 seconds. These units have balanced inputs and outputs, and specifications that don't compromise audio quality. Now you can relax knowing that #*%!!! will never be heard on your station.



Mono, 6 sec delay 60EVBD9416 MFR LIST \$1795.00
Mono, 12 sec delay 60EVBD94112 MFR LIST \$2195.00
Stereo, 3 sec delay 60EVBD9423 MFR LIST \$1995.00
Stereo, 6 sec delay 60EVBD9426 MFR LIST \$2395.00

Call Bradley for a current price quotation.

Eventide BD980 Broadcast Delay

This two channel stereo delay provides 20kHz bandwidth and 90dB of dynamic range with less than 0.02% distortion at 1kHz. Advanced catch up circuitry in the BD980 solves the problem of getting back into delay after a segment is dumped. One push of the DUMP button prevents the undesirable utterance from reaching the air, and the BD980 rapidly rebuilds delay so cleanly it is virtually undetectable. Ingenious delay entry/exit modes require only the push of a button to move from real time to delay, or vice versa. Delay is adjustable up to 10 seconds,



and the BD980 has convenient remote facilities.

BD980 60EV980 MFR LIST \$5495.00

Call Bradley for a current price quotation.



Telos Digital Telephone Hybrid Systems

Telos Systems gives you a real choice in digital telephone interfaces. Now is the time for you to join the hundreds of Telos users who have the best sounding call-in segments. With two models from which to choose, you can now own the right hybrid to meet your budget and programming needs.

Both The Telos ONE and the Telos 100 use proven Telos digital signal processing technology, with all hybrid functions, gain control, and filtering in the digital domain. This all digital approach assures consistently good performance. The result is smooth, natural, two way conversation without up-cutting or announcer voice distortion. An additional benefit of the digital approach is that the hardware is simple and trouble-free.

The Telos ONE yields trans-hybrid loss of greater than 40dB, while sending the legal maximum of -9dBm back to the caller. The input is switchable for mic or line level. Two outputs are provided, and the second output may be optionally set to be a mix of caller and talent audio. Front panel controls allow you to select the "override" function (to duck caller audio when the announcer speaks) and to engage the automatic gain control on the output audio. Special acoustic path processing allows a large gain-before-feedback margin when the Telos ONE is used with open monitor speakers. 14 bit analog-to-digital (A/D) and digital-to-analog (D/A) converters are used and the processing sampling rate is 8kHz. While the noise and distortion specifications are not as critical as in the Telos 100, sound of the Telos ONE is excellent. The Telos ONE is packed in an economical "modern style" case with an external power supply, and rack mount kits are optional.

The Telos 100 takes the digital approach even further. Up to 50dB of trans-hybrid loss can be realized at -9dBm send level. 16 bit A/D and D/A converters are used. The input is oversampled at 2mHz and digitally filtered to a 16kHz rate for processing to yield superior audio performance. Distortion is typically 0.35% THD+N, and signal-to-noise is greater than 60dB, with an effective dynamic range better than 78dB. Both the output gain processing and the "caller override" function are front panel adjustable over a wide range. Other features include three front panel meters, two caller outputs, user adjustable EQ controls beneath the front access panel, and a rack mounting enclosure. The internal power supply is designed to prevent the problems that power line disturbances sometimes create in microprocessor based devices. Telos 100 owners enjoy free software upgrades as features and performance are enhanced.

Whether you are a radio or TV facility, a teleconferencing center, or anyone else who needs to interface to the world of dial-up phones, Bradley has a Telos hybrid for you. The Telos family of products utilizes a building block approach, allowing assembly of a custom tailored system at an off-the-shelf price. If you need to know more about using the telephone for talk programming, call-in segments, intercoms, or teleconferencing, ask your Bradley professional for your free copy of the 50 page Telos Telephone Q & A.

Telos ONE	60TS1	\$985.00
Telos 100	60TS100	\$2450.00



Accessories:

Direct Interface

Connects directly to up to 10 telephone lines. This electronic PABX can interconnect the phone lines with up to two Telos hybrids and two Switch Consoles. The DI features music-on-hold capabilities. Additional interfaces are used to expand hybrid, switch console, and/or phone line capabilities.

60TS100DI

\$1840.00

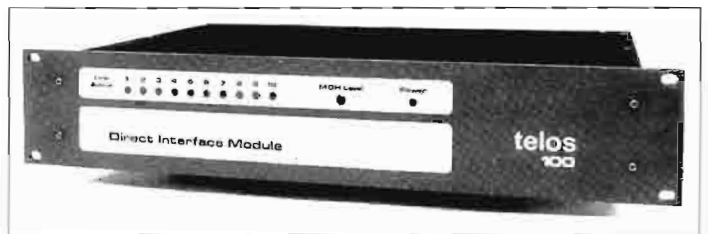

Mitel Deskset

For call screening with the Direct Interface. Features include auto dialer and multiple function LCD display.

60TSMITEL

\$350.00

Key System Interface

Provides interface to 9 phone lines via 1A2 key service. It connects with up to two Telos hybrids and two Switch Consoles. Additional interfaces are used to expand hybrid, switch console, and/or phone line capabilities.

60TS100KSI

\$1050.00

Switch Console

Allows operators to select from among phone lines and conference callers. The Switch Console includes a tone pad for dialing, user programmable buttons for delay control, tallies, etc. and a 99 memory auto dialer. Custom button inserts are provided for personalized line designation.

60TS100SC

\$650.00

Auto-Answer Accessory

Allows the Telos hybrids to auto-answer when used in a single line mode.

For Telos ONE

60TS1AA

\$50.00

For Telos 100

60TS100AA

\$50.00

BE and PR&E Switch Panels

Are available for installation as modules for in Broadcast Electronics Mix Trak 90 consoles and Pacific Recorders & Engineering consoles and turrets. These panels include key pads. Price varies with model.

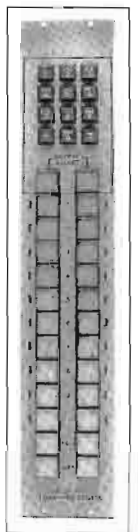

Granite Telcom Digital Voice Announcers

The DVA Series is the tapeless answer to any telephone announcement application. Use them for listener information lines, concerts, sports, weather, etc. A message-on-hold feature also permits DVA units to deliver a message to callers on hold, which is an extra chance to pitch to your clients during usually wasted moments. With 100% solid state audio storage under microprocessor control, your message can be accessed literally millions of times with no loss in quality. The DVA-500 features up to 90 seconds of message time, selectable number of rings before answering, call counter display, elapsed time/record indicator, and battery back-up. The basic DVA-1000 has 64 seconds of message time. It can be expanded to handle messages up to 4 minutes, dual messages, multiple phone lines, and remote message recording. Prices start at less than \$800.00.

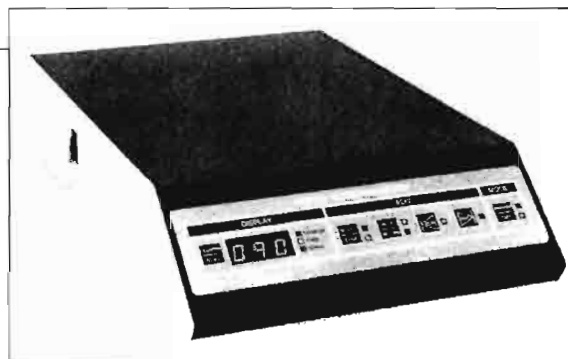

Broadcast Tools Studio Monitor Intercom System

The SMI-5A is a complete intercom and monitoring system in a single rack space unit. Up to five stations can be interconnected using off the shelf 25 pair phone cable. Units are inserted into your current monitor and headphone paths to work in conjunction with your current equipment. The SMI-5A also features two built-in headphone amps with EQ and a front panel electret mic with limiter. Other features include a input for an external telephone interface, "all call" and "privacy" modes, monitor dimming function, and mono summing for phase checking. The system requires one SMI-25P adapter.



SMI-5A Station	60BTSMI5A	<i>MFR LIST</i>	\$699.00
SMI-25P Adapter	60BTSMI25P	<i>MFR LIST</i>	\$150.00

Call Bradley for a current price quotation.

RTS Series 2100 Wireless Intercom

The RTS Series 2100 is designed to provide clear, clean communications without wires. It is a complete wireless system that operates in the 150 to 216MHz band, protected from external radio and electrical interference. Four belt pack transceivers can operate with the Model 2105 base station, and when two base stations are chained together, up to eight headset stations can be tied into a full duplex communication network. The rugged and lightweight Model 2110 belt packs offer up to 24 hour operation on a single battery and numerous operator convenience features. Two belt pack transceivers form a simple, two person link, and the Series 2100 is easily used as an extension to your hard wired intercom for unlimited possibilities.

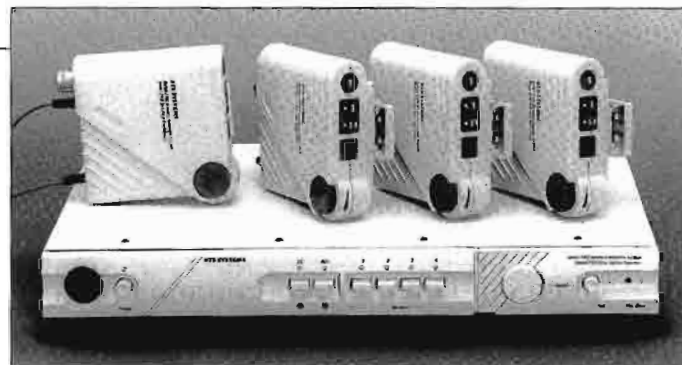

2105 base station	60RT2105	<i>MFR LIST</i>	\$1495.00
2110 transceiver	60RT2110	<i>MFR LIST</i>	\$495.00

Also available:

Series 2200 wireless cue system improves delivery of cues to your talent. Multiple receivers at multiple VHF (72 to 76MHz) frequencies are possible.

Call Bradley for a current price quotation.

Headsets Galore

Whatever your communications needs, Bradley can provide you with the headset and headphone products you need. Beyer, Telex, RTS, and other manufacturer's offer a wide variety of headset models, and Telex "carbuds" are available for IFB. Of course we also provide replacement parts, cables, and connectors to keep your current units in working condition.



The Telos LINK

When you are doing remote location production, wouldn't it be great if you could use a dial-up telephone line to connect intercom systems at each end? The entire crew could then communicate as smoothly and effortlessly as if they were together in the studio. Impossible, you say? Perhaps you've tried jury-rigging with multiple boxes and found the results disappointing with complaints of poor level and feedback.

Presenting the LINK. The LINK is specifically designed to solve the problems of connecting intercom systems to dial-up telephone lines. It uses the same Telos adaptive digital hybrid technology that is used to improve talk shows and teleconferencing in hundreds of installations throughout the world.

The LINK allows natural, full-duplex communication without level or feedback problems. Digital, auto-nulling hybrids are on both the telco and communications paths, so neither party misses a single syllable the other is saying. A powerful digital processor is used to perform all audio processing functions, including automatic gain control, smart gain switching to enhance hybrid performance, high pass filtering to reduce hum and interference, pitch shifting for feedback reduction, and call signal generation. The result of this high technology is significantly improved communication capability.



Installation and operation are simple. The LINK features a built-in interface for RTS, ClearCom, and other intercom systems. Once installed, you never have to think about it again. Other features include a "wet" single channel operation option to provide power to belt packs and metering for both intercom and telco levels. A very useful feature is the built-in auto-answer function. With it, field personnel can simply call in to be connected without operator intervention. Whether at Yankee Stadium, the Kremlin, or from a cellular phone anywhere in the world, your crew is instantly connected with the LINK. Rack mounting kits are available.

The LINK 60TS1L **\$1680.00**

Telos ONE-M Two to Four Wire Interface

Large facilities using McCurdy four-wire intercoms often need the additional flexibility offered by RTS two-wire intercoms. The Telos ONE-M (modification J1963) provides easy interface between these two systems. Each unit provides a single channel of full duplex conversion using Telos digital signal processing technology. Single and dual rack mounting kits are optionally available.

Telos ONE-M 60TS1M **\$985.00**



RTS TW Intercom Systems

The right intercommunication system can make the difference for a successful production. RTS intercoms prove themselves every day in teleproduction, broadcast, and commercial and industrial applications. RTS two wire systems have over 25 available components allowing the broadest variety of configurations. Utilizing a unique design, users are able to conduct two channels of conversation through standard two-conductor cable.

Recently introduced to the TW Intercom System is the MCE325 four channel, user programmable intercom station. It's modular packaging allows it to be used in any of five arrangements: rack mount or portable headset station, rack mount or portable speaker station (with inclusion of the MCS325 Modular Speaker), or console mount headset station. Programming functions allow use in conference-line or dedicated line environments, in two-wire or 4-wire mode, or in a combination of both.

The fourth generation BP325 Portable Headset Station boasts enhanced analog performance and powerful microprocessor control of its digital functions. User oriented features include a microphone limiter, three headphone amps, silent channel selection switching, and simplified controls. The BP325 is the one portable headset station for all of your applications because it includes call-signal indication, can accommodate nearly any headset, and has channel programming to suit the needs of every production.

Also available from RTS is the Series 800 microprocessor-assisted, programmable master stations, Series 4000 IFB system, and several other models. Whatever your intercommunication requirements, let Bradley specify an RTS system that will meet your technical requirements and your budget.



Technics SL-1200MKII Turntable

This turntable is a standard in broadcast and disco use. Its features include quartz lock, slide fader pitch adjustment of $\pm 8\%$, acoustic isolation, 0.7 second startup time, stylus illuminator, and speed strobe indicator. The SL-1200MKII is a complete system that includes tonearm, base, and dust cover. The direct drive mechanism provides the lowest noise and rumble obtainable in this price range.

SL-1200MKII 60TC1200 MFR LIST \$550.00

Call Bradley for a current price quotation.



Broadcast Electronics 12C

The 12C is an economical choice when you require a three speed turntable. Rim drive mechanism results in maximum torque for tightest cueing. Ruggedly constructed with only three moving parts, the 12C is provided drilled for the tonearm you select to use. Tonearm and base not included.

12C 60BR12CO MFR LIST \$465.00

Call Bradley for a current price quotation.

Accessory:
Base for table top mounting.
60BRSB1 MFR LIST \$55.00



Audio-Technica ATP-12T Tonearm

This professional 12" tonearm features rugged, simple design for long use in broadcast environments. For use with Technics turntables; will not fit BE 12C.

ATP-12T 60ATP12T MFR LIST \$275.00

Also available:

Replacement head shell fits Audio-Technica, Technics, ProTec, and other tonearms using the EIA standard head shell mount.

60ATN MFR LIST \$19.95

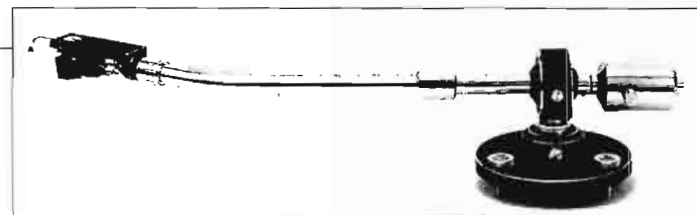

Call Bradley for a current price quotation.

Protec SA-270 Tonearm

This "S" shaped tonearm has a removable headshell, adjustable tracking weight from 0 to 3 grams, and anti-skate.

SA-270 60PRSA270 MFR LIST \$139.95

Call Bradley for a current price quotation.

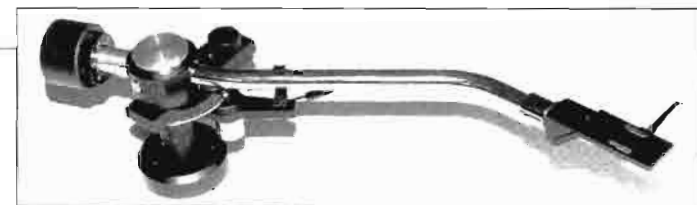

Discwasher Record Care Products

Disc Kit

The Disc Kit from Discwasher combines the Discwasher record cleaning system with D4 fluid, the Zerostat anti-static pistol, and a stylus cleaner with SC-2 fluid.

61DIDK \$34.00

D4 Record Cleaning System

The exclusive slanted fibers and absorbency of the Discwasher pad work together with the D4 Fluid to lift off microdust, fingerprints and smoke particles. D4 cleans without building up residue on the record surface.

61DID4S \$13.65

SC-2 Stylus Care System

The SC-2 includes a precision nylon brush and a stylus-safe cleaning liquid.

61DISC2 \$7.25

Discwasher Refills

D4 fluid sixteen ounce bottle.

61DID4R16 \$14.00

SC-2 fluid 3.5 ounce bottle.

61DISC2R \$1.95

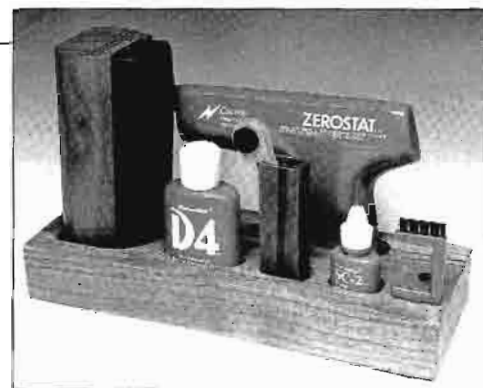

Henry Universal Turntable Controller

The Universal Turntable Controller allows two button remote start/stop and status indication to be accomplished with Technics turntables. This unit will stay in "sync" if the turntable's switch is used for cueing. Each unit handles two turntables and may be controlled by either momentary switches or CMOS circuitry.

Universal Turntable Controller 60HETTC *MFR LIST* \$195.00

Call Bradley for a current price quotation.



Phono Preamplifiers

ATI P-100S Encore Preamp

Our Best Seller! This phono preamplifier provides the excellent performance for which ATI is known in an economical, no-frills enclosure.

P-100S 60AIP100S *MFR LIST* \$279.00

Logitek BPA-200 Preamp

The accuracy of this passive EQ preamp makes it the right choice for highest quality disc-to-cart transfers and on-air use.

BFA-200 60LTBPA200 *MFR LIST* \$385.00

Stanton 310B Phono Preamp

A high quality, low noise phono preamp, the 310B has switch selectable NAB/flat response curves and rumble filter.

310B 60ST310 *MFR LIST* \$295.00



ATI P-1000 Microamp Preamps

The P-1000 can make an audible difference in your audio chain, thanks to precise equalization, high slew rate, and low distortion and noise.

Transformer outputs 60AIP10001 *MFR LIST* \$395.00

Balanced differential outputs 60AIP10002 *MFR LIST* \$375.00

Call Bradley for a current price quotation.

Stanton Phono Cartridges

Stanton offers several series of professional cartridges.

Call your Bradley professional for assistance in selecting the model to best suit your needs.

Model	Part Number	Tracking Force	Stylus Type	Price	Replacement Stylus	Price
981HZMKII	60ST981HZS	.75-1.5 grams	Stereohedron	\$91.00	60STD98S	\$71.00
881MKIIS	60ST881S	.75-1.5 grams	Stereohedron	91.00	60STD81S	44.00
890 AL	60ST890AL	2-7 grams	Spherical	69.00	60STD89AL	27.00
681EEEMKIIS	60ST681EEES	.75-1.5 grams	Stereohedron	60.00	60STD6800EEES	28.50
681SE	60ST681SE	2-4 grams	Elliptical	54.00	60STD6800SE	20.00
680EL*	60ST680EL	2-5 grams	Elliptical	61.00	60STD6800EL	19.95
681A	60ST681A	1.5-3 grams	Spherical	52.00	60STD6807A	17.10
500AMKII	60ST500A	1-2 grams	Spherical	13.85	60STD50A	10.00
500AL	60ST500AL	2-5 grams	Spherical	18.00	60STD5107AL	9.90
500EMKII	60ST500E	1-2 grams	Elliptical	16.00	60STD50E	11.30
500EEMKII	60ST500EE	.75-1.5 grams	Elliptical	18.50	60STD50EE	11.30

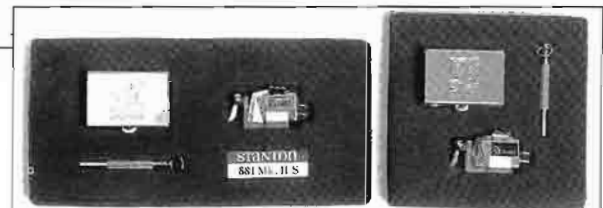

Also available:

Disco pack: 3 replacement styli for 680EL	60STD68	\$54.00
Matched Pair - 680EL cartridges	60ST68ELMP	\$78.00
500AL cartridge disco packed w/2 styli	60ST500ALDP	\$25.50
500AL-MP Matched pair-500AL cartridges	60ST500ALMP	\$33.00
D5107AL-MP Matched pair of styli for 500AL	60STD5107ALMP	\$19.30
D6827 78 rpm stylus for all 680/681 series	60STD6827	\$19.00
D5127 78 rpm stylus for all 500 series	60STD5127	\$12.85

* Packed with two styli

Shure Phono Cartridges

Model	Part Number	Price	Replacement Stylus	Styli Qty Per Pkg	Price
M44-C	60SHM44C	\$21.00	61SHN44C	1	12.50
M44-7	60SHM447	21.00	61SHN447	1	12.50
SC35-C	60SHC35	35.00	61SHS35	1	14.00
SC39-EJ	60SH39EJ	55.00	61SHSS39EJ	1	25.20

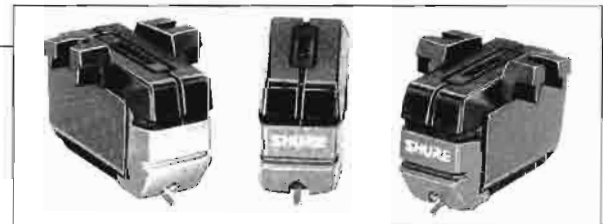

Bradley stocks the wide range of Shure cartridges and styli. Listed are our most requested models. Call us with your requirements. Replacement styli are available for all discontinued cartridges.



ESE ES301E and ES302E Timers



The ES301E is a four digit, one hundred minute timer. Minutes and seconds can be advanced simultaneously or independently in order to pre-set for a specified countdown. This preset time will be automatically held until the timer is started. Counting can be activated up or down from that point or set back to zero. When the "Stop" control is pressed the four digit display is held. Counting direction (up or down) can be changed or time can be reset to zero without stopping the count. It will continue to register elapsed time beyond the zero setting unless stopped. With the ES302E the user can preset times much faster than with the ES301E, because lever wheel type switches are used for the preset feature.

ES301E 60ES301E MFR LIST \$285.00
ES302E 60ES302E MFR LIST \$365.00

Call Bradley for a current price quotation.

ESE ES362A Master Timer



This four digit, 100 minute up/down timer features a serial output capable of driving up to 100 remote slaves. The ES362 has front panel lever switches to preset start times, as well as up, down, stop, and reset controls. A wide variety of table, wall, rack, and console mounted slaves are available. Call or fax for a complete list of slave options.

ES362A 60ES362 MFR LIST \$420.00

Also Available:

ES192A and ES194A economical master clocks also drive slave units with their serial outputs. Both units have a six digit display. The ES192A has a 12 hour format and the ES194A has a 24 hour format.

ES192A 60ES192 MFR LIST \$260.00
ES194A 60ES194 MFR LIST \$260.00

Call Bradley for a current price quotation.

ESE offers a full line of master clock and time control systems, as well as a complete selection of accessories for their clocks and timers. Your Bradley professional can provide you information on the ESE products to meet your needs.

ESE ES520 Timer



The latest up-counting timer from ESE packs it all. The four digit, 60 minute ES520 can be controlled from the front panel start, stop, and reset controls or via two remote options. A momentary short to ground or 5 volt logic "O" can activate any of the functions, and four "trigger resets" can reset the timer using either a momentary or continuous signal. The large LED display makes the ES520 easy to read in all light conditions. The serial output on the ES520 can be used to drive up to 100 remote slave displays.

ES520 60ES520 MFR LIST \$169.00

Call Bradley for a current price quotation.

ESE ES562E & ES564E Timers

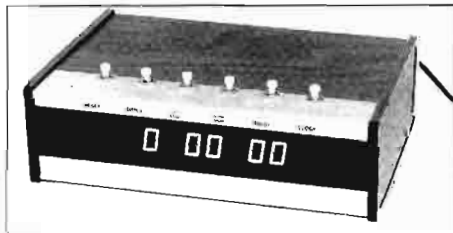

The ES562E (12 hour) and ES564E (24 hour) are combination six digit clocks and count up timers. Since the clock and timers are independent, switching between the clock and timer modes has no effect on the other's status.

ES562E 12 hour 60ES562E MFR LIST \$380.00

ES564E 24 hour 60ES564E MFR LIST \$380.00

Call Bradley for a current price quotation.

ESE ES112E and ED124E Clocks

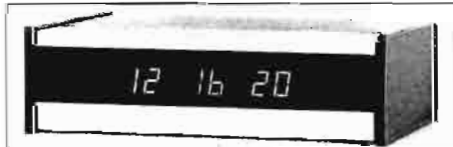

The ES112E (12 hour) and ES124E (24 hour) are solid state, CMOS, six digit clocks. Three simple controls (fast advance, slow advance, and hold) make setting to the precise second easy.

ES112E 12 hour 60ES112E MFR LIST \$200.00

ES124E 24 hour 60ES124E MFR LIST \$200.00

Call Bradley for a current price quotation.

ESE 70 Series



These console mount clocks and timers offer compact enclosures and easy to read .4" red LED displays. The ES172 (12 hour) and ES174 (24 hour) are six digit clocks with fast advance, slow advance, and hold controls. The ES370 is a four digit, 100 minute up/down timer. The ES371 is also a 100 minute timer with leverwheel controls for pre-setting times. Several other models, including combination clock/timers and clock slave units, are available in the 70 series.

ES172 12 hr clk 60ES172 MFR LIST \$192.00

ES174 24 hr clk 60ES174 MFR LIST \$192.00

ES370 timer 60ES370 MFR LIST \$245.00

ES371 timer 60ES371 MFR LIST \$388.00

Call Bradley for a current price quotation.

Time Master & Frame Master Time Calculators

In our business, where every second counts, accurate time calculations are essential. The Time Master calculator works directly in hours, minutes, and seconds and converts to and from each of these formats. It handles 12 hour and 24 hour timing, and includes hourly rate calculation abilities. Ideal for recording, editing, logging, and a host of other time related calculations.



The Frame Master is designed for anyone working with time code. It works directly in 30 non-drop frame, 30 drop frame, frames, and real time. Frame Master performs conversions between these formats, and features both manual and auto-entry. The Frame Master Plus model adds 24fps, 25fps, and custom (user defined) frame rates, Feet-Frames (16mm and 35mm) and several other features for those who work in film. For finding durations, making edit decision lists, logging tapes, and on-line editing, the Frame Master is an invaluable tool.

Time Master 60CITM \$42.00

Frame Master 60CIFM \$79.00

Frame Master Plus 60CIFM P \$99.00



Murphy Studio Furniture

Furniture is often the last consideration when building a studio. The proper furniture, however, can save time and money during installation and make your operators more efficient by positioning electronics and supplies in just the right places. Murphy offers four series of elegant studio furniture that have many improvements and innovations not found in other designs. The deluxe Elite Series (pictured at left) incorporates numerous access panels, a bumper base for durability, a passive ventilation system, and a wire management system. The Premier Series retains most of the important features of the Elite Series, but is more economical. The Dub/Edit Station is a built to order desk/rack combination ideal for computer stations, newsrooms, and a host of other installations.

New for 1991 is the Classic Series. Designed for the facility on a budget, the

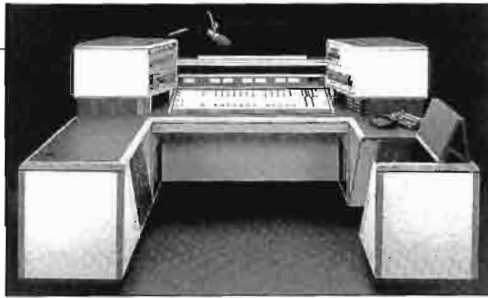

Classic Series uses the same high quality laminates and oak trim found on the higher priced models. Classic furniture is shipped to you ready to assemble, so shipping costs are lower. The full studio complement in the right picture, including the copy stand, has a manufacturer's list of only \$3194.

Your Bradley professional can aid you in designing a Murphy Studio Furniture ensemble that will exactly meet your needs and your budget.

Nigel B. Audio/Video Furniture

Creating a quality work environment requires furniture that has both an appealing design and industrial strength. Nigel B. offers a full range of audio/video furnishings that allow a custom fit in almost any situation. It is constructed of heavy duty steel that is deep coated with baked enamel for a scratch resistant finish. Black Satin enamel is standard, with Banana Yellow, Fire Red, and Mid-West Blue Gloss optional. Worktops are Formica covered particle board with Comfort Edges and cable grommets standard. Worktops are available in black or Storm Grey. Clear instructions, well labelled parts, and supplied tools make assembly a matter of minutes. All bases include heavy duty casters.

Basic workbenches start at less than \$400. The configurations below are just examples of some possibilities. Options include corner units, keyboard shelves, power strips, rack drawers and shelves, and computer monitor platforms.

Junior Workstation has bases angled at 45° for easy access. Each base has 13 rack units of space with front and rear rails. The Jr. Workstation ships in three pieces for easier shipping and installation. It is pictured with the Monitor Bridge Set and one 5U Chassis Unit. 108" long, 32" deep, 28" high with a 30" front opening. Also available is the larger Double Unit Workstation.

Double Desk is 72" long, 32" deep, and 28" high, and has rack storage on both sides. The Double Desk includes front and rear rails and a modesty panel. Also available is a Single Desk that is 52" long and has rack storage on one side.



Accessories:

Monitor Bridge for Junior Workstation

60NB501MB MFR LIST \$675.00

Cable Raceway for Junior Workstation

60NB501CRW MFR LIST \$110.00

Rear Panel for Junior Workstation (2 required)

60NBVLBRP MFR LIST \$69.50

Senior Monitor Bridge for Double Desk

60NBVSMBX MFR LIST \$325.00

5U Chassis Unit w/ front rack rails 60NBVBCH MFR LIST \$147.50
 5U Chassis Set includes enclosure. For use when not mounting in a Monitor Bridge. 60NBVBCS MFR LIST \$319.00

Lazy Susan for 5U Chassis Set 60NBBCLS MFR LIST \$19.95

Call Bradley for a current price quotation.

Junior Workstation	60NB501X	MFR LIST	\$1375.00
Double Desk	60NBVDD501X	MFR LIST	\$935.00
Single Desk	60NBVSD401X	MFR LIST	\$695.00

Ruslang Modular Studio Furniture

If you are building or remodeling, you can add the elegant look of expensive furniture for much less than you might expect. A modular approach permits custom configurations and the ability to match your storage racks to your furniture.

Ruslang production and on-air console tables, pedestals and recorder consoles give you the custom look and versatility you want in your installation. Console tables may be modified to any shape and size. Modular record and tape storage units are available in three widths and in two sizes to accommodate LP's or 10 1/2" tape and for 45's and 7" tape. Units are suitable for mounting on shelves or table-tops, or select floor bases and finished tops. Freestanding, rotating racks are available to hold hundreds of carts or CD's each. They are sturdy and attractive.

Custom design is available for odd shaped rooms, stand-up consoles, or other special requirements. Due to a wide variety of configurations, please call your Bradley professional for details and a quotation.

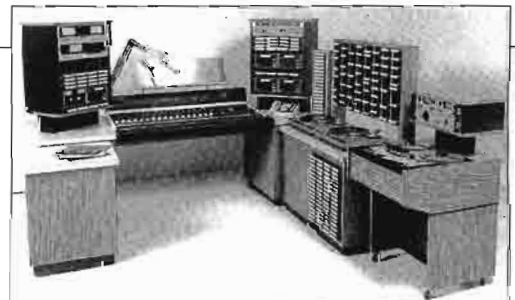

The Cutting Wedge Acoustic Tiles

Acoustic treatment of your rooms is now easier than ever, thanks to The Cutting Wedge. When used to reduce noise, slap echo, and/or standing waves, these charcoal gray tiles can exceed the performance of competing products. Available in four thicknesses, these tiles come in convenient 12" by 12" squares as well as 4' by 8' panels. The small squares can be shipped via UPS in any quantity, so you save on shipping charges. Use the large panels to install 32 square feet at one time with a seamless finish.

Look at the walls in those "problem" rooms. Now see how inexpensive and effective it will be to apply The Cutting Wedge. Your rooms will sound great and look great.

2" thick square	60CW1	\$2.60 ea	\$93.60 case of 40
3" thick square	60CW3	\$3.85 ea	\$103.80 case of 30
4" thick square	60CW4	\$5.30 ea	\$85.86 case of 18
6" thick square	60CW6	\$9.10 ea	\$81.90 case of 10

Note: Minimum order is 10 squares or 10 sheets; shipping charges are additional.

2" thick sheet	60CW2S	\$109.00 ea
3" thick sheet	60CW3S	\$147.00 ea
4" thick sheet	60CW4S	\$181.00 ea
6" thick sheet	60CW6S	\$245.00 ea



Data Accessory Copy Stands

These convenient stands bring your copy close when you need it and move out of the way when you don't. Almond colored. These stands include a "C" clamp for mounting. They are available in letter size with two capacities. The optional extender allows your stand to hold computer printouts or open books.

Letter size 1lb capacity	61LU16007	\$42.00
Letter size 3lb capacity	61LU16008	\$48.00
Extender	61LUEK	\$16.00



Littlite Gooseneck Lamps

- (1) **Littlite 12G** 12" lamp for mounting to consoles that have a BNC connector mount. 61LL12G **\$21.00**
- (2) **Littlite 2/18A** is an 18" lamp kit featuring hi-lo-off switch. 12 volt operation. 61LL2A **\$29.00**
- (3) **Littlite 3/18A** is an 18" high intensity quartz halogen lamp kit with hi-lo-off switch. 12 volt operation. 61LL3A **\$36.00**
- (4) **Littlite WXF AC adapter** for 2/18A or 3/18A. 61LLWXF **\$11.65**

Also Available:
Replacement high intensity quartz bulb. 61LLQ5 **\$7.50**



Pivotelli Mounting Systems

Pivotelli puts your equipment in the right position. These supports are made of the finest solid premium grade steel and are available in three styles. Each holds up to 176 pounds safely and securely and has a 5 year warranty. Supports are packed with hardware for installation into wooden wall studs, brick, or concrete.

The Single Pivotelli has an "L" shaped bracket with a fixed distance from the wall. The bottom support clamps to the sides of the equipment. The Double Pivotelli uses two 12" flex arms which allow the distance from the wall to be adjusted. Mounted equipment may be placed flush against the wall, in a corner, or in any number of positions for optimum viewing or listening. The Triple Pivotelli has a yoke style bracket which securely clamps equipment top to bottom on both sides. Equipment can be moved easily side to side or up and down.

Pivotelli mounts are available in numerous sizes; the prices below are for mounts designed for equipment that is 17 1/2" to 30" wide. Part numbers are for

matte black; gloss white is available at the same price. Your Bradley professional can help you select the exact support for your application.

Single	60PVMLS	<i>MFR LIST</i>	\$119.95
Double	60PVDLS	<i>MFR LIST</i>	\$199.95
Triple wall mnt	60PVTS	<i>MFR LIST</i>	\$264.95
Triple ceiling mnt	60PVTTTS	<i>MFR LIST</i>	\$264.95

Accessory:

Metal stud kit must be used for mounting on metal studs. 60PVM SKL *MFR LIST* **\$10.95**

Call Bradley for a current price quotation

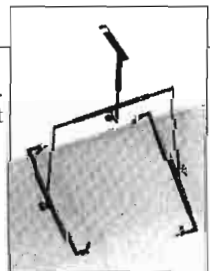

Warning Lights

Fidelipac Warning Lights

Red lettering on a black background provides a highly visible warning that microphones are live. ON AIR or RECORDING legends are available. Lights are 5" high, 10" long, and 2 1/2" deep; and the ON AIR legend is also available in Spanish, French, German, Japanese, and four other languages.

ON AIR	60FP340	MFR LIST	\$69.00
RECORDING	60FP340REC	MFR LIST	\$69.00

McPhilben Warning Lights

These warning lights are functional and elegant. They measure 7 1/2" square, operate on 110VAC, and include two 20 watt lamps. The double faced model is designed for wall or ceiling mounting.

Single faced wall mount	60PRW6142R	\$96.00
Double faced mount	60PRE6242R	\$110.00

BE Studio Warning Light

This classic design light comes complete with a 25 watt red bulb and an attention grabbing flasher. The silkscreened globe housing fastens to a steel mounting plate. Available legends are ON AIR, AUDITION, REHEARSAL, and RECORD. Specify vertical or horizontal lettering. Also available in other languages.

60BR83500X	\$60.00
------------	----------------

Titus Warning Lights

Titus ON AIR and RECORDING lights are beautiful and practical ways of indicating that a studio is in use. Four internal lamps are wired in parallel, and use 24VDC, eliminating the need for relay interface boxes. The mounting base is of solid oiled oak, and overall dimensions are 8 1/8" wide, 4 1/4" high, and 2 1/4" deep. Lettering is on a smoked glass window that is available with either a horizontal or vertical orientation with a silver or a gold frame.

60TIOALXX	MFR LIST	\$125.00
-----------	----------	-----------------



Call Bradley for a current price quotation.

Enberg Alert Monitors

The BA-6 and BA-12 provide visual indication of multiple alert signals. These alerts can be EBS receivers, TTY machines, weather bulletins, transmitter alerts (through your remote control), doorbells, burglar alarms, silence sensors, and cue tones. Two modes of operation are provided and can be individually assigned by channel. Manual Reset requires the operator to reset the monitor, while Auto Reset allows the lamps to stay on from 30 seconds to 30 minutes before shutting off. Any of the monitor's channels has the ability to display telephone ringing voltage with the included interface module. The Alert Monitors simply require a contact closure to trigger their operation. All inputs are opto-isolated, and alerts are displayed with 120 volt, 15 watt flashing lamps. The BA-6 has six lamps, and the BA-12 has twelve. Easy to apply vinyl lettering is included for labeling. Also available are two sizes of remote slave monitors and extra telephone modules.

BA-6 with one phone module	60ENBA6	MFR LIST	\$379.00
BA-6RX rack mounting BA-6	60ENBA6RX	MFR LIST	\$359.00
BA-12 with two phone modules	60ENBA12	MFR LIST	\$749.00

Call Bradley for a current price quotation.

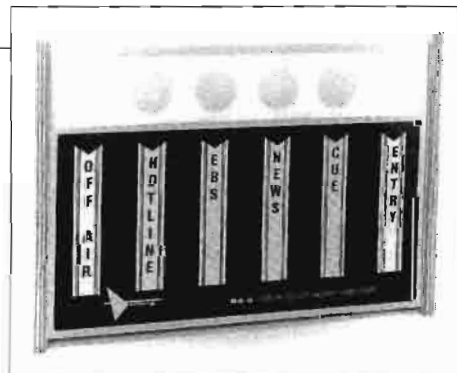

Accessories:

Remote slave monitors with DC control from the BA-6. Up to ten remote monitors may be driven by a single master.

BA-6R six lamp remote	60ENBA6R	MFR LIST	\$199.00
BA-12R twelve lamp remote	60ENBA12R	MFR LIST	\$299.00
Extra telephone module. Each module detects ring for two separate lines.	60ENFN6	MFR LIST	\$35.00

Northern Technologies Surge Protectors

It only takes one powerful line surge to destroy a valuable piece of equipment. Bradley presents transient line protection equipment from Northern Technologies. Our most popular models are the PLS-II, for 15 amp 120VAC circuits, and the TCS-RJ-11 for phone lines. Both respond in less than 5 nanoseconds and use silicon avalanche technology to dissipate tens of thousands of watts per millisecond. We also offer the LAP series for transmitter protection. Engineering assistance to select the power protection equipment for your facility is available by calling Bradley toll-free today.

PLS-II	60NTPLSII	\$139.00
TCS-RJ-11	60NTCSRJ11	\$99.00

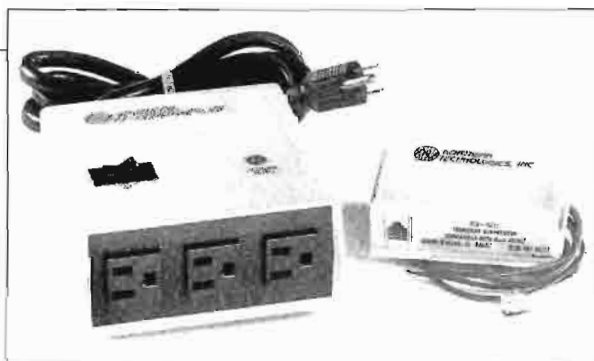

Power Distribution

Antronics UL60S power strip is a heavy duty six outlet box with on/off switch and resettable circuit breaker. 15 amps.

UL60S 61ANUL60S **\$19.95**

Whirlwind AC6R 19" rack mount panel has six outlets, on/off switch, and resettable circuit breaker. 15 amps.

AC6R 61WHPC1 **\$38.00**

Furman PL-Plus has eight switched outlets, a ten foot heavy duty power cord, a front panel LED voltage monitor, and RF filtering. Outlets are rated at 15 amps. The two slide out lamps have a dimmer control.

PL-Plus 60FUPPLUS **\$175.00**

Furman AR-117 AC line regulator protects equipment from problems caused by brownouts and overvoltages. It accepts voltages from 89 to 139 volts, and converts them to US standard 117 volts. Output of 100VAC is also switch selectable. Input capacity 15 amps; output 12 to 15 amps. Unit instantly shuts down to protect your gear should an extreme overvoltage situation occur.

AR-117 60FUAR117 **\$419.00**

Bradley PD10L AC Power Distribution/Rack Illuminator allows you to safely power up to ten pieces of equipment while also protecting them from sudden voltage spikes and damaging power surges. Built-in EMI/RFI filtering will also protect

your audio system from unwanted noise. Eight of the outlets are switched. The PD10L is rated at 15 amps and includes a 6' grounded power cord. The two switched, slide-out lamps illuminate your gear when the PD10L is mounted at the top of your rack.

PD10L 60AR614 **\$124.00**

Bradley PD10LV includes all the features of the PD10L plus a digital voltmeter display on the front panel.

PD10LV 60AR615 **\$189.00**

Accessory:

Replacement bulbs for Bradley panels.

60AR158157 **\$2.75**



Alps Audio and Video Storage Cabinets

Feeling like you're being buried by CD's, carts, or video tapes? Bradley comes to the rescue with the Alps line of high density storage cabinets. Each cabinet has a footprint of only 2 feet by 4 feet, yet stores hundreds of tapes or CD's. Base cabinets are available in heights of 40" and 56", and stackable top cabinets are 45".

Models are available to store CD's, audio cassettes, DAT, broadcast audio cartridges, and open reel tapes in all widths. Cabinets with partitions for all video formats are available to hold both raw and boxed tapes. Partitions can be mixed among drawers in a single unit. Cabinets come in white, almond, and gray laminates.

Prices listed illustrate the value of these cabinets. Truck freight is additional. Your Bradley professional can help configure a cabinet to meet your exact requirements. Give him a call today.

Five drawer base unit holding 2160 CD's

60ALCBA605CD **\$1000.00**

Four drawer top unit holding 2592 CD's

60ALCBA446CD **\$1150.00**

Eight drawer base unit holding 3456 CD's

60ALCBA908CD **\$1250.00**

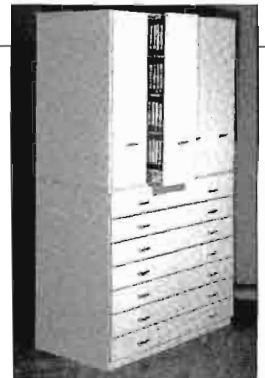

ABCO CD and Cart Racks

These floor standing "Lazy Susans" let you store lots of CD's and carts in a small space. All carousels stand six feet high and include casters. Each consists of several individual wire racks that can be removed and purchased separately for wall mounting.

280 Capacity CD Carousel 22" diameter 60AB280 **\$330.00**

560 Capacity CD Carousel 27 1/2" diameter 60AB560 **\$592.00**

300 Capacity Cart Carousel 22" diameter 60AB300 **\$366.00**

500 Capacity Cart Carousel 27" diameter 60AB500 **\$558.00**

70 Capacity Wire CD Rack 69 1/2"H x 5 1/2"W x 5 1/2"D 60AB70 **\$63.00**

50 Capacity Wire Cart Rack 65"H x 4 1/2"W x 6"D 60AB70 **\$63.00**

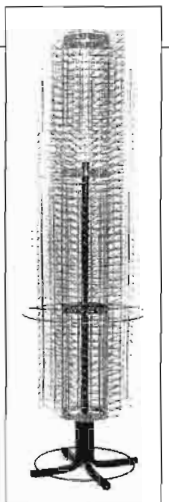

ProRax Cart and CD Racks

These cost effective racks have a mahogany finish.

100 capacity wall cart rack	23 $\frac{1}{4}$ "W x 24 $\frac{1}{4}$ "H x 4 $\frac{1}{2}$ "D		
	60PRW100	MFR LIST	\$99.95
20 capacity wall cart rack	5 $\frac{1}{4}$ "W x 24 $\frac{1}{4}$ "H x 4 $\frac{1}{2}$ "D		
	60PRW20	MFR LIST	\$45.00
80 capacity wall or desk CD rack	23 $\frac{1}{4}$ "W x 15 $\frac{1}{2}$ "H x 4 $\frac{1}{2}$ "D		
	60PRCD80W	MFR LIST	\$104.00

Call Bradley for a current price quotation.



Ruslang CD Racks

Bradley Broadcast makes Ruslang quality available to store your CD's. Since discs are held without shelves, they are easy to keep clean. Wall mount and lazy susan table top units are available. Stack-on units may be placed on top of the lazy susans to double capacity. Available in walnut, oak, black, and other colors.

96 capacity wall unit	18" W x 5 $\frac{3}{4}$ "D x 23 $\frac{3}{4}$ " H.		
	60RLCD96		\$113.00
128 capacity lazy susan	16" Turning radius, 26 $\frac{1}{2}$ " high.		
	60RLCD128LS		\$313.00
256 capacity lazy susan	23 $\frac{1}{4}$ " Turning radius, 26 $\frac{1}{2}$ " high.		
	60RLCD256LS		\$435.00
384 capacity lazy susan	31" Turning radius, 26 $\frac{1}{2}$ " high.		
	60RLCD384LS		\$572.00

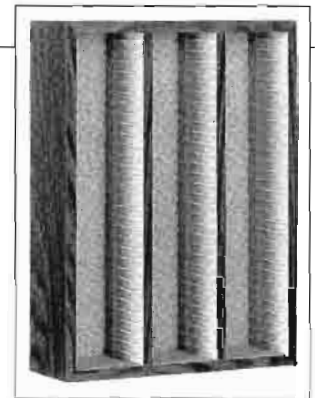

Fidelipac Cart Racks

Fidelipac Tabletop Cart Racks

These carousels have removable wire racks. The TR-48 holds 48 carts in four racks, stands 20" high, and has a diameter of 15". The TR-96 holds 96 carts in 8 racks, stands 20" high, and has a 20" diameter.

TR-48	60FPTR48	MFR LIST	\$104.00
TR-96	60FPTR96	MFR LIST	\$185.00

Fidelipac MR-200 Mobile Cart Rack

Fully loaded, the MR-200 can store 200 carts. It consists of eight WR-25 single column racks mounted on the MRB-1 carousel rack base with casters. The WR-25 can be removed from the carousel even when fully loaded, and is available separately to serve as a 25 cart wall rack.

MR-200 complete	60FPMR200	MFR LIST	\$371.00
MRB-1 base and frame only	60FPMRB1	MFR LIST	\$83.00
WR-25 rack only	60FPWR25	MFR LIST	\$36.00

Call Bradley for a current price quotation.

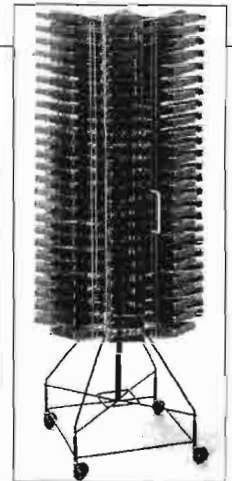
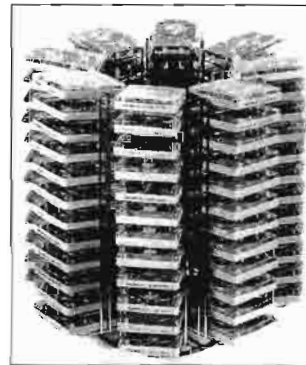

Simpac Cart Racks

Carts, carts, carts. In the studios, in the newsroom, in the offices ... everywhere you look in a radio station you find piles of carts. With these handy Simpac cart racks, you can build your own cart storage to handle as few or as many carts as you like. Each black plastic unit holds 10 carts and comes with mounting hardware.

Simpac Cart Racks	60SICRBK	\$6.30
12 or more		\$5.75 ea



Middle Atlantic RACK ACCESSORIES

Custom Rack Shelves

Now you can put anything in a rack, without modifying the unit.

Custom front panel cutouts are made for your equipment and the complete shelf is shipped to you in two to three weeks. Many patterns are already on file. Some assembly is required. These shelves do not include hardware to secure equipment for transport.



Brushed and black anodized aluminum
61MARSH4A \$98.00

Textured black enamel on steel
61MARSH4S \$89.00

Utility Rack Shelves

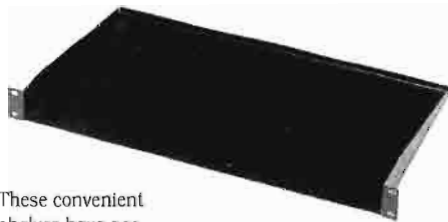

These convenient shelves have one piece construction and come in two sizes. The one space (1 1/2") shelf is 10 1/2" deep and supports up to 35lbs. The two space (3 1/2") shelf is 14 1/2" deep and holds 50lbs. Either may hold taller equipment within its depth and weight limits.

One space 61MAU1 \$29.00
Two space 61MAU2 \$38.00

Also available:

Soundolier rack shelves, made of 16 gauge steel, are available in black textured enamel and in the 24 other Soundolier colors. 4 spaces (7" 14" deep).
60SDSH197 \$33.00

K.D. Shelves

Now you can put together your own



rack shelves. Flush studs are provided with bottoms for easy assembly. K.D. shelves are 16 gauge steel painted with black baked enamel, and can be used with equipment up to 17 1/2" wide. Ears come packaged in sets of two. **For a complete shelf, you need to purchase both a bottom unit and set of ears.**

5 1/4" tall, 15 1/2" deep ears
61MAKDE3 \$30.00

7" tall, 15 1/2" deep ears
61MAKDE4 \$31.00

8 1/4" tall, 15 1/2" deep ears
61MAKDE5 \$32.00

10 1/2" tall, 15 1/2" deep ears
61MAKDE6 \$33.00

12 1/4" tall, 15 1/2" deep ears
61MAKDE7 \$35.00

14" tall, 15 1/2" deep ears
61MAKDE8 \$36.00

15 1/2" deep bottom
61MAKDB \$17.00

5 1/4" tall, 11 1/2" deep ears
61MAKDE3S \$29.00

11 1/2" deep bottom
61MAKDBS \$16.00

Sliding Shelf

This sliding shelf



supports up to 40lbs and pulls out 14". Usable mounting surface is 17 1/2" wide and 15 1/2" deep. Your equipment sits on top, and the flush, spring loaded latch keeps the shelf shut. Unique rear telescoping support fits any rack and does not require rear rails. Occupies one rack space.

61MASS \$89.00

Rack Drawers

These drawers have a fully enclosed top to ensure that no dust goes in and no contents fall out. The front panel has a flush spring loaded handle that latches to keep drawer closed. Full extension, ball bearing slides extend drawer 14" out. Finished in black enamel, these racks may be ordered with a keylock option for security.



2 spaces 61MADWR2 \$98.00
2 spaces w/lock 61MADWR2L \$123.00
3 spaces 61MADWR3 \$119.00
3 spaces w/lock 61MADWR3L \$144.00
4 spaces 61MADWR4 \$143.00
4 spaces w/lock 61MADWR4L \$168.00

Rack Chassis

Use these chassis



for your custom electronics. Flush face is easily removed for punching and the rear panel is full height and removable. Face and rear are black anodized aluminum, while the top, bottom, and sides are steel. These chassis are 10" deep and shipped fully assembled.

1 space 61MACH1 \$54.00
2 spaces 61MACH2 \$61.00
3 spaces 61MACH3 \$66.00

Blank Panels

Fill those unloaded rack spaces with these flanged, black aluminum panels.

1 space 61MABL1 \$11.00
2 spaces 61MABL2 \$12.75
3 spaces 61MABL3 \$15.70
4 spaces 61MABL4 \$17.00

Rack Mount Holders

Our rack mount holders are a great way to keep frequently used media close at hand. All are made of 20 gauge steel with black, baked enamel.

- Compact disc holder for 40 CD's; 4 spaces tall.	61MACDSH	\$53.00
- Cassette holder for 33 audio cassettes; 3 spaces tall.	61MACS	\$50.00
- DAT holder for 27 digital audio tapes; 3 spaces tall.	61MADAT	\$50.00
- 3 1/2" floppy disk holder for 60 floppies; 3 spaces tall.	61MAFD	\$50.00
- VHS tape holder for 14 tapes; 5 spaces tall.	61MAVHS	\$57.00
- LP, 10 1/2" reel tape, & binder holder; 8 spaces tall.	61MALP	\$105.00



Rack Rails



Our best 1/8" thick galvanized steel rails are punched and tapped for 10-32 x 3/4" screws. Side mounting holes are 9/32" diameter. Sold in pairs.

8 spaces (14")	61MARR8	\$11.75
10 spaces (17 1/2")	61MARR10	\$14.10
12 spaces (21")	61MARR12	\$16.75
14 spaces (24 1/2")	61MARR14	\$18.65
16 spaces (28")	61MARR16	\$20.90
18 spaces (31 1/2")	61MARR18	\$22.70
21 spaces (36 3/4")	61MARR21	\$26.00
27 spaces (47 1/4")	61MARR27	\$32.00
45 spaces (78 3/4")	61MARR45	\$46.00

Also available:
Model RFF

This is a 45 space (78 3/4") rail that has tapped holes spaced 5/8"-5/8"-1/4" to fit equipment with non-standard spacing.

61MARRF45	\$51.00
-----------	---------

Fan Panels and Fans



These 3 space panels are punched for 4 1/2" diameter fans and include grills. The quiet, 100 CFM fans are designed for long life and quiet operation, and include line cords.

Panel for 1 fan	61MAFP1	\$26.00
Panel for 2 fans	61MAFP2	\$28.00
Panel for 3 fans	61MAFP3	\$30.00
Fan	61MAFAN	\$30.00

Also available:

Filter Kit with washable filter keeps dust out of your gear. Can be fit over fan panels or used alone. Three spaces tall.

61MAFILTER	\$24.00
------------	---------

Security Covers



Ideal for providing both security and protection, these perforated steel covers are 1" deep and allow easy viewing of control settings. Rubber edging prevents marring of equipment.

1 space	61MASEC1	\$18.00
2 spaces	61MASEC2	\$22.00
3 spaces	61MASEC3	\$24.00

Also available:

Orban acrylic security covers to protect your rack mounted equipment from fiddling fingers or inquisitive eyes. Includes three sets of screws: thumbscrew, Phillips head, and hex socket head (with wrench). Specify clear, blue translucent, or opaque white.

One space	60OBACC11XX	MFR LIST	\$55.00
Two space	60OBACC12XX	MFR LIST	\$60.00
Three space	60OBACC13XX	MFR LIST	\$60.00
Four space	60OBACC14XX	MFR LIST	\$60.00

Call Bradley for a current price quotation.

Vent Panels



These 16 gauge steel panels have one piece construction and are perforated with 5/32" diameter holes yielding 68% open area.

1 space	61MAVT1	\$ 9.35
2 spaces	61MAVT2	\$11.25
3 spaces	61MAVT3	\$13.20
4 spaces	61MAVT3	\$14.40
6 spaces	61MAVT3	\$15.30
8 spaces	61MAVT3	\$16.15
10 spaces	61MAVT3	\$17.35

UCP Punched Panels

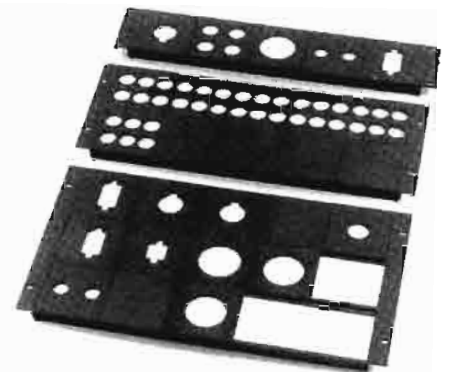

Middle Atlantic has developed a unique way to have custom panels without the cost and time of custom fabrication. Frame kits, which have rack ears and mounting bars, come in sizes from 2 to 10 spaces. Punched modules, which are 2 spaces high and fit 5 across a rack, are provided punched for your choice of connectors. Combinations are unlimited. A fully loaded 2 space frame is less than \$50. Call or fax today for details.

Rack Hardware



Each package contains 10-32 x 3/4" machine screws and flat fiber washers. Available with Phillips machine head, Torx-Post, and a special tamper-proof tapered recess for security. Black.

Phillips , 100 ea	61MAHDWEP	\$16.50
Torx-Post , 50 ea	61MAHDWET	\$12.00
Driver for Torx-Post screws	61MATBIT	\$10.25
Security , 100 ea	61MAHDWES	\$22.80
Driver for security screws	61MABIT	\$1.60
Shoulder washers are non-conductive and are used with our standard washers to isolate equipment from the rails. 100 ea	61MAHDSW	\$6.50



RK Racks

These economical racks combine convenience and great looks. Surface is in black laminate over 5/8" thick, high density particle board. Rails are drilled and tapped with full hole spacing to fit all equipment. Each rack is individually boxed knocked down for convenient UPS delivery. Assembly is fast and easy with supplied tools. New for 1991 are smaller sizes for desk mounting, and additional depth on larger sizes

2 space (3½") 16" deep	61MARK2B	\$48.00
4 space (7") 16" deep	61MARK4B	\$51.00
8 space (14") 18" deep	61MARK8B	\$78.00
12 space (21") 18" deep	61MARK12B	\$84.00

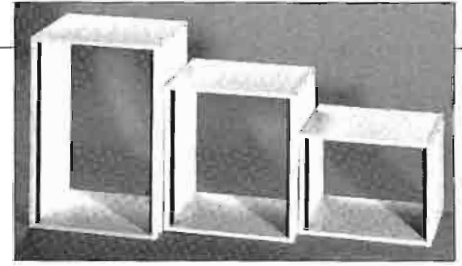

16 space (28") 18" deep	61MARK16B	\$89.00
20 space (35") 18" deep	61MARK20B	\$98.00

KSI INR Racks

Our own line of installation racks, manufactured for us by KSI, is the most rugged and attractive way to handle your 19" rack mounted equipment. Constructed of 3/4" wood multi-ply, the outer surfaces are genuine poplar veneer (not laminated plastic) and have the look of real furniture. Choose from natural poplar, dark wood stain, or black lacquer. Charcoal gray carpeting is available at extra cost. INR racks come with drilled and tapped front rails. All INR racks are built to order and shipment time is generally two to four weeks. Prices include crating; shipping is additional.

Exterior Dimensions:

- Height is 3¾" plus rack height (includes 2" bottom skirt).
- Width is 22¾" overall.
- Racks up to 27 spaces (47¼") are 18" deep.
- Racks 28 spaces (49") and taller are 22" deep.
- Rails are inset 1/2" from the front of the rack.

Standard Options:

- **Rear Mounting Rails** that are drilled and tapped. See prices below.
- **Back Panel** is constructed of 3/4" wood multi-ply. Attaches with hook and loop type fasteners for easy access. See prices below.
- **Hinge and lock set** converts back panel into a functional rear door.
60KBINRHL **\$63.00**
- **Six Inch Skirt** for use when table mounting the rack, or when bottom of gear needs to be higher off the floor. Replaces 2" skirt and adds 4" to overall rack height.
60KBINR6PED **\$28.00**

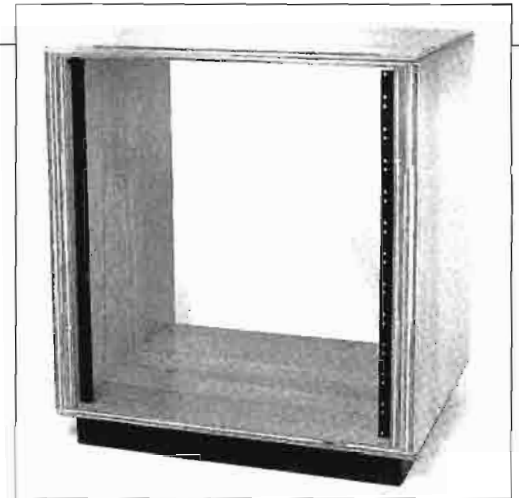

- **Sloped Skirt** replaces the standard skirt. 3" in front and slopes to 1" in rear for use with very short racks to increase visibility of gear when table mounting. There is no charge for this option.
- **Heavy Duty Casters** are rated at one-half ton. Set of four replaces skirt and adds 2" to overall rack height.
60KBINRHDC **\$122.00**
- **Extra Depth Option** for shorter racks increases depth to 22".
60KBINRED **\$24.00**

RACK PART #	RACK SPACES	RACK HEIGHT	RACK PRICE	REAR PANEL	REAR RAILS	RACK PART #	RACK SPACES	RACK HEIGHT	RACK PRICE	REAR PANEL	REAR RAILS
60KBINR4	4	7"	\$83.00	\$21.00	\$12.00	60KBINR18	18	31½"	\$202.00	\$ 63.00	\$ 54.00
60KBINR5	5	8"	83.00	21.00	15.00	60KBINR19	19	33½"	210.00	66.00	57.00
60KBINR6	6	10½"	83.00	21.00	18.00	60KBINR20	20	35"	218.00	69.00	60.00
60KBINR7	7	12½"	102.00	25.00	21.00	60KBINR22	22	38½"	245.00	76.00	66.00
60KBINR8	8	14"	109.00	28.00	24.00	60KBINR24	24	42"	262.00	83.00	72.00
60KBINR9	9	15¾"	118.00	32.00	27.00	60KBINR26	26	45½"	279.00	90.00	78.00
60KBINR10	10	17½"	125.00	35.00	30.00	60KBINR28	28	49"	304.00	97.00	84.00
60KBINR11	11	19¼"	134.00	38.00	33.00	60KBINR30	30	52½"	320.00	104.00	90.00
60KBINR12	12	21"	143.00	42.00	36.00	60KBINR32	32	56"	336.00	111.00	96.00
60KBINR13	13	22¾"	152.00	45.00	39.00	60KBINR34	34	59½"	353.00	118.00	102.00
60KBINR14	14	24½"	169.00	49.00	42.00	60KBINR36	36	63"	380.00	125.00	108.00
60KBINR15	15	26¼"	176.00	52.00	45.00	60KBINR38	38	66½"	396.00	132.00	114.00
60KBINR16	16	28"	185.00	56.00	48.00	60KBINR40	40	70"	417.00	138.00	120.00
60KBINR17	17	29¾"	194.00	59.00	51.00						



Soundolier Equipment Racks

Bradley and Soundolier offer a broad range of equipment racks for every purpose. Our Quick Shipper Program assures shipment of your rack within three working days of your order. Racks eligible for this service are marked (*) below and must be ordered in black textured enamel; you must request this service at the time of your order. Other sizes, or racks ordered in any of the other 24 available colors generally ship in two to three weeks.

The 100 Series racks, our most popular, provide 18½" inches of rackable depth, have fixed side panels, and include a back door with lock. They may be ordered welded or knocked down. Welded racks are more costly to ship, but are sturdier

100 Series Racks

Size	Welded		Knocked Down	
	Part #	Price	Part #	Price
36"	60SDWA10036	\$248.00	60SD10036	\$227.00
42"	*60SDWA10042	\$258.00	*60SD10042	\$238.00
61"	*60SDWA10061	\$296.00	*60SD10061	\$280.00
70"	60SDWA10070	\$330.00	*60SD10070	\$313.00
77"	*60SDWA10077	\$345.00	60SD10077	\$328.00

for extremely heavy loads. Rails are drilled and tapped. Steel or plexiglass front doors are optional. 200 Series transmitter racks offer side panel bracing and other features to make them suitable for your heaviest loads. Rails are front to back adjustable, and price includes locking back and front doors. 200 Series racks may be ordered without front doors, and rear mounting rails are optional.

200 Series Welded Racks, w/ Front Door

77" *60SDWA20077 \$528.00

Accessory:

Roller truck for 100 and 200 Series
*60SDCT1020 \$168.00

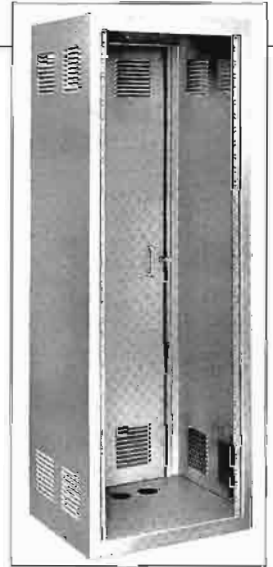

Calzone Studio Series Racks

These sturdy oak veneer racks look as good in your living room as they do in the studio. The upper section is slanted so your equipment is readily accessible and the lower section has a straight vertical mount. A great alternative to tape machine consoles. Tapped and drilled rack rails and 2" double steel swivel casters are included. Shipped knocked down, assembly takes just minutes using quarter turn latch screws. Both models have 8 rack spaces (14") in the lower rack.

8 space (14") upper rack	70CAS88	\$138.00
12 space (21") upper rack	70CAS812	\$152.00



Ruslang Electronic Equipment Racks

These standard 19" racks come in heights from 21" to 70" of vertical mounting space. They are constructed of high-pressure laminates and steel rack mounts. A variety of solid colors or woodgrain finishes are available. Prices are for 18" deep racks. Call for pricing on versions up to 24" deep and for other heights.

12 space (21")	60RLR21S	\$309.00
16 space (28")	60RLR28S	\$328.00
20 space (35")	60RLR35S	\$350.00
24 space (42")	60RLR42S	\$370.00
28 space (49")	60RLR49S	\$388.00
32 space (56")	60RLR56S	\$409.00
36 space (63")	60RLR63S	\$430.00
40 space (70")	60RLR70S	\$452.00

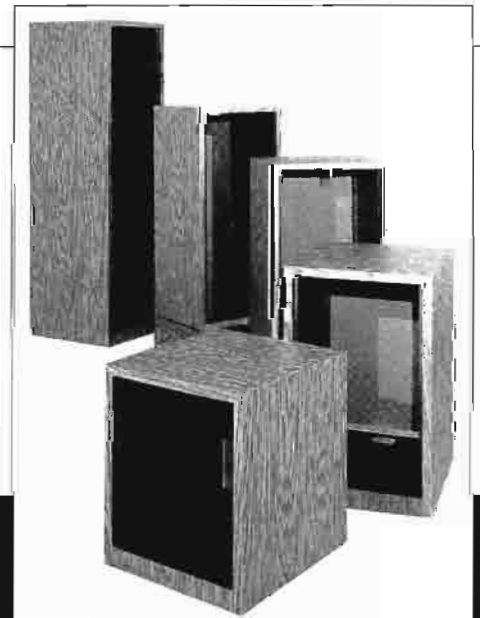

Bradley Broadcast...
Where Service and Engineering Make the Difference

FURNISHINGS

Toll Free: 800-732-7665 • MD & DC: 301-948-0650 • FAX: 301-330-7198 • **Bradley Broadcast**



Benchmark Meter Systems

These "on-line" meters use the finest true VU meters, but are instantly switchable to a PPM mode via front panel control. System references of +4, and +8dBu are selectable. The Peak Hold function can capture and hold the highest peaks for later review, even when monitoring in VU. Sum and difference (L+R, L-R) metering is just a pushbutton away in both modes. Excellent audio design allows audio to be looped through or matrix audio decoded. The three meter version allows continuous monitoring of mono, SCA, or SAP signals. BNC scope outputs can be patched at the buffered inputs and/or the matrix outputs. To round out your system, balanced audio outputs and a stereo headphone amp are optionally available.

SPM-2 two meter system	60BMSPM2	MFR LIST	\$1150.00
SPM-3 three meter system	60BMSPM3	MFR LIST	\$1560.00

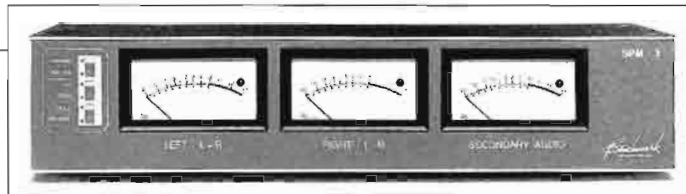

Also available:

Sifam True VU Meter includes a peak LED hole, 12V internal illumination, and die cast mounting bezel. You can count on this 3 1/2" meter for accuracy.

Sifam R22A 60BMVU1 MFR LIST **\$120.00**

Call Bradley for a current price quotation.

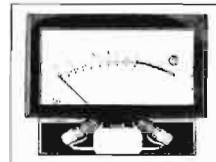

Dorrough Model 40-A Loudness Monitor

The war has raged on for years: VU vs. PPM metering. The VU meter provides an indication of loudness without telling you what's going on electrically. The PPM lets you see the peak levels your electronics have to deal with, but is of limited utility for judging loudness. The Dorrough Loudness Monitor uses a three color, 40 LED array with two simultaneous displays. A bar graph shows perceived loudness while a bright-dot display indicates electrical peak levels. Display range -25 to +14dBm. Input is screw terminal, direct coupled balanced bridging. Zero reference can be set from -30 to +20dBm. Smaller versions are also available.

40-A	60DR40A	MFR LIST	\$475.00
-------------	---------	----------	-----------------

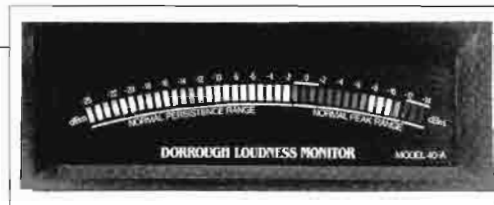

Accessory:
Rack mount kits
(3 1/2" high)

For one meter	60DR40SR	MFR LIST	\$45.00
For two meters	60DR40DR	MFR LIST	\$45.00

Call Bradley for a current price quotation.

Dorrough 1200 Stereo Signal Test Set

The 1200 is a modern version of the classic "gain set." The unit includes two Dorrough Loudness Meters which indicate both peak and average levels on a single display. Front panel controls allow accurate measurement of signals in numerous ranges down as low as -76dBm. The meters may be operated in either Left and Right or Sum and Difference formats. This test set can be invaluable in setting levels, checking cross-talk, and many other measurements. No facility that is serious about its audio quality can afford to be without it.



1200	60DR1200	MFR LIST	\$1650.00
-------------	----------	----------	------------------

Call Bradley for a current price quotation.

Logitek Bright VU

Bright VU is a three color coded LED meter. It bridges into any audio circuit via a balanced high impedance rear panel input. Sensitivity is adjustable to accommodate any system operating level from -20dBm to +20dBm. Ballistics are switchable for either peak or average. Bright VU is ideal for level monitoring in large control rooms where distances make even the largest standard VU meters difficult to read. Individual meter channels can be set to display either average (VU) or peak (PPM) levels. Available in complete, rack mounting sets that are one rack space high, or as individual meters.

Single stereo package	60LTBV2C	MFR LIST	\$515.00
Dual stereo package	60LTBV4S	MFR LIST	\$795.00
Triple stereo package	60LTBV6S	MFR LIST	\$995.00

Call Bradley for a current price quotation.

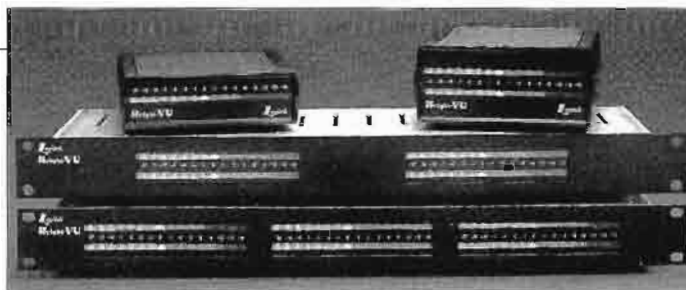

Mono meter in enclosure. Requires power supply.	60LTBVUM	MFR LIST	\$195.00
Stereo meter in enclosure. Requires power supply.	60LTBVUS	MFR LIST	\$330.00
Power supply for two mono or one stereo Bright VU.	60LTBVUPS	MFR LIST	\$50.00



Symetrix SX205 Precision Audio Meter

The SX205 uses dual 16 segment LED displays to measure voltage and power. Front panel buttons select whether each channel will operate under VU or PPM ballistics, and peak hold time may be adjusted by a front panel control. The voltage scale is -39VU to +6VU, and the power display may be set for full scale reading of 100W or 1000W, referenced to 2, 4, or 8 ohms. The SX205 also includes a useful 1kHz sine wave oscillator and the displays may be set for bar graph or dot format. Microprocessor control delivers outstanding accuracy.

SX205 60SYSX205 *MFR LIST* **\$339.00**

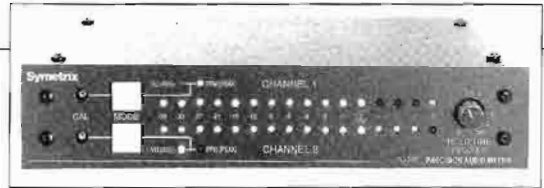

Accessory:
Rack mount kit for one or two SX series units. 60SYRM2
Call Bradley for a current price quotation.

MFR LIST **\$39.00**

Inovonics TVU On-Screen Audio Level Display

Watch your audio levels on the same screen as you monitor your video. The TVU lets you position a VU or PPM display anywhere on your screen. Both displays can be calibrated to your "house" levels, and the VU display offers an adjustable peak flasher function. Video input is bridging or 75 ohm terminating, with a 75 ohm output. Both balanced and unbalanced audio inputs allow the TVU to be fed from a wide variety of sources.

TVU 60INTVU *MFR LIST* **\$620.00**



Accessory:
Rack mount kit for one or two units 60INTVU20
MFR LIST **\$40.00**
Call Bradley for a current price quotation.

Toa DT-910 AM/FM Tuner

The DT-910 provides highly sensitive reception and extremely stable operation. Employing a quartz locked, frequency synthesized, digital tuning system, the DT-910 provides memory for 10 AM and 10 FM preset stations. Front panel controls allow the choice of AM or FM and up or down station selection. Included in the DT-910 is a signal strength meter and automatic next station scan with next station display.

DT-910 60TODT910 *MFR LIST* **\$350.00**



Accessory:
Rack mount kit 60TOMBDT910 *MFR LIST* **\$54.00**
Call Bradley for a current price quotation.

Technics SA-GX100 AM/FM Receiver

The Station File feature of the SA-GX100 allows you to group up to 24 preset stations in six categories and scan within each group. This AM/FM stereo receiver puts out 40 watts per channel into 8 ohms, has 4 audio inputs and a VCR (audio/video) input, A and/or B speaker selector, and 36 key wireless remote. A great choice for the studio, office, or living room.

SA-GX100 60TCSAGX100 *MFR LIST* **\$229.00**

Accessory:
Rack mount shelf 61MATCSAGX100 **\$89.00**



Call Bradley for a current price quotation.

Denon TU-660 AM/FM Tuner

The TU-660 is the first tuner whose AM section meets the NRSC standards for audio de-emphasis, bandwidth, and noise filtering. In addition, it has superior FM Stereo reception ability. Thirty station presets and a full set of tuning modes are among this unit's fine features.

TU-660 60DNTU660 *MFR LIST* **\$330.00**

Call Bradley for a current price quotation.



Accessory:
Rack mount shelf 61MADNTU660 **\$89.00**



Carver PSB-11 AM Stereo/ FM Stereo Tuner

This broadcast reference tuner is designed for full bandwidth reception of both AM and FM stereo signals. AM response is 20Hz to 15kHz ± 0.3 dB with -75dB noise in the AM stereo tuning mode. The Asymmetrical Charge-Coupled FM Detection circuit reduces multipath and noise. Rack mounting chassis and balanced outputs ease installation.

PSB-11 60CVPSB11 MFR LIST \$799.95



Call Bradley for a current price quotation.

Belar AS-1 Audio Sentry

Silence is golden, except when it's your station that's silent! A silence sensor is an absolute necessity for unattended satellite or automation systems, or for AM/FM combo operations where only one station is monitored off the air. The AS-1 has both aural and visual alarms. A front panel push button lets you silence the aural alarm while you're troubleshooting, and rear panel connections allow you to also use an external alarm. Upon restoration of audio, the AS-1 automatically resets. Order an AS-1 today; it's inexpensive insurance.



AS-1 60BLAS1 MFR LIST \$250.00

Call Bradley for a current price quotation.

Gentner Silence Sensor

This is a silence sensor that does something more than just make noise when things get quiet. On detecting silence, an open collector output (capable of sinking 250mA, 48VDC, non-inductive) is activated. Simultaneously, a timer is activated. At the end of the time period, a second open collector output and a relay closure are also activated. Use the first output for an alarm, and the second output for a second, louder alarm while the relay closure starts a backup tape machine. The timer's period is user adjustable over a range of 0-99 seconds or 0-99 minutes.



The Silence Sensor is ideal as a fail safe device when using a dial-up transmitter remote control such as the Gentner VRC-2000.

Silence Sensor 60GESS MFR LIST \$449.00

Call Bradley for a current price quotation.

Logitek Mon-10

The Mon-10 is a stereo 10x1 passive switcher with wire-capture terminal blocks and front panel switching to look at Left, Right, L+R, or L-R and feed the selected signal to the VU meter and internal monitor amp. The meter sensitivity may be selected over a 50dB range in 10dB steps. The monitor amp feeds a front-panel speaker, a front-panel headphone jack, and rear panel speaker connections.

Mon-10 60LTMON10 MFR LIST \$845.00

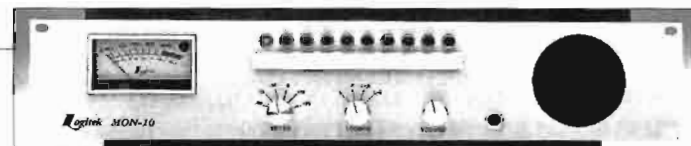

Call Bradley for a current price quotation.

Titus MLW-1 Automatic Stereo Router

The Titus MLW-1 combines a silence alarm, an automatic polarity corrector, and a stereo signal router in one powerful package. The MLW-1 will detect the loss of either one or both audio channels. For the loss of one channel, it will feed the remaining channel into both outputs. If both channels fail, the MLW-1 will automatically switch to one of two backup sources. If the polarity of the audio in either mono or stereo is out of phase, the MLW-1 automatically corrects the problem. An alarm output will alert the operator of any problems, or you could hook it up to an autodialer and have it call you. In your production room, the MLW-1 will be one of your most useful tools. It will take a stereo input and give you an in-phase stereo output, an out-of-phase stereo output, an L+R sum output, an L-R difference output, and both left and right outputs individually, all by pushing the proper button. Four meters on the front panel, together with lighted push buttons, keep you fully informed of its status and operation.



MLW-1 60T1MLW1 MFR LIST \$1800.00

Also available:

The Last Word has all the features of the MLW-1 with the addition of a built-in stereo synthesizer. The Last Word detects mono programming and will automatically insert its built-in or an external stereo synthesizer for uninterrupted stereo transmission.

The Last Word 60T1TLW1 MFR LIST \$2975.00

Call Bradley for a current price quotation.



Precision Power 2300A Phase Chaser

The 2300A is a third generation audio timebase corrector. The 2300A is for radio and TV stations, video post facilities, audio production houses, and anyone who is concerned with proper stereo imaging and absolute monaural compatibility. The 2300A has three important functions. First, using a novel cross correlator design, the unit can detect and correct inter-channel time delay errors caused by tape head azimuth error or other reasons. Second, the Phase Chaser detects polarity reversal and corrects it using a silent crossfade technique. And third, in the event of a channel drop out, the active input is directed to both outputs. Each



Phase Chaser function has user adjustable parameters to optimize its performance in the particular installation.

2300A 60HO2300A MFR LIST \$2995.00
 Call Bradley for a current price quotation.

The Informers

How hot or cold is it outside? What's the temperature in your transmitter room or garage? These are questions we all ask every day. Bradley answers them with the Informers, a pair of inexpensive and extremely accurate temperature sensing devices. Available in a digital readout version or as a voltage output unit, both Informers are factory calibrated to standards that are traceable to those set by the National Bureau of Standards.

The digital readout Informer accurately reads from -40° to 120°F, and has high and low temperature memories with reset. Its small size, 3 way mounting bracket, and large LCD readout allow it to be placed virtually anywhere. The 50' cable with triple sealed sensor lets you put the probe outdoors for continuous readings. A single alkaline AA cell powers it for up to a year.

Designed for transmitter remote control use, the voltage output Informer provides an output of 10 millivolts per degree (100°F equals one volt). Its range of 0° to 230°F permits you to install the probe (via the 18' supplied cable) anywhere, including inside the transmitter's exhaust ducts. Users need to provide the 5 to 12 volts to power the unit.

Let Bradley show you how to stay on top of the temperature without getting financially under the weather.



Digital readout 60TKI \$54.95
Voltage output 60TKITX \$48.95

Conex UM-33 Omni-Q

The UM-33 is a stereo, eight input to one output general purpose cue, monitor, and line amplifier. Uses include network/remote line monitor and buffer amp, automation cue amplifier, transmitter input select/monitor, tape recorder input selector, telephone line source selector, and console input expander. A built-in test oscillator outputs 40Hz, 400Hz, and 7500Hz which can be used for level and response tests, and front panel LED VU meters monitor the UM-33 line output. A monitor amp drives two built-in speakers or provides 2 watts per channel to drive external speakers. Every station has a place for at least one of these versatile units, and at this low price you can afford several.



UM-33 60CNUM33 MFR LIST \$550.00
 Call Bradley for a current price quotation.

Wohler AMP-1A Audio Monitor

The AMP-1A provides high quality, full stereo monitoring in the smallest rack mount package available. The careful acoustic design creates real bass and treble response from below 100Hz to above 10kHz, at levels loud enough for even a busy production control room or mobile truck. Mid- and high-frequency material is reproduced through the left and right speakers, while low frequency material is combined into the center driver. Stereo imaging is quite good when the listener is positioned anywhere in front of the unit. The AMP-1A is only one rack space high and it requires only 15" of depth, including connector space. The unrivaled combination of compact design, ease of use, and clear stereo monitoring make this unit



ideal for VTR's, mobile production vehicles, cable facilities, teleconferencing, satellite links, duplication rigs, security systems, and more.

AMP-1A 60WOAMP1 MFR LIST \$720.00
 Call Bradley for a current price quotation.



Fostex 6301B

No matter how sophisticated a facility you have, it always seems that you can use additional audio monitoring capability. Now it is available in these convenient, high quality self-contained monitors. Measuring only 7¼" x 4¾" x 5", the 6301B packs 10 watts RMS power and 80Hz to 13kHz response into each unit. Use them alone for mono, in pairs for stereo, or use them throughout your station as a house monitor system. Accepts input levels as low as -10dBV. The 6301B has a ¼" TS input. The 6301B/EAV adds an active balanced XLR input and special magnetic shielding, so it can be mounted adjacent to video monitors or other sensitive equipment without causing interference. Keep one pair on the engineer's equipment shelf for special requirements, or take them on remotes for use with your DJ console. Applications for these monitors are practically limitless.

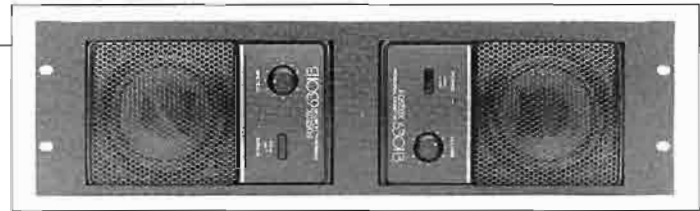

6301B	60FO6301	\$129.00
6301B/EAV	60FO6301X	\$155.00
Accessories:		
Rack kit for single unit	61MA6301RM	\$60.00
Rack kit for two units	61MA6301RMD	\$68.00

Anchor AN-1000 and AN-1400

The AN-1000 is a full range (70Hz to 14kHz, ±4dB) powered monitor speaker. It features a 50 watt MOS-FET amplifier and Anchor's Audio Contour equalization network for full range, low level listening. The unit only measures 5¼" high, 8" wide, and 8½" deep. Line input is ¼" TS, and a balanced XLR mic or line input can be ordered. Anchor offers a wide variety of configuration options.



AN-1000	60AN1000	<i>MFR LIST</i>	\$385.00
AN-1000M with balanced, XLR mic input added.	60AN1000M	<i>MFR LIST</i>	\$436.00
AN-1000L with balanced, XLR line input added.	60AN1000L	<i>MFR LIST</i>	\$436.00
AN-1000S with five line level inputs and selector switch.	60AN1000S	<i>MFR LIST</i>	\$580.00
AN-1000ES with external speaker output added.	60AN1000ES	<i>MFR LIST</i>	\$407.00
AN-1001 unpowered monitor driven by AN-1000. Use with AN-1000ES.	60AN1001	<i>MFR LIST</i>	\$169.00
Accessories:			
SM-001 shielded speaker option. Price is for upgrade at time of purchase.	60ANSM001	<i>MFR LIST</i>	\$24.00

RM-710 single rack mount kit	60ANRM710	<i>MFR LIST</i>	\$46.00
RM-720 dual rack mount kit	60ANRM720	<i>MFR LIST</i>	\$46.00
Also available:			
The AN-1400 powered monitor is standard with a shielded speaker so that it may be used close to video monitors and other sensitive devices. Transformer balanced XLR input and front panel headphone output are provided. The AN-1400 is designed for mounting into one half of a Tektronix or equal rack mount.			
AN-1400	60AN1400	<i>MFR LIST</i>	\$647.00
AN-1400S with two balanced line level inputs and selector switch.	60AN1400S	<i>MFR LIST</i>	\$712.00
Call Bradley for a current price quotation.			

Auratone 5MVC

Here's a unique monitoring system: three independent Auratone 5C monitor speakers in one compact enclosure. Only 5¼" high, it can sit on top of your console or, with optional ears, be rack mounted. Frequency response is 160Hz to 12.5kHz, ±5dB. Power handling is 40 watts for each speaker. Use this great set to simultaneously monitor the mono sum as well as left and right, or use them at the transmitter for simultaneous AM and FM monitoring. Put your imagination to work and you'll find many applications.



5MVC	60AA5MC	<i>MFR LIST</i>	\$172.50
-------------	---------	-----------------	-----------------

Accessory:
Rack ears
 60AA5MCR *MFR LIST* **\$9.95**

Call Bradley for a current price quotation.

Auratone 5CV Super Sound Cubes

These monitors provide amazing performance for their size and price. Durability, smooth full range response, 40 watts RMS power handling, and portability make the Auratone a favorite for comparison and final mixes, auditioning, remotes, and as a reference standard speaker. Walnut woodgrain or black vinyl finish with black foam grille.



Walnut	60AA5C	\$94.00 pr
Black	60AA5CB	\$94.00 pr



JBL Control Monitors

1. Control One

The Control One two way loudspeaker system is a small, high performance monitor especially suited to broadcast and video applications. It is made of a molded polypropylene material with special magnetic shielding. As a result, it can be mounted adjacent to video monitors or other sensitive equipment without causing interference. High power handling capacity and excellent audio quality make it suitable for even your most demanding monitoring needs.

Control One 60JBCNTRL1 *MFR LIST* **\$250.00 pair**

Control One Plus

Identical in shape to the Control One, the new Plus version offers greater bandwidth and better bass response. Produced in matched, mirror image pairs for superior stereo imaging.

Control One Plus 60JBCNTRL1P *MFR LIST* **\$295.00 pair**

2. Control Five

Like the Control One, the Control Five is made of a molded polypropylene material with special magnetic shielding and is especially suited to broadcast and video applications. The system consists of a titanium dome tweeter and a 6 1/2" woofer. The dividing network incorporates protection circuitry to prevent overload damage, and uses high quality components for excellent transient response. The Control 5 is very efficient, and can handle high power for sound output greater than you might expect from a compact monitor system. Mount with Omnimount 75 series or with MTC-53 for rack mounting.

Control Five 60JBCNTRL5 *MFR LIST* **\$395.00 pair**

3. SLT-1

The SLT-1 is a highly versatile, miniature 2-way loudspeaker system that has high sensitivity, amazingly high power capacity, and equally amazing frequency response for its size. It's ideal for use in mobile audio and video installations, small control rooms, edit booths, restaurants, and churches. It includes a mounting bracket for either horizontal or vertical mounting, or can be used unmounted.

SLT-1 60JBSLT1 *MFR LIST* **\$225.00 ea**

4. JBL Control Sub-Bass Systems

Use one of these triple chamber, four woofer systems to complement your Control monitors.

A single SB-1 is used with a pair of Control 1's, while the SB-5 can be teamed with a pair of Control 5's.

They both are capable of adding solid bass with little distortion. Cabinets are designed for floor placement.

SB-1 60JBSB1 *MFR LIST* **\$295.00**
SB-5 60JBSB5 *MFR LIST* **\$375.00**

Accessories:

MTC-2

Universal Mount allows mounting of Control One and Control One Plus monitors on any rigid surface while permitting the speaker to be aimed in almost any direction.

MTC-2 60JBMTC2 *MFR LIST* **\$50.00 ea**

MTC-53 rack mount kit for a pair of Control 5 monitors.

60JBMTC53 *MFR LIST* **\$80.00 ea**

Call Bradley for a current price quotation.

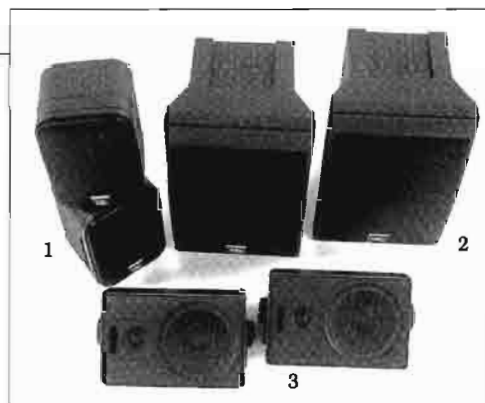

Tannoy System 8 NFM

The single point source design of the System 8 NFM allows for accurate location of sounds within the stereo field. The speaker uses Tannoy's 8" dual concentric driver and the cross braced, energy controlling design. Response is 48Hz to 25kHz ±3dB. Designed for 20 to 120 watt amplifiers, the System 8 NFM has peak power handling of 200 watts. Sold in pairs.

System 8 NFM 60TAS8NFM *MFR LIST* **\$1000.00 pr**

Call Bradley for a current price quotation.



Tannoy PBM Series

For excellent sound quality in applications where space is tight, the award winning PBM near-field monitors really shine. These compact and lightweight enclosures will readily fit on console tops or in small shelf areas. The PBM 6.5 has a 6 1/2" woofer and 3/4" dome tweeter with the smooth, wide range sound characteristic of Tannoy's famous larger studio monitors. The PBM 8 has an 8" woofer for extended low frequency response. The high sensitivity of these speakers permits their use with lower power amplifiers. External finish is vinyl matte grey with black cloth grilles, which are removable. The quality of Tannoy at remarkably low prices brings great sound into everyone's price range. We know you'll be pleased with the sound you'll get from these great small monitors. Sold in pairs.

PBM 6.5 60TAPBM65
MFR LIST **\$350.00 pr**

PBM 8 60TAPBM8
MFR LIST **\$500.00 pr**

Call Bradley for a current price quotation.



JBL and UREI Monitor Speakers

The 4400 series continues the tradition of quality JBL has established in small studio monitors. They produce flat on-axis and smooth off-axis response, critical to accuracy. Careful attention has been given to dividing networks so that undesirable interaction between drivers is negligible. The ribbed dome tweeters use a titanium diaphragm, and the mid-and low-frequency drivers use JBL's exclusive Symmetrical Field Geometry magnetic structure which is designed to reduce distortion components.

The 4406 is a two way monitor for close-in listening. It features a 6½" filled polypropylene woofer, and gives exceptional low frequency response for a small loudspeaker system. Sold in pairs.

The 4408 is a two way, 8" woofer system ideal for broadcast and general monitoring applications.

The 4410 is a powerful three way, 10" woofer studio monitor that gives exceptional spatial detail because of its vertical, in-line driver array.

The 4412 is a three way, 12" woofer studio monitor that has superior efficiency, greater power handling capacity, and extended bandwidth.

The 4312A is a direct descendent of the famous 4310, 4311, and 4312 control monitors. The three carefully matched drivers greatly extend the system's transient capability and bandwidth.

UREI 809A Time Align monitors have become a reference standard because of their unquestioned accuracy in a size and price range suitable for almost any near field monitoring application. This design uses a coaxial driver to achieve very low smear (phase distortion) and super-accurate stereo imaging. The 12" driver incorporates a ceramic magnetic structure which will not degrade over time, even under intense use. Its patented high frequency horn uses a special diffraction buffer for smoothest off axis response. With an efficiency of 93dB SPL/W/M, you'll knock over a wall before blowing one out. Response is 50Hz to 17.5kHz, ±3dB.

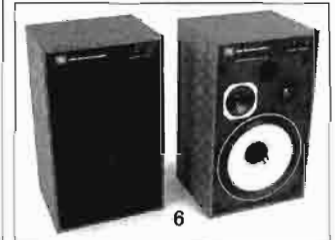
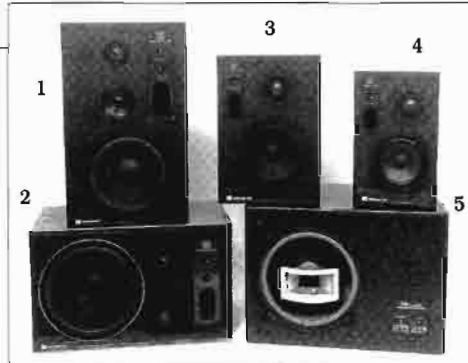

(1) 4410	60JB4410	MFR LIST	\$495.00
(2) 4412	60JB4412	MFR LIST	\$750.00
(3) 4408	60JB4408	MFR LIST	\$325.00
(4) 4406	60JB4406	MFR LIST	\$500.00 pr
(5) 809A	60UR809	MFR LIST	\$895.00
(6) 4312A	60JB4312A	MFR LIST	\$575.00

Accessories:

Set-wall mount brackets for 4406	60JBMC4401	MFR LIST	\$70.00
Rack mount kit for one 4408	60JBMR4408	MFR LIST	\$35.00
Grille for UREI 809 A	60UR809G	MFR LIST	\$50.00

Call Bradley for a current price quotation.

Electro-Voice Sentry 100A

An ultra-compact and economical monitor for use where sound quality is of primary concern. The Sentry 100A features an 8" woofer and a 25 watt SuperDome tweeter that responds up to 18kHz and can survive accidental high frequency blasts from tape head contact during fast forward/rewind. The 100A is extremely popular in broadcast and video production. Finished in black with a removable gray grille.

100A 60ELSEN100 MFR LIST **\$317.00**

Also available:

Sentry 100EL is a powered version of the Sentry 100A which has an internal 50 watt amplifier. 60ELSEN100EL MFR LIST **\$659.00**

Accessory:

Rack mount kit for Sentry 100A and 100EL
60ELSRB7 MFR LIST **\$31.50**

Call Bradley for a current price quotation.



Yamaha NS-10M Studio

In recent years, the Yamaha NS-10M Studio has found wide acceptance as a near-field production reference monitor. Its 7½" woofer and 1½" soft dome tweeter create surprisingly smooth 60Hz to 20kHz response, while still giving the listener a good feel for how the material will sound when played on a more modest system. The NS-10M Studio has become a familiar sight perched on top of most major studios' consoles. It's wise to use monitors that will be compatible with those of other studios when material will be worked on in more than one location. For the price of a pair of NS-10M Studios, that reassurance comes very easily.

NS-10M Studio 60YANS10MS MFR LIST **\$430.00 pr**

Call Bradley for a current price quotation.

Also available:

NS-10MC is a commercial version of the NS-10M Studio intended for installation. The cabinet accommodates several types of mounting brackets, and a black cloth grille is included. These have the identical performance of the studio version. Sold in pairs.

NS-10MC 60YANS10MC MFR LIST **\$530.00 pr**



Omnimount Universal Mounting Systems

These durable and functional mounting systems come in models to meet any installation requirement. The patented ball and clamp assembly enables omnidirectional movement. Wiring can be hidden in the assembly for a dressed installation. The 50 series holds up to 20 pounds, the 75 series is rated for 40 pounds, and the 100 series will hold 70 pounds. The "WB-BC" bottom mount has a double bend tube to hold the speaker from its bottom. The "WA-BC" is of similar design, but has a single bend tube to hold the device from the rear. Also available is the "CA-MP" ceiling mount and several other configurations, and series with greater load handling. Your Bradley professional can help you select the right Omnimount for the job.

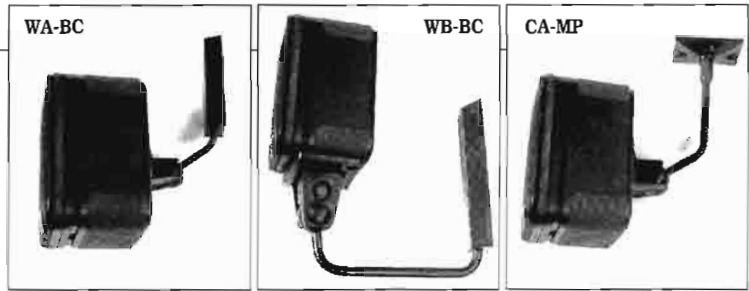

50 WA-BC	600M50WA	\$36.00	75 CA-MP	600M75CAMP	\$54.00
50 WB-BC	600M50WBBC	\$39.00	100 WA-BC	600M100WA	\$62.00
50 CA-MP	600M50CAMP	\$34.50	100 WB-BC	600M100WB	\$65.00
75 WA-BC	600M75WABC	\$54.00	100 CA-MP	600M100CAMP	\$63.00
75 WB-BC	600M75WBBC	\$54.00			

Pivotelli Speaker Brackets

These universal brackets are known for their outstanding performance in a supporting role. They hold speakers weighing up to 44 pounds and between 4" and 10" deep. The speakers are clamped front and back, and, while screw holes are provided on the bottom of the bracket, screwing into most speakers is not required. Speakers can swing side to side and tilt up and down. The distance to the walls is also adjustable. Pivotelli brackets have a 5 year warranty, and are packed with complete hardware for installation into wooden wall studs, brick, or concrete.

Speaker Brackets
60PVSS *MFR LIST* **\$89.95 pr**

Accessory:
Metal stud kit must be used for mounting on metal studs.
60PVMSSK *MFR LIST* **\$9.95**

Call Bradley for a current price quotation.

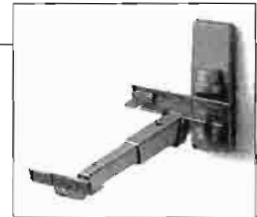

U.S. Audio P45-T Amplifier

The P45-T from U.S. Audio features a toroidal transformer and separate power supplies for each amplifier to produce a super quiet amp with great specs and sound. It delivers 35 watts per channel into 8 ohms, provides a frequency response of 10Hz to 30kHz, and delivers a S/N ratio of better than 100dB. Additionally, built-in peak-limiting circuitry engages just before clipping to prevent distortion. Handles a wide variety of input levels.



P45-T 60WHP45T *MFR LIST* **\$499.00**

Call Bradley for a current price quotation.

Symetrix A-220 Amplifier

Supplying 20 watts per channel, the A-220 is an excellent choice for powering headphones or driving small monitor speakers. Features include independent level controls on each channel, balanced XLR and unbalanced 1/4" TS input connections, and a rear panel switch to select stereo or mono bridge operation. With 0.08% distortion, the A-220 provides quality and value.



A-220 60SYA220 *MFR LIST* **\$349.00**

Call Bradley for a current price quotation.

Tascam PA-20B Amplifier

The PA-20B delivers 20 watts per channel into 8 ohms with 0.08% THD. The unit may also be operated in mono mode, delivering 50 watts. The PA-20B is portable and has been designed to allow placement where other amps often won't fit. It is equipped with both XLR and phono inputs for accepting any common input signal. A single input control is provided. Virtually indestructible in its metal case, this amplifier features multiple resettable electronic protection circuits

to guard against turn-on transients, output overload, DC offsets, and output shorts.

60TEPA20B *MFR LIST* **\$195.00**

Call Bradley for a current price quotation



Carver PM-120/300 Power Amplifiers

These amps pack a host of professional features into a single rack space. Both feature XLR, TRS, and barrier strip inputs, dual front panel level controls, headphone jack, and full protection circuitry. The PM-120 provides 40 watts per channel into 8 ohms, while the PM-300 delivers 110 watts per channel. Extremely low noise and wide, flat response make these an excellent choice to drive small monitors.

PM-120	60CVPM120	MFR LIST	\$560.00
PM-300	60CVPM300	MFR LIST	\$680.00



Also available:

The full range of Carver power amplifiers for sound reinforcement. Call for details. **Call Bradley for a current price quotation.**

Crown D75 Amplifier

The D75 is a most popular choice for control room or production monitor applications where accurate reproduction is a must. This amplifier can drive any type of load without fear of amp burnout, with 35 watts per channel into 8 ohms. THD is below 0.05%, IMD below 0.01%. Complete output protection, direct coupled circuitry with balanced XLR or unbalanced inputs, front panel level controls, and headphone output are all provided. 19" rack mount standard; uses only 1 rack space.

D75	60CR75	MFR LIST	\$549.00
------------	--------	----------	-----------------

Call Bradley for a current price quotation.



Also available:

See the Sound Reinforcement section of this catalog for our complete selection of higher power Crown amps.

Stewart PA Series Amplifiers

In only a half of one standard rack space, the Stewart PA series amps can provide a surprising amount of quality and horsepower. The PA50B provides 25 watts per channel stereo and 100 watts when bridged mono, and the PA100B will supply 50 watts and 200 watts respectively. Specifications rival much more expensive units, with response of 20Hz to 20kHz, ±0.5dB, S/N of 98dB, and distortion at 1kHz a mere 0.1%. The entire chassis on these potent little power amps serves as a heat sink and will keep them cool even when rack mounted and in constant use. Inputs are 1/4" balanced, level controls are tamper resistant screwdriver pots on the front panel.

PA50B	60SEPA50B	MFR LIST	\$279.00
PA100B	60SEPA100B	MFR LIST	\$359.00

Accessories:
Single rack kit
 60SERMK1
 MFR LIST
\$20.00

Dual rack kit
 60SERMK2
 MFR LIST
\$30.00

Call Bradley for a current price quotation.



Yamaha P2075 Amplifier

Yamaha produces professional tools for professional people. Built in a rugged, convection cooled two rack space chassis, the P2075 will provide up to 50 continuous watts per channel, and can be switched into bridged mono operation. The recessed front panel input attenuators are 32 point detented and calibrated for accuracy. On the rear, the inputs are electronically balanced with 1/4" TRS and XLR connectors. Outputs are through binding posts and 1/4" jacks. Comprehensive overload, transient, DC offset, and output speaker relay protection add up to make a safe and reliable amplifier for any application.

P2075	60YAP2075	MFR LIST	\$395.00
--------------	-----------	----------	-----------------

Call Bradley for a current price quotation.



Also available:

Bradley carries the full line of Yamaha power amplifiers for monitoring and sound reinforcement. Call your Bradley professional for details.



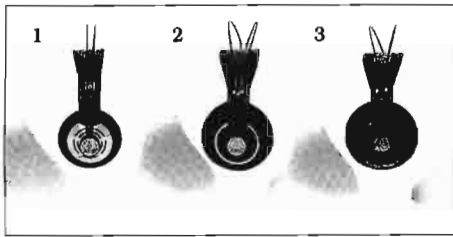

AKG Headphones

(1) K141

A deluxe stereo headphone that is lightweight and comfortable. It is semi-open featuring resonance-free characteristics but with freedom from low frequency side effects. The K-141 provides an extremely broad, flat response almost totally free of coloration. It produces sound which is warm, not boomy; open and present without harshness. Weighs in at only 9½ ounces. 600 ohms. 60AKK141 \$76.00

(2) K240M

This circumaural stereo headphone provides excellent directional sound perspective and distance discrimination, faithfully simulating hearing in natural room conditions. Patented design combines main transducers and 12 passive diaphragms, providing crossover at 200Hz. Weighs 10½ ounces. 600 ohms. 60AKK240 \$91.00

(3) K240DF

A calibrated version of the popular K-240M. The K240DF is designed with a flat frequency response based on European requirements for a reference monitor headphone. 600 ohms. 60AKK240DF \$113.00

Sennheiser Headphones

(4) HD 44

This stereo, under-chin headset provides sound quality and comfort for those who dislike headband-type headphones. Sunglasses not included. 60SNHD44 \$39.00

(5) HD 450

The successor to the legendary 414 series, the HD 450 is lighter (4.7 ounces) and more comfortable. With Sennheiser's unique Open-Aire design, the HD 450 provides higher output and improved accuracy using neodymium iron magnets. 10' replaceable cable. 70 ohms. 60SNHD450 \$69.00

Also available:

HD 450 Studio version has 600 ohm impedance, 1/4" fixed connector, and carrying case. 60SNHD450S \$76.00

See our Field Production section for a variety of headset mic/headphone combinations.

(6) HD 25

The HD 25 is Sennheiser's latest, top-of-the-line studio monitoring model. The supraural design (the headphone sits on top of the ear) offers a comfortable alternative to professionals who spend a great deal of time wearing headphones. Frequency response is accurate to 16kHz. The HD 25 has both the accurate sound you need, and the ruggedness for use in the studio or in the field. Weighs only 5 ounces. 70 ohms. 60SNHD25 \$167.00

(7) HD 540

This Open-Aire design headphone is digital ready. With wide frequency response (16Hz to 25kHz), and resonance damped design, the HD 540 is suitable for critical reference monitoring. Your ears ride free inside the ear pads, eliminating annoying pressure and heat build-up. 600 ohms. 60SNHD540 \$156.00

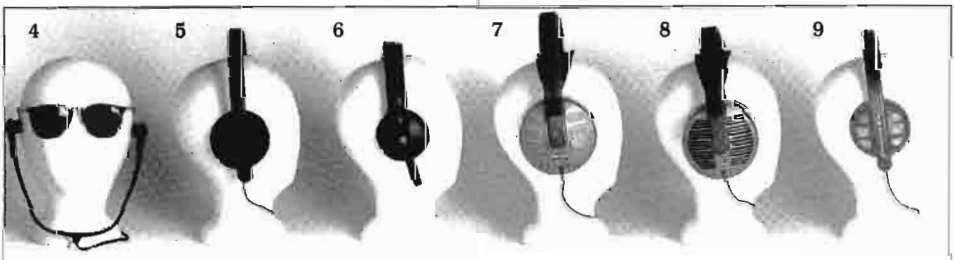

(8) HD 250

For applications requiring a sealed headphone, the HD 250 meets the demand. Response is 10Hz to 25kHz and these lightweight headphones weigh less than 5 ounces. 600 ohms. 60SNHD250 \$177.00

(9) HD 490

Employing all of the technology of Sennheiser's more expensive models, the HD 490 is equalized for more high end and extended low frequency response. 70 ohm impedance. 60NSHD490 \$94.00

Also available

Sennheiser replacement cables

For HD 450 60SN37974 \$22.00
For HD 540, HD 250, and HD 414 series 60SNHZL263 \$22.00

Note: Replacement cushions, drivers, and cables are available for all Sennheiser headphones. Call Bradley for pricing.

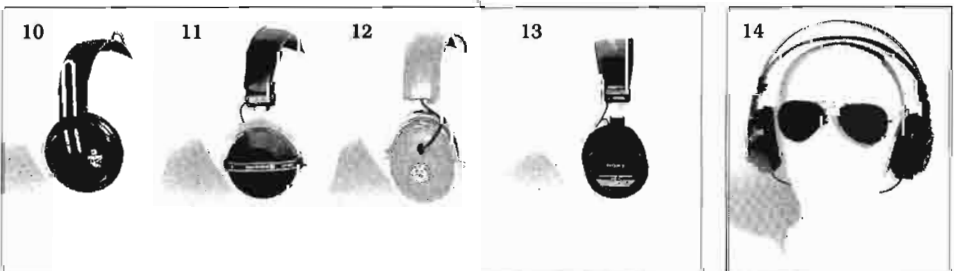

Studio Headphones

(10) Fostex T20RP

A lightweight professional quality dynamic headphone providing superior reproduction using Fostex's exclusive RP technology. Absolutely one of the most comfortable phones you'll wear. 50 ohms. 60FOT20 \$59.00

(11) Beyer DT 220

These closed system headphones combine exceptional comfort, long lasting durability and superior intelligibility. Both the headband and ear cups are foam filled, and the design of the DT-220 ensures high isolation from ambient noise. With a frequency response of 20Hz to 20kHz and high SPL before distortion, these are the headphones for critical monitoring. 400 ohms. 60BEDT220 \$94.00

(12) Koss PRO 4AA

For years, these were broadcasters' number one choice. Recently re-introduced, the PRO 4AA gives you full range (10Hz to 20kHz) with freedom from distortion even at high levels. The patented, air filled ear cushions conform to any head shape, forming a secure seal against outside noise. 100 ohms. 60KOP4AA \$79.00

(13) Sony MDRV6

Lightweight and rugged, these headphones sound great in the studio yet fold up to be easily carried to a remote. Extremely popular in the film and video industries. 63 ohms. 60SOMDRV6 \$79.00

(14) Stanton ST-3.5

You've asked us to find a low cost headphone that sounds good and is rugged. The Stanton ST-3.5 has a black spring steel headband with a leather strap that makes it hard to break. The semi-open design uses 1½" high velocity drivers for accurate reproduction. Impedance is 35 ohms. 60ST35 \$19.95



Rane HC6 Headphone Console

This unique product is more than a headphone distribution amp. A master stereo input drives six independent stereo headphone amplifiers, which provide both front and rear panel 1/4" TRS outputs. Each amplifier also has a separate mono balanced/unbalanced input, allowing the HC6 to be up to six independent amplifiers. A front panel master level control and mono/stereo push button are also provided. Rack mount is standard.

HC6 60RNHC6 *MFR LIST* **\$399.00**



Call Bradley for a current price quotation.

Symetrix SX204 Headphone Amplifier

One of the SX Series half-rack units, the SX204 is a 1 in, 4 out stereo headphone amplifier. Four independent stereo amps will drive even high-impedance headphones to maximum levels. Controls provided are master input level, stereo/mono switch, and individual level controls. Balanced or unbalanced inputs are on 1/4" TRS jacks, outputs also 1/4" TRS.

SX204 60SYSX204 *MFR LIST* **\$299.00**



Accessory:
Rack mount kit for one or two SX series units.

60SYRM2 *MFR LIST* **\$39.00**

Call Bradley for a current price quotation.

Whirlwind Headphone Breakout Box

With two stereo inputs (for daisy chaining) wired to six resistor-bridged outputs, this passive headphone splitter is perfect for the recording studio or remote applications where multiple headphones are used. Housed in a heavy gauge, cold rolled steel box, the box uses locking 1/4" TRS jacks to prevent accidental disconnection.

Headphone Box 61WHBB **\$70.00**



U.S. Audio Headphone Satellite Module

Keep your talent from strangling themselves in the studio. The U.S. Audio PHSAT Satellite Module is designed to accept any stereo input and distribute it to either of two stereo outputs on its front panel. It has parallel 1/4" TRS input/output connectors for daisy chaining as well as separate gain and pan controls and mono/stereo switching for two sets of two headphones. An optional mounting bracket will attach the PHSAT to a standard 5/8" thread mic stand.

PHSAT Satellite Module 60WHPHSAT *MFR LIST* **\$149.00**

Accessory:
PHCLIP mounts PHSAT to mic stand 60WHPCLIP
MFR LIST **\$17.95**

Call Bradley for a current price quotation.



Benchmark Stereo Headphone Amplifiers

You can use additional headphone amps in your consoles, at your patch bay, in the talk studio, and several other locations around the facility. The Benchmark HPA-1 puts the monitoring right where you need it most. Capable of driving both low and high impedance headphones, the HPA-1 includes a gain pot adjustable from Off to +18dB. Requires ±9 to ±22VDC bipolar power to be user supplied.

For a high quality, self contained headphone amp, we offer the IFA-7. Separate left and right XLR inputs ease installation. Requires PS-1 power supply.

HPA-1 60BMHOPA1 *MFR LIST* **\$60.00**

IFA-7 60BMIFA7 *MFR LIST* **\$235.00**

Accessory:
PS-1 power supply for IFA-7. 60BMPS1 *MFR LIST* **\$30.00**

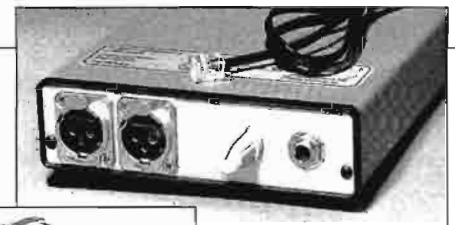

Call Bradley for a current price quotation.



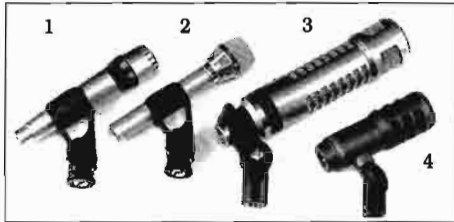

(1) AKG D1200E Microphone

The D1200E has a three position switch that changes the low frequency roll-off to suit your preferences. The elastically suspended capsule reduces handling noise, and an effective wind and pop screen is built-in.

D1200E 60AKD1200 MFR LIST \$250.00

(2) AKG D190E Microphone

The smooth response of the D190E has a slight midfrequency rise for natural sound. Recommended for vocal and announce use, it has an built-in windscreen and a shock mounted transducer.

D190E 60AKD190E MFR LIST \$135.00

(3) Electro-Voice RE27N/D Microphone

This mic may look familiar, but beneath its satin nickel finish it is unlike any other announce mic you've heard. Using a neodymium alloy magnet and a reinforced diaphragm dome, the RE27N/D cardioid has increased sensitivity, undistorted output at high sound pressure levels, and an extended high frequency response. A hum bucking coil reduces interference from lighting and other sources, while the Variable-D design reduces proximity effect for uniform response. The RE27N/D features two bass roll-off switches, a high frequency boost reduction switch, and an integral shock mount and blast filter. Hear how good your voice can sound.

RE27N/D 60ELRE27 MFR LIST \$625.00

Accessory:

Shock mount 60ELRE309 MFR LIST \$89.25

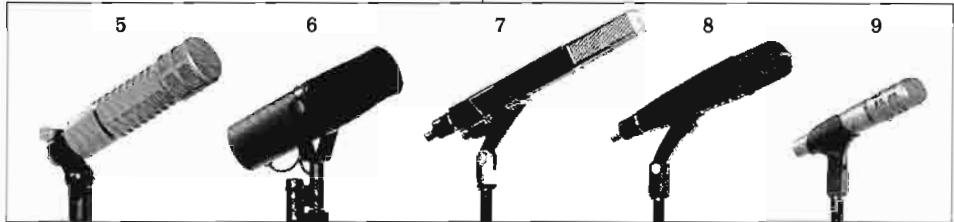

(4) Audio-Technica ATM-25 Microphone

Designed primarily for instrument miking, A-T found that this mic sounded great as an announce mic. The hypercardioid pattern rejects unwanted sounds outside of the pickup pattern and it withstands high sound pressure levels. With a response that enhances both male and female voices, the ATM-25 is a new contender with a moderate price.

ATM-25 60ATATM25 MFR LIST \$240.00

(5) Electro-Voice RE20 can be seen in many of America's premier broadcast stations. The reasons are obvious. Performance that rivals the best condenser mics, undistorted output at high SPL, and a carefully tailored response curve make the RE20 a true industry standard.

60ELRE20 MFR LIST \$525.00

Accessories:

Shock mount 60EL309 MFR LIST \$84.75

Windscreen 60NEWS87 MFR LIST \$28.00

(6) Shure SM-7 is among the finest professional dynamics for voice-over recording in radio and TV work. It features 40Hz to 16kHz response with four selectable response curves, an accurate symmetrical cardioid pattern, and integral air suspension shock mount. Wind, boom, and breath-pop noises are effectively eliminated by its integral foam windscreen.

60SHSM7 MFR LIST \$550.00

Accessory:

Replacement windscreen

61SH90A2089 MFR LIST \$15.50

(7) Sennheiser MD441 is often called acoustically transparent and is widely used in the studio and on the road. The super-cardioid pattern prevents leakage and feedback. Ten position bass contour switch and smooth response from 30Hz to 20kHz make the MD441 one of the best dynamic mics available.

60SN441 MFR LIST \$595.00

Accessory:

Windscreen 61SNMZW441 MFR LIST \$29.00

(8) Sennheiser MD421 is hailed worldwide for its durability and lively sound quality. The dynamic, cardioid element with large diaphragm makes voices "jump right out." The MD421 has a multi-position bass roll-off switch and a smoothly rising response from 30Hz to 17kHz.

60SN421 MFR LIST \$439.00

Accessories:

Windscreen 61SNMZW421 MFR LIST \$26.00

Shock mount 60SNMZS100 MFR LIST \$95.00

(9) Audio Technica AT836 has quickly found favor with musicians and recording engineers because of its outstanding gain-before-feedback qualities in close-up applications. Broadcasters are discovering the great sound of this dynamic cardioid as an announce mic. 60AT836 MFR LIST \$162.00

Call Bradley for a current price quotation.

Electro-Voice RE Series

The Variable-D design of all RE series mics ensures uniform off-axis pickup and eliminates bass-boosting proximity effect.

(10) RE10 is a moderately priced mic for sound reinforcement, broadcasting, or stage work. Its cardioid pattern provides maximum rejection 150° off-axis for improved directional characteristics. Includes bass roll-off switch. 90Hz to 13kHz.

60ELRE10 \$172.00

(11) RE11, electronically similar to the RE10, has a built-in blast filter and Memraflex grille screen.

60ELRE11 \$182.00

(12) RE15 provides better frequency response (80Hz to 15kHz) and is manufactured to tighter tolerances for situations where closely matched mics are required.

60ELRE15 \$255.00

(13) RE16, similar to the RE15 in response, uses a different blast filter, for closest use without "P-Pops." Its rugged, mechanically nested design is highly resistant to damage.

60ELRE16 \$267.00

(14) RE18 has an integral shock mount for superior hand held performance. This mount also effectively eliminates transmission of stand or lectern noises.

60ELRE18 \$279.00

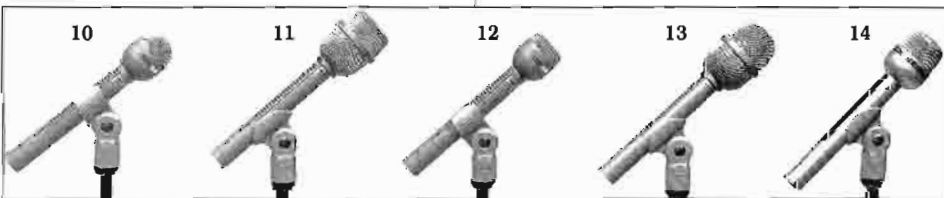

Accessories:

Shock mount clamp designed to provide isolation for RE series or other 3/4" diameter mics.

Gray 60EL313A \$35.00

Black 60EL313 \$35.00

Colored windscreen for RE11, RE16, or RE50.

Select from black, red, orange, yellow, green, blue, and violet.

60EL379X \$11.25

Pop filter for RE18 60EL351 \$12.00

Windscreen for RE18 60EL338 \$22.50

Pop filter for RE11 and RE16 60EL376 \$17.25

Windscreen for RE10 and RE15 mics. Two piece design has zippered rear portion to cover shank of mic. Rear portion can be used on RE11 and RE16.

60EL314 \$22.00

Security clamp for all RE series, except RE20. 60EL340 \$24.00

Replacement clamp for all RE series mics, except RE20. 60EL311 \$11.25

60EL311 \$11.25

Call Bradley for information on replacement clamps and all EV accessories.

Studio Condenser Mics

Audio-Technica 4000 Series

This series of microphones was designed for professional recording and broadcast. They all feature extended, flat frequency response, low self noise with high output, and high sound pressure level handling. The AT4031 is a pressure gradient capacitor mic with a uniform cardioid pattern. The other mics in the series are transformerless, externally polarized capacitor mics with interchangeable capsules. Capsules may also be purchased separately.



- AT4031** cardioid 60AT4031 MFR LIST **\$325.00**
- AT4049** omnidirectional 60AT4049 MFR LIST **\$540.00**
- AT4051** cardioid 60AT4051 MFR LIST **\$540.00**
- AT4053** hypercardioid 60AT4053 MFR LIST **\$610.00**

Call Bradley for a current price quotation.

AKG C414B/ULS

This latest version of one of our most popular mics uses an ultra-linear element for flattest response from 30Hz to 20kHz. This large diaphragm condenser is phantom powered and switchable for four pickup patterns: hypercardioid, cardioid, omni, and bidirectional. The C414B/ULS has a built-in three position attenuator and a selectable bass roll-off. A superior announce mic, its wide range and very low noise make it the microphone of choice for digital recording.



- 60AK414 MFR LIST **\$1045.00**

Accessory:

- Elastic suspension system** 60AKH17A MFR LIST **\$275.00**

Call Bradley for a current price quotation.

Sennheiser MKE 4032

The MKE 4032 is a high quality condenser mic designed for voice applications. The all metal housing is remarkably free from handling noise. The condenser element on this mic will handle a ferocious 140dB of sound pressure level without distortion. Gain varies smoothly over distance, without any unpredictable low frequency boosts in close proximity. A low frequency roll-off filter switch is concealed within the battery compartment, and a recessed three position attenuator switch appears at the base of the windscreen. The MKE 4032 has the tight pick up pattern and smooth response curve necessary for demanding applications. Powered by internal "AA" battery or phantom power.



- 60SN4032 MFR LIST **\$625.00**

Call Bradley for a current price quotation.

Shure SM81

The SM81 is a superb unidirectional condenser mic with the ability to withstand rigorous field use. Extremes of temperature, humidity, or physical punishment will not degrade the performance of the SM81. Very low distortion of 0.5% plus 135dB SPL before clipping insure accurate sound reproduction. Built-in 10dB attenuator stretches upper limit to 145dB SPL. Selectable low frequency response curve to compensate for proximity effect or low frequency disturbance. Mic element capsule may be interchanged with the optional omnidirectional capsule.



- SM81** unidirectional. 60SH81 **\$266.00**

Accessory:

- R104A** omnidirectional capsule. 60SHR104A **\$112.00**

Call Bradley for a current price quotation.

Neumann Condenser Mics

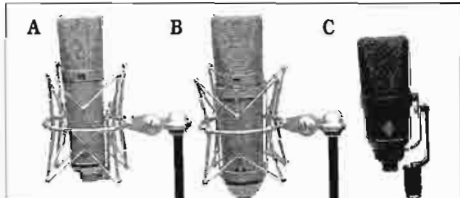

(A) U89, a five pattern studio mic, has exceptional frequency response and overload characteristics. Suiting both instrumental and vocal applications, it handles sound levels up to 140dB SPL with less than 0.5% distortion with the 6dB attenuator switched in. A high pass filter provides 80Hz or 160Hz rolloff. Requires 48V external power. Includes EA89 shock mount suspension, windscreen, and 25' cable.

- 60NEU89Z MFR LIST **\$2500.00**

(B) U87A is the latest version of the recording industry standard. Its fame arises from its good sound characteristic and broad range of use. An excellent vocal mic, it includes three separate switches for pattern selection, frequency response, and pressure sensitivity. Requires 48V external power. Includes Z48 shock mount suspension, windscreen, and 25' cable.

- 60NEU87AZ MFR LIST **\$2680.00**

(C) TLM-170 microphone is highly recommended for everything from voice narration recording to digital orchestral recording. Its five polar patterns and switchable pad and roll-off provide amazing versatility. Neumann's transformerless TLM circuitry provides a clarity and detail of sound previously unattainable. Hear the TLM-170 in your most critical applications and you'll feel as if you've pulled the cotton from your ears. Select black or satin finish.

- 60NETLM170XX MFR LIST **\$2295.00**

Accessories for TLM-170:

- Elastic shock suspension.** 60NEEA170XX MFR LIST **\$225.00**
- Windscreen** 60NEWS89 MFR LIST **\$28.00**

The complete line of Neumann microphones is available from Bradley Broadcast. Models include the SM69 and USM69 stereo mics, the RSM-191 stereo shotgun, and the FET 100 Series of single pattern, capsule mics. Call Bradley for details and a current price quotation.

Shock Mounts

(1 & 3) Tensimount "spider" shock mounts come in three sizes to fit most microphones. Requires use of stand adapter.

- TM1** for mics up to 1 1/2" diameter. 60AKTM1 **\$13.00**
- TM2** for mics up to 2" diameter. 60AKTM2 **\$14.00**
- TM3** for mics up to 2 1/2" diameter. 60AKTM3 **\$16.80**

Accessory:

- Mic stand adapter for Tensimount 61AKSA40 **\$9.00**

(2) Audio Technica 8415 shock mount is designed primarily for the rigors of field production. Elastic suspension accommodates a very wide variety of mics. Versatile and economical. 60AT8415 **\$36.00**

(4) Audio Technica AT8410a "universal" shock mount with "clothes-pin" flexible clamp fits most shapes and sizes of mics without extra sleeves or adapters. Special neoprene suspension cords isolate the mic from shock from every direction. 61AT8410A **\$34.00**

(5) Sennheiser MZS100 is our finest quality studio shock mount. It attaches to any microphone with the mic's own stand adapter. The thumbscrew adjusts the tension of the shock absorbing mechanism so that it can be optimized for the weight of the mic. Looks different, performs wonderfully. 60SNMZS100 **\$82.00**



Hand Held Dynamics

Shure SM57-LC

A rugged cardioid mic for hand held use. Presence boost and low end roll-off for excellent voice intelligibility. Finished in non-glare gray enamel for unobtrusive stage or on-camera use.

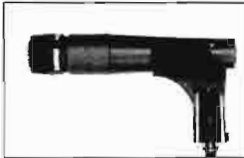

60SH57 MFR LIST \$137.00

Accessory:

Windscreen 61SHA2WS \$10.50

Shure SM58-LC

The world standard professional stage microphone. Cardioid pattern with spherical windscreen and fixed bass rolloff to prevent popping or boominess in close-up use. Rugged enough to withstand a six foot drop with no adverse effects.



60SH58 MFR LIST \$176.00

Also Available:

SM58 version with on-off switch on mic.
60SH58S MFR LIST \$185.00

Accessory:

Windscreen available in a variety of colors.
61SHA61WSXX \$5.00

Shure Beta Microphones

The Beta 57 and Beta 58 feature ultra-uniform supercardioid pickup patterns that reject more unwanted side and rear sounds than a regular cardioid. This results in superior gain-before-feedback characteristics. The Neodymium magnet provides an extra-hot output and the precision-tolerance voice coil gap extends high frequency response. Other design features are an advanced shock isolation system, an extra rugged steel grille, and a hum bucking coil that reduces interference from lighting and power systems. The Beta 58 is recommended for demanding live vocal applications, while the Beta 57's "open" sound will add impact when miking instruments. Matte finish. classic design.



Beta 57 60SHB57 MFR LIST \$258.00

Beta 58 60SHB58M MFR LIST \$258.00

Sennheiser MD431

One of the finest hand held vocal mics available. It features a cardioid pattern, rugged construction and an on/off switch. Low impedance.



60SN431 MFR LIST \$449.00

Call Bradley for a current price quotation.

Electro-Voice 635A

The most popular mic in broadcast for remote or studio use. Virtually indestructible, the omnidirectional 635A has a 80Hz to 13kHz response. The individual mics are packaged with stand adapter. Save by purchasing the 635A in a six pack without stand adapters.

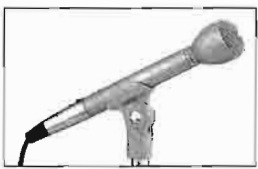

635A 60EL635A \$94.00

Six pack of 635A 60EL635A6 \$490.00

Accessory:

Windscreen 60EL314E \$11.25

Electro-Voice N/Dym Microphones

The neodymium alloy used in the N/Dym series has four times the power of conventional microphone magnets. This allows a smaller magnet and a larger voice coil/diaphragm diameter. The result is better sensitivity, low distortion, high end sizzle, and greater gain with less feedback. Handling noise is virtually absent due to the energy absorbing construction.



N/D257A

The cardioid pattern of this mic is narrow enough to reduce feedback, but wide enough to allow group pickup. An excellent value in a vocal mic.

60ELND257 \$108.00

N/D357A

The N/D357A has a rising presence peak to keep vocal tracks from being buried in the mix. A good choice when you need a single mic to serve a number of uses.

60ELND357 \$153.00

N/D457A

The hypercardioid pattern of the N/D457A makes it most suitable when loud monitors need to cut through the stage volume. It would be hard to find a mic more immune to feedback. The N/D457A is suited for vocals and close-proximity pickup such as guitar cabinets and horns.

60ELND457 \$189.00

N/D757A

At the top of the N/Dym line, this mic gives you studio quality in a very road worthy hand held. The N/D757A has a supercardioid pattern with a smooth presence peak and a switchable bass roll-off filter. Extended response and fast transient ability make the N/D757A a choice for vocals, piano, cymbals, strings, and percussion.

60ELND757 \$253.00

Luxo Studio Desk Mounting Arms

A. Luxo KM-1 Mic Arm

The KM-1 has no external springs and a 41" reach. Balanced for mics weighing two pounds. Requires mounting bracket or riser.

KM-1 Oyster 61LUMK1 \$45.00

KM-1 Black 61LUMK1B \$45.00

B. Luxo LM-1 Mic Arm

Professional spring loaded boom with 41" reach. Balanced for mics weighing one pound. Requires mounting bracket or riser.

LM-1 Oyster 61LULM1 \$38.50

LM-1 Black 61LULM1B \$38.50

Also available:

Luxo LM-2 is similar to LM-1 but has a 26" reach.

LM-2 Oyster 61LULM2 \$38.50

LM-2 Black 61LULM2B \$38.50

C. Luxo Mounting Brackets

C-clamp Oyster 61LUABR \$9.95

C-clamp Black 61LUABRB \$9.95

Table mount Oyster 61LUCBR \$9.95

Table mount Black 61LUCBRB \$9.95

Wall mount Oyster 61LUBBR \$9.95

Wall mount Black 61LUBBRB \$9.95

D. Pro Riser

This rugged all aluminum, 12" pedestal provides for more convenient installation and a longer reach for your Luxo arm.

Oyster 61LURISER \$21.00

Black 61LURISERB \$21.00

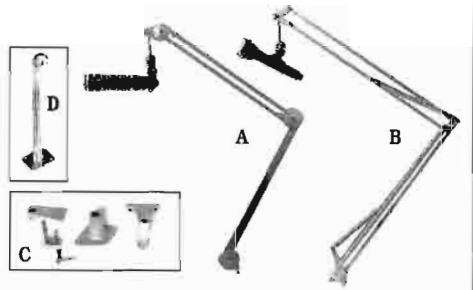

D. C. White Mic Arms

This complete series of mic arms and accessories accommodates virtually all mics, providing strength and durability in microphone installation. Grey, with models in black available by special order at extra cost.

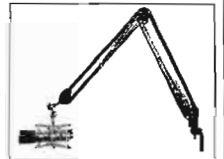

Single mic arm with riser

60OCSMAR MFR LIST \$107.50

Single mic arm only

60OCSMA MFR LIST \$87.00

Two joint single mic arm

60OCTJSMA MFR LIST \$148.25

Triple mic arm with riser

60OCTMA MFR LIST \$345.25

Call Bradley for information on other configurations and mounts and a current price quotation.



Lavaliers

Audio-Technica AT805S

An excellent choice in omnidirectional lavaliers. The high sensitivity electret condenser element has a response from 50Hz to 15kHz. On/off switch. Battery operation.



60AT805S \$62.00

Also available:

AT803B ultra-miniature lavalier. Battery or phantom powered. 60AT803A \$102.00

Shure SM11

The SM11 is the world's smallest dynamic lavalier mic. Optimized response, natural sound quality plus ruggedness make it a leader. The three mounting options provided are lavalier cord, tie bar, and tie tack.



60SH11 \$83.00

Shure SM-84 and SM-83

Noisy studio and outdoor environments, talk shows, and multi-lavalier formats are situations where the SM-84 is vital.



This unidirectional condenser lavalier mic was developed to solve problems of extraneous sound pickup and gain-before-feedback which plague lavalier mics. Shure engineers modified the performance of the widely used SM-83 omnidirectional lavalier by developing a super-cardioid pickup pattern to reject peripheral sounds, while retaining the SM-83's specially tailored response pattern. Includes tie clip, cable, and belt pack powering unit. For many less complex applications, the omnidirectional SM-83 remains an excellent choice.

SM-84 unidirectional. 60SHSM84 \$219.00
SM-83 omnidirectional. 60SHSM83 \$166.00

Sennheiser MKE-2

The popularity of the MKE-2 is phenomenal. The open, natural sound plus the small size (less than 1/4" diameter, approximately 1/16" long) make the MKE-2 unique. Packaged with a wide variety of clips and windscreens, this mic is powered by the K3U module for battery or phantom power operation. Frequency response 40Hz to 20kHz.



Black 60SNMKE23 \$199.00
Flesh 60SNMKE233 \$199.00

Special:

MKE-2 mic and K3U powering module combination. Black mic only in combo. 60SNMKE23C \$334.00

Sony Lavaliers

Since their introduction over 20 years ago, Sony lavaliers have found wide acceptance among professionals because of their clean, accurate sound and their reliability. This latest series provides increased immunity to external noise and the convenience of operation with "AA" size batteries. The ECM-55 has an omnidirectional pattern for the widest variety of applications. The ECM-66 has a unidirectional pattern ideal for musical instrument miking. The ECM-77, a mere 1.5 grams, is Sony's smallest lavalier. The ECM-44 is omnidirectional, and makes Sony quality available at an economical price. All versions come complete with powering system (internal battery or external DC 48V) and are black. Also available are uninterminated versions of all mics for use with wireless systems. Matte Black.



ECM-55 60SO55B \$226.00
ECM-66 60SO66B \$255.00
ECM-77 60SO77B \$255.00
ECM-44 60SO44B \$149.00

Special Purpose

Audio-Technica AT838G

A unique product from Audio Technica is this unidirectional gooseneck mounted dynamic mic.



This one piece unit terminates on a 3 pin male XLR connector for direct mounting onto consoles and panel connectors. Designed for quiet operation, allowing for live movement of mic without loud crunching noises typical of other goosenecks. 14" gooseneck. 19" overall. 60AT838G \$80.00

Shure SM Series

This series of head-worn mics is designed for use in sports, news gathering, and intercommunication systems. They offer an excellent solution to the problem of hands-free, close talking vocal pickup.

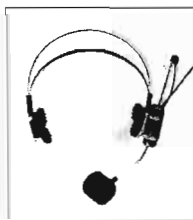

SM10A with mic only 60SH10 \$109.00
SM12A with mic and one earphone 60SH12 \$141.00

You'll find more mics in our Field Production Section.

Audio-Technica UniPoint Series

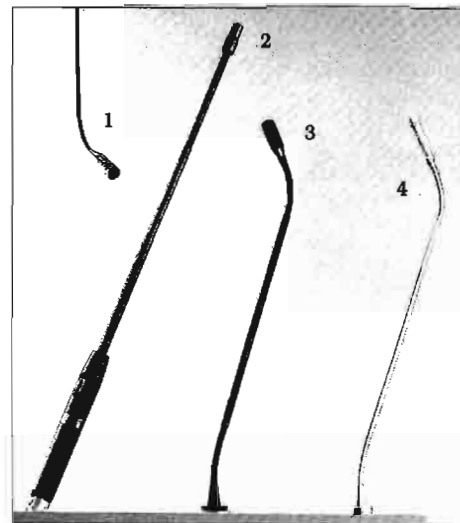

The UniPoint microphone series is designed for great sound. They have a highly symmetrical cardioid pickup and exceptional off-axis rejection for feedback control. Audio Technica has created a very original set of mounts, goosenecks, hangers, and other accessories which make these little mics very powerful problem solvers. All mics can be powered by a single "N" cell or 9-52VDC phantom power.

(1) AT853a is extremely versatile. It can be hung from its own cable using a very clever plastic coated stainless steel hanger or mounted on an equally ingenious stand adapter. Available in black or white.
853a Black 60AT853 \$175.00
853a White 60AT853W \$198.00

Also available:

PM version of the AT853 has the electronics of the power module conveniently mounted on a single gang electrical plate. 25' cable attached to mic mates with mounting plate. Requires 24-48VDC phantom power.
853PMa Black 60AT853PM \$155.00
853PMWa White 60AT853PMW \$174.00

(2) AT859a is a hand held "wand" interview microphone which extends from 11 to 19 inches.
 60AT859 \$166.00

(3) AT857AMa and AT857QMa are both mounted on two stage goosenecks. The AM version is designed for mounting onto a mic stand or its own threaded surface adapter. The QM is designed to plug directly into a chassis mounted female XLR connector and operates only on phantom power.
857AMa 60AT857AM \$209.00
857QMa 60AT857 \$183.00

(4) AT837 is mounted on its own two stage gooseneck and is designed for permanent installation on a podium, pulpit, or other table surface.
 60AT837 \$112.00



Crown SASS

The Crown Stereo Ambient Sampling System (SASS) is a patented stereo condenser mic using PZM technology. It is a mono compatible, near coincident dual capsule array designed for professional applications.

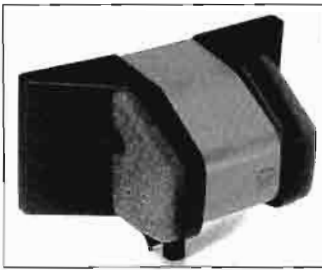

The SASS will serve as a highly accurate main stereo pair for many recording purposes, and can simplify placement of spot mics. The 125° acceptance angle of each side's capsule picks up ambient reflections from the room, providing an open perspective. The SASS can accurately convey the ambient environment for location recording or synched audio ambience where the sound must precisely match movements of the screen image. The half-spherical forward pickup of the mic creates convincing environmental recordings and ambient sound tracks with natural placement of sound events.

Accessories included with the SASS are a wind-screen, foam wind protectors, a hand grip, and a swivel mount with several thread adapters.

60CRSASSP MFR LIST \$899.00

Call Bradley for a current price quotation.

Crown PZM Microphones

These unique mics work on the principle of sound detection, utilizing the pressure zone at an acoustic boundary to eliminate distortion and comb filtering problems. Excellent sensitivity allows pick up of sounds with greater clarity and at a greater distance than conventional mics. PZM's present new opportunities in recording and sound reinforcement, but should not be used in situations where background sounds are undesirable. Their unobtrusive designs make them easy to hide on a podium, table, even on the floor. Mics are black except as noted. Call for our complete PZM catalog, and for power supply and accessory pricing.

PZM-6F is a low profile mic for most exacting recording or sound reinforcement applications. Miniaturized electronics built into the XLR connector make direct phantom powering possible.

60CRPZM6F \$282.00

PZM-6R is similar to the PZM-6F, except with a smoothly rising response for greater high end clarity.

60CRPZM6R \$282.00

PZM-30R has a larger boundary surface than the above mics. The PZM-30R has enhanced high frequency response for bright, crisp sound. Miniaturized electronics built into the microphone cantilever make direct phantom powering possible.

60CRPZM30R \$282.00

PZM-30F is similar to the PZM-30R, but with smooth flat, high frequency response for most accurate pickup.

60CRPZM30F \$282.00

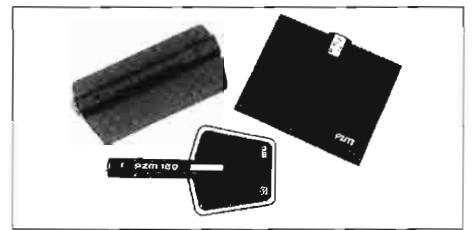

PCC-160 differs from other mics in this series, as it has a phase coherent cardioid pattern. Use wherever improved gain before feedback and articulation are important. Bass boost/cut switch. Heavy construction. Phantom powered.

"Go away" gray 60CRPCC160 \$238.00
White 60CRPCC160W \$238.00

PCC-200 is similar to the PCC-160, but adds a noise gate. Excellent for multiple mic installations.

60CRPCC200 \$267.00

PZM-180 is a low impedance "semi-pro" mic for applications that require PZM advantages but with budget restrictions. Powered by an internal battery ("N" cell) or external phantom power. Male XLR type connector in mic handle. No cable supplied.

60CRI80 \$154.00

Sound Grabber is a moderately priced PZM designed for most music or voice work. Powered by one "AA" battery, the Sound Grabber has an unbalanced, high impedance output. The captive 10' cable terminates on a mini plug, and adapters are included for both 1/4" TS phone and micro applications.

Black finish 60CRSG \$89.00

Shure Automatic Microphone System

The Shure AMS Automatic Microphone System provides a comprehensive, effective approach to the often aggravating problems of multiple mic installations. Advanced microphone, mixer, and logic technologies allow sound sources to turn on and off quickly, quietly, and automatically. With more than one mic active, the system provides gain compensation to prevent feedback.

Each mic and mixer channel contains logic circuitry. This allows each mic to actuate independently. Furthermore, AMS microphones will turn on only when addressed within a 120° acceptance window. Background or crowd noise, regardless of volume, will not "open up" a microphone. The AMS mixer incorporates individual channel logic controls which provide special functions such as a cough/privacy button, channel priority, zone loudspeaker muting, and chairman muting.

Four styles of AMS mics are available for various installation requirements; low profile, gooseneck, probe, and lavalier. Due to the integrated design of AMS, use of non-AMS mics is not appropriate. AMS is ideal in many settings. Churches, courtrooms, broadcasting, teleconferencing, and group meeting places will all benefit from use of AMS.

Call your Bradley professional for full details on all AMS systems and products.

AMS-8000 eight channel mixer
60SHAMS8000 MFR LIST \$2780.00

AMS-22 low profile mic
60SHAMS22 MFR LIST \$205.00

AMS-24 gooseneck mic
60SHAMS24 MFR LIST \$240.00

AMS-26 probe mic
60SHAMS26 MFR LIST \$205.00

AMS-28 lavalier mic
60SHAMS28 MFR LIST \$225.00

Call Bradley for a current price quotation.

Right: AMS-22

Below Left: AMS-24

Below Right: AMS-26

Bottom: AMS-8000

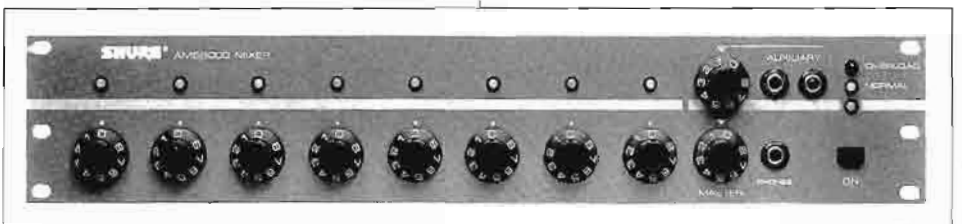

Benchmark MIA-4x4 Microphone Preamplifiers

A microphone and its preamplifier set the dynamic limits for most systems. The preamps used in the MIA-4x4 offer ultra low intermodulation distortion, a 1dB (-130dBu EIN) noise figure, and greater than 200kHz bandwidth. This one unit is one rack space high, and has four preamps with individually selectable 48V phantom power. The total gain range, including a 20dB pad, is -2 to +73dB. The power supply is in a separate chassis for low AC line interference. Through the use of a common mode input filter, RF immunity is superior. The MIA-4x4+ model adds a stereo mix (channels 1 and 3 to the left output, channels 2 and 4 to the right) with a front panel headphone amp to monitor the mix.

This is quality you must hear to truly appreciate.



MIA-4x4	60BMMIA4X4	MFR LIST	\$1325.00
MIA-4x4+	60BMMIA4X4P	MFR LIST	\$1575.00

Also available:

The MIA-4 preamp, which is the heart of the above unit, comes in several versions for custom applications. Your Bradley professional can provide you with the details.

Call Bradley for a current price quotation.

ATI Mic Preamplifiers

ATI has a complete line of high performance mic preamps, each with the features you need for a specific job. The M100 Ultimike is a small, rugged, full featured preamp that can be mounted near the audio source and has an unusually quiet active balanced instrumentation type input stage with impressive hum and RF rejection. Built in are a switchable limiter and lo-cut filter. Gain is adjustable over a wide range, plus a front panel jack allows you 15dB of gain trim from a remote location with a 10K pot. For condenser mics, 48V phantom power is available at the flip of a switch. A phase reversing switch is on the front panel, and XLR connectors are used for inputs and outputs.

The M1000 is a dual microphone preamplifier for use as a stereo mic preamp or for two mono mics. Versions are available with transformer or balanced differential outputs, with or without switchable 48V phantom power. Microphones are a basic necessity. Treat them properly with ATI mic preamps and hear the difference.



Ultimike	60AIM100	MFR LIST	\$329.00
M1000 transformer out	60AIM10001	MFR LIST	\$425.00
M1000 differential out	60AIM10002	MFR LIST	\$395.00

M1000 transformer out, phantom power.

60AIM10001P	MFR LIST	\$455.00
-------------	----------	-----------------

M1000 differential out, phantom power.

60AIM10002P	MFR LIST	\$425.00
-------------	----------	-----------------

Accessories:

Rack mount kit for one M1000	60AI20021	MFR LIST	\$20.00
Rack mount kit for two M1000	60AI20024	MFR LIST	\$25.00

Call Bradley for a current price quotation.

SX202 Dual Mic Preamp

Designed for critical analog or digital recording, the SX202 has variable gain inputs with 15dB pads and selectable 48VDC phantom powering. When used with a stereo pair of mics, the SX202 has the advantages of less than 10° phase shift at 20kHz and a polarity switch on one channel. This unit boasts very low noise and distortion, as well as excellent transient characteristics.

SX202	60SYSX202	MFR LIST	\$289.00
--------------	-----------	----------	-----------------



Call Bradley for a current price quotation.

Accessory:

Rack mount kit for one or two SX series units.	60SYRM2	MFR LIST	\$39.00
---	---------	----------	----------------

Rane MS1 Mic Preamp

Going from the output of a microphone into an otherwise line level world is a simple problem. The simple answer is the Rane MS1 mic preamp with a minimum of noise, distortion, cost, and hassle. Only 1.65"H x 5.1"W x 4.25"D, the MS1 is designed to be installed where you need it. It provides switchable (+15VDC) phantom power, continuous rotary gain trim between 20dB and 60dB, LED overload indicator, XLR input connector, and balanced TRS 1/4" output. The MS1 uses one of the finest ultra low noise amplifier designs available featuring true differential inputs with high common mode rejection. You pay only for what you need and not extra KSI (knobs per square inch).

MS1	60RNMS1	MFR LIST	\$166.00
------------	---------	----------	-----------------



Call Bradley for a current price quotation.



Orban 787A Mic Processor

The 787A is a three band parametric equalizer, compressor, de-esser, noise gate, and compressor gate integrated into a compact and powerful rack mounted system. It stands apart from similar mic processors in that it is fully programmable. Up to 32 different programs can be saved, instantly recalled and A/B compared. In the absence of line power, the memory is held by an internal lithium battery. Control settings can be locked with a security code to prevent unauthorized tampering. The 787A's standard line input will accept a direct mic input with an optional ultra-low noise Jensen transformer mic preamp. Transformer-coupled to ensure RF immunity, this preamp is vastly superior to most console preamps.

The 787A can be used in broadcasting for individually tailoring the sound for any of several announcers. At each change of announcer, the appropriate program can be instantly recalled. In the newsroom, the 787A provides in 3 rack spaces a complete processing facility for dubbing reporters cassette interviews, processing "voicers", and even dramatically improving phone feeds. In multitrack recording and production the 787A can store preferred settings for individual voices. Whatever your audio specialty, the Orban 787A is a powerful processing arsenal.

Call Bradley for a current price quotation.



787A/U	60OB787A	<i>MFR LIST</i>	\$1595.00
787A/UP with Jensen transformer mic preamp.	60OB787AP	<i>MFR LIST</i>	\$1790.00
787A/UX with MIDI, RS-232, or RS-422 serial port.	60OB787AX	<i>MFR LIST</i>	\$1690.00
787A/UPX with Jensen transformer mic preamp and serial port.	60OB787APX	<i>MFR LIST</i>	\$1885.00

Accessories:

Slave channel for 787A for dual mono or stereo operation.

60OB787ASL	<i>MFR LIST</i>	\$1295.00
------------	-----------------	------------------

Remote control

60OB787ARC	<i>MFR LIST</i>	\$295.00
------------	-----------------	-----------------

Symetrix 528 Mic Processor

The 528 is a complete system that contains all the control functions needed for voice processing: mic preamp, compressor/limiter, downward expander, parametric equalizer, and de-esser. It is intended for use as a broadcast announce mic processor, as a complete input stage for public address systems, or as a specialized processor for recording and sound reinforcement. Switchable phantom power is provided for condenser mics. The comprehensive front panel controls and metering enable you to tailor voices to your exact requirements.



528	60SY528	<i>MFR LIST</i>	\$679.00
------------	---------	-----------------	-----------------

Call Bradley for a current price quotation.

Valley 400 Mic Processor

In most programming formats, the name of the game is consistency. This integrated mic processing system is a key ingredient in assuring that your air personalities consistently sound their best. The system starts with a high accuracy, low noise mic preamp followed by a three band equalizer specially contoured for vocal applications. The 400's compressor section is optimized for maximum "punch" with an interactive expander section that assures that your air talent will not sound like they've been sucked through the microphone and into the transmitter each time they take a breath. A switchable de-esser is also provided, making the



400 a complete and cost effective microphone processor. Inputs and outputs are XLR, with 1/4" TRS send/receive jacks.

400	60VP400	<i>MFR LIST</i>	\$679.00
------------	---------	-----------------	-----------------

Call Bradley for a current price quotation.

Stewart Phantom Power Supplies

Stewart phantom supplies are a reliable alternative to supplies that cost too much. They may be used with most microphones or accessories requiring 48 volts DC. The modules contain the audio connectors, power regulator, and all associated isolation circuitry. Up to 12 channels can be powered from a single PS-1 AC converter. Modules are easily interconnected with cables using standard 1/4" TS phone plugs. For field work, use the BPS-1 battery supply which uses two 9 volt batteries to produce 48VDC phantom power.

PMO-1 one channel module	60SEPM1	\$59.00
PMO-2 two channel module	60SEPM2	\$95.00
PMO-4 four channel module	60SEPM4	\$120.00



PS-1 AC converter	60SEP1	\$19.00
BPS-1 battery powered supply	60SEBPS1	\$95.00



Shure L Series Wireless Mics

If you have any doubts about affordable VHF wireless, you can rest a-Shure-d with Shure's L Series. Available in both diversity and non-diversity systems, the performance and price of the L Series will certainly please you. The non-diversity L3 receiver features double tuned RF stages with high gain, low noise MOS-FET'S for sensitive, interference-free operation. The true diversity L4 Receiver features MARCAD which, in addition to providing the benefits of two independent RF sections, combines the signals for improved signal-to-noise ratio and outstanding reception. The L1 body pack transmitter is used with the 839W lavalier, which has an exceptionally wide range frequency response. For hand held applications, choose among units with an SM58 dynamic element, SM96 condenser element, or a Beta 58 element. Systems are priced below, and components are individually available.

Non-Diversity Lavalier System	60SHLS13839	MFR LIST	\$445.00
Diversity Lavalier System	60SHLS14839	MFR LIST	\$580.00
Non-Diversity SM58 System	60SHLS2358	MFR LIST	\$532.00
Diversity SM58 System	60SHLS2458	MFR LIST	\$666.00

Call Bradley for a current price quotation.



Non-Diversity SM96 System	60SHLS2396	MFR LIST	\$572.50
Diversity SM96 System	60SHLS2496	MFR LIST	\$707.00
Non-Diversity Beta 58 System	60SHLS23B58	MFR LIST	\$613.50
Diversity Beta 58 System	60SHLS24B58	MFR LIST	\$748.50

Accessory:

XLR to LEMO adapter to connect any mic to L1 body pack.	60SHWA310	MFR LIST	\$20.00
--	-----------	----------	---------

Sony Wireless

Sony's VHF wireless mic systems offer superior performance due to their innovative design. These units are compact and rugged enough for ENG and EFP. Operating on the 200MHz TV band, they have a potential of 168 usable channels, and phase locked loop synthesized tuning makes it quite simple to change the operating frequencies anytime, anywhere. Bradley can help you develop the system you need using the components described and a wide range of available accessories.

Transmitters:

WRT-410 hand-held microphone/transmitter has a cardioid, dynamic capsule, a built-in compressor and limiter, and excellent shock mounting. 48 channel synthesized tuning.

60SOWRT410	MFR LIST	\$999.00
------------	----------	----------

WRT-420 body pack transmitter with lavalier mic also has 48 channel synthesis. The provided snap-on battery pack yields up to 3 hours continuous duty on two "AA" batteries.

60SOWRT420	MFR LIST	\$1049.00
------------	----------	-----------

Accessories include several antennas and dividers so that multiple receivers can have common antennas. The AC-P210 power supply uses either AC or 12VDC to power up to five receivers and/or combiners. Rack mount brackets, carrying cases, and Betacam attachment kits are some of the other options for your system.



Receivers:

WRR-410 receiver has 168 channel synthesis and can be operated by internal batteries or external 9VDC.

60SOWRR410	MFR LIST	\$1119.00
------------	----------	-----------

WRR-420 is a diversity version of the above.

60SOWRR420	MFR LIST	\$1919.00
------------	----------	-----------

Call Bradley for a current price quotation.

Toa Wireless Mics

Toa's wireless microphone products have been designed to affordably render clear, intelligible audio in auditoriums, schools, churches, conferences, sporting events, sound stages, and more. The transmitters operate reliably from one "AA" battery for more than 30 hours. Unique companding circuitry provides wide dynamic range and excellent signal to noise ratio, and a special tone-key circuit will keep interference from other 170MHz RF sources down to a nearly nonexistent level. Transmitters are either hand held mics or belt packs with attached lavalier mics. Both transmitters have LED indicators to show operation and battery status, and both use microphone elements designed to provide articulate response and a high degree of feedback rejection for live functions. The Toa diversity receiver is modular in design, and will hold up to four receiver modules for a very cost effective high performance system.

Complete diversity system includes one quad channel frame, one receiver module, two whip antennas, and either one hand held mic/transmitter or one body pack transmitter with lavalier mic.

60TOD54	MFR LIST	\$1481.00
---------	----------	-----------

Also available:

A non diversity frame that handles two receiver modules. An available antenna amp/distribution system makes this a powerful, compact, and economical alternative.

Call Bradley for a current price quotation.

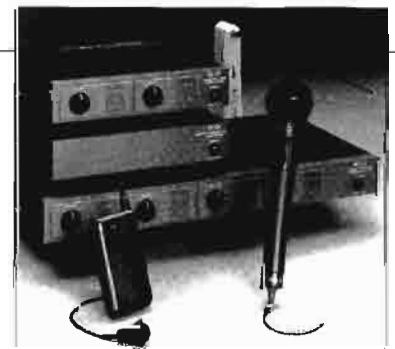

Additional receiver module	60TOWTU840U	MFR LIST	\$391.00
-----------------------------------	-------------	----------	----------

Additional hand held mic/ transmitter	60TOWM240U	MFR LIST	\$328.00
--	------------	----------	----------

Additional body pack transmitter w/lav mic	60TOWM340U	MFR LIST	\$328.00
---	------------	----------	----------

	60TOWM340U	MFR LIST	\$328.00
--	------------	----------	----------



Telex Wireless Mic Systems

Telex provides a wide variety of compatible wireless components so you may assemble a complete system that meets your present and future needs. Select from three equipment groups: the FMR-2 and FMR-50 professional systems, the FMR-4 multichannel systems, and the FMR-25 economy systems.

Use the dollar amounts shown to budget your system. Then call your Bradley professional for a great package deal, and to check out options and accessories too numerous to list here, but including receiver rack mounts, antenna accessories, mic accessories, and carrying cases.

Economy Series

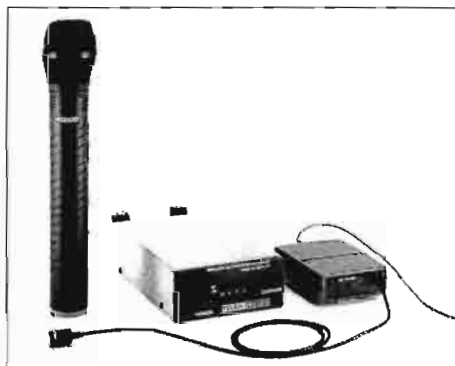

FMR 25 Receiver

- Four stock frequencies
- Single channel operation
- Single antenna
- Use up to four systems together
- Most economical receiver
- 90dB S/N
- 500 foot range

FMR 25TD Receiver

- Ten stock frequencies
- Single channel
- Pos-I-Phase Diversity Antenna System
- Use four systems together
- Economical, diversity provides better reception under difficult conditions (ie: indoors, obstructions)
- 90dB S/N
- 500 foot range

FMR 25 System w/ WT 25 belt pack transmitter with attached lapel mic

60TXFMR25L MFR LIST \$500.00

FMR 25 System w/HT-100/10 hand- held mic/transmitter

60TXFMR25H MFR LIST \$600.00

FMR 25TD System w/WT 25 belt pack transmitter w/attached lapel mic

60TXFMR25TDL MFR LIST \$650.00

FMR 25TD System w/HT-100/10 hand held mic/transmitter

60TXFMR25TDH MFR LIST \$750.00

Multichannel Systems



FMR-4 Receiver

- 20 stock frequencies
 - Frequency agile (4 channels)
 - Pos-I-Phase Diversity Reception
 - Use 18 systems together
 - 104dB S/N
 - 1500 foot range
 - Not DC powerable
 - Absolute finest quality audio reception
- 60TXFMR4 MFR LIST \$1750.00

ENG-4 Portable Receiver

- 20 stock frequencies
 - Frequency agile (4 channels)
 - Single antenna
 - Use up to 18 systems together
 - 104dB, S/N 1000 foot range
 - Portable runs on four "AA" batteries
 - Ideal for camera-mount use or where AC is unavailable
- 60TXENG4 MFR LIST \$1480.00

WT-400 Belt Pack Transmitter

- Frequency agile (2 channels)
 - Lemo connector/XLR adapter optional
 - Uses same mics as WT-200
- 60TXWT400 MFR LIST \$930.00

HT-400 Dual Channel Hand Held Transmitters

- HT-400/10** Condenser, Telex TE 10 head
60TXHT40010 MFR LIST \$1020.00
- HT-400/58** Dynamic, Shure SM58 head
60TXHT40058 MFR LIST \$1130.00
- HT-400/87** Condenser, Shure SM87 head
60TXHT40087 MFR LIST \$1250.00

Professional Systems



FMR-2 Diversity Receiver

- 10 stock frequencies
 - Single channel operation
 - Pos-I-Phase Diversity Reception
 - Use 12 systems together
 - 98dB S/N
 - 1000 foot range. Use over longer distances with improved reception in difficult environments
- 60TXFMR2 MFR LIST \$1170.00

FMR-50 Non-Diversity Receiver

- 10 stock frequencies
 - Single channel operation
 - Single antenna
 - Use 12 systems together
 - 8dB better S/N ratio than FMR-25
 - 1000 foot line of sight usable range
- 60TXFMR50 MFR LIST \$550.00

WT-200 Belt Pack Transmitter

- Single channel
 - Lemo connector/XLR mic adapter included
 - Choose from three lavaliers
- 60TXWT200 MFR LIST \$525.00

WT-50 Belt Pack Transmitter

- Detachable mic (TA4F connector)
 - Choose between a lavalier and a headworn mic.
- 60TXWT50 MFR LIST \$325.00

Microphones for WT-200

- WLM-100** Omni lapel, silver
60TXWLM100 MFR LIST \$135.00
- WLM-200** Omni lapel, black
60TXWLM200 MFR LIST \$135.00
- WLM-300** Cardioid lapel, black
60TXWLM300 MFR LIST \$135.00

Microphones for WT-50

- WLM-50** Omni lapel, grey.
60TXWLM50 MFR LIST \$115.00
- WLM-60** Headworn mic.
60TXWLM60 MFR LIST \$115.00

HT-100 Hand Held Transmitters

- HT-100/10** Condenser, Telex TE-10 head
60TXHT10010 MFR LIST \$370.00
- HT-100/11** Dynamic, Telex TE-11 head
60TXHT10011 MFR LIST \$370.00
- HT100/58** Dynamic, Shure SM58 head
60TXHT10058 MFR LIST \$430.00
- HT-100/87** Condenser, Shure SM87 head
60TXHT10087 MFR LIST \$620.00



Microphone Stands and Booms

1. **AKG KM-251** heavy duty, collapsible floor stand adjustable from 23" to 53".

Chrome	60AKKM251	\$59.00
Black	60AKKM251B	\$59.00

2. **Atlas MS-12C** basic stand with heavy duty base.

Chrome	61ATMS12	\$22.00
Ebony	61ATMS12E	\$22.00

3. **Atlas PSC** two-section collapsible stand.

Chrome	61ATPSC	\$33.00
Ebony	61ATPSC E	\$33.00

4. **Atlas MS-20** heavy duty mic stand with shock mounting.

Chrome	61ATMS20	\$42.00
Ebony	61ATMS20E	\$42.00

5. **Shure S15** ultra-lightweight, collapsible mic stand which can be adjusted to heights of 3½ to 14 feet. It is sturdy and stable enough to hold large, heavy microphones, and yet it weighs only 5 pounds. This stand is the ultimate for location work. Comes complete with vinyl carrying bag and cable strain relief.

	60SHS15	\$138.00
--	---------	-----------------

6. **ST-201A/2** professional two section collapsible mic stand. Lightweight, yet stable, this is our best seller.

Chrome	61KM201	\$33.00
Black	61KM201B	\$33.00

7. **Atlas MS-25** heavy duty mic stand with shock mounting and triangle base so talent can step up close.

	61ATMS25	\$69.00
--	----------	----------------

8. **Atlas MS-4** three section version of the MS-20.

	61ATMS4	\$32.50
--	---------	----------------

9. **Atlas PB-10X** adjustable boom 31" to 47". Chrome.

	61ATPB10X	\$26.50
--	-----------	----------------

10. **Atlas PB-10** 31" fixed boom.

Chrome	61ATPB10	\$19.25
Black	61ATPB10E	\$21.00

11. **Atlas PB-20XE** two section collapsible boom adjustable 21" to 37".

Ebony finish.	61ATPB20XE	\$23.50
----------------------	------------	----------------

12. **SCH-211/2** collapsible boom extends to 38".

Silver	61KM2112	\$18.95
Black	61KM2112B	\$18.95

13. **Atlas SB-36** professional boom/stand with a grip action clutch and air suspension. Stand extends from 50" to 74", and the boom length is 62".

Without casters	61ATSB36	\$156.00
With casters	61ATSB36W	\$180.00

14. **Beyer ST-270** combo weighs a mere 9 pounds. The stand portion is adjustable from 34" through 61½". The 33" fixed length boom permits overall maximum height of 91". Chrome or black with matte black fittings.

Chrome	60BEST270	\$69.00
Black	60BEST270B	\$69.00

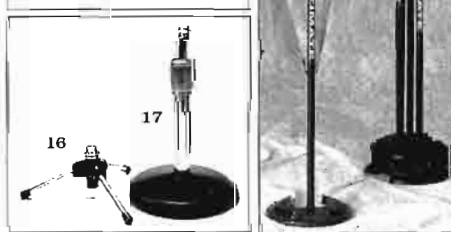
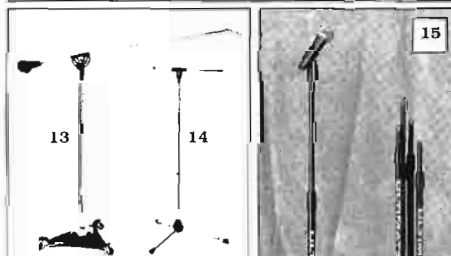
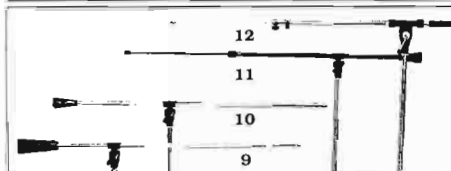
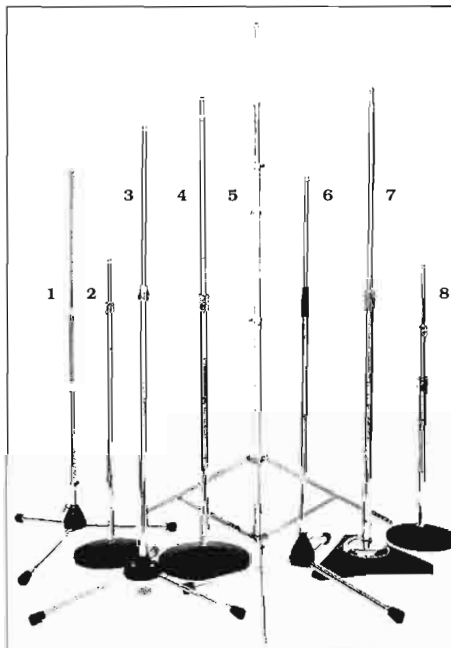

**Bradley Broadcast...
Where Service and
Engineering Make The
Difference**

15. **Ultimate Liberty** has a unique clutch that makes it the easiest stand to adjust. Height ranges from 34" to 64", and the 10" diameter round base allows six stands to be conveniently stacked. Lifetime guarantee.

61USL	\$29.00
-------	----------------

16. **AKG 231** portable, collapsible desk stand is so useful and lightweight, it should be a part of every remote kit. All metal construction for strength and durability, simple leg fold design for reliability, and extremely low weight for portability make this desk stand the most versatile around.

60AK231	\$9.00
---------	---------------

17. **Atlas DS-7** heavy duty adjustable desk stand is our most requested, and now available in either chrome and ebony finish, both with black base.

Chrome	61ATDS7	\$11.25
Ebony	61ATDS7E	\$11.25

Bradley Assembled Mic Cables

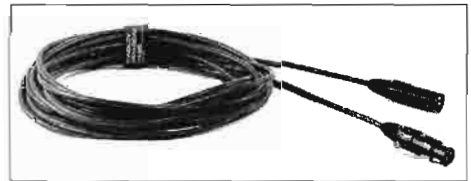

You need them, and Bradley's got them. Our own high quality mic cables, using Neutrik XLR connectors, come in 25' and 50' lengths.

25' cable	61WHMKS20	\$14.50
50' cable	61WHMKS50	\$22.00

Bradley Bulk Mic Cable

Our low impedance mic cable is rugged and reliable. Get as much as you want or as little as you need.

	60AT8300	34¢/ft.
--	----------	----------------

Canare Star Quad Assembled Mic Cables

5 feet	60CAEC005FBXX	\$16.00
15 feet	60CAEC015FBXX	\$20.00
25 feet	60CAEC025FBXX	\$24.50
50 feet	60CAEC050FBXX	\$35.00

Canare cables are made with Neutrik XLR connectors. Black is available from stock. Other colors are special order and are priced the same. All special order cables have a minimum order of 10 cables in any mix of colors and lengths.

Bulk Star Quad	60CAL4E6BK	39¢/ft.
500' reel	60CAL4E605XX	\$182.00
1000' reel	60CAL4E610XX	\$350.00

Black is the only color offered by the foot. Reels are available from stock in black, or in blue, brown, grey, green, orange, purple, red, white, and yellow by special order. Call for pricing on multipair cable with 2, 4, 8, 12, 16, and 24 pairs.



Goosenecks

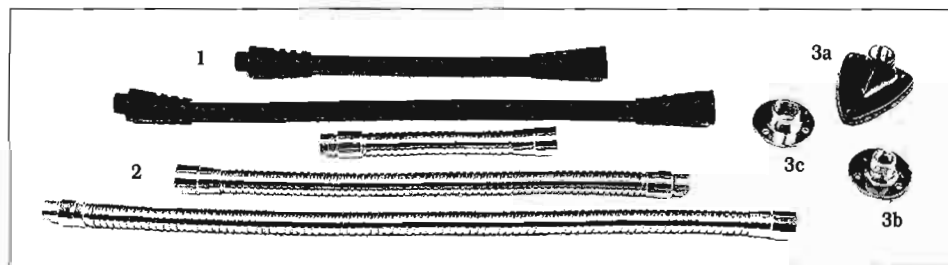

1. Mic-Eze Rubbernecks are unique new goosenecks that eliminate the noise caused by standard goosenecks. Black rubber-like construction.

- 16" Neck** 61ACR16 **\$11.95**
- 10" Neck** 61ACR10 **\$9.95**

2. Standard Goosenecks are now available in both chrome and black finishes.

- 6" Chrome** 61ATGN6 **\$3.80**
- 6" Black** 61ATGN6E **\$3.80**
- 13" Chrome** 61ATGN13 **\$5.60**
- 13" Black** 61ATGN13E **\$5.60**
- 19" Chrome** 61ATGN19 **\$7.45**
- 19" Black** 61ATGN19E **\$7.45**

3. Atlas Gooseneck Mounting Flanges

- a. AD-11B Female 5/8"-27**
 - Chrome** 61ATAD11B **\$3.80**
 - Ebony** 61ATAD11BE **\$3.80**
- b. AD-12B Male 5/8"-27**
 - Chrome** 61ATAD12B **\$3.80**
 - Ebony** 61ATAD12BE **\$3.80**
- c. AD-18B Heavy Duty Female**
 - Chrome** 61ATAD18B **\$6.85**
 - Ebony** 61ATAD18BE **\$6.85**

Shure A58WS Windscreens



These windscreens fit most mics with ball shaped heads. Available colors are orange, red, blue, brown, black, white, green, and, yellow.

- 61SHA61WSXX **\$5.00**

Microphone Mounting Accessories

- 4. "Clothes-Pin" type spring loaded swivel mic adapter.** Fits most mics. 61BEMKV6 **\$12.95**
- 5. Mic-Eze Adapter** is a unique unbreakable mic holder with locking bolt and non-slip grip. 61MEM4 **\$10.60**
- 6. Tapered Swivel Adapter** fits most Shure mics and many other models. 61SF1 **\$4.95**
- 7. Suspenders Stand Clamp** attaches to any tubular stand, such as a mic or drum stand. It has a 5/8"-27 thread mount for mic clamp to be attached. 61LPS420 **\$7.95**

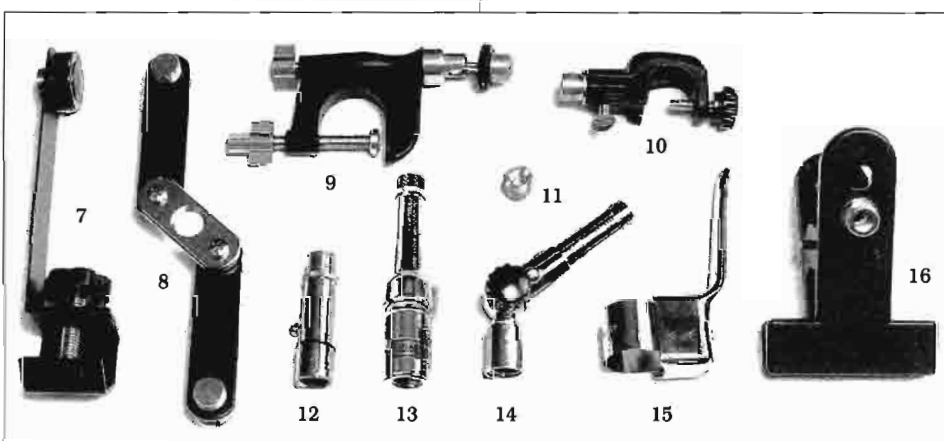
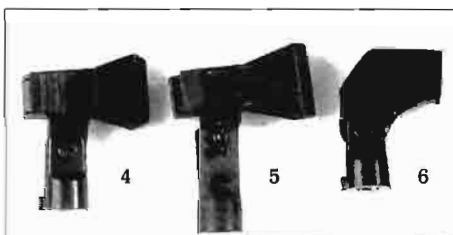

- 8. AKG KM235/1 twin mount** for horizontal extension or installation of 2 mics on one stand. Three pivot points allow flexible mic positioning. 60AKKM235 **\$14.50**

Also available:

- Atlas TM-1** allows installation of 2 or three mics on a single stand. 61ATTM1 **\$12.70**
- Shure A27M** twin mount allows placing two mics vertically on one stand. Designed for M-S stereo miking. 61SHA27M **\$54.00**
- Shure A27T** triple mount is the type used by the President of the US to use three Shure SM57 mics. 61SHA27T **\$99.00**
- 9. Rowi Clamps** allow you to attach your microphone to virtually anything. The clamp jaw opens to 1 1/2", and the mic adapter swivels. Possibly our most popular and useful mic clamp. 60BBRC **\$31.95**
- 10. Atlas CO-1B** clamps to mic stands or booms to allow attaching a second mic. 61ATCO1B **\$12.10**

- 11. MZA-217** 5/8" external to 3/8" internal thread adapter. 61SNMZA217 **\$3.00**

- 12. Atlas VM-1** shock mount adapter reduces vibrations to mic. 61ATVM1 **\$14.25**

13. Atlas LO-2B provides for quick disconnect of mic clamp.

- Chrome** 61ATLO2B **\$11.90**
- Ebony** 61ATLO2BE **\$11.90**

14. Atlas SW-1B swivel attachment makes mic placement more convenient.

- 61ATSW1B **\$19.30**

15. Atlas CH-1B threads onto mic stand and provides a place to hang the mic cable.

- 61ATCH1B **\$9.60**

16. Suspenders Clip Clamp is a spring loaded adapter that clips onto virtually anything. Features a 5/8"-27 thread adapter. Keep a few in your road kit.

- 61LPS413 **\$7.95**

Atlas Adapters

Bradley can assist your next installation with these useful adapters. Chrome.

- 5/8"-27F to 1/2" pipe M 61ATAD1B **\$3.80**
- 3/8" pipe F to 5/8"-27M 61ATAD2B **\$3.80**
- 3/8" pipe F to 5/8"-27F 61ATAD3B **\$3.80**
- 3/4" long, 5/8"-27M thread 61ATAD4B **\$3.80**
- Coupling; 5/8"-27F to 5/8"-27F 61ATAD5B **\$3.80**
- Coupling; 7/8"-27F to 7/8"-27F 61ATAD6B **\$5.35**
- 3" long tube; 5/8"-27M thread each end 61ATAD7B **\$3.80**
- 6" long tube; 5/8"-27M thread each end 61ATAD8B **\$3.80**
- 7/8"-27F to 5/8"-27F 61ATAD9B **\$5.35**
- 5/8"-24F to 5/8"-27F 61ATAD10B **\$6.85**
- 7/8"-27M to 5/8"-27F 61ATAD13B **\$6.10**
- 90° angle tube; 5/8"-27M & F 61ATAD14B **\$6.85**
- "Feed thru", 5/8"-27M & F 61ATAD15B **\$6.85**
- 45° angle tube; 5/8"-27M & F 61ATAD19B **\$6.85**



Shure "Problem Solvers" and Impedance Transformers

These in-line devices are only 4½" long and 3/4" in diameter, and are color coded for quick identification. Extremely handy, they have XLR connectors. Except as noted, they are designed to be used with 150 ohm low level equipment.

Tone generator produces a continuous 700Hz signal capable of driving low impedance balanced lines. Battery operated. 61SHA15TG **\$63.00**

Low pass filter provides a high frequency cutoff to reduce objectionable high frequency noises. 61SHA15LP **\$36.00**

Response shaper provides sibilance filtering (removes presence peak) for recording, broadcasting, and PA applications. 61SHA15RS **\$36.00**

Bridging transformer matches balanced or unbalanced devices of different impedances (33 kilohm primary, 600 or 7500 ohm secondary). 61SHA15BT **\$40.00**

Line input adapter converts low impedance microphone input to bridging line-level input. May be driven from source of up to 50 kilohms and 24dBm. 61SHA15LA **\$36.00**

Switchable mic attenuator provides 15, 20, or 25dB attenuation to prevent preamp overload. 61SHA15AS **\$37.00**

Switchable phase reverser instantly reverses phase of a balanced line of any level. Can be used in either direction. 61SHA15PRS **\$36.00**

Presence adapter adds presence to vocals or instruments. 61SHA15PA **\$36.00**

High pass filter provides a low frequency cutoff to reduce unwanted low frequency noise. 61SHA15HP **\$36.00**

Impedance Transformers

Shure A95U in-line impedance matching transformer with male XLR connector. Male and female 1/4" adapters supplied. 61SHA95U **\$29.00**

Shure A95UF in-line impedance matching transformer with female XLR connector. Male and female 1/4" adapters supplied. 61SHA95UF **\$32.00**

Whirlwind Little IMP in-line impedance matching transformer with female XLR connector to male 1/4" connector. 61WHLI **\$11.50**



Har-Ken Specialties Adapters

This unique series of products is designed to rescue you from that "little problem" that always pops up at the last minute.

XLR Adapters

Surprise! You are on the air in five minutes, and you need to mate with an alien connector. Fortunately, you've got Har-Ken adapters in your kit so you'll meet the deadline with time for a cup of coffee. Specify male or female XLR connector.

Adapter termination

	Price
Three terminal barrier strip	60HK104X \$17.25
Miniature three terminal barrier strip	60HK118X 18.40
Triple binding posts, side mounted	60HK119X 25.30
Triple binding posts, rear mounted	60HK103X 25.30
Phono (RCA) jack (female)	60HK107X 16.10
Phono (RCA) plug (male)	60HK110X 16.10
Mini-plug (TS wired to pins 2 & 3)	60HK121X 16.10
Mini-jack (TS wired to pins 2 & 3)	60HK122X 16.10
Bantam patch field jack	60HK109 33.00
BNC (coax shield & XLR body isolated)	60HK106X 14.70
Telephone line RJ11C (6 pin)	60HK116X 16.10
Telco handset jack-transmit (4 pin)	60HK117TX 16.10
Telco handset jack-receive (4 pin)	60HK117RX 16.10

XLR Universal Two-Fer

Double barrelled so that you will be able to connect any two cables regardless of the gender of their XLR connectors. 60HK115 **\$41.00**



Inline Switchable Audio Pad with XLR connectors

Allows attenuation from 10dB to 40dB in 2dB steps.

600/600 ohm pad	60HK1126	\$63.00
150/150 ohm pad	60HK1121	\$63.00

Phase Reversal & Ground Lifter

Puts both of these functions into a single, compact inline unit with XLR connectors. 60HK113 **\$52.00**

XLR Monitoring Device

Allows you to monitor moderate to high level audio. The TS mini-jack allows you to connect an ear piece or headphone. 60HK111 **\$25.50**



Stereo Microphones

(1) The AT825 from Audio-Technica has two wide range, closely matched condenser elements in an X/Y pattern. The elements are shock mounted to reduce handling noise. The AT825 is mono compatible and produces spatially accurate stereo recordings. Internally battery powered using an "AA" cell, or may be phantom powered. Switchable low cut filter and windscreen included. Why gather sound in mono, when the AT825 makes stereo so affordable.

AT825 60AT825 MFR LIST \$399.00

(2) Sony's MS stereo ECM-MS5 packs an unbelievable amount of performance to handle your every recording requirement. It features three capsule mic elements, assuring superior transient response for clean, uncolored sound. With the adjustable directivity feature, you can select from 6 click stop positions ranging from 0° for mono recording to 127° for a rich, well balanced stereo atmosphere. This mic is at home indoors and out in its sturdy aluminum housing. The ECM-MS5 has switchable low cut filters, and may be powered by phantom power or, with the optional DC-MS5, by battery.

ECM-MS5 60SOECMMS5 MFR LIST \$1250.00

Accessories:

DC-MS5 uses an "AA" battery to power the ECM-MS5. Short and slim, this unit is supplied with a flexible belt holder. 20 hours of consecutive operation can be obtained, and an LED shows battery condition when the power is turned on.

60SODCMS5 MFR LIST \$319.00

Light Wave Super Screen

60LWSSMS5 MFR LIST \$220.00

Light Wave Super Mount Pistol Grip

60LWSMMS5 MFR LIST \$130.00

(3) Shure's VP88, an advanced single point stereo condenser mic, recreates the sonic environment with extraordinary fidelity and meets Shure's legendary standards for ruggedness and reliability. The capsules are in a Mid-Side configuration, and the VP88 offers three switch selectable stereo modes or direct M-S output. Mic elements, stereo matrix, and powering electronics are all in an easy to handle component. Powering is by internal battery or external phantom. Other features include a low frequency roll-off, built-in pop filter, foam windscreen, and 30' Y-cable terminating on two color coded XLR cables. Whether you are just beginning to look at stereo miking, or you want to take your stereo to the next level, consider the advantages of the Shure VP88.

60SHVP88 MFR LIST \$995.00

Accessories:

Lightwave Super Screen

60LWSSVP88 MFR LIST \$258.00

Lightwave Super Mount Pistol Grip

60LWSMVP88 MFR LIST \$172.00

Call Bradley for a current price quotation.



Shotgun Microphones

Let Bradley give you the longest arm in the crowd with a shotgun mic. We've pictured the models our customers tell us provide them with quality and value. Shotgun mics are for applications where close miking is impossible, and most can be hand held, camera or boom mounted, or operated from a fishpole. Long shotguns are best used for sound sources at a distance. Short shotguns are recommended when sound sources may be closer and may have a tendency for moving "off-mic."

(4 & 5) At only 9 ounces and 18", the Audio-Technica AT815 won't load you down. It includes a stand clamp, storage case, windscreen, and 16' cable. The AT815a version is powered by a single "AA" cell, while the AT815R uses phantom power systems from 9 to 52 volts.

The shorter AT835 extended-range condenser mic combines the best attributes of both cardioid and shotgun types. It is packaged with the same accessories as the AT815, is battery operated, and is 14" in length.

AT815 battery powered 60AT815 \$204.00
AT815R phantom powered 60AT815R \$265.00
AT835 battery powered 60AT835 \$185.00

(6 & 7) The Audio-Technica AT4071 is a transformerless, externally polarized line-gradient capacitor shotgun. It's uniform polar pattern and reduced rear pickup contribute to this mic's excellent sound. It has low sensitivity to the "encounter" noise of panning action, and a 150Hz high pass filter is built-in. The AT4071 is 15" long and weighs just 5.8 ounces. Phantom or simplex powering of 12 to 48 volts is required.

The AT4073 is a short shotgun version of the above that is 9" long and weighs a mere 4.2 ounces.

AT4071 60AT4071 \$799.00
AT4073 60AT4073 \$669.00

(8) The Sony ECM 672 is a light-weight, short electret shotgun mic that doesn't sacrifice audio quality or durability to its economical price. It is designed to be mounted on a portable video camera or can be hand held. The ECM 672 will operate for approximately 3000 hours on an "AA" size cell and can also be 48V phantom powered. A built-in LED indicator shows battery condition. This versatile mic also has a two position low frequency roll-off.

ECM 672 60SO672 \$380.00

(9) Sennheiser's RF condenser technology results in microphones with the lowest inherent noise. These mics have fast, distortion-free response to audio transients over an extended frequency range. The MKH 70 long shotgun and MKH 60 short shotgun both have offer a switchable low cut filter, presence boost, and input attenuator. The MKH 70 is 16.4" long and weighs 6.3 ounces, and the MKH 60 is 11.2" and weighs 5.25 ounces. Models listed use 48V phantom powering; models using 12 volt AB powering are available at the same price. Sennheiser shotguns fit the bill when you demand the best.

MKH 70 P48U3 60SNMKH70 \$1349.00
MKH 60 P48U3 60SNMKH60 \$1150.00

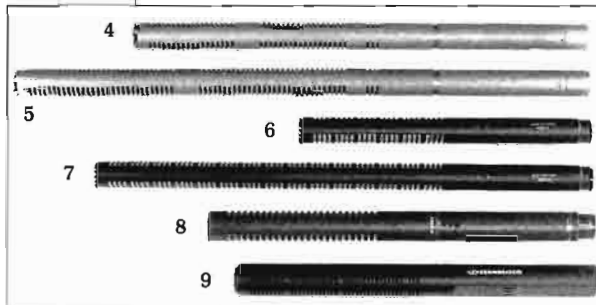

Also available:

Sennheiser MKH 816 and MKH 416 are in wide use in broadcast, film, and recording. Call or fax for details.

Accessories:

Lightwave Super Screens and Super Mounts are available for all shotgun mics. Ask your Bradley professional about wind covers, fishpoles, and other accessories to round out your mic package.

Light Wave Super Screens

For AT815 60LWSS815 \$245.00
For AT835 60LWSS835 \$235.00
For AT4071 60LWSS4071 \$245.00
For AT4073 60LWSS4073 \$235.00
For ECM 672 60LWSS672 \$245.00
For MKH 70 60LWSS70 \$245.00
For MKH 60 60LWSS60 \$235.00

Light Wave Super Mount Pistol Grips

For AT815 60LWSM815 \$125.00
For AT835 60LWSM835 \$120.00
For AT4071 60LWSM4071 \$245.00
For AT4073 60LWSM4073 \$235.00
For ECM 672 60LWSM672 \$130.00
For MKH 70 60LWSM70 \$245.00
For MKH 60 60LWSM60 \$235.00

Mini screens and package discounts are available. Light Wave screens are also available for the shotguns when camera mounted. Call for details and a current price quotation.

In case you've just tuned in, there are plenty of mics back a few pages in the Microphone section

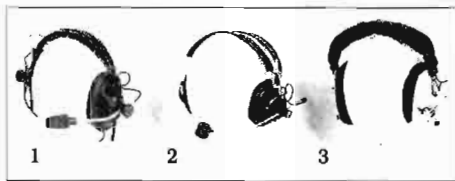

Headsets

(1) Sennheiser HMD 224X

The HMD 224X provides extended headphone frequency response (16Hz to 20kHz) and a shock-mounted super-cardioid microphone in a very high quality package. Circumaural air filled, double layered cushions provide isolation and comfort for the wearer. The microphone's pattern is tailored so that it provides the best response when offset to the side of the mouth, and results in one of the most natural sounding headset mics available. Extremely rugged, the HMD 224X weighs under one pound.

60SNHMD224 **\$215.00**

(2) Shure SM2

The SM2 is loaded with features that make it the ideal choice for professional use. The patented metal boom is designed for total flexibility in mic placement and adjustments for right or left side use. This consistent mouth-to-mic positioning, coupled with the cardioid mic's specially tailored pattern and frequency response, ensures accurate voice reproduction and maximum voice isolation. The rugged metal frame will withstand many seasons of heavy use, and the unit weighs less than 11 ounces. The cable is detachable for quick and easy changes between mono, stereo, or split feed headphone functions. Supplied with cable and windscreen.

60SHSM2 **\$154.00**

(3) Beyer DT 109 and DT 108

Beyer dynamic moving coil microphone/moving coil headphone combinations are especially suited to both remote and studio use. Lightweight and comfortable, the headphone transducer features extended response and is virtually impossible to overload. The wide frequency response of the noise cancelling mic results in a rich, yet clear, transmission. Rugged construction. Headphones are 400 ohms, mic is 200

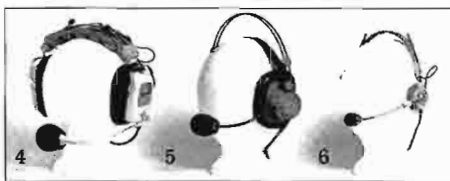

ohms, with other impedances available. Models listed are black; white can be ordered at the same price. Straight or coiled cable required.

DT 109 60BE402982 **\$160.00**

DT 108 60BE402966 **\$126.00**

Straight cable (1.5M) 60BE101907 **\$19.00**

Coiled cable 60BE198900 **\$30.00**

(4) Telex PH-94

Telex "Sportscaster" headsets have long been a favorite of professional announcers. The full cushioned PH-94 features a cardioid mike. The 9' cable includes an in-line cough switch with a handy clothing clip. Mic boom swivels a full 310° so that it can be worn on either side of the head. Washable nylon comfort socks are provided for the earcups.

60TXPH94 **\$187.00**

(5) AKG Q34

This dynamic microphone/headphone from AKG is rugged and comfortable. A noise cancelling close talk microphone is mounted on an extremely flexible arm. A self-adjusting headband and 10 ounce weight make the Q34 a comfortable choice.

60AKQ34 **\$99.00**

(6) Telex PH-24

The PH-24 has a noise cancelling electret mic plus a lightweight design that stays comfortable for your longest on-air shifts. Features include an in-line cough switch, internal battery or external phantom power, and flexible mic boom. Headphones are wired for monaural operation.

60TXPH24 **\$187.00**

Please note:

All headset cables require user-installed connectors.

Light Wave Screens, Mounts & Fishpoles

Bradley and Light Wave Systems offer you the delightful dilemma of the widest selection

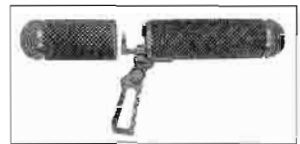

of screens and mounts for your shotgun and field production mics. Super Screens combine superior isolation with thoughtful design for maximum wind attenuation and no loss of midrange frequency response. Use the Super Screen with the Super Mount or the Plus 20 Mount for the very best in mic isolation. Both mounts include a detachable pistol grip. Also available are economical Mini Screens and Mini Mounts, including models for camera mounted mics. Three models of high wind covers are available to provide further protection: the classic Super-Sock, an oversized Super-Sock, and the Windmaster with 3/8" deep fur-like pile.

Light Wave fishpole booms have telescoping cam locks and provisions for internal wiring.

FP12 fishpole 4' to 12'

60LWFP12 *MFR LIST* **\$195.00**

FP6 fishpole 28" to 6'

60LWFP6 *MFR LIST* **\$185.00**

Super-Sock for Super Screen

60LWSSCXXX *MFR LIST* **\$42.00**

Super-Sock for Mini Screen

60LWMSCXXX *MFR LIST* **\$28.00**

Light Wave products are available for over a dozen manufacturer's products. Call Bradley for a current price quotation on the system for your mics.

Rowi Clamps

These clamps allow you to attach your microphone to virtually anything! The clamp jaw opens to 1 1/2", and the mic adapter swivels. Our most useful and popular mic accessory.



Rowi Clamp

60BBRC

\$31.95

Sennheiser Electret Mic System

Start with the K3U universal powering module (mercury battery or phantom power), then add the condenser head that is right for your application. Battery life is approximately



600 hours. An LED indicator flashes at turn on to indicate at least 20 hours remaining. The K3U also has a three position roll-off switch (flat, -7dB at 50Hz, -20dB at 50Hz). The ME80 and ME88 are both

pressure-gradient type microphones. The ME80 acts like a shotgun above 3kHz, cardioid below 3kHz. The ME88 includes foam windscreen.

K3U powering module 60SNK3U **\$176.00**

ME20 omni; 50Hz to 15kHz. 60SNME20 **\$96.00**

ME40 cardioid; 80Hz to 15kHz 60SNME40 **\$134.00**

ME80 super-cardioid; 40Hz to 15kHz.

60SNME80 **\$198.00**

ME88 shotgun; 40Hz to 15kHz 60SNME88 **\$256.00**

Accessories:

Windscreen for ME80. 60SNMZW415 **\$38.00**

Camera mount for shoe-type mounts.

60SNMZG802 **\$62.00**

Replacement battery for K3U 61SNPX23 **\$6.00**

Call for pricing on your complete system.

Stewart BPS-1 Battery Phantom Supply

This single channel, 48 volt phantom power supply is rated for up to 200 hours using a pair of 9 volt alkaline batteries. It can deliver up to 4.5 mA at 48VDC, and has locking XLR connectors. The chassis is all aluminum and the BPS-1 comes with a detachable belt clip.



BPS-1

60SEBPS1 **\$95.00**



Hand Held Microphones

(1) Electro-Voice 635A

The most popular mic in broadcast for remote or studio use. Virtually indestructible, the omnidirectional 635A has an 80Hz to 13kHz response. The individual mics are packaged with stand adapter. Save by purchasing the 635A in a six pack without stand adapters.

635A	60EL635A	\$94.00
Six pack of 635A	60EL635A6	\$490.00
Accessory:		
Windscreen	60EL314E	\$11.25

(2) Electro-Voice DO56L

This omnidirectional mic is shock mounted to isolate the element from both handling and cable noise. The DO56L provides excellent vocal quality. 1 1/2" shank.

DO56L	60ELDO56L	\$139.00
DO56 6 1/2" shank version	60ELDO56	\$128.00
Accessory:		
Windscreen for DO56L and DO56	60EL351	\$12.00

(3) Electro-Voice RE50

You'll see the RE50 at virtually every major news event. That's because this is the mic expressly designed for hand held news gathering. It has the same tailored response and high output of the 635A, and its resilient "mic-within-a-mic" shock mount design achieves a high degree of isolation. The built-in windscreen is a super effective "P-pop" filter. Rugged construction and non-reflective finish allow the RE-50 to go anywhere.

RE50	60ELRE50	\$149.00
Accessory:		
Windscreen	60EL376	\$17.25

(4) Electro-Voice RE45

A highly directional dynamic mic incorporating a neodymium alloy magnet to provide high sensitivity and low weight. The directional pattern of this mic has been carefully tailored to provide smooth off-axis frequency response. Especially designed for hand held use, the RE45 includes a removable Warm-Grip handle which fits over the mic connector and short handle of the mic. A 250Hz high pass filter is incorporated, and a windscreen is provided for outdoor use.

RE45	60ELRE45	\$313.00
-------------	----------	----------

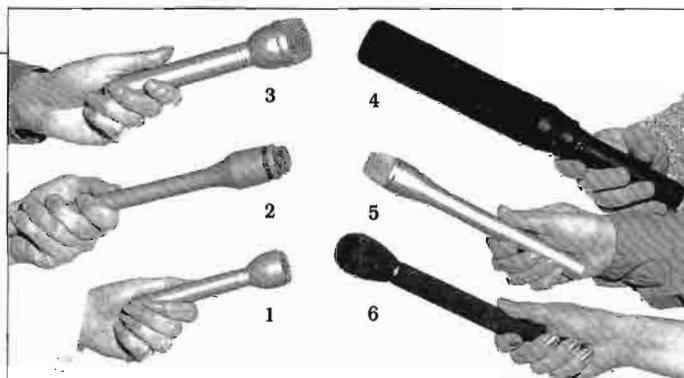

(5) Shure SM63L

The SM63L is a small, elegant, rugged microphone with output up to 6dB higher than comparable mics. Omnidirectional with extended frequency response, a low frequency roll-off gives a natural sounding pickup. The Shure designed and patented mechano-pneumatic shock mount isolation cuts handling noise and an effective humbucking coil rejects interference from strong magnetic fields. The SM63L has an integral wind and pop filter and nearly indestructible grille. It has an extended 9 1/8" handle, weighs less than 4 1/2 ounces, and includes a foam windscreen.

SM63L	60SHSM63L	\$107.00
--------------	-----------	----------

Also available:

SM63 5 1/8" handle version.	60SHSM63	\$92.00
------------------------------------	----------	---------

(6) Beyer M 58

The M 58 is extremely rugged, and will hold up under heavy field punishment. Its unique low mass diaphragm produces unprecedented intelligibility, even off-axis. Shock mounted for low handling noise, the M 58 has a special non-reflective finish that looks great on camera. The 10" shank is balanced for a positive feel in your hand. Probably our finest hand held omnidirectional mic. Packed with foam windscreen.

M 58	60BEM58	\$149.00
-------------	---------	----------

Accessories:

Mic clamp	61BEMKV8	\$13.50
------------------	----------	---------

Bradley ENG Mic Cables

Our popular cables are available in four versions. These cables will stand up to the rigors of field use without damage or failure. Straight cords are 6', while coiled cords extend to over 10'. Designed to be used with the portable cassette decks on the following page: Use the models with 1/8" mini connectors with the PMD 201 and PMD 221, and use the models with 1/4" connectors with the PMD 420 and PMD 430.

XLR female to 1/4" straight cable	61WHENG4	\$12.00
XLR female to 1/8" mini straight cable	61WHENG	\$12.00
XLR female to 1/4" coiled cable	61WHENG2	\$28.00
XLR female to 1/8" mini coiled cable	61WHENG3	\$28.00

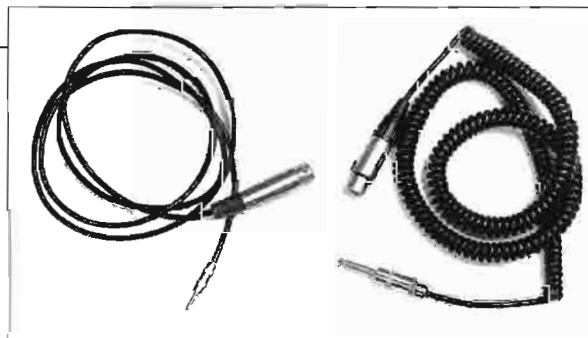

Your Bradley Professional can assist you with all of your audio needs. Call 800-732-7665.

FIELD PRODUCTION



99

Toll Free: 800-732-7665 • MD & DC: 301-948-0650 • FAX: 301-330-7198 • **Bradley Broadcast**

Marantz Portable Cassette Recorders

The **PMD 201** cassette recorder features include: 2 speed operation, auto-shutoff, four way power, VU meter, electret condenser mic, cue and review, and 1/4" headphone jack. This lightweight, low profile package incorporates: switchable limiter, built-in modular telephone jack, varispeed, automatic noise-cancel switch, and metal tape capability. Two head design with separate record and playback level controls. Mic input is 1/8" mini.

PMD 201 60MR201 **\$228.00**

The **PMD 221** contains all features of the PMD 201, plus 3 head design and memory rewind/replay. Mic input is 1/8" mini.

PMD 221 60MR221 **\$272.00**

The **PMD 420** is an economical stereo portable cassette recorder which features Dolby B noise reduction, MPX filter, left and right illuminated VU meters, peak LED's, 3 position mic attenuator, and switchable left mic mono input. A vinyl carry case and shoulder strap are included, along with AC adapter. Mic inputs are 1/4" TS and line inputs and outputs are phono.

PMD 420 60MR420 **\$354.00**

Accessories:

Vinyl carrying case for PMD 221 and PMD 201 60MRCLC221 **\$33.00**

Ni-Cad battery pack for all PMD recorders 60MRRBD430 **\$66.00**



The **PMD 430**, the most sophisticated Marantz stereo portable, adds dbx noise reduction to a full featured compact design. With three head performance, ±6% pitch control, illuminated VU meters, limiter, Dolby B, and bias fine adjust, the PMD 430 takes studio quality cassette recording into the field. Memory rewind, auto shut-off/replay, three step mic attenuator, and headphone jack round out the useful functions built into this advanced recorder. Mic inputs are 1/4" TS and line inputs and outputs are phono.

PMD 430 60MR430 **\$449.00**

Sony TC-D5PRO II Cassette Recorder

The stereo TC-D5PRO II has been the portable, high quality cassette standard for years. The mic inputs are female XLR connectors, line outputs are phono, and the headphone output is 1/4". Powering is by battery, the optional AC supply, or external 6 or 12VDC. Frequency response is excellent with standard cassettes, and Dolby B provides a 6dB improvement in signal/noise ratio. Lighted VU meters, battery check button, and record limiter are other desirable features.

TC-5DPROII
60SOTCD5 **\$779.00**

Accessory:
AC adapter
60SOACD468 **\$44.00**



Bradley "Get The Story" Packs

With this complete ENG kit, you'll be prepared to "get the story" at a moment's notice. Choose between the Marantz PMD 201 and PMD 221 recorders, and we'll put it together with its carrying case, the Shure SM63L mic, an AKG 231/1 desk stand, and a Bradley coiled ENG cable at a great low price.

Package 9101 with PMD 201
\$365.00

Package 9102 with PMD 221
\$409.00



Bradley "Bring It Back Packs"

News gathering can get hectic. That's why Bradley has put it all together with these complete news gathering outfits. Be prepared to get the story first! And if you're ready to gather your news digitally, call us to put together a custom package with a portable DAT recorder.

Monaural Package

This package includes the rugged Marantz PMD 221 three head cassette recorder with case, the Beyer M58 mic with windscreen and clip, Sennheiser HD450 headphones, a coiled ENG cable, a 25' XLR to XLR cable with Cord-Lox, a 13" gooseneck, and a Rowi clamp.

Valued at over \$800.00. **Package 9103** **\$565.00**



Stereo Package

The Audio-Technica AT825 stereo mic and the Marantz PMD 430 three head stereo cassette deck are at the heart of this package. Also included are a windscreen for the mic, a case for the recorder, two 25' XLR to XLR cables with Cord-Lox, and two Whirlwind Little Imp matching transformers.

Valued at over \$1000.00. **Package 9104** **\$728.00**



Shure Mixers

(1) **M267A** is a compact, lightweight, 4 input professional microphone mixer that offers excellent performance and capabilities. Features include peak program limiter, simplex mic power, built-in battery pack, LED power indicator, automatic muting circuit, active gain controls, electronic power supply regulation, powerful headphone amp, and front panel headphone jack with level control. Both mic and line level outputs are provided. Also featured are transformer balanced inputs and outputs, mix buss connection, low cut filters, and low RFI and low noise susceptibility.

M267A 60SHM267 MFR LIST \$520.00

Also available:

M268 five input microphone mixer features 4 transformer balanced mic inputs with simplex power, an auxiliary line input, and a master volume control. Connecting the M268 with the M267A via the latter's mix buss effectively creates a 9 input mic mixer. The M268 can also be used to expand inputs on other current equipment.

M268 60SHM268 MFR LIST \$315.00

M68FC is a practical device for increasing the flexibility of systems requiring multiple mic inputs. The M68FC features 4 mic inputs, Lo-Z or Hi-Z, plus one high level auxiliary input. Both mic and line level outputs are provided.

M68FC 60SHM68FC MFR LIST \$235.00

(2) **FP42** provides all of the features of the industry standard M267A with stereo capability. Four balanced mic/line inputs with pan pots are provided. Each channel provides phantom power, and cue audio is routed to the stereo headphone jacks when a channel control pot is pulled out. It can operate for 8 hours continuously on three 9 volt alkaline batteries. Front panel controls include mono/stereo switch, tone oscillator, limiter on/off, and headphone level control.

FP42 60SHFP42 MFR LIST \$990.00

(3) **FP51** combines a four input, one output microphone mixer with a high quality gated memory compressor. It provides a 40dB compression range with a compression ratio of approximately 10:1 in normal operating range. Once the compression level is set, the FP51 will ride gain automatically. The unit's gated memory mini-



mizes "pumping," resulting in smooth recorded programs and sound reinforcement, while the true average responding compression maximizes output level regardless of the peak-to-average ratio of program material. The peak-responding circuit reduces gain rapidly in response to increases in input signal. The FP51 features phantom power, a tone oscillator, both 1/4" and mini headphone jacks with level control, and an illuminated dual range VU meter that indicates output level, dB compression, and battery condition.

FP51 60SHFP51 MFR LIST \$965.00

(4) **FP16A** is a 1x6 distribution amplifier which will accept a mic or line input and feed any combination of six mic or line outputs. Line in and out jacks allow gang-ing units together for additional output capability or inserting processing. Simplex power is available, and the entire unit may be operated at +4dBm output in continuous use for up to 20 hours on three 9 volt batteries. The battery supply also automatically cuts in if normal AC power fails. Inputs/outputs are XLR and link jacks are 1/4" TS. The FP16A is ideal for remote functions, news conferences, ENG applications, or any place where multiple mic/line outputs are needed.

FP16A 60SHFP16 MFR LIST \$570.00

Accessories:

Rack mount kit for M267 & M268 61SHA268R MFR LIST \$26.00

Rack mount kit for M68FC 61SHA68R MFR LIST \$26.00

Rack mount kit for FP42, FP51, and FP16A.
60SHA16R MFR LIST \$31.00

Call Bradley for a current price quotation.

Electro-Voice ELX-1R Mixer

The ELX-1R mixer is a compact, high-performance audio mixer designed for professional applications where clean audio and reliable operation are important. Extensive RF filtering circuitry and shielding allow use in almost any environment, and input/output circuitry has been optimized to perform with flatter response and far less distortion than what you might expect from such a small, inexpensive mixer. Power can be either AC or external DC (auto switching), with an indicator to show power status. A built-in oscillator helps with level calibration, and a ten segment three color PPD LED bar graph meter shows peak output level and clipping. A simple internal modification will alter the meter to VU operation. A switchable limiter will keep output signals consistent, and it lights an LED to show limiting activity. All four input channels will take a mic or line level signal



and have switchable phantom power. Each of the four channels also has a low cut filter, gain control, and clipping indicator. Outputs are transformer isolated and can be switched from mic to line level. Main input and output connectors are XLR, though the unit also provides a +4dBm output on binding posts. Stacking inputs and outputs are on 1/4" phone jacks. The ELX-1R mounts in a single rack space.

ELX-1R 60ELELX1R MFR LIST \$567.00

Call Bradley for a current price quotation.

U.S. Audio MIX-5 Mixer

There is always a need for a convenient, quality small mixer. U.S. Audio's MIX-5 fits the bill perfectly as a single space, rack mountable five input mixer available in mono and stereo output versions. The first four inputs offer balanced XLR microphone and high impedance 1/4" TS line level connectors, and a stereo auxiliary input (summed on the mono version) is in the last position. Includes a ten segment LED level indicator.



Mono output 60WHMIX5 MFR LIST \$299.00

Stereo output 60WHMIX5S MFR LIST \$399.00

Call Bradley for a current price quotation.



Shure FP12 Headphone Amp

Whether the problem is monitoring or trouble shooting audio lines, boosting headphone levels, or providing a simple intercom system, the convenient FP12 provides the solution. Powered by a 9V battery, this bridging amplifier includes 1/4" TRS and XLR connectors for input and output and permits interconnection of several units. The FP12 includes two pairs of headphone jacks (stereo 1/4" and stereo mini-plug), the ability to accept mic or line level inputs, and up to 96dB of gain. Don't go on your next remote without it!

FP12 60SHFP12 MFR LIST \$255.00

Call Bradley for a current price quotation.



Shure FP11 Mic/Line Amp

This compact, battery operated mic-to-line amplifier provides gain of up to 84dB, adjustable in 6dB steps. The unit has both a balanced XLR mic level input and a mini-jack input for a high level, high impedance source. The output is transformer balanced and appears on both an XLR connector and a set of spring contact binding posts. A very smooth switchable peak limiter and belt clip are included in this rugged, dependable, and reliable unit. Powered by a single 9 volt battery.

FP11 60SHFP11 MFR LIST \$270.00

Call Bradley for a current price quotation.

Shure FP32 Stereo Mixer

Three mic/line channels with center-detented pan pots provide true stereo mixing capability. A concentric, clutched master stereo gain control is also provided. Field users will appreciate its built-in slate mic and tone feature, plus built-in simplex or AB phantom powering. Two illuminated VU meters plus battery check switch are provided, along with carry case and shoulder strap.

FP32 60SHFP32 MFR LIST \$1395.00

Call Bradley for a current price quotation.



Shure FP31 Compact Mixer

This innovative mixer from Shure is one of a kind. Weighing only 2.2 pounds, it packs three mic/line input channels with low-cut filters, a switchable limiter, two tape outputs, and two headphone outputs into an efficient, compact package. A rugged nylon carrying case is included which allows easy access to every mixer function, while allowing you to piggyback the FP31 on your VCR or other equipment. VU meter, battery indicator, meter lamp, phantom power, and headphone volume control round out this incredible mixer.

FP31 60SHFP31 MFR LIST \$1025.00

Call Bradley for a current price quotation.

Zercom MAX-Z Remote Console

This is an elegant and comprehensive unit for all remote broadcast situations. Its basic features include four mic/line inputs with front panel level controls and rear panel trim pots, clock with set controls, 24 minute timer, and telephone keypad with tone/pulse dialing, memory dial, and last number recall. Buttons are provided for channels 1 and 4 which divert audio to the cue buss for "spotters" or other cueing needs. A front panel "line" button is used to connect to a ringing line; it flashes red as the line rings and a beeper announces a call coming through. A separate line loss indicator provides visual and aural notice that a disconnect has occurred.

On the rear panel, both dedicated and dial-up modular jacks are provided. A switchable 2600Hz notch filter is provided to prevent accidental disconnects caused by crowd audio. Outputs include a 1/8" record out, designed to drive a cassette mic input and four mono/stereo headphone jacks, with cue audio appearing on left channel only. If monaural phones are used, cue audio is not heard. Front panel LED's indicate battery status, ringing, line loss, power, and VU level. A front panel "null" control adjusts the ratio of program audio to return line level sent to the headphones. The complete MAX-Z system includes a custom carrying case, built-in rechargeable battery, and 110/220VAC operation. Size is 13" x 17" x 5"; weight 15 pounds.

MAX-Z 60ZEMAXZ MFR LIST \$1095.00

Call Bradley for a current price quotation.

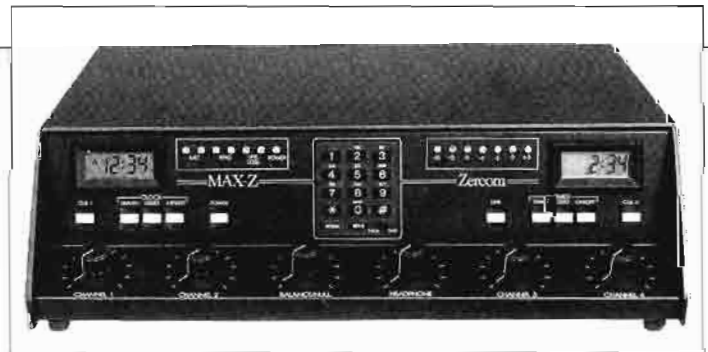

Also available:

MAX-Z II is a smaller version of the MAX-Z with two inputs (one switchable to cue), plus 1/8" tape input, two headset outputs, and 24 hours continuous duty on one battery charge. Front panel indicators display battery and AC status, power on, line active, cue active, and VU indications. A tone/pulse touch pad features last number recall. Weighing only 6 pounds, this compact unit comes complete with carrying case so it is road-ready for your remote requirements.

MAX-Z II 60ZEMAXZII MFR LIST \$600.00

Call Bradley for a current price quotation.

Special Zercom Game of the Week Package

Get a Zercom remote console with carrying case and two Beyer DT109 headsets with straight cables and connectors at a very special price. Put together your own combination by calling or faxing us today.

Max-Z Package 9107 \$1344.00
Max-Z II Package 9108 \$894.00



Gentner Combination Remote Mixer

The intelligently designed Combination Remote Mixer (CRM) provides much greater flexibility and utility than the remote mixer you're using now. The CRM is both a 4 channel mic mixer and a 4 channel headset amplifier. Each mic channel features its own automatic limiter, a useful tool in applications where multiple mics are used and background noise is a problem. Direct mic outputs are provided from each channel for mixing at an outboard mixer. This allows the CRM to be used as a local intercom system and headset driver. The individual input limiters work on these direct outputs as well.

The headphone section is equally versatile. A master external stereo/mono input to the four headsets is provided, which may be mixed with the CRM audio. Plus, each headset has a direct input which may interrupt or be added to the previously mixed input audio. The CRM mixer output section includes a master lim-



iter, peak LED, VU meter, and two line outputs, one active balanced via XLR, the other transformer balanced to binding posts. Both the mic and headphone buss provide expansion ports. There's never been a remote mixer quite like this one!

CRM 60GECRM MFR LIST \$1595.00
Call Bradley for a current price quotation.

Telfax TEN 44 Remote Console

If you've never experienced the simplicity of doing a remote broadcast with a Telfax unit, you are in for a pleasant surprise. Imagine a single piece of equipment that combines the functions of an audio mixer, a telephone, a headphone amplifier, battery pack, and charging circuit all in one compact, lightweight unit. The Electronic Rapid Charge Control recharges the TEN 44 internal battery pack in only three hours. Other features include an up/down timer with large LCD display and alarm; telephone line holding capability on Auxiliary Input "B" for the monitoring or airing of a second phone line; and a master audio "kill" switch to mute all mic inputs. The TEN 44 has four mic inputs and two tape inputs, and four headphone outputs and an auxiliary output that is switchable between mic and line level. Additional standard features are an automatic switch-over from AC to battery operation, switchable tone or pulse dialing, a "Null" switch to minimize crowd noise in headphones, closed circuit cueing channel (switchable on channel four), output level switch for feeding either standard dial tones or loops, accessory jack and switch for interfacing external audio processors (such as low frequency extenders), electronic ringer and LED to indicate incoming calls, and a test tone oscillator. Remote broadcasting has never been easier.

TEN 44 60TF1044 MFR LIST \$1150.00

Call Bradley for a current price quotation.



Special! TEN 44 Game of the Week Package

Get the TEN 44, two pairs of Shure SM2 headsets with connectors, and a PortaBrace run bag at a very special price. Of course we can give you a great deal on a package you design, too.

Package 9105 \$1414.00

Telfax X-30 Mixer

The X-30 is only 6" by 9.3" by 1.5" and weighs less than 3 pounds. But dimensions are the only things that you can call small on this fully loaded phone remote mixer. There are three mic inputs, one tape input, 3 headphone jacks, and a tape output. The internal (and replaceable) Ni-Cad battery can be recharged in just 3 hours for 20 hours of use. Other features include pulse/tone dialing, radio monitor input jack and switch, and AC operation with automatic switching to batteries.

X-30 60TFX30 MFR LIST \$895.00

Call Bradley for a current price quotation.

Special X-30 Game of the Week Package

Get the X-30 and two pairs of AKG Q-34 headsets with connectors as a package and save.

Package 9106 \$984.00



Comrex STLX Sports Console

When you're doing a remote via phone lines, the STLX makes sure you're doing it right. It incorporates a two line frequency extender which sends 5kHz audio over two conventional phone lines. The console includes four mixing channels and four headphone feeds with a sophisticated monitor matrix. Complete telephone interface facilities include a connection to a third phone line for communications. High performance, automatic gain control prevents overload. The STLX also has auxiliary inputs and outputs for PA feed and external monitors. Penny & Giles slide faders and a heavy duty metal housing are only two of the rugged construction details. Requires two line decoding at receive site.

STLX 60CCSTLX MFR LIST \$7750.00

Also available:

STL is similar to above, but with single line frequency extension.

STL 60CCSTL MFR LIST \$4200.00

Accessories:

Deluxe, molded road case for STLX or STL has room for battery pack, headphones, and cables. Detachable casters.

60CCSTLC MFR LIST \$325.00

External Ni-Cad battery supply charges directly from console. Includes automatic switchover to battery power in case of AC failure.

Battery for STLX 60CCSTLXP MFR LIST \$650.00

Battery for STL 60CCSTLP MFR LIST \$450.00

Call Bradley for a current price quotation.



Whirlwind Medusa Press Boxes

Press conferences require a single audio source with multiple feeds so that each journalist can record the proceedings independently. These passive press boxes take a single incoming line-level signal and provide multiple low-Z output feeds from it. Designed to hold up under severe treatment, their cold-rolled steel boxes house state-of-the-art Whirlwind transformers and components which ensure flawless performance year after year.

- 6 Channel** 61WHPB06 \$169.00
- 12 Channel** 61WHPB12 \$294.00
- 16 Channel** 61WHPB16 \$413.00
- 24 Channel** 61WHPB24 \$612.00



Whirlwind Presspower Active Press Box

This innovative press distribution box has presidential features at a school board price. All inputs and outputs are transformer isolated and appear on XLR connectors. Both inputs accept mic or line levels and have low cut filters. A VU meter and a headphone jack with volume control allow easy monitoring of the input level. A total of 16 outputs is provided, so you are well prepared for the crowd. Twelve outputs are mic level fixed at -50dB, two are line level fixed at 0dBV, and two are line level with individual level controls. The variable outputs also appear on 1/4" TRS connectors. A 1kHz tone can be sent to all outputs so everyone can set their levels properly. This press box can be powered by four

9 volt batteries or AC. It is supplied with a carrying case or it may be rack mounted. With the Whirlwind Active Press Box, you can get your favorite politician out from behind a forest of microphones so you can look him/her right in the eyes.

Presspower 61WHAPB \$1579.00



Sound America Voice-Act V • Sound America R/SVP • Shure 50AC Coupler

Voice-Act V makes it possible to transmit any electronic audio material source by telephone. This device screws in place of your phone transmitter, and doesn't interfere with its normal phone operations. The Voice Act V requires no batteries since it operates from the phone line. A two position mike sensitivity switch, and a mini-jack input for a tape recorder allow you to feed just the tape or a mix of the tape and your voice.



For GTE phones 60SAVAGTE \$95.95

For Western Electric phones 60SAVAWE \$87.95

Accessories:

Carry case 60SAVACC \$8.95

Patch cord to connect tape recorder, 6'
60SAVAPC \$3.50

R/SVP (Record or Send Verywell Phone) is a standard 2500 Series Touchtone phone with a built in audio coupler. The panel provided on the phone base has both send and receive mini-jacks. A dual mic sensitivity switch also allows the mic to be muted while feeding a tape, and voice through the phone receiver can be mixed with the tape source.



R/SVP 60SARSVP \$129.00

Shure 50AC is designed to acoustically couple the output of your tape recorder to a telephone handset transmitter in situations where hard wiring is not possible. A strap assembly holds the 50AC in place on any telephone. Its rubber case forms an acoustic seal which blocks external noises. The 50AC also doubles as a tape recorder mic, with frequency response approximating that of a telephone.



50AC 60SH50AC \$45.00



Comrex Single and Dual Line Frequency Extenders

The first name that comes to mind when you think of telephone line frequency extension is Comrex. After all, they invented the technique back in 1976. Frequency extension is an encode/decode system that upgrades telephone lines to broadcast quality. One line systems encode the audio by shifting all frequencies up by 250Hz. At the decode end, frequencies are downshifted 250Hz to restore 2½ octaves of program energy to the low end. In the two line system, 2500 to 5000Hz audio is shifted to the passbands of the second phone line and then restored at the decoder. The result is a full 5kHz of program audio.

Single line encoding is accomplished with either the LX-T Basic extender or the PLXmicro portable extender. The LX-T includes a built-in coupler for direct connection to the phone line. The PLXmicro is battery operated and connects to both standard dial lines and cellular telephones. At the studio end, use either the LX-R Basic decoder or the TH-X Extender/Hybrid with both encoding and decoding, a high quality auto-answering hybrid, and a host of other features.

The compact 2XP two line encoder includes couplers for both program lines and a communications line as well as a touch tone generator. The 2XR two line decoder requires either two couplers or the 2XL auto leveler for connection to phone lines.

LXT one line encoder	60CCCLXT	MFR LIST	\$685.00
PLXmicro portable one line encoder	60CCPLX	MFR LIST	\$1450.00
LXR one line decoder	60CCCLXR	MFR LIST	\$685.00
THX one line extender/hybrid	60CCTHX	MFR LIST	\$2750.00
2XP two line encoder	60CC2XP	MFR LIST	\$3500.00
2XR two line decoder	60CC2XR	MFR LIST	\$3000.00



Top Left: THX, Top Right: LXT
Bottom Left: 2XP, Bottom Right: PLXmicro

Accessories:

Rack mount for LXT or LXR	60CCRA	MFR LIST	\$40.00
Cellular interface for PLXmicro	60CCPLXC1	MFR LIST	\$125.00
AC adapter for PLXmicro	60CCPLXAC	MFR LIST	\$85.00
Case for 2XP	60CCXPC	MFR LIST	\$155.00
2XL Auto Leveler for 2XR.	60CC2XL	MFR LIST	\$1300.00

Includes two built-in, auto-answer couplers. Matches the two telephone lines to equal levels when the test tone is sent from the 2XP.

Call Bradley for a current price quotation.

Comrex Multiline Frequency Extender System

When it comes to remotes by telephone, it doesn't get any better than this. The system consists of the 3XP encoder and 3XR decoder and provides one line (50Hz to 3kHz), two line (50Hz to 5kHz), and three line (50Hz to 8kHz) operation. Comrex's proven noise reduction and automatic equalization and level adjustment assure top quality sound. Dialing and set up can be completely automatic. Audio processing is in real-time, so there is no delay when listening to program sent back to the remote site.

3XP encoder	60CC3XP	MFR LIST	\$6000.00
3XR decoder	60CC3XR	MFR LIST	\$6500.00



Accessory:

Travel case for 3XP	60CCXPC	MFR LIST	\$155.00
----------------------------	---------	----------	-----------------

Call Bradley for a current price quotation.

Gentner Microtel

At one time or another, most broadcasters have needed something like this, but have been forced to design and build their own because nobody manufactured one. Now, at a very reasonable cost, Gentner does the work for you. This battery operated interface system replaces a conventional telephone handset via standard modular connectors and turns your telephone into a complete remote mixer. Inputs are provided for a mic (XLR) and an aux (mini). An additional input allows you to feed the headphone buss with IFB or air monitor. Outputs are provided for headset (1/4" TRS) and high-level (mini), as well as an aux feed jack for tape machines or dedicated loops.



Microtel	60GEMICRO	MFR LIST	\$239.00
-----------------	-----------	----------	-----------------

Accessory:

AC adapter.	60GEXFMR	MFR LIST	\$24.95
--------------------	----------	----------	----------------

Call Bradley for a current price quotation.

Microtel Packages

The only way we could find to improve Microtel is to package it with frequently selected companion gear at very special prices. Now is the time to grab one for the road.

Microtel Package One

Includes the Beyer DT 108 headset with connectors. (Some assembly required.) Your best bet when you're solo in the field.

Package 9109 \$346.00

Microtel Package Two

Includes the popular Electro-Voice 635A mic, a 25' mic cable, and the Sennheiser HD 450SL headphone. Great for that impromptu interview.

Package 9110 \$377.00



Gentner EFT-3100 3 Line Frequency Extender

High-fidelity remotes are now possible with the EFT-3100. Frequency response of 50Hz to 7kHz can be obtained over three standard dial-up lines, or response to 5kHz with two lines. Completely automatic setup using DSP technology simplifies operation of the system, providing auto-dialing, automatic answer, automatic encode/decode, group delay adjustment, phase correction, and equalization. Dual-ended noise reduction delivers an improved signal on noisy phone lines. Processing time is a mere 10 milliseconds, enabling off air monitoring without the problems of excessive delay. Two way operation allows easy cueing of the remote site via the low frequency line. The EFT-3100 incorporates built-in mic and headset amplifiers and a front panel DTMF pad, eliminating the need for extra equip-



ment at the remote site. The EFT-3100 is the answer for easy setup and high quality audio remote broadcasts. Pricing is for set of two units.

EFT-3100 60GEEFT3100 MFR LIST \$6990.00

Call Bradley for a current price quotation.

Gentner EFT Series Frequency Extenders

Those of you who enjoy the sport and challenge of getting Ma Bell to install a loop may find the EFT series useful. The other 99% of us will find it essential. The EFT encoding and processing systems can produce very respectable remote quality using a single dial-up phone line. Using a 250Hz frequency shifting scheme, low frequency response for the system is typically good within 0.5dB all the way down to 50Hz. This restoration of low-frequency response imparts a "warm" and natural character to the audio. Hum and noise, generally added to the phone transmission in the lower frequencies, all but vanish when the signal is decoded.

The EFT's onboard Aphex enhancement convincingly simulates much of the high frequency information lost in the circuit. Units can be set up for single or bidirectional frequency extension. Each unit provides both encoding and decoding functions and a pair of units is required for operation.

Three models are offered. The basic EFT-100 requires the use of a telephone hybrid to properly couple to the phone line. The EFT-900A includes the required hybrid and adds a front panel headphone jack for monitoring. The EFT-1000A adds auto-answer and auto-disconnect features. A DTMF tone may be used to

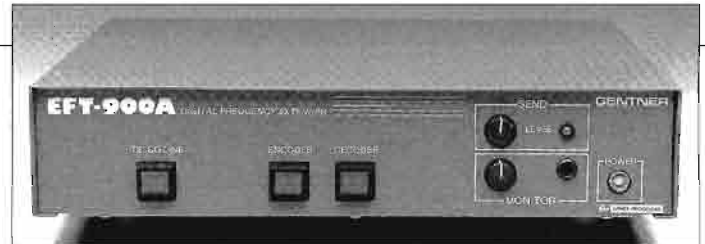

have EFT-1000A units "handshake" to ensure correct encoding/decoding status. EFT models are compatible, so you can use an EFT-100 at the studio where you already have a hybrid and take one of the other models into the field. EFT units are compatible with single line extenders manufactured by Comrex.

EFT100 60GEEFT100 MFR LIST \$549.00

EFT900A 60GEEFT900 MFR LIST \$879.00

EFT1000A 60GEEFT1000 MFR LIST \$1295.00

Call Bradley for a current price quotation.

Hybrid Rack Bags

Hybrid Rack Bags make carrying rack mounted equipment a breeze. Just throw one over your shoulder and you're off! Constructed of nylon Cordura covered 1/4" plywood rackshell with tapped rails for mounting equipment. Foam lined for shock absorption. Standard 19" rack width.

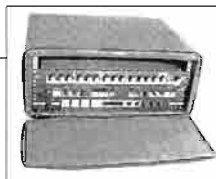

Height	Depth	Item #	Price	Depth	Item #	Price
1 space	14"	70HY114	\$82.00	18"	70HY118	\$89.00
2 space	14"	70HY214	\$87.00	18"	70HY218	\$96.00
3 space	14"	70HY314	\$93.00	18"	70HY318	\$102.00
4 space	14"	70HY414	\$96.00	18"	70HY418	\$108.00

Kangaroo Packs & Cases

Kangaroo products are the preferred choice among professionals because of their user convenience and degree of protection. A complete line of video recorder, camera, and audio packs incorporate Cordura fabric, Evazote foam, nickel-plated steel hardware, and



Velcro hook and loop fasteners. Also available are Super-Tough carriers for camcorder combinations and camera rain covers. Call (800) 732-7665 or fax (301) 330-7198 for complete information and pricing.

Porta-Brace Run Bags

When you need to grab your gear and run, you need the Run Bag from Porta-Brace. Compared with the bag you are using now, the Run Bag holds more, is much sturdier, and can be loaded in a variety of practical ways without dumping one thing on top of another. It's made from rugged blue Cordura with leather handles and shoulder strap. The Run Bag has just enough foam padding to keep its shape and protect your gear while remaining flexible. The full length zipper allows the bag to open flat. The main compartment has two dividers allowing you to create up to three partitions. The main compartment is approximately 7" wide and 9 1/2" high, and three lengths are available. Zippered side compartments and a slip

pocket add even more convenient storage.

18" length 60PBRB1 MFR LIST \$118.00

21" length 60PBRB2 MFR LIST \$123.00

25" length 60PBRB3 MFR LIST \$128.00

Contact your Bradley professional for pricing and information on the full line of Porta-Brace video and audio cases for field production.



Anvil Road Cases

Bradley and Anvil can provide you with rugged, dependable protection for all of your equipment. ATA approved cases for recorders, mixers, cameras, and A/V gear. When you are shipping equipment or checking it as baggage, Anvil ATA cases are your best choice. Lite-Line cases are about one third lighter than ATA cases, and cost 25% less. Lite-Line is a good choice for cases for gear you transport yourself. Custom case requirements can be quoted by phone (usually

the same day) and shipped fast. Cases are shipped in blue unless one of the many other colors available is specified. Remember the expense and hassle the last time your equipment broke in transit? Protect your valuable investment with an Anvil case from Bradley. Remember, if you can move it, Bradley and Anvil can build a case for it.

Anvil Rack Mount Cases

Several styles of ATA approved cases are available for your rack mounting equipment. In addition to the styles listed below, cases can be built to any depth and can include rear rack rails, several styles of casters, locking hasps, stacking corners, and other options.

Standard cases are 14" or 18" front to back rackable depth, and lids leave 2" of additional interior room. Available in 1/4", 3/8", and 1/2" construction. 14" deep racks are available in sizes up to 17 spaces, 18" deep up to 27 spaces.

Shock mounted cases have a 1/4" thick shell surrounded by 2" of foam and can be made up to 27 spaces tall. The outer shell can be 1/4", 3/8", or 1/2" construction. 18" rackable depth; 25" with lids.

Pull-over clamp cases have a unique "case within a case" design with a removable inner rack. Outer shell consists of bottom tray and pull over lid with foam lining. Several combinations of rack and shell construction are available. 18 1/4" rackable depth.

Size	Shallow case 14" deep, 1/4" shell	Standard case 18" deep, 1/4" shell	Shock Mounted 18" deep, 1/4" outer shell	Pull-over clamp 3/8" inner shell, 1/4" outer shell
2 Space (3 1/2")	77AN021414\$218.00Not available	77ANSM021814\$372.00Not available
4 Space (7")	77AN041414\$224.00	77AN041814\$280.00	77ANSM041814\$389.00	77ANPO041814\$344.00
6 Space (10 1/2")	77AN061414\$236.00	77AN061814\$294.00	77ANSM061814\$406.00	77ANPO061814\$370.00
8 Space (14")	77AN081414\$248.00	77AN081814\$309.00	77ANSM081814\$423.00	77ANPO081814\$397.00
10 Space (17 1/2")	77AN101414\$262.00	77AN101814\$324.00	77ANSM101814\$440.00	77ANPO101814\$425.00
12 Space (21")	77AN121414\$273.00	77AN121814\$338.00	77ANSM121814\$458.00	77ANPO121814\$450.00
14 Space (24 1/2")	77AN141414\$295.00	77AN141814\$365.00	77ANSM141814\$483.00	77ANPO141814\$494.00
16 Space (28")	77AN161414\$308.00	77AN161814\$379.00	77ANSM161814\$502.00	77ANPO161814\$520.00

Accessories:

Hasp/Twist-Latch to replace standard Twist-Latch. Allows use of padlock. Four recommended per case.
77ANTLHL \$20.00

Case cart is a collapsible metal cart for transporting cases that do not have casters. 77ANCC \$73.00

Casters are built into the case via a specially constructed caster board.

Light duty casters 77ANLDC \$68.00
Heavy duty casters 77ANHDC \$99.00
H. D. casters w/2-locking 77ANHDC2 \$129.00
H. D. casters w/4-locking 77ANHDC4 \$157.00

The racks listed above are just an illustration of the possibilities.

Rear rack rails 77ANRR per rack space: \$2.25

Rack/Mixer Cases

These cases have a slanted block mounting at the top for a mixer, plus rack space below for other gear. Removable front and top lids plus a rear access door and bottom fan hole are provided. 1/4", 3/8", or 1/2" construction. Below are just some of the configurations in 1/4" construction.

8 space lower rack	77ANRMC8	\$542.00
10 space lower rack	77ANRMC10	\$559.00
12 space lower rack	77ANRMC12	\$577.00
14 space lower rack	77ANRMC14	\$593.00
16 space lower rack	77ANRMC16	\$620.00



Anvil Forge II Rack

These low cost racks let you carry your gear briefcase style. Rugged hardware and light weight make them a popular choice for equipment you transport yourself. They have 14" of rackable depth, and the covers extend 2 inches.

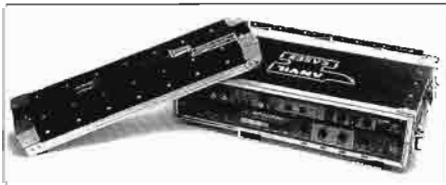

2 space	77ANF2	\$96.00	6 space	77ANF6	\$134.00
3 space	77ANF3	\$116.00	7 space	77ANF7	\$139.00
4 space	77ANF4	\$119.00	8 space	77ANF8	\$143.00
5 space	77ANF5	\$129.00			

Anvil Briefcase

The famous Anvil briefcase is now even better. It is now a Lite Line case, so it weighs less but is just as rugged. Measuring 18" x 13 1/2", the case has a vinyl interior with file folder in the top lid and a key lock. Available in black only with Anvil logo. We buy them by the pallet, so you can get this great price.

77ANBC \$63.00



Bradley DJ Packages

Bradley has put it all together to offer you three professional portable DJ packages. All packages include a pair of Technics SL-1200 MKII turntables with Stanton 680EL cartridges. Your package includes your choice of mixer, and it all comes housed in a rugged Stanton Coffin Case specially designed for this application. Price includes delivery within the continental US.

Economy DJ Package includes Numark DM1175 mixer.
Package 9111 **\$1418.00**

Standard DJ Package includes Numark DM1775A mixer.
Package 9112 **\$1999.00**

Deluxe DJ Package includes Rane MP24 mixer. You deserve the best, don't you?
Package 9113 **\$2314.00**

Digital DJ Package
 If you're ready to spin CD's, Bradley is ready to make it possible. We've put the Rane MP 24 together with the Numark CD6020 Dual Transport CD System described on page 4. These units are packaged with a pair of rugged rack mount cases that are easy to carry and make set up a breeze. Now is the time to do it digitally. Manufacturer's list prices total over \$3600.00.
Package 9114 **\$2798.00**



Special! Upgrade your DJ package by choosing an Anvil ATA case to protect your gear. Add \$220.00 to the package price.

Also available:
Cases for DJ Packages are available separately. Shipping Additional.
Stanton Coffin Case 60STDJC **\$199.00**
Anvil DJ Case 77ANDJC **\$449.00**

Special note: May we suggest combining your DJ package with one of our reinforcement packages? You'll be certain to get the best for your dollars.

Rane MP 24 DJ Mixer

Here's more mixer than you've ever seen packed into four rack units. Nine stereo inputs (three phono, six line) are assignable to four stereo input mixing busses. These busses are, in turn, assignable to a crossfade control, allowing fades between any two sources. Two mic inputs feature 3 band EQ and effects loop. The headphone amp provides level control, a pan control which ranges from full stereo cue to stereo program, or a push button delegates cue to one channel and program to the other. The extensive output section provides a master level slider; separate booth, zone, and light trigger outputs each with individual level controls; a four band EQ; and an adjustable twelve segment, three color LED level meter. This mixer provides all the flexibility you'll ever need.

MP 24 60RNP24 **MFR LIST \$1299.00**



Call Bradley for a current price quotation.

Numark DM1775A Sampling DJ Mixer

The DM1775A features digital sampling and digital effects with 16 bit accuracy, convenient real time control, and full 10Hz to 20kHz bandwidth. This unit allows the DJ to store up to 4 seconds of sampled sound, and a large Start/Stop push-button lets him/her easily keep sample lengths in perfect time for looped repetition. Digital delay enables doubling, chorusing, flanging, phasing, reverb, hardslap echo, long echo, pitch and tempo switching, "stuttering", and a single or looped playback. The DM1775A features 4 stereo line inputs, 2 phono stereo inputs, and 2 mic inputs as well as complete cross-fade capabilities. With the

DM1775A Numark got serious. Now you, and your audience, can have all the fun.

DM1775A
60NU1775 \$880.00

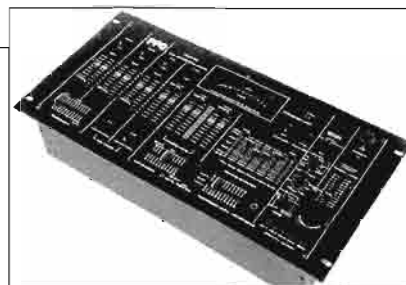

Numark DM1175 DJ Mixer

Numark has packed loads of features into this mixer at a price that will put a smile on your face. There are three stereo phono/line inputs, a stereo tape/line input, and two microphone inputs. Stereo six band EQ, assignable crossfader, pushbutton cue system, VU meter, and recorder output are the convenience features included in this rack mounting mixer. Great sound and great value

DM1175 60NU1175 **\$219.00**

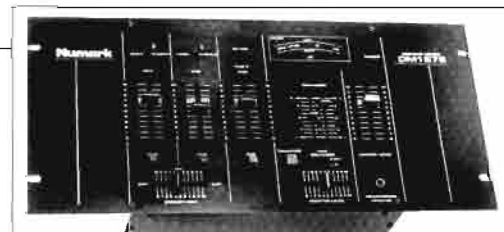

Bradley PA Systems

Bradley PA System I

Bradley has put together a PA package that will keep both the engineer and the accountant happy. The compact and powerful Yamaha EM1800 mixer/amp combines with the efficient, rugged, and great sounding Community CS35 speakers to make an ideal budget system. These components are described in detail on page 111. The package includes the mixer in an Anvil ATA case, a pair of CS35 speakers, one pair of Ultimate Support TS-33T nine foot tripod stands with stand adapters, two 50' heavy duty speaker cables, and Bradley Cord-Lox to keep it all tidy. Retail price is \$2273.00.

Package 9115

\$1498.00 plus freight



Bradley PA System II "The Entertainer 100"

This system has it all: power, performance, and portability. The EV 100M powered ten input, stereo mixer delivers 100 watts per channel continuously into 8 ohms at less than 0.02% distortion, while the patented EV Powerlock limiter and massive external heat sinks provide substantial protection against overdriving the amp or burning up the speakers. The mixer section provides three band EQ, peak indicators, pan pots, separate effects and foldback sends, and variable input pads. Individual slide faders are provided for left, right, and monitor busses. Dual 8 band graphic equalizers and bright fluorescent bar graph meters make setup quick and easy. The speakers are the lightweight EV 100S, with virtually indestructible cabinets. 100° high frequency dispersion provides uniform coverage without "hot spots." 80Hz to 18kHz (±3dB) with usable response 50Hz to 20kHz. 100 watts continuous. Speakers measure 24"H x 15"W x 8.4"D and weigh 28 pounds. Retail price is over \$2900.00.

Package 9116

\$1749.00 plus freight



Bradley PA System III "The Entertainer 200"

Electro-Voice's new 200M stereo powered mixer has a MOSFET amplifier capable of 200 watts per channel into 8 ohms. The amp can be switched between stereo mains or mono mains with powered monitor operation. An onboard, 30 program Lexicon digital effects processor provides studio quality effects. Eight mic/line inputs with phantom power have three band EQ with sweepable mid-band and effects and monitor sends. An additional stereo tape/CD input is also provided. Other features include a nine band stereo EQ and a virtually indestructible chassis. The perfect complement to this mixer is the EV S-200 stage system. The 12" woofer and 1 1/2" dome tweeter use a constant directivity design for full 100° by 100° coverage. The S-200 has a 90Hz to 18kHz -3dB response that can be extended a full octave down to 50Hz with the optional EQ. The S-200 weighs in at only 36 pounds, measures 24" x 15" x 8 1/2", and has 300 watts of long term power handling capacity. Valued at over \$3400.

Package 9117

\$2375.00 plus freight

Accessories:

S-200 EQ 60ELS200EQ \$146.00 when purchased with package.

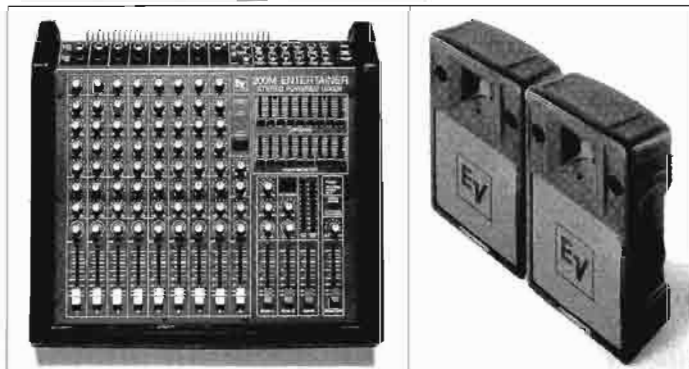

Bradley PA System IV

The Toa MX-401 is a high performance, four channel mixer. Each channel has a 1/4" TS high impedance input as well as an XLR low impedance input. Controls include level, high and low frequency EQ, reverb, and monitor. The master section features a 5 band graphic EQ with 12dB cut/boost, built-in auto-compressor, reverb, monitor, and auxiliary level controls plus a selection of jacks for patching signal processing equipment. At 8 ohms, the MX-401 delivers 100 watts RMS. Our package includes a pair of Toa SL-150 speakers (described on page 111) and two 50' speaker cables.

Package 9118

\$799.00 plus freight

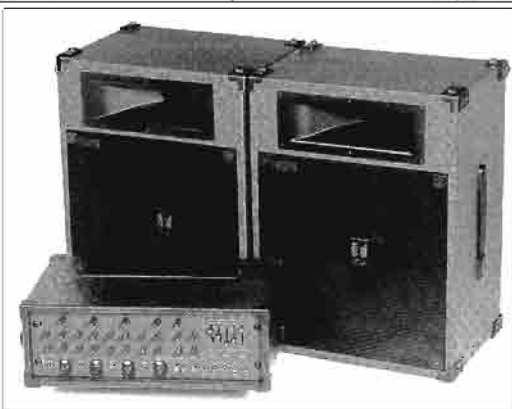

Crown Power Base Amplifiers

Crown's reputation for sonic accuracy and bullet-proof performance is obvious in the Power Base 1 and 2. A computer designed heat sink/fan combination dissipates heat efficiently to protect the amps, while Crown circuitry provides full protection from output shorts, mismatched loads, RF burnout, input DC, and input overload. The Power Base 1 puts out 200 watts per channel into 8 ohms, and the Power Base 2 puts out 320 watts per channel into 8 ohms. Other specifications, which are common to both units, are hum and noise, more than 100dB below rated output; phase response, ± 0.1 dB, 20Hz to 20kHz; 1 watt; gain, 26dB; response, ± 0.1 dB, 20Hz to 20kHz; harmonic distortion, less than 0.1% at rated output into 8 ohms, both channels driven; IM distortion, less than 0.05% at

rated output into 8 ohms, both channels driven; and damping factor greater than 1000. Input connectors are 1/4" TRS jacks and output connectors are binding posts.



Power Base 1	60CRPB1	MFR LIST	\$849.00
Power Base 2	60CRPB2	MFR LIST	\$1079.00

Call Bradley for a current price quotation.

Crown Micro-Tech and Macro-Tech Amps

The Crown Micro-Tech series is the next step up from the Power Base amps. The Micro-Tech series features a huskier power supply, higher output power, and front panel indicators for the high voltage supplies. The Micro-Tech 600 delivers 215 watts per channel into 8 ohms, and the Micro-Tech 1200 delivers 295 watts per channel into 8 ohms with both channels driven. Frequency response, distortion, and noise are similar to the Power Base series.

per channel, and the Macro-Tech 2400 delivers 515 watts per channel, all into 8 ohms, both channels driven. Other performance specifications and input and output connectors are identical to the Micro-Tech amps.



At the top of Crown's line is the Macro-Tech series of miniaturized high technology sound reinforcement amplifiers. These are the amplifiers on which top sound industry professionals rely. Front panel indicators provide information on the high voltage power supplies and the Input/Output Comparator warns of clipping. Also provided are front panel level controls for each channel. The Macro-Tech 600 delivers 215 watts per channel, the Macro-Tech 1200 delivers 295 watts

Micro 600	60CRMT600	MFR LIST	\$995.00
Micro 1200	60CRMT1200	MFR LIST	\$1295.00
Macro 600	60CRMA600	MFR LIST	\$1295.00
Macro 1200	60CRMA1200	MFR LIST	\$1595.00
Macro 2400	60CRMA2400	MFR LIST	\$2095.00

Call Bradley for a current price quotation.

Yamaha Power Amplifiers

At the top of Yamaha's new line of amps is the PC4002M. Capable of 430 watts per channel into 8 ohms or 700 watts into 4 ohms, this amp is designed for precision output. THD is less than 0.005% at 215 watts at 8 ohms from 20Hz to 20kHz, with greater than 80dB of channel separation. Response is 10Hz to 50kHz, ± 1 dB. Twin, two speed, thermostatically controlled fans; mono mode; dual power supplies; full protection circuitry; detented input attenuators; large illuminated peak meters; and both XLR and 1/4" TRS inputs are among the outstanding features. The PC4002M is for anyone who takes sound seriously.

specs are excellent, and electronic and thermal protection circuitry is incorporated. The P2700 and P3500 are fan cooled; the P2160 is convection cooled. Front panel, detented level controls are provided, and input connectors are both XLR and 1/4" TRS.



For more moderate powering requirements, Yamaha and Bradley offer the P2700 (350 watts per channel into 8 ohms), the P2350 (175 watts per channel), and the P2160 (80 watts per channel). All three use simple, yet sophisticated designs for reliability you can count on. Distortion, noise, and channel separation

PC4002M	60YAPC4002M	MFR LIST	\$2795.00
P2700	60YAP2700	MFR LIST	\$995.00
P2350	60YAP2350	MFR LIST	\$795.00
P2160	60YAP2160	MFR LIST	\$595.00

Call Bradley for a current price quotation.

Ashly MOS-FET Power Amplifiers

Ashly's open, modular design features a Class A, full complementary, two stage front end for stability and speed. MOS-FET output devices contribute to both high sound quality and near-perfect reliability, and a self-protection mode works under all conditions including short and open circuits, reactive loads, and high-frequency overdrive. These amps boast perfect overload and square wave response. This results in a series of amplifiers that are powerful and quick, giving you unrestrained, uncolored sound quality with remarkable accuracy.

Call Bradley for a current price quotation.



Ashly's FET series amplifiers are UL listed. The FET-1000 delivers 120 watts RMS per channel (stereo) into an 8 ohm load and 190 into 4. The FET-1500 puts out 175 watts RMS per channel into an 8 ohm load and 250 into 4. The FET-2000 puts out 300 watts RMS per channel into an 8 ohm load, 500 into 4, and 675 into 2. The FET series is available in "M" versions with meters, 1/4" TRS and balanced XLR inputs and "C" versions sans meters, with 1/4" TRS and barrier-strip inputs.

FET-1000M	60ASFET1000M	MFR LIST	\$789.00
FET-1000C	60ASFET1000	MFR LIST	\$699.00
FET-1500M	60ASFET1500M	MFR LIST	\$889.00
FET-1500C	60ASFET1500	MFR LIST	\$799.00
FET-2000M	60ASFET2000M	MFR LIST	\$1099.00
FET-2000C	60ASFET2000	MFR LIST	\$999.00



Community CSX Series Speakers

CSX speakers not only deliver exceptional sonic quality, but are designed to do it night after night. Ferro-fluid cooling of the LF drivers enables them to withstand the rigors of long term, high power use. Internal fuseless protection guards against excessive input levels, while sophisticated filters provide a smooth crossover curve between transducers. The CSX cabinets sport an attractive, durable black carpet finish. Our best sellers are described below.

The CSX25 is the smallest of the series, with a twelve inch two-way configuration. 32 pounds, 18.25"H x 15"W x 13.5"D.

The CSX35 is slightly larger than the 25 and uses a 15" woofer and a larger cabinet volume to produce a more solid low frequency response. 43 pounds, 23.75"H x 17.25"W x 13.5"D.

The CSX52 has a smooth, three-way design which allows for a much more hon-

est reproduction of the important mid-range frequencies, while still using a 15" woofer to produce gratifying low frequency response. These cabinets sound like Hi-Fi speakers, yet they will develop tremendous sound pressure levels. 82 pounds, 33.5"H x 18"W x 18"D.

CSX25	60COCS25	\$205.00
CSX35	60COCS35	\$243.00
CSX52	60COCS52	\$415.00

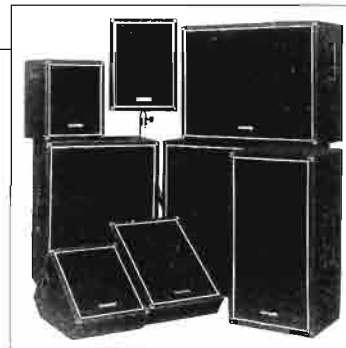

Toa Speakers

Toa's two great lines of reinforcement speakers are constructed to withstand the punishment of the road. The "SL" series consists of the SL-120 with a 12" woofer and the SL-150 with a 15" woofer. Both use a constant directivity 90° horn with a piezo high frequency driver. The SL-120 weighs 29 pounds and measures 20.3"H x 14.8"W x 12.1"D. The SL-150 weighs 36 pounds and measures 23.5"H x 18"W x 12.1"D. Both are 8 ohms and are capable of handling 240 watts of continuous power. Monitor versions are also available.

The "SD" series consists of the 380SD, described in our Sound Reinforcement Package B, and the 300SD. The 380SD weighs 60 pounds and measures 26.8"H x 19.4"W x 15.4"D. The 300SD uses a 12" woofer, weighs 47 pounds and measures

23.1"H x 18.1"W x 12.3"D. Both models are 8 ohms and handle up to 360 watts.

SL-120	60TOSL12	\$199.00
SL-150	60TOSL15	\$245.00
300SD	60TO30SD	\$399.00
380SD	60TO38SD	\$440.00



Yamaha EM Series Powered Mixers

The remarkably small and light EM mixers produce a monaural power rating of 150 watts into a 4 ohm load, and are perfect for small reinforcement, church, school, or club applications. Available in four, six, and eight input versions, the mixers all share the same basic features. Each channel has electronically balanced Lo-Z (XLR) and Hi-Z (1/4" TS) inputs, a switchable 20dB pad with a variable gain control, two independent auxiliary sends, three band 15dB cut/boost EQ, LED channel clipping indicators, and brightly colored knobs for dimly lit venues. The master section includes the mono master, the two auxiliary masters, the controls for the built-in reverb, a six band graphic EQ for feedback control, and an illuminated VU meter. The amplifier section has a large heat sink for cool and quiet operation even during all day shows. Board dimensions are 5 7/8"H x 20 1/8"D, with width ranging from 14 3/8" to 19 1/8" depending on the model.

Call Bradley for a current price quotation.

4 inputs	60YAEM1400	<i>MFR LIST</i>	\$575.00
6 inputs	60YAEM1600	<i>MFR LIST</i>	\$725.00
8 inputs	60YAEM1800	<i>MFR LIST</i>	\$895.00

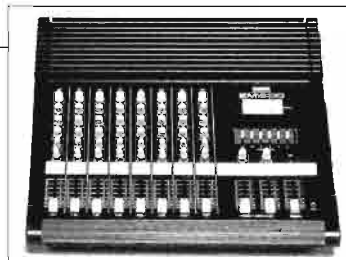

Yamaha EMX Series Powered Mixers

Yamaha's original EMX powered mixers made history because of their features and performance. The latest EMX mixers are available in either six, eight, or twelve input versions. The high performance power amp sections provide up to 160 watts per channel (stereo) into 8 ohms. Each mixer input provides variable input attenuation, a three band EQ, two auxiliary sends, a pan control, and a linear fader. 48V phantom power is available across all inputs. The master section contains the master faders and auxiliary sends, a stereo nine band graphic EQ, and a digital multi-effects processor with 15 top quality reverb, delay, and echo effects. All mixer, graphic EQ, effects processor, and power amp inputs and outputs appear on the rear of the unit and large heat sinks and forced air cooling will let you run this desk all day at a remote with no headaches. Its rugged construction is built to take the hard knocks.

Call Bradley for a current price quotation.

6 inputs, 90 watts/channel	60YAEMX2150	<i>MFR LIST</i>	\$1695.00
8 inputs, 160 watts/channel	60YAEMX2200	<i>MFR LIST</i>	\$1795.00
12 inputs, 160 watts/channel	60YAEMX2300	<i>MFR LIST</i>	\$1995.00



Ultimate Support Stands



Ultimate TS-30T can be varied in height from 3' to 6', and will support up to 75lbs.

Silver 61USTS30T \$78.00
Black 61USTS30BT \$90.00

Ultimate TS-33T will extend to over 9' and support 100 pounds, yet it weighs only 9 pounds!

Silver 61USTS33T \$93.00
Black 61USTS33BT \$108.00

Accessories:

TAD-138 1 1/2" diameter tripod adapter is used with same sized sockets provided by Community, EV, Toa, and others. 61USTAD138 \$8.20

BMB-200K attaches speakers with built-in threaded inserts spaced 4 1/2" to 6" apart, such as those provided by Bose. Mounting screws not included. 61USBMB200 \$16.40

TMB-400K is a unique two part mounting system that consists of a thin plate (screwed to the bottom of the speaker) and a slide-in bracket (attached to the top of the tripod). Mounting screws included. 61USTMB400 \$15.60

MIC-150 provides a threaded microphone adapter. 61USTMIC150 \$15.60

Whirlwind Cable Reels

Simple in design, durable and convenient, these reels make quick work of stowing your cables. For professional applications, they are a necessity, and are available in sizes to handle any job.

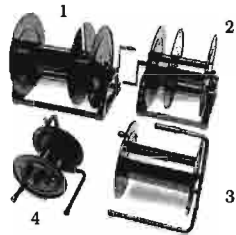

- (1) **WD-3S** Capacity: 2600' of 1/4" OD cable. 61WHWD3S \$271.00
- (2) **WD-3** Capacity: 1400' of 1/4" OD cable. 61WHWD3 \$259.00
- (3) **WD-2** Capacity: 900' of 1/4" OD cable. 61WHWD2 \$152.00
- (4) **WD-1** Capacity: 700' of 1/4" OD cable. 61WHWD1 \$113.00

Note: Capacities for larger outer diameter cables sometimes cannot be accurately computed using the figures quoted for 1/4" cable. Call your Bradley professional for configuration assistance.

Sonic II Hearing Protectors

These protectors reduce the sound pressure level without restricting your normal ability to hear the full audio spectrum of highs and lows. Packed in a plastic box with key chain attachment. 42NOSON2 \$6.95



Also available:

Norton Noise Hushers are disposable ear plugs, made of foam rubber. 42NOD1 99¢

ProCo Multipair Audio Cables

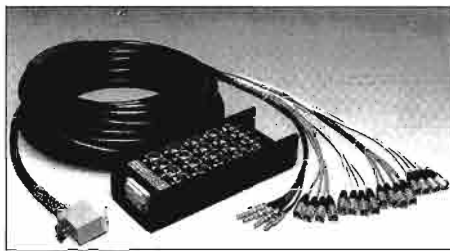

ProCo multipair snakes are built to take the daily abuse of the road. RoadMaster Fan-to-Box assemblies use XLR connectors, and can be configured for up to a total of 40 sends and returns. For applications requiring disconnect capabilities, the heavy duty Helix Standard fits the bill. Now you can configure your own systems using combinations of components that may be changed in the field. The snakes below are just a sample of the possibilities. Contact Bradley with your requirements, and we'll deliver a ProCo snake quickly.

Roadmaster

All prices are for 100' snakes. Call for pricing on other lengths and configurations.

8 sends, 4 returns	60PCFBX0804C	\$272.00
12 sends, 4 returns	60PCFBX1204C	\$353.00
16 sends, 4 returns	60PCFBX1604C	\$416.00
24 sends, 4 returns	60PCFBX2404C	\$572.00

Helix Standard

These examples are just a few of the possibilities. All component prices include multipin disconnect.

Multipair tails (fan outs)

20 connectors	60PCMT204	\$247.00
28 connectors	60PCMT284	\$322.00

Multipair trunks - 100'

20 channels	60PCMK20100	\$562.00
28 channels	60PCMK28100	\$732.00

Multipair trunks with fan outs

20 channels, 25 feet	60PCLT2025	\$348.00
20 channels, 100 feet	60PCLT20100	\$538.00
28 channels, 25 feet	60PCLT2825	\$465.00
28 channels, 100 feet	60PCLT28100	\$728.00

Multipin boxes

20 channels	60PCMB20	\$259.00
20 channels with transformer isolated two way split.	60PCMBBD20	\$1242.00
28 channels	60PCMB28	\$350.00
28 channels with transformer isolated two way split.	60PCMBBD28	\$1704.00

Medusa Cable Reels

A unique heavy duty steel windup storage caddy designed for Medusa systems.

Small capacity, 300' of 1/4" OD cable.	61WHMEDWHS	\$105.00
Large capacity, 500' of 1/4" OD cable.	61WHMEDWHL	\$129.00



Whirlwind Medusa Multipair Systems

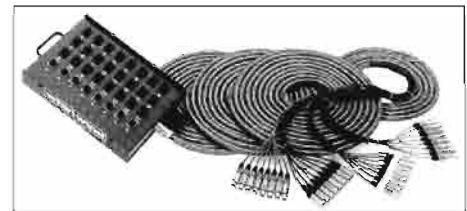

Whirlwind's Medusa systems are individually hand crafted from the finest components available: heavy gauge cold rolled steel stage boxes, thick jacketed ultra-flexible cable, mil-spec strain reliefs, premium grade PVC shrink tubing, and Whirlwind designed connectors. Each Medusa system features 100% foil shielding and numbered, color coded fan-outs for rapid, easy set up. All of this, plus the painstaking attention to detail in assembling Medusa snake systems has made them the finest multi-wiring systems in the world. Medusa snakes are available in 6 to 52 channel configurations, plus specialized versions for multitrack recording systems and for powered mixers. Call Bradley for additional information and pricing on the wide variety of Medusa cables available to you.

Standard Medusa Series

50' - 6 in, 3 out	61WHMS63XL50	\$138.00
100' - 8 in, 4 out	61WHMS84XL100	\$210.00
100' - 12 in, 4 out	61WHMS124XL10	\$262.00
100' - 16 in, 4 out	61WHMS164XL10	\$322.00
100' - 24 in, 8 out	61WHMS248XL10	\$498.00

Medusa Power Series

Incorporates two runs of 14 gauge speaker wire built into, but totally shielded from, the mic and monitor lines that surround them. Ideal for use with powered mixers.

100' - 8 mics, 2 speaker, 1 monitor.	61WHMP8100	\$305.00
100' - 12 mics, 2 speaker, 2 monitor.	61WHMP12100	\$414.00

Shurtape Gaffer's Tape

Bradley features genuine Shurtape Gaffer's tape. This standard of the broadcast, motion picture, and theater industries is indispensable for taping cables, carpets, scenery, and a million other jobs. A strong adhesive, which will stick to just about anything, coats this flexible fabric tape. And even better, the tape peels up quickly & cleanly after the gig.



2" wide, grey 180'
61STGY2 \$13.50 per roll

2" wide, black 180'
61STBK2 \$13.50 per roll

SPECIAL! Buy six rolls of Shurtape for only \$64.80



Cutting Edge Unity 2000 Digital FM Processor

Frank Foti was responsible for a revolution in FM processing in the 1980's. After years of concocting processing systems consisting of both off-the-shelf products and "black boxes," he went to work to design the processor demanded by FM programmers and engineers. The Unity 2000 is the result, and one listen will convince you that this is the processor for your station.

The Unity 2000 is a complete, format flexible digital processor with all six components in a single chassis. The Unity 2000 comes complete with a selectable low frequency equalizer, a digital four band leveller/pre-processor, a digital four band limiter, a distortion canceling clipper drive, a digital stereo generator, and a selectable composite clipper. One keypad and an LCD display control all component functions. Digital control allows you to implement precision adjustment of all processing variables. Plus, the Unity 2000 comes complete with processing presets for AOR, AC, Country, CHR, Urban, Country, Jazz, Easy Listening, and Classical ... or program up to four of your own and save the results.

Both the leveller/pre-processor and the limiter incorporate the revolutionary Intelligent Time Constant Controller that actually learns the music and adjusts attack and release time accordingly. And, it works in real time. RMS timing circuitry generates only the amount of processing needed by the average music level, eliminating the problem of overreacting gain control circuitry so clearly audible in other audio processors. Through the use of Feed Forward technology, the Unity 2000 provides a constant processing ratio, giving the user a "sweet spot" at any level of signal processing. The clipper drive offers a range of ± 5 dB, and includes a

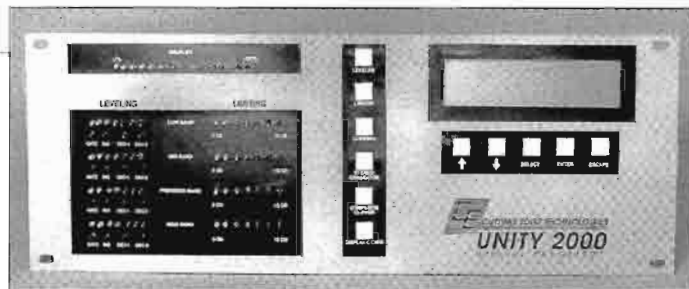

phase linear low pass filter which allows no overshoots. The digital stereo generator provides better than 50dB of stereo separation with no need for adjustment due to analog drift. The user selectable composite clipper is pre-pilot inserted, thereby eliminating the risk of stereo separation loss due to pilot re-insertion.

Other features include adjustable time constants and crossover frequencies, an RS232 port for remote access, security protection against unauthorized adjustment, modular architecture for easy updating, and a port for ancillary devices.

Contact Bradley today for details on how you can hear the Unity 2000 in action on your station. Or, wait until you hear it on your competition. The choice is yours.

Unity 2000 60CEUNITY MFR LIST \$7995.00

Audio Animation paragon Digital Audio Dynamics Processor

Known for their superior CD mastering system, Audio Animation presents their first broadcast product. The paragon uses a unique instant-attack-time limiting system, that provides total peak control without clipping. Four bands of compression and four bands of limiting include user adjustable crossover frequencies, attack times, density, coupling, and mix level. The fully digital DSP makes paragon an excellent match for today's CD formats.

The paragon's unique user interface uses a 9" B&W, VGA video monitor with touch sensitive screen. Users merely press screen icons to change settings. Multiple screens and on-line help are used to simplify control. A factory loaded sound library has five suggested setups for each of seven formats. The paragon can provide comprehensive, high quality processing for radio, TV, and cable. Upcoming add-on components include a 10 band EQ, AES/EBU digital input/output, an FM stereo generator, and a stereo width enhancer.

paragon 60ZAP MFR LIST \$9450.00



CRL Audio Signature

The Audio Signature combines a powerful four band compressor and an advanced microprocessor control system. Separate wideband and multiband controls can take you from virtually no processing to an amazingly aggressive extreme. Adjustable multiband crossovers, real time analysis monitoring, and 8 position audio diagnostic metering add to the Audio Signature's user friendliness and processing power. Four processing settings may be stored and recalled, and the Audio Signature includes an RS-232 port for computer or automation control.

Audio Signature 60CUAS MFR LIST \$5995.00



Call Bradley for a current price quotation.



Orban 8100A1 Optimod FM

How do you describe a classic without stating the obvious? The Orban 8100A1 has established a well deserved reputation as the most effective FM processing system ever devised, bar none. Sophisticated, easy-to-use, and cost effective, this second generation overshoot controlling processor can be quickly set up with a minimum of "tweaking," for formats ranging from purist-classical to extremely aggressive contemporary hit radio. With simple adjustment of gate threshold, interband coupling, release time, HF limiting, and clipping, the 8100A1 is flexible enough for the job, while remaining quite user friendly. Thorough and readable documentation, together with built-in test facilities and modular design make the Orban Optimod FM 8100A1 truly a pleasure to work with.

8100A1/U75 600B8100A MFR LIST \$5550.00

Also available:

8100A1 with FM Filter Card. This filter (formerly referred to as the "Zero Card") is designed to provide additional crosstalk protection for stations utilizing subcarriers and to increase modulation capability. It provides 75dB below 100% modulation

attenuation of the baseband above 61kHz. Two cascaded fifth-order overshoot-compensated low-pass filters provide enhanced performance.

8100A1/U75F

600B8100AF MFR LIST \$6250.00

Accessories:

8100AFC FM Filter Card For existing units. Simply plugs into 8100A1. 600B8100AFC MFR LIST \$700.00

8100AST/U Studio Chassis Enables separation of the "front-end" compressor from the stereo generator and limiter, allowing use with discrete STL systems. 600B8100AST MFR LIST \$1000.00

Call Bradley for a current price quotation.



Orban 8100A/XT2 Six Band Limiter

The XT2 is an accessory chassis for the Optimod FM for stations that desire a louder or more processed sound than that provided by an 8100A1 alone. The XT2 installs in the middle of the Optimod FM processing chain, replacing the 8100A1 high-frequency limiter. When the XT2 is in use, the two band compressor is converted to a slow averaging AGC in front of the six band limiter, ensuring proper input level at all times. The six band limiter acts as an "intelligent automatic equalizer" giving your audio consistent sound from source to source, without producing fatiguing processing artifacts. The design incorporates two bass EQ controls, plus presence and brilliance controls to alter tonal characteristics and achieve exactly the sound you want. This all Orban, all Optimod system assures

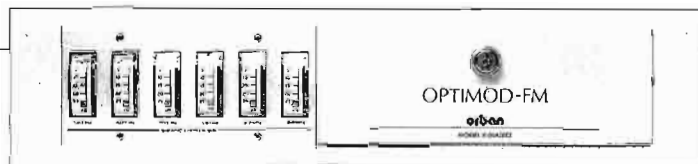

that all parts will work together harmoniously to produce precisely the air sound your format, audience, and market demand.

8100A/XT2 600B8100AXT MFR LIST \$2550.00

Call Bradley for a current price quotation.

CRL Processing Systems

CRL broadcast audio processing is unique in that, by using a multi-unit systems approach, your station can configure a system that precisely fits the needs of your program format. Should you want to change your processing, it is a simple matter to upgrade your CRL system economically.

Four units comprise the CRL FM processing line. The SGC800 Stereo Gain Controller is a high quality stereo coupled multiband AGC with selectable input asymmetry removal, programmable attack/release times, patented Dynafex noise reduction, adjustable AGC gating threshold, and switchable (wide, multi, or combined) processing configuration. Second, there is the SEC800 Spectral Energy Compressor, featuring programmable 3dB gain reduction steps and attack/release time ranges, switchable AGC gating threshold, and adjustable four channel output equalization capability. The third unit in the chain is the SMP850 Stereo Modulation Processor, which is designed to provide spectrum control of pre-emphasized audio free from the loudness loss of multiband limiting or the high frequency loss of wideband limiting. The final step in the system is the SG800A digitally synthesized stereo generator. Features of the SG800A include improved composite output drive capability, optional overshoot corrected audio input low pass filtering, and inputs for two subcarriers.

The CRL AM stereo processing system consists of three units: the SGC800 Stereo Gain Controller, the SEC800 Spectral Energy Compressor, and the SMP950 AM Stereo Matrix Processor. The design of the SMP950 takes into account that AM stereo is quite different from FM stereo. It has a patented matrix processing system designed specifically for AM stereo. The SMP950 incorporates



the NRSC standard pre-emphasis and low pass filtering, as well as a tri-band limiting feature. For monophonic AM operation, CRL provides the same performance and quality as for stereo. The AGC400 Audio Gain Controller, the SEC400 Spectral Energy Compressor, and the PMC450 Peak Modulation Controller are single channel (mono) processors with the same high quality as their stereo counterparts.

AM-2 mono AM system. AGC400, PMC450 60CUAM2 MFR LIST \$3295.00

AM-2S stereo AM system. SGC800, SMP950 60CUAM2S MFR LIST \$4295.00

AM-4 mono AM system. AGC400, SEC400, PMC450. 60CUAM4 MFR LIST \$4795.00

AM-4S stereo AM system. SGC800, SEC800, SMP950. 60CUAM4S MFR LIST \$6395.00

FM-2G stereo FM system. SGC800, SMP850, SG800A. 60CUFM2G MFR LIST \$5895.00

FM-2G "Plus" stereo FM system. SGC800, SEC800, SMP850, SG800A. 60CUFM4G MFR LIST \$7995.00

Call Bradley for a current price quotation.



Gentner Lazer Digital FM Limiter/Stereo Generator

Lazer handles audio purely in the digital domain. Because of this, Lazer provides excellent aural specifications including maximum separation, precise limiting, and virtually no noise. The result is that your audio retains its true sound. Lazer's three band processing is phase linear for maximum transparency. It evaluates signal peaks on the basis of both level and duration, avoiding unnecessary limiting of high frequency material and allowing higher modulation levels.

Front panel buttons and an LCD display let you numerically define operational parameters. You can define pilot injection, release times, limiting thresholds, and other parameters without fear that your settings will drift. Lazer includes the Optical encoder, an advanced analog to digital converter.



Lazer 60GELAZER MFR LIST \$6995.00
 Call Bradley for a current price quotation.

Gentner Audio Prism

The Audio Prism has earned wide acclaim for its unique approach to audio processing. The emphasis is on "clean" using digital control. The Prism uses a four-band parallel layout, with gain change accomplished by smooth, predictable opto-attenuators. A broadband safety buffer automatically keeps the multiband section in its normal operating range, even with widely varying input levels. A built-in pink noise generator and front panel VOM test points make setup quick and repeatable.

Each band is individually gated with a common threshold adjustment. A single "density" control effectively re-programs attack/release times and compression ratios simultaneously. Unlike many other processors, the Prism's "proof" switch simply removes control bias, leaving all audio circuitry on line. A phase rotator, a form of all-pass filter with very precise and predictable frequency/phase characteristics, is used to assure optimum stereo separation regardless of source material. A pair of Audio Prisms used in conjunction with a high quality limiter/stereo generator forms an unbeatable combination. Two units are required for stereo.



Audio Prism 60TRPRISM MFR LIST \$1795.00

Accessory:

RFC-1 replaces card 5 of an Orban 8100A Optimod FM when that unit is used with a pair of Gentner Audio Prisms.

RFC-1 60TRRFC1 MFR LIST \$469.00

Call Bradley for a current price quotation.

Gentner Phoenix AM Processor

The features and performance of the Phoenix will cause you to wonder if its low price is really correct. Included in this small, powerful package are variable asymmetry, a voice phase-rotator, and a low frequency tilt corrector for plate modulated transmitters. The heart of the Phoenix is the digitally controlled Gentner Audio Prism, which is followed by a high quality limiter. Complete with the NRSC standard for pre-emphasis and bandwidth limiting.



Phoenix 60TRPH MFR LIST \$2995.00
 Call Bradley for a current price quotation.

Modulation Sciences CP-803 Composite Processor

A unique product in the broadcast realm, the CP-803 delivers up to 6dB more loudness without increased distortion, swishing, or pumping. Because the CP-803 processes your FM baseband, it can remove unwanted overshoots which cause overmodulation, even at relatively low average levels. Since the CP-803, unlike baseband clippers, does not clip the 19kHz pilot, its use is entirely legal when installation and operation conforms to manufacturer's instructions. Get the best

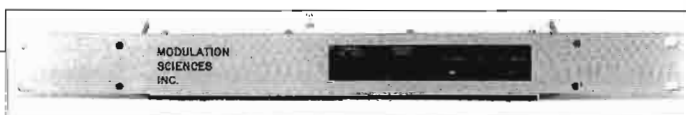

of both worlds, greater dynamic range and increased loudness.

CP-803 60MSCP803 MFR LIST \$1495.00

Call Bradley for a current price quotation.

CRL MBL-100 AM News/Talk Processor

The MBL-100 is a multi-band audio processor specifically tailored to mono AM stations with News/Talk formats. Very high levels of average modulation density are available to extend your station's coverage area. Features include input band-pass filtering, a dual band AGC/Compressor, two equalizer sections, and a three band limiter followed by a final wide-band limiter. Selectable speech asymmetry removal circuitry compensates for the tendency of voice material to play havoc with gain reduction action. Compensation circuitry is available to correct any low



frequency roll-off or high frequency overshoot induced by your transmitter. The unit has a 7.5kHz bandwidth and NRSC-1 pre-emphasis.

MBL-100 60CUMBL100 MFR LIST \$3695.00

Call Bradley for a current price quotation.



Inovonics Broadcast Processors

The 250 digitally programmable processor is modular so that it can be configured for operation in AM, FM, and TV services. It accomplishes the multiple functions of slow, gain-riding AGC; multiband compression and program equalization; and final peak control conforming to FM/TV pre-emphasis characteristics or with fully matrixed processing for AM stereo. Programmability may take the form of either simple remote selection of presets, or of continuous on-line control via computer or modem.

The 255 triband AGC and compressor/limiter is designed for FM processing. Control over program spectral distribution and density allows processing to range from conservative to very aggressive. Feed forward PWM gain reduction yields smooth, colorless operation with any degree of processing.

For monaural AM operation, the 222 incorporates pre-emphasis and low pass functions for NRSC-1 compliance. A sophisticated peak limiter is provided, so this

unit can serve as an economical "stand-alone" processor.

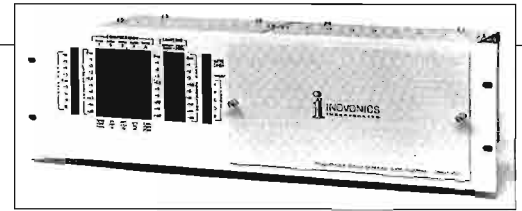

250 for stereo FM and TV	60IN250	MFR LIST	\$3050.00
250 for stereo AM	60IN25001	MFR LIST	\$3050.00
250 for mono AM	60IN25002	MFR LIST	\$2550.00
255 for stereo FM	60IN255	MFR LIST	\$1990.00
222 for mono AM	60IN222	MFR LIST	\$620.00

Call Bradley for a current price quotation.

Inovonics 706 FM/FMX Stereo Generator

The Model 706 features digital synthesis of the composite signal to assure optimum performance and drift-free, adjustment-free operation. Patented filter overshoot compensation yields optimum carrier modulation, even without composite processing. Features include accurate metering of signal levels, three SCA/RDS inputs, built-in composite processor, and remote control stereo and FMX operating modes. A plug-in option incorporates the FMX Coverage Extension Transmission System. When used with the FMX receivers now available, this system can increase your station's noise-free stereo coverage area.

706 Stereo Generator	60IN706	MFR LIST	\$3120.00
706 Stereo Generator w/FMX	60IN70601	MFR LIST	\$3740.00



Also available:

705 Stereo Generator - more basic design and functions than the 706.			
705 Stereo Generator	60IN705	MFR LIST	\$1375.00
705 Stereo Generator w/ FMX			
	60IN70501	MFR LIST	\$1990.00

Call Bradley for a current price quotation.

Modulation Sciences Stereomaxx

Stereomaxx enhances the overall spatial effect of stereo. Stereo image becomes bigger and deeper, and spatial detail is made obvious. The effect on "box" type portables and car radios is dramatic. The Stereomaxx takes the L-R difference signal, which is delayed and split into two signals out of phase with each other. One signal is mixed into each output channel. Since mono inputs create no difference signal, they are not processed. The delay decorrelates the enhancement signal from the stereo program, "filling up" the brief periods of silence between the notes. Average energy of the L-R channel is increased, but not the peak value. Because reinserted signals are out of phase, they are inaudible to mono listeners. Mono compatibility is absolute. An automatic width control senses the "stereo" quality of source material to prevent over-processing.



Controls include depth (amount of delay applied), width (amount of enhancement signals returned to the left and right channels), and diffusion (percentage of enhancing signal that is undelayed.) Front panel LED indicators ease setup. Because the Stereomaxx is operated in the time domain rather than the amplitude domain, it is fully compatible with your present processors. It brings out the differences in musical selections rather than homogenizing your sound.

Stereomaxx	60MSSM	MFR LIST	\$2889.00
-------------------	--------	----------	------------------

Call Bradley for a current price quotation.

Orban 9100B Optimod AM

The Optimod 9100B was designed from the ground up for high-fidelity AM, where quality is every bit as important as loudness. Orban has developed a highly specialized equalizer system to compensate for receiver high frequency rolloff. Special attention was given to eliminating the fatiguing "honky" midrange sound common to other AM processors. Three different characteristic slopes are available on plug-in modules to optimize the 9100B for low-fi receivers, high-fi receivers, or to "split-the-difference."

The system also provides transmitter "EQ" adjustments to precisely tune out transmitter deficiencies such as tilt or ringing. The modular card-frame design protects your investment by permitting low-cost updates as technology moves

forward. It may be purchased as a cost-effective mono system, and upgraded to stereo at a later date. The 9100B meets the NRSC pre-emphasis and low pass filtering standards.



9100B1/U10 Mono	60OB9100B1	MFR LIST	\$4550.00
9100B2/U10 Stereo	60OB9100B2	MFR LIST	\$6350.00

Call Bradley for a current price quotation.



Sonich DBE-1000/B Dynamic Baseband Enhancer

The DBE-1000/B is an FM composite signal processor designed to increase apparent loudness, eliminate baseband overshoots, and enhance your signal while protecting SCA services. Your stereo pilot signal is completely protected even with the most aggressive settings, and the proprietary processing technique eliminates stereo aliasing while supercharging your audio. The DBE-1000/B clipper circuit is a "brick wall" clipper for more density, and the Stereo Correlation Adapter Filter maximizes stereo separation and coverage. Dual mode operation and precision



10-turn pots aide in setting processing to match your format.

DBE-1000/B 60SMDBE1000 **MFR LIST \$1895.00**
 Call Bradley for a current price quotation.

Orban 222A Stereo Spatial Enhancer

The 222A improves your station's spatial image the way the OptiMod maximizes your loudness and impact on the dial: your stereo image will seem magnified, and your listeners will hear more brightness, dynamics, and depth. The 222A detects and enhances the directional cues present in all stereo program material. The effect is vivid and compelling, and survives even the most brutal multipath environments. On-air tests have confirmed complete mono compatibility.

Creating broadcast compatible stereo image enhancement is very difficult. Do it wrong, and you can get increased multipath distortion, mono incompatibility,



unnatural exaggeration of reverberation, increased sensitivity to vertical tracing distortion in disc playback, and otherwise disappointing results. Orban's 222A does it right, delivering a sound that stays crisp, dynamic, and well-defined. This competitive edge is remarkably affordable.

222A 600B222A **MFR LIST \$1200.00**
 Call Bradley for a current price quotation.

Orban 4000A Transmission Limiter

The 4000A is designed to protect transmission links, such as digital links, post/telcom lines, microwave links, and satellite links from overload. The gated, dual band limiter of the 4000A is followed by the Smart Clipper distortion cancelling clipper and the Frequency-Contoured Sidechain overshoot corrector. The result is accurate and transparent limiting without coloration of the audio. Multiple user selectable pre-emphasis curves, built-in 400Hz test tone, remote controllable bypass mode, and minimal controls and indicators make set up and use easy.



4000A1 single channel 600B4000A1 **MFR LIST \$1900.00**
4000A2 dual channel/stereo 600B4000A2 **MFR LIST \$2500.00**
 Call Bradley for a current price quotation.

Excalibur CDA-1 Composite DA

The one input, three output CDA-1 can add flexibility to your transmission facility. Each output has its own 20 turn level control, and can drive up to 75 feet of RG-58 coax. A ground lift switch and transient protection on the power supply are two of the quality features built into the CDA-1. Use it to feed auxiliary STL systems, test equipment, and back up transmitters. Other uses include distributing modulation monitor outputs and subcarrier generator outputs. Frequency

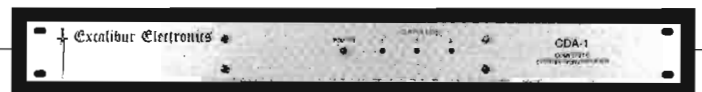

response is DC to 100kHz ± 0.2 dB (less than 0.05dB down at 53Hz), THD is less than 0.01%, and noise is greater than 90dB below 4 volts at unity gain.

CDA-1 60EXCDA1 **\$360.00**

Modulation Sciences Sidekick SCA Generator

The Sidekick combines the four elements needed for successful SCA operation into one package: subcarrier generator, modulation monitor, audio processor, and transmitter tuning aid. The SCA carrier is derived from a frequency synthesizer, permitting changes through user-selectable straps. Crystal control results in outstanding frequency stability over a wide temperature range. The modulation meter meets FCC requirements and eliminates the need for a separate SCA monitor. The Sidekick is designed for 150usec pre-emphasis (75 and zero are strappable). The integral audio filter is overshoot corrected and gives excellent peak control. Built-in test generator and incidental AM noise meter assist with RF tuning, which can result in crosstalk reduction. Each subsystem of the Sidekick has been specially engineered for its task. Together they form a high performance



integrated system. Data transmission versions are also available.

67kHz 60MSSCA67 **MFR LIST \$3835.00**
92kHz 60MSSCA92 **MFR LIST \$3835.00**
 Call Bradley for a current price quotation.



TFT 8900 Reciter

A composite STL is a great way to go, but even the best composite STL receivers are far inferior to even a mediocre FM exciter. TFT, with the 8900 Reciter, has an idea so simple, so effective, that it's amazing no one thought of it before. Here's how it works: The incoming STL signal (in the 950MHz band) is heterodyned to an intermediate frequency of 63MHz, just as in a conventional receiver. But, whereas a conventional receiver would now demodulate the signal to recover the composite baseband, the Reciter heterodynes the IF to your FM operating frequency. The signal stays entirely at RF frequencies and is never demodulated. The result is a quantum leap in audio quality. When used with a TFT 8300 composite transmitter there's <0.02% THD and >85dB S/N ratio. Frequency stability is ± 100 Hz, better than most exciters, and power output is up to 50 watts. Plus, a front panel meter monitors all important internal parameters.

Installation is simple. Your STL receive dish plugs into the input of the Reciter, and the output of the Reciter plugs into your transmitter. That's it! Your existing

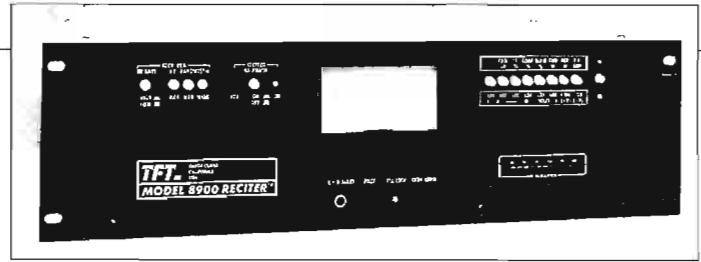

composite STL transmitter stays in service. Also available is a special model for use when synchronizing FM transmitters.

8900 60TT51168910 MFR LIST \$10,450.00

Call Bradley for a current price quotation.

BE FX-50 Exciter

Broadcast Electronics' FX-50 Exciter advances the state of the art in FM broadcasting by an order of magnitude. The FM signal-to-noise ratio on the composite input is typically an incredible 93dB below 100% modulation. Look at these other specs: Distortion (both THD and IMD), typically 0.003%; frequency response, 30Hz to 53kHz, ± 0.025 dB; phase response, $\pm 0.1^\circ$, 30Hz to 53kHz. Many CD players don't perform this well!

RF output on the FX-50 is continuously adjustable from 3 to 50 watts, so you can retrofit it into virtually any FM transmitter. Regardless of its age, the improvement in your transmitter's performance will be nothing short of dramatic.

The FX-50 utilizes an LED modulation display that is more accurate than a modulation monitor. It provides a clear indication of short transient peaks so you can operate at the highest allowable peak modulation levels. An expanded scale

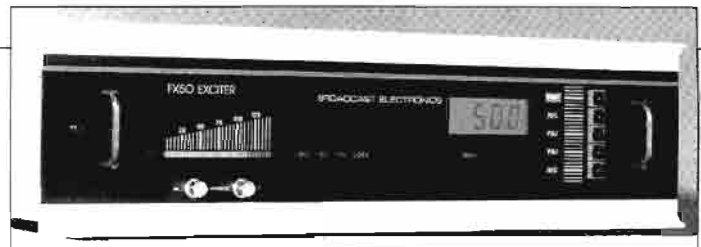

(x10) permits convenient setting of stereo pilot or SCA injection levels and three inputs are provided for subcarriers.

FX-50 60BRFX50 MFR LIST \$6295.00

Call Bradley for a current price quotation.

QEI FM Transmitters

Whether it's located at 7,000 feet and accessible only by helicopter or located through the door in the next room, reliability is the major factor when you are choosing your transmitter. After all, audiences don't listen to stations that aren't on the air.

QEI's "New Reliables" are available in power levels ranging from 150 watts to 30,000 watts. The rack mountable 150, 300 and 500 watt models are all solid state, as is the 1kW, which is self-contained in a stand alone cabinet. 3.5kW, 5kW, 10kW, 20kW, and 30kW models all feature a single grounded grid triode in the final, offering the inherent stability, lower AM noise, simpler power supply, and other advantages which contribute to the superior sound of these transmitters.

The 3.5kW, 5kW, and 10kW models are available for either single or three phase power at the same price, and single phase power is available as an economical option for the 20kW and 30kW models. You'll find these options preferable to paying the power company to run three-phase lines to a remote site.

The 3.5kW transmitter can be field upgraded to 5kW or 10kW in a matter of hours. This is ideal for a Class A station increasing its power, or for any station with a Class upgrade. To demonstrate their commitment to reliability, QEI provides a 15,000 hour warranty on the tube in their transmitters. The 675 Exciter is standard on all QEI transmitters, but the 695 "Transparent Plus" is available as an option. Also available is the ARC-27 microprocessor based remote control.

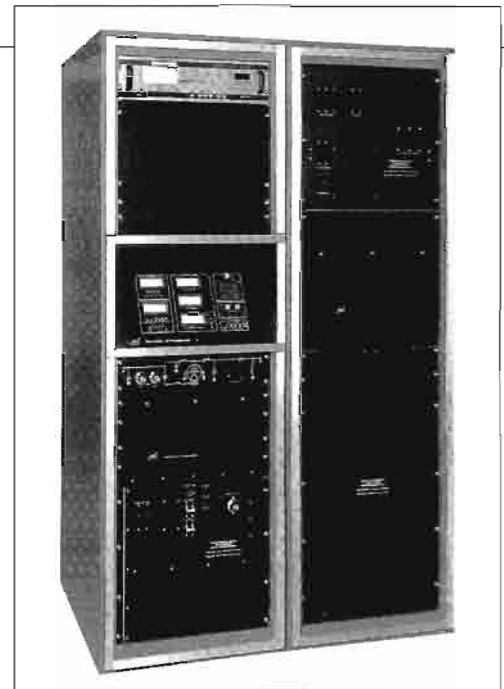

QEI 695 Exciter

The "Transparent Plus" 695 is fully synthesized and can be tuned to any FM broadcast frequency instantly. Its distortion and noise specifications are premium. THD, IMD (SMPTE method), and TIMD are all less than 0.025%; FM noise is greater than 80dB below 100% modulation.

Equal to its outstanding performance are the 695's other features. The built-in modulation display is driven from an actual RF demodulator which, via a rear panel BNC jack, can be driven from your transmitter's monitor port. A built-in spectrum analyzer, requiring only a DC coupled oscilloscope with X-Y capability, displays $\pm 120\text{kHz}$ from your carrier frequency. Complete metering of eight important parameters can be push button selected on the front panel meter. Automatic modulation and power output controls are other important features of this unique exciter.

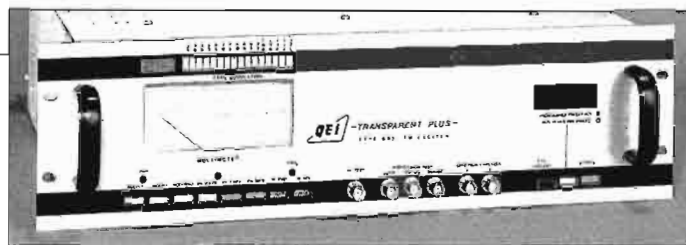

695

60QE695

MFR LIST

\$5295.00

Call Bradley for a current price quotation.

Shively FM Antennas

Shively antennas perform as specified without regard to their environment, as harsh as it may be. A complete variety of Shively antennas is available to suit any station. Educational stations can use the low power 6812. Class A stations will find just what they need in the 6813, with a power rating of 3kW per bay up to 12kW. Non-pressurized versions of the 6813 are available for use with foam-filled line for those who are ready to rid themselves of trouble-prone and expensive nitrogen tanks and dehydrators. The 6810 (10kW per bay up to 40kW) is the perfect antenna for Class B stations and the 6814 is just right for Class C stations.

Panel antennas are available for either single or multi-station operation. Contact us if you are concerned about radiation hazard standards so that we can provide complete information on 0.95, 0.90, 0.75, and 0.50 wavelength spacings to control downward radiation. Of course, Bradley and Shively can provide a complete range of options, including deicers, radomes, null fill, beam tilt, pattern studies, and directional antennas.

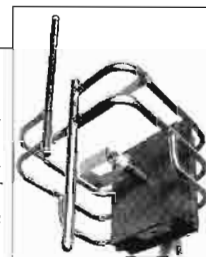

Northern Technologies Power Protection Systems

Don't let a lightning strike take your transmitter down. Northern Technologies offers several series of products that provide the highest level of protection. The LAP Series is a high energy lightning protection system designed to protect your entire facility from external power line surges. The TCS Series is a Silicon Avalanche based transient control system with a redundant back-up stage. Use a TCS device for additional, extremely fast (5 nanoseconds or less) response to protect transmitters and critical microprocessor based equipment. Contact Bradley for details on a system tailored to your facility. Prices start at \$1295.

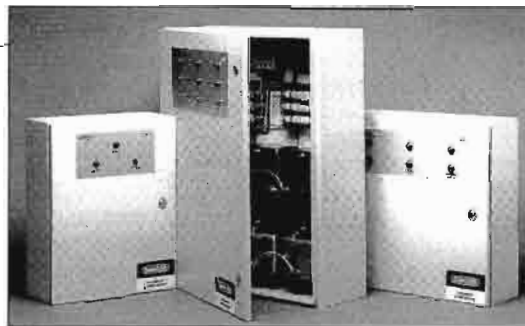
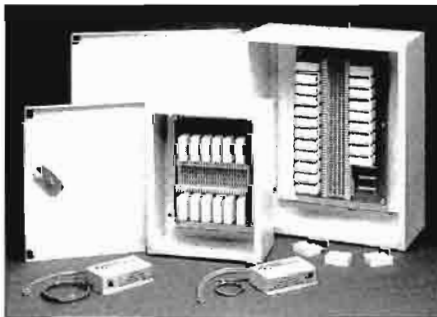

RF Accessories

Many items go into making a complete RF system. Some are rather expensive, some are not. Many are not too glamorous, and don't get the same attention as transmitters or processors. But all are important to the success of your project. Your Bradley professional is trained to help you with every item you need, right down to the smallest fitting. Bradley features:

Cablewave Systems - Transmission line and accessories, including foam and air dielectric lines, rigid line, connectors, grounding kits, splices, and pressurization equipment for either nitrogen or dry air.

Electro-Impulse - RF "dummy" loads up to 50kW.

Comark - FM antennas, rigid line, & coaxial switches.

Coaxial Dynamics - Wattmeters.

Delta - Stereo AM exciters and monitors. Toroidal current transformers, operating impedance bridges for both permanent installation and field use, and antenna monitors.

Potomac Instruments - Field intensity meters covering MF, HF, VHF, and UHF frequencies, as well as antenna monitors.

Kintronics - Antenna tuning units, phasing equipment, power dividers for PSRA and PSSA operation, and isocouplers.

Modulation Sciences - Composite line drivers and distribution amps.

RF EQUIPMENT



119

Toll Free: 800-732-7665 • MD & DC: 301-948-0650 • FAX: 301-330-7198 • **Bradley Broadcast**

Modulation Sciences Modminder

You want increased modulation, but your modulation monitor says you've reached the legal limit. But this may not be the case, because many modulation monitors register overmodulation on brief overshoots they really should ignore.

ModMinder very accurately measures and displays peak FM deviation. By doing so, the ModMinder allows a station to either back off its processing (increasing dynamic range) or to increase its modulation (increasing loudness) or to do some of both. This translates into a 1 to 4dB improvement in modulation, a significant gain in today's extremely competitive marketplace.

The ModMinder works by indicating only those peaks which exceed 1000 µsec.



a parameter which conforms precisely to the most recent (albeit now deleted) FCC rules for modulation monitoring. A microprocessor controls all timing and monitoring functions, assuring you an unusual degree of accuracy. Complete interfacing is provided, including alarm functions, for your remote control system. An RS-232 port offers computer access of monitored information.

ModMinder 60MSFMMM *MFR LIST \$2395.00*

Call Bradley for a current price quotation.

Rallio Design Labs ACM-1 AM Noise Monitor

As stations have pushed the performance of their transmitters to the limit, they have discovered just how much of a problem AM noise is: it degrades stereo performance, it increases crosstalk (especially if you have subcarriers), and it exacerbates the problems caused by multipath propagation. Most modulation monitors cannot accurately measure AM noise. The ACM-1 solves this problem for both synchronous and asynchronous noise by using a precision AM detector located at your transmission line tap where it's not influenced by the cable length. In addition to giving you accurate noise measurements, the ACM-1 provides alarm outputs. You set the alarm limit just above the point of normal AM noise



performance. Then, if your tube starts to go soft or other problems cause AM noise to increase, the ACM-1 will let you know about it before your listeners start to switch stations. Both noise reading and alarm functions can be hooked up to your remote control system. Suitable for TV aural transmitters.

ACM-1 60RDACM1 *MFR LIST \$1595.00*

Call Bradley for a current price quotation.

TFT FM Modulation Monitors

TFT offers two models of efficient and accurate monitors which allow all base-band and stereo monitoring functions to be performed in a single unit. The 884 and 844A both combine, in only 4 rack spaces, three major sub-systems: a frequency agile RF amplifier, an FM main channel monitor, and a stereo monitor. Front panels are well organized and uncluttered. Complete FM stereo performance measurements are quick and easy. A feature unique to TFT is the Peak Modulation Duration Differentiator (PMDD) which separates true modulation peaks from those caused by transient noise, overshoot, and multipath distortion.

The 884 and 844A both use TFT's famous pulse-counting FM discriminator and have outputs for audio monitoring and test equipment. The 844A adds a dual pre-selector to enable rapid "A-B" comparison of your competition. The frequency on both channels is synthesized. Also standard on the 844A is a third meter so you can simultaneously monitor left and right modulation while looking at test parameters, an absence of modulation carrier alarm, and front panel headphone jack.



884 60TT884 *MFR LIST \$3595.00*

844A 60TT844 *MFR LIST \$4920.00*

Also available:

845 SCA Monitor 60TT845 *MFR LIST \$2610.00*

Call Bradley for a current price quotation.

QEI 691 FM Modulation Monitor/Test Set

The 691 is a complete performance measurement instrument for mono, stereo, and SCA. Tuneable in 100kHz steps over the entire FM band, the unit can perform over forty tests when used with an oscilloscope. The front panel includes frequency and test meter outputs, adjustable range peak flasher, peak counter, and easy to read auto-ranging meters. The 691 is extremely accurate and reliable.

691 60QE691 *MFR LIST \$5610.00*

691/01 w/67kHz SCA monitoring
60QE69101 *MFR LIST \$6675.00*

691/02 w/67kHz and 92kHz SCA monitoring
60QE69102 *MFR LIST \$7100.00*

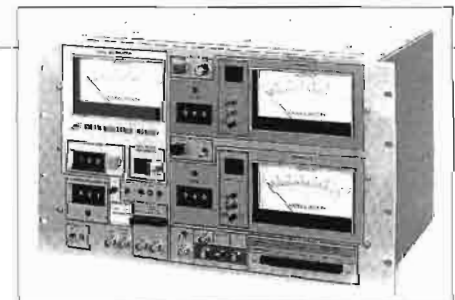

Call Bradley for a current price quotation.



Belar AM Monitors

Belar offers two AM monitors: the AMM-2B and the AMM-3. A unique modulation cancellation scheme is used to recover the unmodulated carrier which provides a reference to modulation peaks. Thus, the instantaneous program peaks are referenced to the instantaneous carrier without the need of accuracy compromising time constants. The AMM-3 has the additional feature of separate meters for simultaneous monitoring of both positive and negative modulation. Individual thumbwheel switches allow setting the positive and negative peak flashers in 1% increments. Audio outputs are provided for both monitoring and test instruments.

AMM-2B	60BLAMM2B	MFR LIST	\$1320.00
AMM-3	60BLAMM3	MFR LIST	\$1590.00

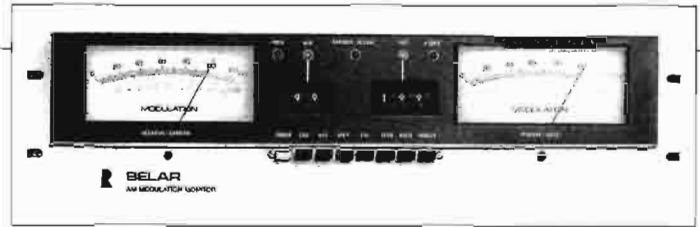

Accessory:

AM RF amplifier	60BLRFA2	MFR LIST	\$650.00
------------------------	----------	----------	-----------------

Call Bradley for a current price quotation.

Belar FM Monitors

Belar's FM monitor lineup includes separate main channel, stereo, and subcarrier monitors. The main channel and stereo monitors have THD and IM (SMPTE) both less than 0.01%, far superior to any other monitor available today. S/N ratio exceeds 90dB, and frequency response is ± 0.25 dB, 50Hz to 15kHz. Autoranging meters on the FMS-2 stereo monitor make noise and crosstalk measurements a snap. The SCM-2 subcarrier monitor can measure up to four different subcarriers.

FMM-2 FM	60BLFMM2	MFR LIST	\$1590.00
FMS-2 stereo	60BLFMS2	MFR LIST	\$1790.00
SCM-2 SCA	60BLSCM2	MFR LIST	\$1790.00

Accessory:

FM RF amplifier	60BLRFA1	MFR LIST	\$650.00
------------------------	----------	----------	-----------------

Call Bradley for a current price quotation.

EBS Monitors

Multi-Technical Services System 3000

This ultimate EBS monitor incorporates multiple monitor receivers and the EBS encoder and decoder into a single unit. NOAA weather service monitoring is also available so you can offer your community the best information and service. Features include three channel scan, manual or automatic operation, program audio loop through, left and right channel outputs, remote operation, and a built-in monitor speaker. The standard unit comes complete with three fixed frequency FM or AM receivers. Your Bradley professional can help you select from the numerous options.

System 3000	60MU3000	MFR LIST	\$1900.00
--------------------	----------	----------	------------------

Accessories:

NOAA NWS receiver module			
60MU3000NOAA	MFR LIST		\$95.00
DTMF reset option	60MU3000DTMF		\$75.00

Multi-Technical Services System 1000

The 1000 Series EBS System offers an encoder, a decoder, and your choice of either an AM or FM receiver in only one rack unit of space. Everything you need to stay legal is here. The front panel is clearly labeled, and provides for activating the encoder or resetting the decoder. An internal speaker allows you to check the reception of your monitored station. Specify frequency when ordering.

AM	60MU1000AM	MFR LIST	\$899.00
FM	60MU1000FM	MFR LIST	\$899.00

Call Bradley for a current price quotation.

Gorman Redlich EBS Encoder/Decoder

The Model CEB offers both EBS two tone encoding and decoding. Any stable receiver may be interfaced with the CEB to provide monitor capability. The CEB may be operated remotely, and mono programming loop-through is standard on the encoder. The decoder automatically demutes the monitor receiver and provides auxiliary alarm contacts. Encoder and decoder, as well as a tunable receiver, are available as separate units.

CEB	60GRCEB	MFR LIST	\$540.00
------------	---------	----------	-----------------

Also available:

Encoder only	60GRCE	MFR LIST	\$375.00
---------------------	--------	----------	-----------------

Decoder only	60GRCD	MFR LIST	\$320.00
---------------------	--------	----------	-----------------

Tunable AM/FM receiver

60GRREC	MFR LIST	\$100.00
---------	----------	-----------------

Call Bradley for a current price quotation.

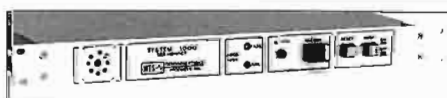
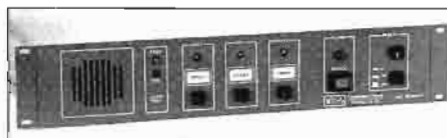

TFT EBS Systems

TFT now makes staying legal with EBS a bit easier for you with the 886 and 887 EBS systems. The 886 (AM) and 887 (FM) have a receiver, decoder, and encoder all in only one rack space. The encoder features crystal controlled oscillators and the decoder features piezoelectric filters to assure stability. Both AM and FM receivers are synthesized, allowing fast, accurate tuning to either a primary or secondary station. Program loop-through is, of course, standard. Unique to the 886 and 887 is the pair of digital counters. One shows the number of days since your last EBS transmission, and the other shows the number of days since your last EBS reception. This helps to avoid FCC citations for incorrect use or non-use of the EBS system.

886 AM	60TT886	MFR LIST	\$2095.00
---------------	---------	----------	------------------

887 FM	60TT887	MFR LIST	\$2095.00
---------------	---------	----------	------------------

Call Bradley for a current price quotation.

Left Top: MTS EBS-3000, Left Center: MTS EBS-1000

Left Bottom: Gorman-Redlich EBS, Below: TFT 886



Gentner VRC-2000 Remote Control



The VRC-2000 is a second generation voice response remote control system. It allows you full transmitter control via any bi-directional audio link, whether dial-up phone line, dedicated phone line, or radio link (such as STL/TSL/SCA). When operated as a stand-alone unit connected to a dial-up line, you can control your transmitter from any telephone anywhere that has a DTMF keypad. The VRC-2000 responds with a synthesized voice. For full-time "on line" remote control, the accessory data interface, together with an IBM compatible PC or Gentner's optional video display terminal, allows your operator to see at a glance the conditions of all metering, status, and command channels, and to control the command channels from a keyboard.

Having a VRC-2000 in charge of your transmitter is just like having a full-time transmitter engineer on duty, except that the VRC-2000 doesn't take coffee breaks, lunch breaks, or naps! When any monitored parameter goes outside the limits you set, the VRC-2000 will call you at the studio, at home, or on your cellular phone and tell you what's wrong. You can then take immediate corrective action. Of course, a security code prevents unauthorized access. A built-in microphone permits audio monitoring of the transmitter site. 32 command outputs (16 raise/16 lower) are provided, as well as 16 metering inputs and 16 status inputs. Setup information is saved in battery protected RAM. 64 commands may be issued by the internal real time clock for pattern, power, or other control changes. Call your Bradley professional today for assistance in configuring your VRC-2000 system.

60GF910072201 MFR LIST \$2995.00

Accessories:

Data Interface consists of a 300/1200/2400bps modem and RS-232 serial port. Required for communication with a printer or data terminal on-site, or with a personal computer or the Video Display Terminal via two-way audio link. Includes Setup VRC-2000 software.

60GF910076201 MFR LIST \$995.00

Command Relay Unit provides relay isolation between the VRC-2000's open collector outputs and any of your equipment requiring relay switching. Handles 8 raise and 8 lower commands. Two required for full 16 raise/16 lower operation.

60GF910073001 MFR LIST \$549.00

Also available:

Many other special purpose accessories are available for the VRC-2000, such as a fail safe unit, video display terminal and printer, antenna monitor, temperature sensor, battery back-up, and interface cables. Your Bradley professional will be happy to assist in determining the accessories and cables you require.

Call Bradley for a current price quotation.

Burk ARC-16 Remote Control



The ARC-16 allows you to have full-time studio control, dial-up control, or both. It has 16 metering channels, 16 raise control outputs, 16 lower control outputs, and 16 status channels. Subcarrier generators for control and/or telemetry are provided at no additional cost. Units have 32 character front panel displays with plain English prompts. The optional digital speech unit (DSU), featuring a digitally recorded human voice, can be installed at either the studio or the transmitter and permits full control from any phone with a DTMF pad. The DSU will also dial a series of phone numbers to announce any alarm condition. Multi-site operation, control of studio equipment from the transmitter, and computer control are other versatile features of the ARC-16.

ARC-16 single unit configuration includes transmitter unit with front panel display and one DSU telephone/speech unit to allow full remote control from any telephone.

60AVARC16SU MFR LIST \$2995.00

ARC-16 conventional 2-unit system includes one studio unit, one transmitter unit, and one set of modems to interconnect by telco, STL, SCA, or TRL.

60AVARC16DU MFR LIST \$3895.00

Accessories:

Interface panel provides barrier strip connections for 8 metering inputs, 8 status inputs, and 8 each raise and lower outputs, plus failsafe. All outputs are isolated with 10 Amp Form C (NO, NC) relay contacts. One panel required for each 8 channels.

60AVIP8 MFR LIST \$495.00

Computer interface can be added at either studio or transmitter to provide RS-232 connection to an IBM PC compatible computer. Software is included to provide complete logging and full-screen display.

60AVCI16 MFR LIST \$495.00

Digital Speech Unit can be added to either the studio or transmitter unit of two unit system.

60AVDSU MFR LIST \$795.00

Studio Status Indicator drives an external set of alarms or annunciators. Independent outputs are available plus a set of latched outputs that may be cleared from the front panel.

60AVSSI MFR LIST \$250.00

Studio Input/Output Unit adds eight channels of input and output at the studio site. May be monitored and controlled from the transmitter or by dial-up when using the DSU.

60AVSIO MFR LIST \$495.00

Antenna monitor interface provides connection to most common antenna monitors.

60AVAMI MFR LIST \$350.00

Call Bradley for a current price quotation.

Burk TC-8 Remote Control



The TC-8 is what broadcasters want in a remote control. A very large dot matrix display reads 4 digit telemetry plus channel number (8 available). 8 status indicators are updated every 400 milliseconds regardless of which channel is selected. The precision dual-slope 12 bit A/D converter is typically accurate to within 0.25%. One person calibration is accomplished via software, so there are no trim pots to wear out. The TC-8 modems can be set up for telco, SCA, or half-duplex mix. An alarm closure warns of any link failure, followed in 45 seconds (adjustable) by failsafe shutdown. An internal battery protects memory contents for up to ten years without power.

The basic units use DB-37 connectors for status, telemetry, and open-collector control. We recommend using the accessory relay panel, which brings all connections out to screw-type barrier strips and isolates the control logic with plug-in 10 amp form-C relay contacts. The TSU dial-up option is connected to the studio unit and allows you full access to all TC-8 readings and control features via a telephone.

TC-8 60AVTC8 MFR LIST \$2495.00

Accessories:

Relay/terminal panel

60AVIP8 MFR LIST \$495.00

Computer interface

60AVCI8 MFR LIST \$495.00

TSU dial-up option

60AVTSU MFR LIST \$595.00

Call Bradley for a current price quotation.

Bradley Crystal One Demodulator

The Crystal One is the world's finest AM monitoring system. It features superb audio response



(DC to 100kHz) and excellent overload characteristics (input accepts >20 volts RF if no O.S.H.A. inspectors are present). Broad tuning (>200kHz) allows simultaneous monitoring of your station, the competition, and most other nearby sources. Genuine lead sulfide (galena) active element and real cat's whisker probe (as long as the warehouse cat doesn't run away).

Crystal One 60BBXTAL

Call Bradley for a current price quotation.



QEI CAT\Link

CAT\Link offers an alternative to equalized telephone line and microwave STL's. CAT\Link's advanced digital signal processing technology gives you high performance using economical T1 data lines. T1 has 1.544MB data capacity, so that the CAT\Link can send a composite stereo signal to your transmitter while simultaneously sending and receiving a host of other audio and control signals. Quality is outstanding, with composite THD <0.01%, S/N ratio >81dB, and response DC to 53kHz, ± 0.001 dB.

CAT\Link consists of a studio unit with an analog-to-digital converter and multiplexer, while the transmitter end holds the digital-to-analog converter and demultiplexer. Besides T1, CAT\Link versions are available to operate over a mile of twisted pair audio cable, over two miles of fiber optic cable, or via a 23GHz microwave link. CAT\Link is modular, so you can add the additional channels you need, when you need them. Imagine sending your composite FM, two 7.5kHz sub-carrier channels, and a 3kHz control signal to your transmitter site while receiving two 15kHz audio channels (perhaps from your satellite dish), a 3kHz telemetry signal, and a data channel all over one link and all in real-time! CAT\Link can accommodate both a stereo FM and its co-located mono or stereo AM, also with return audio from the transmitter.

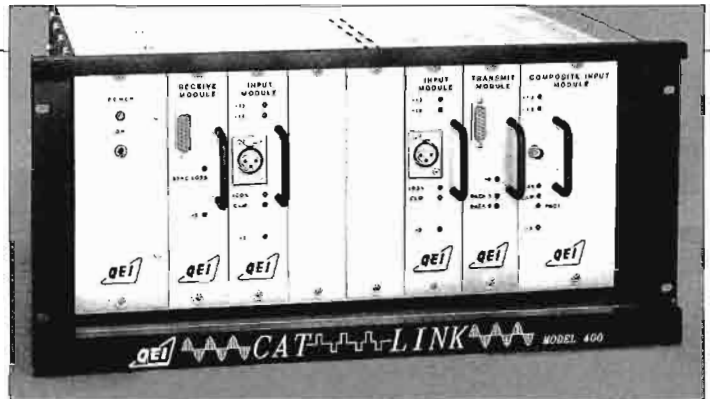

The bottom line is that CAT\Link can improve your on-air quality and increase the reliability of your STL and TSL systems for about the same equipment costs as microwave links. Composite systems start at just \$8500. Your Bradley professional can give you more reasons why CAT\Link is just "purr-ferct" for your station. Call today.

TFT 8300 Composite STL

The 8300 meets the demand for high performance and versatility. Specifically designed for superior performance in dense RF environments, this system boasts performance specs that make it a leader in its class: frequency response ± 0.1 dB from 30Hz to 53kHz, 50dB or better stereo separation, S/N 75dB or better. Up to 14 watts power, full front panel diagnostic metering, and modular construction. Options for the 8300 include hot standby with automatic changeover and an IF repeater for multiple hops without signal degradation. Two year warranty, prompt delivery, and 24 hour support. Put your 8300 system together with Bradley.

8300 composite transmitter 60TT51168300 MFR LIST \$5065.00

8301B composite receiver 60TT51168301B MFR LIST \$4925.00

Also available:

TFT 7700B STL System provides excellent audio quality and reliability in a more economical package. RF output is adjustable from 3 to 12

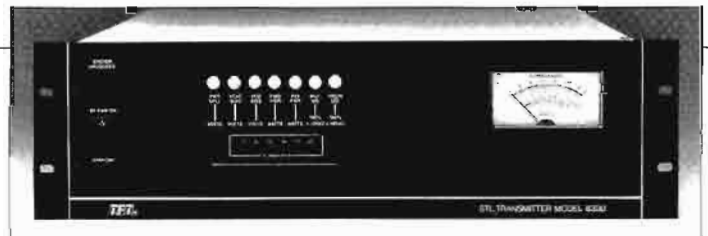

watts. Both transmitter and receiver provide full status and monitoring capabilities for setup, operation and troubleshooting ease.

7700B composite transmitter 60TT51167700B MFR LIST \$4175.00

7707 composite receiver 60TT51167707 MFR LIST \$3415.00

Call Bradley for a current price quotation.

TFT 8600 Discrete Channel STL

TFT's Model 8600 STL, for single channel or dual mono applications, incorporates a true VCO frequency synthesized modulation scheme, reducing distortion and improving signal-to-noise ratio. The 6.5 watt transmitter output comes from on-frequency amplification, yielding greater efficiency and introducing fewer harmful harmonics at the output. The receiver has been designed for 100kHz channel spacing for mono stations; it's ideal for the real world conditions of congested STL bands. The system frequency response is better than ± 0.2 dB from 30Hz to 15kHz; THD and IMD are less than 0.2%; and S/N ratio is better than 70dB, de-emphasized. Dual monaural systems for stereo use a pair of transmitters combined into a single antenna and a receiver splitter to connect two receivers to a single antenna. Plug-in subcarrier cards are optionally available. Bradley offers the quality TFT 8600 as part of complete STL packages. We'll put it all together with cable and antennas at low package prices.

8600A Transmitter 60TT51168600 MFR LIST \$1600.00

8601A Receiver 60TT51168601 MFR LIST \$1440.00



Transmitter combiner 60TTTC MFR LIST \$1221.00

Receiver Splitter 60TTRS MFR LIST \$120.00

Call Bradley for a current price quotation.

RF EQUIPMENT

Toll Free: 800-732-7665 • MD & DC: 301-948-0650 • FAX: 301-330-7198 • Bradley Broadcast

TFT 8888/8889 Remote Pickup

No other RPU system available today gives you the flexibility or performance of the TFT 8888/8889. The 8888 transmitter has three mic/line



inputs, a built-in limiter, a headphone jack with volume control, and a front panel modulation meter to assure top notch audio quality. A test tone generator allows quick setup, and a front panel DTMF input jack allows for system security and cueing. The transmitter is frequency synthesized to allow operation within two, 1MHz wide portions of the 450MHz band. Of course, powering is possible from either 12VDC or 120VAC. Three deviations (5, 10, and 25kHz) are internally selectable, depending on the frequency in use. Full output power is 25 watts, but two lower ranges are selectable for battery conservation. The companion 8889 receiver is also fully frequency synthesized. An on-board microprocessor is in full control, receiving commands from the DTMF code from the transmitter or a telco path. Local manual control can also be used. After access via a user-determined security code, the microprocessor will control the operating channel, bandwidth, and, if used at a repeater site, a companion transmitter. Call your Bradley professional today to have a system configured precisely to your needs.

Transmitter 60TT8888 MFR LIST \$2635.00
Receiver 60TT8889 MFR LIST \$1975.00

Call Bradley for a current price quotation.

Marti Remote Pickups

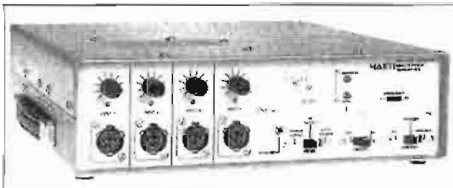

Marti builds the most complete line of remote pickup (RPU) equipment in the business. Making equipment for both the high VHF and the UHF bands, with power levels of 2 watts, 15 watts, and 30 watts. Marti supplies all options: internal battery, external DC, and AC. Operate from anywhere: hand held, portable, vehicular, and aircraft installations, and Marti can supply both mobile and fixed repeaters. Marti and Bradley offer any accessory item you need: fixed and mobile antennas, transmission line and fittings, microphones, installation accessories, you name it.

Call or fax Bradley today and tell us your application. Our professionals will tailor a system to your specific requirements.

Marti STL-10 Discrete Channel STL



This economical aural STL has a proven record of reliable performance. Two subcarriers are optionally available, and complete stereo systems with transmitter combiners and receiver splitters require only one antenna at each site. The STL-10 system features 20Hz to 15kHz, ± 0.25 dB response; less than 0.3% THD; and 70dB or better S/N ratio. Transmitters include calibrated watt meter with forward/reflected power switching, DC power operation capability, and six position metering of transmitter parameters. Call us to discuss your STL requirements, and for system pricing.

Mono 60MTSTL10 MFR LIST \$3250.00

Dual mono includes two transmitters, two receivers, and combiners required for use with single antenna system. 60MTSTL10D MFR LIST \$6925.00

Also available:

PA-48 4' grid parabolic antenna for 950MHz band STL use. 60MTPA48 MFR LIST \$695.00

Marti transmitter/studio links provide reliable remote control telemetry on the 450MHz band. The TSL-15 offers 15 watts and the TSL-30 operates at up to 30 watts. Complete system prices include automatic station identifier. Antenna package includes two yagi antennas, connectors, and jumper cable for 1/2" coax.

TSL-15 60MTTSL15 MFR LIST \$2544.50

TSL-30 60MTTSL30 MFR LIST \$3129.50

TSL antenna package
 60MTTSLANT MFR LIST \$404.00

Call Bradley for a current price quotation.

Scala and Mark Antennas

Bradley offers the full line of Scala and Mark dishes for all applications and frequencies. Most popular with broadcasters are their grid dishes for 950 MHz STL use, available with diameters ranging from 4' to 15'.

Where band congestion is not a factor, and the superior side-lobe characteristics of a full dish are not needed, you may wish to consider the Scala Paraflector or Miniflector. These half-parabolic antennas offer a significant reduction in weight and wind load compared to a full dish, while still providing the high gains necessary for moderate path lengths.

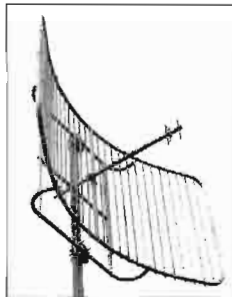

TFT 8700 Transmitter/Studio Telemetry Link



The 8700 transmitter has an output of 6 watts with a continuous duty rating. The 8701 receiver has 1.0uV sensitivity for 12dB SINAD. A rear panel jack on the 8700 transmitter allows a microphone to be plugged in for communications purposes. Both transmitter and receiver can be operated from an external 12V battery during power failures. An optional automatic identifier will give the transmitter's call sign in Morse code every 20 minutes. Using optional multiplexing equipment, the 8700 TSL system can use time division multiplexing to permit up to four stations to share a common TSL transmitter. Each station's telemetry data is "on line" for a one to ten second period. Also transmitted is each station's DTMF identifier. Each station's receiver then activates only when it receives its own code.

8700 transmitter

60TT8700 MFR LIST \$1520.00

8701 receiver 60TT8701 MFR LIST \$1520.00

Accessories:

Automatic identifier

60TT8700OPT01 MFR LIST \$340.00

Multiplex option for transmitter

60TT8700OPT02 MFR LIST \$970.00

Multiplex option for receiver

60TT8700OPT03 MFR LIST \$970.00

Call Bradley for a current price quotation.

Don't forget, too, that Bradley and Scala offer many types of antennas for broadcasters, including remote pickup, TSL, FM translator, and precision off-air monitoring. Special pricing is available when you purchase your antennas as part of a complete equipment package. Call Bradley today. Our engineering know-how stands ready to help you.

Also available:

Scala's 8000/960 950MHz preamp is for situations where your STL signal is marginal, but wind load or other restrictions prohibit a larger dish. It gives you 20dB of gain (equivalent to a several-hundred percent increase in dish size), with noise of only 1.8dB. Due to its modern circuitry, cross modulation and overload characteristics are excellent, allowing it to be used at even the busiest mountaintop site.

Scala 8000/960 preamp with power supply

60SL8000960 MFR LIST \$400.00

Call Bradley for a current price quotation.



Company Name: _____ Call Letters: _____

Address: _____

City: _____ State: _____ Zip: _____

Business Description: _____

Accounts Payable Supervisor: _____ Phone: _____

References:

Give only the names of those you buy from on open account.
Complete information is required for processing.

Name: _____

Address: _____

City: _____

State: _____ Zip: _____

Account #: _____

Phone: _____

Name: _____

Address: _____

City: _____

State: _____ Zip: _____

Account #: _____

Phone: _____

Name: _____

Address: _____

City: _____

State: _____ Zip: _____

Account #: _____

Phone: _____

Bank Name: _____

Address: _____

City: _____

State: _____ Zip: _____

Account #: _____

Phone: _____

In consideration for open account status with Bradley Broadcast, we understand and agree to the following terms and conditions:

1. That all invoices are due and payable 30 days from invoice date.
2. That all equipment ordered and received remains the property of Bradley Broadcast until paid in full.
3. That we will pay a finance charge of 1.5% per month (18% APR) on any unpaid balance which exceeds 30 days of invoice date.
4. That all equipment sold by Bradley Broadcast is covered by standard manufacturer warranty, and no other warranty, expressed or implied, shall supersede this warranty.

We hereby apply for credit and agree to the above conditions of sale on open account.

This form **MUST** be signed by a corporate officer.

We hereby authorize Bradley Broadcast Sales to contact the listed references to request information on our credit history.

Signed: _____

Title: _____

Date: _____

Please fill out completely and return to us at the below address.

**Bradley Broadcast
8101 Cessna Avenue
Gaithersburg, MD 20879
FAX: 301-330-7198**

All references are verified in writing. Please allow appropriate time for processing. Companies you list may decline to provide information. We may request further references.

Pricing:

Price information is provided to assist our clients in budgeting and comparing the value of different products. A price marked MFR LIST indicates the suggested selling price provided by the manufacturer. These prices are subject to discount, and a current price quotation is available by contacting us. Items in our catalog are eligible for quantity, package, and prompt payment discounts, and Bradley offers a number of leasing programs. Prices are subject to change without notice. As one of our goals is to provide you with the best value for your dollar, we are pleased to respond to your requests for pricing information.

To order by telephone:

Call Toll Free (800) 732-7665 to place a phone order. If you are calling from Maryland or the Washington, DC metropolitan area, call (301) 948-0650. One of our salespersons will assist you Monday through Friday, 9:00 AM to 7:00 PM Eastern Time. Visa, MasterCard, and Discover are welcome. **CREDIT CARD ORDERS ARE AUTHORIZED IN FULL AT THE TIME OF PURCHASE.** Net 30 terms are available upon credit approval. A firm purchase order signed by an authorized agent of your company is required for Net 30 purchases. Confirming purchase orders must be marked "confirming" to avoid duplicate shipments.

To order by facsimile:

Orders may be sent to our Fax number, (301) 330-7198, 24 hours a day. Please use our order form or your own purchase order with complete shipping and invoicing information. Fax orders for clients on open account do not require further confirmation, and fax may also be used to confirm telephone orders. Credit card users will also find it convenient to order by fax.

To order by mail:

Fill out the order form, or your own purchase order, enclosing the full amount due or authorizing a credit card charge.

Tax:

Maryland customers must add 5% sales tax. Maryland customers who are tax exempt must furnish signed documentation of their Maryland sales tax exemption number at the time of order or sales tax will be charged.

Emergency orders:

We will be happy to expedite orders on an urgent basis to meet an immediate need. Call for specific details.

When to expect delivery:

All orders are handled quickly and efficiently. Items in stock will be shipped within 24 hours of receipt. Orders are generally shipped via UPS or Federal Express. Oversized or overly heavy items will be shipped truck or air (freight per your instructions). Some items we sell are built to order due to custom requirements or fixed frequency operation. You will be informed at the time of your order of the expected ship date on these items. Sometimes we will temporarily sell out of an item. Back orders are reviewed daily and shipped as soon as we receive the item. Although we make every effort to deliver your order as scheduled, we cannot be responsible for consequential damages resulting from delayed shipments.

Minimum order:

\$15.00 in merchandise. Our minimum shipping and handling charge is \$6.00 per order.

Shipping charges:

Shipping may be paid in several ways. If your order is prepaid, we can provide you with the shipping cost and you may include that charge with your payment. We can also ship your merchandise freight collect, charge the shipping charges to your credit card, or ship via the carrier of your choice using your account number. Shipments to clients with open accounts may have shipping charges prepaid and added to their invoice.

C.O.D. shipments:

C.O.D. orders are limited to items immediately available from stock. We reserve the right to ship C.O.D. only to established clients and recognized broadcast facilities. C.O.D. shipments in excess of \$500 may require payment by cash or certified check. We do not ship C.O.D. via the U.S. mail.

Damaged, defective or incorrect merchandise:

We make every effort to insure that your order arrives safely and in good condition. If any package shows signs of external damage, please do not accept it. We will replace the item when it is returned to our warehouse by the carrier, or we will re-ship immediately upon notification of the problem. In this case, new merchandise will be separately invoiced or charged, with credit or refund issued upon receipt of defective merchandise. When you receive any merchandise, always inspect it before signing. Under present carrier regulations, it is YOUR responsibility to report damage or loss. Always note damage on any shipping documents, and save all packing material and waybills. Request inspection by the carrier immediately. Claims for defective or incorrect merchandise must be reported to us within five days. You will be issued a return authorization (R.A.) number. We will only accept packages marked with an R.A. number. If you order the wrong item, you are responsible for shipping charges to return it. If the error is ours, we will pay for shipping. Merchandise returned for any reason other than defects or damage is subject to restocking fees.

Bradley Broadcast Guarantee:

All merchandise is brand new, fully warranted by the manufacturer, and shipped to you in factory cartons whenever possible. Bradley Broadcast neither offers nor implies any warranty other than that provided by the manufacturer. Bradley does not guarantee the suitability of any product for your intended purpose and is not liable for consequential damages incurred in the use of any product we provide. We maintain an extensive repair facility and are committed to assisting our clients in obtaining prompt repair service as required.

Product specifications are subject to change without notice.

Open account terms:

Please note our credit terms are Net 30 days. Prompt payment is expected. Interest at the rate of 1.5% per month (18% per annum) will be charged to all overdue accounts and further credit privileges suspended or removed at our option. 30 day terms are based upon the shipment date for each item, or our invoice date, whichever is later. We invoice partial shipments and expect payment within 30 days on each shipment. If your institution or company cannot accept partial billings, we will hold merchandise for complete shipment at one time. Postmark date of your payment must be within 30 days of invoice or ship date to be considered timely. We encourage school and government bids and purchase orders. We will automatically recognize purchase orders and bids from all legitimate educational institutions and government agencies.

Catalog requests:

We are pleased to maintain professional users of audio and radio equipment on our mailing list. Please provide call letters, company name, contact name, mailing address, and telephone and fax numbers. We mail catalogs annually and supplements at regular intervals throughout the year.

PRODUCT INDEX

Acoustic Treatment	66
Amplifiers	
Distribution.....	37, 42-44, 46-48, 50, 84, 101, 119
Headphone.....	84
IHF/Pro Interface.....	7, 42-43, 45
Line.....	42, 45-46, 77, 102
Microphone.....	44-46, 90-91, 102
Phono.....	63
Power.....	44, 81-82, 110
Antennas.....	119, 124
Attenuators.....	44-46, 96
Automation.....	16, 22
Cable.....	53-54, 94, 99, 112
Cable Storage.....	53, 112
Cartridges, Tape	
Accessories.....	32, 57
Cart Machines.....	29-31
Carts and Tape.....	32
Storage Racks.....	68-69
Cartridges, Phono.....	63
Cases, Equipment.....	106-109
Cassette	
Accessories.....	24
Duplicators.....	27-28
Mixer/Recorder Combos.....	23
Portable Recorders.....	100
Studio Recorders.....	26-28
Tapes.....	24
Cleaners.....	7, 25, 62
Clocks and Timers.....	64
Compact Disc	
Accessories.....	7
Players.....	4-7
Storage Racks.....	7, 68-69, 71
Compressors.....	34-39
Connectors and adapters.....	54, 96
Consoles and Mixers	
Broadcast On-Air.....	8-10
Mixer/Recorder Combos.....	23
Portable.....	15-16, 101-104, 108
Production.....	10-14, 32
Powered.....	111, 112
Utility Mixers.....	15-16, 48, 50, 101-102
Copy Stands.....	66
Crystal Sets.....	122
DAT	
Recorders.....	2-4
Tape and Accessories.....	3
Delays	
Broadcast Telephone.....	58
Studio.....	40
Digital	
CD Players.....	4-7
Delays.....	40
Recorders.....	2-4
Signal Processors.....	40-41
Workstations.....	1
Direct Boxes.....	46
DJ Equipment.....	108
Duplicators, Cassette.....	27-28
EBS Monitors.....	121
Effects Processors.....	40-41
Equalizers.....	33-34

FM Exciters.....	119
Frequency Extenders, Telco.....	104-106
Furniture.....	65
Headphones.....	83
Headsets.....	60, 98
Installation Accessories.....	50-54
Intercoms and JFB.....	60-61
Interface Accessories.....	4, 42-55, 96
Lamps.....	66-67
Limiters/Compressors.....	34-39
Meters, Audio.....	74-75
Microphones	
Accessories.....	54, 86, 95-98
Cable.....	53, 94, 99, 112
Condensers, Studio.....	86
Dynamic.....	85, 87, 99
Lavaliers.....	88, 93
Phantom Supplies.....	91, 98
Processors.....	91
Preamps.....	44-46, 90-91, 102
Shotgun.....	97-98
Snakes.....	53, 112
Special Purpose.....	88-89
Stands and Booms.....	87, 94
Stereo.....	97
Wireless.....	92-93
Mixers.....	See Consoles
Monitors	
Amplifiers.....	81-82
Meters.....	74-75
Modulation.....	120-121
Phase.....	77
Signal.....	76-77
Speakers.....	78-80
Transmitter.....	120
Mounting Hardware.....	66, 81
Noise Reduction.....	36-37
On-Air/Recording Lights.....	67
Patch Panels and Cords.....	49-52
Phono Cartridges.....	63
Power Distribution.....	67-68
Press Boxes.....	104
Processing Equipment	
Audio Enhancement.....	38-41
Broadcast Transmitter.....	113-117
Compressors/Limiters.....	34-39
Digital.....	41
Effects.....	40-41
Equalizers.....	33-34
Microphone.....	91
Racks	
Equipment.....	72-73
Hardware, Panels, Etc.....	70-71
Storage.....	68-69, 71
Real Time Analyzers.....	55

Recorders	
Cartridge.....	29-31
Cassette.....	26-28, 100,
DAT.....	2-4
Digital.....	4
Multitrack.....	17-21, 23
Reel to Reel.....	16-21
Stands.....	18, 24
Remote Control, Transmitter.....	122
Remote Pickup Equipment	
Microwave.....	124
Telephone.....	102-106
Reporter Kits.....	100, 105
Reverbs.....	See Effects Processors
RF Accessories.....	119
Routing Switchers.....	48-50
Satellite Equipment.....	1
SCA/Subcarrier Equipment.....	117
Silence Sensors.....	76
Snakes.....	53, 112
Sound Systems.....	108-109
Speakers	
Studio Monitor.....	78-80
Mounting Hardware.....	79, 81, 112
Powered.....	77-78
Sound Reinforcement.....	109, 111
Splicing Supplies.....	25
Stereo Synthesizers.....	38, 76
STL/TSL/TRL Equipment.....	123-124
Stylus.....	63
Surge Protectors.....	67-68, 119
Synchronizers.....	20
Tape	
Cartridge Tape.....	32
Cassette.....	24
DAT.....	3
Degaussers/Erasers.....	25, 29, 31
Gaffers.....	112
Head Demagnetizers.....	25
Open Reel.....	24
Storage.....	68-69, 71
Test.....	24, 32
Tape Recorders.....	See Recorders
Teleconferencing.....	56, 89
Telephone Equipment	
Accessories.....	56-59
Announcers.....	60
Couplers.....	57, 104
Hybrids.....	56-60
Remote Equipment.....	102-106
Test Equipment.....	24, 32, 55
Thermometers.....	77
Timers and Clocks.....	64
Tonearms.....	62
Transmitters, FM.....	118
Tuners and Receivers.....	75-76
Turntables.....	62
Warning Lights.....	67
Wire.....	53-54
Workstations.....	1

<p>Abco68</p> <p>Adams-Smith.....22</p> <p>ADC.....51-52</p> <p>AKG.....83, 85-86, 94-95, 98</p> <p>Alps.....68</p> <p>Ampex.....24</p> <p>Anchor.....78</p> <p>Antronics.....68</p> <p>Anvil.....107-108</p> <p>Aphex.....38-39, 42, 47</p> <p>Arcor.....54</p> <p>ART.....35, 40</p> <p>Ashly.....33, 35, 110</p> <p>ATI.....7, 8, 42, 47, 63, 90</p> <p>Atlas.....94-95</p> <p>Audi-Cord.....31</p> <p>Audio Animation.....113</p> <p>Audio Control Industrial.....55</p> <p>Audio Logic.....33</p> <p>Audioarts.....9</p> <p>Audiolab.....25</p> <p>Audiopak.....32</p> <p>Audio-Technica.....62, 85-86, 88, 97</p> <p>Auratone.....78</p> <p>Belar.....76, 121</p> <p>Benchmark.....7, 16, 45, 48, 74, 84, 90</p> <p>Beyer.....60, 83, 94, 98-99</p> <p>Bose.....112</p> <p>Broadcast Electronics.....8-9, 29-30, 62, 118</p> <p>Broadcast Tools.....60</p> <p>Burk.....122</p> <p>Cablewave.....119</p> <p>Calzone.....64</p> <p>Calzone.....73</p> <p>Canare.....53, 94</p> <p>Carver.....76, 82</p> <p>Coaxial Dynamics.....119</p> <p>Comark.....119</p> <p>Community.....109, 111</p> <p>Comrex.....104-105</p> <p>ComStream.....1</p> <p>Conex.....22, 49, 77</p> <p>Cord-Lox.....53, 109</p> <p>CRL.....36, 113-115</p> <p>Crown.....82, 89, 110</p> <p>Cutting Edge.....113</p> <p>Cutting Wedge.....66</p> <p>Data Accessories.....66</p> <p>dbx.....36-37</p> <p>Delta.....119</p> <p>Denon.....5, 7, 75</p> <p>Digitech.....34</p> <p>Discwasher.....7, 62</p> <p>DOD.....14, 33</p> <p>Dorrrough.....74</p> <p>Dyaxis.....1</p> <p>Editall.....25</p> <p>Electro Impulse.....119</p> <p>Electro-Voice.....12, 80, 85, 87, 99, 101, 109</p> <p>Enberg.....67</p> <p>ESE.....22, 64</p> <p>Eventide.....39, 58</p> <p>Excalibur.....7, 43, 45, 117</p>	<p>Fidelipac.....25, 31-32, 67, 69</p> <p>Fostex.....3, 20, 55, 78, 83</p> <p>Furman.....16, 52, 68</p> <p>Geneva.....24-25, 32</p> <p>Centner.....48, 50, 52, 56-57, 76, 103, 105-106, 115, 122</p> <p>Gorman Redlich.....121</p> <p>Gotham.....53</p> <p>Granite Telcom.....60</p> <p>HarKen.....96</p> <p>Hedco.....48</p> <p>Henry.....7, 32, 43, 48, 57, 63</p> <p>Inovonics.....75, 116</p> <p>Intraclean.....7, 25</p> <p>ITC.....32</p> <p>JBL.....79-80</p> <p>Kangaroo.....106</p> <p>Kintronics.....119</p> <p>Klark Teknik.....36</p> <p>Koss.....83</p> <p>KSI.....72</p> <p>Lexicon.....41, 109</p> <p>Light Wave.....97-98</p> <p>Littlite.....66</p> <p>Logitek.....10, 46, 49, 63, 74, 76</p> <p>LPB.....8</p> <p>Luxo.....87</p> <p>Mackie Designs.....13</p> <p>Marantz.....100</p> <p>Mark.....124</p> <p>Marti.....124</p> <p>Maxell.....3, 24</p> <p>McPhibben.....67</p> <p>MicEze.....95</p> <p>Middle Atlantic.....70-72</p> <p>Modulation Sciences.....115-116, 119</p> <p>MRL.....24, 32</p> <p>Multi-Technical Services.....121</p> <p>Murphy.....65</p> <p>Nakamichi.....26</p> <p>Neumann.....86</p> <p>Neutrik.....53-54</p> <p>Nigel B.....7, 24, 65</p> <p>Northern Technologies.....67, 119</p> <p>Numark.....4, 108</p> <p>O.C. White.....87</p> <p>Omnimount.....79, 81</p> <p>Orban.....33-34, 38, 71, 91, 114, 116-117</p> <p>Otari.....16, 18-19, 25, 30</p> <p>Oxmoor.....43, 50</p> <p>Panasonic.....2-3</p> <p>Pivotelli.....66, 81</p> <p>Porta-Brace.....106</p> <p>Potomac Instruments.....119</p> <p>Precision Power.....77</p>	<p>ProCo.....53, 112</p> <p>ProRax.....69</p> <p>Protec.....62</p> <p>QEI.....118-120, 123</p> <p>Radio Design Labs.....44, 120</p> <p>Ramsa.....13</p> <p>Rane.....15, 33-36, 84, 90, 108</p> <p>Revox.....16-17</p> <p>RTS.....55, 60-61</p> <p>Ruslang.....65, 69, 73</p> <p>Scala.....124</p> <p>Scotch.....24-25</p> <p>Sennheiser.....83, 85-88, 97-98</p> <p>Shively.....119</p> <p>Shure.....63, 85-87, 88-89, 92-99, 101-102, 104</p> <p>Shurtape.....112</p> <p>Simpac.....69</p> <p>Somich.....117</p> <p>Sony.....2-3, 20, 83, 88, 92, 97, 100</p> <p>Sound America.....104</p> <p>Soundcraft.....11-12</p> <p>Soundolier.....70, 73</p> <p>Stanton.....63, 83, 108</p> <p>Stewart.....82, 91, 98</p> <p>Switchcraft.....54</p> <p>Symetrix.....34-36, 58, 75, 81, 84, 91</p> <p>Tannoy.....79</p> <p>Tascam.....3-5, 12, 14-15, 20-21, 23, 26-28, 53, 81</p> <p>t.c. Electronic.....34</p> <p>Teac.....27</p> <p>Technics.....4, 6, 27-28, 62-63, 75</p> <p>Telex.....60, 93, 98</p> <p>Telfax.....103</p> <p>Telos.....59, 61</p> <p>Teltek Northwest.....77</p> <p>TFT.....118, 120-121, 123-124</p> <p>360 Systems.....4, 49</p> <p>Titus.....67, 76</p> <p>Toa.....28, 75, 92, 109, 111</p> <p>U.S. Audio.....81, 84, 101</p> <p>Ultimate Support.....112</p> <p>UREI.....35, 80</p> <p>Valley International.....35-36, 91</p> <p>West Penn.....54</p> <p>Whirlwind.....46, 53-55, 68, 84, 96, 100, 104, 112</p> <p>Wohler.....77</p> <p>Yamaha.....10-11, 13, 15, 27, 33, 40, 80, 82, 110-111</p> <p>Zercom.....22, 102</p>
---	--	--

Copyright ©1991 Bradley Broadcast Sales, Inc. Reproduction or transmittal is prohibited. While every effort is made to ensure the accuracy of the information contained herein, Bradley Broadcast is not responsible for typographical errors. Product specifications and prices are subject to change without notice.

Editor Neil Glassman
Art Director Bob Martin
Cover Photography Ed Castle
Printing Hagerstown Bookbinding & Printing

Q A

WHAT DO AIR-TALENT REALLY WANT ?

IT SEEMS WE SPEND A LOT OF
OUR VALUABLE TIME TRYING
TO DETERMINE JUST THAT ONE
THING IS CERTAIN. WHETHER
THEY'RE PRESIDING OVER A HOT
MORNING ZOO, AN EARNEST
POLITICAL DEBATE OR A
RAUCOUS SPORTS CALL-IN,
THEY WANT GOOD PHONES.
DECENT AUDIO.

SIMPLE, INTUITIVE OPERATION.

IN A WORD, TELOS.

YOU AREN'T KEEPING IT FROM THEM—

ARE YOU? ARE YOU?

