

SOUND

ITS FUNDAMENTALS AND
METHODS OF APPLICATION



ENGINEERING DEPARTMENT
LAFAYETTE RADIO MANUFACTURING CO.
100 SIXTH AVENUE • NEW YORK CITY

PRICE FIFTY CENTS



SOUND

ITS FUNDAMENTALS AND
METHODS OF APPLICATION



ENGINEERING DEPARTMENT
LAFAYETTE RADIO MANUFACTURING CO.
100 SIXTH AVENUE • NEW YORK CITY



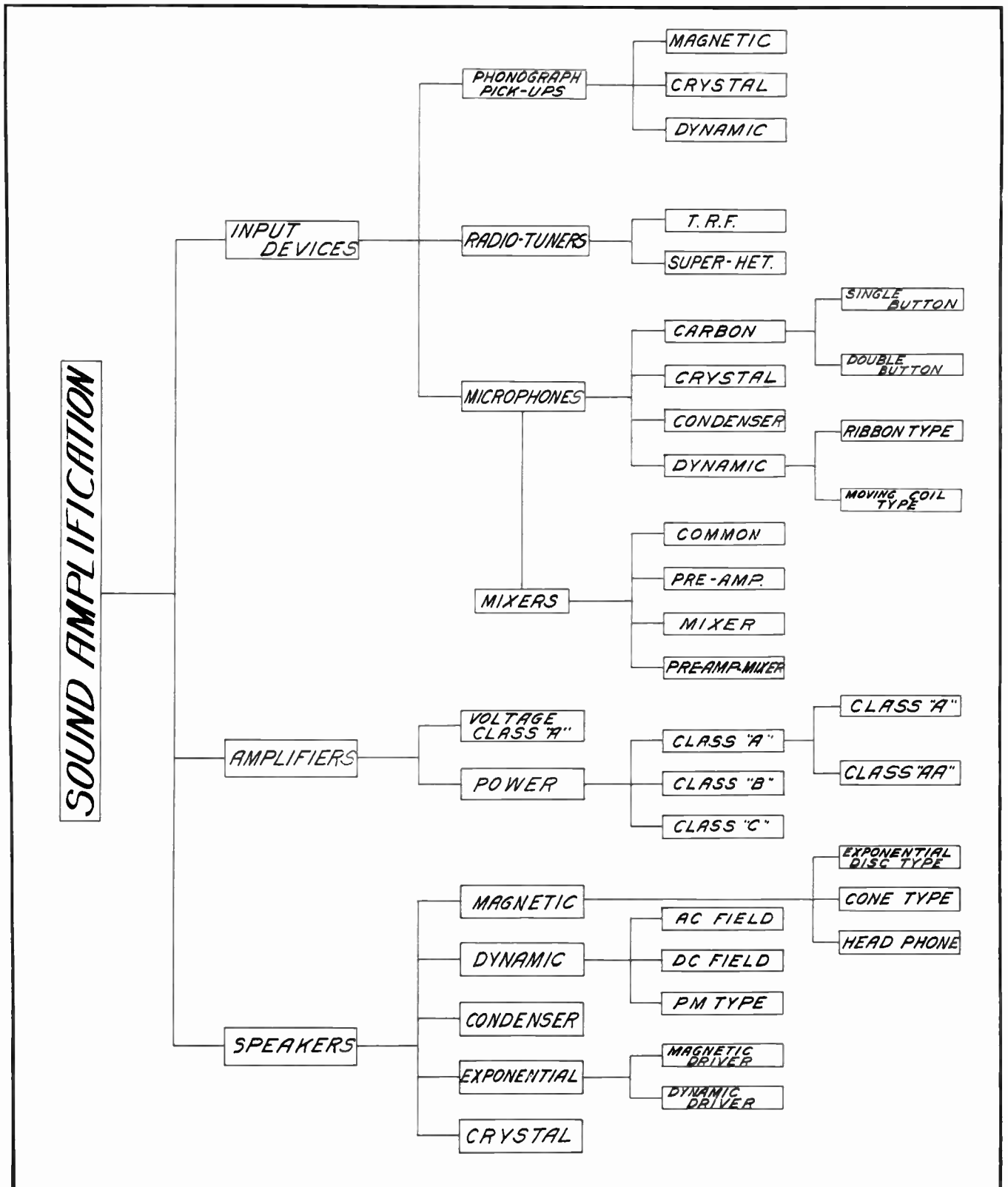

FIGURE 1

SOUND AMPLIFICATION

Introduction

The term "Sound Amplification" is applied to any device, or devices, capable of increasing auditory vibrations of a certain level to a degree that will permit them to travel over an area otherwise impenetrable. Many methods have been developed to accomplish sound amplification and distribution, both **direct** and **indirect**, but only the latter has been found to be satisfactory. The only form of **direct** sound amplification ever developed, which actually amplified to any appreciable degree, was the exponential, or trumpet, horn. This type of direct amplification is also employed as a part of the indirect system which will be discussed in a succeeding chapter.

While we are primarily concerned with only one form of sound distribution, it is well to note a few others. **Radio** probably represents the criterion in sound dispersion since it is possible to transmit the sound created in any one location on the earth to its entire population at the same time. The only factor which prevents us from accomplishing this feat at the present time is the inability of every individual to purchase a receiving set.

Public address, or sound amplifying systems represent the next best form of sound distribution, which is the type that we are concerned with in this manual. While the effectiveness of this system is limited to local areas, not exceeding two or three miles, it has many advantages over radio for covering short distances.

Wired radio, or more correctly wired sound, a variation of the above-mentioned system, is utilized to transmit sound to a number of local areas at the same time from a common source. Many commercial organizations have been formed to supply music to clubs, hotels, restaurants and similar places through this medium.

To use football strategy, let us examine the opposing forces before we enter into the discussion of any particular phase of sound amplification, which is the offense, or our side. Sound, as we know it, is composed of a number of fluctuating air vibrations originating through some effort of a distant body; when these sounds reach our ears we interpret them as such. Hence, the only thing which will hinder the transmission of this sound from its origin to the ear is the opposition of the air as well as any objects which may appear in its path. Any attempt to set definite rules as to the amount of repulsion that would be encountered from the air and surrounding objects, under all conditions, would require many times the space available here. However, it is interesting to note how sound travels under dif-

ferent conditions. In dry air, at 32 degrees Fahrenheit, sound travels at approximately 1,087 feet per second, in glass 18,000 feet per second, in steel 16,400 feet per second and in water 4,708 feet per second. Obviously, air offers greater opposition than any other common medium. The speed of sound waves is much lower than that of other forms of impulses which create noticeable sensations. As a comparison, electrical high frequency impulses have approximately the same speed as light: namely, 972,280,000 feet per second. This accounts for the fact that we can change sound into electrical impulses, hurl it into space, pick it up again at a remote point and convert it back to sound through a loud speaker, in order to obtain rapid and efficient transmission.

In other words, to distribute sound in any form we must overcome the opposition offered by the air in one form or another. To date we have only two methods: radio, and public address or sound amplifiers. Throughout the following pages we have attempted to give as much technical information regarding various types of audio, or sound amplifiers, as is physically possible. Due to our limited space, we cannot go into the details of all the various phases of this art, and, therefore, only the most important subjects have been covered. We have considered as "important subjects" those fundamentals which every sound technician should know in order to cope with the problems he may encounter from time to time. A great deal of important theory has been dispensed with. This we hope to present at a later date in the form of a textbook devoted entirely to theoretical analysis.

Figure 1 is a detailed chart depicting all the various phases of sound amplification. It will be noted that the three integral divisions of this system are the input devices, amplifiers and speakers. The first- and last-mentioned sections are in reality converters. The input devices change the air vibrations into a form suitable for amplification. The speaker in turn changes the amplifier impulses into air vibrations again. Thus we have the definition: "Sound amplification increases the strength of air vibrations by converting them into electrical impulses, amplifying and then reconverting the raised impulses into air vibrations again at a higher level."

Throughout the following pages we have attempted to discuss all of the various phases of sound amplification in the most concise, authentic and practical manner possible. Each subject will be treated in the order of its appearance on the chart.

INPUT DEVICES

PART 1: PHONOGRAPH PICK-UPS

Phonograph pick-ups are listed as the first type of input devices because they are the most common form in use to-day. While it is true that the phonograph is not as popular as it was a few years ago, recordings still remain the integral part of any sound system because they represent the most economical method of obtaining music or other form of entertainment. Recorded music is used by many broadcasting stations for "fill-ins" and for proper time allocation of certain programs, just as the sound man uses it to provide music at a moment's notice.

There are only three types of phonograph pick-ups: the mag-

netic, the crystal and the dynamic. The latter type will not be discussed inasmuch as it is not available commercially.

The **magnetic** type was the first to be developed to any large degree, and it is still the most widely used pick-up. These units are nothing more than miniature generators actuated, or driven, by the grooves in the record as the needle passes over them. This needle is attached to the armature of the generator, so that a voltage is developed, which is applied to the amplifier through suitable coupling arrangements.

In Figure 2 two methods are shown for connecting magnetic

pick-ups to any amplifier. Section "A" shows a high impedance pick-up, 2000 ohms or greater, connected directly to the grid of the first amplifying tube. This is possible because the output of the average high impedance pick-up, around —20 db, is sufficient to excite the average amplifier.

Section "B" illustrates the connections of a low impedance

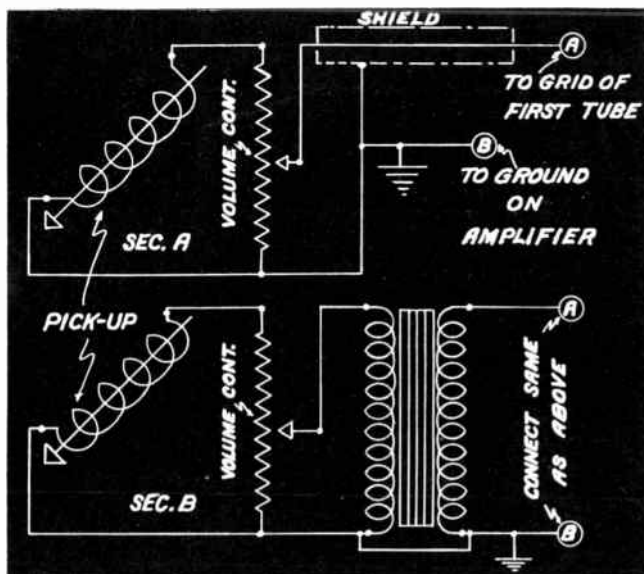

FIGURE 2

pick-up, 200 ohms or less. A transformer is employed to match the impedance of the pick-up to that of the amplifier. The average low impedance pick-up varies from 15 to 200 ohms and usually has a level slightly lower than the high impedance type, approximately —30 db. High impedance pick-ups may be coupled in this manner in order to bring their effective voltage level to a higher point in the event that the amplifier does not have sufficient gain to operate directly.

In both cases a shielded lead is shown between the amplifier and the pick-up or transformer. This is very important in order to overcome inductive hum pick-up and to prevent oscillation in the amplifier. This shield should always be grounded. Inasmuch, as one side of the input is generally grounded, the shield is employed as this lead. This does not apply in the case of A.C.-D.C. and battery amplifiers, or when the grid return of the first amplifying tube is not grounded. Two leads, both shielded, will be required in the latter case.

Magnetic pick-ups give very little trouble other than the periodic changing of needles. When these units do fail to function it is usually caused by what is known as "hardening of the rubbers." These rubbers are utilized to keep the armature of the pick-up in the center of the pole pieces, as shown in Figure 3, and when they deteriorate to the hardening point, the action of the armature is retarded and the pick-up loses its sensitivity. When this condition occurs the rubbers should be replaced with new ones.

PART 2: RADIO TUNERS

It is common practice in a sound system to employ what is known as a tuner in order to select any of the available broadcast programs on the air for distribution locally, especially in hotel and restaurant locations.

A radio receiver consists of two amplifiers—one operating in the ultra high or radio frequencies and the other in the audible spectrum. The latter amplifier is also a sound amplifier. Now, if we remove the local sound or audio amplifier and substitute an external amplifier, the remaining section becomes a radio tuner.

Page 4

A variety of the magnetic pick-up is the **oil damped** type, in which the generator armature and the pole piece are immersed in oil. The effect of this method of dampening is that the overall frequency response is more uniform; also, very little mechanical noise is produced in this unit in comparison to that created by the standard magnetic pick-up. The output impedance of this unit is usually 200 to 500 ohms and, therefore, the diagram shown in Figure 2 for the low impedance unit should be used. The output level of this pick-up is considerably lower than that of the regular magnetic unit, approximately —50 db, and hence a higher

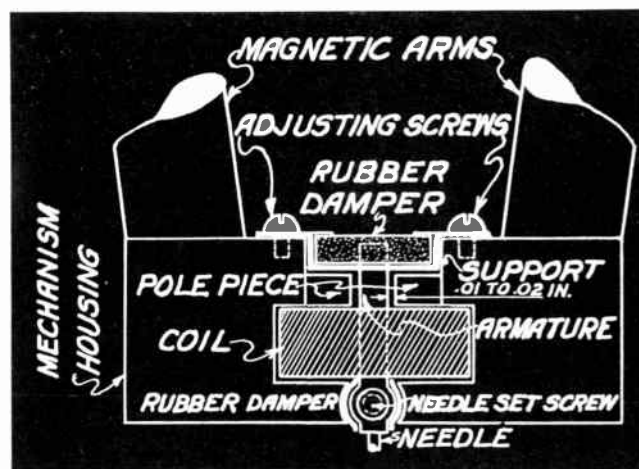

FIGURE 3

gain amplifier will be required. The frequency response of the oil damped phonograph reproducer is slightly superior to that of the standard type, and also since the supporting rubbers are eliminated, this unit does not deteriorate in sensitivity with age.

The latest phonograph pick-up to be developed is the **crystal** type which employs a "rochelle salts" crystal as the voltage generator. The output of this unit is considerably higher than that of the other types mentioned, in the neighborhood of —10 db. The impedance of this pick-up is approximately 60,000 ohms, which accounts for its comparatively high output. A matching transformer is not required to couple this pick-up to the amplifier.

The high frequency response of the crystal pick-up, far above 10,000 c.p.s., is superior to any yet developed. The light weight is also a feature of this unit (about 2 ounces), resulting in very little friction between the needle and the record and thus prolonging the life of records.

It is advisable to use the standard magnetic pick-up in all installations where considerable handling may be required, as this unit is the most rugged of the three types. The oil damped pick-up is recommended for those desiring the best response obtainable from average recordings. The crystal pick-up is not recommended for use in the common type of installation because of its extremely good high frequency response, which results in an over-abundance of scratch noise. This type of pick-up should be confined to high fidelity systems.

For economic reasons the power required to operate the tuner, with the exception of the filament voltage, is taken from the amplifier.

Figures 4 and 5 show two tuners of advanced design, one a superheterodyne and the other a tuned radio frequency set. Comparatively, the superheterodyne excels in every respect except the most important one, i.e., fidelity or tone quality. The frequency response of the T.R.F. type may be considered good up to 10,000 c.p.s., whereas the superheterodyne falls off

sharply above 5000 c.p.s. It is readily apparent that we must be content with a little less selectivity and sensitivity if we desire high quality reproduction. This fact, which cannot be overlooked, will determine in many cases the type of tuner used.

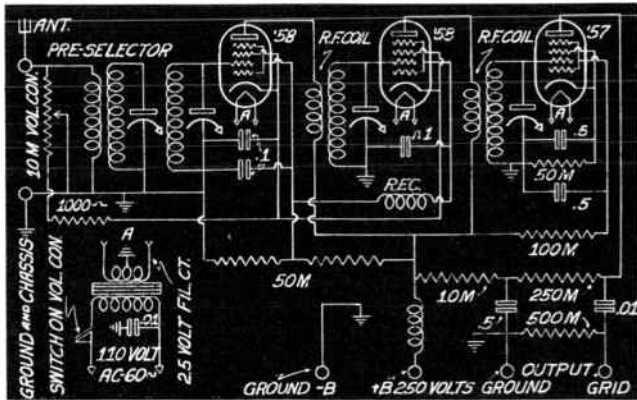

FIGURE 4

However, in many instances where a high degree of selectivity is necessary, very little trouble will be experienced from the tone angle in the average installation, if the superheterodyne tuner is employed. This is due to the fact that it is difficult for the untrained ear to distinguish the actual difference in tone

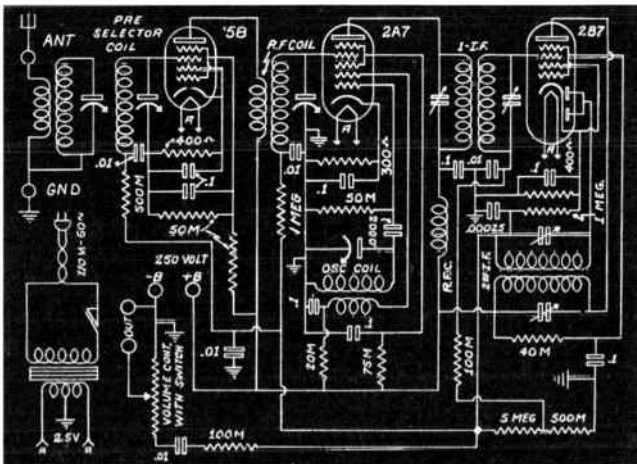

FIGURE 5

quality obtained. Another feature of the superheterodyne tuner is the automatic volume control, the operation of which is familiar to everyone.

The outputs of the superheterodyne and T.R.F. tuners are very high, and if employed near an amplifier having a gain of 60 db, or over, the output is capacity coupled to the grid of the first amplifying tube. If the superheterodyne tuner is to be used at a distance from the amplifier, it is necessary to employ a transmission line, together with an additional 56 voltage amplifier, permitting the output to be properly coupled to a matching transformer. Figure 6 shows how this tuner is connected to a 500 ohm line. The T.R.F. tuner is connected in the same manner by substituting a 56 for the 57 detector. Considerably more gain will be required from the amplifier in the latter case, in the neighborhood of 70 to 80 db.

The selection of the proper type of tuner depends upon the requirements of the sound system. High fidelity installations always employ T.R.F. tuners, while systems which are installed to give good results with a minimum amount of operating difficulty, utilize the superheterodyne tuner.

All of the various laws that apply to the radio receiver for efficient results apply to the tuner likewise. Those who are interested in obtaining further knowledge of this subject are referred to any of the many books available on receiver design.

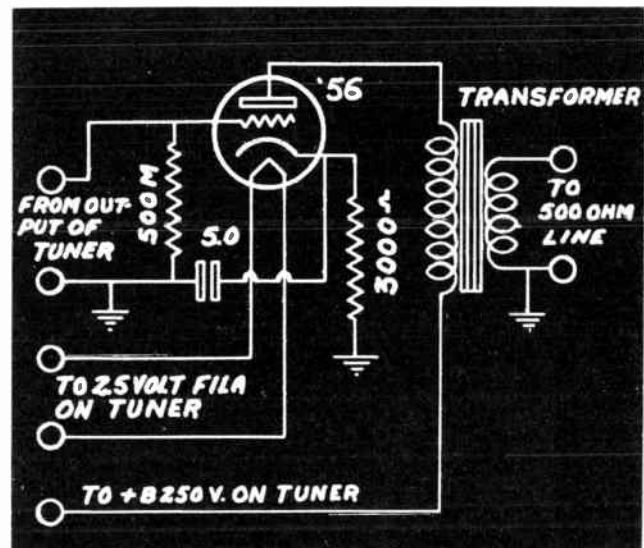

FIGURE 6

PART 3: MICROPHONES

By definition, a microphone is "any device capable of changing air vibrations, or sound, into corresponding electrical impulses." Therefore, the microphone is the most important type of input device, since it is the only unit capable of altering air vibrations to operate an amplifier.

There are essentially four types of microphones: the **carbon**, **condenser**, **crystal**, and **dynamic**. There are many variations of these units, but after all the fancy trade names have been removed they must come under one of the above-mentioned classifications.

The telephone transmitter was the first carbon microphone to be developed, and in its improved form is known as the single button "mike." The principle on which this unit operates is extremely simple. A cup of carbon granules, known as a "button," is placed against a stretched disc of metal called a diaphragm. When this unit is brought in the vicinity of sound, the air vibrations will cause the diaphragm to vibrate. As this diaphragm vibrates, the carbon granules will be compressed and allowed to expand at a definite rate, determined by the frequency of the air pulsations. This in turn will cause the resistance of the button to vary in a similar manner, and if we allow a current to flow

through this button, it will vary in proportion to the variation in resistance. If we insert a convenient form of resistor, or load impedance in the circuit, an alternating voltage will appear, equal to the rate of change of resistance in the circuit. This voltage is applied to the amplifier.

Figure 7 shows the circuit used to couple the single button microphone to an amplifier. A transformer, one dry cell, and a 400 ohm potentiometer are required. The potentiometer is utilized to control the amount of current applied. This is not absolutely necessary in small installations, provided not more than one cell is employed. The transformer forms the load, as well as matching the impedance of the microphone, approximately 200 ohms, to the amplifier. This unit also isolates the D.C. or battery current from the amplifier, so that only the alternating voltage is available at the secondary.

The **double button** carbon microphone is the ultimate in carbon units. By employing two carbon buttons, one on each side of the diaphragm, we eliminate the even harmonic distortion which appears in the single button type. The cause of this even harmonic distortion is the varying D.C. component which occurs in the transformer employed with a single button unit. When

two buttons are used, the resistance of one increases as the other decreases, and the average resistance of the circuit remains the same, thus maintaining the current constant. By referring to the diagram in Figure 8, it will be observed that the local current is supplied through a center tap on the coupling transformer. Therefore, as the current in one half of the transformer de-

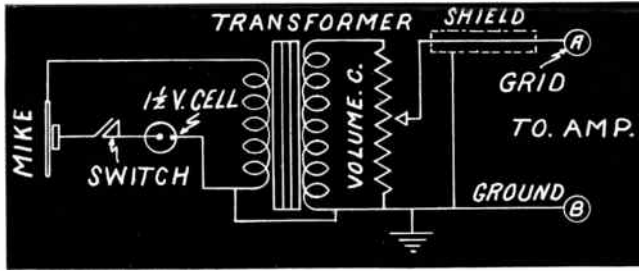

FIGURE 7

creases, 180° out of phase, it increases in the other, and consequently a voltage will appear at the extreme ends of the primary, which is in turn induced into the secondary.

Proper damping is one of the most important factors in the construction of a microphone. The effect of improper damping is analogous to a piano. If we strike a number of strings in succession without immediately damping them, they will interfere with each other and create many beats and harmonics, resulting in distortion of the worst kind. In a microphone, if the diaphragm is not dampened, it will continue to vibrate after the first impulse is applied and interfere with the succeeding impulses.

Damping is accomplished in several ways in the carbon microphone. The major amount is obtained by employing a plate in back of the diaphragm so that a column of thin air is created which acts as a cushion. The more damping employed, the lower the output level, which accounts for the fact that an expensive carbon microphone has a much lower output level than the cheaper ones. Figure 9 illustrates the average level of several different grades of carbon microphones.

Any stretched disc of thin metal will resonate at some frequency, depending on its size and the amount of stretching applied. In the better grades of carbon microphones the diaphragm is stretched so that it resonates at about 5000 to 6000 cycles, or at the point where the frequency response has started to fall, thus extending the effective range. Figure 10 permits a general conception of the frequency response of several grades of carbon microphones.

It is almost impossible to set definite ratings on microphones because they are never operated under the same conditions required for measurement. Figure 11 graphically illustrates how the output of a carbon microphone varies as the distance of the sound from the microphone is increased or decreased. Figure 12 also shows how the output of a microphone varies as the amount of current is altered. The average carbon microphone requires about 10 milliamperes per button, and for a minimum amount of background noise should be operated at about 5 to 7 milliamperes.

AVERAGE LEVEL IN DB UNDER IDEAL CONDITIONS	
90	OVERBUT BEST NINE
75	BEST FOOD IN-HIBER
70	SAVING ONE IN PEARL
65	AND OVER 1" PAD.
60	BEST CARBON MICS
55	\$75.00 STUDIO DA MICS
50	\$10.00-20.00 DIVERSA
45	BEST SINGLE BUTTON
40	\$25.00 DIVERSA BUTTON
35	WALLS STAYS 0.010
30	WALLS STAYS 0.010

COMPARISON OF OUTPUT LEVELS OF CARBON MICROPHONES.

FIGURE 9

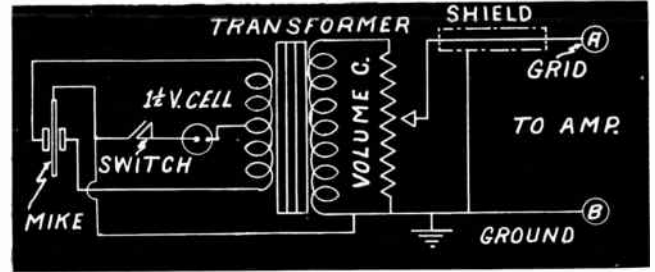

FIGURE 8

Figure 13 shows a typical condenser microphone hook-up. It will be noted that a two-stage amplifier is required to bring the level of this unit up to that of a good carbon microphone. Inasmuch as it is not practical to have this amplifier any distance from the condenser unit, it is always in the same compartment, so that the feeble voltage which occurs, due to the changing capacity as the diaphragm vibrates, will not be lost in the line, and also to avoid the inductive hum that would otherwise result. The output impedance of this amplifier is usually from 200 to 500 ohms for proper transmission to the main amplifier. The pre-amplifier is always battery operated, where a very low hum level is absolutely essential. However, very good results can be obtained from a well filtered A.C. power supply. The output level of the condenser unit is about -95 db, while the level at the output of the pre-amplifier is approximately -40 db.

The next microphone to be developed was the **dynamic unit**, of which there are two types, the **ribbon** and the **moving coil** units. Commercially, the ribbon type is known as the velocity microphone, while the moving coil unit is known as the dynamic microphone. The frequency response of the ribbon type is superior to that of the moving coil type. It is generally conceded that the ribbon type will replace the dynamic unit, because of its uni-directional and superior frequency response characteristics. Both of these units are still in the experimental stage and are therefore not recommended for small installations.

The output level of the ribbon type is much lower than that of the moving coil unit, while the latter has an output slightly greater than the condenser unit. Figure 14 graphically illustrates the various response and output levels obtained from the different types of microphones.

The operating theory of the dynamic microphone is even simpler than that of the carbon type. A ribbon or coil is placed between two strong magnets, and when it is caused to vibrate by the pressure of the sound waves, a voltage is introduced into the coil or ribbon armature, which is in turn coupled to a pre-

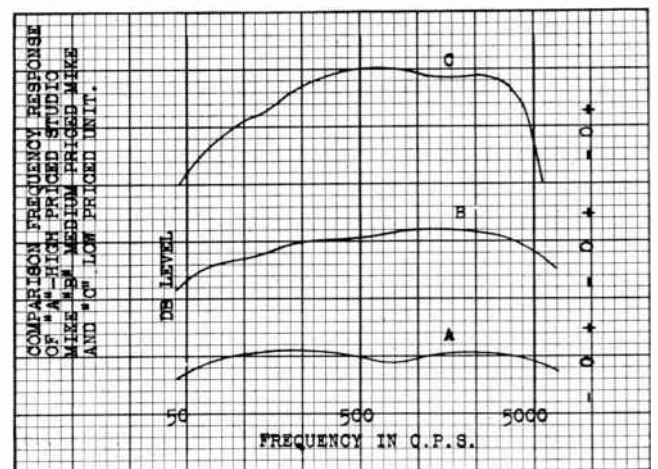

FIGURE 10

Figures 10, 11, and 12 by courtesy Universal Microphone Corp.

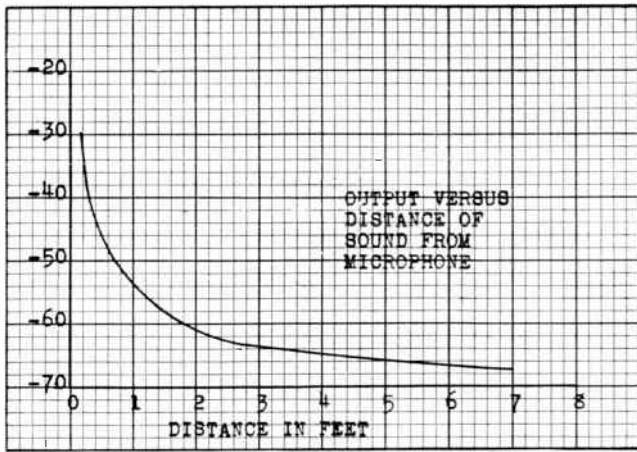

FIGURE 11

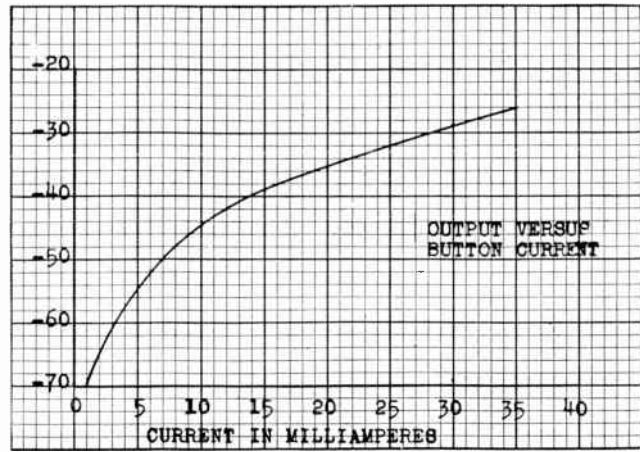

FIGURE 12

amplifier in the same manner that a carbon microphone is coupled to the main amplifier, except that no battery voltage is required. A coupling transformer having the proper impedance is utilized.

The crystal microphone, commercially titled "piezo astatic," is the most recent unit to be developed. This microphone employs the same type of crystal as used in the crystal phonograph pick-up. The advantages of this unit are its relatively high output (about -60 db), freedom from background noise, simple coupling, due to its high impedance (approximately 80,000 ohms at 60 cycles) and its unusually good high frequency response. By referring to Figure 14, the relative standing of the crystal microphone may be seen.

Figure 15 shows several ways to connect a crystal microphone to any amplifier having a gain greater than 80 db. It will be noted that this unit can be connected directly to the grid of the first amplifying tube provided a 5 megohm grid leak is employed, and it is not placed more than ten feet from the amplifier. If the microphone is used at a distance from the amplifier, a special line matching transformer is required having a primary impedance of at least 100,000 ohms.

SELECTING THE MICROPHONE

The selection of the proper microphone to be used with any sound system will depend on the following factors:

1. The amount which can be expended for this device.
2. The frequency response limitation of the auxiliary equipment.
3. Acoustics of the location.
4. Type of sound to be amplified, whether voice, dance music, symphony, or all three.
5. Whether installation is to be mobile or permanent.

Case 1 is perhaps the major factor governing the selection of this type of input device. The double button microphone is by far the best solution because better results can be obtained from this unit than from any of the other less expensive microphones. This microphone is also the solution to case 5, as it is the most rugged type available. Almost all portable systems use this unit in preference to any of the other types.

Unless the auxiliary equipment is capable of responding to frequencies above 6000 cycles with some degree of uniformity, very little is gained by using a high fidelity microphone. This is the answer to case 2.

Case 4 will simply alter the grade of any type of microphone which should be purchased. Practically all of the cheaper units are passable when used on voice only, and even the better quality inexpensive units are passable when used to pick up light music. On all high quality installations the type of microphone for best results will always be either the condenser, ribbon or crystal, depending on the acoustics of the location.

Case 3 presents the greatest problem of all. In more than one section of this manual it is stated the acoustics or surrounding conditions of the location present the major difficulties in either sound distribution or pick-up. No rules can be set as to

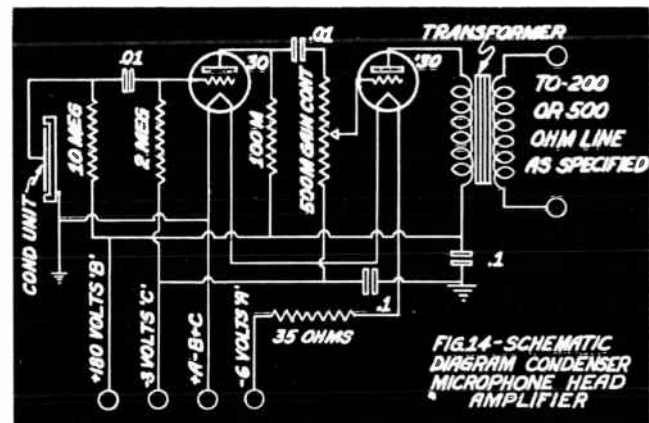

FIGURE 13

the type of microphone for each location, as the conditions are never the same. However, a few simple laws can be kept in mind when selecting this type of equipment. Never employ a carbon microphone when the sound is located at a distance, or when absolute freedom from background noise is desired.

A uni-directional microphone, such as the ribbon or dynamic unit, should always be used where the microphone must be located near the loud speakers. If this is not possible because of the expense involved, a housing should be constructed to give the carbon unit a directional effect. The effect of a uni-directional microphone is self-explanatory. Since this unit will pick up sound waves from one direction many times better than those from the opposite direction, it is obvious that it can be employed to an advantage where trouble is experienced with re-pick-up, or feed-back, from a speaker located in the same or nearby location.

A condenser microphone should be utilized where a minimum of background noise is desired. Condenser microphones are also desirable where maximum frequency response is required from the average public address system.

Ribbon microphones are seldom used for outdoor pick-up because of their delicateness. A sudden gust of wind may destroy the effectiveness of this unit by bending the ribbon too much.

For portable work always use a carbon or condenser microphone, preferably the former.

No definite suggestions are made for the crystal microphone, inasmuch as it is still in the experimental stage. Tests so far show this unit to be rather rugged and no objections can be stated for not using it out-of-doors provided moisture is kept from accumulating on the crystal.

For auditorium use, the choice of a microphone depends upon the quality of reproduction desired, as well as the location of the speakers. If sufficient damping exists between these two units, carbon microphones may be used without difficulty.

Finally, if you are in doubt as to what kind of microphone to employ under certain conditions, consult the distributor or manufacturer, as both of these organizations are in a position to

recommend the proper type of equipment. The publishers of this manual maintain a special consultation department for the sole purpose of giving advice on public address problems.

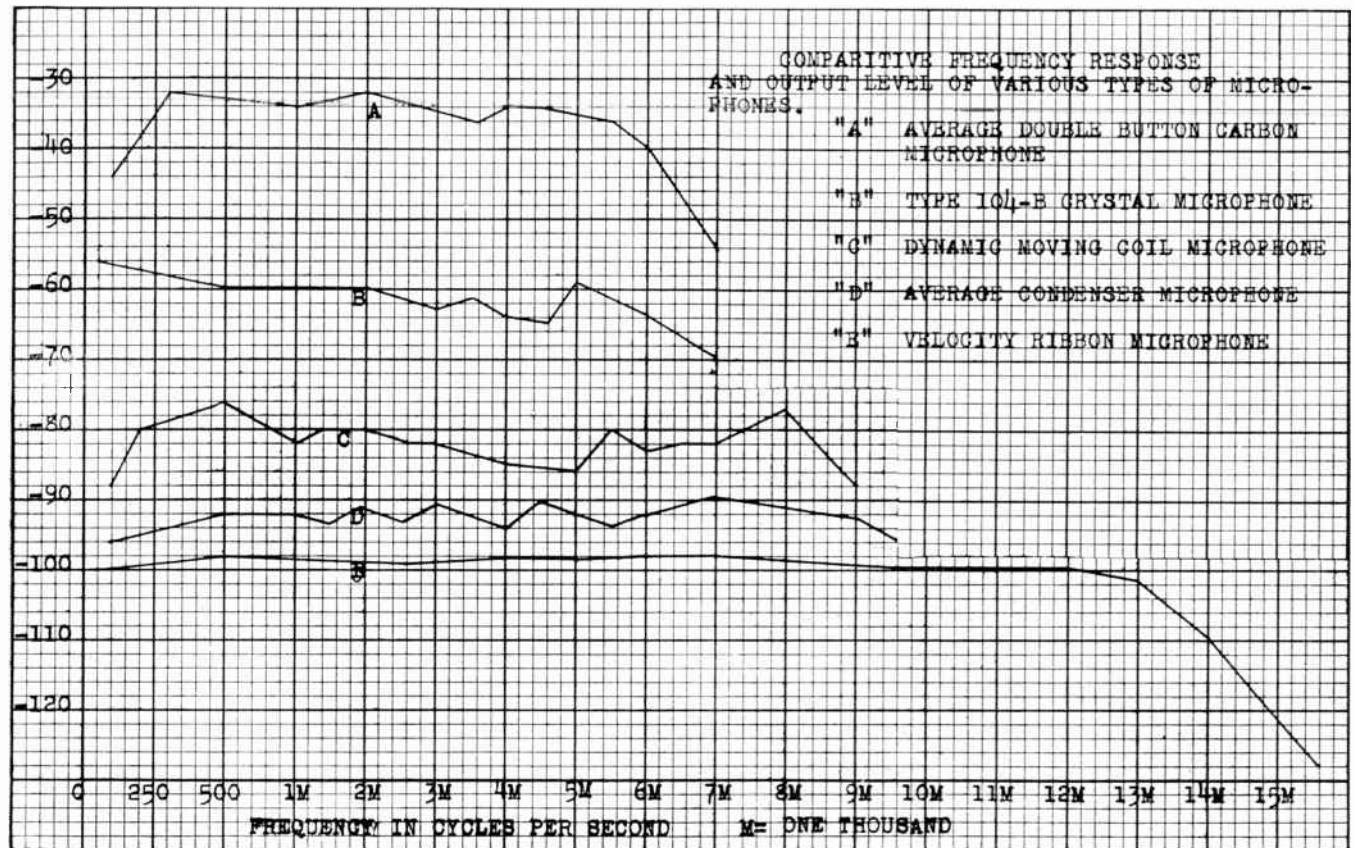

FIGURE 14

PART 4: MICROPHONE MIXERS

From the foregoing discussion it is readily apparent to the reader that the method of coupling the various input devices presents quite a problem. We will not attempt to treat this subject in great detail, but will confine ourselves to a discussion of the various types of coupling systems in use to-day.

Figures 7 and 8, in part 3, illustrate a common form of coupling device employed to match a carbon microphone to any amplifier. This system is employed when the input matching device is located near the amplifier. If desired, a double pole double throw toggle switch may be employed to switch from one type of input to the other without the inconvenience of connecting and disconnecting wires.

Care must be taken to prevent hum pick-up in the output leads of the transformer by shielding them. If the transformer in any type of coupling device is brought within the magnetic field created by the power transformer in the amplifier or any other similar device, such as a phonograph motor, a 60 or 120 cycle hum will result.

Figure 16 is a schematic diagram of a pre-amplifier which may be operated in conjunction with the main amplifier if sufficient gain is not available in this unit. The filament and plate supply is obtained from the main amplifier. No additional equipment is required provided the amplifier has a good filter system and the voltage does not exceed 300 volts. The same type of switching arrangement is employed to change from radio or phonograph to microphone as stated for the above-mentioned coupling system.

Figure 17 is a diagram of a three-position mixer employing constant impedance "T" pads which permit any channel to be operated individually or simultaneously without frequency discrimination. Considerable loss occurs in this unit, and hence,

additional gain must be available from the amplifier to compensate for this loss. By using "universal" line transformers, impedances from 50 to 500 ohms may be obtained, as well as a suitable arrangement for carbon microphones. A transformer is utilized at the amplifier to match the output of the mixer to the amplifier.

In Figure 18 is a schematic diagram of a typical line-to-line matching transformer showing how the various impedances are obtained on both the primary and secondary.

In the majority of cases a pre-amplifier is included with the mixer to compensate for the loss incurred and to provide additional gain if it is required. The output of the mixer is coupled to the pre-amplifier in the same manner as it would be connected to the main amplifier. The output of the pre-amplifier is then transmitted to the main amplifier by means of two transformers: one to match the pre-amplifier to the line, and the other to properly couple the line to the main amplifier. While the pre-amplifier may be any number of stages, depending on the gain required, one is usually sufficient. The average loss which occurs in a three-position mixer is approximately —30 db.

By employing this same scheme, as many channels as are desired may be mixed. However, as the number of channels is increased, the loss will become greater and consequently more gain will be required.

It is often necessary, when using a multi-mixing arrangement, to permanently fix the maximum amount of voltage to be delivered from each channel, especially in simple change-over systems where a common gain control is desired. By operating the various input devices at a common impedance, usually 500 ohms, attenuation pads may be utilized to accomplish this feat.

The correct value for any type of attenuation network may be

accurately determined by using the chart shown in Figure 19. The data shown has been computed to a great degree of accuracy by the research department of the United Transformer Corporation, and may be used for laboratory or professional applications.

In almost every professional application, the "T" type of "pad" is the most practical type to employ, since it is both economical and efficient. Double "TT" and "H" pads are used

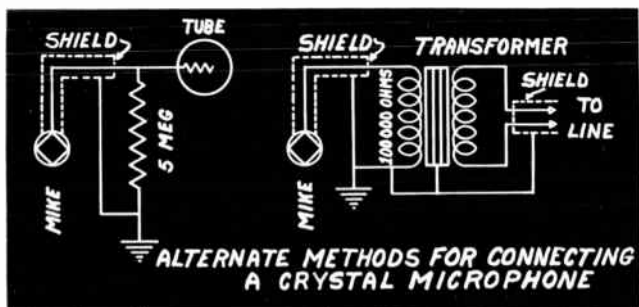

FIGURE 15

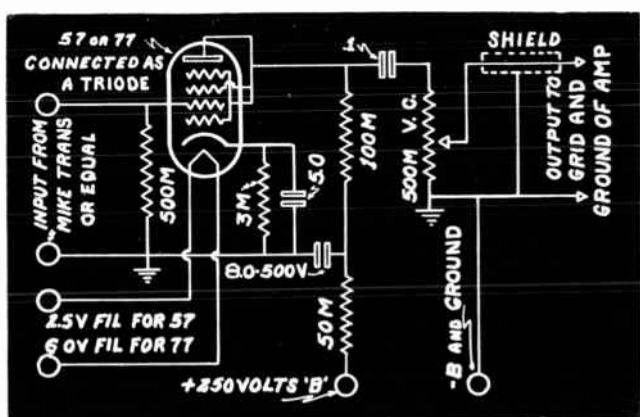

FIGURE 16

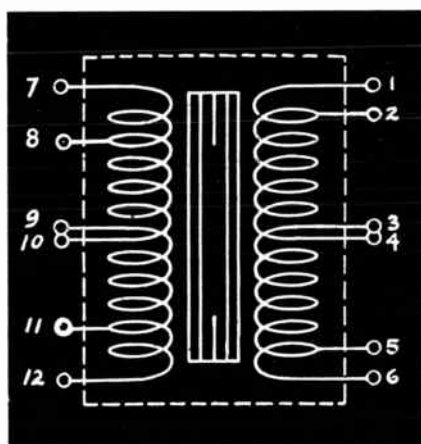

FIGURE 18

PRIMARY CONNECTIONS

50 ohms connect to 8 and 11, join 8 to 9 and 10 to 11
 125 ohms connect to 7 and 12, join 7 to 9 and 10 to 12
 200 ohms connect to 8 and 11, join 9 to 10
 250 ohms connect to 7 and 12, join 8 to 9
 333 ohms connect to 7 and 11, join 9 to 10
 500 ohms connect to 7 and 12, join 9 to 10

SECONDARY CONNECTIONS

500 ohms connect to 1 and 6, join 3 to 4
 333 ohms connect to 1 and 5, join 3 to 4
 250 ohms connect to 1 and 6, join 2 to 3 (Approx.)
 200 ohms connect to 2 and 5, join 3 to 4
 125 ohms connect to 1 and 4, join 1 to 3 and 4 to 6
 50 ohms connect to 2 and 4, join 2 to 5 and 4 to 5

only when it is necessary to maintain constant balance in both sides of the line.

An example of how this chart may be put to practical use is as follows: Assume we desire to couple a radio tuner and a carbon microphone to an amplifier so that it will be impossible to overload it if the gain control is advanced to maximum when operating the radio tuner. In the majority of cases we would require the amplifier to have a gain of 75 or 85 db in order to properly operate the carbon microphone as well as compensate for the losses in the mixing transformers. The average radio tuner requires the audio amplifier to have a gain of approximately 50 db. If we consider the mixing arrangement, namely the transformers, to have a loss of 10 db, an excess gain of 15 or 25 db will be encountered when using the tuner. By inserting a "pad" or attenuator with a loss equal to the excess gain available, we can operate both input devices without fear of damaging the speakers or other equipment due to the extreme overload that would otherwise occur.

A 15 db "T" pad will consist of two series resistors of 300 ohms each and one 185 ohm shunt resistor when operated on a 500 ohm line. These values are close enough to real ones for all practical work.

For line impedances other than 500 ohms, it is only necessary to multiply each resistor by a factor equal to line impedance divided by 500. For example, if a 4000 ohm line is employed, the above 15 db "T" pad would consist of two series resistors of 2400 ohms each, and one 1500 ohm shunt resistor. These values are obtained by multiplying the original resistor by the factor 8, or 4000 divided by 500.

ATTENUATION NETWORK DATA

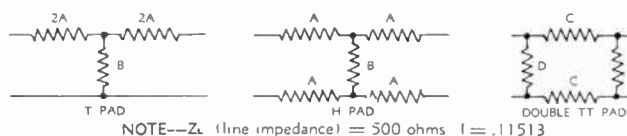

NOTE--Z_L (line impedance) = 500 ohms I = .11513

ATTENUATION	$A = \frac{Z_L}{2} \times \tanh\left(\frac{NI}{2}\right)$	$B = \frac{Z_L}{\sinh(NI)}$	$C = \frac{Z_L}{2} \times \sinh(NI)$	$D = \frac{Z_L}{\tanh\left(\frac{NI}{2}\right)}$
NO. D.B.	A	B	C	D
.1	1.440	43420	2.879	86850
.2	2.878	21720	5.755	43440
.3	4.318	14480	8.635	28950
.4	5.758	10850	11.52	21710
.5	7.193	8685.	14.40	17380
.6	8.635	7232.	17.29	14480
.7	10.07	6198	20.17	12420
.8	11.51	5421.	23.06	10870
.9	12.95	4818.	25.95	9656.
1.0	14.38	4333.	28.85	8690.
2.0	28.65	2152.	58.08	4364.
3.0	42.75	1420.	88.08	2925.
4.0	56.58	1049.	119.3	2209.
5.0	70.03	822.4	152.0	1785.
6.0	83.08	669.4	186.8	1505.
7.0	95.65	558.0	224.0	1308.
8.0	107.7	473.1	264.3	1162.
9.0	119.1	405.9	308.0	1050.
10.0	129.9	351.3	355.8	962.5
15	174.5	183.6	680.8	756.3
20	204.5	101.0	1238.	611.2
25	223.5	56.40	2216.	559.5
30	234.7	31.65	3949	532.7
35	241.3	17.79	7027.	518.0
40	245.1	10.00	12500	510.1
45	247.2	5.624	22230	505.7
50	248.5	3.163	39530	503.2
55	249.2	1.775	70300	501.8
60	249.5	1.0	125000	501.0
65	249.8	.5623	222300	500.5
70	249.8	.3163	395400	500.4
75	249.9	.1779	703000	500.2
80	249.9	1.0	1250000	500.1
85	250.0	.05620	2223000	500.1
90	250.0	.03161	3954000	500.0
95	250.0	.01879	7027000	500.0
100	250.0	.010	12500000	500.0

FIGURE 19

AMPLIFIERS

The second and most essential part of a sound amplifying system is of course the amplifier, inasmuch as this device is capable of raising the sound from its normal level to a higher one. The input devices discussed in the preceding chapters are only means of exciting or controlling the main amplifier.

The sound or audio amplifier of to-day is by no means a perfect device for amplifying sound, as it has many shortcomings. First, it does not amplify all the audible frequencies with the same degree of intensity, and even if it did we would not gain very much, as the devices available for converting this sound

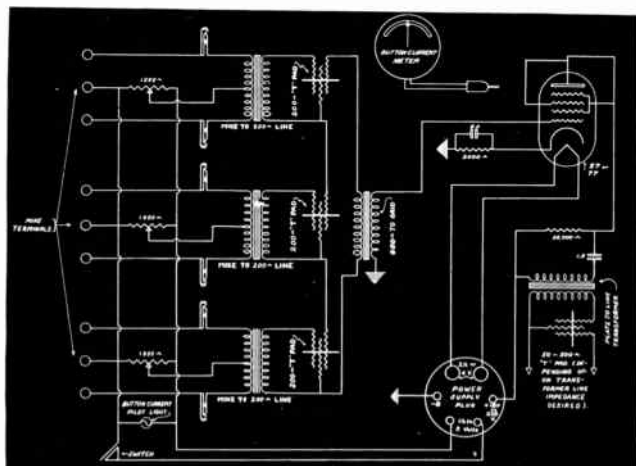

FIGURE 17

into electrical impulses, and vice versa, are likewise imperfect. As an example, it is well to note that the poorest amplifier often has a better frequency characteristic than the best loud speaker.

Second, an amplifier always possesses a certain amount of harmonic distortion, though it is not always audible to the ear. All properly rated amplifiers have a maximum distortion of five percent, which is considered negligible, since ten percent is seldom noticeable. Finally, it has power limitations which greatly alter its effectiveness under all conditions. The selection of the proper sized amplifier will be discussed in a later paragraph.

TUBE REQUIREMENTS

The vacuum tube is directly responsible for the development of the sound amplifier and consequently plays the most important rôle. Furthermore, the type of tubes employed usually denote the system of amplification employed, in the same manner that the class of amplification may denote the type of tubes required. Therefore, it is at once obvious that in order to fully understand the operation of an audio amplifier, as well as to be able to intelligently select the proper type to fulfill your needs, it is absolutely essential that you, the sound technician, fully avail yourself of all the information obtainable on vacuum tubes. While a brief description of the operating theory of the vacuum tube is given in the following paragraph, it is advisable that any one with intentions of entering, or desirous of being successful in the sound profession, should thoroughly familiarize himself with at least the principal functions and ratings of the various types of vacuum tubes on the market to-day. The authors of this manual know of no better source of this information than the RCA-Radiotron Tube Manual, released by that company. This book can be obtained from any of its distributors for the small sum of twenty-five cents.

In very concise terms, the vacuum tube operates on the principle that when a voltage is applied to the input circuit a corresponding but larger voltage will appear in the output circuit. Immediately we obtain a method of rating this function which is known as the voltage gain. Obviously this is rated in terms of the ratio of the input voltage to the output voltage, and depends on the amplification factor of the tube, as well as the constants

of the circuit. Very often the amplification factor stated for a specific tube is mistaken for the voltage gain that will be obtained from this unit in operation. What the rated amplification factor of the tube does do is enable us to calculate the voltage gain we will obtain from a certain circuit with that particular tube. It can be stated then, that the higher the amplification factor of a tube the greater the voltage gain will be if equivalent circuits are employed. Commercial vacuum tubes have been developed with amplification factors ranging from 3 to 1500.

At this point, the reader may have gathered the impression that the amplification factor denotes the status of the tube, i.e., the higher the amplification factor, the better. If the tube is to be used simply as a voltage amplifier—yes. For any other applications—no.

Since we are primarily concerned here, with amplifiers, let us first determine just what services are required of vacuum tubes in order to obtain what we call sound amplification. To begin with, the voltage supplied from the input device may be as low as one millivolt, .001 volts, .000 000 000 007 watt at 150,000 ohms, or a power level of —80db. On the other hand, we may require a level as great as plus 36.6 db in order for the sound to be distributed properly. In other words, our amplifier must raise the power level from —80 db to plus 36.6 db. If the output impedance of the amplifier is 6000 ohms, plus 36.6 db will be equivalent to 28 watts, or approximately .076 ampere at 456 volts. Hence the amplifier must be capable of amplifying or raising .000 000 000 007 watt to 28 watts, 1 millivolt to 456 volts, or in more general terms, raise the power level from —80 db to plus 36.6 db. Furthermore, all of the above constants are alternating ones, which are flexible over the entire audible range from 20 to 17,000 cycles, which means that the amplifier must be capable of amplifying all of the frequencies equally. Also, these constants, since they are alternating ones, will have a certain form, and if this form is altered, distortion will occur. It is then readily apparent that an audio amplifier at its worst is in reality a remarkable device, and also that many factors must be taken into consideration in the construction of this device.

As stated, power is required to drive the loud speaker which must consist of voltage and current. Vacuum tubes have been developed which cause large changes in current in the output circuit when properly excited, and are therefore designated "power" tubes." These tubes require large voltages to excite them, and in most cases do not consume any power from the source of voltage. Tubes of this type are known as "Class A power tubes." Further, any circuit employing this type of tube is known as a Class "A" amplifier.

Now, we cannot excite "power tubes" directly from the input source, since the voltage available is only a small fraction of that required. Hence tubes have been developed which permit large voltage gains at very low power levels. These tubes are known as "voltage amplifiers," and are used only for the purpose of driving the larger "power tubes." Also, the section of the amplifier which employs the latter tubes is called "voltage amplifying division," and if this section is separate, it is usually called a "pre-amplifier." Very often it is necessary to use additional voltage amplification on some forms of input devices in order to operate them with amplifiers designed for use with input devices having comparatively large voltage outputs or power levels. This is commonly referred to as additional pre-amplification, the unit being termed a "pre-amplifier."

AMPLIFIER REQUIREMENTS

From the foregoing we know that an amplifier has many qualities which govern its operation, and before we can properly use this device, we must know its qualities. These are:

1. Gain or voltage amplification
2. Power output
3. Frequency response
4. Harmonic Content

The **gain or voltage amplification** is always rated in decibels in order that we may be able to compare and compute this function, irrespective of the output and input impedances. As an example, assume an amplifier has a gain of 80 db, and the input device has a level of —60 db. Providing no loss occurred in the coupling system between this device and the amplifier, an excess gain of 20 db would be available which must be attenuated. While this may be accomplished in several ways, the most economical method is to use a volume control as shown in Figures 2 and 9. It must also be remembered when using this method of determining the amount of gain required that all reliable manufacturers rate their amplifiers in db gain for maximum output; allowance must be made for the fact that input device rating is the average value, not the maximum, as with the amplifier. In other words, since the amplifier is never operated at an average level greater than one half its maximum rating, as will later be explained, considerably more gain will be obtained than the calculated amount, approximately 10 percent. On the other hand, at least a 5 db loss will occur in the input coupling device which must be taken into consideration. Returning then to our original example, we had an excessive gain of 20 db, minus 5 db loss in the input device, leaving us with 15 db. Adding to this 10 percent additional gain obtained from the amplifier at the lower level, $.1 \times 80 = 8$ db, giving us an actual excess gain of 23 db. From this we can form a law for approximating the gain required to operate a certain sound system, i.e., if the loss in the input coupling system does not exceed 10 percent of the total gain available from the amplifier, the level in db of the input device when subtracted from the gain in db of the amplifier may equal zero or more, but never less. Example: amplifier gain plus 90 db; input device minus 60 —excess gain plus 30 db.

Example number 2: Amplifier gain plus 75 db; input device minus 80 db = 5 db gain short of that required.

The **power output** of an amplifier is the quality which permits it to drive the electro-acoustical converters or loud speakers.

In order to obtain this electrical power, large currents must alternate in the output circuit in the exact form as that of the input voltage. This is accomplished, as we stated before, by "power tubes." These tubes are in reality the backbone of the amplifier, and our final results depend entirely on the ability and efficiency of these units. Since the introduction of power tubes, constant research has been carried on to improve their efficiency. In fact, nearly all the improvements made in the art of sound amplification can be attributed directly to the development of this tube. The first "power tube," namely the 210, required 425 volts plate voltage, consumed 15 watts from the D.C. source, and delivered 4 watts for two tubes in push-pull. Also, the high cost of condensers, transformers, etc., made this amplifier sell at \$150 to \$200. To-day, an amplifier requiring only 300 volts on the plate, delivering more power and using only one tube can be purchased for only \$25. Class "B" amplifiers, which employ special type tubes, are even more efficient.

To-day commercial amplifiers are available with maximum audio power outputs ranging from 2 to 60 watts. In almost every instance different tubes are employed. There are over 25 different types of power tubes available to-day, all having a specific use.

Those who are familiar with amplifiers can approximate the amount of "loudness" which can be obtained from a certain amplifier, provided certain types of speakers are used. Speakers and output transformers govern the amount of volume which will be obtained from any amplifier. This will be discussed thoroughly in a section devoted to the explanation and comparison of power levels.

HARMONIC CONTENT

Due to peculiarities in both power tubes and circuits, secondary currents are generated along with the main signals which are called harmonics. The minimizing of these secondary currents depends on the construction of the tube and its associated parts, mostly on the latter. This is one of the reasons why am-

plifiers of equal power ratings, using different tubes, seldom sound the same. Often amplifiers using the same tubes and having the same power output do not sound alike because of this condition. In this case the fault lies in the design of the unit or the circuit. Cheap transformers are almost invariably the cause in this latter instance. In the opening paragraph of this chapter we stated the harmonic limitations.

The authors hope this will clear up the mystery of the 245 tube to those familiar with its operation. The harmonic content of this tube in push-pull operation was lower than that of any tube ever developed, which resulted in the almost universal phrase, "well, the 245 tubes may not have as much power, but they certainly sound better."

The **frequency response** of an amplifier depends almost entirely on the circuits and the component parts of the unit. Tubes affect the higher frequencies because of the high capacities between elements. This can also be overcome, providing enough attention is given to the design of the circuit, which unfortunately is seldom done by the "low-cost" manufacturers. As will be explained later, a flat frequency response is not always ideal, but is almost invariably desirable. Almost any power tube can be made to respond equally to frequencies between 20 and 17,000. However, in many cases it is not advisable, both from the economical and practical angles.

Returning once more to the problem of selecting the right type of tubes for certain amplifiers, we can say that this will depend entirely on the amount of power and gain required. Since amplifiers are purchased, designed and constructed, this is of practically no concern to the ultimate user of this product. What he really is interested in is whether it will fill his needs. What the consumer does have a right to demand is correct ratings of amplifiers, in order that he may intelligently select an amplifier in the most economical way. As it will be noted in the catalogue pages of this manual, that is just what we have endeavored to accomplish. Unfortunately, this is not the case with most amplifier manufacturers.

Before discussing the more practical phases of the amplifier, let us summarize the requirements placed on vacuum tubes:

1. To amplify or increase minute voltages to values sufficiently large for exciting power tubes;
2. To cause larger alternating currents to flow in output circuits in order that power may be obtained to drive the loud speakers;
3. To accomplish these functions without distorting or changing the wave from its original form;
4. To be as efficient as possible, and to maintain constant output over a period of time. Tubes should always be replaced the moment any sign of deficiency is noted, otherwise unnecessary trouble and expense will be incurred.

SELECTION OF THE PROPER TYPE OF AMPLIFIER

From what has been related in the preceding paragraphs, it might seem that the ideal thing to do would be to always use an amplifier having a flat frequency response from 20 to 17,000 cycles, as much power as possible, and with a gain sufficient for all types of input devices. For many reasons which will be shown, this is not the case. Below are the factors which govern the selection of an amplifier.

1. **The power required.**
2. **Source of sound to be amplified and frequency response necessary for faithful reproduction.**
3. **Type of speakers employed.**

The power required of an amplifier in the public address field varies anywhere from 2 to 60 watts. No definite law can be made for the amount of power that will be required for any given installation, because of the many factors involved. Two of the major factors which govern the amount of power required are: the number of people to be supplied and the acoustics, or the opposition offered by the air and surrounding objects. A 3-watt amplifier with certain associated equipment may be more than adequate for a gathering of people in a medium-sized room,

provided the listeners are not conversing. Yet, it will completely fail if placed in a large room. It may also fail if a great deal of conversation is carried on in the room. It is evident that a certain amount of experience and common sense is required in order to ascertain properly the amount of power necessary for certain conditions.

Throughout the catalogue pages of the manual we have attempted to give the approximate capacities of the various amplifiers in practical terms, or in other words, we have stated some uses for which each amplifier is particularly suited. However, these suggestions should not be considered as criterions, as they are simply given to allow the prospective consumer to obtain some tangible comparison of the various systems.

Also, on page 20, a chart will be found which will also allow some comparison between the power level ratings of amplifiers in decibels and actual sound. One factor which must always be remembered is that the rating of any amplifier is the maximum one, and since sound may at times reach peaks twice its average level, no amplifier should be operated at more than one half its maximum rating. For example, a 15-watt amplifier is considered to have an average output of 7.5 watts. (Note that this is one half of the maximum rating, and not the peak.) The peak rating now being given by amplifier manufacturers is somewhat misleading. An amplifier is measured with a steady signal which is increased until the rise in power output does not continue to increase at the rate it did when the input voltage was increased from zero to one tenth the maximum amount required for full power output. This means that from zero to maximum power no wave form distortion will occur, and the harmonic content will remain low. From this point on, doubling the amount of input voltage may only cause a 10 to 20 percent increase in power output, whereas a 100 percent increase should occur. Peak ratings given in this manual indicate the point at which the power output starts to decline, and is known as the saturation point. This value is given simply to show that the maximum rating is not the peak one, but the actual value at which no wave form distortion occurs. This procedure was made necessary because of the unfair methods employed by some manufacturers in indicating the peak value as the maximum.

Finally, in order to decide on the amount of power necessary for a given installation, rely on your experience and the manufacturers' recommendations, and if you do not find the answer from these two sources, write to our consultation department, giving all details regarding your requirements; we will be more than pleased to suggest as many solutions to your problems as possible. This service is free, so why not take advantage of it?

SOUND SOURCE AND FREQUENCY RESPONSE

The next problem with which we are concerned in choosing the proper amplifier is the source of sound to be amplified, that is, whether it is to be transcribed from a phonograph record, picked up through a microphone, transferred from a radio tuner, or all three. Any of these requirements vitally affect the quality of the amplifier necessary for their amplification. If the amplifier is to be used with a medium-priced phonograph pick-up it is only necessary that the amplifier have a gain of approximately 40 db and a frequency response essentially flat from 60 to 6000 cycles. This means that a system for operation from this input source will be inexpensive. The disadvantage in using an amplifier having a flat frequency response above 6000 cycles is the over-abundance of scratch noise which will be present. For this reason, in many instances filters are used with phonograph pick-ups which cut off the frequencies above 4000 cycles. These units are known commercially as scratch filters. In other words, it is economically unsound to purchase an amplifier with a frequency response above 6000 c.p.s. if it is not to be used.

If the source of sound is from a microphone, the type of amplifier will depend entirely upon the quality of this unit. For instance, if a medium-priced double button carbon mike is employed, the gain of the amplifier should be about 70 db and have a frequency response from 60 to 7000 or 8000 c.p.s. If

a condenser microphone is employed, this frequency response and gain will be sufficient, providing the head amplifier is standard. That is, the head amplifier in the condenser microphone has an output level of —40 db or better. If the output equipment will permit the reproduction of the higher frequencies, up to 10,000 c.p.s., the condenser microphone will be found excellent for use with this type of equipment. If the dynamic or velocity microphone is employed, the frequency response of the amplifier should be as good as the external equipment, from the lowest to the highest. (If you are using input and output coupling transformers that are good from only 60 to 8000 c.p.s., it is of no advantage to have an amplifier with a flat frequency response from lowest to the highest.)

With a radio tuner the same condition exists. If the tuner is a superheterodyne, the amplifier should have a frequency response from 60 to 5000 c.p.s. If it is a T.R.F. type, the response should not exceed 10,000 c.p.s. Frequently this is not feasible if the output equipment responds to 10,000 c.p.s. to any degree, as otherwise inaudible heterodynes or whistles will be heard. Another disadvantage of the high frequency response when using a radio tuner is the increased level of the background noise. The average superheterodyne receiver on the market to-day does not reproduce anything higher than 4000 to 5000 cycles.

The gain required in this instance will depend on the output of the tuner, usually about 50 db. This means that the amplifier should have a gain of approximately 60 db for the average unit. However, some tuners have sufficient output to operate on amplifiers with a gain of only 30 db, while others require even more than 70 or 80 db for proper operation. The required gain of the amplifier for any type of tuner is always stated by reputable manufacturers.

If we require a unit which will operate successfully on all three sources of sound, the frequency response will depend on the quality of all the external equipment, especially the type of microphone to be employed. If carbon microphones are to be used, an amplifier with a response from 60 to 7000 cycles will be sufficient for all three sources. If, when using a phonograph pick-up, the scratch noise is objectionable, a filter may be used on this source only. If a velocity microphone is employed, an amplifier with a gain of approximately 125 db and a frequency response flat from at least 40 to 12,000 c.p.s. should be used, provided the external equipment will respond to those frequencies. Better still, the main amplifier may have an average gain of about 70 db or better, and a pre-amplifier may be used with the velocity microphone. The latter method is better from the standpoint of hum and transmission of the sound from the microphone to the main amplifier, since it is better to transmit sound at a high level than a low one. Most broadcast transmission lines are operated at a level of approximately plus 2.5 db, which corresponds to a wattage level of about 11 milliwatts. When using the phonograph and radio tuner on this type of amplifier, condenser padding may be used to obviate the trouble referred to previously, when these units are used with an amplifier with a frequency response above 6000 to 10,000 c.p.s.

Another condition often encountered is that the input device may have a frequency characteristic which will require the amplifier to have anything but a flat response. A typical example of this is a photo-cell when used to transcribe sound from a film. The amplifier in this case should be down at least 10 to 15 db at 60 cycles, and have a rising characteristic on the high end, otherwise an over-abundance of low frequencies will result. This is due to the characteristics of the average P.E. cell, the output of which is much higher at the lower frequencies. Some types of phonograph pick-ups have the same condition, and very often they cause varied opinions between friends as to their quality because they are not using them on the same amplifier. One will say it has too much bass, the other will claim it is lacking in the lower frequencies.

To summarize, choose your amplifier along lines discussed above, and always keep in mind the frequency response of the external equipment, as an amplifier is only as good as its associated parts. Never use a common phonograph pick-up on a

high fidelity amplifier. It is analogous to playing old mechanically recorded records with electric pick-ups. On the other hand, never use a high fidelity velocity microphone on the average amplifier and speaker combination and expect to obtain the same quality as the broadcast stations have.

All of the rules set down in the preceding paragraphs regarding the use of the various types of input devices apply in the same manner to speakers to a greater degree, inasmuch as the frequency response of the speaker does not compare to the other two sections of the amplifying system, namely, the input device and amplifier. The frequency response of the average input device and amplifier is comparatively flat over its effective range, whereas the response of the loud speaker is a series of peaks. Also, since the operation of the loud speaker is an acoustical function, the location will govern its effectiveness. Laws of acoustics tell us that in order to obtain low frequency vibrations, we must have long wavelength, or large area; for high frequencies we must have short wavelength or small area, hence high frequencies have small cones, low frequencies large cones. The ideal combination is of course two speakers operating in their effective ranges. Economically this is not always possible and we must therefore be satisfied with a happy medium, namely, an eight or twelve inch speaker with a sounding board, often called a baffle, for the lower frequencies. This is about the best arrangement for medium-priced installations. The choice of speakers will be discussed in a later part devoted to that subject, and should be consulted before selecting the amplifier.

The most important effect of the speaker upon the selection of an amplifier is that it directly governs the amount of power that will be necessary under certain conditions. This will also be treated in the section mentioned in the preceding paragraph.

VARIOUS SYSTEMS OF AMPLIFICATION

Before discussing the choice of output and input impedance, it is well to differentiate between the popular systems of audio amplification now in use commercially, which are "ballyhooed" to a degree that is often misleading to those not actively engaged in the sound profession. There are Class "A," Class "AB" or "AAA" (still better, Class "A" Prime), and Class "B." So far as the ultimate consumer is concerned, these are meaningless terms and are of no value to him one way or another. Whether the amplifier employs "A," "B," "C," "D," "E" or "F" amplification does not interest him so long as he obtains an amplifier which will suit his needs. It does interest the designer, since he is able to use these three systems to accomplish more than could ordinarily be obtained from the same amount of equipment.

To the designer these three systems mean simply this. With Class "A" no power will be required from the driving source. With Class "A" Prime, by supplying a small amount of driver current, more power can be obtained provided the tubes will stand the load. Class "B" means that power must be supplied from the driving circuit, but enormous power will be obtained with great efficiency if a great deal of attention is given to the design of the associated equipment. For medium power it is a toss-up between Class "A" Prime and Class "A," depending on the type of tube employed. One of the main disadvantages of Class "A" Prime is that it drives the tubes beyond their normal capacity, resulting in short life. The efficiency of Class "A" Prime is somewhat higher than that of straight Class "A." Class "B" is the most efficient power amplifier and has only one disadvantage, and that is it requires precision design and construction, otherwise the worst form of amplification will result.

The results obtained in laboratories show that Class "A" amplification is always superior except with tubes which have a tendency to draw grid current, such as the type 48 D.C. tubes. Here, Class "A" Prime has been used with excellent results. Class "B" has been found to be more efficient than any other type for power amplification, above 20 watts. In the final analysis, if two amplifiers have equal power, harmonic and frequency characteristics, the form of amplification employed is immaterial.

INPUT IMPEDANCE

The selection of the proper input and output impedances depends, of course, on the type of auxiliary equipment necessary. The average amplifier is never supplied with an input transformer for reasons which would require many times the space available here to enumerate. A few of the major ones are as follows: First, it would be physically and electrically impossible to manufacture a transformer that would properly match all types of input equipment. If a transformer is made to match two or three types of input equipment, it is almost invariably used for only one purpose, which automatically increases the cost of the system. Furthermore, a transformer, especially one operating at a low level such as an input unit and designed for several impedances, is never as efficient as a transformer designed for one specific use. The possible frequency response for the investment is greatly impaired when using a combination transformer. If a number of input sources is employed, the problem of switching attains a complex form. Finally, in commercial amplifiers it would be necessary to mount the input transformer on the amplifier chassis, which is like wishing for a typhoon if you happen to be stranded in a row boat. In fact, if the gain of the amplifier exceeds 60 db, it is almost impossible to eliminate the inductive hum pick-up that results when an input transformer is brought within two or three feet of the amplifier. The best policy is to always keep the input equipment at least three to four feet from the amplifier and other equipment operating on A.C., such as phono motors, filament transformers, etc. The core of the input transformer should preferably be placed at right angles to the core of the power transformer or other sources of possible hum pick-up.

All Lafayette amplifiers, with the exception of the 60 watt Class "B" Booster, are rated at 500,000 ohm input impedance. This does not mean that the associated equipment must equal that value, but rather it indicates the size of the grid leak on the first tube. By knowing this value we can determine whether any loss will be encountered by the shunting effect of the grid leak when an input coupling device is connected to the amplifier. As stated before, no power is required from the input circuit of a voltage amplifier, and therefore any impedance may be connected to this type of amplifier provided enough voltage is available to excite the first audio tube. By referring to the section of this manual devoted to input devices, data will be found which will enable the reader to determine those units which will require matching or input transformers, and those which will be connected direct to the amplifier. In measuring the gain of amplifiers, 150,000 ohms is taken as a value for computation of the gain, while impedances in the order of megohms may be employed provided the input grid leak is increased to a value where it will not affect the input source.

One important factor that must be taken into consideration in coupling input devices to amplifiers is an unusual condition which arises in an amplifier. In an ordinary electrical circuit, if we alter the impedance, the voltage and current will change, but the power will always remain constant. The rating of an amplifier is always in power gain, irrespective of the impedance current, or voltage, and as related several times before, the input of an amplifier functions on voltage only. Therefore, the higher we keep the voltage, the more actual gain will we obtain for the same power input. Hence, always maintain the input impedance as high as possible, as the higher the impedance or resistance the higher the voltage will be.

For example: A 200 ohm pick-up may have a power level of minus 40 db, but since the input impedance is considered to be 150,000 ohms, the actual level will be much lower than the computed amount. Therefore, if we use a matching transformer, which does not increase the power level but rather lowers it about 5 db, we will enlarge the amount of voltage delivered to the grid of the first tube, and we will obtain in actual use approximately the degree of gain stated for the amplifier. In other words, to obtain the rated gain of an amplifier, the input impedance must equal 150,000 ohms for a

stated power level. Allowance should be made for this difference when using input devices with impedances lower than 150,000 ohms.

OUTPUT IMPEDANCE

The output impedance of the amplifier must, of course, match the impedance of the speakers, and this can be accomplished only by use of transformers. The power level at which output transformers are operated is many thousand times higher than that of the input transformers, and hence they can be made with several impedances without injuring the response to a great degree. However, these units are expensive to construct and are supplied with the larger amplifiers only. Most all of the cheaper amplifiers are supplied less output transformers for reasons of economy, as they are seldom used with more than one speaker, which invariably has its own transformer. Medium-sized amplifiers are supplied with output transformers with two windings, one for voice coils of dynamic speakers and the other for line transmission work, usually about 500 ohms. This affords a combination applicable to every installation, inasmuch as a 500 ohm line is essential when using several speakers in different locations. Line matching transformers are employed at each speaker to match the line to the voice coil. Figure 20 illustrates how to match any number of speakers to a 500 ohm line by employing a universal line transformer having secondary impedances of 2, 4, 8, and 15 ohms.

The efficiency of the output transformer directly governs the amount of power which will be transferred from the amplifier to the speaker. All output transformers have a certain amount of power loss regardless of how they are constructed. The best transformers, which sell for \$15 to \$20, have a power loss of approximately 10 percent. The transformers supplied with Lafayette amplifiers which sell for about \$7.00 have a power loss of 15 percent, while the transformers supplied with inexpensive speakers have power losses as high as 50 percent. These ratings are taken at 1000 cycles. After consideration of the above facts, no explanation is necessary of how important a good output transformer is from the power transfer angle. On the other hand, it is not feasible to purchase a \$15 transformer for an amplifier of equal value. It is economically sound to use a transformer with a 15 percent power loss on all amplifiers which involve an investment of more than \$25. The Lafayette special P.A. transformers are of the same type as those used in the Lafayette amplifiers and have a power loss of 15 percent. For amplifiers costing less than \$25, transformers with a power loss of 25 percent may be employed, although better results can be obtained with the more expensive transformers. Very often this is the reason why radio sets which are supposed to have greater audio power than their predecessors do not sound any louder. The manu-

facturers have found it cheaper to use large power tubes and small transformers rather than the opposite. Many a radio owner would be astonished if he knew what could be obtained from his radio set by replacing the present 40 or 50 percent transformer with a 15 percent one.

The remaining characteristic is the frequency response desired from the output transformer, or the "output impedance" of the amplifier. Here again it would be foolish to purchase a transformer capable of reproducing frequencies which your amplifier and speaker are not. Lafayette amplifiers are supplied with output transformers in proportion to the frequency characteristic of the amplifier. High fidelity amplifiers are even listed with two types of output transformers in order that the prospective user may select a unit to match the external equipment. On page 32, where the Lafayette A.C. high fidelity amplifier is illustrated, representative curves are shown which will enable the reader to see how the frequency response of an amplifier may vary with the quality of the output transformer.

It can be said that nearly all reliable manufacturers supply their amplifiers with output impedances to conform to the external equipment with which each amplifier is most likely to be employed. In many instances they are listed both ways, with and without output transformers, in order that you may be spared the additional expense if the standard output transformer does not match your equipment. Invariably they are able to supply the proper transformer for any installation.

In conclusion, choose your amplifier along the lines discussed in the preceding paragraphs, bearing in mind at all times the status of each individual piece of equipment, and keep them always on the same level or standard. Very often velocity microphones are used with \$2.00 coupling transformers, a fairly good amplifier, a poor speaker and output transformer, yet the user wonders why it does not sound as good as the chain programs. On the other hand, he may use the finest of everything except one item and the result will be almost as bad as if everything were of inferior quality.

One phase which was omitted in the preceding paragraphs, was the possible source of power for the amplifier. Amplifiers are available to-day for operation on any source from 6 volts D.C. to any voltage A.C. Under all circumstances amplifiers operated on A.C. are superior to those used on D.C., except pre-amplifiers, where it is often necessary to employ a battery supply in order to eliminate hum. The latest innovation in amplifiers is a model that operates entirely from a six volt car battery. These units are excellent for mobile use, but should be confined to that category, as they consume considerable current from the battery, which is usually supplied by the automobile generator thus making the actual drain nil so long as the car motor continues to run.

SPEAKERS

The final stage of a sound amplifying system performs the most difficult task, that of converting the strong electrical impulses into air vibrations, or sound waves. The device for accomplishing this is known as a loud speaker. This loud speaker, even though it does not respond to all audible frequencies equally, nor acts the same under all conditions, is truly a remarkable unit. No single item can perform as many things at the same time as a loud speaker.

Essentially, only five types of loud speakers, or more correctly, electro-acoustic converters, have been developed. These are: the magnetic, dynamic, condenser, crystal and exponential. The latter type is in reality only a form of the dynamic and magnetic, as will be shown later.

The first type to be developed was the magnetic unit, which has three variations, i.e., the disc diaphragm variety, the cone diaphragm unit, and the exponential or horn type driven by the disc diaphragm unit. All of these units operate on the principle of the effect of a varying current in an electro-magnet. By

placing a suitable diaphragm or metal plate in the vicinity of this magnetic field, vibrations are created by the repelling and attracting forces of this field. This type of speaker has many imperfections which will not be discussed here inasmuch as this device is now obsolete.

However, it is well to note that the common head phone is nothing more than a small magnetic loud speaker. These units have very high sensitivity ratings, but only reproduce a small portion of the audible spectrum at relatively small power levels, which make them ideal for that specific use.

CONE TYPE DYNAMIC SPEAKER

The cone type dynamic speaker was introduced several years ago, as many old-timers will recall, in the form of the RCA-104 unit. At that time, this type of speaker was beyond the reach of the average pocketbook, as it sold for \$275 including the amplifier. To-day, even the smallest midget receiver employs a dynamic speaker.

The secret of the efficiency obtainable in a dynamic speaker lies in the fact that the cone or diaphragm is virtually free to move in any direction, thus allowing it to vibrate at all audible frequencies to a comparatively equal degree. In order to accomplish this free movement it was necessary to reduce the size of the voice coil to a point where it could be fastened to the cone or diaphragm without retarding its movement. The natural inductance and impedance of the coil were then found to be too small to cause any appreciable movement of the cone when a varying current was impressed upon this coil. To overcome this difficulty, an enormous electro-magnetic field was created around this voice coil, by constructing a large electro-magnet, commonly referred to as the "field." This electro-magnet originally consisted of several miles of bell wire wound around a single rod of iron, into which at least 10 watts power was supplied. In fact, the first dynamic speaker had almost ten miles of wire in the field coil.

By creating this enormous field around the comparatively minute moving coil, referred to as the voice coil, the repelling and aiding effect was amplified to a degree where the efficiency was raised many times over that obtained with the magnetic unit. Also, the frequency response, especially on the low end of the spectrum, was greatly enhanced. Many improvements have been made since the introduction of the RCA-104, and to-day we can procure a dynamic speaker employing a 12 inch cone and requiring only 4 to 6 watts field excitation which will produce much better results than we received from the 104 type for almost one-fifth the amount originally expended.

CONDENSER TYPE

A condenser speaker was introduced in 1926, which operated on a radically different principle from the one employed by the magnetic and dynamic units. This unit functioned due to the attraction and repulsion of a thin sheet of metal when electric impulses was impressed upon it. These units never became popular because they were very bulky and expensive to construct. This type of speaker also has many electrical shortcomings which will not be enumerated here, inasmuch as they are no longer of any interest.

EXPONENTIAL TYPE

The exponential speaker, as stated before, is simply a variation of the dynamic and magnetic speaker. A horn having the appearance of a trumpet is attached to either a regular magnetic or dynamic unit in order to further amplify the sound by the oldest known form of sound amplification, "the megaphone effect." The main advantage in using this additional horn or trumpet is that the sound can be concentrated in more or less one direction, which is extremely advantageous for outdoor use. Another feature of the exponential speaker is that the high frequency response is intensified, which is very important for outdoor sound distribution. However, the one distinct disadvantage of this type of speaker is the loss of low frequency notes which occurs, and for this reason it cannot be used where faithful reproduction is desired, thus making it unsuitable for music reproduction in the home or auditorium.

Recently, however, modifications have been made in the exponential section in order to partially overcome some of the difficulties mentioned in the above paragraph, making it adaptable for auditorium use where a directional effect is absolutely essential. We refer to the exponential baffle used in theaters for sound-on-film reproduction and stage pick-up.

The exponential speaker, of both the horn and baffle types, now uses only dynamic drivers for obvious reasons, and therefore requires separate field excitation. The problem of proper field excitation is treated thoroughly in a paragraph devoted to that subject.

CRYSTAL TYPE

The latest addition to the speaker family is the crystal type. This unit employs Rochelle Salt crystals as the driving mechanism instead of the usual magnetic unit. These crystals are made to bend when electrical impulses are impressed on them, thus

producing air vibrations. While this type of speaker is available in units resembling the standard magnetic device, it is seldom employed as an individual speaker because of its inability to reproduce the low frequencies.

The crystal speaker, when used to reproduce the higher notes above 2000 cycles, becomes an excellent device. This unit is always employed in conjunction with a regular dynamic speaker, on high fidelity systems only. By referring to page 49 of this manual, a conception of the physical appearance of this device will be acquired.

By exercising a great deal of care in placing this high frequency speaker so that the phase relation between the two units is correct, the effective range of any public address system may be greatly enlarged. The proper way to mount this unit is to place the rim of the small bell exactly parallel to and at the edge of the dynamic speaker. For this reason the crystal speaker excels the cone type high frequency units, as it is much smaller and can be mounted in the fashion just mentioned. Another advantage of the crystal is that no filters are needed to keep the low frequencies from disturbing the action on the higher notes, as a special coupling arrangement automatically takes care of this condition in the speaker. It can be connected directly to the voice coil of any dynamic, and furthermore requires no field excitation. This speaker will handle more power than the other types of high frequency speakers so far developed.

There are several disadvantages in using the high frequency speaker under certain conditions. If this unit is used on a radio set or amplifier with a tuner, an over-abundance of static, background noise, and heterodyne whistle will result. Broadcasting channels do not permit the transmission of frequencies above 5000 cycles and therefore these units should never be employed with radio sets or tuner-amplifier combinations. Also, when phonograph records are the input source, it is not advisable to use high frequency speakers unless the listener does not object to the additional scratch which results. Finally, never use this speaker if the amplifying system is not capable of producing the higher frequencies above 6000 cycles.

Before discussing the selection and proper matching of the various types of speakers, it is appropriate to ascertain the necessary field supply for the various units.

FIELD SUPPLY REQUIREMENTS

Magnetic units operate by means of small voice coils and large permanent magnets, and hence no external field is necessary.

Dynamic units require external field excitation which must be from a direct current source. By varying the size of wire on the field coil these devices may be operated from potentials ranging from 6 to as high as 500 volts D.C. When it is necessary to obtain the field supply from an alternating source, rectifiers are employed to change the power from A.C. to D.C. Also, since the field coil contains considerable inductance, it is a common procedure to employ this coil as part of the filter system of an amplifier or radio set. With the latter instrument, this is almost invariably the condition.

When the field is used as a choke in the filter system, the field resistance may vary from 200 to 5000 ohms, depending on the amount of current passing through the winding as well as the required amount of field excitation in watts. Fundamentally, Ohm's Law is all that is necessary in order to compute this value; i.e., the resistance in ohms times the current in amperes squared. Example: current passing through the field is 80 milliamperes or .08 ampere, field resistance 1500 ohms. Thus, $1500 \times .08 \times .08 = 1500 \times .0064 = 9.6$ watts.

If the field current is obtained from an A.C. source, a transformer and a rectifier tube are employed in a conventional circuit in order to rectify the A.C. potential. The field in this instance serves as the filter choke, a condenser being employed to by-pass the remaining ripple. Recently, due to the introduction of the 25Z5 rectifier, the cost of this type of field supply has been reduced inasmuch as the transformer can now be eliminated. Where a number of speakers must be operated on alternating current, a separate rectifier capable of supplying the field for all

the speakers may be employed. In some cases this is economically sound, while in others it is not, depending on the number of units involved.

Obviously, when the field supply can be obtained from a 110 volts D.C. lighting supply, no special equipment is necessary. However, the field resistance must be low enough to allow the proper amount of current to flow in the field coil. The wattage obtained from a given field resistance, applied to any constant voltage source, can be ascertained by again referring to Ohm's Law, i.e., wattage equals the voltage times the current in amperes. The current can be obtained by dividing the voltage by the resistance. Assume we have a 1500 ohm field to be applied across a 110 volt source and we desire to know what the field wattage will be. First divide 1500 into 110, which will give .073 ampere or 73 milliamperes. Then it is only necessary to multiply .073 by 110, which gives us 8.03 watts. When the field is obtained from a 6 volt D.C. source the same rule will apply. For example, in order to obtain at least 6 watts field excitation, a resistance of 6 ohms will be required. Referring to the formula, we find that this will permit one ampere to flow, or 6 watts.

If possible, always obtain the field supply from the amplifier, as this is the most economical way, provided the speakers are located nearby. In remote installations, where a number of speakers are employed, it is always advisable to use separate field exciters.

CHOICE OF SPEAKER

Selecting the proper size speaker for various types of installations presents one of the major problems in the art of sound distribution, the reason being that all of the acoustical aspects of the location must be taken into consideration, together with the fact that the available equipment, namely the speakers, is by no means perfect. In one location certain equipment may be more than satisfactory and completely fail in another which appears to be identical.

Reverberation, i.e., the continual rebounding of the air pulsations against the background objects, probably causes more trouble than any other one condition. If the reader will recall, we spoke of the effect of damping a microphone in the second chapter, which is somewhat analogous to the conditions that exist when reverberation occurs. Likewise, the method for overcoming this condition is to dampen or deaden the room. Acoustical experts often are heard to remark when entering a room that it is either "dead" or "alive," which means that the reverberation effect is or is not occurring. Never expect to obtain any results in a room that is "alive." Some steps must be taken to overcome this condition before satisfactory results will be realized. There are several ways of overcoming this condition, depending entirely upon the amount of reverberation present. All of the methods are simply forms of damping; namely, drapes on the walls, heavy carpets on the floors, increased objects in the room and reflectors are some of the schemes employed.

In theaters, it is possible to notice the change in the quality of the sound as the house fills up. This is due to the effect of absorption by the audience.

Echo, known to everyone, presents somewhat of a problem when sound is being distributed in large halls, auditoriums, and outdoors where a "hall" effect is present; namely, a long street with high buildings. Directional speakers can be employed at times to overcome this condition, by facing them in the direction where a minimum amount of echo is encountered. In large halls and auditoriums a number of small speakers operated at a low volume will overcome this trouble. In all instances where echo occurs never operate one loud speaker at a great volume, but rather several speakers at as low a level as possible.

In many locations it will be found advisable to use a combination speaker in order to properly distribute the sound. A typical example is to use one or two large speakers mounted on large sounding boards or baffles for the local area to reproduce the low notes, together with either a trumpet or exponential speaker for the higher frequencies as well as to force the sound into remote locations, where it is not possible to install a speaker. For outdoor locations this combination is ideal. If the investment

prohibits the use of two types of speakers, trumpets should be used for outdoor work, in preference to the cone dynamics.

The efficiency of any amplifier depends on the number of speakers employed, up to a certain point. The number of speakers which can be operated on any amplifier may be estimated by taking one half of the maximum wattage of the amplifier, and dividing that value by .75; we then obtain the approximate number of speakers which can be employed. Example: power output of amplifier 15 watts, 7.5 watts average, divided by .75 gives us ten speakers, provided the coupling is perfect, which is impossible. A minimum of 20 percent loss should be considered, which leaves us with eight speakers instead of ten. Therefore, in this instance, eight speakers should be employed if maximum efficiency is desired. In all cases, use as many speakers as possible up to the capacity of the amplifier as stated, since the fundamental action of any sound system is to create air vibrations. Hence, the more speakers employed, the greater the force of the air impulses.

SPEAKER FREQUENCY RESPONSE

Dynamic speakers depend almost entirely upon the object to which they are mounted for the proper low frequency distribution. As mentioned before, low frequencies, or high wavelengths, are a function of area, and hence these objects should have a frontal area of at least 24 X 24 inches for best results. Very often it is necessary to attach additional sound boards or baffles in order to obtain the proper low frequency response. These baffles are usually made of a very "dead" material called Celotex, in order to prevent the sounding board from resonating, or vibrating excessively at its natural wavelength. Radio sets mounted in console cabinets seem to start vibrating on certain notes, causing an additional sound to be present with that coming from the speaker, sometimes in the form of a blast. This is known as cabinet resonance, and can be overcome by only one method, that of damping the cabinet by using heavier material or adding Celotex to its sides. Fundamentally, a baffle or sounding board performs two functions: it gives area to the low frequencies and also prevents the air pulsations in the rear of the cone from mixing with those coming from the front. This latter function is absolutely essential, since the two air impulses are exactly 180 degrees out of phase, and cause considerable trouble if permitted to collide.

The high frequency response of a cone type dynamic speaker is limited by the construction of the cone, and only by using exponential horns can its response to the higher frequencies be increased. When this method is employed a loss on the low frequency end of the audible spectrum naturally occurs. A high quality dynamic unit will respond to all frequencies between 60 and 4000 cycles to approximately the same degree. In order to extend this range without affecting the low frequency response, or producing a large peak on the middle frequencies, a separate unit must be employed to fully reproduce tones above 5000 cycles.

PROPER MATCHING

Improper matching of a number of speakers when used on the same amplifier is probably the cause of more sound system failures than all of the other mistakes combined. The reason for this is probably because there are so many different types of output impedances, voice coils and transformers, the value of which the sound man has very little chance of determining if it is not indicated on the device. Very little thought is ever given to the fact that improper matching not only causes a frequency and power loss in the line itself, but it also lowers the power output of the amplifier.

The majority of amplifiers, when supplied with output transformers, have two ranges of impedances, namely, a low and high section. The low range may be tapped so that impedances are available from 2 to 15 ohms, while the high range is usually 500 ohms tapped at 250 ohms. Occasionally this latter range is extended even higher for operation of magnetic speakers, between 2000 and 4000 ohms. However, since it is difficult and costly to manufacture a good transformer with both the extremely low and high impedances, and also since magnetic speakers are sel-

dom used to-day, the high range seldom exceeds 500 ohms.

When amplifiers are supplied with these multiple transformers, unless specified, they are to be employed at one impedance only. This limitation, which many sound men fail to consider, is the direct cause of the majority of mismatching troubles. For example: A dynamic speaker having an 8 ohm voice coil will be connected to the proper tap, and an additional speaker will also be connected to the 500 ohm by means of a speaker to line transformer. While this condition does not affect the operation of the transformer, it lowers the power output of the amplifier due to the reflected load on the output tubes. In some instances this will lower the power output of an amplifier more than half, and also increase the distortion to the same degree. In order to couple the two speakers in question, and still employ the 500 ohm line on one of the units, it is necessary to connect the 500 ohm line to the 250 ohm winding of the output transformer, and the 8 ohm voice coil speaker to the 4 ohm winding on the output transformer. This will then give the same reflected load on the power tubes as if either one 500 ohm line or one 8 ohm coil were connected to its respective terminals. For best power transfer and frequency conditions, the value of load connected to a transformer winding should never exceed twice its rated value. That is, nothing higher than a 1000 ohm winding should be coupled to a 500 ohm winding. Also, when the load on two windings is doubled so that both impedances can be used, they must be connected at all times. A 1000 ohm winding cannot be coupled to a 500 ohm winding unless a second winding is also loaded in the same manner, i.e., twice its rated impedance.

POSSIBLE CONNECTIONS WITH A LINE TO VOICE COIL TRANSFORMER

Values shown on the diagram (fig. 20A) are those obtained when the load applied to either winding is exactly as designated, i.e., the voice coil impedance is either 2, 4, 8, or 15 ohms connected

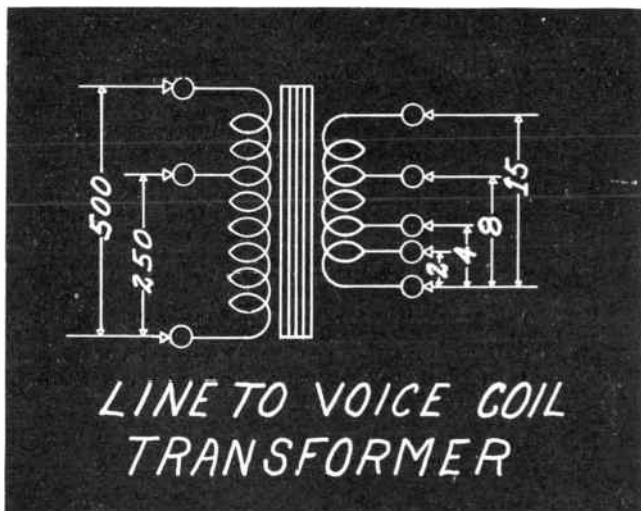

FIGURE 20A

to its respective secondary tap, and the primary is employed with either a 500 or 250 ohm line.

Speakers with 2 ohm voice coils should never be placed more than 5 feet from the transformer. Four ohm voice coils may be located as far as 10 feet from the transformer. It is possible to extend 8 ohm voice coils as much as 25 feet. Fifteen ohm voice coils can be placed at a distance of 50 feet from the transformer without serious loss of power provided a large size wire is used. Large wire should always be utilized to couple the voice coil to the transformer—at least No. 16. Voice coils below 4 ohms should be connected with at least No. 14 gauge wire.

A transformer is an extremely flexible device and may be used in other forms than those specified. In order to enable the sound specialist to reduce the number of matching transformers to a minimum, a few of the possible combinations are given below. As stated in the text, matching transformers always involve power losses as well as frequency discrepancies. Therefore, it is always advisable to operate as many speakers as possible on each matching transformer. If the speaker, or speakers, can be operated directly from the output transformer located on the amplifier, or, in single speaker installations, if the amplifier output transformer

can be placed on the speaker proper, these methods should be employed if you are desirous of obtaining the maximum results from any amplifier installation.

First Variation: Assume we have a 250 or 500 ohm line connected to the proper primary terminals of the matching transformer. Then, any combination of voice coils may be utilized provided the total impedance equals the specified value of the terminals to which they are connected. For example, two 2 ohm voice coils in series should be connected to the 4 ohm secondary "tap." Two 4 ohm voice coils in parallel must be connected to the 2 ohm secondary winding.

Two 15 ohm voice coils in parallel give a total impedance of 7.5 ohms, and in almost every practical application may be connected to the 8 ohm "tap." A variation of one half ohm may be neglected if the impedance is above 4 ohms.

Second Variation: If a 500 ohm line is connected to the 250 ohm primary "tap," the required secondary impedances will be increased by the same ratio, 2 to 1. In other words, the former 2 ohm "tap" will become 4 ohms, the 4 ohm "tap" changes to 8 ohms, the 8 ohm "tap" becomes 16 ohms, and the former 15 ohm "tap" will require a 30 ohm load.

Third Variation: If a 250 ohm line is connected to the 500 ohm primary winding, the secondary impedances will be decreased in the same ratio, 1 to 2. That is, the former 2 ohm "tap" will require a 1 ohm load. The 4 ohm "tap" decreases to 2 ohms, the 8 ohm "tap" to 4 ohms, and likewise the 15 ohm "tap" changes to 7.5 ohms.

Fourth Variation: If a 1000 ohm line is connected to the 500 ohm primary "tap," secondary impedances will be obtained exactly as stated for the "second variation."

Fifth Variation: If a 125 ohm line is connected to the 250

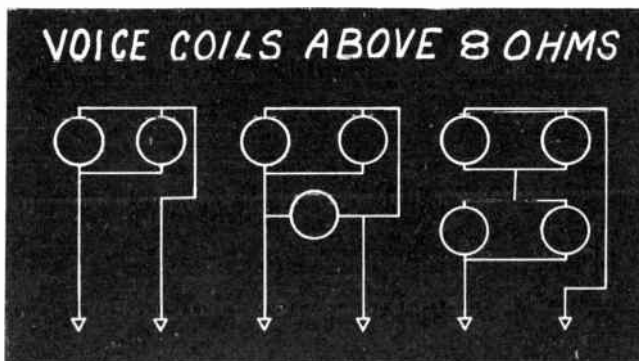

FIGURE 20B

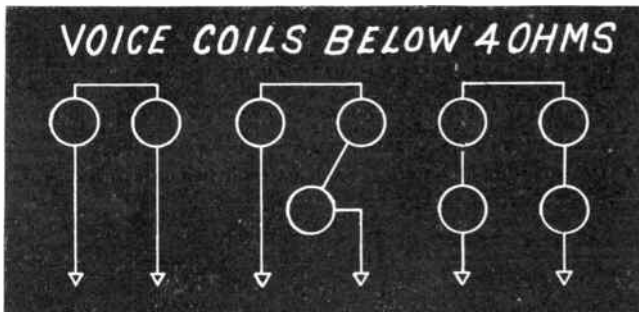

FIGURE 20C

ohm primary "tap," secondary impedances will be obtained exactly as stated for the "third variation."

Hence the rule: If the load on the primary is decreased or increased, the required load on the secondary will be decreased or increased by the same ratio.

Sixth Variation: More than one line may be connected to the secondary terminals of a matching transformer provided their total impedance equals twice the specified value for the secondary tap to which they are connected, i.e., 4 and 8 ohm voice coils may be connected to the same secondary provided the 4 ohm line is connected to the 2 ohm tap and the 8 ohm voice coil is connected to the 4 ohm tap. More than two lines should never be employed in this fashion.

VOICE COIL CONNECTIONS

Figure 20, section B and C, illustrates several ways in which a number of speakers can be connected to a transformer similar to the one shown in section A. In each case when only one voice coil or line winding is employed the total load must equal the specified value. If two voice coils or lines are employed,

the load on each winding should be twice the specified value, or half of it, when they will be connected in series.

The voice coils used in present-day dynamic speakers have impedances ranging from 1 to 15 ohms, and hence at all times require matching transformers. The quality of this transformer governs the amount of power and frequency response which will be transferred to the speaker. The effect of different quality output transformers is discussed on page 14.

PHASE RELATIONS

When two or more dynamic speakers are used on the same baffle or in the same room, it is necessary that proper phasing exist. That is to say, all cones must move in the same direction at the same time. Before mounting the speakers this can be checked by simply turning the two speakers so that their cones face each other. If they are in phase the volume will decrease, if they are not the volume will increase. This is due to the fact that when the speakers are in phase, they are "pushing" and "pulling" at the same time, and if the diaphragms or cones are placed so that the air impulses travel towards each other, they will meet in the center and "buck" each other, thus decreasing the effective volume. If they are out of phase when placed in the position described above, the volume will increase, because one will be "pushing" while the other is "pulling." The effect in this case is analogous to the action of a "push-pull" amplifier.

When two speakers out of phase are placed in their normal operating position, i.e., parallel to each other, distortion will occur, inasmuch as one will be pulling the air back to the same degree as the other forces it out. However, when two speakers are located on opposite sides of a room, and facing each other, they should be out of phase, for the reason described above. In this instance, if the speakers are in phase, the volume in the center of the room will be much lower than in the other case, due to the "bucking" effect which will occur at that point.

Where a number of speakers are employed, they can be checked by matching all of them to a standard. To change the phase relation, if it is not correct when first tried, it is only necessary to reverse the voice coil leads on one of the units. If the speakers are already mounted, the change can be made and the results noted by ear. Simply alter the connections on one voice coil until maximum volume is obtained.

TRANSMISSION TO REMOTE POINTS

In almost every public address installation it is necessary to transfer the output of the amplifier to several remote points. In many installations when this is attempted great losses of power and tone quality usually occur, due to the fact that incorrect impedance lines are employed. When selecting the proper impedance line two factors have to be considered. First, if a high impedance line is employed, the capacity between the two wires will seriously effect high frequency response of the system. If a very low impedance line is utilized, the resistance of the wire will induce large power losses. It has been found that any line between 200 and 500 ohms is the best medium for transmission work. However, irrespective of the line impedance value used, a certain amount of loss will be encountered, due to the additional transformer required. With a 500 ohm line, using Lafayette special P.A. line matching transformers, a loss of approximately 20 percent occurs. Therefore, it is always advisable to connect the speakers directly to the amplifier, if possible, in order to procure maximum power transfer to them. Figure 21 illustrates how to connect any number of speakers by means of a 500 ohm line. This should always be referred to before attempting to arrange a combination of speakers.

In small installations, using only one speaker for phonograph reproduction, etc., a 500 ohm line should never be employed because of the additional loss which results. Also, as stated in a previous chapter, the output transformer should always be included on the speaker for economical reasons.

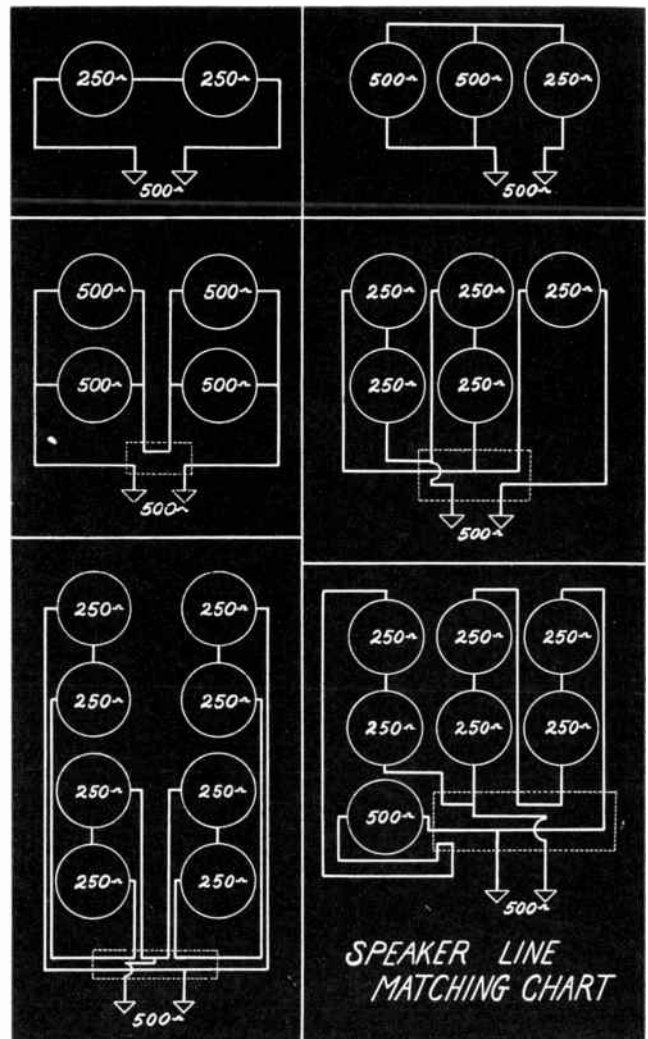

FIGURE 21

Correct methods for connecting from 2 to 8 transmission lines to a 500 ohm amplifier output, employing a standard line to voice coil matching transformer, having a 500 ohm primary tapped at 250 ohms.

EQUAL POWER DISTRIBUTION is obtained only when even multiple combinations are used, i.e., 2, 4, 8, etc.

UNEQUAL POWER DISTRIBUTION is obtained when odd multiple combinations are utilized, i.e., 3, 5, 7, etc.

SEPARATE LINES should be extended to each location so that the actual combining will occur at the amplifier proper.

WHEN ANY TRANSFORMER is employed to couple or match two different line impedances, considerable loss occurs, as stated on page 14. Therefore, as many voice coils as possible should be connected to each transformer by methods shown in fig. 20, sections a, b, and c, in order to keep this loss at a minimum. The minimum loss which occurs in any line combination is approximately 15 percent.

The reader learning for the first time the facts set forth in this chapter regarding speakers will readily realize that in order to obtain proper results from any sound installation, many factors must be taken into consideration. Yet, some of our most experienced sound men fail to realize this condition. The type of orders received by various amplifier manufacturers will substantiate this statement. For instance, an order will come through for a \$100 6 volt mobile amplifier, a \$25 microphone, a \$10 coupling stage and two \$12 8 inch cone type dynamic speakers to be used on a sound truck, when, as stated before, only trumpets are suitable for outdoor work. The amplifier was probably condemned as not having sufficient power by the sound "expert" who placed this order.

Above all, if you do not feel competent to select the proper equipment, either consult a sound expert or write to the manufacturer, who will be more than glad to advise you in the best manner possible. It is always the best policy before purchasing sound equipment to consult the manufacturer as to whether you are correct in your selections.

RECORDERS AS OUTPUT CONVERTERS

A form of output converter not discussed in the preceding paragraphs is the recording unit. This device resembles very closely a standard magnetic phonograph pick-up, and is used solely for the purpose of recording sound on various materials, such as aluminum, celluloid, and special compositions. In this manner, we can transfer Electrical impulses on to plates or records for future use. This direct method of recording is known as "Home" or "semi-professional" recording.

Practically, direct recordings may be made from any good amplifier, simply by feeding the output of this device to a mechanism, consisting of a heavy motor driven turntable and a "cutting head," or an electro-mechanical converter and driver unit.

To properly discuss the art of home recording would require many times the space available here. In view of this fact, only the important requirements will be stated. Also, since the major function of recording involves mechanical and physical laws, which cannot be treated at length here, only the electrical requirements will be given. It is, however, unnecessary for the average operator to know the intricacies of the physical angle, provided he follows very closely the instructions which are included with each recording mechanism.

The electrical requirements are:

First, the amplifier must be capable of responding to all frequencies necessary for good recording with the same degree of amplification. That is, from approximately 90 to 5000 cycles.

Second, the "cutting head" must be capable of converting the electrical impulses into corresponding "cutting" or vibrating physical impulses, to a greater degree on the high end of the audio spectrum, than the low one. This is essential, because the mechanical power necessary to cut at higher speeds, or "vibrations" is much greater than that required for the slower

vibrations. Also, the "cutting head" must be heavy enough to stand considerable power, inasmuch as approximately 2 watts, or a power level of 25 db is required to properly groove the average material. This value varies somewhat, depending upon the type of record material used. Obviously, the harder the material the greater the power required for impression, or "cut."

Third, a level indicator must be employed to check at all times, exactly how much power is being fed into the "cutting head." If this device is not employed, a very "sloppy" record will be obtained, since both under and overcutting will occur. A level indicator consists of a meter, calibrated in decibels, which is connected to the output of the amplifier, in order that the effective power output may be seen at a glance. This device operates on a 500 ohm transmission line, and if the "cutting head" has any other impedance, a suitable matching arrangement must be employed.

Fourth, the records must be made from a material which offers the least cutting resistance, and at the same time, will stand up when it is subjected to the constant wear of the play back needle. At the present time, the best known material for this purpose is a special non-inflammable acetate sprayed on an aluminum base.

Finally, we must know exactly how much pressure to apply in order to properly "cut" the various materials. The exact cutting angle, and number of line per inch must also be known. These factors vary on all recorders and recording materials, which means that we must follow the instructions included with the different devices if the best recording is desired. In conclusion, if the operator will follow very closely the rules mentioned above, as well as those set forth in the instructions included with each recording outfit, a record comparable to the standard phonograph disc in quality will be obtained.

THE DECIBEL AND ITS APPLICATION

INTRODUCTION

One of the most widely used terms in sound amplification is the decibel. Yet it is a known fact that this term, and its function, is the least understood of all the many units and quantities employed to depict certain conditions existing in the process of sound amplification. This abnormal condition has been brought about largely through the lack of forethought on the part of those directly responsible for the presentation of facts governing sound amplification, to the individuals actively engaged in the installation of sound equipment. In the majority of material available on this subject a lengthy discussion is given on the mathematical analysis but practically nothing is said about its application.

Knowing that the above mentioned condition exists, the authors have attempted, in the following paragraphs, to clarify matters so that those to whom this term has long been a mystery will fully understand its function and practical application in the installation of sound equipment.

Above all do not be alarmed if the following discussion appears to be too involved or complex at the start. It is necessary to use quite a number of large terms, in order to properly depict certain conditions, which tend to make the reading of this matter rather difficult. The authors have found that the best way to smooth the reading of this data is to always consider the very large fractional terms simply as very small quantities, rather than to determine just how small each fraction really is. It would be impossible to thoroughly digest the entire contents of the following paragraphs in one reading. Do not be discouraged if you are unable to comprehend fully the action of the decibel even after the fourth or fifth reading. Let your associates read this material and then discuss their reactions with yours and see if they tally. Assume some theoretical or practical examples, obtain the answers, and compare them with the data contained herein. In fact all that is required on your part is that you give the subject just a little more thought than usual and in the end it will be found to be an extremely simple one.

ORIGIN OF THE SYSTEM

The decibel, a unit in the Bell system, was first conceived by its namesake, Alexander Graham Bell, and at that time was known by telephone engineers as a "mile of standard cable," or the actual level of sound which existed after signals from a telephone transmitter, or microphone, had passed through a mile of telephone cable. Later a shorter term was adopted, i.e., the "TU" or transmission unit. Finally the "bel" was decided upon as being the most appropriate name for this function, by a convention held for this purpose. With the introduction of radio and high quality sound amplifying apparatus, a smaller unit was needed, hence the "decibel" which is 1/10 of one "bel."

To begin with the decibel, or db unit, is simply a convenient means of expressing a gain or loss ratio, and DOES NOT SIGNIFY ANY DEFINITE QUANTITY. Originally the "bel" was used entirely to express the loss which occurred in telephone lines. Later, it was found advantageous to use this unit to express both gain and loss in audio frequency circuits by using the smaller unit of this system, the decibel.

Before we consider the effect of ratios in electrical terms let us consider them when applied to some other widely separated field of application, for instance "germs."

If we culture a germ until it has multiplied itself 100,000 times, its mass will be increased by the ratio of 100,000 to 1, or 100,000 times. Instead of expressing this ratio increase in such large terms, suppose we apply the decibel system, using some arbitrary unit rather than the familiar decibel; "gg" or "germ gain" will satisfy our needs in this instance. We further assume that the germ gain is equal to 10 times the logarithm of the ratio increase to the base of 10.

$$\text{"germ gain"} = 10 \times \text{Log}_{10} \frac{\text{Total germs at the finish}}{\text{Total germs at the start}}$$

With this method we would have a 50 "gg" increase rather than a 100,000 ratio gain.

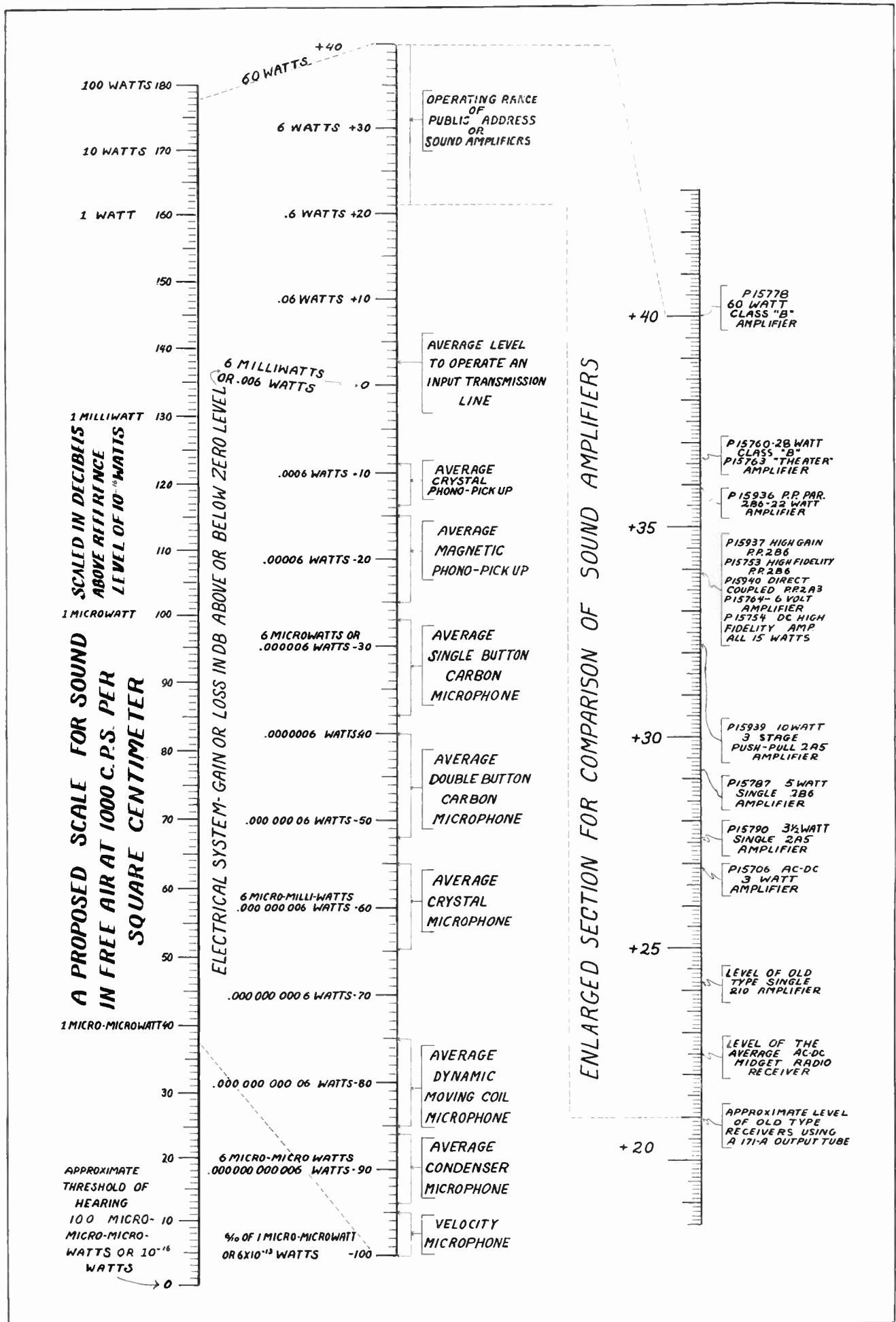

FIGURE 23

Thus:

The logarithm of a number to the base of ten is the number of times which we must multiply 10 by itself to equal that number, i.e., the log of 10 is 1 : 10 times unity is 10. The log of 100 is 2 : $10 \times 10 = 100$. The log of 1000 is 3 : $10 \times 10 \times 10 = 1000$, etc. Therefore, the logarithm of 100,000 is 5 which, when multiplied by the above mentioned factor 10, equals 50 or 50 "gg."

Now if we allow this group of germs to increase until the quantity of 1,000,000 has been reached, our ratio increase will be a million times, or 60 "gg" (the log of 1,000,000 is 6 which when multiplied by the factor 10 of our formulae, equals 60). In other words, we have actually increased the mass of germs by 900,000 units, while on the other hand, the ratio gain has only been increased by 10 "gg." When the original germ increased to 10 units we also had a 10 "gg" increase (ratio 10 times : log of 10 is 1 which when multiplied by the factor 10 = 10). Note that our mass at the start rose only NINE germs for a 10 "gg" increase while our mass at the finish had to rise NINE HUNDRED THOUSAND germs for a similar 10 "gg" increase. In other words, as the level of the mass rises the additional germs needed to effect an equal "gg" increase is not the same. Actually as the level rises, an increasingly greater quantity of germs is required to cause an equal "gg" increase. It goes without saying that 900,000 germs can create more trouble than only 9 germs. Therefore, this system is not applicable in this case, because it does not correctly express the effectiveness at different levels, or volumes of mass. Nevertheless, as will be shown later, this peculiar relation between the actual increase of mass, and the depicted effectiveness, is absolutely essential in order to properly express certain conditions existing in sound amplification. Comparatively, in the case of the germs, the increase in effectiveness is proportional to the increase in the size of the mass, whereas, in sound amplification, the effectiveness is not proportional to the increase in mass power, but rather follows a logarithmic scale.

In order to obtain a direct comparison of the peculiar relation between mass and effectiveness, let us employ practically the same example as the one involving the "germs" so that we may keep this discussion on a common basis.

THE DECIBEL

By definition "a 'bel' is the power loss which occurs in a mile of standard cable at 1000 cycles." Hence, we must consider our loss or gain in POWER and never in voltage or current values. The electrical term for power is the WATT. Substituting Watts for germs in our original example we obtain 100,000 watts output for a 1 watt input, or to express it in the same manner, our mass level increases from 1 watt to 100,000 watts. This is a ratio of 100,000 to 1 or 100,000 times. As stated before the log of 100,000 is 5 which, multiplied by the factor 10, becomes 50 but is now in decibels, instead of being in "ggs."

Our formulae is the same but the reading is different, i.e.

$$\text{DB. Gain} = 10 \times \text{Log}_{10} \frac{\text{WATTS at finish or WATTS OUTPUT}}{\text{WATTS at start or WATTS INPUT}}$$

Following the same procedure as before we now increase the output to 1,000,000 watts, a ratio of 1,000,000 times or 60 db (log of 1,000,000 is 6 which when multiplied by the factor 10 becomes 60).

Likewise, we have only a 10 db increase for a power rise of 900,000 watts. Similarly we also had a ratio increase of 10 db when the level was raised from 1 to 10 watts. In plain words, we have the same condition with watts as we had with germs. Namely, the increase in actual power in watts is not proportional to the increase in decibels. As the power level, or mass, rises, we must add an increasingly greater amount of watts to accomplish the same db rise. We are now at the point where this peculiar effect will work to our advantage if we use it correctly. Therefore note carefully the contents of the following paragraph, because, with the exception of the fact that it is easier to read large ratio gains and losses, in decibels, the conditions discussed therein are the definite reasons for the use of the decibel system.

RESPONSE OF THE HUMAN EAR

The human ear does not respond at all times with the same degree of sensitivity, but rather varies as the average level of sound to which it is subjected increases or decreases. Did you ever try to hear a pin drop in a quiet room? Then, just as the pin struck the floor, some fairly loud extraneous noise, created by the dog or some one opening a door, prevented you from hearing the pin hit the floor? Yet, on second trial, when you had absolute quiet, you heard the pin hit the floor with comparative ease. In both cases the pin generated just as much sound when it hit the floor, but the relative increase of the sound level was entirely different when the noise from the dog or door was present than when only the noise of a quiet room existed. Hence, an equal amount of sound power will not affect the ear to the same degree, when it is applied at different levels. When a person is listening to a high level of sound the additional amount of sound which must be applied to attract his attention is many times greater than the amount required to cause the same reaction when he is listening to a low level of sound.

Figure 22 depicts the function of the ear more clearly than any other method. The action is similar to the filling of an inverted cone with water. When the first two or three pints of water are added the level will rise very rapidly but toward the end many thousand times the amount of water will be required to effect an equal rise to that obtained when the first few pints were added. On the other hand if we use a straight sided cylinder the level will rise the same amount for each pint of water added.

It can be said that the sensitivity of the ear follows very closely a logarithmic scale. That is, as the level of the sound surrounding the ear rises, the amount of power necessary to create an additional sensation unit becomes increasingly greater. Hence, if we wish to express the effectiveness of a loss, or gain, in audio "sound power" as nearly correct as possible, we must employ a logarithmic scale. This scale should start at a level which is to be considered to be the point where the ear first detects sound, i.e., the "threshold of hearing."

When the ear operates at the threshold of hearing it is more sensitive than at any other time. The sensitivity DECREASES at a logarithmic rate until a point is reached where the greatest conceivable amount of additional power will not cause any sensation whatsoever. This is the limit of the hearing ability of an individual.

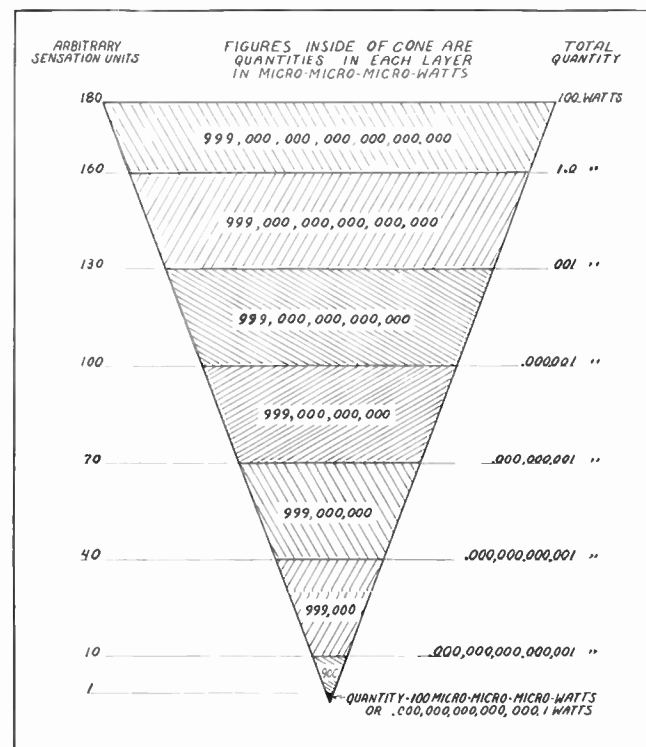

FIGURE 22

CAN YOU ANSWER THE FOLLOWING QUESTION?

1. Why does the motor of an automobile seem to operate with less noise at one time than another?
2. Why does a radio set seem to have more volume and better tone when you are listening to it in a quiet room than when you demonstrate it to friends?
3. Why are you unable to hear a person call you at times even though he has been calling you in the same tone of voice for the past ten years?

The answer to all of the above questions is that the noise level under different conditions does not remain constant at all times, and therefore the sensitivity of the ear does not remain the same. In fact if the ear did not function in this manner our hearing ability would soon be destroyed. If a gun were ever discharged near your ear while you were trying to hear a pin drop, the ear drum would probably burst, since the sensitivity would not decrease rapidly enough to prevent this excessive sound from finding its way to the ear drum.

APPLICATION

The first scale in figure 23, page 20, is for sound per square centimeter of free air, at 1000 cycles per second. The zero level in this instance is considered to be the amount of actual SOUND ENERGY in watts which must be expended, under ideal conditions, to create one arbitrary sensation unit. That is, one sensation unit is established when we first hear sound. This point is known as the threshold of hearing. The threshold of hearing is somewhat analogous to the "freezing point" on a fahrenheit thermometer, or the 32 degree level. Actually ice melts at 32 degrees, while water freezes at the smallest possible degree under that point. The threshold of hearing is reached when any decrease in the level will render the sound inaudible.

This scale will permit a fair conception of just how low the threshold of hearing can be, and also, how rapidly the decibel or "effectiveness" level increases by the addition of only a few thousand microwatts at the start. It will be noted that the ratio of one power level to the next level 10 decibels higher is always the same, but that the actual mass needed to create this new level exceeds the actual ratio increase many times.

Referring again to figure 22, we find this point illustrated in greater detail, since each block indicates just how much additional power has been added to bring the level up sufficiently to create the number of sensation units indicated at the left side of the cone in this illustration. The figures on the right side indicate the total amount of power involved from the beginning to that level. Particular attention should be given to the last step, or level, in this chart. The power necessary to accomplish this final step of 20 sensation units is 100 times greater than ALL of the power required to establish the previous 160 sensation units. It follows then that the greatest efficiency is obtained when the level of sound is at the lowest possible point. For example, if this sound power sold at 1 cent per micro-microwatt, it would cost \$9.99 to raise the power level from 40 sensation units to 70 sensation units. To bring about the SAME 30 SENSATION UNIT RISE from a level of 70 to 100 sensation units, it would cost \$9,990.00 This accounts for the fact that it is more effective to have several speakers operating in widely separated locations at low volume than to have one large speaker operating at great volume in a single location without even taking into consideration the loss of sound due to the resistance of the air.

ELECTRICAL SCALE OF DECIBELS

Returning to figure 23 we find a center scale which is the ELECTRICAL equivalent for the first or SOUND scale. It is this scale with which we are most concerned. The major difference between the two scales at first glance is that the sound scale is graduated only in plus decibels whereas the electrical scale has both plus and minus decibels.

The reason for this is that many of the input electrical devices have electrical power output levels which, after conversion into sound power, are many times lower than the zero, or threshold

of hearing, level. It was generally conceded at the time this chart was formulated, that .006 watts, or 6 milliwatts of electrical power was necessary to create the amount of sound power equal to that produced at the threshold of hearing on the sound chart, i.e., approximately 100 micro-micro-microwatts. This meant that the efficiency of the available means of sound conversion equipment at that time was capable of converting .006 watts of electrical energy into 100 micro-micro-microwatts of sound power. While the efficiency of our present day conversion equipment, namely dynamic speakers, at low levels has increased somewhat, .006 watts is still considered necessary to establish the threshold of hearing. Very often .006 watts is called the threshold of hearing which is incorrect theoretically. However, practically speaking, it amounts to the same thing. In other words if we wish to keep this system on a common basis, we must consider devices having electrical power output levels, which after conversion, do not produce enough sound power to be heard under ideal conditions, as being below zero or "par." Likewise those which produce more sound power than the minimum required for hearing under these same conditions would be considered as being above zero level or "par."

Now, as stated above, if we consider this .006 watt level as zero or "par," all devices which have GREATER electrical power outputs will naturally result in positive gains, or plus decibels, while those with SMALLER outputs will have negative gains, or more correctly losses, which are rated in minus decibel levels.

For example, if an amplifier has a 6 watt output its power level is 1000 times greater than the zero level which is .006 watts, or a power level of plus 30 db (log of 1000 is 3 which when multiplied by the factor 10 equals 30). That is, the amplifier is capable of producing 30 sensation units above the zero level.

At the same time, if we have a phonograph pick-up which has a power output of .000 006 watts, its power output level is 1000 times LESS than the zero level, and hence has a db power level of -30 db.

Now, if we couple this phonograph pick-up to the amplifier so that all of the power is actually transferred, how much gain will be required of the 6 watt amplifier in order to obtain the full power output of this unit? It is at this point that we arrive at the practical use of the decibel system.

PRACTICAL APPLICATION

The requirement is that the amplifier must be capable of developing 6 watts when only .000 006 watts is fed into the input by means of the phonograph pick-up. Hence it must have a POWER GAIN of 1,000,000 times, or 60 db, in order to raise .000 006 watts to 6 watts. Before the solution to this problem is discussed, it will be necessary for the reader to thoroughly understand the distinction between POWER GAIN and POWER LEVEL in order to fully comprehend the explanation which follows.

POWER GAIN is in reality a function similar to POWER LEVEL.

POWER LEVEL is the gain or LOSS above or below a **standard zero level**. In sound application this level is .006 watts. POWER GAIN is the gain, never a loss, above **a level which is the minimum amount of power required by the amplifier for maximum power output**. In other words, POWER GAIN is the ratio increase between the amount of power input and the power output.

To obtain the POWER GAIN of an amplifier we divide the input power into the output power and apply the decibel formulae to that ratio.

$$\text{Decibel Gain} = 10 \times \log_{10} \frac{\text{power output in watts}}{\text{power input in watts}}$$

POWER LEVEL indicates just how much greater the output of an amplifier is above the standard zero level, always in plus decibels

$$(a) \text{ Plus decibels level} = 10 \times \log_{10} \frac{\text{watts output}}{.006 \text{ watts}}$$

POWER LEVEL also indicates just how low the power output of a device, such as a phono-pick-up, microphone, etc., is below the standard zero level. This is always expressed as minus decibels or —db.

$$(b) \text{ Minus decibels level} = 10 \times \log_{10} \frac{.006 \text{ watts}}{\text{Watts output of the input device}}$$

EXAMPLE:

A 60 watt amplifier has an output level of plus 40 db. A certain phonograph pick-up has an output level of minus 30 db. How much POWER GAIN will be required of the amplifier for this combination to operate satisfactorily?

The problem is to raise the —30 db level of the pick-up to the plus 40 db level of the amplifier. Hence it will require a plus 30 db boost, by some means, to raise this —30 db level of the input device up to "par" or zero.

It will also require another 40 db boost to bring the zero level now obtained up to the 40 db POWER LEVEL of the amplifier. All together, we will require a total POWER GAIN of plus 70 db to bring the level of the pick-up from —30 db to plus 40 db. Hence, our amplifier must have a POWER GAIN of 70 db for this combination to operate successfully.

We can say then that the POWER GAIN of an amplifier indicates how low the POWER LEVEL of the input device can be below the POWER LEVEL of the amplifier in question and still produce maximum output when coupled to this amplifier. That is, if the POWER LEVEL of an amplifier is plus 40 db and has a rated POWER GAIN of 70 db, WE NEED ONLY SUBTRACT THE POWER LEVEL OF THE AMPLIFIER FROM THE RATED POWER GAIN and we obtain as our answer THE MINIMUM MINUS POWER LEVEL that an input device can have in order to operate this amplifier at its maximum output, i.e., 70 — 40 = 30.

In the same manner, if we add the plus POWER LEVEL of the amplifier to the minus POWER LEVEL of the input device, we will obtain the amount of POWER GAIN required to operate the system in question, i.e., plus 40 added to minus 30 equals 70 (algebraically the sum of these two quantities would be plus 10, but, since we must consider that a plus 30 db boost is required in order to bring the minus term up to the "par" level, we add the two quantities as though the signs do not exist).

Returning to the **original problem** where a POWER GAIN of 60 db was needed in order to operate a pick-up having a POWER LEVEL of —30 db, in conjunction with an amplifier producing a plus 30 db POWER LEVEL, we note that the POWER GAIN could have been determined simply by adding the two power levels.

If the rated power gain of the amplifier was 70 db, an excess of POWER GAIN of 10 db would be available. Unless this gain is attenuated in some manner the amplifier will be overloaded when this particular device is coupled to it. Therefore since it is always desirable to have some excess gain available in a sound system, a volume control should be employed to compensate for the various levels which the input device may produce under different conditions. It must also be remembered that the rated power output, or POWER LEVEL, of any input device is the average to be expected under ideal conditions, and hence should not be considered as the exact amount of power output to be expected at all times. At least a 10 percent allowance should be made for variations in determining the required amount of gain for any sound system. If an amplifier has considerably more power gain than required, for example, if in the latter instance it was 90 db instead of 70 db, a permanent attenuation control could be installed to cause a loss of 20 db. Complete data on this type of attenuation pad is given on page 9 under the title of "Mixers."

Should the rated POWER GAIN of an amplifier prove to be insufficient to operate with a certain input device, we will of course require additional amplification. However, the majority of commercial amplifiers have sufficient POWER GAIN to operate with any of the common forms of input devices such as carbon microphones, pick-ups, radio tuners, etc. Also, in the

majority of cases, if an amplifier does not have sufficient POWER GAIN a certain type of pre-amplifier is recommended. Likewise, in most cases, if a certain type of microphone does not have a high enough POWER LEVEL to operate on the average amplifiers a special pre-amplifier is listed together with the device. A condenser microphone is a typical example of this procedure.

USE OF FIGURE 23 FOR DECIBEL REQUIREMENTS

By employing the two electrical scales in figure 23 it becomes a comparatively simple matter to make all comparisons of sound equipment, as well as to determine the actual POWER GAIN required to operate any combination.

If you desire to know the amount of POWER GAIN required to operate any input and amplifier combination, simply place one finger on the POWER LEVEL of the input device and another on the POWER LEVEL of the amplifier, add the two figures, and you have the POWER GAIN required.

In order to compare the relative effectiveness of two power amplifiers when all of the power is distributed to a single locality we use the enlarged section of the electrical scale, which is the third scale, or the first scale on the right. For example if we desire to know the relative difference between two power amplifiers, one having a power output of 10 watts and the other 22 watts, we note that a 10 watt amplifier has a POWER LEVEL of 32.2 db while the 22 watt unit has a POWER LEVEL of 35.9 db. Therefore the 22 watt unit will be 3.7 db more effective (3.7 db equals the difference in wattage: 12 watts) provided all of the power is delivered to one location.

In order to increase this effectiveness we must distribute the sound in some manner. Assume that our means of transmission is 50 percent efficient which includes the losses encountered in the lines, transformers, etc., we would be able to transmit 1 watt to 5 separate locations. Now instead of creating one 32.2 db level, as in the first case, we would establish five 1 watt levels or 5 22 db levels making a total of 110 db units. Note the greatly increased effectiveness of the amplifier when the power is distributed in this manner.

Now, if we distribute 22 watts (the output of the second amplifier), with 50 percent efficiency, or 11 watts, to 5 locations or 2.2 watts to each location, we will establish a 25.6 db level at each point or a total of 130 db.

Hence when we distributed all of the additional power to one location only a 3.7 db increase was obtained whereas when we distributed this power to 5 locations the increase was 20 db units (130-110). It follows then, that to obtain the greatest amount of effectiveness from a given amount of power we must distribute this sound to as many locations as is economically possible.

DISCREPANCY IN THE DECIBEL SYSTEM

Only one discrepancy occurs in this decibel system which is as follows:

All measurements are in POWER. The input of an amplifier, however, functions only on the VOLTAGE supplied to it and never (with the exception of a strictly Class "B" Booster) requires power from the input source. By Ohm's law the voltage varies in direct proportion to the impedance or resistance. That is for the same watt power, we can have different values of voltage simply by varying the resistance or impedance. Therefore, the higher the input impedance of the device connected to the amplifier, the greater the amount of voltage supplied and likewise, a higher effective POWER GAIN. 150,000 ohms is the value with which all power calculations are made to determine the POWER GAIN of an amplifier. Therefore if the input impedance which is connected to the amplifier is less than 150,000 ohms, we must expect the gain to be lower than the rated amount. If the input impedance is higher, more than the rated gain will be obtained. For example, if we connect a 2000 ohm pick-up directly to the grid of an amplifier we will not obtain either the effectively rated power level nor the rated power gain of the amplifier. However, if we employ a matching transformer to bring the 2000 ohm impedance up to 150,000, we will obtain

the RATED quantities. In practical application, a phono-pick-up usually has sufficient output to compensate for the mis-match, and hence this procedure is unnecessary.

DECIBEL RATING OF HUM LEVEL

It is common practice, among the larger amplifier manufacturers, to apply the decibel system when stating the hum level of any sound device operated on alternating current. This method is employed because it depicts the effective annoyance which may be expected from this unwanted sound, under average operating conditions, in the same manner that the decibel expresses the effective power output of an amplifier.

As stated, the sensitivity of the human ear decreases as the average level of sound surrounding this organ increases. Likewise, as the POWER LEVEL of an amplifier increases the relative effect of an equal POWER LEVEL of hum, decreases. That is, it is assumed that a microvolt of hum will be more noticeable on a low power amplifier than on a high one. Hence, the HUM LEVEL of an amplifier is rated as being a certain number of decibels below the POWER LEVEL, or maximum power output. HENCE:

The hum level in decibels below maximum output is:

$$DB. = 10 \times \text{Log}_{10} \frac{\text{POWER LEVEL OF AMPLIFIER IN WATTS}}{\text{OUTPUT HUM LEVEL IN WATTS}}$$

EXAMPLE:

Hum level .000 006 watts

Power level of amplifier of 6 watts

Six watts divided by .000 006 watts equals 1,000,000. The logarithm of 1,000,000 is 6, which, when multiplied by the factor 10, equals 60, or 60 db. Hence, our hum level in this case is one million times lower than the power output, or 60 db

below maximum output. If the amplifier had a power output of 60 watts instead of 6 watts, the ratio would then be 10,000,000 to 1, or 70 db below maximum output.

It is apparent from the above example, that the higher the output of the amplifier, the lower the hum level in decibels for an equivalent hum power in watts. That is, for the same hum level in watts, volts, amperes, etc., the actual decibel hum decreases as the power output of the amplifier increases. This peculiar effect again makes the decibel system absolutely essential in order to properly depict this important characteristic of a sound amplifier, so that the sound technician may compare relative hum levels at will.

CONCLUSION

The authors realize that this discussion on the decibel and its application has been very lengthy and somewhat complex. As stated at the beginning, considerable thought must be given to this major function of sound amplification, and therefore we again suggest that you not only read but also study the data contained herein very carefully. To the best of our knowledge this is the first time that any attempt has been made to explain the function of the decibel system to those who need to understand its function most. The authors are greatly interested in finding out the reaction of you, the sound technician, to our attempt to clarify this point. If we have aided you in any manner, or if we have failed to make one or more points clearly understood, won't you let us know? Address all communications to THE EDITORS, SOUND, ITS FUNDAMENTALS AND METHODS OF APPLICATION, LAFAYETTE RADIO MANUFACTURING CO., 100 SIXTH AVENUE, NEW YORK CITY, N. Y.

THE following section of this manual is devoted to a presentation of the products of the Lafayette Radio Manufacturing Co., the publishers of this manual. While, in time, the products described herein may be superceded by newer models, we feel sure that the wealth of information presented in the foregoing pages will serve as a guide and prove of sufficient value to cause you to preserve this book, and to use it in your everyday work.

All of the equipment manufactured and sold by the Lafayette Radio Manufacturing Co. and associated companies must pass the most rigid tests and is continuously subjected to the most careful inspection to insure rigid adherence to the highest quality standards. Prices, despite this care in maintaining a quality standard, are nevertheless surprisingly low. A completely equipped laboratory with the most modern instruments, such as audio oscillators, cathode-ray oscillographs, signal generators, etc., is maintained for the express purpose of assuring and maintaining high quality. You are invited to visit us and inspect this equipment.

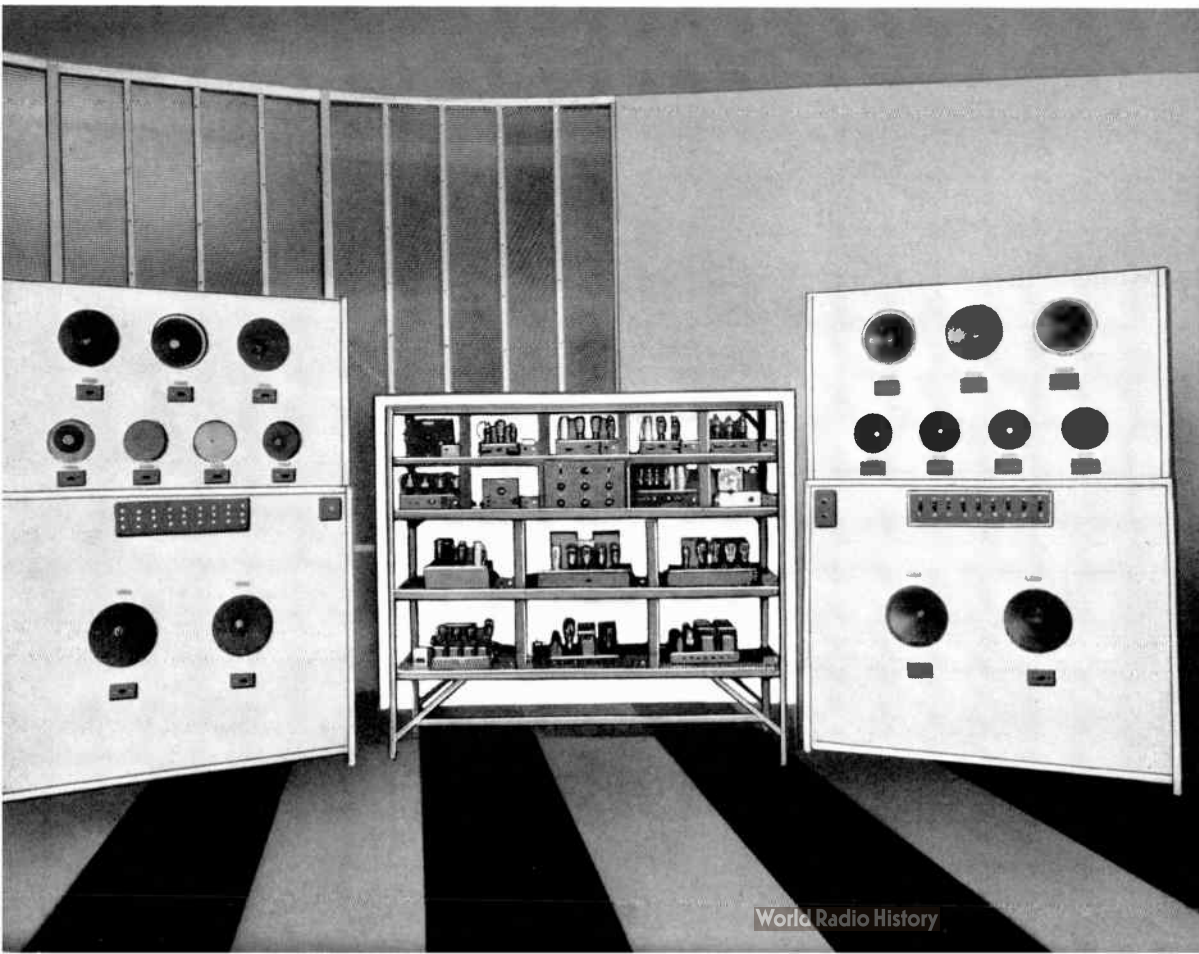

A section of our Auditorium used for demonstrating sound amplifiers and associated equipment.

The "Universal" A.C.-D.C. Amplifier

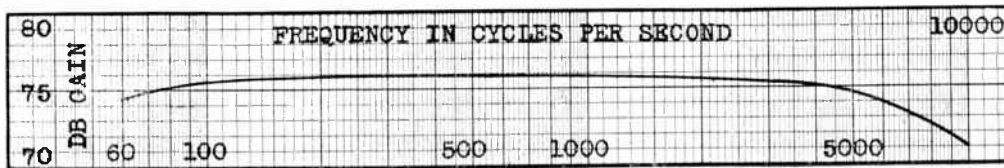

Operates Efficiently On Either Alternating Or Direct Current

MANY dealers make a practice of renting out public address systems and these systems are therefore likely to be used in locations with varying types of current supply. One location may have only A.C. available and still others only D.C. Amplifiers used by road shows, vaudeville acts, demonstrators, etc., are also used under the same handicap. Previously this was overcome by using a cumbersome and expensive converter to change the D.C. to A.C. This is no longer necessary because newer tube developments have made it possible to design an amplifier that will perform satisfactorily irrespective of whether it is operated on A.C. or D.C.

THE CIRCUIT

The circuit of the amplifier is as follows: a 37 triode tube is resistance-capacity coupled to another 37, which in turn is transformer coupled to a pair of 43 tubes in class "A" push-pull. A 25Z5 rectifier is used to supply plate voltage to the tubes and another 25Z5 is used to supply field current for two speaker fields of 2500 ohms each. While the 43 tube is rated by the manufacturers as having an output of 2 watts with 135 volts plate supply, it is actually possible under average conditions, due to losses in the filter system and the self-biasing resistor, to obtain no more than .9 to 1 watt. This difficulty has been overcome by the use of a biasing battery, the life of which is infinite. The power output is 3 watts—peak 4 watts.

TONE QUALITY

Good frequency response has been obtained in this amplifier, as will be seen by a glance at the response curve shown herewith.

POWER

This amplifier has an average output level of 26.9 db and a peak level of 28.3 db.

GAIN

The use of three stages in this amplifier provides the exceptionally high gain of 74.3 db. This is sufficient in most cases to eliminate the need for microphone pre-amplification.

FIELD SUPPLY

Field supply is available for two 2500 ohm speaker fields. This makes it possible to use the cheaper D.C. type of speaker rather than the more expensive A.C. type and considerably reduces the cost of a complete system.

INPUT IMPEDANCE

Input impedance is 500,000 ohms directly to the grid of the 37 tube. A high impedance pick-up can be connected directly to the amplifier without using a matching transformer. Low impedance pick-ups and microphones must be used with a suitable matching transformer.

OUTPUT IMPEDANCE

Output impedance of the amplifier is that of the plate load of the tubes—in this case 5000 ohms. A suitable output transformer with this primary impedance must be used to match the amplifier to the speaker voice coil or line.

HUM LEVEL

Hum level is 57 db below maximum output when operated on A.C. Exceptionally low resistance filter chokes are used so as to obtain all the voltage possible when operated on D.C.

LIST PRICE

UNIVERSAL A.C.-D.C. AMPLIFIER. Dimensions are 16" wide, 7½" deep, 8" high. Model P 15705. Less tubes and less output transformer. **List price . . . \$30.00**
 KIT OF SPECIALLY MATCHED TUBES. **List price . . . \$11.40**
 TWO SPECIALLY MATCHED SPEAKERS with output transformers. Model P 15746. **List price each . . . \$10.00**

A LABORATORY TESTED *Lafayette* PRODUCT

The "Utility" Single 2A5 Amplifier

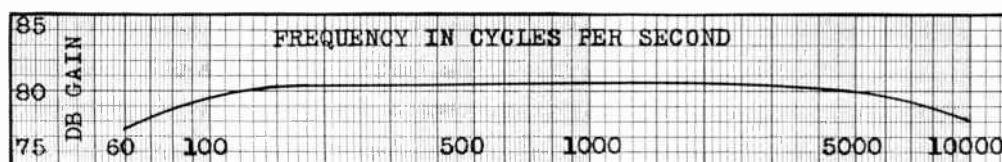

A Competent High Gain Amplifier for General Usage

THIS versatile little unit is the most efficient and compact amplifier for general utility use that could be desired. It is adaptable for use wherever an amplifier that has considerable gain, a fair wattage output with low current consumption, and really good fidelity is required. Many hundreds of these units are being used in connection with phonograph pick-ups where their extreme compactness and excellent tone quality are especially advantageous. Others have been, and are being, used with microphones for demonstration purposes in the retail sales field. Still others are being used with electronic devices, such as photo cells, that are finding wider application in industry every day. In short it is a jack-of-all-trades in the amplifier family, but, unlike its name-sake, it is a master of all of them.

THE CIRCUIT

The circuit used in this amplifier is simple and fool-proof. A high gain type 57 pentode tube is resistance-capacity coupled to a type 2A5 pentode. This provides the extraordinary gain of 80.2 db and the exceptional power output of 3½ watts. Current for these tubes is furnished, in humless form, by a carefully designed rectifying system using an '83 tube.

TONE QUALITY

In the description of an amplifier of this size, and at this price, it might be expected that no mention would be made as to the degree of fidelity obtained. Normally an amplifier of this type would not be expected to have a very good response curve. We are, however, extremely proud to publish the frequency response curve obtained with this amplifier. A glance will show the remarkable flatness obtained over the audio frequency band.

POWER

A conception of the power of this amplifier can be obtained by referring to the chart shown on page 20 and comparing it with the average power level of the amplifier which is 27.6 db. The peak power level is 29.5 db.

SPEAKER FIELD SUPPLY

Field current for any speaker with a 2500 ohm field (requiring no more than 6 watts for excitation) is furnished by the ampli-

fier. This makes it possible to use the cheaper D.C. type of speaker, thereby bringing the cost of a complete system down lower than would be possible if the more expensive A.C. type were used.

INPUT IMPEDANCE

The high impedance input of 500,000 ohms makes it possible to connect a tuner to the amplifier with only a fixed condenser in series. A high impedance pick-up may also be connected directly, without the use of a transformer. Low impedance pick-ups and microphones are, of course, used with suitable matching transformers.

OUTPUT IMPEDANCE

Output is directly from the plate of the 2A5 tube requiring a load impedance of 7000 ohms. Any output transformer having this impedance may be used with the secondary matching either speaker voice coils or lines. Many speakers are already equipped with transformers having this impedance since it is similar to that of the popular 47 tube and they can therefore be used successfully. However, if a number of speakers are to be used, a line matching transformer would be preferable.

HUM LEVEL

Hum level is actually 63.3 db below maximum output level. This has been accomplished through the use of plate filtering for the 57 tube in addition to the condenser input filter circuit using a tuned choke. The speaker field (if used) is employed as an additional choke also by-passed by a filter condenser making a total of three condensers in the filter circuit. A 10,000 ohm bleeder protects the condensers against voltage surges while the tubes are heating.

LAFAYETTE UTILITY HIGH GAIN AMPLIFIER. LIST PRICE
Dimensions are 8" wide, 6" deep, 5½" high. Shipping weight, 15 lbs. Model P 15790. Less tubes, and less output transformer. List price **\$19.90**

KIT OF MATCHED TUBES. List price **\$4.75**

SPECIALLY MATCHED SPEAKER complete with output transformer. Diameter 8". Shipping weight, 5 pounds. Model W 19288. List price **\$8.00**

A LABORATORY TESTED *Lafayette* PRODUCT

The "Little Hercules" 2B6 Amplifier

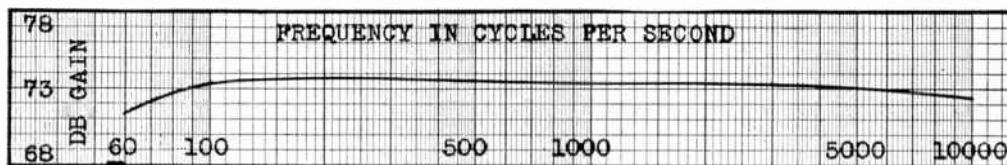

Especially Suitable For Recording Purposes

IN many instances a powerful high quality amplifier is required, yet, for various reasons, it must be extremely compact in size. For such requirements this new 2B6 amplifier is ideally suited. Despite its small size it has both power and an excellent response over the audio frequency band. Due to its faithful frequency response it is especially suited for recording purposes in experimental and home installations. It also finds application in connection with small public address systems and in commercial applications for use with photo-cells, etc. In fact it can be used wherever the compactness of the "Utility" model is desired, but where a greater output than that model amplifier produces is needed.

THE CIRCUIT

The circuit, while novel, is simple and foolproof. A 57 high-gain pentode tube is resistance-capacity coupled to the new dual triode 2B6 tube. A gain of 73.5 db is obtained with the extraordinarily high output of 5 watts. Plate supply for these tubes is furnished, in humless form, by a 5Z3 high vacuum rectifier tube, used in a combination brute force, tuned choke, filter system.

TONE QUALITY

The new 2B6 tube, used in this amplifier, is a specially developed high output dual triode. By using this tube in a carefully balanced circuit an outstandingly fine frequency response curve is obtained. At the top of this page is illustrated a typical response curve obtained with this amplifier and a careful inspection will testify to the unusually faithful frequency response.

POWER

The "Little Hercules" Amplifier has been very conservatively rated at 5 watts with a peak output of 7 watts. This corresponds to a power output level of 29.2 db average, and a peak level of 30.7 db. By comparing this output with the chart on page 20 a clearer conception of its power can be obtained. And by comparing the power output of this amplifier with other amplifiers

of similar dimensions it will be easily realized what a tremendous advancement has been made in the design of this new model.

HIGH GAIN

The gain of 73.5 db permits the use of a carbon microphone (when spoken into directly) without pre-amplification. This is of particular advantage if the amplifier is to be used for the recording of speech only.

INPUT IMPEDANCE

High impedance input (500,000 ohms) to the amplifier makes it possible to connect a radio tuner with only a small fixed condenser in series. A high impedance pick-up can be connected directly. Low impedance pick-ups and microphones must, of course, be used with suitable matching transformers.

OUTPUT IMPEDANCE

Output impedance from the amplifier is directly from the plate of the 2B6 tube—5000 ohms. Suitable matching transformers to match this output to any voice coil or line impedance will be found listed on pages 56-57 of this manual.

RUGGED CONSTRUCTION

In building this amplifier only components of the highest quality are used so that failure due to the breaking down of any part is practically unknown. All components are considerably oversize and are capable of carrying considerably greater loads than are ever placed upon them. Chassis is of heavy steel with spot welded corners and is black crystallized lacquered both inside and out. A standard Lafayette practice.

LAFAYETTE "LITTLE HERCULES" 2B6 AMPLIFIER. LIST PRICE
Size 8½" wide, 6" deep, 5⅛" high. Shipping weight, 17 lbs. Model P 15787. Less tubes and less output transformer. List price **\$25.00**

KIT OF MATCHED TUBES, 1-57, 1-2B6, 1-5Z3. List price **\$5.65**

A LABORATORY TESTED *Lafayette* PRODUCT

"Ultra High Gain" P.P. 2A5 Amplifier

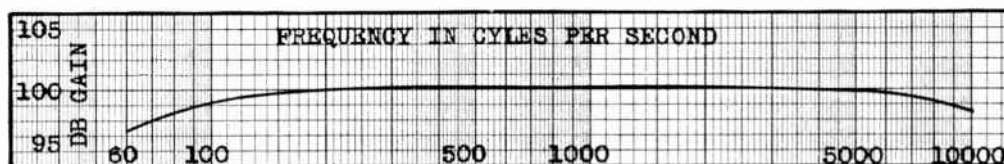
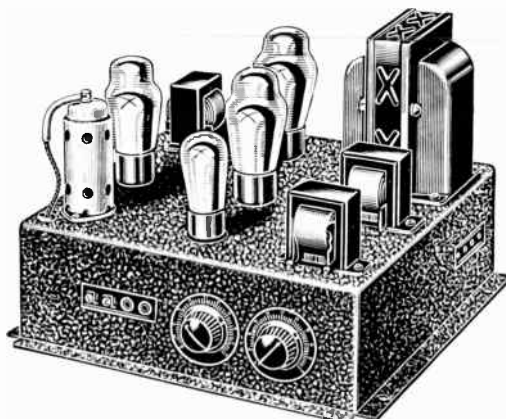

Exceptionally High Gain With a 10 Watt Output

IN many cases an amplifier with nominal power but with fairly high gain is desired. This 3 stage amplifier has been especially designed for such instances. It is excellent for use with a carbon microphone without the need for pre-amplification. And its price is so low that a complete P.A. system consisting of a microphone, input stage and speaker can be assembled at an amazingly low cost. A high gain amplifier such as this is also of advantage for use with various electronic devices. The addition of both gain and tone controls is of great assistance in practically all installations and is seldom found in amplifiers at this price.

THE CIRCUIT

The circuit used consists of the following: a 57 high gain pentode tube resistance-capacity coupled to a type 56 tube which is in turn transformer coupled to a pair of 2A5 tubes in push pull. More than ample plate current is supplied by a 83 rectifier tube. This circuit has a gain of 100.2 db and an average output of 10 watts, with a peak output of 14 watts.

tone quality

In a high gain amplifier tone quality or frequency response is often sacrificed to increase gain. This has not been done in this amplifier, as will be readily seen by a glance at the response curve shown herewith. In certain cases it is advantageous to decrease the high frequency response of the amplifier. This can readily be accomplished by the adjustment of the tone control, which will cause the lows to be more pronounced.

POWER

The power of this amplifier can best be appreciated by comparing its average output level of 32.2 db and its peak level of 33.6 db with the chart on page 20. This, it will be readily seen, is sufficient for the majority of installations.

INPUT IMPEDANCE

This amplifier is equipped with two inputs. The first is into the

first stage and has a maximum impedance of 500,000 ohms. This permits connecting a high impedance device directly to the amplifier. A low impedance device such as a microphone must be used with a suitable matching transformer. A gain control is provided in the first stage only. The second input, which is for use with a phono-pick-up, is into the second stage and is also 500,000 ohms. The reason for furnishing this input is because if a regular pick-up is connected to the first stage, the gain is so great that the power tubes actually overload. This input is not equipped with a gain control and a separate volume control must be provided on the pick-up or device used.

OUTPUT IMPEDANCES

Output impedances are as follows: 8 ohm for voice coil and 500 ohm for line. An additional 2 ohm voice coil output is also available if desired. This amplifier is also available without the output transformer. When so supplied the output impedance directly to the plates of the tubes is 10,000 ohms.

HUM LEVEL

Hum level, despite the high gain, is 64.7 db below the maximum output level. This is due to the use of more than the usual amount of filtering throughout the circuit. The use of heater type tubes throughout also contributes to the low hum level.

CONSTRUCTION

The chassis is of heavy gauge steel with spot welded corners and is finished in durable black crackle lacquer.

ULTRA HIGH GAIN 3 STAGE AMPLIFIER. Dimensions are 12" square, 9½" high. Shipping weight, 30 lbs. Model P 15939. **LIST PRICE**, less tubes and output transformer **\$39.00**

ULTRA HIGH GAIN AMPLIFIER. Complete with transformer but less tubes. Model P 15941. **LIST PRICE** **\$46.50**

KIT OF SPECIALLY MATCHED TUBES. **LIST PRICE** **\$7.55**

A LABORATORY TESTED *Lafayette* PRODUCT

The "De Luxe" P.P. 2A3 Amplifier

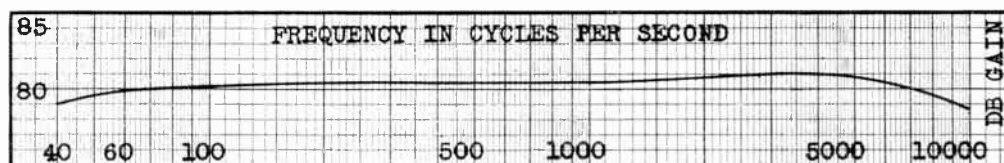
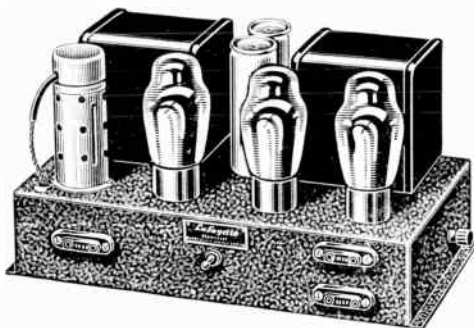

An Excellent 15 Watt Unit For Use In a Medium Powered P.A. System

THIS push-pull 2A3 Amplifier is the ideal unit to use wherever moderate power with outstandingly fine tone quality is desired. Its power output is such as to particularly fit it for use in the average medium sized dance hall, theater or other gathering place. It is for these reasons the most popular unit of this popular line, and it adequately fulfills the demand for an amplifying unit that can be depended upon for satisfactory day-after-day performance in installations of this character.

THE CIRCUIT

The circuit used is of the direct coupled type, which is definitely superior in both gain and frequency response, but which is rarely used in amplifiers at anywhere near this price, because it is more expensive to build due to the high voltage required. It is only because a ready consumer acceptance makes possible quantity production that we are able to offer an amplifier of this type at this price. A 57 pentode is direct coupled to a pair of 2A3 triodes in push pull. A 5Z3 high vacuum tube is used as rectifier. An exceptionally high gain of 80 db with an output of 15 watts (peak 18 watts) is obtained. This gain, in the majority of cases, eliminates the need for pre-amplification when a carbon microphone is used.

TONE QUALITY

The frequency response of this amplifier is particularly good due to the unique method of neutralization employed. A glance at the response curve, shown herewith, will testify to the quality of reproduction obtained with this amplifier. This is of great importance when the amplifier is to be used for the amplification of orchestral music.

THE POWER

The power of this amplifier can best be realized by comparing its average power level of 33.9 db and its peak level of 34.7 db with the chart shown on page 20.

FIELD SUPPLY

Field supply for four 1500 ohm or two 3000 ohm seven watt fields can be obtained from the amplifier, thus eliminating the

need for separate field exciters and thereby considerably reducing the cost of the complete installation.

INPUT IMPEDANCE

Input impedance to the amplifier is 500,000 ohms. This makes it possible to connect a high impedance pick-up directly to the input connections of the amplifier without a matching transformer. A radio tuner can be connected through a small fixed condenser in the same way. Low impedance pick-ups and microphones must be used with a suitable matching transformer.

OUTPUT IMPEDANCES

Output impedances are as follows: When supplied with an output transformer, an 8 ohm voice coil and a 500 ohm line impedance are available at the terminals. An additional 2 ohm voice coil lead, that can be substituted for the 8 ohm lead, is also available. When supplied without the transformer the output impedance directly to the plates of the tubes is 5000 ohms.

HUM LEVEL

The exceptionally low hum level of 75 db below maximum output has been obtained through the careful filtering of the plate supply to all tubes. In the filter circuit two low resistance chokes and 16 mf. of capacity assure good filtering and regulation.

CONSTRUCTION

All components used in the construction of this amplifier are considerably oversize and will safely carry far greater loads than will ever be placed upon them. Chassis is of steel with spot welded corners.

DE LUXE PUSH PULL 2A3 AMPLIFIER. Dimensions LIST PRICE
are 12" wide, 7" deep, 7½" high. Shipping weight, \$53.00
30 lbs. Model P 15940. List price, less tubes and
output transformer

DE LUXE AMPLIFIER complete with output transformer but less tubes.
Model P 15942. List price \$60.00

KIT OF SPECIALLY MATCHED TUBES. List price \$11.15

A LABORATORY TESTED *Lafayette* PRODUCT

High Gain Push-Pull 2B6 Amplifier

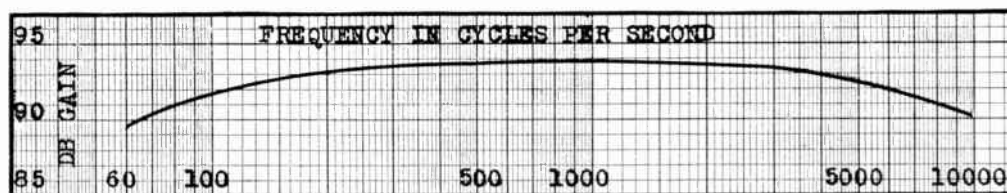
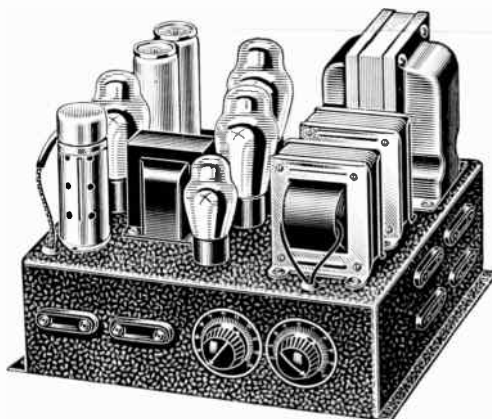

THE excellent performance of this high gain amplifier, and its exceptionally fine dollar value, might easily lead us into using a string of superlatives in describing it. Instead, however, we will let the specifications, given below, give you the true picture of how well it performs. The price, of course, speaks for itself.

THE CIRCUIT

The circuit used is simple and foolproof. A type 57 pentode tube is resistance-capacity coupled to a type 56 triode which, in turn, is transformer coupled to a pair of 2B6 duo-triodes in push-pull. The 2B6 duo-triode is a newly developed tube having a greater gain than former triodes yet retaining all the tone quality (frequency response) advantages of these tubes.

HIGH GAIN

An exceptionally high average gain of 92 db has been obtained thus making possible the use of a carbon microphone without pre-amplification under average conditions. This high gain is also of advantage in many industrial amplifier applications.

tone QUALITY

Tone quality or frequency response of the amplifier is exceptionally good as the curve illustrated above will show. The amplifier is equipped with both gain and tone controls so that the tone and volume may be modified to suit the acoustical conditions of the room.

POWER OUTPUT

The correctly designed circuit incorporating the use of the 2B6 tubes provides a conservatively rated output of 15 watts! And a peak output of 20 watts! This corresponds to an average output level of 33.9 db and a peak level of 35.2 db. By comparing these figures with the chart on page 20 a clearer understanding of their meaning can be obtained. This high power output permits the operation of as many as 10 speakers with ease, more than enough for the average indoor installation and many outdoor installations.

INPUT IMPEDANCE

Standard high impedance (500,000 ohms) input to the amplifier is used. A high impedance phono-pick-up may be connected directly. Low impedance pick-ups and microphones must be used with suitable matching transformers.

OUTPUT IMPEDANCES

The amplifier is supplied in either of two ways—with or without output transformer. When the amplifier is not equipped with an output transformer the output is directly from the plates of the 2B6 tubes having an impedance from plate to plate of 10,000 ohms. With an output transformer the amplifier has the following output impedances; at the terminals—250 and 500 ohm for lines, also, additional voice coil impedances of 2, 4, 8 and 15 ohms.

LOW HUM LEVEL

Due to the use of heater type tubes throughout the hum level has been kept exceptionally low. It is actually 62 db below maximum output. The filter system is especially efficient using large filter condensers and heavy oversize chokes in a combination brute force and tuned choke-circuit.

CONSTRUCTION

Construction throughout is especially rugged. Chassis is of formed steel heavily lacquered both inside and out in black crystalline finish. All components such as condensers, resistors, chokes, power transformer, etc., are considerably oversize and will carry far greater loads than will ever be placed upon them. Chassis dimensions are: 12" square and 9½" high. Shipping weight is 30 lbs.

LIST PRICE
\$45.00
 LAFAYETTE HIGH GAIN PUSH-PULL 2B6 AMPLIFIER. Model P 15937. Less output transformer and tubes. List price
 LAFAYETTE HIGH GAIN PUSH-PULL 2B6 AMPLIFIER. Model P 15938. With output transformer but less tubes. List price \$52.50
 KIT OF MATCHED TUBES, 1-57, 1-56, 2-2B6, 1-5Z3. List price . \$9.35

A LABORATORY TESTED *Lafayette* PRODUCT

The "Mobile" 6 Volt P.A. Amplifier

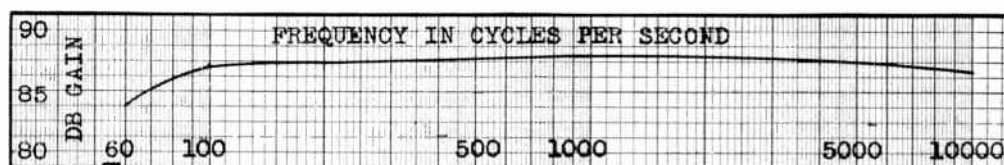
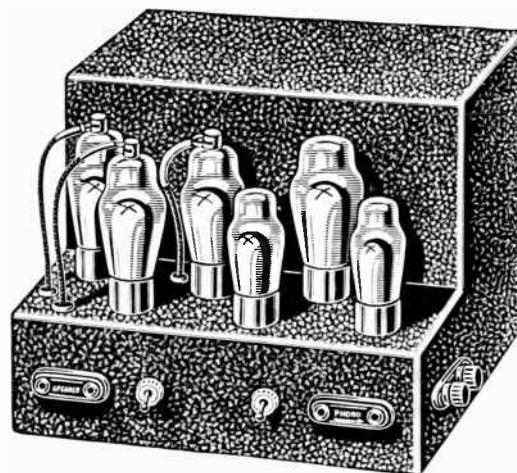

Especially Designed For Use In Sound Trucks, Airplanes, Etc.

AUTOMOBILES known as "sound trucks" because they are equipped with public address systems have become an established method of advertising to-day. Sound trucks are used in several ways, either to attract attention with musical recordings to printed advertising fastened to the side of the truck, or as portable public address systems for lecturers, campaigners, etc. An amplifier built for such use presents many problems. Not only must it be powerful and have excellent tone quality, but it must also be operated from a limited source of current supply and be especially sturdy in construction to withstand the abuse such equipment receives. With these facts constantly before them, our engineers designed this amplifier which, we feel, is without question one of the finest ever designed for this purpose.

THE CIRCUIT

The circuit used in this amplifier is as follows: a 37 triode tube is resistance-capacity coupled to another 37 tube, which is in turn similarly coupled to a 42 pentode tube used as a driver for three type 79 push-pull tubes in class "B." This provides the unusual gain of 86.7 db, which is sufficient to enable the use of a carbon microphone under ordinary conditions without the need of pre-amplification. The normal output wattage is 15 watts with a peak of 17.5 watts. Plate current is furnished by a motor-generator unit of special design.

CURRENT CONSUMPTION

Current consumption from the battery is very low, being only ten amperes at six volts, or sixty watts.

tone quality

In an amplifier of this type it is extremely important that the tone quality be as perfect as possible. This is so for two reasons: First, when the amplifier is used to attract attention through recorded music, the entertainment must really be an

attraction that will make people stop and listen. Second, when it is used as a public address system for a lecturer, the voice must be clearly understood above the street noises. How good the tone quality of this amplifier really is can best be appreciated by examining the frequency response curve printed herewith.

VOLUME

Since an amplifier of this type will be used most often in noisy locations, such as busy downtown streets, etc., it must have ample volume. This amplifier has an average output level of 33.9 db and a peak level of 34.1 db. By referring to the chart on page 20, it will be seen that this is more than sufficient.

INPUT IMPEDANCE

The high impedance input of 500,000 ohms makes it possible to connect a tuner directly to the amplifier through a condenser. A high impedance pick-up may also be connected without the use of a transformer. Low impedance pick-ups and microphones are, of course, used with suitable matching transformers.

OUTPUT IMPEDANCES

Output impedances for either 4, 8 or 15 ohm voice coils are available at the amplifier with a switch to connect either impedance to the terminals. Line impedances of either 500 or 250 ohms are also available at no extra cost.

CONSTRUCTION

Construction is extremely rugged so as to withstand vibration.

LIST PRICE

MOBILE SIX VOLT AMPLIFIER. Dimensions are 14½" wide, 10½" deep, and 8" high. Model P15764. **\$90.00**
 List price, less tubes
 KIT OF MATCHED TUBES. List price \$11.80

A LABORATORY TESTED *Lafayette* PRODUCT

The "High Fidelity" A.C. Amplifier

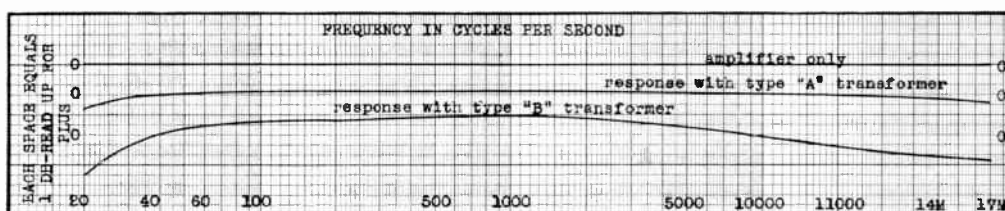
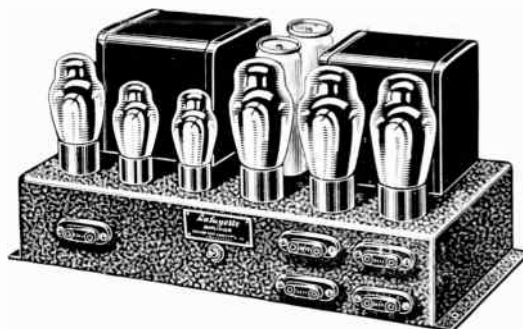

Wherever Tone Quality Is Of Paramount Importance This High Fidelity Unit Is Ideally Qualified

THE term "high fidelity" when applied to an amplifier has become practically synonymous with "high price." An amplifier that had a frequency response flat from 20 to 17,000 c.p.s. was formerly priced at hundreds of dollars and was a strictly custom-built instrument. It was the popular consensus of opinion that quantity production (in order to reduce the cost) was a practical impossibility. To be quite frank about it, we thought so too; nevertheless, we persisted in experimenting and testing and have finally succeeded in developing a high fidelity amplifier that even surpasses our fondest hopes. We'll admit it was no simple job and it is still necessary to do a considerable amount of "custom work" on each individual amplifier. But, approximately 90 per cent of the work can be done with quantity production methods and we are therefore able to sell this unit at a price that defies competition.

tone quality

The frequency response curve, shown herewith, clearly shows how right we are in claiming this to be a "high fidelity" amplifier. It must be remembered that it is of utmost importance, in order to obtain the maximum results of which this unit is capable, that all of the associated equipment—microphones, pick-ups, radio tuners, speakers, mixing transformers, etc.—be of the finest quality obtainable. In connection with speakers, we earnestly recommend the use of high frequency speakers ("tweeters"), together with standard, first quality dynamic speakers.

Circuit

Six tubes in all are used in this specially designed circuit, consisting of one 53, two 56's, two 2B6's and one 83 rectifier, providing a gain of 78 db. This gain is sufficient under average conditions to permit the use of a carbon microphone without pre-amplification.

Power Output

While high fidelity was the primary objective in the design of this amplifier, it is also true that power output was not to be sacrificed in order to gain this end. How carefully we have

guarded against the loss of power output can be realized when notice is taken of the fact that the average output is 15 watts! The peak output is 20 watts. This is equal to an average output level of 33.9 db and a peak level of 35.2 db.

Filter Circuit

It is self evident that in order to attain the finest frequency response the greatest of care must be taken with the plate supply. It is absolutely imperative that it be well filtered and also that the voltage regulation be good enough to take care of a widely varying load. That is why specially designed low resistance chokes and the best of electrolytic condensers, resistors, etc., are used throughout.

Input Impedance

Input impedance is of the standard Lafayette high resistance type, 500,000 ohms. This permits the direct connection of high impedance pick-ups without the use of a matching transformer. Radio tuners can also be connected in the same way through a coupling condenser. Microphones and low impedance pick-ups must be used with suitable matching transformers.

Output Transformer

Two types of output transformers are available. Type A has a frequency response that is down approximately —1.5 db at 20 cycles; is +½ db at 1000 cycles and down only .7 db at 17,000 cycles. This type is unusually good and when the curve of the amplifier is combined with that of the transformer, the resulting curve is still very good. Type B is for general use and is reasonable in price. It is down —1 db at 40 cycles; up 1 db at 1000 cycles and down 3.5 db at 12,000 cycles.

List Price

HIGH FIDELITY A.C. AMPLIFIER. Dimensions are 16" wide, 7" deep, 8" high. Shipping weight, 40 lbs. Model P 15753. Less tubes and output transformer. **List price \$79.00**
 KIT OF MATCHED TUBES \$10.75
 Type A Output Transformer, Model P 15930. **List price \$30.00**
 Type B Output Transformer, Model P 15931. **List price \$9.00**

A LABORATORY TESTED *Lafayette* PRODUCT

The "High Fidelity" D.C. Amplifier

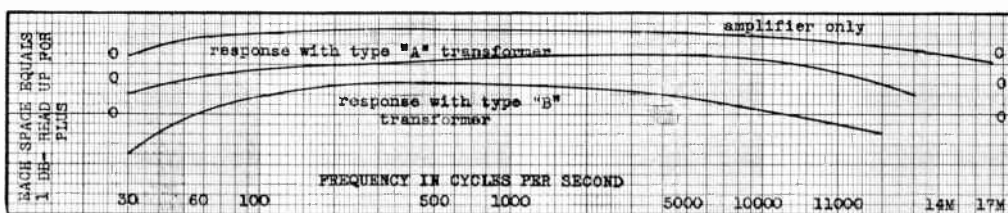

High Fidelity Plus Great Power Output on 110 V. D.C. Now Achieved By a Radically New Design

THE low voltage available in 110 volt direct current operated amplifiers has, in the past, proven to be an almost insurmountable obstacle to quality reproduction and considerable power output. Now, however, after months of careful research and countless hours of testing and experimenting, we have succeeded in bringing to perfection an amplifier so superior in tone quality and power output, that there can be no comparison with any other amplifier offered to date for operation from 110 volt direct current.

TONE QUALITY

Frequency response is so outstandingly fine that we unhesitatingly list this as a "high fidelity" amplifier. The response curve, shown at the top, is that of the amplifier itself. The final response obtained is, of course, dependent upon the output transformer used. Since the response desired will vary with the associated equipment used with the amplifier, two typical transformers are listed below with their specifications. The two lower curves, illustrated beneath the amplifier curve, show the response obtained with these transformers.

POWER OUTPUT

An undistorted output of 15 watts, with a peak output of 20 watts (equivalent to an average level of 33.9 db) and a peak level of 35.2 db, is convincing proof of the superiority of this unit over other direct current amplifiers.

CIRCUIT

A total of six tubes, consisting of one 77, one 37, and four 48's, is used in a specially designed circuit that provides the unusual gain of 80 db. A gain as high as this is of great advantage since it permits the use of a carbon microphone without pre-amplification in a great many cases. Where music and voice is to be picked up at a distance from the microphone, an additional stage of pre-amplification may be necessary.

FILTER CIRCUIT

Contrary to general practice in the construction of direct current amplifiers, this amplifier incorporates a highly efficient filter. The loss in voltage commonly encountered in the filter circuit, due to the use of chokes originally designed for use in A.C. operated amplifiers, has been greatly minimized by designing extra low resistance chokes. These chokes make available practically all of the line voltage for operation of the tubes, and are another reason for the excellent results obtained from the amplifier.

INPUT IMPEDANCE

High impedance input (500,000 ohms) to the amplifier permits the use of high impedance pick-ups directly connected to the amplifier without the use of a matching transformer. Low impedance pick-ups and microphones must, of course, be used with suitable matching transformers.

OUTPUT IMPEDANCE

As mentioned above, two types of output transformers are available, as follows:

TYPE A—This is an unusually fine type and when used with the amplifier has a frequency response that is down about —3 db at 30 cycles; is +1 db at 1000 cycles and down only 2½ db at 13,000 cycles.

TYPE B—This model is well adapted for general use and in addition is extremely reasonable in price. Frequency response is such that it is down 2 db at 50 cycles; plus 1 db at 1000 cycles and down 3 db at 11,000 cycles.

HIGH FIDELITY D.C. AMPLIFIER for 110 V. D.C. operation. Shipping weight, 32 lbs. Model P 15754.	LIST PRICE
Less tubes and output transformer. List price . . .	\$59.00
OUTPUT TRANSFORMER TYPE A. Model P 15932. List price . . .	\$25.00
OUTPUT TRANSFORMER TYPE B. Model P 15933. List price . . .	\$9.00
KIT OF MATCHED TUBES. List price	\$15.00

A LABORATORY TESTED *Lafayette* PRODUCT

Push-Pull Parallel 2B6 Amplifier

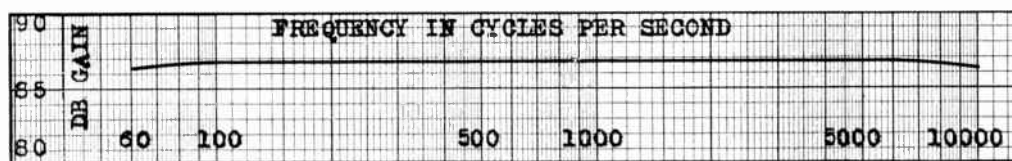
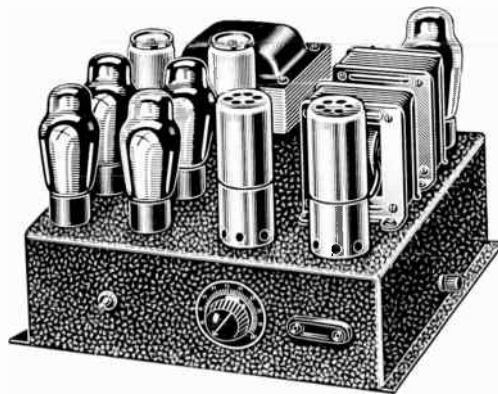

An Ultra-Modern "Class A" Amplifier Conservatively Rated at 22 Watts

INCORPORATING such advanced features as "Phase-Inversion," and "Push-Pull Parallel Output Stage," this amplifier is truly ultra-modern in design. Its output has been very conservatively rated at 22 watts and it is therefore suitable for use in Auditoriums, Dance Halls and similar locations where a fairly large output is required. While this amplifier has not been intentionally built to a "price" it is nevertheless an exceptionally fine dollar value.

UNUSUAL CIRCUIT

The unusual circuit, as used in this amplifier, is as follows: a type 53 duo-triode is used as a phase inverter which is coupled to another 53 duo-triode as a stage of push-pull amplification. This is, in turn, coupled to four 2B6 duo-triodes in a push-pull parallel output stage. Plate current is furnished by an 83 rectifier tube.

All stages are resistance-capacity coupled, thus doing away with the inherent difficulties of transformer coupling such as limited frequency response, hum pick-up, etc.

HIGH GAIN

By using this improved circuit, together with these newly developed tubes, the exceptionally high gain of 85 db has been obtained. A gain as high as this is of considerable advantage since it permits the use of a microphone, under average conditions, without using any additional pre-amplification.

TONE QUALITY

Despite the high output, and gain, of this amplifier the frequency response is especially fine. At the top of this page will be found illustrated the response curve obtained with this amplifier.

22 WATTS POWER OUTPUT

What is perhaps the most outstanding feature of this amplifier is the power output of 22 watts! Peak 30 watts! And it must be remembered that this wattage is in Class "A" amplification—not "A Prime." Translated into db, this wattage is equal to an average power level of 35.9 db and a peak level of 36.9 db. On page 20 will be found a chart showing the relation of

these power levels to some common known value and from which a clearer conception can be obtained of the meaning of these figures.

INPUT IMPEDANCE

Input impedance to the amplifier is of the standard high impedance (500,000 ohms) type. Thus it is possible to connect a radio tuner to the amplifier with only a small fixed condenser in series. High impedance pick-ups may be connected directly but low impedance pick-ups and microphones must be used with suitable matching transformers.

OUTPUT IMPEDANCE

The amplifier is supplied less the output transformer and the output impedance is therefore that of the load required by the tubes—5000 ohms plate to plate. An output transformer having this impedance and the following secondary impedances is available; 500 and 250 ohms for lines, 2, 4, 8, and 15 ohms for voice coils of dynamic speakers.

LOW HUM LEVEL

Due to the use of heater type tubes throughout the hum level has been kept unusually low being actually 71 db below maximum output. A well filtered carefully designed plate supply further contributes to this low level.

CONSTRUCTION

Like all Lafayette amplifiers construction is exceptionally rugged. Chassis is of formed steel with spot welded corners and is heavily lacquered, both inside and out, in an attractive black crystalline finish to protect it against rust. All components are considerably oversize and capable of withstanding far greater loads than will ever be placed upon them. Chassis dimensions are 12" square and 9½" high. Shipping weight 35 lbs.

LIST PRICE

LAFAYETTE PUSH-PULL PARALLEL 2B6 AMPLIFIER. Model P 15936. Less tubes and output transformer. **List price \$59.00**

OUTPUT TRANSFORMER as described above. Shipping weight 5 lbs. Model A 406. **List price \$10.50**
KIT OF MATCHED TUBES, 2-53, 4-2B6, 1-83. **List price \$15.15**

A LABORATORY TESTED *Lafayette* PRODUCT

The "Auditorium" Class "B" Amplifier

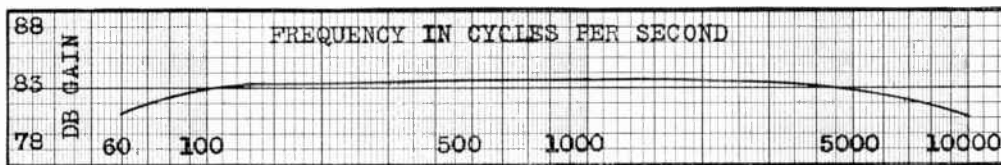
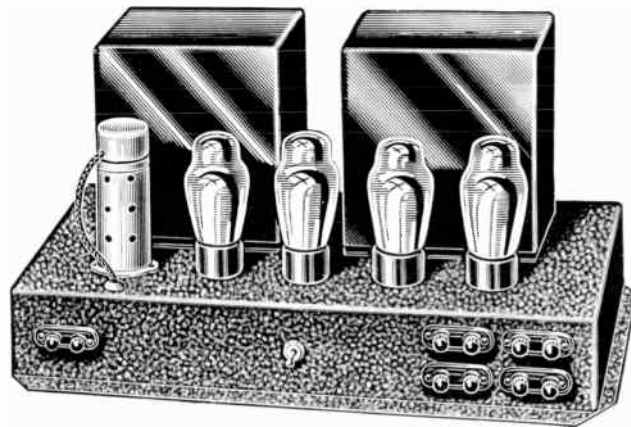

A Power Amplifier for Large Indoor and Moderate Sized Outdoor Installations

INSTALLATIONS in Auditoriums, Theaters, Dance Halls, Lodge Rooms, etc., demand an amplifier that combines great power with excellent tone quality. This direct coupled class "B" amplifier has been especially designed for such installations. It has power—a conservatively rated 28 watts. It has tone quality—a maximum variation of less than four db between 60 and 10,000 cycles. And in addition it is economical to operate, the average drain from the supply line being 85 watts at 115 volts. Its power output is great enough for use in large auditoriums and banquet halls and it will operate as many as 12 speakers to a plus 20 db level. In fact, for all, except the largest outdoor stadium installations, no finer amplifier could be desired.

THE CIRCUIT

It is well known that class "B" amplification is considerably more efficient than the commonly used class "A." It has, however, one drawback and that is a loss in efficiency at the higher frequencies if the circuit has not been properly designed. This shortcoming has been very effectively overcome in this amplifier by using a direct coupled stage preceding the driver which accentuates the higher frequencies, and compensates for the loss in the class "B" stage. The circuit is as follows: a 57 pentode tube is direct coupled to a 59 driver tube, driving a pair of 59 tubes in class "B." An 83 mercury vapor rectifier tube supplies plate current for these tubes.

tone quality

Frequency response of the amplifier is exceptionally fine as can readily be seen by referring to the response curve illustrated at the top of this page. The average gain is 83 db and the maximum variation from 60 to 10,000 cycles is less than 4 db.

POWER OUTPUT

Maximum power output of the amplifier is conservatively rated at 28 watts. The permissible limit considered peak output is 32 watts. This corresponds to an average power output level of

36.6 db and a peak level of 37.2 db. By comparing these figures with the chart on page 20 a clearer conception of their meaning can be obtained.

INPUT AND OUTPUT IMPEDANCES

Input impedance to the amplifier is 500,000 ohms which permits the direct connection of a high impedance pick-up for record reproduction. A radio tuner can also be so connected by using a coupling condenser in series. Low impedance pick-ups and microphones must of course be used with suitable matching transformers.

Output impedances are as follows: 4, 8 and 15 ohms for speaker voice coils, also 500 ohm and 250 ohm line output impedances.

HUM LEVEL

Hum level has been kept extremely low being 73.9 db below maximum output. This has been accomplished through the careful filtering of the plate supply to all tubes. Special low resistance filter chokes are used to assure excellent regulation and the power transformer has been designed to handle 250 Ma. at 450 volts. This is considerably greater than the maximum drain placed upon it at any time, i.e., 150 Ma.

RUGGED CONSTRUCTION

Construction is extremely rugged throughout. Chassis is of formed steel with spot welded corners and is heavily crystalline lacquered both inside and out for protection against rust. Condensers, resistors, etc., are carefully checked before, and after, they are built into the amplifier.

LAFAYETTE "AUDITORIUM" 28 WATT CLASS "B" AMPLIFIER. Overall dimensions are 20" long, 11 1/2" deep, and 10" high. Shipping weight, 61 lbs. Model P 15760. For operation on 110-130 volts 60 cycles A. C. **LIST PRICE \$85.00** List price, less tubes and speakers . . .

KIT OF MATCHED TUBES, 1-57, 3-59's, 1-83. List price . . . \$9.20

A LABORATORY TESTED *Lafayette* PRODUCT

The "Theater" P.E. Cell Amplifier

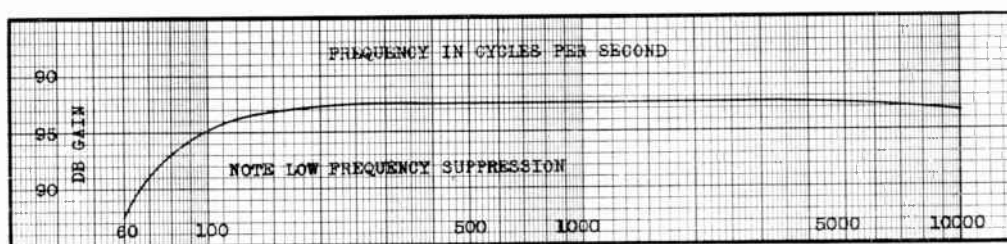
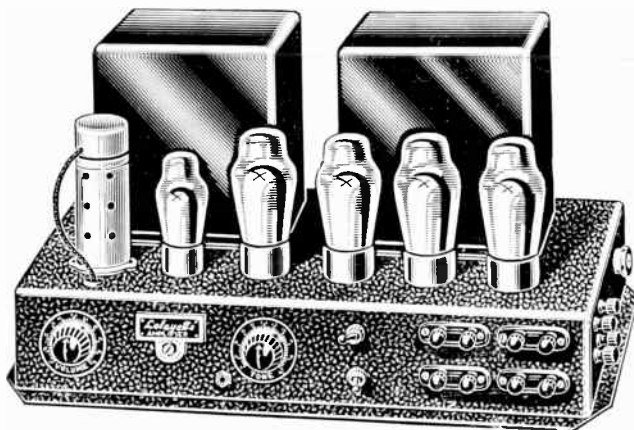

Particularly Designed For Use With Sound On Film

THIS amplifier was developed in response to the demand for a unit that would be reasonable in price and that could be used in the majority of theater installations. With this unit it is now possible for even the smallest theaters to afford the type and quality of reproduction that was previously possible only in the largest theaters, with more expensive equipment. That theater owners appreciate this has been proven by the extraordinary interest that has been shown since this unit was first announced. This special amplifier was particularly designed to be used for sound on film purposes and is equipped with the necessary controls and photo-cell current supply and also incorporates a transformer to supply current for the exciter lamp. The entire unit is complete in itself and does not require a head amplifier as is used in the older type of theater equipment. In addition, it is also to be used with sound on disc, provision having been made for pick-up connections. For P.E. cell use, a gain, or volume, control is provided. A tone control, effective on both pick-up and P.E. cell, is also furnished.

THE CIRCUIT

The circuit used is as follows: a type 57 pentode is resistance-capacity coupled to a 56 triode which, in turn, is similarly coupled to a 59 driver tube driving a pair of 59's in class "B." Plate current is furnished by an 83 tube. This makes a total of four stages, providing the extraordinarily high gain of 96.1 db with an average output of 28 watts and a peak of 35 watts.

TONE QUALITY

This amplifier has been so designed that at the lower frequencies, where the frequency characteristic of the photo-cell rises, the amplifier frequency response drops, and where the photo-cell response drops the amplifier frequency response rises. The amplifier curve is absolutely flat between 120 and 10,000 cycles. Then by combining the response of the photo-cell with that of the amplifier, a practically perfect frequency response is obtained over the entire audio frequency band. The reason the tone con-

trol has been included is because some speakers are peaked at the high frequencies and the control will correct this condition.

POWER

This amplifier has ample volume for the average theater installation, its output level being 36.8 db, with a peak level of 37.2 db. Hum level of this amplifier is extremely low, being 74.4 db below maximum output.

INPUT IMPEDANCES

At the photo-cell inputs the impedance is suitable for the average photo-cells in use to-day. The pick-up input is 500,000 ohms and is suitable for use with a high impedance pick-up without a matching transformer. A low impedance pick-up is used with a matching transformer. A unique method of mike input is used.

OUTPUT IMPEDANCES

Output impedances are 4, 8 and 15 ohms for voice coils and 250 and 500 ohms for lines. A special arrangement is used for the connection of the monitor speaker.

EXCITER LAMP SUPPLY

Exciter lamp supply is furnished for either 8 volt lamps at a maximum of 4 amperes or 10 volt lamps at 7.5 amperes. A changeover switch swings from one lamp to the other, effectively accomplishing instant, smooth projector switching.

CONSTRUCTION

Construction is extremely rugged. All components are oversized and capable of carrying considerably greater loads than will ever be placed upon them. A.C. line is fuse-protected.

28 WATT "THEATER" AMPLIFIER. Dimensions are 11½" high, 11⅝" deep, 19¾" long. Shipping weight, 60 lbs. Model P 15763. **LIST PRICE**
 less tubes but including two photo-cell input plugs and shielded leads **\$149.00**
 KIT OF SPECIALLY MATCHED TUBES. List price \$10.40

A LABORATORY TESTED *Lafayette* PRODUCT

The "Stadium" 60 Watt Power Amplifier

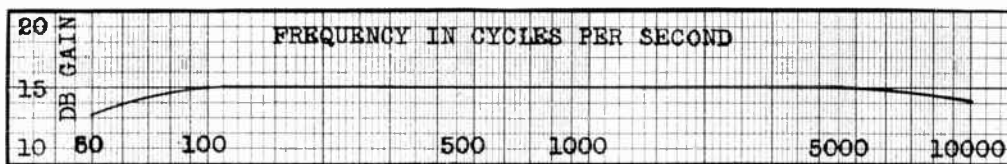
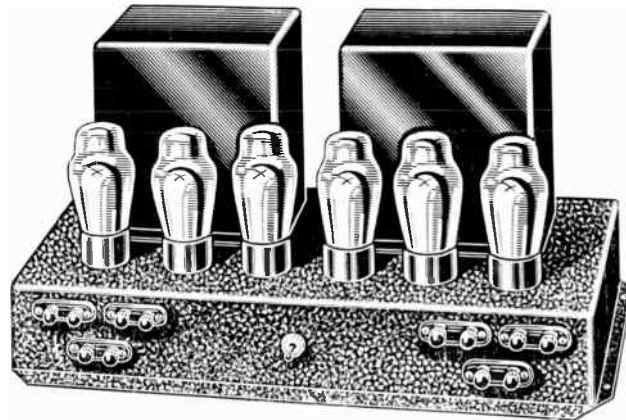

Super Power For The Largest Installations At Low Cost

FOR extremely large stadiums, etc., where great coverage is necessary and where a large number of speakers must be driven, it is absolutely essential that the power output of the public address system be very great. This is because of the fact that the increase in wattage required, to produce audibly the sensation of change in volume, rises rapidly and a point is soon reached where a several fold increase in wattage output becomes barely noticeable to the ear. This can be more readily understood by comparing the output in decibels rather than wattage. This sixty watt amplifier, when used with a suitable driver such as the push-pull 2B6 amplifier listed elsewhere in this manual, is capable of furnishing sufficient output for the largest of stadiums and other installations of similar character. It is also suitable for use in transmitters, where it will 100 percent modulate any transmitter using up to 120 watts of R.F.

THE CIRCUIT

The circuit consists of four 59 tubes in push-pull parallel class "B." Two type 83 mercury vapor rectifier tubes supply ample plate current at all times. These tubes are used in a special bridge rectifying circuit so that each tube is carrying exactly half the current at all times. Current regulation is excellent due to the use of low resistance filter chokes.

TONE QUALITY

Frequency response of the amplifier is very unusual, as can readily be seen in the response curve shown herewith.

POWER

The average power level of this amplifier is 40 db. This is sufficient for outdoor gatherings up to 50,000 people. Truly a giant in performance!

INPUT IMPEDANCE

A special input transformer is supplied so that the amplifier may be driven either from a push-pull amplifier or from a 500

ohm line. If the amplifier you intend using to drive this amplifier does not have a 500 ohm output, it is only necessary to obtain a 500 ohm output transformer to couple it to this amplifier. The wattage input necessary for average output is only 3 watts and the average amplifier rated at this output is sufficient to drive this unit. However, it is advantageous to use an amplifier having a greater output than this to handle maximum peak voltages. We especially recommend the Lafayette push-pull 2B6 amplifier. The peak output with 8 watts input is 80 watts.

OUTPUT IMPEDANCES

Output impedances of this amplifier are as follows: one 500 ohm line and two 250 ohm lines. Various impedances are possible by combining these terminals, for which full instructions are supplied with each amplifier.

HUM LEVEL

To state a hum level on this unit would be very misleading because the actual hum level is dependent upon that of the driver used.

GAIN

In a unit of this type not very much gain is expected but careful design has provided the unusual gain of 15 db.

CONSTRUCTION

Construction throughout is extremely rugged. A wide safety factor has been allowed so that all components are capable of carrying considerably greater loads than will ever be placed upon them. This is particularly important in an amplifier of this size and type, that is to be used for long periods at a time. Chassis is of steel heavily lacquered, both inside and out, in black crystalline lacquer.

LIST PRICE

60 WATT AMPLIFIER. Dimensions are 11 1/2" deep, 20" long, 10" high. Shipping weight, 60 lbs. Model P 15778. List price, less tubes **\$120.00**

KIT OF SPECIALLY MATCHED TUBES. List price **\$11.10**

A LABORATORY TESTED *Lafayette* PRODUCT

A Public Address Consultation Department and an Engineering Department For Your Use

THE publication of this manual was undertaken with the intention of assisting you, the sound man, and through you, the consumer, in the intelligent selection of equipment for public address installation. It is impossible, however, in the limited amount of space allotted to the technical text portion of this manual, to cover every conceivable type of installation you will encounter. You may find that a standard system, such as listed in the next few pages, will not prove satisfactory for some particular location. These systems are merely suggested ones and are by no means the only systems that could be used in the types of installations they are listed for. Nor are they the systems we would recommend for abnormal cases.

In many instances a greater number of speakers are required, in others more pre-amplification is necessary and so on ad infinitum. Because no hard and fast rule can be set that would infallibly govern every possible installation, the publishers of this manual maintain a Public Address Consultation Department in charge of competent engineers.

These men are always ready to assist and advise you in any of your P.A. problems. Write them, giving all the details you possibly can, and you will be given the benefit of their knowledge, cheerfully, and without charge.

Our Engineering Department is also at your service to design special equipment for you. In many cases attempts are made to adapt a standard amplifier or system

for some special installation. This not only proves unsatisfactory in the majority of cases but is often far more expensive in the long run than the cost of a special unit.

Do not let the term "special" frighten you. It does not necessarily follow that a special unit will be expensive. In any event it costs you nothing to have us estimate on your requirements—why not let us do so and surprise you pleasantly with a cost far lower than you ever dared hope for.

We have designed, and built, complete systems for some of the country's leading concerns. These systems are used for many different purposes in a variety of ways. For example, illustrated at the right is a complete "Rack & Panel" system that includes a radio tuner with remote control, an automatic record changing phonograph, a control and mixer panel and many other features too numerous to mention here. This system was designed and built for use by night clubs, dance halls, showboats, and places having similar requirements.

The reason this particular unit is shown and mentioned here is because it happens to be a type that is suitable for use in a majority of cases. It may be suited to your requirements exactly or perhaps some slight variation of this model is what you need. Whatever type of system is required—we are equipped to design and build it and best of all do it reasonably.

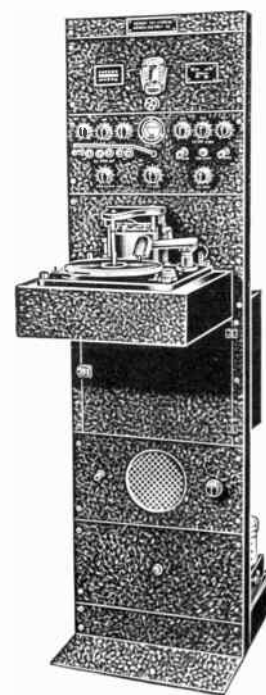

A typical Lafayette "Rack & Panel" Public Address System



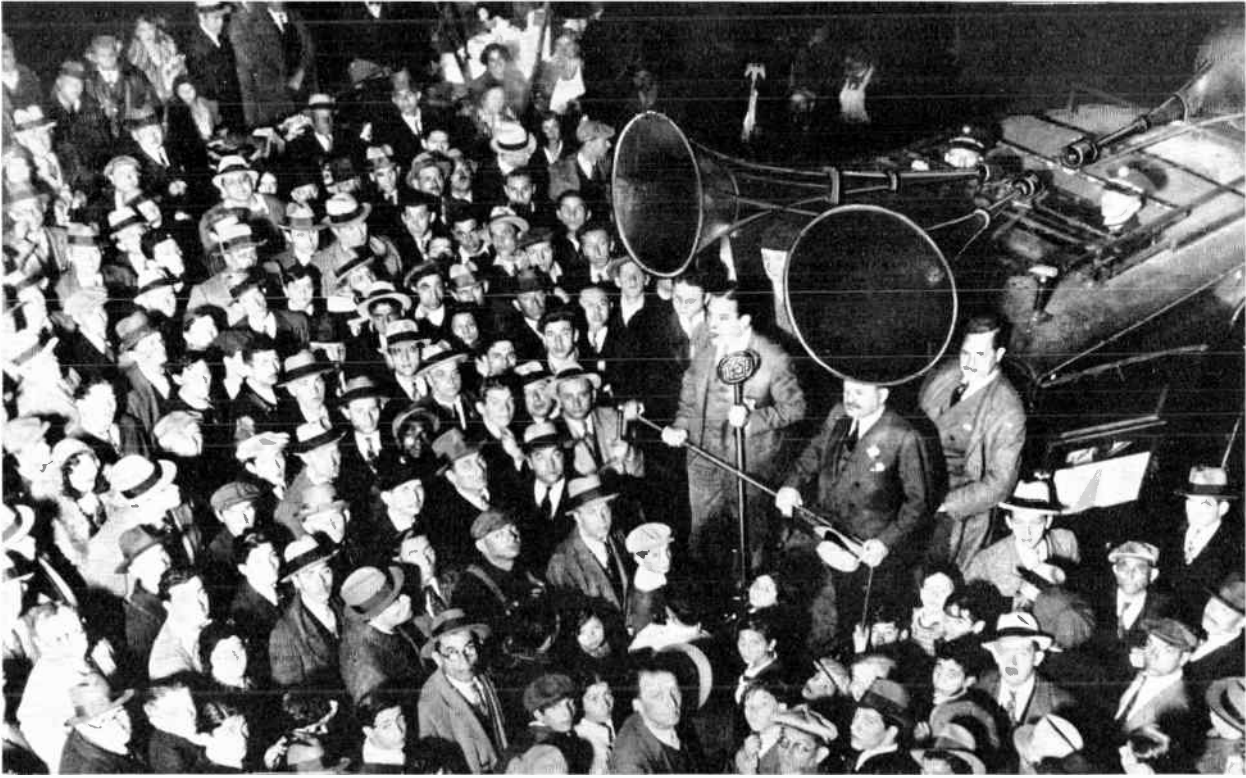

A Complete Battery-Operated Public Address System For Sound Trucks, Etc.

A PUBLIC address system, for use on sound trucks, should be powerful, compact, and, above all, economical to operate. A system that more than adequately fulfills these requirements is illustrated at the lower right hand corner of this page. With a system such as this it is possible to enjoy the advantages of a public address system wherever it can be transported. It can be installed in an automobile, a boat, an airplane or can even be carried, by any method available, and set up in an open field.

The only energy required can be furnished by an ordinary six volt storage battery. A standard 120 ampere hour storage battery will furnish sufficient current for a day's operation. The complete system is so compact that it can be installed in a coupe without decreasing the seating capacity. This feature is of advantage, also, when the system is installed in a truck since it does not require much of the space normally devoted to cargo.

Installation is extremely simple and the current drain very low. The output of the amplifier is 15 watts average and 17.5 watts peak. That this output wattage is ample for outdoor use will be realized by anyone familiar with a push-pull 2A3 amplifier output. The three type 79 tubes used in this amplifier have an output equal to that obtained from a pair of 2A3's in push-pull. A high degree of fidelity has also been obtained, in the design of this amplifier, as will be seen by referring to the frequency response curves, shown for this amplifier, under its individual listing on page 31. For a complete description of the amplifier refer to page 31.

The speakers furnished are the Lafayette 6 volt cone units and trumpets that provide an unusually pleasant tone with a tremendous output. The trumpets, while large and highly efficient, are light in weight, and, due to their square shape, easily mounted and fastened. The speaker fields operate from the six volt storage battery.

The complete system consists of two cone units and trumpets as described above, a senior mike input stage, a model 25 microphone complete with a desk stand and 25 ft. of microphone cable and the Lafayette 6 volt P.A. amplifier. For a detailed description of each of these units refer to their individual listings in other sections of this manual.

Lafayette 6 Volt Battery Operated P.A. System

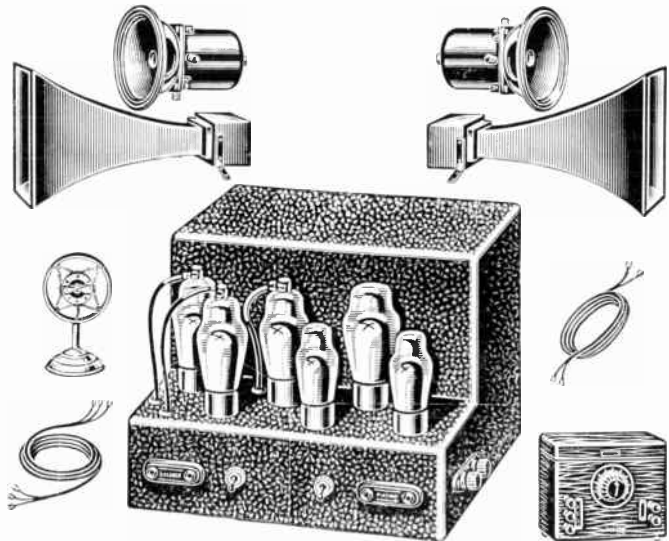

If desired a greater number of speakers may be operated on this system but in that event it will be advisable to use a separate battery for the additional fields. This is to avoid the excessive drain on a single battery that would occur if the amplifier and all the speaker fields were operated on one battery.

LIST PRICE

SIX VOLT P.A. SYSTEM. Complete, as listed above. Shipping weight, 175 lbs. Model P 15747. List price, less tubes **\$230.00**

KIT OF MATCHED TUBES. List price **\$11.80**

Lafayette Utility Single 2A5 P.A. System

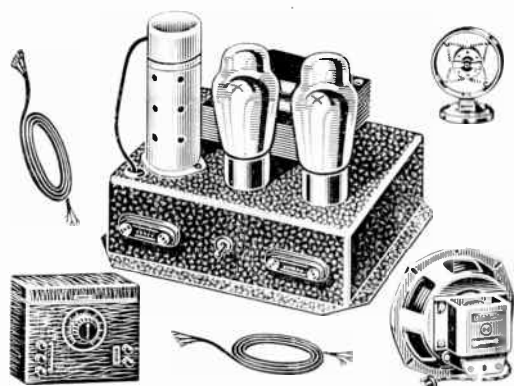

Lafayette High Gain 3-Stage P.A. System

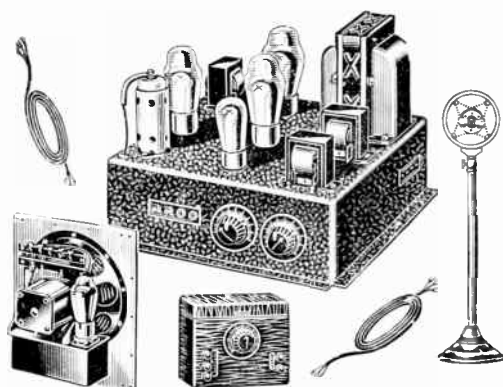

High Gain 3-Stage P.A. System

THE High Gain Three-Stage P.A. System, illustrated above, has been especially designed to eliminate the need for microphone pre-amplification. Pre-amplification is required, with most systems, when it is desired to pick up voice, or music at a distance from the microphone; for example, the amplification of orchestral music. This is because a greater gain is needed than is necessary when the microphone is spoken into directly.

The system includes the high gain three-stage push-pull 2A5 amplifier, with matching transformer, that is fully described on page 28 of this manual. It also includes a model 25 double button microphone with an adjustable floor stand and 25 feet of microphone cable, a senior mike input stage with self-contained button current battery, two R.C.A. type 106 A.C. speakers using tube rectification for the field supply and equipped with special matching transformers so that they may be placed any distance desired from the amplifier without loss in volume or tone quality, and a complete kit of specially matched tubes for the amplifier and for the speakers. For a more complete description of the individual units refer to their respective listings in other portions of this manual.

This system is ideal for use in the average small dance hall, restaurant, etc. A great many of these systems are used by dance halls and restaurants to pick up music from their orchestras and project it into the street to attract customers.

LIST PRICE

HIGH GAIN THREE-STAGE P. A. SYSTEM as described above. Shipping weight, 87 lbs. Model P 15744. **List price** \$150.00

Complete P.A. Average

The "Utility" Single 2A5 System

Illustrated at the left, is suitable for such uses as:

INTER-OFFICE COMMUNICATION

STORE DEMONSTRATORS

HOME ENTERTAINMENT

HEARING AID

LOW POWERED PUBLIC ADDRESS SYSTEMS, Etc.

It is also suitable for many special uses and can be adapted wherever a system with an output of 3 1/2 watts is required. The extreme compactness of this system is a desirable feature in many cases. A large well-known chain of confectionery stores uses several of them in connection with window demonstrations. A prominent metropolitan broadcasting station has installed a complete system in each of its studios.

The system consists of the following: a model 12 double button microphone with a desk stand, one 12-foot shielded microphone cable, a senior input stage, an 8" dynamic speaker with matching transformer and the 2A5 Amplifier complete with tubes.

The individual units will be found listed in other portions of this manual with a complete detailed description and need not be again described here. This system, like all the systems listed in this manual, is carefully tested and adjusted before it is shipped to you and comes complete with full instructions for installing.

LIST PRICE

COMPLETE "UTILITY" SINGLE 2A5 P. A. SYSTEM as described above. Shipping weight, 35 lbs. Model P 15743. **List price** \$59.00



Systems Suitable For Requirements

Push-Pull 2A3 System

THE Push-Pull 2A3 Public Address System, illustrated at the right, has an output of 15 watts. This is sufficient, as a rule, for indoor audiences of from 1500 to 2000 persons. Since, by far, the greatest majority of dance halls, banquet halls, etc., come within this classification, it has, therefore, become one of the most popular systems we manufacture. The use of two speakers permits a more efficient sound distribution than is possible with a single speaker. It is, of course, possible to operate any number of speakers desired up to the full capacity of the amplifier—8 speakers.

This system is suggested for installations such as the following:

Lodge Meeting Rooms	Class Rooms or Auditoriums
Court Rooms	Restaurants
Dance Halls	Beer Gardens, etc.

In installations of this character this Push-Pull 2A3 System will be especially satisfactory, because of its ample power output and its excellent tone quality. All of the components, as listed below, have been selected with the view of obtaining a well balanced system both from an operating and a quality standpoint.

The complete system consists of a Model 25 double button microphone with an adjustable floor stand and 25 feet of microphone cable, a senior input stage, two R.C.A. 106 type A.C. speakers and the push-pull 2A3 amplifier complete with a matched kit of tubes. The individual units are fully described under their respective listings in this manual.

The speakers are equipped with matching transformers so that they may be located any distance desired from the amplifier without loss in tone quality.

PUSH - PULL 2A3 FIFTEEN WATT P. A. SYSTEM, complete as above. Shipping weight, 170 lbs. Model P 15945. **LIST PRICE** **\$166.50**

Lafayette Push-Pull 2A3 Public Address System

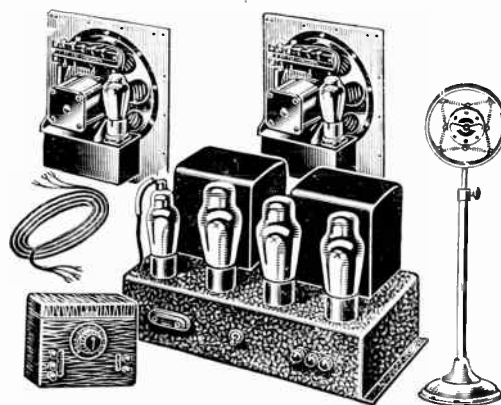

Lafayette Push-Pull Parallel 2B6 Public Address System

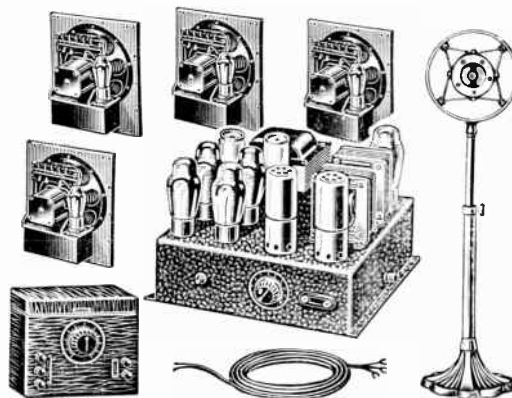

Push-Pull Parallel 2B6 System

THE Push-Pull 2B6 P.A. System, illustrated above, using the new P.P. Parallel 2B6 Amplifier, has an output of 22 watts, making it suitable for installations serving indoor audiences up to 5000 persons. An outstanding feature of this particular system is its excellent tone quality.

This system has sufficient gain in the amplifier to permit the pick-up of music directly from an orchestra, or a singer singing at a distance from the microphone, without the need of additional amplification.

This system is also adaptable for use in many outdoor installations such as:

Swimming Pools	Picnic Grounds
Tennis Courts	Beer Gardens, etc.

Many industrial call systems use this equipment. It consists of a Model 50 double button microphone with an adjustable de luxe floor stand and 25 feet of microphone cable, a microphone, mike control box, four R.C.A. type 106 A.C. dynamic speakers with special matching transformers so that they may be placed any distance desired from the amplifier without affecting tone quality or volume, and the Push-Pull Parallel 2B6 amplifier complete with tubes. The individual units are described in detail in other sections of this manual.

LIST PRICE
PUSH-PULL 2B6 P.A. SYSTEM as described above. **\$260.00**
Shipping weight, 230 lbs. Model P 15944. **LIST PRICE**



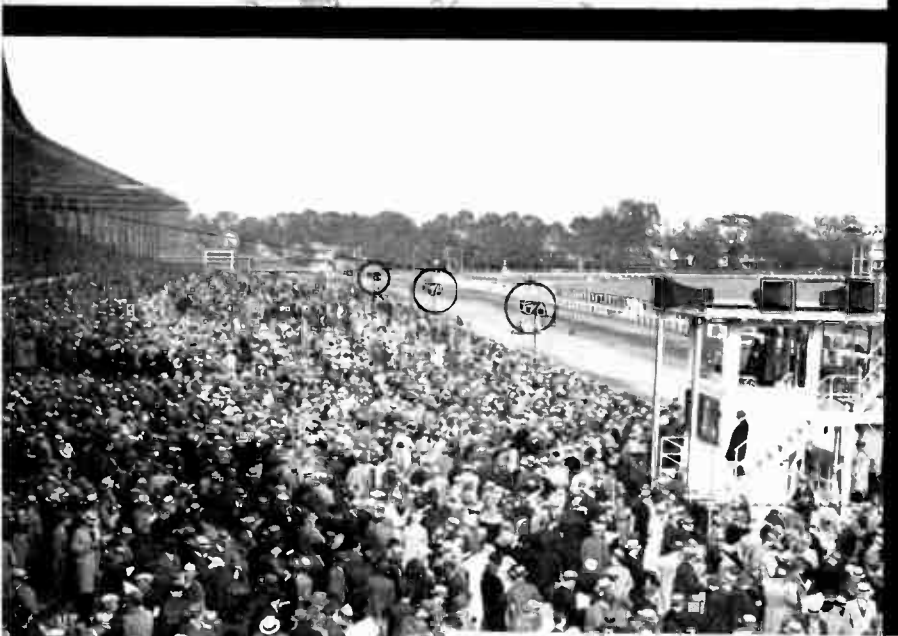

High Powered the Larger

Great Power Plus Tone Quality

POWER is of the greatest importance in a public address system that is to be used for the larger installations. However, it is equally important that tone quality is not lost sight of in the quest for this power. No matter how great the power, if the tone quality is inferior, the system is a failure.

Tone quality can not be of the best if the system is chosen haphazardly. Each individual component must, of necessity, be of good quality, for the inclusion of only one inferior unit will affect the entire installation. With these considerations in mind the following systems are suggested as being representative of the finest type for installations of this character.

THE 28 WATT CLASS "B" PUBLIC ADDRESS SYSTEM

The 28 Watt Class "B" Public Address System illustrated below has a power output that is sufficient for indoor gatherings of 10,000 persons. It is ideal for permanent installations in such locations as theaters, ball rooms, dance halls, skating rinks, churches, etc.

The complete system consists of the following: one Model 50 double button microphone with de luxe floor stand and 25 feet of microphone cable, four R.C.A. 106 type A.C. speakers with matching transformers, one pre-amplifier control box and the 28 watt Class "B" amplifier complete with tubes. The various units are fully described in other portions of this manual.

This system is also priced, below, with ten speakers instead of four. The maximum number of speakers that can satisfactorily be operated with this system is twenty. Any number of speakers up to the maximum may be used as desired. Instructions for the correct matching of speakers is furnished with each amplifier.

28 WATT CLASS "B" PUBLIC ADDRESS SYSTEM complete with four speakers as listed above. Shipping weight 230 lbs. Model P 15720. **LIST PRICE** **\$285.00**

28 WATT CLASS "B" PUBLIC ADDRESS SYSTEM as above, but with ten speakers. Shipping weight 410 lbs. Model P 15781. **List price** **\$435.00**

Lafayette Complete 28 Watt Class "B" P. A. System

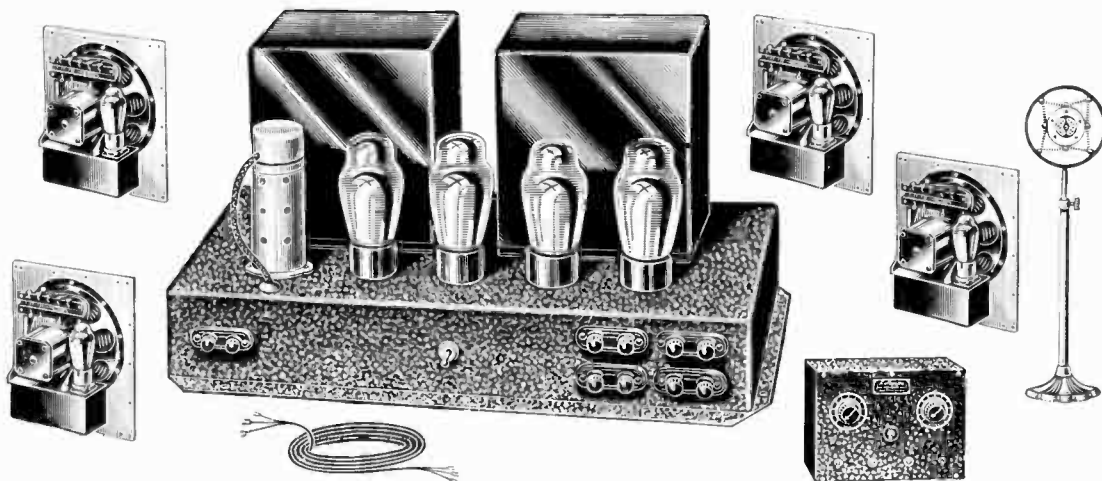

Systems for Installations

The 60 Watt Stadium System

FORMERLY, because of the tremendous power required, installations in large stadiums, air fields, ball parks, football fields, etc., were very expensive. New tube developments plus careful engineering, and a consumer acceptance that makes possible quantity production, have enabled us to bring the cost of such equipment to a surprisingly low level.

Despite its low price, however, this equipment is not only comparable to equipment costing many times as much, but is, in fact, superior in all around performance to many such systems.

The complete stadium equipment, as shown here, does not include speakers. The reason for this is that in a system of this type the location, and number, of speakers used is directly dependent upon the characteristics peculiar to each individual installation. Two suggested types of speaker equipment, suitable for an installation of this character, are listed below.

The complete equipment, exclusive of speakers, consists of the following: one Model 50 double button microphone, one combined phono-mike changeover control unit, a portable pick-up and turntable for record reproduction, a push-pull 2B6 driver amplifier, a 60 watt power amplifier and a complete set of tubes for the pre-amplifier, the driver amplifier and the power amplifier. A floor stand with a 25 foot microphone cable for the microphone is also included, and a full set of operating instructions.

This system is capable of furnishing either voice or musical entertainment to audiences of 50,000 persons. If desired this equipment may be mounted in a rack but is listed without it so as to be flexible enough to fit practically any requirement. Prices of suitable racks will be gladly furnished upon application.

60 WATT STADIUM PUBLIC ADDRESS SYSTEM. Shipping weight, 110 lbs. Model P 15934. List price

LIST PRICE
\$317.50

Lafayette 60 Watt Stadium P. A. System

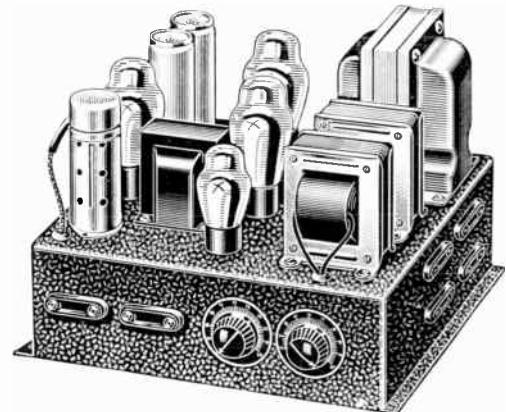
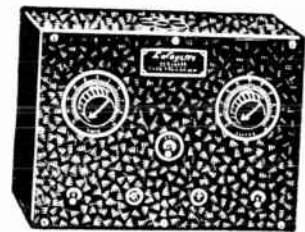
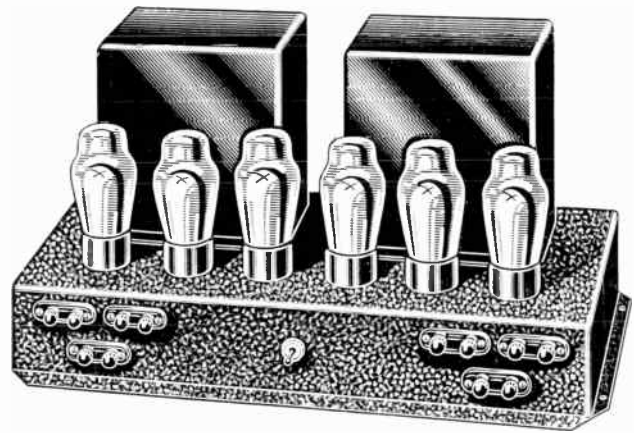

Choice of Speaker Equipment for Outdoor Installation



FOR use with the Stadium System, listed above, either of the two following speaker systems are recommended. For a detailed discussion of the merits of each type refer to the individual descriptions, of each unit, in the speaker section of this manual.

The complete systems include, beside the speaker units and trumpets, a special matching transformer for each speaker, and a field supply. The transformers are for matching the speaker to either a 250 or 500 ohm line.

The speakers furnished are equipped with 110 volt D.C. fields so that they may be operated either from a 110 volt D.C. line direct, or, with the exciters, from a 110 volt 60 cycle A.C. line. If desired, fields for operation from 6 to 8 volt D.C. are available at a slight difference in cost.

EIGHT RACON GIANT DYNAMIC UNITS WITH 3 1/2-FOOT STORMPROOF TRUMPETS complete with transformers for line matching and eight field supplies. Shipping weight 480 lbs.

LIST PRICE
Model Y 19990
List price . . . **\$916.00**

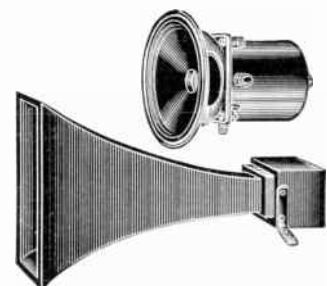

EIGHT CONE UNIT TYPE DYNAMIC TRUMPETS (illustrated at the right) complete with eight transformers for line matching and eight field supplies. Shipping weight, 505 lbs. Model Y 19991. List price **\$525.00**

If a greater number of speakers are desired refer to the speaker section of this manual for prices.

Ultimate in



PORTABLE systems find wide application in various industries for advertising, selling, employee education, lecturers, entertainment, etc. In the past, systems of this type were a miscellaneous collection of separate units carried in trunks or boxes. This, of course, soon proved unsatisfactory, and with new circuit and tube developments came powerful amplifiers that were compact in size, and could be mounted in smaller cases. These have been gradually improved until to-day we can offer such compact and extremely powerful portable systems as are listed on this and the following page.

These systems are without doubt the most advanced units ever developed in power output—convenience of operation and ease of portability. We have made a particular study of this type of equipment and have been fortunate enough to enjoy the confidence of an ever increasing group of customers. This in turn has made possible quantity production so that we have been able to keep quality high and prices low.

The Push-Pull 2A3 Portable P.A. System

Illustrated, at the left, is the Push-Pull 2A3 Portable Public Address System. This system is unquestionably the most powerful stock model portable system, for its size, ever manufactured. The amplifier used is the push-pull 2A3 model which is fully described on page 29 of this manual. Its conservatively rated output of 15 watts is more than ample for any type of work that a portable system could be used for.

The complete system, including everything: amplifier, tubes, microphone, microphone batteries, cables for both the microphone and speakers, two speakers, mixing panel, etc., is housed in a pair of specially designed fabrikoid covered carrying cases. One unique case contains both speakers with their cables and plugs. This case when opened also serves as a stand for each speaker. The other case contains the amplifier, microphone and control panel. This panel provides control over the entire system. It incorporates a master switch with pilot light, a mike current switch with pilot light, a mike current control, a mike current meter, two jacks for breaking into either button line to measure button current, a master gain control, a tone control, a phono-mike changeover switch and all connection terminals, microphone, pick-up, and both speakers.

Extremely rugged 11" concert speakers are used, equipped with special matching transformers and 50 ft. cables with plugs. A special snap-on cover protects each speaker cone during transportation.

The microphone is a standard model 25 double button complete with a desk stand and cable. A special rack is built into the case to hold the mike when not in use. The complete system is so arranged that it can be set up and operated within a few minutes. All that is necessary to do is to open the speaker case, set the speakers wherever desired, plug the speaker plugs into the receptacles on the face of the control panel, connect the mike cable to the three terminals, plug into any A.C. line and it is ready to operate. Dimensions of amplifier case 18 1/4 x 18 1/4 x 11 1/4"; speaker case 18 1/4 x 18 1/4 x 13 1/4". Shipping weight 65 lbs.

LIST PRICE

2A3 PORTABLE P.A. SYSTEM. Complete. As above. Shipping weight 75 lbs. **\$219.00**
Model P 15943. List price, less tubes

EXTRA PAIR MATCHED SPEAKERS. Field supply in case. Shipping weight 40 lbs. Model P 15793.

List price \$59.00

KIT OF MATCHED TUBES. Model P 15713. List price \$11.15



Closed View

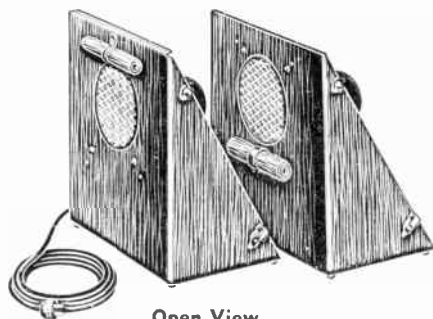
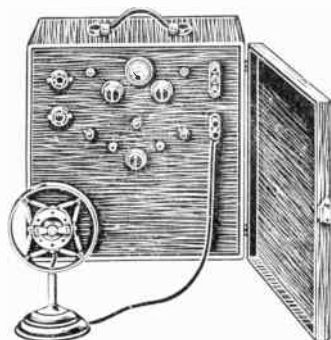

Open View

Portable P.A. Systems

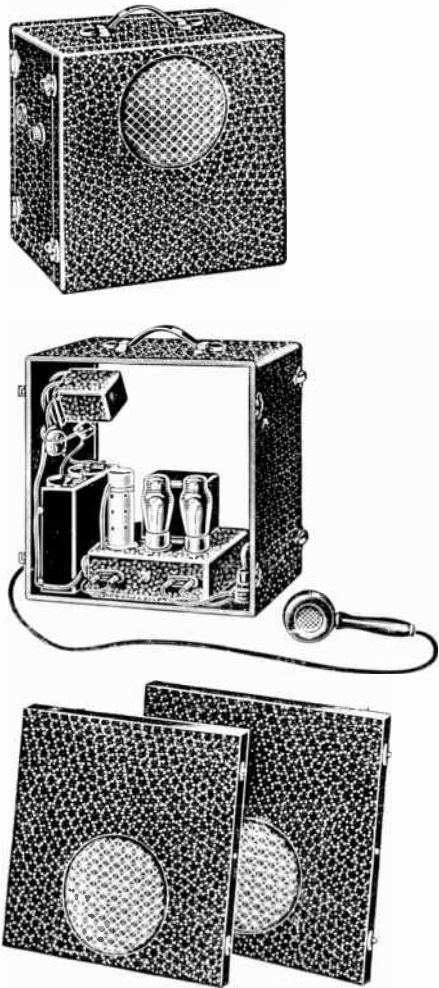

The 2A5 Portable System, illustrated at the left, is extremely compact and highly efficient. Self contained, within the strong carrying case, is the complete system consisting of the single 2A5 amplifier (listed and fully described on page 26 of this manual), two matched dynamic speakers, a hand microphone, two dry cells for button current, a microphone matching transformer and a mike button current control.

Despite its compactness, this system has an output of 3½ watts making it particularly suitable for use by demonstrators in stores, carnival barkers, window demonstrators, etc. It is very easily set up and put into operation. The two speakers are mounted on the removable doors of the case and are equipped with collapsible brackets so that they can be stood upright wherever desired. With the A.C. plug connected to any available 110 volt 60 cycle outlet and the mike plugged into its jack the system is ready to operate. The outside dimensions of the case when closed are 15" square and 10" deep.

- | | |
|--|-------------------------------------|
| PORTABLE 2A5 SYSTEM. Complete, as described above with single button hand microphone. Shipping weight, 50 lbs. Model P 15765. List price , less tubes | LIST PRICE
\$79.00 |
| Same as above, but with double button hand mike. Model P 15734. List price | \$89.00 |
| Same, with two button mike and floor stand. Model P 15736. List price | \$92.00 |
| KIT OF MATCHED TUBES. Complete for above described amplifiers. Includes 1-57, 1-2A5, 1-83. Model P 15737. List price | \$4.75 |

Illustrated, at the right, are two specially designed portable turntables, and pick-ups, for the reproduction of recorded entertainment. These units are particularly adapted for use with the portable P.A. systems described on this, and the previous page, but may, of course, be used with any amplifier. The upper one is for the reproduction of one record at a time. This unit is mounted in an attrac-



tive fabrikoid covered case with heavily plated hardware and incorporates a two speed Green Flyer electric motor with a 12" felt covered turntable. The pick-up is the dual speed, counterbalanced, high impedance type with built-in volume control.

The Capehart Portable Unit, illustrated directly underneath, is capable of playing 10 records, on one side, in sequence. Either 10" or 12" records may be used. A lever permits the repetition, or rejection, of any record at will. Completely automatic, the last record repeating until the master switch is turned off. Mounted in an attractive grained fabrikoid covered case.

- | | |
|---|-------------------------------------|
| LAFAYETTE DUAL SPEED PORTABLE MOTOR AND PICK-UP. Size of case 17¼" x 13½" x 8". Shipping weight, 25 lbs. Model Y 22031. List price | LIST PRICE
\$48.00 |
| LAFAYETTE-CAPEHART PORTABLE RECORD CHANGER. Size 15½" wide, 15½" long, 12" deep. Model Y 22030. Shipping weight 65 lbs. List price | \$125.00 |

The Amplified Speaker, illustrated at the right, consists of the single 2A5 amplifier installed in a polished wood case with a matched dynamic speaker. This unit can be used for inter-office call systems, to electrify phonographs, as an amplified extension speaker, etc. The cabinet is of Gothic design and provides excellent speaker baffling assuring good tone quality. The volume is more than ample and, if desired, additional speakers may be attached to the amplifier.

By adding a microphone, with suitable batteries and a matching transformer, a complete P.A. system is obtained that is equal in results to many higher priced systems. The cabinet dimensions are 17" high, 14" wide, and 9½" deep. This convenient size enables it to be placed in out of the way corners. For a detailed description of the amplifier refer to its individual listing on page 26.

- | | |
|---|-------------------------------------|
| AMPLIFIED-SPEAKER, as described above. Shipping weight, 33 lbs. Model P 15748. List price , less tubes | LIST PRICE
\$39.50 |
| KIT OF MATCHED TUBES for amplifier. Model P 15749. List price | \$4.75 |

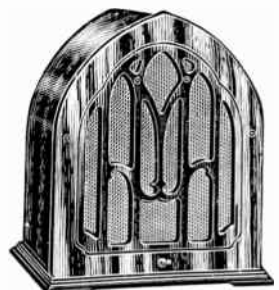
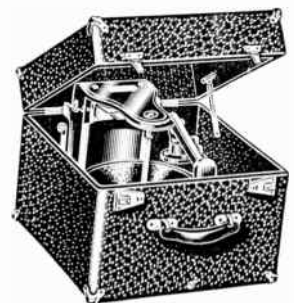

A Remote-Controlled Public Address Tuner for Rack Mounting

IMPORTANT as it is, to have good, clear, understandable Microphone pick-up in a Public Address Installation, it is of equal importance to have a really good Radio Tuner. No matter what the Public Address System is to be used for, there is almost always an occasion when a particular radio program is to be heard. In a commercial installation it may be the advertising broadcast of the company's products. In a hotel, stadium, or other public installation it may be a political speech, etc. So it can be readily seen that a radio tuner should be selected carefully.

Illustrated on this page are two tuners of the tuned radio frequency type. This type of tuner is preferred wherever tone quality is of major importance. In installations where selectivity is of greater importance, due to crowded air conditions, a superheterodyne type of tuner is preferable. The tuned radio frequency tuner is available in two types: the standard model with full vision dial, for mounting in a cabinet, etc., and the Remote Control Model, as illustrated at the right, which has been especially designed for rack mounting and will fit a standard W.E. type rack. The many features of this Lafayette tuner, as listed below, have made this a particularly popular model, which has given great satisfaction in many large and small installations.

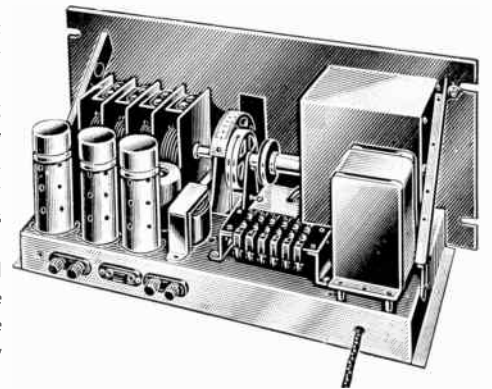

REMOTE CONTROL

This feature permits turning the tuner on or off, adjusting the volume, and the tuning in of any pre-determined station at a distance from the rack. It does not, however, prevent the operation of the tuner in the ordinary manner at the rack. There is nothing complicated in the operation of the remote control, all adjustments, volume, on and off switch, tuning, are accomplished at the touch of a button. The control mechanism is simple and sturdy in construction and will give many years of reliable service.

RACK MOUNTING

The complete tuner, including the remote control mechanism, is mounted on a formed steel chassis securely bolted to a 1/8" thick steel front panel that is slotted to match the mounting holes in the standard W.E. rack. The base is finished in aluminum lacquer and the front panel is in durable black crackle lacquer.

"T.R.F." CIRCUIT

The circuit is identical to the one used in the standard model listed below and provides ample selectivity for average use. Sensitivity is exceptionally fine due to the use of the new pentode tubes and high gain litz-wound R.F. coils. The detector output circuit is so arranged that it may be connected to the amplifier input tube grid with a single lead. The tuner incorporates a built-in filament supply and requires 250 volts of well filtered "B" supply which may, in the majority of cases, be obtained from the amplifier. If this cannot be so obtained it may be furnished by a separate eliminator such as the Lafayette model P15701 listed on the opposite page. Tuner dimensions are 17 1/2" wide, 8" high and 8 1/2" deep.

REMOTE-CONTROL TUNER for 60 db gain amplifiers. **LIST PRICE**
Shpg. wt. 30 lbs. Model P 15700. **\$65.00**
List price, less tubes .

Lafayette "T.R.F." P.A. Tuner

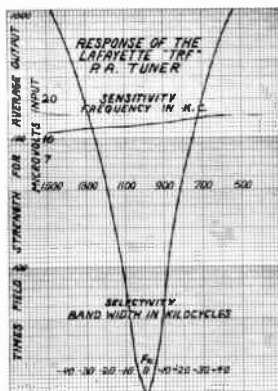
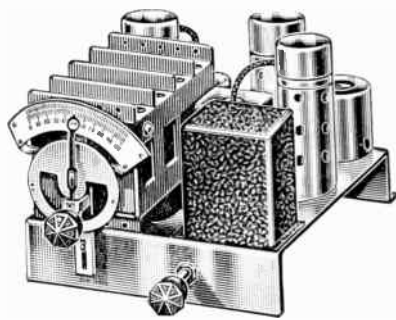

FOR those desiring a P.A. Tuner, similar to the one listed above, but without the Remote Control and rack mounting features, will find this model to be readily adaptable to their requirements. It is compact in size and can be mounted in a space approximately 10" deep, 8" high and 8" wide.

Sensitivity and selectivity have been developed to an unusual degree, closely approaching that of the superheterodyne circuit, yet retaining the "side band" advantages of the T.R.F. circuit that are so important for good tone quality. The curves, illustrated directly underneath the picture of the tuner, graphically show how well this has been accomplished.

CIRCUIT

Circuit used is as follows: a pre-selector stage, tuned by one section of the four gang condenser, is followed by two stages of tuned R.F. using type 58 vario-mu pentode tubes which are followed by the detector stage, tuned by the remaining section of the four gang condenser, and using a type 57 pentode detector. If the tuner is to be transformer coupled to the amplifier or a line, a model using a 56 detector tube is available. When ordering state type of detector desired. See Note.

BUILT-IN FILAMENT SUPPLY

Filament supply for the tuner is self contained and is turned on or off by a switch that is an integral part of the volume control. "B" supply required is 180 to 250 volts at 25 M.A. This may be obtained from the amplifier or from a separate source such as the Lafayette B Eliminator listed on the opposite page.

FULLY SHIELDED

Fully shielded throughout. All coils and tubes are individually shielded to prevent oscillation and extraneous noise pick-up.

FULL VISION DIAL

Full vision dial with a smooth acting vernier is supplied including a matching escutcheon plate and a pair of matched knobs for the dial and the volume control.

STURDY CONSTRUCTION

Chassis is of formed steel aluminum lacquered to prevent corrosion. Outside dimensions are 10" deep, 8" wide and 8" high.

Note: 56 detector requires an amplifier with gain over 60 db, 57 can be under 60 db.

LAFAYETTE "T.R.F." TUNER. **LIST PRICE**
Shipping weight, 12 lbs. Model N 13846. **\$36.00**
List price, less tubes

KIT OF MATCHED TUBES, 1-57, 2-58's for either of the above model tuners. List price \$4.95

The *Lafayette* Superheterodyne Public Address Tuner

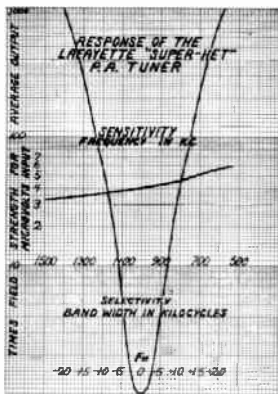
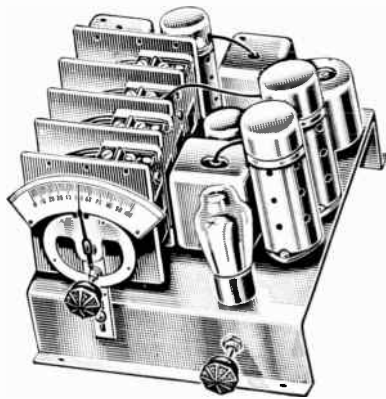

Note in the above curve the exceptionally fine selectivity obtained. By comparing this curve with the one on the adjacent page for the "T.R.F." Tuner the difference between the two tuners in selectivity can readily be seen.



Photo, courtesy of the
Hotel Pennsylvania, N. Y.

IN many metropolitan areas the multiplicity of broadcasting stations makes imperative the use of an extremely selective P.A. Tuner. The Superheterodyne circuit is especially fitted for use under such conditions and, when combined with the new multi-purpose tubes, provides the utmost in selectivity and sensitivity. This new tuner has been designed to take advantage of all the possibilities of this combination and incorporates such valuable features as a tuned pre-selector stage, diode detection, automatic volume control, etc.

A sensitivity of approximately $3\frac{1}{2}$ microvolts per meter has been obtained, yet the noise level is surprisingly low. Two models are available, one with three tubes for high gain amplifiers, and another, with an additional audio stage using a 56 tube for low gain amplifiers. Both models are identical in size and include their own filament supply. Their compactness makes it possible to use these tuners in practically any installation, either permanent or portable, that is operated from 110 volts 60 cycle A.C. Many of these tuners are also being used in connection with one of the smaller amplifiers, and an electric turntable and phono-pick-up, for use in the home, thus providing an exceptionally efficient phono-radio combination at a reasonable cost.

P.A. TYPE SUPERHETERODYNE CIRCUIT

A circuit especially developed by Lafayette engineers for this tuner. A tuned pre-selector stage is followed by a tuned R.F. stage using a type 58 multi-mu pentode which is followed in turn by a 2A7 pentagrid converter tube that serves as both oscillator and first detector, or modulator. This is followed by a 2B7 tube that serves as I.F. amplifier, diode detector, and automatic volume control tube. In the four tube models this is followed by a stage of audio frequency using a type 56 triode.

EXTREMELY SELECTIVE

Exceptionally good selectivity has been obtained without loss of tone quality, yet providing ample 10 Kc. separation between stations. A very favorable image ratio has been obtained in the order of 10,000 to 1.

TUNING METER EASILY ATTACHED

The "B" power change, 33 M.A. without signal and 12 M.A. with signal, makes it very simple to connect a tuning meter. All that is necessary is to insert the meter in the high voltage supply lead. Plate voltage required is a maximum of 275 volts well filtered. This can be obtained from the amplifier or from the B Eliminator listed below. This eliminator is suitable for use with any Lafayette Tuner.

STURDY CONSTRUCTION

Only the finest quality components are used throughout. Chassis is of formed steel protected against rust by a heavy coating of aluminum lacquer. All stages are thoroughly shielded to prevent oscillation. Every care that would contribute to a finer instrument has been taken, starting with the original design and following right through to the finished product.

COMPACT

Compact in design. The complete tuner, including the built-in filament supply, measures only $7\frac{1}{4}$ " high, $10\frac{1}{2}$ " deep and $9\frac{1}{4}$ " wide. Comes complete with full instructions.

THREE TUBE LAFAYETTE
SUPER-HET TUNER for high
gain (over 60 db) amplifiers.
Shpg. wt. 14 lbs Model N
13828. List price, less tubes

LIST PRICE
\$45.00

KIT OF MATCHED TUBES for above. Model N 13829.

List price **\$5.85**
FOUR TUBE SUPER-HET TUNER for low gain (under
60 db) amplifiers. Model N 13830. List price, less
tubes **\$49.00**

KIT OF MATCHED TUBES for above. Model N 13831.
List price **\$7.05**

SPECIAL DESIGNED "B" POWER SUPPLY for use
with any model Lafayette Tuner listed on this and the
adjacent page. Model P 15701. List price . . **\$16.00**

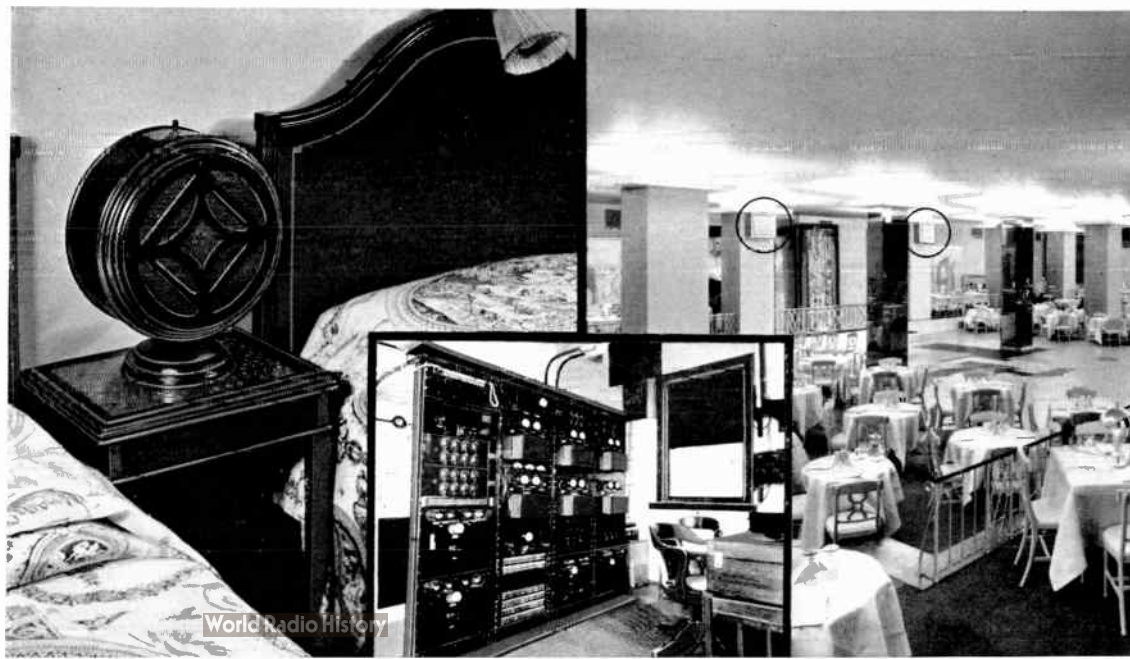



SPEAKERS

NEW "WAVE-FORM SPIDER"

Lafayette Model Dynamics

The greatest improvement in speakers since the development of the dynamic cone. A new wave-form spider that is extremely flexible yet assures absolutely accurate voice coil centering at all times. It is a solid diaphragm that is permanently fastened into place without screws, washers or bolts and that cannot shift its position no matter how great the volume. It does not cover the inside of the voice coil. This spider is made of a specially prepared material moulded into a pattern similar to the wave form produced by a pebble dropped into the water. This shape not only makes the spider very flexible but assists in the proper acoustic distribution of the sound waves. Especially is this of advantage in the higher frequencies.



Model WFC

A very popular size that is generally used in medium sized consoles, etc. Cone is 8" in diameter. Depth overall is 4 1/4". Standard field resistance is 2500 ohms. See note for transformer types. Specify type desired. Shipping weight 10 lbs.

W19142. LIST PRICE \$8.00

Model WFB

A 6" cone of the type used in the majority of midget receivers. Depth 4 1/4". Standard field resistance 2500 ohms. Shipping weight 7 lbs. See note for transformer type. Specify type desired.

W19143. LIST PRICE \$6.00

Model WFA

A full sized 11" cone that is particularly well suited for use in medium and low powered public address systems. Depth 5 3/8". Standard field resistance 2500 ohms. Shipping weight 12 lbs.

W19141. Specify Transformer Type
LIST PRICE \$10.00

Lafayette 14" "PHOTOPHONE Type" Dynamics

All of the desirable qualities of the popular Photophone type of speaker plus many new features that greatly improve its performance and construction have been combined in this newest Lafayette Dynamic Speaker. Designed for use where great power with exceptionally fine tone quality is desired. An extremely large, heavy, field wound with approximately 5 1/4 lbs. of pure copper wire is housed in a pot 5 1/2" long. The cone, made of the finest quality acoustic material, is 14" in diameter and has a 1 1/4" voice coil with an impedance of 8 to 12 ohms. D.C. field resistance is 1000 ohms. This speaker will safely carry 12 watts continuously and 20 watts peak. Workmanship is of the finest and all metal parts are attractively finished in bright cadmium plate. Shipping weight 29 lbs.

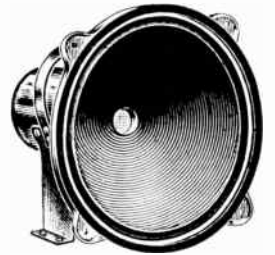

W19153. Lafayette 14" Photophone Type Speaker

W19155. Same but with 2500 ohm field.

W19154. Same but with Six Volt field.

LIST PRICE. Either Type \$25.00

A.C. Model

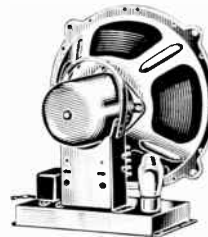

A "Photophone Type" Speaker identical to the D.C. model listed above but including a self-contained field supply for operation from 110 volt 60 cycle A.C. This type of speaker is popularly used for extension speakers where only a limited number of speakers can obtain field supply from the amplifier. Field supply has been especially well filtered and requires one 80 tube as rectifier. Speaker will safely carry 12 watts continuous and 20 watts peak. Shipping weight 29 lbs.

W19137. A.C. Photophone, less tube
LIST PRICE \$35.50

Lafayette Special A.C. Model Dynamic Speaker



A new model 11" speaker for use on 110 volt 60 cycle A.C. A 25Z5 rectifying tube, in conjunction with an oversize filter condenser, is used to obtain field current in humless form. No power transformer is used. Frequency response of the speaker is excellent. Shipping weight 20 lbs. Size 11 1/4" high, 8" wide and 6" deep. See note for output transformer types.

W19149. Lafayette A.C. speaker, less tube
LIST PRICE \$16.00

OXFORD 8 1/2 Inch A.C. Dynamic

An exceptionally fine value in dynamic speakers are these 8 1/2" models that will handle 4 watts continuously. Uses 280 tube which is not included. Transformers to match any type of output tube, as per note at bottom of page, are available. State which type is desired. For 110 volt 60 cycle operation. Compact in size making it suitable for use in portable public address systems and radio receivers of all types. Shipping weight 15 lbs.



W19291. Oxford 8 1/2" A.C. Dynamic Speaker
LIST PRICE \$10.00

UTAH STADIUM 12 Inch Speaker

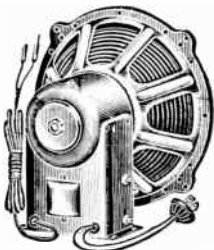

A sturdy powerful A.C. Dynamic Speaker with a 10" cone. The field supply for this speaker is furnished by a six volt dry rectifier. It is available in four models as listed below for either single or push-pull 45's or 50's. Overall size 11 3/8" wide, 12 1/8" high and 7 1/2" deep. Shipping weight 20 lbs.

W19215. For single 45's
W19298. For Single 50's

LIST PRICE. Either Type \$13.50

W19216. For P.P. 45's W19299. For P.P. 50's

LIST PRICE. Either Type \$16.50

Walnut Speaker Cabinet



This cabinet permits the placing of a speaker in the most luxurious surroundings without detracting one iota from the appearance of the room. Walnut veneers, attractively grained, and polished to a satin smoothness, have been fashioned into a particularly handsome cabinet conservative in design. Many public address installations are made in hotel lobbies, club rooms, etc., where the speakers must be hidden. For installations of this character this cabinet will be found to be well suited. In addition proper acoustic design provides the correct amount of baffling for pure tone reproduction.

This cabinet will fit all speakers listed in this manual except Wright-DeCoster 305-15, Lafayette 14" Photophone type, and Oxford 12 1/2" models, which project slightly from the rear. Outside dimensions 30" high, 18" wide, 9" deep. Shipping weight 10 lbs.

Y19848. LIST PRICE \$20.00

NOTE

Lafayette Speakers listed on this page can be furnished with transformers for the following tubes: Single and Push-Pull 38, 43, 45, 47, 53, 59, 59 Class B, 71A, 79, 2A3, 2A5, 2B6; Parallel 38, 45, 47. Specify type desired. Photophone Type Speakers are not supplied with transformers as standard equipment but they can be furnished, if desired, at an additional cost.

and ACCESSORIES

WRIGHT - De COSTER Field Supplies

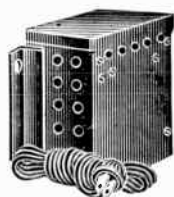

The P. A. 25 Field Supply is designed to operate 1 No. 305 (1800 ohm standard) or 2 No. 315 (3500 ohm standard) in parallel. The output voltage of the supply is 250 volts at .140 amps. Minimum load resistance is 1700 ohms. Uses one 5Z3 or 283 rectifier tube. Dimensions are 7" long, 6 1/2" high, 3 1/2" wide. Shipping weight 10 lbs. Supplied with tube.

W19282. P.A. 25
LIST PRICE . . . \$23.00

The P.A. 26 Field Supply will operate 1 to 3 No. 305 (1800 ohm standard) or 1 to 6 No. 315 (3500 ohm standard) models in parallel. Combinations such as 1-305 and 4-315 models may also be operated successfully. Output voltage of the field supply is 250 volts at .5 amps. Minimum load resistance is 500 ohms. Two 5Z3 or 283 rectifier tubes are used. Output voltage of both P.A. 25 and 26 is very nearly constant regardless of load resistance. Dimensions are 8" long, 6" wide and 6 1/2" high. Shipping weight 18 lbs.

W19283.
LIST PRICE . . . \$32.75

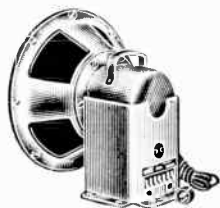

WRIGHT - De COSTER Model 305

Due to the excellent design of the magnetic structure, the model 305 is extremely efficient. This means that an amplifier, to fulfill a certain requirement may be operated below its maximum rating, resulting in much better tone quality.

This model 305 is rated conservatively at 15 watts. It is sensitive enough, however, to operate on as little as 1 watt.

Patented Solid Center Spider

The solid center spider is made of material which is very durable. It maintains the voice coil in a perfectly centered position, but still allows the cone a great freedom of movement. Another outstanding feature of the solid center spider which is most essential when the speaker is to be installed out of doors, is the protection it gives to the air gap against dirt, etc. Furthermore, the entire diaphragm assembly is moisture proof.

Five different input impedances are available: 10 (directly to voice coil), 500, 1000, 1500, and 4000 ohms. These different impedances allow the user a great deal of latitude when matching several speakers to an amplifier, eliminating the need of special matching transformers. Standard field resistance is 1800 ohms for operation on 220 to 275 volts D.C. at 125 to 140 Ma. Any specified field resistance to operate on any D.C. voltage can be furnished on special order. Maximum field dissipation 40 watts, minimum 18 watts. Fields can be operated on A.C. by using the P.A. field supplies listed on this page. Shipping weight 42 lbs.

W19354. Model 305. Dimensions 12 1/8" wide, 9" deep, 12 1/4" high.

LIST PRICE . . . \$48.50

Model 315

Similar to the above except that it is rated at 10 watts and has a 3500 ohm field requiring a maximum dissipation of 25 watts, minimum 12 watts. Size 12 1/8" wide, 8 1/6" deep, 12 1/4" high.

W19353. Model 315. Shipping weight 30 lbs.
LIST PRICE . . . \$37.50

WRIGHT - De COSTER Model 325



Many P.A. installations, both permanent and portable, must be used with a smaller sized speaker than either the model 305 or 315. This does not however preclude excellent sound reproduction. The Model 325 is especially designed for such installations. It has a maximum power handling capacity of 7 watts and is suitable for practically all sound reproducing instruments to be used indoors.

Comes equipped with an output transformer according to your specifications. When ordering specify type desired, i.e., what output tubes you want to use the speaker with. Standard field resistance is 2500 ohms, other resistances can be supplied on special order. This model like all Wright De Coster speakers is equipped with the solid center spider. Cone diameter 10". Outside diameter of cone bracket 12 1/8", depth 8 3/8". All metal parts are cadmium plated. Extremely rugged in construction. Shipping weight 18 lbs.

W19148.
LIST PRICE . . . \$20.00



ELECTROPHONE "Crystal" High Frequency Speaker

Present loud speakers, of either the cone (dynamic) or horn types, reproduce satisfactorily the tones of lower frequencies but fail to respond to those of higher frequencies. The resultant reproduction is muffled and lacks the crispness, and brilliance, of true high quality reproduction. The remedy for this deficiency in high frequency response is now made available in the new high frequency Electrophone.

It has a rising characteristic to 10,000 c.p.s. with a cut off at 20,000 c.p.s. Its response is so adjusted as to complement that of the regular loud speaker, and when used in conjunction with such a speaker, the response curve is leveled off and the frequency range extended. No field current is required, and due to the peculiar properties of the crystal units no filter is necessary. A special matching transformer is built into the speaker housing and is hermetically sealed to protect it against moisture and atmospheric effects. This matching transformer permits connecting the high-frequency speaker terminals directly across the voice coil terminals of the low frequency speaker.

A further beneficial result of connecting the capacitive Electrophone directly across the inductive low frequency speaker is an improvement of the power factor of the circuit. This is especially important in the case of pentode output tubes. Precision construction is used throughout, the horn being made of bakelite moulded in a single piece with a bullet shaped insert in the throat of the horn to form an annular throat passage. Horn length 5 inches, overall speaker length 7 3/4". Shipping weight 5 lbs.

W19279. Electrophone Crystal Speaker
LIST PRICE . . . \$40.00

RACON

High Frequency Dynamic Speaker



The RACON high frequency speaker is an efficient and precision-built unit designed to cover the frequency band from 3,000 to 12,000 cycles. Uniform response up to 18,000 cycles. It is supplied complete with a horn as illustrated. Field can be had for either 6 volt or 110 volt D.C. operation as specified. Voice coil impedance 15 ohms. For A.C. operation the 110 volt field can be excited with a field exciter especially designed for this unit using two 25Z5 tubes. In order to obtain the correct energy distribution from the amplifier to the speakers, and in order to pass the correct frequency band to each speaker, a filter must be used. The Filter Networks listed below are especially designed for this purpose. One range is provided up to 3000 cycles for low frequency transmission and another range from 3000 cycles up for high frequency transmission. A coupling transformer is included in the case for one or two high frequency units as required. Entire assembly is mounted in a cast aluminum case with all necessary binding post terminals. Two models are available—one for operation from a line having an impedance of 500 ohms—and the other for lines having an impedance of 4000 ohms. Dimensions of speaker: 6 3/4" long overall, 3" bell on horn. Shipping weight of speaker 15 lbs. Shipping weight of filter 10 lbs.

W19269. RACON High Frequency Speaker
LIST PRICE . . . \$27.50

W19270. RACON Filter Network for 500 ohm line.
LIST PRICE . . . \$27.50

W19350. Filter Network for 4000 ohm line
LIST PRICE . . . \$27.50

W19351. Field Exciter, less tubes
LIST PRICE . . . \$16.50



TRUMPETS

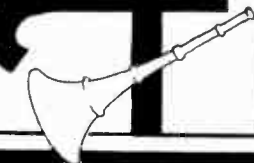

RACON TRUMPETS For Indoor and Outdoor Use

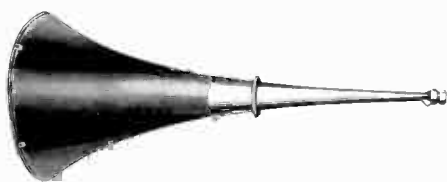

3 1/2 Foot Trumpets

Stormproof Model. Equipped with metal beaded edge, cast aluminum ferrule and suspension ring. Guaranteed for 1 year. For outdoor use in all climates and weathers. Shipping weight 20 lbs. Y19788.

LIST PRICE \$44.00

De Luxe Model. Equipped with metal beaded edge, cast aluminum ferrule and suspension ring. For indoor or temporary outdoor use. Shipping weight 17 lbs. Y19789.

LIST PRICE \$27.50

Regular Model. Equipped with metal beaded edge, metal ferrule and suspension ring. Adapted for 7/8—18 thread unit. For indoor use only. Shipping weight 17 lbs. Y19790.

LIST PRICE \$22.00

4 1/2 Foot Trumpets BELL 24 INCHES ROUND

Stormproof Model. Equipped with rolled on beaded edge and half length cast aluminum tone arm. Two sections easily assembled or disassembled. Especially made for outdoor use. Three suspension points. Coupling for attaching unit. Shipping weight 15 lbs. Y19740.

LIST PRICE \$60.50

De Luxe Model. A special model for indoor use. Has rolled on beaded edge and half length cast aluminum tone arm. Can be taken apart or put together in a few moments. Three suspension points are provided. Has a special flexible coupling to attach unit. Shipping weight 13 lbs. Y19741.

LIST PRICE \$44.00

Racon Directional Trumpets, for dynamic speaker units, are carefully engineered to conserve all of the available power from the unit and to direct it into useful sound coverage without loss in tone quality. They are made of a specially prepared fabric thoroughly impregnated and hardened. Models are available for outdoor, semi-outdoor, and indoor use.

6 Foot Trumpets

BELL 30 INCHES ROUND

Stormproof Model. Equipped with metal beaded edge, cast aluminum throat and 4" suspension ring. For outdoor use in all climates and weathers. Shipping weight 35 lbs. Y19791.

LIST PRICE \$71.50

Regular Model. Equipped with metal beaded edge, cast aluminum throat, and 4" suspension ring. For indoor use only. Shipping weight 31 lbs. Y19792.

LIST PRICE \$55.00

RACON Portable Trumpet

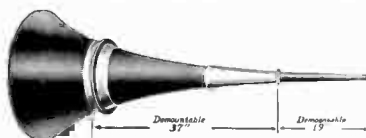

This portable model is especially designed for use where portability is essential and storage space is limited. Systems installed on sound trucks, and in some outdoor locations where they are only used intermittently, will find this demountable trumpet to be of great advantage. It comes apart in three sections, the longest of which is 37". All couplings are of cast aluminum.

This trumpet has been thoroughly storm-proofed and is equipped with a metal beaded edge. Bell is 30" round. Trumpet is 6' overall long. A special loose coupling is provided for attaching unit. Shipping weight 37 lbs. Y19826.

LIST PRICE \$88.00

Lafayette

"Humless" Field Supply

Can be used interchangeably for 1000 or 2500 ohm fields. Light in weight and compact. 7" long, 3 3/8" wide, 6 5/8" high. Two types — for one field using a single 25Z5 tube — for two fields using two 25Z5 tubes. For operation on 110 volt 60 cycle A.C.—for 220 volt operation slightly higher in price. Steel case finished in black crystalline lacquer. Comes complete with tube. Shipping weight 6 lbs. Y19294. Single Field Supply.



LIST PRICE \$9.50

Y19295. Dual Field Supply.
LIST PRICE \$12.00

RACON

Dynamic Field Exciter

These units have been carefully designed to furnish the correct amount of field current for Racon six volt fields. Operate from 110 volt 60 cycle A.C. line. Will not overheat and are exceptionally hum free. Three sizes available. Shipping weight 12 lbs. Y19271. For one Racon Unit.

LIST PRICE \$22.00

Y19272. For 2 Racon Units.
LIST PRICE \$38.50

Y19273. For 4 Racon Units.
LIST PRICE \$66.00

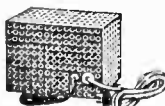

RACON Dynamic Speaker Units Super Giant



Particularly adapted for theatre and auditorium. 6 to 8 volt field excitation. 1.1 ampere consumption at 6 volts 15 ohm voice coil impedance. Continuous operating capacity 25 watts. Peak 50 watts. Shipping weight 20 lbs. Y19754.

LIST PRICE \$66.00

Giant Unit

Handles 20 watts continuously or 50 watts peak. Has 15 ohm voice coil and requires 6-8 volts at 1.1 amps. for field excitation. Has threaded collar for attaching horn or the triple connector described below. Shipping weight 26 lbs. W19265.



LIST PRICE \$55.00

Master Unit

Similar in appearance to the above unit. Continuous operating capacity 20 watts, peak 50 watts. 15 ohm voice coil; 6-8 volts at 1.1 amps. field current. Shipping weight 18 lbs. W19266. Less coupling transformer.

LIST PRICE \$44.00

Junior Unit

Handles 6 watts continuously or 20 watts peak. 15 ohm voice coil. 6 to 8 volts at 1.1 amps. field current. Shipping weight 11 lbs. Complete, less Coupling Transformer. W19267.

LIST PRICE \$33.00

Baby Unit

Continuous operating capacity 5 watts; peak capacity 18 watts. Voice coil 15 ohms. Field current, 6 volts at 1 1/4 amps. Shipping weight 9 lbs. Complete, less Coupling Transformer. W19268.

LIST PRICE \$25.00

Coupling Transformers

A400. Heavy duty transformer for all units described. 4000 ohms impedance.

LIST PRICE \$22.00

A402. Heavy duty transformer with 500 or 4000 ohm impedances.

LIST PRICE \$22.00

A405. General purpose transformer. P.P. 2+5 or 4000 ohms impedance.

LIST PRICE \$8.25



NOTE

The RACON Units listed above are available with 1000 ohm fields at the same prices quoted. This permits their use with the Lafayette Field Exciter listed elsewhere on this page.

On page 49 will be found a description of the new RACON High Frequency Speaker.

PICKUPS

PIEZO-ASTATIC Pick-Up



This pick-up has been designed with the idea of producing for the listener the illusion of absolute reality of tone production. With this pick-up the quality of the music available is limited only by the fidelity of reproduction of the amplifier and speaker system. The Piezo Electric Crystal used in this pick-up is the most perfect agent known for changing mechanical motion to electrical energy. Pick-up has ball bearing pivots and is so arranged that only 2 ozs. of pressure are exerted on the record. Thus slow playing records can be played without the use of additional counterbalancing weights. Pick-ups made with 8 or 12" tone arms. Use 1/2 Meg. Volume control. Shipping weight 5 lbs.

A161. Standard 8" Arm

LIST PRICE \$15.00

A162. Standard 12" Arm

LIST PRICE \$17.50

Aluminum Record Blanks for Recording

The records are aluminum discs and will faithfully record the voice of any person, music or sounds of any type. They can be used to record on both sides and when played with the proper bamboo needles are practically indestructible.



Stock No.	Size	LIST PRICE
A200.	6"	\$0.25
A201.	8"	.40
A202.	10"	.55
A203.	12"	.80

Pre-Grooved Aluminum Records

Stock No.	Size	LIST PRICE
A204.	6"	\$0.35
A205.	8"	.55
A206.	10"	.75
A207.	12"	1.05



VICTOR Two Speed Balanced Pick-Up 33 1/3 and 78 R.P.M.



A low inertia type of pick-up that is suitably counter-balanced for use with both slow playing (33 1/3 R.P.M.) and regular (78 R.P.M.) records. Frequency response of this pick-up is exceptionally fine and makes it ideal for use in public address installations. 28 ohms impedance. An entirely different type of construction is employed using a specially developed damping material and a new method of armature balancing. Base of arm is mounted in a special rubber cushion so that the arm will ride free at all times and thus prevent undue wear of the record. Provided with shielded connecting cable, coupler, and stop rod. Can also be used as a replacement in RCA-Victor Combinations.

A388. Shipping weight 6 lbs.

LIST PRICE \$8.00



RCA VICTOR Balanced Pick-Up

A counter-balanced pick-up made by RCA for use in phono-radio combinations. Has an excellent frequency response and is particularly well suited for use in any permanent or portable public address installation. Pick-up head impedance is 20 ohms and fresh live rubber is used for damping. Can be used with long playing records if desired. Comes complete with stop rod, so that an automatic stop can be used, and a shielded connecting cable.

Shipping weight 7 lbs.

A140. LIST PRICE \$7.50

PACENT Oil Damped Pick-Up

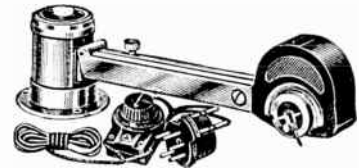

Oil damping has proven to be the most efficient method to use in pick-ups used for talking pictures, broadcasting and public address work. It is preferred not only because of the fact that, unlike rubber, it will not deteriorate with age, but also because the frequency response is superior with fluid damping. This pick-up, besides incorporating the oil damped feature, also has adjustable needle pressure. This eliminates the tendency of the needle to jump out of the groove and considerably prolongs the life of records by reducing the weight of the pick-up on the record. Shipping weight 4 lbs.

A152. LIST PRICE \$35.00

Dual Speed Adapter

Plays Both the NEW and OLD Type Records 33 1/3 and 78 R.P.M.



Many Public Address Systems already include a turntable and pick-up, for record reproduction that will, however, only play the old type records. Attach this to your present phonograph motor and enjoy the new long playing and the regular old style records. Fits all makes of phonographs. Just lift off your present turntable and drop this adapter on in its place. By merely pressing a lever you play either type of record, 33 1/3 R.P.M. the long playing record, 12 to 25 minutes of uninterrupted musical entertainment, or the 78 R.P.M. old style records. Disc is 12" in diameter, will accommodate all types of records. Shipping weight 7 lbs.

Y19893. LIST PRICE \$6.00

Trutest Pick-Up MODEL 15-A

An entirely new development in pick-ups. The unit instead of projecting at an angle is placed in a flat position that considerably improves the frequency response. Both the highest treble and the lowest bass are reproduced as faithfully as the record will permit. A new method of pivoting assures smooth operation and a minimum of needle scratch. Particularly suitable for use with portable, public address turntables. Attractively finished in a beautiful dull gold with built-in volume control. Shipping weight 4 lbs.



A147. LIST PRICE \$11.00

Counterbalance for Trutest Pick-Up

To be used with the above pick-up to assure the correct pressure for operation when used with 33 1/3 R.P.M. records. Shipping weight 4 lbs.

A148. LIST PRICE \$2.00

Lafayette

Dual Speed Pick-Up 33 1/3 or 78 R.P.M.

Designed to meet the needs for playing both 33 1/3 and 78 R.P.M. records with the same pick-up. A scientifically developed instrument that reproduces with absolute fidelity the intricate chromatic elements of the most difficult musical compositions. Available in 2500 or 5000 ohms impedances. Special impedances to order at special prices on request. Specify type when ordering. Shipping weight 5 lbs.



A138. Complete with volume control

A143. Same as above except 200 ohms impedance

LIST PRICE, either type \$12.50

LAFAYETTE Professional, Jr.

Has same general characteristics as above pick-up. Plays 16" records. Specify high or low impedance. Shipping weight 6 lbs.

A137.

LIST PRICE \$19.50

MICROPHONES



Lafayette Model "Fifty"

A new and improved model of this excellent and popular Lafayette microphone. Broadcast type, has stretched dural diaphragm only .002" in thickness. Frequency response is from 50 to 5700 cycles. Buttons are standard 200 ohms each. The model 50 microphones have proven their worth in many types of work under various conditions. Finished in highly polished nickel. 2 1/2" in diameter, 1 1/4" in thickness. Shipping weight 2 1/2 lbs.

M13421.
LIST PRICE \$40.00

Lafayette Model Twenty-Five

A very efficient two button carbon microphone which will give entirely satisfactory service. Frequency response, 70 to 4000 cycles. Resistance, 200 ohms per button. Heavy chromium plated brass frame. Special alloy diaphragm with 24Kt. gold contact points. Size 3" diameter, 2" thick. Shipping weight 4 lbs.



M13420.
LIST PRICE \$20.00

Lafayette Model "Twelve"

An exceptionally fine microphone at this low price. Two button carbon type with dural diaphragm having pure gold spot centers. Buttons are standard 200 ohms each. Bright nickel finish. Extremely rugged construction. 2 3/4" diameter. Shipping weight 2 lbs.



M13392.
LIST PRICE \$10.00

Lafayette Pre-Amplifier

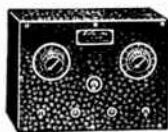

A complete pre-amplifier and control box expressly designed for use in P.A. systems. Can be used on A.C. or 6 volt battery. Plate current to be obtained from the amplifier or a separate "B" eliminator. Incorporates a phono-mike changeover switch, quiet volume or "gain" control, tone control and self-contained button current battery. Average gain 20 db. Size, 10 x 7 1/4 x 5 1/2" deep. Shipping weight 10 lbs.

P15935. Complete with tube for A.C.
LIST PRICE \$25.00

Lafayette Desk Stand

One piece cast stand with 4 3/4" diameter ring. Height, 7 3/4". Soft bronze finish. Shipping weight 3 lbs.

M13495.
LIST PRICE \$3.25

M13381. Similar to above, but with removable 6" ring. Chromium finish. Shipping weight 3 lbs.

LIST PRICE \$4.75



Lafayette Floor Stands



No. 1

M13530.
LIST PRICE \$20.00

Stand No. 2, illustrated at the right, is a large, heavy, all-chromium plated, professional type. The base is weighted with a cast form over which is spun a highly polished metal cover. This makes it difficult to upset the stand. A standard set screw adjustment is provided with a large knurled thumb screw. Extends from 45 to 72". Shipping weight 30 lbs.

M13431.
LIST PRICE \$20.00



No. 2

Stand No. 3 is an exceptionally fine value. It is impressive in size and extremely neat in appearance. Finished in a rich satin silver that is both durable and attractive. Extends from 42 to 72". Shipping weight 17 lbs.

M13428.
LIST PRICE \$11.50

No. 3

Lafayette Tone Control



A vital necessity in every P. A. installation; used with any microphone. Extremely high pitched voices may be toned down and deep, gruff voices modified to a higher frequency. Valuable in case of feed back. 2 1/2 x 5 x 2 1/2". Shipping weight 2 lbs.

M13489.
LIST PRICE \$5.50

Lafayette Input Stages



DOUBLE BUTTON

For two button microphones and consists of potentiometer volume control, transformer, switch and a battery receptacle enclosed in a wooden cabinet 4x6 1/2 x 5 1/2". For matching any two button microphone to filament and grid of tube if connected to amplifier or phonograph jack. The volume control is across the secondary of the transformer. Box finished in black leatherette. Equipped with 6' shielded cable and full directions. Shipping weight 5 lbs.

M13487.
LIST PRICE \$12.00

SINGLE BUTTON

Similar to above; for all single button microphones. Shipping weight, 4 lbs. 3 1/2 x 6 x 3 1/2".

M13488.
LIST PRICE \$8.00

Lafayette Desk Stand

Satin finish stand with 7" die-cast ring and 5" diameter base. Non-adjustable overall height, 13 3/8". Shipping weight 6 1/2 lbs.

M13427.
LIST PRICE \$7.00



SHURE Condenser Microphone



A high quality condenser microphone that has all the features of high priced microphones such as freedom from hiss, high sensitivity, and excellent frequency response yet sells at an almost unbelievably low price.

Complete unit, consisting of an air-damped stretched-diaphragm transmitter head, and a two-stage resistance coupled amplifier, is housed in an extremely attractive die-cast metal case. Transmitter head is equipped with a compensating diaphragm that equalizes pressure and assures constant performance. The frequency response is exceptionally fine from 40 to 10,000 cycles. Output level is -30 db, approximately that of a two button carbon microphone. A special terminal strip provides either 200 or 50 ohm output impedances.

Microphone requires 6 volts at 60 Ma. and 180 volts at 3 Ma., which can be obtained from batteries or the Shure Model 41A Power Supply. Microphone comes complete with 12' shielded color coded cable and is equipped with a threaded collar for attaching to a stand. An adapter is also included so that the microphone may be suspended from the ceiling if desired.

M13507. Microphone complete, including tubes. Shipping weight, 8 1/2 lbs.

LIST PRICE \$60.00

Model 41A Power Supply furnishes 6 volts at 60 Ma. and 200 volts at 5 Ma. Comes complete with plug for mike cable, A.C. cord and plug.

M13508. Shipping weight, 14 lbs.

LIST PRICE with rectifier tube \$40.00



and ACCESSORIES

UNIVERSAL Model "E" Condenser Microphone



An attractive and highly professional appearing unit for use where absolute absence of hiss or other background noises is essential. Contains a two stage amplifier in a beautifully polished Chrome plated cylindrical case. Tubes used in the amplifier draw only 1/4 ampere at 6 volts and 4 mils. at 180 volts. Output level approximately —40 db, 25 feet of shielded rubber covered cable included. Shipping weight, 10 lbs.

M13371. Condenser Microphone with tubes.
LIST PRICE \$90.00

M13372. Desk Stand with clamp for tubular section. Shipping weight, 25 lbs.
LIST PRICE \$6.00

M13373. Chrome plated Floor Stand. Shipping weight, 30 lbs.
LIST PRICE \$16.00

UNIVERSAL Lapel Mike 2-BUTTON

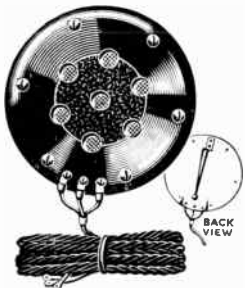

A full-fledged, 2-button natural toned instrument of precision craftsmanship. Thin, compact and light in weight. With this microphone clipped to hat lapel, one need but speak in a natural tone of voice and with head held at any angle, the result

will always be of the highest quality. 2 1/4" diameter, 3/8" thick.

M13438. Shipping weight, 1 lb.
LIST PRICE \$25.00

UNIVERSAL Model "KK"



A substantial two - button Microphone with a very low hiss. It is carefully constructed of the finest materials with a 24K pure gold spot center alloy diaphragm held under tension. Diaphragm thickness is only .002". Frequency range is from 50 to well over 6000 cycles. Buttons are standard 200 ohms each. Entire microphone is finished in 24K polished gold. It is 2 1/2" in diameter and 1 1/4" thick.

M13404. Shipping weight, 2 1/2 lbs.
LIST PRICE \$50.00

UNIVERSAL Model "X"

A very fine Microphone at a very reasonable price. Available in either single-button or two-button types. Resistance 200 ohms per button. Scientifically damped. Duralumin diaphragm, pure gold contact points. Frequency response 100 to over 4000 cycles. Shipping weight, 3 lbs.



M13412. Double-button Model X.
LIST PRICE \$10.00

M13413. Single-button Model X.
LIST PRICE \$7.50

UNIVERSAL Combination Banquet Stand



A Universal Stand that can be used on a table, pulpit, etc., and, when assembled with the two extension tubes included, can be used as a floor stand. Adjustable from 18" to 66". Polished chrome plate. Equipped with blank call letter name plate. Shipping weight, 15 lbs.

M13506. Stand with 8 springs.
LIST PRICE \$12.50

UNIVERSAL Model "LL"



Extra rugged two - button broadcast Microphone. Of high carbon steel ground to within .001 of an inch accuracy. Diaphragm is of alloy of the proper hardness and stretch to secure best results. Pure gold contact points on each side. Materials used and precision manufacture make this model stand out as the superlative microphone, reproducing a range from 30 to 7000 cycles. 3 1/2" diameter, 1 3/4" thick. Shipping weight, 3 1/2 lbs.

M13403.
LIST PRICE \$75.00

UNIVERSAL Model "BB"

The most popular double-button public address Microphone in America. Nearly twice as heavy as any other microphone in its class. Built to hair line precision. An idea of its ruggedness can be obtained by the fact that Model "BB" is 3" in diameter and 2" thick. Built especially for voice pick-up, public address work and for amateur broadcasters, etc. Will give excellent results when used for recording purposes. Beautifully finished in highly polished chrome plate. 24K pure gold spot centers. Frequency response 70 to 5000 cycles. 200 ohms per button. Shipping weight 2 1/2 lbs.



M13405.
LIST PRICE \$25.00

UNIVERSAL Three Channel Mixer



A compact, portable perfectly engineered mixer to handle three two-button or single-button Microphones or Condenser Microphones, low impedance pick-ups, or combination. Fading or blending is accomplished by the use of three mixing transformers (Univ. No. 1310) and three constant impedance T pads. Adjustment of one control does not interfere with volume or tone quality of other channels. Feeds into 400-600 ohm line. Size 4x4 1/2 x 12". Shipping weight, 9 lbs.

M13449.
LIST PRICE \$36.00

PIEZO Electric Crystal Microphone

Unquestionably a step in advance in microphone development. Crystal type. High impedance—does not require a matching transformer, can be connected directly to grid and ground of amplifier. 3" diameter, 1" thick. Finished in chromium. Complete with 6 feet shielded cable. Shipping weight, 2 lbs.



M13363.
LIST PRICE \$21.00

BRUNO "Ribbon" Microphone



The remarkable quality of these microphones caused the Editor of "Radio News" to say: "So superior to the average microphone that there is no comparison." Flat response over entire audio range. Maximum difference, 1db. No hiss—absolutely quiet. Can be used at distance from pre-amplifier. Directional quality makes it easy to eliminate feed-back. Equipped with extra sturdy housing. Complete instructions and amplifier diagram.

M13359. Ribbon Microphone completely assembled and factory tested. Complete with housing and a ribbon to line matching transformer. Shipping weight 4 lbs.

LIST PRICE \$25.00

M13364. A complete Kit of all the parts needed to assemble this microphone yourself, including the housing, and a full set of instructions so that practically anyone can assemble it in a few hours' time. Shipping weight, 4 lbs.

LIST PRICE \$15.00

REPLACEMENT RIBBON FOR MICROPHONES

M13345. Standard type. Two ribbons to a package.
LIST PRICE, per package \$1.25

M13346. Super-sensitive. Two ribbons to a package.
LIST PRICE, per package \$1.75

RIBBON MICROPHONE TRANSFORMERS

Especially designed for use with these microphones. High permeability iron cores.
M13347. R.L. To match Ribbon to Line. **M13349.** L.G. To match Line to Grid.
M13348. R.G. To match Ribbon to Grid. **M13354.** P.L. To match Plate to Line.
LIST PRICE, any type \$5.00

RECORDING



Duall Super Recorder

Features of this recorder include: positive feed giving uniform spacing, no overlapping of lines; feed mechanism

supplied with cutterhead for aluminum or celluloid; cast parts finished in black crackle, other parts heavily chrome plated. Equipped with Professional Type Recorder with perfectly balanced pick-up for play-back. Cutterhead is 15 or 500 ohms impedance. Play-back pick-up standard high impedance. Motor assembly mounted on 16 x 16" panel of 7/8" laminated board, walnut or mahogany finish. Overall depth 10". Special 1/20 H.P. 78 R.P.M. motor is used. Motor has sufficient torque for aluminum or celluloid recordings. Special rim drive together with motor suspension makes the entire assembly run noiseless and without vibration. The standard assembly is built for 80 line recording on 12" records. Feed outside-in. For 115 volt, 50-60 cycle operation. Shipping weight 30 lbs.

Y19889—LIST PRICE \$225.00

Same as Y19889, but with Two-speed Drive motor for 78 and 33 1/3 R.P.M. records. Shipping weight 34 lbs.

Y19890—LIST PRICE \$275.00

16-INCH TURNTABLE AND MOTOR ASSEMBLY

For recording long continuous programs on one blank. Panel 20 x 20 x 7/8". Heavy 16 1/2" turntable driven by 1/20 H.P. motor. Provided with 78 or 33 1/3 R.P.M. drives as desired. Has 80 line feed screw; inside-out or outside-in feeds are furnished. Celluloid cuttinghead. When ordering specify R.P.M. and type of feed. 15 ohm cutterhead, 5000 ohm play-back pick-up. Shipping weight 45 lbs.

Y19886—LIST PRICE \$300.00

Same as above, but with Two-speed Motor. Shipping weight 52 lbs.

Y19888—LIST PRICE \$350.00

Extra feed screw for any desired number of threads. Specify whether for celluloid or aluminum. Shipping weight 3 lbs.

Y19887—LIST PRICE \$20.00

New Low Noise Level Record Blanks

An entirely new development in recording material. These blanks are aluminum coated with a special black Acetate composition that is non-flammable and of time-tried density, making it possible to produce a record equal to commercial recordings. Records can be played back between 75 and 100 times.



Stock No.	Size	LIST PRICE
A351	10"	\$0.85
A342	12"	1.25
A353	16"	2.50

Special playback needle for above records.
A354. LIST PRICE, Pkg. of 10 . . . \$0.25

Sapphire Recording Needle

Will record approximately 25 to 50 records before it requires resharpening.

A359. LIST PRICE \$8.00

New Steel Recording Needles

Good for only 1 or 2 recordings.

A358. LIST PRICE, Pkg. of 10 . . . \$2.00

UNIVERSAL Phono Motor For 110 Volts A.C. or D.C.

One of the few efficient universal phonograph motors on the market at the present time. Works equally well on either A.C. or D.C. current, 110 volts. The electrical and mechanical construction is of the highest grade throughout, assuring silent operation with unvarying speed. Ideal for use in conjunction with the popular A.C.-D.C. sets now being sold. Comes completely equipped with a 12" turntable and automatic stop switch. All metal parts treated to be rust and corrosion proof. Oil holes easily accessible. Mounts on panel by means of three mounting bolts. For use with 78 R.P.M. records only. Shipping weight 11 lbs.

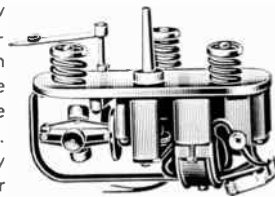

A126. LIST PRICE \$30.00

Record Carrying Cases

A360 Illustrated. For carrying 10" records only. Finished in leatherette. Hardware brass finished. Provided with a strong lock and key. Case lined with protecting material. Size 11 x 11 x 6 1/2". Shipping weight 5 lbs.



LIST PRICE \$5.25

A361. For carrying either 10 or 12" records. Finished in leatherette. Nickel plated brass hardware. Size 13 x 13 x 3 1/2". Shipping weight 6 lbs.

LIST PRICE \$3.00

A362. For carrying either 10 or 12" records. Finished in leatherette. Has protective lining. Brass hardware. Provided with lock and key. Size 13 1/4 x 13 1/8 x 6 1/2". Shipping weight 7 lbs.

LIST PRICE \$5.50

Dual Speed CAPEHART Automatic Record Changer

This dual speed 33 1/3 and 78 R.P.M. Automatic Record Changer is for the continuous playing of either 10" or 12" recordings. Equipped with a balanced electrical pick-up noted for fine tone quality and absence of needle scratch. An excellent device for the home, public address systems, theaters, ballrooms, etc. Completely automatic, last record repeats until re-stacked or when master switch is cut off. An encore may be had of any record. Records may also be rejected by depressing reject lever. Can be mounted in your own cabinet or in our De Luxe Portable Carrying Case. Base 14 1/4 x 14 1/4". Is 7 1/4" above and 3 15/16" below mounting board. Shipping weight 30 lbs.



S17750—LIST PRICE (Mechanism Only) . . . \$100.00

Mechanism mounted in special Portable Carrying Case measuring 15 1/4 x 15 3/4 x 12 1/2". Provided with lock and key. Shipping weight 42 lbs.

Y22030—LIST PRICE \$125.00

GENERAL INDUSTRIES Automatic Record Changer

Uses a powerful two-speed motor that will play both 78 and 33 1/3 R.P.M. records. Plays and changes a stack of seven 12" or eight 10" records. Automatically repeats or rejects any record or plays them manually. Last record repeats until switch is turned off. Entire unit built of heavy gauge metal finished in statuary bronze. High impedance pick-up embodies perfect damping that results in excellent tone quality. Comes complete with built-in volume control. May be built into a suitcase for portable use. Size 15" wide, 14" across front, 5" above and 3 1/4" below plate. Can be furnished for any commercial frequency. Special impedances also available. Prices upon request. Above unit for 110 volts, 60 cycles A.C. Shipping weight 30 lbs.



S17754—LIST PRICE \$52.50

S17763—For 110 volts D.C.—LIST PRICE . . . \$60.50

S17764—For 6 volts D.C.—LIST PRICE . . . \$61.50

CONVERTERS

Battery to 110 V. A.C. Converters

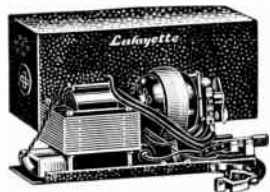

A highly efficient converter furnishing 110 volt A.C. from storage batteries. These units are the most economical ever designed for operating A.C. driven public address systems, portable transmitters, neon signs, etc. They are not recommended for operating A.C.-D.C. Compact receivers. Made in two sizes—one for operation from a 6 volt battery with a 110 volt A.C. output of 60 watts, drawing only 90 watts (15 amperes at 6 volts) from the battery. The other is larger in size and is for operation from a 12 volt battery (or two 6 volts in series) with an A.C. output of 150 watts; drawing only 216 watts (18 amperes at 12 volts) from the battery. In testing voltage output of these units an ordinary A.C. meter cannot be used since this type of meter is inaccurate on the particular wave form. Shipping weight 16 lbs.

N14227. 60 watt A.C. output
LIST PRICE . . . \$36.00

N14234. 150 watt A.C. output
LIST PRICE . . . \$60.00

Gasoline Engine Driven Generators

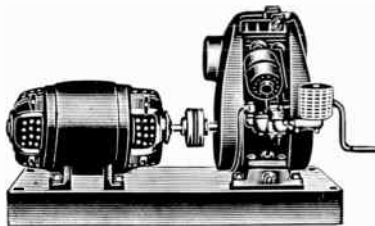

These generators produce a steady reliable source of 110 volt 60 cycle A.C. current for any purpose desired. Gas engines are the air-cooled vertical type. A combination of force feed and splash lubrication is used. Bearings are of babbitt backed with bronze. An efficient carburetion system is used that provides exceptionally economical operation. Air intake is equipped with a cleaner that prevents dust from being drawn into engine. Generator, rated with ample safety factor, has V ring commutator and ball bearings. Both engine and generator have protective end coverings. Special coupling between generator and engine prevents whipping and consequent bearing wear. Base of channel iron. Drip proof construction throughout. Delivers 110 volts, 60 cycle single phase A.C.

Stock No.	V-A Output	Net Weight	LIST PRICE
Y19822	300	165	\$200.00
Y19823	500	220	300.00
Y19824	750	326	425.00
Y19825	1200	410	500.00

Above prices are for Engine and Generator only. If Switchboard and Filter are desired order from following list.

Y19827. Switchboard with live parts enclosed in steel boxes. Includes Voltmeter and switch, fuses and voltage regulator. For any of the above plants. Shipping weight 20 lbs.

LIST PRICE . . . \$45.00

Y19828. Filter System for preventing Generator interference from reaching radio or amplifier. For 300 and 500 V.A. Plants. Shipping weight 15 lbs.

LIST PRICE . . . \$35.00

Y19829. Filter System for 750 and 1200 V.A. Plants.

LIST PRICE . . . \$45.00

GEN-E-MOTOR Converters

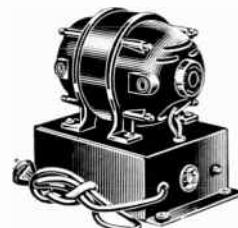

An exceptionally fine series of D.C. to A.C. converters. Highly efficient, compact, good regulation, and quiet in operation due to the use of ball bearings. For radio use a filter is included for the suppression of noise. These units can be supplied for operation from either 32 or 110 volt D.C. Specify type when ordering. Average shipping weight 25 lbs.

Y19840. 80 watt A.C. output

LIST PRICE . . . \$41.50

Y19841. 110 watt output

LIST PRICE . . . \$44.95

Y19842. 150 watt output

LIST PRICE . . . \$49.95

Y19843. 200 watt output

LIST PRICE . . . \$59.95

Y19844. 300 watt output

LIST PRICE . . . \$69.95

Auto "B" Eliminator

Supplies 300 volts at 100 Ma. D.C. from a 6 volt battery. Complete with filter. 3 5/8" x 5 3/4" x 5 7/8". Draws 8.75 amps. at 6 volts.

P14211. Shipping weight 17 lbs.

LIST PRICE . . . \$34.00

JANETTE Rotary Converters

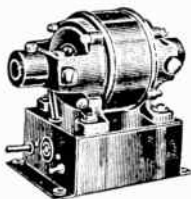

Where only a limited amount of power is required, such as for operation of a radio receiver, amplifier, etc., the most economical method of obtaining alternating current is to use an A.C.-D.C. converter. They are comparatively quiet in operation and require very little attention once installed. The JANETTE Rotary Converter is equipped with a special filter that prevents converter interference

from reaching the radio. The 80 watt size will operate the smaller midget radios and small electric motors. The 110 watt size will operate receivers up to 9 tubes. The 150 watt size is suitable for the larger receivers and the 300 watt size is especially well suited for operating public address systems.

Stock No.	Output Watts	Input Amps.	LIST PRICE	Stock No.	Output Watts	Input Amps.	LIST PRICE
32 V. D.C. to 110 V. 60 cycle A.C.				110-115 V. D.C. to 110 V. 60 cycle A.C.			

Y19806 80 5.4 \$44.00 **Y19807** 80 1.5 \$44.00

Y19800 110 6.5 52.00 **Y19803** 110 1.9 52.00

Y19801 150 8.5 60.00 **Y19804** 150 2.4 60.00

Y19802 300 15.0 77.00 **Y19805** 300 4.0 71.50

6 Volt D.C. to 110 Volts 60 Cycle A.C.

Y19808 30 14 amp. \$40.50 **Y19818** 60 22 amp. \$64.50

110 Volt A.C. Generator for Use in Autos



With this generator it is now possible to have 110 volt A.C., suitable for operating a public address system, neon sign, motor, etc., in your car, sound truck or airplane. It is driven by the engine of your car and requires a small amount of current from the generator. Installation is simple and can readily be made in less than an hour.

The generator is mounted on the engine so that the fan belt will drive the pulley. One wire lead is connected to the battery side of the car generator relay and another wire is connected to the third brush of the car generator. The A.C. generator cannot be damaged irrespective of the car speed. Comes completely equipped with a power switch, double outlet, mounting bracket, shielded cables and complete instructions.

N14248. 50 watt 110 volt A.C. Generator. (Suitable for operating small midget radios, neon signs, small motors, etc.) Shipping weight 30 lbs.

LIST PRICE . . . \$35.00

N14249. 100 watts output. (Suitable for receivers up to 8 tubes and small public address systems.) Shipping weight 35 lbs.

LIST PRICE . . . \$45.00

N14250. 175 watts output. (Suitable for radio receivers, public address systems, neon signs, etc. Shipping weight 40 lbs.

LIST PRICE . . . \$65.00

P.A. AUDIO

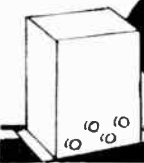

Lafayette SPECIAL P.A. TRANSFORMERS

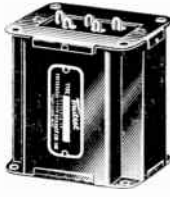

The Public Address series of transformers described below are designed to satisfy the demand for a popular priced quality line having the many exclusive features associated with Lafayette products. All cases are finished in black eggshell enamel to suit exacting commercial requirements as to appearance. Each transformer may be fastened to chassis or rack panel with lugs either at top or bottom. The hous-

ings are symmetrical physically and similar in construction and when grouped in finished equipment present a thoroughly professional appearance. Every possible check is taken to assure uniform electrical characteristics on all components. The multiple tap windings make possible a wide combination of impedance connections without impairing the audio range or frequency response of any unit.



Overall Dimensions

Mtg. Dim.	L	W	H
Type A—1 7/8" x 2 1/8"	2 1/2"	3"	3"
Type B—2 1/8" x 3 7/8"	3 1/8"	4 1/2"	3"
Type C—3 1/8" x 4 1/8"	3 5/8"	4 7/8"	4 1/4"

Input Transformers, Class B

- C5429.** Driver plate to 49, 53, 79 or 89 grids. Type A mtg.
LIST PRICE \$5.50
- C2555.** Driver 46 or 59 plate to 46 or 59 grids. Type A mtg.
LIST PRICE \$5.50
- C2556.** Push-pull 45 or 59 plates to 2-46 or 59 grids. Type A mtg.
LIST PRICE \$6.50
- C2557.** Push-pull 45 or 59 plates to 2-10's, 800's, 830's or RK-18 grids. Type A mtg.
LIST PRICE \$7.50
- C2558.** Push-pull 2A3 or 50 plates to 2-203 grids. Type B mtg.
LIST PRICE \$8.50

Output Transformers, Class B

- D5430.** Push-pull 49, 53, 79, 89 plates to 500, 200, 16, 8, 5, 3 and 1.5 ohms. Type A mtg.
LIST PRICE \$7.00
- D5431.** Push-pull 46 or 59 plates to 500, 200, 16, 8, 5, 3 and 1.5 ohms. Type A mtg.
LIST PRICE \$7.00

Mixing and Matching Transformers

- C2594.** Mixing, 500, 200 or 50 ohm line to 500, 200 or 50 ohm line. Type A mtg.
LIST PRICE \$5.50

Input Transformers, Class A

- C2569.** From 1 plate to 1 grid. Ratio 3:1. Type A mtg.
LIST PRICE \$4.50
- C2570.** From 1 plate to 2 grids. Ratio 2:1 each side. Split secondaries. Type A mtg.
LIST PRICE \$5.00
- C2571.** From 2 plates to 2 grids. 1.75 ratio each side. Primary and secondary each in two sections. Type A mtg.
LIST PRICE \$6.00
- C2572.** 500, 200 or 50 ohm line to single grid. Type A mtg.
LIST PRICE \$6.50
- C2578.** 500, 200 or 50 ohm line to push-pull grids. Type A mtg.
LIST PRICE \$7.50
- C2573.** Single plate or pick-up and carbon mike or low impedance pick-up to one or two grids. Type A mtg.
LIST PRICE \$7.50
- C2574.** Ribbon velocity mike to one or two grids. Type A mtg.
LIST PRICE \$6.50
- C2575.** Ribbon velocity mike to 500, 200 or 50 ohm line. Type A mtg.
LIST PRICE \$6.50

Tube to Line Matching Transformers

- C2576.** From a low level triode plate to 500, 200 or 50 ohms. Type A mtg.
LIST PRICE \$6.50
- C2577.** From a low level push-pull triode plate to 500, 200 or 50 ohms. Type A mtg.
LIST PRICE \$7.50

Output Transformers, Class A

- All secondary impedances of the units listed below are tapped for: 500, 250, 15, 8, 5, 3 and 1.5 ohms.
- C2562.** Primary 8000 ohms plate to plate. Will match 50's, 45's, 43's in push-pull. Single 211, 843, 842, 205D, 48. Type B mtg.
LIST PRICE \$7.00
- C2563.** Primary 5000 ohms plate to plate or 3000 ohms plate to plate. For 5000 ohms will match push-pull self bias 2A3's; single 59 triode, 71A or 2B6. For 3000 ohms in push-pull: fixed bias 2A3's. Type B mtg.
LIST PRICE \$7.00
- C2564.** Primary 2500 ohms plate to plate or 1500 ohms plate to plate. For 2500 ohms will match four self bias 2A3's in push-pull parallel circuit. For 1500 ohms will match four 2A3's, fixed bias, in push-pull parallel. Type C mtg.
LIST PRICE \$10.00
- C2579.** Primary 4000 ohms plate to plate. Will match four 50's in push-pull parallel. Type C mtg.
LIST PRICE \$10.00
- C2592.** Primary 10,000 ohms or 6000 ohms plate to plate. For 10,000 ohms will match push-pull 59 triodes, 71A's, 2B6's; single 10, 41, 268A, 2A3. For 6000 ohms will match push-pull 52A's or single 31, 46, 59 pentode. Type B mtg.
LIST PRICE \$7.00
- C2593.** Primary 4000 ohms plate to plate Will match push-pull 48 triodes or pentodes. Type B mtg.
LIST PRICE \$7.00

Trutest STANDARD REPLACEMENT AUDIO TRANSFORMERS

Only the best material and workmanship is used in construction of these transformers. TRUTEST replacement Audios and Chokes are of medium size, semi-open form, with strap mounting and bottom plate, cadmium plated. Average size 2 1/4 x 2 1/4 x 3/4". Mtg. centers, spaced 2 7/8". Shipping weight 3 lbs.

Matching Transformers

- C1559.** Phonograph pick-up transformer 3000 ohms to grid of tube.
LIST PRICE \$2.70
- C1561.** Double button microphone transformer, 200 ohms each side of center-tap.
LIST PRICE \$2.90
- C1563.** Input pick-up to grid. Primary impedance 500, 1000, 2000, and 4000 ohms.
LIST PRICE \$4.50

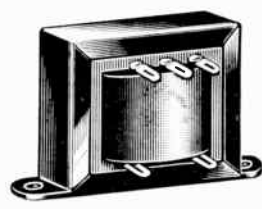

Special Line Transformers

- These units wound on a 1 1/8" core of special high permeability iron.
- C2597.** P.P. 2A5's to 500 ohm line and 2-8 ohm voice coil.
LIST PRICE \$7.50
- D5400.** 500 ohm line to 2-4-8-15 ohm voice coil.
LIST PRICE \$5.90

Outputs

- C1553.** Output, single '45 type tube to a 8-15 ohm voice coil of dynamic speaker.
LIST PRICE \$1.50
- C1554.** Output push-pull '45s type tubes to a 8-15 ohm voice coil of dynamic speaker.
LIST PRICE \$1.70
- C1555.** Output, single pentode to a 8-15 ohm voice coil of dynamic speaker.
LIST PRICE \$1.58
- C1556.** Output, push-pull pentodes, to a 8-15 ohm voice coil of dynamic speaker.
LIST PRICE \$1.70
- C1564.** Output, push-pull, 49's Class B, 238 to a 8-15 ohm voice coil of dynamic speaker.
LIST PRICE \$2.50

TRANSFORMERS



"Linear Standard" Transformers

United Transformer Company "Linear Standard" Components represent the closest approach to the ideal transformer from the standpoint of uniform response, low wave form distortion, high efficiency, thorough shielding and dependability. The curve shown below illustrates the linear frequency response of a typical U T C audio output transformer. As shown, this series

of audio units are linear over a frequency spectrum of 9 octaves, i.e., from 20 to 20,000 cycles. No effort has been spared to assure uniform characteristics on all audio units. Each transformer is individually tested for frequency range. A special grade of high permeability iron is used to house them, and as a result, hum pick-up has been overcome.

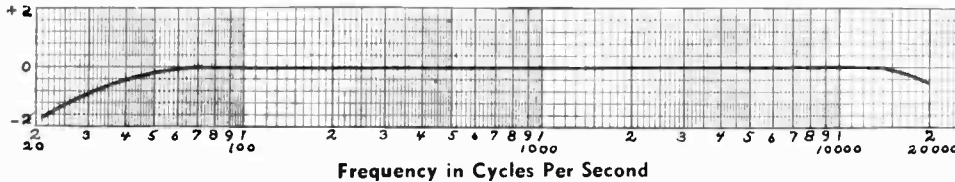
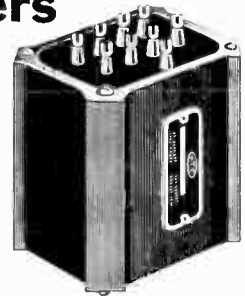

Overall Dimensions

L	W	D	L	W	D
D. 2 1/2"	3"	3 1/8"	F. 5 3/4"	4 3/4"	5 1/8"
E. 3 1/4"	4 1/4"	4 3/4"	G. 6 1/4"	6 1/4"	5 5/8"

Input Transformers

D5401. Primary will match 500, 333, 250, 200, 125 or 50 ohm line, as required for carbon, dynamic microphones, low impedance electro-magnetic or oil damped pick-ups. Secondary in two sections for series or parallel connection. Overall impedance of windings in series 100,000 ohms, impedance of each winding 25,000 ohms. Type D mtg.
LIST PRICE \$15.00

D5402. Primary same as above. Secondary same as above except that overall impedance of windings in series is 200,000 ohms, impedance of each winding 50,000 ohms. Type D mtg.
LIST PRICE \$20.00

D5403. Primary will match a velocity ribbon microphone. Secondary in two sections for series or parallel connection. Overall impedance of windings in series 130,000 ohms, impedance of each winding 32,500 ohms. Type D mtg.
LIST PRICE \$20.00

D5404. Primary designed for 500, 333, 250, 200, 125 or 50 ohm line to 2-50 watt grids at a plus 25 level. Type E mtg.
LIST PRICE \$22.00

Mixing and Matching Transformers

D5405. Mixing, carbon or moving coil mike or low impedance pick-up to a variable impedance line. Primary and secondary windings will match 500, 333, 250, 200, 125 or 50 ohm lines. Type D mtg.
LIST PRICE \$15.00

D5406. Mixing, velocity ribbon mike to a 500, 333, 250, 200, 125 or 50 ohm line. Type D mtg.
LIST PRICE \$15.00

D5407. 30 watt audio line matching transformer. Input designed for 3500, 2700, 2000, 1350, 875, 500, 200, 50 ohms. Output tapped for 30, 20, 15, 10, 7.5, 5, 1.2 ohms. Type F mtg.
LIST PRICE \$20.00

D5408. Crystal mike to 500, 333, 250, 200, 125 or 50 ohm line. Type D mtg.
LIST PRICE \$15.00

Output Transformers

*Secondary tapped at 500, 333, 250, 200, 125, 50, 30, 20, 15, 10, 7.5, 5, 2.5 and 1.2 ohms.

†Secondary tapped at 6000, 5000, 4000, 1800, 1500, 1000, 30, 20, 15, 10, 7.5, 5, 2.5 and 1.2.

‡Secondary tapped at 30, 20, 15, 10, 7.5, 5, 2.5 and 1.2 ohms.

D5409. Primary impedance 8000 ohms plate to plate. Will match push-pull 50's, 45's; single 211, 843, 842, 205D, 48. Secondary*. Type E mtg.
LIST PRICE \$20.00

D5410. Same primary and will match same tubes as above. Secondary†. Type E mtg.
LIST PRICE \$20.00

D5411. Same primary and will match same tubes as above. Secondary‡. Type E mtg.
LIST PRICE \$14.00

D5412. Primary impedance 5000 ohms and 3000 ohms plate to plate. For 5000 ohms will match self bias push-pull 2A3's; single 71A, 2B6, 59 triode. For 3000 ohms will match fixed bias push-pull 2A3's. Secondary*. Type E mtg.
LIST PRICE \$20.00

D5413. Same primary and will match same tubes as above. Secondary†. Type E mtg.
LIST PRICE \$20.00

D5414. Same primary and will match same tubes as above. Secondary‡. Type E mtg.
LIST PRICE \$14.00

D5415. Primary impedance 2500 ohms and 1500 ohms plate to plate. For 2500 ohms will match four 2A3's in push-pull parallel self bias circuit. For 1500 ohms will match four 2A3's in push-pull parallel fixed bias circuit. Secondary*. Type F mtg.
LIST PRICE \$30.00

D5416. Same primary and will match same tubes as above. Secondary†. Type F mtg.
LIST PRICE \$30.00

D5417. Same primary and will match same tubes as above. Secondary‡. Type F mtg.
LIST PRICE \$20.00

D5418. Primary impedance 10,000 ohms or 6000 ohms plate to plate. For 10,000 ohms will match push-pull 59 triodes, 2B6's,

71A's; single 10, 41, 268A, 2A3. For 6000 ohms will match single 31, 46, 59 pentode. Secondary*. Type E mtg.

LIST PRICE \$20.00

D5419. Same primary and will match same tubes as above. Secondary†. Type E mtg.

LIST PRICE \$20.00

D5420. Same primary and will match same tubes as above. Secondary‡. Type E mtg.

LIST PRICE \$14.00

D5421. Primary impedance 18,000 ohms plate to plate. Will match push-pull 845's. Secondary*. Type G mtg.

LIST PRICE \$35.00

Coupling Transformers

D5422. Cascade, single plate to single grid. Turn ratio 2:1 overall. Type D mtg.

LIST PRICE \$10.00

D5423. Input, one plate to two grids. Turn ratio 1 1/2:1 each side of center. Primary and secondary each in two sections. Type D mtg.

LIST PRICE \$13.00

D5424. Input, two plates to two grids. Turn ratio 1.6:1 each side of center. Primary and secondary each in two sections. Type E mtg.

LIST PRICE \$22.00

D5425. Input, two screen grid plates to two grids. Effective ratio 1:1. Type E mtg.

LIST PRICE \$20.00

D5426. Single plate or line to one or two grids. One side of primary winding will match single plate of tubes like the 01A, 12A, 30, 31, 26, 27, 37, 55, 56 or 85. Another primary winding designed for a carbon or dynamic mike or a low impedance pick-up. Secondary in two sections. Total secondary impedance 100,000 ohms. Type D mtg.

LIST PRICE \$20.00

Tube to Line Transformers

D5427. From a single plate like the 01A, 12A, 30, 31, 26, 27, 37, 55, 56 or 85 to 500, 333, 250, 200, 125, or 50 ohm line. Type D mtg.

LIST PRICE \$15.00

D5428. From push-pull plates (same tubes as above unit) to 500, 333, 250, 200, 125 or 50 ohm line. Type D mtg.

LIST PRICE \$15.00

RA. EQUIPMENT

Trutest

Shielded Microphone Cable



Rubber covered shielded mike cable consisting of three color coded conductors in a closely woven tinned copper shielding with 1/8" rubber outer covering. Especially intended for outdoor use. Weather and abrasion proof. Shpg. wt. 10 lbs. per 100 ft.

Q16098.

LIST PRICE—Per Foot	10c.
12 Feet for	\$1.10
25 Feet for	2.25
50 Feet for	4.25
100 Feet for	8.00

Super Service Shielded Microphone Cable



7/8" outside diameter
7 conductors of No. 14 stranded copper wire for 3 and 4 microphones on a mixing panel. Each conductor is color coded. The unusually heavy and close shielding is well protected by a tough live rubber jacket. Shpg. wt. 12 lbs. 100 ft.

Q16099.

LIST PRICE—Per Ft.	35c.
50 Feet for	\$17.00
100 Feet for	30.00

Shielded Microphone Cable



First quality shielded three conductor Microphone Cable. Ends provided with suitable lugs for easy connection.

Q16132. Shipping weight for 50 ft. 2 1/2 lbs.

6 Feet—LIST	\$0.70
12 Feet—LIST	1.00
25 Feet—LIST	2.25
50 Feet—LIST	4.00

5 Wire Rubber Covered Shielded "Mike" Cable



Re-enforced with cord, rubber covered, stranded color coded microphone cable. Heavy cotton braid outer layer, ribbon sleeve shield, 1/8" live rubber. Outside diameter 1 1/8". Shpg. wt. 2 lbs.

Q16100.

LIST PRICE—Per Ft.	18c.
Per 100 Feet	\$15.00

GREEN FLYER Governor Controlled

Two Speed Motor 33 1/3 or 78 R.P.M. for A.C. or D.C.

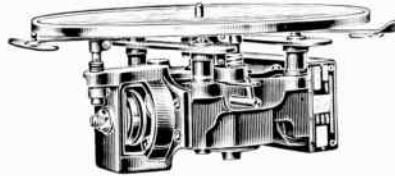

Operation

A new induction type motor that may be adjusted for either o'd style recordings at 78 R.P.M. or the new 33 1/3 R.P.M. records. Gears are completely enclosed and run in oil. Silent laminated Bakelite spiral cut gears. Over-size self lubricating bearings. Will not overheat in closed cabinets. 10" turntable. Has dial and pointed needle indicator. Hardware bronze finish. Automatic stop available at slight extra cost. Shipping weight 15 lbs.

A100. Two Speed 105-120 volt 60 cycle A.C.	LIST PRICE	\$16.50
A102. Single Speed 78 R.P.M. Motor	LIST PRICE	\$13.00

Direct Current Motors for 110 Volts

A101. Single Speed, same as No. A100 but for D.C. 33 1/3 R.P.M.	LIST PRICE	\$21.00
A103. Single Speed 78 R.P.M. Motor for D.C.	LIST PRICE	\$20.00

12" Turntables can be furnished at 40c additional. Specify on order.

Special 6 Volt Motors

Both dual and single speed types. Rugged construction makes them especially suitable for sound truck use.

A127. Two Speed same as No. A100 but for 6 volt operation	LIST PRICE	\$25.00
A128. Single Speed 78 R.P.M. for 6 volt operation	LIST PRICE	\$22.50

Extra Powerful Dual Speed Motors

This motor is similar to the Model A100 listed above, but the field and rotor are approximately 1/2 inch longer and the motor is therefore much more powerful. This type of motor is preferred when an extra heavy pick-up is to be used. If desired it may be used for amateur recording purposes and is particularly recommended for use with 16" or "theater" records for reproducing only. Shipping weight 15 lbs.

A120. For 105-120 volts, 60 cycles A.C.	LIST PRICE	\$17.50
--	-----------------------------	----------------

For D.C. use the Model A101 is especially recommended, this model being very powerful and quiet. Listed above.

GREEN FLYER Spring Driven Motors

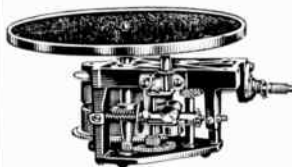

The finest line of spring driven motors made. Master Junior model is a very efficient single spring motor with a capacity of two full 10" selections and comes complete with 9" turntable and accessories. Shipping weight 10 lbs.

A208. Master Junior model	LIST PRICE	\$5.50
Majestic model has two springs that drive motor for 3 full 10" selections. Complete with 10" turntable and accessories.		
A188. Majestic model	LIST PRICE	\$7.00
No. 40 has two extra powerful springs that drive the motor for 4-5 10" records at one winding. Very quiet in operation. Complete with 12" turntable. Shipping weight 12 lbs.		
A187.	LIST PRICE	\$12.50

All motors include the following accessories beside the turntable: winding handle, turntable brake, handle escutcheon, dial and pointer speed regulator, screws and washers for mounting motor. Turntable is velveteen covered and hardware is bronze.

Trutest Scratch Filter

Practically eliminates the irritating, annoying and objectionable scratching caused by the friction of the needle, by filtering this out. Eliminates background noises. Equipped with phone tip jacks for the input side to the pick-up and also with binding posts on the output side to the amplifier, or to the radio phonograph jack. A well-built unit that should last indefinitely without giving trouble. Neatly finished in black. Can be used with any phono-radio combination. Shipping weight 3 lbs.



A118.

LIST PRICE	\$3.50
-----------------------------	---------------

Genuine Diamond Cutting and Grooving Needle

Same type as used in professional recording studios for cutting and grooving aluminum.

A132.	LIST PRICE	\$3.50
--------------	-----------------------------	---------------

Trutest Shielded Microphone Cable with Armored Connectors



Heavy rubber covered shielded cable impervious to oil and water. Connectors heavily armored and clamped to cable.

Stock No.	Size	Shipping Weight	LIST PRICE
Q16080	6'	1 lb.	\$3.50
Q16081	12'	2 lbs.	4.50
Q16082	25'	3 lbs.	8.00
Q16083	50'	5 lbs.	11.00
Q16084	100'	11 lbs.	20.00

Armored Microphone Cable Connectors

No better Connectors made for use with Carbon Microphones. Bakelite throughout, providing perfect insulation; spring contacts insuring positive connections. Heavily armored Plug and Socket locks cable, preventing individual connections from being pulled out. Diameter 1 1/2". Shipping weight 1 lb.



M13401—Plug	LIST PRICE—Each	80c.
M13400—Socket	LIST PRICE—Each	\$1.10



Lafayette

ARCTURUS

PHILCO tubes

Type	LIST PRICE	Type	LIST PRICE
1A6 Pentagrid Converter	\$1.75	42 Power Amplifier Pentode	\$1.60
2A3 Power Amplifier Triode	2.25	43 Power Amplifier Pentode	2.50
2A5 Power Amplifier Pentode	1.60	44-39 Super Con. R. F. Amplifier Pentode	1.50
2A6 Duplex-Diode High-Mu Triode	1.60	45 Power Amplifier Triode75
2A7 Pentagrid Converter	2.20	46 Dual-Grid Power Amplifier	1.55
6A4 Power Amplifier Pentode	1.60	47 Power Amplifier Pentode	1.30
6A7 Pentagrid Converter	2.20	48 Power Amplifier Tetrode	3.00
12A5 Power Amplifier Pentode	2.10	49 Dual-Grid Power Amplifier	1.70
12A7 Pentode H.W. Rectifier	2.20	50 Power Amplifier Triode	4.00
2B6 Power Amplifier Triode	2.50	51 Var.-Mu R. F. Amplifier	1.30
2B7 Duplex-Diode Pentode	2.00	52 Dual Grid Power Amplifier	1.60
6B7 Duplex-Diode Pentode	2.00	53 Twin-Triode Amplifier	1.80
6C6 Triple Grid	1.25	55 Duplex-Diode Triode	1.60
6D6 Triple Grid Super Control Type	1.25	56 Super-Triode Amplifier Detector	1.20
6F7 Triode Pentode	1.80	57 Triple-Grid Amplifier Detector	1.65
5Z3 Full-Wave Rectifier	1.50	58 Triple-Grid Super Con. Amplifier	1.65
12Z3 Half-Wave Rectifier	1.20	59 Triple-Grid Power Amplifier	2.00
25Z5 Rectifier-Doubler	2.00	71A Power Amplifier Triode75
01A Detector Amplifier60	75 Duplex Diode Hi-Mu Triode	1.60
1-V Half-Wave Rectifier	1.25	76 Detector Amplifier	1.20
10 Power Amplifier Triode	5.00	77 Triple-Grid Amplifier Detector	1.80
12A Detector Amplifier Triode	1.30	78 Triple-Grid Super Con. Amplifier	1.80
19 Twin Amplifier	1.50	79 Twin-Triode Amplifier	2.60
22 R. F. Amplifier Tetrode	2.00	80 Full-Wave Rectifier70
24A R. F. Amplifier Tetrode	1.20	81 Half-Wave Rectifier	3.50
26 Amplifier Triode65	82 Full-Wave Rectifier	1.20
27 Detector Amplifier Triode70	83 Full-Wave Rectifier	1.55
29 Twin Grid Detector	3.65	84 Full-Wave Rectifier	1.75
30 Detector Amplifier Triode	1.30	85 Duplex Diode Triode	1.60
31 Power Amplifier Triode	1.30	89 Triple-Grid Power Amplifier	1.80
32 R. F. Amplifier Tetrode	1.90	V99 Detector Amplifier	2.25
33 Power Amplifier Pentode	2.10	X199 Detector Amplifier Triode	1.50
34 Super Con. R. F. Amplifier Pentode	2.15	864 Amplifier Triode	1.60
35 Super Con R. F. Amplifier Tetrode	1.30	12Z5 F. W. Vac. Rectifier	1.50
36 R. F. Amplifier Tetrode	1.50	AF F. W. Mer. Vapor Rectifier	1.80
37 Detector Amplifier Triode	1.20	AC F. W. Mer. Vapor Rectifier	2.05
38 Power Amplifier Pentode	1.45	CA Power Pentode	2.75
39-44 Super Con. R. F. Amplifier Pentode	1.50	PZ Power Pentode	1.30
40 Voltage Amplifier Triode	2.00	PZH Power Amplifier Triode	1.60
41 Power Amplifier Pentode	1.60		



GUARANTEED FOR SIX MONTHS

Lafayette, Philco and Arcturus Tubes are the standard of excellence the world over and we back them up with as broad a guarantee as has ever been placed on a radio tube. We guarantee that they will give efficient service for six months and should any tubes purchased from us fail to do so, we will replace them cheerfully and promptly—without quibbling or red tape. Burnouts and broken glass are the only exceptions. We enjoy the biggest Tube business in the country, which insures you of receiving fresh, perfect merchandise with every order. **Should tube manufacturers reduce or increase prices after this book is published our prices will change accordingly.**

C O N F I D E N T I A L

DEALERS' AND SERVICEMEN'S PRICE LIST OF PUBLIC ADDRESS AMPLIFIERS AND ASSOCIATED EQUIPMENT LISTED IN

SOUND

AND SOLD BY

WHOLESALE RADIO SERVICE CO., 100 SIXTH AVENUE, NEW YORK, N. Y.

This confidential price list, showing both the List Prices and YOUR NET COST PRICES, is for your own use. It should be removed from this manual whenever the manual is to be used for selling purposes. These prices are CURRENT prices and are subject to change without notice. For your own protection check these prices and also the specifications of the various amplifiers and accessories from time to time with the latest catalogs and supplements of the Wholesale Radio Service Co., the SOLE wholesale distributors of Lafayette products.

The Wholesale Radio Service Co. also maintains at its New York Office a specially designed demonstration Auditorium. Here you may bring your own customers at any time during the regular business hours and demonstrate any Lafayette product. It is maintained for your use and is in charge of a competent Public Address Salesman who will give you any assistance you may require. Thus without investing a single penny in a stock of your own you are prepared to sell and demonstrate any type of Public Address Equipment.

For your convenience a space is provided on the rear cover of this book for your imprint. You can hand letter or stamp your name in this space as you desire. No finer advertisement for your firm could be desired than to have one of these manuals for each of your salesmen. In addition to serving as a sales manual this book will help to instruct each salesman in the Fundamentals of Sound and thereby help him to become a better and more efficient representative of your firm.

The Public Address Equipment, listed and described in this book, will be found suitable for the greatest majority of installations. In many cases, however, the Serviceman may find that special equipment is desired or advisable. In such instances, if you will write to us or call upon us, we will be glad to advise you and to quote prices and specifications on suitable equipment.

Address all communications to the Public Address Consultation Dept., c/o Wholesale Radio Service Co., 100 Sixth Avenue, New York City, N. Y., U. S. A.

Page		List Price	Your Cost	Page		List Price	Your Cost
25	Universal A.C.-D.C. amplifier	P15705	30.00	37	60 Watt amplifier	P15778	120.00
	Tubes		11.40		Tubes		11.10
	Speakers	P15746	10.00	39	6 V. public address system	P15747	230.00
26	Utility single 2A5 amplifier	P15790	10.90		Tubes		11.87
	Tubes		4.75	40	Utility 2A5 public address system	P15743	59.00
	Speaker	W19288	8.00		Hi Gain 3-stage system	P15744	150.00
27	Little Hercules single 2B6 amplifier	P15787	25.00	41	Push-pull 2A3 public address system	P15945	166.50
	Tubes		5.65		Push-pull parallel 2B6 system	P15944	260.00
28	Ultra High Gain Push-pull 2A5	P15939	39.00	42	28 Watt Class B system	P15720	285.00
	With output transformer	P15941	46.50		With 10 speaker	P15781	435.00
	Tubes		7.55	43	60 Watt public address system	P15934	317.50
29	De Luxe Push-pull 2A3 amplifier	P15940	53.00		8 Racon speaker and accessories	Y19990	916.00
	With transformer	P15942	60.00	43	8 Lafayette trumpets and accessories	Y19991	525.00
	Tubes		11.15	44	Push-pull 2A3 De Luxe Portable	P15943	199.00
30	Hi Gain Push-pull 2B6 amplifier	P15937	45.00		Extra portable speaker	P15793	59.00
	With transformer	P15938	52.50		Tubes	P15713	11.15
	Tubes		9.35	45	Portable 2A5 system	P15765	79.00
31	Mobile 6V amplifier	P15764	90.00		D. B. hand mike	P15734	89.00
	Tubes		11.80		D. B. mike and floor stand	P15736	92.00
32	Hi Fidelity A.C. amplifier	P15753	79.00		Tubes	P15737	4.75
	Output transformer, type A	P15930	30.00		Lafayette dual speed portable phono	Y22031	48.00
	Output transformer, type B	P15931	9.00		Caphart portable	Y22030	125.00
	Tubes		10.75		Amplifier speaker	P15748	39.50
33	Hi Fidelity D.C. amplifier	P15754	59.00		Tubes	P15749	4.75
	Output transformer, type A	P15932	25.00	46	Remote control tuner	P15700	65.00
	Output transformer, type B	P15933	9.00		T. R. F. tuner	N13846	36.00
	Tubes		15.00		Tubes		4.95
34	Push-pull parallel 2B6 amplifier	P15936	59.00	47	Superheterodyne tuner	N13828	45.00
	Output transformer	A406	10.50		Tubes		5.85
	Tubes		15.15		Superheterodyne low gain	N13830	49.00
35	28 Watt Class B amplifier	P15760	85.00		Tubes	N13831	7.05
	Tubes		9.20		B power supply	P15701	16.00
36	Theatre amplifier	P15763	139.00				
	Tubes		10.40				

Page		List Price	Your Cost	Page		List Price	Your Cost
48	Lafayette wave form spider speaker			51	Dual speed adapter, 33½ and 78 R.P.M.	Y19893	6.00 3.60
	WFC	W19142	8.00 3.95		Lafayette dual speed pick-up, 33½ and 78 R.P.M.	A138	12.50 6.20
	WFB	W19142	6.00 2.95		Lafayette dual speed pick-up, 200 ohm impedance	A143	12.50 6.20
	WFA	W19141	10.00 4.95		Lafayette professional Junior	A137	19.50 9.75
	Lafayette Special A.C. dynamic speaker, less tube	W19149	16.00 7.95	52	Lafayette model 50 microphone	M13421	50.00 19.95
	Utah Stadium 12" A.C. speaker for single 45	W19215	13.50 6.75		Lafayette model 25 microphone	M13420	20.00 9.95
	For single 50	W19298	13.50 6.75		Lafayette model 12 microphone	M13392	10.00 4.75
	For Push-pull 45	W19216	16.50 8.25		Lafayette pre-amplifier	P15935	25.00 12.50
	For Push-pull 50	W19299	16.50 8.25		Lafayette desk stand	M13495	3.25 1.65
	Lafayette 14" photophone type dynamic	W19153	25.00 12.25		Lafayette desk stand with 6" removable ring	M13381	4.75 2.40
	Lafayette 14" photophone with 2500 ohm field	W19155	25.00 12.25		Lafayette floor stand, No. 1	M13530	20.00 11.95
	Lafayette 14" photophone with 6 volt field	W19154	25.00 12.25		No. 2	M13431	20.00 9.95
	Lafayette 14" A.C. speaker less tube	W19137	35.50 17.75		No. 3	M13428	11.50 5.75
	Oxford 8" A.C. dynamic speaker	W19291	10.00 5.85		Lafayette tone control	M13489	5.50 2.75
	Walnut speaker cabinet	W19848	20.00 10.95		Lafayette input double button microphone	M13487	12.00 5.95
49	Wright De Coster field supply PA25	W19282	23.00 13.80		Lafayette single button microphone	M13488	8.00 3.75
	Wright De Coster field supply PA26	W19283	32.75 19.65		Lafayette desk stand	M13427	7.00 3.50
	Electrophone crystal high frequency speaker	W19279	40.00 27.50		Shure condenser microphone including tubes	M13507	60.00 35.28
	Wright De Coster 305 giant speaker	W19354	48.50 28.52		Model 41A power supply	M13508	40.00 23.52
	Wright De Coster 315 speaker	W19353	37.50 22.05	53	Universal E condenser mike with tube	M13371	90.00 35.28
	Wright De Coster 325 speaker	W19148	20.00 11.72		Desk stand with clamp for tubular section	M13372	6.00 3.53
	Racon high frequency dynamic speaker	W19269	27.50 16.15		Chrome plated floor stand	M13373	16.00 9.40
	For 500 ohm line	W19270	27.50 16.15		Universal Lapel mike, 2-button	M13438	25.00 14.70
	For 4000 ohm line	W19350	27.50 16.15		Universal KK mike	M13404	50.00 29.40
	Racon field exciter, less tubes	W19351	16.50 9.70		Universal double button "X" mike (Order by No. 13413-B)	M13412	10.00 5.88
50	Racon Stormproof 3½ foot trumpet	Y19788	44.00 25.88		Universal single button "X" mike (Order by No. 13412-A)	M13413	7.50 4.41
	Racon De Luxe trumpet	Y19789	27.50 16.15		Universal combination banquet stand	M13506	12.50 7.35
	Racon Regular trumpet	Y19790	22.00 12.94		Universal LL mike	M13403	75.00 44.10
	Racon 4½ foot Bell trumpet De Luxe	Y19740	60.50 35.58		Universal BB mike	M13405	25.00 14.70
	Racon 6 foot Bell Stormproof trumpet	Y19741	44.00 25.88		Universal 3 channel mixer	M13449	36.00 21.17
	Regular	Y19791	71.50 42.00		Piezo electric crystal microphone	M13363	21.00 14.70
	Racon portable trumpet	Y19826	88.00 51.74		Bruno standard replacement ribbon for microphone	M13345	1.25 .74
	Racon Super Giant speaker unit	Y19754	66.00 39.20		Bruno super-sensitive replacement ribbon for microphone	M13346	1.75 1.03
	Racon Giant unit	W19265	55.00 32.34		Ribbon mike transformer RL to match ribbon to line	M13347	5.00 2.94
	Racon Master unit	W19266	44.00 25.88		Ribbon mike transformer RG to match ribbon to grid	M13340	5.00 2.94
	Racon Junior unit	W19267	33.00 21.00		Ribbon mike transformer LG to match line to grid	M13349	5.00 2.94
	Racon body unit	W19268	25.00 14.70		Ribbon mike transformer P.L. to match plate to line	M13354	5.00 2.94
	Heavy duty coupling transformer, 4000 ohm impedance	A400	22.00 12.94		Ribbon microphone	M13359	25.00 14.70
	Heavy duty transformer with 500 or 4000 ohm impedance	A402	22.00 12.94		Kit of parts to assemble mike	M13364	15.00 8.82
	General purpose transformer Push-pull 245 or 4000 ohm impedance	A405	8.25 4.85	54	Dual Super recorder	Z19889	225.00 127.50
	Lafayette Humless field supply, single	W19294	9.50 4.75		Dual Super recorder with 2-speed drive motor	Y19890	275.00 157.50
	Lafayette Humless field supply, dual	W19295	12.00 5.95		Dual Super recorder with 16" turntable and motor assembly	Y19886	300.00 175.00
	Racon field exciter for one Racon unit	W19271	22.00 12.94		Dual Super, recorder with 16" turntable and motor assembly and 2-speed motor	Y19888	350.00 199.50
	For two Racon units	W19272	38.50 22.64		Extra feed screw for arm of the above	Y19887	20.00 12.00
	For four Racon units	W19273	66.00 38.80		Low Noise level record blank, 10" 12" (Order by No. A352)	A351	.85 .51
51	Piezo-Astatic pick-up 8" arm	A161	15.00 8.82		16"	A353	2.50 1.50
	12" arm	A162	17.50 10.30		Special playback needle	A354	.25 .15
	Aluminum record blanks, 6" 8"	A200	.25 .15		Sapphire recording needle, 25 to 50 records	A359	8.00 4.80
	10"	A201	.40 .24		Steel recording needles	A358	2.00 1.20
	12"	A202	.55 .31		Universal Phono motor, 110 volts, A.C. or D.C.	A126	30.00 15.95
	Pregrooved aluminum records, 6" 8"	A203	.80 .46		Record carrying cases	A360	5.25 3.15
	10"	A204	.35 .17		Record carrying cases	A361	3.00 1.80
	12"	A205	.55 .29				
	Trutest pick-up, model 15A	A147	11.00 4.95				
	Counterbalance for Trutest pick-up	A148	2.00 1.15				
	RCA Victor 2-speed pick-up, 33½ and 78 R.P.M.	A338	8.00 5.17				
	RCA Victor balanced pick-up	A140	7.50 4.50				
	Pacent oil damped pick-up	A152	35.00 21.00				

Page		List Price	Your Cost
54	Record carrying cases	A362	5.50 3.30
	Dual speed Capehart automatic record changer mechanism only	S17750	100.00 59.50
	Dual speed mechanism mounted in special portable carrying case	Y22030	125.00 72.50
	General Industries automatic record changer	S17754	52.50 31.50
	General Industries automatic record changer, 110 volt D.C.	S17763	60.50 36.30
	General Industries automatic record changer, 6 volt D.C.	S17764	61.50 36.90
55	Battery to 110 volt A.C. converter, 60 watt A.C.	N14227	36.00 19.95
	Battery to 110 volt A.C. converter, 150 watt A.C.	N14234	60.00 34.50
	Gasoline engine driven generator		
	300 volt A output	Y19822	200.00 125.00
	500 volt A output	Y19823	300.00 189.30
	750 volt A output	Y19824	425.00 262.90
	1200 volt A output	Y19825	500.00 302.20
	Switchboard with line parts	Y19827	45.00 28.00
	Filter system for 300 and 500 volt A plants	Y19828	35.00 21.50
	For 750 and 1200 volt A plants	Y19829	45.00 28.00
	Genemotor, 80 watt A.C. output	Y19840	41.50 28.95
	110 watt output	Y19841	44.95 31.45
	150 watt output	Y19842	49.95 34.95
	200 watt output	Y19843	59.95 41.95
	300 watt output	Y19844	69.95 48.95
	Auto B eliminator	P14211	34.00 20.00
	Janette rotary converters		
	32 volt D.C. to 110 volt A.C.		
	80 watt output	Y19806	44.00 30.80
	110 watt output	Y19800	52.00 36.40
	150 watt output	Y19801	60.00 42.00
	300 watt output	Y19802	77.00 53.65
	110-115 volt D.C. to 110 volt A.C.		
	80 watt output	Y19807	44.00 30.80
	110 watt output	Y19803	52.00 36.40
	150 watt output	Y19804	60.00 41.86
	300 watt output	Y19805	71.50 49.88
	6 volt D.C. to 110 volt, 60 A.C.		
	14 amperes	Y19808	40.50 28.35
	22 amperes	Y19818	64.50 45.15
	Generator for use in autos, 50 watt	N14248	35.00 14.95
	100 watt	N14249	45.00 19.95
	175 watt	N14250	65.00 32.50
56	Input transformer, class B, U.T.C.	C5429	5.50 3.30
	Input transformer, class B, PP46-46	C2555	5.50 3.30
	PP45 to 46	C2556	6.50 3.90
	PP45 to 210	C2557	7.50 4.50
	PP50 to 2A3	C2558	8.50 5.10
	Output transformer, class B, U.T.C.	D5430	7.00 4.20
	Output transformer, class B	D5431	7.00 4.20
	Lafayette mixing and matching transformer	C2594	5.50 3.30
	Input transformer, class A, 1 plate to grid	C2569	4.50 2.70
	1 plate to 2 grids	C2570	5.00 3.00
	2 plates to 2 grids	C2571	6.00 3.60
	Input transformer, 500—200—50	C2572	6.50 3.90
	Lafayette 500—200 or 50 ohm line	C2578	7.50 4.50
	Input transformer, class A, single plate or pick-up	C2573	7.50 4.50
	Input transformer ribbon	C2574	6.50 3.90
	Input transformer ribbon	C2575	6.50 3.90
	Tube to line matching transformer	C2576	6.50 3.90
	Input low level triode	C2577	7.50 4.50
	Output transformer, class A	C2562	7.00 4.20
	Output transformer, class A	C2563	7.00 4.20
	Output transformer, class A	C2564	10.00 6.00
	Lafayette output transformer	C2579	10.00 6.00
	Lafayette input transformer	C2592	7.00 4.20
	Lafayette input transformer	C2593	7.00 4.20
	Trutest matching transformer	C1559	2.70 1.15
	Trutest matching transformer D.B. mike trans.	C1561	2.90 1.20

Page		List Price	Your Cost
56	Input pick-up to grid	C1563	4.50 2.25
	Special line transformer	C2597	7.50 4.50
	Lafayette output transformer	D5400	5.90 3.54
	Output transformer, single 45	C1553	1.50 .75
	Output transformer, PP 45	C1554	1.70 .85
	Output transformer, single pentode	C1555	1.58 .79
	Output transformer, PP pentode	C1556	1.70 .85
	Output 233, 238 to dyn.	C1564	2.50 1.25
57	U.T.C. line or stand transformer input	D5401	15.00 9.00
	U.T.C. line or stand transformer input	D5402	20.00 12.00
	U.T.C. line or stand transformer input	D5403	20.00 12.00
	U.T.C. line or stand transformer input	D5404	22.00 13.20
	U.T.C. Mixing and matching transformer	D5405	15.00 9.00
	Input transformer	D5406	15.00 9.00
	Input transformer	D5407	20.00 12.00
	Input transformer	D5408	15.00 9.00
	U.T.C. output transformer	D5409	20.00 12.00
	U.T.C. output transformer	D5410	20.00 12.00
	U.T.C. output transformer	D5411	14.00 8.40
	U.T.C. output transformer	D5412	20.00 12.00
	U.T.C. output transformer	D5413	20.00 12.00
	U.T.C. output transformer	D5414	14.00 8.40
	U.T.C. output transformer	D5415	30.00 18.00
	U.T.C. output transformer	D5416	30.00 18.00
	U.T.C. output transformer	D5417	20.00 12.00
	U.T.C. output transformer	D5418	20.00 12.00
	U.T.C. output transformer	D5419	20.00 12.00
	U.T.C. output transformer	D5420	14.00 8.40
	U.T.C. output transformer	D5421	35.00 21.00
	U.T.C. coupling transformer	D5422	10.00 6.00
	U.T.C. coupling transformer	D5423	13.00 7.80
	U.T.C. coupling transformer	D5424	22.00 13.20
	U.T.C. coupling transformer	D5425	20.00 12.00
	U.T.C. coupling transformer	D5426	20.00 12.00
	U.T.C. tube-to-line transformer	D5427	15.00 9.00
	U.T.C. tube-to-line transformer	D5428	15.00 9.00
58	Trutest shielded mike cable		
	Per foot	Q16098	.10 ft. .06
	12 feet	Q16098	1.10 .65
	25 feet	Q16098	2.25 1.25
	50 feet	Q16098	4.25 2.45
	100 feet	Q16098	8.00 4.80
	Super service shielded cable		
	Per foot	Q16099	.35 ft. .20
	50 feet	Q16099	17.00 9.75
	100 feet	Q16099	30.00 17.50
	Shielded mike cable		
	6 feet	Q16132	.70 .38
	12 feet	Q16132	1.00 .60
	25 feet	Q16132	2.25 1.25
	50 feet	Q16132	4.00 2.35
	5 Wire rubber covered mike cable		
	Per foot	Q16100	.18 .10
	100 feet	Q16100	15.00 9.00
	Green Flyer two speed motor	A100	16.50 9.60
	Green Flyer single speed motor	A102	13.00 6.75
	D.C. motors for 110 volt single speed	A101	21.00 14.25
		A103	20.00 11.95
	Special 6 volt motor, two speed	A127	25.00 14.70
	Special 6 volt motor, single speed	A128	22.50 13.20
	Powerful Dual speed motor, A.C.	A120	17.50 11.75
	Green Flyer spring driven motor:		
	Master Jr.	A208	5.50 3.25
	Majestic	A188	7.00 4.25
	No. 40	A187	12.50 7.45
	Trutest Scratch filter	A118	3.50 1.75
	Diamond cutting and grooving needle	A132	3.50 1.75
	Trutest shielded mike cable:		
	6"	Q16080	3.50 1.75
	12"	Q16081	4.50 2.25
	25"	Q16082	8.00 3.95
	50"	Q16083	11.00 5.50
	100"	Q16084	20.00 9.95
	Armored mike cable plug	M13401	.80 .44
	Armored mike cable socket	M13400	1.10 .58

Page 59				
Type	List Price	Your Cost Lafayette	Your Cost Arcturus	Your Cost Philco
1A6	\$1.75	\$0.79
2A3	2.25	1.12	\$1.22
2A5	1.60	.72	.85	.87
2A6	1.60	.72	.85	.87
2A7	2.20	1.00	1.19	1.19
6A4	1.60	.7287
6A7	2.20	1.00	1.19	1.19
12A5	2.10	.89
12A7	2.20	.99
2B6	2.50	1.25	1.35	1.32
2B7	2.00	.90	1.08	1.08
6B7	2.00	.90	1.08	1.08
6C6	1.25	.60
6D6	1.25	.60
6F7	1.80	.85
5Z3	1.50	.70	.80	.81
12Z3	1.20	.54	.65	.65
12Z5	1.5080
25Z5	2.00	.90	1.08	1.08
01A	.60	.33	.33	.33
1-V	1.25	.55
10	5.00	2.25	2.70	2.70
12A	1.30	.59	.70	.70
19	1.50	.8081
22	2.00	.90	1.08	1.08
24A	1.20	.59	.65	.65
26	.65	.33	.35	.36
27	.70	.35	.38	.38
29	3.65	1.65
30	1.30	.59	.70	.70
31	1.30	.59	.70	.70
32	1.90	.86	1.03	1.03
33	2.10	.95	1.14	1.14
34	2.15	.88	1.16	1.16
35	1.30	.59	.70	.70
36	1.50	.68	.80	.81
37	1.20	.54	.65	.65
38	1.45	.65	.79	.79
39-44	1.50	.68	.80	.81
40	2.00	1.08

Page 59				
Type	List Price	Your Cost Lafayette	Your Cost Arcturus	Your Cost Philco
41	1.60	.7287
42	1.60	.72	.85	.87
43	2.50	.98	1.35	1.35
44-39	1.50	.68	.80	.81
45	.75	.37	.40	.41
46	1.55	.70	.83	.84
47	1.30	.59	.70	.70
48	3.00	1.35	1.62
49	1.70	.7992
50	4.00	1.80	2.16	2.16
51	1.30	.50	.70	.70
52	1.60	.72
53	1.80	.8098
55	1.60	.72	.85	.87
56	1.20	.54	.65	.65
57	1.65	.74	.90	.90
58	1.65	.74	.90	.90
59	2.00	.90	1.08	1.08
71A	.75	.38	.40	.41
75	1.60	.72	.85	.87
76	1.20	.5465
77	1.80	.80	.98	.98
78	1.80	.80	.98	.98
79	2.60	1.05	1.40	1.41
80	.70	.35	.38	.38
81	3.50	1.58	1.89	1.89
82	1.20	.54	.65	.65
83	1.55	.70	.84	.84
84	1.75	.80	.95	.95
85	1.60	.72	.85	.87
89	1.80	.80	.98	.98
V99	2.25	1.00	1.20	1.22
X199	1.50	.75	.80	.81
864	1.40net
AF	1.8098
AG	2.05	1.11
GA	2.75	1.49
PZ	1.3070
PZH	1.6085

Products of the

LAFAYETTE RADIO MANUFACTURING CO.

Sold exclusively by

WHOLESALE RADIO SERVICE CO.

100 SIXTH AVENUE NEW YORK, N. Y.

