

1975 electronics catalog no. 750

# Lafayette

RADIO  
ELECTRONICS

Listen to us, you can't go wrong.





# Belt-Driven "Programmed" Turntables

With 6-Disc Capability—

Pickering 1¢ Cartridge Bonus Too!

B-I-C is a trademark of British Industries Co.,  
Division of Avnet, Inc.

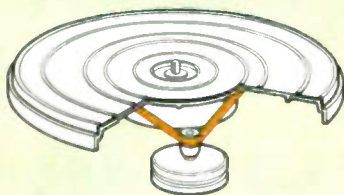
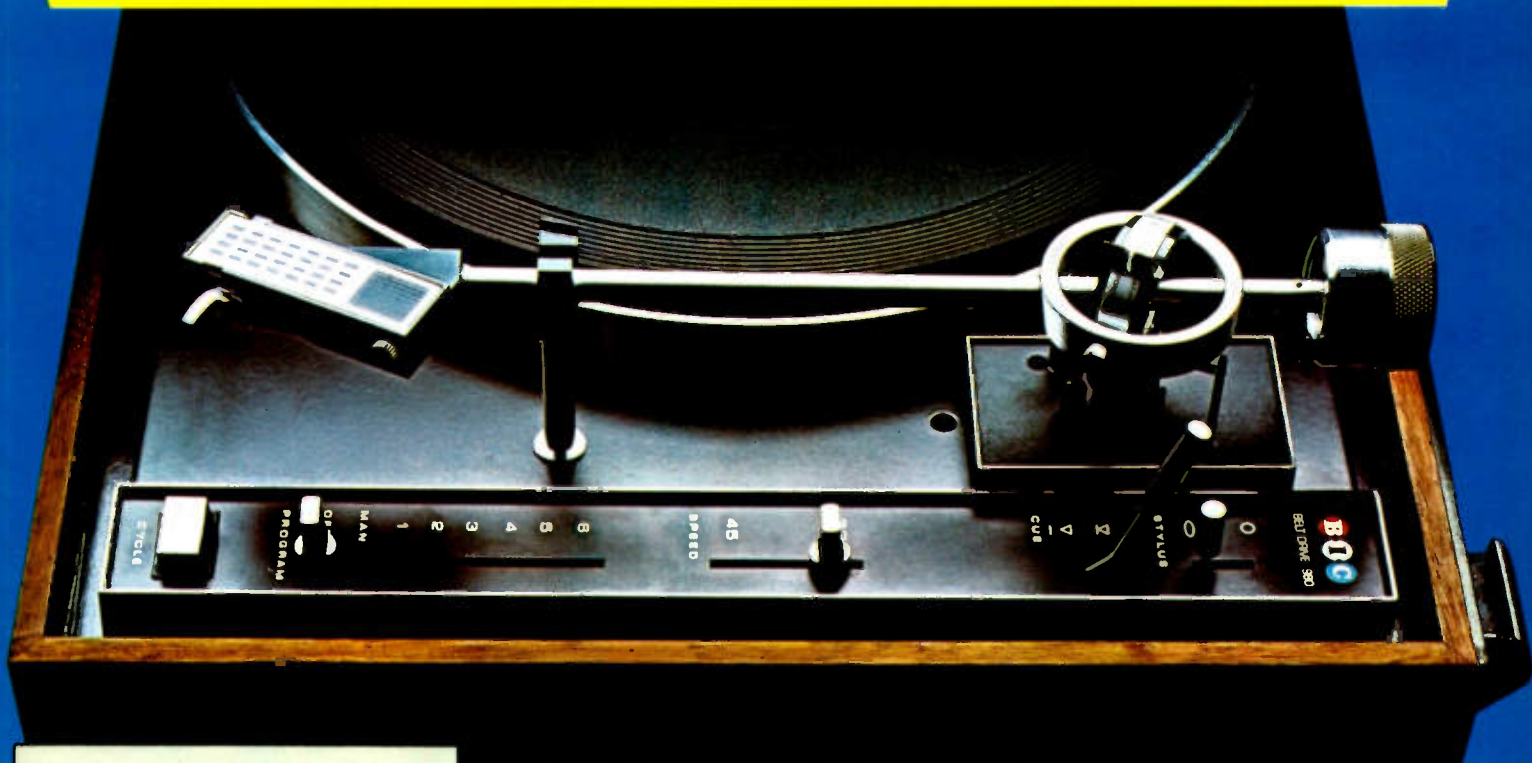

**BELT DRIVE**—Same as on the finest manuals—PLUS slow-speed 24-pole 300-rpm motor for totally inaudible rumble!

Instead of a complicated automatic-play mechanism, these turntables use manual-play design with an entirely separate automatic-play "programmer" — LESS mechanical difficulty, LESS maintenance, LONGER LIFE for turntable and records!

**PROGRAM SYSTEM** — Play a record 1-6 times, play up to 6 records one at a time. Simply set the dial from 1 to 6.

**CARTRIDGE SHELL:** Adjustable overhang (with gauge supplied), adjustable stylus angle for 15° tracking regardless of depth! Foolproof cartridge connector, too!

**CUEING:** Two-way damped cueing with adjustable rate from 1 to 3 seconds!

**ANTI-SKATE and STYLUS FORCE:** Calibrated .25-gram increments on a single linear scale. No separate adjustments.

**FUNCTION CONTROL:** Short-travel touch button cannot jar turntable in motion—outstanding protection.

**TONEARM:** Low-friction, gimbal-mounted—tracks lower than lowest limit of any cartridge now available.



1¢ Cartridge Bonus

### Model 980 with Pickering XV-400E 1¢ Cartridge Bonus

Has all the features discussed at left PLUS solid-state electronic speed control for  $\pm 3\%$  pitch variations, electronic drive, built-in lighted strobe, less base. 2 speeds: 33 $\frac{1}{3}$  and 45 rpm. Size 12 $\frac{1}{4}$ " x 15 $\frac{1}{8}$ " x 6 $\frac{1}{16}$ " above board, 1 $\frac{1}{8}$ " below. For 117 VAC, 60 Hz. Imported. Shpg. wt. 12 lbs.

22 F 92555WXM. With Cartridge .Net 199.96  
21 F 10005WX. Model 980 Alone .Net 199.95

**\$199<sup>95</sup>** Less Base and Cart. **SAVE \$54<sup>94</sup>**  
**\$199<sup>96</sup>** Less Base, with Cart.

### Model 960 with Pickering V-15/AME/IV 1¢ Cartridge Bonus

Has all the features discussed at left, does not have pitch control or lighted strobe. Excellent for all but the most discriminating audiophiles. Less base. Size 12 $\frac{1}{4}$ " x 15 $\frac{1}{8}$ " x 6 $\frac{1}{16}$ " above mounting board, 1 $\frac{1}{8}$ " below. For 117 VAC, 60 Hz. Imported. Shpg. wt. 13 lbs.

22 F 92548WXM With Cartridge .Net 149.96  
21 F 10013W Model 960 Only .Net 149.95

**\$149<sup>95</sup>** Less Base and Cart. **SAVE \$49<sup>94</sup>**  
**\$149<sup>96</sup>** Less Base, with Cart.

### Accessories for B-I-C Models 980 and 960

Stock No.	Model	Description	Shpg. Wt.	Net
21 F 10047W	WB-20	Deluxe Solid Walnut Base	4 lbs.	16.95
21 F 10039W	B-20	Ebony Plastic Base	2 lbs.	7.95
21 F 10021W	D-20	Hinged Dust Cover	2 lbs.	9.95

# NEW! Exciting Electronic Products from CRAIG.

**\$99<sup>95</sup>**  
Less Speakers

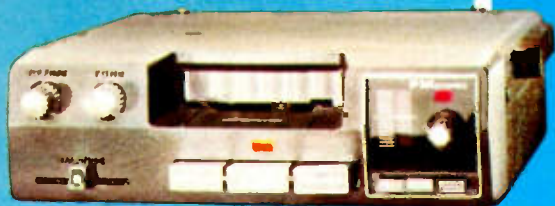

**\$39<sup>95</sup>**



**\$39<sup>95</sup>**

## "Quick-Mount" Car Cassette Player/Stereo FM Radio

- Matrix Circuit for 4-Dimensional Sound with Four Speakers
- Easy Under-Dash Mounting

**Model 3512.** Features slot cassette loading, locking fast forward and rewind, end-of-tape indicator light, precise vernier tuning FM dial, lots more. Plays all pre-recorded stereo cassettes, tunes FM and stereo FM broadcasts. With mounting bracket, all hardware. 12 VDC neg. gnd. 7 $\frac{3}{8}$ "x2 $\frac{1}{4}$ "x7 $\frac{1}{2}$ ". Imported. **17 F 08049W** Shpg. wt. 5 lbs. . . . Net 99.95  
**Deluxe Pair of Car Speakers for Above.** **99 F 63885** Wt. 5 lbs. Imported . . . Net 14.95

## Phone Message Taker

- Use with Cassette Recorders to Take Messages from 30 Seconds Up to Five Minutes

**Model 9502.** The "Craig Connection" that adds versatility to any telephone. Connects to portable cassette recorders with remote-mike input jack (see page 56). Records phone messages automatically. *Does not give any message.* Has built-in monitor speaker, message indicator. No batteries or AC power required. Fits standard 4-pin telephone jack.  
**44 F 11500** Shpg. wt. 1 $\frac{1}{2}$  lbs. . . . Net 39.95  
Check with local phone company for installation requirements, if any.

## Pocket Electronic Calculator

- Constant for All Five Functions
- % Key with Automatic Add, Subtract
- Automatic Floating Decimal
- Overflow, Negative Result Indicators

**Model 4509A.** Performs "lightning fast" addition, subtraction, multiplication and division, percentages. Easy-read, 8-digit,  $\frac{1}{2}$ " LED display, 8-digit capacity. 3 x 1 $\frac{1}{4}$  x 5 $\frac{1}{2}$ ". With batteries, and carry pouch. Imported. **15 F 21509L** Shpg. wt. 1 $\frac{1}{2}$  lbs. . . . Net 39.95  
**Extra "AA" Batteries (Use 4).**  
**99 F 63703** . . . . . Net ea. .22



**STANTON**

## 681 TRIPLE-E

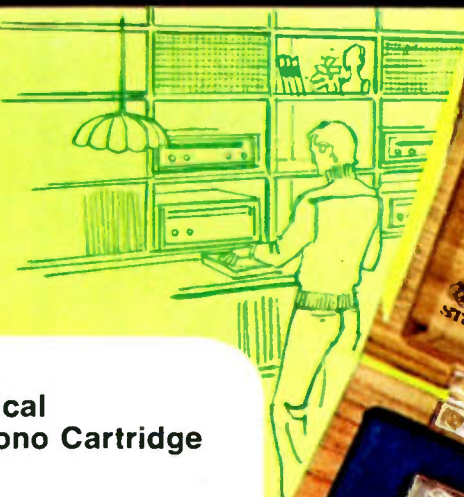

### Calibration Standard Elliptical Stylus Magnetic Stereo Phono Cartridge

One of the finest stereo cartridges available today—designed to serve as a primary calibration standard in recording system checkouts—used by many recording companies! Features a dramatically reduced tip mass—approx.  $\frac{2}{3}$  the size of conventional cartridges for improved tracking at all frequencies. Completely re-designed cartridge body and stylus using many developments associated with Stanton's 4-channel cartridge research. The results are spectacular indeed—response from 10 Hz to above 22 kHz—35 dB nominal channel separation—channel balance within 2 dB—tracking force of 1 to 2 grams (with brush). *Special integrated record brush cleans your records as you play them for better sound and longer record life.* 0.2x0.7 mil elliptical diamond stylus. Mounts on  $\frac{1}{2}$ " centers. Each cartridge is packed with its own individual calibration test—your assurance of exact quality. Use with the finest automatic or manual turntables for absolutely accurate record play. **21 F 24022L** Shpg. wt. 8 oz. . . . . Net 82.00

B

**\$82<sup>00</sup>**

# BSR PHONE BUTLER

Answers Your Phone and Tapes Messages When You're Out... or In

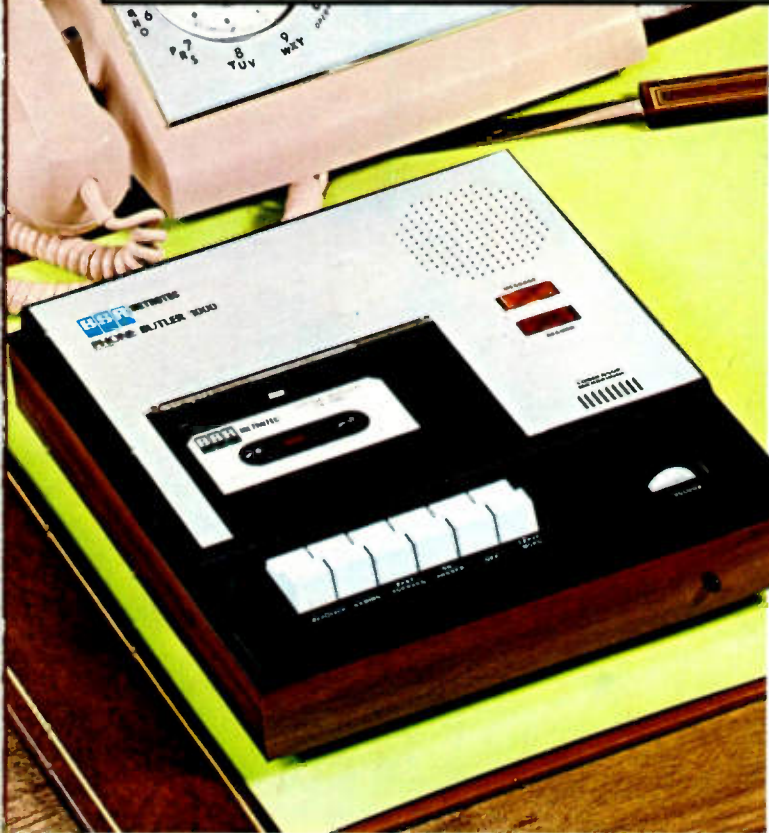

**\$99<sup>95</sup>**

- Records Up to 30 1-Minute Messages
- Answers Your Phone with Up to 30-Second Message
- AC Operated—No Batteries
- Easy In-Line Installation

Keep your phone "at work" all the time with this space-age phone-answering device. Even when you're out or away, it keeps your telephone "in business" for important calls and messages. Answers your telephone with your 30-second message—records a 30-second message for you—plenty of time for callers to leave a message or a number, etc. Serves as a monitor or telephone amplifier too—a push of the button lets you screen incoming calls, listen to caller at full volume. Has pushbutton function controls, message light to indicate messages recorded, volume and fast forward for easy location of more important messages. Can be used with both standard and multi-line phones (with optional adapter cable), below. For 117 VAC, 60 Hz. U.L. listed. 9 x 2 $\frac{3}{4}$  x 10". Imported.

- 27 F 34028W Shpg. wt. 6 lbs. . . . . Net 99.95  
 27 F 34010 Cable for Multi-Line Phone. Shpg. wt. 6 oz. . Net 19.95  
 27 F 34002 Extra Message Tape. Shpg. wt. 2 oz. . . . . Net 4.95

Contact your local phone company for installation requirements, if any.

## ELECTRONIC CALCULATORS

**apf**

**NEW!**

**\$59<sup>95</sup>**



**Pocket 8-Digit with Memory**

- **M+**, **M-**, **MR**, **MC** Memory Keys
- **%** Key for Instant % Figuring
- Automatic Zero Suppression

**Mark 16.** Does it all and then some including chain and mixed problems, automatic constant for addition, subtraction, multiplication and division. Has algebraic logic, floating decimal, exchange key, 8-digit  $\frac{1}{32}$ " LED display with cutoff to save battery power. 3 x 6 x 1". With battery.

- 15 F 54054L Shpg. wt. 1 $\frac{1}{2}$  lbs. . . . Net 59.95  
 15 F 54070L AC Adapter. Wt. 8 oz. Net 4.95



**\$69<sup>95</sup>**

**Portable/Desk 8-Digit Model**

- With Batteries, AC Adapter, Case
- **M+**, **M-**, **MC** Memory, **%** and **Sign Change** Keys, **Constant**

**Mark VI.** THE electronic calculator for tax work, checkbook balancing, even light office work. Has full floating decimal, overflow indicator, minus indicator for true credit balance. Shows zeroes to right of decimal for easy checkbook balancing. Full-size keyboard,  $\frac{1}{4}$ " fluorescent display with cutoff 4 x 1 $\frac{1}{2}$  x 6". Imported.

- 15 F 54013L Shpg. wt. 2 lbs. . . . Net 69.95



**NEW!**

**\$119<sup>95</sup>**

**Scientific "Slide-Rule" Calculator**

- 13 Scientific Functions
- Includes AC Adapter/Charger, Rechargeable Batteries, Case

**Mark 20.** A pocket-size "mini-computer" gives you standard calculator features PLUS scientific functions: Sin, Cos and Tan x, E<sup>x</sup> Log x, XY, 1/x,  $\sqrt{x}$ ,  $\frac{1}{\square}$ , and others. Has algebraic logic, full memory and constant, overflow indicator. Floating decimal, trig functions in radians or degrees. 8-digit  $\frac{1}{32}$ " LED display. 3 x 1 x 6 $\frac{1}{4}$ ". Imported.

- 15 F 54062L Shpg. wt. 2 lbs. . . . Net 119.95

54 Years of Leadership in Electronics  
Means You Can Buy from us with Confidence!

# Lafayette RADIO ELECTRONICS

Listen to us, you can't go wrong.

## Lafayette's 4-WAY GUARANTEE

... gives you real protection

When you buy from Lafayette, you buy with confidence. Lafayette's "4-Way Guarantee" is your assurance that we mean what we say. For 54 years we have given your real protection . . . and shall continue to do so in the future.

### LAFAYETTE AAA GUARANTY

Lafayette Hi-Fi Speakers	= 5 Years
Lafayette Hi-Fi Receivers	= 2 Years
Lafayette Hi-Fi Tuners	= 2 Years
Lafayette Hi-Fi Amplifiers	= 2 Years
Criterion Diamond Styl	= 2 Years

All Lafayette high fidelity components identified as covered by Lafayette's AAA guaranty are guaranteed to be free of defects in material or workmanship from the date of sale for the time period shown above. During that period we will repair (or at our option replace) them without charge for either material or labor. Material must be returned prepaid to us for our inspection. This guaranty does not apply to items which have been subjected to misuse, abuse, alteration, repair without our authorization or used in violation of operating instructions, nor to normal wear and tear. The speaker guaranty does not cover external parts such as cabinets, grille cloth, etc. Serial number must not be defaced. Guaranty is not transferable.

### LAFAYETTE AAM GUARANTY

This guaranty covers Lafayette items so indicated in our catalog which contain several integrated sections in a single unit such as compact and integrated entertainment centers. The time period for each section is as follows

Speakers	= 5 Years
Receiver or Tuner Section	= 2 Years
Amplifier Section	= 2 Years
Recorder Section	= 3 Months
Changer Section	= 3 Months

The terms and conditions of this guaranty are otherwise identical to the AAA Guaranty.

### OTHER GUARANTEES

All merchandise not covered either by the special guarantees on this page or by other specific guarantees in the catalog are covered by a 90-day repair or replacement guarantee (at our option) against defects in material or workmanship.

### SATISFACTION GUARANTEED

If for any reason you are not satisfied with your purchase return it to us within 30 days in the original factory carton and we will exchange it or return your money (less transportation charges). Merchandise returned must be in good condition and not soldered or abused—no holes drilled or changes made in any other way. This policy does not apply to kits, nor to pre-recorded tapes, records, books or merchandise not regularly stocked that has been ordered especially for you.

Claims must be accompanied with original sales slip, shipping documents, or our invoice as proof of date of purchase.

## 3 Easy Ways To Shop Lafayette

Lafayette offers you the widest selection of top quality electronic products. All at Lafayette's low prices. And all covered by Lafayette's "4-Way Guarantee." Lafayette lets you buy with confidence. In any of 3 easy ways:



By Mail



By Phone



In Person



**BY MAIL** You'll get prompt, efficient service when you shop by mail from the comfort of your home. Leisurely select your purchases from the more than 18,000 quality items offered in this catalog. Then just follow the ordering instructions on page 210 and we will do the rest. Master Charge and BankAmericard orders are accepted.

**BY PHONE** Now you can purchase any of the fine products in this catalog by simply calling us. To place any order, just dial 516-921-7500. Our personal service shopper will be happy to take your C.O.D., Master Charge or BankAmericard order.

**IN PERSON AT OVER 100 LAFAYETTE COMPANY-OWNED STORES FROM COAST-TO-COAST** Use this catalog to decide which merchandise you want to see. Then stop in at your local Lafayette store, or at any of the over 380 Lafayette "associate" stores. Courteous, informed sales people are ready to help you make your final decision. Master Charge and BankAmericard orders accepted at every Lafayette company-owned store. See page 207 for the store nearest you.

## USE THIS HANDY INDEX

for the fastest, easiest electronics shopping you've EVER done!

Alarms	197-200
Amateur Gear	232-236
<b>ANTENNAS</b>	
Amateur/SWL	236, 239
CB	242-244, 246
TV, FM, and Access.	160-172
<b>AUTO</b>	
Radios, Tape Players, and Access.	66-69, 70-71, 96, 97, 259, Gate B
Speakers	71, 196
Accessories	188-195
Batteries, Chargers and Eliminators	132-133, 195
Binoculars	218
Books	204-206
Cabinetry	47, 157, 186
Calculators and Office Equipment	211-214, Gates A & B
Cameras	215-217
Cartridges—Needles—Tonearms, Phono	77-81, Gate B
Charge Plan	4
CB	240-258
Color Lights	112
Electrical Access. and Fuses	155-156
Four-Channel Hi-Fi	6-9, 18, 19, 24, 25, 28, 29
Headphones	48-50, 115, 221
<b>HI-FI STEREO</b>	
Amplifiers	20-22, 26, 31
Cabinetry	47
Compacts	5, 34, 35
Four-Ch.	6-9, 18, 19, 24, 25, 28, 29
Modular Units	36
Receivers	10, 12, 14, 16, 26-30
Speakers	37-46
Systems	11, 13, 15, 17, 20-22, 32
Tuners	23, 26, 27, 31
Turntables	2, 50-55
Ignition Systems	191
Index	208-209
Intercoms	118-120
Kits	31, 44, 45, 124-131, 191
Lamps	220
Microphones	92-95, 241
Monitors and Accessories	237-239
Musical Instruments	110-117
Parts	136-154
Phono Accessories	77-85
Power Tools	177-180
Public Address	86-91, 115
Radios—Table, Pocket, Portable, Multi-Band, Police and Weather, Clock	99-109
Record Changers, Turntables	34, 35, 50-55
Relays	138
Semiconductors	134-135
Speakers and Speaker Systems	37-46, 89, 90, 196
Switches	148-149
Tape Recorders, Decks, Players, Cartridges, Cassettes, Reel-to-Reel, & Access.	32, 33, 56-67, 260, Gate B
Telephones and Accessories	121-123, Gates A & B
Telescopes	218
Test Equipment	188, 222-231, 240
Timers	200-201
Tools and Hardware	173-187
TV Sets and Accessories	98
Tubes	140-142
Walkie-Talkies	245-247
Watches and Clocks	203
Weather Instruments	202
Wire and Cable	158-159

SEE PAGE 209 FOR COMPLETE INDEX

# Lafayette Has "EASY-PAY" Plans You'll Like!

Use Your  
Bank  
Charge  
Card



Master Charge and BankAmericard are accepted at all Lafayette company-owned stores and most "Associate" stores. Buy one of our over 18,000 electronics products and just "Charge It." It's the fast, easy, convenient way to shop!

Use one of our  
Convenient  
"No-Money-Down"  
Credit Plans

## EXTENDED PLAN

TAKE UP TO  
2 YEARS TO PAY

- Open a Credit Account by Simply Filling in the Application on the Back of the Order Blank
- Add-on Anytime You Like—With No Money Down and Usually No Increase in Monthly Payments
- Pay Your Balance in 30 DAYS and SAVE on Finance Charges

## STANDARD PLAN

TAKE UP TO  
16 MONTHS TO PAY

### EASY PAY PAYMENT SCHEDULE\*

\$250.01 to \$500.00		STANDARD PLAN		EXTENDED PLAN	
If Unpaid Balance (Amount Financed) Is From	To	Add for FINANCE CHARGE	Monthly Payment Is	Add for FINANCE CHARGE	Monthly Payment Is
\$490.01	\$500.00	\$64.75	\$35.00	\$98.00	\$25.00
480.01	490.00	63.50	34.50	96.00	24.50
470.01	480.00	62.25	33.50	94.00	24.00
460.01	470.00	61.00	33.00	92.00	23.50
450.01	460.00	59.50	32.50	90.00	23.00
440.01	450.00	58.25	31.50	88.00	22.50
430.01	440.00	57.00	31.00	86.00	22.00
420.01	430.00	55.75	30.00	84.00	21.50
410.01	420.00	54.25	29.50	82.00	21.00
400.01	410.00	53.00	29.00	80.00	20.50
390.01	400.00	51.75	28.00	78.00	20.00
380.01	390.00	50.50	27.50	76.00	19.50
370.01	380.00	49.00	26.50	74.00	19.00
360.01	370.00	47.75	26.00	72.00	18.50
350.01	360.00	46.50	25.00	70.00	18.00
340.01	350.00	45.25	24.50	68.00	17.50
330.01	340.00	43.75	24.00	66.00	17.00
320.01	330.00	42.50	23.00	64.00	16.50
310.01	320.00	41.25	22.50	62.00	16.00
300.01	310.00	40.00	22.00	60.00	15.50
290.01	300.00	38.50	21.00	58.00	14.50
280.01	290.00	37.25	20.00	56.00	14.00
270.01	280.00	36.00	19.50	54.00	13.50
260.01	270.00	34.50	19.00	52.00	13.00
250.01	260.00	33.25	18.00	50.00	12.50

100.01 to \$250.00		STANDARD PLAN		EXTENDED PLAN	
If Unpaid Balance (Amount Financed) Is From	To	Add for FINANCE CHARGE	Monthly Payment Is	Add for FINANCE CHARGE	Monthly Payment Is
\$240.01	\$250.00	\$32.00	\$17.50	\$48.00	\$12.00
230.01	240.00	30.50	17.00	46.00	11.50
220.01	230.00	29.25	16.00	44.00	11.00
210.01	220.00	28.00	15.50	42.00	10.50
200.01	210.00	26.50	15.00	40.00	10.00
195.01	200.00	25.75	14.50	39.00	9.75
190.01	195.00	25.25	14.00	38.00	9.50
185.01	190.00	24.50	13.75	37.00	9.25
180.01	185.00	23.75	13.50	36.00	9.00
175.01	180.00	23.25	13.00	35.00	8.75
170.01	175.00	22.50	12.50	34.00	8.50
165.01	170.00	22.00	12.00	33.00	8.25
160.01	165.00	21.25	11.50	32.00	8.00
155.01	160.00	20.50	11.00	31.00	7.75
150.01	155.00	20.00	10.75	30.00	7.50
145.01	150.00	19.25	10.50	29.00	7.25
140.01	145.00	18.50	10.50	28.00	7.00
135.01	140.00	16.75	10.50	27.00	6.75
130.01	135.00	16.25	10.25	26.00	6.50
125.01	130.00	14.50	10.25	24.00	6.50
120.01	125.00	14.00	10.00	23.00	6.25
115.01	120.00	12.50	10.00	21.00	6.25
110.01	115.00	12.00	10.00	20.00	6.00
105.01	110.00	10.50	10.00	18.35	6.00
100.01	105.00	9.25	10.00	17.50	5.75

\*The ANNUAL PERCENTAGE RATE of each FINANCE CHARGE set forth in the tables at left is 17.75%. The number of payments will be the Total of Payments (Amount Financed plus the FINANCE CHARGES) divided by the amount of one monthly payment.

OVER \$500.00. Please write for terms for amounts to be financed over \$500.00.

minimum ORDER—\$30  
minimum "ADD-ON"—\$20

Number of payments will be Total of Payments (Amount Financed plus the FINANCE CHARGE) divided by the amount of one monthly payment.

\$20.01 to \$50.00		STANDARD PLAN		ANNUAL PERCENTAGE RATE	
If Unpaid Balance (Amount Financed) Is From	To	Add for FINANCE CHARGE	Monthly Payment Is	ANNUAL PERCENTAGE RATE	
\$45.01	\$50.00	\$6.00	\$5.00	24.50	
40.01	45.00	5.25	4.75	26.00	
35.01	40.00	4.75	4.25	26.75	
30.01	35.00	4.50	3.70	29.25	
25.01	30.00	3.50	3.35	30.00	
20.00	25.00	3.00	2.70	32.00	

\$75.01 to \$100.00		STANDARD PLAN		EXTENDED PLAN		ANNUAL (%) RATE	
If Unpaid Balance Is From	To	Add for FINANCE CHARGE	Monthly Payment	Add for FINANCE CHARGE	Monthly Payment	ANNUAL (%) RATE	
\$95.01	\$100.00	\$9.25	\$10.00	\$15.65	\$5.50	17.50	
90.01	95.00	9.25	9.75	19.50	14.85	5.50	17.50
85.01	90.00	9.25	9.50	22.50	13.45	5.25	17.75
80.01	85.00	9.25	9.25	23.75	12.00	5.25	17.75
75.01	80.00	9.00	9.00	24.50	10.70	5.00	17.75

\$50.01 to \$75.00		STANDARD PLAN		EXTENDED PLAN		ANNUAL (%) RATE	
If Unpaid Balance Is From	To	Add for FINANCE CHARGE	Monthly Payment	Add for FINANCE CHARGE	Monthly Payment	ANNUAL (%) RATE	
\$70.01	\$75.00	\$8.40	\$8.00	\$24.50	\$10.00	\$5.00	21.25
65.01	70.00	7.80	7.50	24.50	10.00	5.00	21.25
60.01	65.00	7.20	7.00	24.50	10.00	5.00	24.50
55.01	60.00	6.65	6.50	24.50	8.55	5.00	24.50
50.01	55.00	6.10	6.00	24.50	7.25	5.00	24.50

# NEW! Our Best Compact Stereo Systems-Versatile Entertainers with "Component-Quality" Features!

## Lafayette LSC-1000 AM/FM/8-Track/Phono System

One of the best looking AND best performing compacts we've seen! Has the latest solid-state circuitry for crisp, full-fidelity sound reproduction from records, pre-recorded 8-track cartridges, stereo FM and AM; features and controls that make it a joy to own and operate. The FULL-FEATURE BSR 4-speed turntable has a cue/pause control, adjustable anti-skate and stylus pressure, lightweight tonearm and diamond needle cartridge. The 8-track cartridge player has program lights, hinged cartridge door, manual program change. Each 3-way speaker features an 8" woofer, 5" midrange and 3" tweeter with crossover and a special horn duct for increased bass response. There are scratch and rumble filters, a loudness control, AFC for FM, FM Mute circuit and Tape monitor, a stereo/mono switch for cleanest reception. The rear panel has external antenna connections, complete inputs and outputs for adding a tape recorder, even a guitar/microphone input for sing-alongs, PA use or music practice. Special speaker switching lets you select two-speaker stereo, derived 4-channel (with 4 speakers), or two-speaker stereo in separate rooms (with 4 speakers). Stylish walnut finish cabinetry throughout, brushed aluminum and black control area. Receiver/phono, 22 3/4" x 10" x 7 3/4", speakers, 19 1/2" x 11 1/2" x 8 1/4". With 45-rpm adapter, FM dipole antenna and speaker cable. Imported. For 117 VAC. 24 F 03764HWX Shpg. wt. 85 lbs. . . . . Net 299.95



### Look at These Great Features!

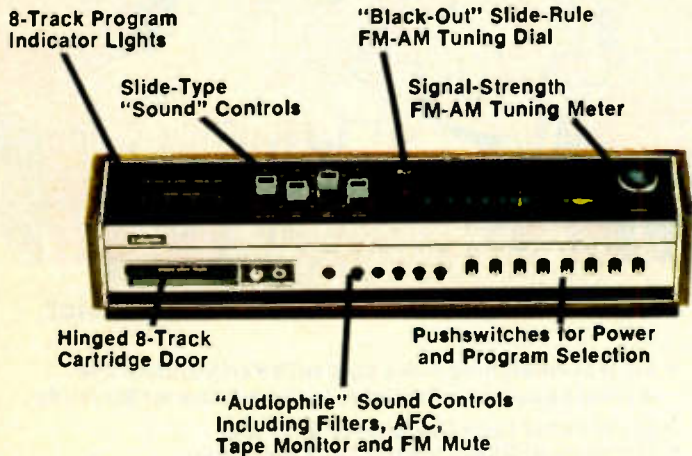

### Features Worth \$\$\$ More!

- Hinged Dust Cover Lets Records Play Even When Closed
- Storage Compartment for 6 Cartridges
- Special Circuit for Derived 4-Channel Sound When 4 Speakers Are Used
- Powerful Solid-State Amplifier for Room-Filling Sound With Low Distortion

**\$299<sup>95</sup>**

No Money Down\*

## NEW! Lafayette LSC-9500 AM/FM/8-Track/Phono System . . .

Now With Circuit For Derived 4-Channel With 4 Speakers

- Built-In Garrard 4-Speed Record Changer
- Stylish Pedestal-Type Base
- Two Acoustic-Suspension Speaker Systems, Each with 8" Woofer, 3 1/2" Tweeter and Cellular Horn Dispersion Duct

**\$259<sup>95</sup>**

With Full-Size Dust Cover

No Money Down\*

The latest version of our popular LSC-9000, the 9500 boasts new for '75 styling improvements and a complete new derived 4-channel circuit. Just add a pair of speakers and get an exciting 4-channel effect from all your stereo records, tapes or FM broadcasts. Has a sensitive AM/FM stereo tuner section; modern slide-controls for bass, treble, volume and balance; an 8-track cartridge player with lighted program indicators and manual program change; a 4-speed record changer with diamond needle ceramic stereo cartridge. Has a front panel tape monitor jack, tape inputs and outputs, stereo headphone jack. The sleek new base and ultra-modern style give it the "look" for years of fine listening. With 45-rpm spindle. Receiver/phono, 23 1/2" x 9 3/4" x 15", speakers, 14 1/8" x 11 1/4" x 6 5/8". For 117 VAC. 24 F 03780HWX Shpg. wt. 63 lbs. . . . . Net 259.95



# The Finest 4-Channel Receiver We've Ever Offered

Lafayette LR-5000 4-Channel Receiver: 35 Watts per channel

RMS Power into 8 Ohms from 20-20,000 Hz—0.5% THD



**NEW!**

**Lafayette AAA 2-YEAR  
GUARANTEE**

See Page 3

**\$599<sup>95</sup>**

No Money Down\*

**Plays SQ 4-Channel with Full-Logic Separation; CD-4 with Plug-in Module\* Regular Matrix for "QS" 4-Channel; Derived 4-Channel; Stereo and Mono**

The LR-5000 represents Lafayette's finest engineering to date: bringing you quality and performance that was UNAVAILABLE AT ANY PRICE just a few years ago! Has Lafayette's famous SQ wavematching full-logic circuitry with Variblend—critically acclaimed by leading hi-fi magazines as the best available; an FM front end using MOS FET's and low-noise transistors for maximum sensitivity; a powerful (140 watts RMS at 8 ohms total), low distortion discrete 4-channel amplifier with direct-coupled output for flat response at EACH and EVERY PORTION of the entire frequency spectrum. Special electronic and relay circuits protect speakers and transistors from overload; there are separate stereo and 4-channel monitoring facilities; full 4-channel main and remote speaker connections; 2/4 channel headphone jack. There's a blackout tuning dial with dimmer switch and center-channel and signal-strength meters, push switches for monitor, stereo-mono, loudness, high filter and FM mute; concentric bass, treble and balance controls and a Master volume control. Walnut-finish wood cabinet. 21 x 5½ x 15" (WHD). For 117 VAC, 50-60 Hz. Imported.

99 F 03261W Shpg. wt. 41 lbs. . . . . Net 599.95

## SPECIFICATIONS

**Amplifier Section. Continuous Power at 8 Ohms:** 35 watts per channel, all channels driven, 20-20,000 Hz. THD: 0.5% at 35 watts, all channels operating at any frequency between 20-20,000 Hz. **Power Bandwidth:** (-3 dB) 10-40,000 Hz, all channels driven. **Input Sensitivity:** Aux 1, 250 mV; Aux 2, 250 mV; Tape Play, 500 mV; Phono (100k ohms impedance) H, 0.6 mV max. at 1.5 mV normal; M, 1.8 mV max 4.5 mV normal; L, 4 mV max., 10 mV normal. **Hum and Noise:** Aux., -80 dB. Phono: -60 dB. Tape Play, -90 dB. **FM Tuner Section:** Usable Sensitivity (IHF): 1.65 µV. Selectivity: 60 dB. S/N Ratio: 65 dB. Total Harmonic Distortion: 0.2%. Image Rejection: -75 dB. IF Rejection: 100 dB. **AM Tuner Section.** Sensitivity: 16 µV.

\* Highly Sophisticated Lafayette CD-4 Module Package

**\$69<sup>95</sup>**

Use with the LR-5000 for CD-4 discrete record play with any good-quality component turntable. Includes CD-4 plug-in, CD-4, test and setup record, low-capacitance phono cables. Imported. Requires special CD-4 phono cartridge, see page 78.

99 F 03527 Shpg. wt. 1 lb. . . . . Net 69.95



**\$\$\$ - More Features for \$\$\$ - More Music!**

- **SQ Wavematching Full-Logic with Variblend for the Widest Separation Available in the 4-Channel SQ Mode**
- **Front Panel Tape Outputs for Easy and Convenient Direct Stereo Tape Recording**
- **FM Detector Output for Discrete 4-Channel FM Broadcasts When FCC Approval Is Granted**

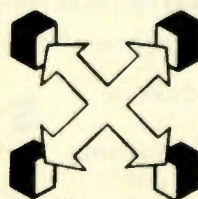

**Full-Logic Wavematching SQ Circuit**  
Provides Left-Right and Front-Rear Separation Equal to Costly Separate Decoders. Also Has Exclusive Lafayette Variblend Circuit!

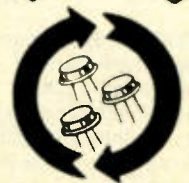

**Phase-Lock Stereo FM Circuit**  
With MOS FET's for the Widest Stereo FM Separation and Least Distortion of Any Stereo FM Circuit We Know Of!



**Dual Tuning Meters**  
Center-Channel FM, Signal-Strength FM and AM for the Easiest and Most Precise Tuning of Any Station!



# Money-Saving LR-5000 Systems—BEST SOUND AROUND

Full-Feature LR-5000 4-Channel System  
with Sound and Style That's Just Super!

**Save  
\$119<sup>65</sup>**

LR-5000 4-Channel Receiver .....\$599.95  
Four Criterion 555 3-Way 10"  
Floor/Shelf Speaker Systems  
(Reg. \$69.95 each) ..... 279.80  
Garrard 62 3-Speed Turntable ..... 69.95  
Base for Garrard 62 Turntable .... 9.95  
Pickering V15 Micro IV/ACE  
Elliptical Magnetic Stereo  
Cartridge ..... 29.95

Total Reg. Price \$989.60  
System Price 869.95

**YOU SAVE \$119.65**

**\$869<sup>95</sup>**

If Purchased  
Separately,  
\$989.60

Great-sounding 4-channel system features our finest receiver, over \$100 savings too! The 555 speakers each have a 10" woofer, 5" sealed-back midrange and 3" tweeter for excellent full-range sound, the Garrard 62 is a fine-quality turntable that pampers your records and plays them perfectly. Includes all cables, speaker hookup wire. 22 F 92696WM Shpg. wt. 172 lbs. .... Net 869.95



Deluxe LR-5000 System—One of the  
Finest 4-Channel Systems You Can Buy!

**Save  
\$159<sup>65</sup>**

LR-5000 4-Channel Receiver ..... \$599.95  
Four Criterion 777 3-Way 10"  
Floor/Shelf Speaker Systems  
(Reg. \$119.95 each) ..... 479.80  
Garrard Zero 100C 2-Speed  
Turntable ..... 209.95  
Deluxe Base for Zero 100C ..... 14.95  
Pickering V15 Micro IV/AME  
Elliptical Magnetic Stereo  
Cartridge ..... 49.95

Total Reg. Price \$1354.60  
System Price 1194.95

**YOU SAVE \$159.65**

**\$1194<sup>95</sup>**

If Purchased  
Separately,  
\$1354.60

Features our finest receiver, Garrard's finest turntable, four 3-speaker, 3-way acoustic-suspension speaker systems for complete total-response sound with YOU ARE THERE realism and presence. The Garrard Zero 100C has the famous "Zero Tracking Error" tonearm, treats records like "royalty"! With all cables, speaker hookup wire. 22 F 92704WM Shpg. wt. 223 lbs. .... Net 1194.95



# Our Full Feature Lafayette 4-Channel Receiver

Lafayette LR-3000 4-Channel Receiver: 15 Watts per channel  
RMS Power into 8 Ohms from 20-20,000 Hz: 0.5% THD



**Lafayette AAA 2-YEAR  
GUARANTEE**  
See Page 3

**NEW!**  
**\$449<sup>95</sup>**

- Plays SQ 4-Channel with Full-Logic Separation, CD-4 with Plug-in Module\*; Discrete 4-Channel; RM (Regular Matrix) for "QS" 4-Channel; Derived 4-Channel; Stereo and Mono

Compare with ANY OTHER 4-channel receiver in this price range and you'll be convinced the LR-3000 offers you the BEST VALUE FOR THE MONEY! Has the features, power and performance you need for a lifetime of beautiful music listening—complete inputs for Phono, Stereo or 4-Channel Tape Recorder; all Aux. equipment; an FM detector to bring you discrete 4-channel FM broadcasts on FCC approval; an advanced MOSFET stereo FM circuit for the finest in present FM broadcast. Has direct-coupled output circuit for flat response over the entire frequency spectrum; slide-rule FM-AM tuning with two meters for pin-point precision; fuse protection for speakers and solid-state circuit. Loudness and treble controls, front-rear balance and Master volume controls. The brushed aluminum front panel, walnut-finish wood case and machined metal knobs give it the look and feel of professional "separate component" equipment. 17½ x 4¾ x 14" (WHD). For 117 VAC, 50-60 Hz. Imported.

99 F 03295W Shpg. wt. 27 lbs. . . . . Net 449.95

## SPECIFICATIONS

**Amplifier Section.** Continuous Power at 8 Ohms: 15 watts per channel, all channels driven, 20-20,000 Hz. THD: 0.5% at 15 watts, all channels operating at any frequency between 20-20,000 Hz. **Power Bandwidth:** (-3 dB) 10-35,000 Hz, all channels driven. **Input Sensitivity:** Aux. 1, 250 mV; Aux. 2, 250 mV; Tape Play, 500 mV. **Phono (100k ohms impedance).** HI, 0.6 mV max. at 1.5 mV normal; M, 1.8 mV max. at 4.5 mV normal; L, 4 mV max. at 10 mV normal. **Hum and Noise:** Aux., -75 dB; Phono, H -45 dB; M, -55 dB; L, -60 dB; Tape Play, -80 dB. **FM Tuner Section:** Usable Sensitivity (IHF): 2.2 µV. **Selectivity:** 40 dB. **Separation at 1000 Hz:** 35 dB. **Capture Ratio:** 2.5 dB. **S/N Ratio:** 65 dB. **IF Rejection:** -90 dB. **AM Tuner Section.** Sensitivity: 20 µV.

\* Highly Sophisticated Lafayette CD-4 Module Package

**\$69<sup>95</sup>**

Use with the LR-3000 for CD-4 discrete record play with any good-quality component turntable. Includes CD-4 plug-in, CD-4 test and setup record, low-capacitance phono cables. Imported. Requires special CD-4 phono cartridge, see page 78.

99 F 03527 Shpg. wt. 1 lb . . . Net 69.95

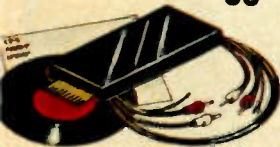

## Sound Features for Great Sound

- SQ Wavematching Full-Logic with Variblend for the Widest Separation Available in the 4-Channel SQ Mode
- Loudness Circuit Increases High and Low Frequencies at Low Volume Levels
- Phase-Lock-Loop FM Circuit Provides Widest Stereo Separation/Least Distortion
- Selector Switch for Main/Remote, Main or Remote Speakers, Stereo/4-Channel Phones

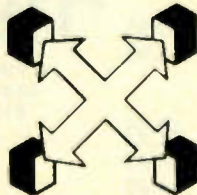

**Full-Logic Wavematching SQ Circuit**  
Provides Left-Right and Front-Rear Separation Equal to Costly Separate Decoders. Also has Exclusive Lafayette Variblend Circuit.

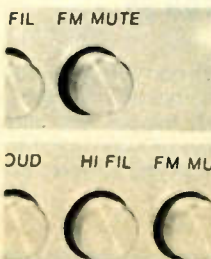

### FM Mute Circuits

Tune FM and Stereo FM from a Background or Total Silence—Stops Annoying Hisses and "Thumps."

### High-Filter Pushbutton

Makes "Old and Scratchy" Records Sound Like New Again, Helps Pull In Weak-Signal FM Stations by Reducing High-Frequency Interference.

# "System Up" with the LR-3000 and SAVE!

## Matched Component 4-Channel System for Years of Fine-Music Listening

LR-3000 4-Channel Receiver .....	\$449.95
Four Criterion 333 8" 2-Way Bookshelf Speaker Systems (Reg. \$44.95 each) .....	179.80
Garrard 40B 3-Speed Turntable ..	49.95
Base for Garrard 40B .....	9.95
Pickering P/ATE-1 Elliptical Magnetic Stereo Cartridge .....	24.95
<b>Total Reg. Price</b>	<b>\$714.60</b>
<b>System Price</b>	<b>624.95</b>
<b>YOU SAVE</b>	<b>\$89.65</b>

If Purchased  
Separately,  
\$714.60

**\$624<sup>95</sup>**

**Save  
\$89<sup>65</sup>**

Fine system for bookshelf placement. The speakers have an 8" woofer and 3" sealed-back tweeter for really good sound, the popular 40B turntable is a quality standard with every fine feature for flawless record play. With all cables, speaker hookup wire.  
22 F 92712WM Shpg. wt. 118 lbs. .... Net 624.95



## Deluxe 4-Channel System with Full-Size Three Way Speakers for Total Response

LR-3000 4-Channel Receiver .....	\$449.95
Four Criterion 666 3-Way 10" Floor/Shelf Speaker Systems (Reg. \$99.95 each) .....	399.80
Garrard 82 3-Speed Turntable ....	119.95
Base for Garrard 82 .....	14.95
Pickering V15 Micro IV/ATE Elliptical Magnetic Stereo Cartridge .....	39.95
<b>Total Reg. Price</b>	<b>\$1024.60</b>
<b>System Price</b>	<b>899.95</b>
<b>YOU SAVE</b>	<b>\$124.65</b>

If Purchased  
Separately,  
\$1024.60

**\$899<sup>95</sup>**

**Save  
\$124<sup>65</sup>**

Big sound and big savings on this deluxe 4-channel system that's matched for magnificent music! The Criterion 666 speakers have acoustic-suspension design for outstanding overall response, the Garrard model 82 has features like two-way damped cueing, ultra-lightweight tonearm, full-feature automatic or manual record play. With all cables, speaker hookup wire.  
22 F 92720WM Shpg. wt. 183 lbs. .... Net 899.95



# NEW! Our Super-Deluxe Lafayette LR-3500 Stereo Receiver!

MOS-FET's and Phase-Lock-Loop FM MPX;  
Direct-Coupled Power Amplifier!



## Walnut Finish Wood Case

LR-3500 Stereo FM-AM Receiver: 47 Watts RMS Per Channel into 8 Ohms from 20-20,000 Hz: 0.5% THD.

**\$399<sup>95</sup>**

No Money Down\*

Virtually "Recording Studio" Realism from All Stereo Records, Tapes, and FM

Our most sensitive FM and AM tuning sections, our best stereo pre-amplifier, and our most powerful stereo amplifier combine to make the performance of the LR-3500 *truly sensational*. And solid-state circuitry, including IF filters and a Phase-Lock-Loop in the tuner, guarantees that you'll still be enjoying this same exceptional performance years from now. The brushed aluminum front panel features concentric left and right channel balance controls, as well as pushbuttons for Loudness Compensation, Flat Tone, 20 dB Audio Mute, Hi Filter, Dial Lamp Dim, FM Interstation Mute, and two Tape Monitors (permitting dual recording or tape duplicating). Plus, a Microphone input jack and a tape and two Headphone output jacks. The rear panel has outputs for main and remote speakers and two tape recorders; inputs for Aux., Phono (with Hi/Lo Mag switch), two tape players, and external AM and FM antennas (internal antennas are supplied); switched and unswitched AC convenience outlets; and a line fuse. In walnut-finish wood cabinet, 19 3/8" x 5 1/4" x 14 1/4". For 117 VAC, 50-60 Hz. Imported.

99 F 03402W Shpg. wt. 34 1/2 lbs. . . . . Net 399.95

**Amplifier Section.** Continuous Power at 8 Ohms: 47 watts per channel, all channels driven, 20-20,000 Hz. THD: 0.5% at 47 watts, all channels operating at any frequency between 20-20,000 Hz. **Power Bandwidth:** (-3 dB) 12-50,000 Hz, all channels driven. **Input Sensitivity:** Aux., 250 mV; Tape Play A and B, 500 mV Mic., 6 mV; Mag. Phono: Lo, 6 mV; Hi, 2.5 mV. **Hum and Noise:** Aux., -75 dB. Tape Play, -90 dB. Mag. Phono, -68 dB Lo; -65 dB Hi. **FM Tuner Section.** Usable Sensitivity (IHF): 1.65  $\mu$ V. Selectivity: 60 dB. Separation at 1000 Hz: 40 dB. Capture Ratio: 1.5 dB. S/N Ratio: 65 dB. Total Harmonic Distortion: 0.25%. Image Rejection: 75 dB. IF Rejection: 100 dB. **AM Tuner Section.** Sensitivity: 16  $\mu$ V.

## Inside, This Receiver Is Absolutely Extraordinary

- **Direct-Coupled Output Circuitry Assures Flat Frequency Response Over Entire Audio Range**
- **Sophisticated Electronic and Relay Circuitry Protects Speakers and Transistors from Damage**
- **Phase-Lock-Loop FM MPX Circuit Maximizes FM Stereo Separation and Minimizes Distortion**
- **MOS-FET's and Low Noise Transistors In the FM Front End Insure Maximum Sensitivity**

Lafayette AAA 2-YEAR  
**GUARANTEE**

See Page 3

## And Outside, Too!



### Two Tuning Meters

Center-Channel FM, Signal-Strength AM and FM Meters for the Most Precise Tuning We Know Of.

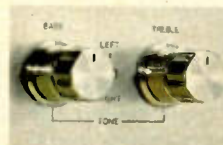

### Full-Range Tone Controls

Offers Complete "Sound Tailoring" for Any Listening Area. "Hard" or "Soft" Rooms; Individual Tastes, Etc.



### Front Panel Tape Outputs

For Easy Setup of Tape Recorders for "Live" Recording with Mikes, Direct Recording from FM or from Records

\*No Money Down—See Page 4 for Lafayette's Easy-Credit Plan

# LR-3500 Stereo Systems—Savings That Sound Great!

## Musically Matched and Money-Saving Too!

LR-3500 Stereo Receiver .....	\$399.95
Two Criterion 555 3-Way 10" Floor/Shelf Speaker Systems (Reg. 69.95 each) .....	139.90
Garrard 62 3-Speed Turntable .....	69.95
Base for 62 Turntable .....	9.95
Pickering V15 Micro IV/ACE Magnetic Stereo Cartridge .....	29.95
<b>Total Reg. Price</b> .....	<b>\$649.70</b>
<b>System Price</b> .....	<b>564.95</b>
<b>YOU SAVE</b> .....	<b>\$84.75</b>

If Purchased Separately,  
\$649.70

**\$564<sup>95</sup>**  
**Save**  
**\$84<sup>75</sup>**



Fine-sounding stereo system designed for years of great sound, big savings too. With all cables, speaker hookup wire.  
22 F 92738WM Shpg. wt. 107½ lbs. .... Net 564.95

## Sensational Full-Sound System

LR-3500 Stereo Receiver .....	\$399.95
Two Criterion 666 3-Way 10" Floor/Shelf Speaker Systems (Reg. \$99.95 each) .....	199.90
Garrard 82 3-Speed Turntable .....	119.95
Base for Garrard 82 .....	14.95
Pickering V15 Micro IV/ATE Magnetic Stereo Cartridge .....	39.95
<b>Total Reg. Price</b> .....	<b>\$774.70</b>
<b>System Price</b> .....	<b>672.95</b>
<b>YOU SAVE</b> .....	<b>\$101.75</b>

If Purchased Separately,  
\$774.70

**\$672<sup>95</sup>**  
**Save**  
**\$101<sup>75</sup>**



Features our 666 3-way 3-speaker acoustic-suspension systems for a full 28-20,000 Hz response, one of Garrard's finest automatic turntables. With all cables, speaker hookup wire.  
22 F 92746WM Shpg. wt. 122½ lbs. .... Net 672.95

## Our Best LR-3500 Music System

LR-3500 Stereo Receiver .....	\$399.95
Two Criterion 777 10" 3-Way Floor/Shelf Speaker Systems (Reg. \$119.95 each) .....	239.90
Garrard Zero 92 Turntable .....	169.95
Base for Zero 92 .....	14.95
Pickering V15 Micro IV/AME Magnetic Stereo Cartridge .....	49.95
<b>Total Reg. Price</b> .....	<b>\$874.70</b>
<b>System Price</b> .....	<b>759.95</b>
<b>YOU SAVE</b> .....	<b>\$114.75</b>

If Purchased Separately,  
\$874.70

**\$759<sup>95</sup>**  
**Save**  
**\$114<sup>75</sup>**



Systematically superior sound and one of Garrard's finest turntables add up to stereo you'll appreciate for years to come. With all cables, speaker hookup wire.  
22 F 92753WM Shpg. wt. 135½ lbs. .... Net 759.95

# New! Lafayette LR-1100 Stereo Receiver

The Finest Sound and Styling We've Ever Offered at This Price



## Walnut Finish Wood Case

Lafayette LR-1100 Stereo FM-AM Receiver: 22 Watts Per Channel RMS Power into 8 Ohms from 20-20,000 Hz; 0.5% THD.

**\$299<sup>95</sup>**

No Money Down\*

*Exceptional Audio Reproduction From All Stereo Records, Tapes, and FM Broadcasts, Wideband AM Circuit, Too*

Get exceptional performance that won't diminish over the years. The LR-1100 will pick out sharp, clear signals from even distant FM stations and produce enough clean power to fill your largest room with the superb sound. The front panel features: an AM/FM signal-strength tuning meter and FM stereo indicator; rotary controls for Speaker Mode and Source Selection; concentric Bass, Treble, Volume, and Balance controls; pushbuttons for Loudness, Tape Monitor, Hi Filter, and FM Interstation Mute; tape and stereo headphone jacks. The rear panel provides: outputs for Main and Remote Speakers and Tape; inputs for Magnetic Phono, Aux, Tape, and external antennas (internal antennas are supplied); line and speaker fuses; and AC convenience outlets. Handsomely-styled with a blackout dial, brushed aluminum front panel, and a rich walnut-finish wood cabinet. Size: 17 $\frac{1}{2}$ "W x 5H x 14"D. For 117 VAC, 50-60 Hz. Imported. 99 F 03410W Shpg. wt. 19 lbs. Net 299.95

## SPECIFICATIONS

**Amplifier Section.** Continuous Power at 8 Ohms: 22 watts per channel, all channels driven, 20-20,000 Hz. THD: 0.5% at 22 watts, all channels operating at any frequency between 20-20,000 Hz. Power Bandwidth: (-3 dB) 10-33,000 Hz, all channels driven. Input Sensitivity: Mag. Phono 6 mV (Lo); 2.5 mV (Hi); Aux., 250 mV; Tape Play, 500 mV. Hum and Noise: Aux., -75 dB; Tape Play, -80 dB; Mag. Phono, -65 dB (Lo), -60 dB (Hi). **FM Tuner Section.** Usable Sensitivity (IHF): 1.75  $\mu$ V. Selectivity: 60 dB. Separation at 1000 Hz: 40 dB. Capture Ratio: 1.5 dB. S/N Ratio: 70 dB. Total Harmonic Distortion: 0.5%. Image Rejection: 75 dB. IF Rejection: 90 dB. **AM Tuner Section.** Sensitivity: 20  $\mu$ V.

**Lafayette AAA 2-YEAR GUARANTEE**

See page 3



## Sophisticated Solid-State Circuitry

- FM Front End MOS-FET's and Low Noise Transistors Insure Maximum Sensitivity
- FM MPX Phase-Lock-Loop Maximizes FM Stereo Separation and Minimizes Distortion
- Fused Output Circuits Protect Speakers

*With Direct-Coupled Output Circuitry That Assures a Flat Frequency Response from Extreme Lows to Extreme Highs at All Power Levels Up to Rated Output*

## Easy-Listening Features, Too!



### Loudness Button

Assures "Lifelike" Sound with Full Bass Response Even at Low Listening Levels.

### High Filter Button

Makes Old and Scratchy Records Sound Good Again.

### Signal-Strength Tuning Meter

Shows Strongest Available Signal on Both AM and FM for Precise, Accurate Tuning.

# Money-Saving Systems Featuring the LR-1100

## Stereo That Sounds Like \$\$\$ More

LR-1100 Stereo Receiver .....	\$299.95
Criterion 555 3-Way 10" Floor/Shelf Speaker Systems (Reg. \$69.95 each) .....	139.90
Garrard 40B 3-Speed Turntable ..	49.95
Base for Garrard 40B .....	9.95
Pickering P/ATE-1 Magnetic Stereo Cartridge .....	24.95
<b>Total Reg. Price</b> .....	<b>\$524.70</b>
<b>System Price</b> .....	<b>454.95</b>
<b>YOU SAVE</b> .....	<b>\$69.75</b>

**\$454<sup>95</sup>**

If Purchased Separately, \$524.70

**Save \$69<sup>75</sup>**



Fine sounding system offers complete music enjoyment from records, FM or AM, nice savings too! With all cables, speaker hookup wire.  
22 F 92779WM Shpg. wt. 91 lbs. .... Net 454.95

## Full-Feature "Top-Sound" System

LR-1100 Stereo Receiver .....	\$299.95
Two Criterion 666 3-Way 10" Floor/Shelf Speaker Systems (Reg. \$99.95 each) .....	199.90
Garrard 62 3-Speed Turntable ..	69.95
Base for Garrard 62 .....	9.95
Pickering V15 Micro IV/ACE Magnetic Stereo Cartridge ....	29.95
<b>Total Reg. Price</b> .....	<b>\$609.70</b>
<b>System Price</b> .....	<b>528.95</b>
<b>YOU SAVE</b> .....	<b>\$80.75</b>

**\$528<sup>95</sup>**

If Purchased Separately, \$609.70

**Save \$80<sup>75</sup>**



You'll like the sound, you'll like the savings too with this outstanding music system. Acoustic-suspension speakers have full 28-20,000 Hz response. Includes all cables, speaker hookup wire.  
22 F 92761WM Shpg. wt. 102 lbs. .... Net 528.95

## Our Best LR-1100 Matched Component System

LR-1100 Stereo Receiver .....	\$299.95
Two Criterion 777 3-Way 10" Floor/Shelf Speaker Systems (Reg. \$119.95 each) .....	239.95
Garrard 82 3-Speed Turntable ..	119.95
Base for Garrard 82 .....	14.95
Pickering V15 Micro IV/ATE Magnetic Stereo Cartridge ....	39.95
<b>Total Reg. Price</b> .....	<b>\$714.70</b>
<b>System Price</b> .....	<b>619.95</b>
<b>YOU SAVE</b> .....	<b>\$94.75</b>

**\$619<sup>95</sup>**

If Purchased Separately, \$714.70

**Save \$94<sup>75</sup>**



Outstanding system featuring full 20-20,000 Hz speaker systems, one of Garrard's finest automatic turntables. With all cables, speaker hookup wire.  
22 F 92787WM Shpg. wt. 119 lbs. .... Net 619.95

# High Performance At A Low Price

## Our New Lafayette LR-310 Stereo Receiver



### Vinyl-Covered Walnut-Finish Metal Case

LR-310 Stereo FM-AM Receiver: 12.5 Watts Per Channel RMS Power into 8 Ohms from 40-20,000 Hz; 0.8% THD.

**\$199<sup>95</sup>**

No Money Down\*

*Outstanding Audio Reproduction From All Stereo Records, Tapes, and FM Broadcasts*

With its excellent FM stereo multiplex tuner, sensitive AM tuner, quality stereo preamplifier, low distortion stereo amplifier, and sophisticated solid-state circuitry, our LR-310 delivers consistently clear, crisp, high fidelity sound. Rotary controls are provided for Bass, Treble, Volume/Balance, Program Selection, and Speaker Mode; pushbuttons for Loudness, Tape Monitor, High Filter, and FM Mute (for silencing FM inter-station noise). The front panel also features a blackout dial, AM/FM signal strength meter, FM stereo indicator, tape and headphone jacks. The rear panel includes: a switchable Mag/Cer Phono input; Aux. Tape Play and Record jacks; Main and Remote Speaker outputs; AC convenience outlets; easily accessible fuses, external antenna inputs (internal antennas are provided). With metal case, 14 $\frac{1}{2}$ "W x 4 $\frac{1}{2}$ "H x 11"D. 117 VAC, 50-60 Hz. 99 F 03428W Imported. Shpg. wt. 21 lbs. . . . . Net 199.95

### SPECIFICATIONS

**Amplifier Section.** Continuous Power at 8 Ohms: 12.5 watts per channel, all channels driven, 40-20,000 Hz. THD: 0.8% at 12.5 watts, all channels operating at any frequency between 40-20,000 Hz. Bandwidth: (-3 dB) 18-36,000 Hz, all channels driven. Input Sensitivity: Aux., 250 mV; Mag. Phono, 4 mV; Cer. Phono, 135 mV; Tape Play, 500 mV.

**Hum and Noise:** Aux. (High-Level) -75 dB; Phono (Low-Level) -60 dB. **FM Tuner Section.** Usable Sensitivity (IHF): 2.5  $\mu$ V. Selectivity: 60 dB. Separation at 1000 Hz: 35 dB. Capture Ratio: 3 dB. S/N Ratio: 70 dB. Total Harmonic Distortion: 0.6%. Image Rejection: 55 dB. IF Rejection: 80 dB. **AM Tuner Section.** Sensitivity: 20  $\mu$ V.

**Lafayette AAA 2-YEAR GUARANTEE**

See page 3

No Money Down—See Page 4 for Lafayette's Easy-Credit Plan



### As Great Tomorrow as Today

- IC and FET Semiconductors in the FM Tuner Plus Ceramic Filters Provide Consistently Superior Sensitivity, Selectivity, Noise Limiting, and Tonal Range
- Fused Output Circuits Protect Speakers

### WITH GREAT UP-FRONT FEATURES



#### Signal-Strength Tuning Meter

Shows Strongest Signal on Both AM and FM for Precise, Accurate Tuning



**Program Selector Switch**  
Rotary Switch for Positive Selection of Aux, Phono, FM, MPX-FIL, and AM.

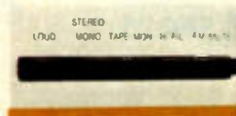

#### Pushbutton Function Switches

Choose Stereo-Mono, Loudness, Tape Monitor, High-Filter and FM Mute.



# SAVE on Component-Matched LR-310 Systems

## "Budget-Pleaser" System with Good Sound

LR-310 Stereo Receiver .....	\$199.95	<b>\$319<sup>95</sup></b>
Two Criterion 333 8" 2-Way Bookshelf Speaker Systems (Reg. \$44.95 each) .....	89.90	
Garrard 40B 3-Speed Turntable ..	49.95	If Purchased Separately, \$374.70
Base for Garrard 40B .....	9.95	
Pickering P/ATE-1 Magnetic Stereo Cartridge .....	24.95	
<b>Total Reg. Price</b> .....	<b>\$374.70</b>	
<b>System Price</b> .....	<b>319.95</b>	<b>Save \$54<sup>75</sup></b>
<b>YOU SAVE</b> .....	<b>\$54.75</b>	

Nice sounding system for apartments, small listening rooms, etc. The 333 speakers have acoustic-suspension design for full sound, the 40B turntable is really precise. With all cables, speaker hookup wire.  
22 F 92795WM Shpg. wt. 72¾ lbs. .... Net 319.95



## "Mid-Priced" LR-310 Music System

LR-310 Stereo Receiver .....	\$199.95	<b>\$364<sup>95</sup></b>
Two Criterion 555 10" 3-Way Bookshelf Speaker Systems (Reg. \$69.95 each) .....	139.90	
Garrard 40B 3-Speed Turntable ..	49.95	If Purchased Separately, \$424.70
Base for Garrard 40B .....	9.95	
Pickering P/ATE-1 Magnetic Stereo Cartridge .....	24.95	
<b>Total Reg. Price</b> .....	<b>\$424.70</b>	
<b>System Price</b> .....	<b>364.95</b>	<b>Save \$59<sup>75</sup></b>
<b>YOU SAVE</b> .....	<b>\$59.75</b>	

The 555 speaker systems feature acoustic-suspension design, 10" woofer, 3" tweeter and 5" midrange for extra presence and realism. With all cables, speaker hookup wire.  
22 F 92803WM Shpg. wt. 92¾ lbs. .... Net 364.95

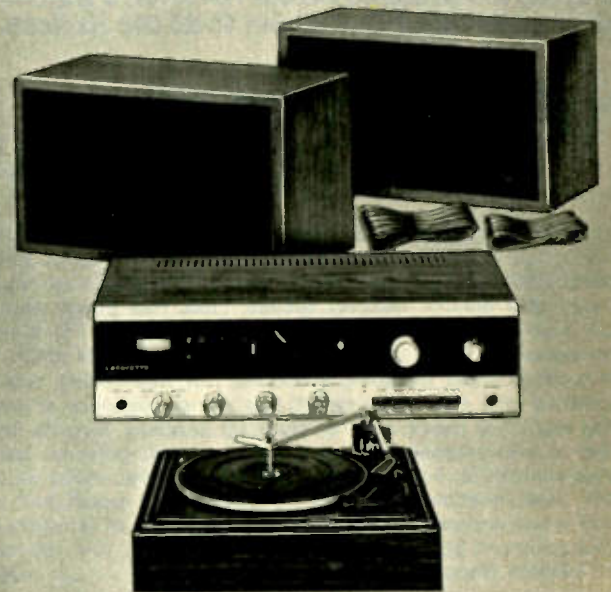

## Our Best LR-310 Component System

LR-310 Stereo Receiver .....	\$199.95	<b>\$438<sup>95</sup></b>
Two Criterion 666 10" 3-Way Floor/Shelf Speaker Systems (Reg. \$99.95 each) .....	199.90	
Garrard 62 3-Speed Turntable .....	69.95	If Purchased Separately, \$509.70
Base for Garrard 62 .....	9.95	
Pickering V15 Micro IV/ACE Magnetic Stereo Cartridge .....	29.95	
<b>Total Reg. Price</b> .....	<b>\$509.70</b>	
<b>System Price</b> .....	<b>438.95</b>	<b>Save \$70<sup>75</sup></b>
<b>YOU SAVE</b> .....	<b>\$70.75</b>	

Great sound and style for cost-conscious music lovers. The 666's feature acoustic-suspension design for excellent overall response, the turntable is full-featured for fine record play. With all cables, speaker hookup wire.  
22 F 92811WM Shpg. wt. 103 lbs. .... Net 438.95



# New! Our Lowest Priced Lafayette Stereo Receiver!

With the Features You Want for Superb Stereo—  
Specs That Assure Outstanding Performance



**Sensational Quality ... Sensational Price!**

**Lafayette LR-85 Stereo FM-AM Receiver: 6 Watts RMS  
Per Channel into 8 Ohms from 40-20,000 Hz; 0.8% THD.**

**\$169<sup>95</sup>**

- **Receives FM and Stereo FM Broadcasts,**
- **Has Inputs for Stereo Phono, Tuner and Tape, Stereo-Mono Mode Switch**

Combines latest solid-state circuitry and straightforward engineering to bring you a basic receiver that's AS GOOD AS YOU'LL FIND FOR THE MONEY! Make it the "heart" of a budget stereo system, use it as part of a quality "second system," too. Has power enough for most high-efficiency speaker systems, a slide-rule FM tuning dial with stereo indicator light and signal-strength AM-FM tuning meter, full tape facilities including a monitor for fine-quality direct tape recording. Has a loudness switch to enhance response at lower volume, high-filter pushbutton to clear up scratchy records and help bring in weak-signal FM broadcasts, volume, balance, bass and treble controls for sound the way you like it, stereo-mono switch and front panel headphone jack. The stylish front panel and walnut-finish wood end-panels give it the look and feel of far more expensive equipment. Size: 17 $\frac{3}{8}$ "W x 5H x 14"D. For 117 VAC, 60 Hz. 99 F 03436W Shpg. wt. 15 lbs. Imported..... Net 169.95

## SPECIFICATIONS

**Amplifier Section. Continuous Power at 8 Ohms:** 6 watts per channel, all channels driven, 40-20,000 Hz. THD: 0.8%. **Power Bandwidth:** (-3 dB) 00-00,000 Hz, all channels driven. **Input Sensitivity:** Aux., 350 mV. Mag. Phono, 5.5 mV. Ceramic Phono, 180 mV. Tape Play, 350 mV. **Hum and Noise:** Aux., -75 dB. Phono, -60 dB. **FM Tuner Section: Useable Sensitivity:** (IHF): 3.5  $\mu$ V. **Selectivity:** 40 dB. **Separation at 1000 Hz:** 35 dB. **Capture Ratio:** 3 dB. **S/N Ratio:** 60 dB. **Total Harmonic Distortion:** 0.7%. **Image Rejection:** 50 dB. **IF Rejection:** 80 dB. **AM Tuner Section: Sensitivity,** 20  $\mu$ V (Ant. terminal).

**Lafayette AAA 2-YEAR  
GUARANTEE**  
See Page 3



## Quality You'll Appreciate!

- **Switchable Magnetic or Ceramic Phono Input—Use Budget or Component-Quality Turntables**
- **Full Tape Inputs and Outputs for Direct Recording from Records and FM**
- **Solid-State Circuit with FET's and IC's for Outstanding Stability and Performance**
- **Flywheel Tuning with Stereo Light and Meter for Precise, Accurate Tuning**

## Complete System-Setup Versatility

Function Selector Switch for Aux. Input; Phono, FM, AM. Tape Monitor Circuit for Adding a 4-Channel Decoder/Amp When You're Ready.



**Total Speaker Control—Select Main, Remote, Main and Remote, Remote Only; Headphones Only. All You Need for Full Stereo in Two Separate Rooms.**

# Component-Matched LR-85 Music Systems

## "Stereo on a Budget" LR-85 System

**\$265<sup>95</sup>**

If Purchased Separately,  
\$314.70

**Save  
\$48<sup>75</sup>**

LR-85 Stereo Receiver .....	\$169.95
Two Criterion 222 8" 2-Way Bookshelf Speaker Systems (Reg. \$29.95 each) .....	59.90
Garrard 40B 3-Speed Turntable ..	49.95
Base for Garrard 40B .....	9.95
Pickering P/ATE-1 Magnetic Stereo Cartridge .....	24.95

Total Reg. Price \$314.70  
System Price 265.95  
**YOU SAVE \$48.75**

Nice-sounding system for great "starter stereo", second music system, etc. The speakers have air-suspension design, the Garrard 40B is a mainstay of low priced quality systems. With all cables, speaker hookup wire.

22 F 92829WM Shpg. wt. 50½ lbs. .... Net 265.95



## Full-Sound LR-85 Music System

**\$292<sup>95</sup>**

If Purchased Separately,  
\$344.70

**Save  
\$51<sup>75</sup>**

LR-85 Stereo Receiver .....	\$169.95
Two Criterion 333 8" 2-Way Bookshelf Speaker Systems (Reg. \$44.95 each) .....	89.90
Garrard 40B 3-Speed Turntable ..	49.95
Base for Garrard 40B .....	9.95
Pickering P/ATE-1 Magnetic Stereo Cartridge .....	24.95

Total Reg. Price \$344.70  
System Price 292.95  
**YOU SAVE \$51.75**

Nice sound and style for system priced this low! Our 333's have acoustic-suspension design, 8" woofer and 2½" cone tweeter for good sound. With all cables, speaker hookup wire.

22 F 92837WM Shpg. wt. 67¾ lbs. .... Net 292.95



## Our Best LR-85 Component System

**\$337<sup>95</sup>**

If Purchased Separately,  
\$394.70

**Save  
\$56<sup>75</sup>**

LR-85 Stereo Receiver .....	\$169.95
Two Criterion 555 10" 3-Way Floor/Shelf Speaker Systems (Reg. \$69.95 each) .....	139.90
Garrard 40B 3-Speed Turntable ..	49.95
Base for Garrard 40B .....	9.95
Pickering P/ATE-1 Magnetic Stereo Cartridge .....	24.95

Total Reg. Price \$394.70  
System Price 337.95  
**YOU SAVE \$56.75**

Excellent sound, compact setup and BIG SAVINGS too, in this deluxe low-power system. The 555's are full sounding 3-ways with 10" woofer, 5" sealed-back midrange and 3" tweeter. The Garrard 40B is one of the Garrard's most popular models. With all cables, speaker hookup wire.

22 F 92845WM Shpg. wt. 87¾ lbs. .... Net 337.95



# Lafayette's Finest "Total" 4-Channel Amplifier



**\$349<sup>95</sup>**

Handles Discrete 4-Channel from Tapes; CD-4 Records with Accessory Module\*; SQ from Records, Tapes and FM with Famous Lafayette Full-Logic Wavematching Circuit; QS (RM) 4-Channel Through Its Matrix Decoder; Derives 4-Channel from Stereo; All Stereo and Monophonic Sources



**New!** Lafayette LA-84 4-Channel Amplifier: 20 Watts RMS Per Channel Into 8 Ohms: 20-20,000 Hz, 0.5% THD Distortion

• **SQ Wavematching Full-Logic with Variblend for the Widest Separation Available in the 4-Channel SQ Mode**

Has latest IC solid-state circuits, complete inputs for adding phono, tuner and tape; a 4-separate-amplifier circuit for discrete 4-channel sources; complete controls for sound tailoring to any listening area. Loudness circuit and high-filter switch; outputs for main and remote 4-channel speakers (8 in all); 4-channel headphone jack for full-volume listening without disturbing others, complete left-right-front-rear balancing controls. The direct-coupled output circuit pro-

vides flat frequency response from extreme lows to extreme highs at all power levels; the fused speaker circuits protect speakers and output transistors; the separate 2- and 4-channel tape monitoring facilities provide complete and versatile tape setup. Good-looking wood case with simulated-walnut finish. 15½ x 4½ x 12¾". 117 VAC, 60 Hz. 99 F 03386W Imported. 20 lbs. . . Net 349.95

**Amplifier Section. Continuous Power at 8 Ohms:** 20 watts per channel, all channels driven, 20-20,000 Hz. THD: 0.5% at 20 watts, all channels operating at any frequency between 20-20,000 Hz. **Power Bandwidth:** (-3 dB) 10-35,000 Hz, all channels driven. **Input Sensitivity:** Aux. 1 & 2, 250 mV. Phono: H, 0.6 mV max at 1.5 mV normal; M, 1.8 mV at 4.5 mV normal; L, 4 mV max at 10 mV normal. 8- and 4-Channel Tape Play, 500 mV. Tuner, 500 mV. **Hum and Noise:** Aux. 1 & 2, -80 dB. Phono: -60 dB. 2- and 4-Channel Tape Play, -80 dB. Tuner, -75 dB.

**\*CD-4 Module Package**

Use the LA-84 for CD-4 discrete record play with any good turntable. Includes CD-4 plug-in, CD-4 test and setup record, low-capacitance phono cables. Imported. Requires special CD-4 phono cartridge, see page 78. Wt. 2 lbs. 99 F 03527 . . 69.95

**\$69<sup>95</sup>**

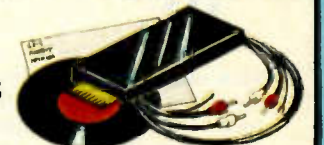

## Low-Priced Discrete 4-Channel Amplifier



**\$129<sup>95</sup>**

**Lafayette LA-222: A Fine Low-Power Amplifier with "Expensive-Model" Features!**

- **Famous Lafayette "Composer" Derives 4-Dimensional Sound from Conventional 2-Channel Sources**
- **SQ Decoding Circuit for Records, Tapes and FM Broadcasts**
- **4-Amplifier Circuit for Discrete 4-Channel Tapes, CD-4 with Demodulator**

An excellent integrated amplifier offering complete 4-channel control facilities; inputs and outputs for a very versatile medium-power setup. Has 4-channel main and remote speaker hookup, concentric front-rear left-right volume/balance controls, a separate power-on-off switch, and front panel stereo headphone jack. 4-channel tape outputs mean you can make your own discrete 4-channel tapes, 4-channel decoded outputs, too. With Aux., Cer./Mag, Phono, Tuner Inputs. Speaker and line protection fuses. Power at 8 ohms: 3 watts RMS per channel; all channels driven 50-20,000 Hz, 1% distortion. With simulated walnut finish metal case, 13½ x 4¾ x 8¾". For 117 VAC, 60 Hz. Imported.

99 F 02800W Shpg. wt. 14 lbs. . . Net 129.95



# Money-Saving LA-84, LA-222 4-Channel Phono Systems

## Fine-Sounding LA-84 4-Channel System

**Save  
\$94<sup>65</sup>**

If Purchased  
Separately,  
\$739.60

**\$644<sup>95</sup>**

Great-sounding component system featuring acoustic-suspension speakers and a fine-quality Garrard turntable. Includes all cables and speaker hookup wire. 155 lbs. 22 F 92878WM ..... Net 644.95

LA-84 4-Channel Amplifier ..... \$349.95  
Four Criterion 555 3-Way 10"  
Floor/Shelf Speaker Systems  
(Reg. \$69.95 each) ..... 279.80  
Garrard 62 3-Speed Turntable ... 69.95  
Base for Garrard 62 ..... 9.95  
Pickering V15 Micro IV/ACE  
Magnetic Stereo Cartridge ..... 29.95

Total Reg. Price \$739.60  
System Price 644.95

**YOU SAVE \$94.65**



## Our Best LA-84 4-Channel Phono System

**Save  
\$124<sup>65</sup>**

If Purchased  
Separately,  
\$924.60

**\$799<sup>95</sup>**

Offers outstanding sound and style, over \$100 savings! The 3-way speakers have mid-range and brilliance controls, the Garrard 82 is a precision-play turntable that pampers your records. Includes all cables, speaker hookup wire. 22 F 92886WM 180 lbs. Net 799.95

LA-84 4-Channel Amplifier ..... \$349.95  
Four Criterion 666 3-Way 10"  
Floor/Shelf Speaker Systems  
(Reg. \$99.95 each) ..... 399.80  
Garrard 82 3-Speed Turntable ... 119.95  
Base for Garrard 82 ..... 14.95  
Pickering V15 Micro IV/ATE  
Magnetic Stereo Cartridge ..... 39.95

Total Reg. Price \$924.60  
System Price 799.95

**YOU SAVE \$124.65**



## Low-Priced LA-222 4-Channel Phono System

**Save  
\$54<sup>65</sup>**

If Purchased  
Separately,  
\$334.60

**\$279<sup>95</sup>**

One of the lowest-priced discrete 4-channel systems you can buy! The 222's are surprisingly good-sounding, the Garrard 40B is a turntable with excellent features for fine record play. Includes all cables, speaker hookup wire. 22 F 92852WM 70 lbs. Net 279.95

LA-222 4-Channel Amplifiers ... \$129.95  
Four Criterion 222 8" 2-Way  
Bookshelf Speaker Systems  
(Reg. \$29.95 each) ..... 119.80  
Garrard 40B 3-Speed Turntable ... 49.95  
Base for Garrard 40B ..... 9.95  
Pickering P/ATE-1 Magnetic  
Stereo Cartridge ..... 24.95

Total Reg. Price \$334.60  
System Price 279.95

**YOU SAVE \$54.65**

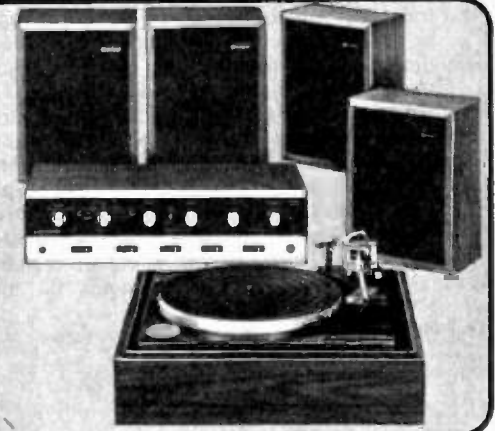

## BIG SOUND LA-222 4-Channel Phono System

**Save  
\$56<sup>65</sup>**

If Purchased  
Separately,  
\$394.60

**\$337<sup>95</sup>**

You won't find a better sounding 4-channel system at this price. The 333's have an 8" woofer with a BIG 2-lb. magnet structure and sealed-back 3" tweeter, they're perfect for shelf, table mounting. Includes all cables, speaker hookup wire. Shpg. wt. 101 lbs. 22 F 92860WM ..... Net 337.95

LA-222 4-Channel Amplifier ..... \$129.95  
Four Criterion 333 2-Way 8"  
Bookshelf Speaker Systems  
(Reg. \$44.95 each) ..... 179.80  
Garrard 40B 3-Speed Turntable ... 49.95  
Base for Garrard 40B ..... 9.95  
Pickering P/ATE-1 Magnetic  
Stereo Cartridge ..... 24.95

Total Reg. Price \$394.60  
System Price 337.95

**YOU SAVE \$56.65**

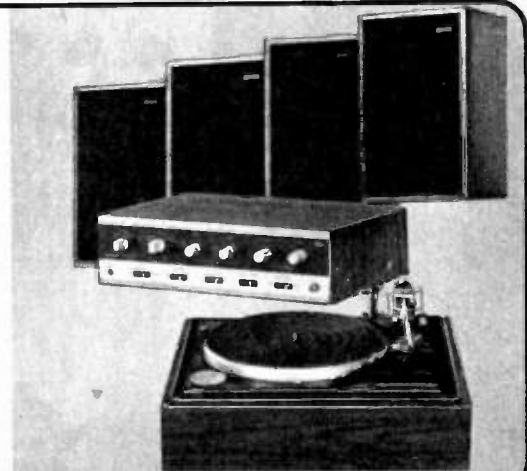



**Lafayette LA-1050: 22 Watts RMS per Channel into  
8 Ohms from 20-20,000 Hz: 0.5% THD**

- Accepts All Stereo Music Sources (Records, Tapes and FM)
- Delivers Exceptional Sound Clarity
- Separate Bass and Treble Tone Controls

- Speaker Mode Selector with Main-Remote, Main + Remote Positions
- Positive-Action Mode Pushbuttons
- Full Tape Inputs and Outputs with Monitor

Engineered with the latest solid-state circuitry to deliver clean, uncolored sound from any component-quality record changer, tape recorder or FM tuner—the LA-1050 does not impose any of its own sound on the program source—it's so clean you'll hardly know it's there! Has input selector with positions for Mike, Phono, Tuner and Aux., pushbutton mode selectors for stereo-mono, loudness, tape monitor, and high filter; speaker selector for Main, Remote, Main + Remote, Phones. Concentric bass and treble controls plus a separate Master volume and balance provide all the

sound tailoring you're likely to need. There's a low/high magnetic phono input, tape inputs and outputs including monitor, tuner and tape play (aux.) inputs, too. The striking brushed aluminum and black front panel and walnut-finish case make the LA-1050 a handsome addition to any system setup. Has one switched and one unswitched AC outlet for associated components, advanced electronic circuit with fuse protection for speakers. 13 x 3 $\frac{3}{8}$  x 9 $\frac{1}{2}$ ". For 117 VAC, 50-60 Hz. Imported.  
99 F 03451W Shpg. wt. 21 lbs. . . Net 149.95

**New! Our Best  
Lafayette Stereo  
Amplifier**

**\$149<sup>95</sup>**

**Lafayette**

**AAA 2-YEAR GUARANTEE**

See Page 3

**SPECIFICATIONS**

**Amplifier Section. Continuous Power at 8 Ohms: 22 watts per channel, all channels driven, 20-20,000 Hz. THD: 0.5%, all channels operating at any frequency between 20-20,000 Hz. Power Bandwidth (-3 dB) 10-30,000 Hz, all channels driven. Input Sensitivity: Aux. 1 and 2, 250 mV; Phono HI, 2.5 mV; Lo, 6 mV. Tuner and Tape Play: 500 mV. Hum and Noise: Phono, -65 dB, all others, -75 dB.**



**BIG-SAVINGS Stereo Phono System  
Featuring the LA-1050**

**Save \$54<sup>75</sup>** If Purchased Separately, \$374.70

**\$319<sup>95</sup>**

- LA-1050 Stereo Amplifier \$149.95
- Two Lafayette Criterion 555 3-Way 10" Floor/Shelf Speaker Systems (Reg. \$69.95 each) 139.90
- Garrard 40B 3-Speed Turntable 49.95
- Base for Garrard 40B 9.95
- Pickering P/ATE-1 Magnetic Stereo Cartridge 24.95

**Total Reg. Price \$374.70**

**System Price 319.95**

**OU SAVE 54.75**

As fine-sounding a system as you'll see at this price! Each Criterion 555 has a 10" woofer, 5-inch sealed-back midrange speaker and 3-inch tweeter for full, rich sound reproduction. The Garrard 40B is a precision record-playing device with light tracking and all controls. With cables, speaker hookup wire. Wt. 93 lbs.

22 F 92605WM . . . Net 319.95

# Popular Lafayette Low-Power Stereo Amplifier



**\$119<sup>50</sup>**

**Lafayette**

**AAA 2-YEAR GUARANTEE**

See Page 3

## SPECIFICATIONS

**Amplifier Section.** Continuous Power at 8 Ohms: 10 watts per channel, all channels driven. 40-20,000 Hz. THD: 0.8%, all channels operating at any frequency between 40-20,000 Hz. Power Bandwidth (-3 dB) 27-35,000 Hz, all channels driven. Input Sensitivity: Aux., 250 mV; phono (mag) 3.5 mV; ceramic, 120 mV. Tuner and Tape Mon.: 500 mV. Hum and Noise: Aux. and Tuner, -75 dB; Phono (mag) -63 dB.

**Lafayette LA-950A: 10 Watts RMS per Channel Into 8 Ohms from 40-20,000 Hz: 0.8% THD**

- Accepts All Music Sources (Records, Tapes, FM and Stereo FM)
- Front Panel Headphone and Tape Jacks
- Pushbutton Mode Switches
- Ceramic or Magnetic Phono Inputs
- Full Tape Inputs and Outputs Including Monitor for Fine-Quality Recording
- Precision-Engineered Solid-State Circuit

An outstanding "mid-power" amplifier with high-efficiency, solid-state circuit — you don't pay for power you don't use! Has ALL THE INPUTS, OUTPUTS and CONTROLS for a very flexible and satisfying music system setup. Has dual concentric bass, treble and volume/balance controls, tape recording outputs on both the front and rear panels for convenient permanent or temporary connection of a tape recorder or deck. Pushbutton power switch so controls can be set just once, other pushbutton switches

for loudness, stereo-mono, tape monitor and high filter. There are rear panel inputs for phono (magnetic or ceramic), tuner and aux. The front panel stereo headphone jack lets you listen with headphones without disturbing others. Good-looking brushed gold-finish anodized front panel and simulated walnut-grain metal cabinet make the LA-950A a functional and attractive component for use just about anywhere. For 117 VAC, 50-60 Hz. 12 x 3 3/4 x 9 1/8". Imported. 99 F 03089W Shpg. wt. 12 1/2 lbs. Net 119.50



## Money-Saving Complete Stereo-Phono System Featuring the LA-950A

Save \$47<sup>30</sup>

**\$246<sup>95</sup>**

If Purchased Separately, \$294.25

LA-950A Stereo Amplifier \$119.50  
 Two Lafayette Criterion 333 8" 2-Way Bookshelf Speaker Systems (Reg. \$44.95 ea.) 89.90  
 Garrard 40B 3-Speed Turntable 49.95  
 Base for Garrard 40B 9.95  
 Pickering P/ATE-1 Magnetic Stereo Cartridge 24.95

Total Reg. Price \$294.25

System Price 246.95

**YOU SAVE 47.30**

Top-quality, lower-priced system really sounds good. The Criterion 333's have air-suspension system design for surprisingly BIG sound, fit just about anywhere on shelf or table. The Garrard 40B is one of that company's most respected changers, has a host of fine features. With all speakers cables and speaker hookup wire. Shpg. wt. 63 1/2 lbs. 22 F 92480WM ... Net 246.95

# Lafayette LA-25 Solid-State Stereo Amplifier



ONLY  
**\$69<sup>95</sup>**  
With Case

Designed for  
**Exceptional Reliability  
and Performance**  
At a Very Modest Price

- Inputs for Magnetic, Ceramic Cartridges
- Main/Remote Speaker Switch

- Front Panel Stereo Headphone Jack
- Speaker Protection Fuses

Fine-quality amplifier faithfully reproduces the full spectrum of audio sound with more than adequate volume and very low distortion. Solid-state with 18 quality transistors, 4 diodes to assure top-notch performance with minimum heat. Has rotary selector switch for Input Source; Bass, Treble, and dual-concentric Volume/Balance controls. Rocker switches for Mode (Mono/Stereo), Speakers (Remote/Main), Power On-Off, Headphone Jack. Rear panel has stereo outputs for main and remote speakers; input jacks for Aux., Tuner, Phono, Tape Recorder; AC convenience outlet; AC line fuse. Special fuses for each channel protect output transistors and speakers. Size: 10<sup>3</sup>/<sub>8</sub>" W x 3<sup>1</sup>/<sub>2</sub>" H x 8<sup>3</sup>/<sub>8</sub>" D. For 117 VAC, 50/60 Hz. Imported. 99 F 02842W Shpg. wt. 9 lbs. . . . . Net 69.95

## Money-Saving LA-25 Stereo Phono System



Save  
**\$39<sup>75</sup>**

**\$174<sup>95</sup>**

If Purchased  
Separately,  
\$214.70

LA-25 Stereo Amplifier . . . . .	\$ 89.95
Criterion 222 8" 2-Way Speaker Systems (Reg. \$29.95 each) . . . . .	59.90
Garrard 40B Turntable . . . . .	49.95
Base for Garrard 40B . . . . .	9.95
Pickering P/ATE-1 Cartridge . . . . .	24.95

Total Reg. Price \$214.70  
System Price 174.95

**YOU SAVE \$ 39.75**

Great sound, with good-looking speakers and a precise turntable.  
22 F 91573WM Shpg. wt. 4<sup>1</sup>/<sub>2</sub> lbs. Net 174.95

### SPECIFICATIONS

**Amplifier Section. Continuous Power at 8 Ohms:** 5 watts per channel, all channels driven. 40-20,000 Hz **THD:** 1% at 5 watts, all channels operating at any frequency between 40-20,000 Hz. **Power Bandwidth:** (-3 dB) 55-25,000 Hz, all channels driven. **Input Sensitivity:** Aux., 125 mV. Tuner, 250 mV. Phono (mag.) 3.5 mV; (ceramic), 250 mV. **Hum and Noise:** Tuner and Aux., -65 dB. Phono, -55 dB.

# LAFAYETTE Stereo 10B Solid-State Amplifier



ONLY  
**\$39<sup>95</sup>**  
With Case

- Compact Size, Neat Styling, Big Performance Stereo Sound
- Main and Remote Speaker Cutouts

- Inputs for Phono, Tuner, Tape (Aux.)
- Separate Volume Controls for Left and Right Channels
- Front Panel Stereo Headphone Jack

An excellent value in a low-power amplifier ideal for beginner or as second stereo system. Compact unit is easily installed on bookshelf or end table. Use with record players, AM, FM, stereo FM tuners. Solid-state circuitry with 10 transistors. 6 diodes provides clean sound, instantaneous operation. Input impedance: 750K ohms. Cross Talk: 45 dB. Hum and Noise: 60 dB below rate output. Transformerless driver and output stages for smooth frequency response with high-impedance crystal or ceramic phono cartridges. Front panel features:

separate volume controls for Left/Right; Bass; Treble; Rotary Switch for Input Source; Slide Switches for Mode, On/Off, Speakers (Main and Remote); Stereo Headphone Jack. Rear panel features: Left/Right channel outputs for main and remote speakers; switched AC convenience outlet (60 watts). Beautifully finished aluminum front panel with complementary metal knobs and attractive metal case. Size: 9W x 3<sup>1</sup>/<sub>2</sub>" H x 6<sup>1</sup>/<sub>2</sub>" D. For 117 VAC, 50/60 Hz. Imported.

99 F 02974 Shpg. wt. 5<sup>1</sup>/<sub>2</sub> lbs. . . . . Net 39.95

## Our Lowest-Priced Stereo Phono System



Save \$10<sup>80</sup>  
**\$94<sup>95</sup>**

Stereo 10B Amplifier \$ 39.95	
Two XL-44 6 <sup>1</sup> / <sub>2</sub> " Speakers (Reg. \$14.95 each) . . . . .	29.90
Lafayette AC-60 Record Player . . . . .	29.95
Base for AC-60 . . . . .	5.95

Total Reg. Price \$105.75  
System Price 94.95

**YOU SAVE \$ 10.80**

Nice sound at a NICE price.  
22 F 91995WM Shpg. wt. 27 lbs. . . . . Net 94.95



# Lafayette Stereo FM-AM Tuners Sound Super!



- \*DOLBY Automatic Noise Reduction Circuit
- Phase-Lock-Loop Multiplex Decoder for Ultra-Wide Stereo Separation with Minimum Distortion
- AAA 2-YEAR GUARANTEE—See Page 3



1 Lafayette LT-D10 Dolby Stereo FM-AM Tuner—Designed for a Lifetime of Fine Music Listening

**\$269<sup>95</sup>**

- 1.5  $\mu$ V IHF FM Sensitivity
- 1.5 dB Capture Ratio
- 65 dB Signal/Noise Ratio

2 Lafayette ST-22 "Budget" Stereo FM-AM Tuner

**\$49<sup>95</sup>**

- 7.5  $\mu$ V IHF FM Sensitivity
- THD: 1% or Less

Our lowest priced stereo FM-AM tuner is a great buy for those on a tight budget—offers excellent performance in economy stereo systems. Has stereo light, automatic stereo switching, AFC for drift-free tuning, solid-state circuit with 11 transistors, 13 diodes and 1 varicap diode. Walnut-finish wood cabinet, 9 $\frac{1}{8}$  x 3 $\frac{3}{8}$  x 6". For 117 VAC, 60 Hz. 99 F 03337W Imported. Shpg. wt. 4 $\frac{1}{4}$  lbs. Net 49.95

3 Lafayette LT-725B Stereo FM-AM Tuner

**\$149<sup>95</sup>**

- 1.7  $\mu$ V IHF FM Sensitivity
- 2.5 dB Capture Ratio
- 65 dB Signal/Noise Ratio

• AAA 2-YEAR GUARANTEE—See Page 3

Top quality tuner with \$\$\$-more features and performance. Advanced solid-state circuit uses 4 IC's, 14 transistors and 19 diodes; a combination tuning meter indicates signal-strength for AM, center-channel for FM; there's automatic stereo switching, pushbutton controls. Separation at 1000 Hz, 35 dB. Front/rear panel tape output jacks, outputs for external antennas too. 12 x 3 $\frac{3}{4}$  x 9 $\frac{1}{8}$ ". For 117 VAC, 50-60 Hz. 99 F 03147W Imported. Shpg. wt. 13 lbs. Net 149.95

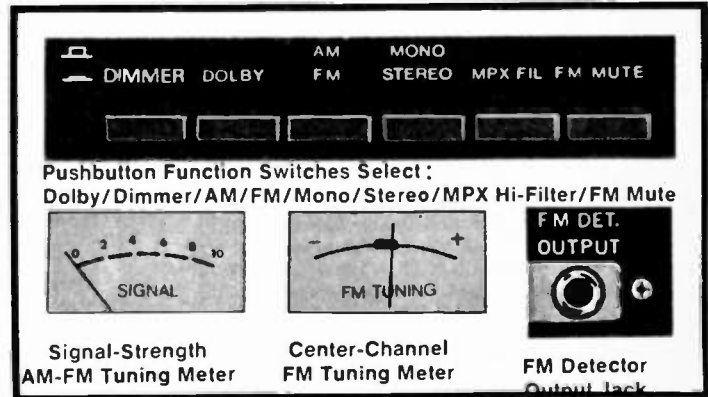

The stereo tuner that offers superior performance without the "superior" price! Features a built-in Dolby type B automatic noise reduction circuit (with switch selected 75  $\mu$ S and 25  $\mu$ S de-emphasis) for hiss-free reception on the growing number of Dolbyized FM broadcasts; a Phase Lock Loop multiplex decoder that "zeroes in" on the exact electronic center of a stereo FM signal—provides ultra-wide stereo separation and minimal 0.2% THD. Dual-gate MOS FET's and IC's for outstanding sensitivity and selectivity of 70 dB. Front panel tape outputs let you hook up a stereo tape recorder, rear panel has fixed and variable level outputs for use with any good amplifier, FM detector output for a 4-channel discrete adapter when it's ready. Also has external AM and FM antenna binding posts, AC convenience outlet. In rich walnut-finish wood cabinet, 15 $\frac{1}{2}$  x 4 $\frac{1}{2}$  x 13". 117 VAC, 60 Hz. 99 F 03139W Imported. Shpg. wt. 12 $\frac{1}{2}$  lbs. Net 269.95

\*Dolby is a Trademark of Dolby Laboratories, Inc.

No Money Down—See Page 4 for Lafayette's Easy-Credit Plan (Minimum Order \$30.00)

Lafayette Cat. No. 750 23

# Lafayette Full-Feature 4-Channel Receivers



**Amplifier Section. Continuous Power at 8 Ohms:** 4 watts RMS per channel, all channels driven, 40-20,000 Hz. **THD:** 1%, all channels operating at any frequency between 40-20,000 Hz. **Power Bandwidth:** (-3 dB) 27-40,000 Hz, all channels driven. **Input Sensitivity:** Aux., 135 mV. Tape Play, 275 mV. Phono (Mag.), 4 mV. (Ceramic) 150 mV. **Hum and Noise:** Aux., -70 dB. Phono, -60 dB. **FM Tuner Section: Usable Sensitivity (IHF):** 6  $\mu$ V. **Selectivity:** 40 dB. **Separation at 1000 Hz:** 35 dB. **Capture Ratio at 500 mV:** 6 dB. **S/N Ratio:** 60 dB. **Total Harmonic Distortion:** 0.8%. **Image Rejection:** 50 dB. **IF Rejection:** 70 dB. **AM Tuner Section: Sensitivity:** 20  $\mu$ V.



## Lafayette Model LR-111 Discrete 4-Channel FM/AM Receiver

**\$179<sup>95</sup>**

Wood Case

- 4 Amplifiers for Discrete, SQ and Derived 4-Channel Program Sources
- Built-In SQ-M Decoder Circuit
- Accepts Optional CD-4 Demodulator for Playback of CD-4 Channel Records

**AAA 2-YEAR GUARANTEE**

See Page 3

The LR-111 reproduces the wonderful sound of discrete 8-track cartridges, reel-to-reel tapes, discrete 4-channel records, SQ quadraphonic records, and SQ FM broadcasts. It has "Composer" circuitry for playback of other encoded 4-channel records such as "QS" (regular matrix) and derives rich 4-channel sound from present 2-channel stereo records, tapes, and stereo FM broadcasts. Includes external FM antenna input and Line Speaker fuses. Walnut finish wood cabinet with attractive brushed brass front panel. Front panel includes blackout tuning dial, signal strength tuning meter, stereo FM light, 4-channel headphone jacks, rotary selectors, front and rear channel balance, other controls. Rear panel includes: 2 & 4 channel speaker outputs, tape inputs and outputs, phono input with Mag/Cer slide switch, other controls. Operates on 117 volts, 50/60 Hz AC. 16 x 4 1/4 x 12". 99 F 03022W Imported. Shpg. wt. 15 lbs. . . . . Net 179.95



**Amplifier Section. Continuous Power at 8 Ohms:** 4 watts RMS per channel, all channels driven, 80-20,000 Hz. **THD:** 1%, all channels operating at any frequency between 80-20,000 Hz. **Input Sensitivity:** Aux 1 and 2, 275 mV. Phono (Mag.), 4 mV. (Ceramic), 150 mV. **Hum and Noise:** Aux., -70 dB. Phono, -55 dB. **FM Tuner Section. Usable Sensitivity (IHF):** 2.5  $\mu$ V. **Selectivity:** 40 dB. **Separation at 1000 Hz:** 35 dB. **Capture Ratio:** 3 dB. **S/N Ratio:** 60 dB. **Total Harmonic Distortion:** 0.7%. **Image Rejection:** 50 dB. **IF Rejection:** 85 dB. **AM Tuner Section. Sensitivity:** 20  $\mu$ V.



## Lafayette Model LR-220 Discrete 4-Channel FM/AM Receiver

**\$249<sup>95</sup>**

Wood Case

- Plays Discrete 4-Channel, SQ 4-Channel, Derived 4-Channel, 4-Channel SQ FM Broadcasts
- 4 Amplifiers for Discrete, SQ and Derived 4-Channel Sources
- Built-In SQ-M Decoder Circuit

**AAA 2-YEAR GUARANTEE**

See page 3

The superb LR-220 delivers the thrilling 4-channel sound of discrete 8-track cartridges, reel-to-reel tapes, SQ stereo quadraphonic records, and SQ FM broadcasts. "Composer" circuitry permits playback of other encoded 4-channel records such as QS (regular matrix) and derives rich 4-channel sound from present 2-channel stereo records, tapes, stereo FM broadcasts. Includes external FM antenna input, line and speaker fuses. Handsome walnut-finish wood cabinet with brushed brass front panel. Front panel: blackout tuning dial, signal strength tuning meter, 4-channel headphone jacks, rotary selectors for input source, front and rear channel balance, other controls. Rear panel 2 and 4 channel speaker outputs, phono input with Mag/Cer slide switch, other controls. 117 VAC, 50-60 Hz AC. 15 7/8 x 4 1/4 x 11 1/4". 99 F 02933 W Imported. Shpg. wt. 21 lbs. . . . . Net 249.95

## Lafayette Criterion® "R-10" Solid State Reverb Amplifier/Speaker System

- A Reverb Amplifier and Speaker
- A Stereo Center Channel, Amplifier and Speaker
- Phono Amplifier and Speaker

Adds center channel to amplifier or receiver. Delivers concert-hall realism when used as reverb amplifier or speaker. Wide-range compliance speaker delivers rich sound. Input sensitivity-ceramic phono-250 mV, center channel-150 mV. Inputs-Reverb, center channel, phono (all inputs use RCA jacks and require leads with RCA plugs). 11 3/4 x 8 1/4 x 5 7/8". For 117 AC, 60 Hz. Imported. 99 F 02446W Shpg. wt., 7 1/2 lbs. . . . . Net 19.95

New  
Low  
Price

**\$19<sup>95</sup>**

Handsome Hand Rubbed  
Oiled Walnut Cabinet

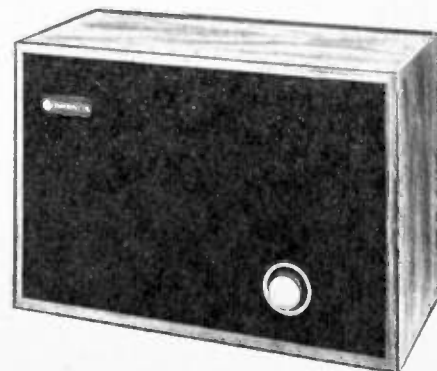

# Outstanding Values In 4-Channel Converters

## 1 Lafayette Model LA-975 SQ Decoder/Amplifier

- Sophisticated SQ Logic Decoder
- Master Volume Control For All 4 Channels
- Plus High Quality Independent 2-Channel Stereo Amplifier

**\$99<sup>95</sup>**

With Case

Add this and two more speakers to your present stereo system for the excitement of 4-channel sound! Advanced SQ circuit provides greater front-back separation and increases the presence of center-front and center-back soloists. Plays discrete 4-channel tapes (reel-to-reel and 8-track) and the popular new 4-channel SQ records. LA-975 must be used with amplifiers or receivers having tape monitor facilities. Also features "Composer" circuit for deriving 4-channel sound from 2-channel stereo records, tapes and stereo FM broadcasts. The LA-975 can also be operated as a high-quality independent 2-channel stereo amplifier. With fully equipped front and rear control panels. 13 x 4 $\frac{3}{8}$  x 10 $\frac{1}{4}$ ". For 117 VAC, 60 Hz. Imported.

99 F 02859W Shpg. wt. 20 lbs. . . . . Net 99.95



**SPECIFICATIONS: Amplifier Section. Continuous Power at 8 Ohms: 10 watts RMS per channel, all channels driven, 20 to 20,000 Hz. THD: 1%, all channels operating at any frequency between 20-20,000 Hz. Power Bandwidth: (-3 dB) 20-35,000 Hz, all channels driven. Input Sensitivity: Tuner/Source 500 mV. Aux., 250 mV. Phono (Mag.), 4.5 mV (Ceramic) 135 mV. Hum and Noise: Tuner, Source, Aux., -75 dB. Phono, -60 dB.**

## 2 Lafayette LA-524 SQ Decoder Auxiliary Amplifier

- Built-In 4-Channel SQ-M Decoder
- 2-Channel Auxiliary Amplifier
- Exclusive Master Gain Control for All 4 Channels of Amplification

**\$59<sup>95</sup>**

With Case

Add LA-524 Quadraural SQ Decoder/Auxiliary Amplifier and 2 more speakers to your present 2-channel stereo system and hear music in the most exciting and stimulating way possible—TRUE 4-channel sound. Music can be heard from any location in room—in front of, to either side of, or behind the listener. Has inputs for discrete 4-channel tapes (reel-to-reel and 8-track) and the new 4-Channel SQ records. Also features "Composer" circuit for deriving 4-channel sound from conventional 2-channel records, tapes, FM broadcasts. Has bass, treble, master volume controls, function selector. The LA-524 must be used with amplifiers or receivers incorporating a tape monitor feature. (Cannot be used as a separate 2-channel amplifier). For 117 VAC, 60 Hz. 10 $\frac{1}{2}$  x 8 $\frac{3}{4}$  x 3 $\frac{1}{2}$ ". Imported.

99 F 02750W Shpg. wt. 10 $\frac{1}{4}$  lbs. . . . . Net 59.95



**SPECIFICATIONS: 5 Watts RMS Per Channel into 8 Ohms from 40-20,000 Hz. THD: 1%. Input Sensitivity: 275 mV. Hum and Noise: -70 dB.**

## 3 Lafayette SQ-M 4-Channel SQ Decoder

- Converts 2-Channel System To Play SQ 4-Channel, Discrete, 4-Channel and Derived 4-Channel
- Master Volume Control for All 4 Channels

**\$24<sup>95</sup>**

Use with 2 more speakers and an additional stereo amplifier to convert your present stereo system to SQ 4-channel. Lets you play all discrete and SQ 4-channel sources, even has a "Composer" circuit that derives an exciting 4-dimensional effect from your present 2-channel sources. Has a magnetic phono input for use with amplifiers or receivers not having a magnetic phono input feature. Master volume control for all 4 channels. Compatible with all 4-channel matrix circuits, too. For 117 VAC, 50-60 Hz. 6 x 7 $\frac{1}{2}$  x 2 $\frac{7}{8}$ ". Imported.

99 F 02768 Shpg. wt. 4 $\frac{1}{4}$  lbs. . . . . Net 24.95



## 4 Lafayette QD-4 Derived 4-Ch. Adapter

**\$14<sup>95</sup>**

- Provides 4-Dimensional Effect From Your Stereo Records, Tapes and FM Broadcasts
- No Additional Stereo Amplifier Required

Use with two more speakers and your present stereo amplifier or receiver to derive an exciting 4-dimensional effect from stereo records, tapes and FM broadcasts. An excellent low-cost way to give your present stereo material "new life." Has volume control, 4-position function switch (Balance, 4-Ch., Front speakers only, Rear speakers only) plus a rear speaker level control. With 3 pairs of cables: 6-ft. pair for adapter to receiver, 15-ft. pair for adapter to front speakers, 25-ft. pair for adapter to rear speakers. 5 $\frac{3}{4}$  x 4 $\frac{1}{8}$  x 2 $\frac{7}{8}$ ".

99 F 02594 Imported. Shpg. wt. 4 $\frac{3}{4}$  lbs. . . . . Net 14.95



# Presenting Pioneer Stereo FM-AM Receivers for '75

**NEW!**

Sophisticated engineering and day-in, day-out reliability make these Pioneer receivers fine choices for quality music systems. Pick your power, pick your price—**EVERY Pioneer receiver shown here represents the latest in state-of-the-art electronics**

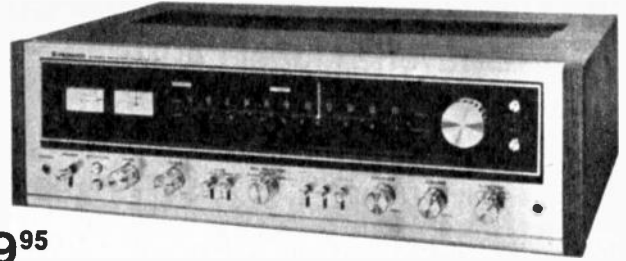

**\$399<sup>95</sup>**



**\$349<sup>95</sup>**



**\$599<sup>95</sup>**



**\$499<sup>95</sup>**

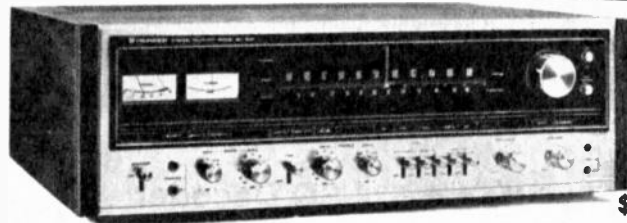

**\$699<sup>95</sup>**

**ALL FEATURE:** Dual tuning meters, Phase Lock Loop (PLL) stereo FM circuits for extra-wide separation and low distortion, complete tape facilities with duplication provisions, direct-coupled amplifier circuits for low distortion and wide power bandwidth. All have walnut-finish wood cases for a decorator touch with any decor.

**1 SX-636.** For average to moderate listening areas—25 watts rms per channel into 8 ohms from 20-20,000 Hz at 0.5% distortion. Click-stop tone controls with "flat" position, precise RIAA phono equalizer, even an AM section with an IC for top performance. FET FM front end. IC IF section with 5-stage limiter. FM sensitivity, 1.9  $\mu$ V IHF. S/N, 70 dB. 18 $\frac{3}{32}$ " x 5 $\frac{3}{32}$ " x 18 $\frac{1}{8}$ ". For 117 VAC, 60 Hz. 21 F 31217WX Imported. 29 lbs. .Net 349.95

**2 SX-737.** Has more power, versatile control features including a RECORDING selector that lets you record directly from FM broadcasts while listening to records, or vice-versa! 35 watts rms per channel into 8 ohms from 20-20,000 Hz at 0.5% distortion. 1.9  $\mu$ V IHF FM sensitivity, 1.0 dB capture ratio, 60 dB selectivity, 70 dB S/N. 19 $\frac{1}{16}$ " x 6 $\frac{7}{32}$ " x 17 $\frac{3}{32}$ ". For 117 VAC, 60 Hz. Imported. 21 F 31209WX Shpg. wt. 35 lbs. .Net 399.95

**3 SX-838.** Has the features of the SX-636 and 737 PLUS switched turnover tone controls for precise adjustments to any listening area, 6-stage IF section, Dolby and 4-Channel adapter terminals, 2 phono inputs. 50 watts RMS per channel into 8 ohms from 20-20,000 Hz, 0.3% distortion, 1.8  $\mu$ V IHF FM sensitivity, 80 dB selectivity. Automatic protection circuit. 20 $\frac{1}{32}$ " x 6 $\frac{7}{8}$ " x 16 $\frac{1}{32}$ ". For 117 VAC, 60 Hz. Imported. 21 F 31167WX Shpg. wt. 44 lbs. .Net 499.95

**4 SX-939.** Features Pioneer's unique twin tone control system. Parallel push-pull direct-coupled output. 10,000  $\mu$ F electrolytic capacitors for absolute stability at any power level. 70 watts RMS per channel into 8 ohms from 20-20,000 Hz, under 0.3% distortion. 1.8  $\mu$ V IHF FM sensitivity, better than 80 dB selectivity. 20 $\frac{1}{32}$ " x 6 $\frac{7}{8}$ " x 16 $\frac{1}{32}$ ". For 117 VAC, 60 Hz. Imported. 21 F 31175WX Shpg. wt. 51 lbs. .Net 599.95

**5 Pioneer's Finest—the SX-1010.** Built for a lifetime of stereo listening enjoyment! All the features of the 939 PLUS 18,000  $\mu$ F capacitors, 7 stage IF limiter, with 3 IC's and phase-linear ceramic filters, 20 db muting switch, outputs for 3 sets of speakers. 100 watts RMS per channel into 8 ohms from 20-20,000 Hz, less than 0.1% distortion. 1.7  $\mu$ V IHF FM sensitivity, over 90 dB selectivity. 20 $\frac{1}{32}$ " x 6 $\frac{7}{8}$ " x 17 $\frac{1}{32}$ ". 117 VAC, 60 Hz. Imp. 21 F 31183WX Shpg. wt. 60 lbs. .Net 699.95

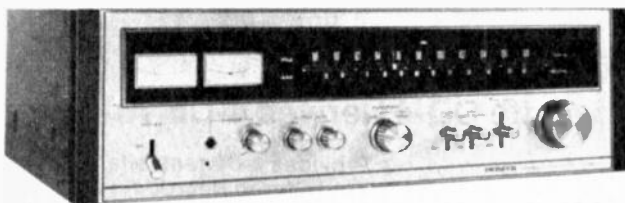

**\$349<sup>95</sup>**

• Phase-Lock-Loop Multiplex Circuit Assures Widest Separation, Lowest Distortion

## Pioneer TX-9100 Stereo FM-AM Tuner

Matched in size and style to the SA-9100 below, can be used in any sophisticated stereo music system. Has a 6-stage limiter and "phase linear" ceramic filters, dual-gate MOS FET front end, 5 gang variable capacitor. Adjustable muting level, special pulse and multiplex noise filters, and separate output level controls for AM, FM and phones make it an excellent tuner. 1.5  $\mu$ V IHF FM sensitivity, 90 dB selectivity, better than 110 dB spurious and image rejection, 1 dB capture ratio, S/N of 75 dB. 16 $\frac{1}{16}$ " x 5 $\frac{1}{4}$ " x 13 $\frac{3}{32}$ ". For 117 VAC, 60 Hz. 21 F 31233WX Imported. Shpg. wt. 24 lbs. .Net 349.95

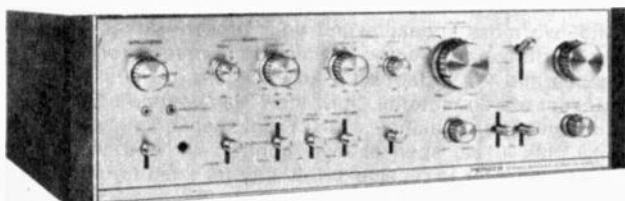

**\$449<sup>95</sup>**

• 60 Watts RMS Per Channel into 8 Ohms, 20-20,000 Hz, 0.1% Distortion

## Pioneer SA-9100 Stereo Amplifier with Split Power Supply and OCL Circuit

For those who insist on "separate" components, the SA-9100 is a stereo control center second to none! Plenty of power, inputs for tuner, two phonos, two aux., 3 sets of speaker outputs, complete filtering and muting with tone defeat switch, full tape facilities, twin tone control system for over 3,000 tonal characteristics. Has full automatic electronic protection circuit, 5-40,000 Hz power bandwidth, 3-stage direct-coupled amplifier, lots more. 16 $\frac{1}{16}$ " x 5 $\frac{1}{4}$ " x 13 $\frac{3}{16}$ ". For 117 VAC, 60 Hz. Imported. 21 F 31225WX Shpg. wt. 33 lbs. .Net 449.95

# NEW! Marantz State-Of-The-Art Components

## 1 Model 2220B Stereo FM-AM Receiver

Marantz quality at a low price! 20 watts RMS per channel into 8 ohms from 20-20,000 Hz, 0.5% THD. Has slide-balance control, direct thumbwheel tuning, center-channel FM, signal-strength AM tuning meter, high and low filters, full tape inputs and outputs including monitor. Detented bass, midrange and treble tone controls. Phase-Lock-Loop FM Decoder. 16 $\frac{1}{2}$ " x 5 x 14". IHF FM Sensitivity: 2.0  $\mu$ V. For 117 VAC, 60 Hz. Imported.  
21 F 50449W Shpg. wt. 32 lbs. . . . . Net 349.95



## 2 Model 2240 Stereo FM-AM Receiver

Deluxe Marantz receiver delivers 40 watts RMS per channel into 8 ohms from 20-20,000 Hz, 0.3% THD. Has features as above PLUS separate tuning meters (signal-strength AM/FM, center-channel FM), a Dolby FM switch for 25  $\mu$ S and 75  $\mu$ S de-emphases on Dolby FM broadcasts. Complete filtering, main/remote speaker switching, tape/source monitoring for two tape recorders. IHF FM Sensitivity: 1.9  $\mu$ V. 16 $\frac{1}{2}$ " x 5 x 14". For 117 VAC, 60 Hz. Imported.  
21 F 50472W Shpg. wt. 44 lbs. . . . . Net 499.95



## 3 Model 2275 Stereo FM-AM Receiver

Power and features galore with a full 75 watts RMS per channel into 8 ohms from 20-20,000 Hz, 0.25% THD. Has a special tone mode switch for selectable frequency turnover points, multi-path and hi-blend pushbuttons to clear up weak-station FM reception, renew old and scratchy records, Dolby switch and Phase-Lock-Loop FM decoder. IHF FM Sensitivity: 1.9  $\mu$ V. 16 $\frac{1}{2}$ " x 5 x 14". For 117 VAC, 60 Hz.  
21 F 50456W Imported. Shpg. wt. 46 lbs. . . . . Net 649.95



## 4 Model 2325 Stereo FM-AM Receiver

Marantz's finest stereo receiver—125 watts RMS per channel into 8 ohms from 20-20,000 Hz, amazing 0.15% THD! Incorporates all the features of the models above PLUS Dolby "Dynamic Noise Filtering" for FM broadcasts and direct tape recording, full tape monitor circuitry for two tape recorders, mode switch for stereo, right, left, reverse and mono. One of the best stereo receivers you can buy! IHF FM Sensitivity: 1.8  $\mu$ V. 19 $\frac{1}{4}$ " x 5 $\frac{3}{4}$  x 18". For 117 VAC, 60 Hz.  
21 F 50464W Imported. Shpg. wt. 65 lbs. . . . . Net 799.95



## 5 Model 3800 Stereo Preamplifier with Dolby\*

Complete sound control center offering these famous Marantz features: ultra-low distortion of less than .01%, wide dynamic range of over 110 dB; flat frequency response of 20-20,000 Hz  $\pm$  .25 dB! Has every input and control including graphic slide-tone controls, selectable frequency turnover points, tape monitor circuitry for two tape recorders, Dolby\* dynamic noise filtering for tape and FM. 15 $\frac{3}{4}$ " x 8 $\frac{3}{4}$ " x 5". For 117 VAC, 60 Hz. Imported.  
21 F 50407WXY Shpg. wt. 20 lbs. . . . . Net 649.95

### "Perfectionist Designed" Components

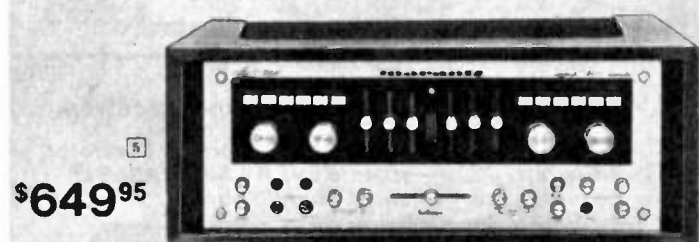

\*Dolby is a Trademark of Dolby Labs, Inc.

## 6 Model 400M Stereo Amplifier

Basic power amplifier offering 200 watts RMS per channel into 8 ohms from 20-20,000 Hz with 0.1% THD. Has 3 $\frac{1}{2}$ " output level meters, front panel overload indicators, left-right gain controls, complete electronic circuit protection. Hum and Noise: 110 dB below rated output! 14 $\frac{1}{2}$ " x 8 $\frac{7}{8}$ " x 5". For 117 VAC, 60 Hz.  
21 F 50431WXY Imported. Shpg. wt. 38 lbs. . . . . Net 699.95  
21 F 50415WXY Model 400. Above, without meters. Imp. . . . . Net 599.95



## 7 Model 120B Stereo FM-AM Tuner

Ultra-sensitive and selective tuner with a built-in oscilloscope for complete 2- and 4-channel signal display, Phase-Lock-Loop circuit for the widest separation and minimum distortion, direct Gyro-touch tuning. Has "Quadradial" output jack for future discrete 4-channel FM broadcasts. IHF FM Sensitivity, 1.8  $\mu$ V. Selectivity, 75 dB. 15 $\frac{3}{4}$ " x 5 $\frac{3}{4}$ " x 13". For 117 VAC, 60 Hz.  
21 F 50423WXY. Imported. Shpg. wt. 30 $\frac{1}{2}$  lbs. . . . . Net 549.95



### Walnut Wood Cases for Marantz Units

- 21 F 50258W For 2220B, 2240, 2275, 4230, 4270. 8 lbs. . . . . Net 29.95
  - 21 F 50480W For 4220. Shpg. wt. 10 lbs. . . . . Net 24.95
  - 21 F 50498WXY For 3800. Shpg. wt. 8 lbs. . . . . Net 32.50
  - 21 F 50506W For 2325, 4400. Shpg. wt. 8 lbs. . . . . Net 39.95
  - 21 F 50514WXY For 400, 400M. Shpg. wt. 8 lbs. . . . . Net 32.50
- Charge It with Your BankAmericard or Master Charge.

# Marantz and Pioneer Discrete 4-Channel Receivers

## marantz 4-Channel Receivers

Famous Marantz Quality  
Now in the Latest 4-Channel Receivers!

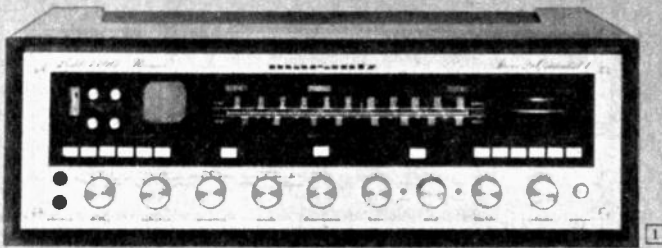

\$1250



\$299.95



\$499.95

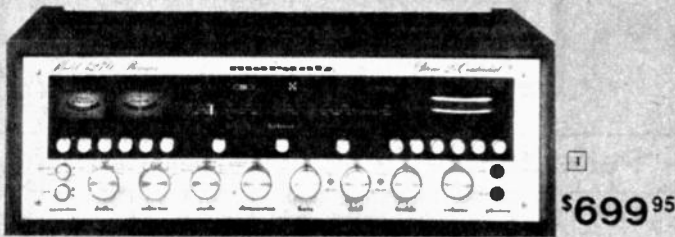

\$699.95

## PIONEER 4-Channel Receivers

Both Include Built-in CD-4 Demodulators for Discrete  
4-Channel Discs—Handle EVERY AVAILABLE  
2- and 4-Channel Sound Source

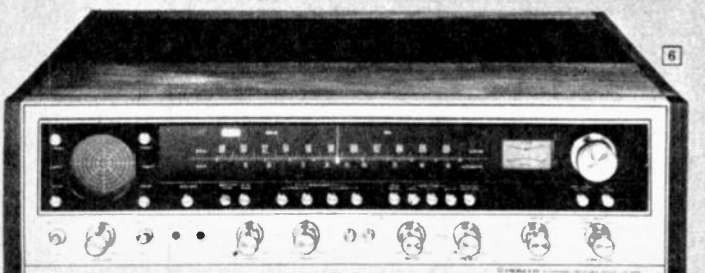
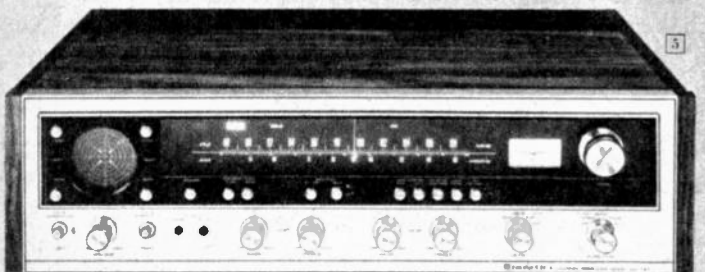

### 1 Model 4400—Marantz's Finest 4-Channel Receiver

One of the best receivers available today—Stereo 2, Quadradial 4 with built-in full process Dolby\* system, PLL FM circuit, oscilloscope tuning display, inputs and outputs for everything, including 4-channel tape recording. 50 watts RMS per channel (four channels driven) into 8 ohms from 20-20,000 Hz. (125 x 2 in the stereo model!) .015% THD. IHF FM Sensitivity: 1.8  $\mu$ V. 19 $\frac{1}{4}$  x 5 $\frac{3}{4}$  x 18". For 117 VAC, 60 Hz. 21 F 50530WXY Imported. Shpg. wt. 70 lbs. . . . . Net 1250.00

### 2 Model 4220 4-Channel FM/AM Receiver

Stereo 2—Quadradial 4 receiver with 8 watts per channel RMS (four channels driven) into 8 ohms from 20-20,000 Hz, 0.9% THD; controls, inputs and outputs for a very sophisticated stereo or 4-channel setup. IHF FM sensitivity, 2.8  $\mu$ V. 14 $\frac{1}{4}$  x 4 $\frac{3}{4}$  x 11 $\frac{1}{2}$ ". For 117 VAC, 60 Hz. 21 F 50399WX Imported. Shpg. wt. 26 $\frac{1}{2}$  lbs. . . . . Net 299.95

### 3 Model 4230 4-Channel FM-AM Receiver

Medium-power 4-channel receiver offering 12 watts RMS per channel (4 channels driven) into 8 ohms from 20-20,000 Hz, 0.5% THD. Has Dolby\* filtering, direct flywheel tuning, dual tuning meters, complete controls with two-tape monitoring. IHF FM sensitivity: 2.8  $\mu$ V. 16 $\frac{3}{8}$  x 5 x 14". For 117 VAC, 60 Hz. 21 F 50381WX Imported. Shpg. wt. 40 lbs. . . . . Net 499.95

### 4 Model 4270 4-Channel FM-AM Receiver

Deluxe 4-channel receiver with 25 watts RMS per channel (4 channels driven) into 8 ohms from 20-20,000 Hz, 0.5% THD. Features Dolby\* filtering, main and remote 4-channel speaker outputs, Quadradial output for discrete FM when it's ready. 1.9  $\mu$ V IHF FM sensitivity. 16 $\frac{3}{8}$  x 5 x 14". For 117 VAC, 60 Hz. 21 F 50522WXY Imported. Shpg. wt. 49 lbs. . . . . Net 699.95

\*Dolby is a Trademark of Dolby Laboratories, Inc.

### Plug-in SQ Logic Decoders for Above Receivers

Model SQA-1. Enhances front-to-rear SQ separation.

21 F 50282 Shpg. wt. 2 lbs. Imported. . . . . Net 49.95

Model SQA-2. Full-logic decoder enhances front-to-rear and left-to-right separation in SQ encoded materials.

21 F 50548Y Shpg. wt. 2 lbs. Imported. . . . . Net 79.95

### 5 Model QX-747 4-Channel FM-AM Receiver

Total-capability 4-channel receiver reproduces all sound sources without the need for extra accessories or adapters. Provides 20 watts RMS per channel (4 channels driven) into 8 ohms from 20-20,000 Hz, less than 0.5% THD. Has separate front and rear bass, treble tone controls, four-channel circular indicator that lets you view all four-channel level adjustments, "Power Boost" circuit that doubles RMS power when used in the stereo mode. Inputs and outputs for 2- or 4-channel tape recorders, signal-strength and center-channel FM tuning meters, program and mode indicator lights. FM tuner section has MOS FET's and 4-gang variable capacitor for outstanding sensitivity of 1.9  $\mu$ V IHF. Special MPX IC provides better than 30 dB separation from 50-10,000 Hz. 21 $\frac{1}{2}$  x 6 $\frac{1}{6}$  x 16 $\frac{1}{2}$ ". For 117 VAC, 50-60 Hz. 21 F 31092WX Imported. Shpg. wt. 42 lbs. . . . . Net 649.95

### 6 Model QX-949 4-Channel FM-AM Receiver

Pioneer's most distinguished contribution to the new 4-channel sound. The QX-949 features total capability with built-in CD-4 demodulator and matrix circuitry for matrix and SQ decoding, inputs for 2 phonos, 2 tape recorders with monitoring and dubbing capabilities, separate center-channel FM and signal-strength FM-AM tuning meters. Has a front-panel 4-channel indicator which shows each channel's output, program and mode lights, pushbuttons for power, loudness, high and low filters, etc. "Power Boost" circuit provides extra power in stereo mode. 40 watts RMS per channel (4 channels driven) into 8 ohms from 20-20,000 Hz, less than 0.3% THD. IHF FM sensitivity, 1.8  $\mu$ V. 21 $\frac{3}{8}$  x 6 $\frac{1}{6}$  x 17 $\frac{1}{2}$ ". For 117 VAC, 50-60 Hz. 21 F 31100WX Imported. Shpg. wt. 51 lbs. . . . . Net 749.95

# CHOOSE Name-Brand Receivers at Lafayette



## KENWOOD Stereo FM-AM Receivers

**1 Model 7400.** 63 watts RMS per channel from 20-20,000 Hz at 8 ohms, 0.3% THD. Meets the critical objectives of the demanding audiophile! Two tuning meters, 3-stereo speaker capability, complete electronic circuit and speaker protection. Has inputs for two phonos, two tape recorders with monitor and dubbing facilities, *bass, mid-range and treble* tone controls. Slide-rule FM-AM tuning dial with linear scale, stereo indicator light. Phase Lock Loop multiplex decoder uses a multi-function IC to achieve exceptional FM stereo separation with minimum distortion—provides the almost theoretical limit of 1.7  $\mu$ V FM sensitivity; better than 30 dB stereo separation at all frequencies. 19 x 6 x 13 $\frac{1}{2}$ ". For 117 VAC, 50-60 Hz.  
21 F 15533WX Imported. Shpg. wt. 31 lbs. . . . . Net 519.95

**2 Model 6400.** 45 watts RMS per channel into 8 ohms from 20-20,000 Hz, 0.3% THD. Features same as above except bass and treble tone controls only, somewhat lower power. 4-channel ready circuit permits addition of any 4-channel decoder/amplifier, FM DET output for future discrete 4-channel FM broadcasts. 1.9  $\mu$ V FM IHF sensitivity. 18 $\frac{1}{2}$  x 5 $\frac{1}{2}$  x 13 $\frac{1}{2}$ ". For 117 VAC, 50-60 Hz.  
21 F 15525WX Imported. Shpg. wt. 30 lbs. . . . . Net 449.95

**3 Model 5400.** 35 watts RMS per channel into 8 ohms from 20-20,000 Hz, 0.5% THD. Kenwood quality at an excellent price! Features as above, except lower power, 1.9  $\mu$ V IHF FM sensitivity, single signal-strength tuning meter. Dual tape monitor facilities, 4-channel ready circuit. 18 $\frac{1}{2}$  x 5 $\frac{1}{2}$  x 13 $\frac{1}{2}$ ". For 117 VAC, 50-60 Hz.  
21 F 15517WX Imported. Shpg. wt. 25 $\frac{1}{2}$  lbs. . . . . Net 379.95

## SHERWOOD Stereo + 4-Channel FM-AM Receivers



**Model S-7310 Stereo/Dynaquad.** 38 watts RMS per channel into 8 ohms from 20-20,000 Hz, 0.5% THD. Has complete inputs and controls, combination signal-strength AM and center-channel FM tuning meter, Dynaquad matr x circuit, all filters and controls including tape dubbing facilities. Has slide-rule tuning with stereo light, mode/speaker pushbuttons, more. 1.7  $\mu$ V IHF sensitivity. 17 $\frac{1}{2}$  x 5 $\frac{1}{4}$  x 13 $\frac{1}{4}$ ". For 117 VAC, 50-60 Hz.  
21 F 61677WX Shpg. wt. 35 $\frac{1}{2}$  lbs. Net 369.95

**Model S-7900A Stereo/Dynaquad.** 60 watts RMS per channel into 8 ohms from 20-20,000 Hz, 0.3% THD. Features direct-coupled output circuit with electronic protection, Dynaquad matr x circuit, all filters and controls including tape dubbing facilities. Has slide-rule tuning with stereo light, mode/speaker pushbuttons, more. 1.7  $\mu$ V IHF sensitivity. 16 $\frac{1}{4}$  x 5 $\frac{1}{4}$  x 14". For 117 VAC, 60 Hz.  
21 F 61214WX Shpg. wt. 30 lbs. . Net 479.95

**Model S-7244 Stereoquad.** 20 watts RMS per channel (all 4 channels driven) into 8 ohms from 20-20,000 Hz, 0.6% THD. FULL-LOGIC SQ decoding, tape dubbing inputs and outputs, power-bridged amplifier circuit that more than doubles power in the stereo (2-channel) mode. 1.9  $\mu$ V IHF FM sensitivity, complete balance controls, 4-channel headphone jacks, more. 18 $\frac{1}{4}$  x 5 $\frac{1}{4}$  x 15 $\frac{1}{4}$ ". For 117 VAC, 50-60 Hz.  
21 F 61665WX Shpg. wt. 40 lbs. . . Net 499.95

## FISHER 4-Channel Receivers

*Famous "Studio Standard" Models Handle Every Available 4-Channel Sound Source Including CD-4 Discs*

**1 Model 534.** 22 watts RMS per channel (4 channels driven) into 8 ohms from 20-20,000 Hz, 0.5% distortion. "Joystick" balance control, FULL LOGIC SQ circuit plus special Fisher "Phase Logic", strapping circuit for full power in stereo mode. Complete controls and inputs. Two tuning meters with stereo beacon, pushbutton mode selectors, main/remote 4-channel speaker provision. Front panel tape recording and headphone outputs. 7 $\frac{1}{4}$  x 23 $\frac{1}{2}$  x 15 $\frac{1}{2}$ ". 117VAC, 50-60 Hz.  
21 F 33791W Shpg. wt. 42 lbs. . . Net 699.95

**2 Model 634.** Fisher's Finest receiver! 35 watts RMS per channel (4 channels driven) into 8 ohms from 20-20,000 Hz. 1.8  $\mu$ V FM IHF sensitivity. Features same as 534 at left PLUS output VU level meters for each channel, concentric bass, midrange and treble tone controls. Pushbutton mode and program selectors, speaker selector for main or remote 2 or 4-channel speakers, lighted program indicators, "Joystick" balance. 7 $\frac{1}{4}$  x 23 $\frac{1}{2}$  x 15 $\frac{1}{2}$ ". 117VAC, 50-60 Hz.  
21 F 33809W Shpg. wt. 45 lbs. . . . Net 799.95

# NEW! Stereo FM-AM Receivers from JVC

## VR-5505—JVC's Lowest-Priced Receiver

- 10 Watts Per Channel RMS into 8 Ohms from 40-20,000 Hz: 1% THD
- Speaker Selector Switch and Indicator Lights for Phones, Main, Remote, Main Plus Remote

A lot of receiver for the money with a signal-strength tuning meter, tape inputs and outputs including monitor, bass, treble, volume and balance controls, loudness and mode switches, separate power on-off switch. Special Indicators show program and speakers being played. 2.2  $\mu$ V IHF FM sensitivity. 18 $\frac{1}{4}$  x 5 $\frac{3}{4}$  x 13". For 117 VAC, 60 Hz. 21 F 22075W Imported. Shpg. wt. 22 lbs. . . . . Net 199.95



\$199<sup>95</sup>

## 1 VR-5515, Advanced Tone Controls, Mixing

- 15 Watts RMS Per Channel into 8 Ohms from 20-20,000 Hz: 0.8% THD

Full-feature receiver with click-stop tone controls for precise settings, separate volume control and mike jack for professional mike mixing, direct-coupled amplifier for clean power. Full inputs, outputs and controls. 2.2  $\mu$ V IHF FM sensitivity. 17 $\frac{3}{4}$  x 6 $\frac{1}{8}$  x 12 $\frac{3}{4}$ ". For 117 VAC, 50-60 Hz. Imported.

\$299<sup>95</sup>

21 F 22067W Shpg. wt. 24 lbs. . . . . Net 299.95

## 2 VR-5525 with S.E.A. and Mike Mixing

- 18 Watts RMS Per Channel into 8 Ohms from 20-20,000 Hz: 0.8% THD

The famous S.E.A. tone control system provides exact control over five separate portions of the frequency spectrum, the signal-strength AND center-channel tuning meters provide "right on" AM/FM and stereo FM tuning. Other features as above. 18 $\frac{5}{8}$  x 6 $\frac{1}{8}$  x 12 $\frac{3}{4}$ ". Imported.

\$369<sup>95</sup>

21 F 22059W Shpg. wt. 27 lbs. . . . . Net 369.95

## 3 VR-5535—JVC's Best, S.E.A. Recording, Too

- 28 Watts RMS Per Channel into 8 Ohms from 20-20,000 Hz: 0.8% THD

Has all features as above, PLUS S.E.A. provision for recording, dubbing and microphone mixing—provides complete tonal control over any sound source. Also high and low filters, FM mute, two aux. inputs, more. 2.0  $\mu$ V IHF FM sensitivity. 18 $\frac{5}{8}$  x 6 $\frac{1}{8}$  x 12 $\frac{3}{4}$ ". Imported.

\$429<sup>95</sup>

21 F 22042W Shpg. wt. 30 lbs. . . . . Net 429.95



## "Master Your Music" with BSR Sound Equalizers

4 Model SLM-1 Sound Level Meter. Measure sound levels and adjust tone controls for "flat" tonal response from your hi-fi system. Also can be used to detect potentially dangerous sound levels in night clubs, discos, etc. Has easy-to-read level meter, coupled to a sensitive built-in mike. In-

cludes a precise test record so that you can tailor the sound response of your listening area. Use in conjunction with frequency controllers below for complete professional control over all sound sources. 16 x 16 x 4". With test record and battery.

21 F 52106 Imported. Wt. 3 lb. . . . . Net 59.95

5 FEW-2 10-Control Frequency Equalizer. Operates in five separate frequency ranges with separate controls for each stereo channel. Adjust the loudness of each frequency range up or down. Highlight soloists, etc., make professional-sound recordings. Distortion less than .007%, noise level, -80 dB. Ideal with SLM-1 sound meter above. 11 $\frac{1}{4}$  x 4 $\frac{1}{2}$  x 7". For 117 VAC, 60 Hz. 21 F 52080W Wt. 5 lbs. . . . . Net 99.95

6 FEW-3 24-Control Frequency Equalizer. Turns your home hi-fi system into a "studio style" control center with 24 individual controls covering 12 full octaves—achieve totally "flat" response, "engineer" records or tape recordings the way YOU want to hear them. Has two VU meters for use with SLM-1 above, other specs as FEW-2 at left. 18 x 5 $\frac{1}{2}$  x 7 $\frac{3}{4}$ ". For 117 VAC, 60 Hz. 21 F 52098W Shpg. wt. 9 lbs. . . . . Net 199.95

BSR

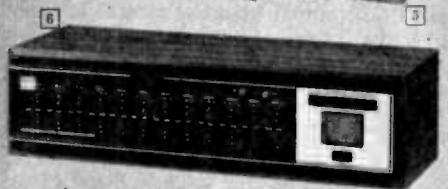



# Solid-State Dynaco Components—Kit or Wired



Kit **\$185**

More-For-Your-Money Sound. Superb Quality—Save Even More When You Build-'Em Yourself

**NEW!**  
Wired  
**\$599**

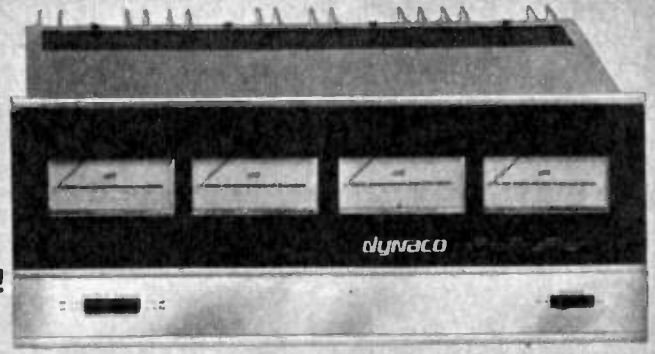

## QSA-300M Stereo-Quadraphonic Amplifier

A truly powerful basic amplifier offering a full 75 watts RMS per channel (4 channels driven!) into 8 ohms from 20-20,000 Hz at less than 0.25% distortion! Can be matched with any good preamplifier, has on-off power switch and four lighted output meters to perfectly monitor each of 4 channels. Internal strapping provides 150 watts RMS in stereo mode. Has heat sink and electronic circuit protection. 18 x 14 x 7". 117-240 VAC, 50-60 Hz. 21 F 23396WXY Factory Wired and Tested. Shpg. wt. 49 lbs. . . . .Net 599.00  
21 F 23404WXY QSA-300 Kit Form. Above, less meters . . . . .Net 399.00  
21 F 23388Y MC-3 Meter Kit. For QSA-300 Kit. Shpg. wt. 10 lbs. . . . .Net 125.00

## SCA-80Q Integrated Stereo Amplifier Kit with Built-in Quadaptor™ for Derived 4-Channel

Versatile kit offers famous Dynaco quality, complete inputs, outputs and controls, built-in Quadaptor that derives 4-dimensional sound from all stereo records, FM broadcasts or tapes. 40 watts RMS per channel into 8 ohms from 20-20,000 Hz, 0.5% distortion. Has tape monitor switch, speaker selector, volume, balance and tone controls, high and low filters. 13½ x 4¼ x 10". For 117-240 VAC, 50-60 Hz.  
21 F 23321W Easy-to-Build Kit Form. Shpg. wt. 17 lbs. . . . .Net 185.00  
21 F 23313W Factory Wired and Tested. Shpg. wt. 17 lbs. . . . .Net 299.00

## 1 Famous PAT-4 Stereo Preamplifier

Offers complete control facilities of any stereo source—for use with Dynaco, any good power amplifiers. Has special Dyna-Tone control circuit for absolutely flat response; volume, tone and balance controls, complete filtering; tuner, phono and tape inputs. Response: 10-100,000 Hz ± 0.5 dB; less than 0.05% harmonic distortion between 20-20,000 Hz at 2 volts output. For 117-240 VAC, 50-60 Hz. 13½ x 4¼ x 8".  
21 F 23255W Kit Form. Wt. 9 lbs. . . . .Net 119.00  
**PAT-4 Factory Wired and Tested.**  
21 F 23263W Shpg. wt. 9 lbs. . . . .Net 199.00



1 **\$119** Kit



**NEW**  
2 **\$179** Kit

## 2 Dynaco PAT-5 Stereo Preamp Kit

The **NEW STANDARD** of preamplifiers—one of the finest available AT ANY PRICE! Has total input versatility with 2 mag. phono, 2 tape with dubbing and monitoring, tuner, Aux., special E.P.L. Input for external equalizer or frequency controller. Volume and balance, dual bass and treble controls, speaker selector, paired stereo-mono switches, more. Response: hi-level inputs ± 1 dB, 10-50,000 Hz; low level inputs ± 1 dB, 30-15,000 Hz (RIAA equal.). THD and IM distortion, less than 0.05% from 20-20,000 Hz. 13½ x 4¼ x 11¾". 117-240 VAC, 50-60 Hz.  
21 F 23420W Kit Form. Wt. 13 lbs. . . . .Net 179.00  
**PAT-5 Factory Wired and Tested.**  
21 F 23412W Shpg. wt. 13 lbs. . . . .Net 289.00



3 **\$175** Kit

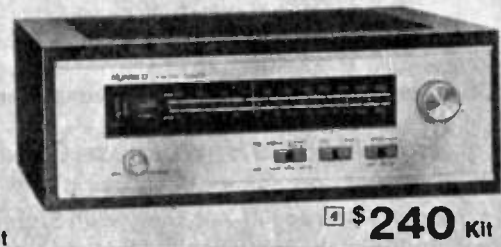

4 **\$240** Kit

## 3 FM-5 Stereo FM Tuner Kit

Quality stereo tuner with an amazing 1.75 μV IHF FM sensitivity. Has DYNATUNE circuit for precise center-channel FM tracking, amplifier-driven signal-strength meter to indicate precise antenna orientation on both weak and strong signals. Automatic stereo-mono switching, more. Capture ratio, 1:5 dB, selectivity, 65 dB. 13½ x 4¼ x 9". For 117-240 VAC, 50-60 Hz.  
21 F 23560WX Kit Form. Wt. 12 lbs. Net 175.00  
**FM-5 Factory Wired and Tested.**  
21 F 23578W Shpg. wt. 12 lbs. . . . .Net 279.00

## 4 AF-6 Stereo AM-FM Tuner Kit

Has the features of the FM-5 PLUS a special wideband AM tuning section with a precisely engineered RF and mixer section for AM that rivals FM quality. AM sensitivity, 50 μV. 13½ x 4¼ x 10½". For 117-240 VAC, 50-60 Hz.  
21 F 23602WY Kit Form. Wt. 13 lbs. . . . .Net 240.00  
**AF-6 Factory Wired and Tested.**  
21 F 23610W Shpg. wt. 13 lbs. . . . .Net 350.00

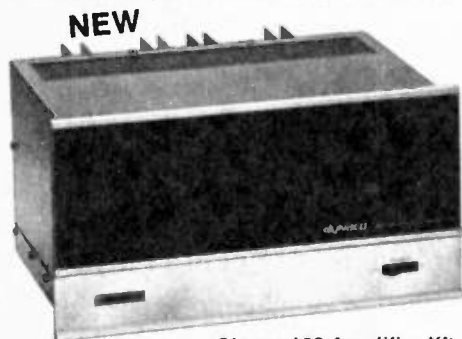

## Stereo 150 Amplifier Kit

Basic stereo amplifier for sophisticated medium power systems—delivers 75 watts RMS per channel into 8 ohms from 20-20,000 Hz at less than 0.25% distortion. Use with Dynaco or any other good preamplifiers as the "power" behind a great-sounding music system. 13½ x 7 x 13". For 117-240 VAC, 50-60 Hz.  
21 F 23370W Kit Form. Shpg. wt. 28 lbs. . . . .Net 225.00  
**Stereo 150 Factory Wired and Tested.**  
21 F 23362W Shpg. wt. 28 lbs. . . . .Net 325.00

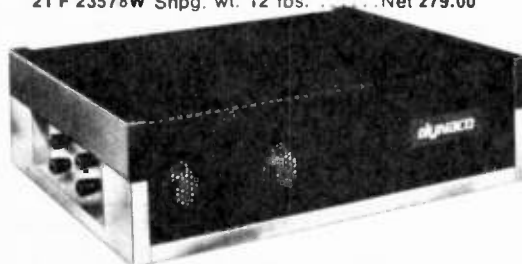

## Stereo 120 Amplifier Kit

Dynaco favorite! Offers pure sound and enough power for most music systems. Solid-state. 60 watts RMS per channel into 8 ohms from 20-20,000 Hz with less than 0.5% distortion. NO interstage or output transformers, complete fuse protection, more. 13 x 4 x 10½". For 117-240 VAC, 50-60 Hz. Shpg. wt. 19 lbs.  
21 F 23230W Kit Form . . . . .Net 179.00  
**Stereo 120 Factory Wired and Tested.**  
21 F 23248W Shpg. wt. 19 lbs. . . . .Net 249.00



## Stereo 400 Amplifier Kit

Features deluxe Dyna-Guard circuit for complete electronic protection, adjustable input levels, more. 200 watts RMS per channel into 8 ohms from 20-20,000 Hz, 0.25% distortion. Freq. response, 10-50,000 Hz + 0, - 1 dB. Noise level is an amazing 106 dB below 200W! 16 x 7 x 12½". 117 VAC, 60 Hz.  
21 F 23628XY Kit Form. Shpg. wt. 48 lbs. . . . .Net 449.00  
**Stereo 400 Factory Wired and Tested.**  
21 F 23636XY Shpg. wt. 48 lbs. . . . .Net 599.00  
**MC-4 Output Level Meter Kit for Above.**  
21 F 23354Y Shpg. wt. 7 lbs. . . . .Net 75.00

Charge It with Your BankAmericard or Master Charge.

# Lafayette Record and Play Stereo Music Centers



1 CASSETTE

Your Choice  
**\$199<sup>95</sup>**

2 8-TRACK

Both include 8-Ft. Speaker  
 Hookup Cables, FM Dipole Antenna

1 **Lafayette SR-50 Stereo FM-AM Music Center with Built-in Stereo CASSETTE Record and Play Deck**

Sophisticated engineering and the latest solid-state circuitry make this an ideal choice for the listener who wants to record his own favorite music on cassettes. Has pushbutton cassette function controls, pop-up cassette-eject mechanism, easy loading, 3-digit tape counter with reset button, other features at left. Receiver/Recorder Section: 18x4½x10", Speakers: 14¾x9¾x5½". For 117 VAC, 60 Hz. 99 F 99699WM Imported. Shpg. wt. 27 lbs. . . . . Net 199.95

2 **Lafayette SR-80 Stereo FM-AM Music Center with Built-in 8-TRACK Stereo Record and Play Deck**

Has all the fine features at left, 8-track recorder with hinged door to protect cartridges, program lights, automatic stop button, automatic and manual program selection. Fine choice for the person who wants to build an 8-track cartridge music library for home or car tape play. Size as above. For 117 VAC, 60 Hz. 99 F 99707 WM Imported. Shpg. wt. 27 lbs. . . . . Net 199.95  
 Deluxe Recording Microphone. Use with SR-50 or SR-80. 99 F 45882 Imported. Shpg. wt. 1 lb. . . . . Net ea. 19.95

**Both Models Have These Great Features:**

- Sensitive Stereo FM-AM Tuner with Stereo Indicator Light
- Walnut-Finish, Acoustically-Matched Speaker Systems, Each with a 6½" Speaker and Multicellular Diffuser for Extra-Wide Dispersion and High-Frequency Sound
- Individual Record-Level Controls and Meters for Each Stereo Channel — Make Well-Balanced Recordings
- Front Panel Microphone Inputs for Easy "Live" Recordings
- Good-Looking Wood Cabinetry with Walnut-Vinyl Finish
- "Blackout" Tuning Dial with "Soft-Blue" Markings
- Front Panel Stereo Headphone Jack for Private Listening
- Input for Ceramic or Crystal Cartridge Phono and Aux.



**\$34<sup>95</sup>**

**Make the Music Systems on These Pages EVEN MORE COMPLETE—Add This Compact Record Player**

**Lafayette MC-22B "Mini" 4-Speed Record Changer—Includes Base, Dust Cover, Ceramic Stereo Cartridge**

Just plug it into ANY music system on these two pages and you're ready for quality record play. Plays 16, 33½, 45 and 78 rpm—even intermixes 10" x 12" records of the same speed. Has precise 2-pole motor, balanced platter, lightweight tonearm, ceramic stereo cartridge with long-life diamond needle. Plays up to six records in a

stack for "continuous" music and can be used manually, too. *Automatically shuts off after last record in a stack has played.* Only 14¾ x 5 x 10", great for compact shelf mounting just about anywhere. For 117 VAC, 60 Hz. Made in England.

21 F 01772W Shpg. wt. 10 lbs. . . Net 34.95

# Lafayette Compact Stereo Music Systems

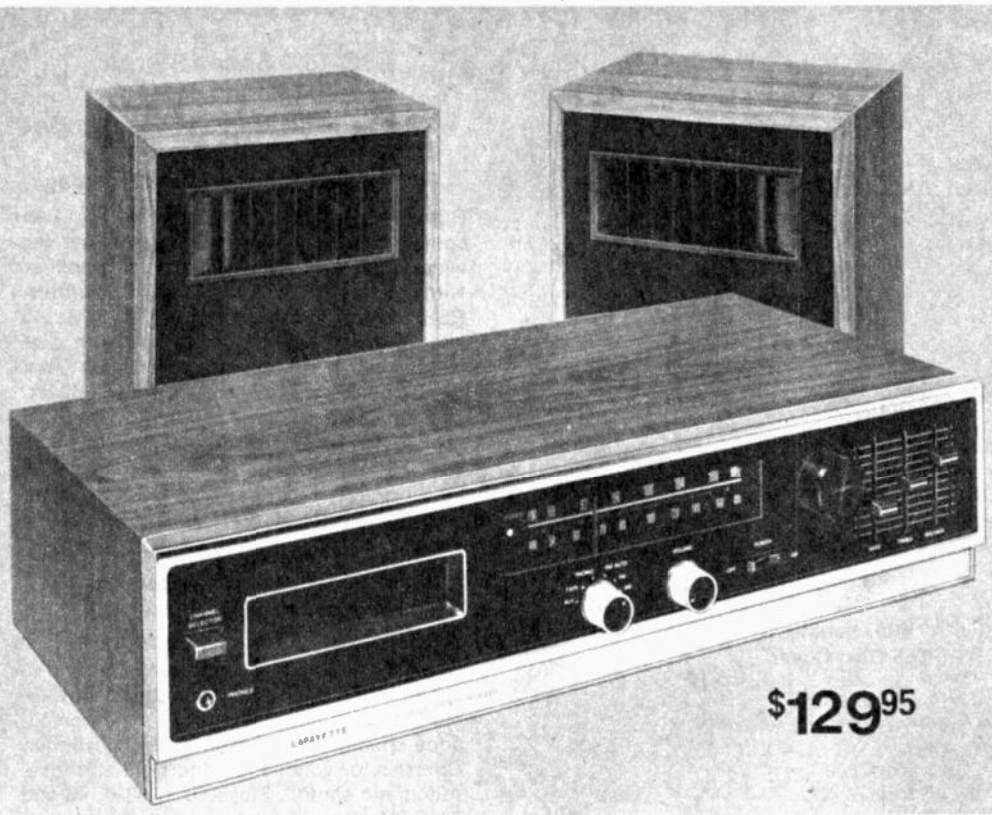

## Lafayette SR-30A Stereo FM-AM 8-Track Playback Music System

*With Two Wide-Range  
Speaker Systems, Each  
with a Multicellular  
Diffuser for  
Excellent Sound*

Compact "modular" system is great for den, rec room, bedroom, etc.—provides good fidelity from stereo FM, mono FM and AM radio broadcasts, PLUS pre-recorded 8-track stereo cartridges. If you already have an 8-track car stereo tape player, it's a great way to make those tapes do "double duty." Has slide-rule tuning dial with stereo light, modern slide-type volume and balance controls, inputs for ceramic cartridge record changer and a second tape player, output jacks for direct tape recording. Tape player has push-button program change, individual program lights, hinged cartridge door. Built-in AM and FM antennas, provision for external FM antenna. Receiver, 18 $\frac{3}{8}$  x 4 $\frac{7}{8}$  x 9 $\frac{1}{4}$ ", speakers, 9 $\frac{7}{8}$  x 14 $\frac{3}{16}$  x 9 $\frac{7}{16}$ ". For 117 VAC, 60 Hz. 99 F 99681WM Imp. Wt. 32 lbs. . . Net 129.95

## Lafayette SQR-20 4-Channel SQ AM/FM Modular Music System

- Four Separate Solid-State Amplifiers
  - 4-Channel SQ Matrix Decoder
  - "Composer" Circuit for 4-Dimensional Sound from 2-Channel (Stereo) Sources
- \$149.95**  
With 4 Speakers

Plays discrete 4-channel from a separate tape recorder or 8-track cartridge player; 4-channel SQ from encoded records, tapes and FM broadcasts (now in wide distribution), even has a "Composer" circuit that "updates" your present stereo records and tapes to exciting 4-dimensional sound! Has slide volume and front-rear balance controls, inputs for magnetic or ceramic phono (no special changer needed for SQ 4-channel records!), stereo FM indicator light. Built-in AM and FM antennas, 4-channel aux. inputs and stereo tape recording outputs. With 4 wide-range 6 $\frac{1}{2}$ " speakers in walnut-vinyl-finish enclosures, speaker hookup wire. Size: Receiver, 16 $\frac{1}{2}$  x 4 $\frac{1}{2}$  x 10 $\frac{1}{8}$ ". Speakers, 8 $\frac{1}{2}$  x 14 $\frac{1}{2}$  x 5 $\frac{1}{2}$ ". For 117 VAC, 60 Hz.

99 F 02867W Shpg. wt. 37 $\frac{1}{2}$  lbs. . . . . Net 149.95

Model SQR-40. Above, with built-in 2/4-channel 8-track cartridge player. Receiver size: 21 $\frac{1}{2}$  x 4 $\frac{5}{8}$  x 11 $\frac{1}{8}$ ".

99 F 02875W Imported. Shpg. wt. 44 lbs. . . . . Net 189.95

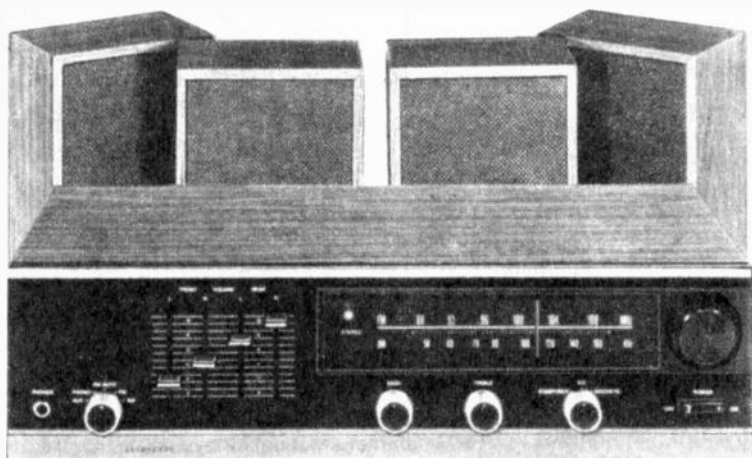

## Lafayette RK-44 8-Track Stereo Cartridge Playback System with Two 5" Speakers

- High-Compliance Speakers for Great Sound
  - Slide Controls for Volume, Tone and Balance
  - "Private Listening" Front Panel Headphone Jack
  - All Three Pieces Have Good-Looking Walnut Finish
- \$79.95**

Nicely-styled, complete 8-track stereo cartridge player that provides excellent sound from all pre-recorded 8-track stereo cartridges. An excellent, inexpensive way for those who own an 8-track car stereo tape player to get more out of their cartridge collection—play your favorite car tapes at home, too. Has a record output jack to transfer the sound on cartridges to cassette or reel-to-reel tapes, input for a ceramic phono, front panel stereo headphone jack. Individual program indicator lights and manual program change button let you select only those portions of a cartridge you wish to hear. The walnut-finish speakers and player section make it a nice addition to almost any decor—great for use in den, rec room, etc. Size: Playback unit, 10 $\frac{3}{4}$  x 4 $\frac{3}{4}$  x 8"; Speakers, 7 $\frac{3}{8}$  x 9 $\frac{3}{4}$  x 4 $\frac{1}{4}$ ". For 117 VAC, 60 Hz. 99 F 16172W Imported. Shpg. wt. 16 lbs. . . . . Net 79.95



# Superbly Styled Phono Compacts From Lafayette



## LSC-15 4-Speed Stereo Manual Phono System

- 2 Acoustically Matched Speakers in Ebony Molded Cabinets
- Front Panel Stereo Headphone Jack

High-impact polystyrene cabinetry. Two speaker systems each with 4" speaker for wide-range hi-fi sound. Solid-state amplifier with separate left and right volume controls. BSR record changer plays 16 $\frac{2}{3}$ , 33 $\frac{1}{3}$ , 45 and 78 RPM. Ceramic cartridge with diamond needle. Size: Control unit, 18x10 $\frac{3}{4}$ x5 $\frac{3}{4}$ ". Speakers, 7x4 $\frac{1}{4}$ x12". 117 VAC, 60 Hz.  
 24 F 03681HW Shpg. wt. 10 lbs. ... Net 34.95  
 24 F 05660 Extra Needle ..... Net 3.99  
 24 F 02568 45-RPM Spindle .... Net 1.49



## LSC-35 Stereo Hi-Fi Automatic Phono System

- Matched Cylindrical Speakers
- Stereo Headphone Jack
- BSR 4-Speed Record Changer

Contains solid-state stereo amplifier and 4-speed automatic record changer with Bubble-top dust cover. Each 4" high-compliance speaker in handsome ebony cylinder. Controls for volume left and right and tone. Automatic shutoff. Plays 16 $\frac{2}{3}$ , 33 $\frac{1}{3}$ , 45 and 78 RPM. Ceramic turnover cartridge with diamond needle. Control Unit: 18 x 10 $\frac{3}{4}$  x 5 $\frac{3}{4}$ ". Each speaker: 7 $\frac{1}{2}$  x 11". For 117 VAC, 60 Hz. Shpg. wt. 14 lbs.  
 24 F 03673HW ..... Net 54.95  
 24 F 05090 Extra Needle ..... Net 3.99  
 24 F 02568 45 RPM Spindle .... Net 1.49



## LSC-75 Stereo FM-AM Automatic Phono System

- BSR 4-Speed Record Changer
- Front Panel Stereo Headphone Jack
- Stereo FM Indicator Light

Four-piece system mounted on decorator-styled ebony base with 2 separate 4" high-compliance speakers. Slide-rule tuning dial, controls for volume left and right, dual bass/treble, built-in AM and FM antennas. Plays 16 $\frac{2}{3}$ , 33 $\frac{1}{3}$ , 45 and 78 RPM. Low-mass pick-up arm. Diamond LP stylus ceramic cartridge. Control unit: 18 x 10 $\frac{3}{4}$  x 5 $\frac{3}{4}$ ". Each speaker: 7 $\frac{1}{2}$  x 11". For 117 VAC, 60 Hz.  
 24 F 03657HW Shpg. wt. 15 lbs. ... Net 79.95  
 24 F 05090 Extra Needle ..... Net 3.99  
 24 F 02568 45 RPM Spindle .... Net 1.49



## Solid-State AM Radio Phonograph

Play-anywhere portable with built-in super-het AM radio. Operates on 4 "D" batteries (included) or 117 VAC, 60 Hz. 45 RPM adapter. Orange and white, high-impact plastic cabinet with carrying handle. 12 x 12 x 3 $\frac{1}{4}$ ".  
 24 F 03699W Shpg. wt. 6 lbs. .... Net 29.95



## Lafayette M50 Manual Phono

Out-of-sight styling kids love! Front-mounted dynamic speaker provides good sound. Separate volume and tone controls. Built-in 45 adapter. Manual. Plays 33 $\frac{1}{3}$ , 45 and 78 RPM. Size: 13 $\frac{1}{2}$  x 14 $\frac{1}{4}$  x 4 $\frac{1}{4}$ ". Integrated carrying handle. For 117 VAC, 60 Hz.  
 24 F 03707HW Shpg. wt. 7 lbs. ... Net 22.95



## Lafayette M30 3-Speed Manual Phono

Crazy to look at, fun to play. Kids love this portable. High-impact, plastic, yellow-orange cabinet. Dynamic speaker. Built-in 45 RPM adapter. Manual. Plays 33 $\frac{1}{3}$ , 45, 78 RPM. 13 $\frac{1}{4}$  x 9 $\frac{3}{4}$  x 4 $\frac{1}{2}$ ". 117 VAC, 60 Hz.  
 24 F 03749HW Shpg. wt. 4 $\frac{1}{2}$  lbs. Net 17.95

# Lafayette Stereo Compacts with Great Sound 'N Style

## LSC-2000 AM/FM/Phono 8-Track Record/Play System

- Record Your Own 8-Track Cartridges Directly from Discs, Stereo FM and AM Radio, "Live" with Microphones Included!
- Full Feature Automatic Garrard Turntable

**\$319<sup>95</sup>** No Money Down\*  
with Full-size  
Dust Cover

One of the most versatile compacts we've ever offered—gives you complete musical command of records, radio & 8-track tapes. Play pre-recorded 8-track cartridges or RECORD YOUR OWN with outstanding fidelity. Has solid-state circuit, FULL-FEATURE GARRARD turntable with cue and pause, diamond needle cartridge; high-sensitivity stereo FM and AM tuner section. Each 3-way speaker has an 8" woofer, 5" midrange and 3" tweeter with crossover and special horn duct for really clear wide-range sound reproduction. There's even extra speaker outputs with switching for two-speaker stereo in separate rooms, or derived 4-dimensional sound (with 4 speakers). Stylish walnut-finish cabinetry throughout, brushed aluminum and black control panel. Size: Receiver/phono, 22¾ x 10 x 7¾" speakers, 19½ x 11½ x 8¼". With dust cover, 45-rpm adapter, FM dipole antenna and speaker cable, two microphones and 1 blank 8-track cartridge. For 117 VAC, 60 Hz. 24 F 03772HWX 63 lbs. . . . . Net 319.95



**\$119<sup>95</sup>** With  
Dust Cover

## New! LSC-120 Solid-State AM/FM Phono Compact Stereo Music System

- Two 5" Air-Suspension Speakers
- 4-Speed Automatic BSR Record Changer

Stylish compact features wide-range speaker systems, each with 5" duo-cone speakers and fully-sealed enclosures, rich-tone grille cloth. Has stereo light, blackout tuning dial, volume, bass, treble and balance controls, full tape inputs and outputs. Walnut-finish cabinetry throughout—receiver/phono, 15¼ x 8½ x 14½"; speakers, 9⅞ x 13⅞ x 4⅞". For 117 VAC, 60 Hz.

24 F 03798HWX Shpg. wt. 38 lbs. . . . . Net 119.95

No Money Down—See Page 4 for Lafayette's Easy-Credit Plan (Minimum Order \$30.00)



**\$89<sup>95</sup>** With Dust  
Cover

## LSC-55 "Modular" 3-Piece Stereo Phono System

- With Two 8" Wide-Range Speakers
- BSR Automatic Record Changer with Cueing

Nice-sounding compact phono system at a really nice price! Plays 7, 10, 12" records at 16⅓, 33⅓, 45 and 78 rpm, has pause control and anti-skate, front panel stereo headphone jack, aux. INPUTS FOR ADDING A TUNER OR TAPE PLAYER. Solid-state amplifier has volume, balance, bass and treble controls. Walnut-vinyl finish. Phono, 16⅞ x 3⅝ x 14⅞", speakers, 9⅞ x 13⅞ x 5⅞". For 117 VAC, 60 Hz.

24 F 03400HW Shpg. wt. 36 lbs. . . . . Net 89.95

# New! SANYO Stereo Compact Music Systems

## New! GXT 4310 Stereo FM/AM Music System

This high-performance compact features an AM/FM stereo receiver, a Garrard automatic record changer and 2 bookshelf speaker systems. Matrix circuitry and rear-channel jacks allow conversion to 4-dimensional sound from any 2-channel source (when you add 2 rear speakers). Record changer has cueing function and adjustable tracking force. With slide volume/tone controls, tape input and output, stereo headphone jack, dust cover. Size: Unit, 19 $\frac{1}{8}$ " x 14 $\frac{3}{4}$ " x 8 $\frac{1}{8}$ ". Speakers: 9 $\frac{1}{4}$ " x 5 $\frac{1}{8}$ " x 14 $\frac{3}{8}$ ". For 117 VAC, 60 Hz.

24 F 67025WX Imported. 29 lbs. Net 159.95



**\$159<sup>95</sup>**  
With Dust  
Cover



- Built-in 4-Dimensional Matrix Circuitry
- Two 6" Full-Range Acoustic Suspension Speaker Systems

## New! DXT 5211 Stereo FM/AM/Phono/8-Track Music System

- Built-in 8-Track Stereo Tape Deck

Great stereo sound from AM/FM broadcasts, 8-track tapes and records plus 4-dimensional sound from 2-channel sources with a built-in speaker matrix circuit (when you add 2 rear speakers). Complete with Garrard record changer with cueing, all input and output jacks, slide volume and tone controls, stereo headphone jack, AM/FM antennas, dust cover. Size: Speakers, 11 $\frac{7}{8}$ " x 7 $\frac{3}{8}$ " x 17 $\frac{1}{2}$ "; Unit, 17" x 14" x 8". For 117 VAC, 60 Hz. Imported.

24 F 67033WX Shpg. wt. 31 lbs. .Net 199.95

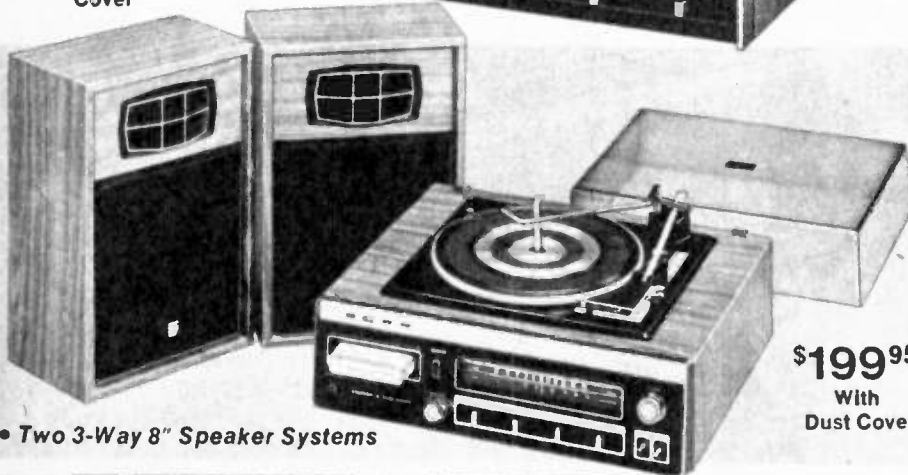

**\$199<sup>95</sup>**  
With  
Dust Cover

- Two 3-Way 8" Speaker Systems

## New! GXT 4511 Stereo FM/AM/Phono/Cassette Music System

- Built-in Stereo Cassette Tape Deck

Combines an AM/FM stereo receiver, a Garrard automatic record changer with cueing, and a built-in stereo cassette tape deck. Record cassettes from the receiver, records or "live" with mikes (not included). Matrix circuit converts any 2-channel source into exciting 4-dimensional sound—when you add a pair of rear speakers. Adjustable recording level monitor, tone control, stereo headphone jack, AM/FM antennas, dust cover, 2 speaker systems. For 117 VAC, 60 Hz. Imported.

24 F 67041WX Shpg. wt. 31 lbs. . .Net 249.95



**\$249<sup>95</sup>**  
With  
Dust Cover

- Two Acoustic-Suspension Speaker Systems

## New! DXT 5489 2/4-Channel Stereo FM/AM/8-Track Music System

- 4 Power Amps and Matrix-SQ Decoder

A deluxe 4-channel stereo receiver with built-in 2-4-channel 8-track tape deck, Garrard automatic record changer with cueing and adjustable tracking force, and 4 3-way acoustic-suspension speaker systems. Special circuitry decodes 4-channel information from SQ 4-channel discs and 2-channel sources. Choose optimum listening conditions with visual spatial control system. Bass and treble slide controls, 4-channel headphone output jacks, complete inputs and outputs. Unit, 21" x 12 $\frac{1}{2}$ " x 9"; Speakers, 9 $\frac{7}{8}$ " x 15 $\frac{3}{8}$ " x 7". For 117 VAC, 60 Hz.

24 F 67058WX Imported. 58 lbs. .Net 299.95



**\$299<sup>95</sup>** With  
Dust Cover

# Low Cost Lafayette Speaker Systems

## Lafayette XL 44 Hi-Fi Speaker System Featuring a Multicellular Diffuser

- **Wide-Range High-Compliance 6½" Speaker**
- **Power-Handling Capacity: 10 Watts**
- **Only 5-1/2 Deep x 9-7/16 Wide x 14-3/16" High**

The low-cost way to get better sound. An ideal replacement system for upgrading modular and compact phono and tape systems. Also serves well as an extension speaker in your home or office. Multicellular diffuser radiates high-frequency sound throughout the listening area. Power handling capacity: 10 watts. Frequency response: 70 Hz to 15,000 Hz. Powerful 6½" wide-range speaker is housed in a handsomely-styled wood cabinet with walnut vinyl covering and a decorative back grille cloth. Impedance: 8 ohms. Size: 9¼W x 5½D x 14¾"H. Imported.

99 F 03204W Shpg. wt. 6 lbs. . . . . Net 14.95



**\$14<sup>95</sup>**

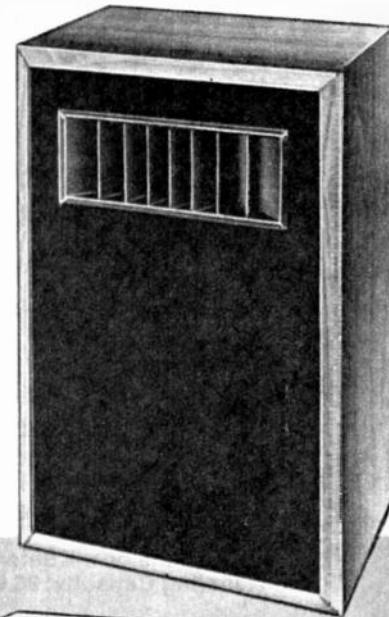

## Criterion "2XA" 2-Speaker 2-Way Compact Acoustic Suspension System

- **Ideal for Use as Hi-Fi System Remote Speakers**
- **60-18,500 Hz Response** • **Handles 20 Watts**
- **Ideal for Low-Powered Amplifiers or Receivers**

This low-cost, highly-compact, 2-way speaker system measures only 9¾W x 7D x 13"H, yet provides excellent sound reproduction. Employs the same design techniques of many high-priced speaker systems. Includes a 5" acoustic suspension woofer with 7/8" voice coil and 1-lb. magnet structure, 3½" cone tweeter which produces crystal-clear sound at frequencies beyond the limit of hearing for most people, and a fiberglass-loaded interior to reduce unpleasant resonances. Wood cabinet with attractive walnut vinyl finish and dark brown grille cloth. Crossover at 4000 Hz. Impedance: 8 ohms. 99 F 02966W Imported. Shpg. wt. 9 lbs. . . . . Net 24.95

**\$24<sup>95</sup>**

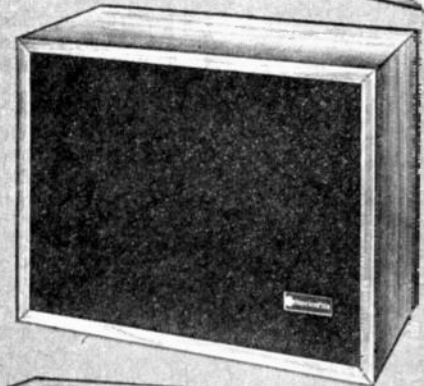

## Criterion 222 2-Speaker 2-Way Air Suspension Systems

- **5-Year AAA Guarantee (See Page 3)** • **Handles 25 Watts**
- **8" Woofer with 30-oz. Magnet** • **Response: 55-18,000 Hz**

Big-size performance from a compact system that easily fits anywhere. A powerful 8" woofer provides smooth bass down to 55 Hz, a 2½" cone tweeter gives sparkling-clean high-frequency response. Built-in 7000-Hz electrical crossover network. Power handling capacity of 25 watts allows compatibility with most amplifiers and receivers. Interior of cabinet is specially designed to damp out unwanted vibrations. Walnut-vinyl finish, charcoal grille cloth. 8 ohms. 13½ x 5½ x 10". Imported.

99 F 03220HW Shpg. wt. 4¼ lbs. . . . . Net 29.95

**\$29<sup>95</sup>**

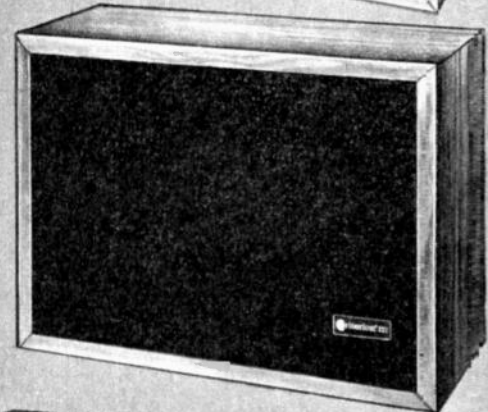

## Criterion 333 8" 2-Way Acoustic Suspension Speaker System

- **5-Year AAA Guarantee (See Page 3)**
- **8" Woofer with 2-lb. Magnet** • **3" Sealed-Back Tweeter**
- **Response: 40-18,000 Hz**

Modest in price without sacrificing any quality or performance. Compact cabinet measures only 18 x 10 x 11". 8" high-compliance woofer with polyurethane-foam-surround produces rich bass down to 40 Hz; 2000-Hz electrical crossover network minimizes intermodulation distortion; 3" sealed-back tweeter widely disperses clean, clear highs. Handles up to 30 watts. ½"-thick wood enclosure covered with protective walnut-finished vinyl, handsomely accented by charcoal brown foam grille. 8 ohms.

21 F 05005HW Shpg. wt. 19 lbs. . . . . Net 44.95

**\$44<sup>95</sup>**



Charge It with Your BankAmericard or Master Charge.

# Lafayette Criterion® Acoustic Suspension Speakers



5-YEAR AAA GUARANTEE, see page 3

## Criterion 444 8" 3-Way 3-Speaker System

Acoustic Suspension—Contemporary Style **\$54.95**  
Power Handling Capacity: 30 watts

- 1—1½" Plastic Dome Tweeter
- 2—3½" Mid-Range with ½" Voice Coil
- 3—8" Woofer with 1¼-lb. Magnet

Exceptional sound reproduction from perfectly matched speakers. Heavy-duty 8" woofer with 1" voice coil in a fiberglass-filled enclosure for deep, natural bass. Electrical crossover at 3,000 and 10,000 Hz. High frequency control adjusts for "hard" or "soft" rooms. Walnut vinyl finish, dark brown grille cloth. Response: 40-19,000 Hz. Imp.: 8 ohms. 11¼ x 20 x 8¼". Imported. 99 F 03279W Shpg. wt. 20 lbs. . . . . Net 54.95

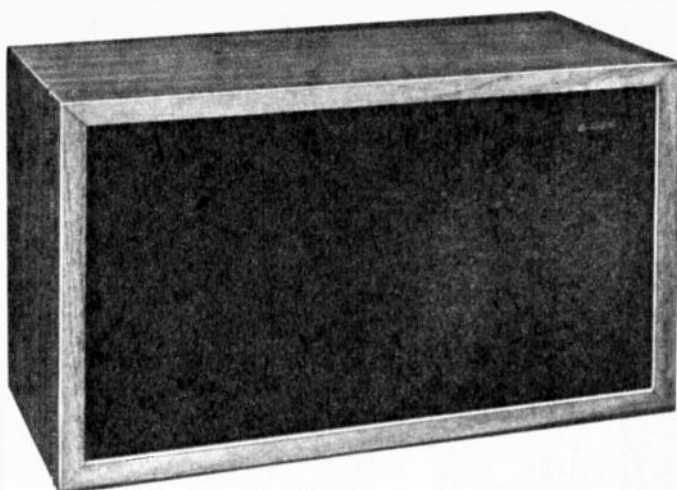
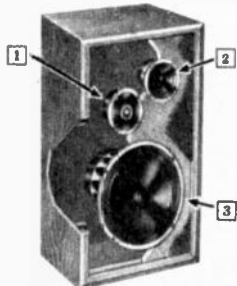

5-YEAR AAA GUARANTEE, see page 3

## Criterion 555 10" 3-Way 3-Speaker System

Clean, Powerful Bass Down to 32 Hz **\$69.95**  
Power Handling Capacity: 50 Watts

- 1—5" Sealed-Back Mid-Range Speaker
- 2—3" Air-Sealed Super Tweeter
- 3—10" Woofer with 4-lb. Magnet Structure

A superb 3-way system at a moderate price. 10" high-compliance woofer has a huge 4-lb. magnet structure and 1½" voice coil. Crossovers at 800 and 3000 Hz. High frequency brilliance control on rear. Acoustically transparent foam grille. Solid ¾" wood enclosure, walnut-finish vinyl. Resp.: 32-19,500 Hz. 8 ohms. 12x21x10". 21 F 05013HW Shpg. wt. 29 lbs. . . . . Net 69.95

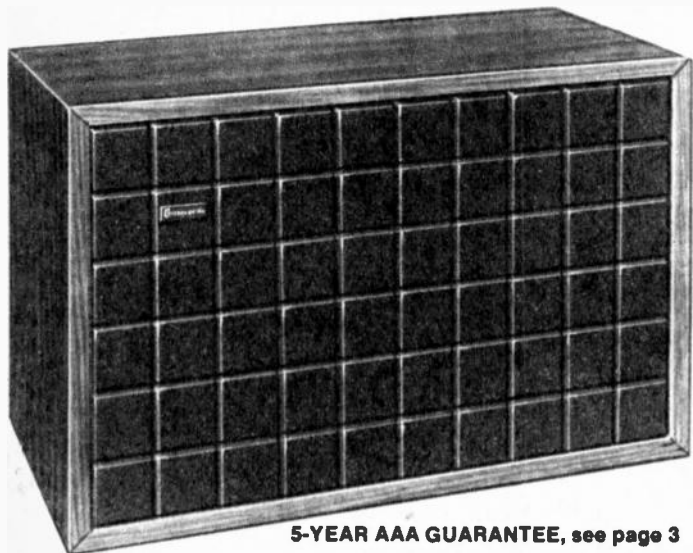
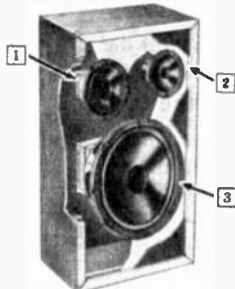

5-YEAR AAA GUARANTEE, see page 3

## Criterion 666 60-Watt 3-Way System **\$99.95**

- 1—6" Sealed-Back Mid-Range Speaker
- 2—2" Super Tweeter with 1¼-lb. Magnet Structure
- 3—10" Woofer with 6-lb. Magnet Structure

For the cost-conscious audio perfectionist! Provides extended frequency response (28-20,000 Hz) and superb smoothness. 10" high-compliance woofer has a sturdy 2" diameter, 4-layer voice coil and polyurethane foam surround. Crossover at 800 and 5,000 Hz. Midrange and brilliance controls. ¼"-thick walnut finish wood enclosure, brown foam grille. Handles 60 watts. 8 ohms. 14½ x 22 x 11". 21 F 05021HW Shpg. wt. 34 lbs. . . . . Net 99.95

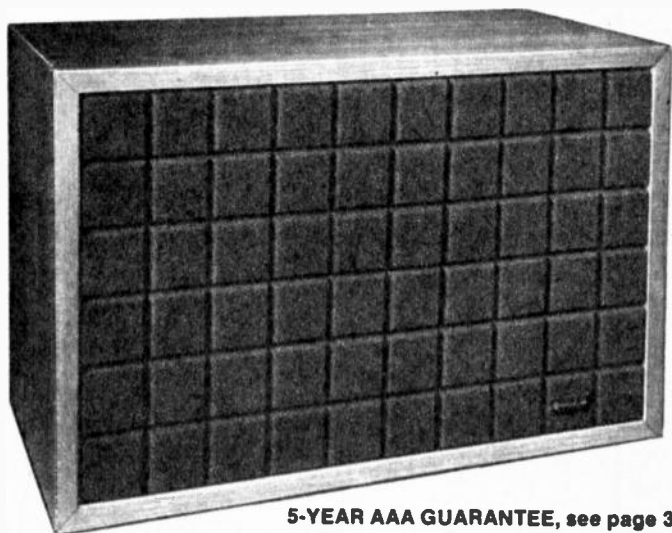
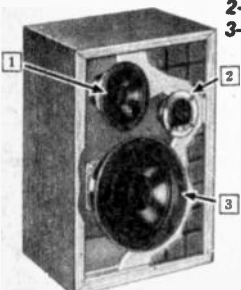

5-YEAR AAA GUARANTEE, see page 3

## Criterion 777 80-Watt 3-Way System **\$119.95**

- 1—2" Super Tweeter with 1½-lb. Magnet Structure
- 2—5" Sealed-Back Mid-Range Speaker
- 3—10" Woofer with 8-lb. Magnet Structure

Distinctive in appearance . . . uncompromising in performance. 10" high-compliance woofer has polyurethane foam surround and 2" diameter, 4-layer voice coil. Crossovers at 800 and 4,000 Hz. High-frequency and mid-range controls on rear. ¼-inch walnut-finish wood enclosure. Charcoal brown grille of acoustically transparent foam. Overall response: 20-20,000 Hz. Handles 80 watts. 8 ohms. 15 x 23 x 12". 21 F 05039HW Shpg. wt. 40 lbs. . . . . Net 119.95

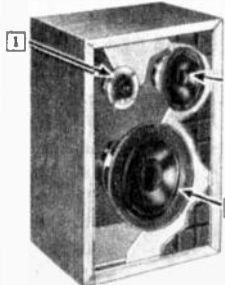



## Lafayette Criterion 888 100-Watt 12" 4-Way Acoustic Suspension Speaker System

- For Shelf or Floor Standing
- 3/4" Oiled Walnut Finish Cabinet with 3-D Acoustically-Transparent Foam Grille
- Powerful 12" Woofer with 12-lb. Magnet Structure, 2 1/2" Voice Coil, 16 Hz Resonance
- Overall Response 19-20,000 Hz

**\$169<sup>95</sup>**

5-YEAR AAA GUARANTEE  
See page 3

Our best floor/shelf system! Offers extended frequency response and extremely wide dynamic range, achieved by the acoustic suspension principle. By using the same cone materials and design in each of its 4 speakers, the Criterion 888 is able to maintain an astonishing transparency and smoothness throughout its full frequency range. Its powerful 12" high-compliance woofer features a massive 4-layer, 2 1/2" diameter voice coil, allowing it to handle exceptionally high transient power. Carefully selected crossover points assure a linear output. Has three controls (HF range, upper mid-range and low mid-range) on rear of enclosure. The charcoal brown grille is made of the most acoustically transparent grille material available—foam. Handsomely finished on all sides in hand-rubbed oiled-walnut.

Overall response: 19-20,000 Hz. Woofer: 12"; 12-lb. magnet structure, Alnico V magnet; 2 1/2" diameter 4-layer voice coil; 16 Hz cone resonance. Lower Mid-range: 6"; 2 1/2-lb. magnet structure; 1" VC. Upper Mid-range: 5"; 2-lb. magnet structure; 1" VC. Tweeter: 2"; 1 1/2-lb. magnet structure; 3/4" VC. Crossovers: 400, 900 and 7000 Hz. Power Handling Capacity: 100 watts. Nominal Impedance: 8 ohms. Minimum Power Requirement: 15 watts (RMS). Dimensions: 15 1/2" x 24" x 12".

21 F 05047HWX Shpg. wt. 55 lbs. Net 169.95

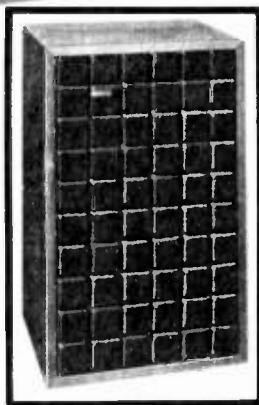
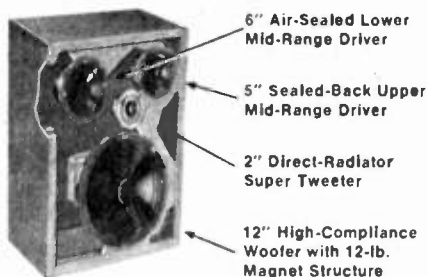
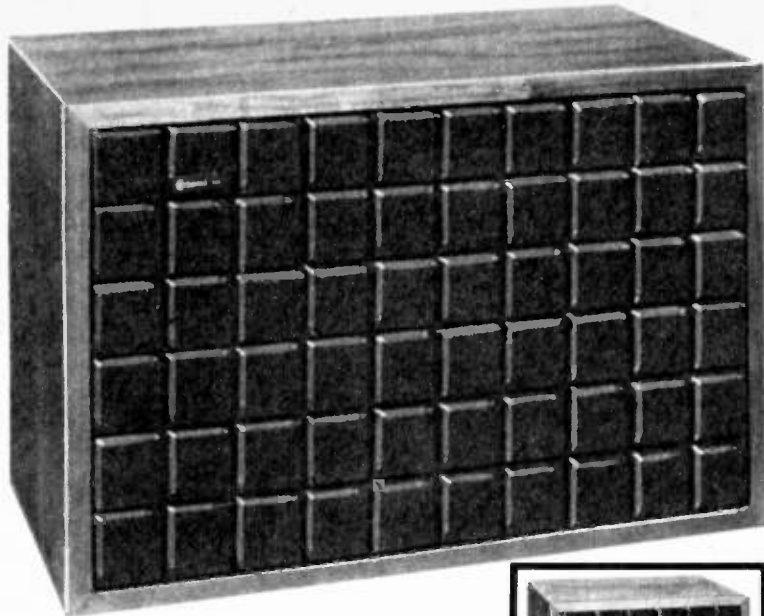

## Our Finest Speaker System—Studio Monitor Quality

### Criterion 999 100-Watt 15" 4-Way Acoustic Suspension Floor System

- 1 2" Direct-Radiator Super Tweeter
- 2 8" Air-Sealed Lower Mid-Range Driver
- 3 5" Sealed-Back Upper Mid-Range Driver
- 4 Massive 15" Woofer with 12-lb. Magnet Structure, 2 1/2" VC, 14 Hz Cone Resonance
- 5 3/4"-Thick Oiled Walnut Finish Cabinet with 3-Dimensional, Acoustically-Transparent Foam Grille

ONLY  
**\$219<sup>95</sup>**

5-YEAR AAA GUARANTEE  
See page 3

An uncompromising floor-standing speaker system that brings you professional studio master monitor quality—rich, robust tones; striking clarity; and brilliant transient performance. The acoustic suspension design of the Criterion 999 assures an overall smoothness and height of transparency that is so vivid, throughout its exceptionally broad frequency range, that it sets the standard for our entire speaker line. The same cone materials and design are used in each of its four speakers to assure the same tonal purity through its full range. The powerful 15" high-compliance woofer has a rugged 4-layer, 3/4" long, 2 1/2" diameter, 27-gauge voice coil—easily handles practically any transient power peaks. Three controls on rear: high frequency, upper mid-range and lower mid-range. Grille is charcoal brown foam. The 3/4" wood enclosure is finished in hand-rubbed oiled-walnut; comes with a 1 1/2"-thick wood base.

Overall response: 18 to 22,000 Hz. Crossover frequencies: 400, 900 and 7000 Hz. Power handling capacity: 100 watts. Impedance: 8 ohms. Minimum power requirement: 15 watts (RMS). Size: 20 x 30 x 16".  
21 F 05054HWX Shpg. wt. 82 lbs. Net 219.95

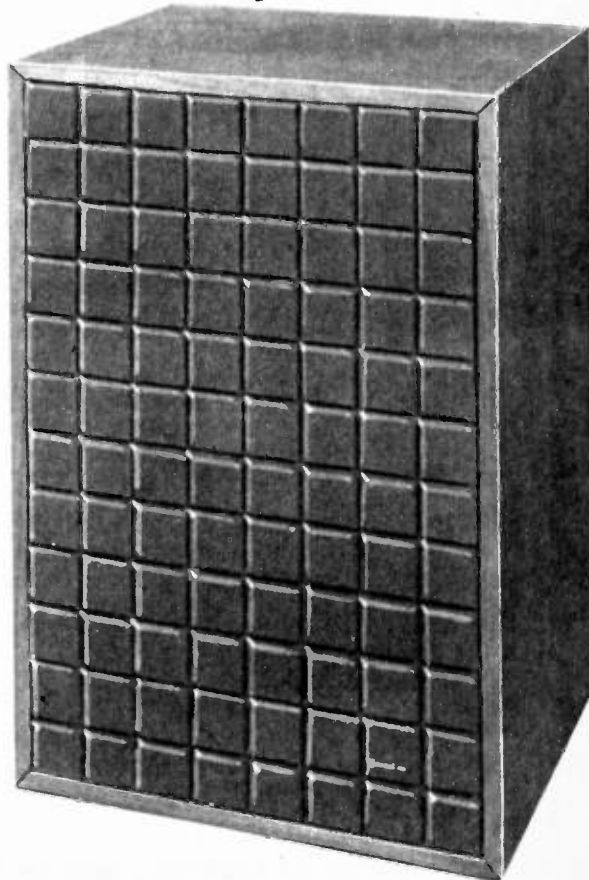
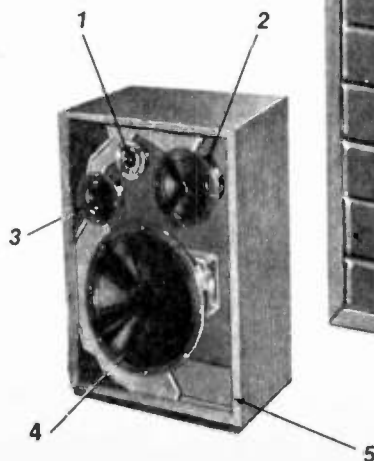

# Lafayette Has the BEST In Name-Brand Speakers!



The B•I•C VENTURI principle (pats. pend.) increases bass energy while suppressing harmonic distortion. The BICONEX™ (pat. pend.) unique horn/driver unit provides efficient output and power handling. Speakers include automatic balance circuitry ensuring aurally "flat" response. Made in U.S.A.

- Efficient Power Handling
- High Sound Output
- Broad Sound Dispersal
- Wide Dynamic Range

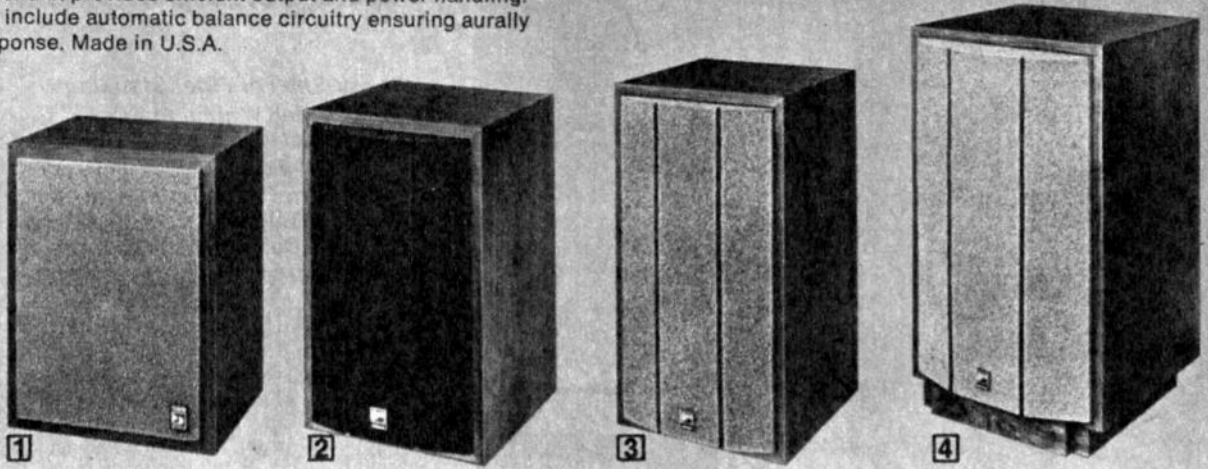

**1 FORMULA 1** Its high sensitivity, producing more sound before amplifier distortion starts, makes it ideal for budget systems. Handles high power inputs up to 50 watts, too. Contains venturi bass (6" woofer) and modified BICONEX HORN. Functions well in a stereo remote or quad set-up. Continuously variable brightness control. 35-17,500 Hz. 8 ohms. 10 7/8" x 10" x 15".  
21 F 32538W Shpg. wt. 23 lbs. . . . . Net 74.95

**2 FORMULA 2** A very sensitive, high power-handling speaker for its size, providing high accuracy and low distortion. Includes a super tweeter which only operates in the last octave, a BICONEX midrange, and 8" woofer. Handles up to 75 watts. Dynamic Total Balance compensation. Full Response: 30-23,000 Hz. Impedance: 8 ohms. 19 3/4" x 12" x 11 1/2".  
21 F 32520WX Shpg. wt. 33 lbs. . . . . Net 112.50

**3 FORMULA 4** Operates equally well as either a shelf or floor-standing speaker, delivering remarkably clear, accurate, clean sound at all volume levels. Handles up to 100 watts input power, with frequency response of 25 to 23,000 Hz. Contains manual and automatic Dynamic Tonal Balance Compensation, 10" woofer. BICONEX mid-range, super tweeter, 8 ohms. 25 x 13 1/4" x 13"  
21 F 32504WX Shpg. wt. 48 lbs. . . . . Net 149.95

**4 FORMULA 6** Most efficient of the series with the greatest power handling capability (up to 125 watts). Has all the B•I•C VENTURI special features plus twin mid (BICONEX) and treble (supertweeter) arrays for wider sound dispersal, but without sacrificing genuine stereo spatial image. 12" woofer. Response: 20-23,000 Hz. 8 ohms impedance. 26 1/4" x 15 3/4" x 14 3/4".  
21 F 32512WX Shpg. wt. 64 lbs. . . . . Net 273.25

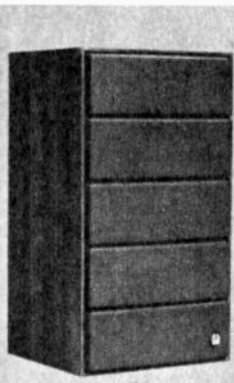

Fine bookshelf 2-way, 2-speaker systems offering broad dispersion and excellent transient response.

## PIONEER PROJECT 60

Ideal for moderate powered systems. 8" woofer with free beating cone; aluminum die cast 2 1/2" horn tweeter; high crossover frequency (5000 Hz) to minimize distortion. Handles up to 20 watts. 50-20,000 Hz; 8 ohms. Shpg. wt. 18 lbs.  
21 F 31126WX . . . . . Net 79.95



## PIONEER PROJECT 80

Optimum bass response with a high compliance 10" woofer in urethane half-roll surround. Hemispherical soft-dome 1 1/2" midrange/tweeter. Handles up to 30 watts. 35-20,000 Hz, crossover at 700 Hz. 8 ohms.  
21 F 31134WX Shpg. wt. 25 lbs. . . . . Net 99.95



## PIONEER PROJECT 100

Easily handles powerful input with a 10" high compliance woofer and 1 1/2" hemispherical dome midrange/tweeter. Rich, oiled walnut cabinet. 30-20,000 Hz, advanced crossover at 700 Hz. To 35 watts. 8 ohms.  
21 F 31142WX Shpg. wt. 40 lbs. . . . . Net 129.95

**marantz.**  
Imperial Bookshelf Speaker Systems with famous Marantz quality, styling and performance.

**MARANTZ IMPERIAL 4G**  
Marantz quality at an amazing price! The Imperial 4G two-way speaker system has an 8" woofer and 1 1/4" tweeter. Handles 15 watts, 40 to 18,000 Hz. Walnut finished vinyl. 8 ohms. 8 1/2" x 11 1/4" x 19 1/4".  
21 F 50340WX Wt. 22 lbs. . . . . Net 59.95

## MARANTZ IMPERIAL 5G

Good-looking walnut finished cabinet housing an 8" woofer and 1 3/4" tweeter. 2-way system with frequency level selector. 15 watts, 35 to 20,000 Hz response. 8 ohms. 12" x 9 1/2" x 23".  
21 F 50308WX Shpg. wt. 31 lbs. . . . . Net 99.95

## MARANTZ IMPERIAL 6G

A 2-way speaker system with a big 10" woofer and a 1 3/4" tweeter. Includes a high frequency level selector switch. Hand-rubbed walnut cabinet. 30 watts, 35-20,000 Hz. 8 ohms. 14 1/4" x 11 1/2" x 25 1/2".  
21 F 50324WX Shpg. wt. 44 lbs. . . . . Net 139.95

## MARANTZ IMPERIAL 7

Marantz's finest bookshelf speaker system, handling 30 watts continuous, 35-20,000 Hz. A 12" woofer, 3 1/2" midrange, 1 3/4" tweeter and high frequency level selector in hand-rubbed walnut. 8 ohms.  
21 F 50316WX 14 1/2" x 11 1/2" x 25 1/2". Wt. 51 lbs. . . . . Net 199.95

# Selected Top-Brand Speaker Systems

**New  
Decade L-16**



1 \$135

**Decade L-26**



2 \$156

**New  
Decade L-36**



3 \$198

**Century L-100**

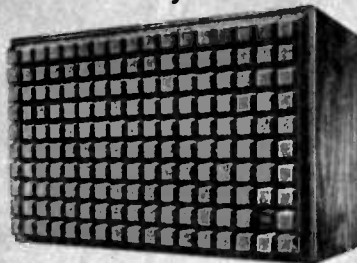

4 \$297

**New  
Jubal L-65**

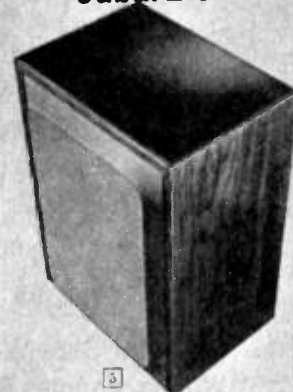

5 \$396



*Top quality over a wide range of prices, including new entries into the lower-priced loudspeaker field.*

**2 Decade L-26 Middleweight**

A 2-way system with crowd-pleasing price and performance. Highly efficient, ideal for pairing with more modest amplifiers. 10" woofer, 1.4" high freq. direct radiator. 35 watts, 8 ohms. 12 3/4" x 13 1/4" x 24".  
21 F 46611WX Shpg. wt. 42 lbs. .Net 156.00

**1 Century L-100**

Consumer version of a professional studio monitor. Oiled walnut enclosure houses a 12" low freq. loudspeaker, 5" midrange transducer, 1.4" high freq. direct radiator. 50 watts, 8 ohms. 14 x 14 x 24".  
21 F 46595WX Shpg. wt. 55 lbs. .Net 297.00

**1 Decade L-16 Welterweight**

Moderate size and price earn it the nickname "Welterweight." 8" low freq. loudspeaker and 1.4" high freq. direct radiator pack a clean and solid "wallop." 35 watts, 8 ohms. 10 1/2" x 10 1/4" x 19 1/4".  
21 F 46645WX Shpg. wt. 28 lbs. .Net 135.00

**3 Decade L-36 Heavyweight**

Named the "Heavyweight" because of the 5" midrange transducer added to the same high and low freq. speakers of the L-26 above. 3-way with the class of the best JBL's. 50 watts, 8 ohms. 13 1/2" x 13 3/4" x 24".  
21 F 46637WX Shpg. wt. 45 lbs. .Net 198.00

**5 Jubal L-65**

An advance into cleaner sound with higher sensitivity, better bass and improved freq. response. 12" low freq. loudspeaker, 5" midrange, high freq. ring radiator. 75 watts, 8 ohms. 24 1/2" x 13 1/8" x 17 1/2".  
21 F 46629WX Shpg. wt. 67 lbs. .Net 396.00



Model 1001A  
\$143

Model 2000AXT



7 \$305

**INFINITY ∞ Excellence & Quality**

**6 1001A.** Utilizes both a transient and an ambient cone tweeter plus a large 12" woofer. 33-21,000 Hz. 8 ohms. Acoustic crossover at 1300 Hz. 20 watts min. 14 x 12 1/4 x 25".  
21 F 12548WX Shpg. wt. 44 lbs. . . . .Net 143.00

**7 2000 AXT.** Employs a wave transmission line tweeter with perfect transience, 12" woofer, and 4.5" midrange. 30-21,000 Hz. 8 ohms. Watts: 20 m.n., 200 max. 14 x 12 1/4 x 25".  
21 F 12522WX Shpg. wt. 64 lbs. . . . .Net 305.00



**DYNACO A-25  
10" 2-Way System**

\$89

with oiled walnut finish

Wide-range response from a 10" extended excursion woofer and soft dome tweeter. 15 watts min. 35-20 k Hz. 8 ohms. 11 1/2" x 10 x 20".  
21 F 23545W Wt. 24 3/4 lbs. . . . .Net 89.00  
**DYNACO A-25VW.** Same as Dynaco A-25, but vinyl-covered, walnut-grained wooden enclosure and dark brown grille cloth.  
21 F 23438W Shpg. wt. 24 3/4 lbs. .Net 79.95



8 \$199<sup>95</sup>

**Fisher**

**Bookshelf  
Speaker  
Systems**

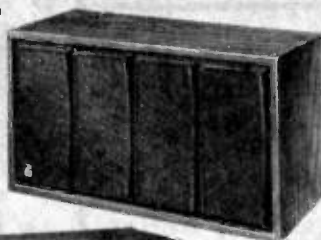

9 \$89<sup>95</sup>

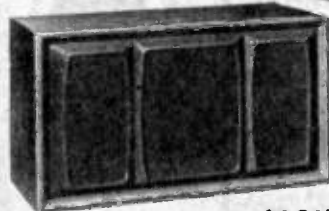

10 \$99<sup>95</sup>

**8 ST-465 Studio Standard Speaker System**

Completely new flare-dome 3 1/2" midrange for flat response and large power handling; Mylar dome tweeter with 1" diameter for wide dispersion; 12" woofer. 40-20,000 Hz. 8 ohms. 20 watts min. Walnut veneer. 14 1/4" x 11 1/8" x 24 1/2".  
21 F 33817WX Shpg. wt. 39 lbs. . . . .Net 199.95

**9 XP-117 Bookshelf Speaker System**

A two-way speaker system in a decorative walnut vinyl cabinet. With an 8" woofer, 3" midrange/tweeter. 35-20,000 Hz. Handles 30 watts max. 8 ohms. 21 x 9 x 11 1/2".  
21 F 33825WX Shpg. wt. 26 lbs. . . . .Net 89.95

**10 XP-160 Three-Way Speaker System**

Natural-sounding, transparent, resonance-free response from a 10" woofer, 5" mid-range, and 3" tweeter. Attractively-styled in a walnut vinyl cabinet. Response 33-20,000 Hz. Impedance: 8 ohms. 23 x 10 x 13".  
21 F 33833WX Shpg. wt. 32 lbs. . . . .Net 99.95

# Lafayette Speakers—Deluxe Woofers, Tweeters And Special Speakers For Do-it-Yourself Systems

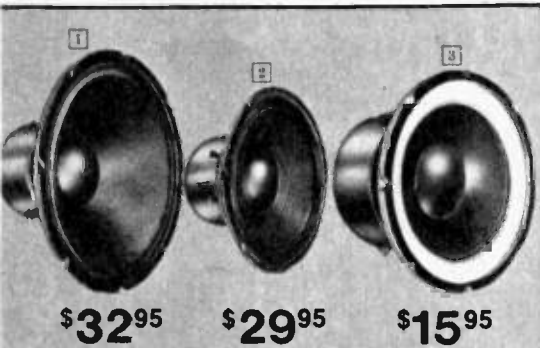

**\$32<sup>95</sup>    \$29<sup>95</sup>    \$15<sup>95</sup>**

## Popular Size Woofers

**1 15" Woofer Handles 55 Watts Peak**  
Mammoth 40-oz. ceramic magnet in a magnetic structure weighing 7¾ lbs. 2" dia. voice coil easily handles 28 watts continuously. Lacquer finish protects against corrosion of the critically dimensioned steel elements. Res. freq.: 50 Hz. Resp.: 20-5000 Hz. Imp.: 8 ohms.  
21 F 47197W Shpg. wt. 14 lbs. . . . . Net 32.95

**2 12" Woofer Handles 50 Watts Peak**  
Same magnet and coil used above. Power handling 24 watts continuously. Lacquered to resist corrosion. Res.: 20-4500 Hz. Imp.: 8 ohms.  
21 F 47205W Shpg. wt. 12¼ lbs. . . . . Net 29.95

**3 8" Woofer Handles 40 Watts Peak**  
20-oz. magnet, a 1½" voice coil and highly-compliant cone suspension. Handles 20 watts continuously. Free air resonance: 55 Hz. Lacquer coated. Res.: 35-7500 Hz. Imp.: 8 ohms.  
21 F 47213 Shpg. wt. 6 lbs. . . . . Net 15.95



**\$10<sup>95</sup>    \$11<sup>95</sup>**

## Midrange Components

**4 8" Direct Radiator Midrange**  
Has closed basket, preventing intermodulation. 10-oz. ceramic magnet, 1" voice coil for high sensitivity. Used with crossover, can handle midrange and hi-frequency power of 30 watts program. Res.: 350-14,000 Hz. Imp.: 8 ohms. Shpg. wt. 4¼ lbs.  
21 F 47189 . . . . . Net 10.95

**5 Deluxe Midrange Horn**  
Hear cymbals and brass with brilliance. Enjoy wide dispersion. Crossover operates at 1,000 Hz. Attach to woofer with 2 simple solder connections. Res.: 600-12,000 Hz. Imp.: 8 ohms. Lacquer finish. 10½ x 4 x 7¾". Handles 60 watts peak. Wt. 3¾ lbs.  
21 F 47247 . . . . . Net 11.95

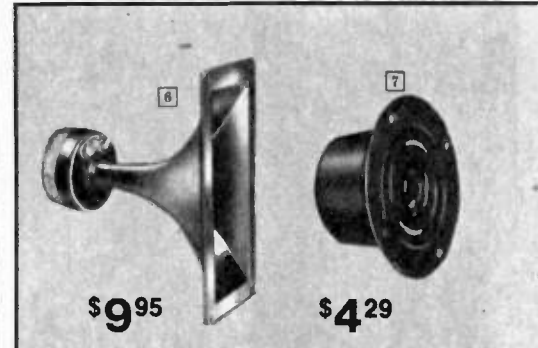

**\$9<sup>95</sup>    \$4<sup>29</sup>**

## Tweeters-Compression

**6 High Efficiency Tweeter Horn**  
Molded compression type featuring high sensitivity, wide dispersion and powered crossover at 4,500 Hz. Handles up to 30 watts. Res.: 2,000-18,000 Hz. Imp.: 8 ohms. 1.4-oz. magnet, ¾" voice coil. Baked lacquer finish. 7¼ x 3 x 6¾".  
21 F 47239 Shpg. wt. 1¾ lbs. . . . . Net 9.95

**7 Direct Radiator Super Tweeter**  
Has aluminum cone, enclosed metal case and leads. High sensitivity and wide dispersion angle. Up to 20 watts. Res.: 4000-18,000 Hz. Recommended crossover frequency: 5,000 Hz or higher. Imp.: 8 ohms. Requires 2½" dia. mounting.  
99 F 01208 Shpg. wt. ½ lb. . . . . Net 4.29



**\$24<sup>95</sup>**

**\$29<sup>95</sup>**

## Heavy Duty 3-Way Coax Speakers

**8 12" Speaker Handles 45 Watts Peak**  
Large voice coil, large 4-lb. magnet for smooth handling of basses. 4" tweeter with Alnico V magnet coaxially mounted with crossover at 4,500 Hz. Handles 23 watts program material. Res.: 35-20,000 Hz. Imp.: 8 ohms.  
21 F 47262W Shpg. wt. 10½ lbs. . . . . Net 24.95

**9 15" Speaker Handles 50 Watts Peak**  
Same combination as above, plus benefit of extra cone area. Handles 25 watts of program material. Res.: 40 Hz. Resp.: 30-20,000. 8 ohms.  
21 F 47254W Shpg. wt. 11 lbs. . . . . Net 29.95



**\$17<sup>95</sup>**

**\$14<sup>95</sup>**

## 12" Wide-Range Coax Speakers

**10 Hi-Power Hi-Fi Speaker**  
General purpose. built to take power peaks up to 45 watts. 20-oz. ceramic magnet, 1½" voice coil. Res.: 35-17,000. Res.: 45 Hz. 8 ohms. Coaxially mounted high frequency cone extends range.  
21 F 47122W Shpg. wt. 7½ lbs. . . . . Net 17.95

**11 Hi-Fi Speaker**  
For medium power amplifiers. Will handle 12-watt program material, 25 watts peak. For limited budget buffs. 5.5-oz. ceramic magnet. Res.: 40-18,500 Hz. Imp.: 8 ohms.  
21 F 47155 Shpg. wt. 5 lbs. . . . . Net 14.95

**\$10<sup>95</sup>**

## 8" Speakers



**12 Coax with 3" Tweeter**  
15 watts peak. Res.: 75 Hz. Resp.: 60-17,000 Hz. Imp.: 8 ohms. Solder lugs.  
21 F 47171 Wt. 2 lbs. Net 10.95

**\$11<sup>95</sup>**



**13 Wide-Range Hi Power**  
30 watts peak. Res.: 45-16,000 Hz. Imp.: 8 ohms. Big 10-oz. ceramic magnet. No soldering needed.  
21 F 47221 3½ lbs. . . . . Net 11.95

**\$6<sup>95</sup>**



**14 Extended-Range Speaker**  
Separate high-frequency cone extends response. 5.5-oz. ceramic magnet. Up to 11 watts, 22 watts peak. Res.: 45-16,000 Hz. Res.: 70 Hz. Solder lugs.  
21 F 47080 2½ lbs. . . . . Net 6.95



**\$10<sup>50</sup>**

**15 6½" Coaxial Speaker**  
Low-distortion 2" tweeter coaxially mounted in protective housing for wide-angle high-frequency propagation. Ideal for stereo pairs up to 8-10W. Frequency range 50-16,000 Hz. Res.: 70 Hz. Imp.: 8 ohms. Built-in elec. crossover network. Needs 5½" dia. cutout. Imported.  
99 F 00283 Wt. 2 lbs. Net 10.50

# Lafayette Install 'Em Yourself Hi-Fi Speakers



**\$14<sup>95</sup>**

## SK-108 8" 2-Way Hi-Fi Speaker

- Rigid Die-Cast Metal Frame
- Cloth Roll Suspension
- 30 Watts Peak Power Handling

Low in price, high in quality—excellent reproduction from 32 to 19,000 Hz. Dual cone design—high compliance woofer and efficient tweeter cone. Solid die-cast metal frame keeps the 1" voice coil and other moving parts in precise alignment with the 12-oz. magnet. Spring-loaded fingertip terminals are color-coded for easy stereo phasing. Resonant freq. 55 Hz. Impedance 8 ohms. Outside dia. 8 1/4"; depth 3 3/8".  
21 F 01780W Shpg. wt. 5 lbs. . . . . Net 14.95

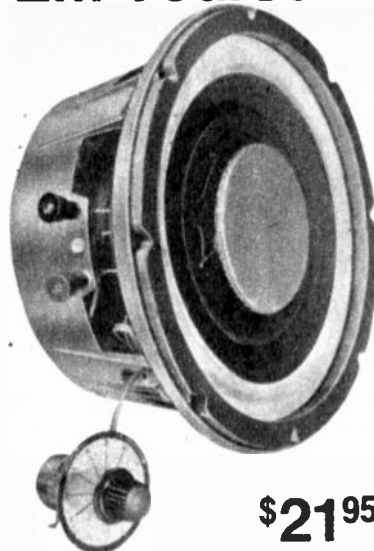

**\$21<sup>95</sup>**

## SK-138 8" 3-Way Hi-Fi Speaker

- Coaxial 3" Tweeter with Screen
- Calibrated Tweeter Level Control
- 30 Watts Power Handling Capacity

Powerful 8" 3-way speaker provides exceptionally clear response, 32 to 20,000 Hz. Rigid die-cast frame for precise alignment of moving parts. Woofer has a cloth roll cone edge treated with permanently viscous compound. Deluxe spring-loaded fingertip terminals. 4500 Hz electrical crossover. Has 12-oz. ceramic magnet, 1" voice coil. Impedance 8 ohms. Free air resonance 45 Hz. Mts. to front or rear. Depth 3 3/8".  
21 F 01806W Shpg. wt. 5 lbs. . . . . Net 21.95

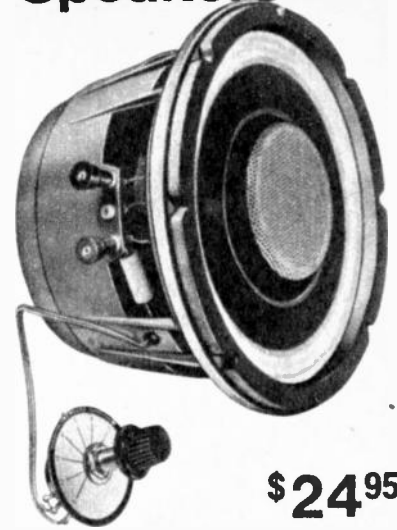

**\$24<sup>95</sup>**

## Deluxe SK-229 8" 3-Way Speaker

- Rigid One-Piece Die-Cast Frame
- Prewired Calibrated Tweeter Control
- 35 Watts Power Handling Capacity

Our best 8" speaker delivers clean, natural sound—28 to 19,500 Hz. High-compliance woofer has cloth roll suspension for smooth bass; 4-lb. magnet structure with 1 1/2" voice coil. Rigid die-cast frame maintains precise alignment of critically-spaced elements. Separate mid-range cone; cone-type super tweeter. Resonance: 38 Hz. Solderless terminals are spring-loaded and phase-coded. Impedance 8 ohms. Made in USA.  
21 F 02051W Shpg. wt. 7 lbs. . . . . Net 24.95

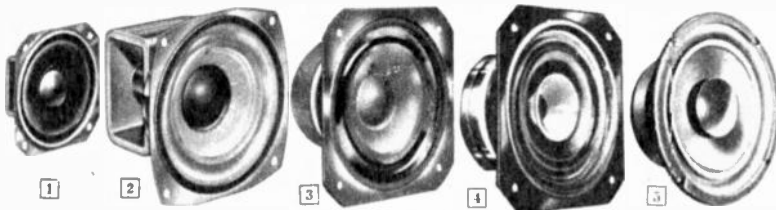

## Miniature Lafayette High-Compliance Hi-Fi Speakers

Designed for Quality Performance in a Compact Area

**1 LAFAYETTE 3" TWEETER.** Foam-mounted cone tweeter gives 1200-20,000 Hz response. 8 watts peak. 8 ohms. 1 1/4" deep. Imported.  
99 F 01562 Shpg. wt. 1 lb. Net 3.99

**2 LAFAYETTE 4" FULL-RANGE SPEAKER.** Only 2" deep. Freq. response 50-16,000 Hz. 8.11-oz. magnet. 8 watts. 8 ohms. Imported.  
99 F 01729 Shpg. wt. 2 lbs. Net 7.95

**3 LAFAYETTE 5" WOOFER.** Deep bass response. 40-9000 Hz. 1-lb. magnet; 1" voice coil. Handles 25 watts music power. 3" deep. Imp. 8 ohms.  
99 F 03477 Wt. 5 lbs. . . . . Net 10.95

**4 LAFAYETTE 5" COAXIAL HI-FI SPEAKER.** Super miniature speaker handles up to 25 watts of power. Frequency range 38 to 19,000 Hz. Heavy 1.1-lb. magnet. Rugged steel frame. Impedance: 8 ohms. Only 2 3/4" in depth. Imported.  
99 F 01703 Wt. 3 lbs. . . . . Net 12.95

**5 LAFAYETTE 6 1/2" DUAL-CONE HI-FI SPEAKER.** Powerful speaker, only 2 1/2" in depth, with 1-lb. magnet. Response, 50-16,000 Hz. Power handling capacity, 15 watts. Rugged steel frame. 8 ohms. Imported.  
99 F 01737 Wt. 3 lbs. . . . . Net 12.50

## Lafayette SK-315 15" 3-Way Die-Cast Speaker

- 15-lb. Magnet Structure
  - Free-Edge Cone Suspension
- \$89<sup>95</sup>**

Lafayette's engineers teamed up with America's leading speaker manufacturer to develop this outstanding 15" 3-way coaxial speaker. Die-cast frame has extra-thick walls to minimize "ringing." The 3" voice coil features aluminum wire for high conversion efficiency. Coaxially mounted mid-range and compression horn-loaded tweeter. Prewired crossover with brilliance control. Capacity: 80 watts peak. Response: 20-20,000 Hz. 8 ohms. Depth 8". Made in U.S.A.  
21 F 01715WX Shpg. wt. 24 lbs. . . . . Net 89.95



## Deluxe Lafayette SK-312 12" 3-Way Die-Cast Speaker

**\$39<sup>95</sup>**

- Free-Edge Cone Suspension
- Handles 70 Watts Peak
- 2" Woofer Voice Coil
- Prewired Crossover with Brilliance Control
- Coaxial-Mounted, Direct-Radiator Super Tweeter

This outstanding 12" speaker is the result of a joint effort between Lafayette's engineering group and the engineering staff of one of America's most-respected speaker manufacturers. Features a rigid pressure die-cast frame with phase-coded speaker terminals. The 6 3/4-lb. magnet structure has an amazing 9000 gauss flux density. The woofer cone is suspended by chemically-treated cloth edges for a low, low free air resonance of only 25 Hz. This suspension also damps standing waves which tend to develop across the cone. Separate mid-range cone and direct-radiator super tweeter. Brilliance control is calibrated for easy adjustment of high-frequency response. Mounts to front or rear of baffle; extra gaskets are included. Overall response—20 to 19,500 Hz. Handles 35 watts program, 70 watts peak. 8 ohms. Outside dia. 12 1/4"; depth 6 1/2". Made in U.S.A.  
21 F 01707W Shpg. wt. 12 lbs. . . . . Net 39.95



# Selected Speakers For "Custom-Built" Sound

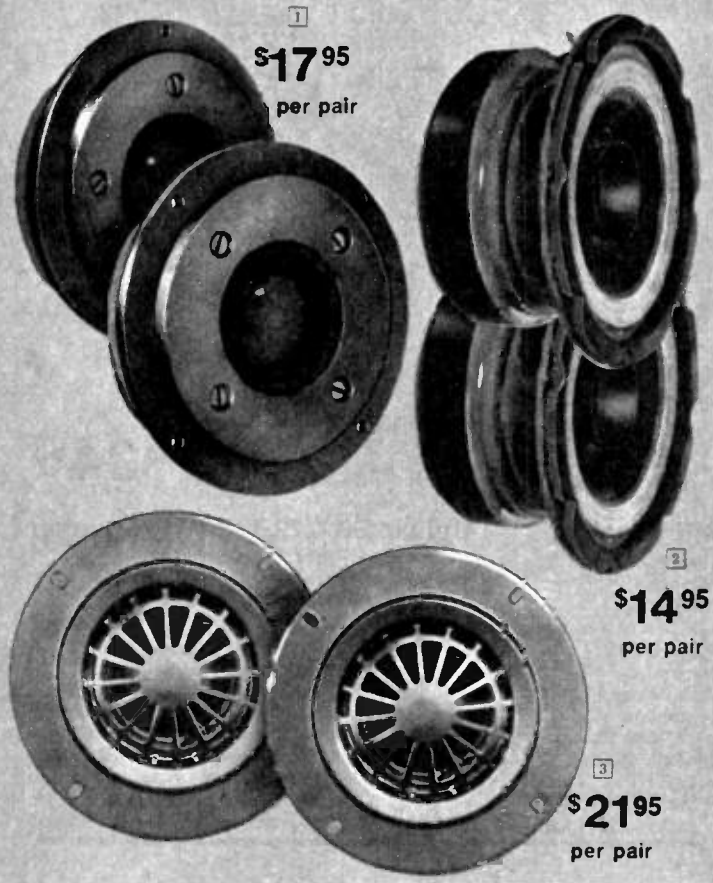

1  
\$17.95  
per pair

2  
\$14.95  
per pair

3  
\$21.95  
per pair

## 1 Matched Pair of High-Power Dome Hi-Fi Tweeters

High-powered 3 1/2" tweeters with dome-shaped diaphragms, perfect for addition to an existing speaker system. 1500-20,000 Hz. Low cone mass provides negligible transient distortion. Handles 40 watts. 9-oz. magnet, 4000 Hz crossover. Imported.

21 F 29500 Shpg. wt. 3 lbs. Net per pair 17.95

## 2 Matched Pair of Acoustic Suspension Speakers

Lafayette Model SK-55. Allows you to build your own home or car stereo acoustic suspension speaker systems or update the performance of existing ones. Handles 20 watts, 8 ohms, 40-18k Hz. 5" speakers with 1 3/4-lb. magnet structures, 2 1/2" depth.

21 F 02069 Shpg. wt. 6 lbs. Net per pair 14.95

## 3 Matched Pair of Dome Hi-Fi Midranges

Update any existing 8-ohm speaker system for superior midrange stereo performance by substituting this sealed back, dome midrange. Handles 40 watts with response of 1000-10,000 Hz. Includes 1200 Hz crossover network. Low transient distortion. Imported.

21 F 29096 Shpg. wt. 3 lbs. Net per pair 21.25

## The Amazing Lafayette Sound Reproducer

USE IN ANY ROOM

Turns Virtually Any Surface into a Speaker

\$7.95 Made in U.S.A.

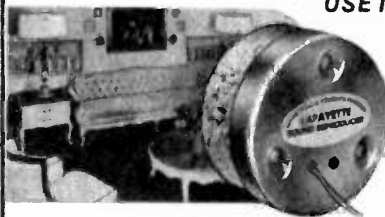

A coneless reproducer that attaches to most any object, transforming it into a sound-

ing board. For 4-, 8- or 16-ohm equipment. With built-in attaching magnet and screws. Size: 2" diameter x 1 1/2" high.

21 F 01590 Shpg. wt. 1 lb. Net 7.95

## Super-Thin LAFAYETTE "Poly-Planar" Speakers



12-Inch Speaker  
\$10.95

Deluxe 12-Inch Speaker  
\$12.95

5-Inch Speaker  
\$5.95

5 12-Inch System  
\$17.95

5 5-Inch System  
\$12.95

8 Outdoor Speaker  
\$8.95

Wafer-type loudspeakers employing a lightweight acoustic panel supported by a frame of polystyrene plastic material to reproduce frequencies from 30-20,000 Hz. Impervious to temperature, humidity, shock and vibration extremes. Low distortion, high electromagnetic efficiency.

## 1 12" Poly-Planar Wide-Range Speaker

Wide range of uses, including hi-fi, marine, etc. Handles 15 watts, 30-20,000 Hz. 1" diameter voice coil; 4.8-oz. magnet. 8 ohms. Operates at temperatures of up to 175°F. 1 1/8" x 14 1/8" x 1 1/8".

21 F 56016 Shpg. wt. 2 lbs. Net 10.95

## 1 Deluxe 12" Poly-Planar Wide-Range Speaker

Same as above, but handles 25 watts, 30-20,000 Hz.

21 F 56081 Shpg. wt. 2 lbs. Net 12.95

## 1 5" Poly-Planar Wide-Range Speaker

Similar characteristics to above but designed especially for small places. Handles 18 watts peak, 60-20,000 Hz. Operates from -20° to 175°F. 8 ohms. 3/4" voice coil. 4 1/2" x 1 1/8" x 8 1/2".

21 F 56024 Shpg. wt. 1 1/4 lbs. Net 5.95

## Grilles for Poly-Planar Speakers

High-impact plastic, walnut grain finish. For custom flush mount.

21 F 56040 For 12" Speaker. Shpg. wt. 2 1/4 lbs. Net 3.95

21 F 56057 For 5" Speaker. Shpg. wt. 11 oz. Net 1.95

## 5 Outdoor Poly-Planar Hi-Fi Speaker Systems

12" System: High-impact, white styrene enclosure. With 8-ft. cable and hardware. Handles 25 watts peak, 40-20,000 Hz. 8 ohms.

21 F 56032W 2 x 13 1/4" x 16 1/4". Shpg. wt. 4 lbs. Net 17.95

5" System: As above, but 5" speaker, 8 watts peak, 70-20 kHz.

21 F 56073 1 3/8" x 6" x 10". Shpg. wt. 2 lbs. Net 12.95

## 6 8" Round Poly-Planar Super-Thin Hi-Fi Speaker

Replaces conventional 8" cone speakers in all applications. Shallow depth—only 1.05". Impervious to environmental extremes. Handles 10 watts, 20-30k Hz. 3/4" voice coil. 8 ohms. 8" diameter.

21 F 56065 Shpg. wt. 1 lb. Net 8.95

Charge It with Your BankAmericard or Master Charge.

# Speakers and Accessories—Build Yourself Great Sound

## Phillips Speaker System Kits

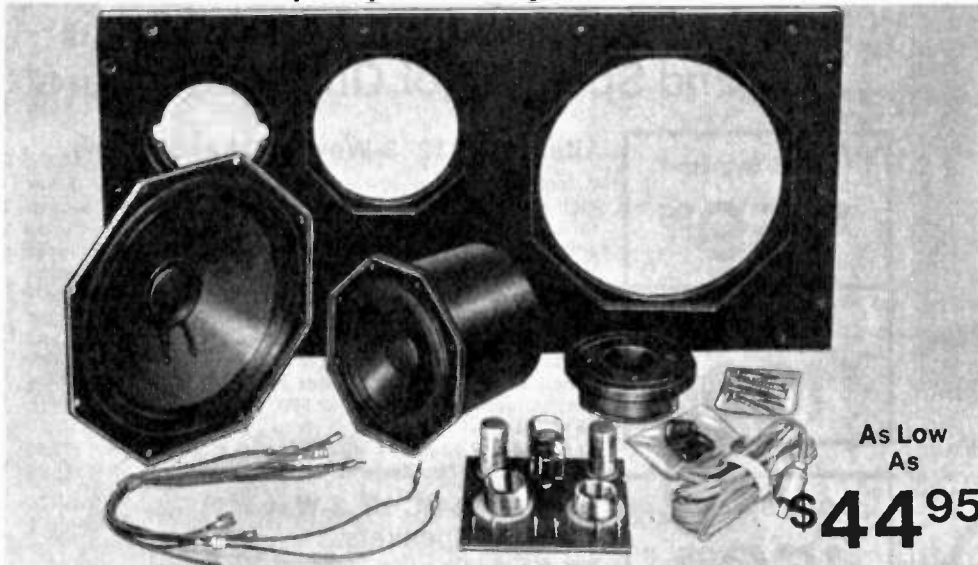

As Low  
As

**\$44<sup>95</sup>**

**1** ADK 0310. Pair of 15-Watt 2-Way High-Fidelity Systems. 8 ohms. 50-18,000 Hz, crossover freq. 2,400 Hz. Build complete loudspeaker baffle assembly for two 2-way systems. No soldering. With 5" woofers, 1" voice coils, 10-oz. magnets, baffle boards, 2 1/4" cone tweeters, instructions. Imported. 21 F 29088W Wt. 6 lbs. . . . Net per pr. 49.95

**2** ADK 2020 30-Watt 2-Way High Fidelity System. 30 watts RMS. 8-ohm impedance, frequency range 45-22,000 Hz, crossover freq. 1,600 Hz. No soldering required. 8" woofer, 1" voice coil, 11-oz. magnet, baffle board, full instructions included. Easy hook-up, color-coded wires. Imported. 21 F 29070W Shpg. wt. 7 lbs. . . . Net 44.95

**3** ADK 2525 40-Watt 3-Way High Fidelity System. 8-ohm impedance, frequency range 42-22,000 Hz. Crossover freq. 500/4,500 Hz. With 8" woofer, 1" voice coil, 11-oz. ceramic magnet, 5" midrange, 1" voice coil, 10-oz. magnet, 1" super-tweeter, baffle board, instructions. Imported. 21 F 29062W Shpg. wt. 11 lbs. . . Net 65.95

**4** ADK 3540 60-Watt 3-Way High-Fidelity System. 8-ohm impedance, frequency range 33-22,000 Hz. Crossover freq. 500-4,500 Hz. With 10" woofer, 2" voice coil, 2-lb. magnet; 5" midrange; 1" voice coil, 10-oz. magnet; 1" super-tweeter; 10-oz. magnet, baffle board and instructions for one enclosure. 21 F 29054W Imp. Shpg. wt. 17 lbs. Net 79.95

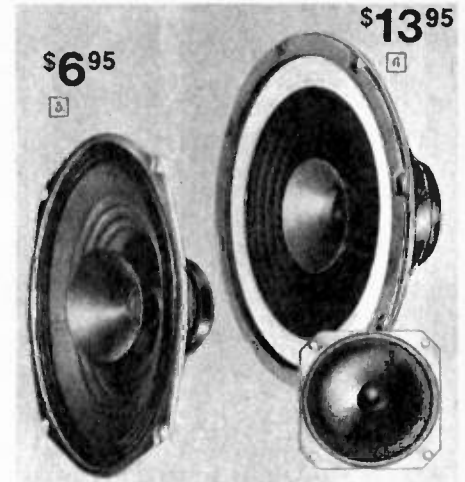

**\$6<sup>95</sup>**

**\$13<sup>95</sup>**

**5** Lafayette 6x9" Wide-Range Speaker. Offers true hi-fi sound, 10-ounce ceramic magnet, 1" voice coil for high sensitivity. Wide-range response: 45-17,000 Hz. Total depth 3", screw terminals, no soldering. Impedance 8 ohms. Outside dimensions 6 3/8" x 9 3/8". Baked-on lacquer-finish. 30 watts. 21 F 47270 Shpg. wt. 3 lbs. . . . Net 6.95

**6** Lafayette Woofer, Tweeter, Crossover Kit. Preassembled wiring harness (color-coded wires) includes crossover capacitor, terminal board for connection with screws or phono pin plug. Woofer has 10-ounce ceramic magnet, cloth-edge cone suspension. Closed-back high-frequency tweeter. Response: 40-20,000 Hz. Imped.: 8 ohms. 21 F 02044W Shpg. wt. 3 1/2 lbs. . . Net 13.95

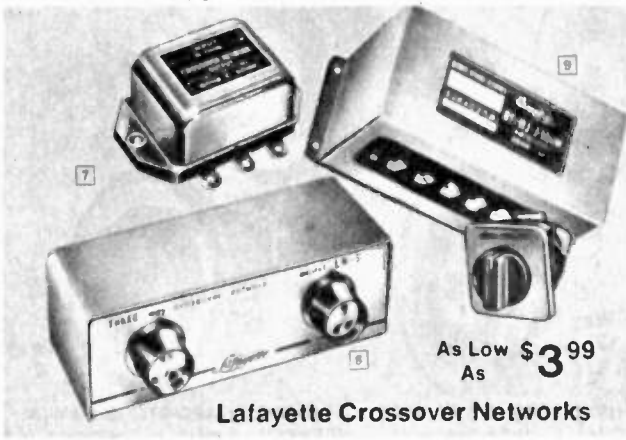

As Low  
As **\$3<sup>99</sup>**

### Lafayette Crossover Networks

- 7** 2-Way Crossover. Designed for 8-ohm woofers and tweeters. Crossover at 3,000 Hz. Lug terminals—easy hookup. Fiber mounting for clear pickup. Mount on inside of speaker cabinet, instructions and metal case. 3 1/2" x 1 7/8" x 1 1/4". Imported. 99 F 01406 Shpg. wt. 6 oz. . . . Net 3.99
- 8** 2-Way Crossover. Set at 2,500 or 5,000 Hz. Brilliance-level control with long shaft and 2 1/2-foot cable. Accessible screw terminals. For 8-16-ohm speakers. Full instructions. Metal case: 5 7/8" L x 2 5/8" H x 2 5/8" D. Imported. 99 F 00218 Shpg. wt. 2 lbs. . . . Net 13.95
- 9** 2- and 3-Way Crossover. Six combinations are possible! For 8-16-ohm speakers. Brilliance and presence controls, 3-foot leads. Use either 2-way or 3-way 6 dB per octave network. Escutcheon plate for external mounting. Imported. 99 F 00226 Shpg. wt. 4 lbs. . . . Net 22.95  
Charge It with Your BankAmericard or Master Charge.

### LAFAYETTE Hi-Fi Acoustic Suspension Speakers

- 1" Voice Coil Diameter
- 1 3/4-lb. Magnet Structure

SK118  
8" Speaker

**\$9<sup>95</sup>**

SK112  
12" Speaker

**\$12<sup>95</sup>**



Quality hi-fi speakers for acoustic suspension systems. Both models have cloth-roll suspension, 8-ohm impedance. Frequency response: SK118 30-20,000 Hz. SK112 28-18,500 Hz. SK118 Depth 3", outside dia. 8 1/8". SK112 Depth 4 1/8", outside dia. 12 1/8". Cabinet plans are included with each speaker. Peak handling power: 30 watts. Viscous edge-roll treatment seals speakers for smooth treble. Great for hobbyists, do-it-yourselfers.

Stock No.	Model No.	Type	Shpg. Wt.	Net ea.
21 F 01756	SK118	8" Speaker	3 lbs.	9.95
21 F 01764	SK112	12" Speaker	4 lbs.	12.95

# utah \$1.00 SPEAKER OFFER!

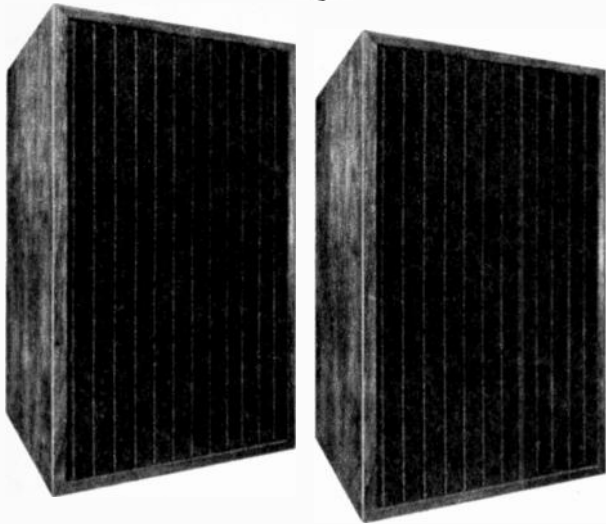

Buy 1 *utah* Speaker at Regular Price  
...Buy 2nd Speaker for Only \$1.00 More!

ONE System  
**\$159<sup>95</sup>**

TWO Systems  
**\$160<sup>95</sup>**

## Utah HS4B 12" 3-Way Speaker Systems

A fantastic speaker system offer! Buy one Utah 12" 3-way high-efficiency system at its regular price, get the second for \$1. Two horn-loaded drivers in the HS4B put new richness and vitality into the middle frequencies, and crisp brilliance into the highs. Heavy-duty 12" woofer has a 6¼-lb. magnet structure and 2" 4-layer voice coil, with resonance of only 28 Hz. Has 3½"x8" midrange compression horn and 1" dome radiator HF driver with 3½"x3½" flared horn. Midrange and HF control. Hand-rubbed oil walnut veneer wood cabinet. Response: 25-19,500 Hz. Power handling capacity: 90 watts peak. Crossover at 2500 and 5000 Hz. Impedance: 8 ohms. 15 x 25¼ x 14".

21 F 47544HW Shpg. wt. 49 lbs. ....Net 159.95  
22 F 92902WM Two Systems. Shpg. wt. 98 lbs. ....Net 160.95

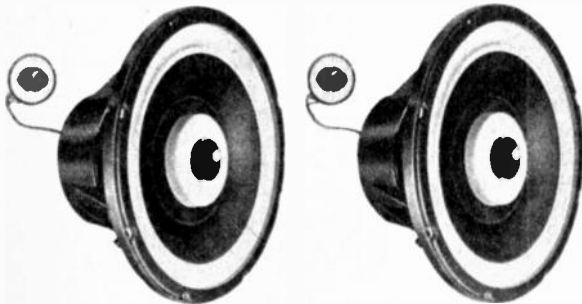

## Utah HL12-HC 12" 3-Way Die-Cast Speakers

Buy one of Utah's finest speakers at our regular price . . . and buy a second for only \$1.00. Powerful 12" speaker features a rigid, die-cast frame for front or rear mounting. Permanently viscous cone edge treatment damps resonances and seats surround fabric. Woofer has 6¼-lb. magnet structure, 2" voice coil; coaxial midrange cone and compression horn tweeter. Prewired brilliance control. Spring-loaded fingertip terminals. Freq. response: 23-20,000 Hz. Power handling: 70W peak. Free air resonance: 25 Hz. 8 ohms. 6½"D. 21 F 47551HW Shpg. wt. 16 lbs. ....Net 59.95  
22 F 92894WM Two Speakers. Shpg. wt. 32 lbs. ....Net 60.95

# utah Hi-Fi Speakers and Speaker Systems

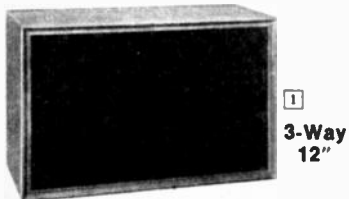

1  
3-Way  
12"

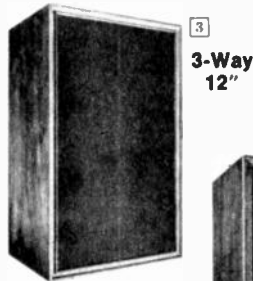

3  
3-Way  
12"

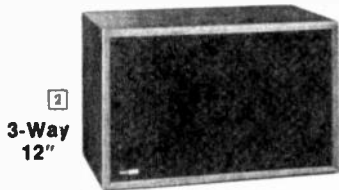

2  
3-Way  
12"

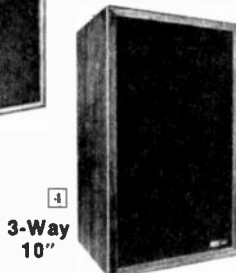

4  
3-Way  
10"



5  
3-Way  
12"

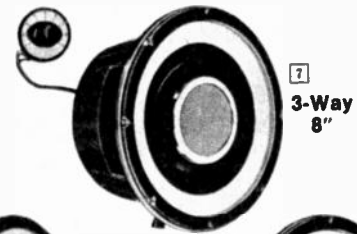

7  
3-Way  
8"

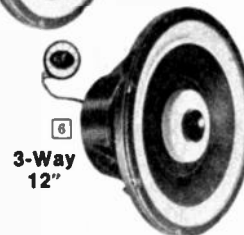

6  
3-Way  
12"

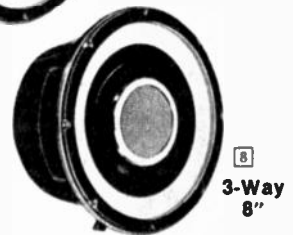

8  
3-Way  
8"

1 **MK-33 DELUXE 3-WAY 12-INCH ACOUSTIC SUSPENSION SYSTEM.** Features 12" high-compliance woofer with viscous-damped cloth roll suspension, 2½-lb. Alnico V magnet assembly, 1½" voice coil. Compression midrange driver; phenolic dome 1" tweeter. 30-20,000 Hz. Capacity: 60 watts. 8 ohms. HF control. 15¼ x 24 x 12".  
21 F 47700WX Wt. 40 lbs. Net 129.95

2 **MK-25 3-WAY 12" ACOUSTIC SUSPENSION SYSTEM.** Has 12" high-compliance woofer with 2¼-lb. Alnico V magnet, 1½" VC; 8" direct radiator midrange; 3½" tweeter. 32-18,000 Hz. Capacity: 50W. 8 ohms. HF control. 14 x 23 x 10"D. 21 F 47692WX Wt. 33 lbs. Net 109.95

3 **UTAH A-90D 3-WAY 12" ACOUSTIC SUSPENSION SYSTEM.** Perfectly matched components; 12" high-compliance woofer with 2¼-lb. Alnico V magnet, cloth cone edges and 1½" VC; 8" midrange; 3½" tweeter with treble control. Hand-rubbed walnut finish. Resp.: 35-18,000 Hz. 30 watts (60 peak). 8 ohms. 14 x 23 x 10".  
21 F 47726WX Wt. 33 lbs. Net 99.95

4 **UTAH A-60D 3-WAY 10" ACOUSTIC SUSPENSION SYSTEM.** Decorator-styled, walnut veneer wood cabinet. 10" woofer has 2-lb. magnet structure. 6" midrange; 3½" tweeter. Resp.: 45-18,000 Hz. Cap.: 20 watts. 8 ohms. 12 x 22 x 8".  
21 F 47664WX Wt. 23 lbs. Net 69.95

5 **UTAH HP12PC-HC 3-WAY 12" SPEAKER.** Offers powerful bass plus sparkling highs, dispersed by horn-loaded compression tweeter. Has 4-lb. magnet assembly, 1½" voice coil. Response: 23-20,000 Hz. Power handling: 45 watts peak. Resonance: 25 Hz. 8 ohms. Depth 5¾".  
21 F 47668W Wt. 13 lbs. .Net 49.95

6 **UTAH C12PC-3TC 3-WAY 12" DUAL-CONE SPEAKER.** Asymmetric frame assures perfect alignment of critical moving elements. Direct radiator tweeter. 4-lb. magnet assembly, 1½" VC. Response: 25-19,500 Hz. Power: 45 watts peak. Resonance: 25 Hz. 8 ohms. 5¾" deep.  
21 F 47650W Wt. 11¼ lbs. Net 44.50

7 **UTAH HP8PC-3TC 3-WAY 8" SPEAKER.** Superb performance at a modest price. Has 4-lb. magnet assembly, handles 35 watts peak. Frequency response: 28 to 19,500 Hz. Resonance: 53 Hz. Imped.: 8 ohms. 7¼" mtg. dia.; 3¾" deep.  
21 F 47718W Wt. 6½ lbs. Net 39.95

8 **UTAH HP8JC-3T 3-WAY 8" SPEAKER.** Dual-cone speaker has a sensitive direct-radiator tweeter. Can be front- or back-mounted to baffle. Response: 32-20,000 Hz. Power handling: 30 watts peak. Has 1¼-lb. magnet assembly, 1" VC. Resonance: 55 Hz. Impedance: 8 ohms. Size: 8¼" dia. x 3¾" deep.  
21 F 47676W Wt. 5½ lbs. Net 29.95



# Lafayette "Decorator" Hi-Fi Furniture—Beautiful!

## 1 Contemporary All-Purpose Shelf Unit

**\$49<sup>95</sup>**

65½ x 30½ x 15½"  
(WHD)

compartments for

- Receiver
- Amplifier and Tuner
- Pull-Out Shelf for Record Changer
- Speaker Systems
- Records • Tapes

"Spruce Up" your stereo with this fine shelf unit that provides you with a good-looking display for your components plus all the storage you're likely to need for records and tapes. Has walnut-colored vinyl PERMANEER finish — resists stains and smears, wipes clean with a damp cloth. Rear panel has outlet holes for easy plug-in of all components, the 15½" depth accommodates most receivers and amplifiers. Speaker sections are fully separated for best stereo effect. Shipped knocked down to save cost, assembles with just a screwdriver.

20 F 16004WX Shpg. wt. 91 lbs. . . Net 49.95

## 2 Chrome/Walnut Record Cabinet

Nicely-styled record cabinet features washable, stain-resistant PERMANEER finish, sturdy press-board construction. Holds up to 150 records, keeps your collection clean and dust free, neat and easily accessible. Upper shelf is great for knick-knacks, serving table, etc. Knocked down.

20 F 16038W Shpg. wt. 26 lbs. . . Net 16.95

## 3 Hi-Fi Component Table

Great for compact and modular systems. Top and bottom shelf of walnut-grain laminated wood, brass holders for up to 80 records. Top shelf, 21 x 19 x 12½", speaker supports 12 x 12". Knocked down, assembles easily.

20 F 54005W Shpg. wt. 13 lbs. . . Net 15.95



components not included

## Decorator Grille Cloth

Description	Stock No.	Net	Stock No.	Net
Natural linen with white slubs	20 F 12532	3.75	20 F 12540	2.05
Dark walnut linen with gold slubs	20 F 12557	3.75	20 F 12565	2.05
Natural beige cane on black ground	20 F 12189	3.75	20 F 12243	2.05
Solid black waffle with interwoven black luster	20 F 12573	4.25	20 F 12581	2.25
Beige waffle weave with walnut thread	20 F 12391	4.25	20 F 12409	2.25
Raised walnut waffle cane	20 F 12631	4.25	20 F 12649	2.25
Fine gold mesh	20 F 12128	4.25	20 F 12201	2.25
Raised walnut figure on black ground	20 F 12805	4.25	20 F 12787	2.25
Heavy gold raised metallic woven on dark ground	20 F 12672	4.25	20 F 12680	2.25
Solid-walnut-heavy lattice weave	20 F 12730	4.65	20 F 12748	2.55
Silver and blue metallic waffle	20 F 12615	4.65	20 F 12823	2.55
Black ground with metallic gold scroll	20 F 12136	4.85	20 F 12219	2.55
Blended walnut tones in diamond	20 F 12433	4.85	20 F 12441	2.55
Raised walnut wicker weave on dark ground	20 F 12480	4.85	20 F 12508	2.55
Walnut woven-wood weave	20 F 12656	4.85	20 F 12664	2.55

## Fiberglass Speaker Insulation

Inch-thick sound absorbent material for enclosures, consoles, etc. Nine sq. ft. with glue and applicator.

**Low As \$1<sup>99</sup>**  
20 F 15014 Shpg. wt. ¾ lb. . . Net 1.99  
20 F 15022 As above, 20 sq. ft. 16 x 16 x 1". Shpg. wt. 2½ lbs. . . Net 3.49

## Level and Screws

**\$3<sup>99</sup>** For accurate turntable leveling to prevent record wear. Four-way bubble-type level, 4 adjusting screws, T nuts.  
24 F 80341 Shpg. wt. 4 oz. . . . Net 3.99

## Music Sounds Better on Speakers You Build Yourself!

### Floor/Shelf Speaker Enclosure

- Solid ¾" Wood Construction
- Acoustically Transparent Grille

Beautifully-designed walnut-veneer speaker enclosures let you use woofers and tweeters to create your own sound system. Feature vented port design and fiberglass lining for improved response from most any components, ¾" wood construction for resonance resistance. Factory-mounted, luxurious, brown tweed grille cloth, mounting board with cutouts for woofer and tweeter. Back has lug terminal strips for easy speaker hookup. All four sides finished in oiled walnut to enhance any decor.

20 F 01501W For 12" Floor/Shelf Speakers. Shpg. wt. 35½ lbs. . . . . Net 36.95  
20 F 01519W For 8" Floor/Shelf Speakers. Shpg. wt. 20 lbs. . . . . Net 24.95

### Our Finest Floor Standing Speaker Enclosure

Build the speaker of your dreams with components you choose and this handsome, quality-crafted deluxe enclosure. Has mounting board with cutouts for 15" (adapter for 12") woofer, 8½", 8" or 6" midrange, and most any tweeter. Precision parts fit together for an air-tight enclosure and better sound, interior acoustic lining prevents reverberation and cabinet resonance. Kit form is sanded smooth, ready to finish, assembled form is walnut-finished on four sides. Good-looking plastic grille, solid ¾" wood throughout. With 2¾" high island-type base. Shpg. wt., 63 lbs.

**Assembled (Walnut Finish)**  
20 F 01451WX . . . . . Net 74.95  
20 F 01493WX Kit (Unfinished) . . Net 49.95

12"  
**\$36<sup>95</sup>**  
23¾ x 14¾ x 12¼" (WHD)

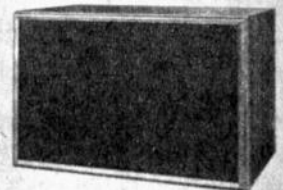

8"  
**\$24<sup>95</sup>**  
18 x 11 x 9" (WHD)

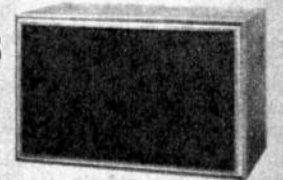

**\$49<sup>95</sup>**  
Unfinished Kit  
**\$74<sup>95</sup>**  
Walnut-Finish Assembled

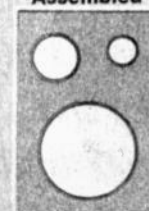

22 x 27 x 16" (WHD)

# See Lafayette For Stereo Headphone Satisfaction



**\$34<sup>95</sup>**

With 6' Coiled Cord



**\$29<sup>95</sup>**

With 6½' Cable



**\$24<sup>95</sup>**

With 5' Cord

## F1000 Two-Way Headphones

- Left/Right Channel Volume Controls
- 2½" Woofer/Tweeter Transducers

Enjoy the "personal" experience of close-up stereo with full-fidelity and all the volume you like. The stereo phones feature specially-designed full-range 2½" woofer/tweeter transducers with individual volume controls, soft, foam-filled earcushions for full comfort and an excellent seal, foam-filled adjustable leatherette headband. Wear 'em for hours without tiring. 20-20,000 Hz response. 8 ohms impedance. With 6-ft. coiled cord, standard ¼" plug. Imported.

99 F 02552 Shpg. wt. 2½ lbs. . . . . Net 34.95

## F990 3½" Transducer Phones

- Airtight Cushions for BIG Sound
- Adjustable, Cushioned Vinyl Headband

Lightweight and comfortable phones feature 3½" wide-range transducers in each earcup for full fidelity "private" stereo listening. The fully adjustable, cushioned, vinyl headband rests gently on your head, the soft earcushions provide an airtight seal so all the sound gets to your ears (where you want it!), not the room. Full 20-20,000 Hz response, 8 ohms impedance. With 6½-ft. cable, standard ¼" phone plug. Imported.

99 F 02099 Shpg. wt. 2½ lbs. . . . . Net 29.95

## F600 "Open-Acoustic" Phones

- Open-Acoustic Design Seems to Completely Surround You with Sound

Specially designed, lightweight phones feature foam cushions which provide an air-tight seal, yet still give the listener a feeling of spaciousness and surround sound. Full-fidelity response from 20-20,000 Hz. 200 ohms impedance. With 5' cord, standard ¼" phone plug for any receiver or amplifier. Imported.

99 F 03329 Wt. 2 lbs. . . . . Net 24.95

## 1 SP77 2½" Transducer Phones

- Left/Right Channel Volume Controls

Good-sounding, 2½" transducer phones feature individual, slide-type volume controls on each earcup for precise sound tailoring, padded cushions and headband. 20-18,000 Hz response. 8 ohms. 6-ft. cord, ¼" plug. Imported.

99 F 02982 Shpg. wt. 1½ lbs. . . . . Net 19.95

## NEW! SP25 Low-Priced Phones

- Ideal for Use with Stereo Phonographs, Lower-Power Stereo Receivers and Amplifiers

Fine-quality stereo headphones at a price most everyone can afford. Offer good sensitivity so they can be used even with low-power stereo phones or consoles, adjustable headband for lightweight comfort. Foam-filled vinyl earcushions seal out room noises. 2¼" transducers provide good-fidelity sound. 35-12,000 Hz response, 8 ohms impedance. Weigh just 10 oz. Imported.

99 F 03238 Shpg. wt. 1 lb. . . . . Net 6.95

## 2 SP55 2½" Transducer Phones

High sensitivity—signal power of 1 to 2 mW provides adequate volume levels. Vinyl headband, foam-filled earcushions with 2½" wide-range transducers. 30-15,000 Hz response, 8 ohms impedance. 5-ft. cord, ¼" plug. Imported.

99 F 01935 Shpg. wt. 1½ lbs. . . . . Net 12.95



**\$19<sup>95</sup>**

With 6' Coiled Cord  
With Individual  
Volume Control



**\$12<sup>95</sup>**

With 5' Cord



**\$6<sup>95</sup>**

With 6' Cord

# Best-Selling Lafayette 4-Channel Headphones



**\$44<sup>95</sup>**

With 6' Cord



**\$29<sup>95</sup>**

With 6½' Cord



**NEW  
LOW  
PRICE!**

## F4400 4-Channel Headphones

- Four Acoustically-Isolated Speakers
- Built-in Derived 4-Channel Circuit

Deluxe discrete 4-channel headphones let you listen to all 4-channel program sources through any 4-channel receiver or amplifier, get 4-dimensional sound from all your stereo sources (2-channel), too! Has four 2¼" full-range transducers, fully padded headband and earcushions, unique baffle plate for excellent front-to-rear acoustic separation. Has 2/4-channel switch. 20-20,000 Hz response, 4-16 ohms impedance. With 6' cord, two ¼" phone plugs for 4-channel amplifiers and receivers.

99 F 02925 Imported. Wt. 3 lbs. . . . . Net 44.95

## F400 "Open Acoustic" 4-Channel Phones

- Was \$39.95 in Catalog 744
- Four Separate 2" Transducers

Fully compatible—use with any 2- or 4-channel amplifier or receiver! Features featherweight foam earcushions, fully adjustable headband, four wide-range 2" transducers with polyester film diaphragms for breathtaking 4-channel sound. The "open acoustic" design enhances the left-right-front-rear separation — sound seems to come from all sides of the room. Full 20-20,000 Hz response, 8 ohms impedance. With 6½' cord, two ¼" phone plugs.

99 F 03188 Imported. Wt. 2 lbs. . . . . Net 29.95

## Lafayette Headphone Accessories

**1** Stereo Headphone Volume Control. For phones without self-contained volume controls. 6' cord, ¼" plug, 2' headphone cord. 99 F 00242 Imported. Shpg. wt. ½ lb. Net 6.50

**2** 10-Ft. Stereo Headphone Extension Cord. Has 3 spade lug terms, instead of phone plug, for amplifiers without stereo headphone jack. 99 F 01695 Imported. Shpg. wt. ¼ lb. Net 2.95

**3** Stereo/Mono Headphone Adapter. In-line phone jack to mini-plug—use stereo phones with mono recorders, port. radios & TV sets. 99 F 63075 Imported. Shpg. wt. 2 oz. Net 1.49

**4** 10-ft. 4-Channel Coiled Headphone Extension Cord. Plugs into 4-channel receivers and amplifiers, lets you extend headphones.

99 F 03212 Imported. Shpg. wt. 1 lb. . Net 6.95

**5** "Y" Adapter for Dual Headphone Listening. Connects two stereo headphones to a single headphone output. ¼" phone jacks. 3 ft. long. 99 F 00960 Imported. Shpg. wt. 6 oz. . Net 3.49

**6** 25-ft. Stereo Coiled Headphone Extension Cord. 3-cond cable lets you listen from anywhere in your room. Standard ¼" plugs, jack. 99 F 01166 Imported. Shpg. wt. ¾ lb. Net 4.49



Only  
**\$5<sup>95</sup>**  
With 9' Cord  
and Plug

- Use with  
Cassette  
Recorders,  
Portable  
Radios,  
TV Sets

**SP-11 Mono Headphones**

Quality headphones for private listening enjoyment from monophonic cassette recorders, portable radios, TV's, etc. Has soft foam earpads, wide-range mylar transducers for 30-13,000 Hz response. Use with any portable mono units with a standard earphone jack. 4 to 32 ohms impedance. Imported.

99 F 03378 Shpg. wt. 1 lb. . . . . Net 5.95



**\$6<sup>50</sup>**

**\$2<sup>95</sup>**



**\$1<sup>49</sup>**



**\$6<sup>95</sup>**



**\$3<sup>49</sup>**



**\$4<sup>49</sup>**



**Headphone Remote  
Control Box \$5<sup>95</sup>**

Connects 1 or 2 sets of stereo headphones to systems without headphone jacks. NO NEED TO DISCONNECT SPEAKERS. Has separate phone volume controls, speaker muting switch. 4¾ x 1¾ x 1¾". 4-16 ohms impedance. Imported.

99 F 00366 Shpg. wt. ¾ lb. . . . . Net 5.95

# Koss, Sennheiser & Pioneer Stereo Headphones



1  
\$54<sup>95</sup>

NEW  
LOW  
PRICE!  
\$52



2

\$90



4  
\$49<sup>95</sup>



**KOSS**

• Listen in Full Privacy, Yet Still Hear What's Going On Around You!

1 **KOSS HV/1LC STEREO HEADPHONES.** Light-weight, hear-thru, high velocity Stereophone has volume-balance controls on each earcup for precise tonal adjustment without getting up and adjusting amplifier or receiver controls. Revolutionary design vents the back sound waves through rear of cup without raising the resonance or inhibiting transient response for superb sound (and you can hear what's going on around you). Response: 20-20,000 Hz. Total harmonic distortion: less than 0.5% at 109 dB-SPL. Impedance: 3.2 to 600 ohms.

21 F 45274 Shpg. wt. 2½ lbs. . . . . Net 54.95

**Model HV-1.** Same as above but without volume-balance controls.

21 F 45258 Shpg. wt. 2½ lbs. . . . . Net 44.95

2 **KOSS PRO/4A DYNAMIC STEREO HEADPHONES.** Offers smooth, fatigue-free response. Has a 1", virtually blowout-proof voice coil, and an oversize diaphragm with 4 sq. inches radiating area. Fluid-filled ear cushions. 10-20,000 Hz. THD: negligible at 95 dB-SPL. 3.2-600 ohms. 21 F 45209 Shpg. wt. 2½ lbs. . . . . Net 52.00

3 **KOSS K/2+2 QUADRAFONE®.** Four 1½" dynamic driver elements (two in each earcup) to surround you with full-dimensional quadraphonic sound from 4-channel matrix or discrete systems. Has volume-balance controls on each earcup. Two-channel selector switch. 10-20,000 Hz. THD: less than 0.5% at 109 dB-SPL. Impedance: 3.2 to 600 ohms. Fluid-filled ear cushions and expandable headphone.

21 F 45225 Shpg. wt. 3½ lbs. . . . . Net 90.00

4 **KOSS K/6LCQ QUADRAFONE®.** For use with stereo or 4-channel systems—offers full 4-channel performance at a 2-channel headphone price. Four 1½" dynamic drivers (two in each earcup) deliver outstanding surround sound from discrete or matrix 4-channel sources, can also be used as conventional stereo phones. Has 2-channel/4-channel selector switch, comfortable fluid-filled earcups. Slide-type volume and balance for precise left-right-front-rear sound tailoring. Expandable headband fits anyone, light enough to wear for hours without fatigue. 20-17,000 Hz. THD: less than 0.5% at 109 dB-SPL. 3.2 to 600 ohms impedance.

21 F 45266 Shpg. wt. 3 lbs. . . . . Net 49.95



5  
\$35

6  
\$57

5 **SENNHEISER HD 424 STEREO HEADPHONES.** Designed for the hi-fi enthusiast who demands the finest in acoustical quality and wearing comfort. Delivers outstanding reproduction over the entire audible frequency range (16 to 20,000 Hz) . . . plus natural reproduction of low frequencies at low sound volume: 2000 ohms impedance Imported.

21 F 58012 Shpg. wt. 1½ lbs. . . Net 57.00

6 **SENNHEISER HD 414 "OPEN-AIRE" STEREO HEADPHONES.** Unique "open air" foam ear cushions drastically reduce weight and bulk (weighs only 5 ounces with cord). Features 1¾" wide-range transducers. Frequency response: 20 to 20,000 Hz. 2000 ohms impedance. Connects directly to either high- or low-impedance outputs. Complete with 10-foot cable and stereo plug. Imported.

21 F 58004 Wt. 1½ lbs . . . Net 35.00

**PIONEER**



7  
\$79<sup>95</sup>

7 **PIONEER SE-700 STEREO HEADPHONES.** The world's first high-polymer stereo headphones, delivering superb tonal quality. Operates using the piezoelectric effect . . . as audio signals reach the headphones, the driver elements of ultra-thin, aluminum-coated, high-polymer film expand and contract, creating an ideal "breathing" motion for natural, unmechanical audio response. Tonal characteristics are comparable to electrostatic headphones, but no matching transformer is needed; they plug directly into headphone jack. Frequency response: 20- 20,000 Hz. Sensitivity: 100 dB/3V. Source impedance: 4 to 16 ohms.

21 F 31266 Shpg. wt. 2 lbs. . . . . Net 79.95

## Low-Priced Lafayette Stereo Record Changers



\$29<sup>95</sup>

### AC60B 4-Speed Changer

- Automatic and Manual Spindles
- Full-Size 10" Turntable

Four speeds. Has pause/cue control, automatic shutoff, anti-skate. Ceramic turnover cartridge with diamond LP needle. Plays 6 records. With cables. For 117 VAC, 60 Hz. Less base. Shpg. wt. 7 lbs.

21 F 01814HW Imp. from England. Net 29.95

21 F 01822HW Ebony Base. 2 lbs. Net 6.95

21 F 01830HW Dust Cover. 2 lbs. .Net 6.95

21 F 01848 45-rpm Spindle. 6 oz. .Net 1.50

21 F 01855 Repl. Cartridge. 2 oz. .Net 6.95



\$34<sup>95</sup>

### MC-22B "Mini" 4-Speed Changer

- Ready-to-Play Outfit
- Perfect for Shelf Systems

Dependable 4-speed changer has automatic or manual play with auto shutoff, intermixes 10" and 12" records. Low-mass tonearm, ceramic cartridge with diamond LP needle. Simulated black leather base, tinted dust cover. 14½ x 5 x 10". For 117 VAC, 60 Hz. 21 F 01772W Made in England . . . Net 34.95

24 F 02568 45-rpm Spindle. 3 oz. Net 1.49

Lafayette Has Over 500 Stores from Coast to Coast

# Ready-to-Play Turntable Outfits from BSR

## Model 810QX Deluxe Automatic Turntable

**\$239<sup>95</sup>**

Includes Base, Pickering XV15/400E Elliptical Cartridge, Tinted Dust Cover

Ready-to-play automatic turntable treats records like the precious investment they are: Gyroscopically-pivoted tonearm mounted on 4 bearings for under 1/4-gram tracking; synchronous motor for constant, accurate speed regardless of voltage or record load, variable pitch control and built-in strobe for precision adjustments. Has anti-skate adjustable for elliptical or conical stylus, heavy 7-lb. die-cast turntable platter for smooth, rumble-free performance, viscous-damped cue/pause, stylus overhang and pressure adjustments, rotating manual play spindle. The stylus wear meter lets you know when to replace your stylus, the "full-program" pushbuttons lets you play the 810QX manually, semi-automatic, full-automatic, or repeat play of a single disc. Includes base, deluxe Pickering XV-15/400E elliptical stylus magnetic stereo cartridge, dust cover. 21 1/2 x 19 x 14". For 117 VAC, 60 Hz. Imported.

21 F 52031W Shpg. wt. 30 lbs. . . Net 239.95

**Model 710QX.** Same as 810QX above, but with 4-lb. turntable platter, single gimbal tonearm mount. With base, Pickering V-15 Micro IV/AME elliptical-stylus magnetic cartridge, dust cover. Imported.

21 F 52049W Shpg. wt. 29 lbs. . . . Net 199.95

With Base, Dust Cover, Cartridge—  
**NOTHING ELSE TO BUY!!!**

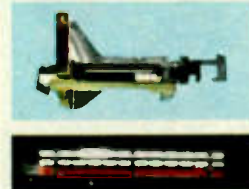

**Sequential CAM System—**  
For smooth, quiet performance.



**Stylus Timer—**  
Shows stylus wear

**GIMBAL-MOUNT TONEARM**  
Tracks low as 1/4 gram.



**PUSH-BUTTON PANEL**  
For automatic, semi-automatic, single or repeat play.

## Complete BSR Turntable Outfits



**\$119<sup>95</sup>**

### Model 2660F

An excellent turntable for "mid-priced" stereo component systems—**READY TO PLUG INTO OTHER COMPONENTS AND PLAY!** Has front controls for really easy operation, level bubble and adjustable feet for perfect horizontal mounting, variable speed control and platter-mounted strobe, stylus-wear meter, slide-in cartridge head with factory-mounted Pickering V15 Micro IV/ATE magnetic stereo cartridge and elliptical diamond stylus. Synchronous motor, viscous-damped cue and pause, adjustable counterweight. Good-looking base with walnut sides, brushed chrome front, tinted dust cover. 17 x 19 x 11 1/2". For 117 VAC, 60 Hz. Imported.  
21 F 52056W Shpg. wt. 20 lbs. . . Net 119.95



**\$69<sup>95</sup>**

### Model 2310X

Latest version of the famous 310X — the **STANDARD** for low-priced turntables. Has a precise 4-pole motor, viscous-damped cue and pause control, adjustable counterweight tonearm and adjustable anti-skate. With walnut-grain and chrome trimmed base, Pickering V-15 Micro IV/ATE elliptical-stylus magnetic stereo cartridge, dust cover. 17 x 19 x 9". 117 VAC, 60 Hz. Imp.

21 F 52064W Shpg. wt. 15 lbs. . . . Net 69.95



**\$54<sup>95</sup>**

### Model 2260X

One of the lowest-priced *magnetic-cartridge-equipped* turntables we know of—for excellent record play with even the lowest-priced component systems. Has counterweighted tonearm, full-size platter, adjustable cue and pause, automatic and single-play spindles. With walnut-finish base, Pickering P/ATE-1 magnetic stereo cartridge, dust cover. 17 x 19 x 19". For 117 VAC, 60 Hz. Imported.

21 F 52072W Shpg. wt. 14 lbs. . . . Net 54.95

**The BSR Quality Story—All BSR turntables are designed to give you the best VALUE-FOR-YOUR-MONEY in their individual price ranges. These models have been individually factory tested to assure that they will perform as described for years of fine record play. The complete outfits on this page include base, cartridge as specified and deluxe hinged dust covers, all hookup cables.**

# Garrard Famous-Quality Automatic Turntables

With Pickering or  
Shure 1¢ Bonus  
**\$209<sup>96</sup>**



With Pickering or  
Shure \$5 Bonus  
**\$214<sup>95</sup>**



## World-Famous Zero 100C

**Famous "Zero Tracking Error"  
Tonearm—Tracks Records the  
Way They're Cut for Flaw-  
less Sound Reproduction**

The outstanding choice for the discriminating music lover—features the "Zero Tracking Tonearm" for perfect tangential tracking—up to 160 times less tracking error than conventional turntables! Has a built-in record counter to tell you when to change your stylus, magnetic anti-skate control, illuminated strobe, Synchro-Lab motor, more. Two-way damped cue/pause control. Plays 33 $\frac{1}{3}$ , 45 rpm. Includes interchangeable automatic and single-play spindles. 15 $\frac{3}{8}$  x 14 $\frac{1}{8}$ ", 4 $\frac{3}{8}$ " above, 2 $\frac{1}{4}$ " below motor board. Less base, cartridge. 117 VAC, 60 Hz. Imported. Shpg. wt. 16 lbs.

- 21 F 28189W Zero 100 alone ..... Net 209.95
- 22 F 91342WM W/Pick. V-15 IV/AME Net 209.96
- 22 F 91359WM With Shure M91E .... Net 209.96
- 22 F 91367WM With Pick. XV15/400E Net 214.95
- 22 F 91375WM With Shure M91ED ... Net 214.95

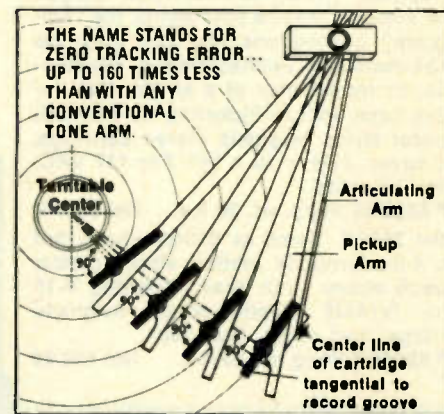

See Page 77 for complete listings  
of Shure & Pickering Cartridges.

## Zero 92—Quality Plus

Has the same fine features and dimensions of of the Zero-100C above, except for magnetic anti-skate, variable speed, record counter and strobe. The lever-type anti-skate control provides precision second only to the Zero 100C; the cartridge carrier and tonearm are identical in every mechanical and electrical respect. In fact, the difference between the Zero 92 and the Zero 100C would be significant only to the most demanding audio perfectionist. 33 $\frac{1}{3}$ , 45 rpm. For 117 VAC, 60 Hz. Imported. Less base, cartridge. Shpg. wt. 15 lbs.

- 21 F 28197W Zero 92 alone ..... Net 169.95
- 22 F 91383WM W/Pick. V-15 IV/AME Net 169.96
- 22 F 91391WM With Shure M91E .... Net 169.96
- 22 F 91409WM With Pick. MV15/400E Net 174.95
- 22 F 91417WM With Shure M91ED ... Net 174.95

## Model 82—Budget-Priced Precision

Similar to Zero 92, except for "Zero Tracking Error" tonearm. Tonearm has conventional fixed offset design, with sliding-weight stylus pressure adjustment and springless anti-skate. Has 2-point record support, pause/cue control, constant-speed Synchro-Lab motor, 15° vertical tracking adjustment. A fine choice for any "mid-priced" component stereo system. 15 $\frac{3}{8}$  x 14 $\frac{1}{8}$ ", 4 $\frac{3}{8}$ " above, 2 $\frac{1}{4}$ " below motor board. 33 $\frac{1}{3}$ , 45, 78 rpm. For 117 VAC, 60 Hz. Imported. Less base, cartridge. Shpg. wt. 14 lbs.

- 21 F 28205W Zero 82 alone ..... Net 119.95
- 22 F 91300WM W/Pick. V-15 IV/ATE Net 119.96
- 22 F 91316WM With Shure M93E .... Net 119.96
- With Pickering V15 Micro IV/AME.
- 22 F 91326WM ..... Net 124.95
- 22 F 91334WM With Shure M91E .... Net 124.95

**1¢ and Cartridge  
\$5.00 Bonuses!**

Buy These Turntables with  
Your Choice of Pickering  
or Shure Cartridges  
SAVE UP TO \$49.95

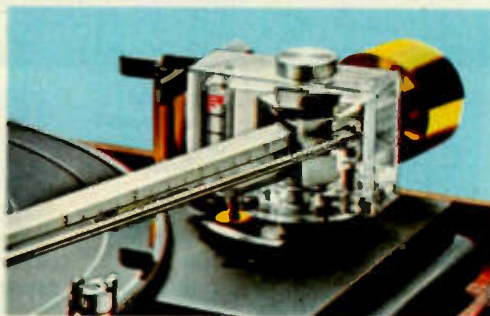

With Pickering  
or Shure 1¢ Bonus  
**\$169<sup>96</sup>**



With Pickering or  
Shure \$5 Bonus  
**\$174<sup>95</sup>**

Choose Any  
of 4  
Cartridges!



With Pickering or  
Shure 1¢ Bonus  
**\$119<sup>96</sup>**



With Pickering or  
Shure \$5 Bonus  
**\$124<sup>95</sup>**

# with Special "Choice-of-Cartridge" Bonuses!



With Pickering  
or Shure 1¢ Bonus  
**\$49<sup>96</sup>** Model 40B



Model 70  
With Pickering or  
Shure 1¢ Bonus  
**\$89<sup>96</sup>**



With Pickering or  
Shure \$5 Bonus  
**\$54<sup>95</sup>**

Model 62  
With Pickering or  
Shure 1¢ Bonus  
**\$69<sup>96</sup>**

With Pickering or  
Shure \$5 Bonus  
**\$74<sup>95</sup>**

### Choose Any of 4 Cartridges!



## Model 40B

One of the most popular Garrard changers, the 40B has a host of features for fine record play. 4-pole shaded "induction surge" motor, adjustable stylus-pressure ratchet, viscous cueing and pause control. 3-speed automatic or manual play. Plays 33½, 45 and 78 rpm. 14½ x 12½", 4¾" above, 3" below motor board. For 117 VAC, 60 Hz. Imported. Less base and cartridge. Shpg. wt. 9½ lbs.

- 21 F 40499W Model 40B alone ..... Net 49.95
- 21 F 40556WM With Pick. PAT/E-1 ... Net 49.96
- 21 F 40564WM With Shure M44E ..... Net 49.96
- With Pickering V-15 Micro IV/ACE.
- 22 F 90310WM ..... Net 54.95
- 22 F 40598WM With Shure M55E ..... Net 54.95

## Model 62

Has \$\$\$-more features for precise record play with minimum fuss and bother. Two-point record support, fixed counterweight tonearm with easy-to-use stylus pressure adjustment, torsion spring adjustable anti-skate. Has cue/pause, full controls for automatic or manual play. 33½, 45, 78 rpm. 14½ x 12½", 4¾" above, 3" below motor board. For 117 VAC, 60 Hz. Imported. Less base and cartridge. Shpg. wt. 10 lbs.

- 21 F 28213W Model 62 alone ..... Net 69.95
- 22 F 91466WM With Pick. V15 IV/ACE Net 69.96
- 22 F 91474WM With Shure M55E ..... Net 69.96
- 22 F 91482WM With Pick. V15 IV/ATE Net 74.95
- 22 F 91490WM With Shure M93E .... Net 74.95

## Model 70

The QUALITY-STANDARD for under \$100 turntables! Low-mass aluminum tonearm, adjustable stylus pressure, slide-in cartridge clip for easy replacement, center-spindle 2-point record support. Has Synchro-Lab motor, "kinetically-matched" turntable platter, cue/pause with downward damping. 33½, 45, 78 rpm. 15 x 13½", 4¾" above, 3" below motor board. For 117 VAC, 60 Hz. Imported. Less base, cartridge. Shpg. wt. 11 lbs.

- 21 F 28221W Model 70 alone ..... Net 89.95
- 22 F 91425WM With Pick. V15 IV/ACE Net 89.96
- 22 F 91433WM With Shure M55E ..... Net 89.96
- 22 F 91441WM With Pick. V15 IV/ATE Net 94.95
- 22 F 91458WM With Shure M93E .... Net 94.95

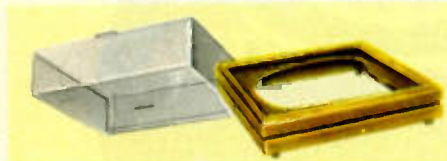

## Garrard Accessories

Stock No.	Model	Description	Net
21 F 28304W	BW-10	Walnut-Finish Base for 40B, 62, 70. 5 lbs.	9.95
21 F 28330W	BW-20	Walnut-Finish Base for 82, 92, 100C. 6 lbs.	14.95
21 F 28289W	D-10	Dust Cover for BW-10. 3 lbs.	7.95
21 F 28296W	D-20	Dust Cover for BW-20. 3½ lbs.	7.95
21 F 40531	FLRS35	45-rpm Spindle for 65B, 55B, 40B, 30, SLX-2, X-10.	2.75
21 F 28254	LRS-50	45-rpm Spindle for 70, 82. 2 oz.	4.50
21 F 28007	LRS-100	45-rpm Spindle for 100C, 92, 82. 6 oz.	4.50
21 F 37966	C2	Cartridge Clip Holder for 40B, SP20B. 2 oz.	4.50
21 F 28239	C3A	Cartridge Clip for 100C, 100, 92, 82. 2 oz.	4.95
21 F 28247	C4	Cartridge Clip for 70, 82. 2 oz.	4.95



**\$159<sup>96</sup>**  
With  
Pickering Cartridge

**Save  
\$39<sup>94</sup>**

## Model 86SB Single-Play Transcription Turntable Outfit

Single-play turntable with all features for fine record play, including precise Synchro-Lab motor, belt-driven 4-lb. turntable, cueing/pause control, sliding weight stylus force setting. Single-play only, tonearm lifts and returns to rest after record is played. With Reg. \$39.95 Pickering V15 Micro IV/ATE magnetic cartridge, base and dust cover. 17½ x 7 x 15¼". For 117 VAC, 60 Hz. Imported. Shpg. wt. 25 lbs.

- 22 F 92563WM With Pick. V15 IV/ATE Net 159.96
- 21 F 28320W 86SB alone ..... Net 159.95



**\$209<sup>96</sup>**  
With  
Pickering Cartridge

**Save  
\$49<sup>94</sup>**

## Zero 100SB Single-Play Transcription Turntable Outfit

Has all the features of the Zero 100C automatic turntable (page 52) including Zero Tracking Error tonearm, cue/pause control damped in both directions, magnetic anti-skate, belt drive motor! Single play only, tonearm lifts and returns to rest at end of record. With Reg. \$49.95 Pickering V15 Micro/IV AME magnetic stereo cartridge, base and dust cover. 17½ x 7 x 15¼". For 117 VAC, 60 Hz. Imported. Shpg. wt. 25 lbs.

- 22 F 92571WM With Pick. V15 IV/AME Net 209.96
- 21 F 28312W 100SB alone ..... Net 209.95

# Save up to \$54.94 on Dual Turntables

with the Lafayette

**1¢ CARTRIDGE BONUS**



Dual's NEW for '75 turntables ALL feature: dynamically balanced tonearm, direct-dial-set stylus force, anti-skate for conical, elliptical or CD-4 stylus, 6% pitch control for both 33 1/3- and 45-rpm speeds, interchangeable single-play and multiple-play spindles, silicon-damped cueing, low-capacitance leads for use with CD-4 cartridges.



## Professional-Quality Dual 1229Q

**\$259<sup>96</sup>**

With cart., less base

Prestige addition to any home stereo system! Features a low-mass tonearm with 1/4-gram tracking, twin gimbal suspension, 12" dia. turntable with 7-lb., dynamically-balanced platter, synchronous high-torque motor for instant starts and constant speeds. Has adjustable stylus overhang, automatic play spindle for up to 6 records, rotating single-play spindle. 14 3/4 x 12", 5" above and 3" below mounting board. Tracks low as 1/4 gram. 117 VAC, 60 Hz. Imported. Less base, cartridge. **21 F 68326W 1229 Only.** Shpg. wt. 19 lbs. . . . . Net 259.95  
**Save \$54.94. 1229 with Pickering XV-15 400E Cart.**  
**22 F 92613WXM Shpg. wt. 19 lbs. . . . . Net 259.96**  
**Save \$54.94. 1229 with Shure M91ED.**  
**22 F 92621WXM Shpg. wt. 19 lbs. . . . . Net 259.96**



## Music Lover's Standard-Dual 1228

**\$189<sup>96</sup>**

With cart., less base

"Mid-priced" turntable for use in all but the very finest component systems. Has features similar to the 1229Q above, with one-piece cast 4-lb. turntable platter, 4-point gyroscopic gimbal tonearm suspension. Damped counterbalance with coarse and fine adjustments, lighted strobe, synchronous high-torque motor. Tracks 1/2 gram. 13 x 10 3/4", 5" above, 3" below mounting board. For 117 VAC, 60 Hz. Imported. Less base and cartridge. **21 F 68300W 1228 Only.** Shpg. wt. 15 lbs. . . . . Net 189.95  
**Save \$49.94. 1228 with Pickering V-15 Micro IV/AME.**  
**22 F 92639WXM Shpg. wt. 15 lbs. . . . . Net 189.96**  
**Save \$49.94. 1228 with Shure M91E. Cartridge.**  
**22 F 92647WXM Shpg. wt. 15 lbs. . . . . Net 189.96**

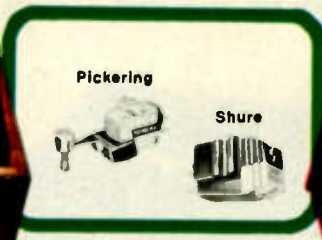

**\$159<sup>96</sup>**

## Dual 1226 Auto/Manual Turntable

With cart., less base

Fine-quality turntable has 4-lb., one-piece die-cast turntable platter, rotating, single-play spindle, 3/4-gram tracking. 12 1/2 x 10 3/4", 5" above, 2 3/4" below mounting board. For 117 VAC, 60 Hz. Imported. Less base and cartridge. **21 F 68284W 1226 Only.** Shpg. wt. 15 lbs. . . . . Net 159.95  
**Save \$49.94. 1226 with Pickering V-15 Micro IV/AME.**  
**22 F 92654WXM Shpg. wt. 15 lbs. . . . . Net 159.96**  
**Save \$49.94. 1226 with Shure M91E.**  
**22 F 92662WXM Shpg. wt. 15 lbs. . . . . Net 159.96**

**\$129<sup>96</sup>**

## Dual 1225 Auto/Manual Turntable

With cart., less base

Even Dual's lowest-priced model for '75 has famous Dual quality. One-gram tracking, fine-adjust counterbalance, 3 3/4 lbs. 12" dia. platter. 12 1/2 x 10 3/4", 5" above, 2 3/4" below mounting board. For 117 VAC, 60 Hz. Imported. Less base and cartridge. **21 F 68318W 1225 Only.** Shpg. wt. 13 lbs. . . . . Net 129.95  
**Save \$39.94. 1225 with Pickering V15 Micro IV/ATE.**  
**22 F 92668WM Shpg. wt. 13 lbs. . . . . Net 129.96**  
**Save \$39.94. 1225 with Shure M93E.**  
**22 F 92670WM Shpg. wt. 13 lbs. . . . . Net 129.96**

### DUAL ACCESSORIES

**MB-10 Walnut-Finish Base.** For 1228, 1226, 1225. Shpg. wt. 3 lbs. **21 F 68243W . . . . . Net 9.95**  
**WB-12 Deluxe Wood Base.** For 1228, 1226, 1225. Wt. 3 1/2 lbs. **21 F 65835W . . . . . Net 14.95**

**WB-19 Wood Base.** For 1229Q. **21 F 66077 Wt. 4 lbs. . . . . Net 15.95**  
**DC-4 Dust Cover** For MB-10, WB-12 Bases. Shpg. wt. 2 lbs. **21 F 68227W . . . . . Net 12.95**  
**DC-9 Dust Cover.** WB-19 base. **21 F 66015W Wt. 2 lbs. Net 15.95**

**CH-12 Cart. Holder.** For 1226, 1225, 1229Q. **21 F 65868 Wt. 3 oz. Net 5.95**

**CH-22 15° Cartridge Holder.** For 1228. **21 F 68110 Wt. 3 oz. . . . . Net 9.95**

**AS-12 45-rpm Spindle.** For all. **21 F 65850 Wt. 4 oz. . . . . Net 9.95**  
**LC-2 Low-cap. cables** for previous Dual models. Wt. 6 oz. **21 F 68292 . . . . . Net 9.95**



**1 Panasonic RQ-711S with Condenser Mike**

Stylish mono recorder is a great take-along for parties, meetings, etc. The built-in condenser mike lets you record unobtrusively, the push-button function controls and pop-in cassette loading make it easy and fun to operate. Has Easy-Matic circuit to regulate recording level, 3" dynamic speaker. With 4 "C" batteries, 117 VAC, 60 Hz line cord. 7 3/8 x 6 1/2 x 3 3/8". Imported. 27 F 12396L Shpg. wt. 3 1/4 lbs. Net 32.88

**2 Craig 2627 with Cue/Review Function**

A "business person's" companion because it has a built-in condenser mike that's perfect for meetings, a cue/review control that permits instant "back-spacing" and repeat PLUS audible Fast-Forward—excellent for dictation! Has automatic end-of-tape shutoff, record level/battery meter, pushbutton control, lots more. Automatic battery charging circuit. Uses 4 "C" cells (order below), 117 VAC, 60 Hz. 5 3/4 x 2 1/2 x 10 1/4". Imp. 27 F 27238L Shpg. wt. 4 lbs. Net 55.95  
99 F 62572 "C" Cells. Use 4 Net ea. 19¢  
Optional Rechargeable NiCad "C" Cells. Use 4. 32 F 48887 Net ea. 4.46

**3 Hitachi TRQ-340 with 3-Way Power**

A "go-anywhere" mono cassette recorder that operates on 4 "C" cells (included!), 117 VAC, 60 Hz house current, or in 12 VDC truck, boat or car (with optional adapter below)! Has built-in condenser mike, pushbutton controls, review button, twin motor system for precise tape speed and consistent performance. Wide-response ferrite head, tape counter, automatic stop, more. 5 1/2 x 2 3/4 x 10 3/8". Imported. 27 F 23195L Shpg. wt. 5 lbs. Net 89.95  
27 F 23203 12 VDC Adapter. 8 oz. Net 19.50

**1 Panasonic RQ-413S with Pause/Review**

Fine-quality recorder great for business people, students, etc. Has built-in condenser mike, automatic stop, digital tape counter, review and pause button, separate volume and tone controls for realistic sound reproduction. Automatic record level control smoothes out voice recordings, easy-to-use pushbutton controls, cassette-eject. Remote mike input. With 4 "C" cells, 117 VAC, 60 Hz line cord, blank cassette. 5 1/2 x 2 3/8 x 10 1/8". Imported. 27 F 12388L Shpg. wt. 4 1/2 lbs. Net 69.95

**Useful and Entertaining Portable Cassette Recorders from Famous Mfrs.**



**1 \$32<sup>88</sup>**



**2 \$55<sup>95</sup>**

**NEW!**



**3 \$89<sup>95</sup>**



**1 \$69<sup>95</sup>**

**Ultra-Compact Monophonic Pocket Cassette Recorders**

**5 Craig 2605 "Electronic Notebook"**

Record your notes and comments while commuting, in waiting rooms, offices, etc. Really tiny cassette recorder has built-in condenser mike and speaker, instant-reset counter, low-battery warning lamp, pause button. 3 1/2 x 5 1/2 x 1 3/8"—perfect for pocket, purse or briefcase. With carry case, handstrap. Operates on 3 "AA" cells (order below), optional AC adapter/recharge kit. Imported. 27 F 27220L Shpg. wt. 2 lbs. Net 114.95  
99 F 62572 "AA" Cells. Use 3 Net ea. 19¢  
117 VAC, 60 Hz Adapter, Ni-Cad Recharge Kit. 27 F 27246 Shpg. wt. 1 lb. Net 19.95

**4 Panasonic RQ-212DS "Mini" Recorder**

Compact size, but full record and play features for people on-the-go. Has digital tape counter, auto-stop, VU/battery meter, pause, fast-forward and rewind. With carry case, AC adapter/recharger, 4 "AA" cells, erase plug. 6 1/2 x 4 x 1 3/4". Imported. 27 F 10283L Shpg. wt. 2 lbs. Net 79.95  
Rechargeable NiCad Battery Pack. RP-9212. 27 F 10275 Shpg. wt. 1 lb. Net 9.95



**5 \$114<sup>95</sup>**

**NEW!**



**4 \$79<sup>95</sup>**

# Portable Cassette Recorders With Built-In AM/FM Radios



**Deluxe Lafayette RK-87 with  
Built-in Condenser Microphone**

**\$69<sup>95</sup>**

Advanced solid-state circuitry. Professional tape monitor facilities. Pause Control for editing or cueing. Automatic Record Level Control. Pushbutton Stop/Eject, Fast Forward, Rewind, Play and Record. Sliderule tuning, telescopic FM antenna, AFC for drift-free FM, and a 3½" speaker. Sturdy

- Records Directly from Radio
- Automatic Shut-Off at End of Tape

plastic case (11½ W x 6½ H x 2¼ "D), handle. With 15-minute tape, batteries and 117 VAC, 60 Hz line cord. Imported.

99 F 16131L Shpg. wt. 7 lbs. . . . . Net 69.95

Remote Control Mike for RK-87. Imported.

99 F 46625 Shpg. wt. 1 lb. . . . . Net 4.95



from **JVC**

**Model 9403 with a Built-In  
Condenser Microphone**

**\$109<sup>95</sup>**

- Battery Checker/Level Meter
- Dual Cone Speaker with Cellular Horn
- Sleep Timer/ Auto Shut-Off

A feature-packed solid-state portable! Variable sound monitoring; input mixing; anti-rolling device; Automatic Level Control; slide tone control; AFC. With batteries and demo tape. 9 x 6¾ x 2¾". For 117 VAC, 60 Hz. Imported.

27 F 78074L Shpg. wt. 6 lbs. . Net 109.95

12V/Neg. Ground Cig-Type Car Adapter

27 F 78082 Shpg. wt. 8 oz. . . Net 14.34

**Lafayette  
RK-225**

**\$49<sup>95</sup>**



**With Remote Control Mike and  
Record Level Indicator Light**

- Records Directly from Radio
- Unique Levers for Fast-Forward and Record Safety Interlock
- Selector Knob: Rewind-Stop-Play

Record live or direct from radio! 3" dynamic speaker provides fine tone. Built-in AM and telescoping FM antennas. Aux and earphone jacks. With batteries and 117 VAC, 60 Hz cord. 11½ x 3 x 6". Imported.

99 F 16016L Shpg. wt. 6 lbs. . . . . Net 49.95

58 Lafayette Cat. No. 750



**\$89<sup>95</sup>**

**Sanyo's M4420 Has a Built-In  
Condenser Mike & Plays Stereo**

- Listen to Stereo Tapes Through Optional Stereo Headphones
- Records Mono Live and from Radio
- Automatic Record Level Indicator

Auto shut-off; battery meter; pause. With blank tape. For 117 VAC, 60 Hz. Uses 4 "C" Cells (below). 11½ x 7½ x 3½". Imported.

27 F 76011L Shpg. wt. 10 lbs. . . . . Net 89.95

99 F 62572 "C" Batteries. Use 4 .Net .19

Our SP25 Stereo Headphones. Imported.

99 F 03238 Shpg. wt. 1 lb. . . . . Net 6.95



**\$129<sup>95</sup>**

**Deluxe JVC 9245 with Built-In  
Condenser Mike and 2 Speakers**

- 5" Woofer/Cellular Horn Tweeter
- 3-Digit Tape Counter/Reset Button
- VU Record Level/Battery Meter
- Input Mixing of 2 Sound Sources

Auto shut-off; auto tape head cleaner; variable sound monitor tone control; built-in AM and FM antennas. With batteries, 117 VAC, 60 Hz cord, earphone, demo tape. 12½ x 8½ x 3¾". Imported.

27 F 78009L Shpg. wt. 10 lbs. . . . Net 129.95

See Pages 132, 133 for Batteries, Pages 75, 76, 260 for Blank Tape.

# "The Quiet Ones"—Lafayette Dolby\* Cassette Decks

## Deluxe Lafayette RK-D50 Dolby\* System Stereo Cassette Record/Play Deck

- Standard/CRO<sub>2</sub>/Ultra-Dynamic Cassette Bias Selector Switches
- Memory Rewind for Instant Location of Recorded Portions of Tape
- Sound-With-Sound and Special Effects Capability
- Pause Control with Lock for Easy Editing
- Individual Left-Right Channel Controls for Mike and Aux. Inputs, Output Level
- 4-Pole Hysteresis-Synchronous Motor for Precise Tape Speed Under All Conditions

A truly outstanding cassette record and play stereo deck for use with even the finest component-quality stereo systems. Features Dolby System Noise Reduction—the process that made cassette recording a serious musical medium; an automatic end-of-tape shutoff that saves electrical power and protects the machine; convenient push-button-type tape function controls for positive action on Record, Play, Fast-Forward, Rewind and Pause. Has 2 lighted record level meters, 2 peak record level indicator lights, 3-digit reset tape counter for easy indexing of selections. Hooks up easily to the aux. or tape inputs of any stereo receiver or amplifier. Striking walnut-finish case and aluminum front panel. 14 $\frac{3}{4}$ "W x 3 $\frac{3}{8}$ "H x 10"D. For 117 VAC, 60 Hz. 99 F 16156W Imported. Shpg. wt. 15 lbs. . . . . Net 259.95

**SPECIFICATIONS:** Records and plays 4-track stereo and two-track mono. AC Bias and Erase Frequency: 100 kHz. Playback Outputs: Fixed 1 V at 0 VU, variable 0-1 V at 0 VU. Frequency Response: 30-20,000 Hz  $\pm$  3 dB. S/N Ratio: 59 dB with Dolby, 49 dB without Dolby. Wow and Flutter: 0.12%. Input Sensitivity: Mike, 1 mV for 0 VU (10k ohms); Aux., 100 mV for 0 VU (47k ohms).

\*Dolby is a Trademark of Dolby Laboratories, Inc.

# NEW!

## Lafayette RK-D750 Dolby\* System Cassette Record/Play Deck—Sensational Price!

- Front Panel Left and Right Channel Microphone Input Jacks
- 3-Digit Tape Counter with Reset Button
- Standard/CRO<sub>2</sub> Bias Level Control
- Tilt-up Record Level Meters for Easy Reading
- Walnut-Finish Case, Functional Front Panel

Now from Lafayette . . . Dolby system recording and playback in a stylish cassette unit that's right for just about any budget! And it's not simply a low-priced deck with Dolby added on—it has a host of other fine features, too: built-in amplifier for headphone monitoring; front panel mike inputs for convenient "live" recordings (order mikes above), tilt-up VU meters and record light, push-button function controls with pop-up cassette stop/eject. The walnut-finish case and textured ebony finish plastic top panel make it a stylish addition to any system. 12 $\frac{7}{8}$ " x 3 $\frac{3}{8}$ " x 9 $\frac{1}{8}$ ". 117 VAC, 60 Hz. 99 F 16255W Imported. Shpg. wt. 8 lbs. . . . . Net 159.95

**SPECIFICATIONS:** Records and plays 4-track stereo and 2-track mono. AC Bias and Erase Frequency: 100 kHz. Playback Output: 0.775 V at 0 VU. Frequency Response: 50-13,000 Hz. S/N Ratio: 55 dB with Dolby, 45 dB without Dolby. Wow and Flutter: less than 0.25% rms. Input Sensitivity: Mike: 1 mV for 0 VU (3.3k ohms); Aux., 100 mV for 0 VU (10k ohms).

It's Hisssss-  
Looooo!



**\$259<sup>95</sup>** less microphones

### Deluxe Dynamic Microphone

Pro-quality dynamic microphone for use with Lafayette RK-D50 and RDK-750 cassette decks. Use two for "live stereo" recordings. 99 F 45882 Wt. 1 lb. . Net ea. 19.95



**\$159<sup>95</sup>** less microphones

# Make Stereo Cassettes BETTER Than "Pre-Recorded"



## Lafayette RK-725 Stereo Cassette Record/Playback Tape Deck

### Fine Features for Fine Sound!

- **Standard/CRO<sub>2</sub> Control** • **Pushbutton Function Controls**
- **Lighted VU/Level Meters** • **Headphone/Monitor Amplifier**
- **3-Digit Reset Counter** • **Walnut-Finish Wood Case**
- **Front Panel Mike Inputs** • **Front Panel Headphone Jack**



**\$109<sup>95</sup>**  
less microphones

A fine addition to any home stereo system, the RK-725 hooks up easily to your stereo amplifier or receiver for full-fidelity record and playback of stereo cassettes. Has bias switch for standard or high-energy tapes, sound-with-sound mixing facilities, record indicator lights, pushbutton controls for record, rewind, fast forward, play, stop/up and pause. Low-impedance stereo headphone amplifier lets you listen or monitor during record and playback. 50-13,000 Hz response, 45 dB S/N, 30 dB channel separation. Wow/flutter, less than .25% RMS. Good-looking cabinet has walnut-finish wood side panels, brushed aluminum front. 12 $\frac{1}{2}$  x 3 $\frac{3}{4}$  x 9 $\frac{1}{8}$ ". For 117 VAC, 60 Hz. 99 F 16149W Imported. Shpg. wt. 8 lbs. . . . . Net 109.95  
99 F 46161 Dynamic Mike for Above. Shpg. wt. 15 oz. . . . . Net 9.95



**\$89<sup>95</sup>**

### Lafayette DNR-50 Dolby\* Noise Reduction Unit

- **Hooks Up to ANY Recorder or Deck with Audio Inputs and Outputs**
- **Dramatically Reduces Tape Hiss for Noise-Free Recordings with Full Response**

Make expert, low-noise recordings with ANY tape recorder or deck—reel, 8-track cartridge or cassette. Improves S/N ratio 5 dB at 1 kHz and 10 dB at 10 kHz—without hindering frequency response or dynamic range. Has built-in Dolby reference meter with Left, Right and L+R positions, slide-lever controls for left and right channels, play/record pushbutton switch. 20-15,000 Hz  $\pm$  2 dB response, 35k ohms impedance, better than 50 dB channel separation. Requires Dolby Calibration tapes below. 9 x 3 $\frac{1}{8}$  x 7 $\frac{1}{8}$ ". For 117 VAC. 60 Hz. 99 F 16206 Imported. Shpg. wt., 5 lbs. . . . . Net 89.95  
28 F 72885 Cassette Calibration Tape. 4 oz. . . . . Net 5.79  
28 F 80003 Reel-to-Reel Calibration Tape. 4 oz. . . . . Net 4.95  
28 F 80011 8-Track Calibration Cartridge. 4 oz. . . . . Net 4.95



**\$169<sup>95</sup>**

### Superscope CD-302 Stereo Cassette Deck with Dolby\* Noise Reduction System

- **Make "Hiss-Free" Pro-Quality Recordings**
- **Std/CRO<sub>2</sub> Bias Selector Switch**

Excellent-quality stereo cassette deck hooks up to your stereo system for "at home" recordings as good as the pros. Features Dolby Noise Reduction, bias selector switch, special limiter circuit which automatically limits maximum recording level to avoid distortion. Has pushbutton function controls, right and left channel record level controls and VU meters, headphone/monitor jack. Response: 40-10,000 Hz std., 40-14,000 Hz with CRO<sub>2</sub> tape. S/N Ratio: 48 dB std., 51 dB CRO<sub>2</sub>, 60 dB with Dolby. Two low-impedance mike inputs, line outputs. Walnut-finish wood base. 12 $\frac{1}{2}$  x 3 $\frac{3}{4}$  x 8 $\frac{3}{8}$ ". 117 VAC. 60 Hz. 27 F 80054W Imported. Shpg. wt., 6 lbs. . . . . Net 169.95

\*Dolby is a Trademark of Dolby Laboratories, Inc.

# Name-Brand Stereo Cassette Record/Play Decks



1 **\$369<sup>95</sup>**

**Unique, Front-Access Cassette Loading System**

## 1 Pioneer CT-F7171 with Dolby\* System

Famous Pioneer quality, "user-oriented" controls! Has bias/EQ switch for all cassettes, Dolby Noise Reduction, LED record and peak indicators, electronically-controlled DC motor, AC bias and erase recording system. S/N ratio, 48 dB (58 dB with Dolby). Less than 2% THD. Mic Sens. 0.2 mV to 90 mV/20k ohms. Walnut-finish case. 16 $\frac{1}{2}$ " x 5 $\frac{1}{8}$ " x 12 $\frac{3}{32}$ ". For 117 VAC, 60 Hz. Imported. 27 F 63001WX Shpg. wt. 23 lbs. Net 369.95

## 2 Famous Teac 450 Dolby\* System Deck

Has every feature for flawless stereo recording. VU-type level meters, Dolby Noise Reduction, pushbutton function controls, pop-up cassette-eject, even cassette storage space. Hysteresis-synchronous motor. S/N ratio: 50 dB, 60 dB with Dolby. Wow/Flutter, 0.07% WRMS. 30-16,000 Hz response. Mic Sensitivity: 0.25 mV/-72 dB (600-10k ohms). 17 $\frac{3}{4}$ " x 4 $\frac{3}{4}$ " x 10 $\frac{1}{4}$ ". For 117 VAC, 60 Hz. Imported. 27 F 15167WX Shpg. wt. 18 lbs. Net 449.50

## 3 Sony/Superscope TC-131SD Dolby\* Deck

Great price for a Dolby-type deck with these features: ferrite head for extra-wide 40-14,000 Hz response, pushbutton controls, VU record level meters, pause control with lock, headphone monitor jack, lots more. Wow/Flutter, 0.22%. S/N, 48 dB, 60 dB with Dolby. Low-impedance mike inputs, line outputs. 15 $\frac{3}{8}$ " x 3 $\frac{3}{4}$ " x 9". 117 VAC. 60 Hz. Imported. 27 F 60759W Shpg. wt. 9 $\frac{1}{2}$  lbs. Net 239.95

## 4 Teac 360S Full-Feature Dolby\* Deck

Features High-Density Permaflux heads for extra-wide response, bias/EQ switch for ANY cassette, automatic output stabilizing network and precision hysteresis-synchronous motor, dual VU meters. Wow/Flutter, 0.7%; 30-13,000 Hz response. S/N ratio: 60 dB with Dolby. Mike input: 600 ohms. 17 $\frac{3}{4}$ " x 4 $\frac{3}{4}$ " x 10 $\frac{1}{4}$ ". 117 VAC, 60 Hz. Imported. 27 F 15142WX Shpg. wt. 18 lbs. Net 379.50



2 **\$449<sup>50</sup>**

**Equalization for Use with Any Cassettes**

\*Dolby is a Trademark of Dolby Laboratories, Inc.



3 **\$239<sup>95</sup>**

**Total End-of-Cassette Shutoff**



4 **\$379<sup>50</sup>**

**Dolby Tone Generator**

## Hitachi Tape Recorders

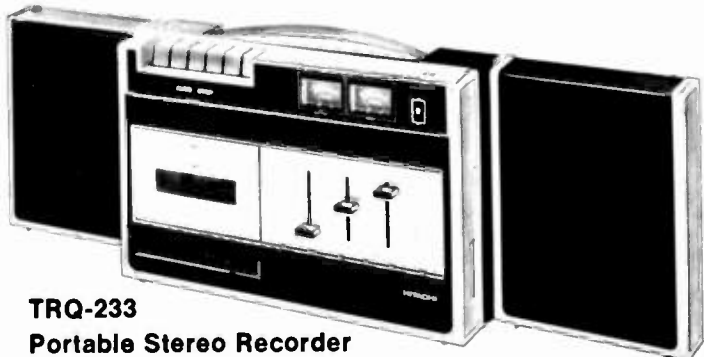

**TRQ-233  
Portable Stereo Recorder**

A great take-along entertainer that plays or records stereo cassettes with excellent fidelity. Has swing-out speakers for true stereo, "Lev-elmatic" record control, pushbutton controls, ferrite head for 100-10,000 Hz response. 6 $\frac{3}{8}$ " x 2 $\frac{1}{8}$ " x 6 $\frac{3}{8}$ ". With 2 microphones, 6 "D" batteries, 117 VAC, 60 Hz line cord. Imported. 27 F 23211W Shpg. wt. 11 lbs. Net 139.95

**NEW! \$149<sup>95</sup>**

**TRK-1271 Recorder with FM-AM Radio and 3-Way Built-In Wireless Mike**

### • Use the Microphone 3 Ways:

1. For Remote Wireless Recording, Wireless Broadcast (For PA Use, Etc.)
2. As a Built-In Condenser Mike
3. As a Standard Line Recording Mike

Features battery/AC operation, 0-60 minute timer/shutoff, record level/battery meter, tape counter, variable monitor system. Sensitive FM-AM radio with telescoping antenna, lighted dial. 11 $\frac{3}{4}$ " x 8 $\frac{1}{4}$ " x 3 $\frac{1}{8}$ ". With batteries, earphone, cassette tape, mike cord, 117 VAC, 60 Hz line cord. 27 F 23237L Imported. Shpg. wt. 8 lbs. Net 149.95



# Lafayette 8-Track Cartridge Record/Play Decks



## NEW! Lafayette RK-990 Deluxe 8-Track Cartridge Stereo Record/Play Deck

Record Cartridges for Playback in Home or Car

### Features for Professional Recording:

- Stop/Eject After Any Program (1 thru 4) or After Entire Cartridge
- Sound-with-Sound/Special Effects
- Concentric Mike and Aux. Volume Controls
- Record Level Meters for Each Channel

**\$189<sup>95</sup>**  
less microphones

### Features for Full-Fidelity Playback

- Stop/Eject After Any Program (1 thru 4) or After Entire Cartridge
- Continuous or Repeat Play of Any Program
- Automatic and Manual Program Selection

Has every feature for full-fidelity stereo recording and playback of 8-track cartridges through your present stereo system. Excellent way to record your favorite music, *in the exact sequence you desire*, for playback at home or on a car stereo tape player. Or transfer your favorite LP records onto cartridges for day-in, day-out play while saving the disc for special occasions. Has an automatic-repeat program selector for repeat-play of any programs (1 thru 4) or entire cartridge, lighted program indicators, pushbuttons for fast-forward and manual eject, stop and play. Record interlock button prevents erasing previously recorded tape. The DC-type governor-controlled motor maintains exact tape speed under various voltage conditions. Nicely styled, too, with walnut-finish case, contrasting front panel. 12W x 3 $\frac{3}{4}$ " H x 9 $\frac{1}{2}$ " D. With cables. For 117 VAC, 60 Hz. Imported. 99 F 16313W Shpg. wt. 16 lbs. . . . . Net 189.95

**SPECIFICATIONS:** Frequency Response: 30-12,000 Hz record and playback. Bias and Erase Frequency: 60 kHz. Output Level: 1 V max. (300 mV av.). Input Sensitivity: Mic., 1 mV; Aux., 100 mV. Channel Separation: 45 dB at 400 kHz. S/N Ratio: 45 dB.

Deluxe Dynamic Microphone **\$19<sup>95</sup>** Each

Fine-quality dynamic microphone for use with either RK-990 or RK-885. Use two for "live" stereo recording. Imported. 99 F 45882 Shpg. wt. 1/2 lb. . Net 19.95



## Lafayette RK-885 8-Track Record/Play Stereo Deck

*Sensational Low Price for a Play AND Record Deck with These Features!*

- Auto-Stop Switch for Play and Record Modes—After Any Program (1 thru 4) or Entire Cartridge
- Fast-Forward Button for Easy Program Location
- Dual Record-Level Meters for Precise Recording

**\$119<sup>95</sup>**  
less microphones

Excellent quality deck, ideal for use with budget and medium-priced stereo systems. Has automatic or manual program selection, record indicator light, lighted program indicators, input jacks for microphones and aux. Has hinged cartridge door to protect tape head mechanism, individual channel volume controls, lots more. Walnut-finish case, 13 x 5 $\frac{3}{4}$  x 8 $\frac{3}{4}$ ". With connecting cables. 117 VAC, 60 Hz. 99 F 16198W Imported. Shpg. wt. 11 lbs. . . . . Net 119.95

**SPECIFICATIONS:** Frequency Response: 50-10,000 Hz  $\pm$  3 dB record and playback. Bias and Erase Frequency: 60 kHz. Output Level: 0.7 V at 0 VU. Input Sensitivity: Mic., 1 mV; Aux., 100 mV. Channel Separation: 30 dB at 400 Hz. S/N Ratio: 40 dB.



# An 8-Track Stereo Record/Play Deck with DOLBY\*

**At Last!**

*The Breakthrough Cartridge Fans Have Waited For—  
Make 8-Track Cartridges as Good as the PRO's!*



EVERY Fine Record and Play Feature!

**\$199<sup>95</sup>**

**NEW!**

- Automatic Stop-Eject After Programs 1 thru 4; or Entire Cartridge—Record and Play Modes
- Volume Controls and Level Indicator for Each Stereo Channel

\*Dolby is a Trademark of Dolby Laboratories, Inc.

## Lafayette RK-D985 8-Track Stereo Record/Play Deck with Dolby Noise Reduction for Hiss-Free Performance!

The Dolby\* system has finally come to 8-track cartridges—enjoy the convenience of continuous-play and easy-handling cartridges PLUS the improved sound quality Dolby is famous for! Has front-panel mike inputs for easy "live" recording, program indicator lights and manual program selector button, separate power-on-off switch for pre-setting controls. Hooks up easily to Aux. or tape inputs of any receiver or amplifier for convenient direct recording. Has fast-forward, record interlock, more. 30-12,000 Hz response, 45 dB S/N, 55 dB S/N with Dolby! Walnut-finish cabinet, 13W x 4<sup>7</sup>/<sub>8</sub> H x 8<sup>3</sup>/<sub>4</sub> D. For 117 VAC, 60 Hz. Imported. Uses high-impedance mikes. 99 F 16321W Shpg. wt. 12 lbs. . . . . Net 199.95



**NEW!**

## Lafayette RK-92 8-Track Playback Deck

**\$34<sup>95</sup>**

- Plays Pre-Recorded 8-Track Stereo Cartridges with Full Fidelity
- Hooks Up to Aux. Inputs of Any Stereo Receiver or Amplifier

Enjoy the wide response and convenient handling of 8-track stereo cartridges at really low cost. Easy hook-up unit plugs into your stereo receiver or amplifier, lets you play pre-recorded 8-track stereo cartridges. If you already own an 8-track car stereo player, it's a great way to make your present cartridges do "double duty." If you enjoy playing your favorite selections over and over, 8-track cartridges are far more durable than discs. Has lighted program indicators, pushbutton program selector, hinged cartridge door to protect tape head from dust and dirt. Nicely styled, too, walnut-finish case with black/silver contrasting front panel. 8<sup>1</sup>/<sub>2</sub> x 4<sup>1</sup>/<sub>4</sub> x 8<sup>3</sup>/<sub>4</sub>". For 117 VAC. Imported. With connecting cables, AC line cord. 99 F 16263W Shpg. wt. 6 lbs. . . . . Net 34.95



**NEW!**

## Lafayette RK-94 2/4-Channel 8-Track Playback Deck

**\$59<sup>95</sup>**

- Add It to Your System for COMPLETE 8-Track Playback Facilities
- 4-Channel Indicator Light

PLAYS EVERY KIND OF PRE-RECORDED CARTRIDGE AVAILABLE—stereo, SQ and discrete Q8 4-channel. Use it now with your present stereo system and it's ready when you are to update to 4-channel. Has program indicator lights, manual program selector, Quadrasonic (4-channel) indicator. Hinged cartridge door, walnut-finish case with black/silver front panel. With 4-channel output cables, AC line cord. 8 x 4<sup>1</sup>/<sub>4</sub> x 8<sup>1</sup>/<sub>2</sub>". For 117 VAC, 60 Hz. Imported. 99 F 16271W Shpg. wt. 8<sup>1</sup>/<sub>2</sub> lbs. . . . . Net 59.95

## Lafayette RK-82 8-Track Playback Deck

**\$49<sup>95</sup>**

- Ideal for Use with Compact, Phonos, Etc.

Good-quality deck offers low-cost playback of 8-track stereo cartridges with fine sound. Has solid-state circuit, pushbutton program selector, lighted program lights, lots more. 8<sup>1</sup>/<sub>2</sub> x 4<sup>3</sup>/<sub>4</sub> x 8<sup>1</sup>/<sub>2</sub>". For 117 VAC, 60 Hz. Imported. 99 F 16107W Shpg. wt. 9 lbs. . . . . Net 49.95



# 8-Track Record and Playback Tape Decks



1 \$339<sup>95</sup>

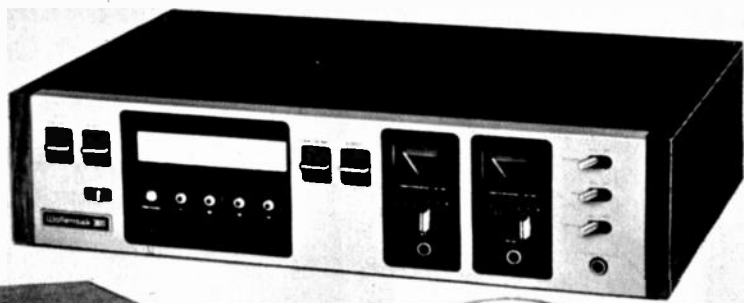

2 \$249<sup>95</sup>



3 \$329<sup>95</sup>



4 \$49<sup>95</sup>



5 \$249<sup>95</sup>

**1 NEW! Wollensak 8075 Record/Play Deck with Dolby System**

- Make "Hiss-Free" 8-Track Cartridges
- Tape Equalization Switch for Special Low-Noise 8-Track Cartridges

Has EVERY feature you need for serious cartridge recording! Digital time counter, auto-eject after programs 1 thru 4 or entire cartridge, VU meters, repeat switch, fast forward and pause controls, more. Dolby circuit for recording and playback of Dolbyized cartridges, Dolby FM broadcasts. S/N better than 50 dB (Dolby off), better than 60 dB with Dolby. Channel separation, 40 dB. Low-impedance mike inputs, 0.25 mV sens. 1 V line output. 19 1/4" x 5" x 10 1/4". For 117 VAC, 60 Hz. 27 F 70105WX Shpg. wt. 17 lbs. . . . Net 339.95

**2 NEW! Wollensak 8055 Record/Play Cartridge Deck**

- Auto-Eject After 1 Thru 4 Programs—Record and Play Modes
- Digital Elapsed Time Counter

Excellent addition to any good component system, great even for small "consoles," too. Has automatic record level control, fast-forward and pause, lighted VU meters, program lights, headphone jack for monitoring. 30-15,000 Hz response, 50 dB S/N. Has 500-ohm mike input with 25 mV sens., 1 V line output, headphone output for low- or high-impedance phones. Good-looking walnut-finish case, 17 3/4" x 4 1/2" x 10 1/2". For 117 VAC, 60 Hz. With 4 patch cords. 27 F 27009WX Shpg. wt. 15 lbs. . . . Net 249.95

**3 Akai CR-80DSS 2- and 4-Channel 8-Track Record/Play Deck**

- 4 Record/Playback Amplifiers
- 4 VU Record Level Meters
- Records 4-Channel Cartridges

THE add-on for any 4-channel receiver or amplifier. Lets you make your own discrete 4-channel cartridges for playback through any 4-channel system. Has 4 level meters, program lights, 4 30k ohm mic inputs, 4 40 mV line inputs, 4 line output jacks. Response: 50-16,000 Hz. S/N, better than 40 dB. Bias frequency, 65 kHz. 19 1/2" x 5 1/2" x 11 1/4". For 100-240 V, 50-60 Hz AC. With 4-channel demo tape, all connecting cables, head cleaning brush. Imported. 27 F 56013WX Shpg. wt. 29 1/4 lbs. . . . Net 329.95

## Portable Players for "Anywhere" Listening



4 \$59<sup>95</sup> With Batteries

**4 Battery/AC Portable 8-Track Stereo Player**

Take it along for fine, full sound—speakers separate for great stereo effect! Operates three ways—at home on 117 VAC, 60 Hz house current; on 8 "D" batteries (included!); from 12 VDC car or boat with adapter cable (included). Has slide controls, program lights, more. Brown/ivory case, 11 1/2" x 9 1/2" x 7 1/2". Imported. 17 F 69538W Shpg. wt. 14 lbs. . . . Net 59.95



7 \$99<sup>95</sup>

**7 Craig Portable Stereo 8-Track Player/Built-in Stereo FM-AM Radio**

Deluxe entertainer is ready to use anywhere—operates on 117 VAC house current, batteries (order below), or 12 VDC. Has AFC, lighted program indicators, stereo headphone jack, more. Automatic battery charging when NICads are used. 11 3/4" x 7 3/4" x 6 1/4". Imported. 17 F 08056W Shpg. wt. 9 lbs. . . . Net 99.95 99 F 62564 "D" Cells. Use 8 . . . Net ea. 19¢



3 \$39<sup>95</sup> With Batteries

**3 Panasonic 8-Track Player**

Colorful, compact player makes a great gift. Operates on batteries or AC, has slide-in cartridge mechanism, 3" wide-range speaker, unique compact design. Plays stereo cartridges monophonically. 7 1/2" x 3 3/4" x 9 1/4". AC cord and batteries. 17 F 31470 Imported. Shpg. wt. 4 lbs. . . Net 39.95

**4 Pioneer H-22 Stereo Cartridge Playback Deck**

- Lighted Program Indicators
- Automatic or Manual Selection
- Good-looking Walnut-Finish Cabinet

Add it to your present stereo system for full-fidelity playback of pre-recorded 8-track stereo cartridges. Special vertical headshift mechanism provides precise tape/head contact, excellent for playing old or worn cartridges. Response, 40-10,000 Hz. 7 1/2" x 4 3/4" x 11". For 117 VAC, 60 Hz. 27 F 53010W Imported. Shpg. wt. 8 lbs. Net 49.95

**5 Telex Automatic 8-Track Changer Playback Deck**

- Continuous Play of 12 Cartridges
- Operates Vertical or Horizontal
- Includes Protective Dust Cover

Automatic stereo 8-track changer offers hours of continuous music—selects and plays up to 12 cartridges in any of 4 modes: plays all programs on all tapes continuously; plays a random selection of tapes; plays individual programs of each tape; repeat-plays the same cartridge. Has instant-on solid-state circuit, durable walnut-finish vinyl-covered base. 18 1/4" x 9" x 6 1/4". For 117 VAC, 60 Hz. Imported. 27 F 26012WX Shpg. wt. 34 lbs. . . . Net 249.95



# Famous-Name Reel-to-Reel Decks and Recorders



**\$249<sup>95</sup>**



**\$319<sup>95</sup>**

**NEW!  
\$249<sup>95</sup>**

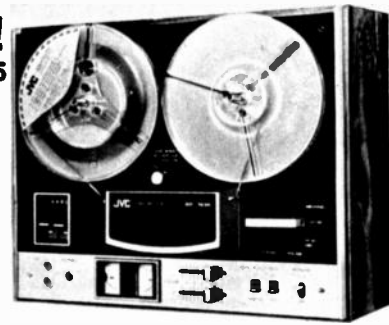

**NEW!  
\$499<sup>50</sup>**

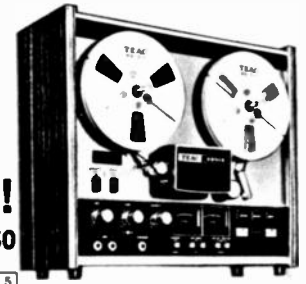

**1 Sony TC-280 3-Speed Stereo Record/Play Deck**

- Wide-Response Ferrite Hyperbolic Head
- Lighted VU Record Level Meters
- Vibration-Free Constant-Speed Motor

Excellent tape deck with famous Sony quality—offers sound-on-sound, sound-with-sound, front panel mike inputs and stereo headphone jack, record equalization switches, tape counter, walnut-wood cabinet. 7½, 3¾, 1½ ips speeds, takes up to 7" reels. Response: 20-20,000 Hz at 7½ ips. S/N, 52 dB, bias frequency, 85 kHz. Wow and Flutter, 0.10% at 7½ ips. Has 2 100k-ohm aux., 2 low-imp. mic inputs, line outputs. With 7" reel, cables. For 117 VAC, 60 Hz. Imported.

27 F 60767W Shpg. wt. 23½ lbs. . . . .Net 249.95

**2 Sony TC-353D 3-Head, 3-Speed Record/Play Deck**

- Full Mike and Line Mixing
- Tape/Source Monitor Switch
- Dual VU Record Level Meters

Has 3-head design for optimum performance and special effects, selector switch for low-noise, high-output tapes, automatic shutoff. Separate record level controls for each channel. Response: 30-20,000 Hz ± 3 dB at 7½ ips. S/N, 52 dB. Two low-imp. mike inputs, 2 100k aux. inputs. Line outputs. With 7" reel, 2 patch cords. Walnut wood cabinet, 15¼ x 13¾ x 7¾". For 117 VAC, 60 Hz. Imported.

27 F 60650W Shpg. wt. 17 lbs. . . . .Net 319.95

F97 Deluxe Mike for Above.

27 F 60809 Shpg. wt. 1 lb. . . . .Net ea. 14.95

**3 JVC RD-1696 3-Speed Stereo Record/Playback Deck**

- 3¾, 1½, 7½ ips Speeds
- Front-Panel Mike, Headphone Jacks
- 4-Digit Reset Tape Counter

Add it to your present stereo system for fine-quality reel-to-reel recordings. Has IC stereo preamps, sound-on-sound and sound-with-sound special effects, dual VU meters. Slide-lever volume controls, pause. Selector switch for standard or low-noise tapes. Response: low-noise tape, 30-18,000 Hz, standard, 30-16,000 Hz. S/N ratio, 52 dB. Two 10k mike inputs, two 0-1.0 V aux. inputs. Line outputs. With 7" reel, patch cord. 15¼ x 12¾ x 7½". Walnut-finish wood case. For 117 VAC, 60 Hz. Imported.

27 F 78090W Shpg. wt. 21 lbs. . . . .Net 249.95

**4 Sony TC-270 3-Speed Complete Stereo Recorder**

Has two detachable full-range speakers, automatic end-of-tape shutoff, speaker monitor switch, aux. inputs for tuner or ceramic cartridge record player, sound-with-sound, lots more. 30-18,000 Hz at 7½ ips, wow and flutter, 0.12%. With 2 mikes, 7" reel, stereo patch cord. 20¾ x 10¾ x 15¼". For 117 VAC, 60 Hz. Imp.

27 F 60783W Shpg. wt. 38 lbs. . . . .Net 379.95

**5 Teac 2300S 3-Motor, 3-Head Record/Play Deck**

- Bias Equalization-St, Low-Noise Tapes
- Computer-Type Transport Controls
- Dual VU Record Level Meters

Top-performing stereo deck records and plays with full fidelity. 7½ and 3¾ ips tape speeds, full monitoring capabilities, 7" reel capacity. Four-digit tape counter with reset. Response: 40-24,000 Hz at 7½ ips, S/N, 58 dB. Has two 600-10k ohm mike inputs, 2 line inputs, line outputs. With 7" reel, cables, head cleaner, and splicing tape. Walnut wood case, 17¾ x 15¼ x 8¾". For 117 VAC, 60 Hz. Imported.

27 F 15159WX Shpg. wt. 40 lbs. . . . .Net 499.50

Model 3300S. As above, but takes 10½" reels.

17¾ x 17¾ x 8¾". 117 VAC, 60 Hz. Imported.

27 F 15191WX Shpg. wt. 44 lbs. . . . .Net 699.50

Remote Control for 2300, 3300S. 16-ft. cable.

27 F 15217 Imported. Shpg. wt. 1 lb. . . . .Net 59.50

**"Pro-Quality" Decks from JVC and Akai**

**Akai 4000DB Stereo Record/Play Deck with Dolby\* System \$369<sup>95</sup>**

Famous Dolby Noise Reduction lets you make "hiss-free" recordings good as the pros! Has wide-response 1-micron-gap tape heads, dual monitoring, sound-on-sound, sound-with-sound, automatic shutoff. Full mike/line mixing, pause control, two VU meters and 4-digit tape counter. Two speeds: 7½ and 3¾ ips. Response: 30-23,000 Hz (±3 dB) at 7½ ips, S/N, better than 55 dB with Dolby. Bias frequency, 105 kHz. Has 4.7k ohm mike inputs, line inputs, line outputs. For 100-240 VAC, 50-60 Hz. 16 x 12¾ x 7¾".

27 F 56088WX Imported. Wt. 28 lbs. . . . .Net 369.95

\*Dolby is a Trademark of Dolby Laboratories, Inc.



**JVC 4RD-1406 2- and 4-Channel Record/Play Deck \$429<sup>95</sup>**

Make your own discrete 4-channel tapes with this deck and any good 4-channel receiver or amplifier. Has 4 VU meters, tape counter with reset, pause position for editing and cueing, automatic stop, lots more. 7½, 3¾ ips speeds. Response: 30-19,000 Hz at 7½ ips. Wow and Flutter: 0.07% at 7½ ips. S/N, 53 dB. Four aux. inputs, 4 tape outputs, front panel mike inputs. 15¼ x 12¾ x 6¾". 117 VAC, 60 Hz. Imported.

27 F 78108W Shpg. wt. 21 lbs. . . . .Net 429.95



**New!**

# See Lafayette for the Finest in Car Stereo Tape Players



**Lafayette "Auto-Mate II" Cassette Player**

**\$39<sup>95</sup>**

Less Speakers

- Small Enough Even for Sports Cars
- Slide Controls for Easy Use While Driving
- Fast-Forward and Eject Pushbuttons

Compact enough to mount in the glove box of most cars, the "Auto-Mate II" still delivers enough power to make your car a moving concert hall! Has slide-volume, balance and tone controls, easy push-in cassette loading, power-on indicator light. 6 x 1 7/8 x 6 3/4", with metal case and mobile mounting bracket and cable. For 12 VDC negative ground systems. Imported.

99 F 16339L Shpg. wt. 4 lbs. . . . . Net 39.95  
99 F 62994 Pair of 3x5" Speakers. Wt. 5 lbs. . . . . Net 7.95



**\$89<sup>95</sup>**

Less Speakers

**Lafayette RK-300 Auto-Reverse Cassette Player**

- Plays Stereo Cassettes Continuously—No Fumbling and Flipping While You Drive
- Slide Controls for Volume, Balance and Tone

An excellent buy in a fine-performing cassette player that gives you continuous, uninterrupted music from an entire cassette—plays both "sides" of the cassette in a single loading! Has a powerful solid-state stereo amplifier, fast-forward, rewind and cassette eject buttons, slide-type tone, volume and balance controls. 7 x 2 1/4 x 7"—mounts under dash in most any car. With mounting bracket and connecting cable. For 12 VDC negative ground. Imported.

99 F 16248L Shpg. wt. 7 1/2 lbs. . . . . Net 89.95  
99 F 63885 Pair of Deluxe Car Spkrs. 5 lbs. Net 15.95



## Introducing the "Fittables"—Stereo FM/FM/AM Tape Players That "Custom Install" In-Dash in Most '67-74 U.S. Cars

These two player/radios are complete with all hardware for custom in-dash installation without add-on kits or dash alterations. Each includes a fully detailed 16-page step-by-step manual for do-it-yourself installation. They look like factory installed, they perform like factory installed, they COST ABOUT HALF of factory installed.

**FIT ALL GENERAL MOTORS CARS EXCEPT:**  
'67, '68 Chevy — '74 Chevy Van — '67-'70 Cadillac — '67 Pontiac — '67 Cutlass F-85.

**FIT ALL FORD CARS EXCEPT:** '67-'72 Ford — '67 Ford Truck — '67-'72 Thunderbird — '67-'72 Mercury — '67-'72 Mark IV.

**ALSO FIT:** '70 to '74 Dodge Darts and Vans — '72-'74 Dodge Trucks — '70-'74 Valiant Dusters — '74 Monaco, Imperial, Chrysler, New Yorker, Plymouth, Fury, Ambassador and Matador.

**Custom In-Dash Installation Kit.** For most foreign cars, U.S. cars (not custom fit) shown above. Specify make, model and year of car, allow 3 weeks for delivery. No COD's.  
17 F 80295Z Shpg. wt. 2 lbs. . . . . Net 7.95

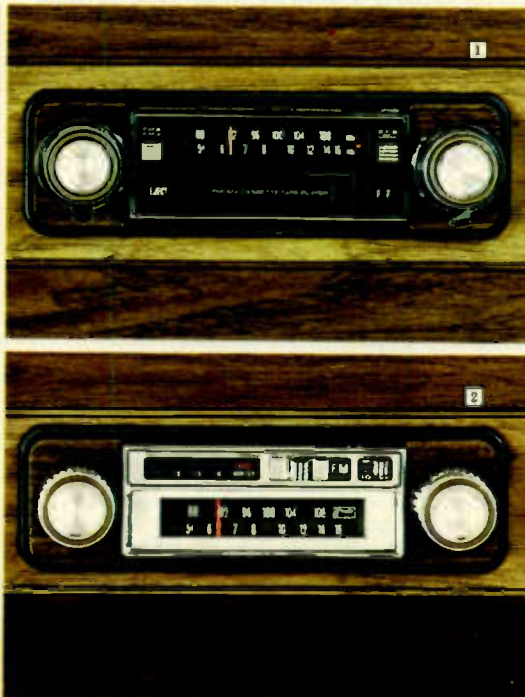

**1 Cassette/Stereo FM/FM/AM Radio**

**\$149<sup>95</sup>** Less Speakers

Versatile car entertainer lets you listen to pre-recorded stereo cassettes, FM and stereo FM, AM, too. Has volume and tone controls, cassette eject and fast forward, stereo FM light and slide-rule tuning dial. Powerful solid-state circuit, good-looking styling. 12 VDC negative ground. 7 x 2 1/2 x 6 1/8".  
17 F 80527W Shpg. wt. 8 1/2 lbs. . . . Net 149.95

**2 8-Track/Stereo FM/FM/AM Radio**

**\$119<sup>95</sup>** Less Speakers

Has the same features as above, but with an 8-track cartridge player instead of a cassette player. Features program indicator lights, automatic or manual selection, easy slide-in cartridge loading. 7 x 2 1/2 x 6 1/8". Imported.  
17 F 80535W Shpg. wt. 8 1/2 lbs. . . . Net 119.95  
Pair of Car Speakers for above Players.  
99 F 63885 Shpg. wt. 5 lbs. . . . . Net 15.95

# Famous-Name Car Stereo Cassette Players

## Pioneer KP-300 Auto-Reverse with Built-in Stereo FM Radio

Full-featured for fine sound! Plays pre-recorded stereo cassettes in both directions for continuous music enjoyment, has lighted direction indicator. Radio has stereo light, easy-to-read tuning dial. Separate volume, tone and balance controls, stereo-mono switch. Eject button. With under-dash mtg hardware. For 12 VDC negative ground. 5½" x 2" x 7¼". Imported.

17 F 85047W Shpg. wt. 7 lbs. . . . Net 129.95

## NEW! Pioneer KP-301 Player/FM Stereo Radio with Auto-Reverse and Dolby\*

Features the famous Dolby\* noise reduction system for the finest car stereo fidelity around—plays Dolbyized pre-recorded stereo cassettes, tunes popular Dolby stereo FM broadcasts, too! Has auto-reverse, manual direction change, Dolby In-Out switch, direction and stereo FM indicator lights. Special grade permalloy head permits playback of high output chromium-dioxide tapes. 40-10,000 Hz response, 0.3% wow and flutter. Other features similar to KP-300 above. For 12 VDC negative ground. With under-dash mounting hardware. 7½" x 2½" x 8½". 17 F 85096W Imported. 6½ lbs. Net 189.95



**PIONEER**  
\$129.95  
Less speakers

**PIONEER**  
\$189.95  
Less speakers



**SONY**  
\$119.95  
Less speakers

**SANYO**  
\$129.95  
Less speakers



### 1 Sony TC-10 Car Player with Total Mechanism Shutoff

- Single-Action Cassette Loading
- Automatic and Manual Eject

Top-performing car cassette stereo player from famous Sony has individual tone and volume controls, locking fast-forward and rewind, famous Sony TMS (Total Mechanism Shutoff) that completely turns off unit after cassette has stopped. Single-action cassette loading and automatic eject allow safe, distraction-free operation even while driving. Attractive black and silver trim styling, compact for easy under-dash installation in most any vehicle. For 12 VDC negative ground 7½" x 2½" x 7½". Imported.

17 F 50025W Shpg. wt. 4½ lbs. . . Net 119.95

### 2 Sanyo FT-403 Stereo Player with Built-in AM/Stereo FM Radio

- Automatic Tape-to-Radio Change
- "In-Dash" Mounting for Custom Look

Designed for total car stereo entertainment, the FT-403 mounts right in the dash on most cars for a factory-installed look at about HALF the factory-installed cost. Has automatic end-of-cassette stop, automatic cassette eject, fast-forward pushbutton, speaker matrix circuit for 4-dimensional sound with 4 speakers. Radio turns off when cassette is inserted, turns on when cassette is ejected. For 12 VDC neg. ground. 7¼" x 3" x 6". With mounting hardware and adjustable shafts. Imported.

17 F 59273W Shpg. wt. 4 lbs. . . . Net 129.95

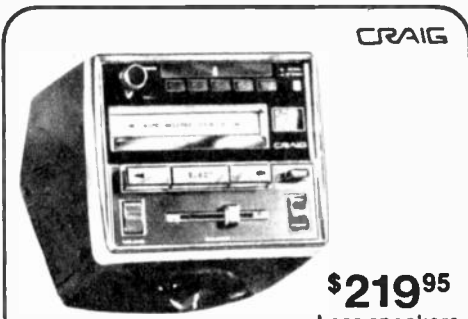

**CRAIG**  
\$219.95  
Less speakers

## 3507 Auto-Reverse with Pre-Set Stereo FM Radio and Dolby

Listen to Dolby cassettes or FM, pre-set your five favorite FM stations for really easy tuning while driving. Floor-mount, with magnetic key lock for easy removal and storage. 6½" x 11¾" x 9¾". For 12 VDC negative ground. Imported.

17 F 08031W Shpg. wt. 10 lbs. . . Net 219.95

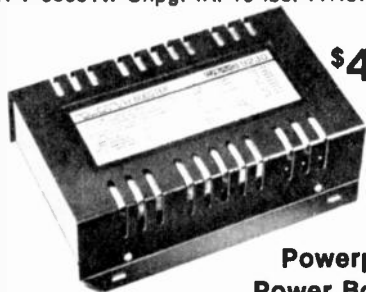

**Powerplay™ Power Booster**

Add it to any car stereo tape player for 12 watts rms more power per channel—improves reproduction of musical transients, lowers distortion at normal listening levels. No controls—may be mounted out of sight behind the dash. 6¾" x 1½" x 5". For 12 VDC negative ground. Imported.

17 F 08064 Shpg. wt. 3½ lbs. . . . Net 49.95

# 8-Track Car Stereo Tape Players—Tune Up!

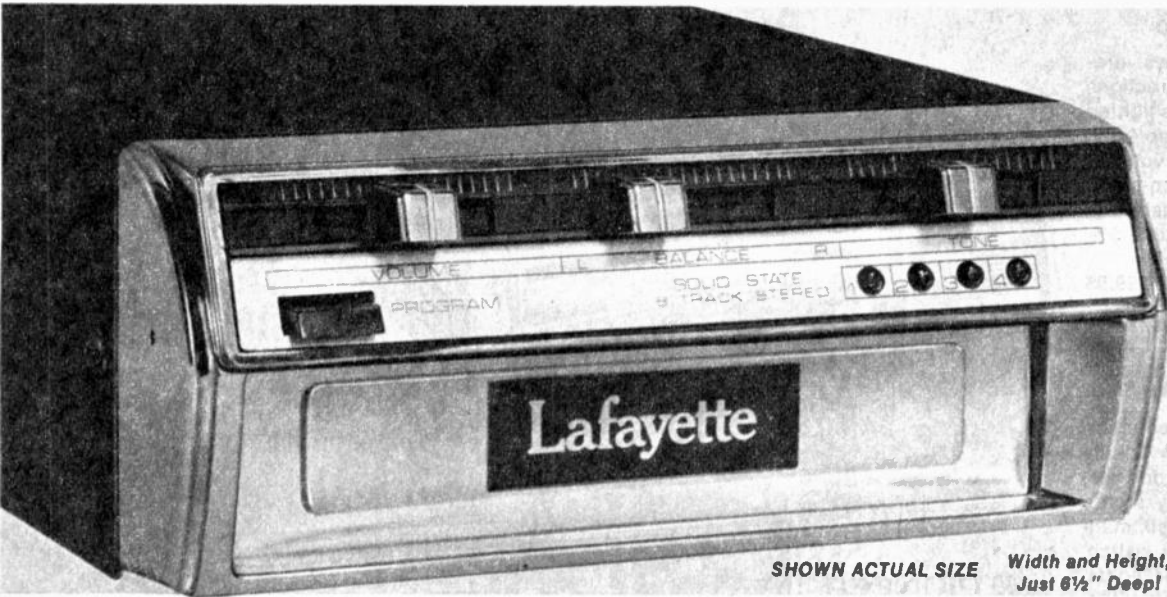

SHOWN ACTUAL SIZE Width and Height,  
Just 6½" Deep!

## Lafayette CP-88 8-Track Car Stereo Tape Player

- Includes Under-Dash Mounting Bracket and All Hardware
- Separate Slide Controls for Tone, Volume and Balance
- Individual Program Indicator Lights • Solid-State Circuit

**\$39<sup>95</sup>** Less speakers

One of the smallest car tape players we've seen—yet it has the performance and features of full-size models! Automatically plays pre-recorded 8-track stereo cartridges, has manual program selector, too. Individual program lights show you where you are on the cartridge; the volume, balance and tone controls let you adjust the sound to your exact musical preference. Vinyl-covered metal cabinet with handsome chrome front—looks good, too. Solid-state

circuit takes the jolts and jars of everyday driving and still performs beautifully. Hinged cartridge door protects tape mechanism when not operating. Wide-range response, S/N, better than 40 dB. With under-dash mounting bracket, all hardware. 4¾ x 2½ x 6½". For 12 VDC neg. gnd. systems. Imp. 17 F 02661W Shpg. wt. 5½ lbs. . . . Net 39.95  
Pair of Lafayette Car Stereo Speaker Systems. For above. Imported.  
99 F 62994 Shpg. wt. 2½ lbs. . . . Net 7.95



**NEW!**

## "Special Feature" 8-Track Car Stereo Tape Players

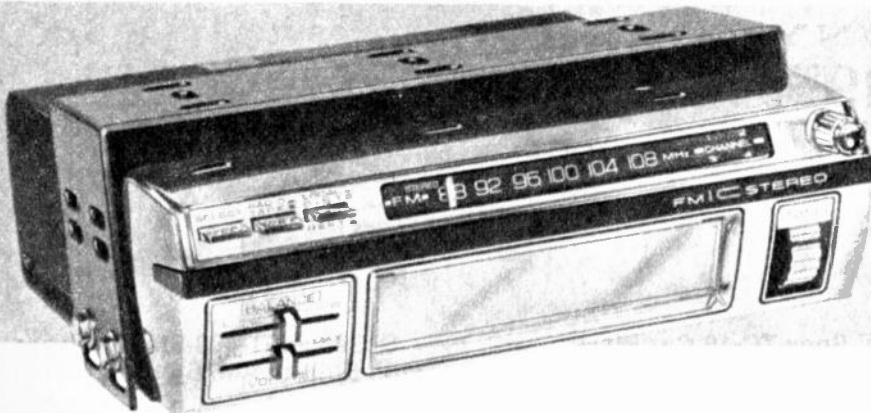

### 8-Track Stereo Player with Stereo FM Radio

- Program Repeat Button • Local/Distance Switch
- Slide-Volume and Balance Controls • Program Lights
- With Bracket and Hardware for Easy Under-Dash Mounting

Versatile car entertainer brings you full fidelity sound from 8-track stereo cartridges, FM and stereo FM radio. Has sliding volume and balance controls, program lights, manual or automatic program selection. Radio has local/distance switch for best reception, slide-rule tuning, stereo light. Advanced solid-state circuit. 8 x 3½ x 8¼". For 12 VDC negative ground. Imported.

17 F 8C063W Shpg. wt. 8 lbs. . . . . Net 87.50

**\$87<sup>50</sup>**  
Less speakers



### Audiovox Player with "Quad" Speaker Matrix

Play stereo cartridges with an exciting 4-dimensional effect! With mtg. bracket an hardware. 6¼ x 2½ x 7¼". For 12 VDC neg. active ground. Less speakers. Imported.  
17 F 80519W Shpg. wt. 6 lbs. . . . . Net 59.95

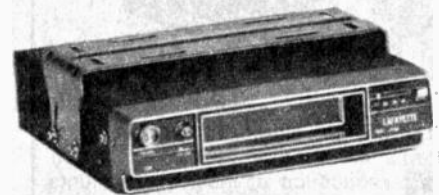

### Lafayette 2/4-Channel Player

Plays 2-channel and discrete 4-channel Q5 cartridges! Has front-rear-left-right balance, pushbutton program selector, more. With under-dash mounting bracket. 8 x 2 x 8¼". 12 VDC neg. gnd. Less speakers. Imported.  
99 F 16065W Shpg. wt. 6 lbs. . . . . Net 99.95

# "Good-Looking" Car Stereo from PIONEER

## Introducing the Pioneer 800 Series 8-Track Cartridge Players and Player/Radios

### Car Stereo with the Hi-Fi Look!

Car Stereo that Sounds Great!

#### 1 TP-828 Deluxe 8-Track Car Stereo Cartridge Player

Sleek 'n' streamlined 8-track cartridge player has slide-controls for tone and balance, fast-forward and repeat, automatic and manual program change, lighted volume and program indicators; large, easy-grip volume control. 30-10,000 Hz response. Wow and flutter, 0.25%. Angled control panel means you mount the TP-828 in the perfect horizontal plane, no distortion—causing shifting and jittering of the cartridge. With mounting bracket and all hardware. 7¾ x 3¾ x 8½". 12 VDC negative ground. Imported. 17 F 85088W Shpg. wt. 7 lbs. . . . . Net 84.95

#### 2 TP-800 8-Track Player with Built-in FM Stereo Radio

Under-dash model similar to the 828 above, but includes a stereo FM radio with a large, illuminated tuning dial pointer, mono/stereo switch for best reception of weak stations, radio on-off switch and tuning knob. 30-12,000 Hz response. Wow and flutter, 0.25%. 7¾ x 3¾ x 8½". For 12 VDC negative ground. Imported. 17 F 85070W Shpg. wt. 7 lbs. . . . . Net 124.95

#### 3 TP-8001 8-Track Player with Built-in Stereo FM/AM Radio

Complete car entertainer offers stereo you'll appreciate for years to come. Features a large, illuminated tuning dial for both stereo FM and AM, stereo-mono switch, AM-FM selector switch. 30-12,000 Hz response. Wow and flutter, 0.25%. Other features as 800 and 828 above. For 12 VAC negative ground. 7¾x3¾x8½". Imported. 17 F 85062W Shpg. wt. 7 lbs. . . . . Net 144.95



NEW!  
\$84.95  
Less speakers

NEW!  
\$124.95  
Less speakers

NEW!  
\$144.95  
Less speakers

## Quality 8-Track Stereo Tape Players from Tenna and Pioneer



Tenna

\$59.95  
Less speakers



Tenna

\$69.95  
Less speakers



PIONEER

\$49.95  
Less speakers

### NEW! TC-80T Mini 8-Track Player

- Built-in Head Cleaner, Alarm
- Fine-Tuning for Worn Cartridges

Features lighted program indicators, separate volume, balance and tone controls, fine tune control that provides positive head/tape alignment—eliminates crosstalk and distortion on old or worn cartridges. Thumbwheel controls provide safe, easy use even while driving, automatic or manual program selection. Hinged cartridge door protects mechanism. 5½ x 3¾ x 7½". With under-dash mounting bracket and hardware. For 12 VDC neg. ground. Imported. 17 F 74751WX Shpg. wt. 4½ lbs. . . . . Net 59.95

### NEW! TC-68T Player with Speaker Matrix Circuitry

- Plays 2-Channel Stereo Tapes with Full-Dimensional 4-Channel Effect

Deluxe 8-track car stereo tape player can be used with two or four speakers—with two speakers it's a conventional stereo cartridge player with rich, full sound, with 4 speakers it plays the same cartridges with 4-dimensional effect! Has fine-tuning, head cleaner and burglar alarm built in, repeat program button and automatic replay of entire cartridge. 5½ x 2 x 6½". For 12 VDC negative ground. With under-dash bracket, hardware. Imported. 17 F 74744W Shpg. wt. 4½ lbs. . . . . Net 69.95

### NEW! TP-232 8-Track Car Player

- Small Enough for Most Glove Boxes
- Automatic, Manual Program Change

Barely bigger than a cartridge itself, but FILLED with Pioneer quality! Only 4¾ x 2 x 6½" — mounts just about anywhere. Has separate tone, balance and volume controls, track lights, plenty of power for car-filling sound. Solid-state circuit uses IC's for outstanding dependability. With bracket, all hardware. 12 VDC neg. gnd. 17 F 85054W Imported. Wt. 3½ lbs. . . . Net 49.95

See page 71 for our complete listing of car stereo speakers.

No Money Down—See Page 4 for Lafayette's Easy-Credit Plan

# Get More Fun Out Of Your Car Stereo



**\$15<sup>95</sup>**

Use Your Car  
Tape Player at  
Home or Office

## Lafayette 115 VAC to 12 VDC Home Power Supply

Now you can enjoy car tape players, CB units in your home by using this convenient power supply that converts 115 volts AC to 12 volts DC instantly. Handles up to 4 amps. Includes safety circuit breaker, heavy-duty binding posts and neon indicator light. For 117 VAC, 60 Hz. 4 3/4" x 3" x 5 3/4".  
17 F 02398 Shpg. wt. 6 lbs. . . . . Net 15.95



**\$5<sup>95</sup>**

Convert Stereo Tapes or Cassettes  
Into "Knockout" 4-Dimensional Sound

## Lafayette 4-Dimensional Car Adapter

Any 2-channel car stereo tape player (8-track or cassette) or FM stereo radio can be converted to 4-dimensional sound with this handy adapter and an additional two speakers. Includes two 3-ft., two 6-ft., and two 15-ft. connecting cables. 15 1/2" x 1 3/4" x 2 1/2". For 12 VDC neg. gnd. Imported.  
99 F 85128 Shpg. wt. 2 lbs. . . . . Net 5.95  
99 F 62994 Two 3x5" Car Speakers. Shpg. wt. 2 1/2 lbs. . . . . Net 7.95

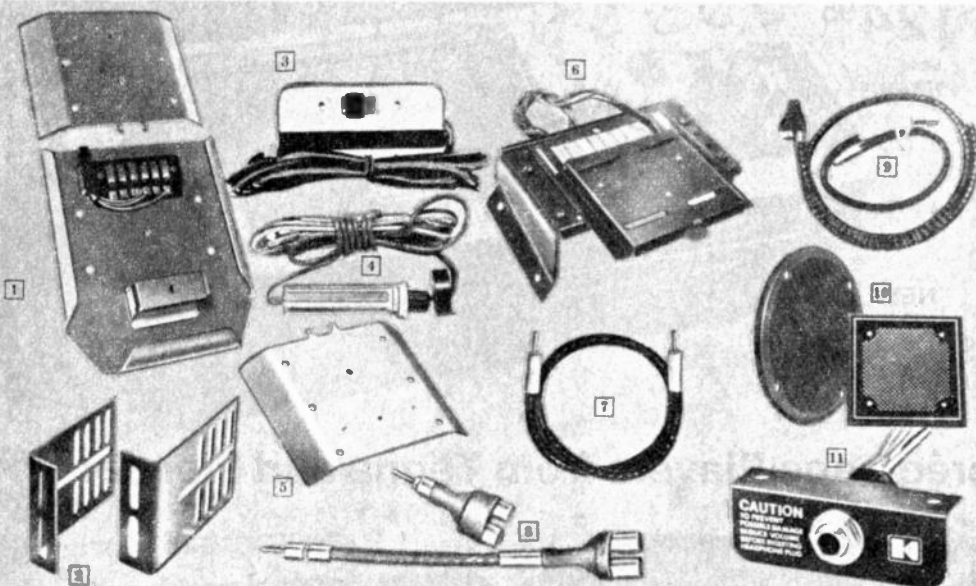

## Versatile Accessories for Car Tape Players

- 1 **Universal Lock Mount for Car Tape Players.** Prevent theft with adjustable mount which installs easily. Just remove or insert your tape player when needed. Complete with lock. 6 1/2" x 1" x 7 1/2". Shpg. wt. 2 1/4 lbs.  
17 F 63010 . . . . . Net 5.95
- 2 **Universal "L" Bracket.** Fits all car stereo tape players. Adjustable slotted bracket makes installation a snap.  
17 F 63044 Shpg. wt. 1 lb. . . . . Net 1.19
- 3 **Universal Power Connector Harness.** Has pin socket for 5, 4, 4-pin "Y" and 4-pin "odd" connections. In-line fuse holder, leads.  
17 F 63028 Shpg. wt. 6 oz. . . . . Net 1.95
- 4 **Car Speaker Switch.** Use your car stereo radio speakers to play your tape player. With wire, chrome plate, and mounting instructions.  
17 F 63036 Shpg. wt. 4 oz. . . . . Net 2.95
- 5 **NEW! Alternate Male Lock Mount.** Use in your second car, camper, boat or trailer. Additional mounting bracket to be used with universal lock mount.  
17 F 63119 Shpg. wt. 1 lb. . . . . Net 3.39
- 6 **Mini Floor Mount.** When dash mount space is limited, use the mini-floor mount. Rests on the hump or floor of the car. Tape player or CB unit slides in or out instantly. 4 1/2" x 3 1/2" x 3 1/2".  
17 F 63085 Shpg. wt. 1 1/2 lbs. . . . . Net 4.95

- 7 **NEW! AM/FM Antenna Extension.** The 18" AM/FM leads allow coupling of the car antenna to your AM or FM radio. Well-shielded, male to male plugs.  
17 F 63101 Shpg. wt. 8 oz. . . . . Net 1.29
- 8 **AM/FM "Y" Connectors.** Connect your car stereo tape player with built-in FM radio to the standard AM radio jack. Choice of two connectors. Shpg. wt. 6 oz.  
17 F 63051 (2 1/4" conn.) . . . . . Net 1.89  
17 F 63069 (Y conn., 5" flex. lead). 6 oz. Net 2.39
- 9 **FM Antenna Lead for Lock and Floor Mount.** Use the Mini Floor Mount or Lock Mount with your under-dash FM stereo tape player or radio.  
17 F 63077 Shpg. wt. 1 lb. . . . . Net 2.95
- 10 **Replacement Grilles for Custom Car Speakers.** Choose from two types of 5" grilles—round or square. Sturdy molded plastic. Complete with hardware.  
32 F 49554 Round Grille. Shpg. wt. 1/2 lb. Net .88  
32 F 49612 Square Grille. Wt. 1/2 lb. . . . . Net .98
- 11 **NEW! Stereo Headphone Jack.** Let your passenger use headphones with your stereo radio or tape player. Installs quickly and easily. Disconnects speakers automatically.  
17 F 63093 Shpg. wt. 4 oz. . . . . Net 2.89

**\$34<sup>95</sup>**

Enjoy Stereo FM  
Sound from Your  
8-Track Player

**Universal 8-Track Stereo  
FM Tuner Cartridge**

Bring the rich-bodied sound of stereo FM music into your car by simply plugging FM Tuner Cartridge into your present player just like an ordinary cartridge. With "Y" antenna.  
17 F 43061L Shpg. wt. 1 lb. . . . . Net 34.95

Play Cassette Tapes  
Directly from Your  
8-Track Player

**\$34<sup>95</sup>**

## Cassette Adapter for 8-Track Players

Fits all standard 8-Track Cartridge Players and allows you to play cassettes off the 8-Track player. Fast-Forward button and automatic cassette eject are fine features of this cassette adapter. No batteries are required and the adapter can be plugged in or out of the 8-Track player at your convenience. Imported.  
17 F 80113 Shpg. wt. 1 1/2 lbs. . . . . Net 34.95

# Speakers for Car Stereo Tape Players

## Popular Priced Auto Speakers from Lafayette

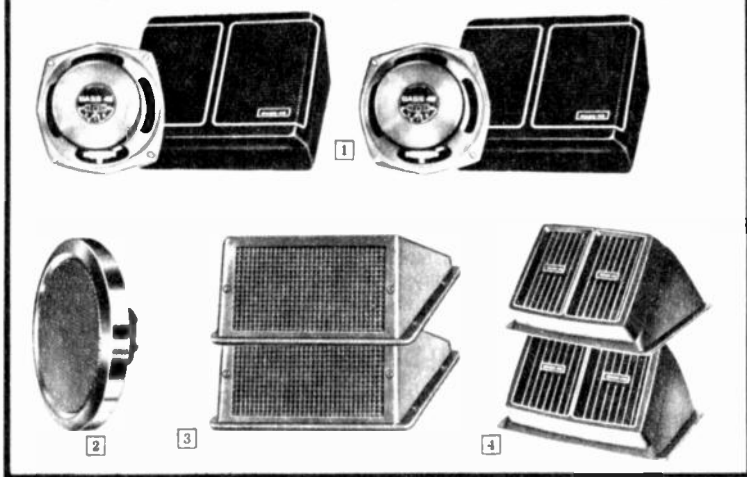

**1 Rear Deck Air Suspension Speakers**  
Pair of rear deck speaker systems, compatible 4 and 8 ohm impedance. 5 1/2" speakers with 12 oz. ceramic magnets. Fully sealed plastic enclosures. With 32' speaker cable. Wt. 6 lbs.  
17 F 74736W ..... Net Per Pair 29.95

**\$29<sup>95</sup>**  
Pair

**2 Lafayette, Flush-Mount Speaker**  
Ideal for use as an auto speaker or anywhere shallow depth is required. Chrome grille, heavy magnet, 8 ohms. 6 1/4" diameter. Imported.  
99 F 01794 Wt. 1 3/4 lbs. .... Net 5.49

**\$5<sup>49</sup>**  
Each

**3 Pair of 3 x 5" Lafayette Speakers**  
Handsome pair of 3 x 5" wide-range ceramic speakers mounted in plastic housing. With cables, mounting hardware. 8 ohms. Imported.  
99 F 62994 Shpg. wt. 2 1/2 lbs. . . Net Per Pair 7.95

**\$7<sup>95</sup>**  
Pair

**4 Deluxe Rear Deck Speakers**  
Louvered grilles adjust to direct the sound. 4 x 6" speakers, 5.36 oz. magnet, 4 and 8 ohms, 32' speaker wire. Black with silver trim. Handles 16 watts of power.  
17 F 74702W Shpg. wt. 7 lbs. . . Net Per Pair 24.95

**\$24<sup>95</sup>**  
Pair

## Deluxe Lafayette Car Speaker System

- Vinyl and Chrome Padded Grilles
- Heavy 5-Ounce Magnets

Pair of all-purpose speaker systems. Either surface mount or flush-mount by removing cabinet. All necessary mounting hardware and wire included. Size with cabinet and grille: 5 7/8 x 2 1/4 x 5 1/4". Handles 10 watts. Imported. Shpg. wt. 5 lbs.  
99 F 63885 ..... Net Per Pair 15.95

**\$15<sup>95</sup>**

Pair



## Lafayette Stereo Hi-Fi Car Speakers

- Handles 10 Watts Per Speaker
- "Quick Mount"—Fastens Easily

**\$16<sup>95</sup>** Pair of 5 1/2" speakers with 5.5 oz. ceramic magnets, Pair cloth roll suspension. 8 ohms. Flange-mounts. With hardware, wire, mounting instructions.  
32 F 01977 Wt. 3 3/4 lbs. Net Per Pair 18.95

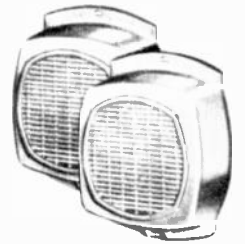

## Trusonic Die-Cast Hi-Fi Car Speakers

- With BIG 2-lb Magnet Structure



**\$34<sup>95</sup>**

Pair

5" full range speaker. Handles 12 watts. Free cone suspension, 2 lb. magnet, 50-18,000 Hz, 8 ohms. With grilles and hardware. Wt. 8 1/4 lbs.  
32 F 49489 ..... Net Per Pair 34.95

## Deluxe Trusonic 6" 2-Way Car Speakers

- 2 lb. Magnet Structure
- 25 Watts Power Handling

**\$47<sup>95</sup>**  
Pair

Custom mounts. Pressure die-cast; 1" voice coil; 45-18,000 Hz; 8 ohms. With wire, instructions, templates. Wt. 8 lbs.  
32 F 49604 ..... Net Per Pair 47.95

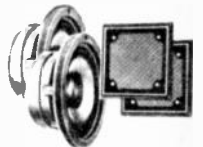

## Deluxe Pairs of Philips Automotive Speaker Systems

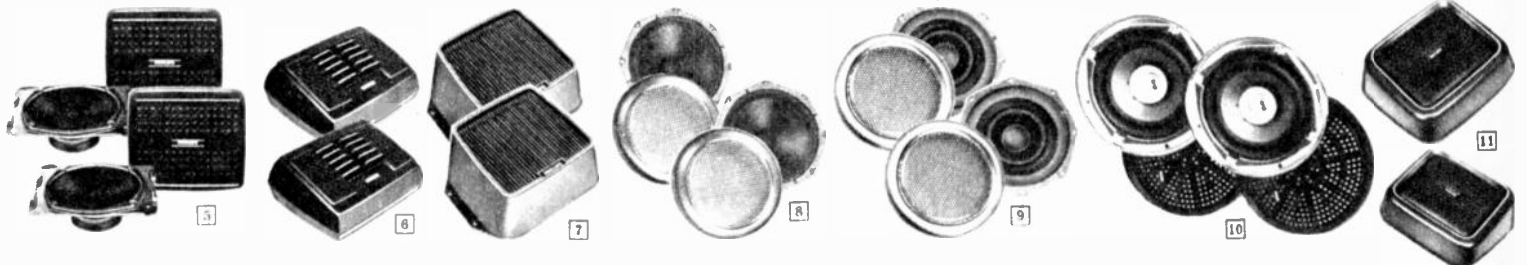

**5 SA20 Flush/Surface Mount**  
Quality 5" compact speakers. Flush or surface-mount. Black with chrome accented finish. 4-8 ohms, handles 10 watts. With mounting hardware. Wt. 2 1/2 lbs.  
32 F 44019 ..... Net Per Pair 14.95

**6 SA1000 Deluxe Rear Deck**  
Each system contains a 4 x 6" air suspension woofer and a 2 1/4" super tweeter. 4-8 ohms; 80-16,000 Hz handles 15 watts. E-Z mount adhesive. Shpg. wt. 7 lbs.  
32 F 44027 ..... Net Per Pair 39.95

**7 SA200 Rear Deck Speakers**  
Pair of 5" speakers. 4-8 ohms, 100-9000 Hz, 10 watts, mounting hardware. 4 lbs.  
32 F 44001 ..... Net Per Pair 16.95

**8 ASP-3 Flush-Mount Speakers**  
5" speakers 4-8 ohms, 100-10k Hz, 10 watts.  
32 F 44076 3 1/2 lbs. .... Net Per Pair 11.95

**9 ASP-2 Flush-Mount Speakers**  
5" spkrs. 10 oz. magnet; tweeter cones, 1" coils 90-17k Hz; 20 watts. 4-8 ohms.  
32 F 44068 5 lbs. .... Net Per Pair 22.49

**10 SA50 Deluxe Flush Mounts**  
5 1/4" air suspension speakers, separate aluminum tweeters, 10 oz. magnets, 1" voice coils, grilles, 80-12,000 Hz, 4-8 ohms, 20 watts. Hardware included. 6 1/2 x 2 7/8".  
32 F 44050 Wt. 6 lbs. .... Net Per Pair 26.95

**11 SA500 Wedge-Type Speakers**  
E-Z mount adhesive installation. 5 1/4" speakers, separate tweeters, 10 oz. magnets, 1" voice coils. 80-12k Hz. 4-8 ohms. 20 watts. 7 1/4 x 7 1/2 x 4 3/4".  
32 F 44043 Wt. 7 lbs. .... Net Per Pair 32.95



# Robins and TruTest Accessories

## 1 Head Cleaner and Test Tapes Cassette or 8-Track

3-way tapes test for proper head alignment, stereo balance, AND clean tape heads, too. Keep your recorder/player in top shape. 28 F 07030 8-Track. Wt. 6 oz. ...Net 1.79  
28 F 07097 Cassette. Wt. 3 oz. ...Net 1.75

## 2 Tape Head Demagnetizers Cassette or 8-Track

Removes excessive magnetic build-up—restores fidelity. Use after 15 hours of unit use. Imported. For 117 VAC, 60 Hz cassette or 8-track. 28 F 07014 8-Track. Wt. 12 oz. ...Net 5.99  
28 F 07071 Cassette. Wt. 8 oz. ...Net 5.99  
For 12 VDC 8-Track Car Tape Players. 28 F 07022 Shpg. wt. 12 oz. ...Net 6.99

## 3 Tape Splicers

For 1/4" or Cassette Tapes

Makes clean, well-bonded splices. Has tape dispenser, cut and trim blades, tape guides, finger holds. Blade centering adjustment. All-metal parts, molded base. Made in U.S.A. 28 F 07170 For 1/4" Tape. 10 oz. ...Net 4.95  
28 F 07113 For Cassettes. 10 oz. ...Net 4.95

## 5 Cassette Demagnetizer

• Cordless—Use Like a Cassette

For use with any cassette recorder or player. Simply "play" as you would a regular cassette — demagnetizes heads, restores fidelity. Use after 15-20 hours of player/recorder use. 28 F 07083 Shpg. wt. 6 oz. ...Net 4.29

## 6 Deluxe Stereo Tape Splicer • Diagonal Cut, "Gibson Girl" Trim

Precision splicer has 1/2"x100" roll of dispensing tape, precision cut & trim blades, "see-thru" windows, replaceable cutter pad and blades. Centering adjustment. Superstrong Cyclocal construction. Instructions. Shpg. wt. 1 lb. 28 F 60096 ...Net 10.49

## 4 Nonabrasive Head Cleaners For Cassette or 8-Track

Removes dust and dirt from tape head and capstan. With special tape and cleaning liquid. Nonabrasive. Shpg. wt. 6 oz. 28 F 07006 8-Track ...Net 1.89  
28 F 07089 Cassette ...Net 1.79

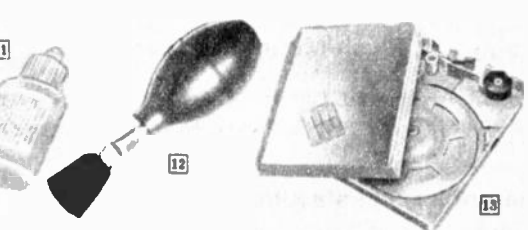
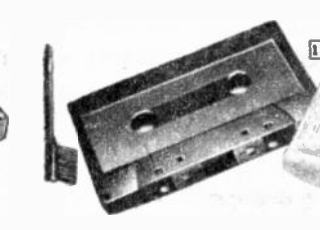
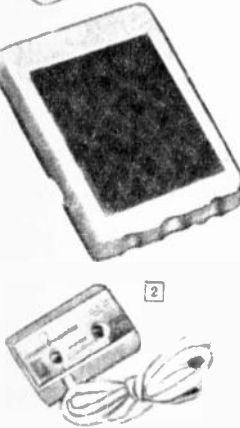

7 Cassette "Sound Salvage" Kit. Complete set of cassette housing and parts. "Recover" tape from broken cassettes by re-assembling them. 28 F 07154 Shpg. wt. 4 oz. ...Net 99¢

8 Mylar Splicing Tape. For splicing recording tape. Mylar base with special formula adhesive. 28 F 07212 1/4"x300". Wt. 3 oz. ...Net 95¢  
28 F 07204 1/2"x200". Wt. 3 oz. ...Net 95¢

9 Head Kleen Kit. For cassette or cartridge players/recorders. 2-oz. bottles of head cleaner and guide lubricant, 25 extra-long tips for cleaning hard-to-reach places. 28 F 72406 Shpg. wt. 11 oz. ...Net 1.79

10 Cassette Test Strobe. Checks cassette units for proper speed. Has built-in light, strobe tape. For 117 VAC, 50-60 Hz cassette units. 28 F 72414 Shpg. wt. 6 oz. ...Net 6.95

11 Cassette Tape Transport Cleaning Kit. Prevents cassette winding and spillage. With cassette head cleaner, capstan fluid and applicator brush. 28 F 72693 Shpg. wt. 10 oz. ...Net 2.29

12 Blower Brush. Rubber blower and soft camel's hair brush ideal for tape units, phonos, cameras, etc. Blows away dust from recorder heads, etc. 28 F 72133 Shpg. wt. 4 oz. ...Net 1.79

13 8-Track Cartridge "Salvage" Kit. "Transplant" valuable tapes from broken cartridges to this complete cartridge housing. Includes splicing patches and label. 28 F 72877 Shpg. wt. 8 oz. ...Net 1.49

14 "Double Header" 8-Track Cartridge Maintenance Kit. Has special non-abrasive head tape at one end, recorder-player drive cleaner at the other. Use as you would a cartridge and "play" away dirt & grime. Includes bottle of head cleaner solution. 28 F 72711 1/2 lb. Net 3.39

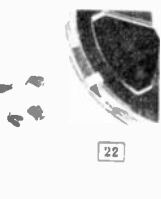
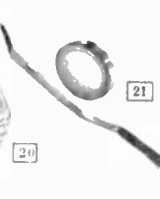
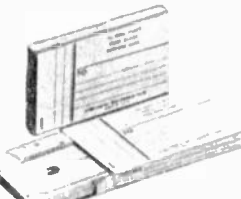
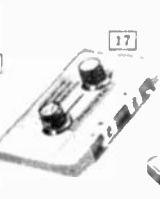
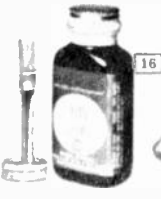

15 White Leader Tape. 1 1/2" mil leader tape 100 ft. x 1/4" wide on 2 1/2" reel. For indexing, etc. 28 F 07220 Shpg. wt. 4 oz. ...Net 89¢

16 Tape Cleaner. For all tape heads, capstans, guides, etc. 2-oz. bottle with felt applicator. 28 F 07162 Shpg. wt. 7 oz. ...Net 79¢

17 Cassette Tape Tension Winders. Inserts in holes of cassettes to wind tape in either direction. Set of 2. 28 F 07147 Wt. 3 oz. ...Net 1.19

18 Economy Tape Mailers for Cassettes. 15 cardboard mailers have "stops" to prevent cass. unwinding. 28 F 07139 Wt. 8 oz. ...Net 1.19

19 Color-Coded Replacement Labels for Cassettes. Pkg. of 20 self-stick labels. Five colors. 28 F 07121 Wt. 3 oz. ...Net 1.19

20 Self-Stick Title Labels. For tape and film canisters, boxes, records, etc. 2x1 1/2". 40 each of 5 colors. 28 F 71507 Shpg. wt. 4 oz. ...Net 1.49

21 Aluminum Foil Sensing and Cueing Tape. For recorders with auto stop and reverse. 1/4"x150" long. 28 F 07238 Wt. 4 oz. ...Net 1.79

22 Reel Tape Clips. Keeps reel tapes from unwinding when stored. Plastic, reusable. For all reels. 28 F 71093 Pkg. of 75. 4 oz. Net 1.25

**89¢ Pkg. of 10**  
**Cartridge Anti-Dust End Caps**  
Protects exposed tape at end of cartridge from dust and dirt, accidental damage. Package of 10. Plastic, reusable. 28 F 07048 Shpg. wt. 4 oz. ...Net 89¢

**89¢ Pkg. of 100**  
**"Audio-Clean" Swabbies**  
Soft cotton tips on 6"-long applicators for getting at hard-to-reach spots on tape, phono, other equipment. 28 F 07055 Shpg. wt. 4 oz. ...Net 89¢





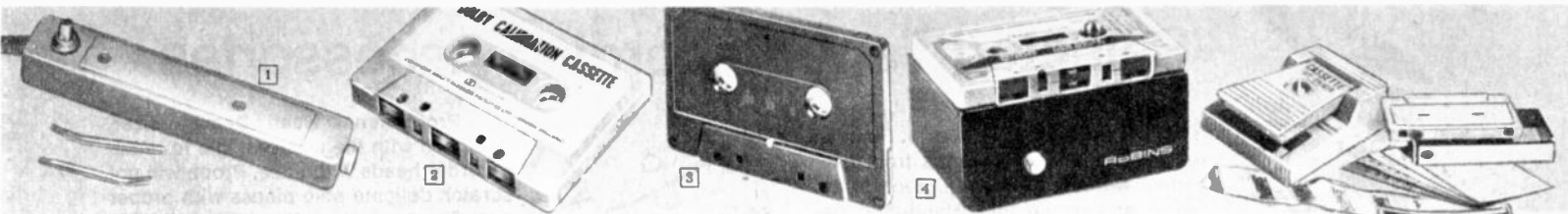

## Keep Your Tape Recording Equipment Like NEW!

**1 Tape Head Demagnetizer.** Features interchangeable tips for cassette, 8-track cartridge and reel-to-reel equipment. Built-in on-off switch. For 117 VAC, 60 Hz. UL listed. Shpg. wt. 1 lb.  
**28 F 07188** ..... Net 7.99

**\$799**

**2 Dolby® Test Cassette.** Helps adjust Dolbyized cassette recorders for optimum performance. Lets you check alignment. Has 400 Hz tone for properly adjusting Dolby noise reduction system. Use as you would a standard cassette. \*Dolby is a Trademark of Dolby Laboratories, Inc. Shpg. wt. 5 oz.  
**28 F 72885** ..... Net 5.79

**\$579**

**3 Stereo Test Cassette and Music Sampler.** Has recorded instructions on how to set tone, stereo balance, volume controls of all cassette recorders for optimum stereo sound and enjoyment. Also has several memorable music selections. For all stereo cassette recorder/players. Shpg. wt. 5 oz.  
**28 F 72901** ..... Net 6.49

**\$649**

**4 Rapid Cassette Rewinder.** Solve your re-winding problems. Rewinds a standard C-60 cassette in only 22 seconds. Easy one-hand operation. Uses "D" cell, order below. Size: 4 x 2¼ x 2".  
**28 F 72794** Shpg. wt. 12 oz. Net 11.49  
**99 F 62564 "D" Cell** ..... Net 19¢

**\$1149**

**5 Complete Cassette Tape Editing Kit.** Includes "Cut 'N Splice" tape splicer, 25 splicing patches, tape tension winder, full supply of self-stick replacement labels, color coded index spots, identification end labels. Great value.  
**28 F 72604** Shpg. wt. 8 oz. ... Net 6.79

**\$679**

**6 NEW! Cassette "Soundcaster."** Play your portable cassette recorder/player thru any AM radio without wires or hook-up. Simply plug "Soundcaster" into earphone jack of cassette unit, place near AM radio. Helps you get better sound from portable cassette units.  
**28 F 32509** Shpg. wt. 8 oz. Net 12.95

**\$1295**

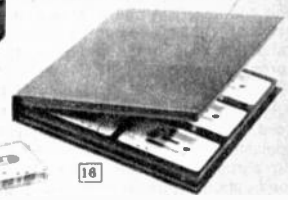
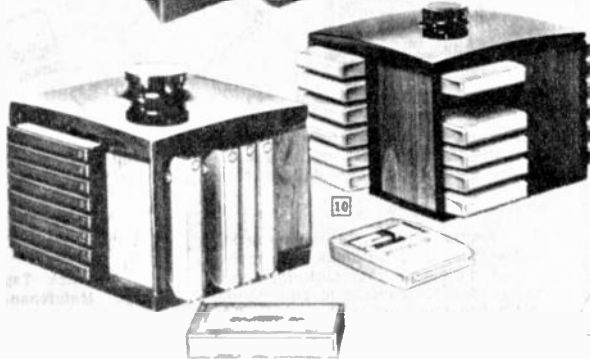
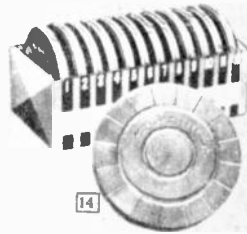
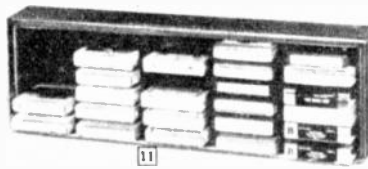
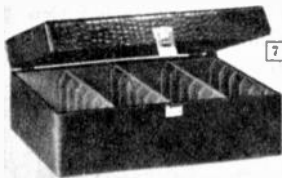
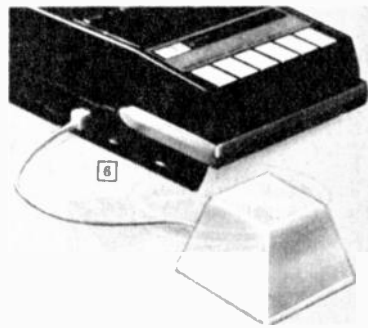

**7 Deluxe 8-Track Tape Carrying Case.** Solid wood case with durable alligator-vinyl covering and attractive plush red interior. Protects tapes from dust 'n dirt, provides easy storage. With sturdy handle, lock and key 17½ x 6½ x 7½". Holds up to 24 8-track cartridges.  
**28 F 78064W** Shpg. wt. 4¼ lbs. .... Net 7.95

**Net 7.95**

**8 Deluxe Attache-Type Cassette Carrying Case.** Similar to above. Holds up to 30 cassettes. Individual compartments. With handle, lock and key. Size: 14½ x 3¾ x 9½".  
**28 F 78072** Shpg. wt. 3¼ lbs. .... Net 7.95

**Net 7.95**

**9 8-Track Cartridge Carrying Case.** Holds up to ten 8-track cartridges. Keeps cartridges neat, orderly, dust free. Has individual compartments for cartridges, lock and key, handy carrying handle. 9 x 6 x 6".  
**28 F 20124** Shpg. wt. 1¾ lbs. .... Net 3.39

**Net 3.39**

**10 Dynasound "Stowaway" Cassette Storage Unit.** "Lazy Susan"-type cassette unit holds to 32 cassettes, keeps 'em neat and fingertip-ready when you want them. Has good-looking walnut-grain finish, black plastic top and swivel base. Units can be stacked. 6¾ x 6¾ x 6¾".  
**28 F 18011W** Shpg. wt. 1½ lbs. .... Net 7.50  
**24-Cartridge Unit.** As above. 9¼ x 9¼ x 9¼".  
**28 F 18003W** Shpg. wt. 1½ lbs. .... Net 10.95

**Net 7.50**

**Net 10.95**

**11 Home Storage Cabinets.** Stylish one-piece molded insert stores tapes in individual compartments for neat stacking and easy cataloging of titles. Fits in bookcase, on wall or shelf, anywhere. Good-looking, simulated walnut-grain finish. Holds 30 cartridges. 24 x 3¾ x 7¾".  
**28 F 78130W** Shpg. wt. 5 lbs. .... Net 8.95  
Holds 36 cassettes. 21 x 2¼ x 8¾".  
**28 F 78155W** Shpg. wt. 4 lbs. .... Net 8.95

**Net 8.95**

**12 8-Track and Cassette Storage Cases.** High-impact plastic cases have individual storage compartments for safe, clean storage of tapes. Good-looking black base with simulated walnut-grain decorator top. 4½ x 5¾ x 12½".  
**TC-300 8-Track Case.** Holds 12 cartridges.  
**28 F 15504** Shpg. wt. 1½ lbs. .... Net 1.99  
**TC-400 Cassette Case.** Holds 15. 4¾ x 3 x 12½".  
**28 F 15512** Shpg. wt. 1 lb. .... Net 1.99

**Net 1.99**

**13 "Lazy Susan" Storage Kits.** Attractively-styled racks have simulated walnut-grain finish, swivel base. Assembles in minutes with just a screwdriver. Holds 48 cartridges.  
**28 F 78171** Shpg. wt. 3¾ lbs. .... Net 6.95  
Holds 48 cassettes.  
**28 F 78189** Shpg. wt. 3¼ lbs. .... Net 6.95

**Net 6.95**

**14 Twist-Lock Styrene Storage Cans.** Twelve dust-free storage cans for reel-to-reel tapes, film, etc. Ribbed for convenient stacking. Center-locking stud prevents movement on all 7" reels, most 3" and 5" reels. 12 cans plus FREE storage box. Shpg. wt. 4½ lbs.

**28 F 65103W** ..... Net 5.99  
**Twist-Lock Cans Only.** Less storage box. 6 oz.  
**28 F 65111** ..... Lots of 6, ea. 50¢; Singly, ea. 55¢

**15 12-Cassette Carrying Case.** Black vinyl case with shoulder strap. Snap-spring lock. Chrome trim. 6½ x 5½ x 3".  
**28 F 27012** Shpg. wt. ¾ lb. .... Net 2.49

**16 Book-Type Cassette Storage Album.** Holds 12 cassettes neatly in recessed compartments. Built-in "stops." Simulated walnut wood-grain cover. 10¾ x 9¾ x 1¼".  
**28 F 07105** Shpg. wt. 11 oz. .... Net 2.89

**17 Plastic Individual Cassette Storage Box.** Snap-open plastic box with clear, hinged cover for easy identification, built-in stops. Wt. 3 oz.  
**28 F 17054** ..... Net ea. 29¢; Lots of 4, Net 99¢

**Lafayette Cat. No. 750 73**

Charge It with Your BankAmericard or Master Charge.

# Selected Tape Recording Accessories



1 \$12.95

**1 Universal Bulk Tape Eraser.** Remove recorded sound in seconds from cassettes, 8-track cartridges, reel-to-reel tapes, and movie film. Hand-held design, reduces recorder wear. Also demagnetize capstans, tape guides, etc. Makes your erased tapes perform like new. U.L. Listed. 117 VAC, 60 Hz. Lightweight!  
28 F 07196 Wt. 2 3/4 lbs. . . . . Net 12.95



2 \$16.95

**2 Lafayette Deluxe Bulk Tape Eraser.** Demagnetize metal tools or 3", 5", 7", 10 1/2" reels with standard 1/4" tape size. Heavy-duty switch, pilot light, custom finished case. 7 1/4 x 4 1/4 x 3 1/2". 117 VAC, 60 Hz. Imported.  
99 F 15182 Wt. 4 3/4 lbs. . . . . Net 16.95



3

**3 Professional Bulk Tape Eraser.** Erases entire reel of tape in seconds. Reduces background noise levels, unwanted signals, etc. Easy operation. For reels up to 10 1/2" diameter, tapes to 1/2" wide. 5 1/4 x 6 3/4 x 3 3/4". 110-120 VAC, 50-60 Hz. 5 amp. U.L. Listed.  
28 F 60245 Wt. 9 3/4 lbs. . . . . Net 47.50



4

**4 Professional Cassette Bulk Tape Eraser.** Removes recorded sound from entire tape in seconds. Restores tapes to "like new" condition. 110 VAC, 50-60 Hz.  
28 F 72265 Wt. 2 1/2 lbs. . . . . Net 16.99

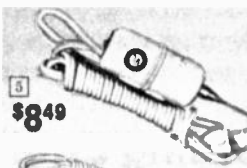

5 \$8.49

**5 Professional Head Demagnetizer.** Designed with the proper angle to reach recorder heads with ease. Probe will not scratch delicate pole pieces with proper use. Chrome-plated. 3 3/8 x 1 1/4". 117 VAC, 50-60 Hz. 6-ft. heavy-duty line cord. Compact. UL listed.  
28 F 60260 Shpg. wt. 10 oz. . . . . Net 8.49



6 \$3.99

**6 Lafayette Tape Head Demagnetizer.** Pencil-shaped head demagnetizer with switch control—turn on-off when needed. 117 VAC, 60 Hz. Eliminates static.  
99 F 15331 Imported. Wt. 9 oz. . . . . Net 3.99



7 \$1.39

## Telephone Pickup Coils

**7 Telephone Pickup Coil.** Plugs into microphone input of tape recorder or amplifier. Attaches to telephone by rubber suction cup. 4 1/2' cable with 1/8" plug.  
99 F 61970 Imported. Wt. 4 oz. . . . . Net 1.39



8 \$3.39

**8 Loop-Type Telephone Pickup Coil.** Sensitive coil for use with recorders, amplifiers, dictating machines, etc. 3-ft. cable with 1/8" plug. Imported.  
28 F 65129 Shpg. wt. 6 oz. . . . . Net 3.39



9 \$8.80

**9 Hum-Bucking Telephone Pickup Coil.** Eliminates high stray hum by its symmetrical hum cancelling design. Use with high-impedance tape recorders, amplifiers, dictating machines. Double suction cup for easy mounting. 5-ft. cable.  
28 F 32012 . . . . . Net 8.60



10 \$1.39

**10 Lafayette Recorder Patch Cord** 6-ft. cord has insulated alligator clips at one end and RCA phono plug at the other. Just attach clips to speaker terminals, and plug other end into tape recorder. Imported.  
99 F 15174 Shpg. wt. 5 oz. . . . . Net 1.39

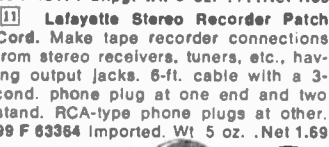

**11 Lafayette Stereo Recorder Patch Cord.** Make tape recorder connections from stereo receivers, tuners, etc., having output jacks. 6-ft. cable with a 3-cond. phone plug at one end and two stand. RCA-type phone plugs at other.  
99 F 63364 Imported. Wt 5 oz. . . . . Net 1.59

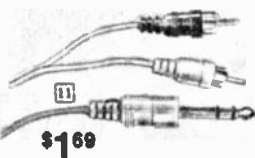

11 \$1.69

**12 Clear Plastic Tape Reels.** Sturdy non-warp plastic reels for recording tapes. Avg. shpg. wt. 4 oz.  
28 F 23052 3" Reel . . . Lots of 4 ea. 15¢  
Singly ea. 17¢  
28 F 23011 3 3/4" Reel . . . Lots of 4 ea. 19¢  
Singly ea. 22¢  
28 F 23029 5" Reel . . . Lots of 4 ea. 35¢  
Singly ea. 39¢  
28 F 23037 7" Reel . . . Lots of 4 ea. 44¢  
Singly ea. 47¢  
5" Low Torque Reel  
28 F 23060 .4-lot ea. 65¢; Singly ea. 70¢  
7" Low Torque Reel  
28 F 23045 .4-lot ea. 85¢; Singly ea. 93¢



12 15¢  
In lots of 4

**19 Tape Head Cleaner.** Remove coating deposits from tape heads and restore pure, true sound.  
28 F 12923 8-Track Clean. 6 oz. Net 1.39  
28 F 16015 Cassette. 4 oz. . . . . Net 1.19



13 \$5.95

**13 Amperex Demagnetizing/Cleaning Cassette.** Demagnetize all cassette recorder heads and guides. Will not damage tape heads.  
28 F 54008 Shpg. wt. 4 oz. . . . . Net 5.95



14 \$6.95

**14 Amperex 8-Track Cartridge Demagnetizer/Cleaner.** Cordless. Demagnetizes and cleans 8-track cartridge heads and guides. No damage to tape heads.  
28 F 54016 Shpg. wt. 8 oz. . . . . Net 6.95

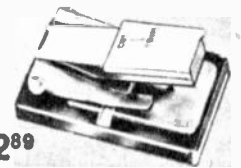

15 \$2.89

**15 Pin Ball 8-Track Cartridge.** Tape head is demagnetized and cleaned as a switching mechanism moves the player head thru all track positions.  
28 F 16023 8 oz. . . . . Net 2.95



20

**17 8-Track Tape Cartridge Maintenance Kit.** All-in-one kit for your 8-track cartridge / cassette tape systems. Keeps heads in top condition. With cleaner, lubricant, applicators, brush, case & instructions. For all 4- and 8-track systems.  
28 F 78015 1/2 lb. . . . . Net 1.95

**20 Metal Storage Cans.** Av. wt. 8 oz.  
28 F 63066 5" Can . . . Lots of 6 ea. 54¢  
Singly ea. 80¢  
28 F 63074 7" Can . . . Lots of 6 ea. 59¢  
Singly ea. 69¢

**16 Cassette Tape Splicer.** Precision instrument for use in splicing and editing of all cassette tapes. Imported.  
99 F 15992 Shpg. wt. 7 oz. . . . . Net 2.89

**21 Lafayette Foot Switch.** Add dictating versatility to any cassette recorder. Foot switch operates cassette. 5-ft. cable with microminiature plug.  
99 F 15810 Imported. Wt. 3/4 lb. Net 4.50

**22 Reel Locks.** Hold tape recorder reels in place. Useful when recorder is in vertical position. Won't interfere with motion. Imported. Shpg. wt. 4 oz.  
99 F 15190 Set of 2 . . . . . Net 69¢



**18 Lafayette Head Cleaner Spray.** Sprays away oxides, dirt, grease on all tape recorders. 5" extension tube pinpoints application. 6 oz.  
28 F 01488 10 oz. Net 1.59

## Professional Sony Tape Recorder Accessories

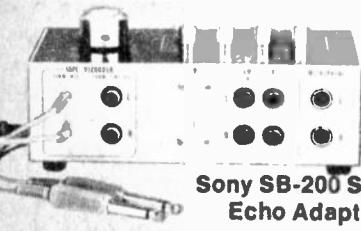

**Sony SB-200 Sound Echo Adapter**

Add special effects to your tape recordings. Use with any stereo tape recorder with separate facilities for recording each channel. Separate buttons for sound-on-sound, echo, volume control. 4 x 8 x 2 1/2".  
27 F 60734 Imported. Shpg. wt. 2 1/2 lbs. . . . . Net 49.95

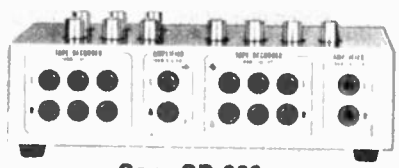

**Sony SB-300 Tape Recorder Selector**

The SB-300 is a sophisticated switching control selector. Expands your tape recorder's capabilities to enable recording, monitoring and dubbing from up to three separate tape sources. Imported. 4 x 8 x 2 1/2".  
27 F 60742 Shpg. wt. 2 1/2 lbs. . . . . Net 59.95

## Editall Tape Editing Kit



Machined precision duraluminum cutting block. Complete with grease pencil, blades, 66" roll of 1/2" splicing tape, instructions, case. Straight or diagonal cuts.  
28 F 38050 Wt. 7 oz. . . . . Net 13.50



**20-Minute Automatic Repeating Cassette**

Endless repeat cassette for sales training, sleep learning, background music, displays, etc. Automatically repeats. Sounds good even after long use.  
28 F 55005 Shpg. wt. 6 oz. . . . . Net 9.98

# Lafayette Recording Tape—Guaranteed to Please!

## Lafayette's Guarantee—You Be the Judge

Lafayette's open reel, cassette and 8-track blank tape is made by outstanding, nationally-known manufacturers. It is first quality, splice-free, red oxide-coated, with full frequency response, uniform output and no "dropouts." Resistant to moisture, heat,

cold and abrasion. We guarantee absolute satisfaction or your money back. If for any reason you are dissatisfied, return the tape within 30 days and we will refund your money (less only transportation charges). You are the sole judge!



### Lafayette 8-Track Mylar Cartridge Tape

As Low As  
**\$1.29**

Continuous loop 8-track cartridges are well lubricated to preserve tape life and reduce head wear. Calendered low-noise, high-output coating on mylar base. High reliability construction assures unexcelled sound reproduction performance. Avg. shpg. wt. 8 oz.

Stock No.	Recording Time	Net each		
		1-5	6-11	12-up
28 F 01548	40 min.	1.89	1.49	1.29
28 F 01439	70 min.	1.95	1.79	1.49
28 F 01355	80 min.	2.25	2.05	1.85



### 1 Lafayette Low-Noise Blank Tape Cassettes

Full-fidelity recording at budget prices. Precision manufacturing standards assures excellent sound reproduction and mechanical reliability. Lubricated and calendered for longer tape life. Imported. Shpg. wt. 4 oz.

Stock No.	Model No.	Playing Time	Net each	
			1-9	10-up
28 F 01579	C-45	45 minutes	.89	.79
28 F 01223	C-60	60 minutes	.99	.89
28 F 01207	C-90	90 minutes	1.49	1.39
28 F 01215	C-120	120 minutes	2.19	1.99

### 2 Lafayette Criterion® Deluxe Blank Tape Cassettes

Low-noise, high-output cassettes manufactured to Lafayette's specifications. Deep lubricated, super-calendered to minimize wear and improve frequency response. Head cleaning tape at one end. High-quality oxide coating for performance superior to conventional tape cassettes. Plastic album box. Imported. Shpg. wt. 5 oz.

Stock No.	Model No.	Playing Time	Net each	
			1-9	10-up
28 F 01587	C-45	45 minutes	1.15	.99
28 F 01306	C-60	60 minutes	1.29	1.16
28 F 01314	C-90	90 minutes	1.99	1.79
28 F 01322	C-120	120 minutes	2.99	2.69

### 3 Lafayette Chromium Dioxide Casette Tapes

Recording cassettes use a chromium-based coating to provide low distortion, increased high frequency levels, and reduced inherent tape noise. Recommended only for recorders with CrO<sub>2</sub> bias switches. Made with Dupont Crolyn® tape. Hard plastic storage box. Imported.  
**C-60 Chromium Dioxide Cassette.** Wt. 4 oz.  
 28 F 01496 ... 1-9, Net ea. 2.49; 10-up, Net 2.29  
**C-90 Chromium Dioxide Cassette.** Wt. 5 oz.  
 28 F 01504 ... 1-9, Net ea. 3.25; 10-up, Net 2.99

### 4 Lafayette Criterion® Wide-Range Hi-Fi Cassettes

Ultra-dynamic hi-fi cassettes are loaded with deluxe features. Advanced grade formulation provides wide dynamic range with frequency response of 30-20,000 Hz. Low-noise, distortion-free, high-output results in top performance for any recording uses. Super-calendering minimizes wear, improves frequency response. Head cleaner at one end. Hinged album storage box. Imported. Shpg. wt. 5 oz.  
 99 F 15651 C-60 60-minute ..... Net ea. 2.39  
 99 F 15901 C-90 90-minute ..... Net ea. 3.59  
 99 F 16032 C-120 120-minute ..... Net ea. 4.75

### Lafayette Reel-to-Reel Recording Tape

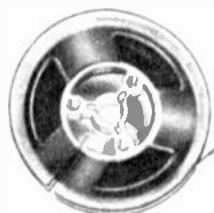

**TENSILIZED MYLAR AND MYLAR TAPES.** Mylar base is strong, durable and virtually impervious to heat, cold and humidity. \* Indicates tensilized mylar; pre-stretched to offset sudden starts and stops and prevent wow. Clear plastic reels. Individually boxed. Avg. wt. 3/4 lb.

Stock No.	Ft.	Reel	Mils	Net each		
				1-4	5-24	25-up
28 F 01090	300	3"	0.5*	.79	.69	.59
28 F 01108	600	3 1/4"	0.5*	1.09	.99	.90
28 F 01058	1200	5"	0.5	1.89	1.75	1.58
28 F 01068	1800	7"	1.0	2.49	2.29	2.09
28 F 01074	2400	7"	0.5	3.49	3.29	3.09
28 F 01231	3600	7"	0.5*	5.29	4.89	4.49

**QUADRUPLE PLAY 1/4-MIL TAPE.** Four times more recording time than standard tapes. Ultra-thin 1/4-mil tensilized mylar; high-density coating. **1100 Ft. on 3 1/4" Reel.** Shpg. wt. 4 oz.

**28 F 01258** ..... Net 2.39  
**2400 Ft. on 5" Reel.** Shpg. wt. 1/2 lb.  
**28 F 01264** ..... Net 4.99  
**4800 Ft. on 7" Reel.** Records 32 hours (all 4 tracks) at 1 1/2 ips, 16 hours at 3 3/4 ips.  
**28 F 01272** Shpg. wt. 3/4 lb. .... Net 9.39

## TDK 8-Track Cartridges, Endless Cassettes & Accessories

**5 TYPE SD 8-TRACK HI-FI CARTRIDGES.** TDK's new 8-track cartridges bring you important technical changes designed to improve cartridge performance. An exclusive mechanism prevents one of the most common causes of jamming—tape looseness—for improved running characteristics with less wow and flutter. Features very broad dynamic range and high signal-to-noise ratio. High saturation levels for real-life sound reproduction. Imported. Shpg. wt. 6 oz.

Stock No.	Type No.	Playing Time	Net each	
			1-9	10-up
28 F 24530	8TR-40SD	40 min.	2.99	2.69
28 F 24548	8TR-80SD	80 min.	3.99	3.59

**7 HEAD CLEANER CASSETTE—Type HC-1.** Recommended for periodic use in all cassette recorders. Removes oxide build-up, restores heads to original condition. Shpg. wt. 5 oz.  
 28 F 24779 ... 1-9, Net ea. 1.19; 10-up, Net 1.07

**For TDK's Full Line of Cassettes and Open Reel Tape, See Back Cover**

**6 ENDLESS CASSETTES.** Provides repeat messages for point-of-purchase advertising, sales displays, telephone answering, background music, etc. Can be used in all conventional recorder/players. Imported. Shpg. wt. 5 oz.

Stock No.	TDK No.	Playing Time	Net each	
			1-9	10-up
28 F 24748	EC-20S	20 sec.	3.99	3.59
28 F 24753	EC-30S	30 sec.	3.99	3.59
28 F 24555	EC-1	1 min.	3.99	3.59
28 F 24563	EC-3	3 min.	4.19	3.77
28 F 24571	EC-6	6 min.	4.59	4.13
28 F 24781	EC-12	12 min.	5.49	4.94

**8 DELUXE 7" METAL REEL AND LIBRARY CASE.** Precision-made, warp-proof anodized aluminum reel with smooth satin finish. Case has hinged cover with self-locking latch action. With self-stick labels. Shpg. wt. 1 1/4 lbs.  
 28 F 24787 ... 1-9, Net ea. 8.99; 10-up, Net 6.29



# Recording Tape and Accessories



Top-performing recording tape from 3M Company for high-output, low-noise operation. In cassettes, 8-track cartridges or reel-to-reel.



Low-Noise Cassette   High-Energy Cassette   Dynarange Cartridge   High-Output Cartridge   Highlander Reel-to-Reel   Dynarange Reel-to-Reel   High-Output Reel-to-Reel

## SCOTCH OPEN REEL TAPE

### Types 228 and 229 Highlander Low-Noise Tape

An economical, low-noise recording tape equally suited for voice and music recording applications. Tough polyester base. Wound on 7" tinted plastic reels and packaged in sturdy cardboard box. Shpg. wt. 1 lb.

Stock No.	Type No.	Playing Time at 7 1/2 IPS	Base	Net each	
				1-11	12-up
28 F 33663	228-R60	60 minutes	1.5 mil	3.49	3.14
28 F 33671	229-R90	90 minutes	1 mil	4.99	4.49

### Types 211, 212, 213 and 214 Low-Noise Dynarange Tape

An excellent multi-purpose tape with signal-to-noise ratio 4-6 dB better than ordinary tapes. Tough polyester base. Wound on tinted plastic reels. Leaders attached. All 7" tapes are packaged in attractive permanent plastic storage case; 5" tape in cardboard box. Avg. shpg. wt. 1 1/4 lbs.

Stock No.	Type No.	Reel	Base	Playing Time at 7 1/2 IPS	Net Each	
					1-11	12-up
28 F 33705	212-R45	5"	1 mil	45 minutes	3.49	3.14
28 F 33713	211-R60	7"	1.5 mil	60 minutes	4.49	4.04
28 F 33721	212-R90	7"	1 mil	90 minutes	5.99	5.39
28 F 33739	213-R120	7"	.5 mil. tens.	120 minutes	8.99	8.09
28 F 33747	214-R180	7"	.5 mil. tens.	180 minutes	11.99	10.79

### Types 206 and 207 High-Output, Low-Noise Tape

A superior open-reel tape offering outstanding output and dynamic range. "Posi-Trak" backing assures smooth tape wind and minimal wow and flutter. Leaders attached. Wound on 7" tinted plastic reels, packaged in attractive, permanent plastic storage case. Shpg. wt. 1 1/4 lbs.

Stock No.	Type No.	Base	Playing Time at 7 1/2 IPS	Net Each	
				1-11	12-up
28 F 33689	206-R60	1.5 mil Polyester	60 minutes	5.99	5.39
28 F 33697	207-R90	1 mil Polyester	90 minutes	7.49	6.74

## SCOTCH CLASSIC Recording Tape

### Top-of-the-Line Professional Tape—Cassettes, 8-Track or Open Reel



Classic tape delivers extremely high output with low noise, due to its ultra-highly-polished surface. Oxide is a gamma-ferric variant developed by 3M that provides dramatically increased sensitivity, with great uniformity of dispersion. Wide dynamic range. Posi-Trak backing on polyester base. Fully compatible with all recorders and tape decks.

**1 CLASSIC CASSETTES.** Unique construction combines chromium dioxide with a layer of gamma ferric iron oxide for superb high end and low end performance. Ultrasonically sealed housing. Plastic album box. Wt. 6 oz.

Stock No.	Type No.	Playing Time	Net Each	
			1-9	10-up
28 F 33820	CL-C-45	45 minutes	2.99	2.69
28 F 33838	CL-C-60	60 minutes	3.49	3.14
28 F 33846	CL-C-90	90 minutes	4.99	4.49

## SCOTCH 8-TRACK CARTRIDGES

**LOW-NOISE DYNARANGE CARTRIDGES.** For all-purpose recording. In cardboard storage case with indexing label. Shpg. wt. 6 oz.

Stock No.	Type No.	Recording Time	Net Each	
			1-11	12-up
28 F 33622	S-8TR-45	45 minutes	2.49	2.24
28 F 33630	S-8TR-90	90 minutes	2.99	2.69

**HIGH-OUTPUT, LOW-NOISE CARTRIDGES.** A superior cartridge offering improved output and dynamic range performance, with minimal wow and flutter. Cardboard storage case with indexing label. Shpg. wt. 6 oz.

28 F 33648	S-8TR-45 HOLN	45 minutes	2.99	2.69
28 F 33655	S-8TR-90 HOLN	90 minutes	3.49	3.14

## SCOTCH CASSETTE TAPES

**LOW-NOISE, HIGH-DENSITY CASSETTES.** All-purpose cassette for great sound at medium price. "Posi-Trak" backing for jam-free performance. Minimal wow and flutter. Plastic album storage case. Avg. shpg. wt. 6 oz.

Stock No.	Type No.	Recording Time	Net Each	
			1-11	12-up
28 F 33556	S-C-45	45 minutes	1.99	1.79
28 F 33564	S-C-60	60 minutes	2.39	2.15
28 F 33572	S-C-90	90 minutes	3.59	3.23
28 F 33580	S-C-120	120 minutes	4.79	4.31

**HIGH-ENERGY CASSETTES.** Cobalt-energized oxide provides balanced sound. Captures high notes without sacrificing the lows. "Posi-Trak" backing. In plastic album storage case. Avg. shpg. wt. 6 oz.

28 F 33598	S-C-45 HE	45 minutes	2.49	2.24
28 F 33606	S-C-60 HE	60 minutes	2.99	2.69
28 F 33614	S-C-90 HE	90 minutes	4.49	4.04

## SCOTCH RECORDING ACCESSORIES

**SPLICING TAPE.** Pressure-sensitive. Average shpg. wt. 2 oz.

Scotch 41—1/2-12.5 Size, 1/2" x 150". Roll in bag.

28 F 33291 ..... Lots of 12, Ea. .80; Singly, Ea. .89

Scotch 41—7/32"L. Size, 7/32" x 66". Less dispenser.

28 F 33309 ..... Lots of 12, Ea. 1.25; Singly, Ea. 1.39

Scotch 620—7/32-66. For splicing Posi-trak backing. 7/32" x 66".

28 F 33754 ..... Lots of 12, Ea. 2.69; Singly, Ea. 2.99

**SENSING TAPE. Type 51 7/32S—**To activate automatic stop and reverse on recorders. 150" long x 7/32" wide. One side foil, other adhesive.

28 F 33150 Shpg. wt. 2 oz. .... Lots of 12, Ea. 1.43; Singly, Ea. 1.59

**LEADER-TIMER TAPE. Type 24-1W—**Has 1-second interval markings for 7 1/2" and 15" per second speeds. 100 ft. x 1/4" wide roll. Shpg. wt. 2 oz.

28 F 33325 ..... Lots of 12, Ea. .80; Singly, Ea. .89

**7" SELF-THREADING REEL. Type PSRT-7—**Snap-tight collar.

28 F 33317 Shpg. wt. 8 oz. .... Lots of 12, Ea. 1.79; Singly, Ea. 1.99

**10 1/2" METAL REEL. Type RB-10 1/2M—**NAB reel with 3 spokes.

28 F 33812 Shpg. wt. 1 lb. .... Lots of 12, Ea. 5.93; Singly, Ea. 6.59

**2 CLASSIC 8-TRACK CARTRIDGES.** Low-noise oxide tape offers excellent high frequency response and exceptional sound. Shpg. wt. 8 oz.

Stock No.	Type No.	Playing Time	Net Each	
			1-9	10-up
28 F 33853	CL-8T-45	45 minutes	2.99	2.69
28 F 33861	CL-8T-90	90 minutes	3.99	3.59

**3 CLASSIC OPEN REEL TAPE.** Provides full spectrum linearity, low noise, high output. Pre-attached leaders and trailers. Packed in "book cover" storage boxes with write-on labels.

Stock No.	Type No.	Playing Time at 7 1/2 IPS	Reel	Feet	Wt. Lbs.	Net Each	
						1-9	10-up
28 F 33879	CL-7R60	60 minutes	7"	1200	1 1/2	7.95	7.15
28 F 33887	CL-7R90	90 minutes	7"	1800	1 1/2	9.95	8.95
28 F 33895	CL-7R120	120 minutes	7"	2400	1 3/4	12.95	11.65
28 F 33903	CL-10R120	120 minutes	10 1/2"	2400	3 1/4	18.95	17.05
28 F 33911	CL-10R180	180 minutes	10 1/2"	3600	3 1/2	22.95	20.65
28 F 33929	CL-10R240	240 minutes	10 1/2"	4800	3 3/4	29.95	26.95

# Lafayette Has the Best Magnetic Stereo Cartridges

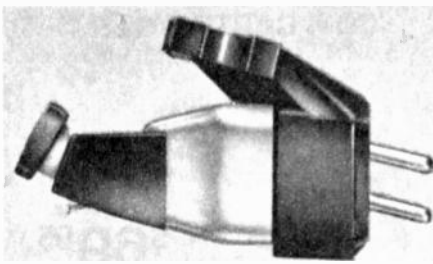

## EMPIRE

Model 66/X. .7 mil spherical diamond stylus. Tracks ¼ to 3 grams. 10-30,000 Hz response. 30 dB separation.

21 F 35263L Shpg. wt. 2 oz. ....Net 19.95

Model 66EE/X. .4x.7 mil elliptical diamond stylus. Tracks ¼ to 2 grams. 10-30,000 Hz response. 30 dB separation.

21 F 35259L Shpg. wt. 2 oz. ....Net 24.95

Model 66E/X. .3x.7 mil elliptical diamond stylus. Tracks ¼ to 2½ grams. 8-30,000 Hz response. 30 dB separation.

21 F 35242L Shpg. wt. 2 oz. ....Net 29.95

Model 66LE/X. .2x.7 mil "nude" elliptical diamond stylus. Tracks ¼ to 2 grams. 8-32,000 Hz response. 30 dB separation.

21 F 35267L Shpg. wt. 2 oz. ....Net 34.95

Model 66PE/X. .2x.7 mil "nude" elliptical diamond stylus. Tracks ¼ to 1½ grams. 8-34,000 Hz response. 30 dB separation.

21 F 35275L Shpg. wt. 6 oz. ....Net 44.95

Model 66QE/X. .2x.7 mil "nude" elliptical diamond stylus. Tracks ½ to 1½ grams. 8-34,000 response. 30 dB separation. For use with new 4-channel CD-4 discs.

21 F 35291L Shpg. wt. 6 oz. ....Net 59.95

## STANTON

Model 661EE. Response: 10-20,000 Hz. Separation: 35 dB, nominal. Output: 0.7 µV/cm/sec, nominal. Tracking Force: ¾-1½ grams. Diamond elliptical stylus, and stylus brush. Wt. 6 oz.

21 F 24006L No Money Down\* ....Net 72.00

## ADC

ADC 220XE Elliptical. Separation: 20 dB. Response: 10-18,000 Hz ± 3 dB. Tracking force: 1½ to 4 grams. Output: 5 µV. Shpg. wt. 6 oz.

21 F 13306L .....Net 22.00

ADC XLM Elliptical. Separation: 30 dB. Response: 10-25,000 Hz. Tracking force: .6 grams. Output: 4 µV.

21 F 13369L No Money Down\* ....Net 50.00

ADC VLM Elliptical. Separation: 30 dB. Response: 10-22,000 Hz. Tracking force: 1 gram. Output: 4 µV.

21 F 13371L No Money Down\* ....Net 46.00

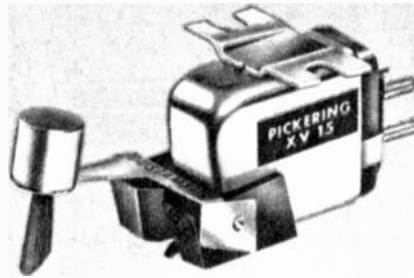

## PICKERING

**DELUXE XV-15 ELLIPTICAL SERIES** — Pickering's Premiere Cartridges. Includes "Dustomatic Brush" which automatically cleans the grooves in advance of the stylus. Specifications: Channel Separation: 35 dB; Normal Output: XV-15/1200E, XV-15/750E—4.4 µV; XV-400E—5.5 µV; XV-15/200E, XV-15/140E—8 µV. Frequency Response: XV-15/1200E 10 to 30,000 Hz; XV-15/750E, 200E, 140E 10-25,000 Hz; XV-15/140E 10-20,000 Hz. Stylus Type: XV-15/1200E .0002" x .0007" elliptical; XV-15/750E—.0004 x .0007" elliptical; XV-15/140E—.0005 x .0007" elliptical; Tracking force: XV-15/1200E—¾ gram; XV-15/750—½ to 1 gram; XV-15/400E—¾ to 1½ grams; XV-15/200E—1 to 3 grams; XV-15/140E—2 to 4 grams. Shpg. wt. 8 oz. each. No Money Down\*.

Stock No.	Model	For	Net
21 F 55299L	XV-15/1200E	Man. Trntbls.	79.95
21 F 53684L	XV-15/750E	Man. Trntbls.	65.00
21 F 53757L	XV-15/400E	Auto. Trntbls.	54.95
21 F 53761L	XV-15/200E	Auto. Trntbls.	49.95
21 F 55232L	XV-15/140E	Auto. Trntbls.	34.95

**V-15 MICRO SERIES.** Incorporates all of the fine characteristics of the XV-15 Series. Narrow and low profile design for simplified mounting. Shpg. wt. 5 oz. each.

**V-15 MICRO IV/AME.** For manual turntables and light tracking automatics. .0004 x .0007" elliptical stylus. Tracking force 1½ ± ½ grams; Output 5.5 µV; Response 20 to 20,000 Hz.

21 F 55224L No Money Down\* ....Net 49.95

**V-15 MICRO IV/ATE.** For automatic turntables. Tracking force 3 ± 1 grams. .0004 x .0007" elliptical stylus; Output 6.5 µV; Response 20-18,000 Hz.

21 F 55174L No Money Down\* ....Net 39.95

**V-15 MICRO IV/ACE.** For record changers. Tracking force 4 ± 1 gram. .0005 x .0007" elliptical stylus; Output 8.0 µV; Response 20 to 17,000 Hz.

21 F 55182L .....Net 29.95

**V-15 MICRO IV/AM.** For manual turntables. .0007" spherical stylus. Tracking force 2 ± 1 grams. Output 6.0 µV. Response 20-20,000 Hz.

21 F 55190L No Money Down\* ....Net 34.95

**V-15 MICRO IV/AT.** For automatic turntables. .0007" spherical stylus. Tracking force 3 ± 1 gm.

21 F 55206L .....Net 29.95

**V-15 MICRO IV/AC.** For record changers. .0007" spherical stylus. Tracking force 4 ± 2 grams.

21 F 55216L .....Net 24.95

**P-SERIES STEREO CARTRIDGES** — Frequency response: 20 to 15,000 Hz. Nominal output: P/ATE-1, 8 µV; P/AT-1, 8.5 µV; P/AC-1, 9 µV; Channel separation: 20-25 dB. Tracking force: P/ATE-1, P/AT-1, 2 to 5 grams; P/AC-1, 3 to 7 grams. P/AC-1, P/AT-1 with .7 mil conical diamond stylus; P/ATE-1 with .0005 x .0008" elliptical stylus. Shpg. wt. 4 oz.

21 F 53680L P/ATE-1 Elliptical .....Net 24.95

21 F 53567L P/AT-1 Conical .....Net 19.95

21 F 53575L P/AC-1 Conical .....Net 17.95

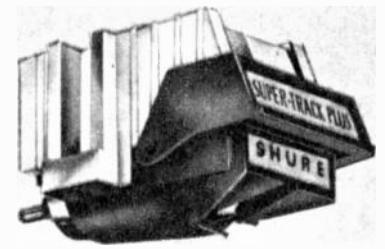

## SHURE

**NEW V-15 TYPE III SUPER TRACK "PLUS" STEREO DYNATIC ELLIPTICAL CARTRIDGE.** Retractable, biradial elliptical .0007" x .0002" diamond stylus. Frequency response: 10 to 25,000 Hz; Channel separation: 28 dB at 1,000 Hz; Output voltage: 3.5 millivolts; Tracking force ¾ to 1½ grams. Shpg. wt. 8 oz.

21 F 62709L No Money Down\* ....Net 77.50

**M91ED DELUXE HI-TRACK STEREO DYNATIC ELLIPTICAL CARTRIDGE.** Retractable elliptical .0007 x .0002" nude diamond stylus. Specifications: Frequency Response: 20-20,000 Hz. Channel Separation: Nominally 25 dB at 1,000 Hz. Output Voltage: 5.0 µV. Tracking Force: ¾ to 1½ grams. Shpg. wt. 8 oz.

21 F 62592L No Money Down\* ....Net 54.95

**THE CUSTOM HI-TRACK SERIES OF STEREO DYNATIC CARTRIDGES.** For use in automatic and manual turntables. Specifications: Frequency Response: 20-20,000 Hz. Channel Separation: Nominally 25 dB at 1,000 Hz. Output Voltage: 5.0 µV. Shpg. wt. 3 oz.

**Model M91E** — .0007 x .0002" elliptical stylus. Tracking Force: ¾ to 1½ grams.

21 F 62444L No Money Down\* ....Net 49.95

**Model M75EJ Type 2** — .0007 x .0004" elliptical stylus. Tracking Force: 1½ to 3 grams.

21 F 62600L No Money Down\* ....Net 44.95

**Model M75B Type 2** — .0006" spherical stylus. Tracking Force: 1½ to 3 grams.

21 F 62616L No Money Down\* ....Net 33.45

**EXTRA-DURABILITY HI-TRACK CARTRIDGES.** Features "snap-in" design for fast, effortless installation. Specifications: Frequency Response: 20-20,000 Hz. Channel Separation: Nominally 25 dB at 1,000 Hz. Output Voltage: M93E and M75-6S, 6.2 µV; M75-6S 9 µV. Shpg. wt. 3 oz.

**Model M93E** — .0007" x .0004" elliptical stylus. Tracking Force: 1½ to 3 grams.

21 F 62436L No Money Down\* ....Net 39.95

**Model M75-6S** — .0006" spherical stylus. Tracking force: 1½ to 3 grams.

21 F 62626L .....Net 27.50

**Model M75CS** — .0006" spherical stylus. Tracking Force: 3 to 5 grams.

21 F 62634L .....Net 24.50

**MODEL M55E ELLIPTICAL STEREO CARTRIDGE.** Elliptical .0007 x .0002" diamond stylus. Tracking force: ¾ to 2 grams. Separation: 25 dB. Output Voltage: 9.3 µV. Shpg. wt. 3 oz.

21 F 62410L .....Net 29.95

**MODEL M44E ELLIPTICAL STEREO CARTRIDGE.** Elliptical stylus (.0004 x .0007") designed for automatic turntables. Tracks from 1¼ to 4 grams. Frequency Response: 20-20,000 Hz. Channel Separation: 25 dB. Output Voltage: 9.3 µV. Shpg. wt. 3 oz.

21 F 62360L .....Net 24.95

**MODEL M7/N21D STEREO CARTRIDGE.** Frequency Response: 20-20,000 Hz. Channel Separation: More than 20 dB at 1,000 Hz. Output Voltage: 4 µV per channel at 1,000 Hz. Tracking Force: 2 to 5 grams. Tracks perfectly in all record changer arms with .7 mil conical diamond stylus. Shpg. wt. 3 oz.

21 F 62063L .....Net 14.95

See Page 76 for CD-4 4-Channel Cartridges plus a complete replacement Diamond Needle listing for Empire, Stanton, ADC, Pickering, GE Magnetic Cartridges.



# Criterion® 2-YEAR GUARANTEED Diamond Needles

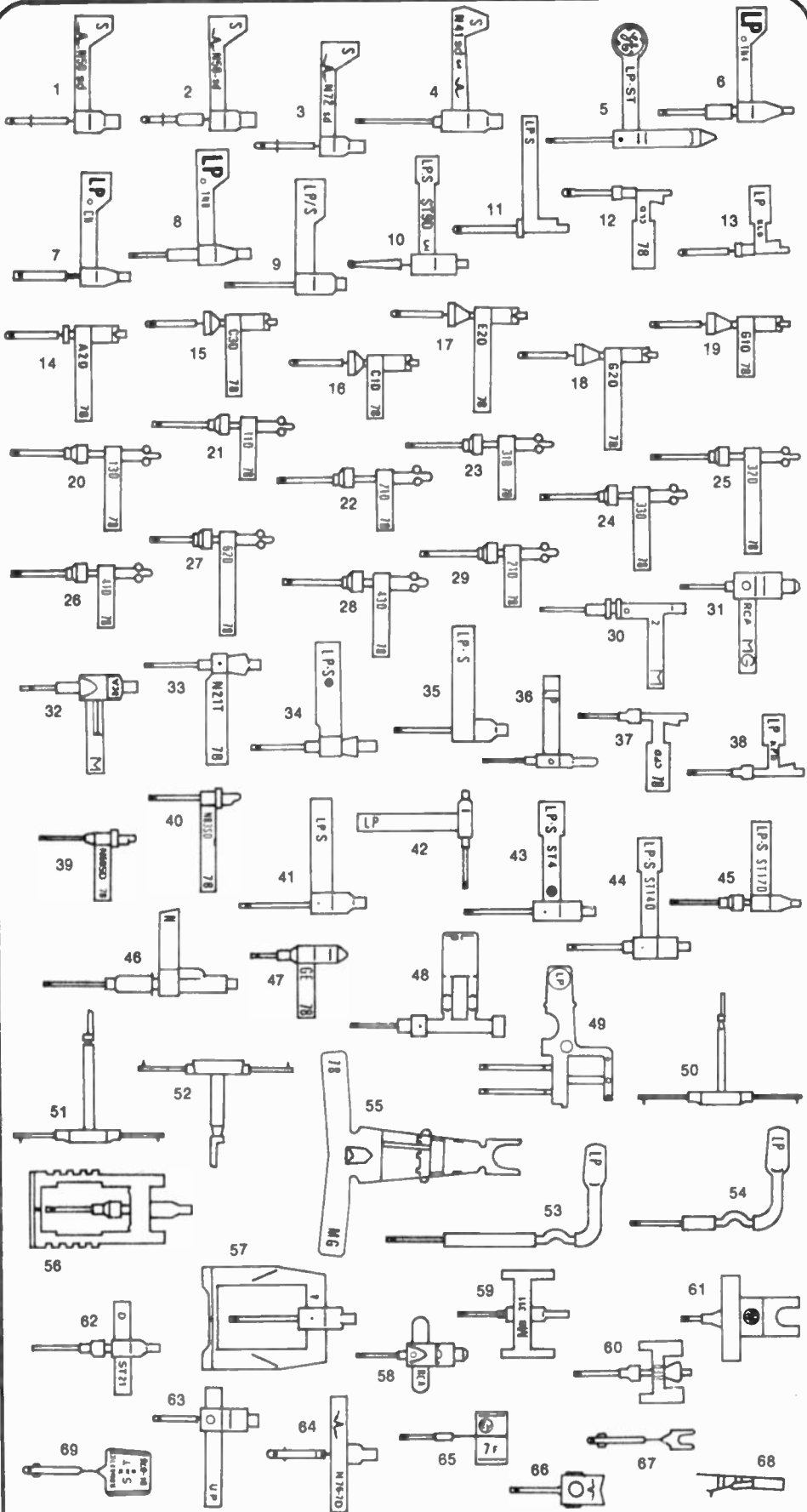

**To Find Your Needle Quickly—Simply Match It to These ACTUAL SIZE Drawings!**

Save Your Records!  
The Replacement Needle  
You NEED is Here!

Each Needle Only  
**\$3.99**

• Precision  
Engineered



Covered by the Lafayette  
**AAA 2-YEAR Guarantee—See Page 3**

Fig.	Stock No.	Type No.	Orig. Mfr.
1	24 F 05009	2120DS	Astatic
2	24 F 05017	2122DS	Astatic
3	24 F 05025	2123DS	Astatic
4	24 F 05033	2117DS	Astatic
5	24 F 05041	2739DS	G.E.
6	24 F 05058	3332DS	Varco
7	24 F 05066	3331DS	Varco
8	24 F 05074	3334DS	Varco
9	24 F 05082	2835DS	Delmonico
10	24 F 05090	2424DS	BSF
11	24 F 05108	2616DS	E-V
12	24 F 05116	2636DS	E-V
13	24 F 05124	2641DS	E-V
14	24 F 05132	3359DS	Tetrad
15	24 F 05140	3361DS	Tetrad
16	24 F 05157	3382DS	Tetrad
17	24 F 05165	3372DS	Tetrad
18	24 F 05173	3363DS	Tetrad
19	24 F 05181	3373DS	Tetrad
20	24 F 05199	3316DS	Tetrad
21	24 F 05207	3310DS	Tetrad
22	24 F 05215	3367DS	Tetrad
23	24 F 05223	3312DS	Tetrad
24	24 F 05231	3314DS	Tetrad
25	24 F 05249	3313DS	Tetrad
26	24 F 05256	3315DS	Tetrad
27	24 F 05264	3308DS	Tetrad
28	24 F 05272	3323DS	Tetrad
29	24 F 05280	3311DS	Tetrad
30	24 F 05298	2918DS	R.C.A.
31	24 F 05306	2912DS	R.C.A.
32	24 F 05314	2915DS	R.C.A.
33	24 F 05322	3224DS	Sonotone
34	24 F 05330	3330DS	Varco
35	24 F 05348	2622DS	E-V
36	24 F 05355	2644DS	E-V
37	24 F 05363	2625DS	E-V
38	24 F 05371	2633DS	E-V
39	24 F 05389	2126DS	Astatic
40	24 F 05397	2130DS	Astatic
41	24 F 05405	2619DS	E-V
42	24 F 05413	2624DS	E-V
43	24 F 05421	2421DS	B.S.R.
44	24 F 05439	2427DS	B.S.R.
45	24 F 05447	2428DS	B.S.R.
46	24 F 05454	2889DS	Philips
47	24 F 05462	2744DS	G.E.
48	24 F 05470	3214DS	Sonotone
49	24 F 05488	2679DS	Euphonics
50	24 F 05496	3454DS	Zenith
51	24 F 05504	3452DS	Zenith
52	24 F 05512	3456DS	Zenith
53	24 F 05520	3213DS	Sonotone
54	24 F 05538	3201DS	Sonotone
55	24 F 05546	2907DS	R.C.A.
56	24 F 05553	2815D	Panasonic
57	24 F 05561	2817D	Panasonic
58	24 F 05579	2916D	R.C.A.
59	24 F 05587	2647D	E-V
60	24 F 05595	2640D	E-V
61	24 F 05603	2752D	G.E.
62	24 F 05611	2429D	B.S.R.
63	24 F 05629	2914D	R.C.A.
64	24 F 05637	2127D	Astatic
65	24 F 05645	2604D	E-V
66	24 F 05652	2677D	Euphonics
67	24 F 05660	3009D	All Brands
68	24 F 05678	2733D	G.E.
69	24 F 05686	3005D	Ronette









# Cartridges From ElectroVoice®



The most popular cartridges are listed. If you need assistance, come to our store where our sales personnel can help you.

## POPULAR REPLACEMENT DIAMOND STYLI FOR SHURE AND EMPIRE CARTRIDGES

-  **A** .7 Mil Diamond Stylus for Shure M7D and M3D Stereo Cartridges.  
24 F 01636 ..... Net 7.50
-  **B** .7 Mil Diamond Stylus for Shure M44 Stereo Cartridge.  
24 F 03061 ..... Net 8.75
-  **C** .6 Mil Diamond Stylus for Empire 880P Stereo Cartridge.  
24 F 03079 ..... Net 7.95
-  **D** .7 Mil Diamond Stylus for Empire 888 Stereo Cartridge.  
24 F 03087 ..... Net 7.95

### REPLACEMENT FOR MOTOROLA

Fig.	Color	Mfg. No.	E-V No.	Stock No.	Net
42	Black/Blue	2-535-BX, 59C80459B01	5124	24 F 81042	7.80
57	Black/Red	59C83643A04, A05, A06, A07, A08	5299D	24 F 81075	9.60

### REPLACEMENT FOR PANASONIC

Fig.	Color	Mfg. No.	E-V No.	Stock No.	Net
11	Black	EPC-35TFC, D	274	24 F 81846	4.98
11	Black	EPC-35TTA, B	5341	24 F 81406	7.20
40	Black	EPC-42STAB2D	5564D	24 F 81414	15.00

### REPLACEMENT FOR R.C.A.

Fig.	Color	Mfg. No.	E-V No.	Stock No.	Net
49	Red	110021, 110023	54	24 F 81893	6.00
28	Silver	75545	159	24 F 81901	2.67
34	Black	115050, 115059	264	24 F 81919	4.89
50	Black	115276, 115277	5170	24 F 81422	11.95

### REPLACEMENT FOR RONETTE

Fig.	Color	Mfg. No.	E-V No.	Stock No.	Net
23	Gray	105, 105D	95	24 F 81430	5.10
23	Gray or White	106, 208	96	24 F 81448	4.77

### REPLACEMENT FOR SEARS

Fig.	Color	Mfg. No.	E-V No.	Stock No.	Net
12	Black	88613	5344	24 F 81653	4.20
43	Black	89002	5026D	24 F 81273	6.90
19	Black	89032	5126	24 F 81307	6.00
56	Black/Silver	89042	5573D	24 F 81158	7.50
13	Black	89111	5572D	24 F 81141	6.60

### REPLACEMENT FOR SONOTONE

Fig.	Color	Mfg. No.	E-V No.	Stock No.	Net
46	Green	2T-S, 2TA-S	38	24 F 81927	4.41
16	Black	21T-S, 21T-SD	150D	24 F 81216	6.60
45	Red	8TA4-S	266	24 F 81935	6.00
45	Red	8TA4-SD	266D	24 F 81943	7.80
14	Black/Gold	9TA-S, 16T, 18T	5553	24 F 81455	4.80

### REPLACEMENT FOR TETRAD

Fig.	Color	Mfg. No.	E-V No.	Stock No.	Net
42	Black/Red	6-32S-A2, 6-32S-75-2	5100	24 F 81000	7.95
42	Black/Red	6-32D-A, 6-32D-75-1	5100D	24 F 81018	9.75
41	Black/Red	8-13D-A5	5104D	24 F 81026	9.75
54	Black/Red	6-11D-P4	5115D	24 F 81034	9.75
42	Black/Blue	2-53S-BX	5124	24 F 81042	7.80
42	Black/Gray	3-42D-A	5271D	24 F 81059	9.60
58	Black/Red	6-21D-MW-1	5276D	24 F 81067	10.80
57	Black/Red	6-31D-M11	5299D	24 F 81075	9.80
42	Black/Blue	2-62S-C	5310	24 F 81083	8.40
41	Black	1-C3D-SN4	5566D	24 F 81794	9.00

### REPLACEMENT FOR ZENITH

Fig.	Color	Mfg. No.	E-V No.	Stock No.	Net
1	Green	142-103	13	24 F 81497	3.57
1	Green	142-106	13D	24 F 81505	5.37
38	Gray	142-92	26	24 F 81513	6.90
38	Gray	142-93	26D	24 F 81521	9.90
2	Blue	142-80	56	24 F 81539	2.37
5	Black	142-124	143	24 F 81711	4.38
16	Black	142-144	149	24 F 81182	5.40
37	Gray	142-111B	220	24 F 81802	6.57
37	Gray	142-110B	220D	24 F 81810	10.17
12	Black	142-165	5148	24 F 81117	3.00
52	Clear	142-167	5188D	24 F 81463	9.57
53	Clear	142-168	5195D	24 F 81471	12.87
33	Black	142-161B	5248	24 F 81992	3.00
42	Black/Gray	142-177	5271D	24 F 81059	9.80
51	Clear	142-163	5371D	24 F 81489	12.57
12	Gray	142-171	5540	24 F 81879	4.80
18	Black	142-149	5549	24 F 81091	3.60

### REPLACEMENT FOR MORSE-ELECTROPHONIC

Fig.	Color	Mfg. No.	E-V No.	Stock No.	Net
19	Black	221, TN4A	5126	24 F 81307	6.00
19	Black	221, TN4AD	5126D	24 F 81315	7.80
17	Black	155D	5595D	24 F 81786	7.50

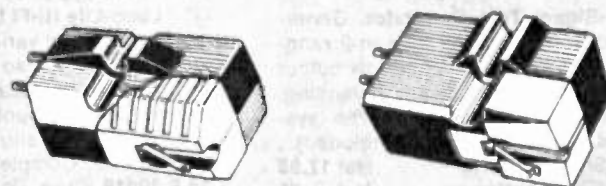

**E** Magne-Ceramic Model 5600D      **F** Magne-Ceramic Model 5601D

## EV Magne-Ceramic™ Cartridges





Get the most out of your console or budget stereo system with a cartridge that looks and performs like a magnetic, but needs no preamp. Flat response, broad separation, light tracking.

- E** Model 5600D. Tracks at 3-5 grams. 600 mV output.  
24 F 38042 For shallow and medium depth arms ..... Net 10.77
- F** Model 5601D. Tracks 2-4 grams. 400 mV output.  
24 F 38059 For medium and deep depth arms ..... Net 10.77

### REPLACEMENT CARTRIDGES FOR LAFAYETTE CHANGERS AND PHONOGRAPHS

Stock No.	For Lafayette Model	Mfr./Type	Net
24 F 29017	200	ST2V	3.60
24 F 38018	400	1116D	9.90
24 F 38026	AC50, AC50B	GP200, 310	9.00
24 F 81273	30	5026D	6.90
24 F 81364	LSC45, LSC45B, LSC100B, LSC8000, LSC8000B, LSC888, LSC9000, LSC2000, LSC9500	TN4BD	7.80
24 F 81861	MC22, LSC90, LSC95, LSC75	SC5H	4.80
24 F 81853	LSC25, LSC35, LSC50, MS24, T60	SX5H	4.20
24 F 81992	MSB, M6	SNH44	3.00
24 F 81349	M10C	TOH44	3.00
24 F 81323	T33, TPS30, TPS35	CN72	3.30
24 F 38034	LSC6000, LSC55	1-A3D-BSR50	9.60
24 F 81158	LSC55, LSC5500, LSC120, LSC1000	BSRSC8H2	7.50

### REPLACEMENTS FOR BSR, VM, GE AND GARRARD 45 RPM SPINDLES

-  **Fig. G.** Flat spindle for use with BSR UA-15SS, UA-25, UA-40, 1500, 2500, 15, 25, 65 and 75 series; McDonald 400, 500, 500A and 600.  
24 F 02204 Shpg. wt. 4 oz. ..... Net 1.49
-  **Fig. H.** For use with BSR Mini-Changers.  
24 F 02568 Shpg. wt. 4 oz. ..... Net 1.49
-  **Fig. I.** For all recent and current VM full-size changers with short centerpost 2 3/4" high.  
24 F 53363 VM 1120 1118) ..... Net 1.49
-  **Fig. J.** For older modol VM changers with long centerpost 4" high VM 1115 (1105).  
24 F 53371 Shpg. wt. 4 oz. ..... Net 1.95
- Fig. K.** Genuine Garrard LRS-20 cylindrical spindle for use with models 30, 40, 40B, 40MKII, 60, 50MKII, SL-55, 55B, SL-65, 65B, SLX, SLX-2.  
24 F 02170 Shpg. wt. 4 oz. ..... Net 3.80
- Fig. K.** For GE: All of the following RD series: 100, 106, 125, 200, 210, 225, 300, 311, 325, 328, 400, 410, 425, 500, 510, 525, 610, 620, 630, 640.  
24 F 38067 Shpg. wt. 4 oz. ..... Net 1.23

# Phono And Hi-Fi Accessories



**1 Lafayette Solid-State Stereo Phono Preamp.** For use with amplifiers not having magnetic cartridge inputs. Compact for quick, easy mounting. Gain: 6 mV input for 0.5 volt output. Input impedance: 50,000 ohms. 117 VAC, 50-60 Hz. 4 x 2 1/2 x 1 1/2".  
99 F 02198 Shpg. wt. 1 lb. ....Net 10.95

**2 Stereo Signal Test Generator.** Generates a low-distortion steady tone in 2 ranges, Hi output for tape inputs and low output for Mic. and phono inputs. For balancing, aligning and troubleshooting stereo systems. Needs 9-volt battery (not included).  
24 F 80937 Shpg. wt. 1 lb. ....Net 17.95  
99 F 60212 9-Volt battery .....Net .39

**3 Stereo Speaker Protector.** Protects costly hi-fi speakers from overload. "Electronic fuse" solid-state limiter automatically limits amplifier output without sacrificing tone quality. Self-powered, needs no batteries or current.  
24 F 80952 Shpg. wt. 1 lb. ....Net 21.49

**4 "Aurorange" Shut-off for Stereo Systems.** Fall asleep to your favorite music without fearing equipment burnup. Simple to set up. No wiring. Works on all systems. Has 6-ft. cord. Operating range: turntable up to 100 watts; amplifiers up to 300 watts. 110 VAC, 50-60 Hz. Size: 4 x 2 3/4 x 1 3/4".  
24 F 80945 Shpg. wt. 2 lbs. ....Net 13.49

**5 IMC Hi-Fi Boxer Fan.** Quiet, slow rotating—delivers enough air to exhaust average enclosure 10 to 30 times per minute to minimize thermal drift and increase equipment life. Easy installation. Pre-lubricated. Complete mounting kit. Easy instructions. 115 VAC, 60 Hz.  
24 F 43018 Shpg. wt. 2 lbs. ....Net 19.95

**6 Long-Life Hi-Fi Blower.** Venturi fan with motor shunt that varies volume of air moved and noise level. Also for Ham radio, TV, other electronic installations. Delivers 50CFM low noise with shunt. Shunt removal delivers 75CFM with slight noise increase. 115 VAC, 60 Hz. Complete.  
24 F 39016 Shpg. wt. 2 lbs. ....Net 11.95

**7 Ball Bearing Heavy-Duty Slides.** Drawer slides, 16 gauge steel. Supports 50 lbs. Ball-bearing, double-extension type. Length: 15", travel length: 11". Extended: 22".  
20 F 52017 Shpg. wt. 2 lbs. ....Net 2.80  
**Short Type.** Same construction as above, but 13" long, travels 9", extends to 18".  
20 F 52025 Shpg. wt. 2 lbs. ....Net 2.45

**8 Stereo/Mono Pick-up.** High output crystal turnover cartridge. Synthetic sapphire needles for LP and standard 78 RPM. Replacement for most manual players. Mounts in 3/16" diameter circular hole.  
99 F 10449 Shpg. wt. 5 oz. ....Net 3.25  
**Synthetic Sapphire LP Rplcmnt. Needle.**  
24 F 04184 Shpg. wt. 2 oz. ....Net 99¢  
**Synthetic Sapphire Std. Rplcmnt. Needle.**  
24 F 04176 Shpg. wt. 2 oz. ....Net 99¢

## Watts Cleaning Tools Extend Record Life



**16 Dust Cover Cleaner.** Cleans plastic or glass covers. Anti-static properties reduce dust accumulation to keep surfaces sparkling clean.  
24 F 19505 Shpg. wt. 10 oz. ....Net 83¢

**17 Disc Preener.** Penetrates every groove, removes oil, dust, grit. Deposits non-toxic ionic compound for anti-static control.  
24 F 25056 Shpg. wt. 4 oz. ....Net 4.95

**18 Manual Parastat.** Heavy-duty cleaner for deep-down accumulations of dust and dirt.  
24 F 25064 Shpg. wt. 12 oz. ....Net 19.95

**19 Record Care Kit.** Includes Parastat, Stylus Cleaner, Humid Mop, New Anti-Static Fluid.  
24 F 25072 Shpg. wt. 1 1/4 lbs. ....Net 24.95

**20 Record Maintenance Kit.** Contains Preener, Stylus Cleaner and Dust Bug.  
24 F 25080 Shpg. wt. 12 oz. ....Net 14.50

**21 Humid Mop.** Keeps Watts tools clean.  
24 F 25098 Shpg. wt. 6 oz. ....Net 4.50

**22 Activating Fluid.** For Dust Bug, Parastat, Preener.  
24 F 25049 Shpg. wt. 2 oz. ....Net 3.00



**9 Deluxe Case for 7" Records.** Solid wood frame, lock corner construction, covered with Pyroxilin-coated cloth. Holds 60 records. 8 x 6 1/2 x 8 1/2". Index and separators.  
24 F 82032 Shpg. wt. 3 lbs. ....Net 4.69

**10 Deluxe Case for 12" Records.** Construction as above. Holds 60 records. 13 1/4 x 7 x 14 1/2".  
24 F 82016 Shpg. wt. 4 3/4 lbs. ....Net 6.29

**11 Hi-Fi Test Record.** For both stereo and mono. Two-sided 12" LP. Simple narrative and instructions to check frequency response, level balance, channel identification, hum, rumble, other characteristics.  
24 F 45070 Shpg. wt. 1 lb. ....Net 3.45

**12 Record Cleaner Kit.** Anti-static, silicon fluid protects as it cleans. Just a few drops for a professional cleaning. Velvet applicator.  
24 F 70045 Shpg. wt. 3 oz. ....Net 1.19

**13 Dust Cover Cleaner.** Cleans plastic or glass covers. Anti-static properties reduce dust accumulation to keep surfaces sparkling clean.  
24 F 19505 Shpg. wt. 10 oz. ....Net 83¢

**14 Record Static and Dust Eliminator.** Spray mist keeps records clean of static-producing surface noises. Also prevents groove and needle wear. Only 2 applications a year. Enough for hundreds of records.  
24 F 70037 Shpg. wt. 10 oz. ....Net 1.19

**15 3-Speed Phono Motor.** Quiet, dependable AC operation assured by shock-mounted friction-drive motor. Speed change control thru idler driving rim of 8" turntable with retractable 45 RPM center adapter. Requires 2 1/2" below base plate.  
24 F 03467 Motor and Turntable. Wt. 2 lbs. Net 7.10  
24 F 35006 Mounting Boards. Shpg. wt. 2 lbs. Net 1.70

# Robins and Trutest Record Care Accessories

Keep Your Records Factory Fresh For Great Sound

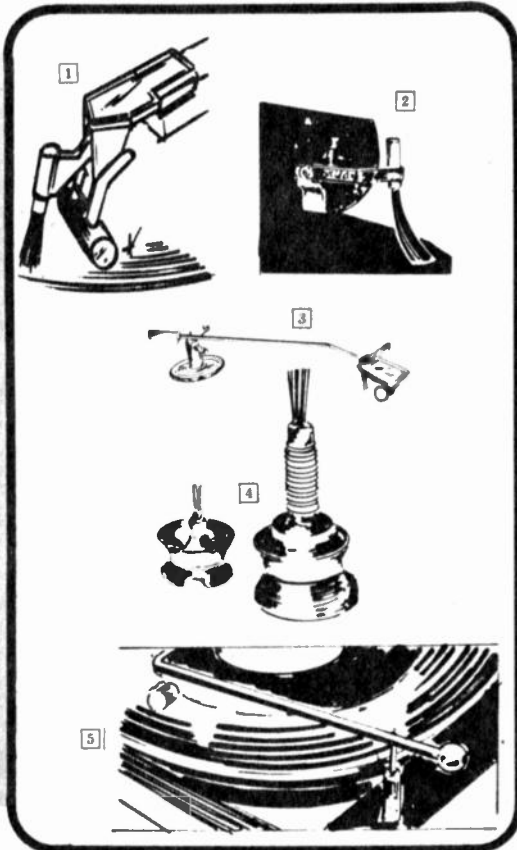

**1 Autochange Groovemaster.** Feather-light tracking brush and cylinder pad gently sweeps dust and grime from grooves. Attaches by self-stick pad to tone arm.  
24 F 80978 Shpg. wt. 5 oz. ....Net 5.49

**2 Clip-on Record Brush**  
Clip to tone arm and it sweeps dust from records automatically.  
24 F 06064 Shpg. wt. 2 oz. ....Net .69

**3 Professional Groovemaster.** Built like precision tone arm. Velvet cylinder, nylon brush. Use any anti-static fluid.  
24 F 80879 Shpg. wt. 14 oz. ....Net 7.59

**4 Adjustable Stylus Brush**  
Adjusts from 3/4 to 2 1/4" ht. to meet all requirements of U.S. and imported turntables. Spring-secured flexible mounted brush removes dust.  
24 F 06023 Shpg. wt. 3 oz. ....Net 1.09

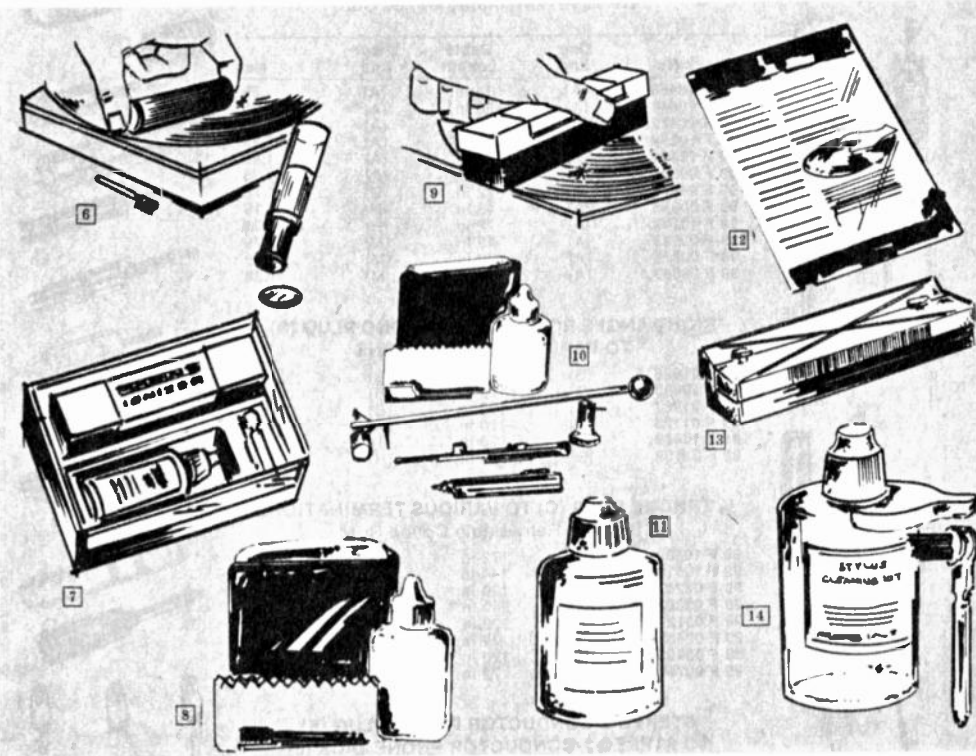

**5 Record Sweep**  
Automatically sweeps dust from grooves. Mounts easily to any phono deck by suction cup.  
24 F 80663 Shpg. wt. 5 oz. ....Net 5.29

**6 Disc Cleaner**  
Stops static and removes dust and grime when held lightly on rotating record.  
24 F 80631 Shpg. wt. 4 oz. ....Net 1.99

**7 Recocare Care.** For CD-4 discs, all stereo records. Disc ionizer eliminates static, removes dust and grime from grooves. Soft velvet pad.  
24 F 80960 Shpg. wt. 10 oz. ....Net 6.79

**8 "Rob-O-Stat" Kit**  
Contains super-soft velvet and foam applicator mit, 1 1/2-oz. bottle of anti-static fluid, polyfoam pad for cleaning.  
24 F 80366 Shpg. wt. 5 oz. ....Net 1.99

**9 Mark IV ionizer.** A must for CD-4 discs. Has soft velvet pad. Permanent anti-static agent is activated by placing a few drops of water in inner chamber under top cover.  
24 F 06007 Shpg. wt. 6 oz. ....Net 3.79

**10 Deluxe Record Care Kit.** Mounts to any phono deck by suction cup. Sweeps dust from grooves while depositing anti-static cleaner.  
24 F 80648 Shpg. wt. 10 oz. ....Net 11.99

**11 Ionizer Reactivating Fluid**  
Anti-static agent used to reactivate record ionizer. Use with any anti-static cleaning device.  
24 F 80911 Shpg. wt. 4 oz. ....Net 1.79

**12 Jockey Cloth**  
Anti-static silicon-treated cloth for cleaning and lubricating records.  
24 F 06072 Shpg. wt. 3 oz. ....Net .49

**13 Record Ionizer**  
When applicator is applied to sides of records, it directs ions in one direction, eliminates static.  
24 F 80903 Shpg. wt. 6 oz. ....Net 3.19

**14 Hi-Fi Stylus Cleaning Kit**  
Cleaning fluid and brush for safe cleaning of stylus. 100% effectiveness.  
24 F 06015 Shpg. wt. 6 oz. ....Net 1.75

**discwasher**  
**Has The Answer**  
*A Truly, Effective Method of Protection for All Your Records*  
**\$12.95**

Apply just a few drops to surface of record through the Discwasher pad. That gives sure protection against all the dangers you've heard about—fingerprints, room dust, grime—even residues left from other "record cleaners." An ingenious, self-contained system. Shpg. wt. 12 oz.

24 F 46508 ....Net 12.95

**Replacement Fluid for Above.**  
24 F 46516 Shpg. wt. 1 oz. ....Net 2.25



## Fine Record Care Products For Optimum Fidelity

**15 Stylus Pressure Gauge**  
Accurately calibrated gauge & counterbalance. Gauges pressure to 1/2 gr.  
24 F 80556 Shpg. wt. 4 oz. ...Net 1.39

**16 Record Spiders**  
Forty hi-impact, plastic, reusable 45 rpm adapters. Easy insertion.  
24 F 06049 Shpg. wt. 4 oz. ...Net 1.19

**17 Protective Sleeves**  
Package of 12 decorative poly-lined sleeves. Windows to show titles.  
24 F 06056 Shpg. wt. 13 oz. .Net 1.59

**18 Album Covers**  
Twelve heavyweight plastic clear covers with thumb notch.  
24 F 80705 Shpg. wt. 8 oz. ...Net 1.49

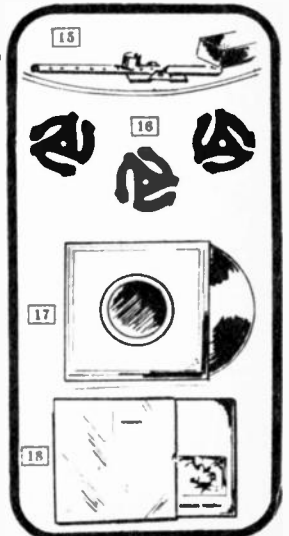

# Lafayette Audio Cables and Adapters

High-quality, shielded audio cables for hi-fi equipment, recorders, etc. Imported. Average shpg. wt. 5 oz.

## RCA PIN-TYPE PHONO PLUG (A) TO VARIOUS TERMINATIONS

\*Denotes Retractable Coiled Cord

Stock No.	One End	Cable Length	Other End	Net
99 F 10456	(A)	18 in.	(A)	.89
99 F 00648	(A)	36 in.	(A)	.99
99 F 10472*	(A)	36 in.*	(A)	1.49
99 F 10076	(A)	72 in.	(A)	1.39
99 F 10464	(A)	144 in.	(A)	1.85
99 F 00598	(A)	72 in.	(C)	1.75
99 F 00871	(A)	72 in.	(D)	1.75
99 F 00655	(A)	48 in.	(H)	1.19
99 F 10209	(A)	72 in.	(H)	1.39
99 F 00853	(A)	48 in.	(M)	.79
99 F 00879	(A)	72 in.	(M)	.99
99 F 00887	(A)	144 in.	(M)	1.39

## RIGHT ANGLE RCA PIN-TYPE PHONO PLUG (B) TO VARIOUS TERMINATIONS

99 F 01026	(B)	18 in.	(B)	.99
99 F 10480	(B)	72 in.	(B)	1.49
99 F 01057	(B)	120 in.	(B)	1.79
99 F 01125	(B)	120 in.	(A)	1.39
99 F 10498	(B)	120 in.	(I)	1.49
99 F 01109	(B)	120 in.	(H)	1.49

## 1/4" PHONE PLUG (C) TO VARIOUS TERMINATIONS

\*Denotes Retractable Coiled Cord

99 F 10506	(C)	72 in.	(C)	1.79
99 F 10514	(C)	144 in.	(D)	2.65
99 F 03287*	(C)	120 in.*	(D)	3.29
99 F 03303*	(C)	240 in.*	(D)	4.69
99 F 03121	(C)	120 in.	(I)	2.65
99 F 03465	(C)	72 in.	(M)	1.75
99 F 03493	(C)	120 in.	(N)	2.19
99 F 00764	(C)	72 in.	(O)	2.69

## STEREO 3-CONDUCTOR PHONE PLUG (E) TO STEREO 3-CONDUCTOR PHONE JACK (J)

\*Denotes Retractable Coiled Cord

99 F 03501	(E)	20 ft.	(J)	3.49
99 F 01168*	(E)	25 ft.*	(J)	4.49

## PHONO JACK (H) TO PHONO JACK (H)

99 F 03519	(H)	72 in.	(H)	1.25
------------	-----	--------	-----	------

## 3.5mm MINIATURE PHONE PLUG (F) TO VARIOUS TERMINATIONS

99 F 10381	(F)	72 in.	(A)	1.29
99 F 10423	(F)	72 in.	(F)	1.35
99 F 10407	(F)	72 in.	(C)	1.49
99 F 10431	(F)	72 in.	(K)	1.69
99 F 10548	(F)	120 in.	(M)	1.35
99 F 10373	(F)	72 in.	(N)	1.49
99 F 10399	(F)	72 in.	(H)	1.59

## 4-WAY ADAPTER PLUG

A versatile 4-in-1 adapter plug for most popular transistor radios and cassette-type recorders. 3.5mm miniature plug; 2.5mm subminiature plug; 3.5mm power jack and 2.5mm coaxial power plug. Imported. 99 F 61046 Shpg. wt. 4 oz. Net 1.29

\$1.29

## HI-FI SPEAKER CABLES

## STEREO AUDIO CABLES

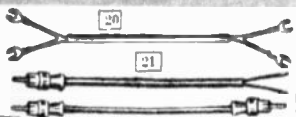

20 Set of 2 15-ft. speaker cables, each with spade lugs on all ends. Clear plastic-covered polarized conductors, 24-gauge copper conductors. Wt. 5 oz. 99 F 36488 Per Set Net. 98

21 Same as above, but set of 2 30-ft. cables with 22-gauge conductors. 99 F 38528 Shpg. wt. 14 oz. Net 1.95

22 Set of 2 15-ft. speaker cables with RCA-type phono plug at one end, tinned and stripped leads at the other. Imp. 99 F 00515 Shpg. wt. 13 oz. Net 2.19

23 As above, but set of 2 30-ft. cables. 99 F 00457 Shpg. wt. 14 oz. Net 3.89

24 A single 20-ft. speaker cable with RCA-type phono plug at each end. Imp. 99 F 10530 Shpg. wt. 4 oz. Net 1.99

25 As above, but a single 40-ft. cable. 99 F 10522 Shpg. wt. 12 oz. Net 2.49



Two shielded insulated cables inside a common chrome grey plastic jacket, providing two completely isolated channels. Avg. shpg. wt. 8 oz. Imported.

Model No.	Length	Type	Net
99 F 01133	36"	Phono pin	1.95
99 F 01141	6'	plugs at	2.35
99 F 10258	12'	all ends	2.85

## 36" AUDIO COILED CABLES



Set of Four Coiled Cables \$3.29

Shielded cables terminated at each end with phono plugs. 36" extended, retract to only 14". Plugs molded directly to cable. One each red, grey, yellow and green. Imported. Shpg. wt. 6 oz. 99 F 01372 Net 3.29

## AUDIO ADAPTERS

Imported

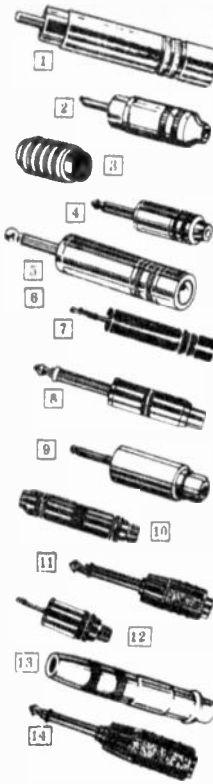

- 2-conductor phone jack input to phono plug output. 99 F 63257 Net 1.25
- 2-conductor 3.5mm mini-jack input to phono plug output. 99 F 63455 Shpg. wt. 3 oz. Net .95
- Phono plug coupler, accepts phono plug at each end. 32 F 52012 Shpg. wt. 3 oz. Net .59
- 2-conductor 2.5mm subminiature jack input to 3.5mm miniplug output. 99 F 63471 Shpg. wt. 3 oz. Net .95
- 2-conductor 3.5mm mini-jack input to standard 2-conductor phone plug output. 99 F 63453 Shpg. wt. 3 oz. Net .95
- 3-cond. standard phone jack to 3.5mm mini-plug output. 99 F 63075 Shpg. wt. 3 oz. Net 1.49
- 2-conductor standard phone jack input to 2-conductor 2.5mm subminiature plug output. 99 F 63489 Shpg. wt. 3 oz. Net 1.19
- 2-conductor standard phone jack output to 2-conductor 3.5mm miniature plug output. 99 F 61178 Shpg. wt. 3 oz. Net .95
- Phono jack input to standard 2-cond. phone plug output. 99 F 62168 Shpg. wt. 3 oz. Net 1.35
- Phono jack input to 3.5mm mini-plug output. 99 F 63448 Shpg. wt. 3 oz. Net 1.35
- 3.5mm miniature jack at both ends. 99 F 63893 Shpg. wt. 3 oz. Net 1.35
- 3.5mm miniature jack input to stereo 3-conductor phone plug output. 99 F 63877 Shpg. wt. 3 oz. Net 1.15
- 3.5mm min. jack input to 2.5mm submin. plug output. 99 F 63901 Shpg. wt. 3 oz. Net .95
- Phono jack input to 1/4" phone jack output. 99 F 63919 Shpg. wt. 3 oz. Net .79
- Stereo 3-cond. phone jack input to 1/4" phone plug output. 99 F 63927 Shpg. wt. 3 oz. Net 1.16

## D.I.N. ADAPTER CABLES

Adapts European 3-contact (180°) and 5-contact (180°) DIN connectors to mate with standard domestic RCA-type phone jacks and plugs. For use with Ampex, Norelco, Grundig, Korting, Uher, Sony and other cassette or tape recorders, radios, phonos, amplifiers, etc. All phono plugs and jacks are color-coded. 69" shielded cables. Imported. Shpg. wt. 6 oz.

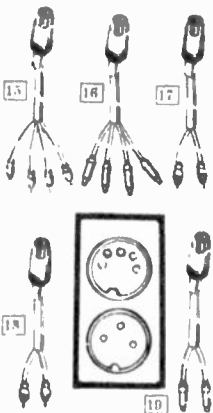

- 5-pin connects to 4 RCA-type color-coded phono plugs. 99 F 63539 Net 3.29
- 5-pin connects to 4 RCA-type color-coded phono jacks. 99 F 63547 Net 3.89
- 5-pin connects to 2 RCA-type color-coded phono plugs. 99 F 63554 Net 2.79
- 3-pin connects to 2 RCA-type color-coded phono plugs. 99 F 63562 Net 2.49
- 3-pin connects to 2 RCA-type color-coded phono jacks. 99 F 63570 Net 2.19

## UNIVERSAL CABLE KIT



\$3.29

Kit contains: 2 phono plugs with 69" connecting cable; phono plug connected to 2 alligator clips by 4" cable; coupler with phono jack and phone jack; phone plug output with phono jack input; and coupler with phono jack at each end. All connecting cables are shielded and insulated. Ideal for connecting tape recorder to phonograph, radio or TV, or tuner to amplifier. 99 F 01356 Imported. Shpg. wt. 6 oz. Net 3.29

## FLEXIBLE Y CONNECTORS AND SHIELDED Y ADAPTERS

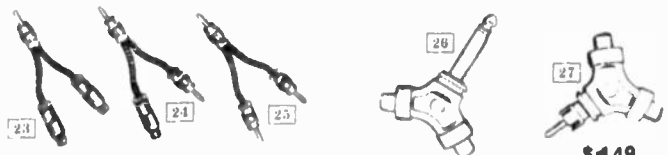

\$1.35 each

\$1.69

\$1.49

For converting Stereo Player to Monaural. Can be used for a Tap-in Meter Monitor connection. Also required on some tape recorders. Imported. 3 oz.

23 Phono plug connected to 2 phono jacks by 4" shielded cable. 99 F 00937 Net 1.35

24 Phono jack conn. to 2 phono plugs. 99 F 00945 Net 1.35

25 Phono plugs conn. together by 4" shielded cable. 99 F 00952 Net 1.35

26 Completely shielded Y-adapters with choice of connectors and terminations. Imported. Avg. shpg. wt. 3 oz. 99 F 00895 Net 1.69

27 Two phono jacks connectors in parallel to a standard 2-cond. phone plug. 99 F 00903 Net 1.49

# T-Pads, L-Pads, Faders, Controls, Connectors

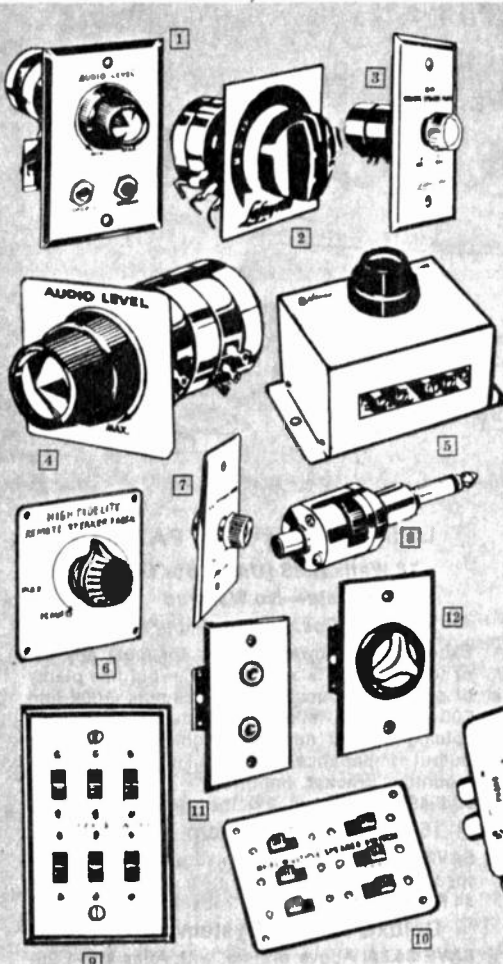

**1** **Deluxe Stereo Level/Balance Control.** Dual concentric 8-ohm L-pads. Plug in extensions or monitors from the front. 4½ x 2¾", 3¾" deep. 99 F 61418 Imported. Shpg. wt. 10 oz. . . Net 5.95

**2** **Lafayette L-Pads.** Use for brilliance or presence control in speakers. 1½" dia., 7/8" deep. With mounting screws, black knob. 99 F 61343 8 ohms. Imported. 5 oz. . . Net 2.89  
99 F 61350 18 ohms. Imported. 5 oz. . . Net 2.89

**3** **Lafayette T-Pad.** Constant impedance control to adjust speaker volume. 8 ohms. 99 F 61388 Imported. Shpg. wt. 9 oz. . . Net 8.95

**4** **Stereo Level Balance Control.** Concentric 8-ohm L-pads for extensions, etc. Gold-finish brass plate, 2½ x 3¼" deep. 99 F 81400 Imported. Shpg. wt. 7 oz. . . Net 4.95

**5** **Lafayette Stereo Level Control.** Controls stereo extension speakers without mismatch with main speakers. Screw terminals, cream finish, gold panel plate. 4½ x 3¾ x 2¾". 99 F 81475 Imported. Shpg. wt. 10 oz. . . Net 8.95

**6** **Lafayette Remote Speaker Faders.** Adjust volume level for radio, TV, hi-fi, remote speaker. Gold plate for panel mounting. 99 F 81384 Imported. Shpg. wt. 3 oz. . . Net 1.35

**9** **Lafayette Multiple 8-Speaker Switch.** Controls up to 6 remote speakers (mono or stereo pair) in up to 63 different combinations. Wall mounting with brass plate. For vacuum tube equipment only. With instructions, hardware. 99 F 00549 Imported. Shpg. wt. 5 oz. . . Net 3.99

**10** **Lafayette Multiple 8-Speaker Switch.** Same as above, but with flat, gold-embossed plate for panel mounting. 3½ x 2¾". 99 F 00883 Imported. Shpg. wt. 4 oz. . . Net 4.29

**11** **Stereo Speaker Wall Jack Klt.** Ivory finish, for mounting in standard outlet box. Ideal for remote speaker hookups in den. rec room, play room, etc. With two ¼" phone plugs, two ¼" phone jacks. 4¾ x 2½". 1" back clearance required. Imported. 99 F 01384 Shpg. wt. 6 oz. . . Net 1.99

**12** **Lafayette Remote Speaker Switch.** For mono use, selects any 1 of 3, or combination of 2 or-3 speakers. Handles to 60 watts power. For tube-type equipment only. 2¾ x 4½". 99 F 00531 Imported. Shpg. wt. 8 oz. . . Net 1.59  
99 F 01745 For solid-state hi-fi . . . . . Net 3.85

**13** **Stereo Selector Switch.** Permits hooking up three stereo sources (phono, tuner, tape) to amplifier with single pair of inputs. Three pairs of phono jack inputs/one output. 24 F 88989 Shpg. wt. 8 oz. . . . . Net 4.74

**14** **Stereo Selector Switch.** Selects up to three speaker pairs. 60 watts audio power. In enclosed case, 4 x 2 x 3". For tube-type equipment only. Imported. 99 F 01018 Shpg. wt. 10 oz. . . . . Net 4.19  
99 F 01752 For solid-state hi-fi . . . . . Net 4.75

**7** **Lafayette Wall-Mount Remote Speaker Fader.** As **6** for in-wall mountings. 99 F 61392 Imported. Shpg. wt. 4 oz. . . Net 1.35

**8** **Volume Control Adapter.** Permits high-volume signals to be fed into high-gain inputs of tape recorders without overloading. Phono jack input, 2-cond. phone plug output. Use in pairs for stereo control. Fully shielded. 99 F 00994 Imported. Shpg. wt. 4 oz. . . Net 2.79

**NEW!**

**\$10<sup>95</sup>**

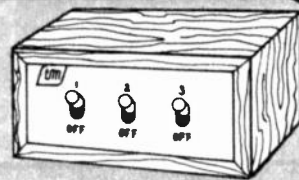

## Lafayette Speaker Selector

Controls to 3 pairs of stereo speakers in any combination. All external connections, phono jack outputs for easy installation. For any equipment, tube or solid-state. Prevents speaker blowouts with high-power amps. Screw terminal inputs. Wood case with walnut vinyl finish.

99 F 83935 Shpg. wt. 1 lb. . . . . Net 10.95

## Switchcraft Complete Cable Assemblies

Quality cables for recorders, hi-fi, musical instruments, etc. All plugs molded directly to various connectors. All are high-impedance with shielded cable except \* low-impedance with unshielded parallel wire. All have grey plastic handles with cable clamp.

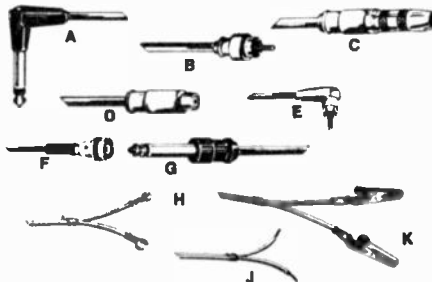

Stock No.	Length	Description	Net
24 F 88013	72"	A to A	2.40
24 F 88047	120"	A to B	2.55
24 F 88082	120"	A to C	3.27
24 F 88070	25"	A to C	4.29
24 F 88849	72"	G to D	2.01
24 F 88237	72"	G to G	2.40
24 F 88245	120"	G to G	3.27
24 F 88858	120"	G to F	3.27
24 F 88280	25"	G to F	4.29
24 F 88310*	72"	G to H	1.38
24 F 88328*	120"	G to H	1.83
24 F 88338*	72"	G to K	1.77
24 F 88148*	25"	H to H	1.68
24 F 88153*	120"	K to K	1.65
24 F 88229	72"	D to D	1.80
24 F 88724	36"	E to E	1.11
24 F 88740	72"	E to E	1.35
24 F 88781	72"	E to D	1.65
24 F 88369*	72"	E to J	.84
24 F 88807	72"	B to C	1.83
24 F 88815	72"	B to E	1.38
24 F 88401	25"	B to F	4.23
24 F 88419*	72"	B to H	.93
24 F 88427*	120"	B to H	1.35
24 F 88435*	72"	B to K	1.65

## Stereo Adapter Cable



4' grey 3-cond. cable with 2 color-coded molded phono plugs. Converts 3-circuit stereo phone plugs (mikes, headsets, etc.) to 2 separate phono jack inputs. Shielded. 24 F 88898 Shpg. wt. 4 oz. . . Net 3.30



## SWITCHCRAFT ADAPTERS

For Mikes, Hi-Fi Cables, Etc. Avg. wt. 4 oz.

Stock No.	Type	Description	Net
24 F 88559	332A	2-Cond. Phone Jack Input to Female Mike Output. With coupling ring	1.50
24 F 88567	334A	Phono Jack Input/Female Mike Output	1.29
24 F 88583	336A	Two-cond. Phone Jack Input/Phono Plug Output	1.50
24 F 88591	338A	Phono Plug to Male Mike Connector	.99
24 F 88625	345A	Two-cond. Phone Plug Output/Phono Jack Input	1.14
24 F 88641	349A	Phono Plug Coupler/Phono Jack Each End	.98
24 F 88906	364A	Two-cond. ¼" Diameter Tini-Jack to ¼" Phone Plug	1.35
24 F 88914	365	Two-cond. ¼" Diameter Tini-Jack to Phono Plug	1.35
24 F 88922	370A	Phono Jack Input to Tini-Plug Output	1.05
24 F 88930	374	Two-cond. Phone Jack Input to Tini-Plug Output	1.53
24 F 88948	383A	Three-cont. Female Mike Input/Two-cond. Phono Jack Output	3.54
24 F 88955	384A	Three-pin Male Mike Input/Two-cond. Phone Jack Output	3.27
24 F 88963	386A	Three-cont. Female Mike Input/Two-cond. Phone Plug Output	3.48
24 F 88971	387A	Three-pin Male Mike Input/Two-cond. Phone Plug Output	3.08

# Quality PA Systems and Components Priced Right!



1 **\$99<sup>95</sup>**



2 **\$49<sup>95</sup>**



4 **\$91<sup>95</sup>**

3 **\$82<sup>50</sup>**

## Complete 25-Watt Indoor PA Systems

Low As **\$120<sup>50</sup>**



PA-25B



Mike



Wall Baffle



12" Speaker

**SAVE \$6.02.** PA-25B amp with wood wall baffle, crystal mike, 12" PA speaker and cable. *Purchased Separately, \$126.52.*  
44 F 92559WM Wt. 33¼ lbs. . . . .Net 120.50

**SAVE \$7.87.** System as above, with 7 x 30¼ x 3¼" 6-speaker sound column speaker, instead of 12" speaker and baffle. *Purchased Separately, \$159.17.*  
44 F 92567WM Wt. 37¼ lbs. . . . .Net 151.50

## SAVE on 25-Watt Portable PA Systems



Low As **\$137<sup>95</sup>**

**SAVE \$6.87.** Complete system includes PA-25B amplifier, 12" PA speaker in carrying case/baffle, high impedance crystal mike, all cable. *Purchased Separately, \$144.82.*  
44 F 92583WM Wt. 47¼ lbs. . . . .Net 137.95

**SAVE \$7.56.** Same as above, except with two 12" speakers. *Purchased Separately \$157.06.*  
44 F 92591WM Wt. 53¼ lbs. . . . .Net 149.50

### 1 Lafayette 25-Watt PA Amplifier

- 25 Watts RMS (Under 5% Dist.)
- Speaker and Voltage Outputs
- Microphone Precedence Switch
- High/Low Mike, Two Aux. Inputs

**Model PA-25B.** Sophisticated solid-state PA amplifier with \$\$\$-more features—anti-feedback circuit, mike precedence switch for instant override, tape recorder input and output, bass, treble and master volume controls, switchable 100k/200 ohms mike input. TWO aux. inputs for phono, tuner or tape. Sensitivity: Mike, high, 4 mV; low, 0.3 mV; Aux. 1, 400 mV; Aux. 2, 200 mV. 4, 8, 16-ohm speaker, 25 and 70.7 V line outputs. With mike connector, 2 speaker connectors. For 117 VAC, 60 Hz. 15¼ x 5¼ x 10½". Imported.  
99 F 46542W Shpg. wt. 22¾ lbs. . . . .Net 99.95  
Desk Mike with precedence.  
44 F 01659 Shpg. wt. 2½ lbs. . . . .Net 19.95

### 2 Lafayette "Tiny-Mite" PA Amp

- 16 Watts RMS (Under 5% Dist.)
- Solid-State—No Warmup
- 12 VDC Pos. or Neg. Ground

Excellent low-power PA amp for most any car or truck. Only 2½ x 1¾ x 3¼"—but has plenty of power and punch! Has two inputs (100k and 600 ohms) for mike, phono, tuner, tape, etc., volume control and pilot light. 8 or 16-ohm output impedance. With mike plug, cables, mounting bracket. Imported.  
99 F 45890 Shpg. wt. 2¼ lbs. . . . .Net 49.95

### 3 16-watt Mobile System

**SAVE \$4.30.** Above, with mike and two horn PA speakers. *Purchased separately, \$86.80.*  
44 F 90694WM Shpg. wt. 5 lbs. . . . .Net 82.50

### 4 Deluxe 16-Watt System

**SAVE \$4.60.** Above system, with Atlas MO-1 25-watt speaker instead of horns. *Purchased Separately, \$96.75.*  
44 F 91031WM Shpg. wt. 8¾ lbs. . . . .Net 91.95

## Bogen® 40-Watt Mobile PA Amplifier



**\$100<sup>50</sup>**

### Choice of Systems Below

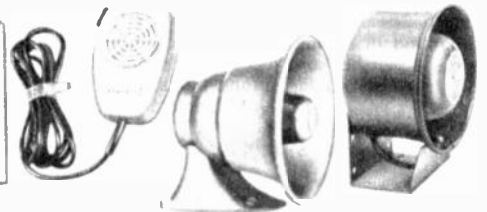

### 40-Watt Mobile Systems

Low As **\$141<sup>95</sup>**

- 40 Watts RMS (Under 5% Dist.)
- Instant-on Solid-State Circuit
- Negative or Positive Ground 12 VDC

Full-feature mobile PA amplifier—great for cars, trucks, boats, etc. Has mic and aux. inputs with individual level controls, radio input (great for amplifying CB signals), complete fuse protection. Sensitivity: mic, 1 mV; aux., 0.4 V. 4, 8, 16-ohm speaker outputs. Rugged metal case, with mounting bracket adjustable to any angle. 8 x 3 x 6¼". American made.  
44 F 12391W Shpg. wt. 8 lbs. . . . .Net 100.50

**SAVE \$8.99.** Complete 40-watt mobile PA system includes Bogen 40-watt PA amplifier, two Atlas MO-1 weatherproof mobile PA speakers with special "fail-safe" mounting bracket, Lafayette 99-45775 push-to-talk dynamic microphone, all cables. *Purchased Separately, \$186.49.*  
44 F 92609WM Shpg. wt. 20½ lbs. . . . .Net 177.50

**SAVE \$7.10.** System as above, but with single Atlas MO-2 speaker for under-hood mounting. *Purchased Separately, \$149.05.*  
44 F 92617WM Shpg. wt. 15 lbs. . . . .Net 141.95

# Medium-Power PA Amplifier and Systems

## Lafayette PA-50B 50-Watt Long-Life PA Amplifier

Solid-state PA amplifier offers years of trouble-free, reliable PA performance. Ideal for most any indoor or outdoor PA application. Has two high/low level (100k/200 ohms) mike inputs with separate volume controls, 2 aux. (phono, tuner or tape) inputs with full mixing, anti-feedback network. The microphone precedence switch permits overriding aux. inputs when required. There's a tape record output jack plus a common record/booster amplifier jack. Sensitivity: High Impedance mike, 4 mV; low-impedance mike, .3 mV, Aux. 1, 400 mV, Aux. 2, 200 mV. 4, 8, 16-ohm speaker, 25 and 70.7 line outputs. AC convenience outlet, AC and DC fuses. With mike and speaker connectors. 15½ x 5¼ x 10½". 117 VAC, 60 Hz. Imp. 99 F 46559W Shpg. wt. 26 lbs. . . . . Net 149.95 Desk Mike. For standard or precedence operation. 44 F 06159 Shpg. wt. 2½ lbs. . . . . Net 19.95



**\$149<sup>95</sup>**

- 50 Watts RMS Power at Less than 5% Distortion
- Switchable High- and Low-Level Mike Inputs
- Aux. Inputs for Phono, Tuner or Tape
- Mike Precedence Switch • 25, 70.7 V Outputs

## Save on Complete 50-Watt PA Systems

- With 12" Speakers** • Lafayette PA-50B 50-Watt Amplifier  
**\$204<sup>95</sup>** • Lafayette 99-46039 Dynamic Mike with Desk Stand
- With Sound Columns** • Choice of Speaker/Baffle or Sound Column  
**\$259<sup>50</sup>** • Two 35-ft. Lengths of Speaker Cable

**SAVE \$10.78.** System with amp, mike, two 12" 30-watt speakers and walnut-grain wall baffles. Heavy-duty speakers feature 1½" voice coils and 1¼-lb. magnets. Purchased Separately, \$215.73.

44 F 92674WM Shpg. wt. 49 lbs. . . . . Net 204.95

**SAVE \$13.53.** System as above, with 30-watt 6-speaker sound columns instead of 12" speakers and baffles. Speakers are 7 x 3¼ x 3¾". Purchased Separately, \$273.03.

44 F 92682WM Shpg. wt. 61 lbs. . . . . Net 259.50

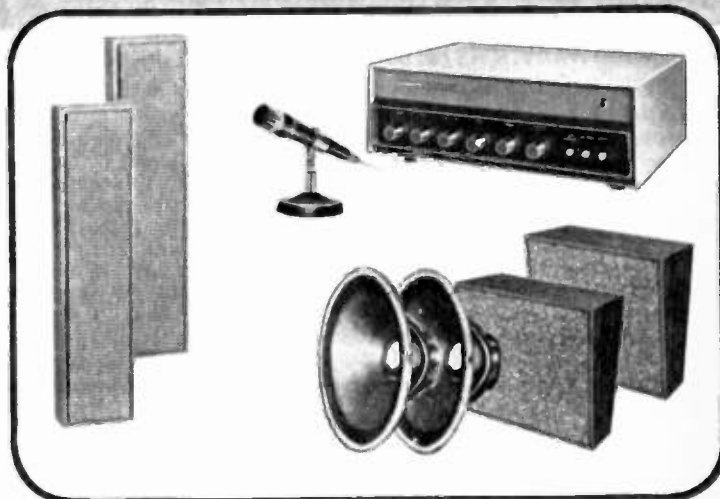

## MORE Money-Saving Systems with the PA-50B!



**Save \$13<sup>01</sup>**

**\$254<sup>50</sup>** Purchased Separately \$267.51

### Constant Voltage Indoor System

- Lafayette PA-50B Amplifier
- Four 8" Speakers and Baffles
- Deluxe 99-46039 Mike with Desk Stand
- Four 35-ft. Lengths of Speaker Cable

Speakers include line-matching transformers for constant-voltage 25 or 70.7 volt output; assures constant volume level over large coverage area.

44 F 92708WM Shpg. wt. 56 lbs. . . . Net 254.50

Charge It with Your BankAmericard or Master Charge.



**Save \$11<sup>18</sup>**

**\$216<sup>50</sup>** Purchased Separately \$227.68

### Take-Along Portable System

- Lafayette PA-50B 50-Watt Amplifier
- Two 12" Heavy-Duty Speakers
- Deluxe 99-46039 Mike with Desk Stand
- Carry Case

Excellent portable system with carrying case for amplifier, mike and accessories. Front and back of case double as speaker baffles for the 12" heavy-duty speakers. Speaker cable.

44 F 92358WM Shpg. wt. 82 lbs. . . . . Net 216.50



**Save \$11<sup>60</sup>**

**\$218<sup>95</sup>** Purchased Separately \$230.55

### Economy Outdoor System

- Lafayette PA-50B 50-Watt Amplifier
- 99-46039 Deluxe Mike with Desk Stand
- Two Electro-Voice PA30A Speakers

Great system for airports, loading platforms, camps—covers up to 100,000 sq. ft! Speakers have weatherized construction, mount-anywhere brackets, all hardware.

44 F 92666WM Shpg. wt. 48 lbs. . . . . Net 218.95

# See Lafayette for PA Equipment That WORKS!

Reliable Systems for All Your PA Needs



**\$179<sup>95</sup>**

### Lafayette Long-Life PA100B 100-Watt PA Amplifier

- 100 Watts (RMS) at under 5% Distortion
- Mike Precedence Switch
- Switchable High/Low Level Mike Inputs
- 25, 70 V Line Outputs

The PA amplifier you need for maximum area coverage of large meeting halls, school auditoriums, etc. All solid-state, 2 switchable (100k/200 ohms) high/low level mike inputs, 2 aux. inputs (phono, tuner, tape, etc.) with complete mixing, switchable anti-feedback network to protect speakers. The mike precedence switch permits microphone override even from a remote location, tape output jack plus recorder and booster amplifier jack. 4, 8 and 16-ohm speaker outputs, 25-

and 70-volt line outputs for larger systems. Has power-on light, AC convenience outlet, AC and DC fuse protection. Sensitivity: High Impedance mike, 4 mV; Low Impedance mike, .3 mV; Aux. 1, 400 mV; Aux. 2, 200 mV. With mike connector, 2 plug-in speaker connectors. For 117 VAC, 60 Hz. 15 1/2 x 5 1/4 x 10 1/2". Imported. 99 F 46567W Shpg. wt. 29 lbs. .Net 179.95 Desk Mike. For standard or remote precedence. 44 F 01659 Shpg. wt. 2 1/2 lbs. . . . Net 19.95

### Complete 100-Watt PA Systems— Buy It All and SAVE!

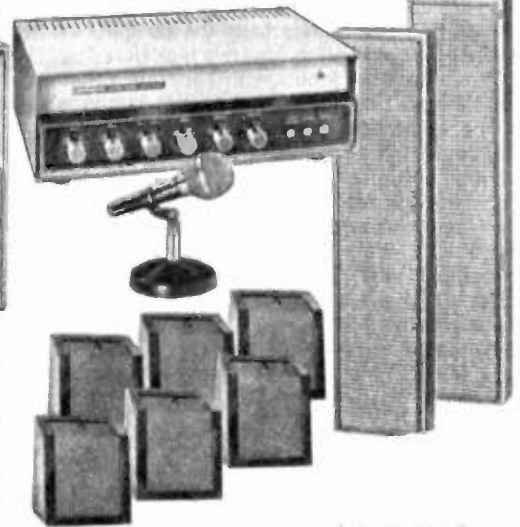

**\$329<sup>95</sup>**

With Wall-Mount Speakers

**\$288<sup>95</sup>**

With Sound-Column Speakers

SAVE \$16.94. Complete system includes PA-100B amplifier. Lafayette 99-45981 dual-impedance "pop-proof" microphone with on-off switch, desk stand and cable, six wall-mount speakers with 25 and 70.7 V line transformers, all hookup wire. Purchased separately, \$346.89. 44 F 92625WM Shpg. wt. 73 1/4 lbs. . . . Net 329.95

SAVE \$14.98. PA100B amplifier with Lafayette 99-45981 deluxe mike, two 30-watt 6-speaker sound columns for optimum voice or music reproduction. speaker hookup wire. Speakers. 7 x 30 1/4 x 3 1/2". Purchased Separately, \$303.93. 44 F 92724WM Shpg. wt. 59 1/4 lbs. . . . Net 288.95

SAVE \$17.53. Above, but with deluxe 60-watt sound columns. 7 1/4 x 4 1/2 x 5". Purchased Separately, \$357.03. 44 F 92732WM Shpg. wt. 78 lbs. . . . Net 339.50

### Complete 100-Watt Outdoor PA Systems

- Lafayette PA-100B Amplifier
- Two Electro-Voice PA30A 30-Watt Outdoor Speakers
- Deluxe Dynamic Desk Microphone

An outstanding system for almost any outdoor area coverage—picnic areas, playgrounds, etc. The dual-impedance mike has "pop-proof" cover, on-off switch and desk stand, the PA30A speakers have adjustable mounting brackets, rugged, weatherized enclosures.

44 F 92641WM Shpg. wt. 46 lbs. . . . Net 248.50  
 SAVE \$15.95 Above system with 4 PA30A Speakers. Purchased Separately, \$321.45.  
 44 F 92633WM Shpg. wt. 58 1/4 lbs. . . . Net 305.50

### Lafayette PA Amplifier Guarantee

**ONE-YEAR GUARANTEE.** All parts guaranteed against defects in material and workmanship for one year. Ship defective parts to us prepaid for replacement or ship amplifier prepaid for repair.

NOTE: For best results with more than 2 individual or sound column speakers in any PA system, use 25 and 70.7 V outputs with line transformers.

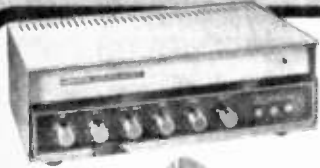

Save \$12<sup>95</sup>  
**\$248<sup>50</sup>**

Purchased Separately 261.45

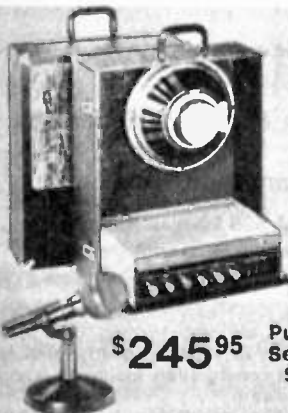
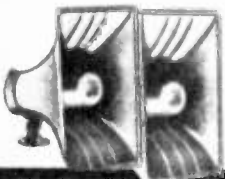

Save \$12<sup>63</sup>  
**\$245<sup>95</sup>**

Purchased Separately \$258.58



### Portable 100-Watt PA System

- Lafayette PA-100B Amplifier
- Two 30-Watt Heavy-Duty Speakers
- Deluxe Dynamic Microphone
- Carrying Case for Amplifier, Speakers, Accessories, Etc.

Complete system sets up anywhere for excellent coverage indoors or out. 99-45981 dual-impedance mike has "pop-proof" cover, desk stand. Speakers are mounted in baffle-carry case for easy setup. Speaker cable. 44 F 92773WM Shpg. wt. 65 1/2 lbs. . . . Net 245.95

### Lafayette Portable PA Case

**\$24<sup>65</sup>**

- Two Baffles In One Case
- Holds Two 12" Speakers

Well-designed case holds PA amplifier and two 12" speakers, has provisions for speaker cable, mike and accessories. Splits in half—each half becomes speaker baffle. Four snap locks. 17 3/4 x 22 x 12 3/4". 44 F 01618W Shpg. wt. 18 1/2 lbs. . . . . Net 24.65





# P.A. Projectors and Speakers

Outdoor and Extension Speakers for Paging, Hi-Fi and Public Address Uses

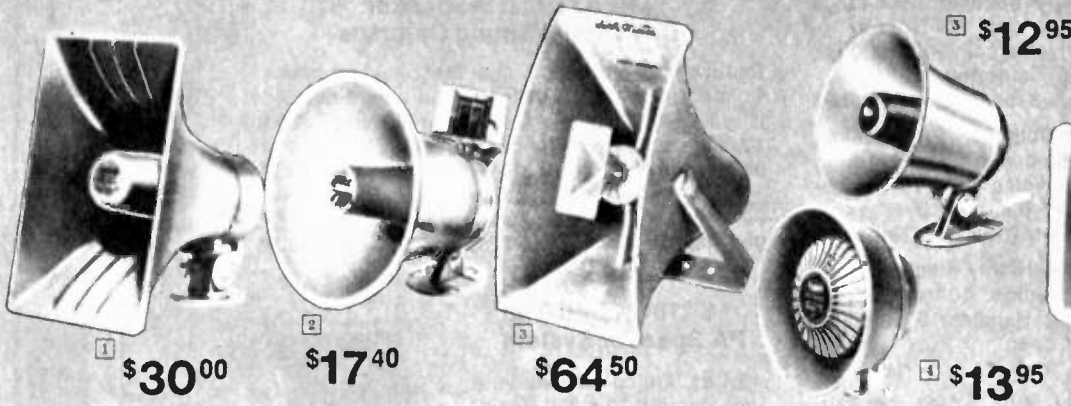

**1 E-V 30-Watt Paging Projector PA-30A.** A rugged, high-impact horn with rectangular design for versatility and wide dispersion. Smooth response for both voice and music: 250-14,000 Hz. Handles 30 watts, 8 ohms. Dispersion: 120° x 90°. EIA sensitivity rating 63 dB. 11 x 6½" x 8½". 44 F 25153 Shpg. wt. 6¾ lbs. . . . Net 30.00

**PA-30AT-7.** Same as Model PA-30A but includes 70.7-volt screwdriver adjustable line transformer with taps at 30, 15, 8, 4, 2 watts. 44 F 25898 Shpg. wt. 8¾ lbs. . . . Net 38.85

**2 E-V 12-Watt Paging Speaker PA-12.** Fiber-polyester construction with round re-entrant design. Wide dispersion. 325-14,000 Hz. 8 ohms, handles 12 watts. 7½ x 7½"D. Shpg. wt. 4 lbs. 44 F 25765 . . . . . Net 17.40

**3 E-V Diffraction Projector 848A.** Very low distortion, wide-range horn and driver system. EIA sensitivity rating 57 dB. 30 watts, 150-10,000 Hz. 8 ohms. Dispersion: 120°. U mtg. bracket. 10½x20½x20". 44 F 25641W Shpg. wt. 17 lbs. . . . Net 64.50

**4 Lafayette Reflex Horn Speaker** Miniature, weatherproof. Ideal for outdoor and marine paging or portable PA. 90° rotating mount. 5 watts. 400-12,000 Hz. 5¼" dia. x 3½"D. Imported. 99 F 46435 Shpg. wt. 2 lbs. . . . . Net 13.95

**5 Lafayette Mini Paging Speaker** 90° dispersion offers maximum intelligibility in high-noise areas. Weatherproof and mounts anywhere. 400-12,000 Hz. 8 ohms. Handles 5 watts, 8 max. 5½" dia. x 4¾"D. 99 F 45080 Imported. Wt. 1½ lbs. Net 12.95

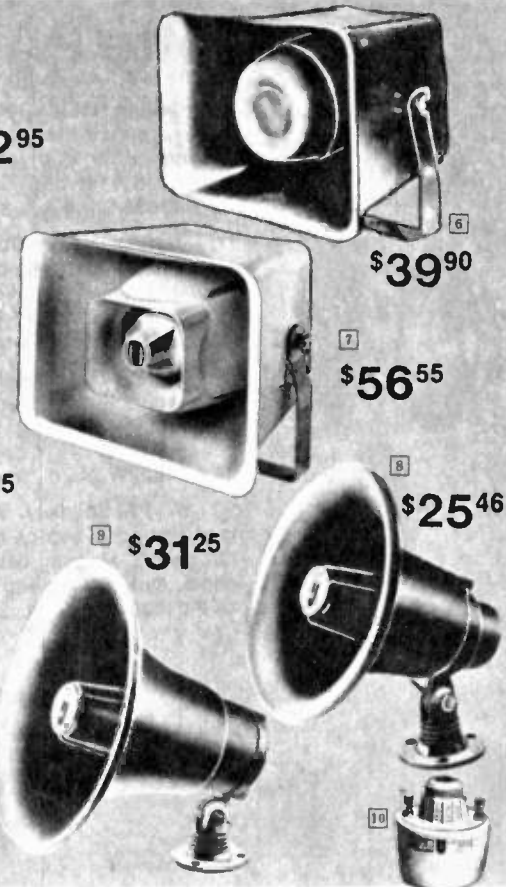

**6 Deluxe Outdoor HI-Fi Speaker** University ELC. For outdoor home hi-fi and stereo music. 6½" full-range speaker in a sealed infinite baffle-type chamber. With woofer compression chamber. U bracket permits up to 180° speaker variation. Dispersion 120°. 100-15,000 Hz. 15 watts. 8 ohms. 12¾ x 9½". 44 F 80307W Shpg. wt. 9 lbs. . . . Net 39.90

**7 Popular Outdoor PA and Hi-Fi Speaker** University MLC. Extra fine sound. 150-15,000 Hz. 2000 Hz crossover. 15 watts, 8 ohms. 120° dispersion. 12¾ x 9½ x 15½". 44 F 80018W Shpg. wt. 10¾ lbs. . . . Net 56.55

**8 University MIL-A8 Paging Speaker** Compact, weatherproof, for all PA fixed and mobile installations. With patented swivel mount. 350-13,000 Hz. 8 ohms. 10 watts. 120° dispersion. 7¼ x 6¾". 44 F 80067 Shpg. wt. 3¼ lbs. . . . Net 25.46

**9 University IB-A8 Paging Speaker** Ideal for fill-in high-power applications or as the main speaker in low-moderate power systems. 250-13,000 Hz. 30 watts, 8 ohms. 90° dispersion. Swivel mount. 10 x 9¼". 44 F 80034 Shpg. wt. 4¼ lbs. . . . Net 31.25

**10 University Trumpet Drivers**

Stock No.	Mod.	Power	Imp.	Lbs.	Net
44 F 80315	ID-40A	40 watts	16 ohms	4¼	29.84
44 F 80182	ID-20	20 watts	16 ohms	2½	21.11



**11 MISCO Weatherproof Speakers** Model MS-3-3BB. Compact, with gimbal-type mounting bracket for wall and desk. 3 watts. 8 ohms. 100-10,000 Hz. 4½x4½x2½". 44 F 52017 Shpg. wt. 1¾ lbs. . . . Net 9.95  
 Model MMS-8F. As above but hi-fi 8" speaker, 8 watts, 70-13,000 Hz. 9 x 9 x 4¼". 44 F 52025 Shpg. wt. 5 lbs. . . . . Net 17.80  
 Model DM-3. Efficient CB remote speaker. 4 watts, 8 ohms. With mount. 4 x 4 x 2½". 44 F 52033 Shpg. wt. 1½ lbs. . . . Net 10.67

**12 4J Portable Music Horn** Model S-PM 8 MS. Indoor/outdoor hi-fi system. 8" dual cone speaker. 10 watts. 8 ohms. 50-12,000 Hz. 14 x 10¼ x 15½". 44 F 28058W Shpg. wt. 7 lbs. . . . . Net 29.65

**13 Lafayette 8" Outdoor Speakers** Handles 20 watts peak. 40-15,000 Hz. Weather-resistant. 8 ohms. 10⅞x10⅞x5⅜". 44 F 33058W Shpg. wt. 7 lbs. . . . Net 14.95  
 Deluxe heavy-duty version of above. 35-19k Hz. 30 watts peak. 44 F 33066W Shpg. wt. 7¼ lbs. . . . Net 17.95

**University Matching Transformers**  
 Model 5433. 30 watts. Primary 45/165/200/250/1000/2000, secondary 4/8/16 ohms; 70V line taps 30/25/20/10/5/2.5 watts. 44 F 80166 2¾" centers. 1 lb. . . . . Net 7.70  
 Model 5434. 15 watts. Primary 45/325/500/1000/2000/4000/8000, secondary 4/8/16 ohms. 70V taps 15/10/5/2.5/.65 watts. 44 F 80174 2" centers. ½ lb. . . . . Net 6.48

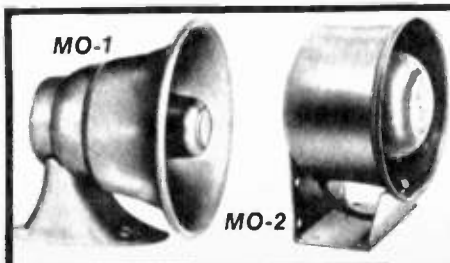

**Atlas Mobile PA Marine and CB Speakers**  
**MO-1.** Weatherproof with one-piece cast bracket. High efficiency. 25 watts, 8 ohms. 300-13,000 Hz. 130° dispersion. 7¼" dia. x 6¾" deep. 44 F 1C346 Shpg. wt. 6 lbs. . . . . Net 35.85  
**MO-2.** Compact, weatherproof, mobile communications speaker with welded steel bracket for limited space. 25 watts, 8 ohms. 300-13,000 Hz. 130° dispersion. 6¾ x 8 x 4¾". 44 F 10353 Shpg. wt. 5¾ lbs. . . . . Net 35.55

# Lafayette PA Sound Columns and Speakers

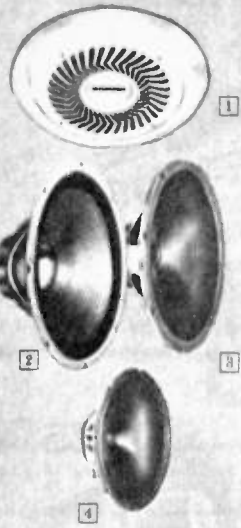

**1 Ceiling Baffle with Speaker.** Wide-range hi-fi response though only 2 1/4" deep. 12-oz. magnet, 1" dia. voice coil. 90-90,000 Hz. 8 ohms. 9 1/2" overall. Imported. 99 F 45056 Shpg. wt. 3 lbs. . . . . Net 13.95

**2 Deluxe Heavy-Duty 12" PA Speaker.** Handles 30 watts (60 peak), 8 ohms. Tough industrial-type 1 1/2" voice coil, 20 oz. ceramic magnet. 12 1/4" dia., 4 3/8" D. 44 F 01600W Shpg. wt. 7 lbs. . . . . Net 14.95

**3 12" PA Speaker.** Highly efficient magnet and coil combination. 10-oz. ceramic magnet, 1" voice coil. Handles 18 watts (36 peak). 8 ohms. 4 7/8" deep. 44 F 01022W Shpg. wt. 5 lbs. . . . . Net 10.95

**4 8" PA Speaker.** With 5.5-oz. ceramic magnet and 3/4" voice coil. Handles 10 watts (20 peak). Magnet assembly can't shift. 8 ohms. Only 2 3/4" deep. 44 F 01030 Shpg. wt. 2 1/4 lbs. . . . . Net 7.95

## LAFAYETTE 6-Speaker Directional Sound Columns

Reduces reverberation and feedback problems. Concentrates or "focuses" sound where needed.

**5** Six 4 1/2" speakers handling 30 watts. 200-10,000 Hz. 16 ohms. Imported. 31 x 7 1/4 x 3 3/4". 99 F 46146W Shpg. wt. 13 1/2 lbs. . . . . Net 49.95

**6** Six powerful 6" speakers handling 60 watts. 70-10,000 Hz. 8 ohms. Imported. 41 1/2 x 7 3/4 x 5". 99 F 46252WX Shpg. wt. 22 1/2 lbs. . . . . Net 76.50

## 7 8" 10W Multi-Tap PA Speaker System

4.64-oz. Alnico magnet, volume control, 70 & 25V transformer with 10, 5, 2.5, 1.25, .625W taps. Imported. 10 3/4 x 4 3/8 x 12 3/8". Wt. 6 1/2 lbs. 99 F 46518W . . . . . Net 22.95

As Low As \$49.95

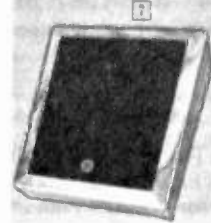
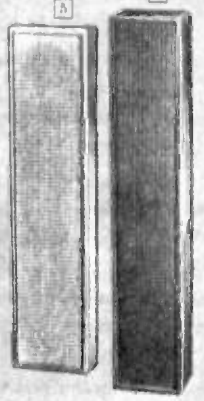

\$22.95

## Lowell PA Speaker Baffles

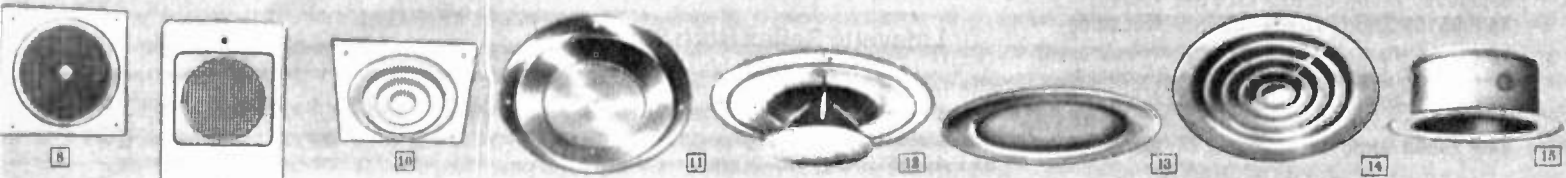

### Flush-Mounting Plastic Baffles

High-impact, lightweight Styrene plastic, white finish. Model ADS80-P has 360° dispersion. Mounting screws supplied.

Stock No.	Type	For	Fig.	Wt.	Net
44 F 50144	ADS80P	8" Ceiling Spkr. 10x10"	10	10 oz.	2.96
44 F 50151	CR80P	8" Ceiling/Wall Spkr. 10x10"	8	8 oz.	1.43
44 F 50169	L35P	3 1/2" Intercom Spkr. 4 1/2 x 7"	9	5 oz.	.94

### Recessed Aluminum Baffles

Satin finish. Model AL has 360° dispersion. Require protective speaker enclosures (see table at right).

Stock No.	Type	Description	Fig.	Lbs.	Net
44 F 50011	RS-6A	For 8" speaker 10 1/4 x 1 1/2"	11	3/4	2.53
44 F 50029	RS-8A	For 8" speaker 12 5/8 x 1 1/2"	11	1	2.50
44 F 50037	RS8AW	As above but white enamel	11	1	2.50
44 F 50048	RS-12A	For 12" speaker 16 7/8 x 1 1/2"	11	1 3/4	3.65
44 F 50052	AL-6A	For 6" speaker 10 3/4" dia.	12	3/4	5.08
44 F 50060	AL-8A	For 8" speaker 12 5/8" dia.	12	1	8.69
44 F 50078	AL-12A	For 12" speaker 18 5/8" dia.	12	2	10.95

### Steel Recessed Baffles

White enamel finish. All grilles have 4 studs on rear to mount speaker. All hardware is furnished. For 8" speakers.

Stock No.	Type	For	Fig.	Wt.	Net
44 F 50201	LK-8	8" Ceiling Speaker 13 1/4" dia.	13	1 3/4	2.53
44 F 50219	CW-8	8" Ceiling Speaker 12" dia.	14	2 3/4	6.21

### 16 Protective Mounting Enclosures

22-gauge welded steel. Rust-proof zinc-chromate exterior, heavily undercoated interior to prevent resonance. †For new construction

Stock No.	For	I.D.	O.D.	Depth	Lbs.	Net
44 F 50086	AL8-A, RS6-A	7 1/4"	11 1/4"	4 3/8"	2 1/2	3.67
44 F 50094	AL8-A, RS8-A, M8	8 5/8"	13 1/2"	4 3/8"	3 3/4	4.21
44 F 50102	AL12-A, RS12-A	12 1/2"	17 1/2"	7 1/8"	8	8.45
44 F 50110	AL8-A, RS6-A	7 5/8"	10 1/8"	4 3/8"	2 1/2	3.68
44 F 50128	AL8-A, RS8-A, M8	8 5/8"	11 3/4"	4 3/8"	3 3/4	4.07
44 F 50138	AL12-A, RS12-A	12 5/8"	16"	7 1/8"	8	9.32
44 F 50177	AL8-A, RS6-A, M8	—	—	—	—	—
	ADS80-P, CR80-P	—	—	3 5/8"	3 3/4	3.76
44 F 50185	L35P	—	—	2"	1	3.05
44 F 50227	CW-8	10"	13 1/8"	5 1/4"	4	6.71

\*Size 8 3/4 x 8 3/4" \*\*Size 8 1/4 x 4"

### 16 Flat Tile Type Panel Baffle

Type M8. Square steel type. Exactly replaces 12 x 12 x 1/2" acoustic tile. Mounting hardware. Zinc chromate undercoat, white lacquer finish. 44 F 50193 . . . . . Net 3.73

## HITACHI Model TIE-250



\$239.95  
Less Lens and Cable

No Money Down\*

Complete System \$1,795



No Money Down\*

## HITACHI Quality CCTV Camera

2 1/2" separate mesh vidicon, over 550 lines of horizontal resolution, automatic sensitivity control and vidicon focus. 4000:1 light compensation range. Requires 75-300-ohm matching transformer and 300-ohm TV cable if used with a regular TV set; PL-259 connectors and RG-59/U cable if used in IF applications with special monitor. 3 x 3.9 x 7 7/8". Imported. 44 F 63014W Shpg. wt. 4 lbs. . . . . Net 239.95

M16-18 16mm F/1.8 Standard Lens.	
44 F 63006 Shpg. wt. 1 lb. . . . .	Net 24.95
44 F 63022 Indoor Soenner. Wt. 10 lbs. . . . .	Net 128.00

## JVC Video & Sound System

Battery-operated, portable video tape recorder; lightweight video camera with F1.8, 15-60mm zoom lens; power pack with battery, recharger, and AC adapter for 117 VAC, 50-60 Hz. Camera features built-in condenser mike and electronic viewfinder. Requires KVR-2U RF converter for use with TV set. 1/2" video tape recorder has automatic audio and video gain controls. Recorder: 5 1/2 x 13 1/4 x 10 1/8"; Camera: 10 3/4 x 2 7/8 x 14 3/8". Imported. No COD's. Allow 2 weeks for delivery. Shpg. wt. 33 lbs.  
27 F 76041XY Complete VTR System . . . . . Net 1795.00  
Model KVR-2U RF Converter.  
27 F 76058Y Shpg. wt. 1 lb. . . . . Net 49.95  
5" Reel, 1200' 1/2" Video Recording Tape.  
27 F 76068Y Shpg. wt. 1 lb. . . . . Net 21.95

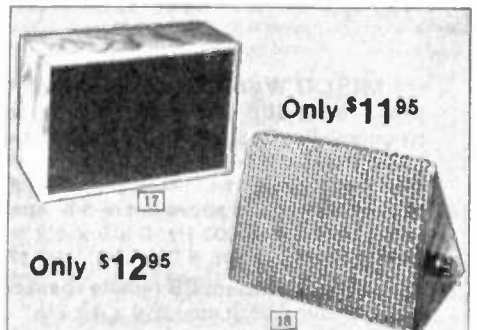

Only \$11.95

Only \$12.95

### 17 LAFAYETTE Shelf Speaker Systems

Ideal as a stereo, TV or radio extension. Attractive walnut-finished wood cabinet. 5-watt 4x8" speaker. 4 or 8 ohms. With 25-ft. cable. Imported. 9 1/2 x 7 3/4 x 3 3/8". 99 F 45502 Shpg. wt. 3 lbs. . . . . Net 12.95

### 18 LAFAYETTE Desk Speaker Systems

Extension speaker for shelf or desk use. Triangular, oiled-walnut finished cabinet. 8" oval speaker. With volume control, 22 ft. of wire. 8 ohms. 7 3/4 x 5 1/4 x 5 1/2". Imported. 99 F 01216 Shpg. wt. 2 lbs. . . . . Net 11.95

# Professional-Quality Mike Mixers, Megaphones

## Lafayette Microphone Mixers



**\$12.95**

### Stereo-Mono Mike Mixer

Solid-state mixer adds versatility to PA or home recording setups. Controls 4 separate signals into a single input (mono); or into separate left and right channel signals (stereo). Has independent mike controls, output jack for standard RCA plugs. High impedance. Phone plug inputs. 6 x 2 1/4 x 3 1/2". Imported.

99 F 45635 Shpg. wt. 1 1/2 lbs. . . . . Net 12.95  
99 F 60212 Battery. Use 1. Wt. 3 oz. . . . . Net 39¢



**\$8.95**

### 4-Input Mike Mixer

Solid-state. Controls up to 4 high-impedance inputs from mikes, tuners, tape recorders, phonos, etc. for complete mixing into single mono signal. Has standard 2-conductor phone inputs, RCA-type phono pin plug output. Operates on 9-volt battery. Imported.

99 F 45353 Shpg. wt. 1 1/2 lbs. . . . . Net 8.95  
99 F 60212 Battery. Use 1. Wt. 3 oz. . . . . Net 39¢

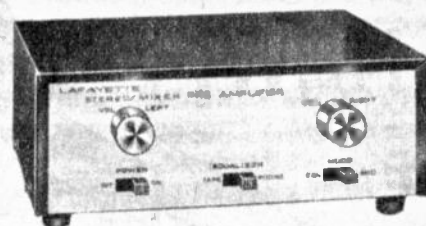

**\$29.95**

### Stereo Mixer/Preamp

Solid-state mixer/preamp for use with any power amplifier without low-level inputs—raises low-level inputs without affecting signal-to-noise ratio. Use as magnetic cartridge preamp, for PA, recordings, etc. Has 2 inputs, volume control for left/right channels, on-off and mode switch, equalization switch. 7 x 2 1/2 x 5 1/2". For 9 VDC and 117 VAC. With battery. Imported.

99 F 01788 Shpg. wt. 2 1/2 lbs. . . . . Net 29.95  
99 F 60212 Replacement battery . . . . . Net 39¢

## Bogen

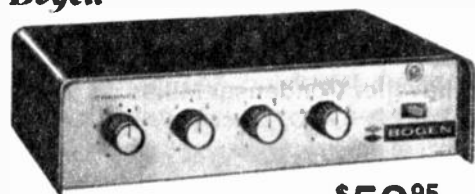

**\$59.95**

### Model MX6A-T Mixer/Preamp

Solid-state. Has 4 microphone, 2 phono inputs—permits complete mixing and fading of any 4 inputs. Connects to high impedance inputs of any PA or stereo amplifier. Gain: Mic, 60 dB; Phono, 20 dB. 50-20,000 Hz  $\pm 2$  dB response. 9 1/4 x 2 5/8 x 6". For 117 VAC. 50-60 Hz.

44 F 12201 Shpg. wt. 5 1/4 lbs. . . . . Net 59.95

## Sound Control Devices

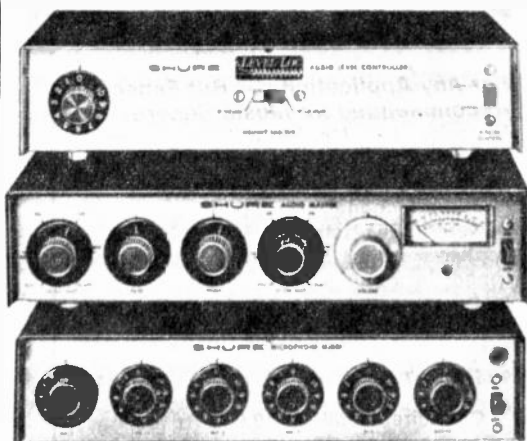

**Model M62V "Level-Loc" Controller.** Automatically locks volume control of sound systems—stops fading, blasting, uneven distribution, etc. Has variable input level, on-off switch. 20-20,000 Hz  $\pm 2$  dB. 100k and 500-ohm input impedance. With battery. 11 1/4 x 2 1/2 x 5 1/4". 44 F 75976 Shpg. wt. 4 lbs. . . . . Net 67.20

**Model M63 "Audio Master".** Use with M68 Series mixers (below) for complete control of high-level input sources. Correct room acoustics, reduce feedback, provide special sound effects, etc. Five outputs: 600-ohm balanced line, high impedance, low and high microphone, headphone monitor. 20-20,000 Hz response. 11 1/4 x 2 1/2 x 5 1/4". For 117 VAC, 50-60 Hz or 30 VDC. 44 F 75844 Shpg. wt. 4 1/4 lbs. . . . . Net 107.40

**Model M88.** Has four high/low impedance mike inputs, aux. input, individual gain controls plus master gain. Male Cannon-type input receptacles. 11 1/4 x 2 1/2 x 5 1/4". For 117 VAC, 50-60 Hz. 44 F 75586 Shpg. wt. 5 lbs. . . . . Net 93.80

**Model M68FC.** Above, with female receptacles. 44 F 75851 Shpg. wt. 5 lbs. . . . . Net 100.80

**Model M68S.** Similar to above, but four inputs with three switchable to left or right stereo channels. Pan control, individual plus stereo master volume controls. For recording, sound systems. High impedance outputs. 117 VAC or 30 VDC operation. 44 F 76115 Shpg. wt. 6 1/2 lbs. . . . . Net 127.80

**Model M68RM Reverberation Mixer.** Similar to models above, with built-in reverberation with adjustable intensity for special effects. Jacks for use with remote reverb. 28 VDC. For 117 VAC, 50/60 Hz. 44 F 75877 Shpg. wt. 8 lbs. . . . . Net 130.80



**\$89.75**



**\$69.95**

### 1 Model MV-16S Megaphone/Siren

Has 16-watts peak power for a full 800 yards voice projection, built-in siren for boat or car use. 12 watts rated output. Weatherproof, noise-cancelling mike, adjustable volume control. Operates on 8 "C" cells (order below), has jack for 12 VDC source (car lighter socket, battery, etc.) 9 x 14"

44 F 30385W Shpg. wt. 7 1/2 lbs. . . . . Net 89.75  
99 F 63687 "C" Batteries. 4 oz. . . . . Net ea. 25¢  
12 VDC Cigarette Lighter Adapter for above.  
44 F 30393 Shpg. wt. 1/2 lb. . . . . Net 6.95

### 2 Model MV-5S Megaphone/Siren

Similar to above, has 6 watts peak power for 300 yard voice projection. 5 watts rated output. For use in emergencies, sporting events, etc. Use 4 "D" cells (order below). 6 1/4 x 8".

44 F 30377W Shpg. wt. 5 lbs. . . . . Net 69.95  
99 F 63661 "D" Cells. Wt. 6 oz. . . . . Net ea. 28¢

## PIONEER



**\$249.95**

### Model MA-62 Six-Channel Mixer/Amp

High-performance solid-state mixing amplifier is perfect for discotheques, small recording studios, disc jockeys, etc.—provides complete and versatile mixing of up to 6 mic/line/phono inputs. Has slide controls for each input, 2 cross-channel pan controls for special effects, mic low-cut filters for each channel. Channel 1, 2, 5 and 6 can be mixed for all left, all right, center output. High impedance inputs. 15 3/4 x 5 3/4 x 10 1/2". For 117 VAC, 50-60 Hz. Imported. 44 F 32001W Shpg. wt. 16 lbs. . . . . Net 249.95

## Solid-State Bullhorn

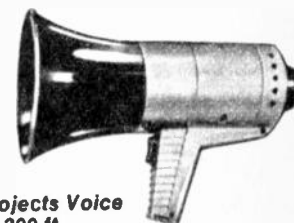

**\$10.95**

• Projects Voice to 200 ft.

Fully transistorized directional megaphone with range to 200 ft. Simply press trigger and talk. With volume control, carry strap. Uses 4 "D" cells, order below. 11" long. USA.

44 F 15097 Shpg. wt. 2 lbs. . . . . Net 10.95  
99 F 62564 "D" Cells. Wt. 5 oz. . . . . Net ea. 19¢

No Money Down—See Page 4 for Lafayette's Easy-Credit Plan (Minimum Order \$30.00)

# Lafayette Professional Series Microphones

**NEW!**



**\$39<sup>75</sup>**  
Your Choice

*Produced to Stringent Specifications . . . "Human Engineered" for Ease of Handling and Mechanical Ruggedness . . . Designed for Top Operating Performance in Any PA, Recording or Sound Reinforcement Application*

**1** **Model MU-100.** The performer's instrument! Unidirectional dynamic for low-noise pickup, ball-type head to reduce "pops" and hisses. For hand-held operation where mechanical noise must be minimized and close-talking proximity effect is desired. 600/50k-ohm dual impedance, 200-10,000 Hz response, -56 dB output. Has on-off switch, Switchcraft connector to body. Cable end free. 2" dia. ball, 6 $\frac{7}{8}$  x 1" diameter body. Imported.  
99 F 46641 Shpg. wt. 2 lbs. . . . . Net 39.75

**2** **Model MU-101.** Unidirectional dynamic provides maximum working distance from the instrument with significant rejection of unwanted background sound. Has dual 600/50k-ohm impedance, on-off switch, Switchcraft connector to microphone body. 200-10,000 Hz resp., -56 dB output. Cable end free. 1.65" dia. head, 7 $\frac{1}{4}$  x 1" body. 99 F 46658 Imported. Shpg. wt. 2 lbs. . . . . Net 39.75

**3** **Model MO-102.** Dynamic omnidirectional—placement is not critical for good sound pickup—ideal for uses where feedback or background noise is not a problem. Has dual 600/50k-ohm impedance, 50-13,000 Hz response, -58 dB output. Cable end free. 1 $\frac{1}{2}$ " dia. head, 7 $\frac{1}{2}$  x 1" diameter body. Imported.  
99 F 46666 Shpg. wt. 1 $\frac{1}{2}$  lbs. . . . . Net 39.75

## Lafayette Electret Condenser Microphones

*For Any Applications — But Especially Recommended for Music Recording or Broadcast — Usable with High or Low Impedance Pre-Amp Inputs*

**4** **Unidirectional.** Cardioid pattern, self-powered FET circuit, 30-16,000 Hz response. -70 dB output. With wind screen, tripod desk stand and floor stand adapter, 20-ft. shielded cable,  $\frac{1}{4}$ " phone plug. With "AA" penlight battery (approx. 8000-hr. life). 10 $\frac{1}{2}$  x  $\frac{7}{8}$ " diameter. Imported.  
99 F 46427 Shpg. wt. 1 $\frac{3}{4}$  lbs. . . . . Net 34.95

**5** **Omnidirectional.** 20-13,000 Hz response, -74 dB output. FET circuit with battery (approx. 1000-hr. life). 10-ft. shielded cable,  $\frac{1}{4}$ " plug. With desk stand. 6 x  $\frac{5}{8}$ " diameter. 99 F 46591 Imported. Wt.  $\frac{3}{4}$  lb. . . . . Net 24.50

**6** **Unidirectional.** For low-noise pickup. 80-15,000 Hz response, -70 dB output. FET solid-state circuit with long-life "AA" battery, stand adapter, 15-ft. cord. Cable end free. 7 $\frac{1}{4}$  x  $\frac{7}{8}$ " diameter. Imported.  
99 F 46724 Shpg. wt.  $\frac{3}{4}$  lb. . . . . Net 19.95

## Lavalier Condenser Mikes



**\$19<sup>50</sup>**

**\$24<sup>50</sup>**

*For Lecturers, MC's, etc.—Anyone Who is "On Mike" for Long Periods of Time—Small Size—BIG Performance*

**7** **Model ML-1.** Has tie-clasp holder, noise-reducing cable to FET preamp and power supply. 600-ohm output impedance. 50-15,000 Hz response, -80 dB output. 1 $\frac{1}{2}$  x  $\frac{3}{8}$ " dia. Omnidirectional. With "AA" battery, shielded cable, phone plug. Imported.  
99 F 46690 Shpg. wt.  $\frac{3}{4}$  lb. . . . . Net 19.50

**8** **Model ML-2.** One of the smallest lavaliers available! Less than  $\frac{5}{8}$ " dia., 1" long. FET preamp and power supply. 800-ohm impedance. 50-13,000 Hz. Omnidirectional. -66 dB output. "AA" penlight 5000-hr. battery. Shielded cable, phone plug. Imported.  
99 F 46708 Shpg. wt.  $\frac{3}{4}$  lb. . . . . Net 24.50



**\$34<sup>95</sup>**



**\$24<sup>50</sup>**

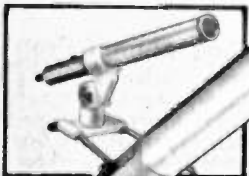

**\$19<sup>95</sup>**

**NEW!**

## Lafayette Dynamic PA Microphone with Switch

**\$10<sup>95</sup>**

*Ideal for Use with Solid-State Mobile PA Amplifiers*

Has high-impact styrol case, hangup clip, flexible shielded cable. Omnidirectional pickup pattern. 300 ohms impedance. -73 dB output. 300-2,500 Hz response. With push-to-talk switch. Gray/black case. Imported.  
99 F 45775 Shpg. wt.  $\frac{3}{4}$  lb. . . . . Net 10.95

## Microphone Accessories

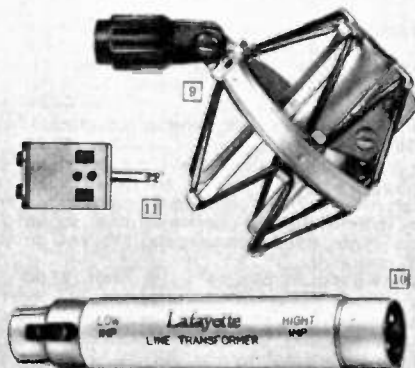

**9** **Shock Mount.** Protects microphone. For use with microphones having barrel diameter of under  $\frac{1}{2}$ ". For stand or boom.  
99 F 46740 Imported. Wt. 2 lbs. . . . . Net 15.95

**10** **Impedance Matching Transformer.** Matches low-impedance microphones to high-impedance mike inputs. For dynamic types (normally not needed for condenser types).  
99 F 46732 Imported. Wt. 1 lb. . . . . Net 9.95

**11** **Switchcraft Audio Mixer.** Two-input high-impedance mixer for sound-on-sound recording, dubbing, etc. Separate gain controls. Two-cond. phone jack inputs to phone plug output. 2 $\frac{1}{2}$  x 1 $\frac{1}{16}$  x 1 $\frac{1}{16}$ ".  
24 F 88666 Shpg. wt. 6 oz. . . . . Net 5.88

# Lafayette General Purpose Microphones

Offer High Value for Most Recording and PA Uses...  
Quality Design and Construction

**1 Deluxe Ball Dynamic.** 250/50k dual impedance, 100-10,000 Hz response. Has on-off switch, ball screen to eliminate "pops" and hiss. Die-cast, satin aluminum finish. 6 1/4" long, ball dia. 2 1/8". With 20-ft. cable, phone plug, desk stand, 5/8"-27 adapter. **99 F 46203** Imported. Wt. 3 lbs. . . Net **24.25**  
Above but 8-ft. detachable cable with mike plug on one end, Imported.  
**99 F 45981** Shpg. wt. 2 3/4 lbs. . . . Net **21.50**

**2 Professional Dynamic.** For all quality recorders, especially solid-state units. 10k ohms impedance, 80-15,000 Hz response, -65 dB output. 5 1/2" long x 1" dia., with 8-ft. cord, phone plug, aluminum trim desk stand, 4 1/8" x 2 1/2". **99 F 45882** Imported. Wt. 1 lb. . . Net **19.95**

**3 Dual-Impedance Cardioid Dynamic.** Unidirectional pickup ideal for stage, PA, sound reinforcement uses. 50k/600 ohms switchable impedance, 100-10,000 Hz response, -57 dB output. With on-off switch, 20-ft. cable, mike stand adapter. 8" long x 1" dia. **99 F 46609** Imported. Wt. 1 3/4 lbs. Net **24.50**

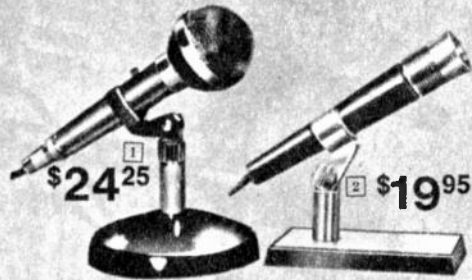

**1** \$24.25      **2** \$19.95

**4 Dual-Impedance Dynamic.** For use in quality PA systems. Omnidirectional. Pop-proof wire mesh grille, 100-10,000 Hz, -58 dB output, 30-ohm high/250-ohm low impedance. For 5/8"-27 thread stands, tiltable thru 90° arc. 7 3/4" x 1 1/2" dia. With 20-ft. cable. **99 F 45460** Imported. Wt. 2 lbs. . . Net **21.00**

**5 Cardioid Dynamic.** For use where feedback is a problem—highly directional pickup. On-off switch. 100-10,000 Hz response, 50k/600-ohm impedance. Mylar diaphragm, satin-chrome finish. 8 1/4" long x 1 1/2" dia. With stand adapter, 20-ft. cord, phone plug. **99 F 46294** Imported. Wt. 1 3/4 lbs. Net **21.95**

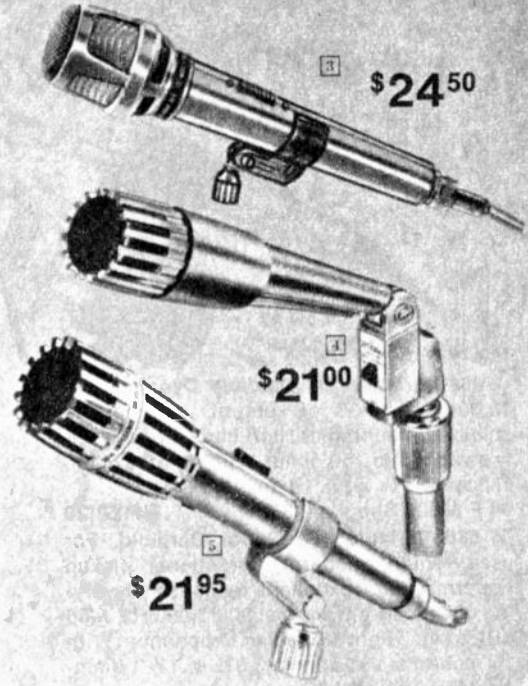

**4** \$24.50

**5** \$21.00

**5** \$21.95

## Quality Microphones for Recording, PA



**6** \$16.95

**7** \$9.95

**8** \$9.95

**9** \$7.95

**10** \$4.95

**6 Dual-Impedance Dynamic.** 50k/250 ohms; 100-10,000 response. -60 dB output. On-off switch, 20-ft. cable with mike plug. Stand adapter. 7 x 1 3/8" dia. Imported. **99 F 46039** Shpg. wt. 1 1/4 lb. . . . Net **16.95**  
**44 F 10098** Desk Stand. 3 lbs. . . . Net **3.65**

**7 4-Way Ball Crystal.** Has push-to-talk/lock-on switch. 1 meg impedance, 100-10,000 Hz response, -55 dB output. With desk stand, lavalier cord, bracket, floor stand adapter. 15" cable. 7 1/8" ball dia. 1 3/4". **99 F 46443** Imported. Wt. 1 1/2 lbs. . . Net **9.95**

**8 Lightweight Dynamic.** Omnidirectional. Hand-held or desk stand use. 10,000 ohms impedance, 70-9,000 Hz response, -67 dB output. On-off switch, 6-ft. cord, phone plug. 6 1/4" x 7/8" dia. With desk stand. **99 F 46161** Imported. Wt. 1 lb. . . . Net **9.95**

**9 4-Way Crystal Mike.** Includes desk stand, lavalier cord and bracket, floor stand adapter. On-off switch. High impedance, 50-9,000 Hz response, -65 dB output. 5" long. With 54" cord. Imported. **99 F 45874** Shpg. wt. 1 lb. . . . . Net **7.95**

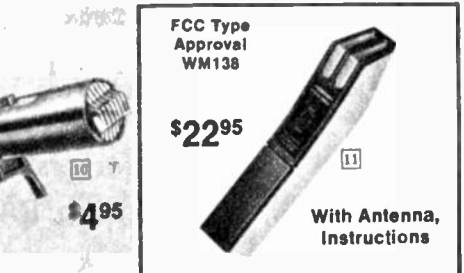

FCC Type Approval WM138

**11** \$22.95

With Antenna, Instructions

**10 Remote Control Cassette Mike.** Universal replacement for cassette recorders with low impedance inputs. On-off switch, 100-9,000 Hz. 4 1/2" x 7/8". With 1/8", 3/32" plugs for most recorders. Imported. **99 F 46625** Imported. Wt. 5 oz. . . . Net **4.95**

**11 FM Wireless Mike.** Transmits to 150 ft. through any FM tuner or radio. Wireless. Clear, static-free performance. 4 3/4" x 1 x 1". **99 F 46674** Imported. Wt. 10 oz. . . . Net **22.95**  
**99 F 60212** 9-V Battery. Use 1 . . . . Net **39¢**

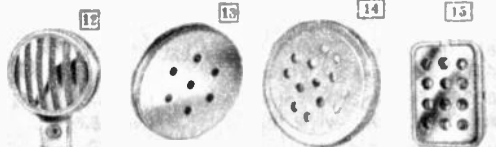

## Miniature Microphones

**12 Lapel Mike.** Frees hands. 1 5/8" diameter, -55 dB output. 5-ft. cord. **99 F 45106** Imported. Wt. 4 oz. . . . Net **2.29**

**13 Miniature Dynamic.** 1 1/16" dia., 3/16" thick. 300-5,000 Hz. 600 ohms. **99 F 45270** Imported. Wt. 2 oz. . . . Net **3.59**

**14 Crystal Cartridge.** Replacement for Popular crystal cartridges. -55 dB output. 2" dia. 1/4"D. **99 F 46757** Imported. Wt. 3 oz. . . . Net **1.79**

**15 Subminiature Crystal Mike.** For hearing aids, etc. 1 3/8" x 1 x 1/4". **99 F 45189** Imported. Wt. 2 oz. . . . Net **1.99**

## Musical Instrument Mikes

**16 Harmonica Contact Mike** High output mike only 1 1/8" x 5/8" x 3/8". For most harmonicas. With 7' shielded cable. Imported. **99 F 45163** 3 oz. . . . Net **2.59**

**17 Round Hole Guitar Mike.** For Spanish guitars, ukeleles, others. Tone, volume controls. 7-ft. cable, phone plug. Imported. **99 F 46351** Wt. 1 lb. Net **8.95**

**18 Contact Mike.** For all stringed instruments. Can be clamped under board cutout. 1 3/4"L. 8-ft. cable. Volume control. Imported. **99 F 45767** 4 oz. . . . Net **4.95**

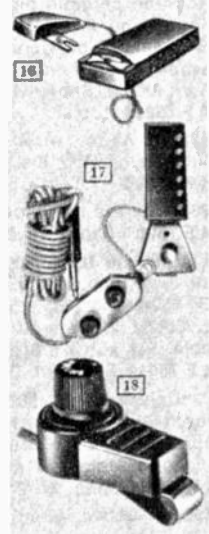

**16**

**17**

**18**

### Lafayette Dynamic PA/Paging Desk Mike

\$19.95

- For Mike Precedence, Standard Operation
- Press-to-Talk
- Dual Impedance

Omnidirectional. Built-in desk stand with push-to-talk bar and lock. For use with Lafayette, other PA amps with mike precedence inputs. 50,000/250 ohms. -60 dB output. With 6-ft. cable. 7 3/4" high, 5 1/4" x 3 7/8" base. **44 F 01659** U.S.A. 2 1/2 lbs. Net **19.95**

# Electro-Voice® Recording, PA, Broadcast Mikes



**1** 664 Variable "D" Cardioid Dynamic. 60-15,000 Hz, -58 dB output, non-metallic shielded diaphragm. High impedance, easily switched to 150 ohms. With on-off switch, 15' cable. 7/8 x 1 7/8" diameter.  
**44 F 25328** Shpg. wt. 3 3/4 lbs. . . . . Net **61.20**

**2** 660 Variable "D" Super Cardioid. For uses requiring sharply directional pickup pattern. Offers excellent response at varying distance from source. 90-13,000 Hz, -56 dB output. High/150 ohms impedance. With 15' cable, stand adapter. 6 1/2 x 1 1/2" diameter. Switchcraft A3F conn.  
**44 F 25864** Shpg. wt. 3 lbs. . . . . Net **64.80**

**3** 671 "Ball-Type" Single "D" Cardioid. "Ball" design emphasizes low frequencies when used close up. Has on-off switch with lock, high/150 ohm impedance. 60-14,000 Hz, -60 dB output. With 15-ft. cable, stand adapter. 6 3/4 x 2" diameter.  
**44 F 25880** Shpg. wt. 2 lbs. . . . . Net **54.75**

**4** 670 Single "D" Cardioid. Provides bass boost when used close up. Superior pop filter. High/150-ohm impedance. 60-14,000 Hz, -58 dB output. 7/8 x 1 1/2" dia. With 15' cable, Switchcraft A3F conn.  
**44 F 25872** Shpg. wt. 3 lbs. . . . . Net **49.20**

**5** 644 "Sound Spot" Unidirectional. Has better than 2.5 times working distance of non-directional mikes, virtually complete rejection of unwanted sound. 40-12,000 Hz, -53 dB output, high/low impedance. 16 x 2 3/8" dia. With 15' cable.  
**44 F 25476** Shpg. wt. 3 1/4 lbs. . . . . Net **87.60**

**6** 647A Lavalier Dynamic. Small size for hand, lavalier cord or stand, etc. 70-10,000 Hz response, -60 dB output, high impedance. With 18-ft. cable, neck cord, belt clip and stand clamp. 3/4 x 3/4" diameter.  
**44 F 25195** Shpg. wt. 1 1/2 lbs. . . . . Net **61.80**

**7** 635A Broadcast Dynamic. Omnidirectional professional pickup. for desk, floor stand, hand-held use. 80-13,000 Hz response, -55 dB output, low impedance. 6 x 1 3/8" dia. With 18' cable.  
**44 F 25591** Shpg. wt. 3 lbs. . . . . Net **56.70**

**8** RE10 "Super Cardioid" Dynamic. Symmetrical directional pickup pattern with frequency response virtually independent of sound source. 80-13,000 Hz response, -55 dB output, low impedance. 6 3/4 x 1 3/8" dia. With 18' cable, stand adapter.  
**44 F 25831** Shpg. wt. 1 lb. . . . . Net **99.60**

**9** RE11. Same as RE10 with blast and pop filter around head.  
**44 F 25858** Shpg. wt. 1 lb. . . . . Net **106.50**

**10** RE15 Deluxe "Super Cardioid" Dynamic. Similar to above, for highest performance applications. 80-15,000 Hz response, -56 dB output. Integral bass compensation switch. 150 acceptance angle.  
**44 F 25849** Shpg. wt. 1 lb. . . . . Net **169.80**

## SHURE Recording, PA, Broadcast Mikes



**9** "Unidyne III" 545SD. Slender cardioid dynamic with symmetrical pickup pattern to eliminate feedback and sound boom. Magnetic reed on-off switch. 50-15,000 Hz. Dual impedance. Output: 50-250 ohms, -57 dB; Hi-Z, -55 dB. 15' cable, 3-pin audio connector. 5 3/8 x 1 3/8" dia.  
**44 F 75984** Shpg. wt. 2 1/2 lbs. . . . . Net **68.40**

545. Above, no on-off switch. Amphenol conn.  
**44 F 75059** Shpg. wt. 2 1/2 lbs. . . . . Net **64.20**

545L. Above, for lavalier, gooseneck and hand-held use. Low impedance only. With 20' cable.  
**44 F 76180** Shpg. wt. 2 lbs. . . . . Net **53.85**

**10** "Unidyne IV" 548SD. Feedback-free unidirectional with magnetic reed on-off switch. 3-pin connector; wind, pop and blast filters. 40-15,000 Hz response, high/low impedance, -55.5 dB. Swivel adapter & 15' 2-cond cable. 6 1/8 x 1 1/8" dia.  
**44 F 75992** Shpg. wt. 2 3/4 lbs. . . . . Net **80.40**

**11** "Unisphere I" 565SD. Ball-type unidirectional with magnetic reed on-off switch, 50-15,000 Hz response. Dual impedance; output 50-250 ohms, -57 dB, Hi-Z, -55 dB. With swivel adapter, 15' 3-cond. cable, 3-pin audio connector. 6 1/2 x 2" dia.  
**44 F 76008** Shpg. wt. 3 lbs. . . . . Net **75.60**

565. Above, less On-off switch. Amphenol conn.  
**44 F 75547** Shpg. wt. 3 lbs. . . . . Net **72.60**

**12** "Unisphere B" 588SA. Ball-type with feedback-free cardioid pickup, shock-mounted cartridge, wind, pop and blast filter, lockable "on-off" switch, 3-pin conn., 15' cable. 50-13,000 Hz response, high impedance. Output: 58 dB. 6 1/2 x 2" dia. Shpg. wt. 2 lbs.  
**44 F 75893** . . . . . Net **43.65**

588SAC. Above, wired for MC1F, MC1M, phone plug. Shpg. wt. 2 lbs.  
**44 F 75885** . . . . . Net **44.85**

588SB. Above low impedance. -59.5 dB output.  
**44 F 75901** Shpg. wt. 2 lbs. . . . . Net **43.65**

**13** "Unidyne II" 55SW. Dynamic unidirectional with 3-way imp. switch. Output: 35-50 ohms, -55 dB. 150-250 ohms, -56 dB. Hi-Z, -55 dB. 50-15,000 Hz. With on-off switch, swivel mount, 15' cable. 7 3/8 x 2 3/8 x 3 1/8".  
**44 F 75018** Shpg. wt. 3 3/4 lbs. . . . . Net **65.40**

**14** "Unisphere A" 585SA. Unidirectional pop-proof with wire mesh screen. 50-13,000 Hz, high impedance, -57 dB output. On-off switch, swivel stand adapter, 15' cable. 6 3/4 x 1 13/16" dia.  
**44 F 75521** Shpg. wt. 2 lbs. . . . . Net **50.85**

585SAC. Above, wired for MC1F, MC1M, phone plug. Shpg. wt. 2 lbs.  
**44 F 75687** . . . . . Net **52.05**



**Accessories**

**Swivel Adapter.** For 515, 545, 548, 565, 580, 588 mikes. For use with standard desk or floor stands.  
**44 F 76164** Wt. 8 oz. Net **4.50**

**Line Transformer.** Connects low impedance mikes to high impedance inputs. MC1F and male Cannon conn.  
**44 F 75414** 14 oz. .Net **14.10**

**585SB.** Low-imp. -59 dB, 2-cond. cable.  
**44 F 75539** Shpg. wt. 2 lbs. . . . . Net **50.85**

**585SAV.** Above, with volume control. No on-off.  
**44 F 75612** Shpg. wt. 2 lbs. . . . . Net **55.65**

**15** "Vocal Sphere" 579SB. Omnidirectional with natural voice reproduction. Wind, breath filters, locking on-off, Cannon connector with 20-ft. cable, swivel stand adapter. 50-15,000 Hz. Low impedance. -59 dB output. 6 3/8 x 1 3/8" dia.  
**44 F 75919** Shpg. wt. 2 lbs. . . . . Net **50.85**

**16** "Unidyne B" 515SA. Unidirectional with cardioid pattern to prevent feedback. 80-13,000 Hz. High impedance. -58 dB output. On-off, swivel adapter, 15', 1-cond. fixed cable. 6 7/8 x 1 1/2" dia.  
**44 F 75661** Shpg. wt. 2 lbs. . . . . Net **30.30**

515SAC. Above, wired for MC1F, MC1M, phone plug. Shpg. wt. 2 lbs.  
**44 F 75950** . . . . . Net **31.50**

515SB-G18. Above, with 18" gooseneck mount. Low impedance, PTT switch for mike and relay circuit, 51" cable. 25 x 1 1/2" dia.  
**44 F 76016** Shpg. wt. 2 3/4 lbs. . . . . Net **35.70**

# TURNER All-Purpose Communications Microphones



**1 Model M+2U.** Amplified ceramic mobile mike providing up to 15 dB gain. Volume control. 300-3000 Hz. -33 dB output.  
**44 F 70183 Relay Switching.** 1 1/2 lbs. .Net 33.00  
**44 F 70191 Elec. Switching.** 1 1/2 lbs. .Net 33.00  
**32 F 47699 Repl. 7-V Batt. Wt. 1 oz. .Net 1.95**

**2 Model 360DM.** Medium impedance (2000 ohms) dynamic mobile mike for transistorized transceivers. 100-8000 Hz. -75 dB output.  
**44 F 70456 Relay Switching.** 1 lb. .Net 12.00  
**44 F 70464 Elec. Switching.** 1 lb. .Net 12.00

**3 Model M+3.** Amplified ceramic with slide-volume control. Modu-Guard® to prevent over-modulation. 300-3500 Hz. Up to 15 dB gain.  
**44 F 70357 Relay Switching.** 1 lb. .Net 36.00  
**44 F 70365 Elec. Switching.** 1 lb. .Net 36.00  
**32 F 47699 Repl. 7-V Batt. 1 oz. .Net 1.95**

**4 Model NC35CDM.** NOISE CANCELLING mobile with 2000 ohms impedance for solid-state units. 300-3000 Hz response. -75 dB output.  
**44 F 70431 Relay Switching.** 1 lb. .Net 21.00  
**44 F 70449 Elec. Switching.** 1 lb. .Net 21.00

**5 Road King 70C.** Amplified ceramic mobile mike especially for truckers. Has NOISE-CANCELLING features to cut background noise. 300-3500 Hz. Slide control for up to 15 dB gain.  
**44 F 70415 Relay Switching.** 1 lb. .Net 39.00  
**44 F 70423 Elec. Switching.** 1 lb. .Net 39.00  
**32 F 47699 Repl. 7-V Batt. 1 oz. .Net 1.95**

**6 Model M+2.** Amplified base station ceramic mike with volume control, touch-to-talk bar, slide lock. 300-3500 Hz. Adj. gain-0-35 dB. For relay or electronic switching.  
**44 F 70167 Shpg. wt. 3 lbs. .Net 39.00**  
**99 F 63729 Replacement 9-V Battery .Net 49¢**

**7 Model +3.** Amplified base station ceramic mike with volume control and compression amplifier circuit. Touch-to-talk bar with slide lock. Matches either relay or electronic switching. 300-3000 Hz response. -23 dB output.  
**44 F 70316 Shpg. wt. 4 lbs. .Net 48.00**  
**99 F 63729 Replacement 9-V Batt. 3 oz. Net 49¢**

**8 Super Sidekick.** Turner's best—matches all AM or AM/SSB CB transceivers. Amplified base station dynamic mike with two gain controls: volume adjustment on top, amplifier gain control on bottom. 300-3500 Hz response. Output level is adjustable to a maximum of -25 dB. For relay or electronic switching.  
**44 F 70407 Shpg. wt. 4 lbs. .Net 51.00**  
**99 F 63729 Replacement 9-V Batt. 3 oz. Net 49¢**

## Atlas Microphone Accessories, Stands, Booms

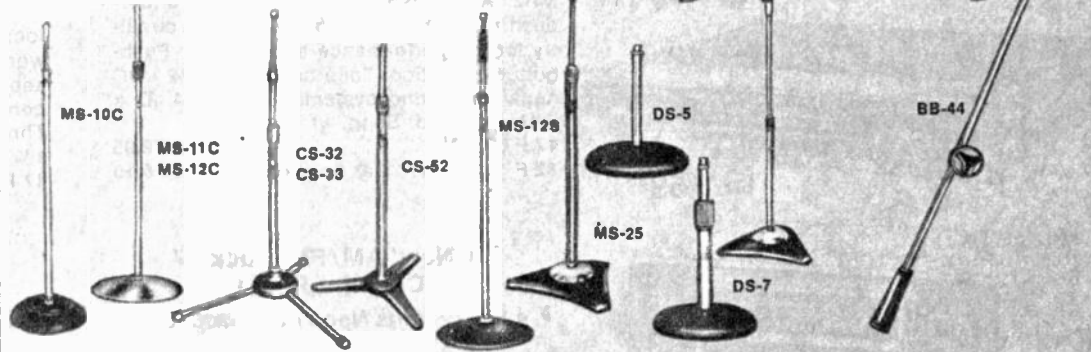
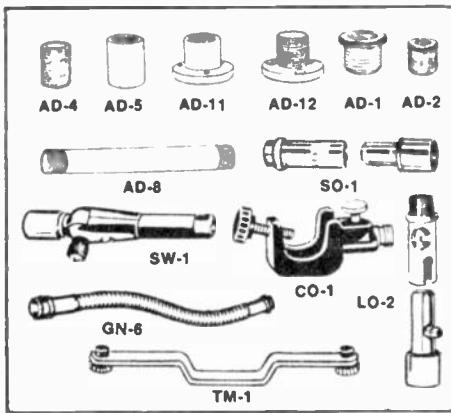

**Mike Flanges & Extension Rods.** Fit 5/8"-27 mikes. Base dia., 1 1/4". Extension rods, male on both ends. Avg. wt. 8 oz.  
**44 F 10155 AD-12 Male Flange** Net 1.08  
**44 F 10163 AD-11 Fem. Flange** Net 1.05  
**44 F 10171 AD-8 6" Ext. Rod** .Net 1.02  
**Mike Adapters.** For adapting special fittings. Shpg. wt. 10 oz. (RCA).  
**AD-1 5/8"-27 female to 1/2" male thread** .Net 1.02  
**AD-2 1 1/8" female pipe to 5/8"-27 male** .Net 1.02  
**44 F 10197** .Net .75  
**AD-4 3/4" long 5/8"-27 male running thread.**  
**44 F 10213** .Net .60  
**AD-5 5/8"-27 fem. to 5/8"-27 fem. coupling** .Net .81  
**44 F 10221** .Net .81  
**Model SW-1 Gyromatic Swivel.** Permits any mike to be locked at any angle. 5/8"-27 thread. 4 1/2" long.  
**44 F 10247** .Net 5.58  
**Model SO-1 "Snap-on" Mike Attachment.** Quick and safe. For all mikes and stands. Two "Snap-on" sections.  
**44 F 10254** .Net 3.35  
**Model LO-2 "Lock-on" for quick disconnection** .Net 10.45

nect of mike from stand. Positive lock when on stand, pushbutton release.  
**44 F 10023** .Net 3.95  
**Model CO-1.** Connect-on 360° swivel attachment. Mounts instrument or second microphone to mike floor stand or to table or desk top. Shpg. wt. 8 oz.  
**44 F 10437** .Net 4.40  
**Model TM-1.** Twin microphone mount for installation of two or three microphones on mike stand, podium or lectern top.  
**44 F 10445 Shpg. wt. 8 oz. .Net 8.85**  
**Model GN-6 Goose Neck.** 6" long. 5/8"-27 thread. Chrome finish.  
**44 F 10478 Shpg. wt. 8 oz. .Net 2.10**  
**Model GN-13.** Same as GN-6 except 13".  
**44 F 10262 Shpg. wt. 10 oz. .Net 2.85**  
**Model GN-19.** Same as GN-13 but 19" L.  
**44 F 10270 Shpg. wt. 1 1/4 lbs. .Net 3.95**  
**Model MS-10C Full Grip Mike Stand.** "Full-Grip" clutch mechanism for fast, quiet adjustments. Base includes self-leveling, shock-absorbing pads plus 3 "anti-tip" points. 5/8"-27 thread. Base dia. 10". Finished in gray shrivel. Height adjustment 35 to 63". Shpg. wt. 10 3/4 lbs.  
**44 F 10031W** .Net 10.45

**Model MS-12C.** As above but heavier and tube extends to 62".  
**44 F 10049 Shpg. wt. 6 1/4 lbs. .Net 10.85**  
**Model MS-11C.** As above but with full chrome-finished base.  
**44 F 10056 Shpg. wt. 10 lbs. .Net 13.25**  
**Model CS-52.** 15" gray base with chrome tube. Height adjusts from 34 to 62".  
**44 F 10312 Shpg. wt. 10 lbs. .Net 12.95**  
**Model MS-12S "Sleeve-Action" Mike Stand.** Fully automatic height adjustment. To lower, just press "Sleeve-Action" control. To raise, any point on the tube that can be grasped. Ht. 39 to 62". 10" dia. gray base, chrome tube. 5/8"-27 thread.  
**44 F 10064 Shpg. wt. 9 1/4 lbs. .Net 23.10**  
**Model CS-32.** Demountable Stand. Fully collapsible to fit in amplifier or speaker-carrying case. Self-leveling legs are skid-proof. Adjustable from 36 to 64". Fully chrome plated. 5/8"-27 thread.  
**44 F 10072 Shpg. wt. 5 1/4 lbs. .Net 13.20**  
**Model CS-33.** As above, but height adjustment of 26-64". Collapses to 22 1/2".  
**44 F 10080 Shpg. wt. 4 3/4 lbs. .Net 15.40**  
**MS-25 Professional Stand.** "Safety Air Lock Cushion." Prevents accidental slippage of telescoping section, smoothly lowers on cushion of air. Grey and

chrome base. Ht. adj. 38 to 67". 5/8"-27 adapter. Shpg. wt. 28 1/4 lbs.  
**44 F 10288** .Net 29.60  
**Model DS-5 "Velvet Action" Desk Stand.** Base dia. 6". Gun metal shrivel finish. Fixed height 4".  
**44 F 10098 Shpg. wt. 2 3/4 lbs. .Net 3.65**  
**Model DS-7.** Like DS-5 but ht. adj. 8-13".  
**44 F 10106 Shpg. wt. 3 lbs. .Net 5.85**  
**Model BS-36 Professional Boom Stand.** Has removable 62" boom with gyromatic swivel joint to keep mike positioned. "Safety Air-Lock Cushion" eliminates slippage. Super-chromed tubes adjust 48 to 72". Chrome and gun metal base.  
**44 F 10122W Shpg. wt. 36 lbs. Net 71.70**  
**Model BS-36W.** Same as above but with swivel casters.  
**44 F 10338W Shpg. wt. 38 lbs. Net 82.10**  
**Model BB-44 Boom Attachment.** For mike floor, desk stands. 31" long, 5/8"-27 thread. Chrome-plated tube. Single knob control.  
**44 F 10494 Shpg. wt. 3 1/2 lbs. .Net 8.45**  
**Carry Case (not shown).** Holds assembled microphone stand and baby boom. Includes external gripper snap-pockets for microphones, cables, and accessories, as well as 33-inch zipper.  
**44 F 10452 Shpg. wt. 2 lbs. .Net 2.95**

# Quality Solid-State Radios For The Car

## NEW LOW PRICES

Both Radios with  
Antenna Connectors  
Less Speakers



1 \$89<sup>95</sup>



2 \$69<sup>95</sup>

### 1 Deluxe Universal AM/FM/MPX Stereo Pushbutton Car Radio

• 5 Tuned AM, 8 Tuned FM Circuits

This powerful solid-state AM/FM/MPX stereo radio employs integrated circuitry for outstanding performance and stability. Includes 5 tuned AM and 8 tuned FM circuits, AFC, local/distance and stereo/mono switches. Die-cast face plate. Flexible antenna lead connector. 12-volt neg. ground operation. 6½ x 5½ x 1½". Imported. Wt. 4½ lbs.

17 F 80121W ..... Net 89.95  
Set of 2 Rear Deck 3x5" speaker systems.  
99 F 62994 Imported. Wt. 2½ lbs. . Net 7.95

### 2 Under-Dash Solid-State FM/FM Stereo Car Radio

• With "Grip-Tight" Mounting Strip

Compact FM/FM stereo car radio measuring only 1½ H x 5 D x 6" W! Operates independently or hooks up to your AM radio. Features an illuminated slide-rule tuning dial, stereo indicator light, and IC circuitry. Slide lever controls for balance and tone, and pushbutton stereo/mono selector. Installs with "Grip Tight" mounting strip. Comes with antenna "Y" connector, mounting hardware. For 12 VDC negative ground systems. Imported.

17 F 80097L Shpg. wt. 2 lbs. . . . Net 69.95



• Receives U.S. Gov't Weather Reports on 162.55 MHz \$79<sup>95</sup>

### 3 Sanyo AM/FM Weathermatic Pushbutton Car Radio

• Measures Only 7-1/8W x 4-9/16D x 2"H

High-performance AM/FM car radio with built-in U.S. Gov't Weather Band—162.55 MHz. Adjustable shafts for in- and under-dash mounting. Powerful solid-state circuitry for top performance and stability. Push-button operation. Tone control. For 12 VDC negative ground systems. 7½ W x 4½ D x 2" H. Imported. Shpg. wt. 6 lbs.

17 F 59190 ..... Net 79.95  
32 F 49166 5x7" Car Speaker . . . Net 5.10

### 4 Solid-State Universal AM/FM Car Radio

• 3 FM, 2 AM Quick-Set Pushbuttons

Enjoy car listening at its finest with this pushbutton AM/FM car radio. Features 5 quick-set pushbuttons (3 FM, 2 AM) and a local/distance switch. With deluxe black, wood grain, and chrome face plate, and a separate 5x7" speaker. Solid-state—7 silicon transistors, 1 FET, 2 IC's, and 5 diodes. Three ceramic IF filters. 6¾ W x 4½ D x 1¾ H. Imp. For 12 V neg. gnd. systems.

17 F 80139W Shpg. wt. 4 lbs. . . . Net 59.95



4 \$59<sup>95</sup>



5 \$59<sup>95</sup>

### 5 New! AM/FM Trucker/Car Mini-Radio

• For 12 Volts Neg./Pos. Ground

Get crisp, clear sound reproduction in a small package that fits easily under-dash. Mounts with "Grip-tight" mounting strips in any car, truck, boat or recreational vehicle. Connects to 12 volt DC negative or positive ground. Includes mounting hardware, "Y" connector, and 5" round speaker. 4½ W x 6 D x 1½ H. Imported.

17 F 80493 Shpg. wt. 1½ lbs. . . . Net 59.95

### 6 New! Universal AM Manual Car Radio

• Compact Size with Built-In Speaker

A high-quality, manual tuning AM radio with fine tone and high sensitivity. Features compact size with built-in speaker and includes mounting hardware and face plate for in- or under-dash installation. Seven silicon transistors, 4 diodes. Two-position tone control. 6½ W x 4¾ D x 1¾ H. Imported.

17 F 80501 Shpg. wt. 9 lbs. . . . Net 19.95



6 \$19<sup>95</sup>



7 \$34<sup>95</sup>

### 7 Deluxe Pushbutton AM Car Radio

• With Full-Range 5 x 7" Speaker

Attractively-styled, under-dash, solid-state AM pushbutton car radio with reversible face plate—black on one side, walnut on the other. Has AGC to prevent fading or blasting, external 5x7" speaker. For 12 volt negative/positive ground systems. 6½ W x 4¾ D x 2" H. Imported.

17 F 80048 Shpg. wt. 5 lbs. . . . Net 34.95

### 8 New! Positive to Negative and 6 to 12 Volt Converter

• Permits Use of 12V Neg. Equipment

The inexpensive solution for installing car radios, stereo and cassette tape players into vehicles with 6 volt negative or 12 volt positive ground systems. Permits standard 12 volt negative ground equipment to be used with these electrical systems. Provides full 3 amp continuous power. 3W x 5 D x 2½ H. Made in U.S.A.

17 F 80485 Shpg. wt. 2 lbs. . . . Net 22.95

6 to 12 V Pos. to  
Neg. Converter



8 \$22<sup>95</sup>



# Custom Car Radios and FM Converters That Install Trouble Free

## NEW!

### Lafayette "Micro-Mini" FM Car Converter

• **Converts AM Car Radio to AM/FM Car Radio**  
 One of the smallest FM converters we've seen—a marvel of solid-state electronics! Converts your present AM car radio into a deluxe FM car radio with one simple-to-make connection, antenna and speaker hookup. Has slide-rule FM tuning dial with oversize printed station markings for easy reading, pushbutton on-off, rugged metal case. With mounting bracket and hardware, cables for AM radio, antenna and speaker connection. For 12 VDC negative ground. 17 F 02679L Shpg. wt. 1 1/2 lbs. . . . . Net 29.95

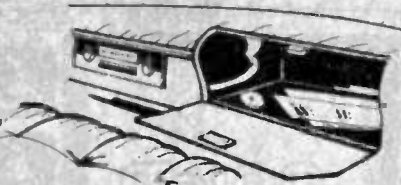

**\$29<sup>95</sup>**

**Only 4 1/8 x 1 1/8 x 5" Deep—Above Front Panel Is ACTUAL SIZE!**

### Custom "In-Dash" Radios for Foreign Cars

Designed exclusively for custom in-dash mounting in Volkswagens, Toyotas and Datsuns. Supplied with all mounting hardware. All radios (except stereo FM models as indicated) are complete with an external speaker. (See page 71 for car stereo speakers.) All feature 5 easy-set pushbuttons, instant-on solid-state circuit and 12 VDC neg. gnd. operation. Imported.



#### Custom Solid-State Radios for Volkswagens

Stock No.	Type	Speaker	For Models	Shpg. wt.	Net
17 F 80196	AM Pushbutton	5" Round	'68-'74 Beetle, '72 Super Beetle	7 lbs.	38.50
17 F 80204	AM Pushbutton	5" Round	'73-'74 Super Beetle	8 lbs.	42.50
17 F 80212	AM Pushbutton	5x7" Oval	'68-'74 Bus	8 lbs.	44.95
17 F 80220	AM Pushbutton	4x6" Oval	'69-'74 Fastback/Square Type 3	7 lbs.	44.95
17 F 80311	AM Pushbutton	5 1/4" Oval	'74 Dasher	7 lbs.	44.95
17 F 80329	AM Pushbutton	5 1/4" Oval	'74 411	7 lbs.	44.95
17 F 80337	AM Pushbutton	5 1/4" Oval	'73-'74 Karman Ghia	7 lbs.	44.95
17 F 80238	AM-FM Pushbutton	5" Round	'68-'74 Beetle, '72 Super Beetle	7 lbs.	72.50
17 F 80246	AM-FM Pushbutton	5" Round	'73-'74 Super Beetle	8 lbs.	72.50
17 F 80253	AM-FM Pushbutton	5x7" Oval	'68-'74 Bus	9 lbs.	74.95
17 F 80261	AM-FM Pushbutton	4x6" Oval	'69-'74 Fastback/Square Type 3	8 lbs.	74.95
17 F 80345	AM-FM Pushbutton	5 1/4" Oval	'74 Dasher	8 lbs.	76.50
17 F 80352	AM-FM Pushbutton	5 1/4" Oval	'74 411	8 lbs.	74.95
17 F 80477	AM-FM Pushbutton	5 1/4" Oval	'73-'74 Karman Ghia	8 lbs.	74.95
17 F 80279	Stereo FM-AM Pushbutton	No Speakers	'73-'74 Super Beetle	6 lbs.	99.95
17 F 80287	Stereo FM-AM Pushbutton	No Speakers	'68-'74 Beetle, '72 Super Beetle	6 lbs.	99.95
17 F 80360	Stereo FM-AM Pushbutton	Two 5" Round	'74 Dasher	8 lbs.	124.95
17 F 80378	Stereo FM-AM Pushbutton	Two 5" Round	'74 411	8 lbs.	121.95
17 F 80386	Stereo FM-AM Pushbutton	Two 5" Round	'73-'74 Karman Ghia	8 lbs.	121.95

#### Custom Solid-State Radios for Toyotas and Datsuns

17 F 80030	AM Pushbutton	5x7" Oval	'68-'74 Toyota Corona, Corina, Celica, Corolla; '73-'74 MK II	6 lbs.	38.50
17 F 80006	AM-FM Pushbutton	5x7" Oval	'68-'74 Toyota Corona, Corina, Celica, Corolla; '73-'74 MK II	6 lbs.	72.90
17 F 80147	Stereo FM-AM Pushbutton	No Speaker	'68-'74 Toyota Corona, Corina, Celica, Corolla; '73-'74 MK II	7 lbs.	99.95
17 F 80154	AM Pushbutton	5x7" Oval	'71-'74 Datsun 610	6 lbs.	42.90
17 F 80162	AM Pushbutton	5x7" Oval	'71-'74 Datsun 620, 1200	6 lbs.	42.90
17 F 80436	AM Pushbutton	5x7" Oval	'74-'75 Datsun B-210	7 lbs.	39.95
17 F 80410	AM Pushbutton	5x7" Oval	'74-'75 Datsun 710	7 lbs.	39.95
17 F 80170	AM-FM Pushbutton	5x7" Oval	'71-'74 Datsun 610	7 lbs.	74.95
17 F 80188	AM-FM Pushbutton	5x7" Oval	'71-'74 Datsun 620, 1200	7 lbs.	74.95
17 F 80402	AM-FM Pushbutton	5x7" Oval	'74-'75 Datsun B-210	7 lbs.	74.95
17 F 80444	AM-FM Pushbutton	5x7" Oval	'74-'75 Datsun 710	7 lbs.	74.95
17 F 80394	AM-FM Pushbutton	5x7" Oval	'73 Datsun 240Z, '74 Datsun 260Z	7 lbs.	74.95
17 F 80451	Stereo FM-AM Pushbutton	Two 5" Round	'74-'75 Datsun B-210	8 lbs.	121.95
17 F 80469	Stereo FM-AM Pushbutton	Two 5" Round	'74-'75 Datsun 710	8 lbs.	121.95
17 F 80428	Stereo FM-AM Pushbutton	Two 5" Round	'73 Datsun 240Z, '74 Datsun 260Z	8 lbs.	121.95



### Model Lafayette FMC Solid-State FM Car Converter

**\$34<sup>95</sup>**

- Compact Enough to Mount in Glove Compartment of Most Cars
- Local/Distance Switch for Improved Reception on Weak Stations
- Converts AM Car Radio to AM/FM Car Radio

wheel-type tuning knob, lighted dial, local/distance switch. With antenna connector, mounting hardware, all cables. 4 1/8 x 1 1/8 x 4 3/4". For 12 VDC negative ground. Imp. 99 F 16214L Shpg. wt. 2 1/2 lbs. . . Net 34.95

### Antenna Specialists Stereo FM/FM Car Radio Antenna Booster



**\$19<sup>95</sup>**

- For Telescoping or Window Antennas
- Excellent value—really improves the reception of FM or stereo FM car radios. Fully self-contained — inserts in antenna line. 1 1/2 x 1 1/2 x 1/2", for 12 VDC negative ground radios. 13 dB ±1 gain. 11 F 38502 Shpg. wt. 1 lb. . . . . Net 19.95

Deluxe car converter hooks up easily to your present AM car radio for fine FM listening. Features .4 μV FM sensitivity, 3 IF stages for top performance, solid-state circuit with IC's. Has slide-rule dial, thumb-charge it with Your BankAmericard or Master Charge.

# "Best-Looking" Color and B/W TV's Are At Lafayette

**SANYO**

**SONY**

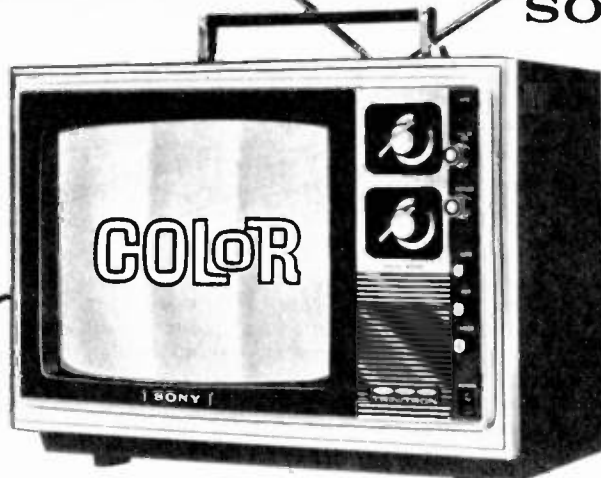

13" Picture Measured Diagonally	15" Picture Measured Diagonally	19" Picture Measured Diagonally
<b>\$299<sup>95</sup></b>	<b>\$329<sup>95</sup></b>	<b>\$359<sup>95</sup></b>
Model 31C35	Model 51C51R	Model 91C53/63

12" Picture Measured Diagonally	15" Picture Measured Diagonally	17" Picture Measured Diagonally
<b>\$359<sup>95</sup></b>	<b>\$429<sup>95</sup></b>	<b>\$489<sup>95</sup></b>
Model KV-1203	Model KV-1510	Model KV-1711
17" Picture Measured Diagonally	19" Picture Measured Diagonally	
<b>\$569<sup>95</sup></b>	<b>\$569<sup>95</sup></b>	
Model KV-1730R	Model KV-1920	

100% Solid-State Color TV's with These Outstanding Features: Instant-on Picture and Sound; Automatic Fine Tuning Systems, Up-Front Unicorn Speaker for excellent sound quality. Walnut-grain finish cabinets for good looks, too.

All feature 100% solid-state circuit, VHF and UHF Detent Tuning, famous Sony one-gun Trinitron picture tube for outstanding brightness and contrast. VHF dipole and UHF loop antennas. Cabinets with carry handles. All are for 120 VAC, 60 Hz.

**Model 31C35.** Compact color TV has "high-phosphor" picture tube, UHF and VHF detent tuning, earphone jack with earphone and 10-ft. cord for late-night or private listening. Built-in VHF and UHF antennas. 20 x 14½ x 16½". For 117 VAC, 60 Hz. Imported.  
17 F 59240WX Shpg. wt. 42 lbs. Net 299.95

**Model 51C51R.** Features "Trimatic" pushbutton automatic tuning for instant corrections of color and hue. "high-phosphor" picture tube, built-in antennas. Equipped for optional Sanyo Audicon remote-control tuning. 21 x 14½ x 17¼". For 117 VAC, 60 Hz. Imported.  
17 F 59257WX Shpg. wt. 50 lbs. Net 329.95

**Model 91C53/63.** Same features as above, with "high-phosphor" picture tube. 17 x 24 x 20½". For 117 VAC, 60 Hz.  
17 F 59265WX Shpg. wt. 68 lbs. Net 359.95

**Model KV-1203.** Charcoal metal cabinet/grey trim. 17½ x 13½ x 15½".  
17 F 33302WX Imported. Shpg. wt. 30 lbs. Net 359.95

**Model KV-1510.** Walnut-grained hardwood cabinet. 20½ x 14½ x 16½".  
17 F 33088WX Imported. Shpg. wt. 42 lbs. Net 429.95

**Model KV-1711.** Simulated walnut-grain low-profile cabinet. 21¾ x 16¼ x 15". 114° deflection angle picture tube.  
17 F 33310W Imported. Shpg. wt. 57 lbs. Net 489.95

**Model KV-1730R.** Rosewood grain hardwood cabinet, swivel base. Four-function remote control. 24¾ x 16¾ x 19¾".  
17 F 33187WX Imported. Shpg. wt. 62 lbs. Net 569.95

**Model KV-1920.** Walnut-grain wood cabinet, 114° deflection angle tube. No remote control. 26½ x 17½ x 16¼".  
17 F 33229WX Imported. Shpg. wt. 71 lbs. Net 569.95



**1 Sharp 2K39 12" Picture Measured Diagonally.** Has automatic gain and frequency control, glare-free tube, 4x3" oval speaker, slimline charcoal cabinet. 117 VAC, 60 Hz. 16½ x 11½ x 10¾".  
17 F 53243WX Imported. Shpg. wt. 21½ lbs. Net 89.95

**2 Hitachi P-03 12" Picture Measured Diagonally.** Features preset memory tuning, noise eliminator circuit, solid-state chassis, 3" round speaker. Slimline cabinet. 117 VAC, 60 Hz. 15 x 10½ x 11½".  
17 F 24418WX Imported. Shpg. wt. 20 lbs. Net 119.95

**3 JVC 3020 5" Picture Measured Diagonally.** "Teeny-Vision." Weighs just 6 lbs., operates on 9 "D" batteries (below) or AC. Take it anywhere. Solid-state circuit. 8¾ x 8¾ x 10". Imported.  
17 F 75030WX Shpg. wt. 7 lbs. Net 99.95    99 F 62564 Batts. Net ea. 19¢

**4 Sony TV-760 7" Picture Measured Diagonally.** Battery/AC operation, glare-free tube, VHF and UHF antennas, front-mounted 4" speaker. 8¾ x 9¾ x 12¾". Keyed AGC. Rugged case.  
17 F 33146WX Imported. Shpg. wt. 12 lbs. Net 129.95

**5 Sony TV-115. 11" Picture Measured Diagonally.** Battery/AC, front-mounted tuning, keyed AGC, black/chrome trim. 11¾ x 12½ x 12¾".  
17 F 33237WX Imported. Shpg. wt. 14 lbs. Net 149.95

**ACCESSORIES FOR SONY TV760 AND TV115**

17 F 32296 Rechargeable Batteries for Above. Shpg. wt. 7¾ lbs. Net 24.70  
17 F 32304 12 VDC Car Battery Cord. Neg. Gnd. Wt. 1½ lbs. Net 19.95  
17 F 32601 Car Window Antenna. Shpg. wt. 2¼ lbs. Net 29.95  
17 F 33096 Car Window Antenna Adapter. Shpg. wt. 8 oz. Net 4.95

# These Lafayette Radios Are "Just Plain" Fun!

**Authentically Styled 1930's AM/FM Radio  
with Modern Solid-State Circuit**

*A Fine Combination of the Old and the  
New! The Nostalgic 30's Style and  
Today's Latest Electronics!*

**Who Knows How Much You'll  
Love This Radio? "THE SHADOW" Knows!**

**\$39<sup>95</sup>**

A "period piece" that's perfect for any period. And with the "old-time" radio broadcasts now in many areas, you can enjoy the old days with real authenticity. Has vernier FM-AM tuning dial, AFC to prevent FM drift, wide-range speaker for good sound. Overall size, 11 x 12½ x 7¾". For 117 VAC, 60 Hz. Imported.

17 F 81087W Shpg. wt. 4 lbs. . . . . Net 39.95

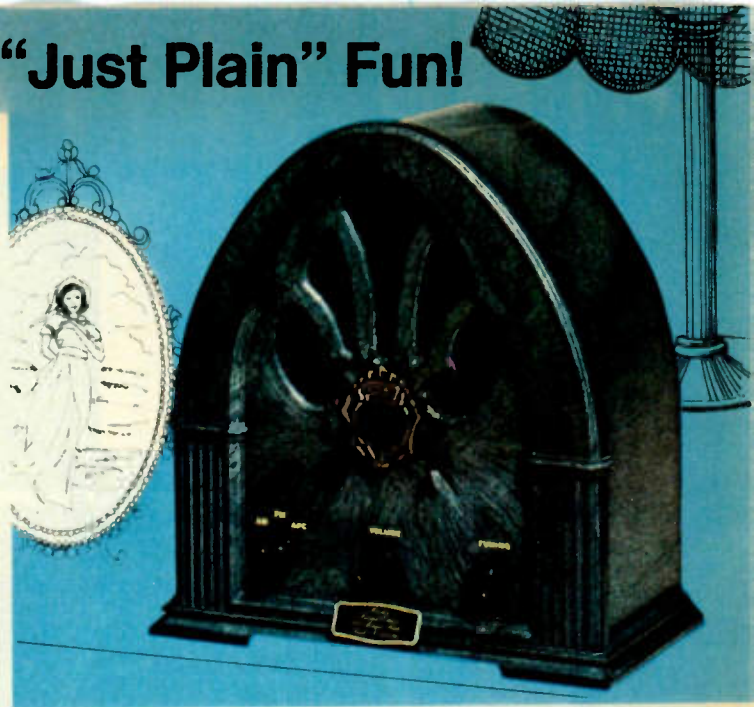

**NEW!**

**\$27<sup>95</sup>**

**Caribbean Cruiser  
AM Radio**



Ahoy, mates! Here's a desk, den or bedroom AM radio with the spirit of the sea—a sleek, masterfully styled replica of a Caribbean Cruiser with a solid-state AM radio built right in. Mounts on its own stand, has volume and tuning controls, 6-transistor circuit. Operates on a single inexpensive 9-volt battery, included. Approx. 3 x 11¼ x 8" high.

17 F 81111W Shpg. wt. 3 lbs. Imported. . . . . Net 27.95

**New! For the Ladies—  
3-in-1 Vanity AM Radio**

**NEW!**

**\$12<sup>95</sup>**



A gift she'll love because it's handy, practical and entertaining, too! A good-sounding solid-state AM radio is built right into the carved plastic base. There's a dispenser box for standard size facial tissues, and the clear plastic case is ideal as a photocube. Approx. 4¾" sq. x 5½" high, with radio/base, 7" high. Imported. Includes 9-volt battery.

17 F 81103W Shpg. wt. 2 lbs. . . . . Net 12.95

**\$29<sup>95</sup>**



**"Silver Ghost" AM Radio**  
"Museum" replica of the famous 1910 Rolls Royce. All-metal body, rubber wheels, chrome details. AM radio includes 9-volt battery. 9½" long. Imported. Wt. 4 lbs.  
17 F 81061L . . . . . Net 29.95  
Save Energy! Use the Lafayette Mail Order Blank

**\$12<sup>95</sup>**



**"Millionaire" AM Radio**  
U.S. dollar bill tops a stack of authentic looking currency—all encased in a block of clear plastic. Walnut-grain base. 7 x 2¼ x 3" with battery. Imported.  
17 F 81079L . . . . . 2 lbs. Net 12.95

**\$22<sup>95</sup>**

**"Phantom II" AM Radio**  
Famous 1931 Rolls Royce with AM radio built right in. Has all metal body, real rubber tires, plastic spokes. 10" long. Imported. Wt. 2½ lbs. With battery.  
17 F 81053L . . . . . Net 22.95

**\$8<sup>95</sup>**



**"Little John" AM Radio**  
Delightful little radio is a built-in toilet tissue dispenser, too! With 9-V battery and self-adhesive mounting strips. 6¼ x 9½ x 3" Imported.  
17 F 81046 . . . . . 3 lbs. . Net 8.95  
Lafayette Cat. No. 750 99

# Sound Value! 3 Compact Pieces—1 Compact Price!

Lafayette SR-10A Solid-State Modular  
AM/FM Stereo Receiver System

Only  
**\$79<sup>95</sup>** with connecting cables

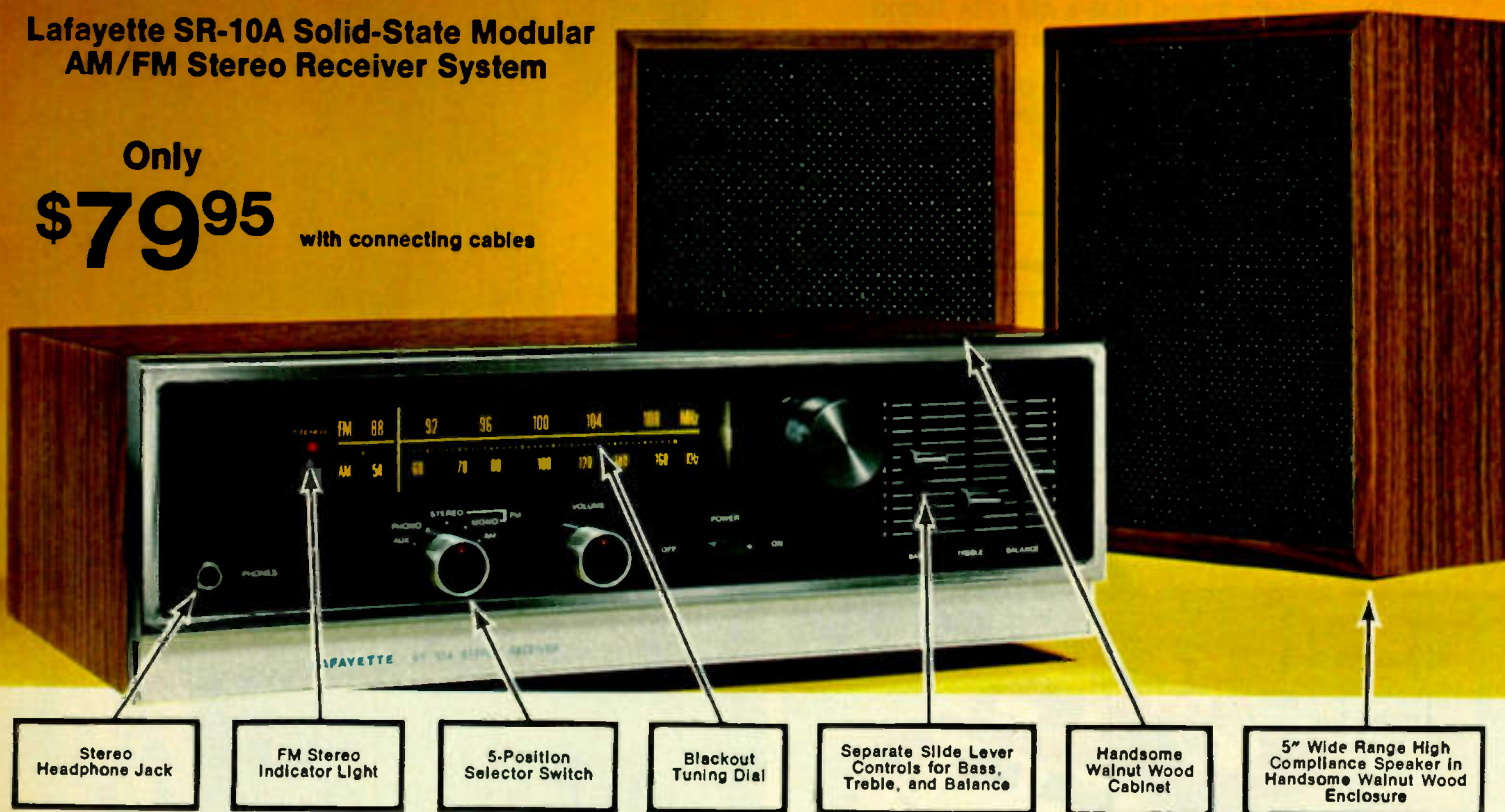

- Stereo Headphone Jack
- FM Stereo Indicator Light
- 5-Position Selector Switch
- Blackout Tuning Dial
- Separate Slide Lever Controls for Bass, Treble, and Balance
- Handsome Walnut Wood Cabinet
- 5" Wide Range High Compliance Speaker in Handsome Walnut Wood Enclosure

Only at Lafayette—this fine AM/FM stereo radio receiver and two matching speaker systems for under \$80! With all solid-state circuitry for dependable high quality performance, the receiver features a blackout and illuminated precision slide rule tuning dial and a special FM stereo sensing circuit for automatic mono/stereo switching. Built-in AFC (Automatic Frequency Control) for drift-free FM reception. Slide levers to control Bass, Treble and Balance. Outputs for a tape recorder and headphone, and an input for connecting a record changer or tape player are also provided. The handsome walnut wood encased receiver measures only 13 3/4" W x 9 1/4" D x 4 3/4" H. Each performance-matched speaker system contains a 5" wide-range speaker housed in a style-matched compact walnut wood enclosure—9 3/4" x 7 3/4" x 4 1/4" D. Two 8 ft. audio cables and connectors. 117 VAC. 60 Hz. 99 F 03162W Imported. Shpg. wt. 17 1/2 lbs. . . . . Net 79.95

### Even The Part You Won't See Has Good Looking Features

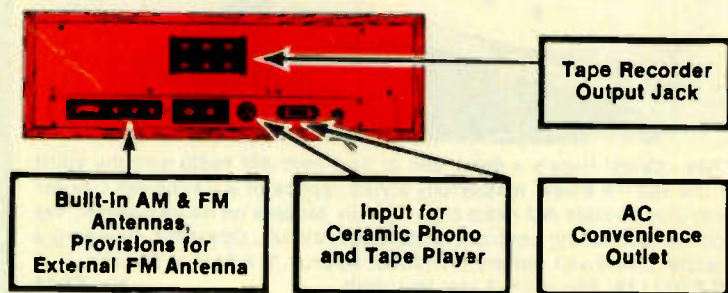

- Built-In AM & FM Antennas, Provisions for External FM Antenna
- Input for Ceramic Phono and Tape Player
- AC Convenience Outlet
- Tape Recorder Output Jack

## **\$59<sup>95</sup>** Deluxe Lafayette 3-Band Solid-State AM/FM/Weather Table Radio

Pushbutton Weather Reports



**Features** Tuneable FM/VHF Circuit for 24-Hour Monitoring of the U.S. Weather Bureau Radio Network System on 162.40 and 162.55 MHz.

- Tuned RF FM and 3 IF Stages • Telescopic FM-VHF Antenna
- Tape Recorder Output Jack • External Speaker Jack

This deluxe AM/FM table radio also tunes the U.S. Weather Bureau's forecasts and observations at the touch of a button. Its reliable all solid-state circuitry includes a tuned RF FM amplifier and 3 IF stages, as well as Automatic Frequency Control. The IC audio section and built-in 5" speaker provide full, rich tone. The front panel features an illuminated vertical slide rule AM/FM tuning dial and a convenient pushbutton for instant Weather Bureau reception. The rear panel has terminals for an external speaker or FM antenna, a tape recorder output jack, and a control for precise tuning to the Weather Bureau station in your area. (Check your local Weather Bureau for the local operating frequency.) AM and FM antennas are built-in, with a whip antenna for the Weather Band also provided. The walnut-vinyl finish wood cabinet measures 15W x 8H x 5 1/2"D. For 117 VAC. 60 Hz. 99 F 35651W Imported. Shpg. wt. 10 3/4 lbs. . . . . Net 59.95

# Fine Sound Attractively Styled... Brand Name Table Radios

## 1 Panasonic RE-6192 FM/AM with Circular Dial

Good-looking and good-sounding table radio is just right for den, rec room, kitchen, etc. Compact design so it takes up little space on table or shelf, 3" dynamic speaker for good sound. Offers sensitive reception from its built-in AM and FM antennas, has pushbutton band selector and on-off power control. 9W x 5 3/4" H x 3 3/8" D. For 117 VAC, 60 Hz. Imported.  
17 F 31272 Shpg. wt. 2 1/2 lbs. . . . . Net 24.88

**PANASONIC**  
**\$24<sup>88</sup>**



## 2 Panasonic RE-6283 FM/AM with Slide-Rule Dial

Deluxe FM/AM table radio features a wide-range 4" speaker for rich tonal quality, easy-to-see, extra-wide slide-rule tuning dial, all solid-state circuit with built-in FM and AM antennas for good reception. Tone control. Handsome antique white with black trim. 11 1/2" W x 5 3/8" H x 4 1/4" D. For 117 VAC, 60 Hz. Imported.  
17 F 34136W Shpg. wt. 3 lbs. . . . . Net 39.95

**PANASONIC**  
**\$39<sup>95</sup>**



## 3 Sony TFM-9430 FM/AM Table Radio with AFC Circuit

Famous-for-quality Sony table radio features pushbutton AFC for drift-free FM—simply tune your favorite station, push the AFC button and the radio is "locked in" for no-drift, steady reception. Has slide-rule dial, 4" speaker, walnut-finish cabinet with pedestal base. Built-in FM antenna, external antenna provision. 11 1/2" W x 7 1/2" H x 4 3/8" D. For 117 VAC, 60 Hz. Imported.  
17 F 33112W Shpg. wt. 4 1/2 lbs. . . . . Net 39.95

**SONY**  
**\$39<sup>95</sup>**



## 4 Sony TFM-9450 FM/AM with 6 1/2" Speaker

Sony's BEST table radio offers component-quality hi-fi sound from its 6 1/2" FULL-RANGE dynamic speaker. Has AFC for "no-drift" FM, continuous tone control, lighted slide-rule tuning, built-in AM and FM antennas, external antenna provision. Loudness control for natural, low-volume sound. The resonant walnut-grain finish wood cabinet provides fine sound, great looks, too. 14 3/8" W x 8 3/8" H x 5 7/8" D. For 117 VAC, 60 Hz. Imported.  
17 F 33252W Shpg. wt. 8 lbs. . . . . Net 59.95

**SONY**  
**\$59<sup>95</sup>**



## Portable or Table FM Radio with TV Sound Monitor Built In

Great way to catch TV news, "color commentary" on football games, etc., even when no TV is present. Elegant solid-state "sound cube" receives regular FM, sound portion of all VHF TV channels (2-13). Has 3" dynamic speaker, telescoping VHF/FM antenna, volume and tone controls, circular tuning dial. With 4 "C" cells, earphone, pillow speaker jack. White plastic cabinet. 5W x 5H x 5"D. Imported.  
17 F 82002 Shpg. wt. 3 lbs. . . . . Net 24.95

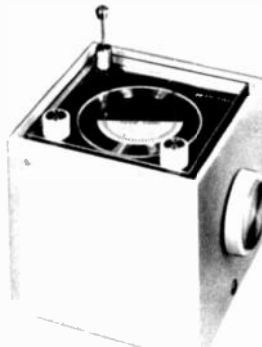

**\$24<sup>95</sup>**

## 5 AM Table Radio with "Instant-On" Circuit

Nicely-styled table radio is a great gift for kids, a handy addition to any "silent" area of the house or garage. Solid-state circuit, super-heterodyne receiver that really pulls in signals, big 3" speaker. Built-in ferrite bar antenna, ivory plastic cabinet. 8 1/4" W x 4 1/2" H x 2 1/2" D. For 117 VAC, 60 Hz. Imported.  
17 F 69447 Shpg. wt. 2 lbs. . . . . Net 9.95

**\$9<sup>95</sup>**

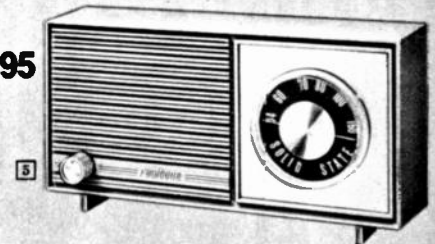

## 6 Stylish FM/AM with Instant-On Circuit

Great style and sound with off-white, high-impact plastic cabinet, front speaker "perforated" grille. Has 3" speaker, precision FM-AM tuning with spun aluminum knobs, front-mounted AM/FM switch. Built-in FM line cord antenna. 11W x 4H x 5 1/2"D. For 117 VAC, 60 Hz. Imported.  
17 F 84503 Shpg. wt. 3 lbs. . . . . Net 19.95

**NEW!**  
**\$19<sup>95</sup>**

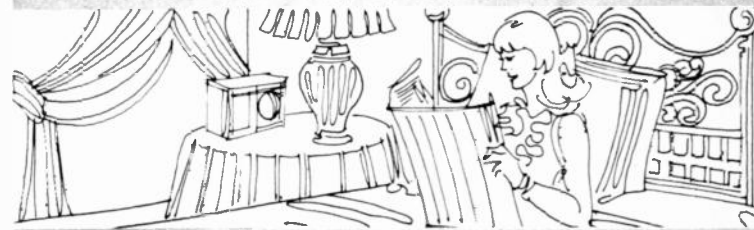

# Lafayette AM/FM Clock Radios Make Mornings Musical —



Made In U.S.A.

**NEW! \$34<sup>95</sup>**

## Lafayette Full-Feature AM/FM Digital Clock Radio

- Up to 60-Minute Sleep/Off Switch
- 10-Minute "Doze" Button
- General-Time Back-Lighted Clock
- Wake to Music or Buzzer Alarm

It's fine entertainment, it's practical, too! Sleek, low-profile clock radio has big, easy-to-read digits, lever-type 0-60-minute sleep switch, thumbwheel alarm and time-set controls. The 10-minute drowse button shuts off alarm for 10 minutes, lets you grab a few "extra winks," the slide-type volume control is easy to use while reclining. Has AM-FM toggle switch, AFC for "no-drift" FM, 3" dynamic speaker. Low-profile walnut-grained cabinet, accented with off-white and black front. 11x4x5½". 117 VAC, 60 Hz. 17 F 02687W Shpg. wt. 4 lbs. . . . Net 34.95



**\$44<sup>95</sup>**

## Stylish Lafayette Solid-State Digital FM-AM Clock Radio

- 24-Hour Clock Shows AM and PM
- Easy-Tune Slide-Rule FM/AM Dial
- 60-Minute Sleep Switch/Auto Shutoff

Top-performing AM/FM clock radio has the style and convenience features that make it a pleasure to own and play. The 3½" speaker delivers fine tonal quality, built-in AFC prevents drift, built-in AM and FM antennas pull in stations all over the dial. Fingertip on-off, drowse and FM-AM buttons, rotary tuning and time-set controls. Polystyrene walnut-grain cabinet with ebony front panel, jacks for external earphone or Pillow speaker. Music alarm only. 11¾ x 4 x 6". For 117 VAC, 60 Hz. Imported. 17 F 02372W Shpg. wt. 5 lbs. . . . Net 44.95



**These Fine-Performing Clock Radios Lull You to Sleep with Your Favorite AM-FM Programs—Wake You Up to Important News, Weather and Morning Information!**



Made In U.S.A.

**NEW! \$39<sup>95</sup>**

## Lafayette Electro-Digit AM/FM Digital Clock Radio

- "Computer-Style" Highlighted Digits
- Space-Age Styling with Pedestal Base
- 3-Hour Sleep Switch

Here's great style and sound in a highly useful and decorative clock radio. Has a modern design with pedestal base and low-profile cabinet, precision Telechron clock movement, 1" highlighted computer readout digits that can be read from most anywhere in the room. Large, easy-to-read rotary tuning dial, up to 3 hours sleep switch, good-sounding 3" speaker. Music or buzzer alarm. Built-in line cord FM, AM ferrite bar antennas. 11½x4¼x5". For 117 VAC, 60 Hz. 17 F 02695W Shpg. wt. 4 lbs. . . . Net 39.95

# Pick Your Performance...Pick Your Price!

## Lafayette AM/FM Digital with Built-in FM/VHF Weather Band

- Lighted Slide-Rule Tuning Dial
- Telescoping VHF/FM Antenna
- 90-Minute Sleep Timer with Shutoff
- Wide-Response 3½" Speaker

Top-performing AM/FM clock radio also lets you know "weather to go!" Has an "instant weather" button that tunes you in to U.S. Gov't. continuous Weathercasts on 162.40 or 162.55 MHz (check your area for exact frequencies), separate 24-hour timer for waking to music. Has built-in AFC, AM and FM antennas, easy-to-read clock digits. Walnut-vinyl wood cabinet, black/silver front panel. With earphone. 12½ x 4¼ x 6½". For 117 VAC, 60 Hz. Imported. 99 F 35388W Shpg. wt. 7 lbs. . . . Net 49.95



**\$49<sup>95</sup>**

## Lafayette Has the Best Name-Brand Clock Radios Too



**\$16<sup>95</sup>**

### 3211 AM Clock Radio

Decorator-design AM clock radio wakes you to music or alarm, has sensitive AM reception. Walnut-grain plastic cabinet, big 3" speaker, solid-state circuit. For 117 VAC, 60 Hz. 8¾ x 4¼ x 3". Imported. 17 F 69454 Shpg. wt. 2¾ lbs. . . . Net 16.95

### 1 RC-6354 FM/AM/Weather

60-minute sleep timer with auto shutoff, lighted radio dial and clock face, 10-minute doze button. Separate Weather On-Off switch for U.S. Gov't. Weathercasts, big 3½" speaker, 2-step tone control, more. Wood-grain cabinet, 13W x 4¾H x 6½"D. For 117 VAC, 60 Hz. Imported. 17 F 34235W Shpg. wt. 6 lbs. . . . Net 64.95

### 2 TFMC660W FM/AM Digimatic

Sleekly-styled "Litetime" clock radio shows the day, date and time (hours, minutes and seconds) in an easy-to-read "black-light" digital display. Has 90-minute timer with shutoff, slide-rule FM-AM dial, volume and tone controls, adjustable music/buzzer level, 24-hour alarm. Large 4" speaker, AFC circuit, more. 15¾ x 4¾ x 7½". For 117 VAC, 60 Hz. Imported. 17 F 33278W Shpg. wt. 6 lbs. . . . Net 69.95

### 3 TRC-340 Digimatic AM

Has 60-minute sleep timer, hour-minute-second digital readout, 2½" speaker. Has music or buzzer alarm, drum-type tuning dial, more. White cabinet. 6½ x 5½ x 5½". For 117 VAC, 60 Hz. Imported. 17 F 33260 Shpg. wt. 3 lbs. . . . Net 24.95

### 4 RC-7254 FM/AM "Jumbo" Digital

Walnut-grain, has extra-large numerals for easy reading from all angles, rotary FM-AM dial, music or chirp alarm. 60-minute timer, 10-minute "snooze" switch, 3½" speaker, external FM antenna terminals. 13½W x 5¾Hx5½"D. For 117 VAC, 60 Hz. Imported. 17 F 34243W Shpg. wt. 4 lbs. . . . Net 79.95

### NEW! 1 Panasonic RC-6354

**\$64<sup>95</sup>**



### NEW! 2 Sony TFMC660W

**\$69<sup>95</sup>**



### NEW!

### 3 Sony TRC-340

**\$24<sup>95</sup>**



### NEW!

### 4 Panasonic RC-7254

**\$79<sup>95</sup>**

# See Lafayette for Radios That Are Really Novel!

**\$4<sup>95</sup>**



**NEW!**

**\$11<sup>95</sup>**



**NEW!**



**\$12<sup>95</sup>**



**\$85<sup>00</sup>**  
**NEW!**

**NEW!**



**\$19<sup>88</sup>**



**NEW!** **\$29<sup>95</sup>**

## 1 "Military-Style" AM Pocket Radio

Boasts the new, clean and streamlined "military style" with a precision rotary tuning dial, front-mounted speaker for good sound, an instant-on solid-state circuit that gives you sound when you want it. Rugged, high-impact, plastic cabinet takes day-in, day-out use. Includes 9-volt battery, private listening earphone. 2 3/4 x 4 1/4 x 1 1/2". Imported. 17 F 02711L Shpg. wt. 1 lb. . . . . Net 4.95

## 4 Headphone Stereo FM/FM Radlo Enjoy Hands-Free Stereo FM Listening!

Panasonic RF-40. One of the lowest-priced ways we know of to get great stereo sound and travelling convenience! Operates on 3 "AA" batteries (included!), brings you full-fidelity stereo sound from FM stereo broadcasts, mono FM listening, too. Has two 2 1/4" speakers, balance control; power, stereo-mono switches, padded earcushions and headband. Use as headphones with your present stereo system! With headphone cord, whip antenna. Imported. 17 F 34250L Shpg. wt. 4 lbs. . . . . Net 85.00

## 2 Lafayette AM/FM Pocket Portable

Good-looking and good-sounding personal portable brings you your favorite AM and FM programs anywhere you go. Has easy-tune slide-rule dial, 2 1/2" dynamic speaker, built-in ferrite AM and telescoping FM antennas to really pull in signals. Black with wood-grain trim, 3 x 4 3/4 x 1 1/2". With battery, strap, earphone. Imported. 17 F 02562L Shpg. wt. 1 1/2 lbs. . . . . Net 11.95  
99 F 60212 Extra 9-V Battery . . . . . Net 39¢

## 5 Panasonic RF-508 AM/FM Pocket Radio

Take-along entertainer that's stylish and sophisticated. Has built-in AM and FM antennas for station-pulling power, easy-to-see circular tuning dial. The 2 1/4" speaker provides good sound, the high-impact case takes plenty of day-in, day-out use. Earphone/ext. speaker jack, volume control. With 9-V battery, carry strap. Imported. 17 F 40286L Shpg. wt. 1 lb. . . . . Net 19.88

## 3 New! Hav-A-Ball AM Radio

The radio with the built-in light show! Listen to your favorite AM radio programs, watch the fascinating lights "dance" to the sounds on the radio. Has volume and tuning controls, brightly-colored, high-impact plastic cabinet. Solid-state circuit, 2 1/4" dynamic speaker for good sound. With battery, bright matching vinyl carrying strap. 4 1/2 x 4 1/2 x 4 1/2". Imported. 17 F 81129 Shpg. wt. 1 1/2 lbs. . . . . Net 12.95

## 6 Sony TFM-3950W AM/FM Weather Radio

Pocketable, "personal" and PRACTICAL, too! Tunes your favorite FM and AM radio programs, 24-hour Gov't weathercasts on 161.0 to 163.3 MHz VHF (check your local area). Has telescoping antenna for weather and FM, built-in ferrite bar for AM, slide-rule tuning dial, more. Uses 9-V battery, order below. 3 3/8 x 3 3/8 x 1 3/4". Imported. 17 F 33286L Shpg. wt. 1 lb. . . . . Net 29.95  
99 F 60212 9-Volt Battery . . . . . Net ea. 39¢

No Money Down—See Page 4 for Lafayette's Easy-Credit Plan (Minimum Order \$30.00)



# Listen To Lafayette AM/FM Battery/AC Portables



1  
\$22<sup>95</sup>

*These Two Radios  
Are Ready to Use—  
All Include Batteries,  
117 VAC, 60 Hz Line  
Cord, and Private  
Listening Earphones.*



2  
\$27<sup>95</sup>

## 1 Upright-Style Solid-State FM-AM Portable

Dramatically-styled, well-designed, the AM/FM portable for people who want good sound at a budget price. Has instant-on solid-state circuit, built-in AFC for drift-free FM reception, easy-to-tune sliderule dial. The sliderule volume control provides visual indication of volume level, the telescoping FM and built-in AM antennas really pick up signals. 3½" dynamic speaker. 5¾ x 9 x 2¾". Imported. 17 F 02554L Shpg. wt. 4 lbs. Net 22.95  
99 F 62572 Extra "C" Cells. Use 4 Net ea. 19¢

## 2 Full-Size Solid-State FM-AM Portable

As good a portable as you'll find at this price, because it offers wide-range sound and features like a full-size, sliderule tuning dial and logging scale for complete tuning accuracy. Has instant-on solid-state circuit, 3½" speaker for excellent sound quality, continuous tone control, telescoping FM and built-in AM antennas. Good-looking black padded cabinet with silver trim. 10¼ x 6¼ x 3¼". Imported. 17 F 02349L Shpg. wt. 5 lbs. Net 27.95  
99 F 62572 Extra "C" Cells. Use 4 Net ea. 19¢

## New Military Look!



3  
\$19<sup>95</sup>

*With Action-Ready  
Shoulder Strap*

## 3 New! Lafayette "Military-Style" FM-AM Portable Radio

- Clean, Sleek, Modern—The Very Latest Look
- Battery or 117 VAC, 60 Hz Operation
- Precise Rotating Tuning Dial with Fixed Pointer
- Rugged, High-Impact Case for Use Anywhere
- Includes AC Line Cord, Carry Strap, Earphone

Fine-sounding, FULL-SIZE FM-AM portable features the latest look for '75. It's clean, modular look gives a suggestion of the advanced solid-state circuit inside. Has high-impact, gray, plastic case with rivet-type construction, positive action toggle switches for selection of AC or DC (battery) power and FM or AM, full telescoping antenna to really pull in FM stations, built-in AM antenna, too. The circular "spiral-like" speaker grille lets the full sound through, gives the unit an appealing modern look. The dial scale rotates with a fixed pointer station indicator for absolute "right-on" tuning. Includes a wide, go-anywhere shoulder strap, 117 VAC, 60 Hz line cord, and private-listening earphone. 6½ x 9 x 3". Imported.

17 F 02703W Shpg. wt. 4 lbs. Net 19.95  
99 F 62572 "C" Cells. 4 required Net ea. 19¢

# Famous-Name AM/FM Portables

With names as reliable as Sanyo, Panasonic, Sony, and Hitachi, you know you're going to get top quality performance and dependable long-lasting service! These outstanding portables can go anywhere you go . . . to brighten up any get-together with the sound of rich, happy music!



1 \$29<sup>95</sup>



2 \$39<sup>95</sup>

**SANYO**

**SONY**



**NEW**

3 \$44<sup>95</sup>



4 \$79<sup>95</sup>

**HITACHI**



5 \$49<sup>95</sup>

**Panasonic**



6 \$59<sup>95</sup>

## 1 Sanyo Stereocast RP-5000 AM/FM Portable

Exclusive "geometric tuning" gives you two tuning bars for easy AM/FM tuning. Features AFC on FM, fine unicone speaker, and lets you enjoy stereo FM programs when you add an optional Stereocast adapter and headphones! Less batteries. 7¼ x 2 x 3¾". Imported.

17 F 59158L Shpg. wt. 2 lbs. . . . Net 29.95

Stereocast Adapter.  
17 F 59075L Shpg. wt. 1 lb. . . . Net 11.95

"AA" Batteries (4 required).  
99 F 62580 Imported . . . . . Net ea. .14

## 2 Sanyo RP-7410 Stereocast Weather-Matic AM/FM Portable

Tunes AM/FM PLUS official U.S. Weather Bureau forecasts on 162.55 MHz. Advanced design Unicone speaker and tone control. Plug in optional Stereocast adapter and headphones for FM stereo. Runs on batteries (order below) or 117 VAC, 60 Hz. Earphone included. 9½ x 5¾ x 2¼". Imported.

17 F 59059L Shpg. wt. 3 lbs. . . . Net 39.95

Stereocast Adapter.  
17 F 59075L Shpg. wt. 1 lb. . . . Net 11.95

"C" Batteries (4 required).  
99 F 62572 Imported . . . . . Net ea. .19

## 3 Sony 7250W Battery/AC FM/AM Portable with High Sensitivity

Versatile take-along entertainer really pulls in the stations! Features easy slide-rule tuning with LED indicators, big 4" dynamic speaker, tone control and AFC. Good-looking, rugged high-impact case with carrying handle. Solid-state circuit. With 4 "C" batteries, earphone, 117 VAC, 60 Hz line cord. 10¼ x 7½ x 3¾". Imported.

17 F 33249L Shpg. wt. 4 lbs. . . . Net 44.95

## 4 Sony MR-9100W Battery/AC Stereo FM-AM Portable

Three self-contained 4x2¾" speakers deliver stereo with full separation from an all-in-one radio that's a delight to own and operate. Has switchable AFC, continuous tone control, FM stereo light, ceramic filters for high selectivity. Operates on 4 "D" cells (included), or 117 VAC, 60 Hz. 10 x 6¼ x 4¼". Imported.

17 F 33120W Shpg. wt. 5½ lbs. . Net 79.95

## 5 Hitachi KH-1047 Battery/AC FM/AM/Weather Portable

Deluxe portable has slide-lever volume and tone controls, easy-to-read slide-rule tuning dial, separate band that tunes U.S. Gov't weather reports on 162.55 MHz (now in most areas) at the push of a button. Has AFC switch, built-in FM/WB rod antenna, AM ferrite core antenna, dial light button for easy tuning even in the dark. 9 x 4½ x 2¾". Operates on 4 "C" cells (included!) or 117 VAC, 60 Hz. Imported.

17 F 24392L Shpg. wt. 4 lbs. . . . Net 49.95

## 6 Panasonic RF-900 Battery/AC AM/FM Portable with Tuning Meter

Nice style, nice price and features for really great sound. Two-step bass boost and continuous treble controls, big 4" speaker, AFC circuit for drift-free FM, and built-in AM and FM antennas bring you fine AM-FM listening. Midnight black cabinet with silver trim. Operates on 4 "C" cells (included), 117 VAC, 60 Hz. 9¼ x 7 x 2¾". Imported.

17 F 31231L Shpg. wt. 4 lbs. . . . Net 59.95

# Multibands With More-For-The-Money Quality



**Lafayette Battery/AC  
4-Band Radio**

**H** Police, Fire,  
**E** Weather, Aircraft  
**A** and All AM and  
**R** FM Broadcasts!

**Only \$34<sup>95</sup>**  
with earphone  
and batteries

A portable radio that really lets you know what's happening! Listen to police and fire calls (High-Band, 145 to 174 MHz), U.S. Weather Bureau forecasts (162.55 MHz), aircraft in flight (108 to 136 MHz), as well as your favorite AM and FM broadcasts. Features slide lever controls, slide rule tuning dial with logging scale, AFC on FM, telescopic antenna, and a 3½" wide-range speaker. Operates on 4 "C" batteries (included) or 117 VAC. Padded cabinet: 9½ x 6½ x 3½". Imported. 17 F 02638W Shpg. wt., 4½ lbs. . . . . Net 34.95  
99 F 62572 Extra "C" Cells (4 req.). Imported. . . . . Net ea. .19



**Instant FM/VHF  
Solid-State  
Weather Radio**

**Only \$12<sup>95</sup>**  
with batteries

**Tunes Every U.S. Weather Bureau  
Station At The Touch Of A Button!**

One of the most useful radlos you can own! Get 24 hour continuous weather reports on 162.55 MHz or 162.40 MHz at the instant touch of a button! (Check your local Weather Bureau for availability and operating frequency in your area.) Solid-state radio features separate volume and fine tuning controls, and a telescoping FM/VHF antenna. Completely portable, it operates on one inexpensive 9 volt battery (included), and is housed in a sturdy, lightweight plastic cabinet. Size: 4½ D x 3¾ H x 3½ "W. 17 F 81020 Shpg. wt., 2 lbs. Imported. . . . . Net 12.95

## Our Top-Quality "Guardian 6600" AM/FM/LW-Police-Fire-Weather-Marine-Aircraft Portable Radio!

- TUNES** 1 LW: 180-380 kHz Beacon      3 MB: 1.6-4.0 MHz Marine  
2 AM: 540-1600 kHz                      4 FM: 88-108 MHz  
6    5 AIR: 108-136 MHz AM/VHF  
**BANDS** 6 POLICE 147-174 MHz FM/VHF High Band Public Service

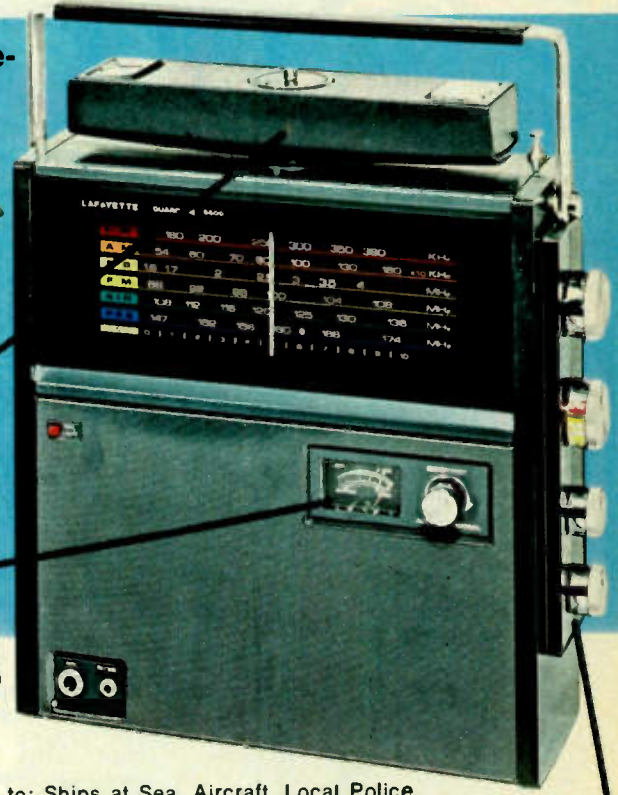

### Our Pocket "Guardian Micro 2" Police-Fire-Weather-AM Radio



**\$14<sup>95</sup>**  
with  
battery &  
earphone

**Tunes  
High Band  
147-176  
MHz FM/VHF & AM**

A powerful solid-state portable that keeps you constantly informed! With ferrite AM, telescopic VHF antennas. 4½ x 2¾ x 1¾". Imported. 99 F 35354L Wt. 1 lb. . . . Net 14.95  
99 F 60212 Extra 9V Bat. .Net .39

**Radio Direction Finder  
180° Rotatable Ferrite  
Loopstick Antenna for  
LW, AM, and MB Re-  
ception PLUS Direction  
Finding on these Bands.**

**Signal Strength Tun-  
ing Meter/Battery  
Condition Meter.**

**Only \$99<sup>95</sup>**  
with earphone  
and batteries

Be where the action is! Listen to: Ships at Sea, Aircraft, Local Police, Fire, and U.S. Weather Forecasts, and Standard AM and FM broadcasts. Individually tuned circuits provide extra sharp reception on each band. With batteries and AC line cord for portable or home use. Dependable solid-state circuitry, Automatic Gain Control, precision slide rule dial with logging scale, telescoping whip antenna, and a big 4" speaker. Size: 11½ H x 10½ W x 3¾ "D. Imported. 99 F 35586W Shpg. wt., 4½ lbs. . . . . Net 99.95  
99 F 62572 Extra "C" Cells (4 req.). Imported. 4 oz. . . . . Net ea. .19

**Adjustable  
Squelch  
Control**

# Lafayette "GUARDIAN" Multiband Portables For Instant Information & Entertainment!



## Lafayette "Guardian 5500" 5-Band AM/FM/ SW/FM-VHF Portable

with 2 Police Bands

ONLY  
**\$79<sup>95</sup>**  
with batteries,  
AC line cord  
& earphone

**TUNES**  
**5**  
**BANDS**

- 1 High Band FM/VHF: 147-174 MHz
- 2 Low Band FM/VHF: 30-50 MHz
- 3 International Shortwave 4-12 MHz
- 4 Standard AM: 540-1600 kHz
- 5 Standard FM: 88-108 MHz

- Two Separate Front-End RF Tuning Sections for Both High and Low Police FM-VHF Bands
- Variable Squelch Control While Tuning FM-VHF Bands—Can Be Used For FM Muting As Well

Outstanding quality, at a price that belies the performance! Listen to Police, Fire, Civil Defense, 2-way Business, and U.S. Weather forecasts (162.55 MHz) on BOTH THE HIGH (147-174 MHz) and LOW (30-50 MHz) FM-VHF bands. Tuning international Shortwave programs is as easy as tuning AM/FM stations. Compelling features include signal strength tuning meter, battery condition meter, dial light, and much more. Operates on 4 "C" batteries (included) or 117 VAC. Complete with earphone and AC adaptor. 10½ x 10¾ x 3¾". Imported.  
99 F 35453W Shpg. wt. 5½ lbs. . . . . Net 79.95  
99 P 62572 Extra "C" Batteries (4 req.) . . . . . Net ea. .19

## Lafayette "Guardian 7700" 6-Band AM/ FM SW/FM-UHF Battery/AC Portable

ONLY  
**\$109<sup>95</sup>**  
with batteries,  
AC line cord  
& earphone

**3 BIG POLICE BANDS**  
FM/VHF High 147-174 MHz  
FM/VHF Low 30-50 MHz  
FM/UHF Ultra-High 450-470 MHz

**plus:**

FM Broadcast: 88-108 MHz  
AM Broadcast: 54-160 KHz  
International Shortwave: 4-12 MHz

- Signal Strength Tuning and Battery Condition Meter
- Covers All 3 Public Service Bands
- Adjustable Squelch Control
- Battery or AC Operation
- Instant-On Solid-State Circuit
- 2 Telescoping Antennas
- Pushbutton Dial Light
- Continuous Tone Control

Incomparable quality! This is our best solid-state multiband portable, providing you with one of the industry's most advanced methods of monitoring the exciting UHF and VHF signals of Police, Fire, U.S. Weather (162.55 MHz), Civil Defense, Forestry, and Conservation. The Guardian 7700 tunes 3 POLICE BANDS—ULTRA HIGH FM/UHF 450 to 470 MHz, HIGH FM/VHF 147 to 174 MHz, and LOW FM/VHF 30 to 50 MHz. You can also receive international shortwave and, of course, AM/FM broadcasts. The dynamic wide-range speaker gives superb tonal quality on all bands. Operates on 4 "C" batteries (included) or on 117 VAC. Complete with output jacks for use with headphone or external speaker. 10½ x 3¾ x 3½". Imported.

99 F 35719W Shpg. wt. 5½ lbs. . . . . Net 109.95  
99 F 62572 Extra "C" Batteries (4 req.) . . . . . Net ea. .19



# NEW! Brand-Name Multi-Band Portable Radios

*These Versatile Radios Bring You Fascinating Entertainment, Important Info, Too!*



**\$59<sup>95</sup>**

**Panasonic FM-AM-VHF Hi Portable**  
 • Battery or AC Operation

**Model RF-1060/Tech 400.** Nicely styled radio brings you important police and fire calls on the 152-174 MHz VHF band, your favorite music, news or sports on FM and AM, too. Has AFC switch for drift-free FM, squelch, built-in antennas, earphone/ext. speaker jack, more. With batteries, 117 VAC, 60 Hz line cord, earphone. 9 3/4" x 7 1/2" x 2 3/4". Imported.  
 17 F 31439L Shpg. wt. 4 lbs. . . . . Net **59.95**



**\$89<sup>95</sup>**

**Panasonic FM-AM-VHF Hi and Lo**  
 • Tunes High and Low Police Bands  
 • Battery or AC Operation

**Model RF-940/Tech 700.** Gives you the BIG STORY of local police, fire and weather on both the 30-50 and 152-174 MHz police/public service bands, AM and FM, too. Has AFC switch, dial lights, 4" speaker, jacks for earphone/ext. speaker. 10 1/2" x 6 1/2" x 2 1/2". With batteries, 117 VAC, 60 Hz line cord, earphone. Imported.  
 17 F 34276L Shpg. wt. 4 lbs. . . . . Net **89.95**



**\$99<sup>95</sup>**

**Sony AM-FM-VHF Hi Police Band**  
 • Highly Selective IC and FET Circuit

**Model ICF5500W.** Famous Sony quality, sleek style and information galore are yours with this deluxe 3-band portable radio. Covers AM-FM-147-174 MHz Hi PSB band. Built-to-last for campers, outdoorsmen, etc. Has dial light for night use, "moving film" tuning dial, switchable AFC, telescoping antenna. 6 1/2" x 8" x 2 1/2". With batteries, shoulder strap and earphone. Imported.  
 17 F 33138L Shpg. wt. 4 lbs. . . . . Net **99.95**

**Hitachi Battery/AC 8-Band "Worldwide" Portable**

- Instant Pushbutton Band Selection
- Dual Telescoping Antennas
- Tuning Meter and Fine-Tune Control
- Slide-Type Volume and Tone Controls

Tunes AM, FM, 30-50 MHz VHF-Low, 152-174 VHF-Hi Police, 108-136 MHz Aircraft, 1.5-4.5 MHz Marine, 4.5-12 MHz SW1, 11.5-22 MHz SW2.

**Model KH-3100.** "Full-service" radio brings you local happenings on both VHF police bands, weather and aviation conditions on marine and aircraft bands, foreign news and views on 2 Shortwave bands, AM and FM, too. Has squelch control, lighted band indicator, pushbutton AFC, world-time-map, BIG up-front speaker, lots more. Leather case with fold-away carrying handle, 11 1/2" x 9 1/2" x 3 1/2". With earphone, batteries, 117 VAC, 60 Hz line cord. Imported.  
 17 F 24400W Shpg. wt. 12 lbs. . . . . Net **149.95**

**\$149<sup>95</sup>**

**Full Local Coverage, 2 International SW Bands, Too!**



**Nordmende Battery/AC "Galaxy" 9-Band Shortwave Radio**

- Woofer and Tweeter for Hi-Fi Sound
- Slide-Type Variable Tone Control
- Full-Band Slide-Rule Tuning Dial
- Pushbutton Band Selectors

Tunes AM, FM, 145-420 kHz LW, 5.90-6.28 MHz (49M), 6.96-7.40 MHz (41M), 9.35-9.90 MHz (31M), 11.50-12.16 MHz (25M), 14.85-15.70 MHz (19M), 17.38-18.35 MHz (16M).

**Model 6606.** An electronic "globe-hopper" that tunes you in to fascinating Shortwave broadcasts from all over the world, ships at sea, local AM and FM, too. Has dual conversion circuit for top performance, two tuning knobs for pre-setting FM or AM/SW stations, powerful amplifier circuit, telescoping antenna. Walnut-grain cabinet with chrome/black trim. 15 1/2" x 7 3/4" x 3". For 6 "C" cells (order below) 117 VAC, 60 Hz.  
 17 F 72235WX Imported. Shpg. wt. 8 1/2 lbs. . . . . Net **169.95**

**99 F 62572 "C" Batteries.** 6 req'd. Imported . . . . . Net ea. **19¢**

**\$169<sup>95</sup>**



No Money Down—See Page 4 for Lafayette's Easy-Credit Plan (Minimum Order \$30.00)

# Solid-Body Electric Guitars—"Hot Rockers"



"Pick Up" Your Performance with These Easy-Play Guitars—They Look Good, They Sound Great, and They're Priced Right



## 1 Two-Pickup with Tremolo

The most popular guitar for day-in, day-out performance! Adjustable pickups, adjustable chrome bridge, chromed compression tremolo. Fast-action, 22-fret rosewood fingerboard. Volume and tone controls, two standby switches, decorated pick guard and acrylic high-lacquer sunburst finish body. 39"L x 12½"W. Imported.

13 F 24821W Shpg. wt. 10 lbs. . . . . Net 59.95  
13 F 24839W Lined Case for Above. Shpg. wt. 4¾ lbs. . . . Net 11.95

## 2 Deluxe Four Pickup with Tremolo

An instrument with great flair and style! Slim-line steel-reinforced neck, variable string guides and adjustable bridge, tremolo with large flat bar. Oval rosewood fingerboard with 20 flat-type frets, on-off and volume controls for each pickup, Master tone control. Ebony pick guard, gold floral inlay, 9 position markers. 40½ H x 13½ W Imported.

13 F 24599W Shpg. wt. 10 lbs. . . . . Net 79.95  
13 F 13261W Lined Case for Above. Shpg. wt. 4¾ lbs. . . . Net 11.95

## 3 Single-Pickup Bass

Double cut-away electric bass guitar is great for performers. Has individual string adjusters, tone and volume controls, chrome tailpiece, laminated steel-reinforced adjustable neck. Rosewood fingerboard and rest, decorated pick guard and high-gloss lacquer sunburst finish. Adjustable bridge for easy action. 42"Lx12¾"W. With cord.

13 F 24805W Imported. Shpg. wt. 10 lbs. . . . . Net 59.95  
13 F 24813W Lined Case for Above. Shpg. wt. 4 lbs. . . . . Net 12.50

## 4 Deluxe Two-Pickup Bass

The "bass-Is" of a great musical group! Professional-grade instrument has maple neck with nickel-silver frets, celluloid-bound, rosewood fingerboard, toggle switch for forward, together, rear pickup activation, Individual volume controls and Master tone. Steel-reinforced, fast-action neck and adjustable bridge. 43"L x 14½"W. With cord. Imported.

13 F 24789W Shpg. wt. 10 lbs. . . . . Net 89.95  
13 F 24797W Lined Case for Above. Shpg. wt. 4 lbs. . . . . Net 12.50



SAVE OVER  
10%

## "Ready-to-Rock" Complete Outfits with Guitar, Case, Cord and Amplifier!

### 2-Pickup Outfit

**\$118<sup>50</sup>** Total Reg. Price  
\$131.85

Includes 13-24821W Guitar, 13-66616W 18-watt Reverb / Tremolo Amp (page 115), plus case and pick-up cord. Shpg. wt. 28 lbs.  
13 F 91374WXM . . . . . Net 118.50

### One-Pickup Bass Outfit

**\$136<sup>95</sup>** Total Reg. Price  
\$152.40

Includes 13-24805W Bass Guitar, 13-01829W 45-watt Bass Amp (page 115) plus case and pick-up cord.  
13 F 91380WXM 44 lbs. . . . Net 136.95

### 4-Pickup Outfit

**\$172<sup>50</sup>** Total Reg. Price  
\$191.85

Includes 13-24599W Guitar, 13-01886W 45-watt Reverb / Tremolo Amp (page 114), plus case and pick-up cord. Shpg. wt. 43 lbs.  
13 F 91382WXM . . . . . Net 172.50

### Two-Pickup Bass Outfit

**\$199<sup>95</sup>** Total Reg. Price  
\$222.40

Includes 13-24789W Bass Guitar, 13-01548W 60-watt Bass Amp (page 114) plus case and pick-up cord.  
13 F 91408WXM 61 lbs. . . . Net 199.95

# Hollow-Body Acoustic Guitars... "Cool Classics"

## Complete 7-Piece "Beginner's Outfit"

• Includes Record Course and Complete Beginner's Book

Nicely-styled steel string guitar is a great way to learn basic guitar play for folk and classics. Steel-reinforced neck, six steel strings, mahogany-colored sides and back, light wood-finish top. With vinyl zippered carrying bag, neck cord, pick, instruction book and record course. 36¼ L x 13W x 3½"D. Imported.

13 F 52921W Shpg. wt. 6 lbs. . . . . Net 24.95

**\$24<sup>95</sup>**



**\$59<sup>95</sup>**



**\$39<sup>95</sup>**



### 1 "Concert Size" Classic with Adjustable Bridge

Nice style, nice sound, NICE PRICE—great for performing or "playing around!" Has steel-reinforced, fast-action neck, adjustable trim, six nylon strings. Light spruce top and special wild-grain back and sides. High gloss finish, laminated neck. 39"L x 14"W. Imported.

13 F 24847W Shpg. wt. 8 lbs. . . . . Net 39.95

Folk-model similar to above, with steel strings and pick-guard.

13 F 24854W Shpg. wt. 8 lbs. . . . . Net 39.95

13 F 24862W Case for Either Above. Shpg. wt. 4 lbs. . . . . Net 11.95

### 2 Decorated "Jumbo" Acoustic Guitar

"Pro-quality" folk guitar features double pick guard, steel-reinforced neck for fine finger action, rosewood fingerboard with inlaid position markers, adjustable pin bridge. Has spruce wood top, inlaid celluloid strips around sound hole, high-gloss, 3-color, sunburst tone finish. Includes plush-lined case and six steel strings. 41½ L x 16W x 4½"D. Imported.

13 F 24771W Shpg. wt. 16 lbs. . . . . Net 59.95

### 3 Famous Yamaha Concert-Size Guitars

Folk or classic—these beautiful instruments will provide you with years of guitar playing and listening pleasure. Made from the finest select woods; aged, cut and dried according to precise specifications and quality control. Each features unique Yamaha fan bracing, precision neck and body shape, delicate inlays and rich, long-lasting finish. Rosewood fingerboards and real wood marquetry make them as good looking as they are good sounding. Imported.

**Model FG-75N Folk Guitar.** Six steel strings, 20 frets, Nato neck, adjustable truss rod, Katsura back and sides. 40L x 14¾W x 4"D. 13 F 52046W Shpg. wt. 8 lbs. . . . . Net 89.95

**Model G-65A Classic Guitar.** Less pick guard. Six nylon strings, 19 frets, spruce top, Nato neck, Katsura back and sides. 39½ L x 14¾W x 4"D.

13 F 52038W Shpg. wt. 8 lbs. . . . . Net 89.95

13 F 52913W Case for Either Above. Shpg. wt. 4 lbs. . . . . Net 11.95

**Yamaha 1090 Guitars... Quality Crafted for Better Sound!**



**\$89<sup>95</sup>**

Folk or Classic

**\$89<sup>95</sup>**

## Magus Chord Organ Ensemble

**\$59<sup>95</sup> With Bench, Music Book**



Play your favorite organ songs in minutes. Does not require any previous training or knowledge of music. Has 37 treble keys, 12 chords and full 3 octave range for most organ pieces. Has walnut-grain end panels, decorator stand and smoked, see-thru music rack. Modern bench has storage space, cushioned seat. Organ, 34 x 17½ x 34½" (HWD). 117 VAC. Imported. 12 F 58102W Wt. 39 lbs. . Net 59.95

## Stylophone Portable Electronic Organ



**\$19<sup>95</sup>**

Here's real family fun with an organ you can take along and play by numbers or notes. Battery-operated and only 6¼ L x 4H x 1½"D. Pencil-size stylus, miniature piano keyboard, 1½ octaves of Vibrato or Flat Tones. Can be plugged into ext. amplifier for big organ sound. With battery, record, 100-tune book. Imported. 1½ lbs. 12 F 71006 . . . . . Net 19.95 99 F 60212 Extra Battery . . . . . Net 39¢

# Got the Rhythm? Get the "Blues" at Lafayette!

Reds, Greens and Yellows, Too, with These Exciting Color Displays



1 \$59<sup>95</sup>



2 \$49<sup>95</sup>



\$39<sup>95</sup> 3

\$24<sup>95</sup> 4



## 1 Frequency-Controlled 4-Channel Lights

See your favorite music in dazzling color! This deluxe color organ connects in seconds to your stereo system or musical instrument amplifier and makes reds, greens, yellows and blues "dance" to your beat in an ever-changing pattern. Four color controls, solid-state circuit, handsome vinyl-covered walnut-grain cabinet. Overall, 15 x 30 x 11". For 117 VAC, 60 Hz.

21 F 03000WX Shpg. wt. 23 lbs. Net 59.95

## 2 Frequency-Controlled 3-Channel Lights

Connects to speaker leads of your amplifier, provides a dazzling display with the color (hue) controlled by the pitch or your music and the brightness controlled by the loudness of your music. Has 3 color controls for precise color mixing, good-looking walnut-grain cabinet with shatterproof front. 12 x 24 x 8". For 117 VAC, 60 Hz.

21 F 25441W Shpg. wt. 11 lbs. Net 49.95

## 3 4-Control Sound-Activated Color Lights

Exclusive 4-in-1 color control gives you precise control over each of the colors in this fine-performing unit—add it to your hi-fi or musical instrument amplifier for a complete color display. High/low inputs let you adjust for sound power levels, colors respond to the amplitude variations of your sound source. Housed in walnut-grain cabinet, 12 x 24 x 8". For 117 VAC, 60 Hz.

21 F 25904W Shpg. wt. 15 lbs. Net 39.95

## 4 Three-Sided Prismatic Audio Lights

Provides a full three-sided display with its one-piece lens that wraps around three sides of the cabinet. Gives display an exciting three-dimensional effect. Solid-state electronic control transposes sound impulses into flashing light patterns. Hooks up to speaker leads of any sound source. Walnut-grain top/bottom of cabinet. 12 x 18 x 6". For 117 VAC, 60 Hz. U.L. listed.

13 F 57003W Shpg. wt. 9 lbs. Net 24.95



5 \$19<sup>95</sup>

\$39<sup>95</sup>  
KIT



6



\$29<sup>95</sup>  
KIT

7

\$13<sup>50</sup> 8

\$19<sup>95</sup>  
KIT



10

\$44<sup>95</sup> 9

5 Electronic Strobe Light. "Freezes" the action at parties and get-togethers. Also can be used for photography, etc. Has 1-10 flash-per-second rate control, 4" chrome reflector; red, blue and yellow filters for exciting color effects. Xenon flash tube. 5½ x 5½ x 4¾". For 117 VAC.

21 F 26092 Shpg. wt. 2½ lbs. Net 19.95

6 Elco 3475 "Sound-Strobe." Connects to speaker leads of your system, the music adjusts the flash rate. Sensitivity control, Xenon bulb. 9½ x 5¼ x 6¾". Shpg. wt. 5¾ lbs.

21 F 25813 Model 3475 Kit Net 39.95

21 F 25821 Model 3475 Wired Net 59.95

Model 3470 Strobe with Rate Adjustment.

21 F 25839 Model 3470 Kit Net 29.95

21 F 25847 Model 3470 Wired Net 44.95

7 Elco Black Light/Strobe Kit. Model BLS-10. Special UV bulb in 18" fixture sheds an "eerie" light on things, making colors and textures come alive! Also has strobe circuit for adjustable on-off rate. Mounts just about anywhere. Jet black cabinet, 18 x 4½ x 4". Shpg. wt. 9 lbs.

21 F 25458W BLS-10 Kit Net 29.95

21 F 25466W BLS-10 Kit Wired Net 39.95

8 18"-Wide Black Light Lamp. Unusual fixture creates a mysterious glow—illuminating paintings, plants, any colorful object in a new and unique way. Has G.E. 15-watt black light bulb, chrome reflector, E-Z mount cabinet for installation just about anywhere. With bulb.

12 F 52501 Shpg. wt. 2¾ lbs. Net 13.50

12 F 52519 Replacement Bulb. 5 oz. Net 6.50

9 3-Channel Control Center. Turns room lights, Xmas tree bulbs, etc., into dynamic patterns of light. TRUE Frequency Control—handles three separate light channels (500 watts each) thru transistorized amplifiers for low, medium and high frequencies. Intensity adjustments, on-off pilot light. For 117 VAC, 15 amps max.

13 F 48002 Shpg. wt. 3 lbs. Net 44.95

10 Elco "Light Sequencer." Model 4600. Arrange color lights, room lights, etc., into a flashing sequential pattern like the "marquee" moving lights of old! Accepts three light sources (150 watts max. each). All-solid-state design. 6 x 3½ x 3". Shpg. wt. 1½ lbs.

21 F 25953 Model 4600 Kit Net 19.95

21 F 25961 Model 4600 Wired Net 29.95



# Got the Blues? Get the Rhythm at Lafayette!

**Solid-State "Sound Enhancers" for Group Special Effects—  
Play It Like the Pros!**

## 1 8-Pattern Automatic Rhythmer

Provides supplemental background beats and rhythmic patterns for groups and soloists. Rhythms include Waltz, Slow Rock, Rock, Fox Trot, Latin, Mambo, Jazz-Waltz, and Cha-Cha (mix rhythms to produce other sounds)—sounds include conga drum, bass drum, snare drum, brushes, claves and maracas. Has tempo and volume controls, switch for starting and stopping rhythms. Walnut-finish cabinet, 11½ x 2½ x 7½". Hooks up easily to any musical instrument amplifier. 13 F 24870 117 VAC, 60 Hz. Shpg. Wt. 6 lbs. . . . . Net 79.95

## 2 19-Rhythm "Super" Automatic Rhythmer

Be your own one-man-band and still get "big group" sounds! Provides 19 computer-programmed rhythms including a special Fox Trot/Swing section with 36 variations. Has sounds of bass drum, large and small congas, claves, cowbell, maracas, snare drum, and cymbal. Rhythms include: Rock 1-2-3-4, Ballad, Western, Bossa-Nova 1-2, Tango, Rhumba, Mambo, Cha-Cha, Samba, Beguine, Meringue, Waltz/Viennese Waltz and Fox Trot/Swing, or mix to produce other sounds. Has tempo/volume controls, on-off switch, pilot light, start switch. High/low impedance outputs, foot control. 9½ x 4½ x 14". For 117 VAC, 60 Hz. Imported. 13 F 66509W Shpg. wt. 10¾ lbs. . . . . Net 199.95

## 3 12-Pattern Automatic Rhythmer

Great way to get better "organized"—provides a complete rhythm section for students, soloists, small groups. Provides 12 distinct rhythms—Waltz, Fox Trot, Rhumba, Samba, Mambo, Slow and Fast Rock, Swing, Bossa-Nova, Cha-Cha, Tango or March, or mix to produce other sounds. Five percussion sounds—Bass Drum, Snare, High Hat, Conga and Claves. Ideal for use with organs. Has on-off volume control, remote-footswitch jack, pilot light, tempo light, pushbutton selectors. Walnut-finish case, 11¼ x 3¾ x 8¾". For 117 VAC, 60 Hz. 13 F 24888W Shpg. wt. 10 lbs. . . . . Net 144.95

## 4 180° Electronic Phase Shifter

Give your instrument that "now" sound with this electronic phase shifter. Provides rolling, "spatially expanded" sounds from guitar or organ, sweeping sounds from all directions, as if they're pulled through a vacuum. Has variable speed and on-off control. black vinyl-covered cabinet. 10¾ x 5 x 6¼". For 117 VAC, 60 Hz. Imported. 13 F 66756W Shpg. wt. 5 lbs. . . . . Net 129.95

## 5 Echo Chamber for Group "Presence"

Use for great special effects from electric guitars, basses and organs. Provides up to 6 echo repeats for "far out" effects. Has volume, echo-balance, echo time and Intensity controls, input for remote-control footswitch. Uses continuous-loop tape — no slippage or breaking! High/low inputs for use with most any instrument amplifier. 10¾ x 5 x 6¼". For 117 VAC, 60 Hz. Imported. 13 F 66640W Shpg. wt. 7 lbs. . . . . Net 114.95  
13 F 66657W Replacement Tape Magazine. Shpg. wt. 4 oz. Net 4.95  
13 F 01514 Remote Footswitch. Shpg. wt. ½ lb. . . . . Net 3.95

## 6 Quadra-Sound-Blender™ Special Effects Device

Hooks up between your guitar and amplifier to create 4 exciting special effects. Wide-range percussive tremolo with variable rate control; repeating echo with adjustable delay; vibrato with variable speed; reverberation with depth control. Has two instrument input jacks, remote-footswitch jack, power switch and pilot light. 14¾ x 4 x 6". For 117 VAC, 60 Hz. Imported. 13 F 52012 Shpg. wt. 7 lbs. . . . . Net 59.95

## 7 "ECHO-VERB "II" 2-Channel Reverb Unit

Offers full dynamic reverberation in a compact unit that's great for small groups and combos. Has two microphone inputs, two instrument inputs, each with individual volume controls for fading and mixing. Separate adjustable reverb control. Has pilot light, remote-footswitch jack, black, vinyl-covered enclosure with carrying strap. 11½ x 3¾ x 6½". For 117 VAC, 60 Hz. Imported. 99 F 92116W Shpg. wt. 3½ lbs. . . . . Net 34.95  
13 F 01514 Footswitch for Above. Shpg. wt. ½ lb. . . . . Net 3.95



1 \$79.95



2 \$199.95



3 \$144.95



NEW

4 \$129.95



5 \$114.95



6 \$59.95



7 \$34.95

See Pages 114-115 for Our Wide Selection of Musical Instrument Amplifiers

# Make Your Group "Go" with These High-Performance Musical Instrument Amplifiers

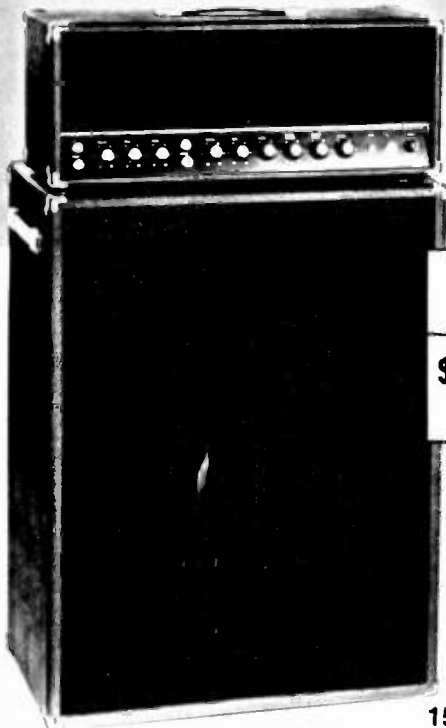

150  
WATTS  
\$239<sup>95</sup>

- Famous Hammond Reverb Units for "Far-Out" Effects
- Two 12" Heavy-Duty Speakers with Single High-Frequency Horn

### 150-Watt "Piggy Back"

#### Amplifier with Reverb-Tremolo, 3 Speakers, 2 Channels

Has "big group" sound at a PA price! Solid-state preamp with high-stability FET's drives a rugged, tube-type output to produce 150 watts of solid music power—(50W RMS @ 5% THD)—plenty of power for today's "heavy" guitar or organ sounds. Has 2-channel Hi and Lo level inputs; volume, bass and treble controls for each channel; tremolo intensity control, pilot light, fuse and on-off switch. Acoustically-designed cabinet with scuff-resistant vinyl finish, black/silver grille. Amp., 22 x 9 x 13½"; speaker, 22½ x 30 x 13½". For 117 VAC. 13 F 01852WX Shpg. wt. 80 lbs. . . . . Net 239.95

Foot Switch for Reverb-Tremolo Remote Control.

13 F 01506 Shpg. wt. 1½ lbs. . . . . Net 7.50

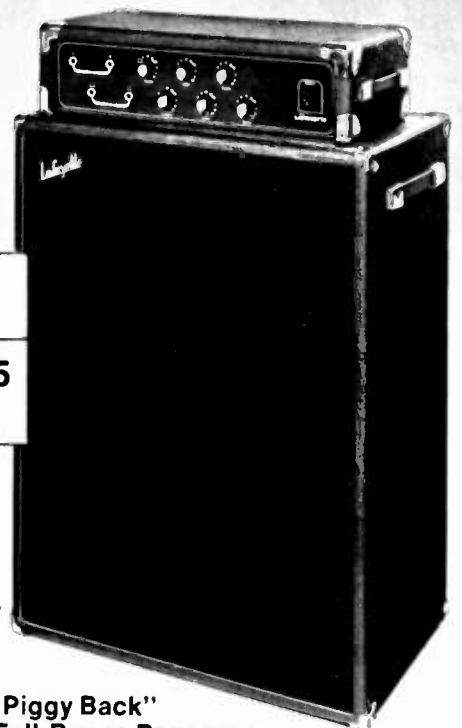

180  
WATTS  
\$219<sup>95</sup>

- Two 12" Heavy-Duty Speakers in "Bass-Reflex" Cabinet
- FET Solid-State Preamp Drives a Long-Life Tube-Type Output

### Lafayette 180-Watt "Piggy Back"

#### Bass Amplifier with Full-Range Response

Wide enough response for use with accordion or organ, but powerful enough to take today's punishment from rock guitars and basses. Specially-engineered for high-bass output using the latest bass reflex cabinet, heavy-duty 12" full-range speakers with extended low-frequency response. Completely solid-state circuit design produces a full 180 watts peak power—(60 watts RMS @ 5% THD). Has 2-channel capability, with volume, bass and treble for each channel, on-off switch, pilot light and fuse. Amp., 19½ x 5¼ x 9½"; speaker, 22½ x 30 x 13½". For 117 VAC. Acoustically-designed cabinet. 13 F 01895WX Shpg. wt. 75 lbs. . . . . Net 219.95

13 F 01895WX Shpg. wt. 75 lbs. . . . . Net 219.95



100  
WATTS  
\$169<sup>95</sup>

### Lafayette 100-Watt Solid-State Reverb-Tremolo Amplifier

Self-contained for easy portability and set-up, puts out 100 watts peak power—25 watts RMS @ 5% THD—through two 10" heavy-duty full-range speakers. Has high, med., low-level inputs, acoustically designed cabinets, lighted power switch, bass, treble and volume controls, more. 24 x 20 x 9½". For 117 VAC.

13 F 01811W Shpg. wt. 48 lbs. . . Net 169.95

Footswitch for Remote Reverb/Tremolo.

13 F 01506 Shpg. wt. 1½ lbs. . . . Net 7.50



45  
WATTS  
\$99<sup>95</sup>

### Lafayette 45-Watt Solid-State Reverb-Tremolo Amplifier

A lot of amp for the money—Hammond reverb, 12" speaker, three instrument inputs. Has two volume/tone controls, two tremolo speed and intensity, one "reverb" depth control. 45-watt peak music power (15 watts RMS @ 5% THD), 10-transistors, 2 rectifiers. Pilot light, on-off switch, fuse. 17 x 22 x 8½". 117 VAC.

13 F 01886W Shpg. wt. 29½ lbs. . . Net 99.95

Footswitch for Remote Reverb/Tremolo.

13 F 01506 Shpg. wt. 1½ lbs. . . . Net 7.50



60  
WATTS  
\$119<sup>95</sup>

### Lafayette Solid-State 60-Watt "Piggy Back" Bass Amplifier

For electric bass, guitar, accordion or combo-organ. Delivers 60 watts peak (20 watts RMS at 5% THD). Features 15" speaker, two-instrument inputs, high/low gain inputs, separate volume and tone controls, on-off switch, pilot light and fuse. Acoustical cabinet. Amp., 14 x 4¾ x 18"; Speaker, 18 x 22½ x 11". For 117 VAC.

13 F 01948W Shpg. wt. 46 lbs. . . Net 119.95

Charge It with Your BankAmericard or Master Charge.

Brand-new offer from  
Columbia Record & Tape Club...

# Any 12 tapes or records for only \$100

If you begin membership by buying just one selection now — and agree to purchase only eight more selections (at regular Club prices) in the coming three years



ALL SELECTIONS\* SHOWN ARE AVAILABLE ON



\* Selections marked with a star are not available in reel tapes

FIRST CLASS  
Permit No. 1030  
Terre Haute, Ind.

**BUSINESS REPLY MAIL**  
No Postage Stamp Necessary if Mailed in the United States

Postage will be paid by  
**COLUMBIA HOUSE**  
1 Music Lane  
Terre Haute, Indiana  
47808



241398 <b>THREE DOG NIGHT</b> ABC/DUNHILL HARD LABOR	240887 <b>THE POINTER SISTERS</b> BLUE THUMB THAT'S A PLenty	239871 * <b>LOGGINS &amp; MESSINA</b> COLUMBIA ON STAGE	238741 <b>RAY CONNIFF</b> COLUMBIA THE WAY WE WERE
240135 * <b>MELISSA MANCHESTER</b> BELL BRIGHT EYES	237974 * <b>DAVID ESSEX</b> COLUMBIA ROCK ON	236141 Gladys Knight & The Pips BUDDAH IMAGINATION	240143 * <b>GEORGE JONES</b> EPIC IN A GOSPEL WAY
233452 <b>GARFUNKEL</b> COLUMBIA ANGEL CLARE	235564 <b>CHER</b> MCA HALF-BREED	230581 * <b>SPOOKY TOOTH</b> YOU BROKE MY HEART SO I BUSTED YOUR JAW	237875 * <b>BARRY WHITE</b> 20TH CENTURY STONE GON'
239855 * <b>MAC DAVIS</b> COLUMBIA Stop And Smell The Roses	240259 * <b>GLY &amp; RALNA</b> BAMPBEE GIVE ME THAT OLD TIME RELIGION	235846 * <b>JERRY LEE LEWIS</b> SOMETIMES A MEMORY AIN'T ENOUGH	237040 <b>SANTANA</b> COLUMBIA LOVE DEVOTION & SURPRISE WELCOME
232587 <b>CHICAGO VI</b> COLUMBIA Feelin' Stronger Every Day	207662 Everything You Always Wanted COLUMBIA To Hear On The Moog	229401 * <b>RAY PRICE</b> COLUMBIA She's Got To Be A Saint	235580 * <b>KRIS KRISTOFFERSON</b> RITA COOLIDGE FULL MOON
237099 * <b>CHARLIE MCCOY</b> INDEPENDENT THE FASTEST HARP IN THE SOUTH	230607 * <b>TANYA TUCKER</b> RECORDED WHAT'S YOUR MAMA'S NAME	229526 <b>THE BEST OF BREAD</b> ELEKTRA If/Make It With You	234757 ENDOR LIGHT & THE LIGHT BRIGADE THE BIG BAND HITS OF THE THIRTIES
226431 <b>CARLY SIMON</b> ELEKTRA NO SECRETS You're No Fun	230771 <b>URIAH HEPP</b> 230772 LIVE Easy Livin' COUNTS AS TWO	228759 * <b>DONNA FARGO</b> DRT My Second Album SUPERMAN	234377 * <b>CONWAY TWITTY</b> MCA YOU DON'T MESS THIS FAR BEFORE
232926 * <b>STEELY DAN</b> ABC Countdown To Ecstasy	235606 * <b>THE STATLER BROS.</b> CARRY ME BACK	228155 <b>ELTON JOHN</b> MCA DON'T SHOOT ME I'M ONLY THE PIANO PLAYER	224485 The Edgar Winter Group EPIC THEY ONLY COME OUT AT NIGHT
234864 <b>PROCOL HARUM</b> CENTRALE GRAND HOTEL	232298 * <b>JOE WALSH</b> ABC/DUNHILL THE SMOKER YOU DRINK THE PLAYER YOU GET.	227439 * <b>TAMMY WYNETTE</b> EPIC KIDS SAY THE DARDEST THINGS	221192 * <b>JIM CROCE</b> ABC YOU DON'T MESS AROUND WITH JIM
229161 * <b>BRENDA LEE</b> MCA BRENDA Nobody Wins	230912 <b>PAUL SIMON</b> COLUMBIA There Goes Rhym'n' Simon	235572 * <b>JERRY WALLACE</b> MCA PRIMROSE LANE DON'T GIVE UP ON ME	201129 <b>CHAIKOVSKY</b> COLUMBIA 1812 Overture Philadelphia Orch., Ormandy
230870 <b>AL GREEN</b> HI CALL ME	234914 * <b>FARON YOUNG</b> Just What I Had In Mind	222018 <b>THE 5th DIMENSION</b> BELL Greatest Hits On Earth	235168 † <b>BOBBY GOLDSBORO</b> LA SUMMER (The First Time)
229781 * <b>CONNIE SMITH</b> COLUMBIA ALADY NAMED SMITH	185840 <b>THE ALPERT &amp; THE TIJUANA BRASS</b> GREATEST HITS	224386 * <b>The Best Of Charlie Rich</b> EPIC Nice 'N' Easy	236893 † <b>THE BEST OF THE ANDREWS SISTERS</b> MCA
226332-226333 <b>NEIL DIAMOND</b> MCA HOT AUGUST NIGHT COUNTS AS TWO	234872 * <b>TRAFIC</b> IRLAND ON THE ROAD	240196 The Incomparable London Photos 2 Mantovani Plays The All Time Greatest Hits	240671 † <b>JERRY VALE</b> COLUMBIA FREE AS THE WIND
240638 * <b>CHARLIE RICH</b> 240839 FULLY REALIZED COUNTS AS TWO	229997 * <b>MAC DAVIS</b> COLUMBIA The Way You Look Today		
207381 <b>TAMMY WYNETTE</b> EPIC Greatest Hits, Vol. 2	224758 <b>LYNN ANDERSON'S</b> COLUMBIA GREATEST HITS		
216750 * <b>FRANK SINATRA</b> COLUMBIA IN THE BEGINNING 1943 To 1951	216655 <b>JOHNNY MATHIS</b> COLUMBIA All-Time Greatest Hits		
202796 <b>RICHARD STRAUSS</b> COLUMBIA Also Sprach Zarathustra Bernstein, New York Philharmonic	238840 * <b>JERRY LEE LEWIS</b> SOUTHERN ROOTS BACK HOME TO MEMPHIS		
239863 † <b>BILLY JOEL</b> COLUMBIA PIANO MAN	236869 <b>THE WHO</b> 236860 QUADROPHENIA TRACK COUNTS AS TWO		
238766 † <b>ROD STEWART</b> FACES LIVE COAST TO COAST OVERTURE AND BEGINNERS	239509 * (SOUNDTRACK) COLUMBIA THE WAY WE WERE		

† Available on records and cartridges only

# Any 12 tapes or \$1.00 records

If you begin membership by buying just one selection now — and agree to purchase only eight more selections (at regular Club prices) in the coming three years

**Take your pick**



12" stereo records



8-track cartridges



tape cassettes



reel-to-reel tapes

\* Selections marked with a star are not available in reel tapes

Columbia Record & Tape Club, Terre Haute, Indiana 47808

Please accept my membership application in the Columbia Record & Tape Club under the terms outlined in this advertisement. Send me the 12 selections indicated here for only \$1.00. Also send me the record or tape I've chosen as my first selection, for which I will be billed only \$4.98, plus processing and postage. I agree to buy 8 more selections (at regular Club prices) during the coming three years—and may cancel my membership at any time after doing so. I am interested in the following type of recordings:

- Be sure to check one box only
- 8-Track Cartridges (3F-W) 9JZ
  - Tape Cassettes (3G-X)
  - Reel-to-Reel Tapes (3K-Y)
  - 12" Stereo Records (3M-Z)

MY MAIN MUSICAL INTEREST IS (check one):  
(But I am always free to choose from any category)

Easy Listening 2  Teen Hits 7  Classical 1  Country 5

Mr.  Mrs.  Miss  
(Please Print) First Name Initial Last Name

Address.....  
City.....

State..... Zip Code.....

Do You Have A Telephone? (Check one)  YES.....  NO  
A.P.O., F.P.O. addressees: write for special offer 0105/F74

Send these 12 for \$1.00

ALSO send my first selection for \$4.98

Here's a great new offer from Columbia — we not only give you a big introductory gift package of 12 records or tapes for only \$1.00... we also give you a saving on the first selection you buy from the Club! Just indicate the 12 albums you want for \$1.00; then choose still one more record or tape as your first selection, for which you will be billed only \$4.98, plus processing and postage (that's a savings of at least \$1.00 off regular Club prices). In exchange...

You agree to buy eight selections (at regular Club prices) in the next three years. Think of it... three whole years in which to buy only eight more selections — that's only two or three a year — and you may cancel your membership at any time after doing so!

Your own charge account will be opened upon enrollment. The selections you order as a member will be mailed and billed at the regular Club prices: cartridges and cassettes, \$6.98 or \$7.98; reel tapes, \$7.98; records, \$5.98 or \$6.98 — plus processing and postage. (Multiple unit sets and Double Selections may be somewhat higher.)

You may accept or reject selections as follows: every four weeks (13 times a year) you will receive a new copy of the Club's music magazine, which describes the Selection of the Month for each musical interest... plus hundreds of alternate selections from every field of music. In addition, about six times a year we will offer some special selections (usually at a discount off regular Club prices). A response card will always be enclosed with each magazine.

... If you do not want any selection offered, just mail the response card provided by the date specified

... If you want only the Selection of the Month for your musical interest, do nothing — it will be shipped automatically

... If you want any of the other selections offered, just order them on the response card and mail it by the date specified.

You will always have at least 10 days in which to make a decision. If for any reason you do not have 10 days, you may return the regular selection at our expense and receive full credit for it. Upon completing your enrollment agreement, you'll be eligible for our bonus plan — which enables you to save at least 33% on future purchases!

NOTE: all applications are subject to review and Columbia House reserves the right to reject any application.

# Lafayette Instrument Amplifiers and Accessories



**45  
WATTS**

**\$79<sup>95</sup>**

## 45-Watt Solid-State Bass Amplifier with 12" Speaker

Great for beginning bass students, part-time performers. 45 watts peak (15 watts RMS @ 5% THD), three inputs including HI-Boost, volume, bass and treble controls, power switch, pilot light. 16x24x8". 117 VAC. 13 F 01829W Shpg. wt. 30 lbs. . . Net 79.95

## "Total Performance" 180-Watt Amplifier with Two Sound Column Speakers

**\$380**

No Money Down\*

- Four Separate Channels, Each with Volume, Bass, Treble and Reverb Controls—Fully Mixable for GREAT GROUP SOUND!

This PA system you NEED for day-in, day-out performing in clubs, halls, meeting rooms, anywhere a quality high-power sound system is not supplied. The all-solid-state power-packed amplifier develops a hearty 180 watts peak music power (60 watts RMS at 5% THD) for "ground shaking" performances. The four separate channels, each with full controls, provide a completely mixable system for ultimate versatility. The two sound column speakers each contain four 10" heavy-duty speakers for wide response, evenly dispersed sound. Has pilot lamp, fuse, on-off switch, jack for remote-control reverb on-off. FET preamplifiers for outstanding stability even under heavy loads—rugged solid-state amplifier circuit for maximum power capability. Amplifier and speakers are enclosed in textured, vinyl-covered, acoustically-designed cabinets, ready for all the punishment you can give them! Amplifier, 19½ x 5¼ x 9½", speakers, 13 x 48 x 11". 117 VAC. 13 F 91366WXM Wt. 100 lbs. . . Net 380.00

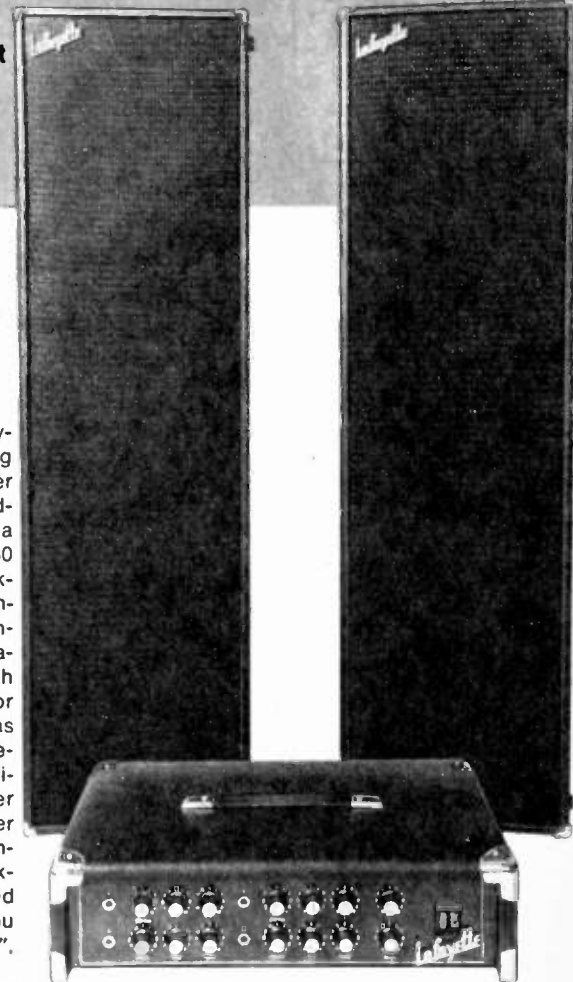

**18  
WATTS**

**\$59<sup>95</sup>**

## 18-Watt Solid-State Reverb-Tremolo with 8" Speaker

Excellent for small setups, puts out 18 watts peak power (6 watts RMS @ 5% THD). Has 3 inputs, bright-glow pilot light, volume, tone, reverb and tremolo controls, vinyl-covered wood cabinet. 13 x 8½ x 6½". 117 VAC. Imported. 13 F 66616W Shpg. wt. 14 lbs. . . Net 59.95



**10  
WATTS**

**\$34<sup>95</sup>**

## 10-Watt Solid-State Amplifier with 6" Speaker

Great for beginning music makers! Three instrument inputs, volume and tone controls, 10-watt peak power (3½ watts RMS @ 5% THD). Has on-off switch, pilot light, compact cabinet. 11¼ x 16½ x 5¼". For 117 VAC. Imported. 13 F 66731W Shpg. wt. 8 lbs. . . Net 34.95

### 1 Cardioid Dynamic Mike

Highly directional cardioid pattern minimizes feedback and reverberation, switch selected 50k or 600-ohm impedance. 100-10,000 Hz response. Satin chrome die-cast case. On-off switch. 8¼ x 1½" dia. With adapter, 15-ft. cord. Imported. 99 F 46294 Shpg. wt. 1¼ lbs. . . Net 21.95

### 2 Deluxe Dynamic Mike

Dual 50k and 250 ohms impedance, omni-directional pickup, 100-10,000 Hz response. Has ball screen to prevent "pops" and air blasts, die-cast case. 6¼ x 2½" max. dia. With 15-ft. cord, adapter, metal desk stand. Imported. 99 F 46203 Shpg. wt. 3 lbs. . . Net 24.25

### Entertainer Mikes and Stand



### 3 Floor Stand

Deluxe Atlas stand with "full-grip" clutch, anti-tip base. Adj. 35-63" H. 5/8"-27 thread. Shpg. wt. 10¾ lbs. 44 F 10031W Net 9.85



15-Ft. Cable with Phone Plug

### Graphic Equalizer



**\$69<sup>95</sup>**

Enhances instruments or microphones—controls 7 separate frequencies. Slide-fader controls with center "lock," master control, high/low input. With batteries. 10 x 2 x 7½". Imported.

13 F 66749 Shpg. wt. 7 lbs. . . . . Net 69.95

### Amplified Headphones

- Practice Without Disturbing Others

**\$34<sup>95</sup>**



Has 4-transistor amp, twin cone 3" speakers, cushioned headband. 50-20,000 Hz response. With 10' coiled cord, power switch, jacks for AC adapter and monitor.

13 F 66723 Shpg. wt. 1¼ lbs. . . . . Net 34.95  
99 F 60212 9-V Battery . . . . . Net ea. 39¢

No Money Down—See Page 4 for Lafayette's Easy-Credit Plan (Minimum Order \$30.00)

# Instant Sound Effects! Just Add Your Group!

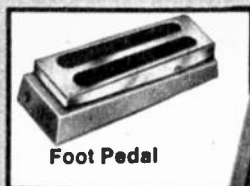

Foot Pedal

\$84<sup>95</sup>

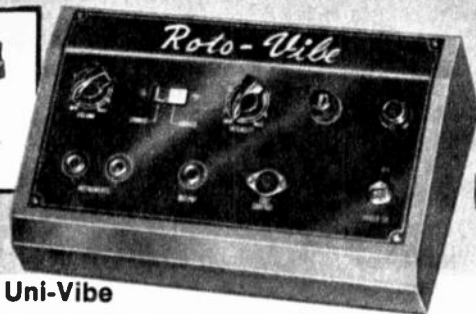

Uni-Vibe

• Add Rotating Speaker Effects and Vibrato to Your Musical Instrument Amplifier—Electronically

Produce the special sound effects now used in modern music through your own instrument amplifier. Rotating speaker sound, voice echo and fade, vibrato, etc. Has remote speed control foot pedal with instant cancel switch, volume, chorus/vibrato, intensity controls, on-off power switch, fuse, pilot light, 2 instrument inputs, amplifier output. For use with any electric guitar or keyboard instrument. 10 x 3 x 6 1/2". For 117 VAC, 60 Hz.

13 F 66400 Imported. Shpg. wt. 9 1/2 lbs. . . . . Net 64.95



2-Channel Reverberation Chamber

• Famous American-Made Folded Line Reverb  
• 4 Instrument Inputs with Slide-Type Faders

\$59<sup>95</sup>

Professional studio-style chamber gives your group reverberation capabilities with a full 2-second delay for really exciting effects. Has all-solid-state design, four inputs with full mixing, master reverb control from zero to maximum delay. Remote control on-off provision, pilot light. Connects easily to any instrument amplifier, PA or hi-fi. 13 1/2 x 6 x 5 3/4". For 117 VAC, 60 Hz.

13 F 66673 Imported. Shpg. wt. 9 lbs. . . . . Net 59.95  
13 F 01514 Remote-Control Foot Switch. Shpg. wt. 1/2 lb. . . Net 3.95

## Musical Instrument Accessories



1 \$14<sup>95</sup>



2 \$36<sup>95</sup>



3 \$34<sup>95</sup>

4 \$16<sup>95</sup>



5 \$10<sup>95</sup>



### 1 Lafayette "Fuzz" Sound

Makes your guitar or bass produce the harmonic effect of several wind instruments. Connects between instrument and amplifier, has on-off foot switch, variable "fuzz" effect control and volume/intensity control. A separate on-off switch in volume control saves battery life. 3 1/2 x 5 1/2 x 2 1/8". Imported. Order battery below.

99 F 91993 Shpg. wt. 1 3/4 lbs. . . . Net 14.95  
99 F 62560 Battery for Above . . . Net 14<sup>95</sup>

### 2 "Super-Fuzz" Box

Give your group today's "in-sound." All-solid-state unit connects between your instrument and amplifier to provide a complete range of controlled and sustained harmonic effects. Has balance control for perfect blend of fuzz and normal tones, tone switch for fuzz or sustain effect, master foot control. 6 1/2 x 3 x 1 7/8". With cord, battery.

13 F 66525 Shpg. wt. 3 lbs. . . . . Net 36.95  
99 F 60212 Extra Battery . . . . . Net 39<sup>95</sup>

### 3 "Big Muff Pi"

Distortion-sustaining device great for lead guitarists. Provides a full spectrum of electronic distortion for "far out" special effects. Has on-off volume control. Controls can be varied for special effects. Rugged steel case with non-slip rubber matting. 5 1/2 x 1 3/8 x 6 3/4". With battery.

13 F 14756 Shpg. wt. 2 lbs. . . . . Net 34.95

### 4 "Screaming Tree" Treble Booster

Foot-switch-operated treble booster gives your guitar the screeching penetration needed for today's "mind-blowing" performances. Provides that extra measure of professionalism for any group. Has volume control, on-off switch. Brushed stainless steel housing, non-slip rubber matting. 3 3/8 x 5 1/4 x 1 1/2". With battery.

13 F 14764 Shpg. wt. 1 lb. . . . . Net 16.95

## Electro-Harmonix Accessories

### 5 LPB-1 "Power Booster" Preamp

Solid-state preamp plugs into the input jack of your amplifier—increases the sound of any electric guitar, bass, organ or microphone up to 10 times! Also can be used with fuzz boxes, wah-wah pedals, etc. Has volume control, boost/off switch, standard phone plug for use with most instrument amplifiers. With battery. 3 x 2 x 1 1/8".

13 F 14749 Shpg. wt. 1 lb. . . . . Net 10.95

### "The Hog's Foot" Bass Booster

Amplifies the sub-harmonics of your bass guitar for a penetrating sound that really stirs your audience. Has convenient foot switch operation, volume control. "Boost/off" switch, brushed stainless steel housing with non-slip matting for use anywhere. 3 3/8 x 5 1/4 x 1 1/2". With battery. (Not illus.)

13 F 14772 Shpg. wt. 1 lb. . . . . Net 16.95



Electro-Harmonix  
Crying Tone  
Pedal  
**NEW!**

\$49<sup>95</sup>

Professional-quality crying tone pedal has 4-position tone bank that lets you sweep 4 separate portions of the frequency spectrum for a complete "wah-wah" effect, reverse switch for "aaawaaw" effect, volume pedal. Long-life construction. With battery.

13 F 14038 Shpg. wt. 1 lb. . . . . Net 49.95

Wah-Wah  
Pedal  
**NEW!**

\$19<sup>95</sup>



Use with any electric guitar or bass to produce a "bluesy" wah-wah effect. Foot-operated, doesn't interfere with performance. High-impact plastic, skid-resistant rubber base. On-off switch and battery. Imported.

13 F 24896 Shpg. wt. 2 lbs. . . . . Net 19.95  
99 F 60212 Extra Battery . . . . . Net 39<sup>95</sup>

Wah-Wah Sound  
and Volume  
Control

\$39<sup>95</sup>



Produces "wah-wah" effect of trumpet or trombone through your electric guitar or bass. Has 8 1/2" foot pedal which also operates as volume control, input jack with on-off switch. 10 x 3 x 3 3/4". Imported.

13 F 66301 Shpg. wt. 3 3/4 lbs. . . . Net 39.95  
99 F 62572 "C" Cells. Use 3 . . . Net ea. 19<sup>95</sup>

# Musical Instrument Speakers And Accessories

Get New Excitement and Real Quality From Your Music

## Super Power Cadence Speakers

- Natural Reproduction of Amplified Instruments
- Delivers Full, Rich Tonal Quality
- Aluminum Dust Cone, Rubberized Cone Edges for Prolonged Life

Improved speakers with heat-proof voice coils and reinforced steel chassis for long life and high power levels. Specially designed to meet the rigid requirements for replacement in electric organs, guitars, bass guitars and accordions. All speakers have 8-ohm voice coils.

As Low As  
**\$11<sup>95</sup>**



**Utah**

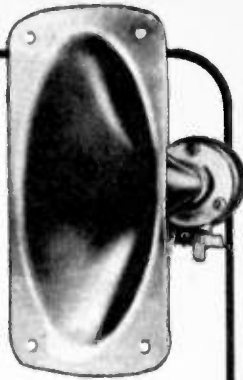

**\$16<sup>95</sup>**

## Instrument Amplifier Horn

Adds exciting overtones to your amplified instrument. Strong, lightweight fiber, resonance-free. Only 3 1/2 x 8 x 8 1/2" deep. When used with the crossover supplied, handles the high frequencies of 50-watt amplifier. With larger amps use 2 horns per woofer. Response: 2000-20,000 Hz. Use with 8- or 16-ohm speakers. 2-8 oz. ceramic magnet.  
32 F 49521 Shpg. wt. 1 1/2 lbs. . . . Net 16.95

Stock No.	Utah Model	Type	Mag. Wt. (Lbs.)	V.C. Struct. (In.)	Peak Dia. (In.)	Audio (Watts)	For Use With	Shpg. Depth (In.)	Wt. (Lbs.)	Net Ea.
32 F 49349	MH-8JC	8"	1 3/4	1	30	Organ, Guitar		3	3	11.95
32 F 49356	MH-10JC	10"	1 3/4	1	35	Organ, Guitar		3 1/4	4 1/4	12.95
32 F 49430	MH-10PC	10"	4	1 1/2	50	Organ, Guitar, Bass Guitar, Accordion		3 3/8	7	19.20
32 F 49364	MH-12JC	12"	1 3/4	1	40	Organ, Guitar		4 1/8	6 1/4	14.30
32 F 49372W	MH-12PC	12"	4	1 1/2	60	Organ, Guitar, Bass Guitar, Accordion		4 3/8	8 1/4	19.95
32 F 49380W	MH-12PXC	12"	6 1/2	1 1/2	70	Organ, Guitar, Bass Guitar, Accordion		5 1/8	10	26.60
32 F 49398W	MH-12RC	12"	7 3/4	2	85	Organ, Bass Guitar		5 1/8	12	46.80
32 F 49505	MH-12R3RA	12"	15	3	120	Bass Guitar		6 3/4	17 1/2	72.50
32 F 49406W	MH-15PXC	15"	6 1/2	1 1/2	75	Organ, Guitar, Bass Guitar, Accordion		6 1/2	11 1/4	30.00
32 F 49414W	MH-15RC	15"	7 3/4	2	90	Organ, Bass Guitar		6 3/8	13 3/4	49.70
32 F 49513	MH-15R3RA	15"	15	3	125	Bass Guitar		8 1/8	20	77.90



## Professional Instrument Speakers

- For String Bass Instruments, Electric Guitars, Electric Organs
- Reproduces Crisp Highs, Full, Clean Lows
- Massive Magnet Structures Up to 17 1/2 Lbs.
- 3" Aluminum Edge-Wound Voice Coils

As Low As  
**\$95**

**Model 417-8C.** 12" speaker. Works with amplifiers rated up to 75 watts. Magnet structure: 10 1/2 lbs. Diameter: 12 1/8". Depth: 5 5/8". Impedance: 8 ohms.

32 F 38508W Shpg. wt. 16 lbs. . . . . Net 95.00

**Model 418B.** 15" speaker. Works with amplifiers up to 100 watts. Magnet structure: 10 1/2 lbs. Diameter: 15 1/8". Depth 7". Impedance: 8 ohms.

32 F 38516W Shpg. wt. 14 1/4 lbs. . . . . Net 105.00

**Model 421A.** 15" speaker. Specifically for bass instruments. Works with amplifiers up to 100 watts. Magnet structure: 17 1/2 lbs. Diameter: 15 1/8". Depth 6 1/8". Impedance: 8 ohms.

32 F 38524W Shpg. wt. 25 lbs. . . . . Net 120.00

Model 417-8C



Model 418B

Model 421A

## Banshee Voice Speakers



- Boosts Vocals Above Instrument Levels

**Model CJ-40.** Voice speaker. Minimizes feedback, boom, annoying harmonics. 150-14,000 Hz. 40 watts peak music power. Mounts on any mike stand. 14 x 6 x 12 1/4". 8 ohms.

44 F 10361W Shpg. wt. 9 lbs. . . . Net 46.50

**Model CJ-125.** "Big Banshee." Has 125W peak music power. 10-12,000 Hz. 23x13x19".

44 F 10379W Shpg. wt. 20 1/2 lbs. . . Net 92.55

**Model SS-4.** Weighted brass speaker stand. Chrome steel tubing, extends over 6 feet.

44 F 10387W 17 1/2 lbs. 22.05

**"Vu-Pitch" 6-String Guitar Tuner.** Now anyone can tune a guitar using principle of sympathetic visible vibration. Great for beginner. Assures rapid, professional tuning.

13 F 48507 6 oz. . . Net 5.25

**Seiko Keywound Metronome with Bell.** Both visual and audible beat, timing from 40 to 208 beats per min. Operates over 1 hour when set on 40 scale. Imp.

13 F 66558 1 1/2 lb. Net 18.95

**Gibson Cassette / Book "How to Play Guitar."** Fast, easy way to learn at your own comfortable pace. Each program contains 60 min. cassette and Instruction book. Shpg. wt. 8 oz.

13 F 52053 Country Guitar Net 18.95

13 F 52061 Rock Guitar Net each 4.95

13 F 52079 Folk Guitar Net each 4.95



\$525



\$18<sup>95</sup>



\$4<sup>95</sup>

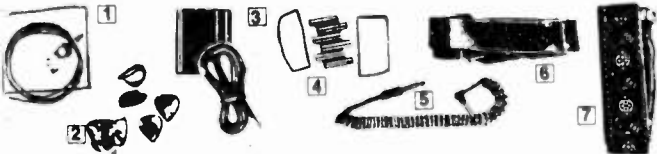

Average shpg. wt. 8 oz.

(1) Guitar Strings. Set of 6, plated copper wire wound. Net 1.79

13 F 22536 (1) Nylon Classic Guitar Strings. Set of 6. Net 1.79

13 F 22544 (1) Electric Guitar Strings. Flat wound. Set of 6. Net 2.59

13 F 22528 (1) Deluxe Electric Guitar Strings. Gibson, flat wound hi-fi strings. Net 5.95

13 F 52871 High quality. Set of 6. Net 8.95

(1) Bass Strings. Flat wound steel, wrapped in silky black nylon. Net .59

13 F 81524 Set of 4. Net 1.69

(2) Guitar Picks—6 Flat, 2 Thumb. Net 1.95

13 F 22569 (3) Adjustable Foam-Padded Guitar Strap. Net 3.95

13 F 22502 (4) Guitar Pitch Pipe. Net 2.50

13 F 22510 (5) Retractable Guitar Cords with Plugs. Net 3.95

13 F 52889 10 Ft. Net 3.19

13 F 52897 20 Ft. Net 3.19

(6) Deluxe Adjustable Bright Sparkle Vinyl Neck Strap for Guitar. Net 2.49

13 F 22585 Brass-Plated Buckle. Net 2.49

(7) Deluxe Adjustable Embroidered Hootenanny Neck Strap. Colorful fabric and leather, brass-plated buckle. Net 2.49

13 F 88016

## "Universal" Acoustic Guitar Pick-up System

**\$39<sup>95</sup>**

- For Steel/Classic
- Easy Mounting
- Reproduce Entire Tonal Spectrum

Complete kit includes Instructions, all cables, adjustable pickup "rail," variable damping system. NOTHING ELSE TO BUY! Shpg. wt. 8 oz.

13 F 66764 . . . . . Net 39.95



## Guitar Self-Instructor for Beginner

**\$150**

Book and record. Chord sounds and pictures with strum-along favorites.

12 F 67079 Shpg. wt. 6 oz. . . . . Net 1.50

# LAFAYETTE Wireless Intercoms—Plug Into AC Outlets

Easy to use ... no wires to attach ... compact



**\$37<sup>95</sup>** 3-Channel Solid-State AM  
Each Station Wireless Intercom

- 3 Simultaneous But Independent Communications on Separate Channels
- Each Station a "Master"
- Built-in Squelch and AGC
- Tone Call Alert Button

Features Call Button with pleasant tone; Press-to-Talk bar with "lock-talk" feature for continuous monitoring; Volume, Channel Selector. Advanced circuit design with built-in pre-set squelch and AGC to prevent overloading and provide high isolation between channels. Dependable fused transformer power supply with pilot light. Solid-state with 5 transistors, 4 diodes. 7 1/4" W x 5 1/2" D x 2 3/4" H. For 117 VAC, 60 Hz. 99 F 46500 Imported. Wt. 3 lbs. Net ea. 37.95

Lafayette  
FM-50 3-Channel  
Wireless Intercom



**\$59<sup>95</sup>**  
Each Station

Automatic  
Squelch,  
Tone Alert

- FM Circuitry Increases Sensitivity, Reduces Noise Interference

Features high-power output and FM circuitry for clear transmission without interference. Improved selectivity reduces adjacent channel interference. Up to 3 simultaneous but independent communications on separate channels. Channel separation 40 dB. Solid-state: 1 IC, 9 transistors, 7 diodes. Press-to-Talk bar with "lock-to-talk." 7 x 5 1/2 x 2 1/2". For 117VAC, 60 Hz. Wt. 3 1/2 lbs. 99 F 46468 Imported. . . . . Net ea. 59.95



## Wireless 2-Station Systems

**\$39<sup>95</sup>**  
2 Stations

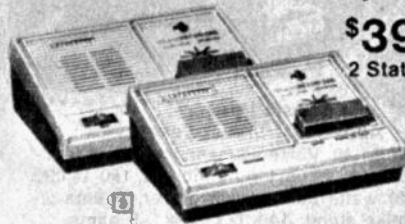

**\$27<sup>95</sup>**  
2 Stations

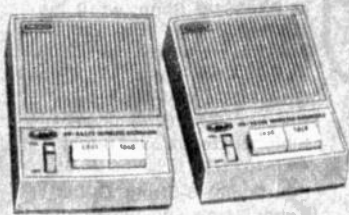

- Instant-on Communications
- Each Unit a "Master"—Use As Many as You Need
- Solid-State Circuitry

**1** Quality 2-Station Intercom System will connect any 2 places serviced by same power line transformer. No wiring. Just plug into AC outlet. Four-transistor circuit. Volume On-Off; Push-to-Talk with "lock-bar"; pilot light. 6 1/2 x 5 x 2 1/2" H. For 110-120 VAC, 60 Hz. Imported. 99 F 45734M Shpg. wt. 4 1/4 lbs. . . . Net 39.95 Extra Station. Imported. Shpg. wt. 2 1/4 lbs. 99 F 45726 . . . . . Net 22.50

**2** "Mini" 2-Station Wireless Intercom. For communication between rooms in your home. Just plug into outlet. Solid-state. Wide range speaker for fine tone quality. Wall-lock button; volume; on/off; pilot light. 3 3/4" W x 5 1/2" D x 1 3/4" H. Imported. For 110 VAC, 60 Hz. 99 F 46278 Shpg. wt. 2 1/2 lbs. . . . . Net 27.95

## LAFAYETTE IM-50 Multi-Station Intercoms Featuring Instant Plug-in Wiring

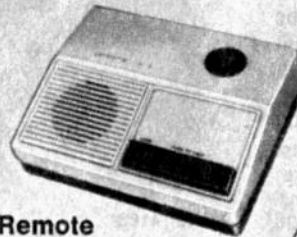

RI-5 Remote  
**\$19<sup>95</sup>**  
ea.



IM-50 Master  
**\$49<sup>95</sup>**  
ea.

- 3 Selective Systems Can Be Hooked Up . . . Master-to-Master; Master-to-Remote; Intermixed
- Very Simple Hook-up for Versatile Systems
- Powerful Solid-State Circuit for Noise-Free Transmissions

Lafayette's IM-50 System. Includes 50-ft. multi-conductor cable with connectors on each end for hooking up Master-to-Master. Multiple 50-ft. cable can be interconnected to extend the distance of each Master-to-Master unit. Remotes are connected to Master by using separate 3-conductor intercom cable (see listing below). Three separate types of installation: (1) Master-to-Master—up to 6 separate stations enabling 3 private conversations or 6 station conferences. (2) Master-to-Remote—1 Master communicates with up to 5 remotes separately or in conference. (3) Master-Remote Intermix—

up to 6 Masters and 30 Remotes. Each Master in Master-to-Master can accommodate up to 5 remotes. Indicator Lights; Call Button. Each 7 x 5 1/2 x 2 1/2". For 117 VAC, 60 Hz Imported.

99 F 46478 IM-50 Master. 3 lbs. . Net 49.95  
99 F 46484 RI-5 Remote. 2 lbs. . . Net 19.95

### CABLE FOR IM-50 SYSTEM

50-ft. 7-Conductor Cable with plug-in connectors on each end for Master-to-Master. 99 F 46492 Shpg. wt. 2 lbs. . . . . Net 12.95

100-ft. 3-Cond. Cable for Master-to-Remote. 32 F 14525 Shpg. wt. 2 1/4 lbs. . . Net 4.35

Charge It with Your BankAmericard or Master Charge.



# Solid-State Intercom Systems For Home And Office



## Executive Series High-Powered Intermix Intercoms

- Each Station Contains Privacy Switch to Prevent Eavesdropping
- Balanced Line Design Eliminates Cross-Talk and Reduces Line Loss
- Remotes Can Originate Calls



Intermix capability permits added versatility in these professional intercom systems. The Executive 7 Master handles any combination of seven master and remotes (including paging horns); the Executive 13 Master, any thirteen stations. Delivers one watt of power for normal station-to-station, with four watts reserved for paging into noisy areas. Model PR-17 relay, connected to a separate P.A. system, allows higher power paging and "hands-free" talk back. Master has monitor light, busy light advising that the station called is busy, and UL listed power supply. Charcoal brown, high-impact cabinets. Requires one pair of wires plus one pair for every station. Add one shielded wire between each remote and its master(s).

44 F 30450 Executive 7 Master (Fig. 1). Shpg. wt. 4 lbs. . . . . Net 82.50  
 44 F 30468 Executive 13 Master. Shpg. wt. 4 lbs. . . . . Net 99.95  
 44 F 30476 Executive 1 Remote (Fig. 2). Shpg. wt. 2 lbs. . . . . Net 19.85  
 44 F 30484 Model PR-17. Paging relay. Shpg. wt. 1 lb. . . . . Net 31.75

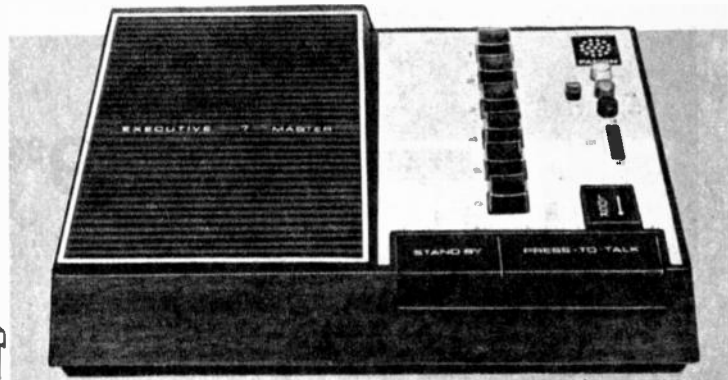

1 \$82.50

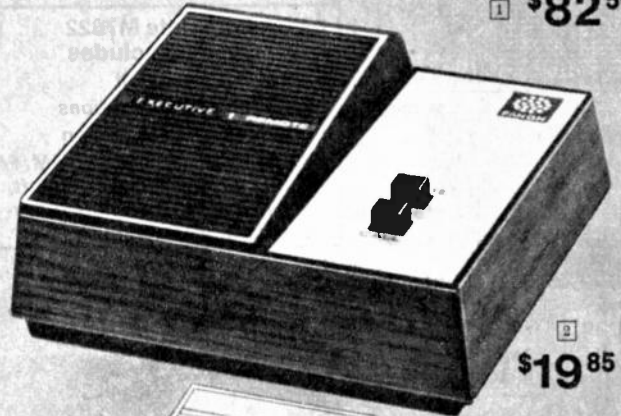

2 \$19.85

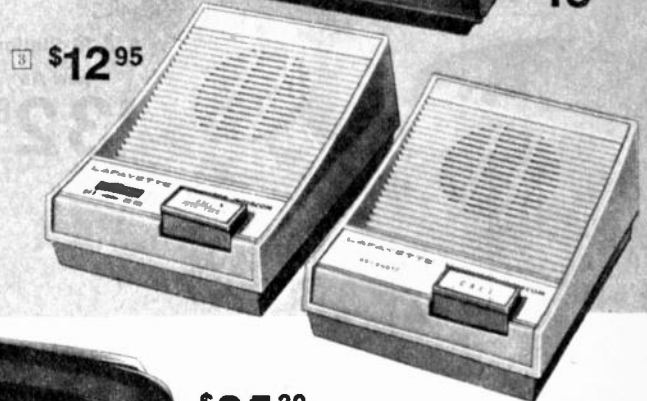

3 \$12.95

## Lafayette Solid-State 2-Station Intercom System

- Simple, 70-foot Plug-in Connecting Cord
- Inter-Unit Tone Calling • Battery Operated

Battery-operated intercom system, especially useful where AC outlets are not readily available. Includes 1 Master, 1 Remote, 70 feet of cable with molded plugs. Master unit features On/Off/Volume control plus Listen/Call-Talk switch. "Beep" tone signaling from either unit operates even when Master is off. Desk- or wall-mounted. Includes 9-volt battery. 2H x 3 1/2 W x 4 1/8" D. Shpg. wt. 1 3/4 lbs.

99 F 46617 2-Station System. (Fig. 3) . . . . . Net 12.95  
 99 F 60212 Extra 9-Volt Battery . . . . . Net .39

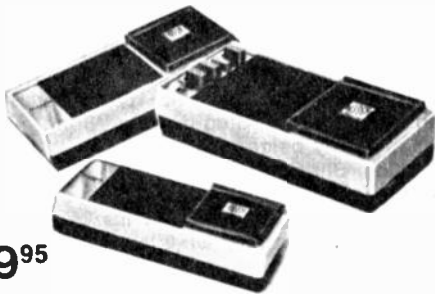

\$49.95

## Fanon IN-404 Solid-State 3-Station Intercom System

- Plug-in Wiring for Instant Installation
- With Two 50-ft. Cables and Plugs

Versatile system features the IN-400 Master Station, two IN-2 Indoor Remote Stations, two lengths of 50-ft. cable. Master accepts up to four remote stations, indoor or outdoor. Master calls any or several rooms desired. Remotes have "beep call" signal. Ivory/brown with wood grain accents. 7 x 3 1/2 x 2". For 117 VAC. Imported.

44 F 30294W Shpg. wt. 15 lbs. . . . Net 49.95  
 Extra indoor remote with 50-ft. cable, plug. 44 F 30302 Shpg. wt. 4 lbs. . . . . Net 10.75  
 Outdoor remote with 50-ft. cable and plug. 44 F 30310 Shpg. wt. 4 lbs. . . . . Net 10.75  
 Additional 100-ft. cable with plugs. 44 F 30328 Shpg. wt. 1 lb. . . . . Net 6.00

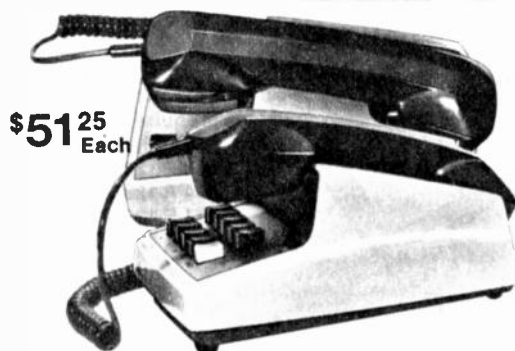

\$51.25 Each

## Fanon Select-Talk Solid-State Internal Telephone System

Features selective tone calling, pushbutton convenience with automatic reset, and with all-master, master-to-remote or full intermix. Operates for paging and talkback with optional relay. Wiring master-to-master: 2 wires plus 1 for each phone; master-to-remote: 3 wires plus 1 for each remote.

Model ST-10. 10-Station Capacity Phone. 44 F 30419 Shpg. wt. 3 1/2 lbs. . . . . Net 51.25  
 Model ST-1. Remote Telephone. 44 F 30427 Shpg. wt. 3 1/2 lbs. . . . . Net 36.25  
 Model PS-CST. Power Supply for ST series. 44 F 30435 Shpg. wt. 1/2 lb. . . . . Net 30.95  
 Model PR-99. Paging Relay. Used with PA. 44 F 30443 Shpg. wt. 1/2 lb. . . . . Net 28.30

\$35.30 Each



## Fanon IN-600 All Master 5-Station Intercom

Features plug-in wiring for "Instant Installation." Fully selective; any station can speak to one or more others. Permits conference calls. Two separate conversations may proceed simultaneously. Includes 50-ft. multi-conductor cable with plugs. Powerful IC circuitry. 117 VAC. 7 x 3 1/2 x 2". Imported.

44 F 30278 Shpg. wt. 3 3/4 lbs. . . . Net 35.30  
 Extra 50-ft. cable (6 cond.) with plugs. 44 F 30286 Shpg. wt. 1 3/4 lbs. . . . . Net 12.75  
 IN-603. 3-Station All Master "Package." Consists of three 5-station masters, two 50-ft. cables with plugs. AC operated. Imported. 44 F 30401W Shpg. wt. 10 lbs. . . . . Net 89.95

# Quality Intercom Systems for Home or Business



M 7021

**\$189<sup>95</sup>**

Complete System  
M 7022

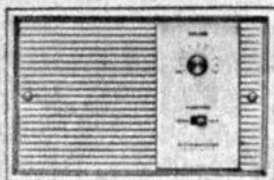

M 7305



M 7306

### Complete M7022 System Includes

- AM/FM Master Unit
- 3 Indoor Remote Stations
- Entrance Remote Station
- Kit with Plaster Frames, AM/FM Antennas, Transformer, 200-ft. 3-Wire Cable, Complete, Easy-to-Follow Instructions

## Emerson-Rittenhouse AM/FM Home Radio-Intercom System

- Radio Automatically Silences During Intercom Calls or While Answering Door
- Complete Room-to-Room Communication. Remote Stations Answer Hands-Free to Master Station
- Answer Door from Any Station. Visitors Can Talk Hands-Free to Master Station

Solid-state, handsomely-styled AM/FM radio intercom system. Intercom permits room-to-room communication, monitoring, door answering. Separate master volume control. Input for phono, tape or chime. Up to 8 stations may be connected to master. Color-coded wiring. Radio has tuned RF for excellent FM performance. Powered by UL listed low-voltage transformer (supplied). Dimensions: M 7022 Master Unit—14½ x 9¾"; M 7305 Remote Station—8¾ x 5½"; M 7306 Entrance Station 2¾ x 4½". For 117 VAC, 60 Hz.

44 F 46043W Shpg. wt. 12½ lbs. . . . . Net 189.95

### Additional Stations and Wire for Above System.

44 F 46050 M7305 Indoor Remote. Shpg. wt. 1¾ lbs. . . . Net 11.95

44 F 46068 M7306 Entrance Remote. Shpg. wt. 1 lb. . . . Net 14.95

32 F 14525 100-ft. 3-Cond. Cable. Shpg. wt. 2¼ lbs. . . . Net 4.35

## BOGEN Telephone Intercom Systems

### TQ Series—Selective Ring—Common Talk

**1** TQ Series. Allows one conversation at a time. "Conference" feature allows talk to as many stations at once as there are receivers. Two models: for up to 6 or 12 stations. Both with snarl-proof 4-ft. handset coil, 6-ft. master cable with junction box for easy wiring. Requires PRS-1A Power Supply (117 VAC, 60 Hz). Phones in sturdy beige plastic.

44 F 12045 TQ6A 6-Station Phone. Less wire. Wt. 4½ lbs. Net 32.80

44 F 12052 TQ12A 12-Station Phone. Less wire. 4½ lbs. . . Net 36.80

44 F 12060 PRS-1A Power Supply. Shpg. wt. 2½ lbs. . . . Net 26.25

Page Adapter (for paging thru a PA system).

44 F 12334 Shpg. wt. 2 lbs. . . . . Net 30.90

### TSL-X Series—Selective Ring—Selective Talk

**2** TSL-X Series. Allows 8 separate conversations at same time with Model TSL-16X; four separate conversations with Model TSL-8X. Each phone with 4-ft. snarl-proof handset cord and 6-ft. master cable with junction box for easy wiring. One PRS-16A Power Supply required to power each system. (Easy, Step-by-Step Wiring Instructions Included). Phones in sturdy beige plastic.

44 F 12359 TSL-8X 8-Station. Shpg. wt. 3¾ lbs. . . . . Net 54.70

44 F 12367 TSL-16X 16-Station. Shpg. wt. 3¾ lbs. . . . . Net 62.85

44 F 12037 PRS-16A Power Supply. Shpg. wt. 2¾ lbs. . . . Net 43.65

44 F 12342 Phone PA Page Adapter. Shpg. wt. 2 lbs. . . . . Net 30.90

### BOGEN 7- and 13-Station Intercoms

**3** All Master System. Multiple-conversation system using up to 7 IE-7 masters or up to 13 IE-13 masters. Any master can call one or more stations. IE-7 and IE-13 masters have volume control, press-to-talk bar with dictate lock, rugged switches with identification strips. For 120 VAC, 50-60 Hz.

**1** Single Master-Multiple Remote System. One IE-7 master and up to six RIE-1 remote stations or one IE-13 master and up to 12 RIE-1 remote stations. Can call one station or several simultaneously. RIE-1 remote station can originate calls to master privately or non-privately. RIE-1 remote has press-to-talk bar, privacy switch. For 120 VAC, 50/60 Hz. Each IE-7 Master Used in a System Requires One JBE Junction Box. Each IE-13 Master Used in a System Requires Two JBE Junction Boxes. (Step-by-Step wiring instructions incl.).

44 F 12318 Model IE-7 7-Station Master. Wt. 3¾ lbs. . . . Net 45.40

44 F 12300 Model IE-13 13-Station Master. Wt. 3¾ lbs. . . Net 55.45

44 F 12292 Model RIE-1 Remote Station. Wt. 2¼ lbs. . . . Net 14.65

44 F 12326 JBE Junction Box. Shpg. wt. 13 oz. . . . . Net 5.70

Lafayette—Your "Single-Trip" Source for Everything in Electronics

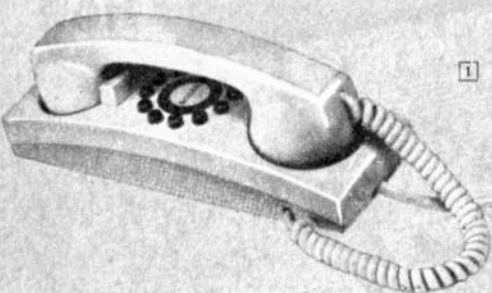

**1** 6 & 12-Station  
Low As  
**\$32<sup>80</sup>**



**2** 8- & 16-Station  
Low As  
**\$54<sup>70</sup>**

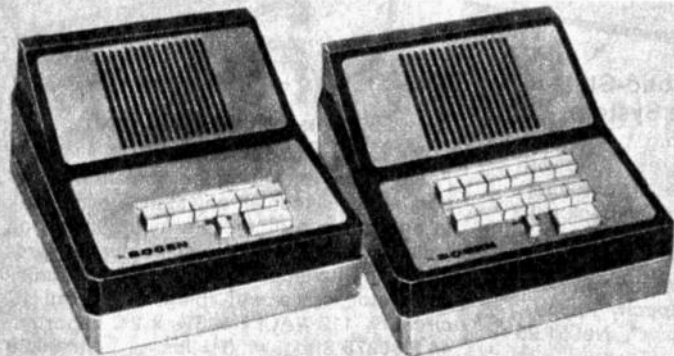

Model IE-7

Model IE-13

**3** **\$45<sup>40</sup>**

**1** **\$55<sup>45</sup>**

# Make Your Telephone a "Full-Time Partner" With These "Space-Age" Automatic Devices from phone·mate

## Telephone Answering/Recording Devices

### Model 300S — Records 20 Thirty-Second Messages

Answers the phone in your own voice and records the caller's message. Operates with any type telephone. Simply plug phone into standard 4-prong jack on Phone-Mate. Also lets you listen to calls without touching phone to "screen out" unwanted calls. Accepts up to 20 messages on standard cassette. In good-looking plastic cabinet, 9½ x 12 x 3½". Includes four long-life "D" alkaline batteries.  
27 F 58043WX Shpg. wt. 14 lbs. . . . . Net 79.50

**\$79<sup>50</sup>**

### Model 400S — Records 30 Thirty-Second Messages

Same features as Phone-Mate 300 above, but with 30-message capacity, deluxe fine-grain walnut-veneer cabinet. Answer-only selector, and monitor switch. Message-received signal flag.  
27 F 58019WX Shpg. wt. 14 lbs. . . . . Net 139.50

**\$139<sup>50</sup>**

### Model 800S — Records 30 Messages, Provides Two Outgoing Messages

Deluxe answerer has all the features of 400S above, plus Erase button to erase previous messages, fast-forward to "skim" messages, two-track answer tape to let you record two different messages and select either one at the flip of a switch, ring-adjust to accept messages after 2nd, 3rd, etc., ring. Earphone for private listening.  
27 F 58035WX Shpg. wt. 16 lbs. . . . . Net 159.50  
KTA Adapter. Lets you use Phone-Mates with Multi-Line Phone Systems.  
27 F 58027 Shpg. wt. 6 oz. . . . . Net 29.95

**\$159<sup>50</sup>**

### Remote-Mate — Dial-In for Your Messages

Attaches to 300S, 400S, and 800S—lets you call in and activate answering device to pick up your messages from any phone in the world! Includes specially coded pocket phone-activator—activates your phone only. Each time you call in, Phone-Mate resets itself at the beginning of the tape and plays any messages you may have. Includes 6 long-life "D" alkaline cells. 9½ x 12 x 2¾".  
27 F 58001WX Shpg. wt. 10 lbs. . . . . Net 129.50

**\$129<sup>50</sup>**

## Automatic Telephone Dialers

### 1 Dial-Mate — Automatically Dials 40 Numbers

Dialing convenience at the push of a single button. Remembers up to 40 of your most-used numbers (even long-distance) and dials the complete number automatically. Easy programming too—all you do is dial the numbers once in the usual way—the magnetic tape on your Dial-Mate remembers them instantly—that's all there is to it! Numbers can be "erased" and changed at will. 11¾ x 3¾ x 12¾". For single-line phone systems.  
27 F 58050WX Shpg. wt. 9 lbs. . . . . Net 79.50  
Dial Mate for Multi-Line Phone Systems.  
27 F 58068WX Shpg. wt. 9 lbs. . . . . Net 89.50

### 2 Star-Touch—The Phone That Remembers

The touch-tone extension phone with the extra touch—automatically redials the last number (up to 14 digits) you have dialed at the touch of the button. Great for re-dialing busy numbers. **DIALING IN POLICE BEFORE YOU RETIRE AT NIGHT FOR EXTRA SECURITY**, even for use as a pushbutton extension phone. Works with any single-line phone system, stylish white cabinet. With standard 4-prong phone plug. 12 x 8 x 8".  
27 F 58084WX Shpg. wt. 6 lbs. . . . . Net 119.50

### 3 Dial-Mate with Phone Conferencer

THE phone accessory for business offices, ad agencies, brokers, anywhere phone use is extensive. Dials up to 40 programmed telephone numbers at the push of a button (see 1 above); also has built-in 4-party conference circuit with up-front controls: dial out on any of other 3 lines, route through to your WATS long-distance line from any phone; set up conference calls; transfer your calls to another number. Operates on 4 "D" cell batteries (included). compact walnut-grain cabinet, only 12x12x3". For multi-line phones.  
27 F 58076WX Shpg. wt. 9 lbs. Less Telephone . . . . . Net 139.50

**Note: Check with Local Phone Company for Installation Requirements, if any, on All Above Items.**

Lafayette—Your "Single-Trip" Source for Everything in Electronics



Model 400S



### All Models Have These Great Features

- Provide 30-Second Outgoing Message
- Fully Self-Contained—No Add-on Recorders Required
- All Attach to Remote Dial-In Module for Extra Convenience



**\$79<sup>50</sup>**



**\$119<sup>50</sup>**



**\$139<sup>50</sup>**

# Phone Answering and Accessory Equipment

You Can Call In For Your Messages  
From Anywhere  
In The World



## COMMAND-A-FONE Telephone Answering and Recording Machine with Remote Playback

**\$579<sup>95</sup>** • Direct Connection to Phone Line  
• Can Work as a Dictating Machine  
• Handles Up to Thirty 30-Sec. Messages

Complete telephone answering and recording device even includes a pocket tone oscillator that allows remote control instant replay of your callers' messages. Messages are recorded on a continuous loop tape. Reserve tape announces when recording tape is full. Outgoing messages are recorded (mike included) on a 20 sec. tape (included). Built-in speaker. 14 x 10½ x 3¼". For 117 VAC, 60 Hz.

27 F 39027WX Imported. Wt. 20 lbs. . . . . Net 579.95

Model AR-747. Same as above but without Call-in Feature.

27 F 39001WX Wt. 20 lbs. . . . . Net 379.95

27 F 39019 Extra 20 Sec. Out going Message Tape. 6 oz. Net 7.50

## tensorphone Model 5000 Answering and Recording System

Answers your telephone on the first ring, activates a recorded announcement in your own voice, records the caller's message. Includes 60 sec. 8-track announcement tape; 60-min. cassette tape for messages (use longer cassette for more messages). Starts recording immediately—even if caller hangs up before your message is over. Excellent security. With monitor provision, "beep tone". Also operates as standard cassette player/recorder. 117VAC, 60 Hz. U.L. listed.

27 F 74024W Shpg. wt. 9½ lbs. . . . . Net 169.95

27 F 74008 Extra 1 Min. Message Tape. Wt. 2 oz. . . . . Net 4.95

- Call Light Indicator
- Interchangeable Announcement Tapes

**\$169<sup>95</sup>**

## VOICECASTER "Hands-Free" Telephones

• A Totally New Concept in Telephone Design

1 Model 1200 with standard dial. Allows hands-free conversation anywhere in the room. The only time you need to be near the phone is when you start or end a call. You can talk or listen from up to 20 feet away. 1-room, 1-phone conference call capability. With voice volume control, standard phone dial and ultra-modern design. Solid-state microcircuitry. Easy installation. For 117 VAC, 60 Hz.

27 F 21520W Shpg. wt. 2 lbs. . . . . Net 129.95

2 Model 1300. Same as above but with pushbutton dial.

27 F 21512W Shpg. wt. 2 lbs. . . . . Net 129.95

Model DB-115. Decorator base. Voicecaster speaker is automatically cut-off upon lifting the handset, permitting conventional telephone operation for added privacy. With handset.

27 F 21504W Shpg. wt. 3 lbs. . . . . Net 49.95



**\$129<sup>95</sup>**

**\$129<sup>95</sup>**

Voicecaster Shown on Optional Base

## 4 Tele-Secretary

Automatically maintains a daily record of all conversations and transactions made on your telephone. Attaches to your phone line or any standard cassette tape recorder with a remote control microphone input jack. Completely self-contained. Size: 1¾ x 1¾ x 5/8". Shpg. wt. 1 lb.

44 F 67007 . . . . . Net 24.95

## 5 5-Position Telephone Conference Caller

Enables anyone having a telephone with 2 or more trunk lines to arrange a conference with 5 outside phones. Easy to install. Includes 5 hold buttons, patch cord for plugging in a tape recorder. Size: 12½ x 3¼ x 6¾". Shpg. wt. 3 lbs.

44 F 69003 . . . . . Net 59.95

## 6 Lafayette Solid-State Deluxe Phone Amplifier

Great for conferences, lets everyone in the room listen to calls. Simply place the phone on the amplifier and adjust the volume. Battery powered with an inductive pick-up. Separate 3" remote speaker. Battery included. Amp: 9¾ x 4¼ x 3"; Speaker: 3 x 4 x 3". Imported. Wt. 1½ lbs.

99 F 91829 . . . . . Net 16.95

99 F 60212 9V Battery . . . . . Net 39¢

## 7 Snap-on Telephone Amp and Hearing Aid

Miniature, portable, designed to fit any modern phone. Has volume control. Ideal for the hard-of-hearing. 2" dynamic speaker. Size: 2½" around, 1" deep. With battery and snap-around band. Imported. Shpg. wt. ½ lb.

99 F 92082 . . . . . Net 10.95

Replacement Alkaline Battery.

32 F 47541 Pkg. of 2. . . . . Net 93¢

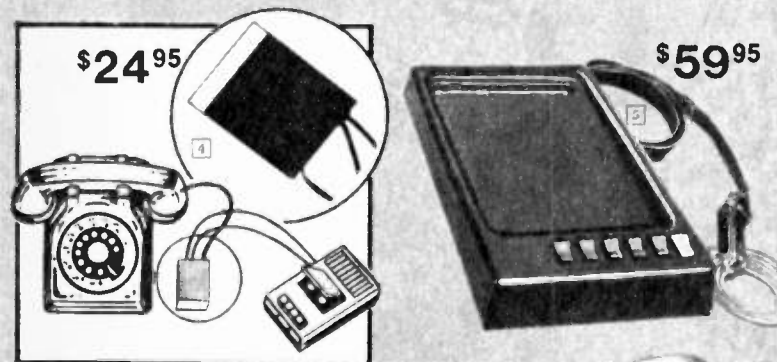

**\$24<sup>95</sup>**

**\$59<sup>95</sup>**

**\$16<sup>95</sup>**

**\$10<sup>95</sup>**

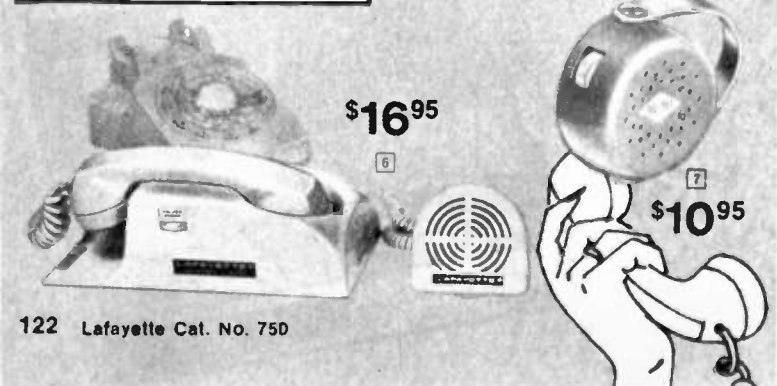

# Call Lafayette for Phones and Phone Aids

## Tomorrow's Phones Today!

All phones below are completely compatible with existing phone systems. All include standard 4-prong phone plug for fast, easy hookup.

**1 "Apollo".** The "Space Age" design phone that's a conversation piece you'll talk with and about! Elegantly styled vertical rectangular shape of transparent Acrylic offset by a flat rectangular base. Chrome and black receiving set on the side. Shows inner working—bell, wires, connections, etc. 9" high, 5½ x 6½" base. With standard phone plug.

44 F 19081W Shpg. wt. 8 lbs. . . . . Net 125.00

**2 "Periscope".** Modern and streamlined—a handsome and practical addition to most any decor. 15½" high cylindrical "periscope" shape in clear Acrylic plastic with 6½" pure white base. Front of "Periscope" is dial for ease and convenience, inner workings of phone are shown clearly. Gleaming chrome and black receiver set.

44 F 19511W Shpg. wt. 11 lbs. . . . . Net 195.00

**3 "Teledome".** Sleek, modern and functional—cube-shaped base of rich black Acrylic is topped by a transparent hemispherical dome that shows phone parts and has an easy to use front-facing dial. Interesting contrast of square and circle. Chrome/black receiver. 12 x 12" base.

44 F 19503W Shpg. wt. 11 lbs. . . . . Net 175.00



**4 Telephone Silencer.** Talk to others in room without caller hearing. Attaches to any phone.

44 F 72007 Wt. 2 oz. . . . . Net 3.98

**5 Dual Phone Listener.** Attaches to phone—lets 2 people listen to a single call. Imported.

44 F 27019 Wt. ½ lb. . . . . Net 1.99

**6 Telephone Plugs and Jacks.** Ivory finish. Jack mates with plug. Imported.

44 F 60036 Plug. 3 oz. . . . . Net 89¢

44 F 60028 Jack. 6 oz. . . . . Net 89¢

**7 Wall-Plate Outlet Kit.** With jack, mtg. bracket for standard outlet box, hardware. Flush mounts.

44 F 86007 Wt. 6 oz. . . . . Net 1.79

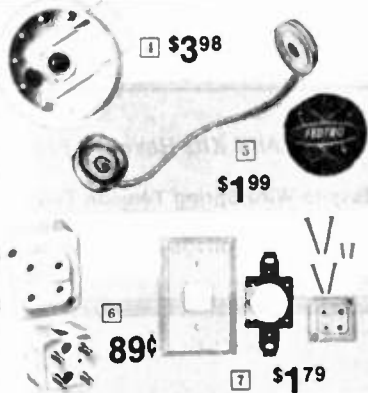

**8 Coiled Phone Cords.** 4-cond. Extends to 5', retracts to 10". Vinyl insulated, metal spade lugs. Imp.

99 F 46005 Shpg. wt. 3 oz. Net 2.39

99 F 46013 Above, 3-cond. Net 2.29

**9 30-Ft. Extension Cord.** Color-coded with 4-pin plug, jack. Imp.

99 F 45395 Wt. ¾ lb. . . . . Net 3.99

**10 Jack-in-a-Plug.** Connects two phones to a single jack. No power loss. Meets Phone Co. regs. Imp.

44 F 19016 Wt. 6 oz. . . . . Net 1.69

**11 Instant Phone Outlet.** Converts junction box to outlet without disturbing present phone connections.

44 F 19057 Imported. 4 oz. Net 1.79



**12 Standard Dial Telephone.** Reconditioned. For extensions, intercoms, private systems. Taken from service, ready to work. Easy 3-wire hookup. With handset, bell, induction coil and cable. May vary slightly from photo.

44 F 18018 5½ lbs. . . . . Net 10.95

**13 Western Electric Sound Powered Handsets.** Simply connect with two-cond. wire and talk! No batteries or power required. Use any number of handsets on a single line. Retractable cord, alligator clips.

44 F 18034 1½ lbs. Net ea. 9.95

44 F 18042 4 lbs. . . . . Net 18.95

**14 French Cradle Telephone.** Stylish reproduction of turn-of-the-century telephone with bell, dial, horn, handset, 5-ft. cord and plug. For private systems or use as extension phone. Ivory with gold trim. 8½ x 8½ x 8¾". Imp.

44 F 19073 8¼ lbs. . . . . Net 54.95

**15 Roaring Twenties Phone.** Good-looking reproduction of the early phones used in the 20's and 30's—great for den, rec room, bar. Black with gold trim. With dial, ringer, induction coil, 4½" ft. cord and plug. 12" high, base diameter, 6". Wt. 6 lbs.

44 F 24008 . . . . . Net 44.95

**16 "Princess-Dutchess" Type Dial Telephone.** Brand-new compact phone adds a touch of elegance to your decor. For private systems, extensions, etc. With buzzer, dial, earpiece, transmitter, 6-ft. coiled cord with plug. Pearl white finish. 4 x 8½ x 4½".

44 F 17010 Imported. Shpg. wt. 3¾ lbs. . . . . Net 34.95



Check with Local Phone Co. for Installation Requirements, If Any

# Lafayette Projects Are Such Fun To Do...

## Lafayette 10-in-1 IC Electronic Project Kit with a Big, Working Integrated Circuit

**Build a Circuit Tester, Amp, Telegraph Transmitter, Radios, 10 in All**

- 10 Educational Electronic Projects
- Enlarged Visualized Integrated Circuit (IC) With Real Working Parts
- Components Mounted on Attractive Wood Molded Panel

Featuring a large-scale example of the miniature IC used in computers and home entertainment equipment, this kit lets you clearly see its components and connections. And easy-to-follow, step-by-step wiring instructions and diagrams show you how to use these components to construct ten fun and informative projects: Crystal Diode Radio; Integrated Circuit Radio; Single Transistor Radio; Record Player Amplifier; Wireless Telegraph Transmitter; Morse Code Oscillator; Test Oscillator; Circuit Tester; Audio Frequency Signal Tracer; and Water Purity Tester. Each assembly and disassembly in minutes! Size: 11 x 1 1/4 x 8". Imported.

99 F 35099 Shpg. wt. 1 1/2 lbs. . . . . Net 12.95  
99 F 60212 Extra 9-Volt Battery . . . . . Net 39¢

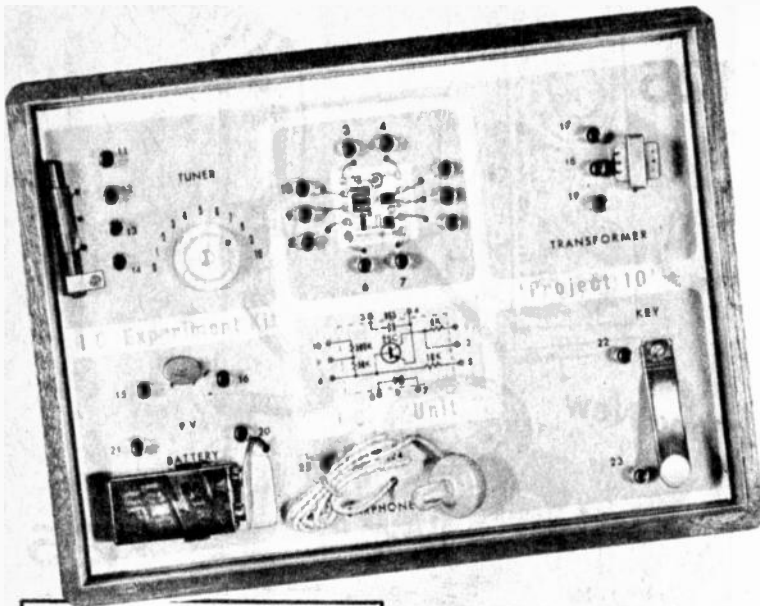

**Enlarged Visualized Integrated Circuit**



Clearly shows the functional components of a typical IC: transistor, capacitor, diode and resistors. A remarkable educational unit!

**\$12<sup>95</sup>**



**All 4 Kits Have the Features You'll Want . . .**

**Easy-to-Wire Spring Tension Terminals—100% Reusable Parts—No Soldering or Tools Required • Absolutely Safe—Entirely Powered by Low Voltage Batteries • No Technical Knowledge Needed**

## Our 150-in-1 IC Electronic Experimenter's Kit with a Big, Working IC and Much More

**Make Electronic Bongo and Organ, A Lie Detector Type Circuit, 150 in All**

- 150 Exciting Electronic Projects
- Enlarged Visualized Functioning IC, Mike, Speaker, Meter, Slide Switch, Solar Battery and CdS Photocell
- In a Compact, Sturdy Wood Carrying Case

A fully-visible, operating IC lets you make 150 different electronics projects in physics, chemistry, sound, broadcasting and household devices. Described both in words and diagrams in the simplified manual, each project utilizes wire spring tension terminals permitting reuse of parts. Batteries are used as a safe, low-voltage power source. Projects include: IC Record Player Amplifier; Click-Type Telegraph; Dual-Purpose Signal Tracer; Radio with Solar Battery Power; Electronic Fish Lure; IC Metronome; Electronic Harmonica; Lie Detector-Type Circuit; High RPM Warning Indicator; and Radio Direction Finder. Size: 15 1/2 x 3 1/2 x 8 1/2". Imported.

99 F 35107 Shpg. wt. 3 1/4 lbs. . . . . Net 39.95  
99 F 62572 Extra "C" Cells (2 required) . . . . . Net ea. 19¢  
99 F 60212 Extra 9V Battery. Imported . . . . . Net 39¢



**\$39<sup>95</sup>**



*Charge It with Your BankAmericard or Master Charge.*

# You'll Almost Forget They're Educational Too!

## Lafayette 20-in-1 Electronic Project Kit With a Solar Cell for Light Experiments

**Build Light Meters, Burglar Alarms, a Voice Transmitter, 20 in All**

- 20 Interesting Electronic Projects
- Contains a Morse Code Chart, Galvanometer and a Solar Battery
- Components Mounted on Five Separate Easy-to-Use Wiring Blocks

Utilizing safe, low-voltage power and spring tension terminals, this kit shows you how to build projects ranging from simple lamp circuits to transistorized communications sets. The kit provides clear and simplified instructions for twenty projects including: Crystal Radio; Transistorized Light Meter; Water Level Warning Circuit; Tone Morse Code Set; Light-Activated Electronic Organ; Wireless Voice Transmitter; Burglar Alarm; Water Purity Tester; Impulse Generator; and Telemetry Transmitter. You need never solder! Fitted case, 15 x 3 1/4 x 10". Imported.

99 F 35214 Shpg. wt. 3 lbs. .... Net 14.95  
99 F 62580 Extra "AA" Battery. Imported .....Net .14

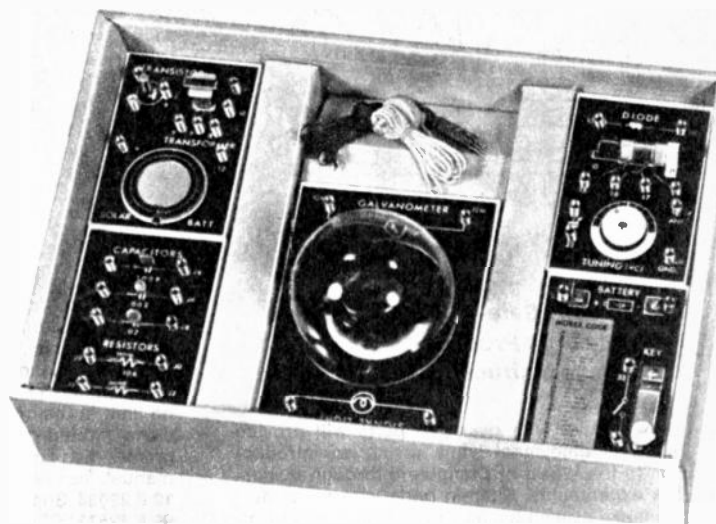

**\$14<sup>95</sup>**



**And Each Supplies Everything You'll Need!**

Each Includes: Tuner; Bar Antenna; Transistor; Capacitor; Transformer; Resistors; Telegraph Key; Earphone; Wire; Battery; Detailed, Simplified, Illustrated Instruction Manual; and Much More!

## Lafayette 80-in-1 Electronic Project Kit With Mike & Speaker for Sound Experiments, 80 in All

**Make Telephones, Remote Control Devices & an Electro-Stethoscope**

- 80 Fascinating Electronic Projects
- Microphone, Baffled Speaker, Volume Control, Solar Cell and Galvanometer
- "Breadboard" Component Arrangement In a Fitted Hardwood Case

Providing an ideal introduction to electronics, this project kit employs spring-type connectors which completely eliminate soldering! An easy-to-follow manual shows in detail how to construct eighty diverse and exciting projects including: Transistor Radios; Two-Transistor Public Address System; Wireless Telegraph; Burglar Alarm; Rainfall Warning System; Electric Tickler; Telephone Set; Computer-Type Circuits; Single-Pulse Muscle Stimulator; and Photo Electric Switch. Comes packed with reusable parts and low-voltage batteries in fitted hardwood case. Size: 15W x 4H x 8 3/4"D. Imported.

99 F 35016 Shpg. wt. 3 lbs. .... Net 27.95  
99 F 62580 Extra "AA" Cells (2 required) .....Net ea. .14  
99 F 60212 Extra 9V Battery. Imported .....Net .39

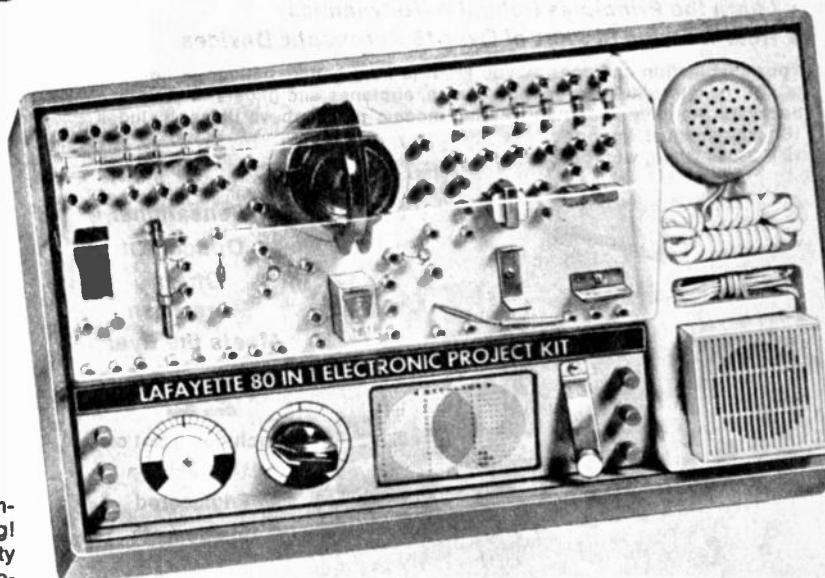

**\$27<sup>95</sup>**

# Science Fun Experimenters Kits by Logix

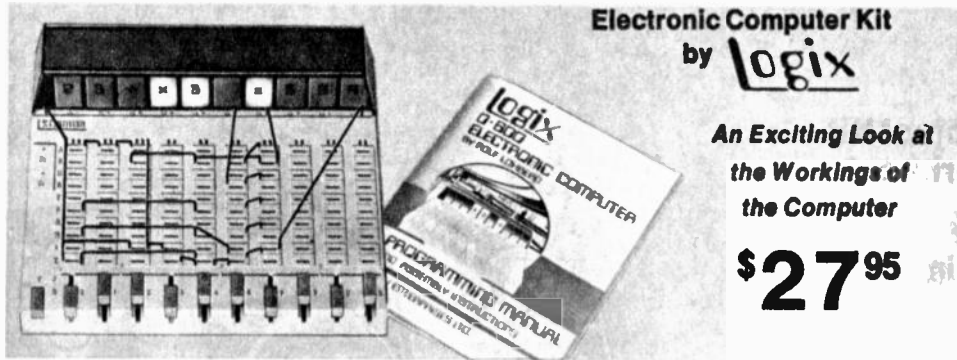

## Electronic Computer Kit by **Logix**

An Exciting Look at  
the Workings of  
the Computer

**\$27<sup>95</sup>**

- **Absolutely Safe—No High Voltage**
- **Variety of 50 Programs**
- **112-Page Instruction Booklet**

Computer kit with over 425 parts will provide hours of enjoyment while giving an introduction to the World of Computers through numerous experiments. Snap-In parts with no soldering make assembly easy. Start with simple projects

and progress to more complex experiments. Play computerized games, forecast weather, solve equations, program telephone calls, translate foreign languages, do crime detection and investigation of cybernetic problems. There is no limit to the creative mind, as there are provisions for individuals to create their own programs. Kit comes complete with instruction manual, less batteries. Imported.

19 F 23036 Shpg. wt. 4¾ lbs. . . . . Net 27.95  
99 F 52572 "C" Cell. For above (3 req.) Net ea. .19



## Telescope/Astronomy Project Kit

- **Powerful 6-Element Lens Refractor Telescope**
- **Moon Map, Rotating Sky Chart Enclosed**

Contains all necessary parts to build a 6-element lens refractor telescope to reveal the mysteries of the sky. Also enjoy an absorbing study of celestial bodies with a moon map and rotating sky chart. Imported.

19 F 23069 Shpg. wt. 1 lb. . . . . Net 9.50



## Complete Aeronautics Lab with Over 100 Experiments

**\$13<sup>75</sup>**

Build a Helicopter,  
Rocket, Glider,  
and a Helium Balloon

## Aeronautics Experimenter's Kit

- **Learn the Principles Behind Aerodynamics**
- **Real Working Models of Over 15 Aeronautic Devices**

Your imagination can soar as you learn to fly a helium balloon, a helicopter, or rockets with recovery parachutes, airplanes and gliders in your own backyard. Actually construct working models of the above items. Includes 160-page manual. Imported.

19 F 23044 Shpg. wt. 3 lbs. . . . . Net 13.75



## Electronics Experimenter Kit

**\$10<sup>95</sup>**

- **Over 40 Fun-Filled Experiments**
- **No Soldering—Snap Fit Assembly—No High Voltage**

A complete course in beginning electronics with a full range of experiments including lie detector, burglar alarm, quiz clock, signal light, radio and lots more! 80-page instruction manual. Imported.

19 F 23051 Shpg. wt. 2 lbs. . . . . Net 10.95  
99 F 62580 "AA" cell. For above (3 required) . . . . . Net ea. .14



## Sensational Optical Kit Offers More Than Meets the Eye!

**\$22<sup>50</sup>**

Includes a Set of  
114 Precision  
Engineered  
Components

## OPTICS Optical and Photography Kit

- **Build a Microscope, Telescope, or 35mm Reflex Camera**
- **Full 112-Page Illustrated Instruction Manual**

A challenging field in photography and optics awaits your eager mind. You can perform over 135 projects relating to prisms, lenses, images, and other light phenomena. Create special effects, study optical illusions. Imported.

19 F 23010 Shpg. wt. 3¾ lbs. . . . . Net 22.50



## Learn Electricity and Electrics Through This Easy Experiment Kit

**\$17<sup>95</sup>**

140 Safe,  
Intriguing  
Experiments  
in Electricity

## ELECTRICS Electricity Experimenter's Kit

- **Create Electromagnets, Alarms, Motors, and Much More!**
- **No Soldering—Easy Assembly—Low Voltage**

Complete kit offers a practical approach to learning electricity through a variety of experiments. Full instructions provide hours of fun and learning.

19 F 23028 Shpg. wt. 3½ lbs. Imported. . . . . Net 17.95  
99 F 62572 "C" Cells. For above (4 required) . . . . . Net ea. .19

Lafayette—Your "Single-Trip" Source for Everything in Electronics



# Enjoy a Leisure Hobby with these Quality Kits



**\$1475**

## Renwal Visible V-8 Engine Kit

There is no better way to learn how an engine works than to see it in action with this 1/4-scale "see thru" model V-8. See the spark plugs fire, the piston rods in action along with 100 other moving parts. Hardware, screwdriver, and easy-to-read manual included. Easy to assemble.  
**19 F 69005** Shpg. wt. 5 lbs. . . . . Net 14.75  
**"C" Batteries.** For above (2 required).  
**99 F 62572** . . . . . Net ea. .19

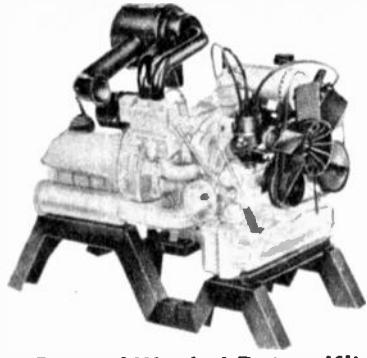

**\$1475**

## Renwal Wankel Rotary Kit

See the rotary "engine-of-the-future" operate with this "see thru" 1/2-scale model in sturdy, high-impact styrene. Show how it works and surprise your friends. Over 220 moving parts, full instructions. You can see spark plugs fire, rotary movements, crankshaft rotation and the other parts—same as a real engine!  
**19 F 69013** Shpg. wt. 4 lbs. . . . . Net 14.75  
**"C" Battery.** For above (2 required).  
**99 F 62572** . . . . . Net ea. .19



**\$650**

## Entex Visible Wankel Rotary Kit

Wankel engine kit has precolored parts that are all visible in operation. The 1/2-scale model has flashing plugs, and rotary discs for combustion. With fewer parts and a more compact size, it is a very efficient engine to study and build. Display stand included.  
**19 F 41004** Shpg. wt. 2 1/4 lbs. . . . . Net 6.50  
**"AA" Cell.** For above (2 required).  
**99 F 62580** . . . . . Net ea. .14

**\$2750**

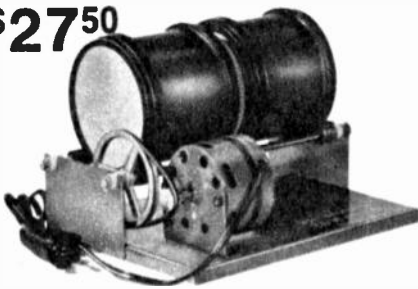

## Thumler's 6-Lb. Capacity Tumbler

Polish rocks with twice the speed as the 8-lb. capacity tumbler cleans and polishes rocks or stones in two heavy-duty barrels. Barrels included, less abrasives and stones, etc. Overload-protected motor, 117 VAC, 60 Hz. See accessory list below.  
**15 F 44535** Shpg. wt. 8 1/2 lbs. . . . . Net 27.50

### Accessories for Tumblers

- Grit and Polish Assortment Kit.** Complete 4-grade abrasive kit containing coarse and fine grits, pre-polish and polish. **15 F 44519** Shpg. wt. 2 1/4 lbs. . . . . Net 3.35
- Crushed Gem Mix.** A 1-lb. deluxe assortment of agate, aventurine, rhodonite and other exotic colored rock which will polish to a jewelry-like finish. **15 F 44527** Shpg. wt. 1 1/2 lbs. . . . . Net 3.35
- Jewelry-Making Kit.** Jewelry blanks for mounting polished stones. Make tie clasp, cuff links, charm bracelet, etc. Includes jeweler's cement, jump rings, etc. **15 F 44501** Shpg. wt. 7 oz. . . . . Net 2.25
- Extra Barrels for Tumblers.** All-rubber-molded, 3-lbs. capacity replacement barrel for tumblers listed on this page. **15 F 44550** Shpg. wt. 1 1/2 lbs. . . . . Net 3.95



**\$1850**

## Photography Darkroom Lab with Enlarger

Photography is the growing hobby of today. This kit comes with Photo Enlarger, Contact Printer, 35mm Projector. It's all complete and very educational. Print and develop your own photos, enlarge them if you like. Comes with developing chemicals, printing and enlarging paper, 3 trays, thermometer, neon safelight, and lenses. A truly unique package at a reasonable price for any photo buff. For 117 VAC, 60 Hz.  
**19 F 30031** Shpg. wt. 4 1/4 lbs. . . . . Net 18.50

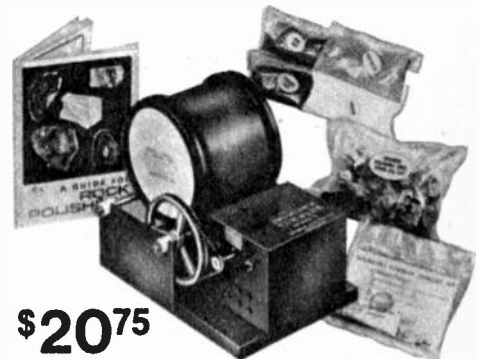

**\$2075**

## Thumler's Gem Stone Tumbling and Jewelry Making Kit

Enjoy the fascinating craft of polishing stones and making them into an art form. This kit is great for the beginner. It comes with a 3-lb. capacity tumbler with rubber barrel, 4 grades of grits and polishing abrasives, a pound of assorted exotic gem rocks, jewelry mountings like tie clasps, cuff links, charm bracelets, etc. Full instructions and a rock identification book included. Quiet operation. For 117 VAC, 60 Hz.  
**15 F 44543** Shpg. wt. 9 lbs. . . . . Net 20.75

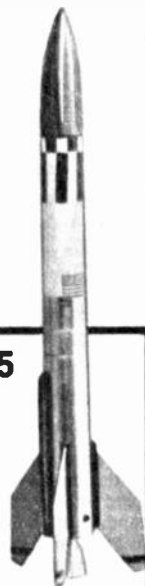

## Valkyrie-2 Rocket Kit

**\$1295**

Safe, fun to use, educational—soars over 1000 feet! Parachute recovery, electrical or mechanical. Working valve, separator and parachute, polished aluminum rocket. Non-flammable, non-toxic propellant. With rocket, firing assembly, launch stand, 1 can of propellant, accessories and instructions. 18 1/2" high x 1" diameter.  
**19 F 75010** Shpg. wt. 2 3/4 lbs. . . . . Net 12.95  
**19 F 75028 Prop.** for 3 Launches. 1 1/2 lbs. Net 1.95  
**32 F 48184 6-V Batt.** Use 1. 1 3/4 lbs. . . . . Net 1.26  
**19 F 75036 Replacement Igniter.** 3 oz. . . . . Net 35¢



## Weather Station Kit

**\$1350**

Don't guess at the weather — predict it! Includes an air tank barometer, a sling psychrometer, rain gauge, cloud chart, weather map and a forecasting manual. 150 ft. of wire. All you need for thorough weather analysis. Safety power cord. For 117 VAC, 60 Hz. Shpg. wt. 3 3/4 lbs.  
**19 F 30023** . . . . . Net 13.50



**\$9995**

## Jerobee Commando MK8B Radio-Controlled Racing Car

Space Age electronics brings you a radio-controlled race car that is just tops in enjoyment and skill. You can race Commando on concrete or asphalt at speeds of 240 scale miles per hour. It's completely assembled and controlled from the hand-held transmitter. No license required.  
**42 F 14003** Shpg. wt. 3 1/4 lbs. . . . . Net 99.96  
**"AA" Cells.** (4 required for receiver).  
**99 F 62580** . . . . . Net ea. .14  
**9-Volt Battery** for transmitter (1 required).  
**32 F 47053** . . . . . Net 1.86  
**Engine Starting Battery.** (1 1/2 V). (1 required).  
**32 F 48671** . . . . . Net 1.26

# Lafayette Fiber Optics Hobbyist Kits



## Hobbyist Fiber Optics Kit

**\$9<sup>95</sup>**

- Includes DC Light Source
- Colored Plastic Fibers
- Makes a Tree and Lamp

Colored plastic fibers let you make beautiful, decorative illumination. You get full instructions on handling, bundling, cutting and terminating optic fibers. Kit contains a 2-cell penlite light source (batteries not incl.), colored plastic fibers, unjacketed 1.8 mil glass fibers, all accessories, plus "Introduction to Fiber Optics Manual."

19 F 32011 Shpg. wt. ½ lb. . . . . Net 9.95  
 99 F 62580 1½V Penlite Cell. (2 required) . . . . . Net ea. .14



## Advanced Fiber Optics Kit

**\$16<sup>95</sup>**

- Make Decorative Tier Sprays
- With DC and AC Light Sources
- Colored Fiber and Flame Tips

Includes a 115 VAC light source with 6-watt lamp! Kit also includes: penlight source (batteries not incl.), 3 hood adapters, 3 mini sprays, colored plastic fibers (20 pcs., each of 5 colors), 10' coil of 200 sheathed glass fibers, 2' coil of sheathed plastic fibers, 10' of 40 mil plastic fibers, plus all accessories and detailed fiber optics information manual.

19 F 32076 Shpg. wt. 1¾ lbs. . . . . Net 16.95  
 99 F 62580 1½V Penlite Cell (2 required) . . . . . Net ea. .14

## Fiber Optics Decorative Light Kits

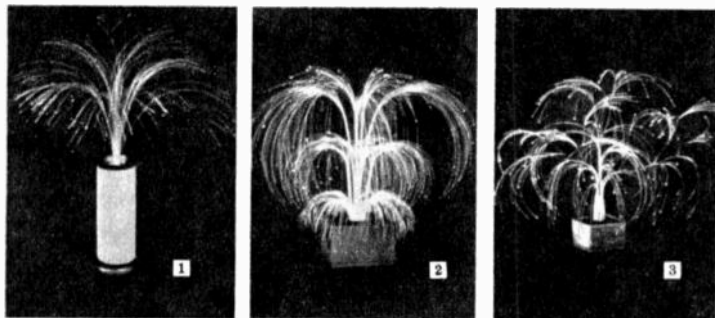

- 1 Fiber Optics Lamp Kit.** Light is transmitted to the ends of the sprouting fibers to glow in sparkling beauty. Has 250 fibers and translucent, illuminated stand and switch. Adjustable height, 15-18". 115 VAC, 60 Hz.  
 19 F 32060 Shpg. wt. 1½ lbs. . . . . Net 9.95
- 2 The Love Fountain.** Black onyx base with gold fountain-styled spray. 13" tall and 12" wide. U.L. listed electrical components.  
 19 F 79004 Shpg. wt. 2¼ lbs. . . . . Net 7.95
- 3 The Willow Tree.** Lighted willow tree with pearlescent fiber. U.L. listed components. 21" tall, 24" wide.  
 19 F 79012 Shpg. wt. 2 lbs. 6 oz. . . . . Net 11.95
- 4 Four Seasons Color Wheel Light Kit.** Combines colored lighted fibers with plastic dip flowers. 17" tall. U.L. components.  
 19 F 79020 Shpg. wt. 3½ lbs. . . . . Net 19.95



## Fiber Optics Accessories

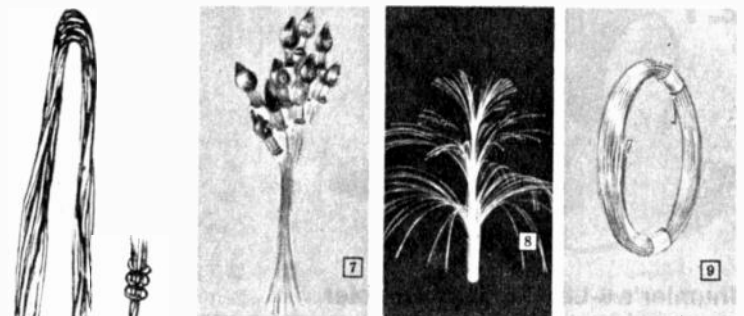

- 5 50-ft. Colored Plastic Fibers.** 50-ft. package, cut into 25 2-ft. lengths; in 5 assorted colors.  
 19 F 32029 Shpg. wt. 7 oz. . . . . Net 2.49
- 6 Bundle of 2000 Glass Fibers.** Package of 12" unjacketed 1.8 mil diameter glass optic fibers.  
 19 F 32052 Shpg. wt. 4 oz. . . . . Net 1.95
- 7 Colored Flame Tip Kit.** Unique, flame-shaped tips add startling effects to illuminated displays. Includes 25 assorted colored plastic flame tips, 25 1-ft. lengths of 20 mil plastic fiber, and instructions.  
 19 F 32045 Shpg. wt. 4 oz. . . . . Net 1.95
- 8 Decorative 3-Tier Fountain Spray.** An assembly of 120 9" plastic optic fibers, pre-formed into a beautiful 3-tiered spray, providing 120 color points. Enhances the beauty of your fiber optics lamps and light displays. With multi-color disc for colorful effects.  
 19 F 32086 Shpg. wt. 5 oz. . . . . Net 4.95
- 9 100-ft. Coil of 20-mil Plastic Fiber.** A 100-ft. coil of 20-mil diameter light-transmitting plastic fiber  
 19 F 32126 Shpg. wt. 7 oz. . . . . Net 1.99



## Skilcraft Dip 'n Mold Candle Maker Kit

**\$12<sup>95</sup>**



## Magic-Glo Black Light Kit

**\$14<sup>25</sup>**

## Battery-Operated "Glo-Lite" Lamp

**\$3<sup>95</sup>**



**Complete Unit —Not a Kit!**

A fountain of multi-colored lights cascades under a clear dome. Uses 2 "C" cells (not incl.) 5" diam. x 6"H. Imp.  
 19 F 16006 Shpg. wt. 1¼ lbs. . . . . Net 3.95  
 99 F 62572 "C" Cells . . . . . Net ea. .19

Charge It with Your BankAmericard or Master Charge.

Create both hand-dipped and molded candles— also makes tapered candles the traditional way, using a metal hand-dipping rig. Create candles in varying combinations of size, shape, scent and color. Contains melting pot with two spouts, pot holder, metal dipping rig, 8 mold forms, 6 non-toxic colors, sandalwood and pine scents, braided wicking, and 7 lbs. of wax. Detailed, illustrated, 24-page instruction book.  
 19 F 59006W Shpg. wt. 11 lbs. . . . . Net 12.95

Lets you see the invisible! Guaranteed completely safe and harmless. Learn invisible detection—write secret messages— study fluorescence and phosphorescence. Set contains black light, lamp stand, fluorescent paint, invisible ink and crayon, 3 fluorescent mineral specimens, phosphoram, optical bleach, brushes, pen, pkg. fluorescent materials. Plus 48-page booklet.  
 19 F 13011 Shpg. wt. 2½ lbs. . . . . Net 14.25  
 19 F 13029 Replacement U-V Bulb . . . . . Net 4.25

# Kits and Adult Games—Educational Fun!

**1 ELECTRO ROULETTE.** An authentic automatic roulette game. Simply press a lever and round and round a rotating light spot goes—where it stops, nobody knows! Each player uses different color chips (included). With table layout. On/off switch. 10½" diam. x 3½".  
**19 F 26005** Less batteries. Imported. Shpg. wt. 3 lbs. .... Net 8.75  
**99 F 62572** "C" batteries (3 required) ..... Net ea. 19¢

**2 ELECTRO MULTI-POKER.** Plays stud poker, draw poker and blackjack (21). Main switch rotates cards, 5 lever switches stop cards either face up or face down. Size: 6 x 4¼ x 3½". Imported.  
**19 F 26039** Less batteries. Shpg. wt. 1¾ lbs. .... Net 5.75  
**99 F 62572** "C" batteries (2 required) ..... Net ea. 19¢

**3 ELECTRO AUTOMATIC SLOT MACHINE.** Precision automatic "one-armed bandit" operates just like the real thing. Just insert coin, pull lever to spin and push buttons to stop. Pays 10 coins on 6 winning combinations, 5 coins on 24 combinations. Automatic bank stores coins. With 50 play coins. Size: 6 x 9½ x 5½". Imported.  
**19 F 26013** Less batteries. Shpg. wt. 4 lbs. .... Net 15.95  
**99 F 62564** "D" batteries (2 required) ..... Net ea. 19¢

*This item not for sale where prohibited.*



**\$875**

**\$1595**

**\$575**

## Minilab Science Kits Easy-to-Build Science Projects

**Electric Bell Kit.** Makes pushbutton bell, buzzer, telegraph key, Morse code. Less battery.  
**19 F 14001** Shpg. wt. 4 oz. .... Net 2.69  
**99 F 62564** "D" Cell (1 req.) ..... Net 19¢

**Electric Motor Kit.** Illustrates electromagnetic principles. Less battery.  
**19 F 14027** Shpg. wt. 4 oz. .... Net 2.69  
**99 F 62564** "D" Cell (1 req.) ..... Net 19¢

**Lens & Light Lab.** Convex and concave lenses are used to bend light, project and focus images, build simple telescope.  
**19 F 14035** Shpg. wt. 4 oz. .... Net 2.69

**Hydraulic Pump Kit** Build working lift, force and compression pumps. Interior cylinder, piston valves and reservoir visible.  
**19 F 14043** Shpg. wt. 4 oz. .... Net 2.69

**Visible Flashlight Kit.** Transparent flashlight shows switch principles. Less battery.  
**19 F 14019** Shpg. wt. 4 oz. .... Net 2.69  
**99 F 62564** "D" Cell (2 req.) ..... Net ea. 19¢

**Weight Measurement Kit.** Double-platform scale uses accurate gram weights.  
**19 F 14050** Shpg. wt. 5 oz. .... Net 2.69

**Camera & Prism Lab.** Build a working pinhole camera, prism, mirror and color filters.  
**19 F 14068** Shpg. wt. 4 oz. .... Net 2.69



**\$269** ea.

**Electric Measurement & Conductivity Kit.** Measure voltage, current, resistance. Less battery.  
**19 F 14084** Shpg. wt. 4 oz. .... Net 2.69  
**99 F 62564** "D" Cell (1 required) ..... Net ea. 19¢

**Sound & Music Lab.** Construct a 2-string musical instrument; experiment with harmony.  
**19 F 14100** Shpg. wt. 4 oz. .... Net 2.69



**Crystal Radio Kit.** Plays indefinitely without batteries or AC power. No tools or soldering. Everything included; illustrated instructions.  
**19 F 14116** Wt. 5 oz. Net 4.98

## Graymark 6-Transistor AM Radio Kit



- Step-by-Step Manual
- Solid-State Superhet
- Plastic Cabinet with Carry Strap

**\$1095**

**FUN TO BUILD** kit is a great way to learn about electronics, get a nice-sounding AM radio, too. Radio has 6-transistor, 2-diode circuit, big 2" speaker. Plays anywhere on a single 9-volt battery (below). With all parts, solder, complete step-by-step instructions and wiring diagram.  
**19 F 11031** Shpg. wt. 12 oz. .... Net 10.95  
**99 F 60212** Battery for above ..... Net 39¢

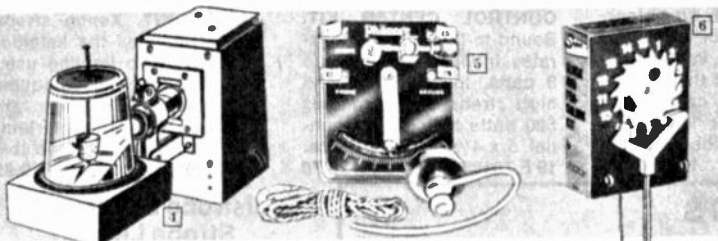

**4 ATOMIC ENERGY LAB.** Ingenious kit for studying basic nuclear physics for experimentation. See vapor trails of alpha and beta particles, and cosmic rays. Instruction book covers a wide variety of experiments. Kit includes radioactive materials.  
**19 F 30015** Shpg. wt. 3½ lbs. .... Net 11.50

**5 SKY ROVER CRYSTAL RADIO KIT.** Easy to assemble—brings in loud, clear reception. Precision wound tuning coil, super-sensitive crystal, bakelite cabinet. No batteries or electricity needed. With earphone and plastic ear-holder, hardware. Requires external antenna (not supplied).  
**19 F 58024** Shpg. wt. 1 lb. .... Net 4.17  
**32 F 30984** Antenna Kit for above. Shpg. wt. 1¼ lbs. .... Net 3.39

**6 SUPER MINILAB CLOCK & PENDULUM KIT.** Does double and single pendulum experiments. Build a simulated stopwatch, a metronome, a timing clock; does pendulum art drawings. Needs no tools, batteries or electricity. Educational fun for anyone from age 8-up.  
**19 F 14128** Shpg. wt. 5 oz. .... Net 4.98

Lafayette—Over 55 Years of Electronics Leadership

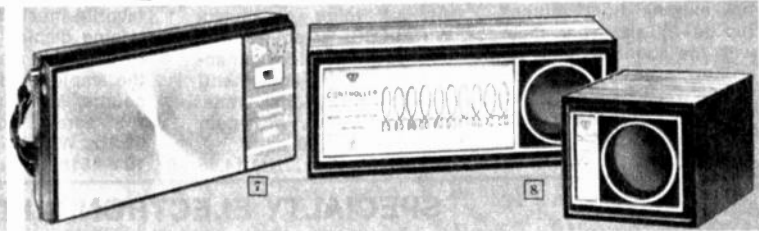

**7 GRAYMARK 8-TRANSISTOR RADIO KIT.** Enjoy the fun of building this superb 8-transistor AM radio with excellent sensitivity, selectivity and rich, full volume. All parts mount directly on the clearly-marked printed circuit board, with all holes pre-drilled. Built-in ferrite rod antenna; AFC. Powered by 4 penlite cells (not supplied). Black plastic case. With wristband, earphone. Detailed instruction manual. Size: 7 x 3 x 1½".  
**19 F 11007** Less batteries. Imported. Shpg. wt. 1½ lbs. .... Net 18.75  
**99 F 62580** "AA" Battery (4 required) ..... Net ea. 14¢

**8 GRAYMARK INFRARED SECURITY SYSTEM KIT.** Gives a piercing alarm, triggered when intruder breaks invisible infrared beam. Consists of two units—lamp exciter and detector. Has internal alarm buzzer, but provides terminals for external bell or buzzer (not provided). Solid-state circuitry, pre-focused optical lens, sensitivity control, hi-intensity low-voltage lamp. Operates up to 75 feet apart. Easy to assemble. Walnut grain plastic cabinets. Power required: lamp unit 115 VAC; detector 3 "D" cells (not supplied). Lamp unit 3¼ x 3 x 4½"; detector 3¼ x 7½ x 4½".  
**19 F 11023** Less batteries. Imported. Shpg. wt. 4¼ lbs. .... Net 29.95  
**99 F 62564** "D" batteries (3 required) ..... Net ea. 19¢

Lafayette Cat. No. 750 129

# Easy-to-Build Kits for the Hobbyist

## EICOCRAFT Project Kits

Eicocraft Kits are educational, useful, easy and fun to build. No technical knowledge is needed. All have pre-drilled printed circuit boards with reliable solid-state circuitry. Easy step-by-step instructions.

**ELECTRONIC ORGAN KIT. EC-2000.** Battery-operated one-octave (8 tones) organ with built-in preamp. Outputs for mellow, bright or flute-like tones. Use with A battery (below)  
**19 F 66116 Shpg. wt. 6 oz. . . . .Net 10.95**

**ELECTRONIC BONGOS KIT. EC-1600.** Produces exciting percussive sounds when used with amplifier and speaker. Use with B battery.  
**19 F 66064 Shpg. wt. 5 oz. . . . .Net 7.95**

**ELECTRONIC SIREN KIT. EC-100.** Gives loud, penetrating "rise-fall" sound. Use with B batt.  
**19 F 66233 Shpg. wt. 6 oz. . . . .Net 6.95**

**VOICE-OPERATED SWITCH KIT. EC-1300.** Audio-activated relay amplifier for remote control of tape recorder, TV, radio, etc. Provides variable time delay. Use with B battery.  
**19 F 66167 Shpg. wt. 6 oz. . . . .Net 8.95**

**LOW BAND POLICE/FIRE CONVERTER KIT. EC-2700.** RF converter operates in 30-50 MHz VHF band—lets you hear police, fire, emergency services on your AM radio. Inductively coupled without interconnecting wires. Use A batt.  
**19 F 66126 Shpg. wt. 5 oz. . . . .Net 7.95**

**FM RADIO KIT. EC-1400.** Receives FM broadcast band. Includes earphone or can be used with an audio amplifier. Use with B battery.  
**19 F 66092 Shpg. wt. 6 oz. . . . .Net 9.95**

**LIGHT FLASHER KIT EC-600.** Each of the two bulbs flash alternately. For signalling, announcing, etc. "Flip-Flop" circuit. Use B battery below.  
**19 F 66241 Shpg. wt. 6 oz. . . . .Net 4.95**

**TREASURE FINDER KIT. EC-1900.** Beat-frequency unit can be used to locate both ferrous and non-ferrous metals. Use with A battery.  
**19 F 66100 Shpg. wt. 6 oz. . . . .Net 10.95**

**HI BAND POLICE/FIRE CONVERTER KIT. EC-2900.** Converts your car or home AM radio to receive police, fire, marine, weather broadcasts in 152-174 MHz band. Use with A battery.  
**19 66134 Shpg. wt. 5 oz. . . . .Net 7.95**

**AUDIO AMPLIFIER KIT. EC-300.** Two-watt amplifier accepts mike, phono, radio, recorder, high-level inputs. Use with B battery and D.  
**19 F 66027 Shpg. wt. 5 oz. . . . .Net 6.95**

**ELECTRONIC "MYSTIFIER" KIT. EC-700.** Fascinating "do-nothing" oscillator circuit of 6 blinking lights whose random geometric sequence of blinks you control. Use with C battery.  
**19 F 66035 Shpg. wt. 5 oz. . . . .Net 5.95**

**EICOCRAFT KIT ACCESSORIES**  
**A. 99 F 60212 9-volt Battery . . . . .Net .39**  
**B. 32 F 46184 6-volt Lantern Battery . .Net 1.26**  
**C. 32 F 46515 9-volt Battery . . . . .Net 3.33**  
**D. 32 F 49026 4" Speaker . . . . .Net 3.20**





**Solid-State Treasure and Metal Detector**

**\$29<sup>95</sup>**

**NOT A KIT—Factory Wired!**

- **Locates Both Ferrous Metals (Iron, Steel, Tin) and Non-Ferrous Metals (Gold, Silver, Copper)**
- **Gives Positive Variable Audio Signal**

Locate Pipes

Find Buried Coins & Metals

Electronically detects metal objects as small as a half-dollar up to 6 inches beneath the ground. Solid-state integrated circuit gives positive audible low-frequency beat signal in the built-in 2 1/4" speaker whenever a metal object is approached. Not a kit—factory wired and tested. 36" handle collapses to 20". Uses 9V transistor battery (not supplied).  
**19 F 67017 Shpg. wt. 3 lbs. . . . .Net 29.95**  
**99 F 60212 9V Battery. Wt. 3 oz. . . .Net .39**

## PSYCHEDELIC LIGHT KITS—Entertaining and Educational



**3-CHANNEL SOUND/LITE TRANSLATOR KIT. EC-4300.** Hook up room lights, any external light sources (up to 3) and vary them with the sound of your favorite music. Handles up to 900 watts (300 watts per input). For 117 VAC, 60 Hz.  
**Shpg. wt. 10 oz.**  
**19 F 66258 . . . . .Net 16.95**



**WIRELESS SOUND/LITE TRANSLATOR KIT. EC-4400.** Keys psychedelic lights to rhythm and intensity of voice or music. WIRELESS — requires NO connection to hi-fi equipment! Handles up to 300 watts. Sensitive mike, high-gain amplifier. Wt. 10 oz.  
**19 F 66266 . . . . .Net 14.95**



**EICOCRAFT MINI COLOR ORGAN KIT.** Converts your favorite music to an entertaining display of multicolor or 3-D patterns varying to the amplitude of the sound source. Molded cabinet; 8 x 8" screen. For 115 VAC, 60 Hz. Wt. 1 1/2 lbs.  
**19 F 66183 . . . . .Net 14.95**



**MOD-U-KIT FREQUENCY CONTROLLED 3-CHANNEL CONTROL CENTER KIT.** Sound-to-light unit separates incoming sound into 3 parts: low, medium and high frequency. Handles 500 watts of light per channel. 5 x 4 1/2 x 2 1/2". 1 1/2 lbs.  
**19 F 70185 . . . . .Net 28.70**



**EICOCRAFT EC-3804 ELECTRONIC STROBE LIGHT KIT.** Xenon strobe light provides the kaleidoscopic audio lighting used by combos, discotheques, etc. Adjustable flash rate control. Ideal for entertainment, display. Wt. 1 1/4 lbs.  
**19 F 66225 . . . . .Net 19.95**

## SPECIALTY ELECTRONIC KITS



**AM Wireless Mike Kit**  
**\$9<sup>15</sup>**

**With Crystal, Mike and Telescoping Antenna**

Transmits your voice through any AM radio. Can be located up to 50 ft. away from the set. Two-transistor circuit. Frequency varied by tunable coil. 3 x 2 x 1 1/4". Less batt.  
**19 F 70094 Shpg. wt. 6 oz. . .Net 9.15**  
**99 F 60212 9V Battery . . . .Net .39**



**Aircraft Receiver Kit**  
**\$6<sup>85</sup>**

**With Earphone and Telescoping Antenna**

Picks up and amplifies airplane-to-ground communications in 100-200 MHz range. Does not interfere with aircraft navigational systems. 3 x 2 x 1 1/4". Needs 9-volt battery.  
**19 F 70066 Shpg. wt. 6 oz. .Net 6.65**  
**99 F 60212 9V Battery . . . .Net .39**



**Lie Detector Kit**  
**\$11<sup>45</sup>**

**Buzzer Reveals White Lies, Gray Lies and Giant Whoppers**

Lots of fun at a party—indicates how big a lie is being told. Operates on the theory of hand perspiration. Easy to assemble; hand probes. 5 x 4 1/4 x 1 1/4". Less battery.  
**19 F 70243 Wt. 1 1/4 lbs. . .Net 11.45**  
**32 F 48275 6V Battery . . .Net 1.54**



**Ministrobe Electronic Strobe Lite**  
**NOT A KIT**  
**Factory Assembled**  
**\$5<sup>95</sup>**

• **Adjustable Flash Rate**  
 • **Battery Operated**

Miniature solid-state strobe for dances, parties, etc. Adjustable—3 to 10 flashes/second. 2 3/4 x 4 x 1 3/4". Less battery.  
**19 F 53074 Wt. 7 oz. . .Net 5.95**  
**99 F 60212 9V Battery Net .39**  
**32 F 66210 #49 Lamp Net .34**

## LAFAYETTE Converter Modules

### LISTEN TO POLICE, FIRE, AIRCRAFT AND SHORTWAVE ON YOUR PRESENT AM SET

Simple to connect to your present AM broadcast radio. 1 3/4" x 3/4" x 1". Control extends 1 1/2". Shpg. wt. 4 oz. each.

**VHF Police, Fire Converter**—Tune calls on 30-50 MHz band. Use D, E, R accessories.  
19 F 55285 .....Net 5.00

**Shortwave Converter**. As above, but tunes 7-12 MHz SW band. Use D, E, R accessories.  
19 F 55301 .....Net 5.00

**FM VHF Police, Weather Converter**. Tune calls on 150-164 MHz FM-VHF. Use D, E, M, R, S accessories listed below.  
19 F 55368 .....Net 5.00

**Aircraft Converter**. As above, but tunes 118 to 128 MHz band. Use D, E accessories.  
19 F 55293 .....Net 5.00

## LAFAYETTE Solid-State Modules

### \$2.98

Each permanent module encapsulates the complete and compact solid-state circuit required for each project—less accessories. Completely wired. With a few additional simple connections to accessories listed below, you create an enjoyable and practical device. Each module is carefully checked for reliability. Complete with instructions, parts lists. 1 3/4" x 1 1/8". Wt. 4 oz.

**Electronic Siren Module**. High volume.  
19 F 55053 Use accessories A, H, I, J ..Net 2.98

**Burglar Alarm Module** with siren alarm.  
19 F 55061 Use accessories A, H, I, K ..Net 2.98

**CB Microphone Preamp Module**. Doubles sensitivity, output. Powered by 1 1/2 V battery.  
19 F 55152 Use accessories B, C, O, Q ..Net 2.98

**AM Wireless Microphone Module**. Transmit from your high-impedance microphone into any AM broadcast band radio. Meets FCC regulations. No license or registration required.  
19 F 55228 Use accessories D, E, L, R ..Net 2.98

**Public Address Amplifier Module**. Clear tone.  
19 F 55111 Use accessories A, G, L, P ..Net 2.98

**Electronic Latching Relay Module**. Ideal for burglar and emergency alarms.  
19 F 55079 Use accessories A, I, K ....Net 2.98

**Bird Call Module** simulates warbling of exotic song birds such as canaries, parakeets, etc.  
19 F 55178 Use accessories B, C, F, I ..Net 2.98

## Accessories

- A. 32 F 48164 Battery, 8 V Lantern ..Net 1.26
  - B. 99 F 62564† Battery, 1 1/2 V "D" ..Net .19
  - C. 34 F 50137 Holder for B ..Net .33
  - D. 99 F 60212† Battery, 9 Volt ..Net .39
  - E. 99 F 62879† Clips for D ..Net .29
  - F. 99 F 60329† 3" Speaker ..Net 1.75
  - G. 44 F 01030 8" Speaker ..Net 7.95
  - H. 32 F 22058 6" Speaker ..Net 4.88
  - I. 99 F 61509† Switch, SPST On-Off ..Net .61
  - J. 99 F 62184† Switch Momentary, NO Net .42
  - K. 34 F 60029† Switch Momentary, NC Net 1.05
  - L. 99 F 45106 Crystal Microphone ..Net 2.29
  - M. 32 F 22510† 5K ohm Control/Switch Net 1.50
  - N. 32 F 22528† 10K ohm Cont./Switch Net 1.50
  - O. 32 F 22544† 1/2 Megohm Cont./Sw. Net 1.50
  - P. 32 F 22551† 1 Megohm Cont./Sw. ..Net 1.50
  - Q. 32 F 10389 Mic Cable, Shielded ..Net 2.31
  - R. 32 F 31909 Wire ..Net .84
  - S. 32 F 24052 Miniature Knob ..Net .19
  - T. 33 F 85283 Matching Transformer ..Net 3.59
- †Imported.

Lafayette—Your "Single-Trip" Source for Everything in Electronics

# For Hobbyists, Experimenters, Kit Builders

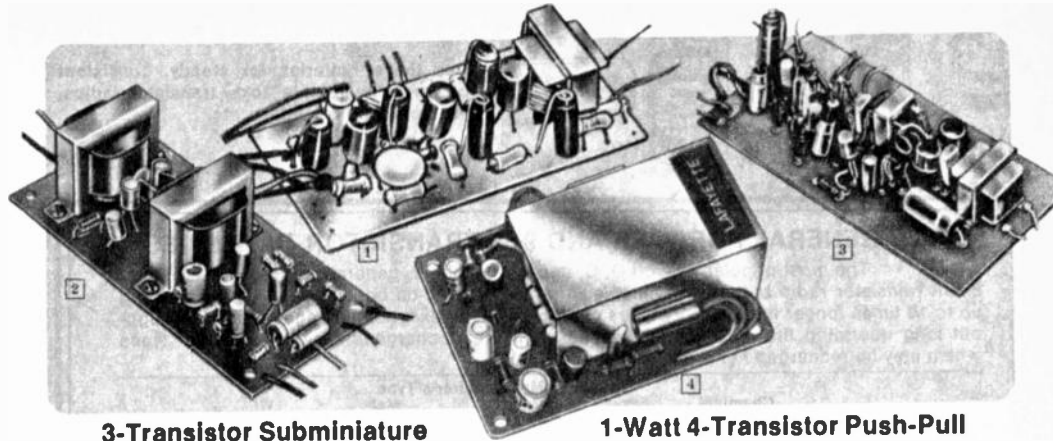

### 3-Transistor Subminiature Audio Amplifier

**\$4.95** • Printed Circuit  
• Multiple Applications

[1] Has input leads for: tape record/playback heads, radio-tuner, crystal or ceramic phono/microphone. Lead terminals for: On-Off, Volume, 4 to 10 ohm speaker. Leads with clips for 9-volt battery. 2 1/4" x 1 1/4" x 3/4". Can be mounted on chassis. Imported. Shpg. wt. 4 oz.  
99 F 90391 Use accessories D, F, L, M ..Net 4.95

### 5-Transistor Push-Pull Audio Amplifier

**\$8.95** • 360 MW Output  
• 3 Stages of Audio

[3] Powerful and sensitive with 3 stages of audio driving a push-pull output stage. For 8-11-ohm speakers. Low impedance input has sensitivity of 300 microvolts. Leads for speaker, Volume, On-Off, battery (9-volt). Input transformer for matching high-impedance to amplifier available as accessory. Imported. Shpg. wt. 5 oz.  
99 F 90375 Use accessories D, F, N, T ..Net 8.95

### 1-Watt 4-Transistor Push-Pull Audio Amplifier

**\$7.95** • Pre-Wired; W/Varistor  
• Output Transformer

[2] Powerful miniature amp! Outputs from record players with magnetic cartridge, tape heads, microphones (not exceeding 20 millivolts) can be connected directly. Higher output devices connected with resistor in series. Leads for: Volume, On-Off, 8-ohm speaker, battery (1.5 volt "D"). 4 7/8" x 1 1/2" x 2 1/4". Imported. Shpg. wt. 5 oz.  
99 F 90383 Use accessories B, M .....Net 7.95

### 3-Watt 4-Transistor Push-Pull Audio Amplifier

**\$10.95** • 4 Transistors, Thermistor  
• Printed Circuit

[4] Versatile amplifier for general purpose. Powerful 3-watt output. Frequency response: 150-10,000 Hz. Input Impedance: 2,000 ohms. Output Impedance: 8- and 16-ohm terminations. Heat sink for power transistors. Use 9V DC power source. 3 x 2 1/4" x 1 1/4". Imported. Shpg. wt. 8 oz.  
99 F 91324 Use accessories F, N .....Net 10.95

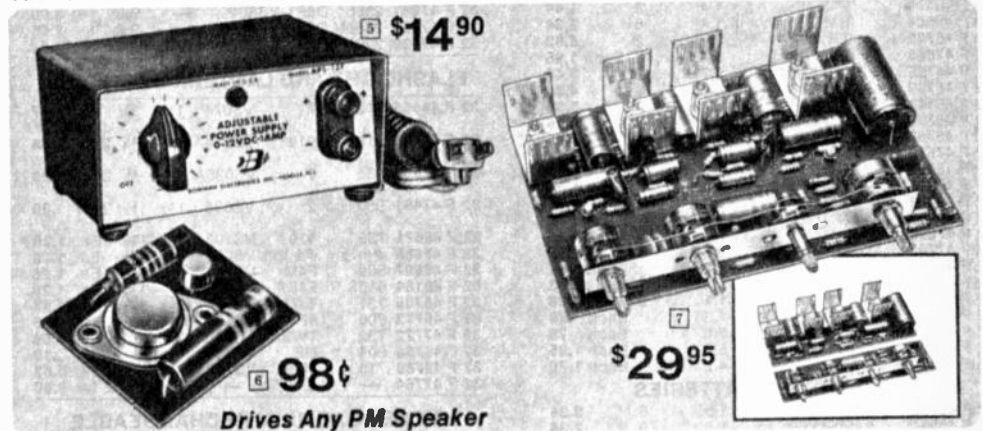

### Adjustable Power Supply Kit

• Simple-to-Build Power Supply  
• Variable 0-12 VDC

[5] Low Voltage DC Power Source used as alternative to batteries. Plugs into regular 110-volt AC, 60 Hz current—adjusts from 0 to 12 volts at a current drain of up to 1 ampere. Neon light indicates "On." Special transformer supplies approximately 16 VAC to a full wave bridge circuit. Special dual transistor filter and circuit regulator. Control varies base voltage of first transistor. 4 x 4 x 1 1/2". Shpg. wt. 1 3/4 lbs.  
19 F 70110 .....Net 14.90

### Code Oscillator Module

[6] Transistorized—ready to connect to any telegraph key, 1 1/2-6 V battery, PM speaker. Matchbook size.  
19 F 15131 Shpg. wt. 3 oz. ....Net .98

### 20-Watt Stereo Solid-State Amplifier Modules

• 2 IC's and 8 Transistors  
• Bass and Treble Controls  
• Response: 30 Hz to 40 kHz  
• Includes Rectifier, Filter

[7] Single Chassis Module. Delivers 10 watts per channel continuous power (RMS) to any 8-ohm speaker. Dual volume control, balance control. Low noise preamp stage. Includes power supply except transformer. 7 3/8" x 1 5/8" x 3/4".  
19 F 09159 Shpg. wt. 1 1/2 lbs. ....Net 29.95

**Split Chassis Module**. Same as above but on two separate printed circuit boards.  
19 F 09167 Shpg. wt. 1 1/2 lbs. ....Net 29.95

**Power Transformer** for above.  
19 F 09175 Shpg. wt. 1 1/4 lbs. ....Net 5.95

# More Power To You With Batteries From Lafayette



## Batteries—Burgess, Eveready, RCA, Mallory

Use these batteries for steady, consistent power in flashlights, toys, transistor radios, portable tape recorders, etc.

### 1.5 V. GENERAL PURPOSE AND 9 V. TRANSISTOR BATTERIES

The most popular 1.5-volt D, C, and AA flashlight, general purpose batteries and 9-volt transistor radio batteries. Available in: standard zinc-carbon; alkaline types featuring up to 10 times longer life; mercury types characterized by excellent voltage stability throughout long operating life plus extremely long shelf life; rechargeable nickel-cadmium types which may be recharged hundreds of times.

Stock No.	Type	Chemical Composition	Replaces Manufacturer's Type				Volts	Wt. Oz.	Net	
			Eve-ready	Burgess	RCA	Mallory				
32 F 47491 D	D	Carbon-Zinc	950	2	VS038	M13F	1.5	8.0	Pkg. of 2 .39	
32 F 47871 D	D	Alkaline	E95	AL2	VS1336	MN1300	1.5	14.0	Pkg. of 2 1.09	
32 F 47590 D	D	Mercury	E42	HG42	—	RM42	1.35	8.0	Each 3.93	
32 F 48895 D	D	Nicad	CH4	CD10	—	CD10	—	1.25	7.0	Each 6.97
32 F 47509 C	C	Carbon-Zinc	935	1	VS035A	M14F	1.5	5.0	Pkg. of 2 .59	
32 F 47889 C	C	Alkaline	E93	AL1	VS1335	MN1400	1.5	8.0	Pkg. of 2 1.09	
32 F 48857 C	C	Nicad	—	CD14	—	—	—	1.25	5.0	Each 4.88
32 F 47756 AA	AA	Carbon-Zinc	915	910	VS034A	M15F	1.5	3.0	Pkg. of 2 .34	
32 F 47525 AA	AA	Alkaline	E91	AL9	VS1334	MN1500	1.5	4.0	Pkg. of 2 .97	
32 F 46857 AA	AA	Mercury	E9	Hg9	VS9	ZM9	1.4	4.0	Pkg. of 2 1.63	
32 F 47400 AA	AA	Nicad	C450	CD6	—	—	—	1.25	3.0	Each 1.89
32 F 48077	Radio 9V	Carbon-Zinc	216	2U6	VS323	M1604	9.0	3.0	Each .54	
32 F 47533	Radio 9V	Alkaline	—	—	VS1323	MN1604	9.0	4.0	Each .99	
32 F 47873	Radio 8.4V	Mercury	E146X	E146X	VS146X	TR146X	8.4	2	Each 1.44	

### MALLORY DURACELL® MERCURY BATTERIES

Types with \* have snap connections. Shipping weight varies from 2 oz. to 10 oz. maximum.

Stock No.	Type No.	Volts	Pkg. of	Net
32 F 47566	RM1	1.4	4	3.12
32 F 47574	RM1R	1.35	4	3.96
32 F 46550	RM12	1.4	2	2.74
32 F 47590 (D)	RM42	1.4	2	Each 3.93
32 F 47808	RM312	1.4	6	1.68
32 F 47780	RM401	1.4	2	1.56
32 F 46818	RM502R	1.35	2	2.76
32 F 47832	RM520	1.4	6	1.20
32 F 47840	RM625R	1.35	4	3.44
32 F 46875	RM640	1.4	2	1.44
32 F 46883	RM675	1.4	6	2.34
32 F 46709	TR115R	6.75	2	5.82
32 F 47665	TR126	8.4	2	Each 1.95
32 F 46725	TR132R	2.7	2	3.44
32 F 46733	TR133R	4.05	2	4.36
32 F 46741	TR134R	5.4	2	5.30
32 F 46758	TR135R	6.75	2	6.26
32 F 46766	TR136	8.4	2	5.66
32 F 47873	TR146X*	8.4	2	Each 1.44
32 F 46782	TR163	4.2	2	4.30
32 F 47681	TR164	5.6	2	Each 1.95
32 F 46808	TR165	7.0	2	5.08
32 F 46818	TR169	12.5	2	Each 4.32
32 F 47899	TR175	7.0	2	Each 1.78
32 F 47707	TR177*	9.8	2	Each 1.95
32 F 47715	TR233	4.2	2	Each 3.54
32 F 46857 (AA)	ZM9	1.4	2	1.63
32 F 46865	ZM12	1.4	2	3.08
32 F 47796	PX13	1.35	2	Each .78
32 F 47808	PX23	5.6	2	Each .78
32 F 47822	PX32	5.6	2	Each 1.95
32 F 47830	7R31	4.2	2	Each 1.76

### SILVER OXIDE BATTERIES

32 F 46956	MS13	1.5	6	2.34
32 F 46931	MS41	1.5	6	2.34
32 F 47848	MS76	1.5	6	Each .46
32 F 47855	PX28	6.0	2	Each 1.95

### DURACELL® ALKALINE BATTERIES

Up to 10 times longer life. Do not require rest period, operate with same efficiency in continuous or intermittent service.

Stock No.	Replaces	Manufacturer's Type	Volts	Wt. Oz.	Per Pkg.	Net
32 F 46972	EPXA25	PX825	APXA25	1.5	2	1.19
32 F 47871	E95	MN1300	AL2	1.5	14	2 1.09
32 F 47525	E91	MN1500	AL9	1.5	4	2 .97
32 F 47889	E93	MN1400	AL1	1.5	8	2 1.09
32 F 47541	E90	MN9100	ALN	1.5	3	2 .93
32 F 48937	E92	MN2400	AL7	1.5	3	1 .48
32 F 47883	532	PX24	APX24	3.0	2	1 1.37
32 F 46451	523	MN1306	AL133	4.5	3	1 1.53
32 F 47426	563	—	—	4.5	2	1 3.60
32 F 47434	564	—	—	13.5	7	1 13.28
32 F 47533	—	MN1604	—	9.0	4	1 .99

### TRANSISTOR AND HEARING AID BATTERIES

Stock No.	Replaces	Manufacturer's Type	Volts	Wt. Lbs.	Net
32 F 48192	1050	230 CS336	M13R	1.5	1/2 .23
32 F 47012	1035	130 VS335	M14R	1.5	1/4 .23
32 F 47020	1015	930 VS334	M15R	1.5	1/4 .19
32 F 48077	216	2U6 VS323	M1604	9.0	3/16 .54
32 F 47046	246	2N6 VS305	M1602	9.0	3/16 1.66
32 F 48986	266	M6 VS322	M1605	9.0	3/16 1.48
32 F 47053	278	D6 VS306	M1603	9.0	1 1.86
32 F 47061	2508	D8P1 VS301	—	9.0	1 3.00
32 F 47095	2356N	C8X VS330	—	9.0	1 2.66
32 F 47129	226	P6 VS300A	M1600	9.0	1/4 .87

### FLASHLIGHT AND LANTERN BATTERIES

32 F 48655	912	7	VS074	1 1/2	1/8	Each .17
32 F 47756	915	910	VS034A	1 1/2	1/4	2 for .34
32 F 47509	935	1	VS035A	1 1/2	3/8	2 for .39
32 F 47491	950	2	VS036	1 1/2	1/2	2 for .39
32 F 48671	735	410	VS106	1 1/2	1 3/4	Each 1.26
32 F 48889	#8 Ign	#6 Ign	VS006S	1 1/2	2 3/4	Each 1.32
32 F 48897	509	F4M	VS040C	6	1 1/8	Each 1.26
32 F 48184	510S	F4BP	VS040S	6	1 3/4	Each 1.26
32 F 48705	731	TW1	VS317	6	3 1/2	Each 2.57
32 F 48713	706	4F4H	VS103	6	6 3/4	Each 5.33
32 F 47772	732	TW2	VS342	12	3 1/2	Each 3.06
32 F 48754	904	ME	VS073	1 1/2	1/4	Each .10
32 F 48788	715	4F5H	VS139	7 1/2	8 3/4	Each 5.63
32 F 47784	—	Z46HD	—	69	6 1/2	2 for 8.80

### NICKEL CADMIUM RECHARGEABLE BATTERIES

Hermetically-sealed, steel-nickel cadmium cells. High-energy, long-lasting, unaffected by idle periods. May be recharged many times. All are 1.25 average discharge voltage. All capacities rated in milliampere-ohm except \* rated in ampere-hours.

Stock No.	Replaces	Manufacturer's Type	Volts	Wt. Oz.	Net
32 F 47467	B20	CD1	20B	20	3 1.73
32 F 47301	B50	CD2	50B	50	2 1.35
32 F 47350	B225	CD4	225B	225	2 1.53
32 F 47368	B225T*	CD4*	225BL*	225	3 1.73
32 F 47392	C450T*	CD6L*	475SCL*	450	3 2.31
32 F 47400	C450	CD8	475SCB	450	3 1.89
32 F 47418	CH1.2	CD12	1.2SCB	1200	4 3.03
32 F 48887	CH1.5	CD14	2.0SCB	1.5+ 5	4 6.68
32 F 48895	CH4	CD10	4.0SCB	4+	7 6.97

\*Types with "T" or "L" identification have Tabs for soldering to cells.

### INDUSTRIAL AND SPECIAL-PURPOSE APPLICATIONS

Stock No.	Replaces	Manufacturer's Type	Volts	Wt. Lbs.	Net
32 F 39019	711	2FH VS101	1 1/2	3/4	1.19
32 F 48192	1050	230 VS336	1 1/2	1/2	.23
32 F 48218	742	4F VS004	1 1/2	1 3/4	1.40
32 F 48226	964	— VS236	1 1/2	1/2	.83
32 F 47137	W356	2F2H VS136	3	1 1/2	3.33
32 F 47180	750	422 VS134	3	1/4	1.73
32 F 47178	703	532 VS346	4 1/2	3/8	1.88
32 F 47202	781	5360 VS028	4 1/2	3/8	1.88
32 F 48242	736	F3 VS067	4 1/2	1 1/4	2.06
32 F 48267	718	2F4	—	6	2 3/4 3.60
32 F 48275	724	Z4	VS068	6	1/4 1.54
32 F 48283	744	F4P1	VS345	6	1 1/4 1.26
32 F 47228	773	5540 VS029	7 1/2	1/2	2.63
32 F 48291	707	D5 VS315	7 1/2	1	1.90
32 F 48309	713	B5 VS129	7 1/2	3/4	3.15
32 F 48317	717	C5 VS065	7 1/2	3/4	1.55
32 F 48234	208	L6 VS130	9	1/4	.70
32 F 48333	411	U10 VS083	—	15	1/4 1.03
32 F 48341	417	K10	—	15	1/4 1.89
32 F 48358	504	Y10 VS074	15	3/8	1.13
32 F 47236	763	4156 VS102	22 1/2	1	2.12
32 F 48366	412	U15 VS084	22 1/2	1/4	1.33
32 F 48374	420	K15	—	22 1/2	1/4 2.25
32 F 48382	505	Y15 VS075	22 1/2	1/4	1.33
32 F 48390	413	U20 VS085	30	1/4	1.34
32 F 48051	415	U30 VS086	45	1/2	1.98
32 F 48342	455	XX30 VS055	45	3/4	2.81
32 F 48101	482	M30 VS013	45	2 1/4	3.33
32 F 48432	484	B30 VS344	45	3 1/2	4.60
32 F 48465	416	UX45 VS318	67 1/2	1/2	2.23
32 F 48473	457	K45 VS082	67 1/2	3/4	3.27
32 F 48481	467	XX45 VS016	67 1/2	1	2.70
32 F 48499	477	P45 VS218	67 1/2	1	3.06
32 F 48515	479	P60 VS219	90	1 1/4	3.33
32 F 48176	490	V60 VS090	90	1 1/4	3.57
32 F 48556	W361	XX69	—	1 3/4	6.46

### PHOTOFASH AND HIGH-VOLTAGE

32 F 48820	491	U160 VS791	240	1	8.32
32 F 48804	497	U320 VS797	510	2	14.65

### BATTERY CLIPS

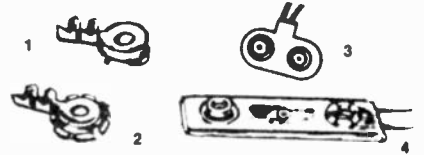

Stock No.	Average Shpg.	Fig.	Wt. 2 oz.	*Imported.	Net Ea.
34 F 10016	1	P6, D5, P8M, M6, XX45, XX30, XX50			.07
34 F 10024	2	K45, P45, P45M, P60, D6, 4D4, N60X, C6X			.07
99 F 62879*	3	2U6, U30, 2N6			.29
99 F 62887*		Same, pkg. of 5			.99
34 F 10040	4	XX50C, P45, P60, N60X			.27

### KEYSTONE BATTERY HOLDERS



Battery holders are made of aluminum alloy. Sturdy construction with insulated nickel-plated brass eyelets. All multiple holders mount batteries side by side except items marked \* mount end to end. Average Shpg. Wt. 3 oz.

Stock No.	Holds	Burgess	Eveready	RCA	Mallory	Net Ea.
34 F 50012	1	7, AL7	912, E92	VS074	MN2400	.25
34 F 50020	2			VS1074		.42
34 F 50053	1	2, 9R	E9, E12		RM12R	.25
34 F 50061	2	Y15	E133, E502,	VS034	TR133R	.40
34 F 50087	3	CD6	505, 915, VS9		ZM9	.55
34 F 50095	4	910	1015E, C450		TR233R	.70
34 F 50103	1	1	935, E93,	VS035	MN1400	.33
34 F 50111	2	AL1	CH1.5			.40
34 F 50137	1	2, D	950, E95,	VS036	RM42R	.33
34 F 50145	2	2, AL2	CH4	VS1336	MN1300	.40
34 F 50152	2	CD10				.51

### IMPORTED PENLITE (AA) BATTERY HOLDERS



# "Power Up" with Long-Life Lafayette Batteries

## Standard Batteries

Stock No.	Voltage	Net ea.	Lots of 10	Replaces Manufacturer's Type			Shpg. wt. ea.
				RCA	Burgess	Eveready	
99 F 62564	1½(D)	.19	1.70	VS036	2	950	5 oz.
99 F 62572	1½(C)	.19	1.70	VS035	1	935	4 oz.
99 F 62580	1½(AA)	.14	1.26	VS034	910	915	3 oz.
<b>Standard 9-Volt Transistor Battery</b>							
99 F 60212	9	.39	3.50	VS323	2U6	216	3 oz.

## Alkaline Batteries

These high energy alkaline batteries provide up to 10 times longer life than ordinary zinc-carbon types in heavy and/or continuous drains, at all temperatures. Especially good for toys, photo, radios, tape recorders, record players and heavy-duty flashlights. Imported.

Stock No.	Voltage	Net ea.	Mallory	Replaces Manufacturer's Type			Shpg. wt. ea.
				Burgess	Eveready	Type	
99 F 63786	1½(D)	.64	MN1300	AL2	E95	7 oz.	
99 F 63802	1½(C)	.52	MN1400	AL1	E93	5 oz.	
99 F 63828	1½(AA)	.45	MN1500	AL9	E91	3 oz.	

## Extra Long Life Batteries

Lafayette's extra long life batteries reduce the frequency of necessary replacement. They use a special chemical formulation which provides more than 50% longer useful life without either diminishing their shelf life or increasing battery weight. Imported.

Stock No.	Voltage	Net ea.	Lots of 10	Replaces Manufacturer's Type			Shpg. wt. ea.
				RCA	Burgess	Eveready	
99 F 63661	1½(D)	.28	2.30	VS036	2	950	8 oz.
99 F 63687	1½(C)	.25	2.10	VS035	1	935	4 oz.
99 F 63703	1½(AA)	.22	1.90	VS034	910	915	3 oz.
<b>Extra Long Life 9-Volt Transistor Battery</b>							
99 F 63729	9	.49	4.00	VS323	2U6	216	4 oz.

## AA Nickel Cadmium Battery

This Lafayette penlite nickel cadmium cell is manufactured to Lafayette's rigid specifications by one of America's best-known manufacturers. Provides up to 500 charge-discharge cycles and the economies resulting from such recharging.

32 F 47400	1½(AA)	1.89	17.50	—	CD6	C450	3 oz.
------------	--------	------	-------	---	-----	------	-------

Lafayette brings you popular batteries, constructed to rigid specifications, at popular prices. Fresh stocks and extra dependability are available in Standard Carbon-Zinc, Extra Long Life, Alkaline and Nickel Cadmium Cells.



## Battery Eliminators, Chargers

### 1 LAFAYETTE 9-VOLT BATTERY ELIMINATOR and CHARGER

Permits standard AC operation of all portables regularly using 9-volt transistor batteries. Also recharges batteries for re-use. Plugs directly into 117 VAC, 60 Hz household wall outlets. Shpg. wt. 1 lb. Imported.

99 F 90151 ..... Net 4.50

### 2 CHART CHARGE NICKEL-CADMIUM BATTERY CHARGER

Charges 1 to 10 nickel-cadmium cells in series from 10 to 250 mA. Utilizes Isolation transformer and solid-state, electronic regulation. Does not require a meter. 6¼ x 6¾ x 2".

34 F 41011 Shpg. wt. 2¼ lbs. Net 12.95

### 3 LAFAYETTE MULTI-PURPOSE BATTERY CHARGER

Charges up to 3 batteries in a relatively short time for less than a penny. Two adjustable compartments for AA penlight, C, and D cells; 2 snaps for 9V transistor. Imported.

99 F 92058 Shpg. wt. ¾ lb. Net 4.75

### 4 9V BATTERY "STORAGE CELL" PLUS CHARGER

Fluid storage-type plays about 15 hours on one charging and recharges overnight. Battery 1½ x 1½". Charger 3½ x 1¼ x ¾". Imp. Wt. 5 oz.

99 F 90169 Batt. & Charger ..... Net 5.99  
99 F 60261 Replacement Batt. Net 2.10

### 5 LAFAYETTE UNIVERSAL 6-, 7½- and 9-VOLT ADAPTER

This switchable 6, 7½ and 9 volt eliminator substitutes converted house current for batteries in hundreds of uses. Reverse polarity connector, four popular terminations to fit nearly all equipment, 300 mA power output. 2½ x 1½ x 1½". Imported.

99 F 35448 Shpg. wt. 12 oz. Net 5.99

### 6 HOME BATTERY CHARGER

Recharges any combination of 4 "D," "C," "AA," or 9-volt transistor batteries at once. Transformer circuitry prevents overcharge. Automatically self-regulating. Shpg. wt. 2 lbs.

34 F 19009 ..... Net 4.95

### 7 AUTOMATIC HOME BATTERY CHARGER

Transformer circuitry charges up to 15 batteries (4 "D," 4 "C," 6 "A," 1 9V) at a time without overcharging. Shock-proof. 7½ x 4¾ x 2¾".

34 F 25006 Shpg. wt. 1½ lbs. Net 8.95

### 8 SHURITE BATTERY TESTERS DC Voltmeters

Stock No.	Range	Net
38 F 59709	0-5	4.80
38 F 59717	0-7	4.80
38 F 59725	0-50	5.40
38 F 59733	0-2-50	5.95

### DC Ammeters

38 F 59790	0-15	4.80
38 F 59808	0-40	5.05

All shpg. wts. 6 oz.

### HEARING AID BATTERY TESTER

Ideal for checking 1.5, 15, 22.5, 30, 33 and 45 volt batteries.

38 F 61648 ..... Net 5.90



As Low As \$4.80



# MOTOROLA HEP Semiconductors



## HEP Cross-Reference Semiconductor Guide

# 50¢

96-page book lists over 43,000 types that can be replaced by HEP types. 10 F 64047 1 lb. Net 50¢



Stock No.	HEP No.	Description	Net
19 F 53504	1	Ge RF Transistor—PNP—100 MHz 150 mW	.89
19 F 54536	3	Ge RF Transistor—PNP—250 MHz 100 mW	1.25
19 F 54544	50	Si RF Transistor—NPN—250 MHz 400 mW	.79
19 F 54023	51	Si RF Transistor—PNP—150 MHz 600 mW	1.28
19 F 54676	52	Si RF Transistor—PNP—200 MHz 400 mW	.95
19 F 54031	53	Si RF Transistor—NPN—200 MHz 600 mW	1.15
19 F 53512	75	Si RF Power Transistor—NPN—250 MHz 3W	2.95
19 F 54742	134	Ge Diode (1N34A Substitute)	.26
19 F 54759	135	Ge Diode (1N60 Substitute)	.26
19 F 54643	170	Si Rectifier—Axial Lead—1000 PIV 2.5 Amp	.82
19 F 54080	175	Full Wave Bridge Rectifier—50 PIV 1 Amp	1.49
19 F 54650	176	Full Wave Bridge Rectifier—200 PIV 1 Amp	2.05
19 F 54114	230	Ge Power Transistor—PNP—TO-3—5 Amp 90 Watt	1.25
19 F 54122	231	Ge Power Transistor—PNP—TO-36—15 Amp 150 Watt	1.99
19 F 54825	232	Ge Power Transistor—PNP—TO-3—7A 90W	2.34
19 F 53520	238	Ge General Purpose Power Transistor—PNP—60V 3A	4.70
19 F 54868	242	Si Med Power Transistor—PNP—60V 3A 6W (Comp to 243)	2.40
19 F 54874	243	Si Med Power Transistor—NPN—60V 3A 6W	1.79
19 F 54601	245	Si Med Power Transistor—NPN—60V 3A 30W (Comp. to 246)	1.99
19 F 57695	246	Si Med Power Transistor—PNP—60V 3A 30W (Comp. to 245)	2.29
19 F 54171	310	Si Unijunction Transistor—300 mW	1.49
19 F 54890	311	Si Bilateral Trigger Diode	.99
19 F 53538	312	Si Photo Transistor	2.49
19 F 54205	556	IC—ECL—3 Input Gate	3.87
19 F 54213	558	IC—ECL—J-K Flip-Flop	4.39
19 F 54429	570	IC—RTL—Quad Input Gate	2.10
19 F 54437	572	IC—RTL—Dual J-K Flip-Flop	3.90
19 F 53843	573	IC—RTL—Hex Inverter	2.30
19 F 54445	580	IC—RTL—Dual 2 Input Gate	.95
19 F 53553	581	IC—RTL—Dual 4 Input Gate	.95
19 F 53561	582	IC—RTL—Dual Buffer	.99
19 F 54478	583	IC—RTL—J-K Flip-Flop	1.49
19 F 54486	590	IC—Linear—High-Frequency Amplifier	3.99
19 F 53579	592	IC—Linear—Stereo Preamplifier	3.25
19 F 53587	593	IC—Linear—1-Watt Audio Power Amplifier	7.95
19 F 53595	594	IC—Linear—FM Stereo Demodulator	5.92
19 F 53546	595	IC—Linear—FM Stereo Demodulator	5.92
19 F 54973	641	Ge General Purpose RF and Audio Amplifier—NPN	1.32
19 F 57513	701	Si General Purpose Audio Power Amplifier—NPN	2.49
19 F 53603	708	Si Low Power RF Amplifier—PNP	1.20
19 F 53611	709	Si UHF Oscillator, Mixer, RF Amplifier—NPN	2.07
19 F 53629	714	Si High Voltage Audio Amplifier—NPN	3.10
19 F 57729	716	Si Gen. Purpose Medium Current Amplifier & Switch—PNP	1.24
19 F 57760	739	Si 2N404 (Germanium) Replacement—PNP	.85
19 F 54221	801	Field Effect Transistor—Audio—N Channel	1.59
19 F 54361	802	Field Effect Transistor—RF—N Channel	1.59
19 F 54635	803	Field Effect Transistor—Audio—RF—P Channel	3.39
19 F 53637	C3000P	IC—TTL—Quad 2-Input NAND Gate	.98
19 F 53645	C3004P	IC—TTL—Hex Inverter	1.18
19 F 53652	C3010P	IC—TTL—Triple 3-Input NAND Gate	.98
19 F 53660	C3020P	IC—TTL—Dual 4-Input NAND Gate	.98
19 F 53678	C3030P	IC—TTL—8-Input NAND Gate	.98
19 F 53686	C3041P	IC—TTL—BCD-to-Decimal Decoder and High-Level Driver	3.12
19 F 53694	C3073P	IC—TTL—Dual J-K Flip-Flop	1.96
19 F 53702	C3800P	IC—TTL—Decade Counter	3.80
19 F 53710	C3801P	IC—TTL—Divide-by-Twelve Counter	3.80
19 F 53728	C3802P	IC—TTL—Seven-Segment Character Generator	3.37
19 F 53736	C6001	IC—Linear—FM IF Amplifier (Rpimnt. for $\mu$ A703 or CA3053)	2.09
19 F 53744	C6002	IC—Linear—Low-Noise Audio Preamplifier	2.50
19 F 57778	C6003	IC—Linear— $1/4$ -Watt Audio Amplifier	1.55
19 F 57786	C6004	IC—Linear—1-Watt Audio Amplifier and Preamp	2.90
19 F 57794	C6007	IC—Linear—Single Toggle Flip-Flop	1.42
19 F 57802	C6008	IC—Linear—1-Watt Audio Amplifier and Preamp	2.50
19 F 57810	C6009	IC—Linear—Electronic Remote-Control Attenuator	2.50
19 F 57828	C6010	IC—Linear—Wide-Band Amplifier	1.53
19 F 57836	C6011	IC—Digital—Dual-Toggle Flip-Flop	2.32
19 F 57844	C6012	IC—Linear—Voltage Regulator	2.89
19 F 57851	C6014	IC—Linear—Voltage Regulator	2.27
19 F 57869	C6015	IC—Digital—Dual-Toggle Flip-Flop with Reset	2.60
19 F 57877	C6017	IC—Linear—Differential/Cascode Amplifier	1.72
19 F 57885	C6049G	IC—Linear—Voltage Regulator (Positive)	3.00
19 F 57893	C6049R	IC—Linear—Voltage Regulator (Positive)	3.75
19 F 57901	C6050G	IC—Linear—Balanced Modulator Demodulator	3.35
19 F 57919	C6051L	IC—Linear—Dual Operational Amplifier	2.75
19 F 57927	C6052P	IC—Linear—Operational Amplifier	2.10
19 F 57935	C6054G	IC—Linear—Voltage Regulator (Negative)	4.15
19 F 57943	C6054R	IC—Linear—Voltage Regulator (Negative)	4.49
19 F 57950	F0021	Field Effect Transistor—VHF/UHF—N-Channel	1.89
19 F 57958	F2004	MOS FET—Dual Gate—VHF—N-Channel	2.50
19 F 57976	F2007	MOS FET—Dual Gate—N-Channel	1.65
19 F 57984	G0002	Ge PNP—Small Signal Transistor *2, 637	2.92
19 F 57992	G0004	Ge PNP—Small Signal Transistor *250, 251	1.16
19 F 58503	G0005	Ge PNP—Small Signal Transistor *253, 254	1.49
19 F 58511	G0006	Ge PNP—Small Signal Transistor *629, 630, 631, 632	3.14
19 F 58529	G0007	Ge PNP—Small Signal Transistor *633, 634	3.14
19 F 58537	G0008	Ge PNP—Small Signal Transistor *635, 636	2.00
19 F 58545	G0010	Ge PNP—Small Signal Transistor *639, 640	2.00
19 F 58552	G6013	Ge PNP—Power Transistor *623, 624, 628	2.67
19 F 58560	G6016	Ge PNP—Power Transistor *642, 643	2.09
19 F 58578	P0001	Si Phototransistor—NPN	4.45
19 F 58586	P0002	Si Phototransistor	2.08
19 F 58594	P1001	Si Darlington Amplifier Phototransistor—NPN	.98

\*Replaces these HEP Nos.

Stock No.	HEP No.	Description	Net
19 F 58602	P2000	Light-Emitting Diode	1.77
19 F 58610	P2001	Light-Emitting Diode	1.49
19 F 58628	P2002	Infrared-Emitting Diode	2.25
19 F 58636	P2003	Light-Emitting Diode	.79
19 F 58644	P2004	Light-Emitting Diode (Diffused Lens)	.89
19 F 58651	R0050	Silicon Rectifier, Axial Lead, 50 PIV 1 Amp	.38
19 F 58669	R0051	Silicon Rectifier, Axial Lead, 100 PIV 1 Amp	.40
19 F 58677	R0052	Silicon Rectifier, Axial Lead, 200 PIV 1 Amp	.42
19 F 58685	R0053	Silicon Rectifier, Axial Lead, 400 PIV 1 Amp	.54
19 F 58693	R0054	Silicon Rectifier, Axial Lead, 600 PIV 1 Amp	.63
19 F 58701	R0055	Silicon Rectifier, Axial Lead, 800 PIV 1 Amp	.72
19 F 58719	R0056	Silicon Rectifier, Axial Lead, 1000 PIV 1 Amp	.85
19 F 58727	R0090	Si "Top Hat" Rectifier—200 PIV 3 Amp	.80
19 F 58735	R0091	Si "Top Hat" Rectifier—100 PIV 3 Amp	.88
19 F 58743	R0092	Si "Top Hat" Rectifier—200 PIV 3 Amp	1.02
19 F 58750	R0130	Si Stud Mount Rectifier—50 PIV 12 Amp	1.23
19 F 58768	R0131	Si Stud Mount Rectifier—100 PIV 12 Amp	1.39
19 F 58776	R0132	Si Stud Mount Rectifier—200 PIV 12 Amp	1.57
19 F 58784	R0160	Si Stud Mount Rectifier—50 PIV 15 Amp	1.53
19 F 58792	R0161	Si Stud Mount Rectifier—100 PIV 15 Amp	1.68
19 F 58800	R0162	Si Stud Mount Rectifier—200 PIV 15 Amp	2.20
19 F 58818	R0700	Si UHF Diode (Hot-Carrier)	1.09
19 F 58826	R0841	Full-Wave Bridge Rectifier, 50 Volt 1.8 Amp	2.42
19 F 58834	R0842	Full-Wave Bridge Rectifier, 100 Volt 1.8 Amp	2.52
19 F 58842	R0843	Full-Wave Bridge Rectifier, 200 Volt 1.8 Amp	2.75
19 F 58859	R1001	Thyristor (SCR)—30V 800 mA	.86
19 F 58867	R1002	Thyristor (SCR)—60V 800 mA	.97
19 F 58875	R1004	Thyristor (SCR)—150V 800 mA	1.19
19 F 58883	R1101	Thyristor (SCR)—50 V 1.6 Amp	1.77
19 F 58891	R1102	Thyristor (SCR)—100V 1.6 Amp	2.00
19 F 58909	R1103	Thyristor (SCR)—200V 1.6 Amp	2.57
19 F 59501	R1215	Sensitive-Gate Thyristor (SCR)—30V 4 Amp	1.25
19 F 59519	R1216	Sensitive-Gate Thyristor (SCR)—60V 4 Amp	1.34
19 F 59527	R1218	Sensitive-Gate Thyristor (SCR)—200V 4 Amp	1.55
19 F 59535	R1220	Thyristor (SCR)—50 V 8 Amp	1.37
19 F 59543	R1221	Thyristor (SCR)—200V 8 Amp	1.72
19 F 59550	R1241	Thyristor (SCR)—50V 8 Amp	2.25
19 F 59568	R1721	Triac—50V 8 Amp	1.25
19 F 59576	R1722	Triac—100V 8 Amp	1.86
19 F 59584	R1723	Triac—200 V 8 Amp	1.90
19 F 59592	R1750	Triac—50V 8 Amp	2.50
19 F 59600	R1751	Triac—200V 10 Amp	3.71
19 F 59618	R2001	Si Bidirectional Switch—8V 2A	1.29
19 F 59626	R2021	Si Unidirectional Switch—8V 2A	1.19
19 F 59634	R2500	Si Voltage—Variable Capacitance Diode—8.1 to 7.5 pf	1.10
19 F 59642	R2501	Si Voltage—Variable Capacitance Diode—9.0 to 11.0 pf	1.10
19 F 59659	R2502	Si Voltage—Variable Capacitance Diode—13.5 to 16.5 pf	1.10
19 F 59667	R2503	Si Voltage—Variable Capacitance Diode—50.4 to 61.6 pf	1.10
19 F 59675	R2504	Si Voltage—Variable Capacitance Diode—50.4 to 61.6 pf	1.10
19 F 59683	R2505	Si Voltage—Variable Capacitance Diode—90.0 to 110.0 pf	1.10
19 F 59691	S0002	Si General Purpose Oscillator, Mixer, Amplifier—NPN	.57
19 F 59709	S0004	Si High Frequency RF Amplifier, Mixer, Oscillator—NPN	.94
19 F 59717	S0007	Si General Purpose Medium Voltage Amplifier—NPN	.59
19 F 59725	S0015	Si NPN, Small Signal Transistor *54, 55, 721	1.05
19 F 59733	S0016	Si NPN, Small Signal Transistor *56, 734	1.40
19 F 59741	S0020	Si NPN, Small Signal Transistor *718, 719, 720, 723	1.38
19 F 59758	S0021	Si NPN, Small Signal Transistor *722, 723, 727, 732	1.05
19 F 59766	S0022	Si NPN, Small Signal Transistor *724, 728, 729, 731	1.14
19 F 59774	S0023	Si NPN, Small Signal Transistor *725, 726	1.07
19 F 59782	S0024	Si NPN, Small Signal Transistor *730, 737	1.10
19 F 59790	S0025	Si NPN, Small Signal Transistor *735, 736, 738	1.12
19 F 59808	S3001	Si RF Power Transistor—NPN—65V 1A 5W P out at 500 MHz	3.75
19 F 59816	S3011	Si Medium Power Transistor—NPN—70V 1A 7W—100 MHz	2.32
19 F 59824	S3020	Si Medium Power Transistor—NPN—60V 1A 5W—150 MHz	1.43
19 F 59832	S3026	Si Gen Purp Amp—NPN—35V 1.5A 8W—50 MHz hFE 550 typ	1.40
19 F 59840	S5001	Si General Purpose Power Amplifier—NPN—70V 10A 90W	2.39
19 F 59857	S9001	Programmable Unijunction Transistor (unijunction characteristics such as R <sub>1</sub> , n, I <sub>v</sub> , and I <sub>p</sub> can be altered (programmed by changing the gate bias & supply resistors))	1.45
19 F 59865	S9100	Si Darlington Amplifier—NPN	.79
19 F 59873	S9120	Si Darlington Amplifier—PNP	.89
19 F 59881	Z0210	4.7 Volt Zener Diode 500mW	.83
19 F 59899	Z0211	5.1 Volt Zener Diode 500mW	.83
19 F 59907	Z0212	5.6 Volt Zener Diode 500mW	.83
19 F 59915	Z0214	6.2 Volt Zener Diode 500mW	.83
19 F 59923	Z0215	6.8 Volt Zener Diode 500mW	.83
19 F 59931	Z0216	7.5 Volt Zener Diode 500mW	.83
19 F 59949	Z0217	8.2 Volt Zener Diode 500mW	.83
19 F 59956	Z0219	9.1 Volt Zener Diode 500mW	.83
19 F 59964	Z0220	10 Volt Zener Diode 500mW	.83
19 F 59972	Z0222	12 Volt Zener Diode 500mW	.83
19 F 59980	Z0402	3.6 Volt Zener Diode 1 Watt	1.22
19 F 59998	Z0405	4.7 Volt Zener Diode 1 Watt	1.22
19 F 53751	Z0406	5.1 Volt Zener Diode 1 Watt	1.22
19 F 53769	Z0408	6.2 Volt Zener Diode 1 Watt	1.22
19 F 53777	Z0413	10 Volt Zener Diode 1 Watt	1.22
19 F 53785	Z0415	12 Volt Zener Diode 1 Watt	1.22
19 F 53793	Z2504	4.7 Volt Zener Diode 5 Watt	2.20
19 F 53801	Z2510	7.5 Volt Zener Diode 5 Watt	2.20
19 F 53819	Z2513	9.1 Volt Zener Diode 5 Watt	2.20
19 F 53827	Z2516	12 Volt Zener Diode 5 Watt	2.20
19 F 53835	Z2519	15 Volt Zener Diode 5 Watt	2.20

\*Replaces these HEP Nos.



# Semiconductors for Hobbyists and Experimenters

## Famous RCA HEP and Experimenter Kits



**10 SILICON DIODES.** Replaces 1N34, 1N34A, 1N48, 1N48, 1N51, 1N60, 1N87, 1N295, etc. 2 oz. 19 F 60012 Pkg. of 10 .....Net .89

**750 MIL EPOXY SILICON RECTIFIERS.** 750 mil 400 PIV Epoxy Silicon Rectifier. Shpg. wt. 3 oz. 19 F 50013 Net ea. .37; 10 for 3.45; 100 for 29.95 750 Mil 700 PIV Epoxy Silicon Rectifier. 19 F 50021 Net ea. .59; 10 for 4.95; 100 for 42.50

**40-WATT HIGH-POWER TRANSISTOR.** Excellent for power supplies, auto replacement, audio output, etc. Bolt mounted. 19 F 15032 Shpg. wt. 3 oz. ....Net .89

**GENERAL PURPOSE DIODES.** Excellent Detectors for transistor and vacuum tube receivers. Equiv. to: 1N34, 1N48, 1N34A, 1N56, 1N38A, 1N69. 19 F 49015 .Net ea. .10; 10 for .90; 100 for 8.50

**GE-509 UNIVERSAL SILICON RECTIFIER.** 1 emp., 1000 PIV, 80 amp. maximum surge. 19 F 26019 .....Net .79

**50-PC EXPERIMENTER'S ADVANCED SEMI-CONDUCTOR ASSORTMENT.** Consists of:

- 5 ea. MADT 50 MHz. HI Frequency Transistors
  - 5 ea. ZENER DIODES—400 mW
  - 2 ea. 3 Ampere DAP Transistors—PNP Germanium TO-5 Case
  - 5 ea. 1N82A HI-Frequency Germanium Diodes
  - 2 ea. SCR .2 Ampere Low Voltage
  - 2 ea. NPN TO-3 Transistors—Silicon Mesa
  - 2 ea. PNP TO-3 Transistors—Germanium Power
  - 27 ea. Silicon Rectifiers—400 mW. Over 25 PIV
- 19 F 15362 Shpg. wt. 5 oz. ....Net 2.49

### STUD-MOUNT SILICON POWER RECTIFIERS



All popular models, 1/8" hexagonal mounting studs. Shpg. wt. 3 oz. per package.

Stock No.	PIV	Pkg. of Net	Stock No.	PIV	Pkg. of Net
<b>2 Ampere Rectifiers:</b>					
19 F 50070	50	4 .49	19 F 42077	200	1 .96
19 F 50088	100	2 .39	19 F 52085	400	1 1.69
19 F 50054	200	2 .59	<b>30 Ampere Rectifiers:</b>		
19 F 50062	400	2 .87	19 F 55419	50	1 .99
<b>8 Ampere Rectifiers:</b>					
19 F 55376	50	2 .99	19 F 55425	100	1 1.39
19 F 55384	100	2 .99	19 F 55434	200	1 1.79
19 F 55392	200	1 .59	19 F 55442	400	1 1.99
19 F 55400	400	1 .99	<b>50 Ampere Rectifiers</b>		
<b>12 Ampere Rectifiers:</b>					
19 F 50039	50	2 1.19	19 F 15140	50	1 1.39
19 F 50047	100	1 .77	19 F 15214	100	1 1.99
			19 F 15222	200	1 2.49

### TRANSISTOR AND RECTIFIER HEAT SINKS As Low As 59¢

- For 1 TO-3 transistor. 22.8 sq. in.† 19 F 15271 Shpg. wt. 4 oz. ....Net .69
  - For 1 TO-3 transistor. 27.85 sq. in.† 19 F 15255 Shpg. wt. 5 oz. ....Net .79
  - For 1/8" Hex. rectifiers. 16.71 sq. in.† 19 F 15263 Shpg. wt. 4 oz. ....Net .59
  - For 1/4" Hex. rectifiers. 22.28 sq. in.† 19 F 15230 Shpg. wt. 5 oz. ....Net .69
  - For 1/2" Hex. rectifiers. 27.85 sq. in.† 19 F 15248 Shpg. wt. 5 oz. ....Net .79
- †Radiating surface.

### TRANSISTOR Z5 SILICONE GREASE



Easily dispenses compound to hard-to-reach areas when replacing transistors. 19 F 61096 Shpg. wt. 4 oz. ....Net 2.92

### QUICK PICK



**DESOLDERING DEVICE**  
For quick and easy removal of transistors and capacitors from congested circuit boards. Easy to use: slide sleeve down firmly to clamp; up to release. Consists of seven tools of different size and color for easy identification. 19 F 61252 Shpg. wt. 3 oz. ....Net 6.55



### MOTOROLA HEP IC EXPERIMENTER KIT

Contains 5 popular RTL integrated circuits: one J-K Flip-Flop; one Dual Buffer; one 4-Input Gate; and two Dual 2-Input Gates, a total of 34 transistors and 48 resistors. Cross-Reference Substitution Guide, "Tips on Using IC's," and 8 IC Project Circuits. 19 F 54528 Shpg. wt. 3 oz. ....Net 3.95

### COMPUTER CIRCUIT EXPERIMENT KIT

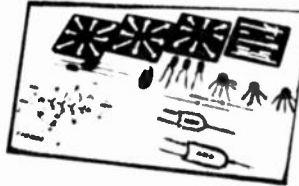

Supplied with all necessary parts including 3 Fairchild  $\mu$ L914 integrated circuits and comprehensive 18-page kit manual. Manual contains instructions, circuit diagrams, pictorial diagrams, and thorough, easy-to-follow discussion of Boolean algebra, logic functions and circuitry (AND, OR, NAND, NOR and INVERTER), truth tables, adders, number system conversion, etc. 19 F 53025 Shpg. wt. 7 oz. ....Net 9.95

### 38-PC. EXPERIMENTER'S SEMICONDUCTOR KIT

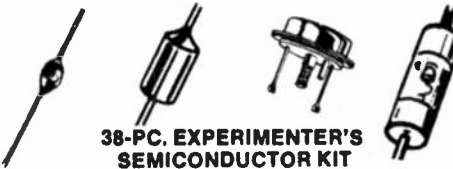

Assortment of 38 semiconductors: 4 ea. PNP General Purpose Transistors; 4 ea. NPN General Purpose Transistors; 2 ea. Power Transistors—TO-3 case; 4 ea. Stud Mount Silicon Rectifiers; 2 amp 200 PIV; 20 ea. General Purpose Germanium Diodes; 4 ea. 1/4-Watt Zener Diodes. 19 F 15347 Shpg. wt. 4 oz. ....Net 2.49

### DECIMAL TO BINARY CONVERTER MATRIX KIT



Kit includes diodes, pilot lamps, pre-etched printed circuit board and instruction manual. Displays binary number on its own pilot lamp readout. Manual contains instructions, circuit and pictorial diagrams and discussion of the binary number system. 19 F 53033 Shpg. wt. 5 oz. ....Net 4.95

### 5-PIECE HEAT SINK KIT



Set of 5 spring-loaded aluminum heat sinks to protect components while soldering. Includes 1 1/2" and 2 1/2" straight and bent jaws, and one 2 1/2" with magnetic base. 14 F 15017 Shpg. wt. 4 oz. ....Net 1.39



### INTEGRATED CIRCUIT PROJECT KITS



Requires only soldering iron. Project kits come complete with:  
• Active and Passive Components  
• Pre-drilled Printed-Circuit Boards  
• Assembly Instructions

- KC4000 Microphone Preamplifier.** For both low and high impedance microphone inputs. 19 F 43752 Shpg. wt. 8 oz. ....Net 6.34
- KC4001 Two-Channel Mixer.** Combine two-input signals into single output. 19 F 43780 Shpg. wt. 8 oz. ....Net 6.64
- KC4002 Audio Oscillator.** Use as code-practice oscillator or to test amateur radio transmitters or hi-fi and other audio equipment. 19 F 43776 Shpg. wt. 8 oz. ....Net 5.25
- KC4003 Audio-Amplifier-Oscillator.** Build a 500 mW audio amplifier or a variable-tone audio oscillator. 19 F 43786 Shpg. wt. 10 oz. ....Net 9.44
- KC4500 Kit Enclosure and Hardware Pack.** Use with Kits KC4000, KC4001, and KC4002. 19 F 43794 Shpg. wt. 8 oz. ....Net 5.09
- KC4004 9-Volt Regulated Power Supply.** Supplies 9 volts DC output with voltage regulation of 3% at a maximum current of 250 mA. 19 F 43661 Shpg. wt. 1 1/4 lbs. ....Net 10.59
- KC4005 Intruder Alarm.** Develops a "whopping" signal for security system. 19 F 43679 Shpg. wt. 8 oz. ....Net 7.94
- KC4006 Fire Alarm.** A low-melting-point solder sets off this warning device. 19 F 43667 Shpg. wt. 10 oz. ....Net 7.94
- KC4007A VHF Converter.** 118-136 MHz Aircraft Band. Shpg. wt. 10 oz. ....Net 11.25
- KC4008A VHF Converter.** 134-150 MHz Ham, Government Space Band. 19 F 43703 Shpg. wt. 10 oz. ....Net 11.25
- KC4009A VHF Converter.** 148-164 MHz Maritime Mobile Police, Fire Band. 19 F 43711 Shpg. wt. 10 oz. ....Net 11.25
- KC4010A VHF Converter.** 160-174 MHz, Police, Fire Band. Shpg. wt. 10 oz. ....Net 11.25
- KC4011 Digital/Display.** 19 F 44008 Shpg. wt. 8 oz. ....Net 5.79
- KC4012 Digital/Counter IC Kit.** 19 F 44016 Shpg. wt. 8 oz. ....Net 5.79

### RCA EXPERIMENTER'S IC VARIETY PACK



Enables the engineer or experienced hobbyist to extend his knowledge of IC's. Contains 5 integrated circuits: two KD2114 transistor arrays, one KD2115 audio amplifier, and two KD2116 transistor arrays. Included is a folder giving 12 useful circuits, their schematic diagrams, parts lists and features. 19 F 53086 Shpg. wt. 3 oz. ....Net 4.92

### Experimenter Books and Manuals

- RCA SOLID-STATE HOBBY CIRCUIT MANUAL.** Complete construction information on 62 circuits of general interest to experimenters. 388 pages. Shpg. wt. 1 lb. 10 F 47109 .....Net 1.95
- MOTOROLA FET EXPERIMENTER'S KIT.** Contains 2 field effect transistors, 2 bipolar transistors, brochure on FET's including a project circuit and FET Cross-Reference Guide. 19 F 54886 Shpg. wt. 4 oz. ....Net 3.95
- MOTOROLA HEP SEMICONDUCTOR CROSS-REFERENCE GUIDE AND CATALOG.** Reference for over 43,000 domestic and imported. 10 F 64047 Shpg. wt. 8 oz. ....Net 5.0

### HEP PROJECT MANUALS



- HEP No. 400 — Solid-State Projects Manual. 10 F 64013 .....Net .50
- HEP No. 407 — IC theory and applications. 10 F 64021 .....Net 1.00
- HEP No. 408 — FET's, theory and applications. 10 F 64039 .....Net 1.00
- EXPERIMENTER'S MANUAL. KM-71.** 138 pages on solid-state devices. 24 complete circuits for dozens of SCR applications. 10 F 47067 Shpg. wt. 1 lb. ....Net .96

# Look to Lafayette for PC Component Values!

## "TECHNIQUES" PRINTED CIRCUIT KITS AND SUPPLIES

### Screen Printing Kit

\$34.95

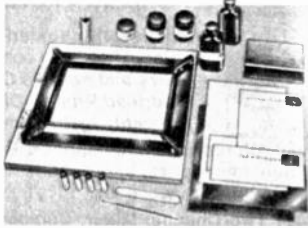

No. 5006. An accurate and rapid means of making large sample quantities or even short production runs of printed circuits. 8x12" frame comes with silk stretched. Includes neoprene squeegee, photo stencil film, etch-resistant ink, blockout medium, all chemicals, instructions. 19 F 88247W Shpg. wt. 12 1/2 lbs. . . . .Net 34.95

### Technician's Printed Circuit Kit

\$11.95



No. 5003. Contains 10 assorted single and double clad XXXP and epoxy glass boards from 4 1/2 x 6" to 3x2 1/4"; 1 tape resist; 1 liquid resist; eyelets; drill; etching solution and directions. 19 F 68064 Shpg. wt. 4 lbs. . . . .Net 11.95

### Fiber Tip Resist Pens

NEW

\$21



Type PRFP. Lets you draw variable-width circuit patterns (fine to thick) directly on copper-clad laminate. Markings resist standard PC etchants. Long-life spare tip included. Package of 12 pens. Shpg. wt. 1 lb. . . . .Net 21.00  
19 F 68544 Red . . . . .Net 21.00  
19 F 68536 Blue . . . . .Net 21.00

### Experimenter's PC Kit

\$5.95

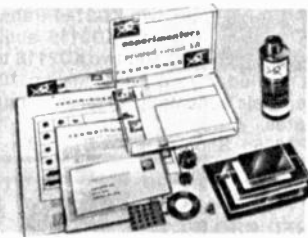

No. 5002. Contains 6 copper-clad boards, dots, etchant, tape resist, eyelets, directions. 19 F 68072 Shpg. wt. 1 1/4 lbs. . . . .Net 5.95

### Negative Artwork Kit

\$12.95

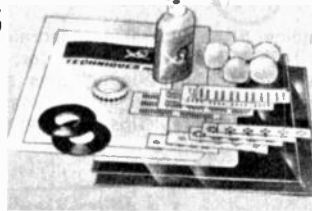

Photo reversing kit converts black-line artwork to "clear" line artwork for exposing pre-sensitized panels. Contains pressure-sensitive, actual size patterns of transistor and IC pads, lines, dots, supplies for two 4 1/2x6" negatives. 19 F 68502 Shpg. wt. 11 oz. . . . .Net 12.95  
19 F 68528 Extra Patterns. 11 oz. . . . .Net 7.95

### Industrial Laboratory Kit

\$39.95



No. 5100. Contains 20 pieces single- and double-clad XXXP and epoxy fiberglass laminates, pre-sensitized and uncoated tape resist; full array of tools, supplies and instructions. 19 F 68015W Shpg. wt. 9 lbs. . . . .Net 39.95

### Ball Point Tubes

Type PRLT. Make resist patterns directly on copper-clad boards. Deposits line 1/16" wide.

- 19 F 68395 Red . . . . .Net ea. 1.50
- 19 F 68403 Black . . . . .Net ea. 1.50
- 19 F 68411 Blue . . . . .Net ea. 1.50
- 19 F 68429 Green . . . . .Net ea. 1.50
- 19 F 68437 Yellow . . . . .Net ea. 1.50

### Pre-sensitized Copper-Clad Panels

1/16" thick, copper-clad one side except # both sides; \* XXXP laminate; † G10 epoxy-glass laminate.

Stock No.	Type	Size	Net Ea.
19 F 68031	PXC-F*	6x9"	2.25
19 F 68049	PXC-B*	6x4 1/2"	1.20
19 F 68058	PXC-C*	3x4 1/2"	.80
19 F 68254	PXE-F†	6x9"	4.20
19 F 68282	PXE-B†	6x4 1/2"	2.25
19 F 68270	PXE-C†	3x4 1/2"	1.40
19 F 68478	PXE-FF†‡	6x9"	5.85
19 F 68486	PXE-BB†‡	6x4 1/2"	3.10
19 F 68494	PXE-CC†‡	3x4 1/2"	1.95

Type P0-8 eight-ounce developer. 19 F 68023 . . . . .Net ea. 1.50

Type PXY-1 one-ounce dye. 19 F 68288 . . . . .Net ea. 75¢

### Printed Circuit Accessories

TAPE RESIST. 320" rolls. Black. Avg. wt. 2 oz.  
19 F 68122 PRT1. 1/2" width . . . . .Net ea. 85¢  
19 F 68130 PRT2. 1/4" width . . . . .Net ea. 85¢  
19 F 68148 PRT3. 3/8" width . . . . .Net ea. 90¢  
19 F 68155 PRT4. 1/8" width . . . . .Net ea. 95¢  
19 F 68298 PRT8. 1/4" width . . . . .Net ea. 1.00

RESIST CIRCLES. Pkg. of 100 each.  
19 F 68163 PRTO-8. 3/16" dia. . . . .Net 90¢  
19 F 68304 PRTO-8. 1/4" dia. . . . .Net 90¢  
19 F 68171 PRL. Touch-up Resist. 1 oz. . . . .Net 60¢  
19 F 68114 PEY12. 125 eyelets . . . . .Net 60¢  
19 F 68312 PTE10. Pkg. 10 terminals . . . . .Net 55¢  
19 F 68098 PE16. Pint Etchant . . . . .Net 1.50  
19 F 68106 PE32. Quart Etchant . . . . .Net 2.65

### G-C Chemicals



**PRINT-KOTE SILVER PRINT.** Pure silver compound. Air drying. Used to repair PC "wires" and touch up connections. 1/2 Troy ounce. Shpg. wt. 4 oz.

13 F 60106 LGC-21-1 . . . . .Net 11.70  
**PRINT-KOTE COPPER PRINT.** High-conductive, fast-drying. Brush-cap 2-oz. jar.  
13 F 61146 Shpg. wt. 7 oz. . . . .Net 2.75

### Masonite Breadboard

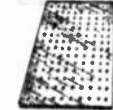

Tempered masonite board with 1/4" holes spaced 1/2" apart to facilitate mounting of parts. 7 3/4 x 11 3/4 x 1/8" thick. Shpg. wt. 8 oz.  
19 F 17012 . . . . .Net 59¢

### Nylon Dial Cord

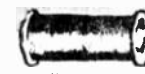

Pre-stretched. Break strength: medium 35 lbs., standard 20 lbs., thin 15 lbs. Avg. shpg. wt. 4 oz.

Stock No.	Type	Diameter	Spool	Net
32 F 80187	Medium	.040"	100'	2.86
32 F 80195	Standard	.028"	100'	2.86
32 F 80203	Thin	.025"	100'	2.86
32 F 80211	Medium	.040"	25'	.91
32 F 80229	Standard	.028"	25'	.91
32 F 80237	Thin	.025"	25'	.91

### Terminal Strips



High-quality bakelite. Solder lugs mounted on 1/16" thick insulation. Mounting holes for 6-32 screws. 5 per package. Average shpg. wt. 6 oz.

Stock No.	Term.	Net	Stock No.	Term.	Net
32 F 12184	2	.48	32 F 12214	7	1.38
32 F 12172	3	.68	32 F 12222	8	1.53
32 F 12180	4	.80	32 F 12230	9	1.73
32 F 12198	5	1.02	32 F 12248	10	1.93
32 F 12208	8	1.17			

### Kit of 48 Solder Lug Strips



Handy assortment of terminal strips with 8 of each type from 1 thru 6 lugs. Shpg. wt. 8 oz.  
32 F 60056 . . . . .Net 1.79

### Vector Integrated Circuit Kits



Kit 30XA. Micro-Vectorboard 4 1/2 x 8 1/2 x 1/8" chassis, wood supports, 100 T42-1 terminals. 19 F 83891 . . . . .Net 4.50

Kit 31X. As above plus Micro bus strip, wire wrap terminals, aluminum chassis rails, brackets, etc. 19 F 83717 . . . . .Net 17.50

### Vector Push-in Terminals, Tools



Type T9.4. Brass, tin-plated; serrated slots.  
19 F 83014. Fits .093" hole. Pkg. 100 . . . . .Net 1.68  
19 F 83410 P122B Insertion Tool for T9.4 . . . . .Net 1.65  
Type T28. Beryllium copper, tin-plated.  
19 F 83022 Fits .062" hole. Pkg. 100 . . . . .Net 1.69  
Type T28S. Same as T28 but silver-plated.  
19 F 83618 Pkg. of 100 . . . . .Net 2.16  
19 F 83063 P91 Tool for T28, T28S . . . . .Net 75¢  
Type T30N-2. Springclip term. for .093" hole.  
19 F 83048 Pkg. of 10 . . . . .Net 1.31  
19 F 83055 P92A Tool for T30N-2 . . . . .Net 64¢  
Type T42-1. Micro-Klip push-in term. for .042" hole.  
19 F 83758 Beryllium copper. Pkg. 100 . . . . .Net 1.91  
19 F 83774 K24C Inbord Pin. Pkg. 100 . . . . .Net 1.28  
Type T44. .025" square wire-wrap pin; slot top.  
19 F 83790 For .042" hole. Pkg. 100 . . . . .Net 4.12  
19 F 83808 A13 Tool for T44 . . . . .Net 1.77

### Perforated Copper-Clad & Unclad Circuit Boards

Holes are 1/16" diameter with 3/16" between centers; 1/16" thick. Shpg. wt. 9 oz.

PERFORATED CLAD			PERFORATED UNCLAD			
Stock No.	Net Each.	Lots of	No. of Holes	Size	Net Each.	Lots of
19 F 36012	.39	100	27	2 7/8 x 3 3/8"	.27	100
19 F 36020	.68	50	35	3 1/2 x 6 3/4"	.49	50
19 F 36038	1.37	25	73	7 1/2 x 6 3/4"	.82	25
19 F 36046	2.05	15	106	10 1/2 x 7 1/2"	1.28	15
			18	18 x 7 1/8"	1.92	15

### Unperforated Copper-Clad Boards

Ideal for transistor and subminiature circuitry. One side copper laminate clad. Average shpg. wt. 14 oz.

XXXP BAKELITE			G-10 EPOXY GLASS		
Stock No.	Size	Net	Stock No.	Size	Net
19 F 71019	9 x 12"	1.50	19 F 37044	9 x 12"	4.20
19 F 71027	6 x 4 1/2"	.49	19 F 37051	6 x 4 1/2"	1.24
19 F 71035	3 x 4 1/2"	.30	19 F 37069	3 x 4 1/2"	.61
19 F 71043	2 x 4 1/2"	.25	19 F 37077	2 x 4 1/2"	.40
19 F 71050	3 x 2 1/4"	.24	19 F 37085	3 x 2 1/4"	.34

# Lafayette Has Values in Coils and Chokes

## MILLER RF CHOKES

Wound on low-loss forms, impregnated with moisture and fungus-resistant varnish.



Phenolic Core Single Layer Windings—  
3/8" dia. 3/8" long

Stock No.	Mfr. Type	Fig.	Inductance	Q	mA	Ohms	Net
34 F 86636	4802	1	1.0 μh	80	2000	.050	.88
34 F 86644	4604	1	1.5 μh	58	1800	.093	.86
34 F 86651	4606	1	2.4 μh	56	1500	.190	.86
34 F 86669	4608	1	3.9 μh	60	1000	.450	.86
34 F 86677	4609	1	5.5 μh	57	850	.670	.86
34 F 86685	4610	1	6.2 μh	57	700	.830	.89
34 F 86693	4611	1	8.2 μh	57	600	1.20	.89
34 F 86701	4612	1	10.0 μh	36	500	1.50	.89

## Iron Core Single Layer Windings—7/32" dia. 7/8" long

Stock No.	Mfr. Type	Fig.	Inductance	Q	mA	Ohms	Net
34 F 86719	4622	1	10 μh	68	1500	.11	.75
34 F 86727	4624	1	15 μh	62	1000	.17	.75
34 F 86735	4626	1	24 μh	65	800	.34	.78
34 F 86743	4628	1	39 μh	70	600	.65	.78
34 F 86750	4629	1	55 μh	72	500	1.0	.84
34 F 86768	4631	1	82 μh	85	450	1.9	.84
34 F 86776	4632	1	100 μh	107	400	3.0	.84

## Iron Core 3-Section Windings—7/32" dia. 7/8" long

Stock No.	Mfr. Type	Fig.	Inductance	Q	mA	Ohms	Net
34 F 86784	4662	2	1.0 mh	83	160	8.6	1.20
34 F 86792	4666	2	2.4 mh	80	160	15	1.32



Black fluted knobs, with and without skirt. Made of thermosetting plastic with high gloss finish. All have recessed brass insert and set screw. Mount on 1/4" shaft. Shpg. wt. 3 oz.

Stock No.	Fig.	Dia.	Ht.	Net Each
				1-24 25-99
32 F 24060	3	1 1/8"	3/8"	.34 .32
32 F 24088	3	1 1/8"	3/8"	.41 .37
32 F 24102	4	2 1/16"	3/8"	.62 .74

## STANDARD PLASTIC KNOBS

Plastic knobs with knurled bodies. Set screw for mounting 1/4" round or flatted shafts. Avg. wt. 2 oz.

Stock No.	Fig.	Dia.	Color	Net Each
				1-24 25-99
32 F 24177	5	1"	Walnut	.19 .17
32 F 24165	5	1"	Black	.19 .17
32 F 24201	7	1 1/2"	Black	.24 .21
32 F 24219	7	1 1/2"	Black	.24 .21
32 F 24227	6	1 1/8"	Maroon	.18 .11

## POINTER, BAR AND LEVER KNOBS

Set screw for 1/4" round or flatted shaft, and white indicator lines. Items marked \* have brass insert. Av. shpg. wt. 2 oz.

Stock No.	Length	Net Each
		1-24 25-99
32 F 24110	2"	.23 .21
32 F 24128	1 1/4"	.34 .32
32 F 24136*	1 1/4"	.22 .19
32 F 24144	1 1/4"	.19 .17
32 F 24151*	1 1/4"	.34 .32
32 F 24169	1 1/4"	.19 .16



## KIT OF 5 MATCHED KNOBS

Steel-gray knob shaft insert will accept 1/4" shaft. 1" diam. x 1 1/8" deep. Imported. Shpg. wt. 5 oz.

99 F 61160 ..... Net 2.18

## MINIATURE KNOBS

Plastic knob, only 3/8" diameter fits 1/8" shafts.

32 F 24052 Walnut. Shpg. wt. 2 oz. .... Net.19

## PRECISION VERNIER DIAL

8 to 1 ratio. 1/4" shafts. Reads counter-clockwise 0 to 100 in 180°. Imported. Shpg. wt. 7 oz.

36mm (1 1/2") diameter Vernier dial, 1 3/16" from front to back.

99 F 60311 ..... Net 1.95



## COUPLERS AND EXTENDERS

Brass couplings (9) and extenders (8). Extender shaft length, 3/4"; over-all length 1 1/8". Avg. shpg. wt. 3 oz. \*Extenders.

Stock No.	Size	Net
32 F 64124	1/4 x 1/4"	.33
32 F 64157*	1/4 x 1/4"	.44
32 F 64165*	3/8 x 1/4"	.44

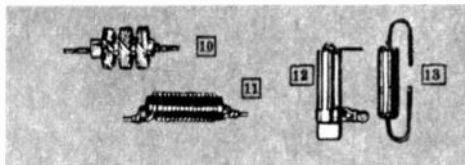

## FERRITE CORE R.F. CHOKES

A new series of R.F. Chokes taking advantage of the high permeability of ferrite cores. These chokes combine high inductance and low D.C. resistance. Size: 1/4" diameter x 7/8" long. 1 1/2" axial leads.

Stock No.	Miller Type	mH	Ohms Max.	mA	Net
34 F 87923	6302	2.5	9	180	1.24
34 F 87949	6306	10	31	100	1.59
34 F 87986	6308	25	82	65	1.59

## MILLER HEAVY-DUTY HASH CHOKES

Molded powdered iron form offer a series of relatively high inductance, high current hash filter chokes.

Stock No.	Miller Type	μh ±20%	Ohms Max.	Amp	Net
34 F 86886	5218	3.35	.010	13	1.88
34 F 86894	5220	8.8	.021	5	1.50
34 F 86610	5240	40.0	.082	2	1.32
34 F 86602	5248	68.0	.054	5	1.50
34 F 86626	5250	100.0	.216	2	1.50

## FREQUENCY SELECTIVE R.F. CHOKES

Designed for maximum efficiency and highest impedance at specific operating frequencies, this group of R.F. chokes eliminates the designer's task of attempting to choose the best coil for a particular application. Designed to cover the major Amateur, Industrial, and Citizens bands. Shpg. wt. 3 oz.

Stock No.	Miller Type	μh	L	Freq. MHz	Fig.	Net
34 F 86897	RFC-14	84	μh	7-20	12	2.34
34 F 86705	RFC-21	38.5	μh	15-30	12	1.58
34 F 86713	RFC-28	24	μh	25-40	13	1.34
34 F 86721	RFC-50	8.2	μh	30-90	13	1.14
34 F 86739	RFC-144	1.72	μh	75-180	13	.80
34 F 86747	RFC-220	.82	μh	160-340	13	.80

## LAFAYETTE MINIATURE IF TRANSFORMERS & OSCILLATOR COILS



As Low As 59¢

Slug-tuned printed circuit mounted miniature IF transformers. All have .455 kHz intermediate frequency. Each with schematic and pin contacts. Ideal replacements for Japanese transistor radios. All units 3/8" square x 3/16" high. Imported. Shpg. wt. 2 oz.

99 F 63000 Oscillator coil inductance 270μh. Net 59¢  
 99 F 63018 1st IF; pri. 70,000 ohms, sec. 1500. Net 79¢  
 99 F 63026 2d IF; pri. 50,000 ohms, sec. 1000. Net 79¢  
 99 F 63034 3d IF; pri. 30,000 ohms, sec. 5000. Net 79¢



## MICA TRIMMERS AND PADDERS

Base of low-loss-ceramic. 1 1/2 x 3/4 x 3/8" in size. 1 1/2" mtg. ctrs. Capacity ranges derived from 3 turns open to tight setting. Avg. shpg. wt. 2 oz.

Stock No.	pF	Net Each
		1-24 25-99
34 F 63386	1.5-15	.37 .32
34 F 63295	2.7-40	.38 .33
34 F 63303	5.-80	.82 .46
34 F 63311	10.-180	.84 .57
34 F 63329	25.-280	.89 .64
34 F 63337	50.-380	.89 .80
34 F 63345	75.-480	.97 .88
34 F 63352	105.-580	1.04 .95

## TINY TUNING CONDENSER WITH DIAL



- For Transistor and Miniature Circuits
- Only 1" Square x 7/16" Deep
- Polyethylene Dielectric
- 385 pF

A new "Poly-Vari-Con" model for use in TRF broadcast band and experimental receivers. Clear, calibrated tuning dial from 530-1600 kHz. Capacity variable from 10-385 pF. Knurled dial is 1/4" dia.; rotation is 180°. Dial is mounted to condenser shaft by 1/8" diam., chrome-plated retainer. Imported. Wt. 3 oz.

99 F 62176 ..... Net 98¢

\$1150

### COILMASTER DELUXE ACCURATE COIL WINDER

Latest model gives greater accuracy than ever. Winds honeycomb, spiderweb and solenoid coils of various widths and diameters. Also suitable for winding chokes, transformers and filter inductors. Indicator counts number of turns on coil. Uses #22 to #40 wire. With wood spools, metal pegholders and extension for making long solenoid coils. Instructions included, but less coil form and pegs. Shpg. wt. 2 lbs.

**32 F 87018 ..... Net 11.50**

### TRANSISTOR TAPPED VARIABLE ANTENNA COIL

- Boosts Signal Pickup
- Super-Selective!

Matches low input impedance of transistors. For 365 to 420 pF variable capacitors. Highly-sensitive with a "Q" of up to 250. With adjustable ferrite core for maximum peaking. Single-hole snap-in mounting, plus bracket. Efficient at all angles. Size: 2 1/2 x 1 1/2" diam.

**32 F 01985 Shpg. wt. 4 oz. .... Net 1.65**

### 455 kHz UNIVERSAL I.F. TRANSFORMER

Exceptionally high gain powdered iron core, compression tuned 455 kHz midget I.F.—only 3/4" square by 1 1/8" high. For both input and output circuits. Supplied with mounting clip.

**32 F 01993 2 per Pkg. Shpg. wt. 8 oz. .... Net 1.88**

### MILLER TRANSISTOR ANTENNAS

Has an inductance of 240 μh and is designed for use with a standard variable condenser having a maximum capacity of 365 mmf. Freq. range 540-1650 kHz, Q at 790 kHz. 650.

**34 F 87485 Type 2001. Shpg. wt. 4 oz. .... Net 2.28**

### MINIATURE STANDARD

Has a fixed inductance of 240 μh and covers a band of 540-1650 kHz. Large pickup area and high Q. Maximum tuning capacity 365 mmf. Q at 790 kHz. 450.

**34 F 88194 Type 2000. Shpg. wt. 3 oz. .... Net 2.88**

### SUBMINIATURE

Adjustable antenna coil with high Q ferrite cores. Inductance range for 2002 is 40-300 μh, for 2007, 150-1000 μh. Freq. range 540-1650 kHz. Q at 790 kHz for 2002, 250; for 2007, 220. Tuning capacity 2002, 250-450 mmf; 2007, 100-250 mmf. Shpg. wt. 4 oz.

**34 F 87493 Type 2002 ..... Net 1.68**  
**34 F 68210 Type 2007 ..... Net 1.98**

### HORIZONTAL LINEARITY AND WIDTH CONTROLS

Iron core variable inductance coils for linearity and width adjustment. Wound on a bakelite form 3/8" in diameter. Mtg. clip fits 3/16" hole. 6300'e—phenolic form. Avg. shpg. wt. 4 oz.

Stock No.	Miller	Millihenries	Net
34 F 88384	6198-A	.054-.50 Tapped	3.04
34 F 88459	6315	4.0-30	1.76
34 F 88491	6319	15-60	2.18
34 F 88525	6322	15-10	1.99
34 F 88541	6324	60-130 Tapped	2.18
34 F 88495	6330	45-215	3.30

### PHENOLIC FORM 3-SECTION R.F. CHOKES

Combines high inductance and low D.C. resistance. Size: 3/8" diameter x 3/4" long. Shpg. wt. 3 oz.

Stock No.	Miller	mH	Ohms Max.	mA	Net
34 F 88293	4652	1.0	19.8	125	.86

### UNIVERSAL ADJUSTABLE OSC. COIL

RF freq. 500-1800 kHz, IF freq. 100-500 kHz. Dimensions 3/8" x 1 1/2" high. Shpg. wt. 3 oz.

**34 F 87049 Miller Type 71-OSC ..... Net 3.98**

**Lafayette Cat. No. 750 137**

# General and Special Purpose Relays

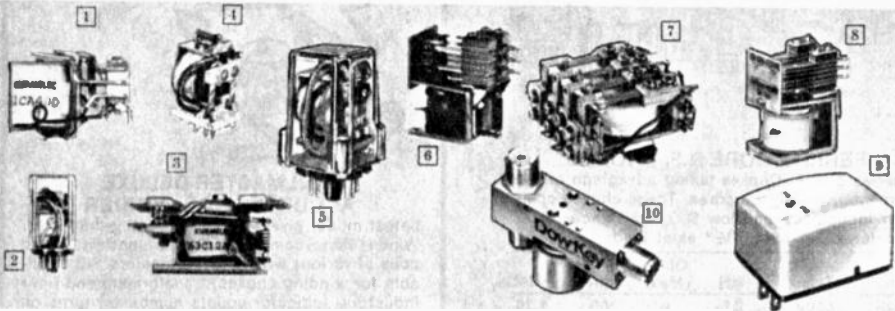

## 1 KURMAN SENSITIVE SPDT RELAYS

Series 51C—Midget—DC Relays. Self-wiping contacts. Standard adj. 10 milliwatts (13,000-ohm relay adjusted for 5 milliwatt). Others can be field-adjusted. Adjustable 2-amp SPDT screw contacts. Mounting: two #6-32 tapped holes on 0.437" centers. 1 1/4 x 1 1/2 x 1 1/2". Shpg. wt. 6 oz.

Stock No.	Type	Coil Ohms	Pull-in mA	Amps	Net
30 F 22001	51CA37D	500	4.5	2	6.95
30 F 22019	51CA40D	2,000	2.3	2	6.95
30 F 22027	51CA42D	5,000	1.4	2	7.25
30 F 22035	51CA43D	8,000	1.2	2	7.65
30 F 22043	51CB44D	13,000	0.6	1	7.65

## 2 SERIES 5D1C—DC RELAYS—DUST COVER

Similar to 51C, with polystyrene-enclosed plug-in. Permits field adjustment without special equipment. Mounting: 8-pin octal plug-in. 2 1/8 x 1 3/8" sq. 6 oz.

Stock No.	Type	Coil Ohms	mA	Amps	Net
30 F 22050	5D1CA37D	500	4.5	2	7.95
30 F 22068	5D1CA40D	2,000	2.3	2	7.95
30 F 22076	5D1CA42D	5,000	1.4	2	8.25
30 F 22084	5D1CA43D	8,000	1.2	2	8.65
30 F 22092	5D1CB44D	13,000	0.6	1	8.65

## 3 KURMAN POWER & ANTENNA RELAYS

Power Relay. Midget heavy-duty industrial control relay for all applications requiring high-speed operation, long life and reliable high current contacts. In clear polystyrene enclosure. Up to 3PDT with standard contacts rated at 10 amps. Coil power 1 watt. Mounting: 8-pin octal for 3PDT, \*DPDT, †3PDT. Size: 2 1/4 H x 1 3/8" square. Shpg. wt. 6 oz.

### DC RELAYS

Stock No.	Type—Volts	Coil Ohms	Pull-in mA	Pull-in V	Net
30 F 22100	26D2C- 12VDC*	108	96	9.5	7.95
30 F 22118	26D2C- 24VDC*	428	48	20	7.95
30 F 22126	26D2C-110VDC†	6800	12	60	8.70
30 F 22134	26D3C- 12VDC†	68	148	10	9.25
30 F 22142	26D3C- 24VDC†	270	75	20	9.25
30 F 22159	26D3C-110VDC†	6800	15	100	9.95

### AC RELAYS

30 F 22167	26D2C-115VAC*	1200	33.7	95	7.95
30 F 22175	26D3C-115VAC†	1200	33.7	115	9.95

Relays for 6VDC SPDT and for 6, 12, 24 and 230 VAC SPDT, DPDT and 3PDT available on order. 3-wk. del.

## 4 MAGNECRAFT 10-AMP RELAYS

Types 588, 588CP. Available as an open relay (588) or with a dustile plastic enclosure (588CP). Enclosed types with SPDT and DPDT contacts have 8-pin octal plug-in bases while the 3PDT types use 11-pin plug-in bases. Open relays supplied with axial-type solder lugs. Size: 588—1 1/4 x 1 1/4 x 1 1/4", 588CP—2 1/2 x 1 1/2 x 1 1/2". Silver alloy gold flashed contacts. UL recognized. Shpg. wt. 5 oz.

Stock No.	Part No.	Coil Volts	Ohms	Con-tacts	Net
30 F 20005	W588AX-15	24VAC	96	SPDT	3.92
30 F 20013	W588X-14	12VDC	120	SPDT	3.80
30 F 20021	W588AX-19	24VAC	96	DPDT	4.85
30 F 20039	W588AX-20	115VAC	2200	DPDT	4.85
30 F 20047	W588X-18	12VDC	120	3PDT	4.31
30 F 20054	W588X-21	6VDC	30	3PDT	4.97
30 F 20062	W588X-23	24VDC	480	3PDT	4.97
30 F 20070	W588ACPX-16	115VAC	2200	SPDT	6.95
30 F 20088	W588ACPX-20	115VAC	2200	DPDT	7.77
30 F 20096	W588ACPX-24	115VAC	2200	3PDT	9.53

## 5 MAGNECRAFT 10-AMP CLASS 12

Multiple contacts. Used widely in industrial controls, communications equipment, and automatic vending machines. Coil dissipation, 3 watts maximum. Size: 1 7/8 W x 1" H. Mounting: Four 6-32 tapped holes on 3/4 x 7/8" centers. Standard Contacts: 1/8"—silver. Rated 10 amps resistive at 115 VAC. Shpg. wt. 8 oz.

Stock No.	Part No.	Coil Volts	Ohms	Con-tacts	Lgth.	Net
30 F 20104	W12X-2	12VDC	64	DPDT	1 1/2"	4.46
30 F 20112	W12AX-2	12VAC	9	DPDT	1 1/2"	4.46
30 F 20120	W12AX-3	24VAC	19	DPDT	1 1/2"	4.46
30 F 20138	W12AX-4	115VAC	645	DPDT	1 1/2"	4.48
30 F 20146	W12AX-8	115VAC	645	3PDT	1 1/2"	5.46

## 6 MAGNECRAFT 15-AMP POWER RELAYS

Class 94. Compact and positive acting relays for either AC or DC. 1/4" dia. silver contacts rated at 15 amps resistive. 5 amps inductive at 115 VAC or 28 VDC. Size: 2 1/2 L x 1 3/4 W x 1 3/8" H. Mounts with 2 tapped holes 6-32 NC -2 2" centers. Shpg. wt. 8 oz.

Stock No.	Part No.	Coil Volts	Ohms	Con-tacts	Net
30 F 20187	W94AX-3	24VAC	21	SPDT	6.17
30 F 20195	W94AX-4	115VAC	480	SPDT	6.17
30 F 20203	W94X-1	6VDC	18	SPDT	6.17
30 F 20211	W94X-2	12VDC	72	SPDT	6.17
30 F 20229	W94AX-9	115VAC	480	DPDT	9.09
30 F 20237	W94X-5	6VDC	18	DPDT	9.09
30 F 20245	W94X-6	12VDC	72	DPDT	9.09
30 F 20252	W94X-12	12VDC	72	3PDT	13.45

## SENSITIVE DPDT MINIATURE RELAY



\$4.98

Extremely small, sensitive relay—weighs only 1/2 oz. Silver and silver-gold-platinum alloy contacts. 100 volts at 300 mA (30 watts), 5,300 ohms DC resistance, DC pull-in current, 0.95 mA. DC, drop-out. Transparent plastic dust cover. Operating time 2-8 millisecc; release time about 1.5 msec. Breakdown voltage: coil to frame, 500V; contacts to frame 350V. 1 1/4 x 1 1/4 x 3/8". Imported. 99 F 60931 Shpg. wt. 4 oz. . . . . Net 4.98

## 7 CARDINAL HEAVY-DUTY PWR. RELAYS

Type CE. 15-amp general purpose open relay. Silver cadmium oxide contacts rated 15 amps operate at 75% of nominal voltage for DC and 80% of nominal voltage for AC. Sensitivity: AC (60 Hz) 5 VA; DC 1.5 W. Solder lug pre-linned terminations. Size: 1 1/4 D x 1 1/4 W x 1 1/4 H (1 or 2 poles); 1 3/4 H (3 or 4 poles). Mounts by 8-32 x 3/8". D tapped hole and 1/4 D locating boss spaced 0.453" center to center. Wt. 8 oz.

Stock No.	Type—Volts	Coil mA	DC Ohms	Con-tacts	Net
30 F 27000	CE-6A-12VAC	420	5.8	DPDT	4.35
30 F 27018	CE-6A-24VAC	210	21	DPDT	4.35
30 F 27026	CE-6A-115VAC	43	500	DPDT	4.35
30 F 27034	CE-6A-230VAC	22	2100	DPDT	5.10
30 F 27042	CE-6D-6VDC	250	24	DPDT	4.35
30 F 27059	CE-6D-12VDC	130	96	DPDT	4.35
30 F 27067	CE-6D-24VDC	63	380	DPDT	4.35
30 F 27075	CE-12A-115VAC	43	500	4PDT	7.19
30 F 27083	CE-12A-230VAC	22	2100	4PDT	7.88
30 F 27091	CE-12D-6VDC	250	24	4PDT	7.19
30 F 27109	CE-12D-12VDC	130	96	4PDT	7.19
30 F 27117	CE-12D-24VDC	63	380	4PDT	7.19

## 8 ALCO ISOLATION CONTROL RELAYS

Permits any on-off power switch or control circuit to be isolated from the dangerous AC line voltage. With 6" leads and two 8/32 thread mounting holes. 8 oz.

Stock No.	Model	Contacts	Circuit	Max. Control Resist.	Net
30 F 12036	FR-105A	SPST		50 ohms	4.65
30 F 12010	FR-102	SPDT		300 ohms	5.20
30 F 12028	FRE-103†	SPDT		400 ohms	7.30

†AC Outlet Plug-in type. Has side jack for plug-in of remote switch or sensor.

## 9 DOW KEY "60" COAXIAL RELAY

Type 60-262842. Heavy-duty SPDT coaxial relay rated 1 KW. Impedance 50 ohms. Life, over 1,000,000 operations. VSWR, less than 1.15:1 from 0-500 MHz. Greater than 100 dB isolation. With UHF coaxial connector and 2 Form C Aux. contacts. Coil voltage, 115 VAC, 3.00 x 0.88".

F 52016 Shpg. wt. 12 oz. . . . . Net 36.95

## AMPERITE THERMOSTATIC RELAYS

Heater-actuated Time-Delay Relays. Operate on AC, DC or pulsating current. Hermetically-sealed in glass envelope with current base. SPST, normally open, closed by heater after delay (in sec.). Heater draws only 2 watts. Contacts rated 3 amps at 115 VAC or 1.0 amp at 220 VAC. Size: 2 3/4 x 1 1/4" diameter. Wt. 5 oz.

Delay Sec.	Normally Open		Normally Closed	
	6.3V AC-DC	115V AC-DC	6.3V AC-DC	115V AC-DC
2	33 F 35015	33 F 35148	2	33 F 35254
5	33 F 35023	33 F 35155	5	33 F 35262
10	33 F 35031	33 F 35163	10	33 F 35270
15	33 F 35040	33 F 35171	15	33 F 35280
20	33 F 35058	33 F 35189	20	33 F 35298
30	33 F 35066	33 F 35197	30	33 F 35306
45	33 F 35072	33 F 35205	45	33 F 35312
60	33 F 35080	33 F 35213	60	33 F 35320
75	33 F 35098	33 F 35221	75	33 F 35338
90	33 F 35106	33 F 35229	90	33 F 35346
120	33 F 35114	33 F 35247	120	33 F 35354
150	33 F 35122		150	33 F 35362
180	33 F 35130		180	33 F 35370

Any of the above . . . . . Net ea. 2.55

## AMPHENOL OCTAL RELAY SOCKETS

Rugged melamine sockets with high insulation barriers. Rated 5 amps. 1250V RMS. \*Has four molded-in threaded inserts for tie points. 103-104 are top mounted. Shpg. wt. 4 oz.

Stock No.	Type	Net Ea.
32 F 19045	146-103	1.79
32 F 19912	146-104*	2.22

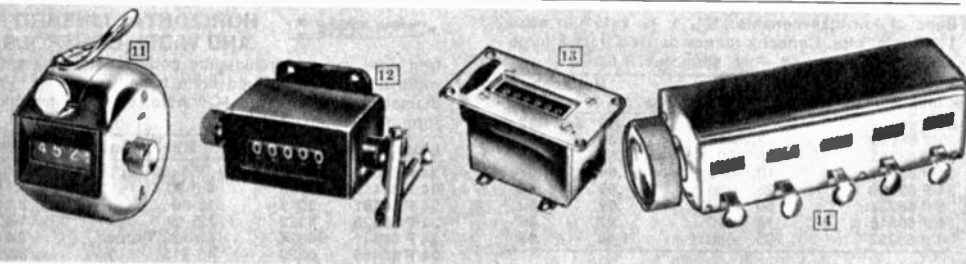

## 11 HAND 4-DIGIT TALLY REGISTER

Registers 0 to 9999. Highly-polished chromium-plated brass case. Large, clearly-read numerals. Knurled reset knob sets register to zero in one turn. Small size: approx. 1 3/4 x 1 3/8". Imported.

99 F 90300 Shpg. wt. 5 oz. . . . . Net 4.75

## 12 5-DIGIT STROKE-ACTUATED RESET COUNTER

Easy-to-mount counter for machine operations. One count per stroke. Drilled mounting flange, actuating arm and spring. Manual or solenoid actuated. Reads up to 99,999; side knob easily resets to zero. 2 1/2 x 1 1/2 x 1 3/8". Imported.

99 F 90292 Shpg. wt. 1/2 lb. . . . . Net 5.95

## 13 6-DIGIT ELECTRIC COUNTER

Activate by any switch, relay, etc. White figures on a black background to 999,999. Built-in selenium rectifier. DC-operated solenoid, chrome-plated. 6" leads. 110 VAC, 50-60 Hz. 2 1/2 x 2 x 1 1/4". Removable front plate: 3/4 x 2". Imported.

99 F 90110 Shpg. wt. 1 lb. . . . . Net 19.50

## 14 MULTI-COUNTER 5-POS. REGISTER

Five-plunger tally in a single, chromium-plated case. Ideal for (1) laboratory use, (2) time and motion studies, (3) production control. Each 3-digit register counts up to 999. Reset knob returns all 5 positions to zero. 5 1/2 W x 1 7/8 H x 1 3/8" D.

99 F 90318 Imported. Shpg. wt. 1 lb. . . . . Net 23.95

# Lafayette Lamps, Bulbs, Pilot Lights, Accessories

## HOBBYIST PILOT LIGHT ASSEMBLIES

• Ideal for the Builder and Experimenter

For both miniature screw and miniature bayonet lamps. Bulb replaceable from front of panel. Transparent plastic dome for 180° visibility except \* = opaque. Front mounting with nickel finish nut and lockwasher. Solder terminals. 3/8" mounting hole. Less lamp. Imported. Shpg. wt. 2 oz.



Screw Stock No.	Color	Bayonet Stock No.	Net ea.	Lots of 10 ea.
99 F 63323	Red	99 F 63398		
99 F 63331	Clear	99 F 63406		
99 F 63349	Amber	99 F 63414	1.09	.99
99 F 63356*	Green	99 F 63422*		

## PILOT LIGHT SOCKETS

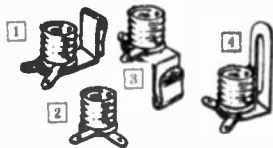

Cadmium plated brackets with tinned brass lugs. Bayonet type with coil spring construction for positive contact. For miniature screw, bayonet, and candelabra base. Avg. wt. 2 oz.

MINIATURE SCREW TYPE				
Stock No.	Fig.	Ea.	10 For	
32 F 28004	1			
32 F 28012	2			
32 F 28020	3	.35	2.60	
32 F 28038	4			
MINIATURE BAYONET TYPE				
32 F 28046	1			
32 F 28053	2			
32 F 28061	3	.39	2.60	
32 F 28079	4			
CANDELABRA TYPE, 115 VOLT				
32 F 28087	1			
32 F 28095	2			
32 F 28103	3	.40	2.60	
32 F 28111	4			

## NEON PILOT LIGHT ASSEMBLIES

As Low As

60¢



Lots of 10

For operation on 110 volts AC. Requires 10k resistor in series. When used with 200V use 250k resistor in series. AC starting voltage 60V. Servicing life, 5000 to 10,000 operating hours. Chrome finish. Imported. 2 oz.

Stock No.	Color	Net Ea.	Lots of 10 Ea.
99 F 62242	Yellow	.76	.60
99 F 62259	Amber	.76	.60
99 F 62267	Red	.76	.60

## METER ILLUMINATING PILOT LAMP

Used in Lafayette "S" and Modulation panel meters. Operates on 6 volts AC or DC. Can operate on 12 volts with 2 lamps in series.



99 F 62622 2 oz. Net .49

Channel Selector Dial Indicator Lamp. Used in Lafayette Citizens Band and communications equipment. Operates on 6 volts AC or DC. 12 volts with series voltage dropping resistor. Size: 3/8" long x 1/2" dia. 9-inch leads. Imported.

99 F 63612 Shpg. wt. 2 oz. .Net .53

## SOCKETS FOR NEON, ARGON AND PILOT LAMPS



- 5 Cleat Receptacle/Edison Socket. 13 F 81276 Shpg. wt. 4 oz. .Net .47
- 6 Receptacle with min. screw skt. 13 F 81284 Shpg. wt. 3 oz. .Net .37
- 7 Receptacle/candelabra socket. 13 F 81292 Shpg. wt. 3 oz. .Net .37
- 8 Recessed receptacle with double contact bayonet socket. Top mntg. 13 F 34010 Shpg. wt. 3 oz. .Net .88
- 9 Double cont. bay. candelabra skt. 13 F 34028 Shpg. wt. 3 oz. .Net 1.78
- 7 Single cont. bay. candelabra skt. 13 F 34036 Shpg. wt. 3 oz. .Net 1.65

## PILOT LAMPS—FLASHLIGHT—AUTO LAMPS, ETC.



Base code: 1—single contact flanged, 2—miniature screw, 3—double contact index, 5—single contact midjet, 6—single contact bayonet, 7—double contact bayonet, 8—midjet screw, 9—miniature bayonet, 10—two-pin, 11—miniature cap, 12—flat clip, 13—wedge. † means 25,000-hour subminiature lamp. Shpg. wt.: box of 10 is 4 oz.; 1 lamp is 2 oz.

Stock No.	Type	V	Fig.	Base	Net 10 For
32 F 66012	PR-2	2.4	9	1	.38 2.13
32 F 66020	PR-3	3.6	9	1	.37 2.21
32 F 66038	PR-4	2.3	9	1	.37 2.21
32 F 66046	PR-6	2.5	9	1	.37 2.21
32 F 66053	PR-12	5.95	9	1	.37 2.21
32 F 66061	PR-13	4.75	9	1	.37 2.21
32 F 66079	12	6.3	17	10	.40 2.39
32 F 66087	13	3.7	14	2	.26 1.59
32 F 66095	14	2.5	14	2	.26 1.59
32 F 66103	27	4.9	14	2	.32 1.90
32 F 66111	31	6.2	14	2	.38 2.29
32 F 66129	40	6.8	10	2	.21 1.23
32 F 66137	41	2.5	10	2	.40 2.40
32 F 66145	42	3.2	10	2	.52 3.14
32 F 66152	43	2.5	11	9	.40 2.40
32 F 66164	44	6.8	11	9	.23 1.37
32 F 66178	45	3.2	11	9	.34 2.04
32 F 66186	48	6.8	10	2	.22 1.34
32 F 66194	47	6.8	11	9	.23 1.37
32 F 66202	48	2.0	10	2	.40 2.40
32 F 66210	49	2.0	11	9	.34 2.01
32 F 66228	50	6.8	14	2	.25 1.47
32 F 66236	51	6.8	15	9	.22 1.31
32 F 66244	53	14.4	15	9	.25 1.47
32 F 66251	55	6.8	15	9	.24 1.46
32 F 66269	57	12.16	15	9	.24 1.41
32 F 66184	67	13.5	15	6	.31 1.84
32 F 66285	81	6.8	15	6	.36 2.16
32 F 66293	82	6.8	15	7	.36 2.18
32 F 66848	93	12	18	6	.49 2.94
32 F 66301	112	1.2	12	2	.26 1.59
32 F 66319	123	1.25	14	2	.27 1.60
32 F 66327	136	1.3	14	2	.35 2.10
32 F 69271	194	14	22	13	.31 1.87
32 F 69263	194A	14	22	13	.58 3.47
32 F 69255	211-2	12.8	20	11	.64 3.24
32 F 69246	212-2	13.5	20	11	.62 3.71
32 F 69230	214-2	13.5	20	11	.53 3.16
32 F 69335	222	2.2	12	2	.38 2.28
32 F 66350	224	2.15	13	4	.35 2.09
32 F 66368	233	2.2	14	2	.36 2.19
32 F 69107	239	6.3	11	9	.42 2.53
32 F 66376	248	2.5	14	2	.53 3.19
32 F 66384	313	28	11	9	.52 3.15
32 F 66392	327	28	16	5	.98 5.88
32 F 66400	328	6	16	5	.76 4.56
32 F 66413	330	14	18	5	1.31 7.87
32 F 66954	387†	28	16	5	.99 5.94
32 F 66963	407	4.9	14	2	.40 2.38
32 F 66418	425	5	14	2	.34 2.06
32 F 66426	428	12.5	14	2	.39 2.34
32 F 66434	432	18	14	2	.45 2.72
32 F 66442	433	18	15	9	.47 2.83
32 F 66459	502	5.1	14	2	.26 1.68
32 F 69222	561	12.8	21	12	.55 3.30
32 F 69214	562	13.5	21	12	.54 3.24
32 F 69289	563	13.5	21	12	.54 3.24
32 F 66467	605	6.1	14	2	.37 2.21
32 F 69040	756	14	11	9	.60 3.57
32 F 69057	757	28	11	9	.66 3.93
32 F 69172	1034	12.8	18	3	.53 3.19
32 F 66475	1129	6.8	18	6	.51 3.07
32 F 66483	1133	6.8	19	6	.51 3.47
32 F 69206	1141	12.8	18	6	.48 2.90
32 F 66715	1156	12	18	6	.63 3.60
32 F 69180	1157	12.8	18	3	.53 3.19
32 F 66491	1446	12	14	2	.47 2.80
32 F 66509	1447	18	14	2	.32 1.91
32 F 66517	1449	14	14	2	.27 1.63
32 F 66533	1477	24	10	2	1.03 6.17
32 F 66541	1487	12.16	10	2	.40 2.40
32 F 66559	1488	14	11	9	.43 2.67
32 F 66586	1490	3.2	11	9	.33 1.99
32 F 66574	1493	6.5	18	7	2.14 12.84
32 F 66889	1700	6	19	6	1.56 9.35
32 F 66562	1768	6	10	8	1.44 8.65
32 F 66590	1815	12.18	11	9	.38 2.29
32 F 66555	1819	28	11	9	.60 3.57
32 F 66608	1820	28	11	9	.80 5.29
32 F 69065	1828	37.5	11	9	.95 5.72
32 F 66616	1829	28	11	9	.63 3.76
32 F 66624	1847	6.3	11	9	.30 1.79
32 F 66632	1891	12	11	9	.25 1.51
32 F 69099	1893	14	11	9	.28 1.56
32 F 69198	1895	14	15	9	.42 2.53

For 105-125 VAC operation. Screw types have resistor in base for 105-125 V; others require external resistor. AC starting voltage shown DC starting voltage 40% higher. Shpg. wt. 2 oz. \*Denotes high brightness types

Stock No.	Type	Watts	Start Volt	Base Type	Each	10 For
32 F 66731	A9A	NE-2E, NE-2	1/10 65	Wire Term.	.22	1.30
32 F 66830	C2A*	NE-2, NE-2H	1/4 95	Wire Term.	.22	1.30
32 F 66798	B7A	NE-45	1/4 65	Cand. Screw	1.87	11.19
32 F 66814	B1A	NE-51	1/25 65	S.C. Bay. Min.	.54	3.24
32 F 66822	B2A*	NE-51H	1/4 95	S.C. Bay. Min.	.54	3.24
32 F 66897	5AH	NE-83	1/4 60	Wire Term.	.47	2.78

## NEON GLOW LAMPS



## Industrial Devices, Lamps, Pilot Lights and Assemblies

### INDUSTRIAL DEVICES OMNI-GLOW NEON PILOT LIGHTS



For use on instrument panels, etc. Will last in excess of 5,000 hours. Built-in NE-2H neon glow lamp and current-limiting resistor. Mounts in 1/2" hole with speed nut (supplied). Complete with 4 1/2" leads. Operates on 95-125 VAC. Available with rounded, cylindrical or square lens, with chrome bezel. Wt. 2 oz.

Stock No.	Lens	Color	Net Ea.
21 ROUNDED LENS			
34 F 52083	Red lens	34 F 52091 Amber lens	
34 F 52018	Clear lens	34 F 52026 White lens	.89
22 ROUNDED LENS			
34 F 52109	Red lens		
34 F 52117	Amber lens	34 F 52125 White lens	.89
23 SQUARE LENS			
34 F 52133	Red lens		
34 F 52141	Amber lens	34 F 52156 Whitelens	.89
24 "GREEN GLO" PILOT LIGHT			
34 F 52653			.Net .96
25 MEDIUM LENS			
34 F 52034	Red lens	34 F 52042 Clear lens	
34 F 52059	Amber lens	34 F 52067 White lens	.89
27 HIGH HAT LENS			
34 F 52166	Red lens		
34 F 52174	Amber lens	34 F 52182 White lens	.89

### PILOT LIGHT ASSEMBLIES WITH SLIDE BASE LAMPS

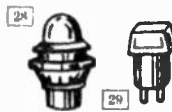

5,000 hours. Easy front panel replacement. Dome screw-in lens has stainless steel bezel, nylon non-strip self-locking fastening nut and mounts in 1/8" hole. Square lens has snap-on lens, spring steel mounting speednut and mounts in 1/2" hole. UL listed. Available complete with lamps, in voltages and color lenses shown. Shpg. wt. 2 oz.

Stock No.	Lens	V	Red Lens	Amber Lens	Green Lens
28 Dome					
12	34 F 52273		34 F 52281	34 F 52290	
24	34 F 52307		34 F 52315	34 F 52323	
120	34 F 52216		34 F 52224	34 F 52232	
Any of the above .Net ea. 1.89					
29 Square					
6	34 F 52489		34 F 52497	34 F 52505	
12	34 F 52513		34 F 52521	34 F 52539	
120	34 F 52547		34 F 52554	34 F 52562	
Any of the above .Net ea. 1.49					

### SLIDE BASE LAMPS

Stock No.	Lamp No.	Volts	Watts	Candles	End Foot	Net Each
34 F 51085	6 PSB	8	.8	800	.75	.64
34 F 51093	12 PSB	12	2.0	2400	.75	.64
34 F 51101	24 PSB	24	1.7	2200	.75	.64
34 F 51143	120 PSB	120	3.0	1600	.75	.64

### AC-DC PILOT LAMPS

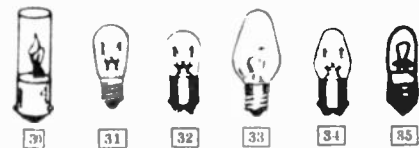

Rated at 115-125V. 1500 hours average use. All are Candelabra Screw base except † are Double Contact Bayonet Candelabra and ‡ is miniature bayonet. All clear except \* is white. Average wt. 2 oz. each.

Stock No.	Type	Fig.	Watts	Ea.	Lots 10 Ea.
32 F 66640	3S6	31	3	.55	.45
32 F 66657	6S6	31	6	.24	.20
32 F 66665	6S6DC†	32	6	.40	.33
32 F 66673	7C7/C	33	7	.21	.17
32 F 66681	7C7/W*	33	7	.34	.31
32 F 66689	10C7DC†	34	10	.40	.33
32 F 66707	T-4 1/2	35	4	.	

# Lafayette-Raytheon Receiving Tubes—Guaranteed 12 Months!

All receiving tubes are guaranteed for 12 months from date of purchase. We will replace any tube not giving efficient performance for a full 12-month period. This, of course, does not apply to burned out or broken tubes.

**ALL TUBES MAY BE ASSORTED FOR QUANTITY PRICE**

Note: Hundreds of tubes not shown below are in stock at Lafayette. Write for information and pricing on any tube types not listed.

Stock No.	Tube Type	Net Each 1- 6- 25- 5 24 Up	Stock No.	Tube Type	Net Each 1- 6- 25- 5 24 Up	Stock No.	Tube Type	Net Each 1- 6- 25- 5 24 Up	Stock No.	Tube Type	Net Each 1- 6- 25- 5 24 Up
36 F 10003	OZ4	3.10 2.95 2.66	36 F 11829	5Y3GT	2.06 1.93 1.74	36 F 13296	6CW5/EL86	1.67 1.55 1.40	36 F 20028	6JR6	4.70 4.35 3.92
36 F 10052	1AD2/1BY2A	3.10 2.95 2.66	36 F 11868	6AB4	2.54 2.35 2.12	36 F 13304	6C8B	3.40 3.15 2.84	36 F 14815	6J5C6	4.48 4.15 3.74
36 F 10060	1AY2A	2.50 2.40 2.16	36 F 11910	6AC10	2.57 2.38 2.14	36 F 13312	6CV5	3.27 3.03 2.73	36 F 14823	6J76A	3.94 3.65 3.27
36 F 10078	1B2C	2.65 2.45 2.21	36 F 11928	6AD10	4.94 4.56 4.12	36 F 13320	6CV7	1.64 1.70 1.53	36 F 14831	6J78	3.11 2.88 2.59
	1B3GT USE 1G3GT/1B3GT		36 F 11938	6AF3/6BR3/6RK19	2.61 2.60 2.34	36 F 13338	6CZ5	3.32 3.08 2.77	36 F 20036	6JUG6	4.67 4.33 3.90
	1BY2A USE 1AD2/1BY2A			6AF4A USE 6D24/6AF4A		36 F 13367	6DC8	2.70 2.50 2.25	36 F 14849	6JUG8	3.70 2.50 2.25
36 F 21000	1DG3A	2.97 2.75 2.48				36 F 13403	6DE4	2.76 2.58 2.32	36 F 14856	6JV8	2.08 2.85 2.57
36 F 10102	1G3GT/ 1B3GT	2.40 2.23 2.01	36 F 11969	8AF9	2.24 2.06 1.87	36 F 13411	6DE6	2.30 2.13 1.92	36 F 14864	6JW8/ECF802	2.16 2.00 1.80
36 F 10136	1K3/1J3	2.72 2.53 2.28	36 F 11977	6AF11	3.16 2.93 2.84	36 F 13429	6DE7	3.11 2.88 2.59	36 F 21919	6JX8/ECB84	2.30 2.13 1.92
36 F 10193	1R5	3.35 3.10 2.79	36 F 12009	6AG9	4.02 3.73 3.36	36 F 13445	6DK6	2.48 2.30 2.07	36 F 14880	6JZ8A	2.48 2.30 2.07
36 F 10266	1V2	1.46 1.35 1.22	36 F 12033	6AH6	3.92 3.83 3.27	36 F 13452	6DL5/EL95	1.64 1.70 1.53	36 F 14898	6K6GT	2.81 2.60 2.34
36 F 10276	1X2B	2.75 2.55 2.30	36 F 12058	6AK5/EF95	3.19 2.95 2.66	36 F 21042	6DN3	2.40 2.23 2.01	36 F 14930	6KA8	2.97 2.75 2.48
	2AH2 USE 2BU2/2AS2/2AH2		36 F 12068	6AL3	1.54 1.43 1.29	36 F 13486	6DN7	3.19 2.95 2.66	36 F 14948	6KDB	5.43 5.02 4.52
	2AS2 USE 2BU2/2AS2/2AH2		36 F 12074	6AL5	1.61 1.68 1.51	36 F 13494	6DQ5	4.86 4.50 4.05		6KDB USE 6U8A/6KDB	
36 F 10326	2AV2	1.92 1.78 1.60	36 F 12090	6AL11	3.46 3.20 2.86	36 F 13502	6DQ6/6GW6	3.27 3.03 2.73	36 F 14955	6KE8	3.70 3.43 3.09
36 F 20069	2BU2/2AS2/ 2AH2	2.62 2.43 2.19	36 F 12116	6AMBA	3.19 2.95 2.66	36 F 13510	6DR7	3.08 2.85 2.57	36 F 21455	6KN6	5.18 4.80 4.32
36 F 10367	2CW4	4.46 4.13 3.72	36 F 12132	6AN8A	3.35 3.10 2.79	36 F 13511	6DSDA USE 6CW4/6DSDA	2.27 2.10 1.89	36 F 20176	6KN6	4.78 4.43 3.99
36 F 10375	2CY5	3.27 3.03 2.73	36 F 12140	6AQ5A/6HG5	2.05 1.90 1.71	36 F 13559	6DTH	2.62 2.43 2.19		6K56 USE 6BN6/6K56	
36 F 10409	2EG4	4.46 4.13 3.72	36 F 12173	6AQB/ECB85	1.86 1.73 1.58		6DWB4 USE 6CJ3/6DWB4/ 6CL3		36 F 15002	6KT6	3.27 3.03 2.73
	2FQ5A USE 2GK5/2FQ5A		36 F 12207	6AR11	3.38 3.13 2.82	36 F 13593	6DX8/ECL84	1.57 1.45 1.31	36 F 15010	6KT8	3.29 3.05 2.75
36 F 10458	2GK5/2FQ5A	2.57 2.38 2.14	36 F 12215	6AS5	2.72 2.53 2.26	36 F 11944	6DZ4/6AF4A	3.27 3.03 2.73	36 F 21083	6KV6A	4.66 4.50 4.05
	2HA5 USE 2HM5/2HA5		36 F 12264	6AU4GTA	3.27 3.03 2.73	36 F 13635	6EA7 USE 6EM7/6EA7		36 F 15044	6KY8A	4.51 4.16 3.78
36 F 10474	2HM5/2HA5	2.27 2.10 1.89	36 F 12272	6AU5GT	3.62 3.35 3.02	36 F 13650	6EB8	3.76 3.50 3.15	36 F 15051	6K28	2.48 2.30 2.07
36 F 10516	3A3/3AW3	2.46 2.28 2.05	36 F 12280	6AU6A	1.81 1.68 1.51	36 F 21703	6EC4A/EY500	2.57 2.38 2.14	36 F 15077	6LG6C	3.70 3.43 3.09
36 F 10540	3AT2	2.38 2.20 1.98	36 F 12298	6AU8A	3.76 3.50 3.15	36 F 13678	6EH5	2.48 2.30 2.07	36 F 15093	6LB6	5.18 4.80 4.32
36 F 10573	3AW2	2.46 2.28 2.05	36 F 12314	6AV6	1.92 1.78 1.60	36 F 13678	6EH7/EF183	2.32 2.15 1.94	36 F 15119	6LC8	3.19 2.95 2.66
	3AW3 USE 3A3/3AW3		36 F 12330	6AW8A	2.72 2.53 2.26	36 F 13718	6EJ7/EF184	2.19 2.03 1.83	36 F 15127	6LE8	3.75 3.48 3.13
36 F 10615	3BL2A	2.43 2.25 2.03	36 F 12348	6AX3	2.36 2.20 1.98	36 F 13728	6EL4A USE 6BK4C/6EL4A		36 F 21889	6LF6	5.13 4.75 4.26
	3BS2A USE 3BW2/3BS2A/ 3BT2		36 F 12355	6AX4GTB	2.57 2.38 2.14	36 F 13734	6EM7/6EA7	3.43 3.18 2.88	36 F 15135	6LF8	3.11 2.88 2.59
	3BT2 USE 3BW2/3BS2A/ 3BT2		36 F 12421	6B10	3.00 2.76 2.50	36 F 13734	6EM7/6EA7	3.43 3.18 2.88	36 F 15150	6LH6A USE 6LJ6A/6LH6A	5.37 4.98 4.48
36 F 10684	3BU8/3GS8	3.24 3.00 2.70	36 F 12447	6BAE/EF93	2.27 2.10 1.89	36 F 21513	6EN4	5.37 4.98 4.48	36 F 15168	6LJ8	2.87 2.48 2.23
36 F 20065	3BW2/ 3BS2A/3BT2	2.61 2.60 2.34	36 F 12470	6BA11	2.97 2.75 2.48	36 F 13775	6ES8/ECB189	2.94 2.73 2.46	36 F 15178	6LM8	1.97 2.75 2.46
36 F 10680	3BZ6	2.48 2.30 2.07	36 F 12496	6BC5/6CE5	2.38 2.20 1.96	36 F 13791	6E97	2.72 2.53 2.26	36 F 15184	6LN8/LCF80	2.76 1.83 1.47
36 F 10696	3CA3	2.48 2.30 2.07	36 F 19772	6BC8/6BZ8	3.35 3.10 2.79	36 F 13817	6EV5	2.97 2.75 2.46	36 F 19796	6LQ8/6JE8C	5.37 4.98 4.48
36 F 10708	3CB6/3CF6	1.69 1.75 1.58	36 F 12553	6BE6	2.32 2.15 1.94	36 F 13833	6EW6	2.19 2.03 1.83	36 F 20390	6LR6	5.37 4.98 4.46
36 F 10714	3CN3B	2.72 2.53 2.28	36 F 12567	6BF11	3.38 3.13 2.82	36 F 13841	6EW7	4.40 4.08 3.67	36 F 20192	6LR8	2.92 2.70 2.43
36 F 19988	3CJ3A	2.97 2.75 2.48	36 F 12611	6BH6	2.70 2.50 2.25	36 F 13874	6E25	3.87 3.40 3.06	36 F 15200	6LT8	2.70 2.50 2.25
	3CY3 USE 3DB3/3CY3		36 F 12637	6BH11	2.66 2.65 2.39	36 F 13999	6FG7	3.19 2.95 2.66	36 F 15216	6LJ8	2.92 2.70 2.43
36 F 20408	3CZ3A	3.19 2.95 2.66	36 F 12652	6BJ6	2.70 2.50 2.25	36 F 14039	6FM7	3.08 2.65 2.57	36 F 15226	6LX8/LCF802	1.76 1.63 1.47
36 F 20101	3DB3/3CY3	2.67 2.48 2.23	36 F 12678	6BK8	2.89 2.68 2.41	36 F 14054	6FQ5A USE 6GK5/6FQ5A	1.61 1.68 1.51	36 F 15234	6LY8	2.81 2.60 2.34
36 F 20424	3DC3	3.19 2.95 2.66				36 F 14062	6FS5	2.48 2.20 2.07	36 F 15242	6M11	4.02 3.73 3.36
36 F 20549	3DF3	2.81 2.60 2.34				36 F 14104	6FV8A USE 6BR8A/6FV8A		36 F 15259	6MD8	5.59 5.33 5.00
36 F 10748	3DG4	3.75 3.48 3.13	36 F 12702	6BK7B	3.19 2.95 2.66	36 F 14104	6FY7	2.11 1.95 1.76	36 F 21729	6ME8	5.37 4.98 4.46
36 F 21018	3DJ3	2.57 2.38 2.14	36 F 12710	6BL7GTA	4.24 3.93 3.54	36 F 50124	6GB3A	3.27 3.03 2.73	36 F 15267	6ME8	3.83 3.55 3.20
36 F 21828	3DS3	3.94 3.65 3.27	36 F 12728	6BL8/ECF80	1.65 1.53 1.38	36 F 14138	6GB5/EL500	2.24 2.08 1.87	36 F 19808	6MF8	2.92 2.70 2.43
36 F 10763	3DTGA	2.30 2.13 1.92	36 F 12736	6BM8/ECL82	1.57 1.45 1.31	36 F 14146	6GC5	3.76 3.50 3.15	36 F 20457	6MG8	1.73 1.60 1.44
36 F 10797	3EJ7/KF184	1.38 1.28 1.15	36 F 12744	6BN4A	2.51 2.33 2.10	36 F 14153	6GE5	3.83 3.55 3.20	36 F 19814	6MK8A	2.97 2.75 2.46
36 F 10839	3GK5	2.35 2.18 1.96	36 F 12751	6BN6/6KS6	3.19 2.95 2.66	36 F 14179	6GF7A	3.21 2.98 2.68	36 F 20822	6MN8	3.27 3.03 2.73
	3GS8 USE 3BU8/3GS8		36 F 12769	6BN8	2.97 2.75 2.48	36 F 14197	6GH8A	1.92 1.78 1.60	36 F 20226	6MQ8	3.16 2.93 2.64
	3HA5 USE 3HM5/3HA5		36 F 12777	6BN11	3.32 3.08 2.77	36 F 14195	6GJ5A	4.05 3.75 3.36	36 F 21091	6MU8	3.59 3.33 3.00
36 F 10847	3HM5/3HA5	2.32 2.15 1.94	36 F 12785	6BQ5/EL84	2.38 2.20 1.98	36 F 14203	6GJ7/ECF801	1.84 1.70 1.53	36 F 21109	6MV8	3.00 2.78 2.50
36 F 10854	3HQ5	3.78 3.50 3.15	36 F 12801	6BQ6GTB/6CU6	3.75 3.48 3.13	36 F 14211	6GK5/6FQ5A	2.61 2.60 2.34	36 F 15309	6S4A	2.48 2.30 2.07
36 F 10862	3JC8A	3.36 3.13 2.82				36 F 14229	6GK6	2.62 2.43 2.19	36 F 15358	6SC7	3.92 3.63 3.27
36 F 10870	3KT8	2.67 2.48 2.23	36 F 12702	6BQ7A/6BZ7	3.02 2.80 2.52	36 F 14252	6GM6	2.35 2.18 1.96	36 F 15408	6SJ7	4.56 4.23 3.81
36 F 10920	3V4	3.11 2.88 2.59	36 F 12819	6BR3 USE 6AF3/6BR3/ 6RK19		36 F 14278	6GN8	3.76 3.50 3.15	36 F 15440	6SL7GT	3.29 3.05 2.75
36 F 10936	4AU6	2.70 2.50 2.25	36 F 12827	6BR8A/6FV8A	3.46 3.20 2.88	36 F 20895	6GS7	2.08 1.93 1.74	36 F 15457	6SN7GTB	2.43 2.25 2.03
36 F 11019	4BZ6	2.27 2.10 1.89				36 F 14310	6GU7	2.54 2.35 2.12	36 F 15507	6TB8	3.32 3.06 2.77
36 F 11027	4CB6	1.86 1.73 1.56				36 F 14326	6GV5	2.89 2.68 2.41	36 F 15523	6T10	3.75 3.48 3.13
36 F 11043	4CS6	2.65 2.45 2.21					6GW6 USE 6DQ6/6GW6		36 F 19822	6U8A/6KD8	2.35 2.18 1.96
36 F 11076	4DK6	2.36 2.20 1.98				36 F 14344	6GW8/ECL86	1.65 1.53 1.38	36 F 15556	6U10	2.46 2.28 2.05
36 F 11084	4DT8A	2.65 2.45 2.21	36 F 12850	6BU8	3.43 3.18 2.86	36 F 14344	6GX6 USE 6GY6/6GX6		36 F 15598	6V6GTA	3.05 2.83 2.55
36 F 11092	4EJ7/LF183	2.40 2.23 2.01	36 F 19996	6BV11	3.32 3.08 2.77	36 F 14351	6GY7	3.62 3.35 3.02	36 F 15614	6W6GT	2.81 2.60 2.34
36 F 11100	4EH7/LF184	2.40 2.23 2.01	36 F 12892	6BW11	3.32 3.08 2.77	36 F 14369	6GY5	3.06 2.85 2.57	36 F 15622	6X4	2.32 2.15 1.94
36 F 21360	4GJ7/ XCF801	1.64 1.70 1.53	36 F 21943	6BX6/EF80	1.61 1.68 1.51	36 F 14377	6GY6/6GX6	2.06 1.93 1.74	36 F 15630	6XS5GT	2.54 2.35 2.12
36 F 11134	4GK5	2.67 2.48 2.23				36 F 14435	6HB7	2.62 2.43 2.19	36 F 15648	6XR8	3.00 2.78 2.50
36 F 21950	4GS7	2.13 1.98 1.78				36 F 14435	6HE5 USE 6JC5/6JB5/6HE5		36 F 15		

### Lafayette Receiving Tubes (Cont'd)

		Net Each					Net Each					Net Each					Net Each										
Stock No.	Tube Type	1-5	6-24	25-Up	Stock No.	Tube Type	1-5	6-24	25-Up	Stock No.	Tube Type	1-5	6-24	25-Up	Stock No.	Tube Type	1-5	6-24	25-Up	Stock No.	Tube Type	1-5	6-24	25-Up			
36 F 16471	10JAB/10LZ8	2.81	2.80	2.34	36 F 17065	12BZ6	2.38	2.20	1.99	36 F 20788	17BR3/17RK19	2.38	2.20	1.98		24JE6C USE 24LQ6/24JE6C					36 F 18790	24JZ8	2.62	2.43	2.19		
36 F 16406	10J8T	3.46	3.20	2.88							17BS3A USE 17AY3A/17BS3A				36 F 20341	24LQ6/24JE6C											
36 F 16414	10JY8	2.21	2.05	1.85	36 F 19863	12CL3	2.46	2.28	2.05		17C5 USE 17CU5/17C5										36 F 18816	25AV5GA	5.13	4.75	4.28		
36 F 16422	10KR8	2.59	2.40	2.16	36 F 21208	12CT3	2.62	2.43	2.19	36 F 18220	17K3C	2.57	2.38	2.14							36 F 18865	25C5	2.57	2.38	2.14		
	10LZ8 USE 10JAB/10LZ8				36 F 17123	12CU5/12C5	2.89	2.68	2.41	36 F 19905	17CT3	2.08	1.93	1.74							36 F 18899	25CG3	2.67	2.48	2.23		
36 F 21158	10T10	3.48	3.20	2.88	36 F 17208	12DQ6B/12GW6	3.11	2.88	2.59												36 F 21588	25DK3	3.05	2.83	2.55		
36 F 21166	10Z10	3.40	3.15	2.84						36 F 18238	17CU5/17C5	2.24	2.08	1.87							36 F 20846	25E5/PL36	3.94	3.65	3.29		
36 F 20275	11AF9	2.40	2.23	2.01	36 F 17248	12DT8	2.40	2.23	2.01	36 F 18246	17D4A/17DM4A	2.81	2.60	2.34							36 F 21604	25HX5	3.21	2.98	2.68		
36 F 16489	11AR11	3.46	3.20	2.88	36 F 20747	12DW4A	2.27	2.10	1.89												36 F 21812	25JZ8	3.13	2.90	2.61		
36 F 20283	11BM8	3.16	2.93	2.64	36 F 21216	12FQ7/12RLL5	2.40	2.23	2.01	36 F 18279	17DQ6B/17GW6	3.38	3.13	2.82							36 F 18958	25L6GT	3.05	2.83	2.55		
36 F 16497	11BO11	3.46	3.20	2.88	36 F 17412	12FX5	2.40	2.23	2.01		17DW4A USE 17AY3A/17BS3A/17DW4A				36 F 20358	26HU5	6.51	6.03	5.42								
36 F 16505	11BT11	4.21	3.90	3.51	36 F 20754	12GB3	5.40	5.00	4.50	36 F 18303	17GJ5A	4.08	3.78	3.40							36 F 21794	26LW6	6.13	5.68	5.11		
36 F 21752	11CH11	4.27	3.95	3.56	36 F 17453	12GE5	3.46	3.20	2.88	36 F 18311	17GT5A	3.75	3.48	3.13							36 F 21307	26LX6	5.51	5.10	4.59		
36 F 21182	11DS5	3.19	2.95	2.66						36 F 18329	17GV5	2.97	2.75	2.48							36 F 20853	29KQ6	6.35	5.87	5.29		
36 F 16539	11FY7	2.27	2.10	1.89	36 F 17479	12HG7/12GN7A	3.38	3.13	2.82												36 F 21620	29LQ6	2.70	2.50	2.25		
36 F 16547	11HM7	3.92	3.63	3.27	36 F 17529	12HL7	2.87	2.75	2.48	36 F 18345	17JB6A	3.94	3.65	3.27							36 F 21315	30AE3/PY88	1.94	1.80	1.62		
36 F 16562	11KV8	4.40	4.08	3.67	36 F 21521	12JF5	2.38	2.20	1.98	36 F 21547	17JF6	4.51	4.18	3.78							36 F 20861	30JZ6	4.00	3.70	3.33		
36 F 16570	11LQ8	3.97	3.68	3.31	36 F 20309	12JQ6	3.19	2.95	2.66	36 F 18360	17JM6	3.97	3.68	3.31							36 F 20879	30KD6	4.67	4.33	3.90		
36 F 16588	11LT8	2.81	2.60	2.34	36 F 17644	12MD8	3.27	3.03	2.73	36 F 18378	17JN6	3.65	3.38	3.04							36 F 21893	30MB6	4.56	4.23	3.81		
36 F 21505	11MS8	3.16	2.93	2.64						36 F 21554	17JQ6	3.35	3.10	2.79							36 F 19038	31JSGC	4.83	4.48	4.03		
36 F 16604	12AB5	2.83	2.63	2.37	36 F 17669	12SA7	4.00	3.70	3.32	36 F 18394	17JZ6A	2.19	2.03	1.83							36 F 21323	31LQ6	5.43	5.02	4.52		
36 F 16638	12AE6A	2.19	2.03	1.83	36 F 17776	12SL7GT	3.35	3.10	2.79	36 F 18402	17KV6A	5.37	4.98	4.48							36 F 21648	31LZ6	5.43	5.02	4.52		
36 F 16646	12AE10	3.70	3.43	3.09	36 F 17778	12SN7GTA	2.97	2.75	2.48	36 F 20804	17Z3/PY81	2.57	2.38	2.14							36 F 19061	33GY7A	3.89	3.60	3.24		
					36 F 17800	12T10	4.00	3.70	3.33	36 F 20812	18GB5/LL500	3.05	2.83	2.55							36 F 19087	34CE3	2.75	2.55	2.30		
36 F 16653	12AF3/12BR3/12RK19	2.81	2.60	2.34						36 F 21257	18GV8/PCL85	2.78	2.58	2.32							36 F 21331	34R3	2.03	1.88	1.69		
		2.43	2.25	2.03	36 F 17842	13CW4	4.81	4.28	3.85	36 F 19921	19CG3	2.21	2.05	1.85							36 F 19129	35C5	2.21	2.05	1.85		
36 F 16711	12AQ5	2.81	2.60	2.34	36 F 17867	13DR7	4.00	3.70	3.33	36 F 21265	19DE3	2.75	2.55	2.30							36 F 20507	35LR6	3.11	2.88	2.59		
36 F 16729	12AT6	1.94	1.80	1.62	36 F 17875	13EM7/15EA7	4.13	3.83	3.45	36 F 18592	19T8	4.29	3.98	3.58							36 F 19178	35W4	1.22	1.13	1.02		
36 F 16737	12AT7/ECC81	2.08	1.93	1.74	36 F 18030	13FM7/15FM7	2.81	2.60	2.34	36 F 18618	20LF6	5.18	4.80	4.32							36 F 19210	35Z5GT	2.32	2.15	1.94		
36 F 16745	12AU6	2.40	2.23	2.01	36 F 17909	13GFTA	3.16	2.93	2.64	36 F 18634	21GY5	3.16	2.93	2.64							36 F 20346	40KD6/36KD6	5.02	4.65	4.19		
										36 F 18642	21H85A	3.19	2.95	2.66							36 F 21661	40KG6	5.43	5.02	4.52		
36 F 16752	12AU7A/ECC82	1.84	1.70	1.53	36 F 17917	13V10	4.00	3.70	3.33	36 F 20820	21JSG6A/23JS6A	6.91	6.40	5.78							36 F 21679	42EC4A/PY500					
		3.67	3.40	3.06	36 F 17925	13Z10/13J10	3.81	3.53	3.18	36 F 18667	21JZ6	3.27	3.03	2.78													
36 F 16778	12AV6	1.59	1.48	1.33	36 F 17941	14BL11	4.46	4.13	3.72	36 F 18675	21KA6	3.11	2.88	2.59							36 F 19277	42KN6	5.18	4.80	4.32		
36 F 16786	12AV7	3.08	2.85	2.57	36 F 17958	14BR11	3.54	3.28	2.91	36 F 21562	21KQ6	6.89	6.38	5.74							36 F 19327	50C5	1.84	1.70	1.53		
36 F 16810	12AX4GTB	2.40	2.23	2.01	36 F 17982	15AF11	2.92	2.70	2.43	36 F 19939	21LG6A	5.37	4.98	4.48							36 F 19343	50EH5	2.43	2.25	2.03		
					36 F 17990	15BD11A	3.35	3.10	2.79	36 F 18683	21LR8	2.75	2.55	2.30							36 F 19384	50HK6	1.30	1.20	1.08		
36 F 16828	12AX7A/ECC83	1.70	1.58	1.42	36 F 18006	15CW5/PL84	1.84	1.70	1.53	36 F 18691	21LJ8	2.75	2.55	2.30							36 F 21356	50JY6	4.05	3.75	3.38		
					36 F 18014	15DQ8/PCL84	2.03	1.88	1.69	36 F 18717	22BW3	2.72	2.53	2.28							36 F 19400	50LGGT	3.32	3.08	2.77		
36 F 16836	12AY3A/12BS3/12DW4	2.27	2.10	1.89	36 F 18063	15EA7 USE 13EM7/15EA7	3.66	3.38	3.22	36 F 18725	22DE4	2.81	2.60	2.34							36 F 19442	53HK7	5.10	4.73	4.26		
36 F 16844	12AY7	3.48	3.23	2.91	36 F 21539	15MF8	2.83	2.63	2.37	36 F 18733	22JF6	4.70	4.35	3.92							36 F 19574	69T3	3.40	3.15	2.84		
36 F 16851	12AZ7A	2.81	2.60	2.34	36 F 18089	16AB/PCL82	2.05	1.90	1.71	36 F 18741	22JG6A	4.56	4.23	3.81							36 F 18855	70Z5	1.73	1.60	1.44		
36 F 16869	12BA4	2.81	2.60	2.34	36 F 18097	16AQ3/XY88	1.59	1.48	1.33	36 F 18758	22JU6	4.61	3.85	3.47							36 F 19590	7027A	4.97	4.60	4.14		
36 F 16877	12BA6	1.73	1.60	1.44	36 F 20499	16LU8A	4.43	4.10	3.69	36 F 18766	22KM6	4.94	4.58	4.12							36 F 19608	7189A	2.83	2.63	2.37		
36 F 16901	12BE3	2.40	2.23	2.01	36 F 18147	17AX4GTB	2.81	2.60	2.34	36 F 21299	22KV6A	4.75	4.40	3.96							36 F 19616	7199	3.81	3.53	3.18		
36 F 16919	12BE6	1.84	1.70	1.53	36 F 18154	17AY3A/17BS3A/17DW4A	2.48	2.30	2.07	36 F 21356 USE 21JSG6A/23JS6A											36 F 19624	7247	2.48	2.28	2.05		
36 F 16935	12BF11	3.66	3.58	3.22						36 F 18774	23Z9	2.89	2.68	2.41							36 F 19632	7344	2.35	2.18	1.96		
36 F 16943	12BH7A	2.35	2.18	1.96	36 F 18162	17BE3	2.48	2.30	2.07	36 F 18782	24BF11	3.35	3.10</														

### Color TV Picture Tubes

Rebuilt, all have 2-Year Lafayette Guarantee (except broken, burned-out tubes)

### Cross-Reference Chart

Left. Col.—prefix # on existing tubes  
Right Col.—type to order for replacement

Stock No.	Type	Wt. Net Lbs. Each	Dud Value
36 F 02083WX	15LP22/NP22	13 74.95	3.00
36 F 02091WX	16CYP22	21 75.95	7.50
36 F 02109WX	16DAP22	21 75.95	7.50
36 F 01978WX	19GVP22/EXP22	30 54.95	3.00

Stock No.	Type	Wt. Net Lbs. Each	Dud Value
36 F 02117WX	19GWP22/EYP22	32 57.65	3.00
36 F 02125WX	19HCP22	26 57.65	3.00
36 F 02133WX	19HNP22	28 70.95	3.00
36 F 02018WX	21FBP22	47 48.95	—
36 F 02141WX	21FJP22	52 51.65	—

Stock No.	Type	Wt. Net Lbs. Each	Dud Value
36 F 02026WX	22JP22/QP22	39 62.65	7.50
36 F 02034WX	23EGP22	43 86.85	15.00
36 F 02158WX	25AJP22	49 73.90	25.00
36 F 02042WX	25XP22/AP22	54 54	73.90
36 F 02166WX	490BK22	24 68.25	5.00

### Color TV Picture Tube Cross-Reference Chart

Type	Use	Type	Use	Type	Use	Type	Use	Type	Use
15N	15LP22	19HM	19HCP22	22AR	22JP22	25AS	25AJP22	25BS	25AJP22
15T	15LP22	19HR	19GWP22	22L	22JP22	25AW	25AJP22	25BV	25XP22
15U	15LP22	19HX	19HCP22	22Q	22JP22	25AX	25AJP22	25BW	25AJP22
15W	15LP22	19JB	19GVP22	22S	22JP22	25AZ	25AJP22	25BX	25XP22
15Z	15LP22	19JD	19GVP22	22Y	22JP22	25AB	25XP22	25BZ	25XP22
19FM	19GWP22	19JH	19GWP22	25A	25XP22	25AC	25XP22	25C	25XP22
19FX	19GWP22	19JK	19GWP22	25AD	25AJP22	25BD	25AJP22	25CB	25XP22
19GS	19GWP22	19JN	19HCP22	25AE	25AJP22	25BF	25AJP22	25G	25XP22
19GX	19EVP22	19JO	19GVP22	25AF	26XP22	25BG	25XP22	25H	25XP22
19GZ	19GWP22	19JW	19HNP22	25AG	25AJP22	25BH	25AJP22	25I	25XP22
19HB	19GWP22	19JY	19GWP22	25AH	25AJP22	25BJ	25XP22	25J	25XP22
19HF	19GWP22	19JZ	19HCP22	25AM	25AJP22	25BK	25AJP22	25K	25XP22
19HJ	19HCP22	19KE	19GWP22	25AN	25AJP22	25BL	25XP22	25L	25XP22
19HK	19HCP22	22AB	22JP22	25AQ	25XP22	25BR	25XP22	400CV	16CYP22
								490AJ	19GWP22

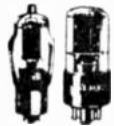

### Special Purpose Tubes from Lafayette



Quality tubes for a variety of uses in receiving and broadcast, hearing aid, power supplies, Hams, etc. All feature dependable quality construction. Quantity users please contact our Industrial Division for prices on five or more types. Also write for other types not shown here. Avg. shgp. wt. 5 oz.

Stock No.	Tube Type	Each	Stock No.	Tube Type	Each
36 F 41008	0A2	1.62	36 F 43483	6111	4.00
36 F 41024	0A3	1.95	36 F 43491	6112	4.40
36 F 41032	0A4G	2.85	36 F 44523	6135	2.85
36 F 41040	0B2	1.81	36 F 43509	6136	3.80
36 F 41065	0B3	2.65	36 F 43517	6146A	5.40
36 F 41073	0C2	2.01	36 F 43525	6146B/8298A	6.55
36 F 41081	0C3	1.90	36 F 43590	6201	3.85
36 F 41099	0D3	1.90	36 F 43608	6202	2.95
36 F 41107	1AD4	5.95	36 F 44531	6205	5.80
36 F 41230	1P39	5.50	36 F 43632	6211A	2.95
36 F 41248	1P40	8.05	36 F 44549	6213	10.35
36 F 41362	2D21	1.80	36 F 44556	6245	14.90
36 F 41396	2E26	5.15	36 F 44564	6247	14.65
36 F 41438	2X2A	6.10	36 F 43665	6265	4.90
36 F 41446	3A4	2.75	36 F 44572	6286	6.20
36 F 41453	3A5	2.97	36 F 43673	6293	6.60
36 F 41669	5R4GYB	2.80	36 F 44580	6336A	28.50
36 F 41677	5UP1	24.15	36 F 44598	6336B	39.20
36 F 44390	6AH6WA	8.20	36 F 43681	6350	2.82
36 F 41719	6AN5	4.56	36 F 42624	5691	10.49
36 F 44408	6AR8	6.75	36 F 42632	5692	9.83
36 F 41727	6AS6	4.25	36 F 42840	5693	8.09
36 F 41743	6AU6WB	3.56	36 F 42856	5727	3.80
36 F 44416	6X4W	3.10	36 F 43012	5751	3.50
36 F 44424	7AK7	9.00	36 F 43038	5755	18.70
36 F 41842	12AT7WB	3.32	36 F 43046	5763	3.00
36 F 41859	12AY7	3.60	36 F 43061	5814A	3.25
36 F 41933	63	2.90	36 F 43095	5823	2.10
36 F 44432	510AX	9.10	36 F 43129	5829	7.40
36 F 44440	512AX	7.85	36 F 43145	5842	9.25
36 F 44457	526AX	11.60	36 F 43152	5844	2.75
36 F 44465	533AX	7.65	36 F 44499	5875	5.65
36 F 44473	534AX	7.65	36 F 44507	5879	2.65
36 F 41990	807	6.05	36 F 43194	5881	3.10
36 F 42006	811A	10.00	36 F 43202	5886	8.65
36 F 42121	866A	5.35	36 F 43244	5899	5.55
36 F 42154	884	3.72	36 F 43251	5902	4.80
36 F 42162	917	11.10	36 F 43269	5915	2.23
36 F 42170	918	7.70	36 F 43277	5963	1.80
36 F 42212	922	5.50	36 F 43285	5964	2.27
36 F 42220	923	6.20	36 F 43293	5965	2.65
36 F 42253	927	11.54	36 F 43699	6360	5.45
36 F 42261	929	6.70	36 F 43715	6397	15.95
36 F 42279	930	7.25	36 F 43731	6418	7.20
36 F 42303	934	10.94	36 F 43806	6550	6.45
36 F 42527	2050A	2.72	36 F 43863	6669/8AQ5	2.03
36 F 44481	5517	6.90	36 F 43871	6871/8CL6	2.93
36 F 42659	5836	6.55	36 F 43897	6679/12AT7	2.19
36 F 42683	5651A	2.19	36 F 43905	6680/12AU7	1.87
36 F 42709	5653	6.85	36 F 43913	6681/12AX7A	1.77
36 F 42741	5870	3.28	36 F 43947	6883	5.45
36 F 42766	5672	4.33	36 F 44036	7081	2.10
36 F 42790	5878	4.33	36 F 44093	7360	5.38
36 F 42808	5686	4.75	36 F 44218	7984	6.40
36 F 43327	6012	9.80	36 F 44317	8077/7054	1.80
36 F 43335	8021 Tube	3.82	36 F 44341	9001	6.20
36 F 43343	6029	12.75	36 F 44358	9002	5.15
36 F 43376	6072A	4.61	36 F 44366	9003	6.52
36 F 43467	6088	6.05	36 F 44374	9005	6.05
36 F 44515	6110	9.75	36 F 44382	9006	3.23

### International Servicemaster High-Fidelity Tubes

Premium quality tubes widely used by hi-fi equipment manufacturers. Types listed are directly interchangeable with equivalent types. Matched Pairs (types ending in MP) consist of two tubes of the listed type, measured and tested with each other to assure maximum balanced output. Avg. wt. 7 oz.

Stock No.	Tube Type	Equiv. Type	Net	Stock No.	Tube Type	Equiv. Type	Net
36 F 53870	EB91	6AL5	1.68	36 F 54282	KT66	—	11.00
36 F 53888	EBC81	6BD7A	3.50	36 F 54290	KT77	—	10.00
36 F 53896	EBC91	6AV6	1.63	36 F 54308	KT88	—	14.50
36 F 53912	EC92	6AB4	2.03	36 F 54571	LCF801	5GJ7	2.00
36 F 54548	EC900	6HA5	2.15	36 F 54332	UL84	45B5	2.50
36 F 53979	ECC88	6DJ8	2.75	36 F 54381	ECL82MP	8BM8MP	5.00
36 F 53995	ECC82	6U8A/6KD8	2.18	36 F 54399	ECL86MP	6GW8MP	5.00
36 F 54019	ECH81	6AJ8	2.90	36 F 54407	EL34MP	6C47MP	9.50
36 F 54027	ECL80	6AB8	2.10	36 F 54423	EL84MP	6BQ5MP	5.00
36 F 54050	EF80	6BX6	1.80	36 F 54431	EL86MP	6CW5MP	4.50
36 F 54068	EF85	6BY7	3.50	36 F 54449	EL90MP	6AQ5MP	4.75
36 F 54076	EF86	6267	2.50	36 F 54456	EL95MP	6DL5MP	5.00
36 F 54084	EF89	6DA6	4.00	36 F 54464	KT66MP	—	22.50
36 F 54100	EF94	6AU6A	1.68	36 F 54472	KT77MP	—	17.50
36 F 54142	EK90	6BE6	1.93	36 F 54480	KT88MP	—	31.00
36 F 54191	EL90	5AQ5A/6HG5	1.90	36 F 54498	UCL82MP	50BM8MP	5.00
36 F 54217	EM34	6CD7	7.50	36 F 54506	UL84MP	45B5MP	5.00
36 F 54241	EZ81	6CA4	2.18	36 F 54514	7189MP	—	5.00
36 F 54258	EZ90	6X4	1.83				

### 10M Series

Individually lab-tested tubes offer tube-to-tube uniformity, section-to-section uniformity under the most stringent specifications. Hum, noise, microphonics and distortion are kept to an absolute minimum. All are in individual plastic foam cushion packing. Any tube failing to give 10,000 hours of effective performance within 2 years from purchase may be returned for no-charge replacement. Av. shgp. wt. 5 oz.

Stock No.	10M Type	Net	Stock No.	10M Type	Net
36 F 54704	6CY5	5.35	36 F 53490	EBC90/6AT6	2.15
36 F 53278	6EU7	4.35	36 F 53508	EBC91/6AV6	2.95
36 F 54712	6EV5	4.70	36 F 53516	EBF89/6DC8	3.05
36 F 53292	6GK5	5.05	36 F 53524	EC90/8C4	4.05
36 F 53334	6T8A	5.15	36 F 53532	EC95/6ER5	4.65
36 F 54720	12BY7A	3.90	36 F 53540	ECC81/12AT7	2.75
36 F 54522	5654/6AK5W	4.50	36 F 53557	ECC82/12AU7	3.35
36 F 53458	7025	3.10	36 F 53573	ECC83/12AX7	3.05
36 F 53425	7247/12DW7	3.35	36 F 53581	ECC85/6AQ8	3.00
36 F 53474	EABC80/6AK8	3.30	36 F 53599	ECC88/6DJ8	5.00
36 F 53482	EB91/6AL5	3.25	36 F 53714	EF95/6AK5	5.20
36 F 53607	ECC91/6J6	4.90	36 F 53722	EF183/6EH7	4.20
36 F 53615	ECC189/6ES8	5.45	36 F 53730	EF184/6EJ7	3.90
36 F 53623	ECF80/6BL8	2.95	36 F 53748	EK90/6BE6	3.75
36 F 53631	ECF86/6HG8	3.70	36 F 53755	EL84/8BQ5	4.25
36 F 53649	ECH81/6AJ8	5.00	36 F 53763	EL90/8AQ5	3.70
36 F 53656	ECL80/6AB8	3.85	36 F 53771	EL95/6DL5	3.25
36 F 53664	ECL84/6DX8	2.90	36 F 53789	HBC91/12A V6	2.55
36 F 53672	EF86/6267	2.80	36 F 53797	PCF80/8A8	2.90
36 F 53680	EF89/6DA6	4.10	36 F 53813	PL84/15CW5	2.70
36 F 53698	EF93/6BA8	3.60			
36 F 53706	EF94/6AU6	3.25			

### Handy Tube Accessories



**1 Pin Straightener.** For novars, novistors, compactrons, large 7, 9 and 10-pin tubes. Marked 6" ruler, too. 13 F 61229 Shgp. wt. 4 oz. Net 77¢



**2 Tube and Parts Extractor.** Nickel-plated spring steel with rubber-cushioned prongs. 13 F 61211 Shgp. wt. 4 oz. Net 1.45



**3 ARGOS TUBE CADDY \$1765** Holds up to 143 Tubes Easy to carry. One fold-out compartment with snap fastened cover, other has built-in separator, space below for tools. Wood construction, vinyl covering. Reinforced. Size: 15 1/4 x 12 1/2 x 8". 12 F 18015W Wt. 7 1/4 lbs. Net 85¢



# Resistors and Resistor Assortments

## FIXED COMPOSITION RESISTORS

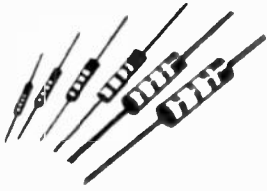

Molded carbon resistors in 1/8- to 2-watt ratings, 5% and 10% tolerance. Made by leading American manufacturers such as Allen Bradley, Speer and IRC to high industry standards. Insulated to have high breakdown resistance. All have E.I.A. color-coded bands for positive identification of ohmage and tolerance. All are factory-fresh stock with full length leads.

### HOW TO ORDER

Specify Stock Number from the price line, code number and ohmage from the tolerance chart.

EXAMPLE: For a 1/2-watt, 3900-ohm, 10% resistor order as 52 F 3087, 3900 ohms. For the same resistor with 5% tolerance order as 52 F 8087, 3900 ohms.

## 10% RESISTORS—SELECT FROM CHART BELOW

Stock No.	Watts	Range—See Chart Below	Net Each—May Be Assorted			
			1-9	10-49	50-99	100 Up
52 F 2	1/4	2.7 ohms to 22 meg.	.13	.11	.07	.05
52 F 3	1/2	1 ohm to 22 meg.	.12	.10	.08	.07
52 F 4	1	2.7 ohms to 22 meg.	.18	.15	.09	.08
52 F 5	2	10 ohms to 22 meg.	.24	.20	.15	.11

## CHART OF AVAILABLE 10% RESISTORS AND ORDERING CODE

Ohms Code	Ohms Code	Ohms Code	Ohms Code	Ohms Code	Ohms Code	Ohms Code	Megs Code
1.0 001	10 025	120 051	1500 077	18K 103	220K 129	2.2 2.2	153
1.2 003	12 027	150 053	1800 079	22K 105	270K 131	2.7 2.7	155
1.5 005	15 029	180 055	2200 081	27K 107	330K 133	3.3 3.3	157
1.8 007	18 031	220 057	2700 083	33K 109	390K 135	3.9 3.9	159
2.2 009	22 033	270 059	3300 085	39K 111	470K 137	4.7 4.7	161
2.7 011	27 035	330 061	3900 087	47K 113	560K 139	5.6 5.6	163
3.3 013	33 037	390 063	4700 089	56K 115	680K 141	6.8 6.8	165
3.9 015	39 039	470 065	5600 091	68K 117	820K 143	8.2 8.2	167
4.7 017	47 041	560 067	6800 093	82K 119	Megs Code	10 169	
5.6 019	56 043	680 069	8200 095	100K 121	T.O	145 12	171
6.8 021	68 045	820 071	10K 097	120K 123	1.2 1.4	15 173	
8.2 023	82 047	1000 073	12K 099	150K 125	1.5 1.49	18 175	
	100 049	1200 075	15K 101	180K 127	1.8 1.51	22 177	

## 5% RESISTORS—SELECT FROM CHART BELOW

Stock No.	Watts	Range—See Chart Below	Net Each—May Be Assorted			
			1-9	10-49	50-99	100 Up
52 F 7	1/4	2.7 ohms to 22 meg.	.28	.22	.14	.10
52 F 8	1/2	1 ohm to 22 meg.	.24	.20	.12	.09
52 F 9	1	2.7 ohms to 22 meg.	.36	.30	.18	.13
53 F 1	1	10 ohms to 22 meg.	.48	.40	.24	.19

## CHART OF AVAILABLE 5% RESISTORS AND ORDERING CODE

Ohms Code	Ohms Code	Ohms Code	Ohms Code	Ohms Code	Ohms Code	Ohms Code	Megs Code
1.0 001	11 026	120 051	1300 078	15K 101	180K 127	2.0 2.0	152
1.1 002	12 027	130 052	1500 077	16K 102	200K 128	2.2 2.2	153
1.2 003	13 028	150 053	1600 076	18K 103	220K 129	2.4 2.4	154
1.3 004	15 029	160 054	1800 079	20K 104	240K 130	2.7 2.7	155
1.5 005	18 030	180 055	2000 080	22K 105	270K 131	3.0 3.0	156
1.6 006	18 031	200 056	2200 081	24K 106	300K 132	3.3 3.3	157
1.8 007	20 032	220 057	2400 082	27K 107	330K 133	3.6 3.6	158
2.0 008	22 033	240 058	2700 083	30K 108	360K 134	3.9 3.9	159
2.2 009	24 034	270 059	3000 084	33K 109	390K 135	4.3 4.3	160
2.4 010	27 035	300 060	3300 085	36K 110	430K 136	4.7 4.7	161
2.7 011	30 036	330 061	3600 086	39K 111	470K 137	5.1 5.1	162
3.0 012	33 037	360 062	3900 087	43K 112	510K 138	5.6 5.6	163
3.3 013	36 038	390 063	4300 088	47K 113	560K 139	6.2 6.2	164
3.6 014	39 039	430 064	4700 089	51K 114	620K 140	6.8 6.8	165
3.9 015	43 040	470 065	5100 090	56K 115	680K 141	7.5 7.5	166
4.3 016	47 041	510 066	5600 091	62K 116	750K 142	8.2 8.2	167
4.7 017	51 042	560 067	6200 092	68K 117	820K 143	9.1 9.1	168
5.1 018	56 043	620 068	6800 093	75K 118	910K 144	10 10	169
5.6 019	62 044	680 069	7500 094	82K 119	Megs Code	11 170	
6.2 020	68 045	750 070	8200 095	91K 120	T.O	143 12	172
6.8 021	75 046	820 071	9100 096	100K 121	1.1 1.1	148 13	172
7.5 022	82 047	910 072	10K 097	110K 122	1.2 1.2	147 15	173
8.2 023	91 048	1000 073	11K 098	120K 123	1.3 1.3	148 16	174
9.1 024	100 049	1100 074	12K 099	130K 124	1.5 1.5	149 18	175
10 025	110 050	1200 075	13K 100	150K 125	1.8 1.8	150 20	176
				160K 126	1.8 1.8	151 22	177

## 100 CARBON 1/2-WATT—10%

All brand-new 1/2-watt, 10% resistors. Color-coded. You get 3 each: 100, 470, 2200 ohms; 4 each: 1K, 4.7K, 22K, 27K, 33K, 47K, .15 meg.; .27 meg.; 5-10K; 10 each: .1 meg., .47 meg., 1 meg., 20 more.

32 F 99047 Shpg. wt. 4 oz. . . . . Net 3.49

## 1/2- & 1-WATT CARBON ASSORTMENT

75 1/2-watt and 25 1-watt resistors. All have the standard RMA color code and axial leads.

32 F 60007 Shpg. wt. 6 oz. . . . . Net 2.49

## 1-WATT CARBON-RESISTOR KIT

50 pieces. Contains 2 each of the following: 3.6 - 22 - 68 - 120 - 180 - 220 - 330 - 560 - 820 - 1500 - 2700 - 3900 - 4700 - 7500 - 8200 - 12K - 18K - 19K - 82K - 150K - 330K - 390K - 560K - 820K - 3.3 Meg.

32 F 60049 Shpg. wt. 5 oz. . . . . Net 2.49

## 1/4-WATT CARBON RESISTOR KIT

100-piece kit. 33 selected values. Body size approx. 1/4" long x 1/2" dia. All +10% tolerance.

32 F 60031 Shpg. wt. 3 oz. . . . . Net 2.49

## IRC PW-10 POWER RESISTORS

10-Watt, wire-wound resistors with axial leads. Rectangular ceramic body. 10% tolerance. Body size 1 1/2" long x 1/2" square.

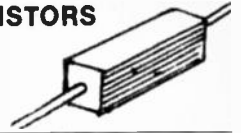

Stock No.	Ohms	Stock No.	Ohms	Stock No.	Ohms
33 F 46004	1	33 F 46178	150	33 F 46378	2500
33 F 46012	2	33 F 46186	200	33 F 46384	3000
33 F 46020	3	33 F 46194	250	33 F 46392	3300
33 F 46038	4	33 F 46202	300	33 F 46400	3500
33 F 46046	5	33 F 46210	350	33 F 46418	3900
33 F 46053	7.5	33 F 46236	500	33 F 46426	4000
33 F 46081	10	33 F 46244	600	33 F 46442	5000
33 F 46079	15	33 F 46289	750	33 F 46459	6000
33 F 46087	20	33 F 46277	800	33 F 46467	7000
33 F 46095	25	33 F 46293	900	33 F 46483	8000
33 F 46103	30	33 F 46301	1000	33 F 46525	10K
33 F 46111	40	33 F 46319	1200	33 F 46541	12.5K
33 F 46129	50	33 F 46327	1250	33 F 46558	15K
33 F 46137	75	33 F 46335	1500	33 F 46586	20K
33 F 46145	100	33 F 46350	2000	33 F 46574	25K
33 F 46160	125	33 F 46368	2250		

Shipping wt. 2 oz. . . . . Net ea. .36

## MALLORY FIXED POWER RESISTORS

Finest quality wirewounds on ceramic cores with vitreous enamel covering. Give full wattage dissipation. Tolerance ±5% on all values above 10 ohms, other ±10%. All types have lug terminals and mounting feet. Lugs and leads are firmly embedded. Size: 3/8" dia. x 2" long. Wt. 4 oz.

### TYPE 2.5HJ—25-WATT FIXED

Stock No.	Ohms	Net Ea.	Stock No.	Ohms	Net Ea.
30 F 53683	1	.83	30 F 53808	200	.83
30 F 53709	3	.83	30 F 53824	500	.83
30 F 53717	5	.83	30 F 53840	1000	.83
30 F 53725	7.5	.83	30 F 53873	2500	.83
30 F 53733	10	.83	30 F 53915	5000	.83
30 F 53741	15	.83	30 F 53949	10K	1.05
30 F 53758	25	.83	30 F 53980	25K	1.17
30 F 53768	50	.83	30 F 54012	50K	1.46

## MALLORY ADJUSTABLE POWER RESISTORS

Same fine quality and construction as the fixed types, but with an exposed section of winding to provide tapping-off of resistance values from 0 to the max. value of the resistor. All with lug terminals, tolerance ±10%, each supplied with 2 mtg. feet and one adjustable clip. Type 2AV 3/8" dia. x 2" long, wt. 3 oz. Type 5AV 3/8" dia. x 4" long, wt. 4 oz. Type 10AV 3/8" dia. x 6 1/2" long, wt. 7 oz.

### TYPE 2AV—25-WATT ADJUSTABLE

Stock No.	Ohms	Net Ea.	Stock No.	Ohms	Net Ea.
30 F 43148	1	1.53	30 F 43262	300	1.53
30 F 43163	5	1.53	30 F 43288	500	1.53
30 F 43171	10	1.53	30 F 43304	1000	1.53
30 F 43197	25	1.53	30 F 43338	2000	1.58
30 F 43205	50	1.53	30 F 43387	5000	1.58
30 F 43221	100	1.53	30 F 43411	10K	1.70
30 F 43247	200	1.53	30 F 43445	20K	1.78

### TYPE 5AV—50-WATT ADJUSTABLE

Stock No.	Ohms	Net Ea.	Stock No.	Ohms	Net Ea.
30 F 43460	1	2.63	30 F 43601	1000	2.05
30 F 43486	5	2.63	30 F 43636	2500	2.11
30 F 43494	10	2.05	30 F 43684	10K	2.17
30 F 43510	50	2.05	30 F 43716	25K	2.52
30 F 43569	250	2.05	30 F 43742	50K	2.75

### TYPE 10AV—100-WATT ADJUSTABLE

Stock No.	Ohms	Net Ea.	Stock No.	Ohms	Net Ea.
30 F 44021	1	2.59	30 F 44104	200	2.59
30 F 44047	5	2.59	30 F 44161	1000	2.59
30 F 44054	10	2.59	30 F 44187	2000	2.87
30 F 44062	25	2.59	30 F 44203	3000	2.67
30 F 44070	50	2.59	30 F 44252	15K	2.98
30 F 44088	100	2.59	30 F 44310	50K	3.99

Stock No.	Net ea.	For Use With	Stock No.	Net ea.
30 F 48352	.07	25 and 50 Watt	30 F 49087	.35
30 F 48360	.12	100 Watt	30 F 49095	.35

## OHMITE OHM'S LAW CALCULATOR

Solves Ohm's Law problems with just one setting of the slide. Has parallel resistance computing scales. Covers range from 0.01 ohm to 100 megohms. Current scale in amperes and milliamperes. 9x3".

34 F 83023 Shpg. wt. 3 oz. . . . . Net .30

## IRC RESIST-O-GUIDE

Pocket size. Identifies resistance values and color code. MIL, EIA and standard values on reverse side.

33 F 45436 Shpg. wt. 2 oz. . . . . Net .24



## POWER TRANSFORMERS

All primaries 117 VAC, 60 Hz. All 6.3V secondaries are C.T. except \* and PC-8414 which has extra 6.3V 3.0A winding. Types with † are for selenium or silicon rectifier circuits or tubes such as 6AX5, 6X4, 6X5, etc. # for half-wave circuits. † Plate V. not center tapped. For half-wave circuits. ‡ For full-wave C.T. circuits.

Stock No.	Stancor No.	Plate VCT	MA	5V Amp	6.3V Amp	Size	Mtg. Type	Wt. Lbs.	Net Ea.
33 F 80946*	PS-8415	125†‡	15	—	0.6	2x2½x1½	S	¾	4.00
33 F 84880	P-8181	150#	25	—	0.5	1½x2½x1½	VE	1½	5.17
33 F 80953*	PA-8421	125†‡	50	—	2.0	2½x3¾x2½	A	2	8.50
33 F 80981	PS8416	125#	25	—	1.0	2½x2½x2½	S	1	4.87
33 F 84930*	PC8418	230#	50	—	2.5	3½x2½x2½	C	2½	7.75
33 F 81050*	PC-8419	480‡	70	—	3.0	2½x2½x3	C	3	8.67
33 F 84864*	P8173	250‡	10	—	.6	2½x2½x3	C-1	1	7.25
33 F 84914	PC8403	250‡	70	2.0	—	3½x2½x3½	C	3½	10.17
33 F 81134	PC-8405	540	120	3.0	3.5	4x3½x3½	C	5½	12.09
33 F 84922	PC8439	350‡	90	—	3.0	3½x2½x3½	C	3½	11.34

## CONTROL/RECTIFIER TRANSFORMERS

Automation-type transformer designed for high-speed automatic equipment. Adapted to relays and pilot lamps. Two secondary windings. Primary 115 or 230V, 50-60 Hz.

Stock No.	Mfr. No.	Fig.	Secondary		Size (Inches)	Mtg. Ctr.	Wt. Lbs.	Net Ea.
			Parallel	Series				
33 F 84815	P-8375	J	6V at 2A	12V at 1A	2½x2½x1½	2½"	1	4.63
33 F 82454	P-6377	J	12V at 4A	24V at 2A	3½x5½x2½	3½"	2½	7.17
33 F 82462	P-6378	NV	12V at 8A	24V at 4A	3½x2½x3	2½x2½"	4¾	12.50
33 F 82447	P-6376	S	6V at 4A	12V at 2A	2½x3½x1½	2½"	1½	5.67
33 F 82470	P-8379	NV	12V at 16A	24V at 8A	4½x3½x3½	2½"	8	22.92
33 F 84785	P-8615	J	24V at 5A	48V at .25A	2½x2½x1½	2½"	1	5.42
33 F 84773	P-8616	J	24V at 1A	48V at 1A	2½x3½x2	2½"	1½	6.25
33 F 84781	P-8617	J	24V at 2A	48V at 1A	3½x3½x2½	3½"	2½	7.50

## RECTIFIER TRANSFORMERS

For full-wave center-tapped or bridge circuits. Each transformer has a tapped primary and a tapped additional winding permitting a wide range of output voltages. All are BV mounting type. Primaries are for 117 VAC, 50-60 Hz operation. With wiring chart.

Stock No.	Stancor No.	Range of AV Volts	Max. D.C. Resistive		Output Load Capacitive	Size	Wt. Lbs.	Net Ea.	
			115V	230V					
33 F 82306	RT-201	11.7 to 29.4	11.2V at 2.0A	23.0V at 1.25A	13.8V at 2.0A	30.0V at 1.25A	3½x2½x2½	4½	8.67
33 F 82314	RT-202	12.0 to 29.8	11.1V at 4.0A	24.3V at 2.0A	14.7V at 4.0A	33.0V at 2.0A	3½x2½x2½	3½	11.00
33 F 82322	RT-204	11.7 to 29.2	12.0V at 8.0A	24.0V at 4.0A	14.5V at 8.0A	32.4V at 4.0A	3½x3½x3½	7½	15.67
33 F 84898	RT-208	12.1 to 29.2	11.4V at 15.0A	23.7V at 8.0A	14.8V at 15.0A	32.5V at 8.0A	4½x3¾x5	12½	30.01
33 F 84906	RT-402	23.0 at 58.0	25.0V at 4.0A	51.5V at 2.0A	33.5V at 4.0A	72.5V at 2.0A	3½x3½x4½	6¾	17.09

## MINIATURIZED CONTROL/RECTIFIER TRANSFORMERS

Primary 230V, 50-60 Hz; Secondary 24V CT.

Stock No.	Stancor No.	RMS	Full-wave	Bridge	Mtg. Type	Size	Wt. Lbs.	Net Ea.
33 F 84732	P-8720	.085	.135DC	.065DC	A	2½x1¼x1¼	¼	3.50
33 F 84740	P-8722	.400	.550DC	.270DC	A	2½x1½x1½	½	4.17

## STANCOR FILTER CHOKES

All rated 1500V Ins. except † 2500V. All type A mounting except ‡ is BH.

Stock No.	Stancor No.	Hys.	Ma	Ohms	Size	Wt. Lbs.	Net Ea.
33 F 81597	C-1003	16.0	50	580	2x3¼x1¾	1¼	3.75
33 F 81698	C-1515	20	15	900	1½x2½x1½	¾	3.50
33 F 81704	C-1707	4.5	50	300	1½x2½x1½	½	2.50
33 F 81712	C-1707	7.0	50	550	1½x2½x1½	½	3.08
33 F 81738	C-1709	8.0	85	250	2x3¼x2	1½	3.50
33 F 81878	C-2343	.75	300	82	1½x2½x1½	¾	2.75
33 F 81886	C-2344†	1.5	10	85	1½x2½x1½	¾	2.25
33 F 81910	C-2685‡	.035	2A	.75	2½x2½x2¾	2½	6.00

## ISOLATION TRANSFORMERS

All have 1500V insul. \* 117. Pri. and tapped sec. with sockets for 105, 115 and 125V. † 115V Pri. to 115V sec. # Primary is two separate 115V windings.

Stock No.	Stancor No.	Fig.	Size	Watts	Wt. Lbs.	Net Ea.
33 F 84856	P-6411‡	A	2x3¼x1¾	15.0	1.0	4.87
33 F 82413	P-8410†	K	3½x2½x2½	50	5	12.09
33 F 84849	P-8406#	C	2½x3¾x2½	50	1.8	6.87
33 F 82421	P-6415*	KC	5½x4½x5¾	350	18¾	38.51

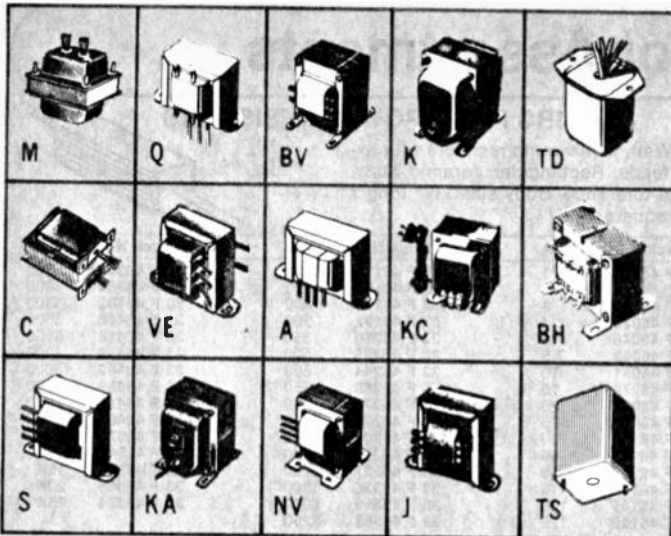

## FILAMENT/CONTROL/RECTIFIER TRANSFORMERS

All primaries 117 VAC, 50-60 Hz except † 117/107V and # 230V, 50-60 Hz.

Stock No.	Stancor No.	Volts	Second. I Amps.	Insul.	Mtg. Type	Shpg. Wt. Lbs.	Net Each
33 F 80847	P-6133	2.5 CT	5.0	7,500	S	1½	6.75
33 F 84674	P-8628	2.5 CT	0.3	1,500	A	¼	2.67
33 F 84682	P-8629	2.5 CT	1.0	1,500	A	¼	2.75
33 F 80888	P-6467	5.0 CT	3.0	2,500	A	3	4.42
33 F 80490	P-6485	6.3 CT	.8	1,500	A	½	3.33
33 F 84690	P-8705#	6.3 CT	.8	1,500	A	¼	3.17
33 F 80508	P-6134	6.3 CT	1.2	3,000	A	1	3.25
33 F 80518	P-8190	8.3	1.2	5,000	A	1½	4.58
33 F 80557	P-8466	6.3 CT	3.0	2,500	A	1½	4.75
33 F 80815	P-3084	6.3 CT	6.0	2,500	BV	2¾	8.17
33 F 80831	P-6458†	8.3 CT	6.0	2,000	A	2	6.92
33 F 80849	P-6464	6.3 CT	10.0	2,000	C	3¾	9.67
33 F 80858	P-6309†	6.3 CT	20.0	2,500	BV	7¾	15.00
33 F 81191	P-8130	10.0 CT	5.0	2,000	BV	3	8.67
33 F 84708	P-8715#	12.6 CT	2.0	1,500	A	1½	4.42
33 F 84716	P-8604	20.0 CT	1.0	1,500	A	1¼	4.67
33 F 81209	P-6469	25.2	1.0	1,500	A	1¼	3.92
33 F 84872	P-8180	25.2 CT	1.0	1,500	A	1½	4.17
					A	1¼	4.08

## STANCOR LINE-TO-VOICE COIL TRANSFORMERS

All are J-type mounting except † 70.7V-type. ‡ Power steps in watts.

Stock No.	Stancor No.	Impedance Pri.	Sec. Watts	Mtg. Ctrs.	Wt. Lbs.	Net Ea.
33 F 80060	A8101	500	6-8/3.2	5	2	2.83
33 F 80086	A8103‡	16/8/4/2/1/0.5‡	4/8/16	16	2½	6.92

## STANCOR UNIVERSAL OUTPUT TRANSFORMERS

Match single or push-pull plates to voice coil. All type A mounting.

Stock No.	Stancor No.	Primary	Watts	Size (Inches)	Wt. Lbs.	Net Ea.
33 F 61282	A3830	3-10K CT	20	2½x3¾x2½	2	6.83
33 F 81308	A3849	1.5-10K	10	1½x2½x1½	¾	5.00
33 F 81332	A3856	4-14K CT	4	1½x2½x1½	¾	4.42
33 F 81266	A3823	4-14K CT	8	1½x2½x1½	¾	5.06

## STANCOR FIXED OUTPUT TRANSFORMERS

All are type A mounting except \* is C.

Stock No.	Stancor No.	Primary	Secondary	Watts	Mtg. Ctrs.	Wt. Lbs.	Net Ea.
33 F 81415	A3327	25K	4	5	2	½	2.92
33 F 81449	A3332	2,000	3.2	3	1¾	½	2.50
33 F 81472	A3801*	6,800 CT	500/250/15/8/4	35	2½x2¾	5¾	13.34
33 F 81506	A3876	2,000	4	5	2	½	2.42
33 F 61514	A3877	5,000	4	5	2	½	2.50
33 F 81530	A3879	10,000	4	5	2	½	2.50

## Staco Variable Transformers

Sliding brush riding on gold commutator surface permits selection of desired output voltage. Excellent regulation, no wave shape distortion. \* 60 Hz operation only on over-voltage. Bench types † are fused with pilot light and

switch. Deluxe types (X) have circuit breaks, pilot light, banana jacks, on-off switch and three-prong plug and receptacle. All 120 VAC, except ‡, 240.

Stock No.	Mfg. No.	Fig.	Hz	Volts	Amps	Description	Size (Inches)	Wt. Lbs.	Net Ea.
33 F 70343	171	1	50/60*	0-120/132	1.75	For Panels up to ¼"	2½" Dia. x 2½" D	2½	12.50
33 F 70335	251	1	50/60*	0-120/132	2.5	For Panels up to ¼"	2½" Dia. x 2½" D	3½	13.60
33 F 70319	501	2	50/60	0-120/140	5.0	For Panels up to ½"	3" x 3¾ x 3¾	6	19.50
33 F 70301	1010	3	50/60	0-120/140	10.0	For Panels up to ½"	5½" x 5 x 4½	12	26.00
33 F 70293X	1510	3	50/60	0-120/140	15.0	For Panels up to ½"	6" x 6" x 4" x 20	50.00	
33 F 70277X	1520	3‡	50/60	0-240/280	9.5	For Panels up to ½"	6" x 6" x 4" x 22	50.00	
33 F 70269	2PF17†	4	60	0-132	1.75	2-Cond. Plug & Socket	3" x 3" x 3½	3½	25.00
33 F 70244	3PN501†	4	50/60	0-120/140	5.0	3-Cond. Plug & Socket	4½ x 6 x 5¾	9	38.00
33 F 70236	2PF1010†	5	50/60	0-120/140	10.0	2-Cond. Plug & Socket	6" x 5 x 4½	13	35.00
33 F 70228	3PN1010†	5	50/60	0-120/140	10.0	3-Cond. Plug & Socket	6" x 5 x 4½	13	41.00
33 F 70210X	3PN1510†	5	50/60	0-120/140	15.0	3-Cond. Plug & Socket	9 x 6½ x 6" x 22	67.00	
33 F 70368	3PN1010V†	6	50/60	0-140	10.0	3-Cond. Plug & Socket 0-150VM	6" x 5 x 4½	13	58.00
33 F 70376	3PN1020V	6‡	50/60	0-280	3.5	3-Cond. Plug & Socket 0-30VM	6" x 4 x 4½	13	66.00

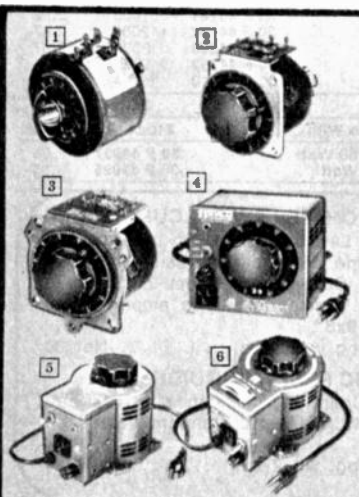

# Quality Transformers and Rectifiers from Lafayette

## Really Useful Voltage Regulators and Adapters!



### 1 World-Wide Razor Adapter

Converts voltages of 105-230 volts to safe 117 VAC, lets you use electric razor, other small electric appliances wherever you travel. Has two sets of prongs for European and Continental outlets, universal AC outlet. 3 1/2 x 4 x 1 3/8". Weighs just 7 oz.  
33 F 88139 Shpg. wt. 10 oz. . . . . Net 10.95

### 2 World-Wide Heat Adapter

Thyristor adapter for American heating devices—electric iron, coffee pot, toaster, etc. Handles 1000 watts. Converts 110-240 VAC. 3 1/2 x 4 x 1 3/8". Weighs just 6 oz.  
33 F 88147 Shpg. wt. 8 oz. . . . . Net 10.95  
33 F 88154 As above, 1500 watts. Shpg. wt. 8 oz. . . . . Net 13.95

### 3 Terado Variable Voltage Adjuster

Corrects high or low AC line voltage—"steadies" up TV, tape recorders, etc. Supplies 300 watts continuous, 500 watts intermittent. Has AC voltmeter, 6-position switch. For 117 VAC, 60 Hz.  
11 F 83286 Shpg. wt. 4 lbs. . . . . Net 24.19

### 4 Terado 1000-Watt 220 VAC to 110 VAC Converter

Great for travelers! Changes most foreign voltages to 117 VAC for American appliances. With three plugs for all European outlets. 3 1/2 x 3 1/2 x 6". Provides true sine-wave output for steady power.  
11 F 83302 Shpg. wt. 8 1/2 lbs. . . . . Net 30.95

### 5 Automatic TV Voltage Regulator

400-watt, solid-state regulator restores shrunken TV pictures during "brown-outs," increases set sensitivity. For color or B/W TV's. Simple plug-in installation.  
32 F 40068 Shpg. wt. 4 lbs. . . . . Net 22.50

### 6 Lafayette 500-Watt Variable Voltage Control

Toroidal-wound core transformer delivers steady, accurate 0-130-volt power for industrial classroom and laboratory applications. With 2-cond. cord, on-off switch, 2 cond. outlet. 5 1/2 x 5 1/2". For 117 VAC, 60 Hz.  
99 F 80287 Imported. Shpg. wt. 8 1/4 lbs. . . . . Net 24.95  
13 F 10184 Replacement 5A Fuses for above. Pkg. of 5 . . . . . Net 68¢

## STEP-DOWN AUTO TRANSFORMERS

230 to 115V. All supplied with 6' heavy-duty line cord and built-in receptacle.



Stock No.	Fig.	Watt-age	Lbs. Wt.	Net Ea.	Stock No.	Fig.	Watt-age	Lbs. Wt.	Net Ea.
33 F 88097	7	20	1 1/4	6.52	33 F 88030	8	250	6 1/4	14.09
33 F 88105	7	40	2	7.11	33 F 88048	8	350	7 3/4	15.72
33 F 88113	7	60	2 1/4	8.68	33 F 88055	8	500	10 1/4	19.42
33 F 88121	7	80	1 3/4	9.63	33 F 88063	8	750	13 1/4	24.81
33 F 88014	8	100	3	8.93	33 F 88071W	8	1000	16 1/2	27.92
33 F 88022	8	150	4 1/4	10.70	33 F 88089W	8	1500	21 3/4	36.91

### High-Density Selenium Rectifiers

130 VAC, 380 max. PIV. Shpg. wt. 4 oz.

33 F 45378	0-75 mA	Net 81¢
33 F 45388	75-150 mA	Net 1.00
33 F 45394	150-300 mA	Net 1.28
33 F 45410	400-500 mA	Net 1.81
33 F 45345	750 mA	Net 2.28

### Sarkes-Tarzian Silicon Rectifiers

1 amp. Max. PIV, 400, \*600.

10	33 F 59098	F-4, 130 VAC	Net 56¢
11	33 F 59108	F-6, 195 VAC	Net 80¢
11	33 F 59058	M-500, 130 VAC	Net 98¢
12	13 F 82045	M-500 Holder	Net 28¢
12	13 F 82052	M-500 Dual Holder	Net 44¢

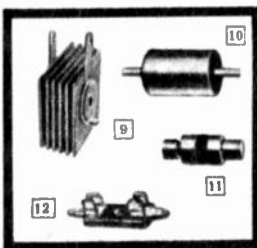

## General-Purpose Voltage Transformers

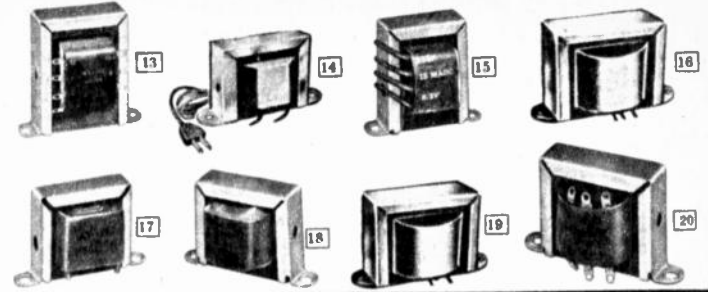

### 13 Line-to-Voice Coil

25-volt line transformer with primary tapped 39, 78, 156, 312, 625 and 1250 ohms; secondary 4, 8, 16 ohms; power tapped at 16, 8, 4, 2, 1, 0.5 watts. 3 1/2 x 2 3/4 x 2 1/4". Mounting dimension, 2 3/8".  
33 F 84823 Wt. 1 1/2 lbs. . . . . Net 8.50

70-volt line transformer with primary tapped 10, 5, 2.5, 1.25, .625 watts; secondary, 5, 8 and 16 ohms. 2 x 1 1/2". 2 3/8" mtg. ctrs. Imported.  
99 F 82846 Wt. 3/4 lbs. . . . . Net 3.49  
Lots of 3, ea. 3.29; Lots of 6, ea. 2.79

### 14 Power Isolation

Great for amplifiers, intercoms, receivers—isolates circuits from AC power line. Primary, 117 volts; sec. 105 volts no load—82 volts with 150 mA filament load. 2 1/4 x 2 x 1 1/2".  
33 F 75029 Wt. 1 1/4 lbs. . . . . Net 2.99

### 15 Selenium Power

Replacement transformer for circuits using selenium rectifiers or tubes such as 6AX5, 6AX4, 6X5. Pri.: 117 VAC, 60 Hz. 1/2-wave at 15 mA with 6.3 V, 0.6 A filament winding. 3 x 2 3/8 x 1 3/8". 2" mtg. ctrs.  
33 F 34059 Wt. 3/4 lbs. . . . . Net 3.87

### 16 Universal Input

Rated 2 watts, 70-20,000 Hz ( $\pm 2$  dB) response. Primary imp., 100 ohms; sec., 200 ohms CT. Primary res., 1.8 ohms; sec., 2.7 ohms. Unbalanced primary current, 200 mA DC. 1 1/2 x 1 1/8 x 1 1/8".  
33 F 85796 Wt. 7 oz. . . . . Net 1.79

### 17 Universal Output

Match any single or push-pull output to any voice coil. Wt. 3/4 lb.  
33 F 75037 4-watt . . . . . Net 3.29  
33 F 75045 8-Watt . . . . . Net 3.69

### 18 50L6 Output Transformer

Matches 50L6, 35L6, 25L6, etc., to 3-4ohm voice coil. 1 1/2 x 1 1/4 x 1 1/8". With 1 3/4" mounting center.  
33 F 37011 Wt. 5 oz. . . . . Net 1.58

### 19 24-Volt Filament

Primary 117-volt, secondary 24 volts at 1 amp. 2 1/4 x 1 1/8 x 1 1/8". 2 1/4" mounting centers. Imported.  
99 F 82663 Wt. 1 1/2 lbs. . . . . Net 2.89

### 20 6.3-Volt Isolation

Primary 115 VAC, secondary 6.3 volts at 1 amp. 1 3/4 x 1 1/2 x 1 1/2". 2 1/4" mounting centers.  
33 F 37029 Shpg. wt. 1/2 lb. Net 1.79

## Top-Quality Transistor Transformers

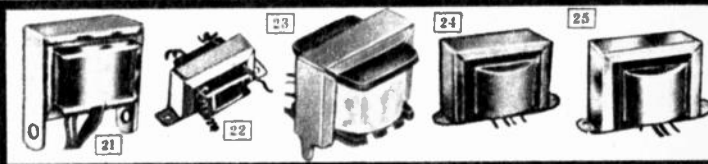

### 21 Subminiature Audio Input

Only 1/2 x 1/2 x 1/2"—for all miniature circuits. 3" color-coded leads. Pri., 200,000 ohms; sec., 1000 ohms. Pri. res., 1400 ohms, sec., 50.5. Imp.  
99 F 60345 Shpg. wt. 2 oz. . . . . Net 1.39

### 21 Subminiature Output

Only 1/2 x 1/2 x 1/2", has center-tapped 500-ohm primary, 8-ohm secondary. Pri. res., 50 CT; sec., 1.7 ohms. 3" leads. Imported.  
99 F 81293 Shpg. wt. 2 oz. . . . . Net 1.09

### 22 Miniature Output

5/8 x 5/8 x 1 1/8"—2000-ohm primary to 10-ohm voice coil. Matches most transistor outputs. Imported.  
99 F 81012 Shpg. wt. 3 oz. . . . . Net 1.09

### 23 Subminiature Output

Modulation and audio output transformer only 3/4 x 5/8 x 5/8". 500-ohm CT primary—8 and 3k ohm secondaries. With schematic. Imported.  
99 F 81327 Shpg. wt. 3 oz. . . . . Net 2.29

### 24 Standard 6-Watt Output

For high-output transistors in radios, PA systems, etc. 70-20,000 Hz ( $\pm 2$  dB) response. 48-ohm CT primary, 3.2-ohm secondary. Pri. res., 1.1 ohms, sec., 0.3 ohms. Unbalanced primary current, 500 mA DC. 1 1/8 x 1 1/8 x 1 1/8".  
33 F 85788 Shpg. wt. 3/4 lb. Net 2.47

### 25 Universal 10-Watt Output

Hundreds of uses for hobbyist and experimenter. 10 watts push-pull. Primary tapped at 8, 12, 16, 24, 32 and 48 ohms; sec., 4, 8 and 16 ohms. 3 1/8 x 2 1/4 x 2 3/8".  
33 F 75011 Wt. 2 3/4 lbs. . . . . Net 5.79

## Stancor Voltage Corrector

Ups voltage during "brown-outs," prevents burned motors. Provides approx. 12% voltage boost when line voltage drops to 105 volts or below. Cuts out when voltage returns to normal. Ideal for air conditioners, radios, TV's, etc. 10 x 5 1/4 x 6". For 117 VAC, 60 Hz. Handles to 15 amps.  
33 F 84831W Shpg. wt. 16 lbs. . . . . Net 66.00



# Argonne®

## Quality Transistor Transformers

- Nickel-Steel Laminations
- Mylar Outer Wrap
- Wound on Nylon Bobbins
- Color Coded Leads

Efficiently designed to meet the needs of miniaturization. Excellent power handling capacity and frequency responses with minimum distortion. All are nickel-steel laminations. Applications under "TYPE" show typical use. UBC is unbalanced current. Many units may be used for other applications as well. Size: All are ¾ x ¾ x ¾" except \* are 1 x ¾ x ¾". Average net wt. 1¼ oz.; average shpg. wt. 4 oz. Made in U.S.A.

**\$3.59**  
EACH

### PRICE SCHEDULE

#### QUANTITY BUYERS

- Lots of 10 Assorted 3.35
- Lots of 25 Assorted 2.95
- Lots of 50 Assorted 2.80
- Lots of 100 Assorted 2.55

**WRITE FOR PRICES ON LARGER QUANTITIES**

Stock No.	Arg. No.	Type	IMPEDANCE		UBC Pri. DC MA	Pow M.W.	DC Ohms	
			Pri. Ohms	Sec. Ohms			Pri.	Sec.
33 F 85242	AR-141	Input*	500,000	1,500 CT	.3	350	3600	60
33 F 85259	AR-142	Input*	500,000	200 CT	.3	350	3500	20
33 F 85267	AR-143	Input*	250,000	200 CT	.5	350	3600	20
33 F 85283	AR-100	Input*	200,000	1,000	.5	100	3850	90
33 F 85291	AR-126	Input*	150,000	1,500 CT	2.	100	3700	55
33 F 85309	AR-101	Input*	100,000	3,000 CT	.5	100	3600	60
33 F 85317	AR-145	Input*	100,000	2,000 CT	.5	350	3000	50
33 F 85804	AR-177	Input*	100,000	1,000 CT	.5	350	3000	27
33 F 85812	AR-178	Input*	100,000	500 CT	.5	350	3000	13
33 F 85333	AR-146	Input*	100,000	50	.5	350	3000	1.6
33 F 85358	AR-128	Input*	50,000	1,500 CT	2.	100	3000	50
33 F 85374	AR-148	Input	50,000	500 CT	1.	175	1300	20
33 F 85382	AR-149	Input	50,000	200 CT	1.	175	1300	10
33 F 85390	AR-147	Input	50,000	30 CT	1.	175	1300	1.5
33 F 85820	AR-179	Input	30,000	1,200 CT	1.	175	810	32
33 F 85838	AR-180	Driver	25,000	1,000	1.	175	810	32
33 F 85846	AR-181	Driver	20,000	5,000 CT	1.	175	650	65
33 F 85416	AR-103	Driver*	20,000	2,000 CT	1.	100	400	50
33 F 85424	AR-104	Driver	20,000	1,000	1.	100	400	50
33 F 85432	AR-151	Driver	20,000	800 CT	1.5	175	600	60
33 F 85465	AR-131	Output	20,000	3.2	.5	100	400	0.3
33 F 85853	AR-182	Driver	15,000 CT	15,000 CT	1.	100	550	800
33 F 85861	AR-183	Driver	15,000	600 CT	1.5	175	550	18
33 F 85028	AR-152	Driver	15,000	200 CT	1.5	175	550	10
33 F 85879	AR-184	Driver	10,000	10,000 CT	2.	175	400	560
33 F 85887	AR-185	Driver	10,000	5,000 CT	2.	175	400	290
33 F 85044	AR-108	Driver	10,000	3,000 CT	1.5	100	200	100
33 F 85051	AR-109	Driver	10,000	2,000 CT	1.5	100	500	50
33 F 85895	AR-198	Driver	10,000	1,000 CT	2.	175	400	60
33 F 85069	AR-153	Driver	10,000	200 CT	2.	175	400	10
33 F 85085	AR-132	Output	10,000	8	1.	100	600	.6
33 F 85093	AR-133	Output	10,000	3.2	1.	100	600	.3
33 F 85101	AR-158	Input	5,000 CT	80,000	2.	175	350	1800
33 F 85127	AR-156	Input	5,000	30,000	2.	175	150	1300
33 F 85135	AR-155	Input	5,000	10,000	2.	175	150	450
33 F 85143	AR-154	Input	5,000 CT	7,500 CT	2.	175	150	400
33 F 85150	AR-173	Driver*	5,000	3,000 CT	2.	350	200	90
33 F 85176	AR-134	Output*	4,000 CT	8	4.	250	150	.8

Stock No.	Arg. No.	Type	IMPEDANCE		UBC Pri. DC MA	Pow M.W.	DC Ohms	
			Pri. Ohms	Sec. Ohms			Pri.	Sec.
33 F 85184	AR-135	Output*	4,000 CT	3.2	4.	250	150	.3
33 F 85200	AR-113	Driver	3,000 CT	1,000	9.	150	100	60
33 F 85903	AR-186	Driver	2,500 CT	2,500 CT	2.	350	180	260
33 F 85911	AR-187	Output	2,500	600 CT	2.	350	180	70
33 F 85218	AR-114	Output	2,500	11	10.	150	50	1.1
33 F 85226	AR-115	Input*	2,000 CT	8,000 CT	2.	150	150	660
33 F 85929	AR-188	Driver*	2,000	2,000 CT	3.	300	160	210
33 F 85473	AR-175	Driver	2,000	1,500 CT	2.	350	150	60
33 F 85937	AR-189	Driver	2,000 CT	1,000 CT	2.	175	200	130
33 F 85234	AR-116	Output*	2,000	200	4.	250	120	20
33 F 85945	AR-190	Output	1,500 CT	600	4.	175	100	28
33 F 85481	AR-159	Driver	1,500	500 CT	4.	175	100	20
33 F 85952	AR-192	Driver	1,000	1,000 CT	2.	175	100	140
33 F 85499	AR-136	Output*	1,000 CT	100	4.	250	120	10
33 F 85507	AR-137	Output*	1,000 CT	8	4.	250	120	.9
33 F 85960	AR-193	Output	900 CT	600	2.	175	41	30
33 F 85523	AR-160	Output	800 CT	3.2	5.	175	40	.3
33 F 85978	AR-194	Driver	600 CT	600 CT	3.	175	24	23
33 F 85986	AR-195	Output	600 CT	600	3.	175	24	23
33 F 85994	AR-196	Output	600 CT	150	3.	175	24	7
33 F 86661	AR-197	Output*	600	3.2	3.	350	20	.3
33 F 85531	AR-162	Output*	500 CT	500 CT	5.	350	18	18
33 F 85549	AR-163	Output	500 CT	150 CT	5.	175	18	8
33 F 86679	AR-117	Output	500 CT	30	5.	175	20	2
33 F 85564	AR-118	Output	500 CT	16	5.	100	20	1.5
33 F 85572	AR-164	Output	500 CT	8	5.	175	18	.8
33 F 85580	AR-119	Output	500 CT	3.2	5.	100	20	.3
33 F 85606	AR-120	Output	400 CT	11	1.	150	20	.9
33 F 85614	AR-167	Output	400 CT	8 or 3.2	5.	175	16	.6/3
33 F 85630	AR-121	Output	300 CT	3.2	6.	150	20	.25
33 F 85648	AR-139	Output*	250 CT	8	2.	250	15	.7
33 F 85655	AR-122	Output*	250 CT	8 or 3.2	2.	150	11	.3
33 F 85705	AR-170	Output*	160 CT	8 or 3.2	8.	350	10	.6/3
33 F 85713	AR-176	Output*	125 CT	8	8.	350	4	.7
33 F 85721	AR-174	Output*	125 CT	3.2	8.	350	6	.3
33 F 85739	AR-171	Output	100 CT	10 CT	10.	175	4	.8
33 F 85747	AR-172	Output*	48 CT	8 or 3.2	15.	350	2.3	.6/3
33 F 85754	AR-125	Input	3	4,000	15.	250	14	50

## Mueller Clips and Insulators



### 1 MINI-GATOR CLIP

\*Cad. plated steel. †Solid copper. Length 1 ½", alligator jaws open ½", #20 or smaller wire. Wt. 2 oz.

Stock No.	No.	Ca.	Lot 10 Ea.	Lot 100 Ea.
32 F 35009	30*	.10	.07	.058
32 F 35389	30C†	.12	.08	.07

### 2 MICRO-GATOR CLIP

Smallest-made alligator clip for use on P.C. boards, tiny terminals, and other crowded spots. \*Cad. plated steel. †Solid copper. #20 or smaller wire. 1 ½" open. Avg. shpg. wt. 2 oz.

Stock No.	No.	Net Ea.	Lot 10 Ea.	Lot 100 Ea.
32 F 35330	34*	.08	.05	.046
32 F 35348	34C†	.10	.07	.06

### 3 TEST CLIP WITH MESH TEETH

Pee-Wee clip for general test purposes. Cad. plated steel except \*C is solid copper. Shpg. wt. 2 oz.

Stock No.	No.	Amp.	Size	Net Ea.	Lot 10 Ea.	Lot 100 Ea.
32 F 35017	45	5	1 ½"	.12	.08	.07
32 F 35025	45C*	10	1 ½"	.23	.18	.136

### 4 FLEXIBLE INSULATORS

Avg. shpg. wt. 4 oz.

Stock No.	Ins.	Clip Color Series	Net Ea.	Lot 10 Ea.	Lot 100 Ea.
32 F 35462	13	Red 11	.98	.69	.59
32 F 35470	13	Black 11	.98	.69	.59
32 F 35488	23	Red 21	.48	.34	.29
32 F 35496	23	Black 21	.48	.34	.29
32 F 35504	26	Red 24A & 25	.34	.24	.205
32 F 35512	26	Black 24A & 25	.34	.24	.205
32 F 35546	32	Red 30	.05	.04	.03
32 F 35553	32	Black 30	.05	.04	.03
32 F 35561	36	Red 34	.05	.04	.03
32 F 35579	36	Black 34	.05	.04	.03
32 F 35587	47	Red 45	.08	.06	.05
32 F 35595	47	Black 45	.08	.06	.05
32 F 35629	62	Red 60	.06	.05	.039
32 F 35637	62	Black 60	.06	.05	.039
32 F 35645	87	Red 85	.08	.06	.05
32 F 35652	87	Black 85	.08	.06	.05

### 5 CROCODILE CLIPS

Cad. plated steel except \* copper. Shpg. wt. 2 oz.

Stock No.	No.	Size	Conn.	Net Ea.	Lot 10 Ea.	Lot 100 Ea.
32 F 35140	85	2 ½"	Screw	.14	.10	.083
32 F 35157	85C*	2 ½"	Screw	.28	.20	.169

### 6 2" ALLIGATOR CLIPS

\*Copper, others steel. All fit banana plugs. Wt. 2 oz.

Stock No.	No.	Open Conn.	Net Ea.	Lot 10 Ea.	Lot 100 Ea.
32 F 35173	60	¾" Std.	.12	.08	.071
32 F 35181	60S	¾" Screw	.14	.10	.081
32 F 35199	60CS*	¾" Screw	.21	.15	.129

### 7 INSULATED ALLIGATOR CLIPS

\*Copper, others cad. plated steel. Size: 2 ½" screw connections. Avg. shpg. wt. 2 oz.

Stock No.	No.	Color	Net Ea.	Lot 10 Ea.	Lot 100 Ea.
32 F 35421	60HS	Red	.19	.13	.113
32 F 35439	60HS	Black	.19	.13	.113
32 F 35447	60CHS*	Red	.26	.18	.157
32 F 35454	60CHS*	Black	.26	.18	.157

### 8 BATTERY CLIPS—STEEL AND COPPER

\*Are solid copper, all others are lead plated. Wt. 8 oz.

Stock No.	No.	Amp.	Size	Net Ea.	Lot 10 Ea.	Lot 100 Ea.
32 F 35066	24A	25	2 ¼"	.36	.26	.219
32 F 35082	11A	100	6"	1.78	1.24	1.07
32 F 35371	25C*	75	3"	.62	.44	.37
32 F 35090	21C*	100	4 ½"	1.59	1.12	.96

### 8 FULLY INSULATED ALLIGATOR CLIPS

Copper, 2 ½" long. Shpg. wt. 1 oz.

Stock No.	No.	Color	Net Ea.	Lot 10 Ea.	Lot 100 Ea.
32 F 35686	63C	Red	.31	.22	.188
32 F 35694	63C	Black	.31	.22	.188

### INSULATED ALLIGATOR CLIP

Sturdy nickel-plated brass jaws with plastic insulated thumb rest and insulated barrel. Strong spring with hard bite. Solder lug connection. Overall length 2 ½". Imported. Shpg. wt. 2 oz. Supplied in Red and Black.  
 99 F 62192 Red  
 99 F 62200 Black ..... Net ea. .18; 10 for 1.69

### LAFAYETTE KIT OF 20 INSULATED ALLIGATOR CLIPS

Two kits of insulated alligator clips. Kit A consists of 20 large-size clips. Kit B consists of 20 small-size clips. All have sturdy nickel-plated jaws with strong spring and hard bite. Each kit contains 10 red and 10 black alligator clips, carded and bagged. Imported.  
 99 F 62358 Kit B (1 ½"). Shpg. wt. 8 oz. .... Net 1.59  
 99 F 62366 Kit A (2 ½"). Shpg. wt. 8 oz. .... Net 1.98

### KIT OF 10 JUMPER LEADS

10 handy 14" leads with miniature insulated alligator clips attached to each end. Clips and leads color coded. 5 pairs, each a different color. Imported. Wt. 5 oz.  
 99 F 00572 ..... Net 1.79

### KIT OF HEAVY-DUTY JUMPER LEADS

Kit of 5 jumper leads each 48" long with battery clip terminations. Imported.  
 99 F 00564 Shpg. wt. 8 oz. .... Net ea. 2.95

### FAHNESTOCK CLIPS

Brass clips that assure

# Lafayette Has Connectors!

## AMPHENOL MICROPHONE CONNECTORS SERIES 75. PRESSURE TYPE—SINGLE CONTACT Polished chrome-plated brass fittings with 1/4"-27 thread.

Shpg. wt. 3 oz.	Stock No.	Type	Fig.	Description	Net Ea.
	32 F 19060	75-MC1F	1	Cable Plug	...84
	32 F 19078	75-MC1M	2	Cable Jack Fits Above	...58
	32 F 19086	75-PC1M	3	Receptacle, Open	...59
	32 F 19102	75-MC1F-A	4	90° Cable Jack	...1.77
	32 F 19110	75-MC1P	5	Phone Plug Adapter	...82

## SERIES 91. 3- and 4-CONTACT TYPES Polarized microphone connectors for portable equipment. Strain-relieving clamps. \*3-contact type. †4-contact type. Shpg. wt. 3 oz.

Stock No.	Mfg. No.	Fig.	Description	Net ea.
32 F 19284	*91-MC3F	6	Female Cable Jack	...1.23
32 F 19292	*91-PC3F	7	Female Chassis Recept.	...87
32 F 19300	*91-MC3M	8	Male Cable Plug	...1.21
32 F 19318	†91-MC4F	6	Female Cable Jack	...1.28
32 F 19326	†91-PC4F	7	Female Chassis Recept.	...83
32 F 19334	†91-MC4M	8	Male Cable Plug	...1.26
32 F 19342	*91-MC3F1	8	Female Cable Plug	...1.29
32 F 19359	*91-MC3M1	6	Male Cable Jack	...1.16
32 F 19375	†91-MC4F1	8	Female Cable Plug	...1.34
32 F 19383	†91-MC4M1	6	Male Cable Jack	...1.21

## LAFAYETTE MINIATURE MIKE CONNECTORS (9) Mike Plug for low-voltage use. 1/4x1/2".

99 F 62630	Imported. Shpg. wt. 3 oz.	Net 1.95
(10) Chassis Socket for above.	1/4" mounting hole.	
99 F 62648	Imported. Shpg. wt. 3 oz.	Net 1.25
(11) Mike "Y" Connector. 2 male and 1 female.		
33 F 80012	Shpg. wt. 3 oz.	Net 1.45
Single-Contact Mike Connectors. Cord mounted, knurl grips, nickel-plated brass. 3/8"-27 thread.		
32 F 64173	Female (12). Shpg. wt. 3 oz.	Net 57¢
32 F 64181	Male (13). Shpg. wt. 3 oz.	Net 48¢

## ROBINS XLP CANNON CONNECTORS Interchangeable and mates with Cannon XLR Connectors as well as Switchcraft and Amphenol. Shpg. wt. 5 oz.

Stock No.	Mfr's. No.	Fig.	Contacts, Type Mount	Net Ea.
33 F 29059	XLP-3-11	14	3-Socket	...2.02
33 F 29067	XLP-4-11	14	4-Socket	...2.54
33 F 29075	XLP-3-12	15	3-Pin	...1.93
33 F 29083	XLP-4-12	15	4-Pin	...2.37
33 F 29448	XLP-3-15	16	3-Socket, Right Angle	...4.58

## PANEL AND WALL MOUNT RECEPTACLES

33 F 29174	XLP-3-13	17	3-Socket, Wall or Panel	...2.18
33 F 29463	XLP-3-14	18	3-Pin, Wall or Panel	...1.38
32 F 29240	XLP-3-31	19	3-Socket, Wall	...2.24
33 F 29265	XLP-3-32	20	3-Pin, Wall or Panel	...1.52
33 F 29281	XLP-3-35	21	3-Socket, Wall	...5.18
33 F 29299	XLP-3-38	21	3-Pin, Wall	...4.83
33 F 29307	XLP-4-38	21	4-Pin, Wall	...5.43

(22) PL-259 Low-loss Coax Connectors. Shpg. wt. 4 oz.  
 42 F 69106 For RG-58/U ..... Net ea. 79¢  
 42 F 89114 For RG59/U ..... Net ea. 79¢  
 (23) PL-259 Connectors for RG8/U or RG11/U. Pkg. of 2.  
 40 F 21028 Shpg. wt. 6 oz. .... Net 1.49  
 (24) In-Line Splicer. Splice or extend cable without tools.  
 32 F 11505 For RG58/U. Shpg. wt. 2 oz. .... Net 1.29  
 32 F 11513 For RG59/U. Shpg. wt. 2 oz. .... Net 1.29  
 (25) Tansistor Sockets. 3- or 4-pin. 3/8x3/8".  
 99 F 62614 Imported. Shpg. wt. 2 oz. .... Net 1.85  
 (26) Low-loss Trans. Sockets. Top-mount ears.  
 33 F 87271 3-Pin. Shpg. wt. 2 oz. .... Net 70¢  
 33 F 87289 4-Pin. Shpg. wt. 2 oz. .... Net 77¢  
 (27) IC Sockets. 1x.3" grids, round, flat pins.  
 32 F 85182 14-Pin. Shpg. wt. 2 oz. .... Net 50¢  
 32 F 85170 18-Pin. Shpg. wt. 2 oz. .... Net 50¢  
 (28) Compactron Socket. 12 pins, 4 ground lugs.  
 33 F 87018 Shpg. wt. 2 oz. .... Net 37¢  
 (29) Novar Socket. Bottom mount saddle plate.  
 33 F 87255 9-Pin. Shpg. wt. 2 oz. .... Net 28¢  
 (30) Amphenol Saddle Socket. 1" mounting. 1 1/2" ctrs.  
 32 F 20851 Shpg. wt. 3 oz. .... Net 40¢  
 (31) Amphenol "MIP" Sockets. Molded plate for 1 1/2" mounting centers. 1 3/8" hole except 1 1/8", 1 3/8" mounting centers. Localt socket. Shpg. wt. 3 oz.

Stock No.	No./Prongs	Net	Stock No.	No./Prongs	Net
32 F 20415	77-MIP-4	.29	32 F 20480	88-8	.37
32 F 20423	77-MIP-5	.32	32 F 20498	88-8X	.55
32 F 20431	77-MIP-6	.35	32 F 20508	77-MIP-9	.36
32 F 20486	77-MIP-7S	.38	32 F 19052	77-MIP-11	.37
32 F 20464	77-MIP-8	.32	32 F 20522	77-MIP-12	.43

(32) Horizontal Output Color Test Adapters. \*2-pin interrupted, †3-pin.  
 33 F 87092 For \* 8J6S, 8JM6. Shpg. wt. 3 oz. .... Net 4.95  
 33 F 87100 For † 8J6S, 8JM6. Shpg. wt. 3 oz. .... Net 5.25  
 (33) Amphenol Min. 7- and 9-pin Sockets. "3/8" hole. 7/8" mounting centers. 1 3/4" hole. 1 3/8" center.

Stock No.	Mfg. #	Pins	Net	Stock No.	Mfg. #	Pins	Net
32 F 20787	147-500*	7	.48	32 F 20803	59-409*	9	.51
32 F 20795	147-505*	7	.49	32 F 20811	59-410*	9	.52

Pomona Test Adapters. \*For use with all 7- and 9-pin sockets including those with captive shields. Wt. 3 oz.

Stock No.	Type	Fig.	Pins	Description	Net ea.
33 F 57027	TVS-8	34	8	Octal	2.50
33 F 57076	1779	34	9	Novar	2.75
33 F 57043	TVS-12	35	12	Compactron	2.95
33 F 57050	1447	35	7*	Miniature	2.35
33 F 57068	1449	34	9*	Miniature	2.45

(36) Amphenol Octal-Type Relay Sockets. Five amps at 1250 V rms. \*Four threaded inserts for tie-points. Top-mounted. Shpg. wt. 4 oz.  
 32 F 19045 Type 146-1031.88    32 F 19912 Type 146-104\* 2.34

Lafayette—Over 55 Years of Electronics Leadership

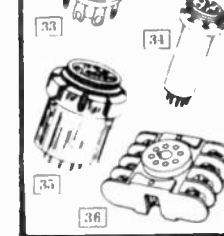
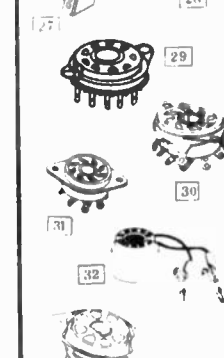
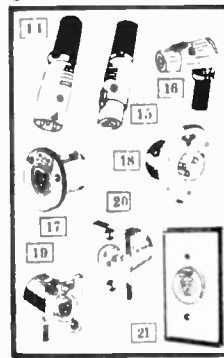
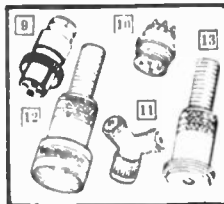
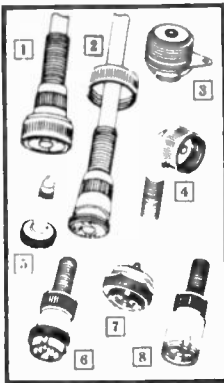

## AMPHENOL BNC CONNECTORS

BNC SERIES. Compact "Quick-Connect-Disconnect" single-contact bayonet-type locking connectors. All are low-voltage and weatherproof Shpg. wt. 2 oz.

Stock No.	Mfg. No.	Fig.	Mil. No.	Description	For RG Cable	Net ea.
32 F 21199	31-203	37	UG290A/U	Receptacle		1.05
32 F 21215	31-238	38	UG625B/U	Receptacle		.96
32 F 21223	31-102	38	UG657/U	Receptacle		1.54
32 F 21231	31-221	38	UG1094/U	Receptacle		.84
32 F 21249	31-002	39	UG88/U	Plug	55U, 58U	.99
32 F 21256	31-202	39	UG88C/U	Plug	55U, 58U	.99
32 F 21272	31-012	39	UG260U	Plug	59U, 62U, 71U	1.12
32 F 21280	31-005	38	UG89U	Straight Jack	55U, 58U	1.63
32 F 21298	31-001	41	UG291U	Panel Jack	55U, 58U	1.74
32 F 21306	31-008	40	UG274U	T-Adapter		3.06
32 F 21314	31-206	38	UG909U	Panel Jack	58U	2.00

## AMPHENOL COAXIAL CONNECTORS

SERIES 83. UHF coax connectors for all RF applications. All connectors single contact except \* are dual. Connectors mate by 3/8"-24 thread couplings. Wt. 3 oz.

Stock No.	Mfg. No.	Fig.	Mil. No.	Description	Net ea.
32 F 19961	83-1AP	42	UG-646/U, M-359 49192	Adapter, Right Angle	2.29
32 F 20027	83-1J	43	PL-258, 49191	Adapter, Straight	1.31
32 F 20035	83-1R	44	SO-239, 49194	Receptacle	.68
32 F 20043	83-1SP	45	PL-259, 49190	Plug	.78
32 F 20050	83-1SPN	45	PL-259A, 49195	Plug (Mica-Filled/Bake)	1.28
32 F 20068	83-1T	46	M-358, 49199	Adapter, Tee	3.73
32 F 20167	83-168		UG-176/U	Adapter, Reducing	.25
32 F 20175	83-185		UG-175/U	Adapter, Reducing	.24
32 F 20233	83-798	44	SO-239A	Receptacle	1.76
32 F 20258	83-822	45	PL-259	Plug (Teflon)	1.09

## MINIATURE SHIELDED CONNECTORS

Molded bakelite cadmium-plated brass shells, for cables to 1/4" in diameter. PCG series take 7/8" hole. 1 1/4" long. Fig. 47, Male. Fig. 48, Female. Fig. 49, Chassis Connectors. Wt. 3 oz.  
 (47) 32 F 19490 91-MPM-3L. 3 Cont. .... Net 48¢  
 (47) 32 F 19516 91-MPM-4L. 4 Cont. .... Net 51¢  
 (47) 32 F 19532 91-MPM-5L. 5 Cont. .... Net 54¢  
 (48) 32 F 19557 91-MPF-3L. 3 Cont. .... Net 56¢  
 (48) 32 F 19573 91-MPF-4L. 4 Cont. .... Net 60¢  
 (48) 32 F 19599 78-PCG-3. 3 Cont. .... Net 57¢  
 (49) 32 F 19607 78-PCG-4. 4 Cont. .... Net 68¢  
 (49) 32 F 19615 78-PCG-5. 5 Cont. .... Net 71¢

(50) F-59 Connector for RG59/U Cable. Shpg. wt. 4 oz.  
 18 F 58109 Pkg. of 5 ..... Net 1.19  
 (51) F-56 Connector for RG6/U Cable. Shpg. wt. 4 oz.  
 18 F 58117 Pkg. of 5 ..... Net 1.29

## BEAU PLUG CONNECTORS

Beauchaine Series 3300. Cable types have insulated polypropylene backshells, with clamps (UL and CSA listed). Recessed types have black paint over plated steel shell. Contacts rated 750 V rms, 10 amps. Shpg. wt. 4 oz.

PLUG WITH CLAMP (Fig. 52)					SOCKET WITH CLAMP (Fig. 55)				
Stock No.	Mfg. No.	# of Contacts	Net Ea.	Stock No.	Mfg. No.	# of Contacts	Net Ea.		
34 F 20015	P-3302-CCT	2	.73	34 F 20163	S-3302-CCT	2	.75		
34 F 20023	P-3303-CCT	3	.81	34 F 20171	S-3303-CCT	3	.83		
34 F 20031	P-3304-CCT	4	.85	34 F 20189	S-3304-CCT	4	.87		
34 F 20049	P-3306-CCT	6	.95	34 F 20197	S-3306-CCT	6	1.01		
34 F 20056	P-3308-CCT	8	1.06	34 F 20205	S-3308-CCT	8	1.13		
34 F 20064	P-3310-CCT	10	1.15	34 F 20213	S-3310-CCT	10	1.27		
34 F 20072	P-3312-CCT	12	1.24	34 F 20221	S-3312-CCT	12	1.45		
34 F 20080	P-3315-CCT	15	1.65	34 F 20239	S-3315-CCT	15	1.85		
34 F 20098	P-3318-CCT	18	1.94	34 F 20247	S-3318-CCT	18	2.09		

ANGLE BRACKET PLUGS (Fig. 53)					ANGLE BRACKET SOCKETS (Fig. 56)				
Stock No.	Mfg. No.	# of Contacts	Net Ea.	Stock No.	Mfg. No.	# of Contacts	Net Ea.		
34 F 20312	P-3302-AB	2	.37	34 F 20460	S-3302-AB	2	.39		
34 F 20320	P-3303-AB	3	.41	34 F 20478	S-3303-AB	3	.43		
34 F 20338	P-3304-AB	4	.45	34 F 20486	S-3304-AB	4	.47		
34 F 20346	P-3306-AB	6	.55	34 F 20494	S-3306-AB	6	.61		
34 F 20353	P-3308-AB	8	.64	34 F 20502	S-3308-AB	8	.72		
34 F 20361	P-3310-AB	10	.72	34 F 20510	S-3310-AB	10	.84		
34 F 20379	P-3312-AB	12	.81	34 F 20528	S-3312-AB	12	1.00		
34 F 20387	P-3315-AB	15	1.09	34 F 20536	S-3315-AB	15	1.26		
34 F 20395	P-3318-AB	18	1.29	34 F 20544	S-3318-AB	18	1.45		

DEEP BRACKET PLUGS (Fig. 54)					DEEP BRACKET SOCKETS (Fig. 57)				
Stock No.	Mfg. No.	# of Contacts	Net Ea.	Stock No.	Mfg. No.	# of Contacts	Net Ea.		
34 F 20619	P-3302-DB	2	.68	34 F 20767	S-3302-DB	2	.72		
34 F 20627	P-3303-DB	3	.72	34 F 20775	S-3303-DB	3	.74		
34 F 20635	P-3304-DB	4	.77	34 F 20783	S-3304-DB	4	.79		
34 F 20643	P-3306-DB	6	.88	34 F 20791	S-3306-DB	6	.90		
34 F 20650	P-3308-DB	8	1.01	34 F 20809	S-3308-DB	8	1.09		
34 F 20676	P-3312-DB	12	1.26	34 F 20825	S-3312-DB	12	1.45		
34 F 20684	P-3315-DB	15	1.68	34 F 20833	S-3315-DB	15	1.90		
34 F 20692	P-3318-DB	18	1.97	34 F 20841	S-3318-DB	18	2.14		

# Cutler-Hammer Switches



## AC-DC Toggle Switches Light-Duty—3 to 6 Amps

For use on small, motor-driven tools and appliances. 1/2 dia. threaded stem. Length of stem 1/2 except +1/2 and 3/4. All have solder lug terminals except # 6" wire leads. † screw terminals. All 3 amps at 250 V except ‡ 1 amp. UL listed. Shpg. wt. 3 oz.

Stock No.	Mfr's. Type	Con-tacts	Fig.	Net Each	
				1-24	25-49
34 F 33028	8280-K14*	SPST	1	.85	.79
34 F 33042	8280-K18	SPST	1	.85	.79
34 F 33067	8282-K14†	SPDT	7	1.08	1.00
34 F 33117	8295-K7†‡	SPST	3	1.03	.95
34 F 33141	8360-K7	DPST	7	1.54	1.42
34 F 33166	8363-K6*	DPST	5	1.78	1.64
34 F 33174	8363-K7	DPDT	5	1.78	1.64
34 F 33208	8370-K7	DPST	7	1.67	1.53
34 F 33257	8375-K7‡	DPDT	4	2.45	2.26
34 F 33299	8391-K8#	SPST	2	1.16	1.08

## Heavy-Duty—10 to 20 Amps

All bakelite bodies, screw terminals and quick make-and-break contacts. 1/2 threaded stem 1/2 long. UL listed. All 10 amps at 250 V except ‡ 20 amps. Shpg. wt. 4 oz.

Stock No.	Mfr's. Type	Con-tacts	Fig.	Net Each	
				1-24	25-49
34 F 33364	7360-K8	DPST	6	2.96	2.74
34 F 33406	7402-K4‡	DPST	8	3.98	3.69

## On-Off Plate for Toggles

34 F 33935 Wt. 3 oz. Net ea. 1-9 1.32; 10-99 1.22

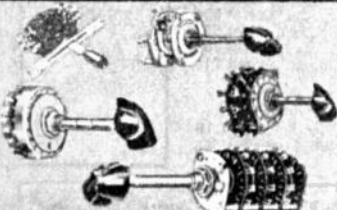

## Multigang Rotary Switches

Phenolic wafers. 1/2" betw. gangs. 3, 4 gang 1". Indexing 30°. 1 fixed, 1 adjust. stop. V. breakdown 1000 VAC or VDC. Cont. memb. silver-coated. 2" notched shaft req. 3/8" mtg. hole. \*Have addl. off pos. with all circ. open. Wt. 8 oz.

Stock No.	Mfg. No.	Gng.	Pos. Pts.	Per Pole	Net Ea.
30 F 40425	1315L*	1	2	5	2.79
30 F 40433	1313L*	1	3	3	2.79
30 F 40458	1321L	2	2	11	3.41
30 F 40486	1325L*	2	4	5	3.41
30 F 40482	1322L*	2	8	2	3.41
30 F 40490	1331L	3	3	11	4.30
30 F 40508	1335L*	3	6	5	4.30
30 F 42686	1333L*	3	9	3	4.30
30 F 40516	1341L	4	4	11	5.06
30 F 40524	1345L*	4	8	5	5.06
30 F 40532	1351L	5	5	11	8.47
30 F 40565	1355L*	6	12	5	7.33

## Phenolic Miniature Rotary Switches

Contact rating 350 mA at 500 volts RMS resistive load. Shaft 2" long x 1/4" dia.; 1/2" spacing between wafers. Wafers are 1 1/4" dia. 30° indexing. Overall dia. 1 1/8". Adjustable stop, lock washer, nut. Shpg. wt. 4 oz.

Stock No.	Mfr. No.	Cir. Sec.	Per Sec.	Pos.	Net Each	
					1-4	5-9
30 F 41738	4M2215	2	1	5	2.24	1.87
30 F 31746	4M2121	1	2	11	3.06	2.68
30 F 41787	4M2225	2	2	5	3.06	2.68
30 F 41837	4M2161	1	6	11	6.30	5.27

## AC Toggle Switches Light-Duty—6 Amps

For use in radios, appliances, etc. Rated 6 amps at 125 V and 3 amps at 250 V. \*Center-off-position. Threaded stems are 1/8" dia., stem length 1/2. UL listed. Shpg. wt. 3 oz. †Indicates screw terminals. ‡Indicates solder terminals.

Stock No.	Mfr's. Type	Con-tacts	Fig.	Net Each	
				1-24	25-49
34 F 33430	7580-K4†	SPST	9	1.09	.83
34 F 33463	7581-K8†*	SPDT	9	1.03	.95
34 F 33513	7582-K6‡	SPDT	9	.84	.78
34 F 33539	7590-K6‡	DPST	6	1.12	1.03
34 F 33554	7591-K8†*	DPDT	8	1.25	1.18
34 F 33570	7592-K6‡	DPDT	6	1.25	1.18

## "Rockette" Switches

Fig. 12. Nylon rocker-type actuator. .250" terminals. Needs 1 1/4 x 1/8" hole. UL/CSA listed. 3 oz.

Stock No.	Mfr's. Type	Con-tacts	Fig.	Net Each		
				1-24	25-49	
34 F 34184	8134K21A1M52	6	3	SPST	.80	.74
34 F 34107	8144K20A1M52	15	10	SPDT	1.01	.94
34 F 34115	8142K21E6M52	15	10	DPST	1.39	1.28

## SPST Midget Switch

Type 8097-K3. Bat handle 1/8" from end of threaded stem. 3 amps at 125 VAC. .75 at 250 VDC. Screw terminals. Threaded stem dia. 1/8", stem length 1/2". Shpg. wt. 2 oz.

Stock No.	Fig.	Net Each	
		1-24	25-49
34 F 33018	11	.72	.67

## Ceramic Selector Switches

Ideal for RF circuits. All non-shorting. Ceramic insulation, silver-plated contacts. 1/2" spacing between gangs. Volt. breakdown 500 VAC or DC. Max. non-breaking resist. load 10 amps. 1" mtg. radius. Notched shaft 2L x 1/4" dia. with 3/8 x 3/8" bushing. Adjustable stop. \*Types have added "OFF" position preceding others. With nut and lockwasher. Shpg. wt. 5 oz.

### SINGLE GANG

Stock No.	Mfg. No.	Poles/Gang	Pos./Pole	Net Each	
				1-4	5-9
30 F 40573	172C	1	11	3.15	2.62
30 F 40581	173C*	2	5	3.15	2.62
30 F 40599	174C*	3	3	3.15	2.62

### Dial Plates



3100J, 3200J and Mallory 1300L switches. 1 1/4" base. Wt. 2 oz.

Stock No.	Mfg. No.	Stock No.	Marking
30 F 40684	1-2	30 F 40771	Off 1-3
30 F 40672	1-3	30 F 40789	Off 1-4
30 F 40680	1-4	30 F 40797	Off 1-5
30 F 40698	1-5	30 F 40805	Off 1-6
30 F 40706	1-6	30 F 40613	Off 1-7
30 F 40748	1-10	30 F 40821	Off 1-8
30 F 40755	1-11	30 F 40639	Off 1-9
30 F 40763	1-12	30 F 40847	Off 1-10
Any of above ..... Net ea. .21			

## Mallory Single Gang Rotary Switches

Single gang, phenolic wafer. 1 1/4" diameter and 30° indexing. 2" notched shaft with 3/8" threaded bushing 1/2" long. With nut and lockwasher. Shpg. wt. 5 oz.

Shorting Type Stock No.	Mfg. No.	Non-Shorting Stock No.	Mfg. No.	Pos. Poles	Net Ea.	
						30 F 40011
30 F 40029	31112J	30 F 40144	32112J	1	12	1.38
30 F 40045	3123J	30 F 40169	3223J	2	3	1.38
30 F 40052	3128J	30 F 40177	3228J	2	6	1.36
30 F 40080	3134J	30 F 40165	3234J	3	4	1.40
30 F 40086	3143J	30 F 40201	3243J	4	3	1.40

## Mallory Phenolic Action Switches

Phenolic sections. 6000 series: mtg. brackets w/round holes 1 1/2" apart; 5000 series: elongated holes in bracket w/2 1/2" ctrs. Volt. rating 500 VAC-VDC. Max. unbreaking current resistive load, 6 amp at 6 VAC. 20° indexing with knob and hardware. Shpg. wt. 5 oz.

Stock No.	Mfg. No.	Poles/Gang	Pos./Pole	Net Each	
				1-4	5-9
30 F 41209	5124	2	4	1.84	1.53
30 F 41225	8143	4	3	1.52	1.23

### Non-Shorting

30 F 41233	5224	2	4	1.84	1.53
30 F 41241	6242	4	2	1.80	1.33
30 F 41258	6243	4	3	1.60	1.33

## Miniature Lever Switches

Phenolic-type single section. Contact rating 350 mA at 500 V RMS resist. load. 30° indexing. Mtg. holes 1 1/2" apart. \*Pos. action, spring return. †Spring return. With lever knob. Shpg. wt. 3 oz.

### SHORTING TYPES

Stock No.	Mfr. No.	Cir.	Pos.	Net Ea.	
				1-4	5-9
30 F 41472	6M1213	2	3	1.58	1.31
30 F 41498	6M1213U*	2	3	2.06	1.73

### NON-SHORTING TYPES

30 F 41514	6M2213	2	3	1.58	1.31
30 F 41522	6M2213S	2	3	1.79	1.50

## Standard Duty—8 to 16 Amps

Designed for use on small motors and similar equipment. Bakelite case with screw terminals. 1/2 threaded stem x 1/2 long. UL listed. 8 amp at 250 V; 16 amp at 125 V. Shpg. wt. 3 oz.

Stock No.	Mfr's. Type	Con-tacts	Fig.	Net Each	
				1-24	25-49
34 F 93943	7320-K3	DPST	8	1.72	1.59
34 F 33950	7321-K3	SPST	8	1.84	1.70

## Standard-Duty—10 to 15 Amps

All have 1/2 diameter threaded stem. 1/2 long except 1/2 long, and \* center off, all rated 10 amps at 250 VAC and 15 amps at 125 VAC. UL listed. Avg. shpg. wt. 4 oz. †Indicates screw terminal. ‡Indicates solder terminals.

Stock No.	Mfr's. Type	Con-tacts	Fig.	Net Each	
				1-24	25-49
34 F 33598	7500-K14†	SPST	9	1.03	.95
34 F 33612	7501-K13†	SPST	9	1.09	.83
34 F 33653	7503-K13†*	SPDT	9	1.03	.95
34 F 33695	7505-K4†	SPDT	9	1.03	.95
34 F 33703	7580-K5†	DPST	6	1.63	1.50
34 F 33745	7562-K4†*	DPDT	6	2.00	1.85
34 F 33786	7584-K6†	DPDT	6	2.00	1.85
34 F 33851	7611-K2†	3PST	10	2.68	2.48
34 F 33877	7613-K2†*	3PDT	10	3.29	3.05
34 F 33893	7615-K2†	3PDT	10	3.29	3.05

## Arrow-Hart Momentary Pushbutton Switches

Metal base, lam. phenolic sections, slotted sleeve 1/2" dia., 1/4" long. 1A, 125 VAC. Wt. 3 oz.

Stock No.	Mfg. No.	Net Each	
		1-24	25-49
2-CIRCUIT N.O., ONE N.C.			
34 F 34537	3392	1.55	1.43
NORMALLY CLOSED—SPST			
34 F 34560	3391	1.27	1.18
NORMALLY OPEN—SPST			
34 F 34594	3391F	1.27	1.18

Type 3391-194 Snap-On Insulator Buttons for any of the above switches. Shpg. wt. 2 oz.

34 F 34828 Red ..... Net ea. .28

34 F 34838 Black ..... Net ea. .28

## Switchcraft Tini-Switch

1-piece plastic shaft in red, black. Low-level circuits only. NO = normally open, NC = normally closed. Threaded 1/4" bushing. 1/2" long. 2 oz.

### BLACK TYPE

Stock No.	Mfg. No.	Contacts	Net ea.
34 F 60011	961	SPST-NO	1.05
34 F 60029	962	SPST-NC	1.05
34 F 60037	963	SPDT	1.25

### RED TYPE

34 F 60045	951	SPST-NO	1.05
34 F 60052	952	SPST-NC	1.05
34 F 60060	953	SRDT	1.25

## Lafayette Foot Switch



ONLY \$4.95

Rated at 10 amps, 125 VAC. Min. foot pressure. Cord and plug. Skid proof base. 2 1/2" sq. x 1" high. Imported. Shpg. wt. 1 lb.  
99 F 80707 ..... Net ea. 4.95

# Top-Quality TOGGLE SWITCHES

- 1 SPST Bat Handle**  
Rated 3 amps—125V. Body size 1 1/4 x 3/4 x 1/2" behind panel. Bushing 3/8" diam., 1/8" long. Bat handle 1/2" long. Imp. Wt. 3 oz.  
99 F 61509 ..... Net ea. .61  
In lots of 10 ..... Net ea. .52
- 2 Heavy-Duty 6-Amp DPDT**  
Rated 250 V at 3 amps or 125 V at 6 amps. Switch body 1 1/4 x 3/4 x 7/8" behind panel incl. terminals. Bushings 1/2" dia., 1/8" long. Bat handle 1/2" long. Shpg. wt. 3 oz.  
99 F 61517 Imported .. Net ea. .72  
In lots of 10 ..... Net ea. .66
- 3 6-Amp DPDT Center Off**  
Rated 6 amps, 125 VAC. 1 1/4 x 3/4 x 1" behind panel including screw terminals. Bushing 1/4 x 1/8" diam., 3/8" long. Bat handle 1/2" long. Shpg. wt. 3 oz.  
99 F 61483 Imported .. Net ea. .98  
In lots of 10 ..... Net ea. .89
- 4 10-Amp SPDT Center Off**  
Rated 10 amps at 125 V. Silvered lugs for low-loss connect. 1 1/4 x 3/4 x 3/8" D behind panel. Bushings 3/8" dia., 1/8" L. Handle 1/2" L. 3 oz.  
99 F 61558 Imported . Net ea. .83  
In lots of 10 ..... Net ea. .74

## Specialty Switches

- 5 Miniature Momentary**  
Single-pole, two-circuit push-to-make. Beryllium copper leaf contacts. 1/2" depth 1/8", protrudes 3/8" behind panel. Bushing 1/4" diam., 3/8" long. Washer, mounting nut. Wt. 3 oz.  
99 F 62184 Imported .. Net ea. .42  
In lots of 10 ..... Net ea. .37
- 6 Illuminated P.B. Switch**  
Lights in "ON" position. SPST type. 10 amps at 125 VAC, 8A at 250 VAC. Insulation resistance, 100 megohms. More at 500 VDC. Solder term. Mount in 1/4" hole, 1 1/2" behind panel. Wt. 3 oz.  
99 F 61921 Imported .... Net 3.55
- 7 Sub-Miniature Momentary**  
Pushbutton switch. SPST, non-snap action. Rated 115 VAC at 100 mA. 3/4 x 3/4" L. Bushing 1/4" L. 2 oz.  
99 F 61590 Imported .. Net ea. .35  
In lots of 5 ..... Net ea. .32
- 8 4-Pole 3-Position**  
Four-pole rotary selector switch, 3 pos. per pole. Spring-loaded, pos. detent action. Shorting type. Overall dia. 1 1/4". Depth behind panel, incl. lugs, 3/4". Bushing 3/8 x 3/8". 1/4" knurled shaft, 1 1/4" long. Shpg. wt. 3 oz.  
99 F 61566 Imported .. Net ea. .79  
Lots of 10 ..... Net ea. .71

- 9 Master Disconnect Switch**  
Protects cars, boats against fires from shorts, battery run-down, theft by ignition "jumping." Steel construction. 6 or 12 V. 1 1/4 lbs.  
11 F 87012 ..... Net 7.99
- 10 Heavy-Duty Lock Switch**  
Heavy-duty bakelite Insures min. internal resistance, greater current carrying capacity. Extra heavy contacts. Terminals recessed to prevent shorting. Installs any hole 3/4" to 1 1/2" dia., any panel to 3/4" thick. 2-terminal single throw. Prevents tampering with auto equip. and marine equip. Wt. 5 oz.  
33 F 64015 ..... Net 1.69

- 11 Delay Action Switches**  
Install in regular wall outlet. Keeps outside lights on for 60 sec. Rated 10 amps 125 V. Wt. 5 oz.  
34 F 38058 11A ..... Net 2.99
- 12 Magnetic Proximity Switch**  
Many uses in the home—burglar alarm system, electric trains, etc. As magnet approaches switch, circuit closes. 1 millisecond actuation. 15 W resist. max. up to 1 amp to 250 V. 2 3/8" with leads. 3 oz.  
34 F 44015 ..... Net 1.98

- 13 Magnetic Reed Switch Kit**  
Four magnetic reed switches. One magnet. Ideal for switching circuits, window alarms, liquid level alarms, rotat. counting. 2 miniature magnetic switches rated 0.5 amps, 10 watts max. 2 large switches rated 1 amp, 15 watts max. 2 oz.  
19 F 21261 ..... Net 2.96
- 14 Mercury Switch Kit**  
• Silent—Swift—Positive Action  
• Hermetically Sealed In Glass  
Five mercury switches. Tilt-activated. Max. load at 115 VAC resistive. Largest switch rated at 5 amps., 115 VAC with smaller types rated to 1 amp., 115 VAC or less.  
19 F 21253 Wt. 4 oz. . Net ea. 2.98

- 15 Illuminated "See-Saw" Switch**  
SPST. Rocker arm type, rated at 125 VAC, 10 amp. Mounts flush in panels up to 1/8" thick. Req. mtg. hole 1 1/2 x 3/8". Mtg. cent. 1 1/8". Shpg. wt. 1/4 lb.  
99 F 62598 Imported .. Net ea. 1.82  
Lots of 10 ..... Net ea. 1.66

- 16 DPDT "See-Saw" Switch**  
Flip action, rocker arm type equip. switch. Mounts flush in panel up to 1/8" thick. Req. rectangular mtg. hole 1/2 x 1 1/8" long. Mtg. centers 1 1/8". Rated 4 amps at 125 VAC. Imported. Shpg. wt. 1/4 lb.  
99 F 61574 ..... Net ea. .91  
Lots of 10 ..... Net ea. .84

- 17 4PDT Lever Switch**  
Telephone type. 3-pos. lever action. Non-induction construction. 4 sets SPDT contacts. 3 locking pos. Insul. rollers. Panel mt., 1 1/4" mtg. ctrs. 2 1/2" L behind panel. 3/8 W x 1 1/4" H. Shpg. wt. 3 oz.  
99 F 61491 Imported Net ea. 1.39  
In lots of 5 ..... Net ea. 1.25

**18 Slide Switches**  
Compact slide switches in cadmium steel housings. All rated 3 amp at 125 VAC. 1 1/8" mtg. ctrs. 3 oz.

Stock No.	Circuit	Net Each	10 For
34 F 37035	SPST	.19	1.65
34 F 37043	SPDT	.22	1.95
34 F 39114	DPST	.24	2.51
34 F 39122	DPDT	.26	2.35

- 19 SPDT Slide Switch**  
1/8" deep for panel mounting. Contact resist. 1/2 ohm or less; Insul. res., 20 megohms at 500 VDC, max. AC current 0.5 amps. Withstands 600 VAC. 3/8 x 1 1/8 x 3/8". Switch body, mtg. ears add 1/2" to overall length. Mtg. ctrs. 1". 2 oz.  
99 F 61897 Imported ..... Net .39

- 20 Mini DPDT Slide Switch**  
Perfect for ultra-small switch applications. Rated current capacity, 3 amps at 125 V. Can withstand up to 1000 VAC. Solder lug terminals. Measures 1/8 L x 1/4 W x 3/8" D. Mtg. ctrs.: 1/8". Shpg. wt. 2 oz.  
99 F 61863 Imported ..... Net .38

- 21 3PDT AC-DC Slide Switch**  
Rated at 500 microamps at 100 V. Solder lug terminals. 3/4 W x 3/8 L x 7/8" D. Overall incl. 3/8" trigger. Mtg. ctr. 1 1/8". Shpg. wt. 4 oz.  
99 F 61665 ..... Net ea. .45  
In lots of 10 ..... Net ea. .40

- 22 Midget Knife Switches**  
Black bakelite base. Matching insul. knob handle. Plated brass cont. for pos. low resist. connect. Imported.

- SPDT KNIFE SWITCH**  
Overall size 1 1/8 x 2 3/8". Wt. 2 oz.  
99 F 61525 Net .35 ea.; 10 for 3.00

- DPDT KNIFE SWITCH**  
Overall size 1 1/8 x 2 3/8". Wt. 3 oz.  
99 F 61533 Net .57 ea.; 10 for 6.50

- 23 Subminiature Switches**  
Toggle DPDT, AC Switch. Rated at 10 amps, 125 VAC. Tested through 100,000 cycles. Resistance, 0.01 ohms. Insul. resist. 100 megohms at 500 VAC. Max. down voltage 1000 VAC. 1/2 x 1/2 x 1/8". Bushing 1/4 D x 3/8" L. Handle 3/8" L. Behind panel depth, incl. lugs, 3/4". Mtg. hardware. Shpg. wt. 2 oz.  
34 F 34180 23A Imp. . Net ea. 1.98  
Lots of 10 ..... Net ea. 1.79  
Above except momentary push-button action. Shpg. wt. 2 oz.  
34 F 21005 23B Imp. . Net ea. 3.20  
Lots of 10 ..... Net ea. 2.18

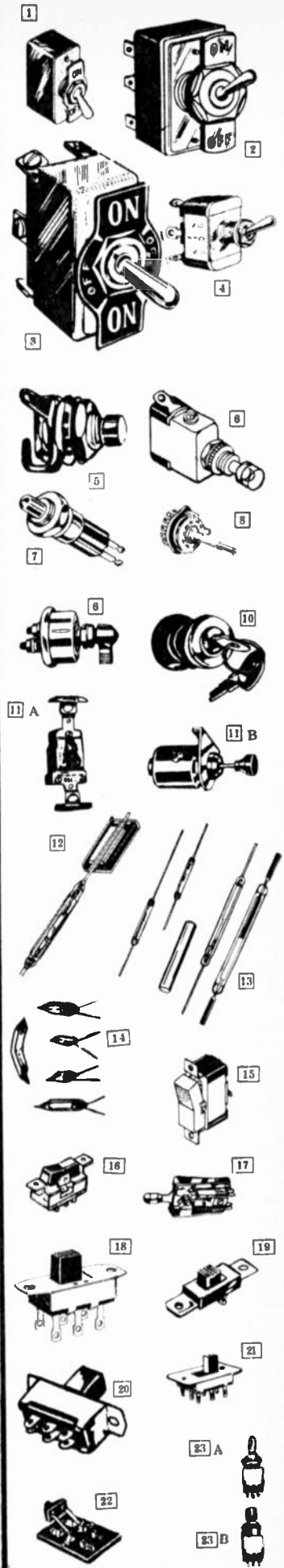

- ### LINEMASTER
- 24 72 "Executive" 2 momentary SPDT**  
switches side by side. 15 amps, 125 VAC. 4 1/2 x 4 x 1 1/8".  
34 F 36086 1 1/2 lbs. .... Net ea. 6.35
- 25 T51-S "Treadlite" Compact SPDT**  
momentary contact rated 7 amps at 125-250 VAC, 1/4 HP at 115 VAC. Base 3/2 x 2 3/4 x 1".  
34 F 36011 Wt. 10 oz. .... Net ea. 3.05  
T-51-SC-3. Same as above with 3-conductor cord & 3-prong grounded series plug. UL listed.  
34 F 36078 Wt. 1 1/4 lbs. .... Net ea. 5.90  
491-S "Compact." SPDT momentary contacts rated 10 amps 125VAC, 1/2 HP at 115 VAC. 2 1/8 x 2 1/2 x 2 1/8". Wt. 9 oz.  
34 F 36037 ..... Net ea. 3.75  
491-SC3. Same with 8-ft. cord, 3-prong grounded series plug. UL listed.  
34 F 36094 Wt. 1 1/4 lbs. .... Net ea. 6.90

- ### TAPESWITCH
- 27 Tapeswitch Flexible Switch Mats.** Less than 5 lbs. pressure. 24 V or less rec. 3/8" thick; water-resist. cov. Wt.: 17x23 mat, 1 1/2 lb.; 6x23" mat, 10 lbs. 17x23" mat with 6-foot cord.  
33 F 66010 ..... Net ea. 17.21  
6x23" Stair Tread with 18" Lead.  
33 F 66028 ..... Net ea. 7.05
- 28 Tapeswitch Ribbon Switches.** Act. with 12 oz. pressure. 4" leads. 1/8" thick. Rated 1 amp., 117 VAC or 26 VDC. Wt.: 2-ft. length, 7 oz.; 6-ft. length, 7 oz.  
33 F 66036 2-foot length . Net ea. 5.18  
33 F 66044 5-foot length . Net ea. 9.42
- 29 Cut-to-Length Switching Runner.** 5"Lx 30"Wx1/8" thick. 5 lbs. nominal foot pressure. 2 1/8" centers wired in parallel polyethylene envelope. Indoor use only.  
33 F 66077 Wt. 2 1/2 lbs. .... Net ea. 13.75

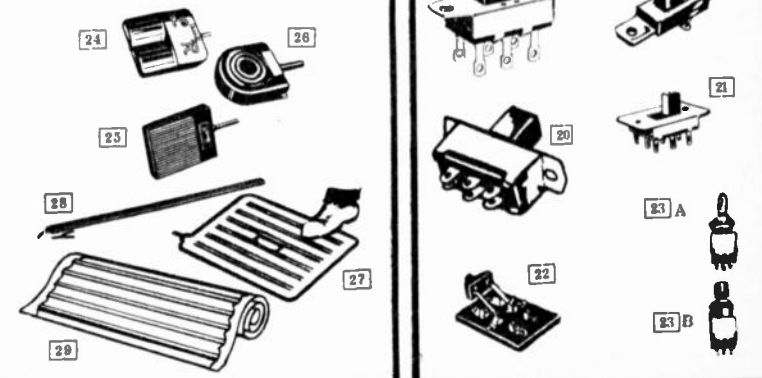

# Lafayette Plugs, Jacks, Adapters for Every Need

## PHONO PLUGS AND JACKS



- 1** Single Prong Shielded Plug. RCA-type, used extensively for mike, phono, etc. Shpg. wt. 3 oz. **32 F 64579** ..... 10 for .56; singly, ea. .07
- 2** Phone Jack. Accepts RCA-type phono plug. Mounts in rear of panel. Shpg. wt. 3 oz. **32 F 64587** ..... 10 for .79; singly, ea. .09
- 3** Finger Grip Plug. Phone plug with finger grip. **32 F 78173** Wt. 2 oz. . 10 for 1.39; singly, ea. .15
- 4** Feed Thru. Accepts male phono plug at both ends. Shpg. wt. 3 oz. **32 F 52012** ..... Net .59

## PHONO PIN JACK



RCA-type female input jack. Mounts securely in single 1/4" hole by means of locknut on jack. Screws, nuts and washers unnecessary. Imp. **99 F 82341** Wt. 3 oz. . . . 4 for 1.33; singly, ea. .37

## ALL SHIELDED PHONO PLUG JACK



- 5** Removable shell for easy soldering of wires. Positive ground connection through unique ground lug reduces hum to a minimum. Extra-long handle makes removal from amplifier a snap. Completely shielded in bright nickel plate on brass body and shell. Fits all RCA-type jacks. 1 3/8" long. Imported. Shpg. wt. 2 oz. **99 F 62390** ..... Net .41
- 6** Extension Cable Jack for use with above or any other type phono plug. Imported. **99 F 62408** Shpg. wt. 2 oz. .... Net .26

## 10 COLOR CODED PHONO PLUGS



**\$1.49**

Kit contains 10 RCA-type phono plugs in assorted colors—Black, Red, Yellow, Blue and White. Plastic shell with finger grip. Plugs are semi-solderless type—need only spot solder at tip. Fit standard RCA-type phono jacks. Imported. **99 F 83273** Shpg. wt. 3 oz. .... Net 1.49

## DOUBLE PHONO JACK AND PLUG SET



Set consists of two phono male plugs and a dual female socket. Excellent for such dual signal applications as

stereo equipment. Sturdy solder contacts are used throughout construction. **99 F 63307** Shpg. wt. 3 oz. .... Net .45

## BEAU BARRIER STRIPS



Sturdy closed-back barrier strips moulded in black bakelite are ideal for permanent installations as well as breadboard and experimental work. Two mounting holes on each end of strip. See headings about each series for size specifications. Avg. shpg. wt. 5 oz.

**TYPE 14000—15 AMP.** Leakage path between terminals is 3/8". Base is 7/8" wide x 1/2" high.

Stock No.	No. of Con- tacts		Net Each	Stock No.	No. of Con- tacts		Net Each
	1-49	50-99			1-49	50-99	
33 F 86016	1	.20	.17	33 F 86117	11	.81	.70
33 F 86026	2	.23	.20	33 F 86125	12	.89	.77
33 F 86034	3	.29	.25	33 F 86133	13	.99	.86
33 F 86042	4	.33	.29	33 F 86141	14	1.02	.89
33 F 86050	5	.40	.35	33 F 86156	15	1.05	.91
33 F 86067	6	.49	.43	33 F 86166	16	1.15	1.00
33 F 86075	7	.53	.46	33 F 86174	17	1.21	1.05
33 F 86083	8	.60	.52	33 F 86182	18	1.27	1.10
33 F 86091	9	.68	.57	33 F 86190	19	1.33	1.18
33 F 86109	10	.68	.59	33 F 86208	20	1.38	1.20
				33 F 86216	21	1.41	1.23

## 2- CONDUCTOR PHONE PLUGS

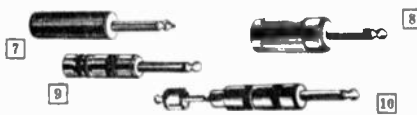

Phone plugs for a wide variety of applications with choice of handle sizes and materials. All sleeves fit standard 1/4" phone jacks. Wt. 3 oz.

- 7** Slim Phone Plug. Smooth bakelite handle. Solder terminals with cable clamp. Imported. **99 F 62218** ..... Net .45 ea.; 10 for 4.05
- 8** Barrel Phone Plug. Ribbed plastic barrel handle. Screw terminals. Imported. **99 F 62234** ..... Net .68 ea.; 10 for 5.94
- 9** Shield Slim Plug. Ribbed chromed metal handle. Solder terminal with cable clamp. Imported. **99 F 62150** ..... Net .99 ea.; 10 for 9.00
- 10** Phone to Phono Plug Adapter. Adapts from standard phone plug to RCA-type phono plug. Overall length 2 7/8 x 1/2" diameter. Imported. **99 F 82168** ..... Net 1.35

## PHONE JACKS FOR 1/4" PLUGS



- 11** Open Circuit Jack. Standard open circuit phone jack. 3/8" bushing, 1/2" long. Complete with mounting hardware. Imported. **99 F 62135** ..... Net .40 ea.; 5 for 1.80
- 12** Closed Circuit Jack. Same as above but closed circuit phone jack. Imported. **99 F 62226** ..... Net .40 ea.; 5 for 1.80
- 13** Extension Cable Jack. Fits standard 1/4" phone plug. Screw terminals. Barrel plastic handle matches barrel plug above. Imported. 3 oz. **99 F 62143** ..... Net .55 ea.; 3 for 1.48

## SUBMINIATURE PHONE PLUG JACK



Subminiature "phone plug" and jack. Only 1" long x 1/4" diameter overall. Pin dia. 1/8". Excellent for transistor and subminiature applications. Plug has removable sleeve. Jack can be mounted on panel up to 1/8" thick. Jack can be used for open and closed circuits. Imp. **99 F 62101** Plug Shpg. wt. 3 oz. .... Net .39  
**99 F 62119** Jack Shpg. wt. 3 oz. .... Net .34

## SUB-MINIATURE PLUG ADAPTER



Designed for most transistor radios with earphone jacks. Provides 2 jacks for earphones, speakers, etc.; can be used in instruments with 1/8" dia. jack. Overall size 2 1/4 x 1/16 x 3/4"D. Imp. **99 F 63109** 2 oz. . . Net 1.09

## ULTRA MINIATURE PLUG & JACK



Plug is 1 3/8" overall. Pin dia. 3/32". Jack mounts on panels up to 3/32" thick. Needs 3/32" mtg. hole. Extends 1/2" behind panel. Three-circuit jack can be used open or closed. Imported. **99 F 63141** Wt. 2 oz. Net .35

## HEAVY SHIELDED PHONE PLUGS AND JACKS



- 13** Sturdy, heavy brass, nickel-plated phone plugs with screw terminal connections. Threaded insulated cable outlet may be removed for larger cables to pass through. Body dia. 3/4". Pin dia. 1/4". Overall length 3 1/4". Wt. 3 oz. Imp. **99 F 82291** Plug ..... Net ea. 1.21
- 14** Matching in-line phono jack, same construction as plug. Overall length 2" Imported. **99 F 62283** Jack ..... Net ea. .89

## 3 CONDUCTOR PHONE PLUG & JACK



- 15** 3-Conductor Phone Plug. 1/4" dia. Black bakelite handle. Solder lugs. Imported. **99 F 61194** Shpg. wt. 2 oz. .... Net .67
- 16** 3-Conductor Phone Jack. Open circuit. Imp. **99 F 61186** Shpg. wt. 2 oz. .... Net .59

## LAFAYETTE FLAT PHONE PLUG



Two-conductor all-metal phone plug for standard 1/4" jack, body only 3/32" thick. Shielding crimps to body, center lead to solder terminal. Imported. **99 F 62786** Wt. 2 oz. . . Net ea. .53

## PHONE PLUG TO JACK ADAPTER



**\$1.25**

Brass, nickel-plated adapter. Has standard phone jack on one end to take regular phone plug, and RCA-type phono plug on other end. **99 F 63257** Imported. Shpg. wt. 3 oz. . . Net 1.25

## KIT OF 6,5-WAY BINDING POSTS



**\$1.69**

- For Banana Plug
- For Phone Tip Plug
- For Spade Lug
- For Alligator Clip
- For Strand of Wire

For panels 1/8" to 1/4" thick. Assortment of 6 pieces: 3 Red and 3 Black. Imported. Wt. 4 oz. **99 F 63943** Binding Post Kit ..... Net 1.69

## JUMBO 5-WAY BINDING POSTS



This versatile binding post is designed to accept spade lugs, phone tip lugs or wire which is held firmly in place by tightening down the head. Adequate room is allowed for connections with alligator plugs. Banana plugs will firmly seat in the top mounting hole. May be mounted in panels from 1/8" to 1/4" thickness. Sturdily made with non-removable head piece. Imported. 2 oz. **32 F 64603** Black ..... Net .42  
**32 F 64611** Red ..... Net .42

## 3-CONDUCTOR PLUG AND JACK SET



A finely-built 3-conductor plug and jack set. Uniquely made so that jack can be used as normally open although one circuit may be used as normally closed. Heavy-gauge construction. Plug 1 1/8" overall. Jack mounts in 3/32" hole in panels up to 1/8" thick. Pin dia. 3/16". Imported. **99 F 83261** Shpg. wt. 2 oz. .... Net .99

## LAFAYETTE STEREO PHONE JACK



For insertion of standard 1/4" dia. three-conductor plug. Will switch out speakers and allow operation of only headphones or extension speakers. Many uses. Imported. **99 F 62739** Shpg. wt. 2 oz. .... Net ea. .79

## EUROPEAN AUDIO CONNECTORS



Made to European DIN engineering specs. Fully shielded in plastic snap-on shells. Will mate with sockets on Norelco, Grundig, Telefunken, Uher, etc. Imported.

- 3-Pin Audio Plug. Fig. A.** **34 F 31012** Shpg. wt. 2 oz. .... Net 1.19
- 5-Pin Audio Plug. Fig. B** **34 F 31020** Shpg. wt. 2 oz. .... Net 1.39
- 5-Pin Audio Plug. Fig. C** **34 F 31038** Shpg. wt. 2 oz. .... Net 1.39



# Top Quality Plugs—Jacks—Binding Posts

**SMITH PLUGS AND JACKS**

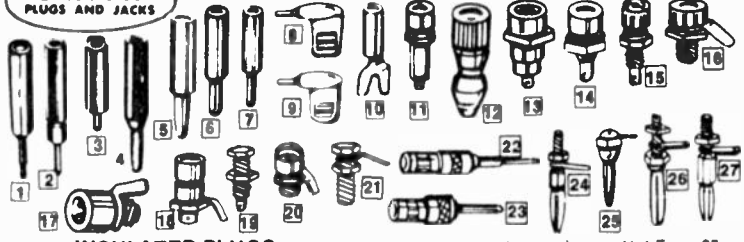

### INSULATED PLUGS

**Fig. 1.** Insulated Tip Plug. Heavy-duty. Solder-type. 1" handle. 2 1/2" overall.  
**32 F 64645 Red** . . . . . Net Ea. .25  
**32 F 64652 Black** . . . . . 10 for 2.25  
**Fig. 2.** Insulated Solderless Tip Plug. 1" handle. 1 3/4" length overall.  
**32 F 64660 Red** . . . . . Net Ea. .25  
**32 F 64678 Black** . . . . . 10 for 2.25  
**Fig. 3.** Insulated Short Tip Plug. Solder type. 1" handle. 1 1/2" length overall.  
**32 F 64686 Red** . . . . . Net Ea. .20  
**32 F 64694 Black** . . . . . 10 for 1.80  
**Fig. 4.** Insulated Banana Plug. Spring-type. Internal set screw for soldering. 1" handle. 1 3/8" length overall. Phosphor-bronze.  
**32 F 64702 Red** . . . . . Net Ea. .35  
**32 F 64710 Black** . . . . . 10 for 3.15  
**Fig. 5.** Solderless Insulated Banana Plug. Spring-type. 1" handle. 1 3/8" overall.  
**32 F 64728 Red** . . . . . Net Ea. .30  
**32 F 64736 Black** . . . . . 10 for 2.70  
**Fig. 6.** Solderless Insulated Banana Plug. Split-type. 1" handle. 1 3/8" overall.  
**32 F 64744 Red** . . . . . Net Ea. .28  
**32 F 64751 Black** . . . . . 10 for 2.52  
**Fig. 7.** Insulated Banana Plug. Spring-type. 1" handle. 1 3/8" overall. Solder-type.  
**32 F 64769 Red** . . . . . Net Ea. .30  
**32 F 64777 Black** . . . . . 10 for 2.70  
**Fig. 8.** Molded Meter Banana Plug.  
**32 F 64785 Red** . . . . . Net Ea. .46  
**32 F 64793 Black** . . . . . 10 for 4.32  
**Fig. 9.** Molded Meter Tip Plug.  
**32 F 64801 Red** . . . . . Net Ea. .35  
**32 F 64819 Black** . . . . . 10 for 3.15  
**Fig. 10.** Insulated Spade Lug. 3/4" handle. 1 3/8" length overall.  
**32 F 64827 Red** . . . . . Net Ea. .16  
**32 F 64835 Black** . . . . . 10 for 1.44

### INSULATED JACKS

**Fig. 11.** Phone Tip or Banana Plug. Mounts in 3/16" hole.  
**32 F 64843 Red** . . . . . Net Ea. .25  
**32 F 64850 Black** . . . . . 10 for 2.25  
**Fig. 12.** 5-Way Binding Post. Takes phone tips, banana plugs, spade lugs, alligator clip, wire. All-insulated-type.  
**32 F 64868 Red** . . . . . Net Ea. .55  
**32 F 64876 Black** . . . . . 10 for 4.95  
**Fig. 13.** Nylon All-Insulated Tip Jack. 1" overall. Mounts in 3/8" hole.  
**32 F 64884 Red** . . . . . Net Ea. .25  
**32 F 64892 Black** . . . . . 10 for 2.25  
**Fig. 14.** Insulated Tip Jack. 1 1/4" overall length. Mounts in 3/8" hole.  
**32 F 64900 Red** . . . . . Net Ea. .20  
**32 F 64918 Black** . . . . . 10 for 1.80  
**Fig. 15.** Nylon Insulated Tip Jack. With nylon washer. 1" overall length. Mounts in 3/8" hole.  
**32 F 64926 Red** . . . . . Net Ea. .30  
**32 F 64934 Black** . . . . . 10 for 2.70  
**Fig. 16.** Insulated Banana Jack. 3/4" overall length. Mounts in 3/8" hole.  
**32 F 64942 Red** . . . . . Net Ea. .20  
**32 F 64959 Black** . . . . . 10 for 1.80  
**Fig. 17.** Instruments Banana Jack. 4 7/8" overall length. Mounts in 3/8" hole.  
**32 F 64967 Red** . . . . . Net Ea. .23  
**32 F 64975 Black** . . . . . 10 for 2.07  
**Fig. 18.** Nylon Insulated Banana Jack. With nylon washer. Overall length 1 5/8". Mounts in 3/8" hole.  
**32 F 64983 Red** . . . . . Net Ea. .31  
**32 F 64991 Black** . . . . . 10 for 2.79

### METAL JACKS

**Fig. 19.** Metal Tip Jack. for 1/4" hole.  
**32 F 64371** . . . . . Net Ea. .20  
 10 for 1.80  
**Fig. 20.** Metal Banana Jack. 1/4" hole.  
**32 F 64389** . . . . . Net Ea. .19  
 10 for 1.71  
**Fig. 21.** Metal Banana Jack. 1/4" hole.  
**32 F 64397** . . . . . Net Ea. .19  
 10 for 1.71  
**Fig. 22.** Solderless Phone Tip. Sr 2 3/4" lng.  
**32 F 64405** . . . . . Net Ea. .21  
 10 for 1.89  
 100 for 17.96

### NON-INSULATED PLUGS

**Fig. 23.** Solderless Phone Tip. Jr. 1 3/8".  
**32 F 64413** . . . . . Net Ea. .21  
 10 for 1.89  
**Fig. 24.** Banana Plug. Spring-type. 1 3/8" overall. 6-32 x 1/2" stud.  
**32 F 64421** . . . . . Net Ea. .33  
 10 for 2.97  
**Fig. 25.** Banana Plug. Spring-type screw in head. 1 3/8" overall.  
**32 F 64439** . . . . . Net Ea. .33  
 10 for 2.97  
**Fig. 26.** Banana Plug. Spring-type. 1 3/8" overall. 6-32 x 3/8" stud.  
**32 F 64447** . . . . . Net Ea. .33  
 10 for 2.97  
**Fig. 27.** Banana Plug. Split-type 1 1/4" overall. 6-32 x 1/2" stud.  
**32 F 64454** . . . . . Net Ea. .22  
 10 for 1.96

### 28 "SPEEDI-MOUNT" JACKS

Unusual dished lockwasher permits fast assembly. Teeth embed into jack and panels, prevents pulling out and turning. Mounts in 3/8" hole in panels up to 3/16" thick. Shpg. wt. 2 oz.  
**No. 279 Accepts Tip Jacks**  
**32 F 65105 Red** . . . . . Net .10  
**32 F 65113 Black** . . . . . Net .10  
**No. 396 Accepts Banana Jacks**  
**32 F 65121 Red** . . . . . Net .10  
**32 F 65139 Black** . . . . . Net .10

### 29 DUAL BANANA PLUG

No. 210 moulded polystyrene dual binding post with brass nickel-plated plugs on 3/8" centers. Mates with standard binding posts. Polarity indicated on top and side. Wire held by internal set screw. May be stacked. Shpg. wt. 3 oz.  
**32 F 65048 Black** . . . . . Net .88  
**32 F 65055 Red** . . . . . Net .88

### 30 SMITH TEST PRODS

Brass, nickel-plated plugs mounted in 4" moulded butyrate handles. Shpg. wt. 2 oz.  
**No. 302 Solderless Test Prod-Type**  
**32 F 65063 Red** . . . . . Net .33  
**32 F 65071 Black** . . . . . Net .33  
**No. 317 Phono Needle Test Prod**  
**32 F 65089 Red** . . . . . Net .36  
**32 F 65097 Black** . . . . . Net .36

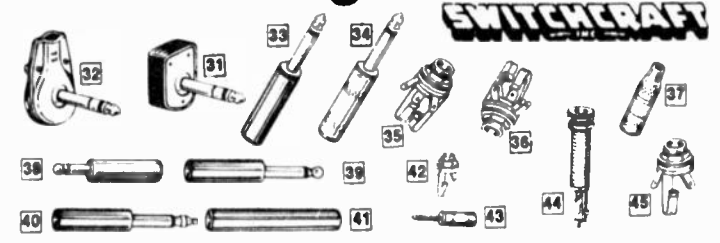
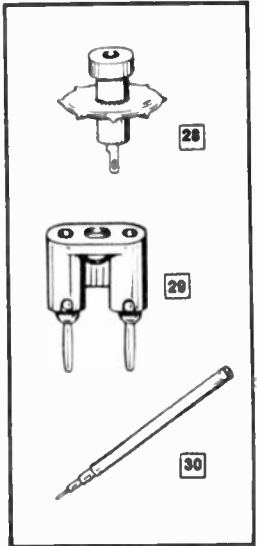

### SWITCHCRAFT 3-CONDUCTOR FLAT PHONE PLUGS

1/4" flat phone plugs with removable plastic cap for easy connection of wire leads. Ideal for use where space is limited. Tip rods are 1 3/8" long. All metallic parts are of nickel-plated brass. All plugs have screw-type terminals except #238 which is solder-type. Shpg. wt. 3 oz.

Stock No.	Mfr. No.	Fig.	Color	Net Each
34 F 60391	230	31	Black	1.29
34 F 60409	S-230	31	Black	1.62
34 F 60417	235	31	Red	1.29
34 F 60425	238	32	Metal	1.55

### SWITCHCRAFT "LITTEL PLUGS" AND JACKS

"LITTEL-PLUGS" PHONE PLUGS. Compact quality plugs. Fit standard 1/4" phone jacks except \* with .206 diameter sleeve and † with short sleeve for Reverse recorders. In plastic handle or with brass nickel-plated shells for shielding Solder terminal has built-in cable clamp. Handle 1 1/16" long. 1/2" dia. Avg. shpg. wt. 3 oz.

Stock No.	Type	Fig.	Cnd.	Term.	Net	Stock No.	Type	Fig.	Cnd.	Term.	Net
34 F 60126	240	33	2	Screw	.75	34 F 60185	287	33	3	Solder	1.05
34 F 60136	245	33	2	Screw	.75	34 F 60193	280	34	2	Solder	1.02
34 F 60144	250	33	2	Solder	.72	34 F 60201	S-280	34	2	Solder	1.02
34 F 60151	S-250	33	2	Solder	.75	34 F 60219	R-280	34	2	Solder	1.32
34 F 60169	255	33	2	Solder	.72	34 F 60227	297	34	3	Solder	1.32
34 F 60177	260	33	3	Screw	1.20						

**35 "LITTEL-JAX" PHONE JACKS.** Accept standard 1/4" phono plugs, except \* with .210" J.D. sleeve and † mates with 480 Mil-type "Littel-Plug." Abbrs.: SCC—single closed ckt.; OC—open ckt. 3/4" dia. 1 3/8" overall; 3/8" diameter threaded shank. 3/32" long. Average shpg. wt. 2 oz.

Stock No.	Cond.	Ckt.	JanType	Net	Stock No.	Cond.	Ckt.	JanType	Net
34 F 60235	11	2	OC	.42	34 F 60276	C-12A	2	SCC	JJ-089 .72
34 F 60243	C-11	2	OC	JJ-034 .83	34 F 60284	12B	3	OC	— .51
34 F 60250	S-11	2	OC	.45	34 F 60292	C-12B	3	OC	JJ-033 .72
34 F 60266	12A	2	SCC	.45	34 F 60300	13B	3	SCC	— .75

"TINI-PLUGS" SUBMINIATURE PHONE PLUGS. 2-conductor phone plugs for use with "Tini-Jax." Only 1 1/8" in length. In plastic- or metal-shielded handles. Pin diameter 1/8". Shpg. wt. 2 oz.

Stock No.	Type	Fig.	Handie	Terminals	Net	Stock No.	Type	Fig.	Handie	Terminals	Net
34 F 60316	740	33	Black	Screw	.69	34 F 60342	755	33	Red	Solder	.66
34 F 60326	745	33	Red	Screw	.69	34 F 60359	770	34	Metal	Screw	.98
34 F 60334	750	33	Black	Solder	.66	34 F 60367	780	34	Metal	Solder	1.55

**36 "TINI-JAX" SUBMINIATURE PHONE JACKS.** 2-conductor jacks for "Tini-Plugs." Only 2 1/2" long. Abbrs.: OC—open ckt.; CC—closed ckt.; Avg. shpg. wt. 2 oz.

Stock No.	Type	Cond.	Terminals	Net
34 F 60375	41		OC	.39
34 F 60383	42A		CC	.42

**37 "TINI-EXTENSION JAX."** An extension or cable jack to mate with "Tini-Plugs." Two conductors with metal housing for ruggedness and electrical shielding. Solder lug terminals. 2 oz.

Stock No.	Type	Fig.	Cond.	Old S.C. No.	Jan Type	Net
34 F 60066	430	38	2	PL-55	PJ-054B	1.17
34 F 60094	440	39	2	PL-55	PJ-055B	1.17
34 F 60102	480	40	3	PL-68	PJ-068	2.73
34 F 60110	820	41	2	JK-28	JJ-026	1.65

**42 SWITCHCRAFT "MICRO PLUGS AND JAX."** 2-conductor plug for use with cables of up to 3/8" O.D. Nylon insulation is used between tip and sleeve. Pin diameter 3/32". Shpg. wt. 2 oz.

**43 Ultra-miniaturized Jack** for above. Solder lugs and spring grip.  
**34 F 60433 (42)** Black handle (No. 850) . . . . . Net .63  
**34 F 60441 (42)** Red handle (No. 855) . . . . . Net .63  
**34 F 60490 (42)** Natural aluminum handle (No. 880) . . . . . Net .83  
**34 F 60508 (43)** Jax (No. TR-2A). Shpg. wt. 2 oz. . . . . Net .46

**44 SWITCHCRAFT "THICK PANEL JAX."** A long bushing allows mounting in panels of up to 1 1/4" in thickness with a 3/8" diameter hole. Features shielding and solder terminals. No. 151 is 2-conductor and mates with 240, 245, 250, 255, 270 and 280 plugs. No. 152B is 3-conductor and mates with 260, 267, 269 and 297 plugs. 3 oz.

Stock No.	Description	Net	Stock No.	Description	Net
34 F 60474	No. 151	1.38	34 F 60482	No. 152B	1.50

**45 SWITCHCRAFT STEREO "LITTEL-JAX."** A 3-conductor jack specially designed for switching out speakers when connecting stereo headphones. Mts. in 3/8" dia. hole.  
**34 F 60466** Switchcraft No. 14B. Shpg. wt. 2 oz. . . . . Net .99

# Quality Name-Brand Capacitors for Every Use

**CORNELL—MALLORY—SPRAGUE—CENTRALAB  
TUBULAR ELECTROLYTIC CAPACITORS**

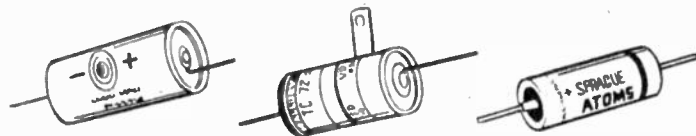

## STANDARD BRANDS

Because no one manufacturer offers all sizes, we have made this integrated list. Your order will be filled with one of the 4 famous brands illustrated. We will supply any particular manufacturer's brand specified if available in the size desired. Avg. shpg. wt. 4 ozs.

**Cornell Blue Beaver.** Cornell Dubilier types BR and BBRD are dry electrolytics in compact aluminum cases. Highest quality for TV general replacement with extra safety for high surge voltages in power supplies. Very low leakage. Operating temperature up to 85°C.

**Sprague "Atoms."** Sprague "Atoms" TVA and TV are dry electrolytics in extremely compact metal cases. They are designed to withstand high surge voltages and high ripple currents making them ideal for TV replacements, power supplies, etc. Leakage is very low. Efficient at temperatures to 85°C.

**Mallory TC.** Mallory type TC electrolytic capacitors are housed in aluminum containers. These compact units are of the highest quality and are ideal for use in TV, radio and general replacement in electronic circuitry. Low leakage and built-in safety factors against high voltage surges. Operating temperature up to 85°C.

Stock No. Cap. Mfd. W.V. Net

### SINGLE SECTION

Stock No.	Cap.	Mfd.	W.V.	Net	Stock No.	Cap.	Mfd.	W.V.	Net
33 F 15082	1000	3		1.30	34 F 55482	20	250		1.78
34 F 84011	50	6		.77	34 F 55508	40	250		1.87
34 F 55102	100	6		.83	34 F 55518	50	250		1.87
34 F 75043	100	12		.83	34 F 55524	60	250		1.94
34 F 75076	1000	12		1.62	34 F 83401	150	300		2.99
34 F 55144	100	15		.84	34 F 83419	200	300		3.82
34 F 15090	200	15		1.12	34 F 55532	4	350		1.01
34 F 65151	250	15		.92	34 F 75159	10	350		1.69
34 F 55169	500	15		1.14	34 F 55573	20	350		1.78
34 F 55177	1000	15		1.62	34 F 75399	60	350		2.75
34 F 55185	2000	15		1.67	34 F 83443	100	350		2.93
34 F 56233	4000	15		3.42	33 F 15447	150	400		2.57
34 F 56241	5000	15		3.79	34 F 55815	1	450		.92
34 F 84029	2	25		.73	34 F 55823	2	450		1.01
34 F 84110	5	25		.73	34 F 55831	4	450		1.25
34 F 75084	10	25		.77	33 F 15157	5	450		1.18
34 F 55193	20	25		.79	34 F 55649	8	450		1.78
34 F 55201	25	25		.79	34 F 55656	10	450		1.78
34 F 55219	50	25		.83	34 F 55672	16	450		1.89
34 F 55227	100	25		.86	34 F 55680	20	450		1.94
34 F 55235	250	25		1.08	34 F 55698	30	450		2.69
34 F 55243	500	25		1.53	34 F 55706	40	450		2.80
34 F 56258	1000	25		1.67	34 F 75175	50	450		2.82
34 F 56266	2000	25		3.38	34 F 55714	60	450		2.82
33 F 15108	1	50		.87	34 F 55722	80	450		2.99
34 F 75100	2	50		.73	34 F 75183	100	450		3.82
34 F 55268	10	50		.79	34 F 83427	150	450		4.48
34 F 55276	25	50		.83	34 F 83435	200	450		5.39
34 F 75128	50	50		.88	34 F 55748	8	500		1.78
34 F 55284	100	50		.95	34 F 75191	10	500		1.78
34 F 55292	150	50		1.14	34 F 55771	20	500		1.94
34 F 55300	250	50		1.14	34 F 55821	16	600		2.35
34 F 55318	500	50		1.81	34 F 75209	20	600		2.42
34 F 56274	1000	50		2.36					
34 F 58189	1500	50		2.53					
34 F 58197	2000	50		3.77					
34 F 55326	4	150		.91					
33 F 15116	5	150		.98	34 F 55912	20-20	150		1.40
34 F 55334	8	150		.92	34 F 55938	30-30	150		1.44
34 F 55342	10	150		.94	34 F 55979	50-30	150		1.58
34 F 55375	20	150		1.04	34 F 55987	50-50	150		1.68
34 F 55391	30	150		1.25	34 F 55995	80-40	150		1.76
34 F 55409	40	150		1.69	34 F 58084	8-8	450		1.56
34 F 55417	50	150		1.78	34 F 75308	10-10	450		1.64
34 F 55425	60	150		1.78	34 F 58118	20-20	450		2.00
34 F 55433	80	150		1.98	34 F 58126	30-30	450		2.60
34 F 55441	100	150		1.96	34 F 83450	40-40	450		3.00
34 F 55458	150	150		2.10					
34 F 75134	200	150		2.13					
34 F 75373	300	150		2.93	34 F 56324	30-25-20	150		2.40
34 F 83393	150	200		2.81	34 F 58365	40-40-20	150		2.48
33 F 15421	200	200		1.83	34 F 58381	80-40-20	150		2.64
33 F 15132	10	250		1.16	33 F 15280	80-50-50	150		2.94

### DUAL SECTION— COMMON NEGATIVE

### TRIPLE SECTION

## TWIST-PRONG CAPACITORS



Orders will be filled with one of the brands above.

## DUAL-SECTION TWIST-PRONGS (Cont'd)

SINGLE-SECTION TWIST-PRONGS				DUAL-SECTION TWIST-PRONGS			
Stock No.	Mfd.	DCWV	Net	Stock No.	Mfd.	DCWV	Net
34 F 83278	160	250	4.49	34 F 77023	4.67	50-50	4.50
34 F 58015	200	250	3.73	34 F 77072	5.10	80-40	4.50
34 F 76348	40	450	2.85	34 F 15397	4.18	30-30	5.00
34 F 76371	80	450	3.93	34 F 77163	4.88	40-40	5.00
34 F 76389	100	450	4.47				
34 F 76439	30	500	2.65				

DUAL-SECTION TWIST-PRONGS				TRIPLE-SECTION TWIST-PRONGS			
Stock No.	Mfd.	DCWV	Net	Stock No.	Mfd.	DCWV	Net
34 F 76789	50-30	150	2.62	34 F 79698	40-40-40	150	3.02
34 F 76611	80-80	400	5.18	34 F 74095	20-20-20	450-450-25	3.20
34 F 76987	20-20	450	3.125	34 F 74111	40-40-20	450-450-25	4.36
34 F 77015	40-40	450	4.25	34 F 74236	20-20-20	450	4.16
				34 F 74319	40-40-40	450	5.38
				34 F 74350	80-40-20	450	5.70

## QUADRUPLE-SECTION TWIST-PRONGS

Stock No.	Mfd.	DCWV	Net Each
34 F 74723	80-40-10-100	400-400-400-200	5.48
34 F 83302	30-20-160-40	450-450-250-150	6.24
34 F 83310	60-50-20-50	450-450-250-50	6.24
34 F 83328	80-50-10-20	450-450-450-25	6.00
34 F 74848	40-30-10-20	450-450-450-25	4.89
34 F 74939	20-20-20-20	20-20-20-20	4.74
34 F 73014	40-40-20-20	40-40-20-20	5.32
34 F 73113	20-20-10-10	20-20-10-10	4.69

## ECONOMY TUBULAR ELECTROLYTICS

Color-coded, insulated, flexible leads. Avg. shpg. wt. 4 oz.

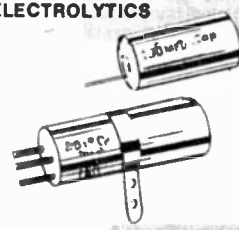

Stock No.	Mfd.	DCWV	Net Ea.
32 F 01183	40	450	.90
32 F 01381	100	450	1.53
32 F 01191	40-40	150	.79
32 F 01209	50-30	150	.79
32 F 01217	50-50	150	.89

## WIDE-RANGE ELECTROLYTIC

Exact Replacement for Many Popular Types  
Compact unit provides exact replacement for 8 original standard 200 WVDC capacitors: 50-50, 70-30, 75-30, 60-40, 80-40, 50-50, 70-50, 80-50 mfd. Used in home radio receive-



## CERAMIC DISC KIT—48 VALUES

Values included range from .001 mfd to 2 mmfd. Voltage ratings range from 50 to 5000 volts DC. Ideal selection for servicemen, builders and experimenters. Shpg. wt. 3 oz.  
32 F 60023 ..... Net 1.49

## LAFAYETTE SUBMINIATURE SQUARE CERAMIC CAPACITORS

75-Volt Microminatures. Designed for greatest capacitance in the smallest size. Wt. 2 oz.  
ers. 1" diameter, 2 1/2" long. For printed circuit board mounting.  
33 F 56300 Shpg. wt. 3 oz. Net 1.73

## STANDARD BRANDS CERAMIC DISC CAPACITORS

Stock No.	Cap.	Stock No.	Cap.	Stock No.	Cap.	Stock No.	Cap.
32 F 01472	5µm	32 F 01605	47µm	32 F 01720	250µm	32 F 01845	.0015µm
32 F 01480	6.8µm	32 F 01613	50µm	32 F 01738	270µm	32 F 01852	.0018µm
32 F 01498	10µm	32 F 01621	56µm	32 F 01746	300µm	32 F 01860	.002µm
32 F 01506	12µm	32 F 01639	68µm	32 F 01753	330µm	32 F 01878	.0022µm
32 F 01514	15µm	32 F 01647	75µm	32 F 01761	390µm	32 F 01886	.0025µm
32 F 01522	18µm	32 F 01654	82µm	32 F 01779	470µm	32 F 01894	.0027µm
32 F 01530	20µm	32 F 01662	100µm	32 F 01787	470µm	32 F 01902	.003µm
32 F 01548	22µm	32 F 01670	120µm	32 F 01795	560µm	32 F 01910	.0033µm
32 F 01556	25µm	32 F 01688	150µm	32 F 01803	680µm	32 F 01938	.0047µm
32 F 01563	27µm	32 F 01696	180µm	32 F 01811	750µm	32 F 01944	.005µm
32 F 01571	30µm	32 F 01704	200µm	32 F 01829	.001µ	32 F 01951	.0058µm
32 F 01589	33µm	32 F 01712	220µm	32 F 01837	.0012µ	32 F 01969	.01µm
32 F 01597	39µm						

## HIGH CAPACITY DISC

.02 µf. Shpg. wt. 2 oz.  
32 F 09491 . . . 10 for 1.80; Singly, ea. .20

# See Lafayette for All Your Capacitor Needs

## Sprague Miniature Metal-Case Aluminum Electrolytic Capacitors

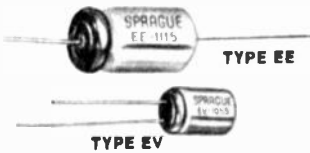

Reliable miniature aluminum electrolytic capacitors are hermetically sealed in metal cases. Av. wt. 2 oz. Imported.

### TYPE EE MINILYTIC AXIAL LEAD ELECTROLYTICS

Stock No.	μF	WVDC	Net
34 F 83468	1	25	.42
34 F 83476	1	50	.42
34 F 83484	2	50	.42
34 F 83492	5	25	.42
34 F 83500	5	50	.45
34 F 83518	10	16	.42
34 F 83526	10	25	.45
34 F 83534	10	50	.61
34 F 83542	25	16	.45
34 F 83559	25	25	.61
34 F 83567	25	50	.61
34 F 83575	50	16	.61
34 F 83583	50	25	.64
34 F 83591	50	50	.64
34 F 83609	100	12	.64
34 F 83617	100	25	.64
34 F 83625	100	50	.69
34 F 83633	200	25	.69
34 F 83641	250	16	.69
34 F 83658	250	25	.78
34 F 83674	500	25	1.02
34 F 83682	1500	6	1.02
34 F 83690	2000	6	1.08

### TYPE EV VERTILYTIC VERTICAL ELECTROLYTICS

Stock No.	μF	WVDC	Net
34 F 83708	1	63	.45
34 F 83716	2.2	50	.45
34 F 83724	3.3	25	.39
34 F 83732	4.7	25	.39
34 F 83740	4.7	50	.39
34 F 83757	10	25	.39
34 F 83765	10	63	.40
34 F 83773	15	25	.45
34 F 83781	22	25	.45
34 F 83789	33	25	.45
34 F 83807	47	6.3	.39
34 F 83815	47	25	.48
34 F 83823	100	6.3	.45
34 F 83831	100	16	.54
34 F 83849	100	25	.63
34 F 83856	100	50	.61
34 F 83864	220	10	.64
34 F 83872	220	25	.61
34 F 83880	330	10	.63
34 F 83888	330	25	.99
34 F 83914	470	16	.99
34 F 83922	470	25	1.23
34 F 83930	1000	6.3	.99
34 F 83948	1000	16	1.44
34 F 83955	1000	25	1.89

## Standard Brand Dipped Mylar-Paper Capacitors

100 WVDC				600 WVDC				
Stock No.	Cap. Mfd.	Net Ea. 1-24	In Lots of 25-49	50-99	Stock No.	Cap. Mfd.	Net Ea. 1-24	
34 F 87016	.005	.20	.14	.12	34 F 82312	.001	.18	.12
34 F 87032	.0068	.20	.14	.12	34 F 82320	.0012	.18	.12
34 F 87057	.01	.20	.14	.12	34 F 82338	.0015	.18	.12
34 F 87065	.015	.20	.14	.12	34 F 82346	.0018	.18	.12
34 F 87073	.02	.20	.14	.12	34 F 82353	.002	.18	.12
34 F 87081	.022	.20	.14	.12	34 F 82361	.0022	.18	.12
34 F 87099	.025	.20	.14	.12	34 F 82379	.0025	.18	.12
34 F 87115	.033	.22	.15	.13	34 F 82387	.0027	.18	.12
34 F 87123	.04	.22	.15	.13	34 F 82395	.003	.16	.12
34 F 87131	.047	.24	.17	.14	34 F 82403	.0033	.18	.12
34 F 87149	.05	.24	.17	.14	34 F 82411	.0039	.20	.14
34 F 87156	.056	.24	.17	.14	34 F 82429	.004	.20	.14
34 F 87164	.068	.25	.16	.15	34 F 82437	.0047	.20	.14
34 F 87180	.1	.28	.19	.16	34 F 82445	.005	.24	.15
34 F 87198	.15	.32	.23	.19	34 F 82452	.0056	.20	.14
34 F 87206	.2	.25	.18	.15	34 F 82460	.006	.20	.14
34 F 87214	.22	.25	.18	.15	34 F 82478	.0068	.24	.15
34 F 87222	.25	.25	.18	.15	34 F 82502	.0082	.20	.14
34 F 87230	.33	.35	.24	.20	34 F 82510	.01	.24	.16
34 F 87248	.47	.35	.24	.20	34 F 82528	.012	.22	.16
34 F 87255	.5	.46	.32	.27	34 F 82536	.015	.27	.18
34 F 87263	.68	.46	.32	.27	34 F 82544	.02	.27	.19
34 F 87271	1.0	.46	.32	.27	34 F 82551	.022	.23	.17
					34 F 82569	.025	.25	.17
					34 F 82577	.027	.25	.17
					34 F 82585	.03	.25	.17
					34 F 82593	.033	.30	.20
					34 F 82601	.035	.30	.20
					34 F 82619	.039	.26	.18
					34 F 82627	.04	.26	.18
					34 F 82635	.047	.30	.22
					34 F 82643	.05	.30	.22
					34 F 82650	.056	.28	.19
					34 F 82666	.06	.36	.25
					34 F 82676	.068	.36	.25
					34 F 82692	.082	.36	.23
					34 F 82700	.1	.42	.29
					34 F 82718	.15	.42	.30
					34 F 82726	.2	.49	.35
					34 F 82734	.22	.49	.35
					34 F 82742	.25	.50	.36
					34 F 82761	.33	.67	.46
					34 F 82779	.47	.91	.65
					34 F 82787	.5	.92	.66

### 200 WVDC

Stock No.	Cap. Mfd.	Net Ea. 1-24	In Lots of 25-49	50-99
34 F 82015	.02	.27	.16	.14
34 F 82031	.047	.27	.19	.15
34 F 82049	.05	.27	.19	.15
34 F 82056	.1	.30	.22	.17
34 F 82064	.15	.38	.26	.20
34 F 82072	.2	.40	.29	.22
34 F 82080	.22	.44	.30	.23
34 F 82098	.25	.46	.31	.24
34 F 82114	.47	.62	.44	.34
34 F 82122	.5	.64	.46	.35

### 400 WVDC

Stock No.	Cap. Mfd.	Net Ea.	In Lots of 1-24	25-49	50-99
34 F 82130	.01	.22	.16	.12	
34 F 82148	.015	.22	.16	.12	
34 F 82155	.02	.23	.16	.12	
34 F 82163	.022	.23	.16	.12	
34 F 82189	.03	.26	.18	.14	
34 F 82197	.033	.26	.18	.14	
34 F 82205	.04	.29	.20	.15	
34 F 82213	.047	.30	.20	.16	
34 F 82231	.05	.30	.20	.16	
34 F 82239	.056	.29	.21	.16	
34 F 82247	.086	.31	.23	.18	
34 F 82262	.1	.31	.23	.18	
34 F 82296	.22	.46	.33	.25	
34 F 82304	.25	.48	.34	.26	
34 F 87800	.33	.55	.39	.30	
34 F 87818	.47	.64	.46	.35	
34 F 87826	.5	.72	.51	.39	

## Cornell-Dubilier "Quietone" Filters



**Type IF-4.** A cylindrical filter for use with small radios and portable TV sets for reduction of interference caused by appliances such as electric shavers, fans, adding machines, etc. Rated 110V AC-DC, 5 amps. 34 F 58130 Shpg. wt. 4 oz. Net 2.02



**Type IF-24.** Fluorescent Noise Filter. Dual capacitive type filter for eliminating fluorescent noise. Flexible leads, bracket for mounting. For 110V AC-DC. Cylindrical metal case 7/8" dia., 1 1/8" long. 34 F 58163 Shpg. wt. 4 oz. Net 2.22



**Type IF-6.** A plug-in cylindrical filter for elimination of moderate interference of fluorescent lighting, electric shavers, etc. Has binding post terminal for grounding. Rated 110V AC-DC, 10 amperes. 1 1/8" dia., 2" long. 34 F 58148 Shpg. wt. 5 oz. Net 3.12



**Type IF-54.** A capacitive-inductive filter with greater efficiency than that above. Rated 110-220V AC-DC, 2 amperes. Has flexible leads, lead for ground. Rectangular metal case 2 x 2 x 1 1/4". With tabs for mounting. UL listed. 34 F 58171 Shpg. wt. 8 oz. Net 5.19

## Artisan Universal Time Capsule®

**NEW!**

AC/AC Automatic Time Delay—24 to 240 Volts—1-1000 Seconds

**\$14.95**

A Single Device for Most ANY Time Delay Use



Your wired-in time-delay problems are over—this ONE device operates in ANY circuit load from 24 to 240 volts. AC or DC. Provides exact time delays from 1 second to 1000 seconds: 1 sec. = short or 0 ohm—add 10k ohms per second of delay; i.e., 3 sec. = 20k. Temp. range, -15°C to +85°C, operating current, 1 A. 2 1/2 x 3/4 x 2 1/2". Solder lug terminals. 30 F 82007 Shpg. wt. 8 oz. Net 14.95

## Miniature Sensitive Relay

Ideal for Radio-Control of Planes, Boats, Etc.

Long-Life Molded Construction

**\$3**



Very sensitive relay with PC terminations and enclosed molded construction. Contacts rated 2 amps, 28 VDC to 115 VAC. Nom. Current, 4.3 mA; max. pickup current, 3.2 mA. Resistance, 5000 ohms (±10%). Gold alloy contacts. 1 1/8 x 1 1/8 x 1 3/16". 30 F 53005 Shpg. wt. 4 oz. Net 3.00

## Selenium and Solar Cells

**1 Solar Drive Motor.** Has anti-friction bearings. Use with S4M or 2 S1M's in parallel. Operates 0.35 to 1.5 V. Shpg. wt. 4 oz.

**19 F 29132** Net 3.95

**2 International Rectifier B3M.** Selenium Solar Cell. 0.2 to 0.4 volt output, 1 1/2 to 2 1/2 mA. Plastic case with adhesive disc. 1 1/8 x 1 1/8 x 3/16".

**19 F 29033 Shpg. wt. 2 oz.** Net 2.76

**3 S1M Silicon Solar Cell.** 0.3 to 0.4 volt output, 10-16 mA (full sunlight). Plastic case as above.

**19 F 29041 Shpg. wt. 2 oz.** Net 2.40

**2 S4M.** High efficiency version of S1M. 25-40 mA.

**99 F 29124 Shpg. wt. 4 oz.** Net 4.40

**3 Lafayette Self-Generating Selenium Cells.** Sensitive to white, colored, ultra-violet light. Output of 100 μA at 100 footcandles with 100-ohm load. 1 1/8 x 3/16". Imported.

**99 F 62432 Shpg. wt. 2 oz.** Net 5.96

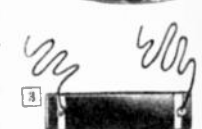

## DATAK Instant Lettering Sets

1/8" high gothic typeface with letters, numbers, popular electronic schematic terms. Transfers instantly onto smooth, dry surface. Looks like actual printed material. 3x5" sheets in each set.

**9561.** 24-sheet set. Black letters, words, numbers.

**32 F 75047 Shpg. wt. 4 oz.** Net 5.95

**9591.** 24-sheet set as above. White.

**32 F 75054 Shpg. wt. 4 oz.** Net 5.95

**Meter and Dial Marking Kit.** 12 5x7" sheets—switch patterns, arcs, graduations, letters, numbers, etc.

**32 F 75013 Shpg. wt. 4 oz.** Net 5.95

**32 F 75070 16-Oz. Protective Spray** Net 2.95



# Volume Controls, Pads, Electrical Accessories



## Miniature Volume Controls \$150

Audio taper controls with D.P.S.T. switches. Mount in  $5/16$ " holes in panels up to  $1/4$ " thick.  $1/4$ " flatted shaft is  $3/4$ " long. Dimensions:  $1/2$ " W x  $1$ " x  $1$ " O. Mounting nut and washer supplied. Imported. Shpg. wt. 3 oz.  
 32 F 22510 5K ohm 32 F 22544  $1/2$  Meg.  
 32 F 22528 10K ohm 32 F 22551 1 Meg.  
 32 F 22536 100K ohm  
 Any of above ..... Net ea. 1.50

## MALLORY MIDGETROLS

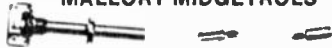

Carbon element Midgetrols are rated 1-watt linear or  $1/2$ -watt audio. Size  $3/16$ " dia. with  $2 3/8$ " x  $1/8$ " dia. shafts. With two shafts, knob adapters for knurled and push-on knobs, one Pal-nut. Shpg. wt. 4 oz.

### EXPLANATION OF MALLORY TAPERS

Taper 1—For audio or antenna shunt circuits  
 Taper 2—For series circuits or cathode voltage controls  
 Taper 4—Linear taper for voltage divider circuits

Stock No.	Ohms	Tpr.	Stock No.	Ohms	Tpr.
33 F 11107	100	4	33 F 11362	50K	4
33 F 11115	500	4	33 F 11370	75K	1
33 F 11111	500	2	33 F 11388	100K	1
33 F 11123	750	2	33 F 11396	100K	2
33 F 11131	1K	2	33 F 11404	100K	4
33 F 11149	1K	4	33 F 11412	125K	4
33 F 11156	1500	2	33 F 11420	150K	1
33 F 11164	1500	4	33 F 11438	200K	4
33 F 11172	2K	4	33 F 11446	250K	1
33 F 11180	2500	2	33 F 11453	250K	2
33 F 11198	3K	4	33 F 11461	250K	4
33 F 11206	3K	2	33 F 11479	500K	1
33 F 11214	5K	1	33 F 11487	500K	4
33 F 11222	5K	4	33 F 11495	750K	1
33 F 11230	10K	1	33 F 11503	1 Meg.	2
33 F 11248	10K	2	33 F 11529	1 Meg.	1
33 F 11255	10K	4	33 F 11537	1 Meg.	4
33 F 11263	15K	1	33 F 11545	1.5 Meg.	4
33 F 11271	15K	2	33 F 11552	2 Meg.	1
33 F 11289	20K	1	33 F 11560	2 Meg.	4
33 F 11297	20K	4	33 F 11578	2.5 Meg.	4
33 F 11305	25K	2	33 F 11586	3 Meg.	1
33 F 11313	25K	1	33 F 11594	3 Meg.	4
33 F 11321	25K	4	33 F 11602	5 Meg.	2
33 F 11339	30K	4	33 F 11610	5 Meg.	1
33 F 11347	50K	1	33 F 11628	5 Meg.	4
33 F 11354	50K	2	33 F 11638	10 Meg.	4

Any of above ..... Singly ea. 1.18

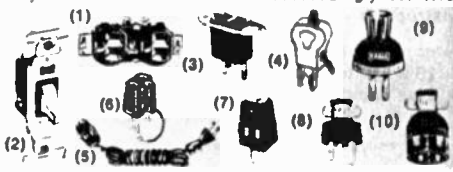

- (1) E-Z WIRE PARALLEL GROUNDING DUPLEX WALL OUTLET. Breakoff terminals for 2 separate 3-wire circuits. Easily wired by pressure terminals or screws. UL listed. 15 amps; 125V. 13 F 81193 ..... Net ea. .75; 10 for 8.65
- (2) E-Z WIRE QUIET SWITCH. Ultra-quiet action switch—no clicking noise. Has screw, and E-Z wire pressure terminals. 15 amps; 120V. UL listed. AC only. 13 F 81201 ..... Net ea. .81; 10 for 7.29
- (3) CHASSIS AC RECEPTACLE. Mounts from top or bottom. Mounting centers  $1 1/8$ ". UL listed. 15A, 125 VAC/DC. Solder terminals. 13 F 09048 ..... Net .20
- (4) JIFFY PUSH-PULL PLUG. Attaches in 5 seconds without any tools. Spring prongs. Brown. UL listed. 13 F 81136 ..... Net ea. .22; 10 for 1.99
- (5) CUBE TAP EXTENSION. Trio tap with safety pluge. 20 ft. of vinyl cord. AC plug. Brown. UL listed. 13 F 81532 ..... Net 1.32
- (6) PARALLEL GROUNDING ADAPTER. Adapts 3 wire tools and appliances to 2-wire AC outlets. 15A, 125V.  $3 3/4$ " ground lead and lug. UL listed. 13 F 81151 ..... Net ea. .37; 10 for 3.33
- (7) RUBBER CUBE TAP. 3 outlets. Unbreakable one-piece soft rubber construction. UL listed. 13 F 81102 ..... Net 37
- (8) PARALLEL GROUNDING RUBBER PLUG. With cord. clamp. U ground. Dia.  $1 1/2$ ". 15 amps; 125V. 13 F 81219 UL listed. ..... Net .85
- (9) FLEXIBLE RUBBER HANDLE PLUG. Can be used for heavy-duty work. 15 amps; 125V. 13 F 81078 ..... Net ea. .18; 10 for 1.48
- (9) FLEXIBLE RUBBER HANDLE CONNECTOR. 15 amps; 125V. 13 F 81367 ..... Net 1.77
- (10) RUBBER CORD CONNECTOR. With pull handle for extension cords.  $1 1/4$ " diameter. With cord clamp. Two-wire. UL listed. 13 F 81144 ..... Net .84

154 Lafayette Cat. No. 750



## Sub-miniature Variable Controls

Carbon composition potentiometer built for the most compact installations. Ideal for printed circuits. Imported. Shpg. wt. 2 oz.  
 Size:  $3/8$ " Dia. x  $1/8$ " Thick

Stock No.	Ohmage	Net	Stock No.	Ohmage	Net
99 F 61428	1,000	.39	99 F 61442	10,000	.39
99 F 61434	5,000	.39	99 F 61459	50,000	.39

## 5,000-Ohm Volume Control

A volume control with the proper resistance, dimensions and mounting for replacement in thousands of transistor radios. A 5,000-ohm potentiometer with S.P.S.T. switch. Only  $5/16$ " dia. x  $1/2$ " total depth. Easy to install in printed circuits. Comes with  $1/8$ " dia. knob. 99 F 60196 Imported. Shpg. wt. 2 oz. .... Net 79¢

## Mallory Push-Pull Controls

Carbon element controls with a Push-Pull-type SPST switch permanently attached. Switch rated at 6 amps/125V. UL listed. Rated 1 watt linear or  $1/2$  watt audio. Size  $1/8$ " dia. with 2" long x  $1/4$ " dia. shaft. No assortment for quantity prices. Wt. 3 oz.

Stock No.	Mfg. No.	Ohms	Taper	Net Each	
				1-24	25-49
33 F 12808	PP-13R	1K	1	1.53	1.38
33 F 14820	PP-252R	2.5K	1	1.53	1.38
33 F 14838	PP-253R	25K	1	1.53	1.38
33 F 12816	PP-15A	100K	1	1.53	1.38
33 F 12832	PP-254A	250K	1	1.53	1.38
33 F 12840	PP-55A	500K	1	1.53	1.38
33 F 12857	PP-55L	500K	4	1.53	1.38
33 F 12865	PP-16A	1 Meg.	1	1.53	1.38
33 F 12873	PP-16L	1 Meg.	4	1.53	1.38
33 F 12899	PP-26A	2 Meg.	1	1.53	1.38
33 F 14853	PP-36L	3 Meg.	4	1.53	1.38

## Mallory Subminiature 5-Watt Control

Wire-wound control rated at 5 watts. Breakdown voltage 900 VAC RMS. Linear taper  $\pm 10\%$  tol. Dim.  $3/4$ " dia. x  $3/8$ " depth.  $1/4$ " shaft dia. Bushing dia.  $3/8$ " with  $32 \times 3/64$ " thread. No assortment for quantity prices. Shpg. wt. 3 oz.

Stock No.	Ohms	Ea.	10-49	Stock No.	Ohms	Ea.	10-49
33 F 13269	1	1.57	1.41	33 F 13442	300	1.57	1.41
33 F 13277	2	1.57	1.41	33 F 13459	400	1.57	1.41
33 F 13285	3	1.57	1.41	33 F 13467	500	1.57	1.41
33 F 13293	5	1.57	1.41	33 F 13475	600	1.57	1.41
33 F 13301	6	1.57	1.41	33 F 13483	750	1.57	1.41
33 F 13319	8	1.57	1.41	33 F 13491	1K	1.57	1.41
33 F 13327	10	1.57	1.41	33 F 13509	1500	1.64	1.48
33 F 13335	15	1.57	1.41	33 F 13517	2K	1.64	1.48
33 F 13343	20	1.57	1.41	33 F 13525	2500	1.64	1.48
33 F 13350	25	1.57	1.41	33 F 13533	3K	1.64	1.48
33 F 13368	30	1.57	1.41	33 F 13541	4K	1.64	1.48
33 F 13376	40	1.57	1.41	33 F 13558	5K	1.64	1.48
33 F 13384	50	1.57	1.41	33 F 13566	7500	1.71	1.54
33 F 13392	60	1.57	1.41	33 F 13574	10K	1.71	1.54
33 F 13400	75	1.57	1.41	33 F 13582	15K	1.77	1.59
33 F 13418	100	1.57	1.41	33 F 13590	20K	1.77	1.59
33 F 13426	200	1.57	1.41	33 F 13608	25K	1.69	1.88
33 F 13434	250	1.57	1.41				

## Ohmite Wire-Wound Rheostats

Vitreous enamel rheostat with copper graphite control brush except \* silver graphite contact brush. Ohmage above 5000 have silicone ceramic coating. Ratings indicated are at full setting. Less knob. Average shpg. wt. 5 oz.

Stock No.	Mfg. No.	Ohms	Net Each	
			1-4	5-9
30 F 81445	0145*	10	6.74	5.74
30 F 81460	0147	25	5.89	5.01
30 F 81486	0149	50	5.89	5.01
30 F 81494	0150	75	5.89	5.01
30 F 81510	0151	100	5.89	5.01
30 F 81551	0155	350	8.89	5.01
30 F 81569	0156	500	5.89	5.01
30 F 81635	4200	7500	8.14	6.92

5150 Knob for Model H.

30 F 81684 ..... Net ea. 33¢

## Mallory Printed Circuit Minitrols

Carbon transistor controls, all linear taper rated  $1/2$  watt. Diameter  $1/2$ ". No shaft. All open screwdriver slot adjustment.  $1/4$ "-32 bushing. Choice of horizontal or vertical mount. Shpg. wt. 3 oz.

### 13 Type MTC-1

Res. Ohm	Stock No. Vertical Mount	Stock No. Horizontal Mount
100	33 F 16379	33 F 16650
200	33 F 16387	33 F 16668
250	33 F 16395	33 F 16676
300	33 F 16403	33 F 16684
500	33 F 16411	33 F 16692
750	33 F 16429	33 F 16700
1000	33 F 16437	33 F 16718
1500	33 F 16445	33 F 16726
2000	33 F 16452	33 F 16734
3000	33 F 16460	33 F 16742
5000	33 F 16478	33 F 16759
6000	33 F 16486	33 F 16767
6800	33 F 16494	33 F 16775
10000	33 F 16502	33 F 16783

Any of above ..... Net each 41¢

### 14 Type MTC-4

Res. Ohm	Stock No. Vertical Mount	Stock No. Horizontal Mount
15K	33 F 16510	33 F 16791
20K	33 F 16528	33 F 16809
25K	33 F 16536	33 F 16817
50K	33 F 16544	33 F 16825
100K	33 F 16551	33 F 16833
120K	33 F 16559	33 F 16841
180K	33 F 16577	33 F 16856
250K	33 F 16585	33 F 16866
325K	33 F 16593	33 F 16874
450K	33 F 16601	33 F 16882
500K	33 F 16619	33 F 16890
1 Meg.	33 F 16827	33 F 16898
2 Meg.	33 F 16835	33 F 16916
5 Meg.	33 F 16843	33 F 16924

Any of above ..... Net each 41¢

## Mallory T- and L-Pad Attenuators

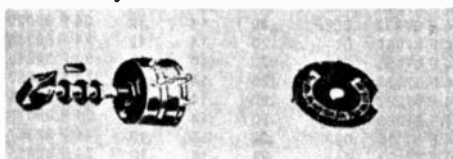

For level control of low impedance audio circuits. Rated at 15 watts peak audio, 4 watts DC. Accessories furnished: one bar knob, one dial plate with matched rotation, one nut, one lock washer. Bushing  $3/8$ "-32x $3/8$ ", shaft  $1/2$ x2" long. Shpg. wt. 6 oz.

### L-PADS

Stock No.	Mfg. No.	Ohms	Stock No.	Mfg. No.	Ohms
33 F 13764	L4	4	33 F 13814	L100	100
33 F 13780	L8	8	33 F 13855	L600	600
33 F 13798	L15	15	33 F 13863	L1000	1K
33 F 13806	L50	50	33 F 13889	L3000	3K
Singly Each ..... 3.11					

### L-A-PADS

Same as above with a  $3/8$ "-32x1" bushing. Two nuts, 2 lock washers.  $1 1/2$ x $1 1/2$ " dial plate. Shpg. wt. 6 oz.

Stock No.	Mfg. No.	Ohms	Stock No.	Mfg. No.	Ohms
33 F 13905	L8A	8	33 F 13913	L16A	16
Singly Each ..... 3.25					

### DUAL L-PADS

Ganged pads for stereo use. Same specifications as single L-Pads. Bushing  $3/8$ "-32x1". Shpg. wt. 8 oz.

Stock No.	Mfg. No.	Ohms	Stock No.	Mfg. No.	Ohms
33 F 13921	LL8	8	33 F 13947	LL50	50
33 F 13939	LL16	16			
Singly Each ..... 6.49					

### T-PADS

Stock No.	Mfg. No.	Ohms	Stock No.	Mfg. No.	Ohms
33 F 13988	T8	8	33 F 14051	T500	500
33 F 13996	T15	15	33 F 14069	T600	600
33 F 14010	T50	50			
Singly Each, Shpg. wt. $1/2$ lb. .... 4.03					

## Attachable Midgetrol Switches



Midgetrol types U, UT and UDT— with dummy terminal. Breaks at 2.5 amps, resets by turning to "off" position. ST types rated 6 amps/125V. DT types rated 3 amps/125V. Wt. 3 oz.

Stock No.	Mfg. No.	Description	Net Each	
			1-24	25-49
33 F 11891	US-26	S.P.S.T.	.47	.43
33 F 11909	US-26T	S.P.S.T.*	.58	.52
33 F 11917	US-27	D.P.S.T.	.58	.52
33 F 11925	US-28	S.P.D.T.	.58	.52

# Fuses, Fuse Holders and Circuit Breakers

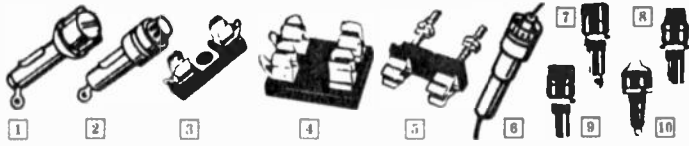

**LITTELFUSE MOUNTINGS AND EXTRACTOR POSTS.** Mounts and fuse holders for every application. \*Includes fuse. Fig. 10 is 3AG indicating fuse post. Average shpg. wt. 3 oz.

Stock No.	Fig.	For Fuses	Description	Net Ea.
13 F 11760	1	3AG, 3AB	Panel mount, screw slot	.74
13 F 11776	2	3AG, 3AB	Panel mount, finger knob	.74
13 F 11786	1	8AG	Panel mount, screw slot	.74
13 F 11810	3	8AG	Single fuse, lug terminal	.27
13 F 11828	3	3AG, 3AB	Single fuse, screw terminal	.47
13 F 11844	4	8AG	Double fuse, lug terminal	.46
13 F 11877	5	3AG, 3AB	Below panel mounting	.74
13 F 11885	6*	SFE (9A)	Auto inline fuse retainer	.47
13 F 11893	6*	SFE (14A)	Auto inline fuse retainer	.47
13 F 11901	6*	SFE (20A)	Auto inline fuse retainer	.47
13 F 11984	10	3AG, 90-125V	#344125 indicating fuse post	2.33

**MINIATURE 3AG FUSE EXTRACTOR POSTS.** Shortest 3AG fuse posts. Test Post hole in knobs. UL listed. Body and knob meet MIL-P-14F type CFG. Rated at 15 amps, 250 volts. Fig. K has straight bottom terminals, behind-panel length 1 1/8". Figs. L, M have right angle bottom terminals, behind-panel length 1 3/4". Fig. L has knurled knobs. Figs. K, M have fluted knobs. Shpg. wt. 3 oz.

Stock No.	Mfg. No.	Figure	Net Each		
			1-99	100-499	500 Up
13 F 11927	342014	7	.52	.43	.34
13 F 11935	342022	8	.52	.43	.34
13 F 11943	342004	9	.52	.43	.34

**LITTELFUSE EUROPEAN EQUIPMENT FUSES.** Used in European instruments, tape recorders, radios, hi-fi equipment and Hickok test equipment. 5x20mm. Rated at 250V. 5 fuses per pkg. Shpg. wt. 3 oz.

Stock No.	Amps.	Per Pkg.	20 Pkgs. Per Pkg.	Stock No.	Amps.	Per Pkg.	20 Pkgs. Per Pkg.
<b>Type 211 Standard Fuse</b>				<b>Type F212 Standard Fuse</b>			
13 F 12107	1/2	1.83	1.53	13 F 12131	1/2	1.71	1.43
13 F 12198	1 1/2	1.50	1.25	13 F 12149	3/10	1.71	1.43
<b>Type 211 Medium</b>				<b>Type 212 Standard</b>			
13 F 12750	1	1.74	1.35	13 F 12206	1 1/4	1.20	1.00
<b>Type 213 Slow-Blow Fuse</b>				<b>Type 212 Standard</b>			
13 F 12180	1	1.74	1.45	13 F 12214	2	1.20	1.00
13 F 12248	2	1.74	1.45	13 F 12602	5	1.41	1.18
13 F 12255	4	1.74	1.45	13 F 12743	1	1.20	1.00

**SNAP-ON FUSE HOLDER.** For fast replacement of pigtail fuses. One side of dual holder clips on to blown fuse. New fuse fits into other side.



13 F 12388 ..... Each .27; 10 for 2.43

Fuse Holder

## Littelfuse Fuses and Fuse Holders

**TYPE 3AG STANDARD FUSES. Series 312000.** Quick-acting for low time-lag applications such as amplifiers, auto radios. UL listed. 1 1/4 L x 1/4" diam. All rated 250 volts. 5 fuses per pkg. Shpg. wt. 3 oz.

Stock No.	Amps.	Per Pkg.	20 Pkgs. Per Pkg.	Stock No.	Amps.	Per Pkg.	20 Pkgs. Per Pkg.
13 F 10085	1/4	.75	.63	13 F 10143	1 1/2	.57	.48
13 F 10101	3/8	.75	.63	13 F 10150	2	.57	.48
13 F 10119	1/2	.75	.63	13 F 10188	3	.57	.48
13 F 10127	3/4	.75	.63	13 F 10176	4	.66	.55
13 F 10135	1	.57	.48	13 F 10184	5	.66	.55
13 F 12503	1 1/4	.57	.48	13 F 10192	6	.66	.55

**3AG STANDARD PIGTAIL FUSES. Series 316000.** Same as series 312000 above but with pigtails. 5 fuses per pkg. Shpg. wt. 3 oz.

Stock No.	Amps.	Per Pkg.	20 Pkgs. Per Pkg.	Stock No.	Amps.	Per Pkg.	20 Pkgs. Per Pkg.
13 F 11539	1	.99	.83	13 F 11562	3	.99	.83
13 F 11547	1 1/2	.99	.83	13 F 11588	5	1.02	.85
13 F 11554	2	.99	.83				

**MINI BREAKER.** Complete circuit protection—fits in standard Edison base fuse receptacle! Time delay for starting surges. Never needs replacing—just reset! UL listed. Shpg. wt. 4 oz.



Stock No.	Amps	Net Ea.	Stock No.	Amps	Net Ea.
12 F 70024	10	1.89	12 F 70040	20	1.89
12 F 70032	15	1.89	12 F 70057	30	1.89

**DEARBORN CIRCUIT MONITOR.** Checks proper wiring of 3-wire outlets. Just plug into outlet, coded lights tell exactly what circuit condition is present: circuit OK, improper ground, improper neutral, reversed polarity, reversed ground and power, and power off.



12 F 73002 Shpg. wt. 1/2 lb. .... Net 6.95

Lafayette Has Over 500 Stores from Coast to Coast

**TYPE 3AG SLOW-BLOW FUSES. Series 313000.** High time lag to withstand heavy surges, blows quickly on shorts. Units through 5 amps are rated 125 volts and are UL listed, above 7 amps rated 32 volts. 5 fuses per pkg. 1 1/4 L x 1/4" diam. Shpg. wt. 5 oz.

Stock No.	Amps.	Per Pkg.	20 Pkgs. Per Pkg.	Stock No.	Amps.	Per Pkg.	20 Pkgs. Per Pkg.
13 F 10259	1/4	1.74	1.45	13 F 10416	1 1/2	1.62	1.35
13 F 10309	3/8	1.74	1.45	13 F 10432	2	1.62	1.35
13 F 10317	1/2	1.74	1.45	13 F 10440	2 1/2	1.29	1.08
13 F 10325	3/4	1.74	1.45	13 F 10457	3	1.29	1.08
13 F 10341	1	1.74	1.45	13 F 10465	3.2	1.29	1.08
13 F 10358	1 1/4	1.74	1.45	13 F 10473	4	1.29	1.08
13 F 10366	1 1/2	1.74	1.45	13 F 10481	5	1.29	1.08
13 F 10374	1 3/4	1.74	1.45	13 F 10507	7	1.29	1.08
13 F 10382	2	1.74	1.45	13 F 10523	10	1.29	1.08
13 F 10390	3	1.74	1.45	13 F 10531	15	1.29	1.08
13 F 10408	4	1.62	1.35	13 F 10549	20	1.29	1.08

**TYPE 8AG INSTRUMENT FUSES. Series 361000.** Designed for high-speed action to protect delicate electrical equipment. All rated at 250 volts, except 3 and 5 amps rated 125 volts. 5 fuses per pkg. 1 L x 1/4" diam. Wt. 3 oz.

Stock No.	Amps.	Per Pkg.	20 Pkgs. Per Pkg.	Stock No.	Amps.	Per Pkg.	20 Pkgs. Per Pkg.
13 F 11356	1/100	3.03	2.53	13 F 11430	1	.57	.48
13 F 11364	1/32	2.58	2.15	13 F 11448	1 1/2	.57	.48
13 F 11398	1/4	.75	.53	13 F 11455	2	.57	.48
13 F 11414	1/2	.75	.53	13 F 11463	3	.57	.48
13 F 11422	3/4	.75	.53	13 F 11471	5	.57	.48

**TYPE 3AB FUSES. Series 314000.** Steatite enclosed, ARC-Quenching Powder-filled fuses. Will not shatter against quick shorts. Medium time-lag types through 15 amps. UL listed. All 250 volts. 1 1/4 L x 1/4" dia. 5 fuses per pkg. Shpg. wt. 3 oz.

Stock No.	Amps.	Per Pkg.	20 Pkgs. Per Pkg.	Stock No.	Amps.	Per Pkg.	20 Pkgs. Per Pkg.
13 F 11812	2	1.08	.90	13 F 11653	10	.93	.78
13 F 11638	5	.93	.78	13 F 11679	15	1.08	.90
13 F 11648	8	.93	.78	13 F 11687	20	1.08	.90

**LITTELFUSE AUTO FUSES. Series 307000.** Medium-acting fuses designed for auto use. Length according to current to guard against over fusing. All 1/4" diam. 5 fuses per pkg. Shpg. wt. 3 oz.

Stock No.	Amps.	Per Pkg.	20 Pkgs. Per Pkg.	Stock No.	Amps.	Per Pkg.	20 Pkgs. Per Pkg.
13 F 12263	4	.39	.33	13 F 12305	14	.39	.33
13 F 12289	7.5	.39	.33	13 F 12313	20	.39	.33
13 F 12297	9	.39	.33				



HJM HKP



4405



4408

**BUSS FUSE MOUNTINGS.** Convenient methods for mounting fuses on equipment, radio, TV, instruments, etc. Fuses easily replaced. Wt. 3 oz.

Stock No.	For	Net Ea.	Stock No.	For	Net Ea.
13 F 62029	HJM 3AG	.50	13 F 62045	4405 3AG	.26
13 F 62037	HJM 8AG	.50	13 F 62052	4408 3AG	.44

**DUAL FUSE HOLDER WITH CLEAR PLASTIC COVER.** Dual fuse holder for popular 3AG, 3AB and 8AG fuses with durable, clear plastic, protective cover. Rated 250 volts, 3 amps. Has right angle bottom solder terminals. 99 F 63372 Imported. Shpg. wt. 2 oz. ... Net ea. .42; Lots of 10, Net ea. .35

## MALLORY TV CIRCUIT BREAKERS

Tripping mechanism is temperature-compensating for constant protection. Normal tripping time is 10 seconds or less. Twist tab mounting lugs.

\*High Surge Type. Shpg. wt. 3 oz.

- Just Reset
- UL Approved
- Not a Fuse



Current—Amps			Current—Amps			Current—Amps					
Stock No.	Hold Break	Net	Stock No.	Hold Break	Net	Stock No.	Hold Break	Net			
33 F 15629	.325	.50	.97	33 F 15678	1.79	2.75	.97	33 F 15710	3.25	5.0	1.05
33 F 15637	.49	.75	.97	33 F 15686	1.95	3.0	.97	33 F 15728	3.9	6.0	1.05
33 F 15645	.65	1.0	.97	33 F 15694	2.44	3.75	1.05	33 F 15736	4.00	2.5	1.29
33 F 15652	1.3	2.0	.97	33 F 15702	2.92	4.5	1.05	33 F 15744	3.00	5.0	1.29
33 F 15660	1.46	2.25	.97								

Type CBB adapter for bushing mount. Bushing 3/8"—32x1/4" with nut.  
33 F 14798 ..... Net .20

**ELECTRIC DOOR CHIME.** Contemporary design, blends well with any decor. Two notes front door, one note rear. Provincial white, gold leaf trim. Installation instructions included. 4 3/4 H x 7 1/4 W x 2 3/8" D. Shpg. wt. 2 lbs.

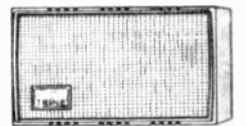

12 F 48509 ..... Net 5.95

**(11) POLISHED BRASS LIGHTED PUSHBUTTON.** Surface mount, equipped with miniature electric bulb. No special wiring required.

12 F 48525 For 6-18V. Shpg. wt. 5 oz. ... Net 1.89

**(12) "QUICK MOUNT" SIGNAL TRANSFORMER.** For bells, buzzers, chimes. Thermal switch prevents overload. Rated 16V, 10W.

12 F 48541 UL listed. Shpg. wt. 15 oz. ... Net 3.49

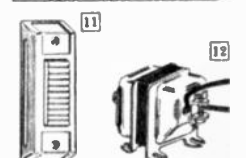

# Lafayette Electrical Accessories



## Electronic Light Dimmer Control

**\$4.95**

2-Year Guarantee!  
UL listed

• Push-On—Push-Off Dial  
• Full Range—Total Darkness to Full Brightness

Push on or off at any light level. Fits into standard single gang wall box without rewiring. Incandescent lamps to 600 watts.

12 F 01037 Shpg. wt. ½ lb. . . . . Net 4.95

3-Way Dimmer for fixture controlled by two switches.

12 F 12505 . . . . . Net 5.95

\*Parts and Labor, ship postpaid to Lafayette



## "Ultrasonic Whistle Control"

**\$15.95**

• The Amazing Electro-Sonic Switch that Turns Anything Electrical On or Off

Turns appliance on or off with just the blow of a whistle. Complete with pocket and bulb whistle. 300-watt capacity. For 110 VAC, 60 Hz.

12 F 78522 Shpg. wt. 1 lb. . . . . Net 15.95

Extra Bulb Whistle for above.

12 F 78530 Shpg. wt. 3 oz. . . . . Net 1.19

## Outlet Expanders

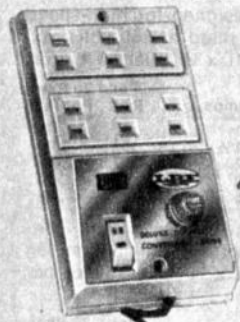

**\$6.95**

**1 Fused Power Convenience Center**  
Adds 6 fused outlets anywhere. With fuse, heavy duty 8' line cord. Imported. 120 VAC, 15 amps.  
99 F 92090 Shpg. wt. 1 lb. . . . . Net 6.95  
13 F 11679 5 extra fuses. . . . . Net 1.08

**2 Power Control Outlet Box**  
Six 3-wire grounded outlets controlled by one switch. Steel enclosed; contains circuit breaker. 15 amps. 13½ x 2¼ x 2". With card.  
12 F 15508 Wt. 2 lbs. . . . . Net 11.95

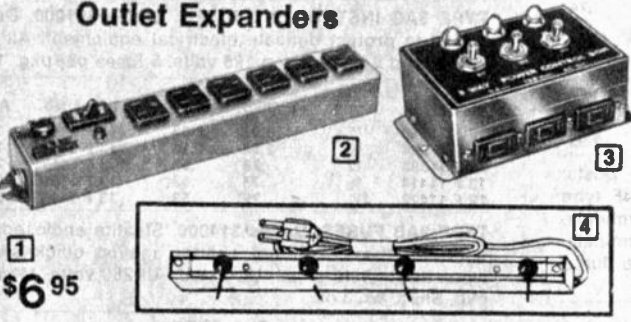

**3 3-Way Power Control**  
Three individually controlled outlets, each with indicator light. Rated 5 amps at 125 volts AC/DC. Imported.  
99 F 80079 Wt. 1 lb. . . . . Net 5.35

**4 Electric Outlet Expander**  
Use 8 appliances at once. 15 amp max. at 125 volts. 4' cord. 12" x 1 in.  
12 F 13529 Wt. ½ lb. . . . . Net 2.19  
12 F 13537 Above 2' cord. . . . . Net 3.39

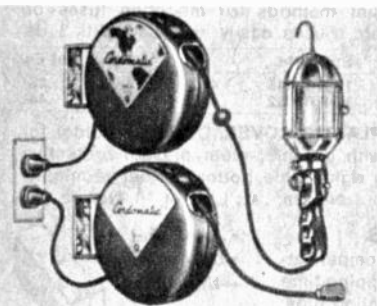

## CORDOMATIC Power Outlet Reel — Your Choice

**\$10.95 ea.**

**REEL WITH LIGHT.** Retracts automatically; 20' cord mount swivels; UL listed.  
13 F 83025 Wt. 4¾ lbs. . . . . Net 10.95  
**3 WIRE CORD.** 16 gauge; pulls to 20'; Retracts. 9 amps. U.L. listed.  
13 F 83629 Wt. 3¾ lbs. . . . . Net 10.95

## Vinyl Plastic Electrical Tape

10,000V breakdown. 60' x ¾" x .007" thick. UL listed. Imported. Wt. 6 oz.  
99 F 80152 . Net ea. 1.19  
In Pkg. of 3 Net ea. 99¢

## Lafayette 110V. Electric Bell

Ideal as an alarm bell. 4¾" across, 2¼" deep. Imported. Wt. 1 lb.  
99 F 90235 . . . . . Net 6.95



## Indoor-Outdoor Extension Cords

16-gauge, 10 amp, 2 and 3-wire cords. 3 cond. cords have 3 prong plug.

Stock No.	Feet	Shpg. Wt.	Net
12 F 55504*	25 ft.	1¾ lbs.	2.50
12 F 55512*	50 ft.	2½ lbs.	4.26
12 F 55520*	100 ft.	5¼ lbs.	7.76
12 F 55538†	25 ft.	2 lbs.	3.85
12 F 55546†	50 ft.	3¾ lbs.	6.45
12 F 55553†	100 ft.	5¾ lbs.	12.70

\*2-Conductor †3-Conductor

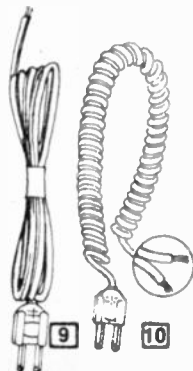

**9 Appliance Cord**  
6' replacement line cord. 1 stripped, 1 plug end. Wt. 5 oz.  
12 F 39011 . . . . . Net .49

**10 6 Ft. Coiled Appliance Cord**  
Self-adjusting coiled cord with plug at one end. Shpg. wt. 5 oz.  
12 F 13511 . . . . . Net 1.95

## Photo Electric Security Lighting

Help prevent burglary, vandalism, accidents. Lights turn on at sunset, off at sunrise.

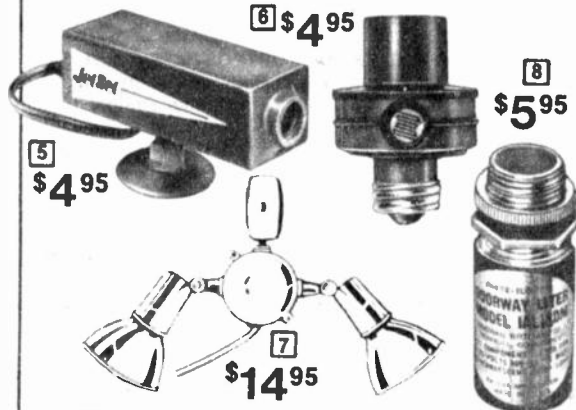

**5** \$4.95  
**6** \$4.95  
**7** \$14.95  
**8** \$5.95

**5 AUTOMATIC LIGHT CONTROL.** Just attach lamp, plug into wall socket. Responds to daylight, not flashes. Handles 300 watts. UL listed. Imp.  
12 F 46511 Shpg. wt. ¾ lb. . . . . Net 4.95  
**6 OUTDOOR LIGHT CONTROL.** Waterproof. Screws into fixture socket. 300 watts. UL listed.  
12 F 46503 Imported. Shpg. wt. ½ lb. . . . . Net 4.95  
**7 AUTOMATIC OUTDOOR LIGHTING.** Adjustable aiming. Uses spots or floodlights, not included. UL listed.  
12 F 53509 Shpg. wt. 2 lbs. . . . . Net 14.95  
**8 PHOTO-ELECTRIC CONTROL.** Installs in outdoor fixtures, post lanterns, etc. UL listed. 120 volts, 800 watts max. 1 x 1 x 2¼".  
13 F 64504 Shpg. wt. 6 oz. . . . . Net 5.95



## Touch-A-Matic Nite Lamp

Touch on/off. All bakelite long-life bulb. Ivory color. 3½" long.  
13 F 81540 Shpg. wt. 4 oz. . . . . Net .86

## Remote Control Switch

• For TV, Hi-Fi, Lamps, Etc.

Remote control on/off switch on 15' cord. 750 watts capacity.  
12 F 13503 Shpg. wt. ½ lb. . . . . Net 2.39

## The "Cli-Mate" Fully Automatic Thermostat

**\$19.95**

• "Positive Ventilation" for Accurate Control

Accurate sensing. Adjustable "on" control; pilot light; built-in thermometer. 115 VAC, 15 amps. Wt. 2½ lbs.  
12 F 17009 . . . . . Net 19.95



# Flashlights and Lanterns



\$14.95



\$4.79

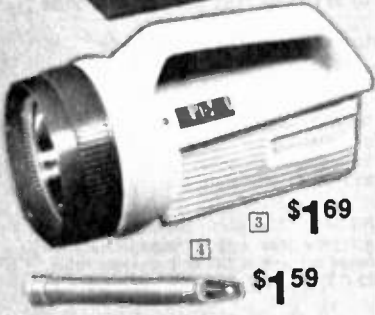

\$1.69

\$1.59

- 1 Burgess Fluorescent Lantern. Great for car, home, boat. Offers wide-angle, shadow-free fluorescent light. Lightweight design, easy to carry anywhere. Powered by a safe, heavy-duty 12-volt battery (incl.). 13 F 80583 Wt. 5 1/2 lbs. ...Net 14.95 Replacement Battery (TW2-X). 32 F 39076 Wt. 3 1/2 lbs. ...Net 3.12
- 2 Burgess Cordless Lamp. Indoor/outdoor cordless lamp for safe, trouble-free lighting. Great for camping, boating or emergencies. Unbreakable blue and white plastic case, 8 x 7 x 5" shade. 13 F 80591 Wt. 1 1/2 lbs. ...Net 4.79 Battery for above (TW-1). 1 req'd. 32 F 48705 Wt. 3 1/4 lbs. ...Net 2.57
- 3 Power Beam Lantern. Battery-powered lantern in rugged, non-corrosive plastic case. Has safety glow lens ring, carrying handle, on-off switch. Great for boaters, floats if dropped in water. 4 x 8 1/4 x 4 3/8". Requires 4 "D" cells, order below. Made in U.S.A. 12 F 79009 Wt. 3/4 lb. ...Net 1.69 "D" Cells for above. Use 4. 99 F 82584 ...Net ea. 19¢
- 4 New! "Lightning Bug." SAFE to use anywhere, because it produces light without heat or flame—mixes two safe, NON-TOXIC chemicals for 3 to 4 hours of bright light. Use for camping, hiking, marine, theatrical effects, power failures, etc. No batteries—simply break inner tubing to mix chemicals and produce light. Non-reusable. Six inches long. 12 F 19500 Shpg. wt. 1/2 lb. Net 1.59

# PREMIER Metal Products

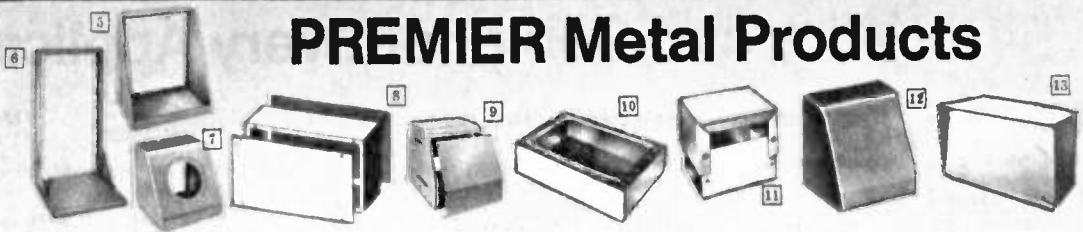

## 5 TABLE TYPE RELAY RACKS

#16 gauge steel-finished in smoke blue vinyl. Base constructed of one piece, similar to a chassis. Panel mounted holes are tapped for 10-32 machine screws. Shipped knocked down.

Stock No.	Mfr. Type	H x W x D"	Panel Space	Lbs.	Net
12 F 85923W	TR-2119	25x21x12"	21x19"	18 1/4	19.63
12 F 85972W	TR-2819	32x21x12"	28x19"	21	23.67

## 6 TELEPHONE TYPE RELAY RACKS

#12 gauge steel finished in smoke blue vinyl. Vertical members and top crossbrace are included together. Panel mounting holes are tapped for 10-32 machine screws. Racks shipped knocked down. Base punched to accommodate type CA-4 casters.

Stock No.	Mfr. Type	H x W x D"	Panel Space	Lbs.	Net
12 F 85899W	RR-800	39 1/4 x 20 x 18 3/8"	36 3/4 x 19"	34	37.40
12 F 85907WX	RR-801	74 1/4 x 20 x 20 7/8"	71 3/4 x 19"	50 1/2	44.45
12 F 85915WX	RR-802	79 1/2 x 20 x 20 7/8"	77 x 19"	52	51.25

## ALUMINUM PANELS

Aluminum panels, type MAP, bright aluminum protected both sides by peelable masking paper. Type ARP painted gray both sides. 19" wide, 1/8" thick.

"MAP" Masked Aluminum	Type		Type		"ARP" Light Gray Enamel		
Stock No.	Type	Ea.	Hgt.	Lbs.	Stock No.	Type	
12 F 85477	319	3.07	3 1/2"	1 1/4	12 F 86830	319	3.24
12 F 85485	519	4.21	5 1/4"	1 3/4	12 F 86848	519	4.29
12 F 85493	719	5.10	7"	2	12 F 86855	719	5.51
12 F 85501	819	6.04	8 3/4"	2 1/2	12 F 86863	819	6.42
12 F 85519	1019	7.48	10 1/2"	2 3/4	12 F 86871	1019	7.72
12 F 85527	1219	8.62	12 1/4"	3 1/4	12 F 86889	1219	8.95
12 F 85535	1419	9.94	14"	4 1/2	12 F 86897	1419	10.23

## 7 UNIVERSAL METER CASES

For a 2 or 3" meter. Center hole for 2" meter increases to 3" meter hole by simply removing a knock-out. 4 3/8 x 4 1/2 x 4 1/4". Supplied with two 1/2" dia. knockouts for feed-through Insulators or Volume Controls. Type SC-23 #20 gauge steel. Type ASPC-23 #18 gauge (.040) aluminum—natural finish. Average shpg. wt. 1 lb.

Stock No.	Type	Net
12 F 83167	SPC-23	3.39
12 F 83175	ASPC-23	3.31

## 8 METAL UTILITY CABINETS

Two removable sides for easy accessibility. Flanged edges and spot-welded corners. #16 gauge (.051) aluminum in natural aluminum finish. Avg. shpg. wt. of steel cabinets 6 1/4 lbs.

Gray Hammertone		Natural Aluminum		
Stock No.	Net	HxWxD"	Stock No.	Net
12 F 86251	3.24	4x4x2	12 F 83480	2.82
12 F 86269	3.68	4x5x3	12 F 83498	3.00
12 F 86277	3.86	5x6x4	12 F 83506	3.24
12 F 86285	6.42	5x9x8	12 F 83514	5.38
12 F 86293	5.14	8x6x6	12 F 83522	4.71
12 F 86301	6.42	8x9x5	12 F 83530	5.38
12 F 86319	8.20	12x7x6	12 F 83548	7.29
12 F 86327	10.53	15x9x7	12 F 83555	9.92

## 9 SLOPING PANEL CABINETS

Rounded top corners and a removable front panel. Back of cabinet is perforated and has opening for leads. Constructed of 20 gauge steel. Finished in gray hammertone.

Stock No.	HxWxD"	Use Chassis	Lbs.	Net
12 F 85840	8x8x8	7x7x2	4 1/4	9.43
12 F 85857	8x10x8	7x9x2	5 1/4	10.85
12 F 85865	8x14x6	7x13x2	7	11.27
12 F 85873	9x18x8	7x17x3	8 1/4	14.94
12 F 85881	12x18x12	10x17x3	13	19.10

## BAKELITE CASES AND PANELS

All-black bakelite with rounded corners and recessed threaded inserts for mounting panels. Walls 1/8". Panels are 3/32" thick. Average shpg. wt. 1 1/2 lbs.

Stock No.	Size	Lbs.	Net
19 F 20016	6 1/4 x 3 1/4 x 2"	1/2	1.14
19 F 37010	Panel for above	1/4	.45
19 F 20024	6 3/4 x 5 1/4 x 2 1/4"	1	1.59
19 F 37028	Panel for above	1/2	.81
19 F 20032	8 3/8 x 7 3/8 x 3"	1 1/2	2.79
19 F 37036	Panel for above	1/2	.75

**BUILDER'S PANEL KIT** One plain black bakelite panel, 3 perforated boards with holes on 3/8" centers, and 1 aluminum panel outlet. Fit 99-82721 case above.  
 99 F 63380 Shpg. wt. 1/2 lb. Net 1.49

## BAKELITE UTILITY CASES WITH ALUMINUM PANEL

Sturdy bakelite box features smooth, rounded corners and recessed inserts for screw mounting of aluminum panel. Hardware imported. Average shpg. wt. 1/2 lb.

Stock No.	Size	Net
99 F 80772	3 1/4 x 2 1/4 x 1 1/2"	.89
99 F 80780	4 x 2 1/2 x 1 1/2"	1.09
99 F 80785	5 1/4 x 2 1/2 x 1 1/2"	1.19
99 F 82721	6 3/8 x 3 1/8 x 1 7/8"	1.49
99 F 80784	7 3/4 x 4 1/2 x 2 3/8"	2.29

## 10 ALUMINUM CHASSIS

Chassis are of one-piece construction with gussets spot-welded to the bottom flanges for additional strength. Made of #18 gauge (.040) aluminum except † are #14 gauge (.064) in natural aluminum finish. Bottom plates have holes to match chassis and have 4 pressed dimples. Average shpg. wt. 3 1/4 lb.

CHASSIS				BOTTOM PLATES	
Stock No.	Size (Inches)	Lbs.	Net	Stock No.	Net
12 F 81906	4x6x1 1/2	1/4	2.82	12 F 82870	1.28
12 F 81914	4x6x2	1/4	2.82	12 F 82870	1.28
12 F 81922	4x6x3	1/4	3.42	12 F 82870	1.28
12 F 81930	4x8x2	3/8	3.00	12 F 82888	1.53
12 F 81948	4x17x3	1	4.10	12 F 82896	1.60
12 F 81955	5x7x2	1/4	2.82	12 F 82904	1.41
12 F 81963	5x7x3	1	3.42	12 F 82904	1.41
12 F 81971	5x10x3	3/4	3.42	12 F 82912	1.53
12 F 81989	5x13x3	3/4	4.10	12 F 82920	1.72
12 F 81997	5 1/2 x 9 1/2 x 1 1/2	1/2	3.00	12 F 82938	1.53
12 F 82037	7x7x2	1	3.13	12 F 82961	1.53
12 F 82045	7x9x2	1	3.24	12 F 82979	1.53
12 F 82052	7x11x2	3/4	3.42	12 F 82987	1.60
12 F 82060	7x11x3	7/8	4.54	12 F 82987	1.60
12 F 82078	7x12x3	7/8	4.29	12 F 82995	1.64
12 F 82102	7x17x3	1	5.02	12 F 83035	2.45
12 F 82110	8x10x2 1/2	1	4.10	12 F 83043	2.09
12 F 82128	8x12x3	1	4.41	12 F 83050	2.58
12 F 82177	10x14x3	1 1/4	4.96	12 F 83092	2.69
12 F 82193	10x17x3†	2 3/4	6.55	12 F 83100	2.88
12 F 82250	12x17x3†	2 1/2	7.23	12 F 83134	3.68
12 F 82284	13x17x3†	3 1/2	7.54	12 F 83142	3.98
12 F 82300	17x17x4†	4 1/4	10.10	12 F 83159	5.38

## 11 ALUMINUM MINIBOXES

Two-piece case made of #16 gauge (.051) aluminum. Each section forms 3 sides. Flanges

NATURAL ALUMINUM		GREY HAMMERTONE			
Stock No.	Net	Size (Inches)	Lbs.	Stock No.	Net
12 F 83670	1.17	2 1/4 x 2 1/8 x 1 1/4"	1/4	12 F 83845	1.41
12 F 83688	1.28	3 1/4 x 2 1/8 x 1 1/4"	1/4	12 F 83852	1.53
12 F 83696	1.41	4x2 1/2 x 1 1/4"	1/4	12 F 83860	1.60
12 F 83704	1.53	4x2 1/4 x 2 1/4"	3/8	12 F 83878	1.84
12 F 83712	1.60	5x2 1/4 x 2 1/4"	3/8	12 F 83886	1.96
12 F 83720	1.72	5x4x3	3/4	12 F 83894	2.09
12 F 83738	1.72	5 1/4 x 3x2 1/2"	1/2	12 F 83902	2.08
12 F 83746	2.26	6x5x4	1	12 F 83910	2.69
12 F 83753	2.82	7x5x3	1 1/8	12 F 83928	3.31
12 F 83761	3.68	8x6x3 1/2	1 1/2	12 F 83936	4.41
12 F 83779	3.86	10x6x3 1/2	1 1/2	12 F 83944	4.59
12 F 83787	5.38	12x7x4	2	12 F 83951	8.42
12 F 83795	5.58	17x5x4	2 1/4	12 F 83969	8.79
12 F 83803	3.24	10x2x1 1/2"	3/4	12 F 83977	3.86
12 F 83811	3.68	12x2 1/2 x 2 1/4"	1	12 F 83985	4.41
12 F 83829	1.53	4x2x2 3/4"	1/2	12 F 83993	1.84
12 F 83837	1.53	4 1/4 x 2 1/4 x 1 1/2"	1/2	12 F 84017	1.84

## 12 SLOPING PANEL UTILITY BOXES

Steel and aluminum sloping panel cabinets with round-top corners and sloping front. Opening in rear of box. #20 gauge attractively finished steel. #18 gauge (.040) aluminum—natural aluminum finish. 4 1/2 H x 4 1/4" D.

Stock No.	Width	Type	Lbs.	Net 1-49
GRAY HAMMERTONE				
12 F 80650	4 3/8"	SPC-1200	1	3.34
12 F 80676	6 3/4"	SPC-1202	1 1/2	3.77
ALUMINUM				
12 F 80700	5 3/8"	ASPC-1201	1/2	3.49
12 F 80726	7 3/4"	ASPC-1203	3/4	3.68

## 13 SLOPING COMPACT CABINETS

Two-piece unit made of #20 gauge cold rolled steel. Front, bottom and back form one "U"-shaped unit which screws to one-piece cover and sides. Two-tone finish.

Stock No.	H.W.D.	Lbs.	Net	Stock No.	H.W.D.	Lbs.	Net
12 F 85931	6x10x7"	4 1/4	10.28	12 F 85956	3x8x5"	2 1/4	9.19
12 F 85949	7x12x8"	6 1/4	11.27	12 F 85964	5x5x5"	2 1/4	9.68

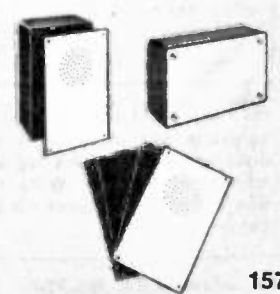

# Wire and Cable for Every Application



## Single Conductor High Impedance Mike Cable

Shielded. No. 25 tinned stranded wire; 3x33 copper and 4x33 copperweld tinned, cellulose yarn braid, polyethylene insulated, tinned copper braid shield, chrome-vinyl jacket. Type 8410 has rubber insulation and black rubber jacket.

Beld. No.	Out Diam.	Wt. 100 Ft.	25-Ft. Spool		50-Ft. Spool		100-Ft. Spool	
			Stock No.	Net	Stock No.	Net	Stock No.	Net
8411	.144"	2 lb.	32 F 13089	2.31	32 F 13097	3.66	32 F 13105	6.95
8410	.245"	4 1/4 lb.	32 F 13162	5.21	32 F 13170	9.10	32 F 13188	16.80



## 2-Conductor Low-Impedance Miniature and Standard Mike Cables

All cables shielded. Miniature types 8420 and 8413 both No. 24 stranded tinned. 8420 has polyethylene insulation and chrome vinyl jacket, 8413 rubber insulation and black rubber jacket. Stranded types: 8422 is 22 stranded tinned, poly insulation and chrome vinyl jacket; 8412 No. 20 stranded tinned, rubber insulation and black rubber jacket; 8402 same as 8412 but brown hypalon jacket; 8428 is heavy-duty No. 18 stranded tinned, black neoprene jacket for studio use.

Beld. No.	Out Diam.	Wt. 100-Ft.	50-Ft. Spool		100-Ft. Spool	
			Stock No.	Net	Stock No.	Net
8420	.185"	2 3/4 lb.	32 F 13212	6.44	32 F 13220	12.10
8413	.190"	3 lb.	32 F 13253	9.66	32 F 13261	17.85
8422	.231"	4 1/4 lb.	32 F 13295	7.25	32 F 13303	12.55
8412	.268"	5 3/4 lb.	32 F 13337	10.15	32 F 13345	19.45
8402	.268"	6 1/4 lb.	—	—	32 F 15399	20.10
8428	.295"	7 3/4 lb.	—	—	32 F 13386	25.45



## Shielded Cables for PA and Intercom 2-Conductor—Twisted Pair—Shielded Cables

Stranded tinned copper conductors except No. 8739 is solid. Tinned copper spiral wrapped shield. Overall chrome vinyl jacket.

Beld. No.	Gauge	Lbs. 100 Ft.	50-Ft. Spool		100-Ft. Spool	
			Stock No.	Net	Stock No.	Net
8739	22	2 1/2	32 F 13519	6.20	—	—
8737	22	2 3/4	32 F 13527	6.63	32 F 15415	14.35
8759	20	3	32 F 13535	8.31	—	—
8790	18	4 3/4	32 F 13543	10.35	32 F 15449	22.20
8780	16	5 3/4	32 F 13550	13.05	—	—



## Multiple-Conductor Unpaired Unshielded Cable

All conductors No. 22 unshielded stranded tinned copper except \* include two No. 18 conductors. Each conductor vinyl insulated cabled. Chrome vinyl jacket.

Beld. No.	Conds.	O.D.	Lbs. 100 Ft.	25-Ft. Spool		100-Ft. Spool		250-Ft. Spool	
				Stock No.	Net	Stock No.	Net	Stock No.	Net
8443	3	.150"	2 1/4	32 F 14244	1.88	32 F 14525	4.94	32 F 15902	10.00
8444	4	.168"	2 1/2	32 F 14251	2.14	32 F 14533	6.55	32 F 15910	13.60
8445	5	.180"	3	32 F 14269	2.58	32 F 14541	7.58	32 F 15928	16.20
8446*	6	.222"	4 1/4	—	—	32 F 14558	11.05	32 F 15936	24.15
8447*	7	.246"	5	—	—	32 F 14566	13.15	32 F 15944	28.20
8448*	8	.250"	5 3/4	—	—	32 F 14574	13.90	32 F 15951	30.70
8449*	9	.261"	6 1/4	—	—	32 F 14582	14.70	32 F 15969	33.15
8456	10	.260"	5 3/4	—	—	32 F 14988	14.80	—	—
8457	12	.260"	5 3/4	—	—	32 F 14970	16.65	—	—
8458	15	.320"	8 3/4	—	—	32 F 14947	28.40	—	—
8459	25	.370"	11 3/4	—	—	32 F 14954	41.35	—	—



## Coaxial and Special Purpose Cable

### RG Low-Loss Coaxial Cables

Excellent for RF, amateur and citizens band applications. All branded with standard type numbers and meet requirements of RG cables. Avg. shpg. wt. per 100 ft. 12 lbs.

RG Type	Imp. Ohms	50-Ft. Length		100-Ft. Length		250-Ft. Length		500-Ft. Length	
		Stock No.	Net	Stock No.	Net	Stock No.	Net	Stock No.	Net
RG-8-U	52	32 F 17080	13.75	32 F 30315	24.45	32 F 17098	54.20	32 F 30323WX	114.25
RG-11/U	75	—	—	32 F 30349	24.05	32 F 17114	61.60	—	—
RG-58/U	53.5	32 F 17122	4.96	32 F 30364	8.49	32 F 17130	21.00	32 F 30372WX	35.85
RG-58A/U	50	32 F 17148	5.45	32 F 30224	9.50	—	—	32 F 30232WX	41.70
RG-59/U	73	32 F 17155	5.25	32 F 30398	8.60	32 F 17183	21.25	32 F 30406WX	35.98

### Low-Loss Polyfoam Coax

Lower attenuation and capacitance result in signal strength increases up to 35%. Available only in lengths listed.

RG-11/U 75-ohm coax feeder with non-peaking attenuation characteristics. It is ideal for distribution lead-in. 10 3/4 lbs. 32 F 31214 100-ft. Coil ..... Net 24.55

RG-59/U 72-ohm coax cable for improved FM and TV reception. Minimizes noise, ghosts and color smears. Recommended for color TV. Shpg. wt. 3 1/4 lbs. 32 F 31248 100-ft. Coil ..... Net 8.45

RG-8/U 50-ohm impedance cable with minimum signal loss and stray radiation for increased antenna system efficiency. 32 F 30463 100' Coil. 5 3/4 lbs. Net 24.95

RG-58/U 53.5-ohm impedance cable with low loss and increased operation range for use in CB and amateur radio. 32 F 31180 100' Coil. 2 3/4 lbs. .Net 8.35

## Belden Duofoil 75-Ohm Coax



Belden 8228. Low loss 100% shielded VHF/UHF color or black and white. No. 18 solid bare copper conductor with low-loss polyethylene insulation. Polyester film with aluminum lamination on both surfaces. Has 4 No. 28 solid tinned copperweld drain wires spirally wrapped. Overall PVC black all weather jacket is only .242" O.D.

32 F 17411 100 Ft. Shpg. wt. 3 3/4 lbs. .... Net 8.35  
32 F 17403 500 Ft. Shpg. wt. 15 3/4 lbs. .... Net 27.15

## Coiled Microphone and Telephone Cords

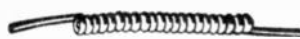

Have insulated cadmium bronze conductors except \* has 5 strands tinned copperweld and 18 strands tinned copper. Microphone cables have black neoprene jacket except † has gray vinyl; telephone cables, black vinyl jacket. Type 8605 shielded; type 8497, 1 shielded and 2 unshielded conductors, all others unshielded. Telephone cables have spade terminals and strain relief. Shpg. wt. 1/2 lb.

Stock No.	Beld. No.	Cond.	Type	Extends		
				From	To	Net
32 F 14236	8415*	4	Mic	11 1/2"	6'	2.21
32 F 15084	8497*	3	Mic	11 1/2"	6'	2.43
32 F 17395	8605†	1	Mic	2 1/2"	12'	2.43
32 F 15118	8495	3	Tel	10"	4 1/2'	2.24

## ATTENTION QUANTITY BUYERS

Lafayette has many other special purpose wires and cables for almost every hookup application. Write for information and prices on types not listed in this catalog.

## Belden Test Prod Wire



Extremely flexible. limp, rubber-covered hi-voltage lead. No. 18 stranded tinned cotton wrap. 5000 working volts. Shpg. wt. 100 ft. 4 1/4 lbs. \*Red. †Black.

Beld. No.	10 Ft.		25 Ft.		100 Ft.	
	Stock No.	Net	Stock No.	Net	Stock No.	Net
8899*	32 F 17239	1.17	32 F 17254	1.86	32 F 17270	5.94
8899†	32 F 17247	1.17	32 F 17262	1.86	32 F 17288	5.94



## Vinyl-Covered Multiple Paired Cable

For balanced line intercom system and telephone wiring. Unshielded No. 22 solid tinned copper conductors, vinyl insulated, cabled in pairs, chrome vinyl outer jacket. Available only in lengths listed.

Beld. No.	No. of Conds.	O.D.	Lbs. 100 Ft.	100-Ft. Spool	
				Stock No.	Net
8741	4	.201"	3	32 F 15787	6.30
8742	6	.240"	3 3/4	32 F 15803	8.40
8743	12	.305"	6 3/4	32 F 15829	13.80
8744	18	.354"	8 3/4	32 F 15845	20.20

## 2-Conductor, Twisted Pair, Unshielded



All have tinned stranded copper conductors except \* are solid copper. Types with † have chrome vinyl jacket overall, others without jacket. All conductors have vinyl insulation.

Gauge	O.D.	Lbs. 100'	100-Ft. Spool		500-Ft. Spool	
			Stock No.	Net	Stock No.	Net
22*	.112"	1 1/4	32 F 13717	3.09	—	—
19*	.130"	1 3/4	32 F 13030	4.05	—	—
18	.175"	2 1/2	32 F 13725	5.90	32 F 15571	23.20
22†	.150"	2	32 F 13741	3.81	—	—
18†	.226"	3 3/4	32 F 13766	6.95	32 F 15805	28.35

## Belden 8290 Shielded Permohm 300-Ohm Color TV Lead-in



Designed for 82-channel color TV reception, 8290 Permohm combines the strong signal strength of twin-line with the clean signal of shielded cable. Shielded to eliminate ignition and other interference caused by line pick-up. Weatherproof. Wt. 6 lbs. per 100 ft. Available only in lengths listed below.  
32 F 15357 50 ft. Net 7.85 32 F 15373 100 ft. Net 13.45  
32 F 15365 75 ft. Net 10.50 32 F 15977 500 ft. Net 62.85

## Individually Shielded Zip Cord



Two conductors No. 24 (7x32) individually shielded in spiral wrap. Gray plastic jacket over each conductor. Ideally suited for audio, hi-fi, stereo and laboratory use. Shpg. wt. 1 lb. per 25 feet.  
32 F 31693 25-ft. Spool ..... Net 4.40  
32 F 31701 50-ft. Spool ..... Net 6.30

## Intercom Wire



2-conductor twisted. Flexible, tinned copper with plastic insulation over each conductor. Shpg. wt. 2 lbs. per 100 ft. Available only in lengths listed below.  
32 F 30521 100-ft. Coil ..... Net 2.20  
32 F 30539 250-Ft. Spool ..... Net 5.20

3-conductor twisted. Same construction as above. Shpg. wt. 1 lb. per 100 feet.  
32 F 30547 100-ft. Coil ..... Net 3.10  
32 F 30554 250-ft. Spool ..... Net 7.60

3-conductor twisted. Same construction as above but with outer plastic jacket overall. Shpg. wt. 2 lbs. per 100 ft.  
32 F 30562 100-ft. Coil ..... Net 7.36  
32 F 30570 250-ft. Spool ..... Net 17.95



# Quality Hookup Wire and Antenna Accessories

## UHF-VHF OPEN LINE

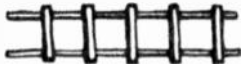

300-OHM. Attenuation averages only 1.9 dB over entire UHF band. No. 18 copper-weld wire—pure polyethylene separators spaced at 6". Spaced only 1/2" between conductors. Shpg. wt. 2 lbs. per 100 ft. Available only in lengths listed below.

32 F 36106 100-ft. coil .....Net 5.45  
 32 F 36114 250-ft. coil .....Net 12.65  
 32 F 36122 500-ft. spool .....Net 24.95

450-OHM. Similar to above. 1" spacing between conductors.

32 F 36130 100-ft. coil .....Net 5.45  
 32 F 36148 250-ft. spool .....Net 12.65  
 32 F 36155 500-ft. spool .....Net 24.95

## LIFELINE DELUXE TWIN LEAD



**Guaranteed for Life of Your Antenna**

Guarantee: If this deluxe 300-ohm line fails to last the life of your antenna we will replace it at no charge. 20-gauge deluxe twin lead, prestretched copper conductors with finest brown polyethylene insulation. Chemically protected against deterioration. Special "waste-free" dispenser package. Wt. 2 1/4 lbs. per 100 ft.

32 F 36153 100-ft. package ....Net 3.20  
 32 F 36460 1000 ft. ....Net 29.30

## FOAM TV TWIN LEAD



**For UHF-VHF and Color TV**

A flat 300-ohm twin lead with the conductors totally encased in and surrounded by polyethylene foam with an outer black polyethylene jacket. Has high resistance to ultraviolet rays, oil, fumes, moisture, salt air and abrasion. 20-gauge stranded copper conductors. Available only in lengths listed below. 3 1/2 lbs. per 100 ft.

32 F 36031 50-ft. Coil .....Net 2.90  
 32 F 36049 100-ft. Coil .....Net 4.95  
 32 F 36015 500-ft. Coil .....Net 21.80  
 32 F 36023W 1000-ft. Coil .....Net 42.25



**300-OHM TWIN LEAD**

BROWN. High-quality, low-loss lead-in for all TV and FM installations. 55-mil polyethylene dielectric — 22-gauge copper leads. Shpg. wt. 1 lb. per 100 ft.

32 F 89121 100-ft. Coil .....Net 1.98  
 32 F 89139 500-ft. Coil .....Net 8.20  
 32 F 89147 1000-ft. Coil .....Net 15.50

CLEAR. Better blend with baseboards.

32 F 89154 100-ft. Spool .....Net 2.10  
 32 F 89162 500-ft. Spool .....Net 8.66  
 32 F 89170 1000-ft. Spool .....Net 16.40

## HEAVY-DUTY

300-ohm brown twin lead with 80-mil thick polyethylene insulation and 20-gauge copper conductors. Wt. 1 1/4 lbs. per 100 ft.

32 F 89188 100-ft. Coil .....Net 2.55  
 32 F 36452 1000-ft. Coil .....Net 20.15

## FIBERGLASS GUY LINE

Non-metallic, non-conductive, non-radiating guy line for minimum loss. 1000 pounds tensile strength. Will not rot, shrink, stretch or sag. Wt. 3 1/2 lbs. per 100 ft.

32 F 45016 100 ft. ....Net 6.75

## STEEL GUY WIRE

Six strands of No. 20 high-tensile-strength, galvanized steel wire.

33 F 31014 50-ft. Roll. Shpg. wt. 1 lb. ....Net 1.95  
 33 F 31022 100-ft. Roll. Shpg. wt. 2 lbs. ....Net 3.25  
 33 F 31030 500-ft. Roll. Shpg. wt. 10 lbs. ....Net 12.95

## VINYL-COVERED GUY WIRE

Steel guy wire as above with translucent green vinyl. Covering weatherproof, nonstretch, long lasting.

32 F 28494 50-ft. Roll. Shpg. wt. 1 1/2 lbs. ....Net 2.10  
 32 F 36502 100-ft. Roll. Shpg. wt. 2 1/2 lbs. ....Net 3.95  
 32 F 36510 250-ft. Roll. Shpg. wt. 6 1/4 lbs. ....Net 9.90

## ALUMINUM GUY WIRE

7-18-gauge stranded wires. Breaking strength 500 lbs.

34 F 46275 100-ft. Roll 1 1/4 lbs. ....Net 3.95

## ALUMINUM GROUND WIRE

No. 8 gauge solid conductor.

33 F 31048 50-ft. Coil. Shpg. wt. 1 lb. ....Net 1.79  
 33 F 31055 100-ft. Coil. Shpg. wt. 1 1/4 lbs. ....Net 3.09  
 33 F 31083 500-ft. Coil. Shpg. wt. 9 lbs. ....Net 12.50



## SHIELDED "CONCO-FOAM"

Assures excellent VHF, UHF, Color and B&W TV and FM reception in crowded areas where reception is critical. 22-gauge, solid copperweld conductors, foam insulation, mylar-aluminum foil shield, stranded tin copper down wire, black polyethylene outer jacket. Spade terminals included. Wt. 4 3/4 lbs. per 100 ft.

32 F 31687 50-ft. Coil .....Net 5.59  
 32 F 31675 75-ft. Coil .....Net 6.49  
 32 F 31683 100-ft. Coil .....Net 11.29

## ROTATOR CABLES



**4-CONDUCTOR FLAT.** Flexible stranded No. 20 copper encased in tough plastic insulation. 2 1/2 lbs.

32 F 89105 100-ft. Coil .....Net 6.18

**4-CONDUCTOR ROUND HEAVY-DUTY.** All 18-gauge stranded flexible conductors, plastic insulated and jacketed. Shpg. wt. 5 3/4 lbs.

32 F 17106 100-ft. Coil .....Net 10.85

**5-CONDUCTOR FLAT.** Same construction as 4-cond. flat. Shpg. wt. 2 3/4 lbs.

32 F 36312 100-ft. Coil .....Net 8.65

**6-CONDUCTOR ROUND.** No. 22 stranded copper conductors. Vinyl insulated, vinyl jacket. 100' coils only.

32 F 14863 Shpg. wt. 3 3/4 lbs. ....Net 9.18

## ANTENNA WIRE

Finest grade, high-tensile-strength copper for all antenna requirements. Avg. shpg. wt. 2 1/2 lbs.

32 F 36189 75-ft. 7/22 bare .....Net 3.95  
 32 F 36197 100-ft. 7/22 bare .....Net 5.25  
 32 F 36221 75-ft. 7/26 bare .....Net 1.89  
 32 F 36239 100-ft. 7/26 bare .....Net 2.39  
 32 F 30091 100-ft. 12 solid enamel .....Net 2.39  
 32 F 30109 100-ft. 14 solid enamel .....Net 4.79

**COPPERWELD.** Copper outside conductor bonded to steel core. Non-stretch, hard drawn, high-conductivity copperweld wire.

32 F 36247 75-ft. 12 Solid .....Net 4.45  
 32 F 36254 100-ft. 12 Solid .....Net 5.69  
 32 F 36262 75-ft. 14 Solid .....Net 3.25  
 32 F 36270 100-ft. 14 Solid .....Net 4.80

## ANTENNA STRAIN INSULATORS



(1) Brown glazed porcelain. Shpg. wt. 3 oz.  
 32 F 30093 .....Lots of 10, ea. .21; Singly, ea. .29  
 (2) 1 1/2" long. Dry glazed porcelain.

32 F 32459 Shpg. wt. 2 oz. ....Net ea. .38

## CONSOLIDATED ANTENNA KIT

Ideal for small crystal, diode and transistor broadcast, and shortwave sets. 50 ft. 7x26 bare copper wire, 25 ft. rubber-covered lead-in wire, 10" window lead-in strip, 2 antenna and 2 stand-off insulators. Simple printed instructions. Shpg. wt. 1 1/4 lbs.

32 F 30964 .....Net 3.39



## CONSOLIDATED 3-WAY ANTENNA SYSTEM

• Makes Any of 3 Marconi and Doublet Systems

Uniquely designed set of parts for construction of any of 3 types of short- and long-wave antennas. All parts supplied for either a doublet, double doublet or inverted L antenna system. Contains 100 ft. bare aerial wire, 50 ft. twisted, insulated transmission line, 4 insulators, 2 screw eyes, doublet lightning arrester, window lead-in strip, ground clamp and complete instructions. Shpg. wt. 3 3/4 lbs.

32 F 31859 .....Net 11.95

## SPEAKER-LAMP CORD



UL listed, two-conductor zipcord for lamps, speaker leads, etc. All No. 18-gauge except \* is 16-gauge. Wt. 4 3/4 lbs. per 100 ft. Only in lengths below.

## PLASTIC INSULATION POT

32 F 31743 Black 25 ft. ....Net 1.80  
 32 F 31768 Brown 25 ft. ....Net 1.80  
 32 F 31778 \*Brown 25 ft. ....Net 3.50  
 32 F 31800 Black 100 ft. ....Net 8.25  
 32 F 30026 Brown 100 ft. ....Net 6.25  
 32 F 31826 \*Brown 100 ft. ....Net 11.00  
 32 F 31834 Gray 100 ft. ....Net 8.25  
 32 F 31842 White 100 ft. ....Net 8.25  
 32 F 30497 Brown 250 ft. ....Net 12.75

## MINIATURE ZIP-CORD PARALLEL CABLE



Multi-purpose miniature zip cord. 2-conductor, 24-gauge stranded. Extremely flexible for hi-fi installations, auto speakers, low voltage control, etc. Available in white, brown, gray, clear.

Avg. shpg. wt. 1 lb. per 100 ft.

32 F 89238 25 ft. white .....Net .96  
 32 F 89246 25 ft. brown .....Net .96  
 32 F 89253 25 ft. gray .....Net .96  
 32 F 89261 25 ft. clear .....Net .96  
 32 F 89279 50 ft. white .....Net 1.39  
 32 F 89287 50 ft. brown .....Net 1.39  
 32 F 89295 50 ft. gray .....Net 1.39  
 32 F 89303 50 ft. clear .....Net 1.39  
 32 F 89311 100 ft. white .....Net 2.05  
 32 F 89329 100 ft. brown .....Net 2.05  
 32 F 89337 100 ft. gray .....Net 2.05  
 32 F 89345 100 ft. clear .....Net 2.05



Convenient spools of plastic insulated wire. Shpg. wt. 25 ft. 5 oz.; 100 ft. 1/4 lb.

## THERMOPLASTIC HOOK-UP WIRE

Stock No.	Description	Net	Stock No.	Description	Net
32 F 31891	#20 Solid—25' Red	.84	32 F 89402	#20 Stranded—25' Red	1.05
32 F 31909	#20 Solid—25' Black	.84	32 F 89410	#20 Stranded—25' Black	1.05
32 F 31917	#20 Solid—25' Blue	.84	32 F 89426	#20 Stranded—25' Blue	1.05
32 F 31925	#20 Solid—25' Green	.84	32 F 89436	#20 Stranded—25' Grn.	1.05
32 F 31933	#20 Solid—100' Red	2.82	32 F 89444	#20 Stranded—100' Red	3.45
32 F 31941	#20 Solid—100' Black	2.82	32 F 89451	#20 Stranded—100' Blk.	3.45
32 F 31958	#20 Solid—100' Blue	2.82	32 F 89469	#20 Stranded—100' Blue	3.45
32 F 31966	#20 Solid—100' Green	2.82	32 F 89477	#20 Stranded—100' Grn.	3.45

## BELL WIRE



No. 18 solid 2-conductor twisted pair. Plastic insulated. Wt. 1 1/4 lb. per 100 ft.

32 F 36288 100-ft. Coil .....Net 4.80  
 32 F 36296 500-ft. Coil .....Net 20.70



## HOOK-UP WIRE ASSORTMENTS

Various colors, gauges and insulation. Convenient kit of six 25-ft. coils. 3/4 lb.

32 F 79007 .....Net per kit 2.30  
 Five 100-ft. coils. Shpg. wt. 1 1/2 lbs.  
 32 F 79015 .....Net per kit 8.95



## BARE NICKEL CHROMIUM WIRE

For electrical heating appliances and devices whose operating temperatures do not exceed 1650°F. Ideal for compact resistance required of heavy-duty rheostats and controls. 1/4 lb. spools. Shpg. wt. 7 oz.

Stock No.	Size	Net
32 F 31404	14	3.95
32 F 31412	16	4.05
32 F 31420	18	4.20
32 F 31438	20	4.30
32 F 31446	22	4.88



## MAGNET WIRE

Finest quality. Available in plain enamel or heavy FORMVAR insulation. See FORMVAR listing for approximate footage per lb. Available in 1/2-lb. spools only. Shpg. wt. 1/4 lb. Plain enameled 1/2 lb. spools.

B&S Size	Stock #	Net	B&S Size	Stock #	Net
14	32 F 31586	1.50	28	32 F 30711	2.20
16	32 F 30598	1.65	30	32 F 30737	2.30
18	32 F 30612	1.79	32	32 F 30752	2.40
20	32 F 30638	1.85	34	32 F 30778	2.60
22	32 F 30653	1.90	36	32 F 30794	4.15
24	32 F 30679	1.98	38	32 F 30810	4.70
26	32 F 30895	2.10	40	32 F 31802	7.70

## HEAVY FORMVAR IN 1-LB. SPOOLS

Stock No.	B&S Size	Feet	Net
32 F 30828	14	78	3.75
32 F 30836	16	124	3.90
32 F 30844	18	198	3.95
32 F 30851	20	313	4.05
32 F 30869	22	501	4.50
32 F 30877	24	798	4.65
32 F 30885	26	1200	5.60
32 F 30893	28	1999	6.10
32 F 30901	30	3200	6.40
32 F 30919	32	4900	6.70
32 F 30927	34	7950	7.80
32 F 30935	36	12,800	12.35
32 F 30943	38	20,000	15.55
32 F 30950	40	31,700	23.80

Shpg. wt. 1 1/2 lbs.

# Lafayette Antennas Make Your TV "Look" BETTER!

**COLOR  
Approved**

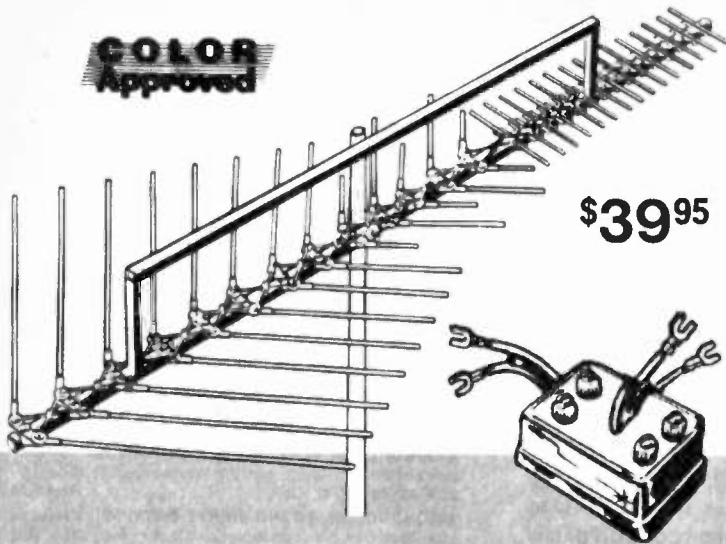

**\$39<sup>95</sup>**

## LVL-UV Log-Periodic Antennas For VHF-UHF-FM/Stereo

- One Down Lead for All 3 Signals
- Powerful Log Periodic Design
- High Front-to-Back Ratio—High Gain
- Goldenized Finish for Long-Lasting Protection

Super color-engineered antennas of famous log periodic design for color TV and stereo FM. Improve the performance of any TV or FM set. All antennas are preassembled. VHF elements are reinforced with triple-strength sleeves at pivot points. The goldenized finish provides weather protection. Larger model features boom brace supports for greater rigidity. Supplied with a 3-way splitter for VHF, UHF and FM operation. Less mast.

### 41-ELEMENT "EXTREME FRINGE" ANTENNA

41 individual elements, 26 for VHF/FM, 15 for UHF. Has 1" square 15-ft. boom with brace boom supports. Shipped express only. Shpg. wt. 13 lbs. 18 F 01802WX ..... Net 39.95

Complete with  
VHF-UHF-FM  
Signal Splitter  
**NO EXTRA CHARGE!**

**3 ANTENNAS IN 1**  
UHF-VHF-FM  
CHANNELS 2-83

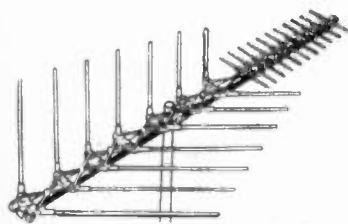

**\$24<sup>95</sup>**

### 25-ELEMENT "FRINGE" ANTENNA

25 individual elements, 14 for VHF/FM, 11 for UHF. Has 1" square 10'1" boom. 18 F 01828W Shpg. wt. 9 lbs. .... Net 24.95

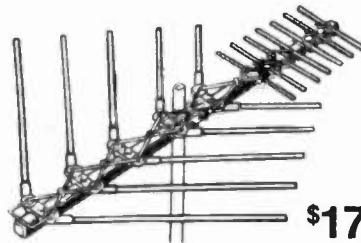

**\$17<sup>95</sup>**

### 17-ELEMENT "SUBURBAN" ANTENNA

17 individual elements, 10 for VHF/FM, 7 for UHF. Has 1" square 7' boom. 18 F 01836W Shpg. wt. 6½ lbs. .... Net 17.95

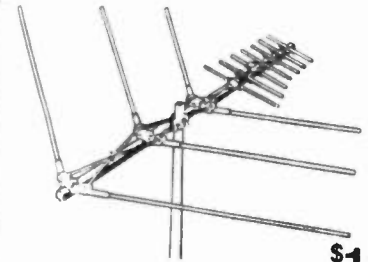

**\$12<sup>95</sup>**

### 13-ELEMENT "METROPOLITAN" ANTENNA

13 individual elements, 6 for VHF/FM, 7 for UHF. Has 1" square 30" boom. 18 F 01844W Shpg. wt. 4½ lbs. .... Net 12.95

## Lafayette "Technicolor" High-Gain Antenna

FOR VHF-UHF AND FM/STEREO

- Uses One Down-Lead Only
- With UHF-VHF-FM Splitter
- Rugged Twin-Boom Construction

"Extreme Fringe" — 51-element antenna with INTEGRATED design for increased gain and front-to-back ratio. Staggered tuning for flat broadband performance. Phasing conductors integrated with boom eliminate need for separate harness. Weather-resistant, goldenized finish. Boom length, 110½".

18 F 02271W Shpg. wt. 9 lbs. .... Net 46.95

**51 ELEMENT  
\$46<sup>95</sup>**

**3 ANTENNAS IN 1**  
UHF-VHF-FM  
CHANNELS 2-83

## Lafayette "Techni-Power" Color TV Antennas

UHF-VHF-FM CHANNELS 2-83

- VHF-UHF-FM Signal Splitter
- Only One Down-Lead
- For Color or Black and White Plus FM

Corner reflector yagi combination brings in uniform gain on VHF-UHF plus FM. Built of high-tensile-strength aluminum with 1" square boom and a gleaming, goldenized finish for lasting protection. Factory preassembled for simple installation. Includes 3-way signal splitter for good isolation and low loss. Less mast.

### 35-ELEMENT "DEEP FRINGE" ANTENNA

Boom length, 119". Shipped express only. 18 F 02248WX Shpg. wt. 12 lbs. .... Net 34.95

### 23-ELEMENT "NEAR FRINGE" ANTENNA

Boom length, 80½". Shpg. wt. 8 lbs. 18 F 02255W ..... Net 21.95

**35 ELEMENT  
\$34<sup>95</sup>**

**23 ELEMENT  
\$21<sup>95</sup>**

## Lafayette Super Color 'Tenna FOR VHF-UHF-FM/STEREO

**26  
ELEMENT**

**\$29<sup>95</sup>**

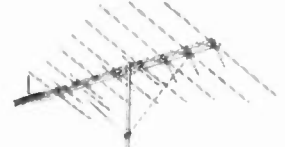

For fringe area reception on all VHF/UHF/FM channels. High front-to-back ratio minimizes co-channel interference. Rugged aluminum harness, with rust-proof clips, delivers maximum signal to set. Boom length 105" with aluminum boom support. With VHF/UHF/FM Splitter. 18 F 01638W Shpg. wt. 9 lbs. .... Net 29.95

## Lafayette "Prime Area" VHF-UHF-FM Antenna

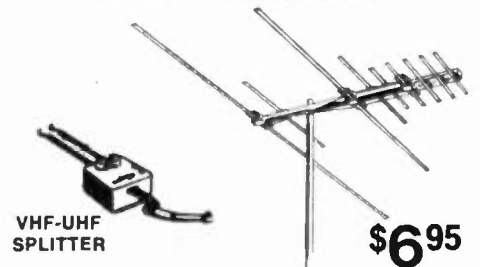

VHF-UHF  
SPLITTER

**\$6<sup>95</sup>**

Nine-element antenna receives sharp, clear pictures on all VHF-UHF channels 2 to 83, plus FM Stereo. Features 5 VHF and 4 UHF elements. Gold-colored, anodized, all-aluminum construction. One downlead needed to set. Less mast. 18 F 02230W Shpg. wt. 3 lbs. .... Net 6.95

# Lafayette "Signal-Pulling" Outdoor TV/FM Antennas

## TWIN-BOOM VHF-UHF-FM/Stereo Log-Periodic Antennas

- Extra Long Super Sensitive Capacitor-Coupled VHF Elements
- Multiple Directors and UHF Driven Elements for Maximum Picture Power
- Twin-Boom Construction for Extra Strength
- Goldenized Finish for Long-Lasting Protection

New frequency independent design permits all elements to work together on both low and high bands for maximum front-to-back ratio and high dB gain. Extra-long, up to 55" reinforced aluminum VHF elements. Combines mechanical rigidity with superior electrical performance. This superior construction virtually does away with interference caused by wind and vibrations. Features heavy-duty insulators, rust-resistant hardware and lasting, goldenized finish. Complete with splitter to separate VHF, UHF and FM signals. Less mast.

- 63-ELEMENT "ULTRA-FRINGER" ANTENNA.** 63 individual elements, 22 for VHF/FM, 41 for UHF. Has heavy-duty 3/4" square "Twin-Boom" and boom brace support. Boom length 15'2". Shpg. wt. 16 lbs.
- 18 F 02172WX** Shipped Express Only..... Net **\$56.95**
- 45-ELEMENT "DEEP-FRINGER" ANTENNA.** 45 individual elements, 16 for VHF/FM, 29 for UHF. Has heavy-duty 3/4" square "Twin-Boom" and boom brace support. Boom length 11'2". Shpg. wt. 12 1/2 lbs.
- 18 F 02180WX** Shipped Express Only..... Net **\$36.95**
- 27-ELEMENT "NEAR-FRINGER" ANTENNA.** 27 individual elements, 12 for VHF/FM, 15 for UHF. Has heavy-duty 3/4" square "Twin-Boom." Boom length 7'10". Wt. 9 lbs.
- 18 F 02198WX** Shipped Express Only..... Net **\$22.95**

## LVL Log-Periodic Antennas for VHF and FM/Stereo

- Intensifies Color or Black and White Pictures . . . Plus FM
- Excellent Front-to-Back Ratio . . . High dB Gain
- Sharp-Narrow Directivity and Selectivity
- Flat TV Color Response—Plus FM Signal
- Protective Goldenized Finish

Lafayette's powerful, revolutionary LVL—designed specifically for VHF true-to-life color reception plus black and white. Also reaches out to pull in static-free FM and stereo FM signals. Four models to choose from for ideal performance. Heavy aluminum-reinforced insulator cups—heavy-duty insulators—special back-up brackets and square boom! Triple-thick sleeved elements, double contact drive line and air-insulated spacers provide maximum signal delivery to set. Less mast and twin lead. 36-element antenna has boom brace supports.

Stock No.	Range	Elements	Boom Length	Shpg. Wt.	Net
18 F 01851W	Suburban	10	4' 8"	6 lbs.	12.50
18 F 01869WX	Near Fringe	14	6' 11"	† 8 lbs.	17.95
18 F 01877WX	Deep Fringe	20	9' 5"	†10 lbs.	23.95
18 F 01893WX	Ultra Fringe	36	14' 4"	†13 lbs.	37.95

\*Important Note—Shipped Express Only.

## POWER BEAM VHF ANTENNA

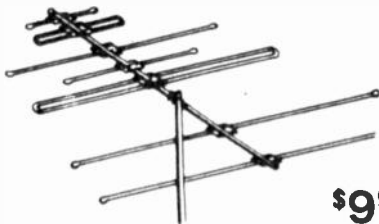

**\$9.95**

The ideal metropolitan VHF TV antenna. For Chs. 2-13. Broad-band, sharply directive. Full-length elements, all-aluminum construction. 300-ohm impedance. Less mast.

18 F 01026W Shpg. wt. 4 1/2 lbs. . . . . Net **9.95**

## FAMOUS VHF-FM COLOR 'TENNA

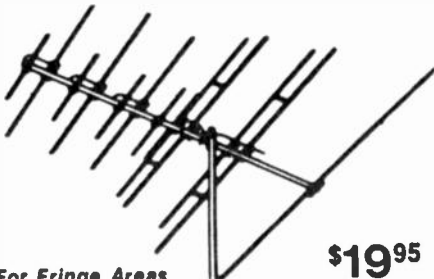

**\$19.95**

• For Fringe Areas

Twelve twin-driven elements for flat high-gain response across entire VHF band. 100% pre-assembled for easy installation. Less mast and lead-in. Shipped Express Only—See page 210.

18 F 01018WX Shpg. wt. 6 1/2 lbs. . . . . Net **19.95**

Charge It with Your BankAmericard or Master Charge.

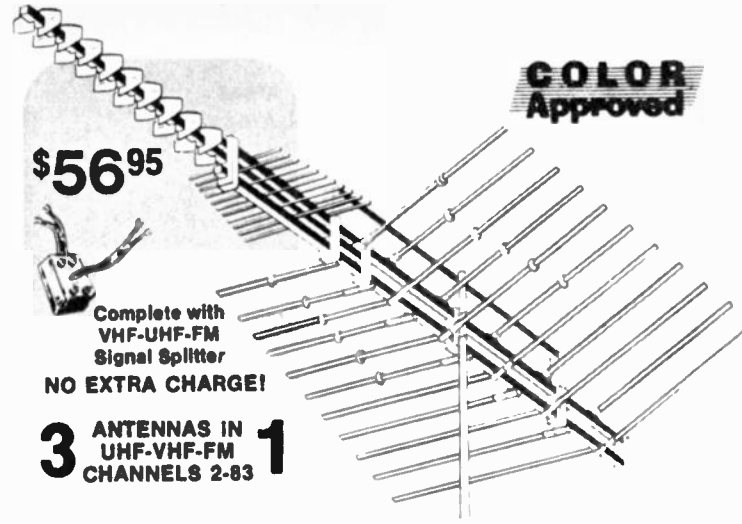

**\$56.95**

Complete with VHF-UHF-FM Signal Splitter

**NO EXTRA CHARGE!**

**3 ANTENNAS IN 1**  
**UHF-VHF-FM CHANNELS 2-83**

**COLOR Approved**

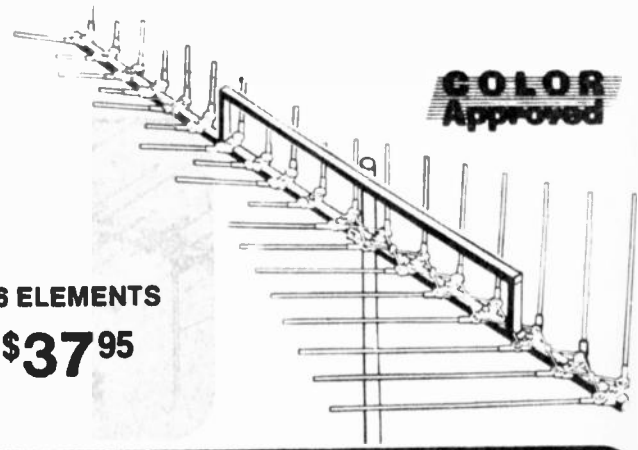

**36 ELEMENTS**

**\$37.95**

**COLOR Approved**

## LAFAYETTE Antenna Outfits with ALLIANCE Rotator System

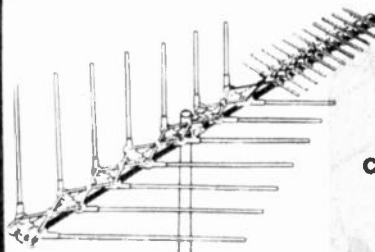

"FRINGE" ANTENNA  
18-01828W

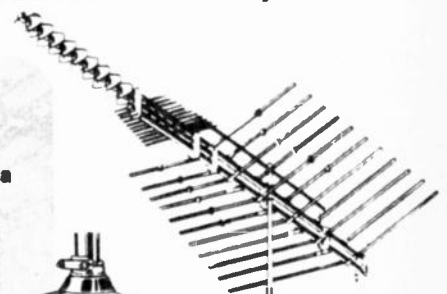

"ULTRA-FRINGER" ANTENNA  
18-02172WX

**SAVE**  
When You Buy Complete Antenna Outfit

As Low As  
**\$74.95**

ALLIANCE  
U-100 Control Unit

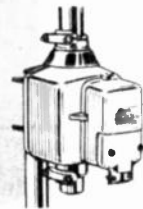
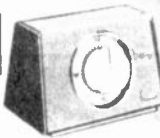

ALLIANCE  
U-100 Rotator Unit

Choice of Chimney or Tripod Roof Tower Installation

Your choice of Lafayette's 25-element "Fringe" antenna or Lafayette's 63-element "Ultra-Fringe" antenna PLUS Alliance's Model U-100 Automatic Rotator System (See Page 168). Also choose heavy-duty 3-ft. Tripod Roof Tower Mount with pitch patches and lag screws or a heavy-duty "Y"-type Snap-in Chimney Mount with 12-ft. 3/4" stainless steel straps. All include: 100 feet of heavy-duty rotor cable; 100 feet of foam twin lead; 1-5-ft. and 1-2 1/2-ft. Gold-Kote 16-gauge steel mast; 4-3 1/2" wood screw-eye standoffs, 1-7 1/2" wood screw-eye standoff, and 2 dual mast snap-on insulators. Shipped Express only.

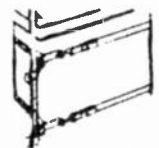

Heavy-duty  
Chimney Mount



Heavy-duty  
Tripod Roof  
Tower Mount

**COLOR Approved**

Stock No.	Antenna	Mount	Shpg. wt.	Net
18 F 90458WXM	"Ultra-Fringe"	Chimney	40	96.95
18 F 90441WXM	"Ultra-Fringe"	Tripod-Roof	44	99.95
18 F 90433WXM	"Fringe"	Chimney	35	74.95
18 F 90425WXM	"Fringe"	Tripod-Roof	39	76.95



# Quality VHF/UHF/FM Antennas

For Extremely Weak VHF Signal Areas and Extremely Weak UHF Signal Areas

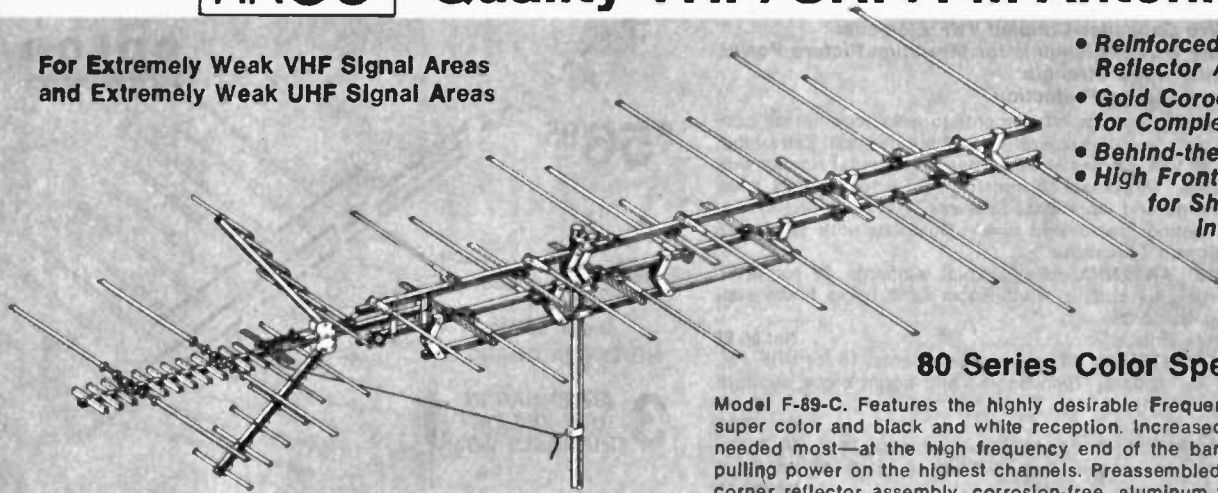

- Reinforced Tubular Corner Reflector Assembly
- Gold Corodized Finish for Complete Weather Protection
- Behind-the-Set Signal Splitter
- High Front-to-Back Ratio for Sharper Pictures in Every Area

## 80 Series Color Spectrum

Model F-89-C. Features the highly desirable Frequency-Dependent Concept for super color and black and white reception. Increased element space where it is needed most—at the high frequency end of the band—assures highest signal-pulling power on the highest channels. Preassembled, snap-out construction has corner reflector assembly, corrosion-free, aluminum feed point terminals, metal-reinforced insulators and heavy-duty rivets. Rugged 3/4" square boom with "lock-tite" no-tilt saddle bracket to fight high winds. Complete with behind-set signal splitter. 54 UHF/VHF/FM elements; 31 VHF/FM elements; 23 UHF elements. Boom length 172 1/2". Turning radius 96 1/2". Shipped express only.

- Flat Response on Every Channel
- Isolation Stub Fights Ghosts
- Pre-assembled Snap-Out Construction

**\$76<sup>75</sup>**

18 F 30488WX Shpg. wt. 15 3/4 lbs. .... Net 76.75

For Very Weak VHF Signal Areas and Extremely Weak UHF Signal Areas

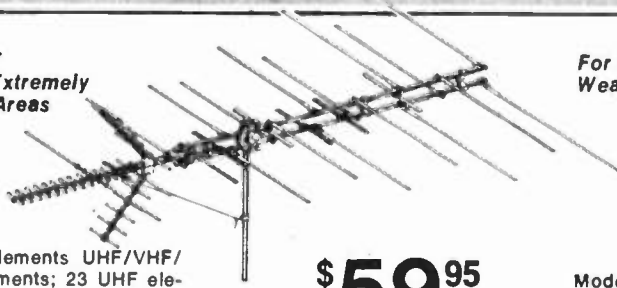

Model F-88-C. 47 elements UHF/VHF/FM; 24 VHF/FM elements; 23 UHF elements. Behind-set splitter. Boom length 141 3/4". Shipped express only.  
18 F 30496WX Wt. 12 1/2 lbs. ... Net 59.95

**\$59<sup>95</sup>**

For Moderate VHF Signal Areas, Weak UHF Signal Areas

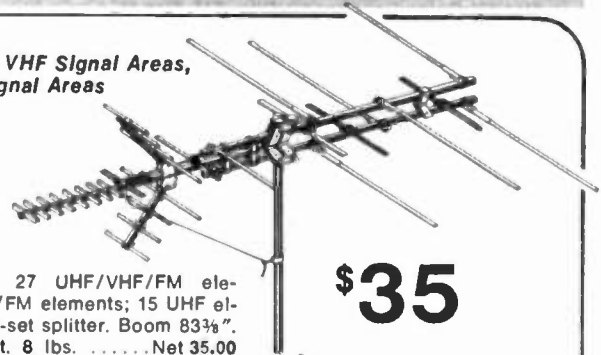

Model F-86-C. 27 UHF/VHF/FM elements; 12 VHF/FM elements; 15 UHF elements. Behind-set splitter. Boom 83 3/4".  
18 F 30512W Wt. 8 lbs. .... Net 35.00

**\$35**

For Weak VHF Signal Areas, Very Weak UHF Signal Areas

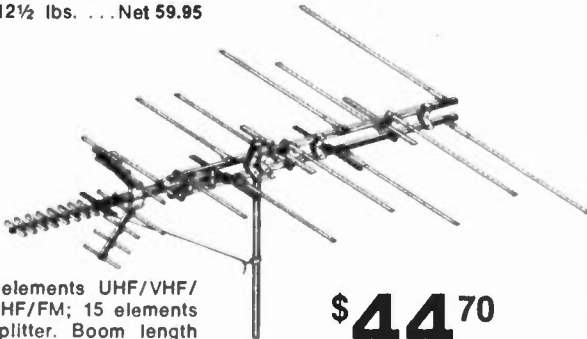

Model F-87-C. 33 elements UHF/VHF/FM; 18 elements VHF/FM; 15 elements UHF. Behind-set splitter. Boom length 106 5/8". Shipped express only.  
18 F 30504WX Wt. 10 1/4 lbs. .... Net 44.70

**\$44<sup>70</sup>**

For Moderate VHF Signal Areas, Moderate UHF Signal Areas

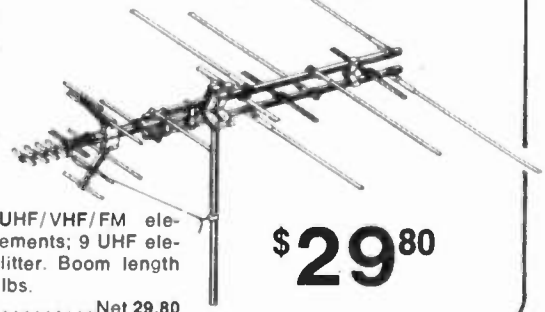

Model F-85-C. 21 UHF/VHF/FM elements; 12 VHF/FM elements; 9 UHF elements. Behind-set splitter. Boom length 68 5/8". Shpg. wt. 7 1/4 lbs.  
18 F 30520W ..... Net 29.80

**\$29<sup>80</sup>**

## JFD Stellar 2001 Electronic TV Antenna

INSTALLS ON SLANTED OR (FLAT) ROOF UP TO 40°

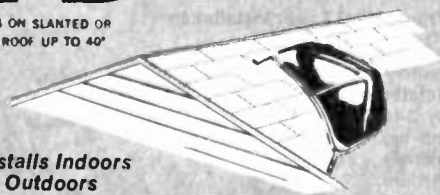

- Installs Indoors or Outdoors
- Permanently Tuned for Peak Reception
- Sealed, Weather Resistant

**\$59<sup>95</sup>**

Space-age electronic TV antenna assures outstanding UHF/VHF reception. Only 34 x 28" across, less than 4" thick. Weighs only 5 lbs. Printed circuit elements are etched on solid copper and integrated with a solid-state amplifier that powerfully boosts signal. Sealed, break-resistant housing. Matches reception of larger antennas up to 50 miles from station! Includes 50-ft. coaxial cable, mounting brackets and hardware, power supply with 2-set 300-ohm coupler. Less mast. \*Shipped express.

18 F 39380W Shpg. wt. 10 lbs. .... Net 59.95

Chimney Mount Kit. Contains two 12" stainless steel straps, 3-ft. mast, two mast standoffs and universal mounting bracket.

18 F 39398W Shpg. wt. 10 lbs. .... Net 13.69

## JFD Auto/Marine Antenna Kit

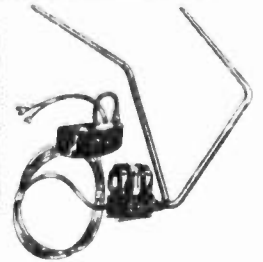
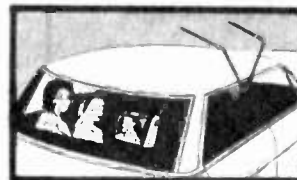

As Low As **\$26<sup>61</sup>**

- TV in the Back of Your Car
- Installs in Minutes

Excellent pictures from all directions on VHF, plus true fidelity on FM whether in motion or standing still. Triple chrome-plated brass construction. Six-position clarifier. Shielded coax. 30 ohms.

Model ATV111. (Auto) with 10-ft. coaxial cable.

18 F 39331 Shpg. wt. 3 1/2 lbs. .... Net 26.61

Model MTV222. (Marine) with 30-ft. coaxial cable.

18 F 39323 Shpg. wt. 4 lbs. .... Net 27.30

# Antennas From Lafayette—For Fine VHF/UHF/FM Performance

## "Color-Wedge" for Chs. 2-83 And FM Stereo

- For Superb Color and Black and White, FM and FM Stereo
- Exclusive Built-In Cartridge Housing For Optional Solid State Preamp

As Low As **\$49<sup>95</sup>** Model CW 1001 Antenna Accepts Either 300 or 75 ohm Cable

High-gain 82-channel antennas with high front-to-back ratio and sharp directivity ensure ghost-free reception. Narrow, vertical reception lobe prevents pick-up of such noises as airplane flutter, amateur transmission, etc. Perfect no-loss coupling between VHF and UHF sections and precise impedance match. Wedge design of VHF elements provides maximum VHF capture area for increased gain . . . up to 50% shorter than most comparable antennas. Easy to install. For extra power, use Super Colortron Cartridge. (See listing below.)

\*Shipped Express

Stock No.	Model No.	Elements	Area Coverage	Boom Lgth.	Shpg. Wt.	Net
18 F 60782WX	CW-1001	48	Extreme Fringe	135"	*21½	84.75
18 F 60840WX	CW-980	38	Deep Fringe	114"	*18	83.50
18 F 60857WX	CW-960	27	Fringe	77"	*13½	49.95

## WINEGARD Super Colortron Antennas

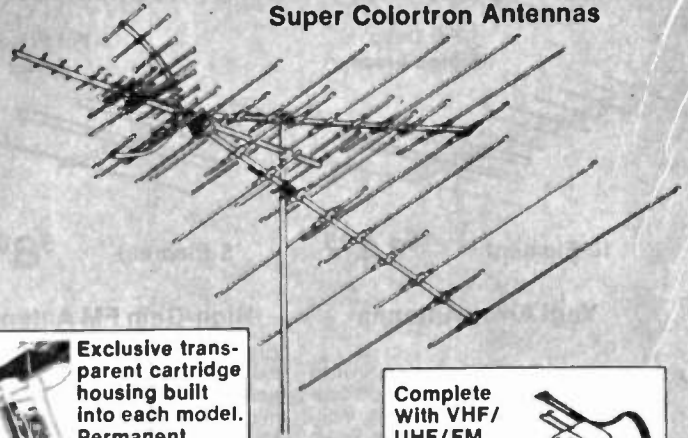

Exclusive transparent cartridge housing built into each model. Permanent weather protection.

Complete With VHF/UHF/FM Signal Splitter

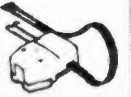

## WINEGARD

### Solid-State Cartridge Amplifiers for all Super Colortron Antennas

- Amplifies All VHF/UHF/FM Signals

As Low As **\$35<sup>95</sup>**

Printed circuit design with silicon transistors provides 15 dB gain VHF, 14 dB gain UHF. For 117 VAC, 60 Hz.

Model AC-823B. For 300-ohm download.

18 F 60659 Shpg. wt. 1 lb. . . . . Net 35.95

Model AC-895B. For 75-ohm cable.

18 F 60923 Shpg. wt. 1 lb. . . . . Net 37.58

Cartridge Amplifier Housing. Makes possible use of Super Colortron Cartridge Preamp (above) on any 300-ohm antenna. Mounts on boom or mast.

18 F 60931 Shpg. wt. 12 oz. . . . . Net 4.95

## WINEGARD High Gain 82 Channel Super Colortron Antennas

Pin-point directivity. High front-to-back ratio. Exclusive impedance correlators. Vertical resonant UHF reflectors provide high gain. FM control elements allow user to peak antennas for extra-long-distance FM and FM stereo. Built-in cartridge housing holds 300/75-ohm terminal board (included) for weather-tight download connection. For extra power, use Super Colortron Cartridge Amplifier at left. \*Shipped Express

Stock No.	Mod-el #	Ele-ments	Area Cov.	Boom Lgth.	Shpg. Wt.	Net
18 F 60618WX	SC-810	23	Near Fringe	81"	*9½	36.75
18 F 60626W	SC-800	18	Sub-urban	64"	8	29.00
18 F 60634W	SC-790	13	Metro-politan	44"	6½	24.75

As Low As **\$24<sup>75</sup>**

- Complete with VHF/UHF/FM Signal Splitter

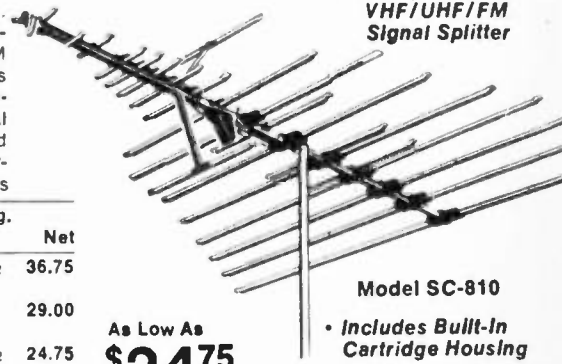

Model SC-810

- Includes Built-In Cartridge Housing
- Single Download

# JFD Color-Best Log Periodic Antennas For VHF/UHF/FM

New ultra-powerful design combines sensitive log-periodic design with performance-proved corner reflector. Result: the brightest, sharpest color pictures ever seen on your TV screen—even in fringe areas. High front-to-back and front-to-side ratios reject noise, ghosts and snow. Capacitor-coupled dipoles plus integrated corner reflector capture more signal. Rugged twin-boom construction. (Model LPV-UC 150 is reinforced with U-boom brace.) Corrosion-resistant, gold-colored, anodized aluminum throughout. Less mast. \*Shipped Express.

- Multi-Element UHF Driver
- Super-Sensitive Corner Reflector
- Rugged Triple Square Crossarm Construction
- Color-Tuned Capacitor Coupled Dipoles

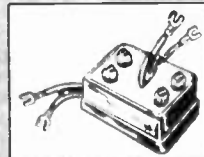

With VHF/UHF/FM Signal Splitter

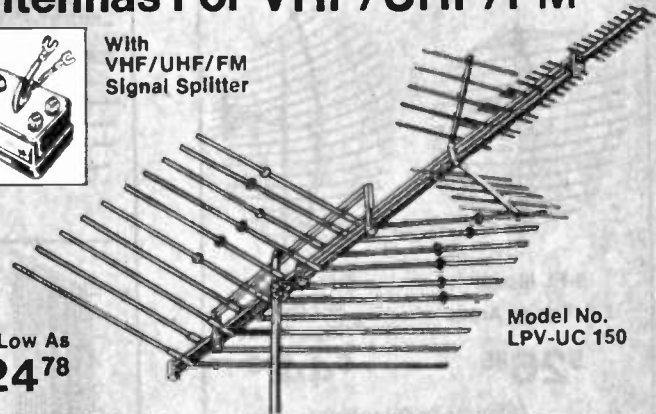

Model No. LPV-UC 150

As Low As **\$24<sup>78</sup>**

Stock No.	Model No.	Elements	Area Coverage	Boom Lgth.	Shpg. Wt.	Net
18 F 39356WX	LPV-UC 150	40	Deep Fringe	172"	*14	63.42
18 F 39364WX	LPV-UC 90	27	Fringe	119"	*11	43.48
18 F 39372W	LPV-UC 40	15	Suburban	75"	7	24.78

## Conical Window Antenna



1 VHF model, 4 full-size dipoles, 2 high frequency dipoles. Complete with mounting hardware, less 300-ohm twin lead. Base spans up to 44".

18 F 01380W Shpg. wt. 3 lbs. . . . . Net 8.95

2 VHF/UHF Model same as above plus 8-element UHF sections.

18 F 01646W Shpg. wt. 3 lbs. . . . . Net 12.95

18 F 01398 Extension bar to 60". . . . . Net 2.39

18 F 01406 Extension bar to 72". . . . . Net 2.99

For Channels 2 to 13 and FM Stereo

## JFD LPV-TV Color Log Periodic VHF/FM Antennas

Highest gain for color and black and white on all VHF channels. Cap-electronic dipoles. High S/N ratio eliminates snow. Sharp directivity, narrow beamwidth and high f/b ratio reject ghosts and interference. Easy assembly. Models LPV-TV130 and LPV-TV190 reinforced by powerful U-boom. All models gold-colored, anodized for protection. Less mast. \*Shipped Express

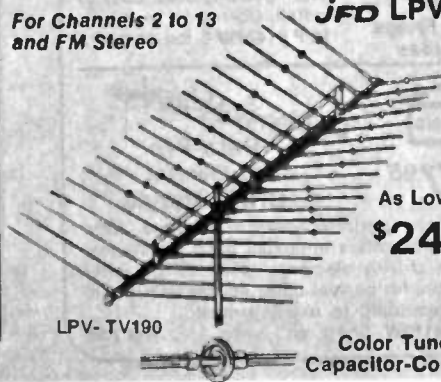

As Low As **\$24<sup>58</sup>**

LPV-TV190

Color Tuned Capacitor-Coupled

Stock No.	Model No.	Elements	Area Coverage	Boom Lgth.	Shpg. Wt.	Net
18 F 38846WX	TV190	45	Extreme Fringe	205"	*17	79.87
18 F 38820WX	TV130	30	Fringe	143"	*14	51.43
18 F 38796W	TV60	11	Suburban	70¾"	6½	24.58

# FM And UHF Antennas & Converters At Lafayette

## Lafayette FM Antennas for the Audiophile Seeking Superb Reception



For Deep Fringe Areas  
10-Element \$14.95

### Yagi Array Antenna

Double-driven Yagi array provides added gain. All-aluminum, goldenized construction. Fiberglass insulators. Torsion-lock hardware. Boom length 128". Easy to install.  
18 F 01281W Wt. 8 lbs. .Net 14.95



For Fringe Areas  
5-Element \$8.95

### High-Gain FM Antenna

High-gain design ideally suited to FM reception. Trouble-free operation in severe weather. Fully automatic, snaplock brackets for easy installation. Boom length 72". Goldenized finish.  
18 F 01497W Wt. 5 lbs. .Net 8.95



Omnidirectional Pickup  
For Fringe Areas  
\$11.95

### Lafayette "Stereo Stack"

Designed for stereo Omnidirectional high-gain sensitivity is achieved thru "stacking" 7 folded dipole elements. All-aluminum construction, goldenized finish. Mounts to top or side of mast.  
18 F 02283W Wt. 4 1/2 lbs. .Net 11.95



Gold Finish  
WINEGARD  
7-Element \$23.00

### High Gain Antenna

"Super Colortron" FM antenna for all areas. High front-to-back ratio and beam width for rejecting unwanted signals. Excellent 300-ohm matched impedance. Rugged construction. Boom length 81".  
18 F 80915W Wt. 8 1/2 lbs. .Net 23.00

## FINCO High Gain Broad Band FM Antennas



For Deep Fringe Areas  
10-Element \$28.95

Model FM-5. Twin-drive elements with "T" match stubs. 9.8 dB gain thru entire FM band. Fidelity phasing provides 27.1 front-to-back ratio with 1.25 SWR. Braced square boom 10 ft. long. Easy to install.  
18 F 30231WX Wt. 8 lbs. .Net 28.95



For Fringe Areas  
6-Element \$19.95

Model FM-4G. Stereo FM. Geometrically designed to provide 9.5 dB gain with twin-driven element and impedance control stubs. Square boom with locking brackets for non-tilt elements. Boom length 93".  
18 F 30249WX Wt. 6 lbs. .Net 19.95



All-Directional  
\$7.95

Model FMT. All-directional antenna mounts on present TV mast. Two folded dipoles matched with 1/4 wave phasing stub for optimum gain and all-direction radiation pickup pattern. Gold finish.  
18 F 30470W Wt. 3 3/4 lbs. .Net 7.95



Ideal for Apartments  
\$12.95

Model FM-WT. Window-mounted FM antenna ideal where rooftop antenna is impractical. Omnidirectional. Horizontal or vertical mounting. Sturdy, expandable window frame mount fits any window up to 42"W.  
18 F 30462W Wt. 4 1/2 lbs. .Net 12.95

### Lafayette Parabolic UHF Antenna

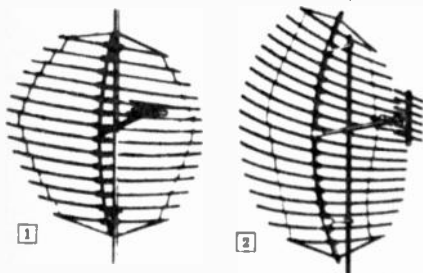

5-Ft. Model  
For Fringe Areas

\$26.95

7-Ft. Model  
For Deep Fringe Areas

\$44.95

#### Ultimate in Directivity. Rugged Construction

1 Has high front-to-back ratio. Signals reaching any part of parabola concentrate on the driver mounted at the exact focal point. Provides up to 18.6 dB gain. Pre-assembled. All-aluminum with gold-corrudized finish.  
18 F 01901W Shpg. wt. 7 3/4 lbs. .Net 28.95

2 With multiple element construction, has extremely high front-to-back ratio with narrow beam width to eliminate ghosts. All-aluminum assembly is fitted with vibration dampers for quiet high-wind operation. For channels 14-83. Impedance 300 ohms. Gold-corrudized finish.  
18 F 01927WX Shpg. wt. 13 1/4 lbs. .Net 44.95

### Lafayette UHF Corner Reflector

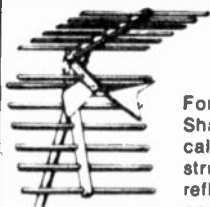

\$6.95

For fringe areas. High gain. Sharp horizontal and vertical directivity. Rugged construction. Large aluminum reflector screen. Easy, fold-open assembly. Gold finish.  
18 F 01448W 3 lbs. Net 6.95

### Bow-Tie UHF Antenna

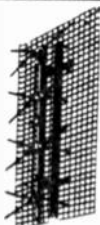

For Fringe Areas

\$7.95

Four-bay with high 12 dB gain. Flat response across entire spectrum. Excellent directivity. Unique "cross-over" phasing bars. Easy to install. Corrosion resistant.  
18 F 01422W 5 lbs. Net 7.95



\$7.95



### Para-Pro 27-Element UHF Antenna

High-gain periodic design requires little space and offers minimum wind resistance. Eleven driven elements, plus 16 parasitic directors for perfect color across UHF band. Easy mounting to existing mast.  
18 F 38113W Shpg. wt. 3 lbs. .Net 7.95

### BLONDER-TONGUE UHF Converters

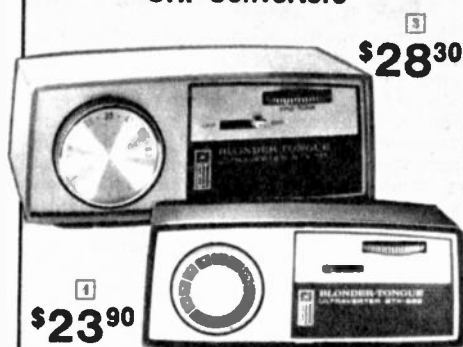

\$28.30

\$23.90

- Illuminated Dial and Vernier Tuning
- Add UHF to TV Sets Having VHF Only
- Economical, Quick Solution to Costly Repairs on Newer U/V TV Sets

3 Model BTX-111. Converter/amplifier for prime, medium and weak areas. Solid-state. Adds and amplifies all UHF channels (14-83). Double-tuned UHF input circuits. UHF loop antenna. For 117 VAC, 60 Hz. UL listed.  
18 F 18319 Shpg. wt. 2 lbs. .Net 28.30

4 Model BTX999. For prime and medium signal areas. Low-noise, virtually drift-free circuit. With UHF indoor loop antenna. For 117 VAC, 60 Hz. UL listed.  
18 F 18301 Shpg. wt. 2 lbs. .Net 23.90

# Color VHF/UHF Indoor Antennas

• Superior picture quality • Attractive styling

**Electroplated 24K Gold Elements**

**\$29<sup>95</sup>**



"Regency" Rotating Antenna. For color, B&W, FM stereo. Signal, picture and color controls with rotating 46" power booster arms and High Inductance Grid allows pinpoint signal pickup. Gear-controlled color tuning loops. 12-position level control reduces ghosts, tear, smear. VHF/UHF leads, decorator styled. 18 F 12437 Wt. 4 1/2 lbs. . . Net 29.95

**All Channels 2 to 83**

**\$24<sup>95</sup>**



"Imperial." Six-section all brass elements with 24K gold electroplate. Pinpoint signal pickup. Signal and picture controls for color and black and white. Gear-controlled tuning loops, 12-position signal level control. Walnut finish. Separate VHF/UHF leads. 18 F 12429 Wt. 4 1/2 lbs. . . Net 24.95

**Power Booster Elements**

**\$19<sup>95</sup>**



"Color Champion." Channels 2 to 83, color and black and white, plus FM stereo. 5-section 46" brass elements give superb reception. 12-position picture correction control for excellent pictures. Isolation network switch allows sharper color register, separate VHF/UHF leads. 18 F 12411 Wt. 4 1/4 lbs. . . Net 19.95

**Filter Control**

**\$14<sup>95</sup>**



"Color King." Color phasing loops and filter coupled with 46" brass telescoping arms. 12-position correction control with silver-plated contacts clear up ghosts and snow in most difficult areas. Separate VHF/UHF leads provide low-loss, matched impedance. 18 F 12221 Wt. 3 1/2 lbs. . . Net 14.95

**Radar Loops**

**\$12<sup>95</sup>**



"Deluxe" Antenna. 46" telescoping arms coupled with adjustable radar loops for sharper pictures on all channels 2 thru 83. 12-position dual control to orient antenna to strongest signal. Static control. Separate VHF/UHF leads. 18 F 12080 Wt. 3 3/4 lbs. . . Net 12.95

**Color and black and white**

**\$8<sup>95</sup>**



"Radarcoil." All channels. Utilizes 46" brass 4-section telescoping arms, plus 12-position switch for efficient reception and to eliminate ghosts and snow. Separate leads for VHF and UHF. Walnut finish. 18 F 12122. Wt. 2 3/4 lbs. . . Net 8.95

**12-Position Switch**

**\$6<sup>95</sup>**



"Power King." Color and black and white channels 2 thru 83, plus FM stereo. Concentric rings and 39" telescoping arms for sharpest pictures ever. 12-position control. Separate VHF/UHF leads. Walnut finish. 18 F 12155 Wt. 2 lbs. . . Net 6.95

**Universal Behind-Set Antenna.** For portable and console TVs. 5-section dipoles extend to 38" with 360° swivel. Collapses behind set. Excellent replacement. Shpg. wt. 3/4 lb. 18 F 71011 . . . Net 3.95

**\$3<sup>95</sup>**

**4-Section Dipole Antenna.** Adjusts for best pictures on all VHF channels and FM. Handsome finish, slip-proof felt-padded base. With 300 ohm twin line. 1 1/4 lbs. 18 F 38408 . . . Net 1.69

**\$1<sup>69</sup>**



**Reduces Hum and Noise**

**\$8<sup>95</sup>**



FM Stereo Multiplex. Features 1/4 wave 4-section precision arms, 3/4 wave induction coil, 12-position station direction control. Plus noise filtering circuit. For strong reception on FM band. 18 F 12197 Wt. 2 1/4 lbs. . . Net 8.95

**\$9<sup>95</sup>**

**\$13<sup>95</sup>**



## Color VHF/UHF Antennas

"Montego." Interacting impedance matching circuits work with phased loops and adjustable ball-pivoted 45" telescoping dipoles to pull in sharp color and black and white on channels 2 thru 83. Separate VHF and UHF twin leads. High quality polished chromated brass elements. 18 F 39208 Shpg. wt. 3 lbs. . . Net 9.95

"Le Mans." 14-position picture tuning control. Ball-pivoted 45" telescoping color-accented dipoles deliver top-quality color and black and white on channels 2 thru 83. Separate VHF and UHF twin leads. High quality polished chromated brass elements. Elegantly styled. 18 F 39216 Shpg. wt. 4 lbs. . . Net 13.95

**Attachable UHF Loop.** Omni-directional pickup for strong reception. Easy to install. Universal lugs fit any UHF converter or TV. 5 oz. 18 F 38754 . . . Net 99¢

**99¢**



**FM Twin Line Antenna.** Folded dipole. Six-foot lead-in with spade lugs. For behind cabinet, under rug, any concealed place. Imported. Wt. 4 oz. 99 F 40297 . . . Net 1.29

**\$1<sup>29</sup>**



**Attractive Design**

**\$5<sup>95</sup>**



UHF "Bow Tie" Antenna. Minimizes snow and ghosts. Provides excellent UHF reception. Attaches to any set with 300 ohm wire. Black bow ties are sharply set off by attractive golden grid. Decorator designed and perfect for any interior. 18 F 63240 Wt. 2 1/2 lbs. . . Net 5.95

# See Lafayette for the Best in TV Accessories

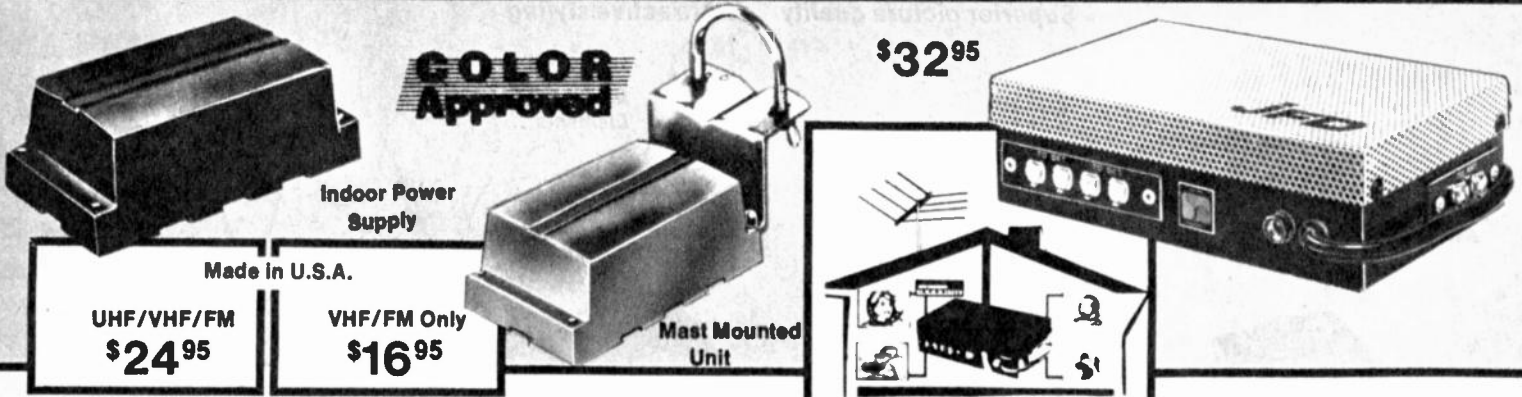

**COLOR Approved**

**\$32<sup>95</sup>**

**Indoor Power Supply**

Made in U.S.A.

**UHF/VHF/FM  
\$24<sup>95</sup>**

**VHF/FM Only  
\$16<sup>95</sup>**

**Mast Mounted Unit**

## Lafayette Color-Amp. Transistorized UHF/VHF/FM Antenna Preamp/Booster

- Gain of 20 dB VHF/FM—10 dB Gain on UHF
  - For Channels 2-83, FM and Stereo FM Antennas
- Low-noise, high-gain, solid-state circuit really improves reception in fringe areas. Has exclusive lightning protection circuit, latest RF circuit design, weatherproof outdoor housing with mounting bracket and "no-strip" screw terminals. Separate power supply plugs into 117 VAC, 60 Hz line, has isolation transformer to eliminate shock hazard. 300-ohm input and output. For 117 VAC, 60 Hz.

18 F 02149 Shpg. wt. 1 1/2 lbs. . . . . Net 24.95

## Lafayette Color-Boost VHF/FM Antenna Booster

Similar to above, for use with any VHF/FM antenna only. Offers 14.6 dB gain on VHF/FM. Single 300-ohm input, output. 117 VAC, 60 Hz.

18 F 02131 Shpg. wt. 1 1/2 lbs. . . . . Net 16.95

## Lafayette Transistorized 4-Set VHF/UHF/FM Antenna Booster and Distribution Amplifier

- Has 300-Ohm Input to Four 300-Ohm Outputs
- Ideal for Through-the-Home Entertainment Systems
- Improves Color, B&W, FM and Stereo FM Reception

Use up to 4 TV or FM receivers from a single antenna! High-efficiency, 3-transistor indoor amplifier boosts and distributes VHF/UHF and FM signals to as many as four TV or FM receivers. Has three Noverload® silicon transistors for up to 6 dB VHF gain and 6.5 dB UHF gain at each of four 300-ohm outputs. 15 dB isolation between outputs. High input signal capability boosts weak signals, but will not overload on strong signals. Perforated cabinet. 8 1/4 x 2 x 4". For 117 VAC, 60 Hz.

18 F 02214 Shpg. wt. 1 1/2 lbs. . . . . Net 32.95

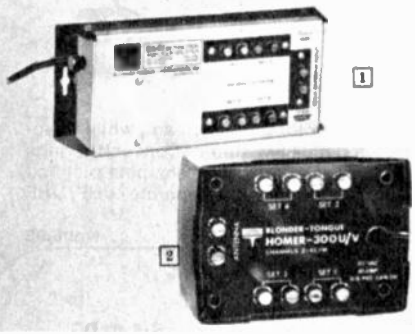

## BLONDER-TONGUE

TV and FM Boosters

### 1 4-Set VHF-FM Distribution Amplifier

- For Color and B&W
- For Up to 4 Sets

**\$23<sup>97</sup>**

Model DA-4V-300. Solid-state booster/amp for Channels 2-13 plus FM. Offer 6 dB gain at each output, high S/N, flat response. Excellent isolation between outputs. Prevents interaction from set to set. For 300-ohm systems. 8 1/4 x 3 1/4 x 1". For 117 VAC, 60 Hz.

18 F 18335 Shpg. wt. 1 1/4 lbs. . . . . Net 23.97

### 2 4-Set VHF/UHF/FM Amp/Coupler

- For Channels 2-83 Plus FM
- For 300-Ohm Outputs

**\$18<sup>60</sup>**

Model 300 U/V. Low-noise transistor circuit offers 8.5 dB gain on VHF and FM, 2.5 dB on UHF. Has 300-ohm balanced input/four 300-ohm outputs. Stripless screw terminals. 3 x 4 1/4 x 1 1/8". For 117 VAC, 60 Hz. Use up to 4 TV/FM sets from one antenna.

18 F 18392 Shpg. wt. 3/4 lb. . . . . Net 18.60

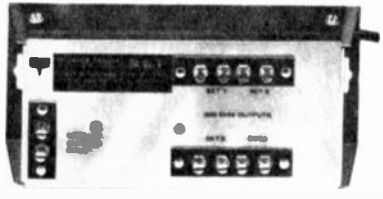

### 4-Set VHF/UHF/FM Solid-State Distribution Amplifier

- Four 300-Ohm Outputs
- Channels 2-83 Plus FM

**\$38<sup>99</sup>**

Model DA-4UV-300. All-channel distribution amplifier is ideal for TV/FM systems using up to 4 different TV or FM sets. Uses patented ICEF circuit for excellent response, has 4-way lightning and surge protection. 300-ohm twin-lead input, four 300-ohm outputs. Gain at each output: VHF, 7 dB; UHF, 8 dB. 8 1/4 x 3 1/2 x 2 1/4". For 117 VAC, 60 Hz.

18 F 18343 Shpg. wt. 1 lb. . . . . Net 38.99

### 4-Set VHF/UHF/FM 75-Ohm Distribution Amplifier

Model DA-4UV-75. Similar to above, except 75-ohm inputs and outputs. Gain to each output: VHF, 5 dB; UHF, 10 dB. For 117 VAC, 60 Hz.

18 F 18442 Shpg. wt. 1 lb. . . . . Net 43.22

166 Lafayette Cat. No. 750

### Mast-Mount 4-Transistor VHF/UHF/FM Antenna Amplifier

**\$45<sup>35</sup>**

- For Color or Black-and-White



Mast Mount Unit

Voyager. Weatherproof all-channel TV amplifier has silicon transistor circuit, separate 300-ohm inputs and outputs for UHF and VHF, FM overload filter. Lightning protection. Gain: VHF (channels 2-13) 15 dB; UHF (channels 14-83) 12.5 dB. With hardware. 2 1/2 x 3 1/2 x 1 3/8". Power supply, 4 1/2 x 3 1/2 x 1 3/8". For 117 VAC, 60 Hz. 2 lbs.

18 F 18095 . . . . . Net 45.35



Remote Power Supply

### Mast-Mount VHF/FM Amplifier

Horizon. Above, but two-transistor circuit for VHF/FM only. 2-set coupler—use 2 sets from 1 antenna. VHF gain, 16 dB. 2 1/2 x 5 x 3 3/8". Power supply: 4 1/2 x 3 1/2 x 3 3/8".

18 F 18103 Shpg. wt. 1 1/2 lbs. . . . . Net 33.93

### Mast-Mounted High-Gain VHF/FM Antenna Amplifier

- 30 dB Gain on VHF-FM
- Solid-State Circuit
- For Deep-Fringe Areas

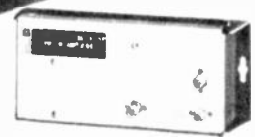

**\$57<sup>50</sup>**

Model AB-30

One of the most powerful antenna amplifiers available for at-home use—offers an amazing 30 dB gain on all signals! Can be used in hotel or motel distribution systems—will drive up to 50 sets in a properly designed distribution system. Mast-mounted amplifier has 300-ohm input and 75-ohm output. Separate indoor power supply has 75-ohm input and output. Power supply can be mounted anywhere indoors. With 75-ohm coax cable connectors. Mast mount amplifier, 5 1/4 x 3 3/8 x 3 3/8", indoor power supply, 8 1/4 x 3 1/2 x 2 1/4". 117 VAC, 60 Hz.

18 F 18376 Shpg. wt. 2 1/4 lbs. . . . . Net 57.50

Prices and Specifications are Subject to Change Without Notice.



# Lafayette Has Products for "Better-Looking" TV

## Winegard Color TV/FM Boosters



1 \$34<sup>95</sup>



2 \$32<sup>95</sup>



3 \$56<sup>95</sup>

### 1 VHF/UHF/FM Booster/Coupler

**Model BC-382.** Solid-state, all-channel booster/amplifier has four 300-ohm outputs with 8 dB gain at each output. Low-noise, high-isolation circuit. 300-ohm input to four 300-ohm outputs. For 117 VAC, 60 Hz.

18 F 60733 Shpg. wt. 2 1/4 lbs. .... Net 34.95

**Model BC-782.** Above, with 75-ohm outputs.

18 F 60741 Shpg. wt. 2 1/4 lbs. .... Net 37.95

### 2 VHF/FM Booster/Coupler

**Model BC-234.** Solid-state booster/amp provides 10 dB gain on all signals at each of its four 300-ohm outputs, 17 dB gain at the single 75-ohm output. 75- or 300-ohm inputs. For 117 VAC, 60 Hz.

18 F 60758 Shpg. wt. 2 1/2 lbs. .... Net 32.95

### 3 25 dB VHF-UHF-FM System Amp

**Model DA-825B.** Ideal for motels, small apartments, etc.—drives up to 16 TV or FM sets with 26 dB gain on VHF signals, 23 gain on UHF. Has 75-ohm inputs and outputs, low-noise circuit. Passes super-band and mid-band frequencies for use in CATV systems. Has built-in FM trap, regulated power supply, lightning protection circuit. For 117 VAC, 60 Hz.

18 F 60709 Shpg. wt. 2 1/4 lbs. .... Net 56.95

### 15 dB VHF-UHF-FM Amplifier

**Model DA-815.** (Not shown). 75-ohm, 82-channel TV amplifier provides up to 15 dB gain on all signals. Has silicon transistor circuit, fixed FM trap. For all-channel or separate VHF and UHF antennas. Accepts standard F-type connectors on either RG-59/U or RG-11/U cable. 117 VAC, 60 Hz.

18 F 60972 Shpg. wt. 2 1/4 lbs. .... Net 36.95

### 4 VHF-UHF-FM 2-Transistor Amp

**Model RD-830.** Two-transistor circuit provides 20 dB gain on VHF and FM signals, 10 dB gain on UHF. Has single 300-ohm input and output. High-pass filter, lightning protection. Mounting hardware. 117 VAC, 60 Hz.

18 F 60873 Shpg. wt. 1 1/2 lbs. .... Net 26.95

**Model RD-870.** 75-ohm output.

18 F 60881 ..... Net 26.95

### 5 VHF/UHF/FM 2-Set Booster

**Model BC-830.** Doubles input signals on all channels, operates two sets from a single antenna. Average gain of 5.25 dB at each output. Lightning protection circuit. 300-ohm inputs and outputs. 117 VAC, 60 Hz.

18 F 60717 Shpg. wt. 3/4 lb. .... Net 16.95

### 6 FM Supercharger

**Model FM-340.** Adds 17 dB gain (up to 8 times more signal) on FM and stereo FM broadcasts. For fringe, deep-fringe areas. 300-ohm input, output. 117 VAC, 60 Hz.

18 F 60642 Shpg. wt. 3/4 lb. .... Net 15.95

### Distribution System Accessories

**Model VTF-73A.** Flush mount line tap matches 75-ohm input to 300-ohm output. With plug. 18 F 60774 Shpg. wt. 7 oz. .... Net 4.50

**Model SM-1.** Surface-mount wall box for outlets or line tap-offs. 18 F 60907 Shpg. wt. 6 oz. .... Net 69¢

**Model LS-27.** Two-way line splitter divides 75-ohm signal into equal parts. Use with multiple outlet systems. With F-59 connectors. 18 F 60956 Shpg. wt. 1 lb. .... Net 4.50

**Model LS-47.** As above, but 4-way line splitter. 18 F 60964 Shpg. wt. 1 lb. .... Net 7.95

**Model SP-2382.** Provides 12 dB gain on VHF/FM, 14 dB UHF at each output. Has 300-ohm input and two 300-ohm outputs. Indoor power supply for 117 VAC, 50-60 Hz. 18 F 39158 Shpg. wt. 2 1/4 lbs. .... Net 44.95

**Model SP2300.** Above, VHF/FM only. No UHF. 18 F 39182 Shpg. wt. 2 1/4 lbs. .... Net 35.95

**Indoor VHF/UHF/FM Amp/Coupler.** Operates up to 4 TV sets from a single antenna. 300-ohm input splits to four 300-ohm outputs with 6.5 dB gain at each. 5 x 3 1/2 x 1 1/4"—mounts anywhere. For 117 VAC, 60 Hz. 18 F 39166 Shpg. wt. 2 lbs. .... Net 34.95

**Model PC4312.** Above, VHF/FM only. 8 dB gain. 18 F 39174 Shpg. wt. 2 lbs. .... Net 26.95

## FINCO

### Indoor 2-Set FM Signal Booster

\$21<sup>95</sup>



- 20 dB Gain
- For FM, Stereo FM

**Model 65-7.** Low-noise transistorized FM amplifier improves reception on weak FM and stereo FM signals, even where strong local signals are present. Has isolation transformer, 300-ohm input, two 300-ohm outputs. 1 3/4 x 4 x 4 1/2". 117 VAC, 60 Hz.

18 F 30421 Shpg. wt. 1 1/2 lbs. .... Net 21.95

\$32<sup>30</sup>

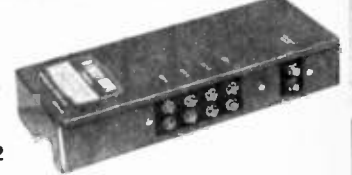

G-922

### 4-Set VHF/UHF/FM Amplifier

**Model G-922.** Solid-state circuit has flat response, high gain of 6.5 dB VHF, 5 dB UHF at each output. Single 300-ohm input to four 300-ohm outputs. 15 dB isolation. With all hardware. For 117 VAC, 60 Hz.

18 F 30538 Shpg. wt. 1 1/4 lbs. .... Net 32.30

**Model 923.** Above, for 75-ohm systems.

18 F 30546 Shpg. wt. 1 1/2 lbs. .... Net 34.50

**Model 920.** VHF/FM only. 8 dB average gain. 18 F 30553 Shpg. wt. 1 1/2 lbs. .... Net 24.95



Mast-Mount Unit

Indoor Power Supply

\$42<sup>35</sup>

### 10 Mast-Mounted VHF/UHF/FM Amplifier

**Model G-956.** 4-transistor, all-channel amplifier has built-in 2-set coupler to operate two TV/FM sets from a single antenna. 14 dB VHF, 12 dB UHF gain. 300 ohms input/outputs. For 117 VAC, 60 Hz.

18 F 30561 Shpg. wt. 3 lbs. .... Net 42.35

### Mast-Mounted VHF-FM Amp

**Model G-950.** Above, except VHF/FM only. 13 dB gain. One-transistor circuit.

18 F 30579 Shpg. wt. 3 lbs. .... Net 22.05

### Antenna Booster/Amplifiers for Clear, Crisp Reception



Mast-Mount Unit

\$26<sup>95</sup>

Indoor Power Supply

\$15<sup>95</sup>

\$16<sup>95</sup>

\$44<sup>95</sup>

Indoor Power Supply

Mast-Mount Unit

\$34<sup>95</sup>

JFD



# Alliance Tenna-Rotor® Systems

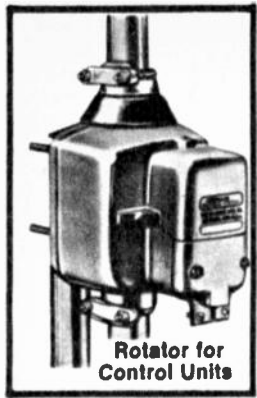

Rotor for Control Units



1 \$43.58



2 \$33.68



3 \$23.10



4 \$28.64

5 \$3.53

• Factory Lubricated for Life • Weather Protected • External Hardware Corrosion Resistant • Full 360° Rotation • Will Handle the Largest Color TV Antenna in Winds in Excess of 90 M.P.H. • Magnetic Brake, No Drift

1 Model C-225. Automatic Rotor System with transistorized control box. Accepts masts to 1 3/4" O.D. Guy wire accesses. Solid-state control case features phase-sensing bridge circuit. Silent operation. Size: Rotor: 7 3/4" x 4 1/4" x 8". Control Case: 6 1/2" x 4 1/4" x 5". 115 VAC, 60 Hz. 80 watts. Uses 5-cond. cable. UL listed. 18 F 14011W Shpg. wt. 9 1/2 lbs. . . . . Net 43.58

2 Model U-100. Automatic Rotor System. Accepts masts to 1 3/4" O.D. Control box fully automatic. Guy wire accesses. Has positive mechanical stop at end of rotation. Sizes: Rotor:

7 3/4" x 4 1/4" x 8". Control Case: 7 x 4 1/2 x 4". 115 VAC, 60 Hz at 65 watts. Uses 4-cond. cable. UL listed. 18 F 14037W Shpg. wt. 9 1/2 lbs. . . . . Net 33.68

3 Model K-22. Manual Rotor System. Economy model. Fingertip control of rotation. Automatic signal light. Sizes: Rotor: 7 3/4" x 4 1/4" x 8". Case: 5 x 5 x 4". 115 VAC. 60 Hz at 50 watts. Uses 4-cond. cable. UL listed. 18 F 14045W Shpg. wt. 8 3/4 lbs. . . . . Net 23.10

4 Model T-45. Manual Rotor System. Slight pressure on control bar rotates antenna through full 360°. Expanded meter scale for easy-to-read direction indication. 115 VAC, 60 Hz at 70 watts. Sizes: Rotor: 7 3/4" x 4 1/4" x 8". Control Case: 6 1/2" x 4 1/2" x 2 1/2". Uses 5-cond. cable. UL listed. 18 F 14029W Shpg. wt. 10 lbs. . . . . Net 28.64

5 Thrust Bearing Bracket. For stacking antennas. Withstands winds up to 90 MPH. Prevents buckling and bending. 18 F 14052 Shpg. wt. 2 lbs. . . . . Net 3.53

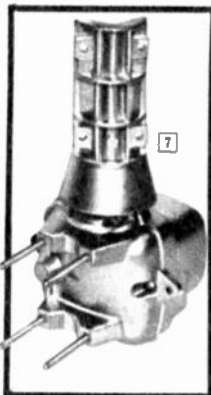
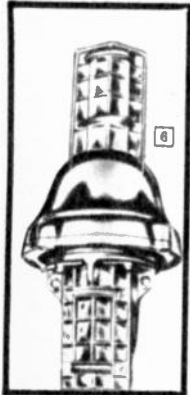

## CDE Cornell Dublier Rotor Systems

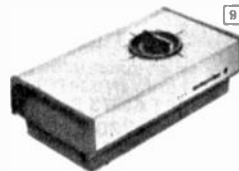

Advanced Design, Heavy-Duty CDE Rotor Systems Provide Simple, Automatic Operation

Model AR-22L. (Units 6 & 8). Electromechanical control. Direction accuracy within ±2%. Heavy-duty, bell-shaped housing. For largest TV/FM antennas or stacked arrays. Accepts masts 7/8" to 2 1/8" O.D. Uses 4-wire cable. 115 VAC, 60 Hz. UL listed. 42 F 86076W Shpg. wt. 15 lbs. . . . . Net 49.95

Model AR-40. (Units 6 & 9). Solid-state controlled. Direction accuracy within ±1%. Accepts masts 7/8" to 2 1/4" O.D. Uses 5-wire cable. 115 VAC, 60 Hz. (Uses same bell rotor as AR-22L). UL listed. 42 F 86118W Shpg. wt. 14 lbs. . . . . Net 54.95

Model AR-33. (Units 6 & 10). Fully-automatic pushbutton antenna rotor for 5 specific stations. Quiet-operating, solid-state circuitry. Rugged silicon transistors, heavy-duty relay contacts. Thermally-protected transformer. 110/120 VAC, 50/60 Hz. UL listed. 42 F 86100W Shpg. wt. 16 lbs. . . . . Net 64.95

Model AR-20L. (Units 7 & 8). For average-sized TV/FM antennas. Accepts masts from 7/8" to 2 1/8" O.D. Control Box Size: 5 x 7 1/2". Uses 4-wire cable. For 110/120 VAC, 60 Hz. UL listed. 42 F 86126W Shpg. wt. 13 1/2 lbs. . . . . Net 39.95

### CABLES FOR ALLIANCE, CDE and BLONDER TONGUE

100-ft. 4-Conductor Flat Cable. 32 F 89105 Shpg. wt. 2 1/2 lbs. . . . . Net 6.18

100-ft. 5-Conductor Cable. 32 F 36312 Shpg. wt. 2 3/4 lbs. . . . . Net 6.85

### Blonder-Tongue Ultramatic 1000 Rotor

Automatic Solid-State Control Box. Turn knob, press, and antenna turns. Decorator-styled, illuminated. Heavy-duty.

Rotor. Accepts mast diameters up to 1 1/2". High torque. Rugged, weather-resistant aluminum. For 117 VAC, 60 Hz. Easy to install. Use 5-cond. cable. 18 F 18459W 7 1/2 lbs. . Net 49.95

### WINEGARD Cablemate

\$13.95

Connects both cable signal and antenna signal to TV receiver. Works with any good outdoor TV antenna. Lets VHF, UHF, FM midband and superband signals pass through. Has 75-ohm cable TV input connector, plus choice of 300- or 75-ohm antenna input. Back-of-set mounting. 18 F 60949W Shpg. wt. 1 lb. . . . . Net 13.95

### Rembrandt TV Ghost Eliminator

\$6.95

Improves any existing antenna, indoor, outdoor or built-in. Receives from all directions, filters out interference, tunes in "hard-to-get" channels. Works on any channel, any location, any antenna. All TV sets. Plugs into 117 VAC, 60 Hz. 18 F 12064 UL listed. Shpg. wt. 1 1/4 lbs. Net 8.95

Charge It with Your BankAmericard or Master Charge.

# TV-FM Couplers-Splitters-Combiners-Transformers-Filters

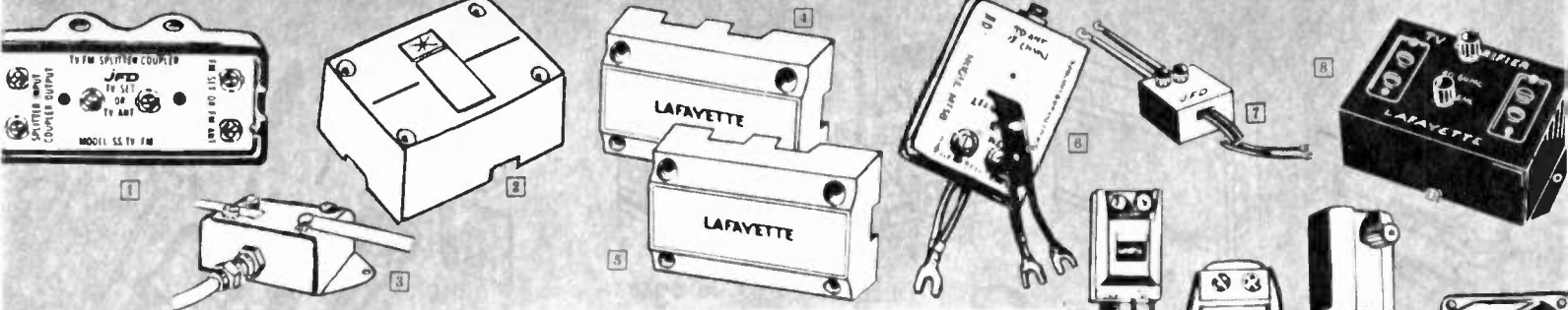

**1 JFD SC42. 2-Set VHF/UHF/FM Coupler.** Combines 2 TV or FM sets from 1 TV or FM antenna. Color, black & white. Quick connections. 300 ohms input and output.  
18 F 38135 Shpg. wt. 5 oz. .... Net 2.75

**1 JFD SC62. 3-set VHF/UHF/TV Coupler.** Similar to above except couples up to 3 TV or FM sets from 1 TV or FM antenna.  
18 F 38143 Shpg. wt. 6 oz. .... Net 3.30

**1 JFD SC72. 4-Set VHF/UHF/FM Coupler.** Similar to above except couples up to 4 TV or FM sets from 1 TV or FM antenna.  
18 F 38150 Shpg. wt. 6 oz. .... Net 3.75

**1 JFD SC20. 2-Antenna Combiner (VHF/UHF).** Combines separate VHF and UHF antennas so that only one 300-ohm download is required. Most mounting hardware supplied.  
18 F 38127 Shpg. wt. 5 oz. .... Net 3.49

**1 JFD SSTV/FM TV/FM Splitter Coupler FM Filter.** Sends FM signal to FM set—TV signal to TV set. Also use as FM bandpass. Eliminates amateur, citizen band pickup. 300-ohm impedance. With hardware.  
18 F 39125 Shpg. wt. 10 oz. .... Net 3.75

**2 Blonder-Tongue A-102U/V. 2-Set UHF/VHF Coupler.** Couples two TV or FM sets from one TV/FM antenna. Low loss with excellent isolation. 300 ohms. No-strip terminals.  
18 F 18327 Shpg. wt. 5 oz. .... Net 2.82

**3 JFD SC42-730. 2-Set 75-300-Ohm Coupler/Matching Transformer.** Use with apartment house master antenna systems. One 75-ohm input, two 300-ohm outputs. Coaxial Input fitting.  
18 F 39349 Shpg. wt. 8 oz. .... Net 5.75

**4 Lafayette 4-Set VHF/UHF/FM Coupler.** Up to four TV or FM sets. Low signal loss. Easy to install. No-strip 300-ohm input, output terminals.  
99 F 40321 Shpg. wt. 5 oz. .... Net 2.49

**5 Lafayette 2-Set VHF/UHF/FM Coupler.** Up to two TV or FM sets from one antenna. Low signal loss. Easy to install. No-strip 300-ohm input and output terminals.  
99 F 40313 Shpg. wt. 5 oz. .... Net 1.95

**6 JFD MT-56. VHF/UHF Splitter 75-300-Ohm Matching Transformer.** 2-way 75- to 300-ohm transformer; also splits VHF/UHF signal from all-channel single 75-ohm download into separate VHF/UHF outputs.  
18 F 39133 Shpg. wt. 6 oz. .... Net 3.75

**6 JFD MT-58. VHF/UHF/FM Splitter 75-300-Ohm Matching Transformer.** Similar to above except splits VHF/UHF/FM signal into VHF/UHF and FM outputs.  
18 F 39190 Shpg. wt. 4 oz. .... Net 5.30

**7 JFD SS21. Indoor VHF/UHF Signal Splitter.** Splits VHF/UHF signal from all-channel 300-ohm single download into separate VHF/UHF output. Terminals behind TV set. Easy mounting.  
18 F 39083 Shpg. wt. 3 oz. .... Net 2.30

**7 JFD SS83. Indoor VHF/UHF/FM Signal Splitter.** Similar to above except splits signal into VHF/UHF and FM outputs.  
18 F 39091 Shpg. wt. 5 oz. .... Net 2.95

**8 Lafayette TV Filterizer.** Eliminates any antenna interference (diathermy, ignition, amateur/CB, etc.). Two tuning knobs. 4 x 2 3/4 x 1 1/2".  
99 F 40172 Shpg. wt. 1 lb. .... Net 5.95

**9 Lafayette Indoor VHF/UHF Signal Splitter.** Separates VHF and UHF from an 82-channel, 300-ohm single line installation. Back of set. No-strip input terminals. Pre-attached leads.  
99 F 40339 Shpg. wt. 3 oz. .... Net 1.95

**10 Lafayette Indoor VHF/UHF/FM Signal Splitter.** Separates signals from a single 300-ohm line installation for feeding into 82-channel TV set and FM receiver.  
99 F 40032 Shpg. wt. 3 oz. .... Net 2.75

**11 Jerrold RFT-300 Tunable FM Trap.** Eliminates interference from strong stations in industrial service or FM broadcast. Attaches to input 300-ohm terminals of TV set amplifier.  
18 F 36121 Shpg. wt. 8 oz. .... Net 2.95

**12 JFD SC42-75. 2-Way TV/FM 75-Ohm Line Splitter.** Splits one 75-ohm VHF/UHF/FM line into two 75-ohm lines. Also combines two 75-ohm lines into one line. Mating plugs supplied.  
18 F 39109 Shpg. wt. 5 oz. .... Net 6.50

**13 JFD SC72-75. 4-Way TV/FM 75-Ohm Line Splitter.** Splits one 75-ohm VHF/UHF/FM line into four 75-ohm lines. May be combined with SC42-75 for any number of lines. With plug.  
18 F 39117 Shpg. wt. 8 oz. .... Net 8.70

**14 Finco 3007 FM Band Pass Filter.** Eliminates hams, electric motors, aircraft, fluorescent lamps and auto ignition.  
Up to 40 dB attenuation.  
18 F 30165 Shpg. wt. 5 oz. .... Net 4.95

**15 Lafayette Lo-Pass Line Filter.** Uses dual ferrite core cells to eliminate industrial RF, neons, appliances. 110-125 VAC, 60 Hz. 350 watts.  
99 F 40057 Shpg. wt. 1 lb. .... Net 4.99

**15 Vidaire Color Ghost Eliminator.** Reduces color fringing, multiple images, interference caused by strong radio and TV transmissions. Adjustable to all channels. 300 ohms.  
18 F 80020 Shpg. wt. 5 oz. .... Net 3.99

**16 JFD HP50. High Pass Filter.** Outdoor, indoor. Hi-pass wavetrap eliminates Ham, citizens band, police, fire, marine interference. Low insertion loss. No-strip terminals. 300 ohms.  
18 F 38200 Shpg. wt. 4 oz. .... Net 3.79

**17 Blonder-Tongue 3413 Indoor VHF/UHF Cablematch.** Especially suited for matching TV set inputs to a coax distribution system. Match 75-ohm cable to 300-ohm input.  
18 F 18384 Shpg. wt. 4 oz. .... Net 1.95

**18 Vidaire Signal Attenuator.** For all TV sets with excessive signal. Eliminates poor sync, multiple images, buzz, beats in picture. For all signal areas. Easy installation.  
18 F 80012 Shpg. wt. 4 oz. .... Net 3.59

**19 TV & Radio Noise Filter.** Helps eliminate radio and TV noise caused by household appliances. Just plug into any wall outlet.  
18 F 19010 Shpg. wt. 4 oz. .... Net 1.39

**20 Coaxial Shielded Cable Kits.** High-quality 75-ohm RG-59U low-loss cable with connectors on both ends to fit all above matching transformers.  
18 F 58075 50 Ft. Shpg. wt. 2 lbs. .... Net 6.50  
18 F 58083 75 Ft. Shpg. wt. 2 3/4 lbs. .... Net 8.50  
18 F 58091 100 Ft. Shpg. wt. 3 1/2 lbs. .... Net 10.50

**21 Lafayette Indoor/Outdoor VHF/UHF/FM 75-300-Ohm Matching Transformer.** 82-channel VHF/UHF transformer matches 300-ohm antenna or TV set to 75-ohm coax. Weatherproof. Ideal for color.  
99 F 40347 Shpg. wt. 4 oz. .... Net 2.39

**22 MT-51. JFD VHF/UHF/FM Coaxial Cable Matching Transformer Kit.** 75-300-ohm impedance match. Includes outdoor and indoor units. Ideal for color TV.  
18 F 38895 Shpg. wt. 1/2 lb. .... Net 5.12

**22 MT-59. JFD Matching Transformer Kit with VHF/UHF/FM Splitter.** Similar to above except indoor unit has separate VHF/UHF/FM outputs. With fittings.  
18 F 39141 Shpg. wt. 1/2 lb. .... Net 7.59

**Easy Installation  
Top Performance**

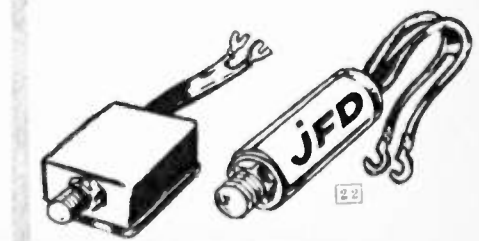

# Lafayette Antenna Installation Accessories

(1) \$1350

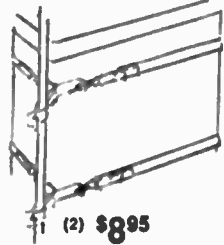
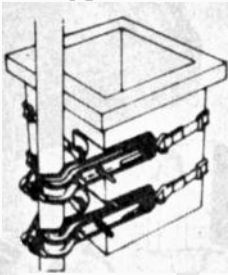

(2) \$895

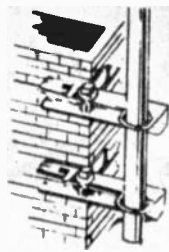

(3) \$595

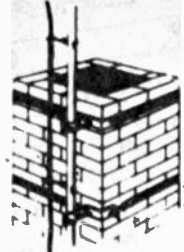

(4) \$350

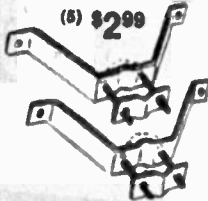

(5) \$299

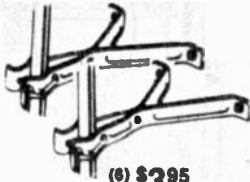

(6) \$395

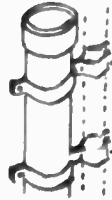

(7) \$295

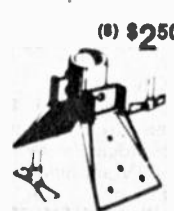

(8) \$250



(9) 99¢

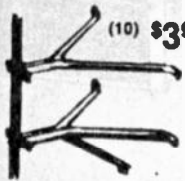
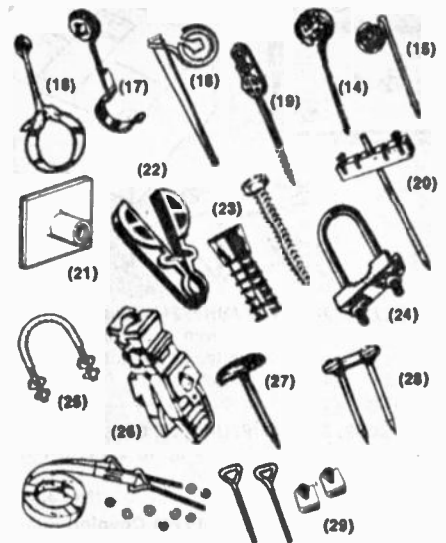

(10) \$395

(1) South River CMA500SS. Heavy-Duty Chimney Mount. Cast aluminum alloy mount, six aluminum corner brackets. With 2 12" 3/4"W stainless steel straps. For masts to 2". Shpg. wt. 3 3/4 lbs.  
18 F 66012 .....Net 13.50  
Above, 18" Straps. ....Net 14.95  
18 F 58277

(8) Peak or Flat Roof Mount. Fully adjustable. For up to 1 1/2" masts. Rust-resistant. Shpg. wt. 1 lb.  
18 F 83083 Set of 2 .....Net 2.50

(9) All-Angle Mount. For 1/2" to 1 1/4" masts. With hardware.  
18 F 01992 Wt. 10 oz. ....Net 99¢

(10) Heavy-Duty 12" Wall Mount. Steel tubing with leg supports. For 1 1/2" masts. Shpg. wt. 2 1/2 lbs.  
18 F 83059 Set of 2 .....Net 3.95

(10) Adjustable 18" Wall Mount. As above. Shpg. wt. 4 1/2 lbs.  
18 F 63067 Set of 2 .....Net 7.95

(11) South River EM-48AL. Heavy-Duty 48" Aluminum Eave Mount. For 2 1/4" masts. Also supports ground-up telescoping masts to 50 ft. Shpg. wt. 5 lbs.  
18 F 56426W .....Net 7.95

(12) South River Heavy-Duty Tripod Roof Towers. No guy wires needed, fully adjustable. With roof-sealing patches. For 1 1/4" masts.  
HDT-3 3-ft. Tower.  
18 F 56285W Wt. 8 1/4 lbs. Net 9.50  
HDT-5 5-ft. Tower.  
18 F 56293W 13 1/2 lbs. ....Net 14.95

HDT-100. 10-ft. Tower.  
18 F 56459W Wt. 37 lbs. Net 28.95

(13) South River Universal All-Position Roof Mount. For slopes, peaks, sidewalls, corners. 5 1/2 lbs.  
APM. 1 1/2" Masts.  
18 F 56319 .....Net 5.95  
APM-LM. 2 1/2" Masts.  
18 F 56327 .....Net 8.95

(14) SCREW-EYE STANDOFF. Shpg. wt. 7 oz.  
18 F 01679 3 1/2" .....Pkg. of 4 39¢  
18 F 01687 5 1/2" .....Pkg. of 4 49¢  
18 F 01695 7 1/2" .....Pkg. of 4 59¢  
STAINLESS STEEL SCREW-EYE STAND-OFF.  
18 F 01703 3 1/2" .....Pkg. of 4 89¢

(15) DRIVE-IN STAND-OFF. Avg. shpg. wt. 4 oz.  
18 F 01711 .....Pkg. of 2 45¢

(16) ADJUSTABLE STRAP-TYPE STAND-OFF.  
18 F 01729 7 1/2" Shpg. wt. 6 oz. ....Pkg. of 2 59¢  
18 F 01737 3 1/2" .....Pkg. of 2 49¢

(17) "CLIP-ON" STAND-OFF. 3 1/2" l. For 1 1/4" mast.  
18 F 01745 Shpg. wt. 4 oz. ....Pkg. of 2 45¢

(18) SUPER NAIL INSULATOR. For brick, mortar, etc.  
18 F 01752 3 3/4" long. Shpg. wt. 4 oz. ....Pkg. of 2 45¢

(19) COLOR VHF/UHF SCREW-EYE STAND-OFF.  
18 F 01760 5 1/2" long. Shpg. wt. 5 oz. ....Pkg. of 2 59¢

(20) OPEN-LINE STAND-OFF. 5 1/2" nail-type.  
18 F 58067 Shpg. wt. 8 oz. ....Pkg. of 5 99¢

(21) STAND-OFF SUPPORT. Use with any screw-eye, adhesive back for siding, etc.  
18 F 37012 Shpg. wt. 2 oz. ....Net ea. 25¢

(22) COLOR INSULATORS.  
18 F 01778 Shpg. wt. 4 oz. ....Pkg. of 6 39¢

(23) LAG SCREWS AND EXPANSION SHIELDS. 1/4" dia. shank x 1 1/2" long.  
18 F 63364 Shpg. wt. 4 oz. ....Pkg. of 4 99¢

(24) MAST CLAMP. Galvanized steel.  
18 F 01950 Shpg. wt. 5 oz. ....Net 55¢

(25) U BOLTS. Made of galvanized steel.  
18 F 02024 Shpg. wt. 5 oz. ....Pkg. of 2 45¢

(26) BEHIND-SET QUICK CLIP. Can't short out.  
18 F 02057 Shpg. wt. 4 oz. ....Pkg. of 2 45¢

(27) INSULATED NAILS. For 300-ohm.  
18 F 02032 Shpg. wt. 4 oz. ....Box of 50 79¢

(28) DOUBLE-HEAD INSULATED NAILS. 300-ohm.  
18 F 02040 Shpg. wt. 5 oz. ....Box of 50 88¢

(29) STAINLESS STEEL REPLACEMENT KIT. Complete, for all strap-type mounts. Two 12-ft. 3/4" straps.  
18 F 63091 Shpg. wt. 1 1/2 lbs. ....Net ea. 2.09



(11) \$795



(12) Low As \$950



(13) Low As \$595

(2) South River ST-SN. "Y"-Type Chimney Mount. Two 12" 3/4"W stainless steel straps, heavy-duty bkts., snap-in sockets hold mast for easy installation. For up to 1 1/2" masts. 100% stainless steel!  
18 F 56400 Wt. 3 3/4 lbs. ....Net 8.95

(3) Ratchet-Type Chimney Mount. Two 10" 3/4"W stainless steel straps, for masts to 1 1/2" O.D. Heavy-gauge brackets. Rustproof.  
18 F 63315 Wt. 3 3/4 lbs. ....Net 5.95

(4) "Z"-Type Chimney Mount. Two 10" stainless steel 3/4"W straps, for up to 1 1/2" masts. Rustproof.  
18 F 01653 Wt. 2 1/4 lbs. ....Net 3.50  
HD, with 12 3/4" Straps.  
18 F 02222 .....Net 4.50

(5) 4" Wall Brackets. Special U-bolt holds antenna masts to 1 1/2" O.D. 100% stainless steel.  
18 F 01988 Wt. 1 lb. ....Set of 2 2.99  
Above, rust-resistant steel.  
18 F 01661 .....Set of 2 1.29

(6) South River ST-SN-6. 8" Snap-In Wall Brackets. Snap-in sockets hold masts for easy installation. Up to 1 1/2" masts. Stainless steel.  
18 F 56418 Wt. 3 lbs. ....Net 3.95

(7) Two 8" Snap-In Vent Pipe Mounts. Heavy-gauge, rust-resistant.  
18 F 63349 Shpg. wt. 1 lb. Net 2.95

## Complete Antenna/Rotor and Antenna-Only Installation Kits

Low As \$2150

### A Chimney or Roof-Mount for Rotor Installation

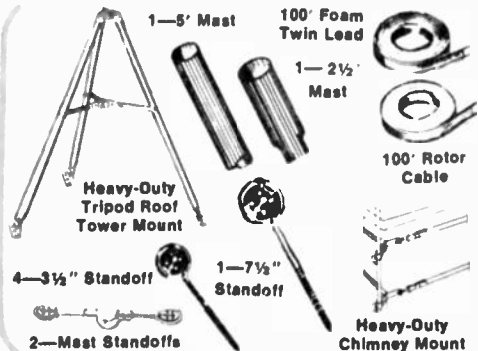

1-5' Mast  
100' Foam Twin Lead  
1-2 1/2" Mast



100' Rotor Cable



Heavy-Duty Chimney Mount

Low As \$1150

### B Chimney or Wall Mount for Non-Rotor Installation

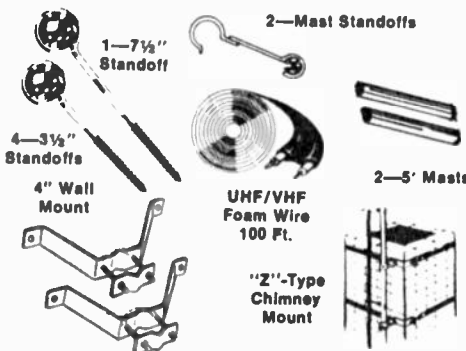

1-7 1/2" Standoff  
4-3 1/2" Standoffs  
4" Wall Mount



UHF/VHF Foam Wire 100 Ft.



2-Mast Standoffs  
2-5' Masts



"Z"-Type Chimney Mount

For use with the antenna and rotator of your choice. All kits include everything you need for complete installation.

**CHIMNEY-MOUNT ANTENNA/ROTOR KIT.** Accessories "A" at left. "Y"-type chimney mount with two 12-ft. stainless steel straps. Less rotor.  
18 F 56392W Shpg. wt. 25 lbs. ....Net 21.50

**TRIPOD ROOF TOWER MOUNT KIT.** Accessories "A" at left, heavy-duty 3-ft. tripod roof tower with pitch patches and lag screws. Less rotor.  
18 F 56384W Shpg. wt. 29 lbs. ....Net 24.95

**CHIMNEY-MOUNT ANTENNA KIT.** Accessories "B" at left, "Z"-type heavy-duty brackets, 12-ft. stainless steel straps.  
18 F 56434W Shpg. wt. 10 lbs. ....Net 14.95

**WALL-MOUNT ANTENNA KIT.** Accessories "B" at left, set of two 4" wall brackets with rust-resistant finish. Shpg. wt. 8 lbs.  
18 F 58442W .....Net 11.50

# Accessories for Professional Outdoor Antenna Installations

Ground Rods, Clamps, Towers, Etc.

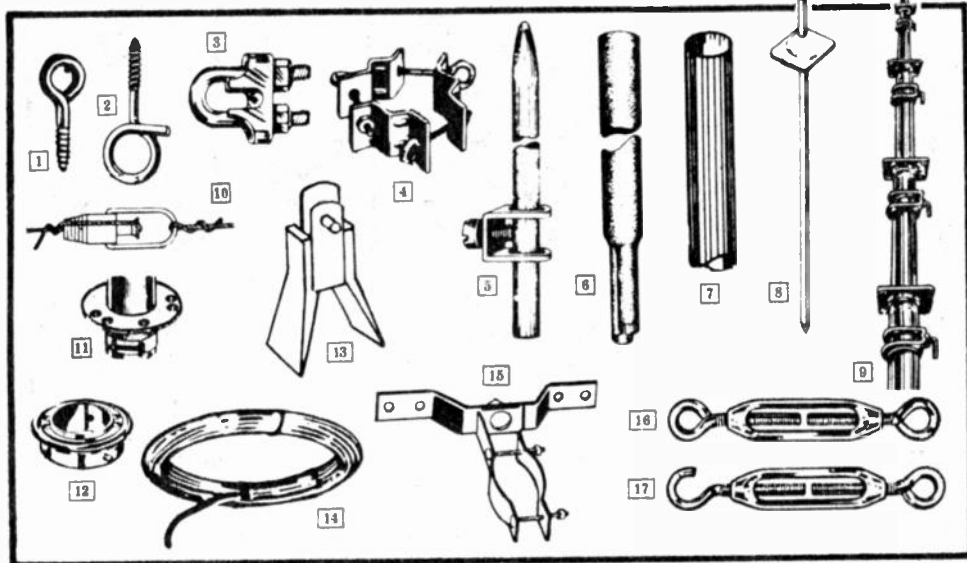

- (1) Closed Eye Bolt. 1/4x5". For guy wires. 18 F 63224 Shpg. wt. 5 oz. ....Net.15
- (2) Guy Wire Hook Eye. Permanent anchor. 18 F 02016 Shpg. wt. 6 oz. ....Pkg. of 5 Net.59
- (3) Cable Clamp. For 3/8" dia. Spliceless. 18 F 63372 Shpg. wt. 4 oz. ....Pkg. of 3 Net.89
- (4) 3-Way Guy Wire Clamp. For up to 2 1/4" masts. With 3 eye bolts. 18 F 63208 Shpg. wt. 10 oz. ....Net.89
- (5) 3/4" Plated Ground Rod. 4-ft. steel yoke. 18 F 72159W Shpg. wt. 1 1/2 lbs. ....Net 1.69
- (6) Gold-Kote Steel Mast. 1 1/4" O.D. Gold-baked enamel finish. 18 F 63257W 5', 20-gauge. Shpg. wt. 2 lbs. ....Net 1.59
- 18 F 63265WX 10', 20-gauge. Shpg. wt. 4 lbs. Net 2.79
- 18 F 63273W 5', 16-gauge. Shpg. wt. 4 lbs. ....Net 2.49
- 18 F 63281WX 10', 16-gauge. Shpg. wt. 4 lbs. Net 4.50
- (7) Aluminum Antenna Masts. 19 gauge, 1 1/4" O.D. 18 F 38176W 5', Shpg. wt. 1 1/4 lbs. ....Net 2.19
- 18 F 56145WX 10', Shpg. wt. 2 lbs. ....Net 3.95
- (7) Heavy-Duty Aluminum Mast. 16-gauge, for larger color antennas. Alodized. 18 F 39257 WX 10-Ft. Shpg. wt. 3 lbs. ....Net 5.25
- (7) Super-Heavy-Duty Aluminum Masts. High-strength aluminum alloy. For rotors, larger antenna arrays. 1 1/4" O.D., full 1/4" wall. 18 F 56202WX 10-Ft. Shpg. wt. 5 1/4 lbs. ....Net 10.25
- 18 F 56269WX 10-Ft. 1 1/2" O.D. ....Net 11.25
- (8) Ground Mast Base. Steel welded for support of ground-up antenna masts. Cone-shaped plate seats bottom of mast securely. For 1-2 1/4" dia., 20-50' masts. 18 F 56467 Shpg. wt. 3 lbs. ....Net 2.49
- (9) Telescoping TV Masts. With all guy rings, clamps and hardware. 18- and 20-gauge walls, 10-ft. sections with precision fittings. 1 1/4" to 2 1/4" O.D. Shipped Express only.

- 18 F 56095WX 50'. 5-sect. Wt. 35 1/2 lbs. ....Net 27.95
- 18 F 56103WX 40'. 4-sect. Wt. 26 1/2 lbs. ....Net 22.95
- 18 F 56111WX 30'. 3-sect. Wt. 18 1/2 lbs. ....Net 15.95
- 18 F 56129WX 20'. 2-sect. Wt. 13 lbs. ....Net 10.95
- (10) Ball-Type Guy Wire Tightener. Cast zinc. 18 F 01935 Shpg. wt. 6 oz. ....Net 1.09
- (11) Guy Wire Ring and Collar. Up to 1 1/4" masts. 18 F 63356 Shpg. wt. 6 oz. ....Net .89
- (12) Cast Aluminum Guy Wire Ring and Collar. Up to 1 1/4" masts. 18 F 81051 Shpg. wt. 7 oz. ....Net 2.50
- (13) Heavy-Duty Peak/Flat Roof Mount. Swivel base, up to 2 1/4" masts. 18 F 56186 Shpg. wt. 3 lbs. ....Net 2.59
- (14) Six-Strand 20-Gauge Galvanized Steel Guy Wire. 33 F 31014 50-Ft. Shpg. wt. 1 lb. ....Net 1.95
- 33 F 31022 100-Ft. Shpg. wt. 2 lbs. ....Net 3.25
- 33 F 31030 500-Ft. Shpg. wt. 8 1/4 lbs. ....Net 12.95
- Aluminum Ground Wire. 33 F 31048 50-ft. Coil. Shpg. wt. 1 lb. ....Net 1.79
- 33 F 31055 100-ft. Coil. Shpg. wt. 2 1/4 lbs. ....Net 3.09
- 33 F 31083 500-ft. Coil. Shpg. wt. 8 1/4 lbs. ....Net 12.50
- Aluminum Guy Wire. 7-18 gauge stranded wires. Breaking strength, 500 lbs. 34 F 46275 100-ft. Roll ....Net 3.95
- (15) 5" Wall-Bracket Mast Mount. For 3 3/4" masts, larger installations, etc. Aluminum. 18 F 56376 Shpg. wt. 1 1/2 lbs. ....Net 3.39
- (16) Steel Turnbuckle. Rustproof, galvanized steel, takes up guy wire slack. 7 1/2" open, 5 1/2" closed. 18 F 72175 Shpg. wt. 5 oz. ....Net .49
- (17) Steel Turnbuckle. As above, with hook and eye. 18 F 72183 Shpg. wt. 5 oz. ....Net .49

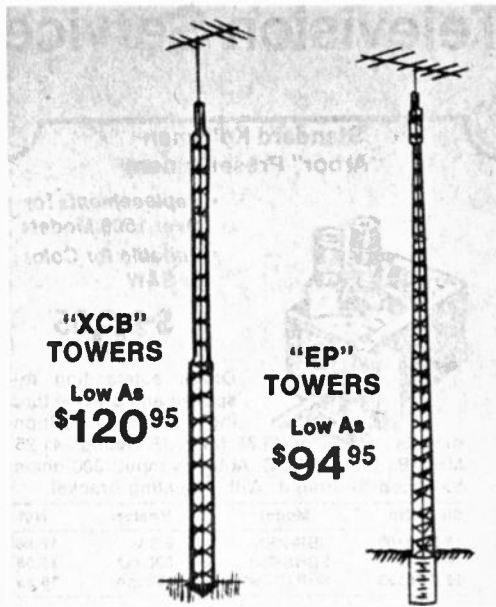

"XCB" TOWERS  
Low As \$120<sup>95</sup>

"EP" TOWERS  
Low As \$94<sup>95</sup>

SPAULDING "STRATO TOWERS"  
"EP SERIES"  
Install on Ground or Roof

High-quality, beaded channel construction. All riveted, no welds to rust. Rugged, zinc-plated steel. More strength—less wind resistance at tower top. Top sections accept any rotator. All sections factory assembled. Each tower consists of one or more 8-ft. sections plus an 8-ft. mast, base plate, house bracket and mast kit assembly. Free-standing installations require guying every 16 feet. Roof mount and guy wires are extra.

Stock No.	Type	Hgt.*	Sect.	Wt.	Net
18 F 73025XZ	EP-2	22'	2	51 lbs.	84.95
18 F 73038XZ	EP-3	30'	3	71 lbs.	115.95
18 F 73041XZ	EP-4	38'	4	90 lbs.	129.95
18 F 73058XZ	EP-5	46'	5	109 lbs.	144.95
18 F 73074XZ	EPR-1	Roof Mount Base	2	2 lbs.	8.75
18 F 73082XZ	GS-12	Guy Station	3 1/2	3 lbs.	7.50

"XCB SERIES"—CYLINDER BASE  
No Concrete Required

Extremely high-strength, self-supporting towers. Self-aligning hinge base for quick, easy installation. Can be assembled on the ground and hinged up or built vertically, section upon section. All-riveted, 100% galvanized steel construction prevents rust. With 4' base, hinged feet, 8' mast, mast kit, 8' tower sects.

Stock No	Type	Hgt.*	Sect.	Wt.	Net
18 F 73090XZ	X-16CB	23'	2	89 lbs.	120.95
18 F 73108XZ	X-24CB	31'	3	120 lbs.	141.95
18 F 73116XZ	X-32CB	39'	4	155 lbs.	175.95
18 F 73124XZ	X-40CB	47'	5	184 lbs.	214.95
18 F 73132XZ	X-48CB	55'	6	272 lbs.	259.95

\*Height includes antenna mast. Shipped FOB Frankfort, Ind. No COD. Send full remittance or use LAFAYETTE'S Easy Pay Plan. Shipping charges collected on delivery.

## Wall-Plugs, Connectors, Bushings, Etc.

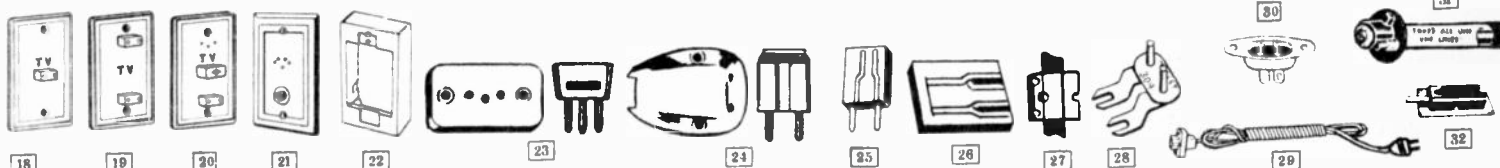

- (18) Lafayette Single TV/FM Wall Plate. Fits standard outlet box. For 300 ohms. With plugs and mounting bracket. Ivory. With plugs. 99 F 40131 Imported. Shpg. wt. 4 oz. ....Net 1.59
- (19) Lafayette Duplex TV/FM Wall Plate. For two antennas, 300-ohm twin lead. With plugs. 99 F 40149 Imported. Shpg. wt. 4 oz. ....Net 1.99
- (20) TV-FM Rotor Wall Plate. 4- or 5-wire rotor outlet, two 300-ohm twin-lead outlets. With plugs. 99 F 40305 Imported. Shpg. wt. 5 oz. ....Net 3.29
- (21) Mosley TV-FM Coax Wall Plates. 75 ohms. 18 F 42087 One TV, FM outlet ....Net 3.85
- 18 F 42095 TV-FM, 4- or 5-Wire Rotor ....Net 5.20
- (22) Surface-Mount Wall Box. For all std. wall plates. 99 F 40024 Imported. Shpg. wt. 6 oz. ....Net .59

- (23) Universal TV-FM Plug and Socket. 300 ohms. Imp. 99 F 40065 ....Net ea. .49
- (24) Deluxe Surface Outlet and Plug. For 300-ohm twin lead, speaker wire. Ivory plastic. 18 F 57259 Shpg. wt. 3 oz. ....Net 1.19
- (25) Solderless Twin-Lead Plug. 99 F 40073 Imported. Shpg. wt. 2 oz. ....Net .39
- (26) Solderless Twin-Lead Socket. 99 F 40081 Imported. Shpg. wt. 2 oz. ....Net .49
- (27) Twin-Lead Splice. No soldering. 18 F 70096 Shpg. wt. 2 oz. ....Net .35
- (28) Antenna Connector. Standard 1/2" spacing. 18 F 42012 Shpg. wt. 3 oz. ....Net .60
- 99 F 40081 Socket for Above. Imported ....Net .49

- (29) TV Line Cord. 6-ft. brown. Molded plug one end, rubber plug other. UL listed. 18 F 41014 Shpg. wt. 4 oz. ....Net .49
- 18 F 74015 As above, polarized terminals ....Net .59
- (30) Interlock TV Line Socket. For all TV receivers. 18 F 27187 1 1/4" mounting. Shpg. wt. 3 oz. ....Net .29
- (31) Universal Bushing. For coax, twin-lead. Fits walls to 1/2" thick. 3/4" hole required. 18 F 72019 Shpg. wt. 4 oz. ....Net 1.70
- (32) Mosley Roof-Thru, Wall-Thru. For antenna, rotor lead-in. No roof cement needed. 18 F 42079 Shpg. wt. 5 oz. ....Net 2.20

Lafayette—Over 55 Years of Electronics Leadership

# Television Service Aids and Accessories

## Standard Kollsman "Arbor" Preset Tuners

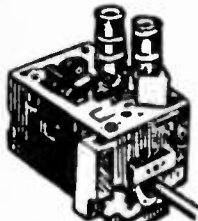

- Replacements for Over 1500 Models
- Suitable for Color or B&W

**\$16<sup>95</sup>**

Offers outstanding response and precise tuning. Thirteen position detents. I.F. Video: 45.75 MHz. I.F. Sound: 41.25 MHz. B: 125-145 VDC. Antenna input: 300 ohms balanced to ground. With mounting bracket.

Stock No.	Model	Heater	Net
18 F 20109	SBR-250	6.3 V	16.95
18 F 20117	SBRS-252	600 mA	16.95
18 F 20125	SBR4S-251	450 mA	16.95



**\$2<sup>95</sup>**



**\$8<sup>75</sup>**

### Color TV Purifiers

**1** Lafayette 7" Color TV Purifier. Demagnetizes color tube for sharper reception. Simply plug in, rotate in front of set. Imported. 117 VAC, 60 Hz. 99 F 40248 Shpg. wt. 1 lb. . . . . Net 2.95

**2** GC 7" Color TV Purifier. Great for in-the-field servicing, fits right in tube caddy. Eliminates stray colors, purifies picture. UL listed. For 117 VAC, 60 Hz. 18 F 84022 Shpg. wt. ¾ lb. . . . . Net 8.75

**3** Stancor 13" Degaussing Coll. "Pro" quality. Has switch to de-energize coil without pulling plug. 9-ft. cord. For 117 VAC, 60 Hz. 18 F 57028 Shpg. wt. 4½ lbs. . . . . Net 12.95



**\$12<sup>95</sup>**

### Replacement Antenna Rods

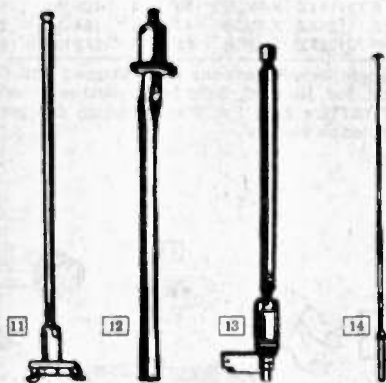

11

12

13

14



15

16

17

### JFD Lightning Arresters

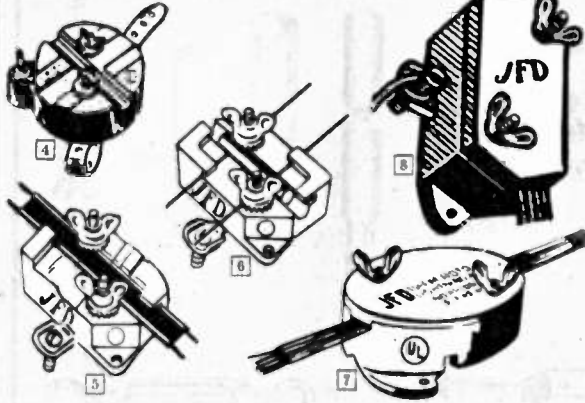

**4** Model AT131S. Economy VHF/UHF Arrester. For flat, tubular, oval twin leads. Sawtooth washers, low-loss material reduces capacity and inductance for maximum signal transfer. With stainless steel strap, hardware. 18 F 38010 Shpg. wt. 6 oz. . . . . Net 1.39

**5** Model AT105S. The "Little Giant." Fits all leads, makes positive contact without wire stripping. For VHF/UHF. With strap and hardware. 18 F 39307 Shpg. wt. 9 oz. . . . . Net 2.19

**6** Model AT110S. Deluxe arrester for flat, tubular, oval twin leads, open transmission lines. High dielectric construction. For UHF/VHF. With strap and hardware. 18 F 38051 Shpg. wt. 5 oz. . . . . Net 2.69

**7** Model AT104S 4-Wire Rotator Arrester. No stripping or splicing necessary. Simply tighten cover for positive contact with lines. With stainless steel strap and hardware. 18 F 38069 Shpg. wt. ½ lb. . . . . Net 2.95

**8** Model AT106S. As above, protects 5-wire antenna rotator lead-ins. With stainless steel strap and hardware. 18 F 38911 Shpg. wt. ½ lb. . . . . Net 3.95

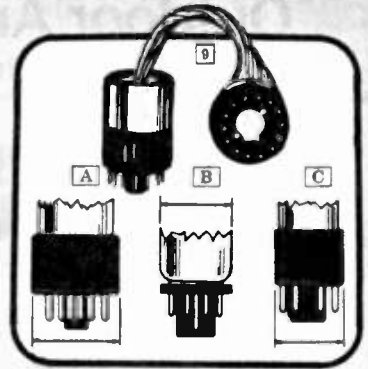

**Complete Kit \$5<sup>95</sup>**



**9** COLOR TV TUBE BRIGHTENERS Boosts filament voltage, brings out lost sharpness and detail in color picture tubes. Plugs in between picture tube and socket. No wiring or switching needed. For round tubes with 12-pin base. 18 F 46070 Shpg. wt. 1 lb. . . . . Net 5.50 For 12-pin rectangular tubes. 18 F 46088 Shpg. wt. 1 lb. . . . . Net 5.95

**9** A Universal Tube Brightener. For black and white, magnetic or electrostatic tubes, parallel or series circuits. For duodecal 12-pin base. 18 F 46005 Shpg. wt. 8 oz. . . . . Net 1.79

**9** B Sylvania-Type 110° Brightener. 18 F 46021 Shpg. wt. 8 oz. . . . . Net 2.39

**9** C Universal 110° Brightener. Heavy-duty unit for series or parallel wired filaments, electromagnetic or electrostatic focus 110°. 18 F 46013 Shpg. wt. 8 oz. . . . . Net 2.39

**10** South River Lightning Protection Kit. Model GND-ANT. Complete kit protects your TV from lightning. Has 50-ft. aluminum ground wire, coppered-steel ground rod and clamp, UL listed lightning arrester, 6 nail fasteners, warning tag and instructions. 18 F 56194 Shpg. wt. 2¾ lbs. . . . . Net 5.95

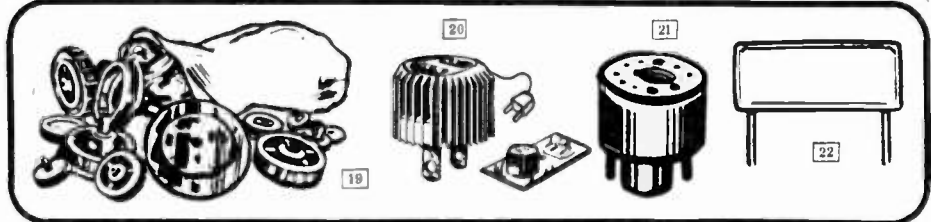

Exact Replacement Antennas for Sony and Panasonic TV sets. Shpg. wt. 8 oz.

**11** 18 F 39265 Pana. AN-109, AN-209. . . . . Net 4.95

**12** 18 F 39273 Pana. AN-29, 32, 52, 59. Net 5.95

**13** 18 F 39281 Sony 500U, 900U, 920U. Net 4.29

**14** 18 F 39299 Sony 700U, 710U. . . . . Net 5.95

**14** Universal Antenna Replacement Rods. For 4, 5, 6, 7 section rods. Shpg. wt. 4 oz.

18 F 54009 4-section, 38" long . . . . . Net 1.49

18 F 54017 5-section, 38" long . . . . . Net 1.79

18 F 54025 6-section, 40" long . . . . . Net 2.19

Swivel Base. Fits most Japanese sets.

18 F 54033 7-section, 40" long . . . . . Net 2.39

**15** Lafayette Color TV Tuner Cleaner and Lubricant. Non-toxic, non-flammable. Will not harm plastic. 6-oz. spray can with injector needle. 18 F 01984 Shpg. wt. 11 oz. . . . . Net 1.19

18 F 02156 16-oz. spray can. 1¼ lbs. Net 2.39

**16** Injector Tuner-Clear Lubricant. As above, 3-oz. spray can with injector needle. 18 F 34043 Shpg. wt. 8 oz. . . . . Net 1.10

18 F 34050 6-oz. spray can. Wt. 12 oz. . . . . Net 2.10

18 F 34068 16-oz. spray can. 1¼ lbs. . . . . Net 2.99

**17** "No-Noise" Volume Control Contact Cleaner. 6-oz. spray can with 5" "extender needle." 18 F 43010 Shpg. wt. 11 oz. . . . . Net 1.99

**18** Chemtronics "Frost Aid." Circuit coolant pinpoints bad capacitors and transistors. 8-oz. spray can with needle. 18 F 52011 Shpg. wt. 1 lb. . . . . Net 1.98

**19** 50-Piece TV Knob Kit. Replacement TV knobs—channel selector, fine tuning, volume, etc. Quality constructed, useful and attractive. Many with gold lettering or inserts. 32 F 99021 Shpg. wt. 1 lb. . . . . Net 1.99

**20** Tube Guard. Prevents voltage surge to radio, TV or hi-fi—extends tube life. Handles 600 watts. For 117 VAC, 60 Hz. 18 F 31106 Shpg. wt. 4 oz. . . . . Net 2.95

**21** Horizontal Bar Generator. Provides horizontal lines for black-and-white TV's, permits precise yoke setting. 18 F 27013 Shpg. wt. 4 oz. . . . . Net 3.19

**22** Fusible Resistor Kit. Includes one each: 4.7, 5.6, 7.5, 9.0 and 22-ohm resistors. 18 F 79048 Shpg. wt. ¼ lb. . . . . Net 1.39

# Lafayette Has Tools For Better Servicing

## REPAIR CRADLE

G.C. stand makes repair work easy. Complete 360° rotation permits you to lock the chassis at the best working angle. Sturdy construction. Adjustable width. Shpg. wt. 4 1/4 lbs.  
**13 F 60890** ..... Net \$6.55



## ILLUMINATED - INSPECTION MIRROR

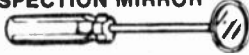

Battery-powered inspecting tool with insulated shaft. Locking switch for on-off and one-hand operation. With bulb but less batteries. 12 1/4" long. Wt. 5 oz.  
**13 F 60825** ..... Net \$3.14  
**89 F 62580** Batteries for above. (2 req.) ..Net ea. .14

Made of metal shaft with 1" dia. glass mirror and plastic handle. Length 7 3/4".  
**13 F 60148** Shpg. wt. 3 oz. .... Net .62

## CORD STRAIN RELIEFS

Package of 5 rubber cord strain reliefs prevents all standard line cords from pulling loose. Fits 3/8" holes. Imported. Shpg. wt. 2 oz.  
**89 F 62747** ..... Net .44



## 24" PICK-UP TOOL



Has mechanical fingers that will pick up and hold screws, nuts and bolts. Just press button to open, release button to close. Flexible shaft.  
**13 F 55551** Shpg. wt. 7 oz. .... Net 1.29

## CRYSTAL-CLEAR ACRYLIC SPRAY

\$1.69



Goes on clear, dries in minutes—tough, pliable, lasting. Prevents deterioration and moisture breakdown of insulation. 1 pint can.  
**13 F 14873** Wt. 1 1/2 lbs. ... Net 1.69  
 Lots of 3 ..... Net ea. 1.49

## ECCOBOND 26 EPOXY ADHESIVE

Repairs tools, hardware, furniture, boats. Permanent adhesion to metals, pastics, paper, ceramics, etc. Cures in four hours at room temperature—in minutes at 150° F. Can be sanded or worked — takes paint readily. White color. Mixes easily.  
**14 F 51053** Wt. 8 oz. .... Net 2.95



\$2.95

## SEVEN LUBRICANT KIT

Kit stands or hangs. The right lubricant for every job. White Grease — All-Purpose Oil — Graphite Powder — Dry White Lubricant — Liquid Graphite — Penetrating Oil — Silicone Grease Stick.  
**13 F 37500** Wt. 1 lb. Net 2.69



\$2.69

## CHEMICALS

83¢



**Pilotbond Cement.** Sticks anything to anything. Dries rapidly—waterproof—very high strength.  
**13 F 60973** 2-ounce bottle. Shpg. wt. 7 oz. .... Net .83  
**Red-X Corona Dope.** Prevents corona shorts in Hi-Voltage circuits. Flexible—fast drying.  
**13 F 60981** 2 oz. Shpg. wt. 7 oz. .... Net 1.05  
**Electronic Contact Cleaner.** New red cleaner, made with DE-OX-ID. Fast drying—universal contact cleaner. Shpg. wt. 7 oz.  
**13 F 61013** 2 oz. .... Net .63  
**Service Cement.** For repairing speakers and general radio work. Vibration-proof, waterproof—fast drying.  
**13 F 61062** 2 oz. Shpg. wt. 7 oz. .... Net .63

## PRECISION OILER

Instrument for precision oiling. Spout is only .003" dia. Made of stainless steel and butyrate. Filled with clear, non-staining machine oil. Can be refilled. Hypo action prevents messy, harmful over-oiling.  
**14 F 83106** Shpg. wt. 3 oz. ... Net 1.09



## SOLDERLESS TERMINALS WITH CRIMPING TOOLS



As Low As \$13.95

**NON-INSULATED TYPE TERMINAL ASSORTMENT.** Contains 180 ring, spade, flanged spade, hook, quick disconnect terminals and butt connectors in wire ranges 22-18 through 12-10, plus Universal Crimping Tool in plastic box.  
**13 F 43011** Wt. 2 3/4 lbs. ... Net 13.95

**INSULATED TYPE TERMINAL ASSORTMENT.** Contains 120 ring, spade, flanged spade, quick disconnect terminals and butt and closed-end connectors in wire ranges from 22-18 through 12-10, plus Universal Crimping Tool in plastic box.  
**13 F 43029** Wt. 2 1/2 lbs. ... Net 14.95

## Waldom Solderless Terminals and Connectors

Crimp or rapidly and make positive, uniformly reliable connections. Column headed "Type": ST is Spade Tongue; HT is Hook Tongue; FS is Flanged Spade; RT is Ring Tongue; BC is Butt Connector (length of non-insulated 3/4", insulated 1 3/4"); QDM is Quick Disconnect Male; QDF is Quick Disconnect Female; NI is Nylon Insulated Closed-End Connector. Avg. shpg. wt. 10 oz. .... Net 1.09

Type	Fig.	Wire Range	Slud Size	NON-INSULATED TYPES		INSULATED TYPES	
				Qty.	Stock No.	Qty.	Stock No.
ST	1	22-18	5-6	40	13 F 73804	18	13 F 73794
ST	1	16-14	8	35	13 F 73812	15	13 F 73802
ST	1	—	10	40	13 F 73820	18	13 F 73810
ST	1	16-14	5-6	35	13 F 73838	15	13 F 73828
ST	1	16-14	8	35	13 F 73848	15	13 F 73838
ST	1	16-14	10	35	13 F 73858	15	13 F 73848
HT	2	22-18	5-6	40	13 F 73861	18	13 F 73851
FS	3	22-18	5-6	35	13 F 73878	15	13 F 73868
FS	3	16-14	5-6	40	13 F 73886	18	13 F 73876
RT	4	22-18	5-6	40	13 F 73895	15	13 F 73877
RT	4	22-18	8	40	13 F 73703	18	13 F 73893
RT	4	22-18	10	35	13 F 73711	15	13 F 73888
RT	4	16-14	5-6	40	13 F 73723	15	13 F 73901
RT	4	16-14	10	35	13 F 73737	16	13 F 73918
RT	4	12-10	10	25	13 F 73745	10	13 F 73935
BC	5	22-18	—	40	13 F 73752	10	13 F 73927
BC	5	16-14	—	40	13 F 73760	16	13 F 73943
QD	6	18-14 1/4"	Male	30	13 F 73778	10	13 F 73968
QD	6	18-14 1/4"	Female	30	13 F 73786	10	13 F 73992
NI	7	22-14	OD 3/4", I.D. 1/2"	20	13 F 73978		
NI	7	16-10	Lgh. 3/4", I.D. 3/8"	15	13 F 73984		

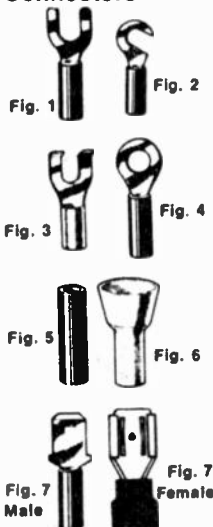

## Waldom Radio and TV Hardware



Av. Shpg. wt., 4 oz.

**Fig. 8—Vinyl Gommets**  
 Stock No. Size Net Qty.  
**13 F 43912** 1/8" 15 .59  
**13 F 43920** 3/16" 10 .59  
**13 F 43938** 1/4" 10 .59  
**13 F 43946** 5/16" 10 .59  
**13 F 43953** 3/8" 10 .59  
**13 F 43961** 1/2" 10 .59  
**13 F 43979** 5/8" 3 .59

**Fig. 9-10—Solder Lugs—Hot Tin Dipped**  
 Stock No. Fig. Hole Qty. Net  
**13 F 43987** 9 #6 20 .59  
**13 F 43995** 9 #8 20 .59  
**13 F 43417** 10 #6 20 .59  
**13 F 43425** 10 #8 20 .59

**Fig. 11—Knob Set Screws**  
 Stock No. Qty. Net  
**13 F 42516** Assortment 20 .59

**Fig. 12—Metal Washers, Nickel Plated**  
 Stock No. Qty. Net  
**13 F 42534** Assortment 100 .59

**Fig. 13—"C" Washers**  
 Stock No. Qty. Net  
**13 F 42583** Assortment 35 .59

**Fig. 14—Extruded Fiber Washers**  
 Stock No. Qty. Net  
**13 F 42609** Assortment 40 .59

**Fig. 15—Tension Springs**  
 Stock No. Size Qty. Net  
**13 F 42625** Assorted Large 15 .59  
**13 F 42633** Assorted Small 15 .59

**Fig. 16—Rubber Feet**  
 Stock No. Size Qty. Net  
**13 F 42674** 3/4" O.D. 10 .59  
**13 F 42682** 1/2" O.D. 10 .59

## WALDOM HARDWARE KITS

**SELF-TAPPING SHEET METAL KIT**  
 Contains balanced assortment of plated self-tapping, slotted hex head sheet metal screws in sizes: #4 x 3/8", #6 x 1/4", #6 x 1/2", #6 x 3/4", #8 x 1/4", #8 x 3/8", #8 x 1/2", and #8 x 3/4". Total of 145 pieces in handy compartmented plastic box with hinged cover.  
**13 F 73190** Shpg. wt. 3/4 lb. .Net 1.95



**230-PC. SCREW & NUT KIT**  
 Round-head plated machine screws in sizes 4-40 x 1/2, 6/32 x 3/4, 8/32 x 1/2, sheet metal screws, #6 x 1/2 and assortment of nuts.  
**13 F 73206** Shpg. wt. 3/4 lb. .Net 1.95

**BINDER HEAD ASSORTMENT**  
 Same as above but machine screws have binder heads.  
**13 F 73216** Shpg. wt. 3/4 lb. Net 1.95

**30-PC. WOOD SCREW KIT**  
 Eight sizes for #4, #6 and #8 holes.  
**13 F 73224** Shpg. wt. 3/4 lb. .Net 1.95

## UNIVERSAL ALIGNMENT TOOL KIT



A handy, all-purpose kit in a convenient vinyl pouch. Six basic essential tools from 4 1/4" to 7" L, with 12 serviceable sides that will service the majority of TV sets, FM, AM, CB, Ham instruments, etc.  
**12 F 30028** Shpg. wt. 4 oz. .... Net 2.39

## LOCKING FORCEPS



All stainless steel 5 1/2" long. They have unusual holding qualities necessary in many servicing situations.  
**14 F 23011** Straight Nose. Shpg. wt. 4 oz. .... Net 3.95  
**14 F 23029** Curved Nose. Shpg. wt. 4 oz. .... Net 3.95

## 1-lb. MIXED HARDWARE ASSORTMENT

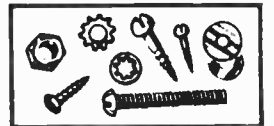

Provides the parts for an unlimited number of repair jobs. Packaged in a handy plastic box.  
**13 F 61245** Wt. 1 1/4 lbs. ... Net 1.63

## CRIMPING TOOL WITH BOLT CUTTER



Make connections fast without soldering. Cuts and strips wire 22 to 10 gauge. Wire cutter at tip for close work. Crimps both insulated and non-insulated terminals. Bolt slicer accommodates 6 sizes of bolts, 4-40, 5-40, 6-32, 10-32 and 10-24.  
**13 F 44001** Shpg. wt. 3/4 lb. ... Net 5.95

## CRIMPING TOOLS AND TERMINALS \$2.95



Solderless terminal crimp tool cuts any size wire up to 10 gauge, strip wire easily. Crimps terminals quickly. Easy to use with insulated handles. With assorted solderless terminals and connectors. Imported.  
**13 F 70006** Shpg. wt. 3/4 lb. ... Net 2.95

## 9-PC. ALIGNMENT TOOL KIT

Model 8455. Contains nine essential TV tools in roll-type case: K-tran, channel tool, short tool for RF and IF, core aligner, universal aligner, oscillator tool, long reach aligner, duplex aligner, flex, tuning wand.  
**13 F 80817** Shpg. wt. 8 oz. Net 7.65

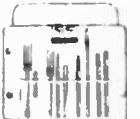

\$7.65

## 5-PC. COLOR T.V. ALIGNMENT TOOL KIT

Model 8454. For all standard adjustments in color TV. Made of natural Delrin®. "Extend-It" makes each tool a long-reach aligner.  
**13 F 61203** Shpg. wt. 4 oz. Net 2.74



## 9-PC. CB ALIGNMENT TOOL KIT

Model 9210. For tuning IF transformers, RF coils, antennas, oscillator coils, etc. Plastic carrying case. Shpg. wt. 4 oz.  
**13 F 61237** ..... Net 5.38



# Solder Guns—Irons—Kits

**U.L. Listed**  
**\$3.49**

**U.L. Listed**  
**\$2.99**

## 1 Lafayette Soldering Gun

Comfortable, contoured pistol grip. 30-watt ventilated element is just right for working on printed circuits and miniature electronic equipment. Easily replaceable tip. Imported. 115 VAC.  
**99 F 80830 Shpg. wt. ¾ lb. . . . . Net 3.49**  
**99 F 80285 Replacement Tip. Wt. 2 oz. . Net .49**

## 2 Lafayette 30-Watt Soldering Pencil

Nine inches long—weighs a mere 2 oz. less the cord—for reaching easily into "parts-packed" chassis. Especially suited for precision electronic wiring. Highly stable heating assures long life. Replaceable, screw-in, nickel-plated, copper tip. 110-120 VAC/DC. Imported.  
**99 F 80350 Shpg. wt. ¾ lb. . . . . Net 2.99**  
**99 F 80285 Replacement Tip. Wt. 2 oz. . Net .49**

# Weller

## Dual-Heat Soldering Guns

**100-140 WATTS**  
**As Low As \$10.95**

**145-210 WATTS**  
**As Low As \$11.95**

### 3 100-140-Watt "Expert" Soldering Kit

**Model 8200-PK.** Compact design and built-in prefocused spotlight. Break-proof plastic utility case can be used to hold other parts or tools. Consists of 8200 gun with exclusive tip grip which assures constant heat. Dual heat feature gives choice of 100 or 140 watts. Three soldering tips, tip changing wrench, nylon flux brush, soldering aid and all-purpose solder. High impact plastic case. UL listed.  
**13 F 39159 Shpg. wt. 3 lbs. . . . . Net ea. 11.85**  
**Lots of 3 . . . . . Net ea. 10.95**

### 4 100-140-Watt Dual-Heat Gun

**Model 8200.** Dual heat solder gun only, featured in above kit. Includes tip, instruction book. 120 VAC, 60 Hz. UL listed.  
**13 F 39142 Shpg. wt. 2¾ lbs. . . . . Net ea. 9.80**  
**Lots of 3 . . . . . Net ea. 8.80**

### 5 240-325-Watt Heavy-Duty Kit

**Model D-550 PK.** A professional, heavy-duty soldering kit featuring the dual heat 240-325-watt Weller gun. Consists of all-purpose solder, cutting tip, soldering tip, smoothing tip, tip changing wrench and instruction booklet. High-impact plastic case with carrying handle. UL listed.  
**13 F 39183 Shpg. wt. 4½ lbs. . . . . Net ea. 16.65**  
**Lots of 3 . . . . . Net ea. 14.95**

**Model D-550.** 240-325-watt heavy-duty gun.  
**13 F 39175 Shpg. wt. 4 lbs. . . . . Net ea. 14.15**  
**Lots of 3 . . . . . Net ea. 11.35**

### 6 145-210-Watt Professional Gun

**Model D-440.** Increased wattage—dual spotlights—rugged plastic case—featherweight balance. Comes equipped with cord, plug and one tip. Dual heat. For 110-120 VAC, 60 Hz. UL listed.  
**13 F 39167 Shpg. wt. 4¼ lbs. . . . . Net ea. 13.30**  
**Lots of 3 . . . . . Net ea. 11.95**

### Weller Replacement Tips and Parts

Stock No.	Type	Description	Avg. shpg. wt. 3 oz.	Net
13 F 39191	7300	2 Copp. tip for B, S-107, D-207	.99	
13 F 39209	8125	2 Plated tip for 8200, 8100B	.99	
13 F 39217	8125N	Tip nuts w/tip for 8200, 8100B	.99	
13 F 39225	7135	2 Copp. tip, D-440, 8100, 8200	.99	
13 F 39233	7135N	Tip nuts w/tip, D-440, 8100, 8200	.99	
13 F 39241	7250	2 Copp. tip, S-500, D-550, 8250A	.99	
13 F 39256	7250N	Tip nuts w/tip, S-500, D-550, 8250A	.99	
13 F 39274	6110	Cutting Tip for D-440, 8100, 8200, 8100B	.99	
13 F 39282	6120	Smoothing tip for D-440, 8100, B8200	.99	
13 F 39290	6130	Cutting tip for D-550, 8250A	.99	
13 F 39308	6140	Smooth. tip for D-550, 8250A	.99	
13 F 39316	7323	Switch for all one-heat mods.	1.50	
13 F 69324	7324	Switch for all dual-heat mods.	1.50	
13 F 39423	ST-1	1/16" screwdriver tip for WPS	1.30	
13 F 39431	ST-2	3/32" screwdriver tip for WPS	1.30	
13 F 39449	ST-3	1/8" screwdriver tip for WPS	1.30	
13 F 39530	ST-4	3/16" screwdriver tip for WPS	1.30	

### 7 25-450-Watt Soldering Kit

**Model 450K4.** Kit contains Model 450 25-450-watt gun that automatically regulates heat to suit the job and three interchangeable tips for 25 to 450 watts of heat power. Complete with solder and carrying case. UL listed.  
**13 F 65360 Shpg. wt. 4 lbs. . . . . Net 17.95**

### 8 Lightweight Soldering Pistol

**WEN 75.** Has spotlight, trigger on-off. Draws only enough current necessary with ATR—50W surge and 30W operating produces 100W heat. Transformer voltage is low for cool handling. 120 VAC. UL listed.  
**13 F 65279 Shpg. wt. 1¾ lbs. . . . . Net 6.25**

### WEN REPLACEMENT TIPS Shpg. wt. 3 oz.

Stock No.	Type	Description	Net
13 F 65220	45F7	25-100W tip for 222, 450	2.50
13 F 65238	45M7	100-200W tip for 222, 450	2.50
13 F 65246	45A7	200-45W tip for 450	2.50
13 F 65204	75A7	Standard tip for 75	2.20
13 F 65212	75B7	Fine tip for 75	2.20
13 F 65295	19B4	Replacement tip for 100	1.20
13 F 65253	45S7	Plastic Cutter Attachment for 222 and 450	1.20
13 F 65261	45P57	Flat Iron Attach. for 222, 450	1.20

**WEN**  
**\$17.95**

**WEN**  
**\$6.25**

**Low As \$3.50**

**\$5.45**

## 7 Professional Soldering Irons

Professional lightweight iron for miniature soldering, kit building and production work. Stainless steel barrel. Long life double coated tips. Only 7¾" long; 1¾ oz. Complete with tip and 2-wire cord. For 120 VAC, 60 Hz. Shpg. wt. 8 oz.

Stock No.	Mfg. No.	Description	Net Each
13 F 39415	WP-25	25-watt iron, 1/8" tip	5.45 4.35
13 F 39597	WP-40	40-watt iron, 1/8" tip	6.70 5.35

## 8 Soldering Iron Kit

**Model SP-23-K.** Kit contains: 25-watt iron; 5 ft. 60/40 rosin core solder; 3 pre-tinned, plated copper tips; solder aid tool and instructions.  
**13 F 39456 Shpg. wt. ¾ lb. . . . . Net 5.45**

**Model SP-23.** 25-watt soldering pencil.  
**13 F 39464 Shpg. wt. ½ lb. . . . . Net 3.50**

**Cone-shaped tips for SP-23 iron.**  
**13 F 39548 (Pkg. of 2) . . . . . Net 1.00**

**Gunmaster Universal Solder/Desolder Tip**  
**\$1.29**

Fits any twin-heating element gun—Weller, Craftsman, Wen, etc. Has hollow bore tip for desoldering, solid-slug tip for soldering. Permanently mounted on gun.  
**13 F 42005 Shpg. wt. 3 oz. . . . . Net 1.29**

**\$5.95 X-Acto "Extra Hands"**

One of the handiest solder and hobby aids ever! Alligator spring clips hold work at any angle for soldering, glueing, etc. Heavy base prevents tipping, can be held in vise or clamped. Approx. 5½ x 5½".  
**13 F 74289 3 lbs. . . Net 5.95**



**Ungar®**

# Precision-Made Soldering Irons



**\$12.42**



**\$2.50**



**\$7**

## Imperial 6010 45-Watt Soldering Kit

Contoured design for easy fingertip control. Includes 45W, 120V heat cartridge, gives up to 950°F tip temperature. Perma-cooled handle, no heat build-up. Cord, heat cart., 3 tips. UL listed.  
 13 F 21991 Shpg. wt. 8 oz. .... Net 12.42  
 13 F 21223 Taper chisel replacement tip. Net .68

## 777 "Clean-Room" Handle

Easy-grip 777 pencil-type handle accepts wide range of tips, tiplets, thread in elements. Convection-cooled handle, full length, insulated cord. 5" long. UL listed.  
 13 F 21868 Shpg. wt. 6 oz. .... Net 2.50

## 7070 Technician Soldering Kit

Handy kit is a must for any technician—ideal for use in small circuitry work. With perfect-balance handle and safe cork grip, 3 interchangeable thread-on copper tips, #1237 heating unit. 42W, 120 VAC. UL listed.  
 13 F 21900 Shpg. wt. 10 oz. .... Net 7.00

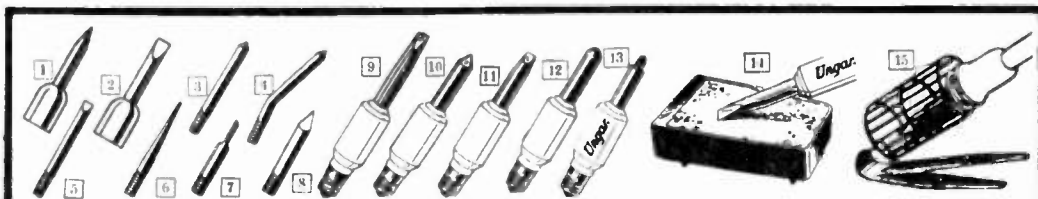

### Accessories for Soldering Ease

#### Tiplets and Mini-Tips

100 series mini-tips (3/4" L x 1/8" O.D.) used with 1237, 4037 & 145 units. 300 series tiplets (1" L x 1/8" O.D.) use 535, 1235, 4035 heating units & Princess soldering irons. 800 series tiplets (3/4" O.D.) used with 4045 unit. PL series is silver-plated. Shpg. wt. 3 oz.

Stock No.	Mod.	Fig.	Type	Net
13 F 21629	PL111	1	Pencil	1.10
13 F 21637	PL113	2	Chisel	1.10
13 F 21645	PL331	3	Pencil	.85
13 F 21652	PL332	4	Offset	.85
13 F 21660	PL333	5	Chisel	.85
13 F 21678	PL338	6	Needle	.85
13 F 21686	PL340	7	Micro	.85
13 F 21694	PL823	8	Pyramid	.97
13 F 21702	PL824	5	Chisel	.97
13 F 21710	PL833	5	Chisel	1.30
13 F 21728	PL834	4	Offset	1.30
13 F 21736	111	1	Pencil	.53
13 F 21744	113	2	Chisel	.53
13 F 21751	331	3	Pencil	.35
13 F 21769	332	4	Offset	.35
13 F 21777	333	5	Chisel	.35
13 F 21785	823	8	Pyramid	.40
13 F 21793	824	5	Chisel	.40

#### Element Units with Tips

4000 Series, Super Hi-Heat. 850-1000°F tip temp. 50 watts. Tellurium copper base, plated with iron and pure silver. For 120 V. AC DC. For 776 and 777 Handle. Wt. 4 oz.

Stock No.	Type	Fig.	Desc.	Net
13 F 21462	4033	9	1/4" Chis.	4.33
13 F 21470	4036	10	Pyramid	4.33
13 F 21488	4039	11	3/8" Chis.	4.33

1200 Series, Hi-Heat. 750-800°F tip temp. 42 watts. Silver-plated solid Armco pure iron. \*Copper tip. For 120 V. AC DC. Avg. wt. 4 oz.

Stock No.	Type	Fig.	Desc.	Net
13 F 21496	1233	9	1/4" Chis.	2.98
13 F 21504	1236	10	Pyramid	2.98
13 F 21512	1239	11	3/8" Chis.	2.98

500 Series, Standard. 650-700°F tip temp. 27 watts. Tellurium copper tip. For 120 V. AC DC. Wt. 4 oz.

Stock No.	Type	Fig.	Desc.	Net
13 F 21520	533	9	1/4" Chis.	2.05
13 F 21538	536	10	Pyramid	2.05
13 F 21546	539	11	3/8" Chis.	2.05

#### Heating Units

For 776 & 777 handles. Use interchangeably with any triplet except \* for 800 and † for 100 series. For 120 V. AC DC. Shpg. wt. 4 oz.

Stock No.	Type	Fig.	Desc.	Net
13 F 21405	4045*	12	850°-50W	4.33
13 F 21413	4035	12	850°-50W	4.33
13 F 21421	4037†	13	850°-50W	4.33
13 F 21439	1235	12	750°-42W	2.98
13 F 21447	535	12	650°-27W	2.05
13 F 21454	1237†	13	750°-42W	2.98

#### Ungar Kleen Tip #400

Phenolic tray, two sponges, and a bracket will keep tips super clean.  
 13 F 21819 Wt. 4 oz. .... Net 1.53  
 13 F 21975 Refill sponge .Net .62

#### Soldering Iron Holders

Adjustable angle. Attaches anywhere.  
 #6800 for Imperial & 3-wire irons.  
 13 F 21157 Wt. 10 oz. .... Net 2.72  
 #8000 for Standard Line.  
 13 F 21165 Wt. 10 oz. .... Net 2.72

**\$16.58** <sup>17</sup>



**Ungar**

**\$11.78**

<sup>16</sup> Model 6975 Featherweight pencil, with 10-watt capsule, 3 copper tips. Known as the lightweight. Offers fingertip control with high heat for critical miniature soldering.  
 13 F 21876 Shpg. wt. 5 oz. .... Net 11.78

<sup>17</sup> Princess Soldering Station. Model 6900. Above pencil w/holder, sponge. Very handy.  
 13 F 21884 Shpg. wt. 7 oz. .... Net 16.58  
 13 F 20795 Replacement sponge .Net 70¢

#### HEAT CAPSULES

For use with Princess miniature soldering irons. Heat ranges from 550°F (10 watts) to 1000°F (18 watts). Shpg. wt. 3 oz.

Stock No.	Model	Tip Temp.	Watts
13 F 21934	6910	550°F to 650°F	10
13 F 21892	6915	700°F to 800°F	15
13 F 21942	6918	900°F to 1000°F	18

Net ea. .... Net 5.90

#### REPLACEMENT TIPS

See Left for Listing under Tiplets and Mini-tips. #PL-300 and 300 Series will fit Princess Heat Capsules.

<sup>18</sup> Hot-Vac De-Soldering Tool. Model 7800. Remove solder efficiently, no mess. Hot-Vac melts, removes solder.  
 13 F 21850 Shpg. wt. 10 oz. .... Net 16.58  
 13 F 21959 Repl. tip .... Net 1.07  
 7825 De-Soldering Attachment. Similar to 7800 above, but only includes attachment. For use with #4037 heating unit and #777 handle.  
 13 F 20878 Shpg. wt. 6 oz. .... Net 10.92

**Ungar**



**\$7.50**

## 3-Wire 45-Watt Soldering Iron

Model 145. Three-prong plug grounds solder tip, eliminates static which could damage delicate components. Cool-grip handle, flexible power cord, meets NASA, other Gov't specs. Tip temp., 900-1,000°F. 120 VAC, 45 watts. Less tip. Use same tiplets and minitips as #PL-100 and 100 series.  
 13 F 20860 Shpg. wt. 1 lb. .... Net 7.50

**Black & Decker**

**\$14.99**



Model 9301 Cordless Soldering Pencil. New! Very portable, use anytime, anywhere. Built-in light, easy on-off switch. Great for hobbyists or electricians. Includes two nickel cadmium batteries, charger and tool rest. Heats in seconds. UL listed.  
 12 F 68000 Shpg. wt. 2 1/4 lbs. .... Net 14.99  
 12 F 68018 Replacement Chisel Tip .... Net 2.99  
 12 F 68026 Precision Soldering Tip .... Net 2.99

**WAHL**

**\$19.95**



## Deluxe Cordless Soldering Iron

Amazing versatility! Solder up to 100 joints on one battery charge. Heats in 5 seconds to 700°F tip temp. Includes built-in light, batt. re-charger, pushbutton switch, fine solder tip.  
 13 F 82506 Shpg. wt. 1 lb. .... Net 19.95  
 13 F 82514 Reg. Tip for general use .Net 1.99

# Welders—Torches—Solder

## SOLIDOX

- Generates 5000° Flame
- Lightweight—Portable
- Cuts 3/8" Bolts

**\$34.95**



### Oxygen Welding Torch Kit

Uses oxygen pellets and propane, the new welding method that's safe and convenient! Single valve control. Includes torch, propane cylinder, 2 tips, pellets (100 min. burn time), safety glasses, igniter, brazing rods, stand, instructions.

- 14 F 50501W Wt. 12 lbs. .... Net 34.95
- Large Tip Pellets. 65-min. burn time.
- 14 F 50519 Shpg. wt. 2 1/2 lbs. .... Net 2.95
- Small Tip Pellets. 90-min. burn time.
- 14 F 50550 Shpg. wt. 2 1/2 lbs. .... Net 3.19
- Oxygen Rich Pellets. 65-min. burn time.
- 14 F 50527 Shpg. wt. 2 1/2 lbs. .... Net 3.19
- 5-Piece 18" Welding and Brazing Rods. Assorted bronze, nickel/silver and aluminum.
- 14 F 50543 Shpg. wt. 6 oz. .... Net 1.49
- Replacement 14-oz. Propane Cylinder.
- 13 F 26511 Shpg. wt. 2 1/4 lbs. .... Net 1.59

### Braze—Weld—Silver Solder

#### Miniature Torch Sets



#### 'Cub' Torch

- Reaches 2500° F
- Precision-Point Accuracy
- Replaceable Butane Cylinders

**\$4.95**

Solders and Brazes

## Microflame

### 1 Miniature Welding Torch Set

Welds, brazes, cuts most metal. Completely self-contained, produces 5000° pin-point flame. For delicate printed circuit repair, jewelry, shop, dental lab, tool and model making. Includes 2 tip sizes; 1 butane and 1 oxygen cylinder; gaskets; instructions. 5 1/4 L x 2 W x 1 1/4".

- 14 F 42508 Wt. 1 1/4 lbs. .... Net 19.95

### 2 Deluxe Miniature Torch Set

As above but 6 Micronox, 3 LP gas cyls.; 12 brazing rods; bench bracket.

- 14 F 42532 Wt., 2 1/2 lbs. .... Net 28.95
- 14 F 42516 Butane Cyl. (2) .... Net 1.29
- 14 F 42524 Micronox Cyl. (2) .... Net 1.29

### 3 "Cub" Butane Utility Torch

Completely self-contained. Directional, adjustable flame solders and brazes. With windguard and butane refill.

- 14 F 42573 Wt. 1 lb. .... Net 4.95
- 14 F 42581 Butane Cyl. (Pk-2) .... Net .99



**\$11.95**

### "Flexi-Fire" Torch

- Positive Control Valve On Torch Handle

Versatile torch, complete with 4' flexible hose and molded hand grip. Specially designed wire legs assure proper positioning. Brass construction, light weight. Operates in ANY position.

- 14 F 50568 Wt. 1 lb. .... Net 11.95
- 14 oz. Propane Cylinder
- 13 F 26511 Wt. 2 1/4 lbs. .... Net 1.59

**MARK 35**

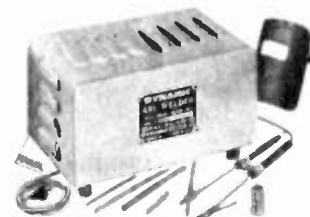

**\$19.95**

### Portable Electric Arc Welder

- Braze, Weld, Solder, Cut • 11,000° F

Make your own repairs—even on auto bodies. Cuts and welds 1/4" metals with 1/8" welding rods and 1/4" carbon. Completely portable. Includes welding and carbon rods, protective mask, holders, 10' H.D. cables, ground clamps, brazing rods, flux, solder, instructions. Fused for 30 amps. For 115V AC or DC. 60 Hz.

- 13 F 20548 Wt. 7 1/4 lbs. .... Net 19.95

### Kester Solder & Flux Spyralline Solder



- 4 KESTER "44" RESIN CORE SOLDER. Wt.: 1-oz. spool, 4 oz.; 1-lb. spool, 1 1/2 lb. 40% tin, 60% lead.
- 14 F 32012 1/16" Dia. 1 oz. Net 59¢
- 14 F 32020 3/32" Dia. 1 lb. Net 4.95
- 14 F 32046 1/16" Dia. 1 lb. Net 4.95
- 50% tin, 50% lead.
- 14 F 32111 1/16" Dia. 1 lb. Net 5.95

- KESTER PASTE FLUX
- 14 F 32137 2-oz. can ... Net 39¢

- 5 SPYRALINE SOLDER. 60% tin, 40% lead. 11", 1/16" Dia. Wt. 4 oz.
- 14 F 39058 ..... Net 1.19

- 5 SPYRALINE PRINTED CIRCUIT TOUCH-UP SOLDER. Melts 240-320°F. Shpg. wt. 4 oz.
- 14 F 39066 ..... Net 1.29

- 6 MULTICORE DISPENSER PAKS. Shpg. wt. 4 oz.

- | Stock No.  | Tin/Lead | Gauge | Ft. | Net  |
|------------|----------|-------|-----|------|
| 14 F 35072 | 60/40    | 18    | 14  | 1.39 |
| 14 F 35080 | 60/40    | 22    | 21  | 1.39 |

- 7 MULTICORE 5 CORE SOLDER. 1-lb. reels. Shpg. wt. 1 1/2 lbs.

### Solder & Flux



Stock No.	Tin/Lead	Ga.	Dia.	Net
14 F 35031	60/40	16	.084"	6.95
14 F 35056	60/40	18	.048"	7.39
14 F 35098	60/40	22	.028"	8.90
14 F 35106	63/37	20	.036"	8.90

- 8 SOLDER & FLUX KITS. Silver solder 1/2" dia., 60" coil. Others are 1/4" dia., 100". Shpg. wt. 4 oz.
- 14 F 39074 Silver ..... Net 1.99
- 14 F 39082 Aluminum ..... Net 1.59
- 14 F 39090 Stainless Steel Net 1.59

### Turner

**\$9.95**



**\$3.95**



- 9 Turner Blow Torch Kit. Sweats fittings, solders, bends metals. Heavy-duty & chisel point tips; flame spread; spark lighter; fuel tank. Handy steel chest. UL listed.
- 13 F 26503 Shpg. wt. 5 lbs. ... Net 9.95
- Super-capacity fuel tank for standard propane torches, stoves, etc.
- 13 F 26511 Shpg. wt. 2 1/4 lbs. Net 1.59

- 10 MINI-TORCH BLOW TORCH AND SOLDERING KIT. 3500°F, pin-point flame charged by a butane cartridge which gives 30 min. of continuous service. Ideal for wiring, appliance and plumbing repairs. Weighs about 4 oz. Complete with 2 chargers, soldering tip and coil of rosin core solder.
- 13 F 45016 Shpg. wt. 8 oz. ... Net 3.95
- Extra Chargers. Pkg. of 4.
- 13 F 45073 Shpg. wt. 7 oz. ... Net 1.45

### SOLDERING AIDS



#### G.C. SERVICE TWEEZERS

### SOLDERING AIDS. Shpg. wt. 3 oz.

Stock No.	Net
14 F 24019 Prid. Ct.—Strt. Tip	1.19
14 F 24027 Prid. Ct.—Ang. Tip	1.19
14 F 24035 Prid. Ct.—Scrp. Tip	1.19
14 F 24043 Straight Tip	1.39
14 F 24050 Angled Tip	1.39

- "SAL-MET" FLUX. Non-corrosive, for all metals. 1-oz. tube. Wt. 3 oz.
- 14 F 49016 ..... Net 1.39

- G.C. SERVICE TWEEZERS. 3 oz. ea. Polished nickel-plated spring steel. Self-closing. 6 1/2". Blunt points.
- 13 F 60858 ..... Net 1.21
- Heavy-duty. 6 1/2". Slide-lock, blunt.
- 13 F 60866 ..... Net 1.38
- Precision. 4 1/2". Pointed.
- 13 F 60874 ..... Net .83
- All 3 above in leatherette case.
- 13 F 60882 ..... Net 3.75

# Hobby Tools and Lathes

## DREMEL® Moto-Tool Kits



**\$36<sup>95</sup>**

• Compact Machine Shop—Versatile!

**Model 271 Moto-Tool Kit.** High-speed precision steel cutters polish, grind, sand, drill. Compact case contains bristle brushes, polishing tips, sanding discs & bands, mandrels, dressing stone, cutting wheels, chuck wrench, and much more. Four collets ( $\frac{1}{8}$ ,  $\frac{1}{16}$ ,  $\frac{1}{32}$  &  $\frac{1}{64}$ "). .8 amp motor. 117 VAC. UL listed. Polyethylene case.  
**14 F 43050** Wt. 3 lbs. . . . .Net **36.95**  
**Model 281. Deluxe Moto-Tool Kit.** Similar to above, ball bearings & .9 amp motor.  
**14 F 43225** Wt. 3 lbs. . . . .Net **48.95**  
**Model 381. New variable-speed Moto-Tool Kit.** Similar to model 281 except with Dial-A-Speed control. 5000-25,000 RPM.  
**14 F 43233** Wt. 4 lbs. . . . .Net **56.95**

## DREMEL® Moto-Tool Accessories



**\$11<sup>50</sup>**

**1 Model 223 Universal Stand.** Holds Moto-Tool at any angle. Cast iron base, quick action clamp. Shpg. wt. 3 $\frac{3}{4}$  lbs.  
**14 F 43092** . . . . .Net **11.50**  
**2 Model 229 Router Attachment.** Calibrated depth control, removable edge guide for free hand and surface routing. Instructions.  
**14 F 43159** Wt. 1 $\frac{1}{2}$  lbs. . . . .Net **9.50**  
**High Speed Router Bits**  
**No. 650  $\frac{1}{8}$ " Straight Cutter Bit**  
**14 F 43187** Wt. 3 oz. . . . .Net **3.50**  
**No. 852  $\frac{3}{16}$ " Straight Cutter Bit**  
**14 F 43175** Wt. 3 oz. . . . .Net **3.50**  
**No. 654  $\frac{1}{4}$ " Straight Cutter Bit**  
**14 F 43183** Wt. 3 oz. . . . .Net **3.50**  
**No. 610 Convex Edger for Beading**  
**14 F 43191** Wt. 3 oz. . . . .Net **3.50**  
**No. 632 Veining Bit for Line Work**  
**14 F 43209** Wt. 3 oz. . . . .Net **3.50**  
**No. 640 "V" Grooving Bit for Lettering**  
**14 F 43217** Wt. 3 oz. . . . .Net **3.50**

**\$9<sup>50</sup>**

## DREMEL Multi-Purpose Moto-Shop

**\$74<sup>95</sup>**



**Model 572.** Flexible accessory shaft gives added versatility. Has 15" jigsaw, for grinding, drilling, routing, sharpening, deburring, carving. Oilless bronze bearing 3450 RPM rotary motor. Instant-action wrenchless chuck, neoprene cover. 3 sanding discs, cloth buffing wheel, mounting bracket, 4 saw blades & 12-piece cutter set are included. UL listed. 117 VAC, 60 Hz. Shpg. wt. 17 lbs.  
**14 F 43068W** . . . . .Net **74.95**

### 12-Pc. Rotary Steel Cutter Set



Assortment of 12 steel burrs of various shapes. Tempered steel for use on metal, plastic or wood.  $\frac{1}{8}$  &  $\frac{3}{32}$ " shafts. Handy box. Wt. 3 oz.  
**13 F 50032** . . . . .Net **2.95**

### 6-Pc. Mounted Stone Set



Six assorted grinding stones & wheels. Mounted on  $\frac{1}{8}$  &  $\frac{3}{32}$ " shafts. Ideal for hobby tools. Shpg. wt. 5 oz.  
**13 F 50016** . . . . .Net **1.95**

### 8-Pc. Brush & Stone Set



Eight assorted pieces mounted on  $\frac{1}{8}$  or  $\frac{3}{32}$ " shafts. 2 bristle brushes, 2 wire wheels and 1 steel bun in box. 4 oz.  
**13 F 50024** . . . . .Net **2.75**

Charge It with Your BankAmericard or Master Charge.

## UNIMAT Miniature Machine Shop

**\$199<sup>50</sup>**



• All Purpose 5-in-1 Metal-Machining Workshop  
 • Mill, Bore, Saw, Buff, Sand, Polish, Grind!

Multi-Functional! Converts to vertical mill, drill press, grinder. Extra attachments available include: lathe chuck, jig saws, flexible shaft, lathe bed, power feed, threading attachment, precision collets and cutting tools. 900-7,200 RPM  $\frac{1}{8}$  HP motor gives 11 speeds. Drill press arm, lathe dog, grindstone, arbor, tool post, allen wrench, deep wood chest. 44-page manual included. 117 V AC/DC. Imported.  
**14 F 10141W** Shpg. wt. 25 lbs. . . . .Net **199.50**

## UNIMAT Attachments and Accessories

**Model 1001.** 3-jaw lathe chuck with reversing jaws, key & back plate.  
**14 F 10133** Wt. 1 lb. . . . .Net **37.95**  
**Model 1002.** 4-jaw lathe chuck with reversing jaws. Independent adjust.  
**14 F 10075** Wt. 1 lb. . . . .Net **39.95**  
**Model 1005.**  $\frac{1}{4}$ " drill chuck & key.  
**14 F 10158** Wt. 8 oz. . . . .Net **12.95**  
**Model 1210.** 5 x 3" milling table.  
**14 F 10026** Wt. 2 $\frac{1}{4}$  lbs. . . . .Net **19.95**  
**Model 1010.** Vise jaws open 1 $\frac{1}{2}$ ". Mounts on cross slide, mill table.  
**14 F 10034** Wt. 1 lb. . . . .Net **17.95**  
**Model 2820.** Set of 6 lathe tool bits.  
**14 F 10059** Wt. 1 lb. . . . .Net **19.95**  
**Model 1290.** Power feed attachment.  
**14 F 10067** Wt. 4 $\frac{3}{4}$  lbs. . . . .Net **49.95**  
**Model 1080.** Jig Saw Attachment. Cuts to center of 16", with 12 blades.  
**14 F 10117** Wt. 5 lbs. . . . .Net **49.95**

## Sabre-Lathe Multi-Purpose Shop Tool

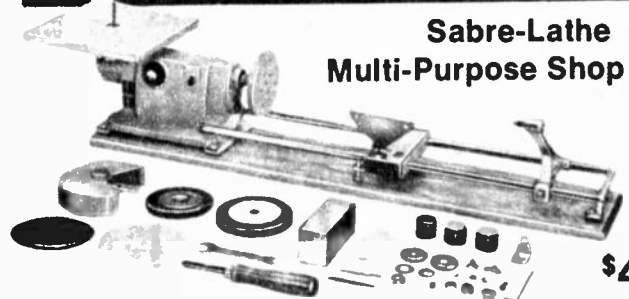

**\$44<sup>95</sup>**

We mean multi-purpose: wood-turning lathe, sabre jig saw, bench grinder, disc or drum sander, horizontal drill, all can be used by the home craftsman to turn out creative pieces. Portable. Powered by  $\frac{1}{8}$  HP motor for 3,100-3,700 RPM speed. Includes full instruction booklet, sabre saw blades, sanding table, chisel, sanding discs. Lathe has 18" bed, 4" throat for spindle or face plate turning. For 117 VAC, 60 Hz.  
**13 F 85509W** Shpg. wt. 17 $\frac{3}{4}$  lbs. . . . .Net **44.95**

## Engraver and Vibrator Tools

**3 BVI Electric Pencil Engraver**  
 Protect your goods from being stolen by identifying with this pencil engraver. Writes on metal, wood or plastic. Tough steel point, marks won't rub off. Decorate luggage, sporting goods, etc. 7 x 3 x 2". 117 VAC, 60 Hz. UL listed.  
**13 F 80542** Wt. 10 oz. . . . .Net **6.95**

**\$6<sup>95</sup>**

**1 Dremel Electric Engraver**  
 Writes like a pencil, heavy-duty, marks all types of material. Adjusts fine or heavy lines. With carbide engraving point. Engrave garden tools, sporting goods, cameras, etc. For 117 VAC, 60 Hz.  
**14 F 43142** Wt. 1 $\frac{1}{2}$  lbs. . . . .Net **12.95**

**\$12<sup>95</sup>**

**5 Burgess Vibro-Tool Kit**  
 File, saw, carve, de-burr with this multi-functional tool. With carbide-tipped engraving point, knife blade, saw blade, 2 half-round  $\frac{1}{2}$  &  $\frac{1}{8}$ " chisels, V-shape & flat edge chisel, abrasive point. Rugged 2-speed motor.  
**13 F 80575** Shpg. wt. 2 $\frac{1}{4}$  lbs. . . . .Net **21.95**

**\$21<sup>95</sup>**

# Lafayette Has Values In Power Saws and Garden Tools

## Black & Decker



Jig Saw <b>\$8<sup>99</sup></b>
Two-Speed Jig Saw <b>\$14<sup>99</sup></b>

**Model 7504 Jig Saw.** Burnout-protected motor, cutting blade. Capacity: hardwood 1", softwood 1 1/2". .20 hp max. output motor has 3,200 SPM. Cut wood, metal, plastic. Starts its own holes. 117 VAC, 60 Hz. 2.1 amps UL listed. Real timesaver! Double insulated.  
12 F 68853 Shpg. wt. 3 1/4 lbs. . . . . Net 8.99

**Model 7514 2-Speed Jig Saw.** Tackle tough jobs easily. Burnout-protected motor. Double insulated. Calibrated tilting shoe for mitre or bevel cuts. High speed 3,200 SPM. Low speed 2,500 SPM. Has cutting blade, .25 hp max. motor output. 2.3 amps. 117 VAC. 60 Hz. UL listed.  
12 F 68861 Shpg. wt. 3 1/4 lbs. . . . . Net 14.99

### Heavy-Duty Variable Speed Sabre-Jig Saw

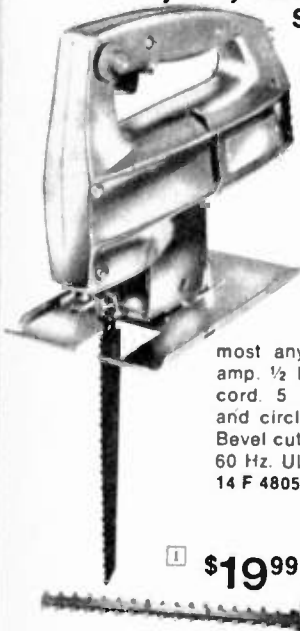

**\$31<sup>95</sup>**

- Cuts Through 6" Logs

Dial variable speed control from 0-5200 SPM. Cuts through most any material. Has 5 amp. 1/2 hp motor with 6'3" cord. 5 blades, rip guide and circle cutter included. Bevel cuts to 45°. 117 VAC. 60 Hz. UL listed. 6 1/4 lbs.  
14 F 48059 . . . . . Net 31.95

**\$19<sup>99</sup>**



**\$14<sup>99</sup>**

**\$39<sup>99</sup>**

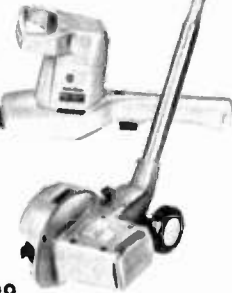

# SKIL

## Deluxe 7 1/4" Circular Power Saw

- Safe Non-Binding Blade Guard
- Safety Switch Button
- Die-Cast Housing
- Sawdust Ejector Keeps Work Clean

**Model 574.** Easy-set bevel, depth adjustments. 7 1/4" combination blade and blade wrench. Powerful 1 3/4 hp motor designed to be trouble free. Cutting depth 90°, 2 3/8"; 45°, 1 7/8". Full safety features let any craftsman, do-it-yourselfer tackle those big jobs. 10 amps. 117 VAC. UL listed. 3-wire cord and plug.  
13 F 69263 Wt. 11 1/2 lbs. . . . . Net 34.95  
13 F 69123 Rip Fence for above Net 2.29  
13 F 69370 Carry Case. 5 3/4 lbs. Net 11.95

**\$34<sup>95</sup>**



**\$19<sup>99</sup>**

### Black & Decker

## 7 1/4" Circular Power Saw

- 1 HP Motor Burnout Protected
- Cuts Through 2" Lumber

**Model 7301.** Powerful 1 hp motor with a 7 1/4" blade cuts easily through lumber. Sawdust ejection system for good visibility in area of work. Easy bevel and depth adjustment. Cutting depth 90°, 2 3/8"; 45°, 1 7/8". For 117 VAC. 9 amps. UL listed. Includes 7 1/4" blade.  
12 F 68812 Shpg. wt. 14 lbs. . . . . Net 19.99  
12 F 68895 Rip Fence for above . . . Net 2.25



**7 1/4" 3-in-1 Circular Saw Blade Pack.** 1 combination, 1 cross-cut, and 1 plywood. Standard 5/8" arbor with diamond knock-out. For either saw above.

12 F 68846 Shpg. wt. 3/4 lb. . . . . Net 4.95

## Quality Gas or Electric Chain Saws



Electric  
As Low As  
**\$59<sup>95</sup>**

- With "Chipper" Chain and Bar
- With Built-in Oiler

Balanced, quiet cool operation. For professional or industrial use on dozens of jobs. Chain adjusts to eliminate slack. 2500 ft. per minute chain travel. Self-lubricating. 117 VAC. UL listed.  
10" Model. Cuts up to 10" with 10 amp 2 hp motor.  
14 F 48158W Shpg. wt. 14 lbs. Net 59.95  
15" Model. Cuts up to 15" with 12 amp 2 1/2 hp motor.  
14 F 48166W Wt. 15 1/2 lbs. . . Net 79.95



12" **\$134<sup>99</sup>** Gasoline 16" **\$144<sup>99</sup>**

- Automatic or Manual Oiling

Direct-drive 2.2 cu. inch displ. engine, feather-touch starter, retardant muffler, hard-tipped cutter bar, automatic oiling. 6 1/2 lbs. (without bar and chain).  
12" Model. Cuts up to 24" dia. trees.  
14 F 67554W . . . . . Net 134.99  
16" Model. Cuts up to 32" dia. trees.  
13 F 69446W . . . . . Net 144.99

## Black & Decker Power Tools for Your Lawn

1 Model 8114. Double-edged Hedge Trimmer. Balanced handle, double insulated, no ground wire needed. 13-inch blade, trigger on-off. Front & rear handles. 117 VAC. 60 Hz. 2.2 amps.  
12 F 68721 6 1/2 lbs. Net 19.99

2 Model 8280. Cordless Electric Grass Shear. Trim around trees, shrubs, fences, etc. Paddle-type triggerswitch to prevent accidental starts. Includes batteries, charger.  
12 F 68796 2 3/4 lbs Net 14.99  
Blade Sharpener.  
12 F 68788 . . . . . Net 1.99

3 Model 8220. Deluxe Lawn Edger and Trimmer. Trim or edge grass fast, easy, no hard work. 8" winged blade, trenches to 3/4 wide on its 1st pass. 117 VAC, 60 Hz. 6 amps. Shpg. wt. 18 1/4 lbs.  
12 F 68770W . . . . . Net 39.99

DELUXE DRILL

**Black & Decker**

UTILITY DRILL



\$21<sup>99</sup>

Variable Speed 3/8" Drill with Infinite Speed Lock

- Drill Speed Locks Anywhere From 0-1000 RPM

**Model 7120.** Heavy-duty drill offers double reduction gear for tough jobs. Improved 1/2 hp, 2.5 amp burnout-protected motor. Capacity: 3/8" steel, 3/4" hardwood. 117 VAC. UL listed. Rugged aluminum housing. 12 F 68739 Shpg. wt. 4 lbs. Net 21.99



\$10<sup>49</sup>

3/8" Power Drill

- Double Insulated for Safety

**Model 7104.** Double-insulated, double reduction gear delivers high-power drilling action. Well-balanced. Recessed center locker button prevents accidental "lock-on." Capacity: steel 3/8", hardwood 3/4". 1200 RPM. .22 hp motor, 2 amps. 117 VAC. UL listed. Great for homeowner or workshop use. Shpg. wt. 3 1/8 lbs. 12 F 68887 ..... Net 10.49

**Complete 48-Piece Power Workshop With 2-Speed Heavy-Duty 3/8" Drill**

A complete workshop for any job! All attachments powered by 3-amp 3/8" 2-speed drill with self-locking trigger switch. Low speed (1600-RPM), high-speed (2000-RPM). Includes 0-45° tilting portable saw, table saw attachment, lever-action drill press stand with post & base, bench stand, 9 drill bits, gear chuck & key, 4 1/2" crosscut & rip saw blade, rubber backing pad, paint mixer, 3" grinding wheel, 12 assorted sanding discs, slide mount drill handle, 3-wire cord adapter set, 6-ft. heavy-duty extension cord, full instruction booklet. UL listed drill. 117 VAC. 60 Hz. 13 F 47509W Wt. 12 lbs. Net 34.95



\$34<sup>95</sup>

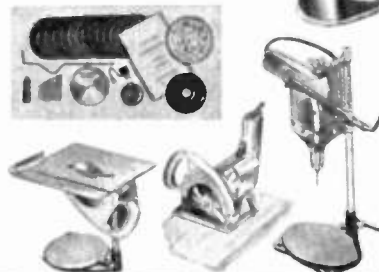

**Quality Power Tools Packed with Punch**

Heavy-Duty 4-Speed 1/2" Reversible Drill

\$44<sup>95</sup>

- Polished Aluminum Die-Cast Housing

**Model 950.** Hi-torque for heavy jobs! Two lever control, electronic gear reduction for precise speeds. Reversing 4 speeds permit backing out from material. Jacobs geared chuck & key. 6 amp, 1/2 hp motor. 117 VAC with 3-wire cord. UL & CSA listed. 11 x 8 1/2 x 3 1/2". 13 F 65337 Shpg. wt. 10 lbs. Net 44.95



**SKIL POWER TOOLS XTRA-TOOL**

\$49<sup>99</sup>

- Drill • Drive • Hammer • Chisel

**Model 599.** XTRA tool sands, scrapes, drills, grinds, buffs, polishes, mortises, hammers in masonry, wood and metal. Operates in forward or reverse. double-insulated. Adjustable speed control. 1/2 hp burnout-protected motor, 0-850 RPM. 117 VAC, 3.2 amps. UL listed. 13 F 69420 Shpg. wt. 4 1/2 lbs. Net 49.99  
Accessory Starter Kit. With 1/2" gouge, 1/4" scraper and 1/4" bit. Shpg. wt. 8 oz. 13 F 69438 ..... Net 4.98



**WEN Sander-Polisher**

**Model 940.** Polish at 1800 RPM, sand at 3400 RPM. 2 speeds give sanding & polishing mobility. 1/2 hp motor. 117 VAC. UL listed. Shpg. wt. 9 3/4 lbs. 13 F 65188 ..... Net 37.95



\$37<sup>95</sup>

**WEN 2-Way Sander**

**Model 300.** Use as orbital or straight sander. Push-pull switch, 2.6 amps, 1/2 hp, double-insulated, enclosed handle. 4000 orbits or 4000 SPM. Built-in front guide. 117 VAC. UL listed. Shpg. wt. 3 3/4 lbs. 13 F 65402 ..... Net 19.95



\$19<sup>95</sup>

**4" Belt Sander**

**Model 2530.** Heavy-duty 8-amp motor moves 15,000 surface ft. per minute. 117 VAC, 3-wire cord. 60 Hz. Uses 4x21 3/4" belt. UL listed. Shpg. wt. 12 1/2 lbs. 13 F 85517 ..... Net 44.95  
Sanding belts for abv. 4 oz. 13 F 85525 Coarse Net 1.19 13 F 85533 Med. Net 1.19 13 F 85541 Fine Net 1.19



\$44<sup>95</sup>

**Black & Decker**

3/4-HP Router Kit



\$47<sup>99</sup>

**Model 7611.** Powerful burnout-proof motor cuts, routs, grooves, trims wood, plastics, etc. Depth adjusts for precision. 22,000 RPM. 117 VAC, 5 amps. With guides, full manual, 2 wrenches, 1/4" steel 2-flute bit. UL listed. Shpg. wt. 8 lbs. 12 F 68820 ..... Net 47.99

**ARCO 1" Portable Vertical Belt Sander**



\$26<sup>95</sup>

- Sharpen, sand, grind, polish metal, steel, wood, plastics

For any 1/4 - 1/2 hp motor with 1/2" shaft. 19" high, with 50-grit, 1 x 42" abrasive belt. Less motor. Wt. 11 3/4 lbs. 12 F 18502 ..... Net 26.95  
Sanding Belts for Above. 12 F 18510 Heavy Net 99¢ 12 F 18528 Medium Net 99¢ 12 F 18536 Fine Net 99¢

**Black & Decker**

5" Bench Grinder



\$31<sup>99</sup>

**Model 7900.** Keep all household tools sharp! Sharpens knives, hatchets, mower blades, chisels, drill bits, etc. 8 1/2"-wide wheel. Self-oiled bearings. Includes 1/2"-wide, 5" medium grit & 5" coarse grit wheels, tool rests, guard covers, eye shields, rubber feet. 3,400 RPM. 117 VAC, 2.2 amps. UL listed. Wt. 11 lbs. 12 F 68713W ..... Net 31.99

# Power Tools & Accessories Make BIG Jobs Easy

## SHOPMATE

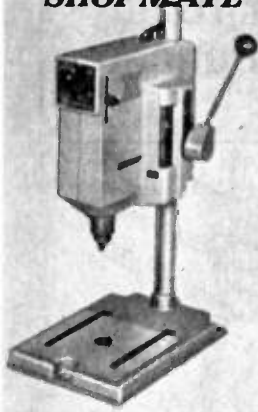

- Portable 3/8" Variable Speed Drill Press**
- Solid-State, Lightweight
  - Safety On/Off Button
  - Variable Speed 700 to 2000 RPM
  - 12-Position Drill Handle

**\$59<sup>95</sup>**

Model 2620. Offers full torque feedback. Depth adjustment accurate for drilling 0" to 2 1/2". Drills to center of 10" circle. Double reduction gears, permanently lubricated bearings. Heavy-duty die-cast base. 2.7 amp motor. 117 VAC, 60 Hz. 7W x 8H x 10"D. 13 F 85566W Shpg. wt. 13 lbs. . . Net 59.95

## Pneumatic Air Hammer Kit

**\$32<sup>95</sup>**

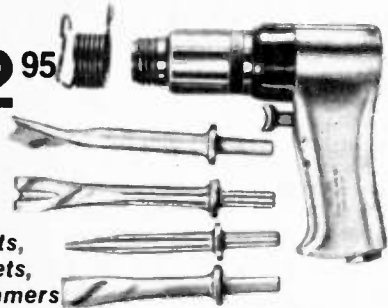

- Cuts, Rivets, Hammers

A heavy-duty, 7 1/2"-long pneumatic hammer, powerful enough to drive 1/4" steel rivets easily, sturdy enough for foundry chipping and scaling, versatile enough for auto repair work. Operates at 100-150 PSI. Includes 4 bits: 3/4" cold chisel, spot weld buster, tapered punch, T-type panel cutter. Bits change easily.

12 F 11507 Shpg. wt. 5 lbs. . . . . Net 32.95



**\$32<sup>95</sup>**

## 2-in-1 Sander and Drill Kit

Versatile 2-in-1 pneumatic tool kit gives you both a sander and high-speed power drill with just the addition of an adapter (included). Reaches speeds of 16,000 RPM on 120 lbs. of air pressure. Sander has 5" disc capacity, drill is recommended for use with bits up to 1/4". Complete with chuck adapter and key.

12 F 11515 Shpg. wt. 5 lbs. . . . . Net 32.95

## Quality Motor Speed Controls and Drill Bit Sharpener



**\$14<sup>95</sup>**

- 3-Position Switch: Variable-Off-Full Speed

Deluxe Variable Motor Speed Control. Ideal for all workshop power tools. Extend machine life—reduce wear with correct speeds. For AC-DC or DC motors to 7.5 amps. 120 VAC, 3-wire line cord. Automatic circuit breaker included. 2 1/2 x 4 5/8 x 1 1/8" (WHD). 13 F 27014 1 1/4 lbs. . . Net 14.95



**\$11<sup>95</sup>**

- Ideal for Electric Drills, Saws

"Jiffy" Variable Motor Speed Control. Constant speed variation from 0 to full speed. For universal AC-DC and series DC motors. 5 amp load rating. Circuit breaker. For 117 VAC, 50-60 Hz. 3 x 2 1/2 x 1 1/8". Shpg. wt. 1 lb. 13 F 27006 . . . . . Net 11.95



**Black & Decker**  
Automatic Drill Bit Sharpener

**\$19<sup>99</sup>**

- Works Like A Pencil Sharpener

Model 7980. Sharpens steel twist bits (not carbide tipped). Accepts 11 sizes (1/8 to 3/8"). Double Insulated. 1/7 hp, 1.9 amps. 117 VAC, 50-60 Hz. 12 F 68747 5 1/2 lbs. . . Net 19.99



**\$14<sup>95</sup>**

## Drill Press Stand

- Fully Adjustable

For use with any 1/4" or 3/8" drill or 1/2" compact. Converts hand drill to powerful drill press. Spring return tension. For 2 1/2" stroke, 5-1 leverage. 20"H. Base: 5 1/4 x 6". Shpg. wt. 7 lbs. 14 F 62555 . . . Net 14.95



**\$12<sup>95</sup>**

## 14-Piece Drill Set

Top-quality, high-speed drill set with center punch and sizes 1/16, 1/8, 3/16, 1/4, 5/16, 3/8, 7/16, 1/2, 5/8, 3/4, 7/8 and 1". 3/16, 3/8 and 1/2" with 1/4" shafts. With plastic case and built-in shelf. Shpg. wt. 1 1/2 lbs. 13 F 18112 . . . Net 12.95



**\$6<sup>95</sup>**

## 13-Piece Drill Set

Precision-ground high-speed drills and center punch in a plastic case. Drill sizes: 1/16-1/4". 9 oz. 13 F 18500 . . . Net 6.95

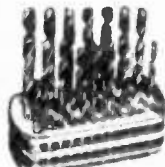

**\$17<sup>95</sup>**

## 29-Piece Drill Set

Precision twist drills with indexed stand. 1/16-1/2" by 64ths. Sizes larger than 1/4" have turned-down shanks. Imported. Shpg. wt. 2 1/2 lbs. 13 F 55775 . . . Net 17.95



**\$7<sup>95</sup>**

## Speed Reducer

Fits onto any electric drill for heavy-duty screwdriving. Reduces forward speed 11 to 1; reverse 4 to 1. With slotted and #2 Phillips bits. Shpg. wt. 3/4 lb. 14 F 14549 . . . Net 7.95



**\$10<sup>95</sup>**

## "Arco-Saw" Attachment

- With "Dado-Arbor"

Cuts any groove. Attaches to all 1/4" and 3/8" drills. Depth & level gauges. Adjustable rip. Instructions, bracket, clamp. Shpg. wt. 3 lbs. 14 F 14275 . . . Net 10.95

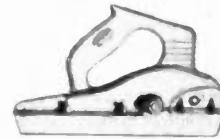

**\$5<sup>95</sup>**

## Planer Attach

1 1/4" wide cut. Depth adjustment. For 1/4 or 3/8" drills. Wt. 3 lbs. 14 F 62530 . . . Net 5.95



**\$4<sup>95</sup>**

## Jig Saw Attach

With blade. For any power drill. 1 1/4 lbs. 14 F 14259 . . . Net 4.95

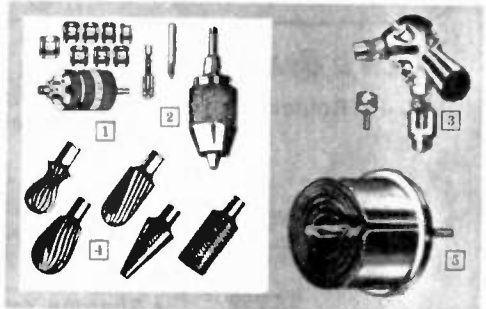

1 Arco 11-Pc. Screw & Nut Driver Drill Attachment. With flat bits, holders, socket wrenches. 14 F 14218 Shpg. wt. 1 lb. . . . . Net 5.95

2 1/2" Chuck for 1/4" Drills. Converts 1/4" electric drills to 1/2" capacity. Also for 1/2x24 shafts. 13 F 55270 Imported. Shpg. wt. 3/4 lb. . . Net 1.95

3 Right Angle Drive. Runs drill at 1/2 or double speed. Fits 1/4" chuck or drill spindle. 14 F 36039 Shpg. wt. 1 1/2 lbs. . . . . Net 4.50

4 5-Pc. Rotary File Set. Hardened and tempered tool steel. Cuts, enlarges, routs, shapes, finishes. With 1/4" shank. 13 F 50180 Shpg. wt. 1/2 lb. . . . . Net 4.50

5 7-Blade Deep Hole Saw. Fits any electric drill or press. Cuts holes from 1 to 2 1/2" dia. 13 F 55262 Imported. Shpg. wt. 1 lb. . . Net 1.99

# Home/Workshop Tools and Aids

## 1 Power Staple Gun 1000 Kit

An all-chrome, extra-heavy-duty staple gun with built-in staple extractor and 3 boxes of 1000 ea. powerpoint staples ( $\frac{1}{8}$  x  $\frac{1}{2}$  x  $\frac{3}{8}$ ""). Features special heavy-duty drive power lever, reload indicator window, swing-open bottom, safety lock, wire attachment, instructions. With case. Staples below  
13 F 58241 Shpg. wt. 6 lbs. . . . . Net 14.95

## 2 Power 2001 Nail Gun Kit

Install paneling or molding, hang insulation, lay floor covering, repair furniture. Drives  $1\frac{1}{2}$ " nails flush or countersinks them. With safety guard.  
13 F 58258 Shpg. wt. 7 lbs. . . . . Net 18.88

Package of 500  $1\frac{1}{2}$ " Nails. Shpg. wt. 4 oz.  
13 F 58266 (Off-White Tone) . . . . . Net 98¢  
13 F 58274 (Light Wood Tone) . . . . . Net 98¢  
13 F 58282 (Med. Wood Tone) . . . . . Net 98¢  
13 F 58290 (Dark Wood Tone) . . . . . Net 98¢

## 3 Cable Tacker. Model 300. Swingline fast-action staple gun reaches into tight places. Fires staples $\frac{1}{4}$ x $\frac{3}{8}$ ".

13 F 58092 Shpg. wt. 2½ lbs. . . . . Net 16.50  
13 F 58100 1000 Staples. 8 oz. . . . . Net 1.99

## 4 Heavy-Duty Staple Gun. Drives 5 staple sizes (below). Built-in staple extractor.

13 F 58126 Shpg. wt. 2 lbs. . . . . Net 9.50

Stock No.	Leg Length	Shpg. wt.	Pkg. of 1000
13 F 58134	$\frac{1}{4}$ "	7 oz.	.85
13 F 58142	$\frac{3}{16}$ "	7 oz.	.70
13 F 58159	$\frac{3}{8}$ "	8 oz.	.70
13 F 58167	$\frac{1}{2}$ "	9 oz.	.80
13 F 58183†	$\frac{5}{8}$ "	8 oz.	.85

†Special Loktite Staples

## 5 X-Acto Knife and Tool Set. Model 84.

Contains 3 handles, 4 routers, 2 punches, plane, 1" sander, spoke shave, balsa stripper, 11 blades and 4 gouges.  
13 F 74230 Shpg. wt. 2¼ lbs. . . . . Net 12.50

Replacement blade for fine-angle cutting.  
13 F 74073 No. 11, pkg. of 5 . . . . . Net 59¢

## 6 X-Acto Cordless Power Drill Set. Model 376.

Polish, deburr, carve, grind, drill. With center punch, grinder, drill bit, 3 precision collets, holder. Less batteries.  
13 F 74248 Shpg. wt.  $\frac{3}{4}$  lb. . . . . Net 6.75

99 F 62572 "C" Batts. (2 req.) . . . . . Net ea. 19¢

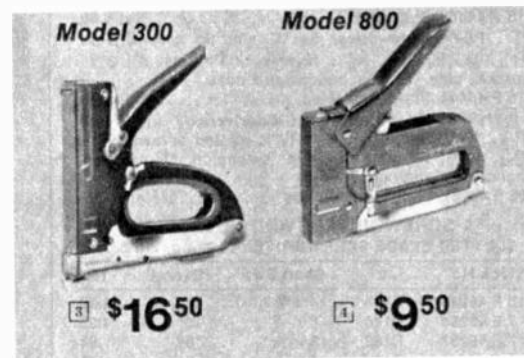

## 80-Watt Ultrasonic Cleaner

\$82<sup>50</sup>



### • Completely Self-Contained

Model 450. Serves a variety of cleaning applications. Automatic power control, pilot light. No adjustments necessary. Stainless steel worktop and sides. One quart stainless steel tank,  $3\frac{1}{2}$  x 8 x  $2\frac{1}{2}$ ". Removes grease, tar, wax, sulphides, fluxes and fingerprints from precision parts. Generator freq.: 80 kHz. RF input power: 80 watts. All-transistor. For 117 VAC, 60 Hz.  
15 F 23059 Shpg. wt. 4 lbs. . . . . Net 82.50

## 40-Watt Ultrasonic Cleaner

\$54<sup>95</sup>



### • One Pint Stainless Steel Tank

Model 250. Similar to above except with 1-pint stainless steel tank, tank size  $3\frac{1}{2}$  x  $3\frac{1}{2}$  x  $2\frac{1}{2}$ " deep, RF input power: 40 watts.  
15 F 23067 Shpg. wt. 2½ lbs. . . . . Net 54.95

## Solid-State Ultrasonic Cleaner

\$32<sup>95</sup>



### • Ideal for Hobbyist

High-frequency, vibrates at 77 kHz. Cleans jewelry, coins, contact lenses, etc., by disintegrating and dissolving dirt. Transistorized, all-metal unit with stainless steel cleaning cup  $2\frac{1}{4}$ " dia. x  $1\frac{1}{2}$ " deep. Includes sample cleaners, jewelry brush, tweezers. For 117 VAC, 60 Hz.  
15 F 23042 Shpg. wt. 1½ lbs. . . . . Net 32.95

# DYMO

Helps You Organize Your Home,  
Office or Storeroom

## 7 Mark VI Label Maker Kit

- Wide or Narrow Spacing
- Tape Cutoff Lever

Model 1006-05. Makes raised-letter labels. Includes tool, 2 horizontal and 1 vertical wheels, case, five 12-ft. tapes. For  $\frac{1}{4}$ " and  $\frac{3}{8}$ " labels. With handy cutoff lever.  
14 F 41617 Shpg. wt. 1¼ lbs. . . . . Net 7.50

## $\frac{1}{4}$ " and $\frac{3}{8}$ " Labelmaker

Model 1006-02. Lightweight label maker, embosses both  $\frac{3}{8}$ " and  $\frac{1}{4}$ " tape. Rugged Cyclocac® tool, only  $7\frac{1}{2}$  x 3". Wide or narrow spacing. 12-ft. vinyl tape, 6-ft. cloth marking tape.  
14 F 41492 Shpg. wt. 1 lb. . . . . Net 4.50

## Label-Making Tools and Kits

### 8 Deluxe Tapewriter Kit

- Two Horizontal and One Vertical Letter-Embossing Wheels

Model 1570-01. Deluxe label-making kit. Heavy-duty, chrome-plated tool embosses both  $\frac{1}{2}$ " and  $\frac{3}{8}$ " vinyl or cloth marking tapes. With carrying case, 12-ft.  $\frac{3}{8}$ " vinyl tape, 12-ft.  $\frac{1}{2}$ " vinyl tape.  
14 F 41609 Shpg. wt. 1¾ lbs. . . . . Net 26.95

### 12-Ft. Vinyl Embossing Tapes

$\frac{1}{4}$ -INCH		$\frac{3}{8}$ -INCH		$\frac{1}{2}$ -INCH	
Stock No.	Net.69	Stock No.	Net.89	Stock No.	Net.1.19
14 F 41021	Blue	14 F 41120	Black	14 F 41187	Black
14 F 41039	Green	14 F 41138	Red	14 F 41203	Red
14 F 41047	Red	14 F 41153	Blue	14 F 41211	Blue
14 F 41518	Wal. Grain	14 F 41161	Green	14 F 41229	Green
14 F 41070	Black	14 F 41526	Wal. Grain		

14 F 41625  $\frac{3}{8}$ " Cloth Marking Tape, 6-ft. long Net .99

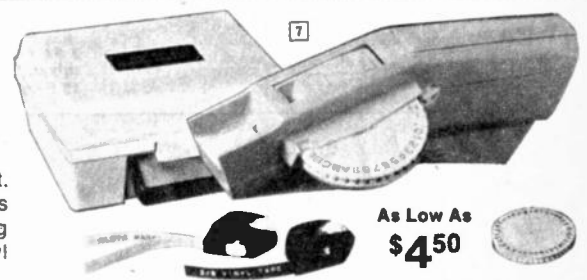

# Quality Tools For Home and Workshop

## XCELITE

### PROFESSIONAL SCREWDRIVERS AND NUTDRIVERS

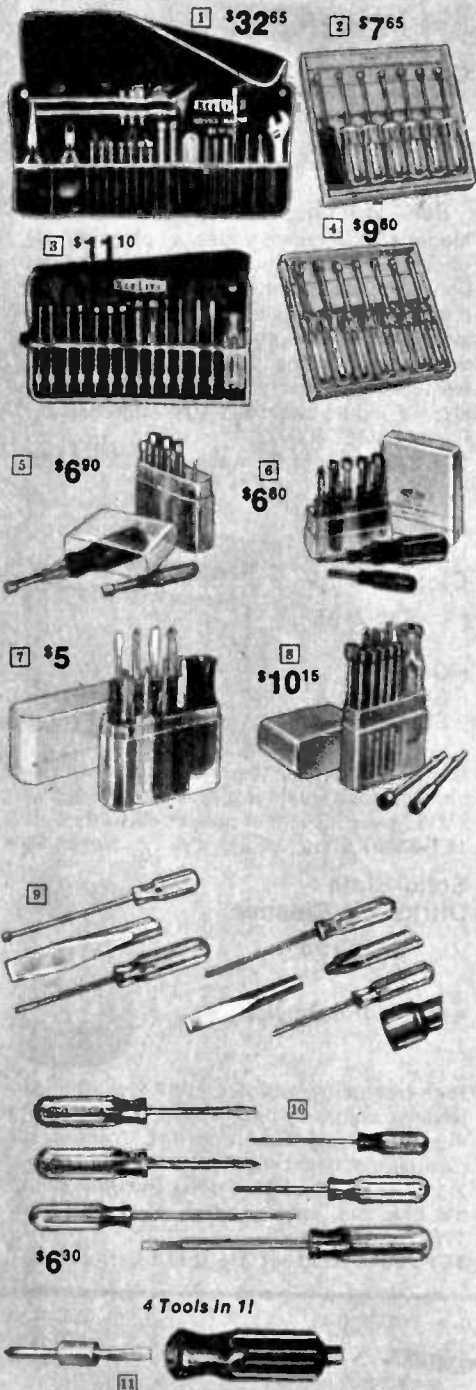

1 \$32.65

2 \$7.65

3 \$11.10

4 \$9.80

5 \$6.90

6 \$6.80

7 \$5

8 \$10.15

9

10

\$6.30

4 Tools in 1!

11

1 99SM Service Master Tool Kit. 23 pieces—6" long nose, 5" diagonal, 6" adjustable wrench, 9 regular nutdrivers (3/16 to 1/2"); 1/4, 3/16, 3/8" stubby nutdrivers; #1, #2 Phillips, 2 slotted (3/16 and 1/4"), 2 reamers, extension. In roll-up vinyl case. 13 F 46436 Shpg. wt. 3 1/4 lbs. . . . . Net 32.65

2 "Tray Blen" 1277B Nutdriver Set. 7 color-coded nutdrivers. Fold-away stand. Hex sizes 3/16", 1/2", 3/4", 5/8", 3/4", 1 1/2", 3/8". 13 F 46469 Shpg. wt. 1 3/4 lbs. . . . . Net 7.65

3 99PR Nutdriver Screwdriver Set. 14 pieces. 9 nutdrivers (3/16 to 1/2"), slotted screwdrivers (3/16 and 1/4"), Phillips (#1, #2). Roll-up kit. 13 F 46212 Shpg. wt. 1 3/4 lbs. . . . . Net 11.10

4 "Tray Blen" 1477B Nutdriver Set. With 7 hollow shaft, color-coded nutdrivers (1/4", 3/8", 1/2", 5/8", 3/4", 7/8", 1 1/2"). "Snap-lock" case. 13 F 46477 Shpg. wt. 2 lbs. . . . . Net 9.60

#### COMPACT DOUBLE-DUTY TOOL SETS

5 PS-120 Compact Nutdriver Set. 10 nutdrivers (3/32, 1/8, 5/32, 3/16, 1/4, 5/16, 3/8, 1/2, 5/8, 3/4), 3 1/2" pocket size. "Torque amplifier" handle, plastic case. 13 F 46022 Shpg. wt. 3/4 lbs. . . . . Net 6.90

6 PS-130 Screwdriver and Nutdriver Set. 3 1/2" pocket size. Torque amp handle. 3 slotted screwdrivers (1/8, 3/16, 1/4"), #1 and #2 Phillips, 5 nutdrivers (3/16, 1/4, 5/16, 3/8"). 13 F 46588 Shpg. wt. 3/4 lb. . . . . Net 6.60

7 PS-88 Screwdriver Set. 5 slot lip screwdrivers (3/32, 1/8, 5/32, 3/16, 1/4"); #0, #1, #2 Phillips. All 3 1/2" pocket size. Torque handle and case. 13 F 46444 Shpg. wt. 9 oz. . . . . Net 5.00

8 99PS-50 Screwdrivers-Nutdrivers. 7 nutdrivers (3/16, 1/4, 5/16, 3/8, 1/2, 5/8, 3/4"); slotted screwdrivers (3/16, 5/32"); #1, #2 Phillips; 4" extension. 1 1/8" x 4 1/8" handle. Plastic case. 13 F 46451 Shpg. wt. 1 1/2 lbs. . . . . Net 10.15

#### 9 SCREWDRIVERS AND NUTDRIVERS

SLOTTED BLADE SCREWDRIVERS—shpg. Wt. 6 oz.

Stock No	#	Shaft Size	Overall	Net
13 F 46246	R144	4 x 1/4"	8"	1.25
13 F 46253	R146	6 x 1/4"	10"	1.25
13 F 46287	R183	3 x 1/8"	5"	.51
13 F 46295	R184	4 x 1/8"	6 1/2"	.61
13 F 46311	R188	8 x 1/8"	10 1/2"	.81

SET-SCREW TYPE—with pocket clip

13 F 46337	R3323	3 x 3/32"	5"	.51
PHILLIPS SCREWDRIVERS—alloy steel				
13 F 46345	X101	3" #1 pt.	6 1/2"	1.01
13 F 46352	X102	4" #2 pt.	7 3/4"	1.25
13 F 46360	X103	6" #3 pt.	10"	1.82
13 F 46378	X108	6" #1 pt.	10"	1.18

HOLLOW SHAFT NUTDRIVERS—Shpg. Wt. 6 oz.

13 F 46485	HS-6	3/16"	6 1/4"	1.28
13 F 46493	HS-7	7/32"	6 1/4"	1.28
13 F 46113	HS-8	1/4"	7"	1.28
13 F 46121	HS-10	5/16"	7"	1.28
13 F 46162	HS-16	1/2"	7 1/4"	1.49
13 F 46170	HS-18	5/8"	7 1/4"	1.52
13 F 46188	HS-20	3/4"	7 3/4"	1.76

10 Xcelite SRX33 6-Piece Screwdriver Set. See-thru plastic case. Chrome vanadium blades with tough shockproof plastic (UL) handles. With 4 slotted blade screwdrivers—1/8, 3/16, 1/4, 5/16", #1, #2 Phillips-type. Overall length 6 1/2 to 10 1/4". 13 F 46550 Shpg. wt. 1 1/2 lbs. . . . . Net 6.30

11 4-Way Pocket Tool. It's a 1/4 and 3/16" nutdriver, a #1 Phillips screwdriver, and a 3/16" slotted screwdriver. Shpg. wt. 5 oz. 13 F 46236 . . . . . Net 2.19

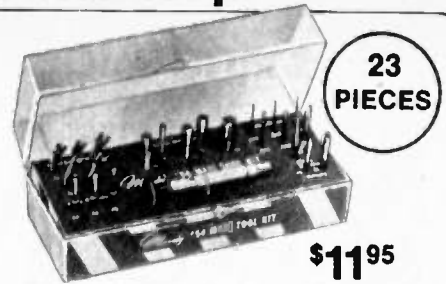

23  
PIECES

\$11.95

#### 23-Pc. Moody Miniature "Maxi" Tool Kit

- 22 Interchangeable Tools
- Packaged in Clear Plastic Box

All tools correctly heat-treated and nickel-plated. Knurled, chuck-type handle. Suitable for a wide variety of uses. Six screw drivers—.025", .040", .055", .070", .080", .100", 2 cross-recessed wrenches—0 and 1, 5-open-end and 5 socket wrenches—3/4", 3/8", 3/4", 1/8", 1/2", 3/32". Nos. 4, 6, 8 Allen-type, and an awl. 14 F 27103 Shpg. wt. 12 oz. . . . . Net 11.95



\$3.20  
6 Pieces

6-Pc. Precision Screwdriver Set of hardened, tempered, rustproof blades. From #1 to #6, width of blades 0.8-3.8mm. Chrome-plated brass handles with 3.5-8.0mm dia. Wt. 3/4 lb. 13 F 56039 . . . . . Net 3.20

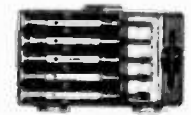

\$3.20  
5 Pieces

5-Pc. Miniature Nut Driver Set. Hardened and tempered blades. Chrome-plated knurled brass handles with swivel heads. 3/4", 3/8", 3/4", 1/8", 3/32". T-bar for extra leverage. 13 F 56294 3/4 lb. Net 3.20



\$3.50

Self-Adjusting Socket Wrench. Adjusts automatically from 1/4" to 3/8". High tensile strength sockets. Insulated handle. 6" long. 14 F 22500 Shpg. wt. 1/2 lb. . . . . Net 3.50



\$2.59

3-Pc. Swivel Action Screwdriver Set. Tops of screwdriver swivel for ratchet-action. 1/4", 3/16" slotted, #2 recess. Hardened and tempered. Rustproof. Nickel plated blades. Extra large handles. Unbreakable clear amber. 13 F 23518 1 lb. . . . . Net 2.59



6-PIECE  
\$3.20

#### Hollow Shaft Nut Driver Set

• Heavy-Duty Plastic Handle  
Hollow blade permits tightening of nut over long screws. Slim-line styling reaches anywhere. Rustproof finish. Sizes: 3/16", 1/4", 5/16", 3/8", 1/2", 5/8", 3/4". Each nut driver is 5 1/2" long. 13 F 55833 Shpg. wt. 1 lb. Net 3.20  
182 Lafayette Cct. No. 750

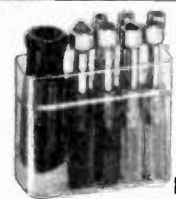

9-PIECE  
\$3.95

#### Compact Nutdriver Set

• Handy Plastic Case  
Precision-ground hardened and tempered, rust-proof finish blades, color-coded handles. Hex openings: Black — 1/8", clear — 3/16", blue — 1/4", amber — 1/4", orange — 5/16", yellow — 3/8", green — 1/2", red — 3/8". One interchangeable large handle. Wt. 3/4 lb. 13 F 56195 . . . . . Net 3.95



9-PIECE  
\$3.20

#### Compact Screwdriver Set

• Handy Form-Fitted Case  
Color-coded plastic handles and hardened, tempered, rustproof finish blades. Includes: Slotted: (green — 3/16", black — 3/32", red — 1/8", orange — 3/16", yellow — 1/4". Phillips: (blue — #0, orange — #1, yellow — #2). One interchangeable large handle. 13 F 56179 Shpg. wt. 1 lb. . . . . Net 3.20



13-PIECE  
\$7.50

#### Screwdriver & Nutdriver Set

• Precision Ground Steel  
One jumbo grip handle & 13 blades: 2 slotted 3/16", 1/4" screwdrivers, 2 Phillips, 7 nutdrivers 3/16", 1/2", 1/4", 3/32", 3/16", 1/2", 3/8", hex openings, 1 1/4" hole depth, and 4" extension blade. All hardened, tempered, rustproof. Compact, sturdy case. 13 F 56187 Wt. 1 3/4 lbs. . . . . Net 7.50



# High-Quality, Low-Priced Workshop Accessories

## Automatic Wire Stripper and Cutter

Automatically cuts, strips all types of electrical insulated wire quickly and easily. Works on all standard gauges from 12 thru 24. Automatic stay-open feature. Complete with wire guide. Insulated handle. Versatile and handy. Imported.



\$6.50

## Wire Stripper and Cutter

For any size wire, stranded or solid. Adjustable arm for varying wire size. Strips wire from 10-24 gauge. Built-in spring for self-opening. Ring latch to hold blades in closed position. Made of hardened tool steel, finely ground cutting edges.



\$1.69

## Super Electrician's Knife

3 high-carbon steel blades: knife, skinning & screwdriver. Locks open. Solid Tenite handle with belt loop. Size 3 1/2".



\$2.95

## 6-Pc. Wood-Carving Set

Drop forged, tempered tool steel. Razor sharp cutting edges. Has straight, corner, firmer, 1/2" and 1/4" straight gauge, front, bent, parting tool chisels. Tough plastic handle.



NEW! \$16.95

14 F 65444 1 1/4 lbs. Net 16.95

\$2.10

## Contour Gauge



Easy to use. Press the gauge's steel teeth against any irregular surface to exactly match and hold the shape taken. 6" long.

14 F 52051 Imported. Shpg. wt. 3/4 lb. Net 2.10

## Hobby Motor

Motorize hobby tools, dental or jewelers' lathes, sewing machines. 1/15 hp mot.—5000 RPM full load, 15,000 R-P-M no-load speed. 3 1/2 x 2 1/4 x 2 3/4" (LHW). For 117 VAC or DC. Fan-cooled, permanent oilite bearings. 12" cord lead. Two tapped 10-32 mounting holes on 2 1/4" centers.



\$10.95

19 F 24109 Wt. 2 lbs. Net 10.95

## Flexible Shaft Attach With 1/4" Chuck

Operates off any fixed or portable drill. Drill at any angle anywhere. Capacity up to 1/4" size drills. 36" overall length with chuck. Operates to 6000 RPM. Imported.



\$3.95

13 F 56112 1 1/4 lbs. Net 3.95  
32 F 64124 Net 4.56

## Variable Speed Foot Control

Regulate the speed of small motors. Speed varies from 0 to max. speed of motor. Max. 110 watts. 10-ft. cord with 2-way outlet for motor & light. 1 amp.



\$5.95

12 F 54010 2 1/4 lbs. Net 5.95  
Lafayette Has Over 500 Stores from Coast to Coast

**XCELITE**

## Pliers and Cutters



1 \$4.65

2 \$4.89

3 \$5.05

4 \$4.60

Fully-polished hammer, forged from high-grade tool alloy steel. Rust-resistant, plastic-coated cushion grip handles. Avg. shpg. wt. 1 lb.

Stock No.	Type Fig.	Description	Net
13 F 46584	55CG	4 5" diag. cutter	4.60
13 F 46576	51CG	2 6 1/2" long nose with cutters	4.89
13 F 46592	56CG	1 6" Ndle. Nose Plier	4.65
13 F 46600	57CG	3 7" hvy. dty. diag. ctr.	5.05

**CHAN NEL LOCK**

## Little Champ Precision Pliers



Fine quality small pliers are drop forged from high-grade steel. Plastic cushion grip handles. Wt. 5 oz.

\$3.80

Stock No.	Type Fig.	Description	Net
13 F 30059	41-G	5 4 1/4" Diagonal Cutter	4.65
13 F 30067	42-G	6 4" End Cutter Nipper	4.65
13 F 30075	43-G	7 4 3/4" Needle Nose	4.10
13 F 30083	44-G	8 4 3/4" Flat Nose	3.89
13 F 30091	45-G	9 4 1/2" Round Nose	4.39
13 F 30109	47-G	10 4 3/4" Needle Nose Cutter	4.75
13 F 30117	48-G	11 4 3/4" Trnsvs. End Cutter	4.65
13 F 30125	49-G	12 4 1/2" Curved Needle Nose	4.45



13 6 1/4" Long Nose Pliers. Durable drop-forged steel pliers with hardened and tempered side cutting edges. Insulated handles for protection and easy grip. Thin nose gets to tight spots. Polished and lacquered finish. Imported.

13 F 55783 Shpg. wt. 7 oz. Net 2.29

14 6 1/4" Diagonal Cutting Pliers. Fully drop-forged steel pliers with hardened and tempered side cutting edges. Shock-proof handle for protection and comfort. Rustproof finish is completely polished and lacquered. Imported.

13 F 55791 Shpg. wt. 9 oz. Net 2.29

15 8" Slip-Joint Pliers. Reach into most areas, adjust to most any position. Strong gripping head. Insulated cushion-grip handles. Drop-forged steel for long life. chrome-plated finish.

13 F 55817 Imported. Shpg. wt. 9 oz. Net 2.59

16 Lightweight Long Nose Pliers. For delicate work, hard-to-get-at areas. Spring closing — holds wires, nuts, screws firmly. 8 3/4" long. Soft, plastic-colored handles.

14 F 26014 Shpg. wt. 5 oz. Net 1.75

## Wire Bending Jig



Forms wire sizes up to 1/4" diameter. Has steel slots and bending pins for eyes, angles, curves, circles, straight wire, etc. Shpg. wt. 1/2 lb.

14 F 70103 Net 1.39

## "Hoppy" Level and Incline Finder

- Split-Image Transit
- Measures Little as 1/8" Rise/Fall at 25'



\$8.95

Precision instrument accurately measures level and degree of incline. Ideal for patio layout, fencing, terracing, bricklaying, etc. Eliminates need for 2-man crews on most measuring jobs. Measure a minimum of 1/8" rise or fall at 25 ft. 1 1/4 lbs.

14 F 18011 Net 8.95

Case for Above.

14 F 18045 3/4 lb. Net 4.95

Combines Carpenter's Level with Surveyor's Transit — Really Handy!



\$4.59

\$5.29

## Famous Channellock Electronic Pliers

Precision-machined, forged from high-grade steel. Slender reach, matched jaws, rugged, dipped plastic grips. 728G has built-in wire stripper. Shpg. wt. 10 oz.

17 738G 8" Long Nose. Net 4.59

18 728G 7 1/2" Diagonal Cutter. Net 5.29

13 F 30034 Shpg. wt. 10 oz. Net 5.29

## Dual Rivetool Kit

\$5.49



Famous "Pop" Rivetool and two interchangeable nose pieces—one for 1/8" steel or aluminum, other for 3/16" aluminum rivets. With 1/8" and 3/16" assorted rivets, backup plates.

13 F 54083 Shpg. wt. 1 1/2 lbs. Net 5.49

## Rivets for Above Kits

Stock No.	Desc.	Thkness	Qty	Net
13 F 54026	1/8" Steel	1/8"	25	.49
13 F 54034	1/8" Steel	1/4"	20	.49
13 F 54042	1/8" Steel	1/2"	15	.49
13 F 54091	3/16" Alum.	1/4"	15	.77
13 F 54109	3/16" Alum.	1/2"	12	.77
13 F 54117	3/16" Alum.	3/8"	10	.77
13 F 54059	1/8" Backup Plate		40	.77
13 F 54125	3/16" Backup Plate		30	.77

**NEW \$9.95**

• Glues Just About Anything to Just About Anything

### Thermogrip Electric Glue Gun

Bonds most metals, plastic, and wood in 60 seconds with easy-to-use, ultra-strong, hot-melt glue. Simply put glue stick onto barrel and squeeze out melted glue over areas to be bonded. With gun, three 4"-long glue sticks, full instructions. For 117 VAC, 60 Hz.

13 F 54166 Shpg. wt. 1 1/2 lbs. Net 9.95  
14-Pc. All-Purpose 1 3/4" Glue Sticks.  
13 F 54174 Shpg. wt. 4 oz. Net 9.95

# HEAVY-DUTY 18" BENDING AND FORMING BRAKE

**\$34<sup>95</sup>**

**Clean, Smooth Bends**

**Handles up to 18" width in up to 16-gauge thickness**

1 Rugged, heavy-duty, all-steel construction and unique design permits forming chassis, boxes, covers, trays, etc., by means of 1"-deep slots in brake-bar which allows corners to fold in. Provides flange edges up to 1" high. Easy to adjust for thickness, accuracy, angle of bend. Features built-in clamps. Imported.  
99 F 80640W Shpg. wt. 16½ lbs. ....Net 34.95

## 18" BENDING AND FORMING BRAKE

**\$11<sup>95</sup>**

2 Handles up to 18" width, up to 16-gauge thickness, by cutting 1"-deep slots in brake bar to fold corners in 90°. Flange edges to 1" high. Ideal for small 1-slot jobs. Less clamps.  
14 F 11073 Shpg. wt. 7 lbs. ....Net 11.95

Bends and Forms Up to 90° in Metals Up to 16-Gauge Thickness

### 3" Swivel-Base Vise

**\$14<sup>50</sup>**

For engineers and mechanics. Jaw opening 3". Base swivels 360°. Locks firmly in any position. Jaws grooved for gripping circular objects. Four holes in base permit permanent fixing to bench. All-steel parts. Chrome-plated. Imported.  
14 F 64551 Shpg. wt. 71 lbs. ....Net 14.50

### Heavy-Duty 4" Swivel-Base Vise

**\$16<sup>95</sup>**

Swivels full 280°. Jaw width: 4". Removable pipe jaws open to 4¾". Self-lubricating graphite bronze bearings. Imported.  
13 F 55890 Shpg. wt. 17¾ lbs. ....Net 16.95  
Heavy-Duty 6" Model. As above. Opens to 6¼".  
13 F 56120W Shpg. wt. 26¼ lbs. ....Net 24.95

### Wilton Electronic Vise

**\$24<sup>95</sup>**

For small sub-assemblies and intricate electronic work including printed circuits. Rubber protected jaws 2½"W with 6½" opening. Power-arm positioner gives superior positive lock and fast on-off action with horizontal handle.  
14 F 80029 Shpg. wt. 2¾ lbs. ....Net 24.95

3 Adel Hand "Nibbling" Tool cuts sheet metal like a punch and die. Ideal for template and model parts. Cuts in all directions.  
14 F 12055 Shpg. wt. 10 oz. ....Net 5.95  
Replacement punch for above.  
14 F 12063 .....Net 3.35

4 BernzCutter Cutting Tool Kit. Cuts plastics, laminates, floor tile, sheet metal, pegboard or paneling. Form-fitting handles. Instructions. 3 blades, metal, plastic, shaper.  
14 F 31501 Shpg. wt. 1 lb. ....Net 5.95

5 Complete Metal Workshop. Four tools in one. Rivets, Punches, Shears, Forms. Handles stock up to 1" wide, 16-gauge.  
14 F 11016 Shpg. wt. 5½ lbs. ....Net 12.95  
Extra Punch Sets. Avg. shpg. wt. 30 oz.  
14 F 11024 Hex—¾", ½" and ¼" ....Net 2.59  
14 F 11032 Square—½" and ¼" ....Net 1.79  
14 F 11040 Rect.—½" x ¾" and ½" x ¼". Net 1.79  
14 F 11065 Round—½", ¾", ½", ¼" ....Net 3.49

6 Nut Splitter. Compact time-saver only 4¾" long. Will split nuts up to ¾" across flats.  
14 F 52069 Shpg. wt. 1 lb. ....Net 6.95

7 12 Needle Files. Swiss pattern. All are double cut for sharper, faster cutting. 12 assorted flat, oval, round, triangular, and edge files. For hobbyists, jewelers, etc. Imported.  
14 F 64536 Shpg. wt. ½ lb. ....Net 7.95

8 Miniature Improved Holst. 2000-lb. capacity. Weighs only 1½ lbs. High-tensile-strength 65-ft. rope. Ideal for hunters, boat owners, etc.  
13 F 19060 Shpg. wt. 2 lbs. ....Net 6.50

9 40-Piece Tap and Die Sets. National. Coarse and fine thread. For mechanics, machinists, engineers. One tap and die in each of the following: 4-36, 12-24, ¾-16, ¾-24, 6-32, ½-20, ¾-20, ½-20, 8-32, ¼-28, 7/16-14, ½-13, 10-32, ¾-18, ¾-24, ½ Pipe Tap; plus long handle adjustable tap wrench, "T" handle tap wrench, die handle, screwdriver, screw pitch gauge, hinged box. Imported.  
13 F 55882 Shpg. wt. 3½ lbs. ....Net 14.95  
40-Piece Metric Tap and Die Set. With the following sizes in mm: 3 x 0.35, 3 x 0.6, 4 x 0.5, 4 x 0.75, 5 x 0.5, 5 x 0.9, 6 x 0.75, 6 x 1.0, 7 x 0.75, 7 x 1.0, 8 x 1.0, 8 x 1.25, 10 x 1.25, 10 x 1.5, 12 x 1.5 and 12 x 1.75.  
13 F 56252 Shpg. wt. 3½ lbs. ....Net 15.50

**\$17<sup>95</sup>**

### LAFAYETTE CHASSIS PUNCH SET

Five most-needed round hole punches. For sockets, plugs, controls, panel lights, etc. T-handle included. Punch sizes: ½", ¾", ¾", 1" and 1½". Also included: tapered reamer, fitted case, instructions. Imported.  
99 F 80244 Shpg. wt. 2 lbs. ....Net 17.95



Greenlee Type 730 Round Hole Chassis Punches. Cut holes in metals up to 16-gauge thick with turn of an ordinary wrench. No sawing, reaming or filing. Avg. wt., sizes ½ to 1½", 1 lb.; 2 to 3" 3 lbs.

Stock No.	Size(")	Net ea.	Stock No.	Size(")	Net ea.
13 F 29010	½	3.60	13 F 29119	1½	4.25
13 F 29028	¾	3.60	13 F 29135	1¾	4.25
13 F 29036	¾	3.60	13 F 29267	1¼	4.25
13 F 29044	1½	3.60	13 F 29432	1½	5.30
13 F 29051	¾	3.60	13 F 29275	1½	5.30
13 F 29069	1½	3.60	13 F 29283	1½	5.80
13 F 29077	¾	3.60	13 F 29309	1¼	8.05
13 F 29085	1½	4.10	13 F 29325	2	10.60
13 F 29093	1	4.10	13 F 29333	2½	11.45
13 F 29101	1½	4.25	13 F 29341	2¼	11.90

TYPE 731. Square holes, punches. Shpg. wt. 1 lb.  
Stock No. Size(") Net ea.  
13 F 29143 ½ 9.65  
TYPE 732. Keyed Sockets, Punches. Av. wt. 1 lb.  
Stock No. Size(") Net ea.  
13 F 29416 1¼ 11.95  
13 F 29424 1¼ 13.10  
Rplcmt. drive screws for 730, round hole, punches above. Avg. wt. 8 oz.

For ½", ¾", ¾".  
13 F 29200 .....Net 35¢  
For 1¼" through ¾".  
13 F 29218 .....Net 40¢  
For 1" through 1½".  
13 F 29226 .....Net 40¢  
For 1½" through 1¾".  
13 F 29234 .....Net 70¢  
For 1¾" through 2½".  
13 F 29242 .....Net 80¢  
For 2¾" and 3".  
13 F 29259 .....Net 4.40

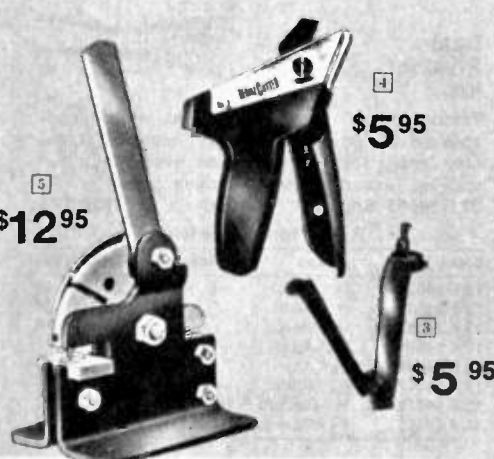

# Socket Sets, Wrenches and Tool Boxes

## 124-Piece Master Mechanics Tool Set

- Chrome-Vanadium Socket Set
- Metal Chest with Drawer, Lock, 2 Keys

Includes 17-pc.  $\frac{1}{2}$  and  $\frac{3}{8}$ " square drive socket set with seven  $\frac{3}{8}$ " sockets ( $\frac{3}{8}$ - $\frac{3}{4}$ " ),  $\frac{3}{8}$ " rubber grip reversible ratchet. 3 ext.  $\frac{1}{2}$ " drive rubber grip flex handle, six  $\frac{1}{2}$ " drive sockets, ( $\frac{1}{2}$  to 1"),  $\frac{1}{2}$  to  $\frac{3}{8}$ " adapter. 12-pc.  $\frac{1}{4}$  square drive socket set with 8 sockets  $\frac{3}{16}$ - $\frac{3}{8}$ ". Reversible ratchet. flexible shaft handle, extender and metal box. Also 5 open-end and 3 box wrenches. 7 nut drivers. spark plug wrench. 7 hex keys. hack saw with 13 blades, 6-pc. tap and tap wrench set. 24-pc. ignition wrench set. 6" slip-joint plier, punch and chisel set. 9 drill bits. 6 screwdrivers and rack, awl and pry bar. Box, 20 $\frac{1}{2}$ " Wx8Hx11" $\frac{1}{2}$ ".  
**13 F 47517W** Shpg. wt. 25 lbs. ....Net 49.95

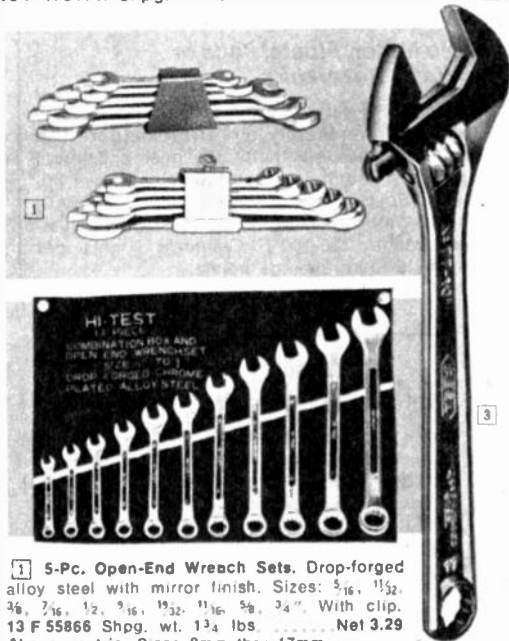
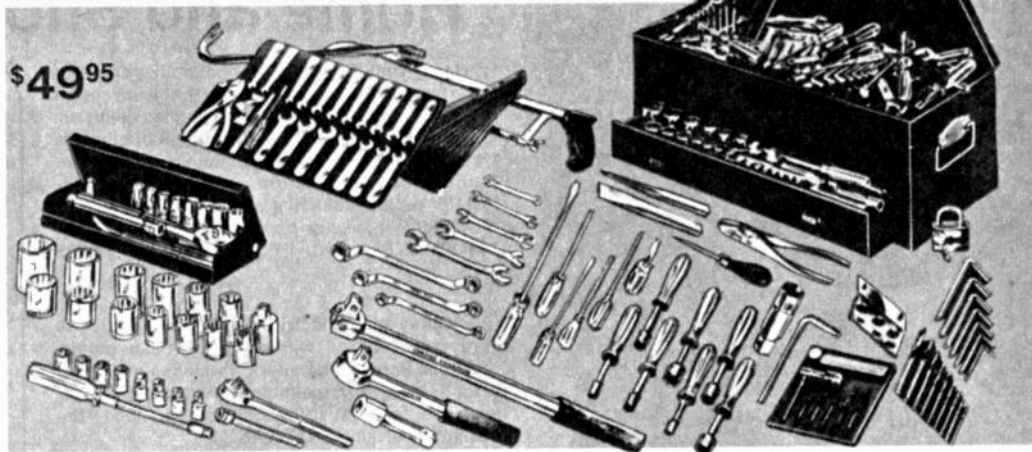

- 1** 5-Pc. Open-End Wrench Sets. Drop-forged alloy steel with mirror finish. Sizes:  $\frac{5}{16}$ ,  $\frac{11}{32}$ ,  $\frac{3}{8}$ ,  $\frac{7}{16}$ ,  $1/2$ ,  $\frac{9}{16}$ ,  $\frac{13}{32}$ ,  $\frac{11}{16}$ ,  $\frac{3}{4}$ ,  $3/4$ ". With clip. **13 F 55866** Shpg. wt. 1 $\frac{3}{4}$  lbs. ....Net 3.29  
 Above, metric. Sizes 8mm thru 17mm. **13 F 56146** Shpg. wt. 1 $\frac{1}{4}$  lbs. ....Net 3.29  
**5-Pc. Open-End and Box-Ends in Same Wrench.** Ends offset.  $\frac{3}{8}$ ,  $\frac{7}{16}$ ,  $1/2$ ,  $\frac{9}{16}$ ,  $\frac{3}{4}$ ,  $1\frac{1}{2}$ ". **13 F 55874** Shpg. wt. 1 lb. ....Net 3.29  
**2** 11-Pc. Combination Wrench Set. Drop-forged alloy steel, chrome-plated. In vinyl rollup kit.  $\frac{3}{8}$ ,  $\frac{7}{16}$ ,  $1/2$ ,  $\frac{9}{16}$ ,  $\frac{3}{4}$ ,  $1\frac{1}{2}$ ,  $1\frac{1}{2}$ ,  $1\frac{1}{2}$ ,  $1\frac{1}{2}$ ,  $1\frac{1}{2}$ ,  $1\frac{1}{2}$ ". 6 to 13" lengths. **13 F 56138** Imported Shpg. wt. 5 $\frac{1}{4}$  lbs. ....Net 17.95  
 Above, metric. 7-15, 17, 19mm. 4 to 9 $\frac{3}{4}$ " long. **13 F 56278** Imported. Shpg. wt. 5 $\frac{1}{4}$  lbs. ....Net 13.95  
**3** Drop-Forged Adjustable End Wrenches.

Stock No.	Lgth.	Max. Jaw	Wt.	Net
13 F 55668	6"	3 $\frac{1}{2}$ "	8 oz.	2.39
13 F 55676	8"	"	11 oz.	3.19
13 F 55684	10"	4 $\frac{1}{8}$ "	1 lb.	4.50
13 F 55692	12"	5 $\frac{1}{8}$ "	1 $\frac{3}{4}$ lbs	5.95

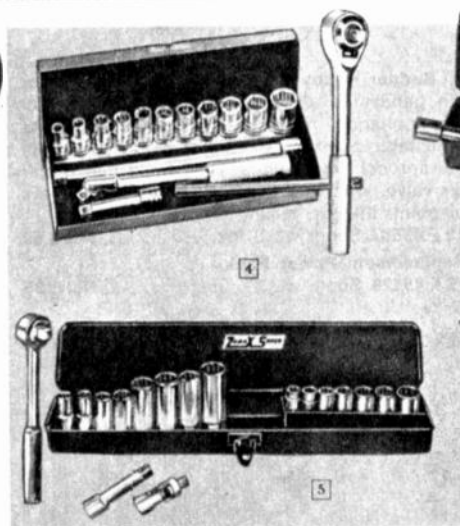

**4** 17-Pc.  $\frac{1}{4}$ " Drive Socket Set. Chrome-plated, drop-forged steel. 6-pt. sizes:  $\frac{7}{16}$ ,  $\frac{7}{32}$ ,  $\frac{9}{32}$ ,  $\frac{5}{16}$ ,  $\frac{11}{32}$ ,  $\frac{3}{8}$ ,  $\frac{7}{16}$ ,  $1/2$ ". 8-pt. sizes:  $\frac{1}{4}$ ,  $\frac{5}{16}$ ", 2 and 6" extensions. 5 $\frac{1}{4}$ " flex handle. 4 $\frac{1}{2}$ " crossbar. 5 $\frac{1}{2}$ " reversible ratchet, heavy-gauge storage box. Imported. **13 F 55643** Shpg. wt. 2 $\frac{1}{4}$  lbs. ....Net 7.95

**5** 19-Pc.  $\frac{3}{8}$ " Drive Socket Set. Mechanic's quality. Has both standard and deep sizes:  $\frac{3}{8}$ ,  $\frac{7}{16}$ ,  $1/2$ ,  $\frac{9}{16}$ ,  $\frac{11}{16}$  and  $3/4$ ". 12, 5 $\frac{1}{8}$ " std. size  $\frac{3}{8}$ " and  $\frac{19}{16}$ " spark plug sockets with neoprene inserts. 3" ext., universal joint. 8" reve-sible ratchet. Enamelled metal tool box. **13 F 56302** Imported. Shpg. wt. 6 lbs. ....Net 21.95

**6** 16-Pc.  $\frac{1}{2}$ " Drive Socket Set. Chrome-plated, drop-forged steel.  $\frac{7}{16}$ ,  $1/2$ ,  $\frac{9}{16}$ ,  $\frac{5}{8}$ ,  $\frac{11}{16}$ ,  $3/4$ ,  $7/8$ ,  $15/16}$ , 1,  $1\frac{1}{16}$ ,  $1\frac{1}{8}$ " and  $1\frac{1}{16}$ " spark plug socket with neoprene insert. 5 ext., 15 flex handle, reversible ratchet, heavy-gauge box. Imported. **13 F 56310** Shpg. wt. 9 lbs. ....Net 27.95

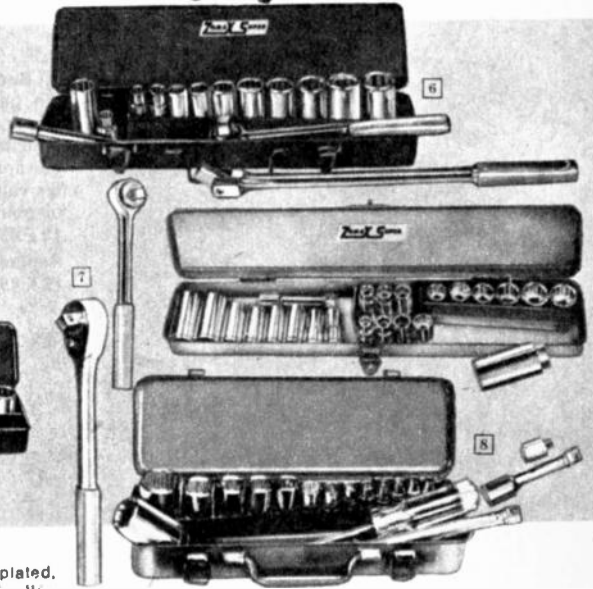

**7** 25-Pc.  $\frac{3}{8}$ " Drive Metric Socket Set. Chrome-plated 6 and 12-pt. sockets. Standard sockets: 7, 8, 9, 10, 11, 12, 13, 14, 15, 16, 17, 18, 19mm. Deep sizes: 10, 11, 12, 13, 14, 15, 17 and 19mm.  $\frac{13}{16}$ " spark plug socket. With 3" extension. 8" ratchet. Heavy box. **13 F 56203** Shpg. wt. 5 $\frac{1}{4}$  lbs. ....Net 24.95

**14-Piece Socket Set.** (Not shown). Converts  $\frac{3}{8}$ " drive ratchets to metric. Sizes 7-19mm. In wall-mountable carrying case. **13 F 56336** Shpg. wt. 1 $\frac{1}{2}$  lbs. ....Net 5.95.

**8** 21-Piece Combination  $\frac{1}{4}$  and  $\frac{3}{8}$ " Drive Socket Set.  $\frac{1}{4}$ " drive 6-pt. sizes:  $\frac{3}{16}$ ,  $\frac{1}{32}$ ,  $\frac{1}{4}$ ,  $\frac{5}{32}$ ,  $\frac{3}{16}$ ,  $\frac{11}{32}$ ,  $\frac{3}{8}$ ,  $\frac{7}{16}$ ,  $1/2$ ". One  $\frac{1}{4}$ " dr. 8-pt.  $\frac{3}{16}$ " socket.  $\frac{3}{8}$ " drive 8" reversible ratchet, spinner handle, 3 and 8" extensions.  $\frac{3}{8}$ " drive 12-pt. sockets:  $\frac{3}{16}$ ,  $\frac{9}{16}$ ,  $\frac{11}{16}$ ,  $\frac{3}{4}$ " and  $\frac{13}{16}$ " spark plug socket with neoprene insert.  $\frac{3}{8}$  to  $\frac{1}{4}$ " drive adapter. In storage box. Imported. **13 F 55585** Shpg. wt. 3 $\frac{3}{4}$  lbs. ....Net 13.95  
 Metric. 2 $\frac{1}{4}$ " drive—4-9mm, 7 $\frac{3}{4}$ " drive—10-19mm. **13 F 56328** Imported. 3 $\frac{3}{4}$  lbs. ....Net 13.95

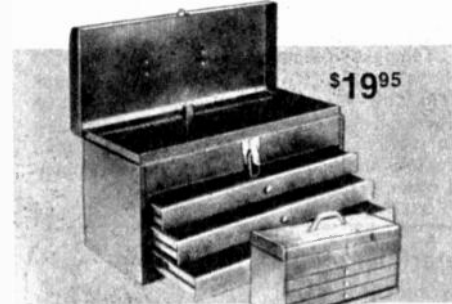

**3-Drawer Tool Chest.** Rugged construction. Drawers have full suspension slides, may be locked in place even if cover is closed. Electrically welded, heavy-gauge steel, baked enamel silicone-treated finish. 20W x 10 $\frac{1}{2}$ H x 8 $\frac{1}{2}$ "D. 3 drawers. 18 $\frac{1}{2}$ W x 11 $\frac{1}{2}$ H x 7 $\frac{1}{2}$ "D. **13 F 19508W** Shpg. wt. 18 lbs. ....Net 19.95

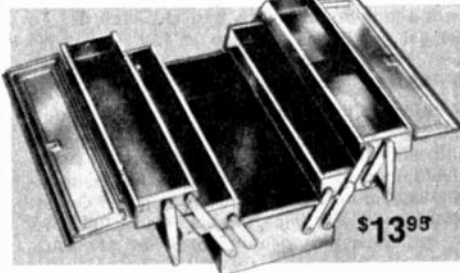

**Mechanic's 4-Tray Cantilever Tool Box.** Has full-size storage compartment PLUS four easy-glide trays. Extra-heavy-gauge steel, heavy-duty round handles, padlock eyes for locking. Bottom compartment is large enough for bulky tools. Baked blue enamel finish. 17Wx8Hx8 $\frac{1}{4}$ "D. **13 F 56104W** Shpg. wt. 16 lbs. ....Net 13.95

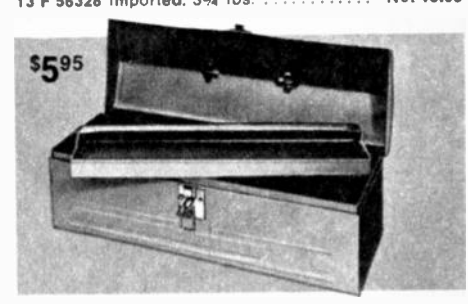

**Hip-Roof Tool Box with Lift-Out Tray.** Great for homeowners, handymen. Electrically welded, heavy-gauge steel, full-length hinge; plated handle will not break or pull out. Lift-out tray for smaller tools, large compartment for bulky tools. 19W x 7H x 7 $\frac{1}{4}$ "D. **13 F 42500W** Shpg. wt. 7 lbs. ....Net 5.95

# See Lafayette for the Best in Home and Shop Accessories



1 \$49<sup>95</sup>



3 \$8<sup>50</sup>

\$13<sup>95</sup>

1 **Heavy-Duty Sprayer.** Economically priced for the homeowner or hobbyist. Precision engineered. Compact, lightweight. Handles paint, oil, insecticides, wax, etc. Quiet-running diaphragm type compressor. One-quart aluminum canister. Delrin thread insert to prevent fouling. Plugs into 115V outlet. Maximum pressure of 40 psi. 8-ft. air hose. 7-ft. power cord. UL listed. 14 F 67562 Shpg. wt. 13 1/4 lbs. .... Net 49.95

2 **"Spray-All" Electric Sprayer.** All-purpose spray-gun for use with all water-base paints, enamels, acrylics, lacquers, varnishes and spray insecticides. Unbreakable. Graduated, 28-oz. jar. Five-position spray control. Includes Viscosimeter strainer. 117 VAC. 12 F 43518 Shpg. wt. 2 lbs. .... Net 13.95

3 **Badger Hobby & Touch-Up Air Brush Kit** for the handyman, craftsman or hobbyist. Perfect for appliance, furniture, boat touch-ups. Has adjustable paint tip for fine or heavy spray, 15-oz. aerosol power pack, vinyl hose and on-off air valve. With red, blue, yellow and black jars of paint, thinner, mixing jar, instructions. 13 F 45537 Shpg. wt. 3 lbs. .... Net 8.50  
**Replacement Power Pack.** 13 F 45529 Shpg. wt. 1 1/2 lbs. .... Net 1.95

## THERMO-MIST™



\$79<sup>95</sup>

### Modern Solid-State Humidifier

- Maintenance-Free Operation
- No Motor, Floats, Pads or Water Reservoirs

For Hot Air Heating Systems. Adds moisture to the air. Prevents "dry air" problems: cracked furniture, static electricity, dry nose and throat problems. Thermal sensor maintains proper humidity. Spec.: 5 1/2" W x 3 3/4" H x 3 1/2" D. 117 VAC, 60 Hz. Water pressure: 25-150 lbs./in.<sup>2</sup>. Adjustment range: 120-180°F. Capacity: 9 gals. per day. 6-10-room average house. 14 F 85069 Shpg. wt. 5 lbs. .... Net 79.95

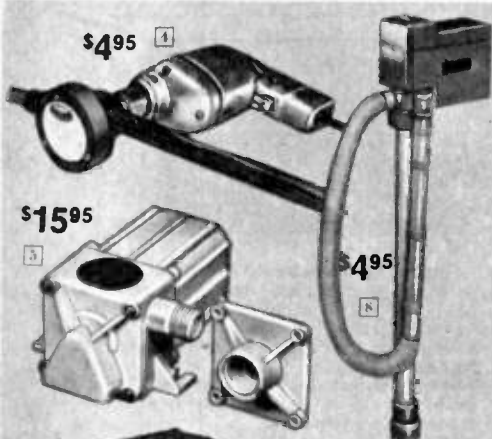

\$4<sup>95</sup>

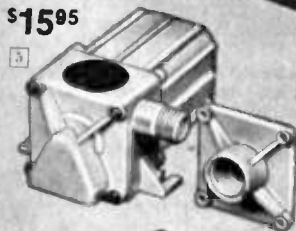

\$15<sup>95</sup>

\$4<sup>95</sup>



Low As \$17<sup>50</sup>

\$39<sup>95</sup>

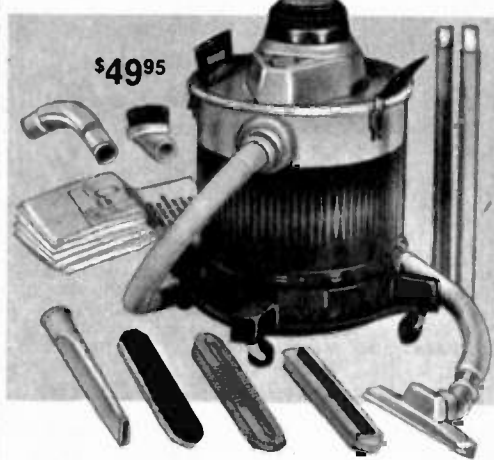

\$49<sup>95</sup>

## Aqua-vac...

### Deluxe 8-Gallon Wet and Dry Vac

Fantastic combination of Shop-Vac pickup power and portability. Picks up heavy debris, wet and dry. High-powered performance—1 peak HP motor does the job quickly and easily. Air-cooled and fully moisture protected. Epoxy-phenolic-coated steel vac has automatic float shutoff. 8-gallon capacity. Includes 6-ft. x 1 1/4" hose, 10" master nozzle with rug, brush and squeegee shoe inserts, 2-piece 40" extension wand, crevice tool, round brush, 4-wheel plastic dolly, 5 paper filter bags, curved extension tube. 13 F 35728W Shpg. wt. 24 lbs. .... Net 49.95

1 **Powerful Self-Priming Pump.** Works off any electric drill. Pumps liquids to 10 feet vertically or prime a maximum distance of 50 feet horizontally. Handles to 200 gallons per hour with 2,000 RPM 1/4" drill at temps. from 40-180°F. With 3-ft. hose, hose fittings, oil-changing kit. 13 F 33780 Shpg. wt. 10 oz. .... Net 4.95

2 **12-Volt DC Submersible Pump.** Fits under marine engine stringers and duckboards. To 400 gal./hr. Draws 1.5 amp at 12V. Outlet 3/8" N.P.T. male. Needs 3/8" I.D. hose. 2 1/8" x 2 1/8" x 5 1/2". 13 F 89071 Shpg. wt. 1 1/4 lbs. .... Net 15.95

3 **Submersible Pow-R-Pak Pumps** for underwater use. Circulates and dispenses water and mild acid solutions for air conditioning, photo developing, etc. Corrosion-resistant. Hermetically-sealed motor. Overload protection. Outlet: E200 has 1/4" std. pipe thread E400, E700 have 3/8" std. pipe thread. 6-ft. cord. For 117 VAC, 60 Hz. Avg. size: 2 5/8" x 4 x 4".

Stock No.	Gals. per Hr. at Mod.	Fl. Ft.			Lbs.	Net
		1	3	6 Max.		
13 F 89048	E-200	220	155	80	7" .40	3 17.50
13 F 89055	E-400	400	320	220	11" .91	4 1/2 19.95
13 F 89063	E-700	700	540	430	13" 1.9	4 1/2 29.95

4 **Puddle Gulper.** Complete pumping system. Electric motor pump. 7-ft. inlet hose. Rust-proof, built-in strainer for motor protection. 3-prong

grounded plug. 117 VAC, 60 Hz. 360 gal./hr. Self-priming. 8-10 ft. vertically, 25 ft. horizontally. Pulls water once pumping 20' vert., 50' hor. 13 F 33764 Shpg. wt. 8 lbs. .... Net 34.95

5 **Lafayette Battery-Operated Utility Pump.** Pumps non-corrosive liquids. Empties clogged sinks, washers, tubs. Use to fill vacuum bottles. 13 1/2" draw tube. 2 1/2" flexible plastic hose. Not for use with gasoline. Operates on 2 "D" cells. Pumps 1 1/2 gallons per minute. Tough, durable plastic housing and tubes. Imported. 99 F 80012 Shpg. wt. 1 lb. .... Net 4.95

6 **"Tempest" Submersible Pump.** Delivers 1300 gallons/hr. at 3 ft. vertically. Easily portable. Needs only 1/2" water depth to pump. Built-in, screened inlet for continuous duty. For use with garden hose or 1" pipe. Ideal for sump pumping, draining swimming pools, re-circulating water in fountains. 115 VAC, 60 Hz. 13 F 33772 Shpg. wt. 10 lbs. .... Net 39.95

## Waterfall Pump Kit

Lovely waterfall of cascading water constantly recirculated by electric pump. Gal./hr.: 180 at 1 ft. 140 at 3 ft.; shutoff at 10 ft. Outlet 3/8"; inlet 1/2". Load: .65 amps; 43W. 8-ft. hose, 7-ft. sealing poly, pump filter. 13 F 89022 5 1/4 lbs. Net 24.95



# Storage Cabinets *Untangle* Your Home Workshop

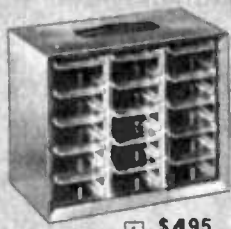

1 \$495

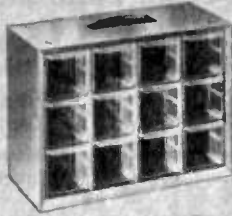

2 \$750

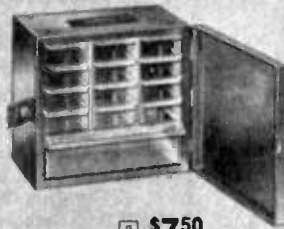

3 \$750



4 \$995

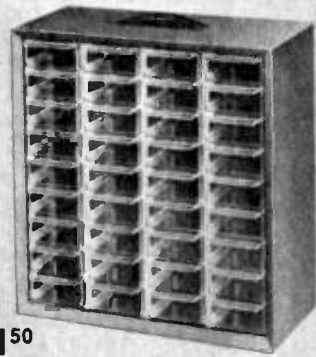

5 \$1150

**1 AKRO-MILS 15-Drawer Cabinet**  
11-615. Portable with an all-steel frame. 10x8x6" with 15 "see-thru" drawers, each 2 3/4 x 1 1/4 x 5 3/4". With dividers and labels.  
13 F 76250 Shpg. wt. 4 1/4 lbs. . . . Net 4.95

**2 AKRO-MILS 12-Drawer Cabinet**  
11-712. Contains double-deep drawers. 9 1/2 x 13x6 1/2" with twelve 2 3/4 x 2 x 5 3/4" drawers. With dividers and labels.  
13 F 76318W Shpg. wt. 7 lbs. . . . Net 7.50

**3 AKRO-MILS Locking Cabinet**  
11-413. Portable cabinet with locking steel door. Drawers: 12 1 1/4 x 2 3/4 x 5 3/4"; 1 jumbo — 2 1/2 x 8 3/4". 10x9x6" overall. Stacks.  
13 F 76219W Shpg. wt. 5 1/2 lbs. . . Net 7.50

**4 RAACO Combination Cabinet**  
15-drawer, welded steel cabinet. Drawers: 12 reg. 1 3/8 x 2 1/2 x 5 3/8"; 2 large 2 1/4 x 5 3/8 x 5 3/8"; 1 jumbo 2 1/4 x 10 7/8 x 5 3/8". Overall: 11 1/4 x 12 1/2 x 5 3/4". Stacks with other RAACO units.  
13 F 77514W Shpg. wt. 5 1/2 lbs. . . . Net 9.95

**5 AKRO-MILS 36 or 50 Drawers**  
11-636. 36-drawer steel frame cabinet. Size: 13x6 1/2 x 13 1/2. Drawers: 2 3/4 x 5 3/4 x 1 1/4".  
13 F 76292W Shpg. wt. 9 lbs. . . . Net 11.50  
11-650. Above 16x15x6 1/2", 50 drawers.  
13 F 76300W Shpg. wt. 12 lbs. . . . Net 14.50

**6 RAACO 48-Drawer Cabinet**  
Large welded steel frame, 12x22x5 3/4". 48 crystal-clear drawers, each 1 3/8 x 2 1/2 x 5 3/8". Metal shelves support heavy loads. With dividers and index cards. Imported.  
13 F 77506W Shpg. wt. 11 1/2 lbs. . . Net 17.95

**7 RAACO Combination Cabinet**  
Three drawer sizes in 1 large steel frame, 22x12x5 3/4". 30 clear plastic drawers: 24 1 3/8 x 2 1/2 x 5 3/8"; 4 2 1/4 x 5 3/8 x 5 3/8"; 2 2 1/4 x 5 3/8 x 11". With dividers and index cards. Stacks with other units. Imported.  
13 F 77035W Shpg. wt. 11 1/2 lbs. . . Net 17.95

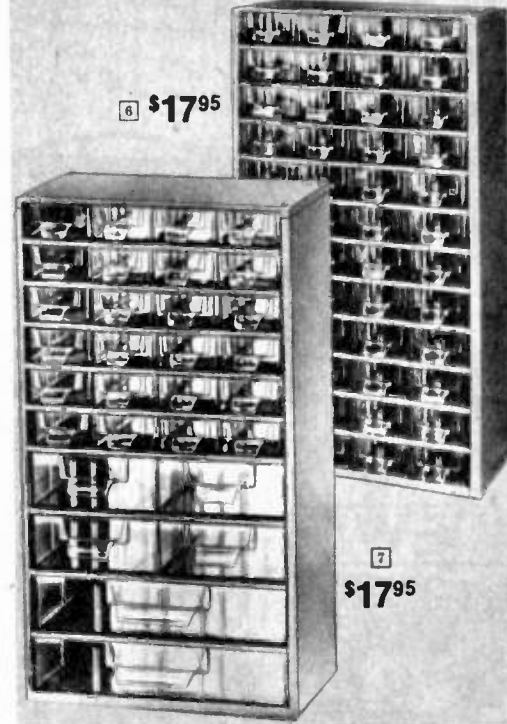

6 \$1795

7 \$1795

## AKRO-MILS Modular Cabinets

Welded steel frames, see-thru drawers. With labels and dividers. Units stack.

**Fig. 8. Model 17-136.** 36 compact drawers, 2 3/4 x 5 3/8 x 1 1/4". Cabinet size: 18 x 6 x 9 1/2".  
13 F 76102 Shpg. wt. 11 lbs. . . . . Net 19.70  
**Fig. 9. Model 17-416.** 16 large drawers, 4 x 11 x 2 1/8". Cabinet size: 18 x 11 x 11".  
13 F 76128W Shpg. wt. 21 1/2 lbs. . . . . Net 29.35

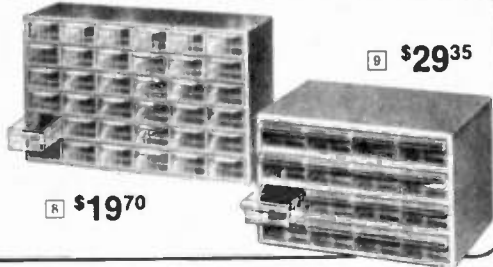

8 \$2935

9 \$1970



10 \$26995

11 \$17650

## 10 Portable Power Generator

**• 3 H.P., 4-Cycle Lauson Engine**  
Features a permanent magnet alternator—no brushes, belts, slip rings or commutators. Produces 1250 watts continuous, 115 VAC from a 3-hp, 4-cycle Lauson engine. 1/2-quart capacity fuel tank.  
13 F 49026WX Shpg. wt. 70 lbs. . . Net 269.95

**11 Tiny Tiger Portable Generator**  
Model 5001-1. Supplies both 115 VAC, 350 watts and 12 VDC, 12 amps. Features a 1-hp, 2-cycle Ohlsson & Rice air-cooled engine with high-capacity magneto ignition, 6-pint, premixed (24:1 gas:oil) fuel capacity. "Hush-Tone" muffler. 8 1/2 x 8 1/2 x 10 1/4".  
12 F 35522 Shpg. wt. 16 1/2 lbs. . . Net 176.50  
*Lafayette—Your "Single-Trip" Source for Everything in Electronics*



12 \$2995

## 12 Tool Storage Center

Heavy-gauge, welded steel storage center with 3 shelves in cabinet body plus peg-board panels on doors. Hasps on door accommodate any standard padlock, magnetic catch holds door closed. 30 x 30 x 12"  
14 F 25529W Shpg. wt. 33 lbs. . . Net 29.95



13 \$2495

## 13 Heavy-Duty Work Bench

Heavy-gauge steel frame, balanced weight design for stability. 1" thick, high-impact prestwood top surface. 34 x 48 x 24".  
14 F 25503WX Shpg. wt. 55 lbs. . . Net 24.95  
**36"-Long, 2-Tiered Tool Rack** for above.  
14 F 25511 Shpg. wt. 5 lbs. . . . . Net 3.95

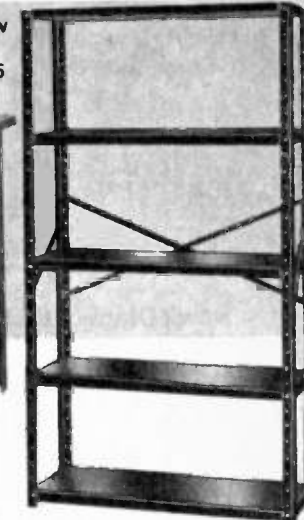

14 As Low As \$1295

## 14 5-Shelf Steel Storage Unit

Has snagproof, rounded posts and edges; braced back and sides for strength. Includes hardware for easy assembly. Adjustable shelves. Baked-on enamel finish.  
**5-Shelf Unit Size: 12x30x66"H.**  
13 F 58506W Shpg. wt. 22 lbs. . . . Net 12.95  
**5-Shelf Unit Size: 18x36x72"H.**  
13 F 58514W Shpg. wt. 30 lbs. . . . Net 16.95

# Lafayette Has Electronic Auto Test Equipment

## 1 Deluxe Solid-State Engine Analyzer

- Large 6" D'Arsonval Double-Jeweled Meter
- Rugged Steel Case Baked Enamel Finish
- Electronically Tunes Any Car Made
- Rear Storage Compartment

**MEASURE:** Dwell or Cam Angle; Engine Speed; Carbon Suppressor Spark Plug Cable  
**ADJUST:** Carburetors; Points  
**CHECK:** Condensers; Coil Resistance; Batteries; Lamps; Fuses; Relays; Switches; Alternator Diodes; Shorts and Opens in Wiring  
**TEST:** Alternators; Generators; Regulators

For all 6, 12, 24 or 32V electrical systems: regular, transistorized or magneto ignition; 8, 6 or 4 cylinder, 4 or 2 cycle engines. Measures 0-3.2, 0-16, 0-32 VDC; cam-dwell angle 0-45°, 0-60°, 0-90°; RPM 0-1200, 0-6000, 0-2400, 0-12,000; -5 to +90 amps; 0-100,000 ohms. Operates on a D cell battery. With 5½-ft. leads, instructions, clamps, plugs, jacks, probes, connectors. 12 x 6½ x 6".

11 F 24502 Shpg. wt. 7¾ lbs. . . . . Net 49.95  
 99 F 63661 Battery for Above. Imported . . . . . Net 28¢

## 2 Solid-State Engine Analyzer

- Test Dwell or Cam
- Large 6" D'Arsonval Double-Jeweled Meter
- Operates on "AA" Cell

Performs all of the same functions and good for the same wide range of engines as above. Ranges: 8 cyl., 0-1200, 0-4500 RPM, 0-45°; 6 cyl., 0-1600, 0-6000 RPM, 0-60°; 4 cyl., 0-2400, 0-9000 RPM, 0-90°. Measures 0-16 volts with charging ranges for 6 and 12V systems, -5 to +90 amps, 0-100,000 ohms.

11 F 24528 Shpg. wt. 6 lbs. . . . . Net 39.95  
 99 F 63703 Battery for Above. Imported . . . . . Net 22¢

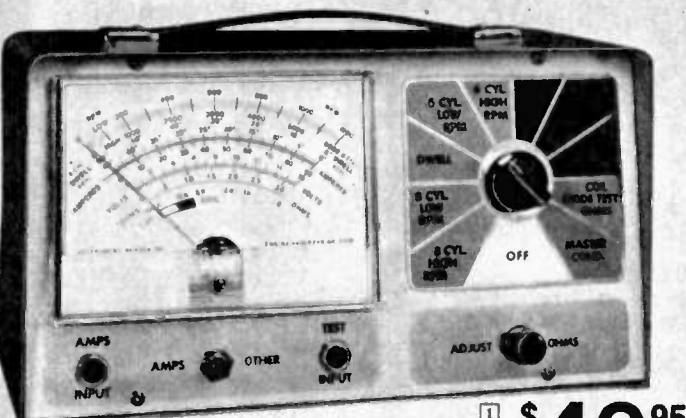

1 \$49.95

\$39.95



**NEW!**



Hawk \$24.95



\$26.95

\$16.95



\$29.95

### 3 Hawk Diagnostic Tune-Up Kit

- Mini Dwell-Tach Tester
- Pushbutton Release Compression Tester
- Neon Timing Light

Perfect for the do-it-yourselfer. Contains: Dwell-Tach Tester with 3" D'Arsonval meter—accurately measures cam dwell 0-45, 0-60 and idle RPM 0-1200, 0-1600 on 4, 6 or 8-cylinder engines; Compression Tester; shock-proof Neon Timing Light—with pre-focused lens and leather-grained finish; Remote Starting Switch—operates by squeezing handle to crank engine.

11 F 41506 Shpg. wt. 5 lbs. . . . . Net 24.95

188 Lafayette Cat. No. 750

### 4 Tach-Dwell Points Tester

Hand-held. With 6" D'Arsonval meter for 4, 6 or 8-cyl. engines, 6 or 12V systems. Adjust idle and points; eliminate creeping, stalling. Has lo (0-1200), high (0-6000) RPM tach scales; 0-45°, 0-60° dwell. Instructions. 11 F 43510 Shpg. wt. 2 lbs. . . . . Net 26.95

### 5 Lafayette 3 1/2 inch Dwell-Tach

Electronically adjust carburetor, point gap, engine RPM. Locates defective spark plugs. D'Arsonval meter. For 4, 6 or 8-cyl. engines; 6 or 12V systems. 0-3000 RPM; 5-45°, 20-60° dwell. Point resistance check. Instructions. 6¼ x 3¾ x 2".

11 F 01054 Shpg. wt. 1½ lbs. . . . . Net 16.95

### 6 Deluxe 6 inch Dwell-Tach

- Electronically Tune-Up Any Car
- Three Dwell Scales
- Low- and High-Range Tach Scales
- Giant 6" Easy-to-Read Scale

Easy-to-read meter makes it simple for anyone to adjust points and carburetion, and service automatic transmissions. Measures dwell on three scales: 0-45°, 0-60°, 0-90°. Dual range tachometer 0-1000 RPM for precise carburetor adjustments, 0-5000 RPM suitable for making all other tests at high engine speeds. Complete with instruction manual. Shpg. wt. 2½ lbs.

11 F 24536 . . . . . Net 29.95

Charge It with Your BankAmericard or Master Charge.

# Auto Timing Lights—Latest Test Equipment

## Deluxe AC or DC Powered Timing Lights—Kit or Wired

- Ultra Brite Xenon Strobe Tube
- Heavy-Duty Wire and Grips

Ultra-bright Xenon timing lights—the ultimate in a mechanic's light. Special solid reflector design increases the usable light output for easy use, day or night. Plus—the light is shock-protected in a heat-resistant case that is not affected by oil or grease. Circuitry is fully transistorized and diode-protected against improper polarity. Heavy-duty, extra-long leads and contoured, balanced pistol grip let you reach the most inaccessible timing marks with ease. The Xenon flashtube is easily replaceable. Power is controlled by a trigger switch.

### DC POWER TIMING LIGHTS

For 6 or 12 volts, positive or negative ground.  
 11 F 42611 Wired. Shpg. wt. 2 lbs. . . . .Net 22.95  
 11 F 42561 Kit Form. Shpg. wt. 2 lbs. . . . .Net 16.95

### AC POWER TIMING LIGHTS

For 110 VAC, 60 Hz. Shpg. wt. 2 lbs.  
 11 F 42579 Wired . . . . .Net 12.95  
 11 F 42587 Kit Form . . . . .Net 10.95



DC Wired <b>\$22<sup>95</sup></b>	DC Kit <b>\$16<sup>95</sup></b>
AC Wired <b>\$12<sup>95</sup></b>	AC Kit <b>\$10<sup>95</sup></b>



## DC Powered Timing Light & Dwell Tach Combination

- Keeps Car in Tune for **BETTER Gas Mileage**
- Lets You Set Ignition Timing
- Measures Engine RPM and Dwell Angle

Two fine instruments in one! It's a dwell tach for measuring cam dwell angle and engine speed . . . and a DC-powered timing light with brilliant white Xenon tube that flashes bright, blue-white light when trigger is squeezed. Works on 4-, 6- or 8-cylinder engines; 6 or 12 volts, positive or negative ground. Solid-state circuitry; tough cyclolac case. 3" meter with color-coded dial, zero adjustment.  
 11 F 41514 Shpg. wt. 1½ lbs. . . . .Net 34.95

## Professional DC Timing Light

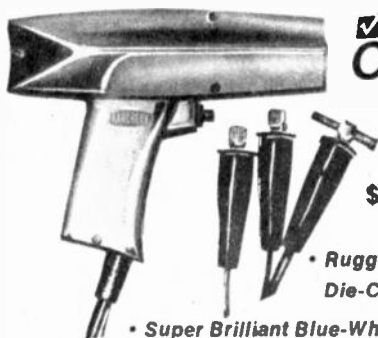

**Kar Check**

**\$27<sup>95</sup>**

- Rugged Chrome Die-Cast Metal Case
- Super Brilliant Blue-White Xenon Tube

Gives ample flash intensity for setting engine timing under any light conditions. Connects to car battery; shock-mounted internal components take constant use without damage. Trigger-activated for longer bulb life; prefocused. Unbreakable lens; heavy-duty clips electronically bonded to grease and oil resistant leads. Flex-Guard strain-relief bushing. Operates on 6- or 12-volt system; universal spark plug adapter. Burnout proof and shock protected.  
 11 F 43502 Shpg. wt. 3½ lbs. . . . .Net 27.95

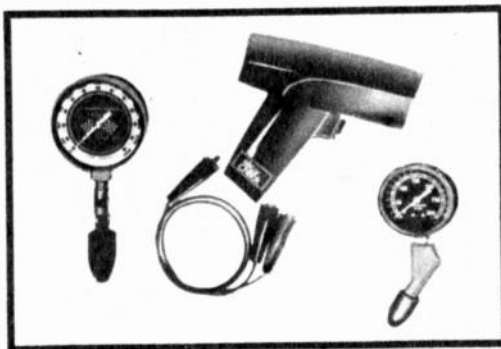

## Tune-Up Kit **\$13<sup>95</sup>**

- Lets You Tune Engine for Peak Efficiency
- Accurate Testing and Timing of Any Engine

Complete tune-up kit includes: Compression Tester to locate valve, ring, piston and cylinder troubles with 2½" dial; Vacuum and Pressure Tester to check intake vacuum, fuel pump and sticky valves with 2½" dial; Ignition-powered Timing that connects to any 6-, 12- or 24-volt system; and convenient Remote Control Starter Switch.  
 11 F 43536 Shpg. wt. 2½ lbs. . . . .Net 13.95



**Hawk**

## "Lil Hawk" Engine-Off Timer

**\$3<sup>98</sup>**

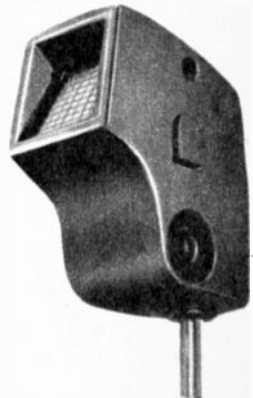

Lets you set the ignition timing without starting the engine. Eliminates the danger of whirling fan. Easy to use on any car. Just place timer in distributor cap, insert coil wire in timer, pre-set timing marks and loosen distributor. Then turn key on and move distributor until light flashes. That's all—the engine is then timed, and you can tighten the distributor, replace coil wire and slam the hood.  
 11 F 41522 Shpg. wt. 1 lb. . . . .Net 3.98

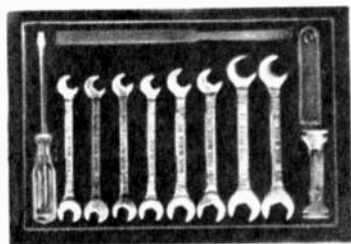

**\$1<sup>99</sup>**

## Wrench & Ignition Sets

Each set includes eight double open-end wrenches of hardened, plated steel; thickness gauge with 6 blades; spark plug gauge; screwdriver; point file; plastic box. Shpg. wt. 8 oz.  
 "Inch" Set. ¼" to ¾" wrenches.  
 11 F 31523 . . . . .Net 1.99  
 Metric Set. 4mm thru 11mm sizes.  
 11 F 31531 . . . . .Net 1.99



**\$6<sup>50</sup>**

## Point Setting Tool Kit

Sets' points without finding high spot on cam or removing distributor. Even does dual points in one operation. Includes 5 micro-precision rings with feeler gauges, adapters, and tool for hex-wrench GM cars. List of popular cars displayed inside cover of box. Shpg. wt. ¾ lb.  
 11 F 31507 . . . . .Net 6.50

## Spark Plug/Ignition Gauge

Handy combination tool has wires and narrow blades to gap both points and plugs. Decimal sizes and metric equivalents permanently etched. Fifteen 1¼ x ¼" blades, .012-.032"; wire gauges, .022-.040"; file.  
 14 F 52077 Shpg. wt. 8 oz. . . . .Net 2.49

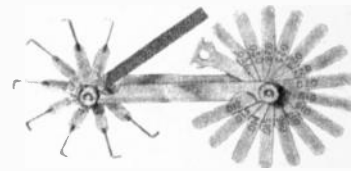

## Spark Plug and 6/12-Volt Tester

- With Retractable Test Probe Needle and Alligator Clip

For testing 6- and 12-volt wiring on cars, boats, trailers or any low-voltage system. Test spark plugs, fuses; find faulty sockets, shorts, broken wires. Quick and easy visual test with neon flash.  
 11 F 31515 Shpg. wt. 4 oz. . . . .Net 1.95

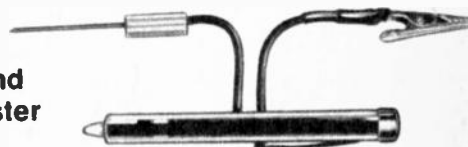

# "DO-IT-YOURSELF" Auto Accessories

**AUTO GAUGES**   **CRUISE CONTROL**   **DEFROSTER/DEFOGGERS**



**Deluxe 3 1/4" Ammeter-Water-Oil Pressure Gauge**

**\$29<sup>95</sup>**

- All-Electric
- No Tubing

End guesswork and space problems with this 3-in-1 gauge. Illuminated dial face gives accurate individual readings of current from -60 to +60 amps, oil pressure from 0 to 80 lbs., and water temperature in cold/normal/hot ranges. For 12-volt negative ground systems. Universal mount. Chromed metal bezel with black wrinkle case finish. Includes wire, senders. 11 F 42595 Shpg. wt. 2 lbs. . . . . Net 29.95



**Deluxe 3 1/4" Gas Saver Vacuum Gauge**

**\$15<sup>95</sup>**

- Shows Miles Per Gallon—Helps Improve Gas Economy

Saves up to 40% of your gasoline dollars by showing you how to drive for the best economy or power. Checks your engine constantly by measuring its manifold pressure on a clear, 4-color illuminated dial. Fits any car, with universal mount. Chrome-plated metal bezel with baked black wrinkle finish case. With T-connector, 6-ft. vacuum tubing, instructions. 11 F 42603 Shpg. wt. 1 1/4 lbs. . . . . Net 15.95



**3 1/2" High-Performance Solid-State Tachometer**

**\$19<sup>95</sup>**

- Accurate 0-8000 RPM Scale

Attractive, easy-to-read 0-8000 RPM tachometer features a precision-jeweled D'Arsonval meter that assures steady, accurate readings. Adjustable shift indicator pointer. Zener-stabilized circuitry for accuracy of ±2%. Individually factory calibrated. Chrome case with black trim, easy-mount bracket. For 4-, 6- or 8-cyl. engine; any 12-volt system. 11 F 38098 Shpg. wt. 1 1/2 lbs. . . . . Net 19.95



**"Talisman 12" Digital Clock**

**\$19<sup>95</sup>**

Battery-operated digital clock shows you the time and the day. Clock face is tilted for easy visibility, has built-in light. Perfect for car dashboard, office, home, boat or recreational vehicle. Operates from "C" battery (included). 2 1/2 x 3 3/4 x 3". Imported. 11 F 55506 Shpg. wt. 1 lb. . . . . Net 19.95

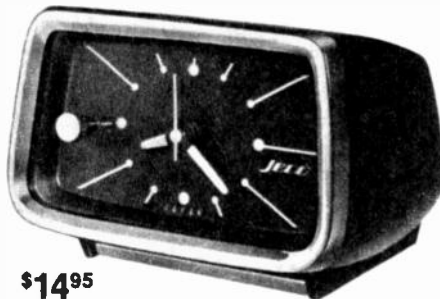

**\$14<sup>95</sup>**

**Auto/Marine Battery Clock**

Operates up to one year on single "C" battery (order below). Easy-to-read black face with luminous hands, markings and sweep second hand. Fiber mesh fastening arrangement attaches to any surface—removes easily. Fast/Slow regulator. Black/chrome. 2 1/4 x 3 3/4 x 3 3/4". 99 F 85243 Imported. Wt. 1 lb. . . . . Net 14.95  
99 F 62572 Battery for above . . . Net ea. 19¢

**Solid-State Auto Electrical Tester**

**\$6<sup>50</sup>**

- Plugs into Cigarette Lighter



Accurately checks your car, truck or boat's electrical system without getting "under the hood." Indicates the condition of the battery, generator or alternator, and voltage regulator. Meter has a jeweled D'Arsonval movement accurate to ±2%; large multi-colored dial. Sealed one-piece body. 11 F 77500 Shpg. wt. 3/4 lb. . . . . Net 6.50



**Easy to Install**  
**\$23<sup>50</sup>**

**Electric Speed Control**

Permits you to drive at a constant speed over level surface, by automatically holding the throttle steady. Once you reach desired speed, simply pull out knob and the Speed Control holds that speed. Allows instant acceleration for passing; ceases to function when brake pedal is depressed. For all cars. 11 F 59011 Shpg. wt. 2 lbs. . . . . Net 23.50

**Deluxe Airway Universal Compass**

Precision compass features fingertip regulators with 8 gears and special magnets for added accuracy and quick compensation. Design allows up to 30° tilt. Calibrated in 5° intervals. Universal bracket mounts in any position in car, boat. With adhesive plate for windshield mounting. Chrome/black finish. Illuminated. 11 F 65059 Shpg. wt. 12 oz. . . . . Net 5.95

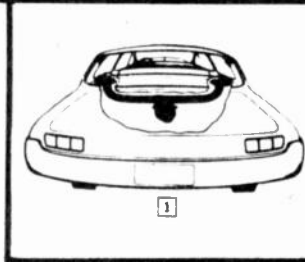

**1 Rear Window Defroster/Defogger Kit**

Eliminates the hazardous driving conditions caused by steam, fog or frost on rear window. Air drawn from interior of car blankets the window, removes condensation and frost, prevents accumulation of snow while car is moving. Easily installed in trunk. Adjustable louvers direct air where needed. Dash switch controls operation. Fits all cars (except station wagons, convertibles and rear engine cars) with 12V system. Wt. 5 1/4 lbs. 11 F 12507 . . . . . Net 17.95

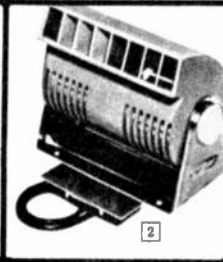

**2 Rear Deck Auto Fan**

Defogs rear window for better vision, safer driving. Fully enclosed motor and fan for safety. Universal mounting bracket; variable height adjustment. With switch and hardware. For 12-volt cars. 11 F 51505 Shpg. wt. 1 lb. . . . . Net 9.95

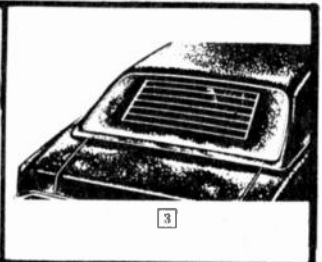

**3 Rear Window Defroster/Defogger**

Looks and operates like original equipment. Self-adhesive, solid-metal grid bonds directly to rear window—no unsightly plastic shield to obscure your vision or trap moisture. Heat is distributed evenly to all parts of the glass. Includes dashboard switch. Grid size: 12x33". For 12 volts. 11 F 65596 Shpg. wt. 1 1/2 lbs. . . . . Net 6.95

*Prices and Specifications are Subject to Change Without Notice.*



# Electronic Ignition Systems—Door Openers

DELTA

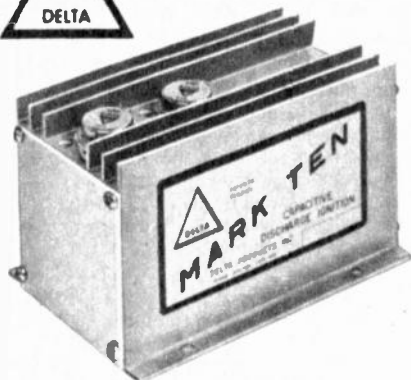

## DELTA MARK 10 Capacitive Discharge Ignition System

WIRED <b>\$44<sup>95</sup></b>	KIT <b>\$34<sup>95</sup></b>
-----------------------------------	---------------------------------

With Silicon-Controlled Rectifier

- Quick, Easy Installation
- Constant Spark to 10,000 RPM

Solid-state ignition system eliminates point bounce problems and positively fires plugs regardless of point condition. Fast rise time prevents fouling; spark plugs last 3 to 10 times longer. Point contacts last indefinitely. Eliminates misfiring, reduces oil contaminants, prolongs engine life. Assures smoother and more efficient operation in all weather. Installs easily with only two connections to existing coil, leaving standard system intact. Mounts anywhere—uses very small amount of power. Operates with all tachometers. For 12-volt negative ground.

11 F 84506 Wired. Shpg. wt. 2½ lbs. . . . . Net 44.95  
11 F 84514 Kit Form. Shpg. wt. 2½ lbs. . . . . Net 34.95

DELTA



## DELTA MARK 10B Capacitive Discharge Ignition System

WIRED <b>\$54<sup>95</sup></b>	KIT <b>\$44<sup>95</sup></b>
-----------------------------------	---------------------------------

With VARI SPARK® Circuitry

- Restores Power Lost by Smog Control Devices
- Switch for Standard Ignition

Specifically designed for modern engines with emission control devices . . . special circuitry controls spark duration as well as spark intensity to help overcome rough idling, surging, slow starting, hesitation and extremely poor mileage. Gives you smoother operation at all speeds, dramatically improving acceleration and economy. Plugs will last 3 to 10 times longer, points indefinitely. And you'll get faster, easier starts in all weather. For any 12-volt negative ground system. Installs easily with two simple connections to existing coil, leaving standard system intact. Handy switch provides instant return to standard ignition.

11 F 84522 Wired. Shpg. wt. 2½ lbs. . . . . Net 54.95  
11 F 84530 Kit Form. Shpg. wt. 2½ lbs. . . . . Net 44.95

## JUDSON See/Dee Electronic Ignition System

**\$19<sup>95</sup>**

- Quick, Easy Installation
- Improves Mileage and Performance

SEE/DEE System gives you a better and smoother-running engine, faster starts, and extended plug and point life. Reduces chance of ignition failures and the need for tune-ups. System current is completely controlled by zener diode. For 6 or 12 volts, negative ground, single or dual points.

11 F 35516 Shpg. wt. 1 lb. . . . . Net 19.95

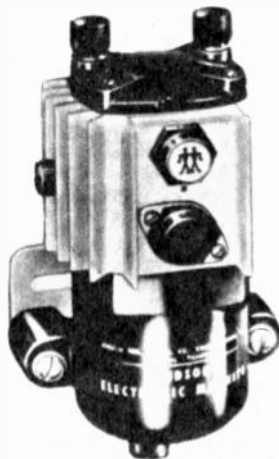

## JUDSON Electronic Magneto Ignition System

**\$42<sup>95</sup>**

- Quick, Easy Installation
- Silicon Components
- Reduces Fuel Consumption

Positively improves performance! Like a mechanical magneto used on racing cars, the electronic magneto provides a minimum of 30,000 volts with the fastest rise time of any system available. It's like having a permanent tune-up; doubles plug and point life, gives better gas mileage, allows instant starts in sub-zero weather . . . even with heavy carbon deposits and fouled plugs. Operates on 6- or 12-volt systems, single or dual point. Won't interfere with operation of radio or electronic equipment. Uses silicon components . . . fully protected by zener diodes. Completely sealed against water and corrosion. Simple installation by transferring wires from present coil and connecting an additional wire to ground. Size: 7½ x 3½".

11 F 35508 Shpg. wt. 4¼ lbs. . . . . Net 42.95

## Radio Controls for Any Electronic Garage Door Opener

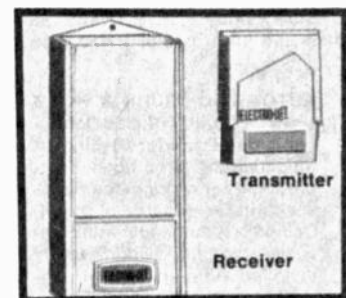

Transistorized  
Tone-Coded  
Receiver and  
Transmitter

**\$64<sup>95</sup>**

Radio Control System consists of two units: a transistorized Tone-Coded Transmitter and a Receiver. Operates any electrically-controlled door opener from up to 100 feet away. Tone modulation circuitry gives you complete security; only your personal pocket-size Tone-Coded Transmitter can trigger the receiver. Installs in minutes. Complete System.

13 F 82217 Shpg. wt 1¼ lbs. . . . . Net 64.95

Extra Transmitter for second car.

13 F 82159 Shpg. wt. ¾ lb. . . . . Net 23.95

Lafayette—Over 55 Years of Electronics Leadership

## ELECTROLIFT

- Separately-Housed Mechanical and Solid-State Controls
- Built-in Garage Light Timer

## Deluxe Heavy-Duty Garage Door Opener

**\$179<sup>95</sup>**

Heavy-duty "Belt" chain drive ½ HP motor easily lifts doors up to 22 ft. wide and 8 ft. high; up to 200 lbs. pulling force. Use it with single, double sectional, 1-piece, wood, metal or fiberglass doors. Easy installation; only 1½" headroom needed. Wall-mounted, solid-state receiver. Pushbutton for indoor operation. Door automatically stops and reverses when it meets an obstruction. Dual light goes on when door opens, stays on two minutes after door closes. Individually-keyed Tone Coding maintains maximum security. For 117 VAC, 60 Hz. UL listed.

13 F 82209W Shpg. wt. 65 lbs. . . . . Net 179.95

### ACCESSORIES

Extra Transmitter for second car.

13 F 82159 Shpg. wt. ¾ lb. . . . . Net 23.95

Key Switch for outdoor operation. With 2 keys.

13 F 82043 Shpg. wt. ½ lb. . . . . Net 5.95

Outside Quick Release Lock. Used to open door from outside when electricity fails.

13 F 32134 Shpg. wt. ½ lb. . . . . Net 5.95

16-oz. Dry Spray Silicone Spray Lube.

13 F 82142 Shpg. wt. 1½ lbs. . . . . Net 2.95



No Need to Get Out of Car—  
Door Opens Automatically

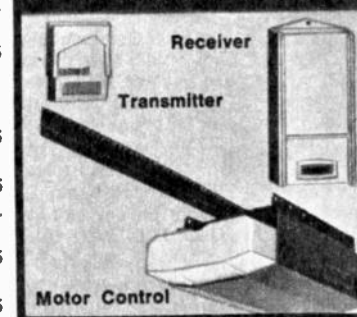

# Radarsentry—Auto Lights and Lamps

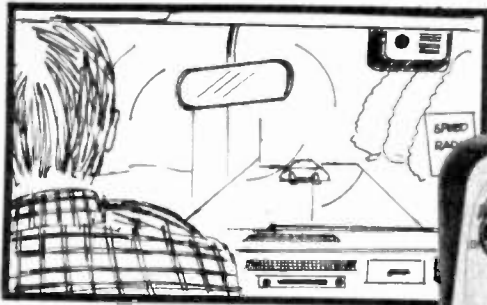

With Long-Life Mercury Batteries

KIT \$25.95

WIRED \$34.95

## RADAR SENTRY . . . Warns of Traffic Zones!



- Miniaturized—Transistorized—Clips on Sunvisor
- Gives Advance Warning • Rugged Printed Circuit

Miniature electronic detector gives an audible warning whenever it intercepts a radar beam. Dual-band circuit detects all commonly-used police radar speed meters and traffic control devices, both vertically and horizontally polarized, to promote safer driving. Two 1000-hour mercury self-testing batteries (equivalent to 35,000 miles of driving at 35 MPH). Weighs only 13 oz.; measures 3 5/8" x 2 1/4" x 3 3/4". Complete with batteries, sunvisor clip and instructions.

11 F 42017 Wired. Shpg. wt. 1 1/2 lbs. . . . . Net 34.95  
11 F 42462 Kit Form. Shpg. wt. 1 1/2 lbs. . . . . Net 25.95

Not intended for resale in States where use is forbidden.

### TRIPP-LITE Professional Revolving Warning Light

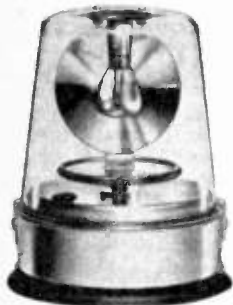

\$24.95

- Magnetic Mount
- Plugs into Lighter

Instantly converts any vehicle for emergency use. Emits 90 high-visibility flashes per minute. Belt-driven rotary beacon. Heavy-duty magnetic mount. 7 1/4" high, 5 3/4" diameter.

11 F 89588 Red. Shpg. wt. 2 3/4 lbs. . . . . Net 24.95  
11 F 89596 Blue . . . . . Net 24.95  
11 F 89604 Amber . . . . . Net 24.95  
11 F 89612 Green . . . . . Net 24.95

### Emergency Light



\$9.95

Warning light flashes in all directions. Magnetic suction cup base holds the light firmly in place. Signals for help for miles around.

For 12-volt cars, trucks, boats. Plugs easily into cigarette lighter. Shpg. wt. 3 lbs.

11 F 46505 Red . . . . . Net 9.95  
11 F 46513 Blue . . . . . Net 9.95  
11 F 46521 Amber . . . . . Net 9.95

### Revolving Beacon with Amber Lens \$4.95



Giant amber turret lens is 5" in diameter; flashes and rotates a full 360°. Bright enough to signal help for miles around. For use on autos, trucks, boats, docks, etc. Big suction cup base will mount on any smooth surface. Brilliant finish. Uses 3 "D" batteries (not incl.).

11 F 14503 Shpg. wt. 1 1/2 lbs. . . . . Net 4.95  
Batteries for above (3 required).  
99 F 62564 Imported. . . . . Net ea. 19¢

### Quartz Iodine Hand Spotlight \$19.95



- Projects Powerful Beam Over 1/4 Mile

Hand-held portable spotlight is 3 times brighter than sealed-beam lights, lasts 2 1/2 times longer. Super-energized Halogen quartz iodine bulb; wide 6" bulb face. 15-ft. coiled cord plugs into cigarette lighter. All-chrome. 12-volt. Imported. Shpg. wt. 2 1/2 lbs.

11 F 91006 . . . . . Net 19.95

### Quartz Iodine Ultra Light \$34.95



Thin-line spotlight has dual beams that converge to form 1 powerful beam that shines for over a mile. 360,000 candlepower, yet draws only 5 amps; plugs into 12-volt car lighter. Extra-heavy-duty 15' cord. Fingertip switch; pistol grip handle; built-in hanging hook. 2 1/2 lbs.

11 F 52552 . . . . . Net 34.95

### Portable Hand Spotlight \$34.95



- 35,000 Candlepower Sealed Beam
- 9-ft. Cord and Plug

Plug-in portable spotlight is a real "lifesaver" in emergencies — provides dependable, instant, powerful light. Finger-grip handle with on-off switch.

Flexible. 9-foot cord; sealed beam; convenient hang-up hook. Rich chrome plate on die-cast metal. Fits most cigarette lighter sockets in 12-volt cars — an essential light when you're driving at night.

11 F 16250 Shpg. wt. 2 lbs. . . . . Net 5.95

### Quartz-Iodine Fog & Driving Lamps



- Stainless Steel Slim-Line Case

High power, long life lamps give life-saving illumination. Wide angle, sharp cut-off fog lamp beam penetrates heavy fog. Driving lamp concentrates a narrow

beam. Sealed lens and reflector. Fully adjustable mounting bracket. 12 volts. 5 3/8" dia., 2 1/2" deep. Fog lamp; amber fluted.

11 F 82542 Shpg. wt. 2 1/4 lbs. . . . . Net 13.95  
11 F 82559 Driving lamp; clear . . . . . Net 13.95  
11 F 82567 Replacement bulb . . . . . Net 4.50  
11 F 82575 Switch and 10' cable . . . . . Net 1.39

### Quartz-Iodine Fog and Driving Lamps \$18.95

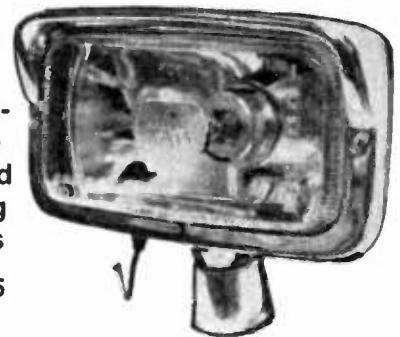

200,000-candlepower, ultra-powerful, rectangular lights give penetrating illumination. Handsome, slimline, chromed housing with adjustable mounting bracket. 12 volts. Wt. 2 1/2 lbs.

11 F 45002 Driving lamp; clear . . . . . Net 18.95  
11 F 45010 Fog Lamp; amber . . . . . Net 18.95  
11 F 82575 Switch and 10-ft. cable . . . . . Net 1.39

### AUTOMATIC TRUNK & HOOD LIGHT. Bright, diffused light illuminates trunk for loading or unloading . . . or hood compartment for making engine inspection or repairs at night. Completely automatic with Honeywell mercury switch. Easily installed. All hardware, wire included. 12 volts. Wt. 1/2 lb.

11 F 43015 . . . . . Net 2.29

### AUTO SPOTLIGHT. Trim, lightweight design for boat or car. Just plug into 12-volt cigarette lighter. Has on-off switch, plus 10-ft. cord for extra mobility. Chrome-plated case with safety reflector on back. Imported. Shpg. wt. 1 lb.

11 F 61025 . . . . . Net 2.95

# Auto Accessories and Specialty Items

## DUO-VOLT® 12- & 110-Volt Hand Vacuum Cleaner

- With Crevice Tool, Nozzle, Dusting Brush



**\$26<sup>95</sup>**

Compact, yet extremely powerful vacuum for house and car. In the house, it plugs into 110 VAC, 60 Hz outlet; in the car it operates from 12 VDC cigarette lighter (with adapter supplied). Durable steel body — remarkably lightweight. Long-reach, heavy-duty cord. "Toss-Away" bags for easy disposal. Convenient handle. On-off switch. With wide "Pik-all" upholstery nozzle, dusting brush and crevice tool.

11 F 67527 Shpg. wt. 6 lbs. .... Net 26.95

## Ben Air® Super Power Auto Vacuum



A smart, portable accessory for every car owner. Super-power suction cleans in seconds. Specially designed nozzle gives easy access to hard-to-get-at places—under seats, ash trays, crevices, etc. Lightweight, durable rust and dent-proof construction make it ideal for boats, planes, trailers and tents, too. Easy to handle and well balanced. Plugs into 12-volt cigarette lighter socket. Size: 17" long x 4" wide.

1 F 22506 Shpg. wt. 2½ lbs. .... Net 11.95

## Electroplating Kits

As Low As **\$8.50**

- Replate Chrome, Silver or Gold

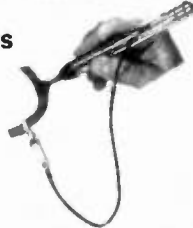

Restores old plating to its original beauty by electroplating with pure silver, 24K gold or chrome-like metal. Plate new articles with equal safety and ease. Kits include battery case, plating brush, holder, wire, solution, directions. Less "A" batteries, order 4 for chrome-plate kit, 2 for others.

Chrome Plating Kit; covers 12-20 sq. ft.

11 F 25509 Shpg. wt. 1½ lbs. .... Net 14.95

Silver Plating Kit; covers approx. 2 sq. ft.

11 F 25525 Shpg. wt. 1¼ lbs. .... Net 8.50

Gold Plating Kit; covers approx. 1 sq. ft.

11 F 25533 Shpg. wt. 1¼ lbs. .... Net 18.95

Refills for above; coverage as in basic kit.

11 F 25517 Chrome. Shpg. wt. 1¼ lbs. Net 5.95

11 F 25541 Silver. Shpg. wt. 1½ lbs. Net 4.95

11 F 25558 Gold. Shpg. wt. 1 lb. .... Net 9.95

99 F 62580 "AA" Battery .... Net ea. 14¢

## 25-ft. 12-Volt Trouble Lamp

All-purpose emergency light for shop, garage or "on-the-road" use. Operates from 12-volt battery. Color-coded alligator clips. With 50-watt bulb. 2½ lbs.

12 F 44516 .... Net 4.50

Replacement Bulb.

12 F 44524 .... Net 89¢



• Check Your Local Noise Abatement Ordinances.

## HORN

**\$13<sup>95</sup>**

- Painted Bell
- With Horn Button



An authentic motor-driven horn, approved as an exact reproduction in sound and appearance by members of antique car and horseless carriage clubs. Black, wrinkle-plated housing. With button, wire, bracket and instructions.

11 F 30012 6-volt. Shpg. wt. 3¼ lbs. \*Net 13.95

11 F 30020 12-volt. Shpg. wt. 3¼ lbs. \*Net 13.95

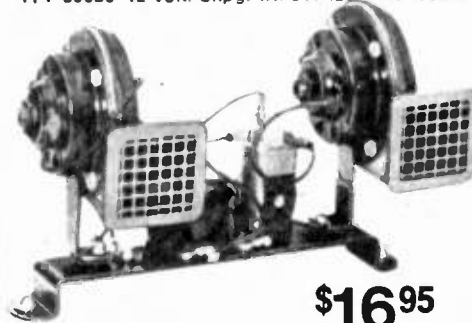

**\$16<sup>95</sup>**

## Continental Horn

Twin continental electric horn automatically alternates between high and low notes like European police horns. Clear, crisp tones really attract attention. Mounts under hood of virtually any car, in any available space. With horn button control, wire, mounting hardware, instructions. Black enamel finish with bright chrome grille. 12 volts. Size: 3½ x 5½ x 9".

11 F 44500 Shpg. wt. 3¼ lbs. .... \*Net 16.95

## Air Conditioner Recharge Kit



Your auto air conditioner may not be cooling properly due to lost refrigerant. Complete do-it-yourself kit will replace this loss. Designed for safety and easy use, it will service all car air conditioners. Includes a 15-oz. can of "Freon 12" refrigerant, positive locking metal valve clamps, high pressure charging line with safety check valve. Instructions. Wt. 1¼ lbs.

11 F 65588 .... Net 4.95

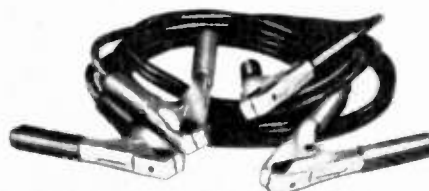

## 12-ft. Battery Booster Cable

Tangle-free cable twins with 100% copper conductor. One side is color-striped for quick polarity identification. Heavy insulation. Essential for starting stalled cars.

11 F 19528 Shpg. wt. 4 lbs. .... Net 5.95

## "FIAMM" Electro Compressor Air Horn

As Low As **\$24<sup>95</sup>**



- Range of ½ Mile

Model 32. Custom chromed trumpets with loud, clear, piercing continental tone. For trucks, sports cars, emergency vehicles, etc. Compressor pumps air to trumpets instantly when horn is pressed. Town & Country switch permits use of original horn in city. 12 volts. From Italy.

11 F 82500 Shpg. wt. 4½ lbs. .... \*Net 27.95

Model 22. Same as above, but trumpets are enameled, die-cast metal.

11 F 82518 Shpg. wt. 4½ lbs. .... \*Net 24.95

## BEEP-BEEP

### Horn

**\$7.50**

Newest sound sensation! Distinctive BEEP-BEEP sound really gets out, gets immediate attention. Powerful 4 x 5½ x 6½" horn is easily installed in any car. With hardware and button. Black/red. 12 volts. Shpg. wt. 2¼ lbs.

11 F 44534 .... \*Net 7.50



**\$6.95**

## Universal 4.5 to 12V Adapter for 12-Volt Car/Boat Battery

Switchable 4.5, 6, 7.5, 9 or 12 volts DC (to 300 mA) for operation of transistorized tape recorders, radios, etc. Plugs into cigarette lighter. Solid-state circuit provides constant, regulated supply of power. With plugs. Imported.

99 F 85250 Shpg. wt. 6 oz. .... Net 6.95

## Headlight Buzzer

- Reminds You to Turn Off Lights When You Park Your Car

Sound off with an audible noise when you turn off your ignition without turning off your lights. Saves your battery, eliminates service calls. Easy to install under dash. Wt. 5 oz.

11 F 50010 .... Net 3.50



**\$3.50**



**89¢**

## Cigarette Lighter Plug

Run 6- or 12-volt accessory from cigarette lighter receptacle of your car—battery chargers, shavers, lights, etc. Imported.

99 F 85136 Shpg. wt. 3 oz. .... Net 89¢

Lafayette Cat. No. 750 193

# Auto Antennas, Inverters, Noise Suppressors

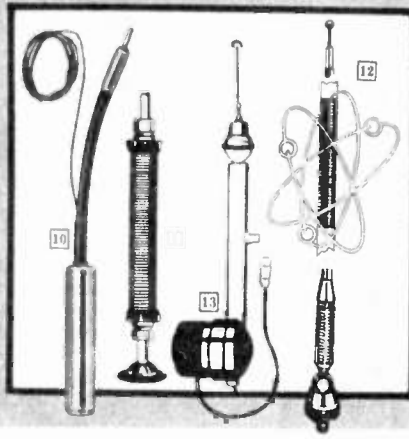
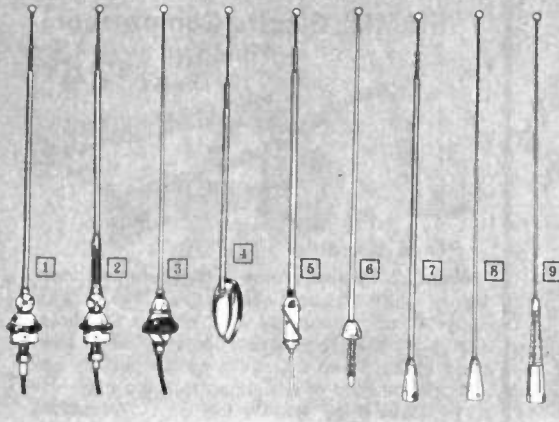

- 1 Universal Mount Antenna.** 3-section, mounts anywhere. Swivel ball adjusts to any angle. 59" collapses to 23". With 48" lead.  
11 F 74119 Shpg. wt. 1 lb. .... Net 3.19
- 2 "Flex-O-Matic" Universal Antenna.** Heavy-duty "bounce back" spring mount, adjustable swivel ball. 63", collapses to 28". 48" lead.  
11 F 74077 Shpg. wt. 9 oz. .... Net 4.69
- 3 Stainless Steel AM/FM Antenna.** Adjustable mount, tapered ground—springs back without breaking. Fixed length 31". With 48" lead.  
11 F 74143 Shpg. wt. 1 lb. .... Net 4.69
- 4 Continental Single Side Mount.** For trucks, VW's, etc. 60", collapses to 24". 32" lead cable.  
11 F 88010 Shpg. wt. ¾ lb. .... Net 3.29
- 5 Top Mount for VW's.** For '67's and up. 38", collapses to 15". Fits pre-punched VW hole. Chrome-plated. With 42" cable.  
11 F 74135 Shpg. wt. 1 lb. .... Net 3.29
- 6 Stainless Steel Replacement Mast for Chryslers.** Exact replacement. Thread-in mast, tapered ground. 31". For '68 to '74 Chryslers, Plymouths and Dodges.  
11 F 74168 Shpg. wt. 8 oz. .... Net 2.49
- 7 Replacement Antenna Mast.** 3-section 57". Mounts on existing stub of broken antenna. Lock-on mount.  
11 F 74051 Shpg. wt. 9 oz. .... Net 1.95
- 8 FM/AM Stainless Steel Replacement Mast.** One-piece rod with tapered ground that springs back without breaking. 31" length. Mounts on stub of broken antenna with set screw.  
11 F 74150 Shpg. wt. 9 oz. .... Net 2.49

- 9 Spring-Back Replacement Mast.** One-piece stainless steel, 27½" long. Mounts over existing stub. Set screw.  
11 F 74069 Shpg. wt. 9 oz. .... Net 1.29
- 10 Auto Antenna Booster.** Gives extra power and signal pickup from any auto antenna, even windshield types. Has built-in transistor circuit, installs with no tools or cutting. For AM/FM/stereo FM antenna systems.  
11 F 71081 Shpg. wt. 1 lb. .... Net 5.95
- 11 Auto Antenna Booster.** Electrically equivalent to 110-ft. antenna! Installs in 4 easy steps. Fits all but 4-section antennas.  
11 F 89026 Shpg. wt. ½ lb. .... Net 3.50
- 12 Power House Auto Antenna.** 3-section antenna mounts on all cars. has built-in booster to increase signal-pulling power of your car radio. Stainless steel mount w/swivel base. 48" cable.  
11 F 71073 Shpg. wt. 1 lb. .... Net 5.50
- 13 "Tennamatic" Electric Auto Antenna.** For most 12 VDC cars. Operate antenna at the flip of a switch. Mast extends to 35", retracts to 1¼". 15-lb. thrust assures free action even in cold weather. Rear mount with 18-ft. antenna lead-in, 20-ft. electric harness. With all hardware and instructions.  
11 F 71024 Shpg. wt. 6¼ lbs. .... Net 28.50
- Front-Mount Electric Antenna.** As above, with 54" lead-in, 72" electric harness.  
11 F 71016 Shpg. wt. 6¼ lbs. .... Net 26.50



**24 TRIPP LITE 500W Inverter/Charger**  
Model PV-500B. Heavy-duty inverter with 500 watts continuous (550 intermittent) output—can operate large color TV's, ½" power drills or combinations of smaller tools and appliances. Converts 12 VDC to 117 VAC, 60 Hz. Fused, polarity protected. Also use as battery charger rated 10 amps. With pilot light, binding post terminals. 9½ x 5 x 9".  
11 F 89562 Shpg. wt. 19¼ lbs. .... Net 129.95

**25 terado 500W Inverter/Charger**  
Mark I. Portable, solid-state 450-500-watt unit converts 12 VDC into 117 VAC, 60 Hz for operation of appliances, power tools, etc. Provides steady power for radios, TV's, electric tools and test equipment. Also has battery charger with 10- or 20-amp charge rate and trickle charge. With ammeter, 12 VDC input holes, front panel fuses, standard 117 VAC outlet. 12½ x 6 x 6".  
11 F 63260W Shpg. wt. 20½ lbs. .... Net 141.28

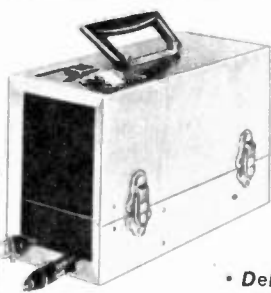

**terado TRAV-ELECTRIC**  
**\$10232**  
• Self-Contained Power Supply with Battery and Automatic Recharger  
• Delivers 117 VAC, 60 Hz at 125 Watts Continuous

Model 50-160. Take electricity with you! Operate power tools, lights, appliances using 117 VAC, 60 Hz. Great for use in power blackouts! Has self-contained, rechargeable, 30-amp storage battery, automatic overcharge protection, meter for charge rate and hours of output. 12 x 5½ x 8". Recharge in standard outlet.  
11 F 63161 Shpg. wt. 36¼ lbs. .... Net 102.32

**6-, 12-Volt Vibrators**  
Direct replacements for the most popular types.  
6-Volt 4-Prong. Replaces Mallory 294, 859, 901M, 1601, Radiart 5300, 5301, many others.  
32 F 56013 Shpg. wt. 4 oz. .... Net 3.50  
12-Volt 3-Prong. Replaces Buick, Olds, Pontiac, GM part No. 122-0155, Mallory G874, CD, 6330, Delco 850, Vokar 3129.  
32 F 56021 Shpg. wt. 4 oz. .... Net 3.50  
12-Volt 4-Prong. Replaces Mallory G859, Motorola 45B22000, Philco, Mopar 83-0025-1, ATR 1840, Vokar 4120, most later 12-volt vibrators.  
32 F 56039 Shpg. wt. 4 oz. .... Net 3.50



**14 Inside Window Antenna**  
Fits all cars, installs in minutes. Laminated, 2-ply, crystal-clear, adhesive tape. For FM and AM reception. With instructions.  
11 F 65562 Shpg. wt. 5 oz. .... Net 2.95

**terado 15 12 VDC/117 VAC Inverters**  
Vibrator-type inverters with automatic frequency control. Filtered. For car lighter socket.  
"Senior." 40W constant, 50W Int. 2½ x 2½ x 4½".  
11 F 63062 wt. 2¼ lbs. .... Net 30.67  
"Dynamo." 25W. 2 x 2 x 3¼".  
11 F 63179 Shpg. wt. 2 lbs. .... Net 22.05  
**16 Trav-Electric Converters.** Polyethylene case. 15-20 watt rating. 3½ x 4¼ x 2¼".  
12 VDC/117 VAC. For car lighter.  
11 F 63047 Shpg. wt. 2 lbs. .... Net 13.00  
220 VAC/117 VAC. Foreign travel, etc.  
11 F 63294 Shpg. wt. 2 lbs. .... Net 9.75



**17 Noise Suppressor Kit**  
For 6, 8 cylinders. Suppresses wide-band pulse noise from spark plugs, generator "hash," etc. With suppressors, light or ammeter by-pass capacitors.  
11 F 71065 Wt. 6 oz. .... Net 3.39



**18 Car Stereo Noise Eliminator**  
Effectively kills interference from ignition system or alternator. With choke, full instructions.  
11 F 60506 Shpg. wt. 6 oz. .... Net 2.10

## Auto Antenna Leads and Connectors



- 19 3-Way "Y" Connector.** Hook up FM radio to AM radio jack.  
11 F 74184 Shpg. wt. 4 oz. Net 1.49
- 20 Adapter.** Converts Motorola to Delco fitting.  
11 F 66016 .... Net 19¢
- 21 Motorola Jack.**  
11 F 66024 .... Net 29¢
- 22 Motorola Plug.**  
11 F 66032 .... Net 19¢
- 23 Auto Antenna Extension, Replacement Leads.** Shpg. wt. 5 oz.  
54". Universal Replcmnt.  
11 F 74085 .... Net 1.39  
24". Universal Extension.  
11 F 74093 .... Net 99¢  
36". Universal Extension.  
11 F 74101 .... Net 1.29

# Power Inverters and Battery Chargers

**TRIPP LITE**

## Inverters



**\$39<sup>95</sup>**

- Converts 12VDC to 115 VAC
- Plugs into Lighter

### 115W Transistorized Inverter

PV-115. Converts 12 VDC to 115 VAC, 60 Hz. 115 watts continuous. For operation of TV's and recorders in boats, planes, vehicles, etc. 4 3/4 x 4 3/4 x 3".

11 F 89653 Shpg. wt. 6 lbs. . . . . Net 39.95



**\$54<sup>95</sup>**

- Provides Household Current Anywhere

### 200W Transistorized Inverter

Changes 12 VDC to 115 VAC, 60 Hz. 200 watts continuous, 220 watts intermittent for standard appliances. With on-off switch, fuse. Rugged. 5 x 5 x 3 1/2".

11 F 89661 Shpg. wt. 7 lbs. . . . . Net 54.95

**\$89<sup>95</sup>**

- For Your Car, Boat, Trailer, Plane



### 350W Transistorized Inverter

PV-350. Operates your household appliances and tools while traveling. Converts 12 VDC to 115 VAC, 60 Hz. 350 watts continuous, 385 intermittent. 3 1/2 x 6 1/2 x 9".

11 F 89570W Shpg. wt. 13 lbs. . . . . Net 89.95

**PV-1000FC \$319<sup>95</sup>**



**PV-250FC \$119<sup>95</sup>**

### Frequency-Controlled Transistorized Inverters

For mobile labs, repair stations, police units, 1 Hz freq. regulation permits use of freq. sensitive devices.

Stock No.	Model	Watts Cont.	Intr.	Size	Shpg. Wt.	Net
11 F 89620	PV-250FC	250	275	3 1/2 x 6 1/2 x 9	13	119.95
11 F 89638W	PV-500FC	500	550	5 x 9 1/2 x 9"	19	219.95
11 F 89646W	PV-1000FC	1000	1100	5 x 9 1/2 x 17"	45	319.95



### 1 Sure-Fire 6-Amp Charger

- Automatically Turns On and Off
- Circuit Breaker • Accurate Ammeter

WS-20. Solid-state, shuts off when battery is fully charged, back on when charge level falls. For 6 or 12V batteries. With two 8-ft. cables, 6-ft. power cord. For 117 VAC, 60 Hz. UL listed. 8 x 5 1/2 x 6 1/2".

11 F 76536 Shpg. wt. 9 lbs. . . . . Net 23.95

### 2 Lafayette Booster Charger

- For 6-, 8- or 12-Volt Batteries
- 50 Amp Boost • 10 Amp Charge

Starts cars fast in cold weather. Meter indicates battery condition, charging and booster rate, correct polarity. 6-ft. cables. Auto-reset circuit breaker. UL listed. 8 x 5 3/4 x 6".

11 F 01062 Shpg. wt. 11 3/4 lbs. . . . . Net 34.95

### 3 Sure-Fire Booster Charger

- 500-Watt Boost, 6, 8 or 12 Volts
- 10 Amp and Trickle Charge

WS-100-1J. Faster starting & charging of batteries in cold weather. Circuit breaker. UL listed. 12 x 7 x 9".

11 F 76544W Shpg. wt. 22 1/4 lbs. . . . . Net 54.95

WS-200-20. As above, but 1000 watts boost, 20 amps and trickle. 12 x 9 x 9".

11 F 76551W Shpg. wt. 32 1/4 lbs. . . . . Net 79.95

### 4 Sure-Fire 3-Amp Charger

- For Both 6- and 12-Volt Batteries
- Automatic Reset Circuit Breaker

For quick starts in all weather. Meter shows battery condition, rate of charge. Steel case. 6-ft. leads, 50-amp clips. For 117 VAC, 60 Hz. UL listed. 6 x 4 1/2 x 5 3/4".

11 F 76049 Shpg. wt. 5 lbs. . . . . Net 13.95

### 5 Hy-Charge® 2-in-1 Charger

- For 6- and 12-Volt Batteries
- 1 Amp Charge Rate • Circuit Breaker

Can't overcharge — automatically tapers off. One-amp "safe" charge rate prevents buckling. 117 VAC, 60 Hz. 5 x 3 1/2 x 3".

11 F 76023 Shpg. wt. 3 lbs. . . . . Net 9.50

### 6 Schauer 6-Amp Charger

- For 6 and 12 Volts • Built-in Meter
- With Circuit Breaker Protection

B-6612. Charges batteries in from 3 to 7 hours. Ammeter shows exact rate of charge. Steel case, battery cables. 117 VAC, 60 Hz. UL listed. 9 3/8 x 6 x 6 1/2".

11 F 55183 Shpg. wt. 9 lbs. . . . . Net 18.95

### 7 Schauer 10-Amp Charger

- For 6- and 12-Volt Batteries
- With Meter • Circuit Breaker

C-6612. Heavy-duty charger, brings batteries to full charge in 2 to 6 hours. Ammeter shows rate of charge. Steel case. 117 VAC, 60 Hz. UL listed.

11 F 55191 Shpg. wt. 11 3/4 lbs. . . . . Net 24.95

### Power Converter

**\$14<sup>95</sup>**

- 110 VDC, 2000W from Your Alternator
- Two Outlets
- On/Off Switch



Operates portable power tools on AC/DC or DC only brush-type motors, not air conditioners or TV's. For Delco, Ford, Chrysler alternators only.

11 F 50507 Shpg. wt. 2 lbs. . . . . Net 14.95

Lafayette Cat. No. 750 195

# Replacements Speakers and Baffles



**Utah Microgap PM Speakers**  
MICROGAP precision in centering of voice coil gives increased and uniform sensitivity. All heavily cadmium-plated, rustproof construction. All with Alnico V magnets. All voice coils 3-4 ohms except 12" is 8 ohms and intercom units are 45 ohms. †With provision for mounting transformer. ‡For tape recorders. \*For intercoms.

Stock No.	Size & Shape	Prog. Power (W)	Mg. Oz.	Fig.	Shpg. Wt.	Net Ea.
32 F 49141†	5x3 Oval	4	.55	4	¾	2.67
32 F 49018	3½" Sq.	3	.68	1	½	2.70
32 F 49026†	4" Sq.	5	1.2	1	½	3.20
32 F 49034	4x6 Oval	5	1.2	4	¾	4.08
32 F 49042†	5" P.C.	5.5	1.2	2	¾	3.78
32 F 49455	6" P.C.	6	.68	2	1	3.45
32 F 49463	8" P.C.	8	1.47	2	1½	4.47
32 F 49083†	12" Rnd.	14	6.8	3	5¾	10.01
32 F 49125*	3½" Sq.	4	.68	1	½	3.77
32 F 49133*	4" Sq.	4	.68	1	½	3.63

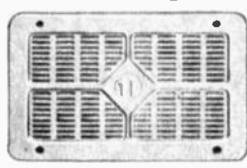

## Speaker Grilles

Handsome perforated metal grilles for rear seat speaker use or other installations. Avg. shpg. wt. ¾ lb.  
**Chrome Grilles**  
32 F 34010 5 x 7" .....Net 1.59  
32 F 34028 6 x 9" .....Net 1.59  
**Gray Grilles (Nonreflecting)**  
32 F 34069 5 x 7" .....Net 1.49  
32 F 34077 6 x 9" .....Net 1.49

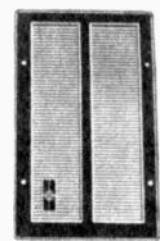

**Deluxe Speaker Grilles**  
Dress up original or accessory installations. Contemporary styled, 2-toned slotted grille. High-impact Cycholac. Black and chrome.  
5 x 7" Grille.  
32 F 57029 Shpg. wt. 6 oz. Net 2.40  
6 x 9" Grille.  
32 F 57003 Shpg. wt. 6 oz. Net 2.50

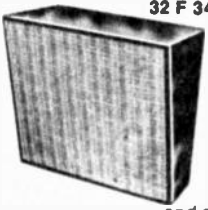

## Modern Speaker Baffles

Sturdy plywood for indoor PA and paging systems. Intercoms, extension speakers, etc. Good-looking walnut vinyl covering.

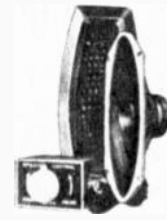

## 2-Way Rear Seat Speaker Kit

**\$10<sup>95</sup>**

Two-way dual cone 4 x 10" auto speaker provides full hi fidelity. Impedance 8-10 ohms with 10-oz. magnet. Power capacity 15 watts. With black die-cast grille, fader control. Complete with all mounting hardware and instructions.  
32 F 49620 Shpg. wt. 3½ lbs. ....Net 10.95

## Replacement Auto PM Speakers



Have multi-impedance voice coils for all transistor sets. Match 40, 20, 8 ohms or less. Slimline.

Stock No.	Size & Shape	V.C. Imp.	Peak Mag. (W)	Shpg. Ozs.	Shpg. Wt.	Net
32 F 22049	6x9 Oval	Multi-ohm	7	1.47	1½	5.33
32 F 22148	6x9 Oval	Multi-ohm	12	5.0	2¼	7.28
32 F 22056	6 Rnd.	Multi-ohm	7	1.47	1	4.88
32 F 22155	4x10 Oval	Multi-ohm	7	2.15	1½	5.87



**Utah Auto Speakers**  
For all types of auto sets, especially transistor. Voice coil impedance 10/20/40 are 40-ohm tapped for either imp.

Stock No.	Size & Shape	V.C. Imp.	Mag. Oz.	Shpg. Wt.	Net
32 F 49166	5x7 Oval	10/20/40	1.47	1	5.10
32 F 49174	4x10 Oval	10/20/40	2.15	1½	5.67
32 F 49182	6x9 Oval	10/20/40	1.47	1½	5.33



**Utah Deluxe Auto Speakers**  
Hi-fidelity type cloth edge rolls. Separate high-frequency cone. Hefty ceramic magnet. Easy wiring. Less switch.

Stock No.	Size & Shape	V.C. Imp.	Mag. Oz.	Shpg. Wt.	Net
32 F 49562	4x10" Oval	8-10	10	3¼	9.95
32 F 49570	5x7" Oval	8-10	10	2½	9.95
32 F 49588	6x9" Oval	8-10	10	2½	9.95
32 F 49596†	6x9" Oval	8-10	10	2½	11.19
32 F 49638	6x9" Oval	8-10	16	3¼	13.95



## Exact Replacement Miniature Speakers

Alnico PM speakers for replacement in transistor sets. \*Mtg. holes on 2" ctrs. †On 1½" ctrs. Imp.

Stock No.	Fig.	Dia.	Dpth.	Ohms	Wt.	Net
99 F 60352†	5	1½"	¼"	10	5 oz.	1.75
99 F 60360	7	2"	¼"	8	3 oz.	1.45
99 F 60972*	6	2½"	¼"	10	6 oz.	1.45
99 F 60329	8	3"	¼"	8	3 oz.	1.75



## Four-Way Stereo Fader Control

• Controls 4 Speakers in Stereo  
**\$3<sup>99</sup>**

Designed to enhance your listening enjoyment! This remarkable Stereo Fader Control can be used as stereo balance control for four-speaker car stereo units. It adjusts the level of front and rear speakers to suit your listening pleasure. The control also works as individual left and right balance control simultaneously. Completely mounted in attractive black and silver trim molded plastic cabinet with wires for connections. Mounting hardware and instructions.  
99 F 85235 Shpg. wt. 6 oz. ....Net 3.99

## Deluxe 2-Way Rear Seat Speaker Kit

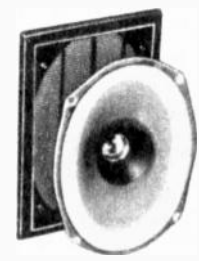

**\$18<sup>95</sup>**

A 6 x 9" auto speaker with coaxially mounted 2" tweeter for high frequencies. Impedance 8-10 ohms. 12-oz. magnet has power handling capacity of 15 watts. With black grille accented with chrome. Speaker balance control, hardware, wire, instructions.  
32 F 44035 Shpg. wt. 4 lbs. ....Net 18.95



## Rear Seat Controls

Available completely mounted on black and silver metal plate with ivory pointer knob, plus wiring, mounting hardware, instructions.  
**Fader Type (Fig. 9).** Controls volume of both front and rear speakers. Gradually reduces on one while increasing volume on other.  
32 F 22585 Shpg. wt. 3 oz. ....Net 1.49

**Switch Type (Fig. 9).** Gives choice of front speaker alone, rear speaker alone or both together.  
32 F 22577 Shpg. wt. 3 oz. ....Net 1.49

**Pushbutton Type (Fig. 10).** Just push button and select front speaker alone, rear speaker alone, or both together.  
32 F 22569 Shpg. wt. 3 oz. ....Net 1.49

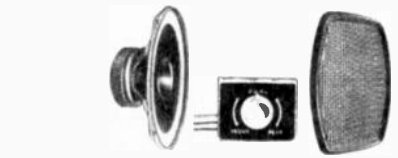

## Rear Speaker Kits for Auto Radios

Complete Kits for Adding Extra Speakers in Rear of Car. Include: Speaker, Deluxe Grille, Wire and Simple Wiring Instructions. Fader-controlled kits are supplied with a fader which controls volume of both speakers (front & rear) simultaneously. Gradually reduces volume of one speaker while increasing volume of the other. For use with transistorized auto radios.  
\*Include Two Speakers with Grilles for Stereo

Stock No.	Spkr.	Imp. Ohms	Mag. Oz.	Wt. Lbs.	Net
32 F 49646	6x9	4-8	.68	1¼	8.96
32 F 49653	6x9	10/20/40	1.47	2	8.81
32 F 49661*	6x9	8-10	10	3¼	14.08
32 F 49679*	6x9	8-10	16	3¼	16.43
32 F 49695*	4x10	8-10	10	3¼	14.06

# Auto and Home Theft Protection Devices



**On-Guard® Deluxe**  
Siren Vehicle Alarm

**\$31<sup>88</sup>**

- Features Ignition Cutoff Switch

- Protects Doors, Hood and Trunk
- Maximum Security Dual Purpose Lock

Loud, piercing, police-type siren. Ignition cutoff switch prevents engine from starting when alarm is on. Includes 12V siren and trumpet; 1 hood, 1 trunk, and 4 door switches; hood and trunk brackets; lock switch (factory wired); built-in dust cover; 2 keys; instructions; 2 warning decals; hardware.

11 F 62544 Shpg. wt. 6¾ lbs. . . . . Net 31.88

**Cutoff Timer with Automatic Reset.**

11 F 62510 Shpg. wt. 4 oz. . . . . Net 8.95

Not for resale in States where forbidden.

**LOGATOR** Vehicle Alarm Siren

**\$19<sup>88</sup>**

- Protects Doors, Trunk and Hood

- Pick-Proof Key Lock, Two Keys

Penetrating police siren and trumpet remain on until manually reset by pick-proof lock switch. Supplied with relay, six alarm activator switches, wire, terminals, screws and exterior mounting key lock with 2 keys. Ideal for cars, wagons, trailers, trucks, vans.

11 F 62064 Shpg. wt. 6¾ lbs. . . . . Net 19.88

**8" Bell Vehicle Burglar Alarm System.**

Same as above with but with bell, less siren.

11 F 62114 Shpg. wt. 6½ lbs. . . . . Net 19.88

**Cutoff Timer with Automatic Reset.**

11 F 62510 Shpg. wt. 4 oz. . . . . Net 8.95

Not for resale in States where forbidden.



**\$169<sup>50</sup>**

**Safe 'N Sound Wireless**  
Security System by Phone-Mate

- Remote Sensors Send Coded Signals
- Alarm Sounds for 5 Minutes, Resets
- Fail-Safe—Prevents False Alarms
- Code Number Turns System On-Off

A complete security system for home or office. Any intrusion through protected doors, windows or other openings sounds the alarm. Includes Master Unit which sets for either instant alarm or 30 sec. time delay; 3 self-contained door/window Sensors which transmit coded signal up to 50 ft. to master; Personal Emergency Transmitter with push-button to trigger alarm (portable); warning decals. Requires no tools, wires or special skills to install. Uses 117 VAC, 60 Hz house current with battery back-up. UL listed.

14 F 68503 Imported. Wt. 6 lbs. . Net 169.50

**Extra Door/Window Sensors.**

14 F 68511 Shpg. wt. 4 oz. . . . . Net 12.50

**"C" Battery.** For Master Control (4 req.).

99 F 63687 . . . . . Net ea. .25

## Electronic Siren Vehicle Alarm System

Unit senses any current drain caused by opening door, hood or trunk. Requires no individual door switches.

**\$29<sup>88</sup>**

- Easy Installation
- 100% Solid-State

Includes hood and trunk switches and brackets (for cars without hood or trunk lights); electrical switch lock (factory wired); dust cover; 2 keys; wire; hardware; instructions; 2 warning decals.

11 F 62536 Shpg. wt. 3 lbs. . . . . Net 29.88

**Cutoff Timer with Automatic Reset.**

11 F 62528 Shpg. wt. ¼ lb. . . . . Net 8.95

Not for resale in States where forbidden.



## Auto Sentry Car Burglar Alarm

Any current drain (door or trunk opening, etc.) activates car horn. You deactivate by pushing a 5-button combination. Also has start, delay. Alarm activates after 15 seconds unless proper buttons are pushed. Mounts easily. 2¼ x 3½ x 3".

11 F 42538 Shpg. wt. 1½ lbs. . . . . Net 31.95

11 F 42553 Relay for Ford, Foreign Cars . . . . Net 4.50

11 F 43015 Automatic Trunk or Hood Light . . Net 2.29

## Electric Hood or Trunk Lock

Protects vital engine parts from theft. Locks hood or trunk with normal closing, unlocks when ignition switch is turned on by ignition key. For all 12-volt systems. Includes hardware.

11 F 37504 Shpg. wt. 1¾ lbs. . . . . Net 11.95

Lafayette—Your "Single-Trip" Source for Everything in Electronics



**\$31<sup>95</sup>**

**\$11<sup>95</sup>**



## ON-GUARD Horn Burglar Alarm



**\$7<sup>95</sup>**

Activates vehicle's horn when anyone opens a door, trunk or hood. Shuts off with alarm key. Includes 6 switches.

11 F 62023 Shpg. wt. ¾ lb. . . . . Net 7.95

## Solid-State Vehicle Horn Alarm

**\$7<sup>95</sup>**

Sounds car horn if intrusion detected. Concealed on-off switch. Wt. 1 lb.

11 F 37520 . . . . . Net 7.95



# Prevent Tomorrow's Loss—PROTECT Today!

**\$139<sup>95</sup>**

Key Switch

Hookup Wire

FC-100 Control Center

3 Fire/Heat Sensors

8-Inch Bell

Door/Window Switches

TAMPER SWITCHES

2 Door Cords

EMERGENCY BUTTONS

**Eico Professional-Quality Burglar/Fire Alarm System**

**Model SS-500.** Offers outstanding house-wide burglar and fire protection. Features the famous Eico FC-100 Master control center which accepts up to 9 remote on-off stations. Has indicator lights for alarm-on and circuit test, meter and battery test switch, fail-safe power supply (for 117 VAC, 60 Hz, automatically switches to optional battery if power fails). Outfit includes 1 remote switch with lamp, key switch, 4 door/window magnetic switches, 2 door cords and tamper switches, 2 "Panic" buttons which override all sensors, indoor/outdoor bell, all hookup wire, warning decals. Also includes 3 fire/heat sensors which react at 135°, sound alarm or optional klaxon horn. With 34-page easy-installation handbook. Less battery.

14 F 33507W Shpg. wt. 16 lb. . . . . Net 139.95

**Entrance Key Switch with Signal Light.**

14 F 33572 Shpg. wt. 1 lb. . . . . Net 12.95

**Additional Remote Station with Lamps.**

14 F 33549 Shpg. wt. 6 oz. . . . . Net 4.50

**100-ft. 2-Conductor Wire.**

14 F 13624 Shpg. wt. 3 lbs. . . . . Net 5.30

**Standby 6-Volt Battery.**

32 F 48705 Shpg. wt. 3¼ lbs. . . . . Net 2.57

**Heavy-Duty Tamper-Proof Metal Box for Battery, Bell and Circuit**

**\$54<sup>95</sup>**

**Offers Complete Burglar and Fire Protection**

**\$74<sup>95</sup>**

**Model FC-100 Master Control Alarm Center** **\$74<sup>95</sup>**

Design your own alarm system around this deluxe master alarm device (described above). Use accessories above, other accessories on page 199.

14 F 33580 Shpg. wt. 6 lbs. . . . . Net 74.95

**1 On-Guard Solid-State Burglar Alarm System.** Guards windows, doors, other entry points by sounding a loud 8" bell upon intrusion. Sound continues until YOU turn it off with a key lock switch mounted right on the control box (also permits exit and re-entry without sounding alarm). With 4 door/window switches, panic button, 2 keys, decals, 100 ft. of wire, instructions. Operates on 12-volt lantern battery (order below).

14 F 13558W Shpg. wt. 13½ lbs. . . . . Net 54.95

14 F 13624 Extra 100 Ft. of Wire Net 5.30

32 F 47772 12-V Battery. ¾ lb. . . . . Net 3.06

**2 On-Guard Fire and Burglar Alarm System.** Has burglar alarm system same as above, also includes separate klaxon horn, 3 135° heat sensors for living area, 1 190° sensor for furnace or boiler room, 200' hookup wire, insulated nails, other accessories as above. Rugged, tamperproof alarm housing. Order extra wire, battery above.

14 F 13590W Shpg. wt. 20 lbs. . . . . Net 74.95

14 F 13624 Extra 100 Ft. of Wire Net 5.30

32 F 47772 12-V Battery. ¾ lb. . . . . Net 3.06

See page 199 for additional accessories.

**\$59<sup>95</sup>**

**Time-Delay Burglar Alarm System**

Installs easily—NO DRILLING needed for entrance door shunt locks. Alarm activates after you leave premises. 20-second time delay lets you enter and shut off alarm, "Home/Away" switch cuts off time delay while you're home. Four door/window switches, on-off and panic/test buttons, metal alarm box, decals, 100-ft. wire, handbook. Uses 12-V battery (order below).

14 F 33606 Shpg. wt. 13 lbs. . . . . Net 59.95

14 F 13624 100' of Extra Wire. 3 lbs. Net 5.30

32 F 47772 Battery 12-V. Wt. ¾ lb. . . . . Net 3.06

**On-Guard Solid-State Fire Alarm System**

**\$29<sup>95</sup>**

24-hour protection against fire in your home or office. With control panel, test/panic button, three 135° thermostats, 100 ft. of hookup wire, nails, mounting hardware, horn & instructions. 6V battery (not incl.).

14 F 13632 Shpg. wt. 3½ lbs. . . . . Net 29.95

14 F 13624 100 Ft. of Wire . . . . . Net 5.30

32 F 48002 Battery for above . . . . . Net 1.25

See page 199 for additional accessories.

**NEW!**

**\$31<sup>95</sup>**

UL Listed

**3 Smoke, Gas, Heat Detector**

On-Guard Model SM-5. Self-contained, ideal for home, business, office. Detects gas to 200 PPM, 2% to 4% smoke obscuration, heat at 135° F. automatically sets off powerful buzzer. Has indicator light with 70,000-hour life. Uses less than 3¢ electricity per month. For 117 VAC, 60 Hz. Imported. 4¼ x 4¾ x 2½".

14 F 13764 Shpg. wt. 1¼ lbs. . . . . Net 31.95

**4 Residential Smoke Detector**

Dual photocell design — sounds loud alarm when 2% smoke is detected. Has trouble-signal to indicate malfunction, safety lock to prevent accidental unplugging. UL listed. Nicely styled unit for wall mounting. 6¼" dia., 2" deep. For 117 VAC, 60 Hz.

13 F 83645 Shpg. wt. 1½ lbs. . . . . Net 39.95



# Burglar and Fire Alarm Accessories

**Junior®  
EARSPLITTER**

- Electronic Siren
- Varies Hi-Lo

**\$26.88**

Ear-piercing, rapid, yelping sound. Similar to the latest police car sirens. Waterproof trumpet: 4¾ L x 5¼" H. Driver: 2¾ x 2 x 1". 109 dB at 10', 6-12 VDC at ½ A.  
14 F 37508 Shpg. wt. 2½ lbs. .Net 26.88

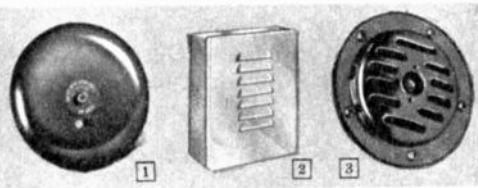
**1 8" Indoor/Outdoor Alarm Bell.** Extra-loud sound, low battery drain. Operates on 6-12 VDC. Mounts in or out of house.  
14 F 33523 Shpg. wt. 4 lbs. . . . .Net 12.50

**2 Steel Bell Box.** Heavy-gauge steel louvered cabinet with mounting plate for 8" bell and tamper switches. 12 x 9 x 4".  
14 F 33531 Shpg. wt. 3 lbs. . . . .Net 9.95

**3 Weatherproof Warning Horn.** Extremely loud. Ideal for use with alarm systems. For 6-12 VDC. With mounting bracket.  
14 F 13731 Shpg. wt. 1 lb. . . . .Net 7.50

## 7 Deluxe Ultrasonic Intrusion Alarms

Invisible ultrasonic waves detect movement in an area up to 300 sq. ft. Triggers 117V lamps, bells, sirens up to 5 amps. 30-sec. exit delay. Immediate activation or 20-sec. delay on entry. Automatically resets. Terminals for use with most burglar/fire sensor devices. For 117 VAC, 60 Hz. Size: 10½ x 3 x 5½".  
14 F 11503 Shpg. wt. 4 lbs. . . . .Net 79.95  
99 F 90235 3½" Bell. Shpg. wt. 1 lb. . . . .Net 6.95  
12 F 39011 6-ft. Line Cord . . . . .Net .49

## 8 Delta Ultrasonic Intrusion Alarm

Ultrasonic beam covers an area up to 30 ft. in front of unit. Sets off 110V bell, lamp or siren. Automatically resets. Features: Variable timer; 10-sec. delay to leave the protected area; Controls for on-off sensitivity and range. Handles to 500W, 117 VAC. Walnut finish. 10¾ x 3¼ x 3¼".  
12 F 56510 Shpg. wt. 3 lbs. . . . .Net 69.95

## 9 Delta Horn/Delay Combo

For above intrusion alarm. Delay of 20 sec. before built-in horn is activated. Horn operates 10 sec. on, 5 off. Handles 575 watts. 7 x 3¼ x 3¼".  
12 F 58536 Shpg. wt. 1¾ lbs. . . . .Net 29.95

## 10 110V Police-Type Siren

Sharp, penetrating sound. Extremely durable. Ideal for use with alarm systems. For 117 VAC, 50-60 Hz. 1 amp. 5¼ x 8" long.  
14 F 13574 Shpg. wt. 4¼ lbs. . . . .Net 19.95  
Outdoor Siren Cabinet. 6 x 8 x 10½".  
14 F 13582 Shpg. wt. 3 lbs. . . . .Net 9.95



**\$79.95**

**\$69.95**

**\$29.95**

**\$19.95**

**Easy Plug-in Installation**



**4 Indoor Twin Klaxon Horn Alarm.** Ear-piercing. Ideal for alarm system use.  
14 F 33515 Shpg. wt. 1 lb. . . . .Net 7.95

**5 Timer/Automatic Shut-Off.** Shuts off the alarm horn or bell after about 10 min. Indicator light shows that alarm was tripped.  
14 F 33598 Shpg. wt. 1 lb. . . . .Net 19.95

**6 One-Way Door Viewer.** Easy installation. Requires ½" dia. hole in any standard door (up to 1¾" thick). Rustproof.  
14 F 65020 Shpg. wt. 4 oz. . . . .Net 1.29

**Fire Escape Ladder**

**\$17.95**

- Attach to Windowsill
- Lightweight Aluminum
- Stand-off Arms Keep Ladder Away from Wall



15-ft. chain ladder attaches quickly to any double-hung or casement window-sill. Holds up to 1000 lbs.  
13 F 75013W, Shpg. wt. 8 lbs. Net 17.95

## Burglar and Fire Alarm Accessories

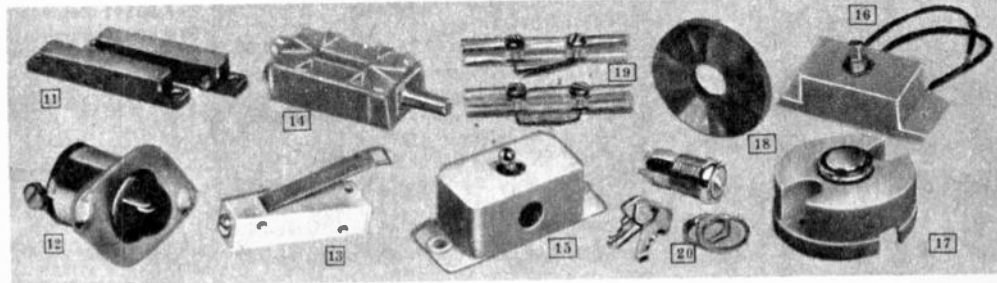

**11 Magnetic Reed Door/Window Switch.** For use in closed circuit systems where surface mounting is necessary. Two sets of switch and magnet.  
14 F 13657 Shpg. wt. 4 oz. . . . .Net 4.50

**12 Door/Window Switch.** Pressure from any direction pushes plunger. For closed circuit system. Flush mounts. Fits ¼" hole.  
14 F 13665 Shpg. wt. 4 oz. . . . .Net 1.95

**13 Window Security Switch.** Leaf contact switch for casement awning, double-hung windows, sliding doors. Closed circuit. With hardware.  
14 F 13673 Shpg. wt. 4 oz. . . . .Net 2.25

**14 Tamper Switch.** For casement windows and preventing tampering. For closed circuit systems, bells, boxes, control centers. Hardware.  
14 F 13661 Shpg. wt. 4 oz. . . . .Net 1.95

**15 By-Pass Switch.** Permits by-passing a window or door while maintaining protection, also use as exit/entry switch in rest of the system.  
14 F 33564 Pkg. of 2. Wt. 6 oz. . . . .Net 4.50

**16 Test or Panic Button.** Momentary contact switch for use with all closed circuit alarm systems. With hardware.  
14 F 13699 Shpg. wt. 4 oz. . . . .Net 1.50

**17 Heat/Fire Sensors.** Open circuit sensors. Cover area up to 20x20 ft. Resets. With mounting screws.  
14 F 13707 135°—Living areas . . . . .Net 2.95  
190°—For attics, boiler rooms, etc.  
14 F 13715 . . . . .Net 2.95

**18 Window Foil.** Protects glass doors and windows. Closed-circuit. Self-adhesive. 200"x¾"W.  
14 F 13749 Shpg. wt. 4 oz. . . . .Net 3.95

**19 Foil Connectors.** Connects window foil to protection circuit. For closed-circuit systems.  
14 F 13756 Pkg. of 2. Wt. 4 oz. . . . .Net 1.60

**20 Key Lock Switch.** Replacement for any alarm. Ideal for auto systems. With dust cover, 2 keys.  
14 F 13723 Shpg. wt. 8 oz. . . . .Net 2.69

# INTERMATIC Automatic Time Switches

**1** Type T101. Turns equipment on and off once in 24 hours or from 1-12 on-off operations a day with extra trippers. Min. on- or off-time 1 hour, max. 23 hours. Manual SPST switch rated at 40 amps. 125 VAC, 60 Hz. 7 3/4" x 5" x 3". UL listed.  
**13 F 27022** Shpg. wt. 3 lbs. . . . . Net **13.84**  
**Type T103.** As above, but with DPST switch.  
**13 F 27600** Shpg. wt. 3 lbs. . . . . Net **15.31**

**2** Type T171. "Skipper" automatic operation can skip operations on selected days. Ideal for offices, factories. Up to 12 on and off operations by adding extra trippers. Min on-off time 1 hour, max. 23 hours. 110-120 VAC, 60 Hz. 40 amps. 7 3/4" x 3". SPST switch. UL listed.  
**13 F 27063** Shpg. wt. 3 lbs. . . . . Net **17.98**  
**Type T175.** SPDT. Opens 1 circuit, closes another. Skips either on or off operation.  
**13 F 27071** Shpg. wt. 3 lbs. . . . . Net **19.31**  
**Type P171-30.** Same as T171, but plug-in version. 3-wire cord and receptacle.  
**13 F 27675** Shpg. wt. 3 3/4 lbs. . . . . Net **19.98**

**3** Type C8815. Cyclor Timer. For fans, pumps, motors. Uses up to 10 sets of trippers, each providing 5 sec. duration cycle. Operations may range from 5 sec. to 9 min., 55 sec. SPDT switch at 20 amps per pole. 125 VAC, 60 Hz. 7 3/4" x 5" x 3". UL listed.  
**13 F 27634** Shpg. wt. 3 3/4 lbs. . . . . Net **24.65**  
**Set of 12 Combination On-Off Trippers.**  
**13 F 27717** Shpg. wt. 3 oz. . . . . Net **75¢**

**4** Type T1905. For many on-off operations, from 1 to 96 every 24 hours. Min. on or off period 15 minutes, max. 23 hours, 45 minutes. Ideal for control of air conditioning, heating, ventilating. Handles 20 amps at 125 volts, 60 Hz. 7 3/4" x 5" x 3". UL listed.  
**13 F 27139** Shpg. wt. 3 lbs. . . . . Net **24.65**  
**Type T1975.** As above, with "Skipper" for selected days.  
**13 F 27360** Shpg. wt. 3 3/4 lbs. . . . . Net **25.98**

**5** Seven-Day Time Switches. Programmed weekly, daily with different on-off each day. Up to 4 operations daily. Rated 40 amps. For 125 VAC, 60 Hz. UL listed.  
**Model V46401 4PST.** 7 1/2" x 11 3/4" x 3 1/4".  
**13 F 27659** Shpg. wt. 6 3/4 lbs. . . . . Net **29.65**  
**Model V46107 DPDT.** 8 1/2" x 12" x 4 3/4".  
**13 F 27667** Shpg. wt. 6 3/4 lbs. . . . . Net **29.65**

**6** Type T185 Time Switch. Where multiple on-off cycles of 5 to 60 minutes are required in 24 hours. Up to 12 combinations. Min. interval between start of each cycle 1 3/4 hours. 40 amps. 125 VAC, 60 Hz. 7 3/4" x 5" x 3". UL listed.  
**13 F 27048** Shpg. wt. 3 1/4 lbs. . . . . Net **21.98**  
**Extra trippers for above.**  
**13 F 27725** Shpg. wt. 4 oz. . . . . Net **3.50**

**7** Type LS7041. Lawn Sprinkler with 14-Day Skipper. Permits pre-programmed watering up to 3 zones. 24-hour time dial, "skipper." 120 VAC, 60 Hz. 5 amps. UL listed.  
**13 F 27592** Shpg. wt. 3 3/4 lbs. . . . . Net **21.98**

### Switch Accessories

**TRIPPERS.** Set of On-Off for models T101, T103, T171, T175, P171-30.  
**13 F 27097** Shpg. wt. 3 oz. . . . . Net **50¢**  
**COMB. ON-CUTOUT TRIPPER.** For Skipper types only.  
**13 F 27733** Shpg. wt. 3 oz. . . . . Net **1.00**  
**SKIPPER SCREW.** For Skipper types only.  
**13 F 27741** Pkg. of 3. Shpg. wt. 2 oz. Net **40¢**

### Mallory Sonalert Electronic Audible Signal Device

Solid-state. No mechanical wear, no RF noise, low current drain. Used in fault alarms in computers, fire signals, appliances, security, other applications. Size: all 1 1/8" dia. x .781" long except † are 1.38" long. Installed weight: all 1 1/4 oz. except † are 2 oz. All with silicon transistors.

Stock No.	Type No.	Operating Voltage	Freq. Hz	Intensity dB	Current mA	Net
12 F 74018	SC628	6-28DC	2900	68-80	3-14	6.20
12 F 74026	SC628H	6-28DC	4500	68-80	3-14	7.19
12 F 74034†	SC628P	6-28DC	2900	68-80	3-14	11.24
12 F 74042†	SC628A	6-28AC DC	2900	68-80	3-14	9.92
12 F 74067†	SC110	30-110AC	2900	68-80	4-16	9.92

### RHODES MARK-TIME SWITCHES



**8** Wall Box. To 1 hr., turns off attic fan, porch lights, heating units, etc. 20 amps, 125 VAC, 60 Hz. Fits any stand. wall box. UL listed.  
**13 F 85020** Wt. 1 lb. Net **7.50**  
**Model 90015.** To 12 hours.  
**13 F 85038** 3/4 lb. . . . . Net **7.95**

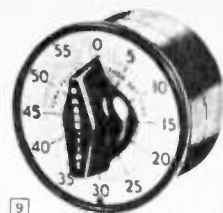

**9** Built-in Industrial Time Switch. Installs in 4" octagon switch box. 20 amps, 125-240 VAC. UL.  
**13 F 85079** 15 minutes. Shpg. wt. 3/4 lb. Net **8.50**  
**13 F 85087** 30 minutes. Shpg. wt. 3/4 lb. Net **8.50**  
**13 F 85103** 60 minutes. Shpg. wt. 3/4 lb. Net **8.50**  
**Adapter for 4" Octagon Switch Box.**  
**13 F 85095** Shpg. wt. 8 oz. . . . . Net **59¢**

**10** 2130 Precision Speed Timer. For precise 1 second to 1 hour timing. Two speeds, bell.  
**13 F 85053** Shpg. wt. 1 lb. . . . . Net **7.50**

### Lafayette Photo Electronic Relay System with Receiver, Electronic Relay, Exciter Lamp



- Ready to Operate
- For Bells, Buzzers, Counters
- "Invisible Light" Operation
- Effective Range to 50 Ft.

**\$34.95**

Excellent for use as alarm, counting system, etc. Anything breaking the beam triggers a relay which can be connected to a bell, buzzer, counter, etc. Has an infra-red filter for "invisible light" (reduces range to 25 ft.), variable sensitivity, switch for intermittent operation. Easy setup—simply "aim" exciter lamp to receiver across area to be covered. Each unit, 3 1/2" x 2 1/2" x 4 1/2". For 117 VAC, 60 Hz. Imported.

- 99 F 91027** Shpg. wt. 4 1/2 lbs. . . . . Net **34.95**
- 99 F 90144** Replacement Bulb . . . . . Net ea. **1.09**
- 99 F 90235** Electric Bell. Shpg. wt. 12 oz. . . . . Net **6.95**
- 99 F 90110** Electric Counter. Shpg. wt. 1 lb. . . . . Net **19.50**

### INFRARED BURGLAR ALARM



**\$44.95**

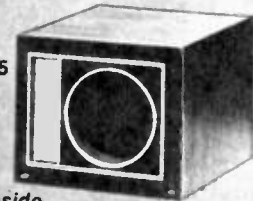

- Piercing Alarm Sounds Inside When Intruder Breaks Beam

Protection for home, office, shop. Install this alarm yourself. Plugs into house current. No special tools needed. A lamp unit operating on 117 VAC, 60 Hz transmits beam up to 75 feet to supersensitive photo cell. Operates on "D" battery. Any break in beam, including power failure, causes continuous or intermittent alarm. Lamp: 3 1/4" x 3 x 4 1/2". Detector: 3 1/4" x 7 1/8" x 4 1/2".  
**14 F 87503** Shpg. wt. 3 1/2 lbs. . . . . Net **44.95**  
**14 F 33515** Accessory Horn. Shpg. wt. 1 lb. . . . . Net **7.95**

### Swiss Pocket Timer

- Buzzes at Any Pre-Set Time up to 120 Minutes



Avoid parking tickets, late appointments. Use as phone call timer, etc. Just set dial and buzzer will sound on time. On chain. 1/4 lb.  
**13 F 31115L** Net **7.50**

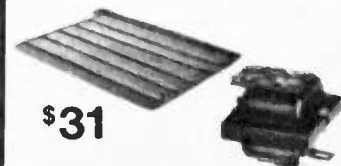

**\$31**

**Chime Annunciator Kit.** Announces visitors, guards against theft. Signals entrance into office, store, etc. Two-note chime.  
**32 F 66051** Wt. 4 lbs. . . . . Net **31.00**

# Automatic Timers For Everywhere In Your Home

For Easy Living and Convenience—Save Energy, Too!



\$19<sup>95</sup>

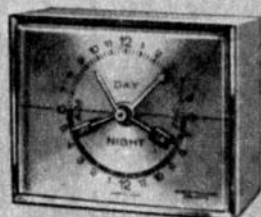

\$13<sup>50</sup>

**1 Digital Automatic Clock and Timer.** Repeats cycle every 24 hours. Pushbutton controls on top for convenience. Smart wood-grained plastic case. Makes any appliance automatic. 4½ x 3½ x 7½". UL listed. 15 amps (1875 watts).  
**13 F 28525** Shpg. wt. 1 lb. 14 oz. .Net 19.95

**2 Westclox 24-Hour Clock and Switch Timer.** Turns lights, appliances on and off. Sweep-second hand. Wood-tone case with gold-color dial. 24-hour cycle. Handles up to 1800 Watts (15 amps). For 117 VAC, 60 Hz. UL listed.  
**13 F 56500** Shpg. wt. 2 lbs. . . . .Net 13.50



Low As  
\$12<sup>50</sup>



\$12<sup>95</sup>

**3 Intermatic E-941 Air Conditioner Timer.** Automatically turns air conditioner on and off. Max. on, 22 hrs., 45 min. Min. on, 15 min. 117 VAC, 60 Hz. 12 amps full load, 15 amps total load.  
**13 F 27618** Shpg. wt. 1¾ lbs. . . . .Net 12.50  
**E-942.** Above except 250 VAC, 60 Hz.  
**13 F 27626** Shpg. wt. 1¾ lbs. . . . .Net 13.95

**4 AMF/Paragon Timite® Mini 24-Hour Timer.** Turns on yard, night lights. Automatic on-off every 24 hours. Manual trip lever. 4½H x 2¾W x 3¼"D. Fits over US single gang handy box. 15 amp. 1800 W. 1 HP, 12 amps, full load. For 120 VAC, 60 Hz. UL and CSA listed.  
**13 F 17510** Shpg. wt. 1¾ lbs. . . . .Net 12.95

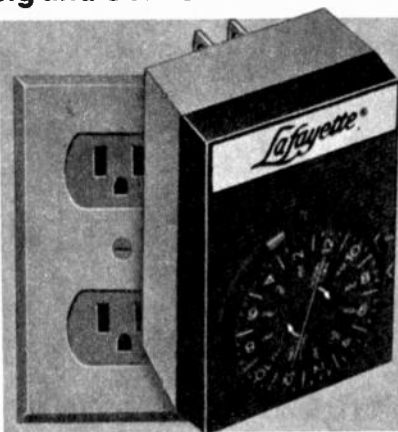

\$5<sup>95</sup>

• Turn Lights On or Off . . .  
 • Give Your Home a "Lived-in" Look—Discourage Prowlers  
 • No Wiring Required

**5 Lafayette Plug-in 24-Hour Timer.** Cordless. Plugs directly into wall socket. Maximum "on" time: 21½ hours; min. "on" time: 2½ hours. One-year parts/labor guarantee. Capacity: 12 amps, 1500W. 117 VAC, 60 Hz. UL listed. 2¾ x 3¾ x 1¼".  
**13 F 01738** Shpg. wt. 2 lbs. . . . .Net 5.95

**7 AMF/Paragon TV Timer.** Turns TV set off automatically. Adjusts from 15 min. to 6 hours. Elegant, simulated teakwood faceplate. Black case blends with any decor. Perfect for TV's up to 840 watts. 3¼H x 5½L x 2½"D. For 120 VAC, 60 Hz. 6-ft. cord, piggyback plug.  
**13 F 17593** Shpg. wt. 1¾ lbs. . . . .Net 9.95

**8 Lafayette TV Timer Control.** Turns off set automatically while you sleep. 500W capacity. Ideal for hi-fi, hair dryer, electric blanket. Set turn-off from 5 min. to 1 hour. 10-ft. cord.  
**99 F 80798** Imported. Wt. 1 lb. . . . .Net 6.95

**9 Intermatic Time-All multiple program timer.** Turns lights and appliances off up to 12 times. 15 amps, 1875W. 3 x 4½ x 3¾". Accepts up to 12 sets of trippers below. For 117 VAC, 60 Hz.  
**13 F 27683** Shpg. wt. 1¾ lbs. . . . .Net 10.95  
 Additional 2 sets on-off trippers.  
**13 F 27691** Shpg. wt. 3 oz. . . . .Net 75¢

**10 Intermatic In-Wall Timers.** Similar to 9 above, but mounts in existing wall outlet or switch box. 5½H x 3¼"W. Order additional trippers above.  
**Model E-1022.** Two outlets, one timed, one continuous. For wall outlet. Ideal for air conditioners. Shpg. wt. 2¼ lbs.  
**13 F 27758** . . . . .Net 13.95  
**Model E-1020.** For outdoor lights, etc. For switch box. Shpg. wt. 2¼ lbs.  
**13 F 27766** . . . . .Net 12.50



\$8<sup>44</sup>

**6 Lafayette Techni-Timer II.** Makes any lamp or appliance completely automatic. Repeats cycle every 24 hours. Handles loads up to 1875 W. Cap. 15 amps. No special wiring. Min. "on" time: ½ hour; max.: 22¾ hours. 2¾ x 3¾ x 1¼". For 117 VAC, 60 Hz. UL listed. Shpg. wt. 1¾ lbs.  
**13 F 01803** . . . . .Net ea. 8.44



\$9<sup>95</sup>



\$6<sup>95</sup>



\$10<sup>95</sup>

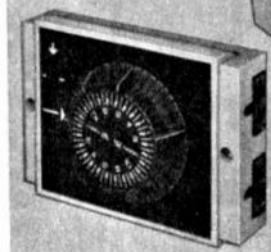

Low As  
\$12<sup>50</sup>



\$6<sup>95</sup>

## 5-Hour "Ringer Timer"

**5-Hour "Ringer Timer."** Signals end of pre-set time period. Loud, long-ringing bell. Easy-to-read, crystal-covered dial. Red dial window shows hours from 1 to 5. Attractive, high-impact white plastic case. Imported.  
**13 F 13501** Shpg. wt. ¾ lb. . . . .Net 6.95

# Let Lafayette Keep You "On Top" of The Weather

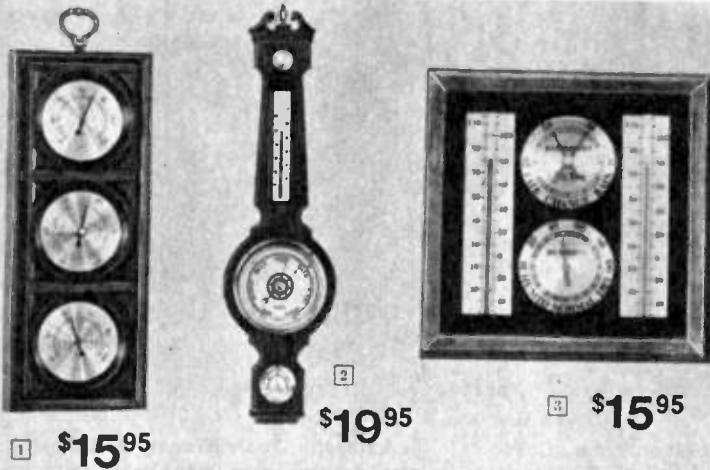

1 \$15.95

2 \$19.95

3 \$15.95

1 **Springfield Home Weather Station.** 3-in-1 thermometer, barometer and humidity meter. Simulated hand-rubbed wood-grain finish case with extra-large, spun gold color dials. 20" tall, mounts vertically or horizontally.

13 F 40066 Shpg. wt. 3¼ lbs. . . . . Net 15.95

2 **Springfield "Wellington" Home Weather Station.** In true English style — finely etched metal dials, simulated mahogany finish, polished brass details. Has thermometer, barometer, humidity meter. 24" tall, 5" dial.

13 F 40082 Shpg. wt. 5 lbs. . . . . Net 19.95

3 **TCA Modern-Style Weather Watcher.** Combination indoor/outdoor thermometer, barometer, humidity gauge set in simulated walnut-grain case accented with an antique black inset. Black scales, brushed satin background. 48" remote sensing tube. 8¼ x 8¼".

13 F 16132 Shpg. wt. 2 lbs. . . . . Net 15.95



1 \$4.95

**NEW!**

Springfield  
Liquid Crystal  
Digital Thermometers.



5 \$5.95

4 **Wall-Mount Digital Thermometer.** Sturdy Styron® plastic case, gold tones and a clear lens. Reads °Fahrenheit temperatures in two-degree intervals from 66° to 88°. Arrow indicates temperatures above or below this range. 3¼" wide x 11½" high. Numbers appear large enough for easy reading from anywhere in the room.

13 F 40108 Shpg. wt. 1 lb. . . . . Net 4.95

5 **Desk-Style Digital Thermometer.** Same as above, except desk model for office, den, rec room, etc. Plastic case with walnut finish and brilliant golden accents. Size: 11"L x 2½"H.

13 F 40116 Shpg. wt. 1 lb. . . . . Net 5.95

## Indoor/Outdoor Thermometer/Humidity Meter



\$10.70

Wood-grain case has three precise weather indicators: indoor and outdoor thermometer, and humidity meter. Gold color with easy-to-read metal scales. With 4' capillary tubing. 14 inches tall.

13 F 40033 Shpg. wt. 1¼ lbs. . . . . Net 10.70

## Taylor Precision

### Weather Instruments

\$109.95

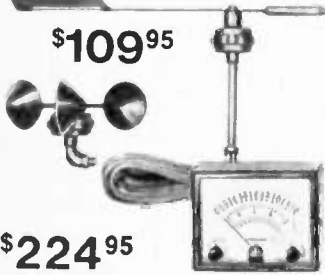

### Windscope Wind Speed and Direction Indicator

Two-position knob shows wind speed or direction on easy-to-read indoor gauge. Corrosion-resistant outdoor parts, 60-ft. lead-in. Indoor gauge has mahogany finish, 6½ x 5". Includes battery, 60-ft. lead-in & instructions. Shpg. wt. 9 lbs.

13 F 74511W . . . . . Net 109.95

\$224.95

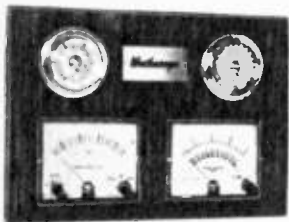

### Weather Station—Weatherscope

Indicates temperature, atmospheric pressure (barometer), wind speed and direction. Includes outdoor roof unit with 60-ft. lead-in wire, 20-ft. capillary tubing, 17 x 12" walnut-finish indoor indicator with brass bezels. W/battery, instructions.

13 F 74503W 16 lbs. Net 224.95

\$71.95



### Weather Hawk Recording Thermometer or Barometer

For labs, weather stations, schools, etc., records outdoor temperatures from -40°-120°F on a continuous 7-day chart. Has 8' capillary tubing, black plastic case with clear cover, 13x7". Has 13 charts, ink and instructions. 117 VAC, 60 Hz.

13 F 74529W 8½ lbs. Net 71.95

7-Day Barometer. As above, but measures 29-31" pressure, for altitudes to 10,000 ft.

13 F 74537W 5 lbs. . Net 71.95

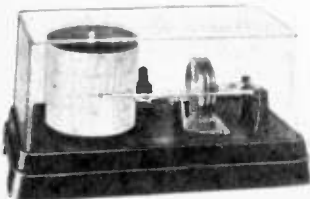

\$6.95

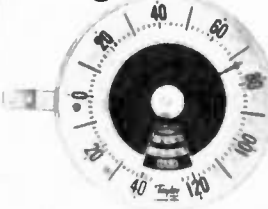

### Taylor Max.-Min. Dial Thermometer

Shows current temperature, maximum and minimum for the day also. Has translucent white plastic case, dark blue numerals and graduations on black-lighted case. Rust-proof bracket for 360° mounting, center-knob for adjusting dial.

13 F 74271 Shpg. wt. 1 lb. . . . . Net 6.95

### Thermometer/Humidity Meter

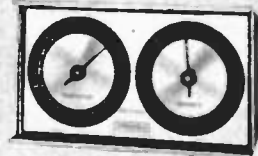

\$3.95

Springfield. Practical and accurate, suitable for home or office use. Easy-to-read dual metal dials in a simulated leather case that stands or hangs. 5½ x 3½ x 2".

13 F 40074 Shpg. wt. 1 lb. Net 3.95

### Dwyer Wind-Speed Indicator

• Great for Pilots

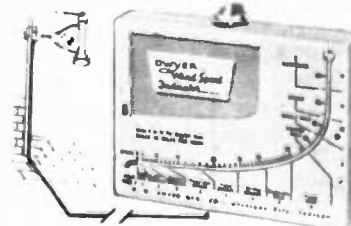

\$24.95

Deluxe wind velocity indicator reads just like a thermometer—the wind velocity registers in a liquid-filled tube. Has vane-type external fittings for mounting on an outside elevated point, attractive gray indicator with jet-black calibrations. Includes 50-ft. tubing to connect outer unit to wind gauge. Gauge size: 7¾ x 5¾ x 1".

13 F 62508 Wt. 3¾ lbs. Net 24.95

• For Sportsmen, Yacht and Gun Clubs, Etc.

# Lafayette Has the "Time"-Liest Values Around



1  
\$13<sup>95</sup>

2  
\$18<sup>95</sup>

3  
\$22<sup>95</sup>

4  
\$119<sup>95</sup>

**NEW**  
Shows Hours  
and Minutes  
in Easy-to-Read  
Digital Display

1 **Sportsman's Calendar Watch.** Hermetically-sealed, pressurized case gives max. protection to 5 atmospheres. Swiss-crafted movement. Luminous hour markers and hands. Shows time in 12 world-wide cities. Indicates elapsed diving time. Automatic daily calendar, unbreakable main spring and sweep second hand. Polished chrome case, stainless steel back, waterproof strap. Shpg. wt. 7 oz.  
13 F 31487L ..... Net 13.50

2 **Swiss-Made Alarm Watch.** Dial features sweep second hand. Gilt numerals and markings on face. Shock-resistant, anti-magnetic movement with unbreakable mainspring. Gold-tone case with stainless steel back. Real lizard strap.  
13 F 31545L Shpg. wt. 8 oz. .... Net 18.95

3 **Swiss Double-Button Chronograph.** Performs 5 functions in addition to telling time: tachometer for measuring speed, telemeter for measuring distance of sound, elapsed timer, parking meter timer, and stop-watch with 30-minute register. Shock- and water-resistant, anti-magnetic movement. Unbreakable mainspring.  
13 F 31511L Shpg. wt. 13 oz. .... Net 22.95

4 **Solid-State Liquid Quartz Computer Watch.** Continuous digital readout. Accurate to 1 min./year. Water-, shock-resistant. Anti-magnetic. Handsome, gold-plated case with adjustable link band. Operates on easily replaceable batt.  
13 F 31552Z Shpg. wt. 1 lb. .... Net 119.95  
Shipped prepaid directly from factory. No COD. Send full remittance or use Lafayette's Easy-Pay Plan.

5 **17-Jewel Multi-Year Calendar Watch.** Easy-to-read universal calendar shows dates, months, days of week, and year to 1991. Shock-resistant, anti-magnetic Swiss movement. Sweep second hand. Elegant chrome finish case, hands and raised markers. Lizard strap.  
13 F 31495L Shpg. wt. 8 oz. .... Net 24.95

6 **Man's Digital Watch.** Shows hours and minutes in large, easy-to-read numerals. Precision, shock-resistant, anti-magnetic Swiss movement has unbreakable mainspring. Brushed gold-tone finish case with genuine lizard strap.  
13 F 31529L Shpg. wt. 14 oz. .... Net 16.95  
Lady's Model.  
13 F 31537L Shpg. wt. 14 oz. .... Net 16.95

7 **1/10-Second Timer.** Large hand registers 1/10 sec. to 30 sec. Small hand reads to 15 min. Start, stop, continue from crown, 7-jewel movement.  
13 F 31032L Shpg. wt. 6 oz. .... Net 16.95

8 **1/5-Second Timer.** Similar to above, ideal for sports. 60 sec. turn.  
13 F 31040L Shpg. wt. 6 oz. .... Net 16.95  
1/10-Second Track Timer. Not illus. 10-sec. turn, small hand to 10 min. Stop/start and reset.  
13 F 31065L Shpg. wt. 5 oz. .... Net 19.95  
Decimal Timer. Not illus. 7-jewel movement. 1/10th min. outer dial, registers to 1 min. 30-min. inner dial. Pushbutton start, stop and zero.  
13 F 31016L Shpg. wt. 6 oz. .... Net 17.95

9 **Cordless Electric Pendulum Clock.** American traditional style in walnut tones. Runs up to a year on a "D" cell. Size: 14H x 9W x 2"D.  
13 F 30547W Shpg. wt. 2 lbs. .... Net 17.95  
Battery. For above.  
99 F 63661 Imported. .... Net 28.95

10 **Copal Deluxe Digital Alarm Clock.** Features very large numerals, illuminated face. Hour cards marked AM/PM. "Snooze button" turns alarm off for additional 3 minutes' sleep. Rotary second indicator. Measures 7W x 4 3/8 x 3 1/4"D. Precision synchronous motor. Bronze-colored aluminum cabinet. For 117 VAC, 60 Hz.  
13 F 16546 Imported. Shpg. wt. 3 lbs. Net 24.95

11 **Copal Compact Digital Alarm Clock.** Features easy-to-read black numerals on a white background, illuminated for night use. 24-hour alarm system. Precision synchronous motor. Distinctive simulated walnut grain finish cabinet. 5 3/4 x 2 3/4 x 3 3/8". For 117 VAC, 60 Hz. Imported.  
13 F 16538 Shpg. wt. 1 1/2 lbs. .... Net 15.95  
13 F 16520 Charcoal Grey ..... Net 14.95  
13 F 16512 White Cabinet ..... Net 14.95

12 **Copal Compact Digital Alarm Clock with Day of Week.** Displays time and day in bold letters and numerals. Illuminated face. 24-hour alarm system. Precision synchronous motor for accurate performance. Stylish simulated walnut grain finish. Size: 7 1/4 W x 2 3/4 H x 3 3/8" D. Imported.  
13 F 16553 Shpg. wt. 1 1/2 lbs. .... Net 19.95



\$24<sup>95</sup>

5

\$16<sup>95</sup>

6



## Swiss Stop Watches

7  
8  
Low As \$16<sup>95</sup>

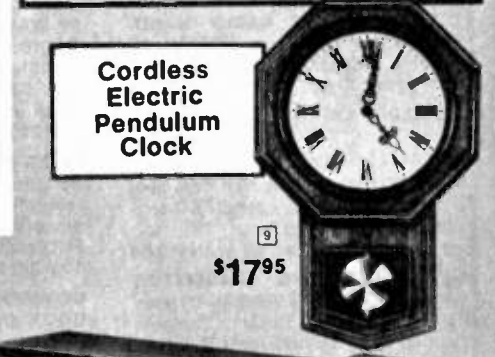

## Cordless Electric Pendulum Clock

\$17<sup>95</sup>



\$24<sup>95</sup>



\$19<sup>95</sup>



Low As \$14<sup>95</sup>

# Informative Books for Radio Amateurs

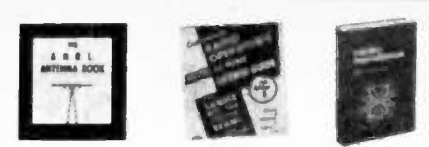

**RADIO AMATEUR'S HANDBOOK.** Latest edition. Packed with theory and practical design, information on station equipment, audio and RF circuits, HF, VHF, and UHF, phone and C.W., receivers, transmitters, antennas, mobile equipment, etc. 10 F 89010 Wt. 2 1/4 lbs. . . . Net 4.50

**FM AND REPEATERS FOR THE RADIO AMATEUR.** Covers FM history, mobile installations, receivers, transmitters, antennas, repeater problems and cures, test equipment, selecting a rig, techniques, and repeater clubs. With excerpts from FCC regulations. Glossary. 232 pgs. 10 F 89218 Shpg. wt. 1 lb. . . . Net 3.00

**ANTENNA BOOK.** Gives antenna and transmission line theory, plus instructions for building amateur antennas for all bands from 160 meters up into the UHF regions. 330 pages. 10 F 89036 Wt. 1 lb., 6 oz. . . . Net 3.00

**RADIO AMATEUR'S VHF MANUAL.** VHF history. Covers receiving and transmitting principles, techniques and construction; antenna and feed system design; microwaves; test equipment; interference; VHF hints and kinks. 6 1/2 x 9 1/2". 360 pages. 10 F 89184 Wt. 1 lb., 6 oz. . . . Net 2.50

**WORLD RADIO TV HANDBOOK 1974.** Contains details on every shortwave and TV station throughout the world. Each station identified by call, frequency, station personnel, address, power, programs and language, license fee, identification signals and network affiliation. 404 pages. Imported. 10 F 12012 Wt. 1 lb., 6 oz. . . . Net 7.50

**RADIO AMATEUR CALL BOOK — UNITED STATES SECTION.** Latest edition. 10 F 50095 Wt. 2 lbs., 6 oz. . . . Net 9.95

**FOREIGN RADIO AMATEUR CALL BOOK.** Latest edition. 10 F 50103 Shpg. wt. 2 lbs. . . . Net 8.95

**AMATEUR STATION LOG BOOK.** 10 F 89135 Shpg. wt. 10 oz. . . . Net 7.75

**A COURSE IN RADIO FUNDAMENTALS.** Includes electric charge, magnetic fields, amplifier circuits and much more. 184 pages. 10 F 89226 Shpg. wt. 10 oz. . . . Net 2.00

**GATEWAY TO AMATEUR RADIO.** Set of 4 books for all hams. In addition to "Radio Amateur's License Manual" below, contains "How to Become a Radio Amateur," "Learning the Radio-Telegraph Code," "Operating an Amateur Radio Station." 10 F 89119 Wt. 1 lb., 5 oz. . . . Net 2.50

**SINGLE SIDEBAND FOR THE RADIO AMATEUR.** A selection of the best SSB articles appearing in QST magazine. Thoroughly discusses theory. 253 pages. 10 F 89069 Shpg. wt. 15 oz. . . . Net 3.00

**AMATEUR RADIO MAP OF THE WORLD.** 30 x 40". 10 F 89127 Shpg. wt. 15 oz. . . . Net 2.00

**RADIO AMATEUR'S LICENSE MANUAL.** Prepares for FCC exams for Novice, Technician, Conditional, General, Advanced and Extra Class ham license. Typical exam questions, study materials and complete regulations. 120 pages. 10 F 89085 Shpg. wt. 9 oz. . . . Net 1.00

**AMATEUR RADIO THEORY COURSE.** (No. 10201). Complete home study theory course covering Novice, Technician, conditional and general classes. Almost 400 typical F.C.C. questions to help prepare for exams. 10 F 57041 Shpg. wt. 14 oz. . . . Net 4.95

**RADIO HANDBOOK (No. 24030).** 19th Edition. Provides extensive, simplified theory on almost every phase of radio practice, specifically written for the amateur, technician and engineer. Broadest reference coverage, up-to-date, original data. 10 F 24017 Shpg. wt. 3 lbs Net 14.95

**EASI-GUIDE TO SHORTWAVE LISTENING.** Lists foreign stations, countries, explains radio waves, etc. Helps you "listen to the world" through SW radio. 160 pages. 10 F 24702 Shpg. wt. 10 oz. . . . Net 3.50

**RADIO AMATEUR DX GUIDE.** The guide manual for DX enthusiasts. Features a listing of foreign prefixes, great circle maps, section map, time conversion charts, contest and field day log, world-wide postal information, great circle bearing tables, etc. 10 F 50137 Shpg. wt. 10 oz. . . . Net 2.50

**COMMERCIAL OPERATOR'S Q & A LICENSE GUIDE.** These books cover the exam material for F.C.C. licenses. Includes questions and simplified answers and a sample F.C.C.-type examination. 3rd Class. 48 pages. 10 F 57066 Shpg. wt. 5 oz. . . . Net .90

2nd Class. 160 pages. 10 F 57116 Shpg. wt. 11 oz. . . . Net 2.25

1st Class. 80 pages. 10 F 57124 Shpg. wt. 6 oz. . . . Net 1.50

**COMMERCIAL RADIO THEORY COURSE.** (No. 15-01). By Martin Schwartz. Complete course for FCC First and 2nd Class Radiotelephone license. 21 lessons from basic electricity through radio transmission and reception. Includes FCC-type multiple choice tests. 10 F 57157 Shpg. wt. 1 lb. . . . Net 5.95

**UNDERSTANDING AMATEUR RADIO.** Written for the beginner. Simply explains the elementary principles of electronic and radio circuits, transmitters, receivers and antennas. 6 1/2 x 9 1/2". 320 pages. 10 F 89192 Wt. 1 1/4 lbs. . . . Net 2.50

**RADIO OPERATOR'S LICENSE Q & A MANUAL (No. 0432X).** 7th Edition. By Milton Kaufman. Has been completely updated in accordance with the latest FCC examination requirements for any radio-telephone operator's license. Contains elements I, II, III, IV, VIII and IX. Questions and answers for elements III and IV completely revised; all other elements have been updated. 576 pgs. 10 F 12848 Wt. 2 1/4 lbs. . . . Net 7.45

**RADIOTELEGRAPH OPERATOR'S LICENSE Q & A MANUAL (No. 0772).** By Milton Kaufman. Completely updated study manual for obtaining FCC 3rd, 2nd and 1st class radiotelegraph licenses. Covers elements I, II, V, VI, VII and VIII plus direction finders and automatic alarm equipment. 400 pages. Clothbound. 10 F 12095 Wt. 1 1/2 lbs. . . . Net 13.75

**VHF HANDBOOK FOR RADIO AMATEURS.** By Herbert Brier and William Orr. Latest facts on FM theory, operation, repeaters, equipment, etc. Satellite and moonbounce, DX propagation, more. 330 pages. 10 F 50160 Wt. 1 lb., 6 oz. . . . Net 5.95

**CUBICAL QUAD ANTENNAS.** By William I. Orr. 2nd Edition. Handbook of quad assembly and data. X-Q high gain, 7 MHz to 50 MHz quads. Tri-Gamma 3-band single feed. Gains, front/back, patterns. Simplified and improved construction. 112 pages. 10 F 50038 Shpg. wt. 8 oz. . . . Net 3.95

**BEAM ANTENNA HANDBOOK.** By William I. Orr. 4th Edition. Covers construction, installation, and evaluation. New, simplified designs. Full dimensional charts are given for the 6, 10, 15, 20 and 40 meter bands! 200 pages. 10 F 50079 Shpg. wt. 13 oz. . . . Net 4.95

**BETTER SHORTWAVE RECEPTION.** By William I. Orr. 3rd Edition. Covers the exciting field of shortwave radio for the SWL and the radio amateur. DX tuning hints, international broadcasting, etc. 156 pages. 10 F 50061 Shpg. wt. 10 oz. . . . Net 3.95

**SIMPLE LOW-COST WIRE ANTENNAS FOR RADIO AMATEURS.** By William I. Orr. 2nd Ed. Describes how to build, install and tune dipoles, ground planes, beams, Marconis, multi-bands, and "Invisible" antennas for apartment dwellers. Computer-figured lengths in feet and inches. 192 pages. 10 F 50145 Shpg. wt. 7 oz. . . . Net 4.95

## Interesting and Informative Books for CB'ers

**CITIZENS BAND RADIO HANDBOOK.** 4th Ed. Sams (20839). By David E. Hicks. Completely updated. 10 F 23613 Shpg. wt. 9 oz. . . . Net 4.95

**CB RADIO ANTENNAS.** 2nd Edition. Sams (20567). By David E. Hicks. 10 F 23621 Shpg. wt. 8 oz. . . . Net 3.50

**HOW TO BE A HAM.** By Ken Sessions, Jr. (K6MVH). Latest FCC regulations. 192 pages. 10 F 41938 Shpg. wt. 10 oz. . . . Net 3.95

**1-2-3-4 SERVICING TRANSISTOR CB AND TWO-WAY RADIO.** By Forest H. Belt. 1st Edition. Explains popular test method for CB radios and communications. Covers AM, FM and SSB. 256 pages. 10 F 24736 Shpg. wt. 2 lbs. . . . Net 5.25

**EASI-GUIDE TO CITIZENS BAND RADIO.** 1st Edition. By Forest H. Belt. Gives you all the information you need to obtain and use your own CB two-way radio system. Fully illustrated. 144 pages. 10 F 24728 Shpg. wt. 10 oz. . . . Net 3.50

**99 WAYS TO IMPROVE YOUR CB RADIO.** By Len Buckwalter. (Sams 20515). Operate, service and maintain CB equipment. Invaluable to those interested in CB. 128 pages. 10 F 23597 Shpg. wt. 9 oz. . . . Net 2.95

**ABC'S OF CITIZENS BAND RADIO.** By Len Buckwalter. 3rd Edition. Latest info for serious CB'ers and beginners. Has operating procedures, FCC regulations, etc. 128 pages. 10 F 24710 Shpg. wt. 10 oz. . . . Net 3.95

**COMMERCIAL FCC LICENSE HANDBOOK.** By Harvey F. Swearer. Up-to-date questions and answers for 1st, 2nd and 3rd Class Radiotelephone license exams, plus broadcast and radar. 150 illus. 444 pages. 10 F 41946 Wt. 1 1/2 lbs. . . . Net 5.95

**SECOND-CLASS RADIOTELEPHONE LICENSE HANDBOOK.** (20824). By Edward M. Noll. New 4th edition. Complete study course for elements I, II and III of latest FCC exams. 10 F 24249 Shpg. wt. 14 oz. . . . Net 5.95

**FIRST-CLASS RADIOTELEPHONE LICENSE HANDBOOK.** (20804). By Edward M. Noll. Contains questions and answers based on revised FCC element 4, needed to qualify for a 1st class license. 416 pages. 10 F 23050 Wt. 1 1/4 lbs. . . . Net 6.50

**CB RADIO OPERATOR'S GUIDE.** (GL/Tab No. 499). By Robert M. Brown. Includes buying base and mobile station equipment, installation, antennas, improvements, troubleshooting, emergency assistance, etc. 192 pages. 10 F 41680 Shpg. wt. 9 oz. . . . Net 4.95

**CB RADIO SERVICING GUIDE.** 2nd Edition. Sams (20722). By Leo G. Sands. Detailed procedures for tuning up, testing, and trouble-shooting. Explains FCC regulations. Step-by-step analysis of transmitter circuits. 160 pages. 10 F 22094 Shpg. wt. 9 oz. . . . Net 3.95

**PRACTICAL CB RADIO SERVICING.** By Freeland and Sands (Hayden/Rider 0777). Practical guide for servicing CB and two-way radio equipment. 192 pages. 10 F 12772 Shpg. wt. 10 oz. . . . Net 6.60

**CBer's HOW-TO BOOK.** (No. 0718). By Leo G. Sands. Selecting, installing, operating, testing, repairing and modifying CB equipment. CB Codes and Channels. 128 pages. 10 F 12087 Shpg. wt. 9 oz. . . . Net 4.55

**QUESTIONS & ANSWERS ABOUT CB OPERATIONS.** Sams (20893). By Leo G. Sands. Questions and answers about the four classes of CB radio. 112 pages. 10 F 24306 Shpg. wt. 7 oz. . . . Net 2.95

**THE TRUTH ABOUT CB ANTENNAS.** (Radio Publications). How to buy or build, install, and adjust efficient CB antennas for strongest signals. "Truth Table." 240 pages. 146 illus. 10 F 50152 Shpg. wt. 1 lb. . . . Net 4.95

## FAMOUS HOWARD W. SAMS PHOTOFACT FOLDERS

Complete servicing data for over 91,000 post-war home entertainment products—radios, TV's, stereo, etc. Includes full charts and instructions, illustrations, etc. Famous Sams standard notation schematics, exploded views, etc. Easy to order—specify make and model of set—allow two weeks for delivery.

**10 F 24744Z** Shpg. Ppd. Net ea. 4.50

**FREE ANNUAL INDEX.** Lists all available photofacts for sets made since 1946.

**10 F 21229** Shpg. wt. ½ lb. . . . **FREE BINDER FOR PHOTOFACT SETS.**

Black leatherette binder holds 10 folders. Hardboard. 9½ x 11½ x 6".

**10 F 21237** Wt. 3¼ lbs. . . . Net 8.00

**ELECTRONICS SELF-TAUGHT WITH EXPERIMENTS AND PROJECTS.**

By Jim Ashe. Includes useful, entertaining, informative projects using IC's, lab-type equipment you can build and calibrate. 288 pages. 191 illus.

**10 F 41953** Wt. 1½ lbs. . . . Net 5.95

**1-2-3-4 SERVICING HI-FI TURNTABLES.**

By Forest H. Belt. 1st Edition. Popular time-saving servicing method applied to automatic and manual turntables. Fully illustrated. 192 pages.

**10 F 24793** Shpg. wt. 10 oz. Net 4.95

**SELECTING AND IMPROVING YOUR HI-FI SYSTEM.**

By Harvey Swearer. Handy guide to the latest in home equipment with tips on how to get the most for your money. Discusses 4-channel, placement, more. 224 pages. 122 illus.

**10 F 41961** Shpg. wt. 10 oz. Net 4.95

**USING THE SLIDE-RULE IN ELECTRONICS TECHNOLOGY.**

Written for beginning and advanced students, discusses all scales with detailed examples. Graded difficulty problems develop speed and accuracy. 120 pages.

**10 F 11626** Shpg. wt. 8 oz. . . . Net 3.75

# Television Servicing Books

**COLOR TV TRAINING MANUAL.**

(20736). 3rd Edition. Describes science of color, requirements and make-up of composite color signal, servicing procedures. Outlines use of color test equipment. Illus. 240 pages. 8½ x 11".

**10 F 21286** Wt. 1 lb., 12 oz. . . . Net 7.95

**TV SERVICING GUIDE.** (No. 20361).

Trouble-shooting procedures based on analysis of symptoms with picture tube photos with possible causes for each symptom. 132 pages. 8½ x 11".

**10 F 21401** Shpg. wt. ¾ lb. . . . Net 3.70

**TV TUBE SYMPTOMS AND TROUBLES.**

(No. 20476). By Robert G. Middleton. Second edition. A picture book of TV troubles caused by defective tubes. Clearly explained and depicted in photos. Illustrated. 96 pages. 5½ x 8½".

**10 F 23282** Shpg. wt. 6 oz. . . . Net 2.85

**COLOR TV TROUBLES.** Vol. 1

(20120). By PF Reporter Editorial Staff. Outlines trouble clues and procedures which have been field tested for repairs, alignment and sync problems, convergence, etc. Fully illustrated with photos. 96 pgs.

**10 F 24611** Shpg. wt. 7 oz. . . . Net 2.85

**PINPOINT TV TROUBLES IN 10 MINUTES.**

By Harold P. Manly. 50 detailed trouble-finding charts point out most probable causes of TV defects. Over 160 waveform photos. 372 pages. 394 illus.

**10 F 42019** Shpg. wt. 2 lbs. . . . Net 5.95

**PICTORIAL GUIDE TO COLOR TV CIRCUIT TROUBLES.**

By Forest H. Belt. Contains 200 waveform photos taken from malfunctioning sets. 256 pages, 262 illus.

**10 F 41995** Shpg. wt. 1 lb. . . . Net 4.95

**199 COLOR TV TROUBLES AND SOLUTIONS.**

By Robert L. Goodman. Includes difficult TV problems listed by mfr. and chassis no.—Admiral, GE, Magnavox, Motorola, Philco, RCA and Zenith. Complete with schematics. 224 pages.

**10 F 41987** Shpg. wt. 1 lb. . . . Net 4.95

**KWIK-FIX™ TV SERVICE MANUAL.**

By Forest H. Belt. Helps pinpoint "tough dog" TV troubles. Has troubleshooting charts. 384 pages.

**10 F 42027** Shpg. wt. 2 lbs. . . . Net 5.95

**COLOR TV SERVICING GUIDE.** 2nd Edition.

By Robert G. Middleton. Fully updated with servicing info for all color TV's. Great for servicemen and technicians. 112 pages.

**10 F 24827** Shpg. wt. 10 oz. Net 4.95

**HOW TO USE COLOR TV TEST INSTRUMENTS.**

By Robert L. Goodman. Thoroughly explains modern color TV test equipment with tips on how to get the most from your investment. 256 pages. 230 illus.

**10 F 42001** Wt. 1½ lbs. . . . Net 4.95

**RAPID TV REPAIR.** (No. 60).

Handy, practical service manual which lists hundreds of "tough-dog" troubles alphabetically, many cross-referenced. 224 pages. Illustrated.

**10 F 41334** Shpg. wt. 11 oz. Net 4.95

**HOW TO SELECT AND INSTALL ANTENNAS.**

(No. 0786). By Lon Cantor. Covers TV, stereo, UHF, VHF, or complete master TV systems—mechanical as well as electronic. Includes special consideration of local, fringe and near fringe area problems. 112 pages.

**10 F 12038** Shpg. wt. 7 oz. . . . Net 4.25

**FUNDAMENTALS OF TELEVISION.**

(No. 0391). By Walter H. Buchsbaum. Emphasis is placed on understanding essential working principles; mathematics is held to an absolute minimum. The key circuits are explained with practical troubleshooting procedures. 291 pages.

**10 F 11808** Wt. 1¼ lbs. . . . Net 7.95

**HOW TO TROUBLESHOOT A TV RECEIVER.**

(No. 0342). 3rd Ed. By J. Richard Johnson. Step-by-step guide tells where to start and how to continue in troubleshooting all TV receivers. Discusses test patterns and cross-hatch patterns, tubes, controls, sound troubles, etc. 128 pages.

**10 F 10198** Shpg. wt. 9 oz. . . . Net 5.70

**HOW TO TEST . . . ALMOST EVERYTHING ELECTRONIC.**

(No. 132). By Jack Darr. Practically every testing technique for almost every kind of electronic equipment. Hundreds of illustrations make text crystal clear. Soft-bound. 160 pages.

**10 F 41557** Shpg. wt. 7 oz. . . . Net 2.95

**HOW TO USE YOUR VOM-VTVM AND OSCILLOSCOPE.**

(No. 438). By Martin Clifford. A guide for the application of the most frequently used test instruments. 192 pages.

**10 F 41607** Shpg. wt. 9 oz. . . . Net 3.95

## Transistor, Tube, SCR Manuals and Books

**ABC'S OF TRANSISTORS.** 2nd Edition.

(Sams 20440). By George B. Mann. Explains what transistors are and how they operate, in simple terms. Covers servicing and testing procedures. 112 pages.

**10 F 24595** Shpg. wt. 7 oz. . . . Net 2.95

**TRANSISTOR SUBSTITUTION HANDBOOK.**

14th Edition. (No. 21040). By the Howard W. Sams Engineering Staff. Updated guide lists over 100,000 substitutions in easy-to-use format that eliminates double-checking. 160 pages.

**10 F 24801** Shpg. wt. 14 oz. Net 2.95

**1974 TUBE CADDY—TUBE SUBSTITUTION GUIDE.**

(0804X). By H. A. Middleton. Eight sections listing over 16,000 direct subs. Covers foreign TV tubes on the American market. 144 pages.

**10 F 11915** Shpg. wt. 5 oz. Net 1.99

**50 IC PROJECTS YOU CAN BUILD.**

By Ronald M. Benray. Author-invented projects that can be built in an evening or two and demonstrate the new technology of integrated circuits. 128 pages.

**10 F 12780** Shpg. wt. 9 oz. . . . Net 4.55

**PINPOINT TRANSISTOR TROUBLES IN 12 MINUTES.**

(No. 430). By Louis E. Garner, Jr. Quick-reference table tells exactly where to find appropriate troubleshooting charts and service procedures for practically every type of transistorized device. 495 pages, 243 illus.

**10 F 41813** Wt. 1½ lbs. . . . Net 6.95

**25 SOLID-STATE PROJECTS.** (5881).

By Rudolf F. Graf and George J. Whalen. Sequential turn-signal system, telephone call timer, a TV remote-sound system, a shortwave RF preselector, and electronic dice—every project includes detailed instructions, numerous photos and diagrams, and a complete parts list. 120 pages.

**10 F 12798** Shpg. wt. 8 oz. . . . Net 4.90

**RCA RECEIVING TUBE MANUAL RC-29.**

Contains complete technical data on all current tubes. Tuner, receiver, amplifier, intercom and other circuit diagrams, socket diagrams, tube dimension drawings, resistance-coupled amplifier data, tube curves, etc. 752 pages.

**10 F 47133** Wt. 1¼ lbs. . . . Net 2.50

**SEMICONDUCTORS FROM A TO Z.**

(No. 493). By Phillip Dahlen. Includes basic diodes and transistors, FET's, integrated circuits, photo devices, varicaps, SCR and zener diodes and much more. Explains operation, circuitry and applications. 256 pages. Soft-bound.

**10 F 41706** Shpg. wt. 14 oz. Net 5.95

**GE TRANSISTOR MANUAL.** (Revised 7th Ed.).

Expanded "Reader's List" of basic reference works on transistor theory and application; new chapter explaining transistor reliability. New experimenter's chapter with 17 circuits for building; expanded hi-fi chapters; expanded radio receiver chapter; and a complete explanation on how to interpret a spec sheet. 596 pages.

**10 F 36201** Shpg. wt. 1 lb. . . . Net 2.00

**GE SCR MANUAL.** 5th Edition.

Basic theory, ratings and applications. Covers regulating circuits and controls, test circuits, light-actuated devices, trigger and turn-off circuits. New information and applications for triacs and thyristors. Illustrated. 687 pages. Soft-bound.

**10 F 36235** Wt. 1½ lbs. . . . Net 3.00

**TRANSISTOR SPECIFICATIONS MANUAL.**

6th Edition. (Sams 20974). Contains the electrical and physical parameters for virtually all of the transistors now in use. Provides physical data; identifies leads and terminals for each transistor. 160 pp.

**10 F 24660** Shpg. wt. 14 oz. Net 4.50

**RCA TRANSISTOR, THYRISTOR & DIODE MANUAL.** (SC-15).

Basic technology, operating principles, characteristics and ratings, applications and testing data for more than 770 semiconductor devices. 770 pgs.

**10 F 47042** Wt. 1¼ lbs. . . . Net 2.50

**RCA LINEAR INTEGRATED CIRCUIT FUNDAMENTALS.** (IC 42).

Covers general considerations, differential and operational amplifiers, transfer characteristics, equivalent circuit models, frequency response, phase compensation and circuit applications for communications, TV, radio, instrumentation, telemetry, data-processing and control. 416 pages.

**10 F 47075** Wt. 1¼ lbs. . . . Net 2.50

**NEW IC FET PRINCIPLES AND PROJECTS.**

By Ken Sessions and Don Tuite. Simple to sophisticated projects for the student or hobbyist. 160 pages. Over 60 illus.

**10 F 41979** Shpg. wt. 12 oz. Net 3.95

## Audio and Stereo Books

**HOW TO BUILD SPEAKER ENCLOSURES.** (No. 20520). By Badmaieff and Davis. Drawings and instructions for building various enclosures, including testing techniques. Discusses drivers, horns and cross-over networks. 144 pages.

10 F 23902 Shpg. wt. 8 oz. .Net 3.95

**HI-FI STEREO HANDBOOK.** 4th Ed. (No. 20918). Covers tape and disc systems, multiplex, speakers, enclosures. Includes latest solid-state techniques for tuner preamplifiers, amplifiers, control circuits. 400 pp.

10 F 24498 Wt. 1 1/4 lbs. .Net 5.95

**HOW TO SELECT/USE/TROUBLESHOOT CASSETTE AND CARTRIDGE TAPE RECORDERS.** (No. 5509). By Murray P. Rosenthal. Selection, use, and maintenance of cassette and cartridge tape recorders. With charts. 144 pages.

10 F 12178 Shpg. wt. 1 lb. .Net 4.55

**AUDIO SYSTEMS HANDBOOK.** (No. 494). By Norman H. Crowhurst. Covers amplifiers, equalizers, mixers, filters, distribution systems, program sources, reverberation, hi-fi home systems, public address, speaker systems, acoustics and more. 192 pages. Soft-bound.

10 F 41714 Shpg. wt. 11 oz. Net 4.95

**TAPE RECORDERS — HOW THEY WORK.** (No. 20989). By C. Westcott and R. Dubbe. Covers drive motors, volume indicators, equalization circuits, amplifiers and magnetic heads. Also response, tape overloads, and more. 240 pages.

10 F 24819 Shpg. wt. 11 oz. Net 5.50

**AUDIO CYCLOPEDIA.** 2nd Edition. (No. 20675). By Howard M. Tremaine. Includes the latest solid-state and integrated circuits. Thousands of topics in acoustics, recording and sound. Covers basic principles, components and devices, film recording, studio techniques, audio installations, measurements, etc. Over 1600 illustrations. 1760 pp.

10 F 24157 Shpg. wt. 4 lbs. Net 29.95

**99 WAYS TO IMPROVE YOUR HI-FI.** (No. 20876). By Len Buckwalter. Includes 99 helpful projects to enhance hi-fi enjoyment. Installation, FM stereo, phonos, turntables, amplifiers, tape equipment, speakers, headphones, microphones, etc. 128 pages.

10 F 24652 Shpg. wt. 12 oz. Net 3.50

**HI-FI LOUDSPEAKERS AND ENCLOSURES.** (No. 0721). 2nd Edition. By Abraham Cohen. Answers all questions about loudspeakers and enclosures; design, construction or crossover network, etc. Discusses the room as part of the acoustic circuit. 216 pages.

10 F 12582 Wt. 1 1/2 lbs. .Net 6.85

**HOW TO SERVICE TAPE RECORDERS.** (No. 4736). By C. A. Tuthill. Updated guide offers a detailed analysis of the operation of modern tape recorders and gives detailed directions for maintenance and troubleshooting. Covers both mono and stereo recorders. 165 pages.

10 F 11832 Wt. 1 1/2 lbs. .Net 4.95

## General Interest Books

**BUILDING AND INSTALLING ELECTRONIC INTRUSION ALARMS.** 1st Edition. By John E. Cunningham. Detailed explanation of how to select, construct, install and maintain electronic intrusion alarms. 136 pgs.

10 F 24751 Shpg. wt. 8 oz. .Net 4.50

**ELECTRONIC SECURITY SYSTEMS.** 1st Edition. By Leo G. Sands. Latest info on all types of electronic security systems—closed circuit TV, alarms, etc. illus. 288 pages.

10 F 24769 Wt. 1 1/2 lbs. .Net 5.95

**GUIDE TO THE NATIONAL ELECTRICAL CODE.** (No. 23193). Conforms to the 1971 National Electrical Code. Offers an interpretation and simplification of all rulings in the Code. Illustrated. 512 pages.

10 F 24355 Wt. 2 1/2 lbs. .Net 6.95

**BASIC ELECTRICITY.** (No. 0039). By Van Valkenburgh, Nooger, Neville, Inc. Famous illustrated training course used by the Navy. 624 pages.

10 F 11386 Wt. 2 lbs., 5 oz. Net 16.70

**ELECTRIC GENERATING SYSTEMS.** (No. 23179). By Loren J. Magee. Selection, installation and operation of generating systems. Includes troubleshooting techniques. 384 pages.

10 F 24314. Wt. 1 1/2 lbs. .Net 5.95

**PRACTICAL ELECTRICITY.** (No. 23160). Revised 2nd Ed. Comprehensive coverage of electric theory, circuits, house wiring, lighting, heating, intercommunication and alarm installations. 496 pages.

10 F 24561 Shpg. wt. 2 lbs. .Net 5.95

**ELECTRIC MOTORS.** (No. 23150). Covers construction, hookups, control, maintenance and troubleshooting of all types of electric motors. 432 pages.

10 F 24520 Shpg. wt. 2 lbs. .Net 5.95

**THE ELECTRONIC INVASION: A Detailed Technical Explanation of Electronic Bugging and Debugging.** (No. 0779). By Robert M. Brown. Discusses the secret techniques, devices, circuits, users and suppliers of bugs and anti-bugs. A buyer's directory and a section on eavesdropping and the law. 176 pages.

10 F 11972 Shpg. wt. 10 oz. Net 5.70

**RADIO-CONTROL HANDBOOK.** 3rd Ed. (No. 93). By H. G. McEntee. Up-to-date version of the standard in the field. New ideas for remote control of model boats, planes and cars by radio. Information on servos and actuators as well as receivers and transmitters. 320 pages.

10 F 41425 Shpg. wt. 1 lb. .Net 6.95

**HOW TO BUILD A WORKING DIGITAL COMPUTER.** (No. 0748). By Alcosser, Phillips and Wolke. Detailed techniques for building an inexpensive working computer, with all component specifications and step-by-step instructions. Theory explanations precede construction. Programming explanation and solution of actual problems. 176 pages.

10 F 11006 Shpg. wt. 11 oz. Net 5.45

**INDUSTRIAL CONTROL CIRCUITS.** (No. 0202). By Sidney Platt. Circuits governing the initiation, processing, and finishing stages of industrial electronic equipment. 200 pages.

10 F 10602 Shpg. wt. 12 oz. Net 5.45

**REFERENCE DATA FOR RADIO ENGINEERS.** 5th Ed. (No. 20678). Prepared under the direction of the ITT staff. 50 percent of the text is new material not covered in previous editions. Over 1100 pages.

10 F 23928 Shpg. wt. 4 lbs. Net 20.00

## Home and Auto Service Guides

**DO-IT-YOURSELF ENCYCLOPEDIA.** (23207). Prepared and edited by How-To Associates. Thousands of photos and guides to hundreds of home improvements and maintenance projects. 1024 pages.

10 F 24777 Shpg. wt. 4 lbs. Net 10.50

**HOME APPLIANCE SERVICING.** (No. 23214). How to make repairs of vacuums, washing machines, dryers, irons, toasters, blenders, refrigerators, ranges, much more. Fully illus. 608 pages.

10 F 24785 Wt. 2 1/4 lbs. .Net 6.95

**HOUSE WIRING.** 2nd Ed. (No. 23210). Simple explanations, over 100 illustrations and concise analysis of many rulings contained in the National Electrical Code. 192 pages.

10 F 24363 Wt. 1 1/2 lbs. .Net 5.95

**HOME REFRIGERATION AND AIR CONDITIONING.** (No. 23133). All the necessary data on modern units, systems, machines and refrigerants. Covers principles, operation and servicing procedures. 576 pages.

10 F 24512 Wt. 2 1/4 lbs. .Net 6.95

**AUTOMOBILE GUIDE.** 3rd Edition. (No. 23192). By Frederick E. Bricker. Theory and operation of each automotive part in easy-to-understand terms. Numerous illustrations show internal views of working parts. Includes instructions for servicing. 800 pages.

10 F 24348 Wt. 2 1/2 lbs. .Net 8.95

**AUTO ENGINE TUNE-UP.** (No. 23181). By Richard S. Roeing. Complete tune-up procedures for all types of auto engines. Includes full adjustment data for carburetors, ignition, valves, etc. Includes transistorized ignitions. 376 pages.

10 F 24330 Shpg. wt. 2 lbs. .Net 5.95

**OIL BURNERS.** (No. 23151). Revised 2nd Ed. Fully covers the theory of construction, installation, operation, testing, servicing and repair of all oil burner equipment. Includes combustion, ignition systems, electrical wiring and control diagrams. 304 pp.

10 F 24553 Wt. 1 1/2 lbs. .Net 5.50

## Easy "TEACH-YOURSELF" Books

**TEACH YOURSELF GEOMETRY.** By P. Abbott. Geometrical truths, formal proofs of the geometrical propositions. Other areas treated are: parallel straight lines, theorem of Pythagoras, solid geometry, prisms, and much more. 334 pages.

10 F 31129 Shpg. wt. 12 oz. Net 2.50

**TEACH YOURSELF TRIGONOMETRY.** By P. Abbott. Requiring only a knowledge of high school algebra, this course provides the essentials of trig as applied to physics, navigation, surveying and engineering. Over 465 problems with answers to aid the student's progress. 204 pages.

10 F 31087 Shpg. wt. 9 oz. Net 2.50

**TEACH YOURSELF THE SLIDE RULE.** By Burns Snodgrass. A comprehensive course book enabling you to perform fast and accurate calculations with the slide rule. Full instruction covering A, B, C, D, LL, L, S, T and other special purpose scales. 20 illustrations. 80 problems. 207 pages.

10 F 31137 Shpg. wt. 10 oz. Net 2.50

**TEACH YOURSELF CALCULUS.** By P. Abbott. Puts calculus within the reach of anyone with an elemen-

tary knowledge of algebra and geometry.

10 F 31095 Shpg. wt. 12 oz. Net 2.50

**TEACH YOURSELF ELECTRONICS.** By W. P. Jolly. For the student and layman. Basic electronics devices and circuits, and their application. Illustrated with line drawings and diagrams. Also covers lasers, traveling wave tubes, cryoelectronics and thyristors. 220 pages.

10 F 31277 Shpg. wt. 8 oz. .Net 2.50

**TEACH YOURSELF ELECTRICITY.** By C. W. Wilman. Current, resistance, voltage, Ohm's law, chemical effects of current, circuits, motors, inductance, capacitance, transformers, converters, measuring instruments, etc. Over 250 problems. Illustrated. 184 pages.

10 F 31103 Shpg. wt. 12 oz. Net 2.50

**TEACH YOURSELF ELECTRONIC COMPUTERS.** By F. L. Westwater. Explains how a digital computer works and what it can do. Prepared specifically for laymen and beginning science and engineering students. Illustrated. 151 pages.

10 F 31327 Shpg. wt. 9 oz. Net 1.50

**SIMPLIFIED RADIOTELEPHONE LICENSE COURSE.** Current. Vol. 1: 3rd Class License with Endorsement. Vols. 1 & 2: 2nd Class License. Vols. 1, 2 & 3: 1st Class License.

Vol. 1. 136 pages.

10 F 12236 Shpg. wt. 10 oz. Net 4.90

Vol. 2. 308 pages.

10 F 12244 Wt., 1 1/2 lbs. .Net 5.70

Vol. 3. 136 pages.

10 F 12251 Shpg. wt. 10 oz. Net 4.90

**BASIC AIR CONDITIONING.** (2 Volumes). (No. 0793). By Gerald Schweitzer. Explains operating principles, installation, and servicing of both self-contained room-type units and central systems. Covers all major components in detail. Troubleshooting charts and procedures, complete glossary. 280 pages.

10 F 12269 Wt. 1 1/2 lbs. .Net 11.20

**BASIC ELECTRONICS—EXPANDED COURSE.** By Van Valkenburgh, Nooger & Neville, Inc. (No. 0049). Covers vacuum tube diodes, power supplies, oscillators, amplifiers, detectors, receivers and transmitters plus semiconductors, transistors and FM. Used by the Navy to train technicians. 666 pages. Cloth-bound.

10 F 10669 Wt. 2 lbs., 9 oz. Net 19.50

**QUESTIONS AND ANSWERS FOR ELECTRICIANS EXAMINATIONS.** 4th Ed. (No. 23200). A comprehensive guide to preparing for the various electrician's license examinations. Contains theoretical information, definitions, specifications and regulations of the National Electrical Code. 288 pages.

10 F 24371 Wt. 1 1/2 lbs. .Net 4.50



# Over 100 Convenient Lafayette Company-Owned Stores Coast-To-Coast Offering The Finest In Personal and Catalog Shopping

## Friendly Sales People

Friendly service is what Lafayette is all about. Qualified, experienced sales people give smart buyers money-saving tips. We believe every customer should get the best. We offer the best in Electronics.

## Expert Technical Help

A staff of Audio and Electronics experts work with the largest selection of audio and electronics products in the world. **THEY HAVE TO KNOW MORE!** Personalized service is another one of Lafayette's specialties.

## World's Biggest Selection

Choose from a variety of over 18,000 quality electronic products. Anything in 4-channel, stereo, cameras, test equipment, radios. Your "Energy-Saving" Single-Trip Store for Everything in Electronics.

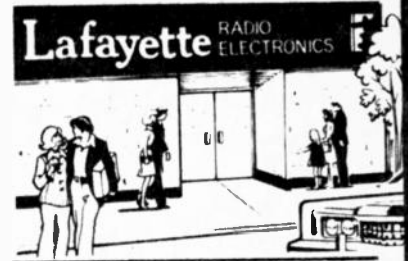

## CALIFORNIA

**CANOGA PARK**  
21725 Vanowen Street  
(213) 883-4445  
**CARSON**  
717 E. Artesia Blvd.  
(213) 532-5740  
**COSTA MESA**  
2300 Harbor Blvd.  
(714) 646-7791  
**HUNTINGTON BEACH**  
Opening Fall '74  
**NORTHRIDGE (Granada Hills)**  
17023 Devonshire Street  
(213) 368-3757  
**ORANGE**  
1988 N. Tustin Avenue  
**PANDRAMA CITY**  
8413 Van Nuys Blvd.  
(213) 894-8187  
**WEST COVINA**  
Opening Fall '74  
**SANTA MONICA**  
3223 Wilshire Blvd.

## CONNECTICUT

**BRIDGEPORT**  
Lafayette Plaza  
303 State Street  
(203) 384-9337  
**ENFIELD**  
State Line Plaza  
136 Elm Street  
**HAMDEN**  
2100 Dixwell Avenue  
(203) 248-2182  
**WEST HARTFORD**  
357 North Main Street  
(203) 236-0693  
**MANCHESTER**  
391 Broad Street  
(203) 646-2711  
**MILFORD**  
Connecticut Post Shopping Center  
(203) 874-6726  
**STAMFORD**  
2311 Summer Street  
(203) 327-9168

## GEORGIA

**ATLANTA**  
47 West Paces Ferry Road, N.W.  
(404) 237-8206  
**DECATUR**  
4610 Memorial Drive  
(404) 292-4311  
**DUNWOODY**  
44 Ashford-Dunwoody Road  
(404) 394-4806  
**FOREST PARK**  
4051 Jonesboro Road  
(404) 361-6866

## ILLINOIS

**ARLINGTON HEIGHTS**  
450 E. Rand Road  
(312) 398-1720  
**CHICAGO**  
228 S. Wabash Avenue  
(312) 922-6355  
**CHICAGO**  
7601 S. Cicero Avenue  
(312) 767-5400  
**CHICAGO/NEW TOWN**  
3124 N. Broadway  
(312) 935-4720  
**MORTON GROVE**  
7032 Golf Road  
(312) 966-4034  
**NORRIDGE**  
4159 Harlem Avenue  
(312) 457-0468  
**SCHAUMBURG**  
1255 E. Golf Road  
(312) 882-5267  
**VILLA PARK**  
133 W. Roosevelt Road  
(312) 495-0750

## INDIANA

**INDIANAPOLIS**  
6242 E. 82nd Street  
(317) 849-5493  
**INDIANAPOLIS**  
4000 Georgetown Road  
(317) 293-7443  
**INDIANAPOLIS (Greenwood)**  
870 N. U.S. Route 31S  
(317) 888-4479  
**INDIANAPOLIS**  
E. Washington St.

## MARYLAND

**BALTIMORE/CATONSVILLE**  
1122 N. Rolling Road  
(301) 747-9400  
**GLEN BURNIE**  
316 S. Ritchie Hwy.  
(301) 760-5700  
**MARLOW HEIGHTS**  
4620 St. Barnabas  
(301) 899-6966  
**MT. RAINIER/HYATTSVILLE**  
3191 Queens Chapel Road  
(301) 779-7020  
**ROCKVILLE**  
824 Rockville Pike  
(301) 762-8847  
**TOWSON**  
815 Taylor Avenue  
(301) 825-7750  
**DUNOALK**  
Danville Square

## MASSACHUSETTS

**BOSTON**  
899 Boylston Street  
(617) 536-1995  
**BROOKLINE**  
1048 Commonwealth Avenue  
(617) 267-8900  
**BURLINGTON**  
One Great Meadow Road  
(617) 273-1785  
**DANVERS**  
Endicott Plaza  
(Rt. 128 & Endicott St.)  
(617) 233-6710  
**NATICK**  
1400 Worcester Street  
(617) 875-6146  
**WEST ROXBURY**  
1530 V.F.W. Parkway  
(617) 327-0300

## MINNESOTA

**BROOKDALE CENTER**  
5515 Xerxes Avenue N.  
(612) 566-6910  
**EDINA**  
3240 Southdale Circle at York Ave.  
(612) 920-9100  
**ROSEVILLE**  
2383 N. Fairview Avenue  
(612) 633-8753

## MISSOURI

**ST. LOUIS/JENNINGS**  
8976 Jennings Station Road  
(314) 868-3055  
**ST. LOUIS/BRIDGETON (St. Ann)**  
10939 St. Charles Rock Road  
(314) 291-1160  
**ST. LOUIS/CRESTWOOD**  
9222 Watson Road  
(314) 842-1414

## NEW JERSEY

**EAST BRUNSWICK**  
595 Route 18  
(201) 257-9505  
**NEWARK**  
24 Central Avenue  
(201) 622-1660

## NEW JERSEY—cont.

**PARAMUS**  
182 Route 17  
(201) 261-8800  
**WATCHUNG (Plainfield)**  
Route 22 West  
(201) 756-5100  
**TOTOWA**  
410 Route 46  
(201) 785-1763

## NEW YORK

**BROOKLYN**  
2265 Bedford Avenue  
(212) 469-8900  
**BUFFALO (Amherst)**  
3600 Sheridan Drive  
(716) 833-2826  
**BUFFALO (West Seneca)**  
3001 Ridge Road  
(716) 675-7887  
**COMMACK**  
6173 Jericho Turnpike  
**FARMINGDALE**  
1650 Broadhollow Road  
(516) 420-1830  
**FLUSHING**  
137-10 Northern Blvd.  
(212) 539-8706  
**HEMPSTEAD**  
120 N. Franklin Street  
(516) 538-6464  
**JAMAICA**  
92-35 Merrick Blvd.  
(212) 291-7000  
**LAKE GROVE**  
2848 Middle Country Road  
(516) 585-3600  
**LAWRENCE**  
307 Rockaway Turnpike  
(516) 239-1616  
**LYNBROOK**  
381 Sunrise Hwy.  
(516) 887-9800  
**MANHASSET**  
1480 Northern Blvd.  
(516) 627-5303  
**MASSAPEQUA PARK**  
5288 Sunrise Hwy.  
(516) 799-1454  
**NEW ROCHELLE**  
218 North Avenue  
(914) 235-5101  
**N.Y.C.—45th Street**  
49 West 45th Street  
(212) 757-3121  
**Lexington Avenue**  
1294 Lexington Avenue  
(212) 876-8350  
**17 Union Square West**  
(212) 924-4433  
**Warren Street**  
45 Warren Street  
(212) 964-0334  
**REGO PARK**  
95-20 Queens Blvd.  
(212) 897-1000  
**ROCHESTER/IRONDEQUIT**  
999 Ridge Road East  
(716) 467-1310  
**ROCHESTER/PITTSFORD**  
3330 Monroe Avenue  
(716) 586-6331  
**ROCHESTER/GREECE**  
3200 W. Ridge Road  
(716) 227-3550  
**SAVILLE**  
Sunrise Hwy. & Taft Avenue  
Opening Fall '74  
**SCARSDALE**  
691 Central Avenue  
(914) 472-2700  
**STATEN ISLAND**  
2409 Richmond Avenue  
(212) 761-8300  
**SYDDET**  
111 Jericho Turnpike  
(516) 921-7700  
**SYRACUSE (East)**  
2544 Erie Blvd. East  
(315) 446-3800

## NEW YORK—cont.

**SYRACUSE (West)**  
3548 W. Genesee Street  
(315) 488-4921  
**WESTBURY**  
541 Old Country Road  
(516) 333-8360

## OHIO

**COLUMBUS**  
856 Hamilton Road  
(614) 861-8660  
**COLUMBUS**  
3395 Cleveland Avenue  
(614) 267-3106  
**COLUMBUS**  
4676 West Broad Street  
(614) 878-6462  
**CINCINNATI/SPRINGDALE**  
11711 Princeton Pike  
(513) 671-6500  
**MENTOR**  
7531 Mentor Avenue  
(216) 951-4038  
**NORTH OLMSTED**  
Great Northern Blvd.  
(216) 734-5900  
**PARMA HEIGHTS**  
6425 Pearl Road  
(216) 884-2393  
**WARRENSVILLE HEIGHTS**  
21907 Emery Road  
(216) 662-8448  
**TOLEDO**  
Miracle Mile Shopping Center  
(419) 479-9167  
**TOLEDO (Woodville)**  
4619 Woodville Road  
(419) 691-3525

## PENNSYLVANIA

**BRIDGEVILLE (Collier)**  
Washington Pike  
(412) 221-7888  
**KING OF PRUSSIA**  
Routes 202 & 23  
(215) 265-3300  
**LANCASTER**  
2153 Lincoln Plaza  
(717) 397-3681  
**MONROEVILLE**  
4045 William Penn Hwy.  
(412) 373-0060  
**OXFORD VALLEY**  
Oxford Valley Mall  
(215) 752-0267  
**PLEASANT HILLS**  
525 Clairton Blvd.  
(412) 653-5543  
**PHILADELPHIA**  
8156 Ogontz Avenue  
(215) 885-2140  
**PITTSBURGH**  
4801 McKnight Road  
(412) 366-0810

## RHODE ISLAND

**PROVIDENCE**  
1224 N. Main Street  
(401) 521-4444  
**WARWICK**  
Bald Hill Road

## VIRGINIA

**FALLS CHURCH**  
Plaza 7 Shopping Center  
(703) 534-5772

## WISCONSIN

**MILWAUKEE/GREENFIELD**  
4830 S. 76th Street  
(414) 282-3280  
**WAUWATOSA**  
10515 W. North Avenue  
Opening Fall '74

Interested in Having Your Own Lafayette Store? See insert next to page 66.

# Lafayette Your One Dependable Source For Everything in Electronics



## Commercial Sales Department

The Commercial Sales Department services state, county, and city Purchasing Departments; educational and medical facilities, police, fire, and civil defense departments; churches, civic and social organizations; as well as commercial and manufacturing organizations. A special staff is prepared to give advice, quotations and prompt service.

Original Electronic equipment manufacturers consult our Industrial Electronics Division.

For Personalized Service, Phone or Write:

Lafayette Commercial Sales Department  
P.O. Box 260, Syosset, L.I., N.Y. 11791  
Phone (516) 921-7700

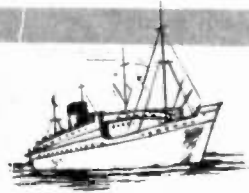

## International Sales Division

Specializes in export shipment for quantity industrial and dealer orders as well as single item purchases throughout the world. An expert knowledge of shipping and routing gives you the fastest and most dependable service.

**WRITE TO:** Lafayette Radio Electronics Corporation  
International Sales Division P.O. Box P  
Syosset, L.I., N.Y. 11791, U.S.A.

### Export Terms:

Full payment must accompany your order. Enclose check or draft; or remit international Postal Money Order or confirmed, irrevocable Letter of Credit. All payments should be in U.S. Dollars payable at U.S. Bank. Include 20% above merchandise value to cover international postage, insurance, consular fees and other export shipping and handling costs. Slightly more should be allowed for heavy items and ocean or air freight shipments. These charges cannot be accurately predetermined —overpayments are promptly refunded.

We reserve the right to route order by the best method when order does not indicate routing or when method suggested is impractical or not possible. All prices F.O.B. our warehouses and subject to change without notice. Enclose Import License and/or Consular Declaration where so required.

## Industrial Electronics Divisions

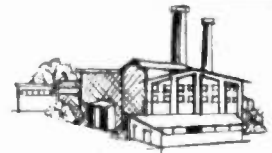

Lafayette's Industrial Electronics Divisions SPECIALIZE IN SEMI-CONDUCTORS and TANTALUM CAPACITORS. Overnight delivery can be made to all parts of U.S.A. via AIR CARRIERS. Large OEM quantity prices and availability from Lafayette's vast inventories can fill your production needs immediately. In addition to the material in this catalog, the following are some of the leading lines of semi-conductors supplied by Lafayette:

### IC's and SEMI-CONDUCTORS

- Dickson • General Instruments
- General Semiconductors
- Microsemiconductors
- N.A.E. • Raytheon • Sensitron
- Teledyne • Transitron
- Silicon Transistor\* • Solid Power

\*Natick, Mass. only.

### VOLTAGE REGULATORS\*

- General Radio Variacs®

### TANTALUM CAPACITORS (CSR Types)

- Dickson

Lafayette supplies from stock the above brands and others:

JAN, JAN-TX, JAN-TXV, S1N type transistors and diodes.

### Cut costs of

IMMEDIATE SHIPMENTS ..... production delays!  
OEM PRICES (always competitive) ..... purchases!  
DEEP INVENTORIES (single shipments) ..... receiving!  
QUALITY PRODUCTS (leading mfrs.) ..... production failures!  
PROMISES KEPT ..... expediting!

For production quantity OEM needs or for R&D requirements, write or phone for complete, expert personalized service.

### NEW YORK AREA

1327 Second Avenue  
New Hyde Park, L.I., N.Y. 11040  
Phone: (516) 488-6600

### NEW ENGLAND AND CANADA

1400 Worcester Street  
Natick, Mass. 01760  
Phone: (617) 875-6146 (Natick)  
(617) 969-6100 (Boston)

### Enterprise Number in Major Cities

TELEX, N.H.P., N.Y. TLX 96-0255 LAFIND EL

## HOW TO RETURN MERCHANDISE

(Merchandise Returned Must Be in New Condition)

We want you to be completely satisfied with every item you purchase from us. If there is an irregularity in your shipment and you find it necessary to return an item to us, follow these instructions:

### PARCEL POST SHIPMENTS

- 1) Place all order papers, invoices, correspondence and your instructions in an envelope inside your package.
- 2) On the outside of your package, mark "First Class Mail Enclosed" (directly below the postage) and add an additional 10¢ postage. Do not send the letter separately; it will delay our speedy adjustment handling.
- 3) Pack the merchandise securely and send to:

Customer's Service Dept.  
LAFAYETTE RADIO ELECTRONICS  
111 Jericho Turnpike  
Syosset, L.I., N.Y. 11791

- 4) For your protection, report damaged receipts to your postman and enclose his report with your papers.

### BY EXPRESS OR TRUCK

If your shipment is received damaged, obtain a report from your express agent or trucker, and mail to us. Wait until you receive our instructions on how to return.

(Note: Merchandise not regularly stocked that has been ordered for you is NOT returnable for refund or exchange.)

### WEST COAST SHIPMENTS

No more than 4-day, door-to-door delivery via United Parcel Service to California, Washington and Oregon.

Parcels utilizing this rapid service must weigh no more than 50 pounds and measure up to 108 inches in combined length and girth. When ordering, add 30¢ per lb. plus the UPS Zone 4 charges.

### IF IT IS NECESSARY TO WRITE US

Before writing, please compare papers or invoices with merchandise received. You will find explanations on your order papers about how your order has been handled. Sometimes merchandise arrives before or after order papers. Please wait until you have both before writing. If you write, be sure to include all papers concerning the order. Please give names of

items, catalog numbers, quantity, color, price, and any special information you think necessary. The more details you give us, the more quickly your adjustment will be made. On Easy Payment orders, be sure to include your EP account number on package and correspondence.

Prices and Specifications are Subject to Change Without Notice.

# General Catalog Index

- A**
    - Adapters, Audio .....84
    - 85, 147, 150
    - Adhesives .....173
    - Adult Games .....178
    - Air Brush Kit .....186
    - Air Hammer .....180
    - AMATEUR EQUIPMENT**
      - 232-236
      - Ammeter .....227, 231
      - AMPLIFIERS**
        - Antenna .....97, 163
        - 166, 167
        - Audio .....130, 131
        - Hi-Fi .....18, 20-22,
        - 25-27, 31
      - Linear .....233
      - Musical Instrument .....114, 115
      - Public Address .....86-
      - 88, 115
    - ANTENNA EQUIPMENT**
      - Amateur .....171, 236
      - Amplifiers .....97, 163
      - Connectors .....171,
      - 194, 236
      - Couplers .....166,
      - 167, 169, 240
      - Installation Equip. ....170, 171, 243
      - Leads, FM .....70, 165
      - Lightning Arrestors .....172, 243
      - Marine .....236
      - Masts & Towers .....171, 194
      - Matchers .....169, 235,
      - 240
      - Mounts .....170, 171,
      - 194, 239, 243, 244
      - Outlets .....171
      - Rotators .....161, 168,
      - 236, 243
      - Splitters .....167, 169
      - Twin Lead .....159, 165
      - Wire & Cable .....151, 249
      - 168, 169, 171, 253
    - ANTENNAS**
      - Amateur/SWL .....236
      - Auto .....162, 194
      - Citizens Band .....242,
      - 244, 246, 252, 253
      - FM .....164
      - Marine .....162
      - Monitor .....239
      - Transistor .....244, 253
      - Trucker .....245, 252
      - TV .....160-165, 173
      - Audio Cables .....84
      - Auto Generators .....29
      - AUTO EQUIPMENT & ACCESSORIES**
        - 70,
        - 91, 96, 97, 186-
        - 190, 192-195, 197
        - Auto Analyzers .....188,
        - 189, 230
        - Kit .....230
        - Auto Radios .....96, 97
        - Auto Speakers .....Gate B,
        - 66, 68, 71, 196
        - Auto Tape Access. ....67,
        - 70
      - Auto Tape Players .....Gates A&B, 66-69, 259
    - B**
      - Baffles, Speaker .....90,
      - 196
      - Barlow Lens .....218
      - Barrier Strips .....150
      - BATTERIES** .....132, 133
      - Battery Supplies .....Chargers, Eliminators .....133, 194, 195, 226,
      - 234, 257
      - Chargers, Auto .....194,
      - 243
      - Holders .....132
      - Testers .....133, 230
      - Bench .....187
      - Binding Posts .....150
    - ADC** .....77, 78
    - Akal .....64, 65
    - Akre-Mits .....187
    - Alico .....138
    - Alliance .....161, 186
    - Altec-Lansing .....117
    - Ameco .....235
    - AMF/Paragon .....201
    - Amperite .....138
    - Ampex .....74
    - Amphenel .....147
    - Amprobe .....227
    - Antenna Specialists .....97, 239, 244
    - APF .....Gate A
    - Argonne .....148
    - Argus .....215, 218
    - Arrow Mart .....148
    - ASCOM .....240
    - Atlas Sound .....89, 115,
    - 117
    - Audio Technica .....94
    - Audiovox .....98
    - Avanti .....244
    - B&K .....223-227
    - B&W/Waters .....235
    - Badger .....186
    - Beia .....217
    - Bauer .....215
    - Belden .....158
    - Beraz .....484
    - B-I-C .....2, 20
    - Black & Decker .....175,
    - 178, 179, 180
    - Blender-Tongue .....164,
    - 166, 169, 169
    - Bogen .....88, 91, 120
    - Bowmar .....212
  - Brother** .....213
  - BSR** .....Gate A, 30, 51
  - Burgess .....132, 197, 177
  - Buss .....155
  - Buss .....177
  - Cardinal .....138
  - Caslo .....211, 212
  - Centralab .....152
  - Channeleok .....189
  - Chemtronics .....137
  - Commaster .....211
  - Commodore .....203
  - Cordmatic .....156
  - Cornell-Dubilier .....152,
  - 153, 168, 236, 243
  - Cervus .....211
  - Craig .....Gate B, 57,
  - 64, 67
  - Cushcraft .....236, 239,
  - 244
  - Cutter Hammer .....148
  - Datak .....153
  - Dejux .....217
  - Delta .....191, 189
  - Dow Key .....138
  - Drafttite .....214
  - Drake, R. L. ....234,
  - 235, 240
  - Dramel .....177
  - Dual .....54
  - Dwyer .....202
  - Dymo .....181
  - Dynacne .....31, 41
  - Eagle .....220
  - Eico .....112, 130, 198,
  - 226, 228-230, 235
- Binoculars** .....218
- Black Lights** .....112, 128,
- 219
- Books** .....135, 204-206
- Bulbs** .....139
- Bull Horn** .....91
- BURGLAR ALARMS** .....131,
- 197-200
- C**
  - CABINETS**
    - Hardware & Utility .....157, 187
    - Hi-Fi .....27, 47
    - Speakers .....47
  - CABLE**
    - Assemblies .....84, 85,
    - 239, 241
    - Connectors .....84, 147,
    - 239, 241
    - Cables, Audio .....84
    - CALCULATORS** .....Gates
    - A&B, 211-213
    - Calibration Tape .....60
    - CAMERAS** .....90, 215-217
    - Candle Maker Kit .....128
    - Capacitors .....152, 153
    - Tester .....226, 230
    - Cartridge .....63, 64, 66,
    - 68, 69, 259
    - Recorders .....62-64
    - Cartridges, Phono .....77,
    - 78, 80, 81
    - Calibration Standard .....Gate B
    - Four-Channel .....78
    - Cartridges, Tape .....Blank .....75, 76
    - Pre-Recorded .....73
    - Cassette Decks .....59-61
    - Players .....Gate B, 66,
    - 67, 259
    - Recorders .....56-58, 61
    - Cassettes, Tape .....75, 76,
    - 260
    - Charge Plans .....260
    - Chassis Boxes .....157
    - Chemicals .....136, 173
    - Circuit Breakers .....155
    - Circuit Tester .....228
    - CITIZENS BAND (CB) EQUIPMENT** .....89, 235,
    - 240, 241, 245-258
    - Antennas .....242-244,
    - 246, 252, 253
    - SWR Meter .....235
    - Testers .....235
    - Two-Way Radios .....248-251, 254, 255
    - Walkie-Talkies .....245-247
    - Cleaners, Chemical .....181
    - Clips .....146
    - Clock-Radios .....102, 103
    - Clocks .....190, 201, 203
    - Closed-Circuit TV .....90
    - Coaxial Cable .....158, 169,
    - 243
    - Code Equip. ....131, 234,
    - 235
    - Coils & Forms .....137
    - Color Bar Generators .....225, 226, 229
    - Color Organs .....112, 130
    - Commercial Sales .....208
    - Compacts, Stereo .....34
    - Compass .....190
    - CONNECTORS**
      - Antenna .....171, 194,
      - 236
      - Audio .....84, 150, 251
      - Cable .....84, 147, 154
      - 173, 241
      - Coaxial .....147, 236
      - Converters, FM .....97
      - Power .....96, 145, 193,
      - 195, 240
      - UHF .....154
      - Cords, Appliance .....158
      - Counter .....138
      - CRT Tester/Rejuvenator .....228
    - D**
      - Decade Boxes .....230
      - Defogger .....190
      - Demagnetizers, Tape .....72-74
      - Demodulator .....6, 8, 18
      - Desk .....214
      - Dials & Access. ....137,
      - 148
      - Dial Cord .....136
      - Dimmers, Light .....156
      - Diodes .....135
      - Dolby Unit .....60
      - Drafting Sets .....214
      - Drills & Access. ....179,
      - 181
      - Dwell Tach .....188, 189
    - E**
      - Easy Pay .....4
      - Echo Chamber .....113
      - Electroplating .....193
      - Educational Kits .....124,
      - 125
      - Electric Eye Equip. ....156
      - 189
      - Engine Analyzer .....156
      - 230
      - Engravers .....177
      - Equalizer .....30, 91, 115
      - Erasers, Tape .....74
      - Experimenters Kits .....124-126, 135
      - Exposure Meter .....215
      - Extension Cords .....49,
      - 123, 156
    - F**
      - Faders .....85
      - Fiber Optics .....128
      - Field Strength Meters .....235
      - Film .....217
      - Filters .....153, 169, 240
      - Fire Alarms .....198
      - Flashcubes .....217
      - Flashlights .....157
      - FM-AM RADIOS**
        - RECEIVERS, TUNERS: See Item Wanted.
        - Four Switch .....74, 114,
        - 116, 148
      - FOUR-CHANNEL HI-FI**
        - 5-9, 18, 24, 25, 28, 29,
        - 32, 49, 50, 63, 65, 78
      - Frequency Standard .....235
      - Fuses & Holders .....155
    - G**
      - Garage Door Opener .....191
      - Generator .....187
      - Grip Dip Meter .....235
      - Grille Cloth .....47
      - Grinders .....179
      - Guarantees .....3
      - Guitars .....110, 111
    - H**
      - Ham Equip: See Amateur Equip.
      - Handy Index .....3
      - Hardware .....173
      - HEADPHONES**
        - Adapter .....49
        - Amplified .....115
        - Communications .....221, 235
        - Four Channel .....49, 50
        - Remote Control .....49
        - Stereo Hi-Fi .....48-
        - 50, 58
    - I**
      - IC's .....135, 136
      - Ignition Systems .....191
      - Insulators .....146
      - INTERCOMS & ACCESS.**
        - 118-120, 158
      - Inverters .....194, 195,
      - 226, 240
    - J**
      - Jacks, Phone & Phono .....70, 123, 150, 151
    - K**
      - Keys, Code .....234
      - Kits, Builders .....31, 45,
      - 112, 124, 125, 127, 129-
      - 131, 136, 191, 196, 224,
      - 226, 228-230, 235
      - Knobs .....137, 172
    - L**
      - Labelmakers & Tapes .....181
      - Lamps .....139, 157, 192,
      - 193, 217, 220
      - Lamp Bulbs .....216
      - Lenses .....136
      - Lettering Kit .....153
      - Light Detector .....130
      - Light Dimmers .....156
      - Lights, Musical .....112
      - Line Cords .....156, 171
    - M**
      - MARINE RADIOS** .....108,
      - 253
      - Masts, Antenna .....171,
      - 194
      - Megaphones .....91
      - Metal Locators .....130
      - Meters .....30, 215, 231,
      - 235, 240
      - Metronome .....117
      - MICROPHONES** .....56,
      - 58-60, 62, 65, 86-88,
      - 92-94, 115, 130, 241,
      - 249, 251, 255
      - Stands .....115, 241
      - Microscope and Access. ....219
      - Mixers, Audio .....91, 92
      - Monitors & Access. ....237-239
      - Motors & Fans .....82,
      - 137, 153, 183
      - Motor Speed Control .....180, 183
      - Multi-Meters .....222,
      - 223, 230
      - Musical Instruments .....110, 111, 130
      - Speakers & Access. ....93, 116, 117
    - N**
      - Needles, Phono .....79
      - Noise Suppressors .....194, 240,
      - 182
      - Nutdrivers .....182
    - O**
      - Organs, Chord .....111
      - Oscilloscopes .....225, 229
    - Outlets, AC** .....154, 156
    - Outlets, Phone** .....123
    - P**
      - Pads, T&L .....85, 154
      - Panet Meters .....231
      - Parts Cabinets .....187
      - Perf Boards .....136
      - Pencil Sharpener .....214
      - Phaser .....113
      - Phonograph .....34
      - Photoelectric Equip. ....156, 200
      - Photo Developing .....215
      - Pianner .....180
      - Pilot Lights .....139, 241
      - PLUGS**
        - Phone & Phono .....84,
        - 150, 151
        - Telephone .....123
        - TV and FM .....171
        - Power Booster .....67, 194
        - Power Supplies .....70, 131, 226, 227,
        - 232, 248, 250, 253,
        - 255-257
        - Power Tools .....177-181
        - Preamplifiers .....27, 31,
        - 82, 91, 115, 131,
        - 239, 240
        - Printed Circuit Components .....136
        - Probes .....225, 227-230
        - PUBLIC ADDRESS EQUIP.**
          - 86-90, 92-94,
          - 115, 131, 158
        - Pumps .....186
      - Q**
        - Quadrasonic Equip: See 4-Channel Hi-Fi
        - R**
          - Radar Detector .....192
          - RADIOS**
            - Auto .....96, 97
            - Cassette Recorder .....58
            - Clock .....102, 103
            - Headphone .....104
            - Kit .....130
            - Multi-Band .....107-109
            - Novelty .....99, 104, 105
            - Portable .....104-106
            - Table .....100, 101
            - Weather .....100, 103,
            - 104, 107
          - RECEIVERS**
            - Aircraft .....130
            - Amateur .....232, 234
            - Four-Channel .....6, 8,
            - 24, 28, 29
            - Scanners .....237, 238
            - Stereo .....10, 12, 14,
            - 16, 26, 27, 29, 30
            - TV & FM .....101
            - Record Care Aids .....82, 83
            - Records Changers & Supplies .....Gate B, 2, 32,
            - 50-54, 83
            - Record Demodulators (4-Ch.) .....6, 8, 18
            - Recording Tape .....74,
            - 76, 229, 260
            - Rectifiers .....145, 173
            - Reel-to-Reel Tape Decks & Recorders .....65
            - Relays .....138, 153
            - Resistors .....143, 172, 235
            - Reverb Systems .....113,
            - 116
            - RF Generator .....225,
            - 229, 235
            - Rheostats .....113
            - Rhythmer .....154
            - Rotators, Antenna .....161, 168, 236, 243
          - S**
            - Sanders .....179, 180
            - Saws & Access. ....178,
            - 180
            - Securedriver .....182
            - SECURITY EQUIP.** .....156,
            - 197-200
            - Semiconductors .....135
            - Sequencer .....112
            - Shipping Info .....210
            - Signal Generators .....82,
            - 92, 225, 227, 230
            - Signal Tracers .....227-230
            - Slide-Rules .....214
            - Siren .....130, 131, 199
            - Smoke Detector .....198
            - Socket .....147
            - Socket Wrenches .....182,
            - 185
            - Solar Cell .....137, 153
            - Soldering Irons & Supplies .....174-176
            - SPEAKERS**
              - Amateur .....232
              - Auto .....Gate B, 66, 68,
              - 71, 196
              - Controls .....85, 196
              - Crossover .....45
              - Drivers .....89
              - Enclosures .....47, 90
              - Extension .....45, 90
              - Grilles, Auto .....70,
              - 196
              - Hi-Fi .....42-46, 89
              - Insulation .....47
              - Kits .....45
              - Midrange .....42, 44
              - Outdoor .....44, 89
              - Protector .....82
              - Public Address .....89,
              - 90, 115
              - Replacement .....43, 42,
              - 43, 196
              - Switches .....70, 85, 196
              - Tweeters .....42-44
              - Wire .....84, 159
              - Woofers .....42, 43
            - SPEAKER SYSTEMS**
              - Hi-Fi .....24, 37-41,
              - 44-46, 89
              - P.A. ....89, 90
              - Sprayer .....186
              - Stereo Gun .....181
              - STEREO EQUIPMENT:** See Item Wanted and Hi-Fi Systems.
              - Storage Units .....73, 187
              - Store Addresses .....207
              - Strobe Flash .....215
              - Strobe Lights .....112, 130
              - Styl, Phono .....78-81
              - Substitution Boxes .....226, 230
              - Sugar Refractometer .....219
              - Sweep Generators .....229
              - Switches .....70, 74, 85,
              - 114, 115, 130, 148,
              - 149, 154, 156, 199,
              - 200, 235, 235
            - T**
              - Tachometers .....188-190
              - TAPE**
                - Calibration .....60
                - Labeling .....181
                - Recording .....74, 75,
                - 260
                - Splicing .....72, 76
                - Tape Decks .....59-65
                - Four-Channel .....65
                - Tape Players .....Auto .....Gate B, 66-69,
                - 259
                - Home .....62, 63
                - TAPE RECORDERS** .....56,
                - 58, 61-65
                - Tape Recording Accessories .....72-76
                - Telephones & Access. ....Gate B, 74, 120-123
                - Telephone Amplifier .....122
              - Sams Publications** .....204-208
              - Sanya .....36, 55, 58, 67,
              - 98, 99, 108, 259
              - Schauer .....195
              - Scotch .....78
              - Miller, J. W. ....117
              - Sencore .....223, 224, 226
              - Senheiser .....80
              - ServiceMaster .....142
              - Servitor .....227
              - Shakespeare .....236,
              - 239, 244
              - Sharp .....98
              - Sherwood .....29
              - Shophmate .....180
              - Shure .....77, 78, 91, 94
              - Shurite .....133, 231
              - Simpson .....55, 57, 84,
              - 101, 103, 104, 108, 109
              - Phillips .....55, 71
              - Phone-Mate .....121, 197
              - Pickering .....77, 78
              - Pioneer .....26, 28, 40, 50,
              - 55, 61, 64, 67, 69, 91
              - Pemena .....147
              - Premier .....157
              - Raaco .....187
              - Radio Publications .....204
              - Raytheon .....140, 141
              - RCA .....132, 134, 135,
              - 205, 223-225, 231
              - Regency .....163, 234, 238
              - Rombrandt .....165, 188
              - Rhodes .....200
              - Robins .....83, 147
              - Roem-Spaniding .....171
            - Taylor** .....202
            - TDK** .....75, 280
            - Teac .....81, 65
            - Techniques .....136
            - Telax .....18
            - Tenna .....122
            - Toner .....194
            - Toradio .....145, 194
            - Texas Inst. ....212
            - Thoras .....55
            - Triplet .....223
            - Tripp-Lite .....192, 194,
            - 195
            - Tru-Test .....83
            - Turner .....178
            - Ungar .....175
            - Unimat .....177
            - Unisonic .....211, 213
            - Unitrax .....211, 213
            - University .....198
            - Utah .....48, 117, 198
            - Vibroplex .....324
            - Vidairo .....168
            - Voicecaster .....122
            - Wahl .....175
            - Walidom .....93
            - Watts .....174
            - Wan .....174, 179
            - Western Electric .....122
            - Westlock .....201
            - Wilton .....184
            - Winegard .....163, 164,
            - 167, 168
            - Wellensak .....84
            - X-Acto .....174, 181
            - Yamaha .....111

# Index to Manufacturers

- Electra .....238
- Electro-Harmonix .....116
- Electro-Lift .....191
- Electro-Voice .....80, 81,
- 89, 94
- Elmenco .....153
- EMC .....230
- Emerson-Rittenhouse .....120
- Emice .....231
- Empire .....77, 78
- Eveready .....132
- Faden .....91, 119
- Finco .....162, 164, 167,
- 169
- Fisher .....29, 41
- GAF .....216, 217
- Garrard .....52, 53
- General Cement .....136,
- 172, 173, 176
- G. E. ....205
- Gibson .....117
- GL/Tab .....204
- Gunnmaster .....174
- Hawk .....180, 189
- Hayden-Rider .....204
- Nickak .....225, 227
- Nitachi .....57, 81, 90,
- 98, 108, 109
- Hy-Gain .....235, 236,
- 239, 240, 244
- IMC .....82
- Infinity .....41
- Injectorall .....172
- Intermatic .....200, 201
- International .....142
- Int'l Rectifier .....153
- IRC .....143
- JBL .....41
- JBT .....231
- JFD .....162, 163, 165,
- 167, 169, 127
- Jerobee .....154, 169
- E. F. Johnson .....235, 240
- Judson .....191
- JVC .....30, 58, 65, 90
- Karwood .....188, 189
- Kenwood .....29
- Kester .....176
- Kings Point .....212
- Kodak .....215, 217
- Kullisman .....172
- Koss .....50
- Krylon .....173
- Kurman .....138
- Leader .....225
- Litliffese .....155
- Litronix .....211
- Logix .....126
- Lowell .....90
- Magnacraft .....138
- Magnus .....132, 143,
- 148, 192-195, 200
- Marantz .....27, 28, 40
- Mercury .....223, 224
- Microflame .....178
- Miller, J. W. ....117
- Miranda .....218
- Misco .....89
- Mosley .....171, 243
- Motrola .....134, 135
- Mueller .....148
- Multicore .....176
- New-Tronics .....236, 239
- Nordmende .....109
- Ohmite .....143, 157
- On-Guard .....197, 198
- Panasonic .....55, 57, 84,
- 101, 103, 104, 108, 109
- Phillips .....55, 71
- Phone-Mate .....121, 197
- Pickering .....77, 78
- Pioneer .....26, 28, 40, 50,
- 55, 61, 64, 67, 69, 91
- Pemena .....147
- Premier .....157
- Raaco .....187
- Radio Publications .....204
- Raytheon .....140, 141
- RCA .....132, 134, 135,
- 205, 223-225, 231
- Regency .....163, 234, 238
- Rombrandt .....165, 188
- Rhodes .....200
- Robins .....83, 147
- Roem-Spaniding .....171
- Sams Publications .....204-208
- Sanya .....36, 55, 58, 67,
- 98, 99, 108, 259
- Schauer .....195
- Scotch .....78
- Miller, J. W. ....117
- Sencore .....223, 224, 226
- Senheiser .....80
- ServiceMaster .....142
- Servitor .....227
- Shakespeare .....236,
- 239, 244
- Sharp .....98
- Sherwood .....29
- Shophmate .....180
- Shure .....77, 78, 91, 94
- Shurite .....133, 231
- Simpson .....55, 57, 84,
- 101, 103, 104, 108, 109
- Phillips .....55, 71
- Phone-Mate .....121, 197
- Pickering .....77, 78
- Pioneer .....26, 28, 40, 50,
- 55, 61, 64, 67, 69, 91
- Pemena .....147
- Premier .....157
- Raaco .....187
- Radio Publications .....204
- Raytheon .....140, 141
- RCA .....132, 134, 135,
- 205, 223-225, 231
- Regency .....163, 234, 238
- Rombrandt .....165, 188
- Rhodes .....200
- Robins .....83, 147
- Roem-Spaniding .....171
- Sams Publications .....204-208
- Sanya .....36, 55, 58, 67,
- 98, 99, 108, 259
- Schauer .....195
- Scotch .....78
- Miller, J. W. ....117
- Sencore .....223, 224, 226
- Senheiser .....80
- ServiceMaster .....142
- Servitor .....227
- Shakespeare .....236,
- 239, 244
- Sharp .....98
- Sherwood .....29
- Shophmate .....180
- Shure .....77, 78, 91, 94
- Shurite .....133, 231
- Simpson .....55, 57, 84,
- 101, 103, 104, 108, 109
- Phillips .....55, 71
- Phone-Mate .....121, 197
- Pickering .....77, 78
- Pioneer .....26, 28, 40, 50,
- 55, 61, 64, 67, 69, 91
- Pemena .....147
- Premier .....157
- Raaco .....187
- Radio Publications .....204
- Raytheon .....140, 141
- RCA .....132, 134, 135,
- 205, 223-225, 231
- Regency .....163, 234, 238
- Rombrandt .....165, 188
- Rhodes .....200
- Robins .....83, 147
- Roem-Spaniding .....171
- Sams Publications .....204-208
- Sanya .....36, 55, 58, 67,
- 98, 99, 108, 259
- Schauer .....195
- Scotch .....78
- Miller, J. W. ....117
- Sencore .....223, 224, 226
- Senheiser .....80
- ServiceMaster .....142
- Servitor .....227
- Shakespeare .....236,
- 239, 244
- Sharp .....98
- Sherwood .....29
- Shophmate .....180
- Shure .....77, 78, 91, 94
- Shurite .....133, 231
- Simpson .....55, 57, 84,
- 101, 103, 104, 108, 109
- Phillips .....55, 71
- Phone-Mate .....121, 197
- Pickering .....77, 78
- Pioneer .....26, 28, 40, 50,
- 55, 61, 64, 67, 69, 91
- Pemena .....147
- Premier .....157
- Raaco .....187
- Radio Publications .....204
- Raytheon .....140, 141
- RCA .....132, 134, 135,
- 205, 223-225, 231
- Regency .....163, 234, 238
- Rombrandt .....165, 188
- Rhodes .....200
- Robins .....83, 147
- Roem-Spaniding .....171
- Taylor .....202
- TDK .....75, 280
- Teac .....81, 65
- Techniques .....136
- Telax .....18
- Tenna .....122
- Toner .....194
- Toradio .....145, 194
- Texas Inst. ....212
- Thoras .....55
- Triplet .....223
- Tripp-Lite .....192, 194,
- 195
- Tru-Test .....83
- Turner .....178
- Ungar .....175
- Unimat .....177
- Unisonic .....211, 213
- Unitrax .....211, 213
- University .....198
- Utah .....48, 117, 198
- Vibroplex .....324
- Vidairo .....168
- Voicecaster .....122
- Wahl .....175
- Walidom .....93
- Watts .....174
- Wan .....174, 179
- Western Electric .....122
- Westlock .....201
- Wilton .....184
- Winegard .....163, 164,
- 167, 168
- Wellensak .....84
- X-Acto .....174, 181
- Yamaha .....111

# SHIPPING AND DELIVERY INFORMATION

Use our Order Blank . . . To assure fast delivery fill in all information requested (Please Print). Always give your Zip Code! We'll send you new order blanks each time you order.

How to figure Shipping Charges . . . See ZIP CODE CHART to find your shipping zone. To calculate charges refer to PARCEL POST chart or UPS chart if an asterisk appears next to your zip code. We will ship the most economical or fastest way. Items not shippable



## REA EXPRESS INFORMATION

Items not shippable Parcel Post or UPS are sent Railway Express. The letters WX identify these items. **DO NOT SEND MONEY** for express charges with your order. Express charges are collected upon delivery at no extra cost to you. Insurance is included in your express rates. Be sure to specify your nearest Express Office if there is no agent in your town.

### APPROXIMATE REA EXPRESS CHARGES

Zone	1&2	3	4	5	6	7	8
0-150 Pounds	11.47	12.45	14.18	20.08	21.78	23.56	25.66
151-300 Pounds	6c	7c	9c	15c	17c	21c	25c
Over 300 Pounds							

## ABOUT C.O.D. ORDERS

(Minimum Order \$10.00, 20% Deposit)

If you order COD, the post office collects a handling charge, plus a money order fee, in addition to the regular parcel post charge. (We cannot accept COD's for APO's, FPO's or for special-order merchandise). The extra COD fees are:

### PARCEL POST COD FEES:

\$10.01 to \$25.00	.80	\$ 50.01 to \$100.00	1.00
\$25.01 to \$50.00	.90	\$100.01 to \$200.00	1.10

### MONEY ORDER FEES:

From 10.01 to 50.00	.35
From 50.01 to 100.00	.40



## EXPORT ORDERS

Minimum acceptable order \$10.00 in U.S. Currency. All prices are net FOB our warehouse and subject to change without notice. Allow 20% over merchandise value for shipping costs. Overpayments are promptly refunded.

Parcel Post to APO and FPO addresses are considered Domestic Mailings. Use Zone 1 & 2 Rates for New York, Zone 8 for San Francisco and Seattle.

COD orders are not acceptable outside continental limits of the United States. Each order must be accompanied by payment in Cash or U.S. Dollar Draft Payable at a U.S. Bank. Foreign Currencies are not acceptable.

We reserve the right to route order by the best method where order does not indicate routing or when method suggested is impractical or not possible. Enclose import license and/or consular Declaration where so required by your Government.

## SHIPPING WEIGHTS

All weights shown in this catalog are as accurate as we can determine. Use these weights and rate charts to determine shipping charges.

## TERMS

The prices listed in our catalog are net. All trade and cash discounts have already been deducted.

All prices are net, FOB shipping point. PRICES, SPECIFICATIONS AND CONDITIONS OF SALE ARE SUBJECT TO CHANGE WITHOUT NOTICE.

Parcel Post and UPS charges should be included with fully paid orders. We refund any unused.

Please do not send currency or stamps.

210 Lafayette Cat. No. 750

by Parcel Post or UPS will be shipped separately by Railway Express.

**Cash Orders** . . . Please remit full amount, including amount you calculate for shipping charges, tax, handling charge or insurance. Do NOT send Currency or Stamps. We refund any excess.

**COD Orders** . . . Ordering by COD is more expensive for you. You pay an extra fee (see COD Chart). For COD orders you must send a 20% deposit and pay the bal-

ance when your package arrives. No COD's under \$10. **Easy Pay Orders** . . . Indicate on the order blank whether a "new" or "add-on" Easy Pay order and fill in all information requested on back of the order blank.

Fill in your credit charge card number, bank number and credit card expiration date in spaces provided on order blank. Amount for merchandise plus shipping charges, and tax (if any) will be billed to your credit charge account. (Less any deposit.)

## USE YOUR ZIP CODE TO FIND YOUR SHIPPING ZONE FOR PARCEL POST OR UPS

This zone chart lists the first three digits (prefix) of the ZIP Codes of the sectional center facility of address. To determine the zone distance to a particular post office, ascertain the ZIP Code of the post office to which the

parcel is addressed. The first three digits of that ZIP Code are included in this chart, to the right thereof of the. If an (\*) appears to the left of your ZIP prefix refer to UPS chart for charges. Otherwise use Parcel Post chart.

Zip Code Prefixes	Zone	Zip Code Prefixes	Zone	Zip Code Prefixes	Zone	Zip Code Prefixes	Zone	Zip Code Prefixes	Zone
006-009	7	080-066	2	*178-199	2	*339	6	*469	5
*010-013	2	087-089	2			*350-364	5	*470	4
*014	3	090-098	1	*200-218	3	*365-386	8	*471-472	5
*015-018	2	*100-116	2	*219	2	*367-374	5	*473	4
*019	3	*117-118	2	*220-238	3	*376	4	*474-479	5
*020-024	2	*119-127	2	*239-253	4	*377-388	5	*480-489	4
*025-026	3	*128-136	3	*254	3	*387	6	*490-491	5
*027-029	2	*137-139	2	*255-266	4	*388-389	5	*492	4
*030-033	3	*140-149	3	*267	3	*390-392	6	*493-499	5
*034	2	*150-154	4	*268-288	4	*393	5	*494	5
*035-043	3	*155	3	*289	5	*394-396	6	*500-503	6
*044	4	*156	4	*290-293	4	*397	5	*504	5
*045	3	*157-159	3	*294	5			*505	8
*046-049	4	*160-161	4	*295-297	4	*400-402	5	*508-507	5
*050-051	3	*162-163	3	*298-299	5	*403-406	4	*508-519	6
*052-053	2	*164-185	4			*407-409	5	*520-538	5
*054-059	3	*166-169	3	*300-324	5	*410-419	4	*540	6
*060-067	2	*170-171	2	*325	6	*420-427	5	*541-549	5
*068-077	2	*172-174	3	*326-329	5	*430-458	4	*550-554	8
*078	2	*175-176	2	*330-334	6	*460-466	5	*556-559	5
*079	2	*177	3	*335-338	5	*467-468	4	*560-578	6

## HOW TO ESTIMATE PARCEL POST CHARGES



Less than 16 oz., all zones allow 10¢ for first 2 oz., 8¢ for each additional 2 oz. Find the weight of your merchandise in the extreme left-hand column of the chart at right. Pay the amount listed for Parcel Post shipment to your zone. A fraction of a pound is charged as a full lb. For example, if the weight is 6 lbs. and 1 oz. to Zone 3, postage would be for 7 lbs. (1.13). Over 40 lbs. shipped truck or express. See below.

### AIR PARCEL POST SHIPMENTS

We will ship your order via Air Parcel Post upon your request. Rates are given in the table below. Size and weight limits: 70 lbs. and 100 in. (length plus girth).

13¢ per ounce, up to 8 ounces

Zones	1, 2 & 3	4	5	6	7	8
1st Lb.	1.25	1.25	1.25	1.30	1.30	1.30
For Each Extra Lb.	.50	.58	.70	.78	.90	1.04

### MINIMUM ORDER CHARGE

ORDERS UNDER \$5.00	50¢
PARCEL POST	\$ 5.00 to 15.00 20¢
HANDLING	15.01 to 50.00 30¢
CHARGE	50.01 to 100.00 40¢
	100.01 to 150.00 50¢
	151.01 to 200.00 60¢

## PARCEL POST SHIPMENT

Parcel Post Rate Chart. Items keyed "WX" are not shippable Parcel Post (Example = 18-01882WX). Figure Parcel Post Charges only for items not keyed WX. (See REA Express Information.)

Weight 1 Lb. & Not Exceeding	Zone							
	1st to 150 mi.	2nd to 300 mi.	3rd to 450 mi.	4th to 600 mi.	5th to 750 mi.	6th to 900 mi.	7th to 1050 mi.	8th to 1200 mi.
2	\$0.61	\$0.72	\$0.75	\$0.83	\$0.92	\$1.02	\$1.12	\$1.21
3	0.85	0.78	0.83	0.92	1.04	1.18	1.32	1.45
4	0.69	0.84	0.90	1.01	1.16	1.33	1.51	1.89
5	0.73	0.90	0.98	1.10	1.26	1.49	1.71	1.93
6	0.77	0.96	1.05	1.19	1.40	1.84	1.90	2.17
7	0.81	1.02	1.13	1.28	1.52	1.80	2.10	2.41
8	0.85	1.08	1.20	1.37	1.64	1.95	2.29	2.85
9	0.89	1.14	1.28	1.46	1.78	2.11	2.49	2.89
10	0.93	1.20	1.35	1.55	1.88	2.26	2.68	3.13
11	0.97	1.28	1.43	1.64	2.00	2.42	2.88	3.37
12	1.01	1.32	1.50	1.73	2.12	2.57	3.07	3.61
13	1.05	1.38	1.58	1.82	2.24	2.73	3.27	3.85
14	1.09	1.44	1.65	1.91	2.36	2.88	3.48	4.09
15	1.13	1.50	1.73	2.00	2.46	3.04	3.66	4.33
16	1.17	1.56	1.80	2.09	2.60	3.19	3.85	4.57
17	1.21	1.62	1.88	2.18	2.72	3.35	4.05	4.81
18	1.25	1.68	1.95	2.27	2.84	3.50	4.24	5.05
19	1.29	1.74	2.03	2.36	2.96	3.68	4.44	5.29
20	1.33	1.80	2.10	2.45	3.08	3.81	4.63	5.53
For Ea. Extra Lb. Add	0.04	0.06	0.08	0.09	0.12	0.18	0.20	0.24

## UNITED PARCEL DELIVERY

United Parcel Service Rate Chart (use if an \* appears next to Zip Code). Items keyed "WX" are not shippable UPS. (See REA Express information.)

If your area is serviced by UPS and the service or rates are to your benefit, we will route your order via United Parcel Service. This fast, economical service is available for parcels up to 50 lbs. and 108 inches in length and girth.

### ANY FRACTION OF A POUND OVER THE WEIGHT SHOWN TAKES THE NEXT HIGHER RATE

Wt. Not to Exceed	Zone								Wt. Not to Exceed	Zone							
	2	3	4	5	6	7	8	2		3	4	5	6	7	8		
1 lb.	\$.59	\$.61	\$.63	\$.66	\$.69	\$.72	\$.77	26 lb.	\$1.98	\$2.46	\$3.13	\$3.78	\$4.56	\$5.47	\$6.64		
2 lb.	.84	.88	.93	.98	1.04	1.10	1.17	27 lb.	2.02	2.56	3.23	3.91	4.72	5.68	6.88		
3 lb.	.70	.78	.83	.91	1.00	1.10	1.24	28 lb.	2.07	2.83	3.33	4.03	4.87	5.85	7.11		
4 lb.	.75	.83	.93	1.03	1.15	1.29	1.47	29 lb.	2.13	2.71	3.43	4.18	5.03	6.04	7.35		
5 lb.	.81	.91	1.03	1.16	1.31	1.48	1.71	30 lb.	2.18	2.78	3.53	4.28	5.18	6.23	7.58		
6 lb.	.86	.98	1.13	1.28	1.46	1.67	1.94	31 lb.	2.24	2.86	3.63	4.41	5.34	6.42	7.82		
7 lb.	.92	1.06	1.23	1.41	1.62	1.88	2.18	32 lb.	2.29	2.93	3.73	4.53	5.49	6.61	8.05		
8 lb.	.97	1.13	1.33	1.53	1.77	2.05	2.41	33 lb.	2.35	3.01	3.83	4.66	5.65	6.80	8.29		
9 lb.	1.03	1.21	1.43	1.68	1.93	2.24	2.65	34 lb.	2.40	3.08	3.93	4.78	5.80	6.99	8.52		
10 lb.	1.08	1.28	1.53	1.78	2.08	2.43	2.88	35 lb.	2.46	3.16	4.03	4.91	5.98	7.18	8.76		
11 lb.	1.14	1.36	1.63	1.91	2.24	2.62	3.12	36 lb.	2.51	3.23	4.13	5.03	6.11	7.37	8.99		
12 lb.	1.19	1.43	1.73	2.03	2.39	2.81	3.35	37 lb.	2.57	3.31	4.23	5.18	6.27	7.58	9.23		
13 lb.	1.25	1.51	1.83	2.16	2.55	3.00	3.59	38 lb.	2.62	3.38	4.33	5.28	6.42	7.75	9.46		
14 lb.	1.30	1.58	1.93	2.28	2.70	3.19	3.82	39 lb.	2.68	3.46	4.43	5.41	6.58	7.94	9.70		
15 lb.	1.36	1.66	2.03	2.41	2.86	3.38	4.05	40 lb.	2.73	3.53	4.53	5.53	6.73	8.13	9.93		
16 lb.	1.41	1.73	2.13	2.53	3.01	3.57	4.29	41 lb.	2.79	3.61	4.63	5.68	6.89	8.32	10.17		
17 lb.	1.47	1.81	2.23	2.66	3.17	3.78	4.53	42 lb.	2.84	3.68	4.73	5.78	7.04	8.51	10.40		
18 lb.	1.52	1.88	2.33	2.78	3.32	3.95	4.76	43 lb.	2.90	3.78	4.83	5.91	7.20	8.70	10.64		
19 lb.	1.58	1.96	2.43	2.91	3.48	4.14	5.00	44 lb.	2.95	3.83	4.93	6.03	7.35	8.89	10.87		
20 lb.	1.63	2.03	2.53	3.03	3.63	4.33	5.23	45 lb.	3.01	3.91	5.03	6.18	7.51	9.08	11.11		
21 lb.	1.69	2.11	2.63	3.16	3.79	4.52	5.47	46 lb.	3.06	3.98	5.13	6.28	7.66	9.27	11.34		
22 lb.	1.74	2.18	2.73	3.28	3.94	4.71	5.70	47 lb.	3.12	4.06	5.23	6.41	7.82	9.48	11.56		
23 lb.	1.80	2.26	2.83	3.41													

# Count on Lafayette for Electronic Calculators

All Add, Subtract, Multiply and Divide—Other Features as Specified

Only 3 3/8 x 1 1/4 x 3 1/2"!



**Commodore Minuteman-6 Hand-Held Model**

**\$19<sup>95</sup>** • 5/32" Display  
• Fixed 2-Place Decimal

Palm-size calculator great for pocket or purse. Has six-digit calculating capacity with easy-to-read, 5/32", bright-red LED display. No decimal or fixed 2-place decimal for easy checkbook balancing. Clear key. Use 9-volt battery (below). Wt. 4 oz. 15 F 18505L Shpg. wt. 1 lb. Net 19.95  
**9-Volt Battery for Above.**  
99 F 60212 Imported . . . . Net 39¢



**NEW**

**Pocket-Size 8-Digit with Floating Decimal**

**\$29<sup>95</sup>** • Minus Sign and Overflow Indicators

Litronix 1101. Has 8-digit 5/32" display. Clear key to erase entire problem, clear entry key to erase previous entry. Performs chain, mixed calculations. Four "AA" cells or optional AC adapter. 3 x 6 x 3/4", 7 oz. Imported.  
15 F 24503L Shpg. wt. 1 lb. Net 29.95  
15 F 24511L AC Adapter .Net 4.95  
99 F 63703 Batts. Use 4 Net ea. 22¢



**Unisonic.**

**NEW**

**Pocket-Size 8-Digit with Constant, % Key**

**\$34<sup>95</sup>** • Bright 1/4" Display  
• Floating Decimal

Unisonic 890. Deluxe pocket calculator with a % key for automatic figuring of markups and discounts, constant that lets you multiply or divide a series of numbers by the same number. Includes batteries, carry case. 3 1/2 x 6 x 1 1/4", only 10 oz. Imported.  
15 F 11526L Wt. 1 1/2 lbs. .Net 34.95  
15 F 11534L AC Adapter .Net 4.95



**UNITREX**

**NEW**

**8-Digit Model with Square Root and % Key**

**\$39<sup>95</sup>** • Fixed, Floating Decimal  
• +/- Sign Change Key

Unitrex 80R. Great for students. Has a square root key for instant square roots in geometry and trig, % key, sign-change key, credit balance overflow indicators. Easy-to-read 5/32" number display. Constant switch, floating or preset 0-, 2-, 4-place decimal setting. 2 3/4 x 4 3/4 x 3/4", weighs 8 oz. With battery. Imp. 15 F 10569L Shpg. wt. 1 lb. Net 39.95  
15 F 10551L AC Adapter .Net 4.95

**Casio**



**NEW**

**\$49<sup>95</sup>** Mini-Memory  
**\$59<sup>95</sup>** Mini-Memory with √

**8-Digit Models with 16-Digit X Capacity**

• 6 1/8 x 3 3/4 x 1 1/4"  
• Weighs 9 Oz.

Mini-Memory. Has accumulating-type memory with indicator to accumulate totals for instant recall, % key, floating decimal, x/÷ constant, overflow and credit balance indicators. 1/4" green display. With batteries, carry case. Imported.  
15 F 12508L Shpg. wt. 1 lb. Net 49.95  
Mini-Memory with Square Root. Above, square root key, no % key.  
15 F 12516L Shpg. wt. 1 lb. Net 59.95  
15 F 12524L AC Adapter .Net 4.95

**commodore**



**NEW**

**8-Digit "Sliderule" with Memory, %, √, x<sup>2</sup>, 1/x**

**\$59<sup>95</sup>** • 3 x 6 x 1 1/2"  
• Weighs 15 Oz.

Commodore Minuteman 2SR. Features TRUE memory with addition and subtraction from stored numbers, square, square root and reciprocal keys, % key, floating decimal and negative display for true credit balance. Operates on rechargeable NiCad batteries (included). 117 VAC. 60 Hz with adapter/battery charger (also included!). 8-digit 5/32" red display.  
15 F 18513L Shpg. wt. 1 lb. Net 59.95



**Unisonic.**

**Deluxe 8-Digit "Sliderule" with Memory, %, √, x<sup>2</sup>, 1/x**

**\$74<sup>95</sup>** • Exchange Key  
• Large 1/4" Display

Unisonic 739. Figures squares, square roots, reciprocals, percentages; even has an exchange key to retrieve a constant figure at any point in the calculation, +/- sign change key, automatic constant, floating decimal, memory. Automatic overflow protection. Operates on batteries, 117 VAC. With batteries/adapter, case. Imported. 3 1/2 x 6 x 1 1/2", weighs 10 oz.  
15 F 11518L Wt. 1 lb. . . . . Net 74.95

**corvus**



**NEW**

**Scientific Notation Slide-Rule 10-Digit**

**\$89<sup>95</sup>** • 3 x 6 x 1 1/4"  
• Weighs 8 Oz.

Corvus 411. Features constant for all five functions, π, 1/x, √x and x<sup>2</sup> functions, exchange key, full floating decimal, direct-access memory. Automatic conversion to scientific notation with 10-digit 5/32" display — 8 in mantissa, two for exponents, two for signs. With rechargeable NiCad batteries, AC adapter.  
15 F 23505L Shpg. wt. 1 lb. Net 89.95  
Corvus 415. 8-digit, %, EX, 1/X keys. Floating decimal, 5-function constant, 4-button memory. With rechargeable NiCad batteries.  
15 F 23513L Shpg. wt. 1 lb. Net 79.95  
Lafayette Cat. No. 750 211

See next page for "Scientific" Calculators.

**KingsPoint**  
**THE Calculator for**  
**Scientists, Engineers,**  
**Technicians,**  
**STATISTICIANS**

\$139<sup>95</sup>



**Does It ALL—and then  
 Some—All You Need in  
 a Hand-Held Calculator**

- 39 Separate Entry/Function Keys
- Algebraic Problem Entry
- $x^2$ ,  $x$ ,  $1/x$  Convenience Keys
- Scientific Notation Entry or Automatic Floating Decimal
- Memory Register for Storage/Constant Plus Two Extra Memories for Two-Level Parenthesis Operations

# Scientific Calculators

## 1 Kings Point Portable with 39 Keys

- Algebraic Operation Means You Enter Problems Just as You Would Write Them Out Longhand
- 14 Digits—10 Mantissa, 2 Exponent, 2 Sign

Model SC-40. Do transcendental functions (Sin, Cos, Tan, Log,  $1n^x$ ,  $e^x$ ,  $xy$ , etc.). Has factor reversal ( $x \leftrightarrow y$ ), separate  $\pi$  key. Performs full chain calculations with any sequence desired; automatic indications for overflow, underflow, forbidden operations ( $1/0$ , etc.). Trig functions have degree or radian indicator, has sign selection and display for both mantissa and exponent, separate I memory register. Battery-saver display cutoff, low battery indicator, bright red  $\frac{3}{2}$ " display.  $6\frac{5}{8}$ " L x  $3\frac{1}{2}$ " W x  $1\frac{5}{8}$ " H. Weighs just 11 oz. With rechargeable batteries, 117 VAC, 60 Hz. Adapter/charger. Imported. 15 F 13506L Shpg. wt. 2  $\frac{1}{2}$  lbs. . . . . Net 139.95

## 2 Casio FX-10 Pocket-Size 8-Digit Model

• Batteries and AC Adapter •  $3\frac{3}{4}$  x  $5\frac{7}{8}$  x  $8\frac{1}{4}$ " • Weighs 12 Oz.  
 Has four arithmetic functions, 10 scientific functions—log,  $1n$ ,  $e^x$ ,  $a^n$ ,  $1/x$ ,  $^{\circ}999$ , sin, cos, tan and  $\sqrt{\quad}$ . Separate  $\pi$  key can be used with all other functions. Algebraic operation, automatic floating decimal, true credit balance.  $\frac{1}{4}$ " bright green display. Includes batteries and 117 VAC, 60 Hz adapter. Imported.

15 F 12532L Shpg. wt. 1 lb. . . . . Net 99.95

## 3 Bowmar MX-100 20-Function 8-Digit Model

- Omni Constant for Use with All Functions
- Floating Decimal • Algebraic Logic

Amazing hand-held calculator performs complex functions with "space-age" speed. Has all arithmetic, log, exponent functions— $M\pm$ , M recall, M clear, X/memory exchange, X/Y register exchange, degree/radians switch, more. Negative display, overflow indicator, etc.  $\frac{3}{16}$ " display size. Operates on rechargeable NiCads or 115/230 VAC. 60 Hz adapter/charger (both included). With case.

15 F 48528L Shpg. wt. 1 lb. 6 oz. . . . . Net 119.95

MX-140 "Advanced Scientific." As above, with scientific notation, algebraic operation with 2-level parenthesis.  $\frac{3}{32}$ " display for 10-digit mantissa, two-digit + or - exponent.

15 F 48544L Shpg. wt. 1 lb. 6 oz. . . . . Net 159.95

## 4 Bowmar MX-90 Professional Pocket Slide-Rule

- Memory Plus, Memory Minus, Memory Accumulate
- Algebraic Entry • 10-Digit 3/16" Display

Has arithmetic functions, square roots, automatic reciprocal and automatic % keys, omni-constant for use with each function,  $\pm$  exchange/register. Full floating decimal system, negative number display; - sign, low battery, overflow and memory indicators.  $3 \times 5 \times 1\frac{1}{2}$ ". With rechargeable batteries, 117/230 VAC, 50-60 Hz adapter/battery charger, case.

15 F 48551L Shpg. wt. 2 lbs. . . . . Net 79.95

Model MX-55. Similar to above, but 8-digit, 5-function +, -, x,  $\div$  and automatic % key. No scientific functions.

15 F 48536L Shpg. wt. 2 lbs. . . . . Net 49.95

## 5 Texas Instruments SR-10 Slide-Rule Portable

- Display 8-Digit Mantissa with 2-Digit Exponent
- Arithmetic Functions, Squares, Roots, Reciprocals

Provides high-number math capabilities with an 8-digit readout—automatically switches to scientific notation when results exceed 8 digits! Floating decimal; --, overflow, low battery indicators. Operates on rechargeable NiCad batteries (included), or 117 VAC, 60 Hz adapter/charger (also included!).  $3.1 \times 6.3 \times 1.5$ ". Weighs just 9 oz. Bright red  $\frac{3}{32}$ " display.

15 F 25500L Shpg. wt. 1  $\frac{1}{2}$  lbs. . . . . Net 74.95

## 6 TI-2550 Five-Function Memory Portable

- Has Full Four-Button Memory Plus % Key
- Constant Can Be Used with All Functions

Great for students! The special removable rechargeable NiCads can be replaced with standard penlights when AC power is not available. Adds, subtracts, multiplies, divides, does instant %, has full memory.  $\frac{3}{32}$ " display. Full floating or 2, 4 preset decimal; --, overflow, memory indicators.  $3.2 \times 6.5 \times 1.8$ ". With batteries, 117 VAC, 60 Hz adapter/charger, case.

15 F 25518L Shpg. wt. 1  $\frac{1}{2}$  lbs. . . . . Net 79.95

**Casio**

10 Scientific Functions,  
 Separate  $\pi$  Key, Four-  
 Function Constant,  
 Floating Decimal

\$99<sup>95</sup>

**Bowmar**

"Scientifics" with  
 Full-Feature  
 Memories



\$119<sup>95</sup>



\$79<sup>95</sup>



\$74<sup>95</sup>

**Texas Instruments**  
**Famous-Quality**  
**Pocket Calculators**

\$79<sup>95</sup>

# 12-Digit Electronic Calculators

## 1 Unisonic 1211 Pocket Model with Memory

- CM, RM, M+, M-, Full-Feature Memory • 5/32" Display
- % Key for Discounts, Markups, Etc. • Weighs 10 Oz.

**Model 1211.** BIG 12-digit number capacity, 12-digit display and features like full memory and floating decimal make this a fine calculator buy. Has automatic constant, % key, sign-change key, exchange key. With batteries, case, 117 VAC, 60 Hz adapter. 3½ x 6 x 1½". 15 F 11542L Imported. Shpg. wt. 2 lbs. . . . . Net 79.95

## 2 Unisonic 774SQ "Executive" Desk-Top

- Four-Key Memory, %, Square Roots, Reciprocals
- Floating or Fixed Decimal • Large 7/16" Display

Advanced desk-top calculator has the features for complex home or office work, 12-digit capacity. Has a full-feature MR, MC, M+, M- memory with sub-total capability, 5/4 round-off key, exchange key to retrieve constant, sign-change key. Zero suppression automatically drops zeroes to right of answer. 7½ x 9 x 2". 117 VAC, 60 Hz. 15 F 11559L Imported. Shpg. wt. 3 lbs. . . . . Net 99.95

## 3 Unitrex 12PPM 12-Digit Desk-Top Printout Calculator

- Provides Instant Results Plus a Permanent Record
- Has Full Feature Memory, Exchange Key, Constant

Advanced print-out calculator has every fine feature including 12-digit capacity and memory, gives an instant automatic printout on standard 2½" tape — with negative entries, negative subtotals and credit balances printed in red. Has automatic paper advance and alignment preselection of decimal from 0 to 6 places, fixed result to 6 places, power and memory lights, overflow indicators. 8½ x 11¾ x 3¾". For 117 VAC, 60 Hz. UL listed. Imported. 15 F 10585L Shpg. wt. 10½ lbs. . . . . Net 199.95

**Model 12PPS.** Above, with 0-7 decimal selection, less constant and memory. 15 F 10536L Imported. Shpg. wt. 10½ lbs. . . . . Net 159.95

## 4 Unitrex 12-Digit Desk-Top with Memory

- Separate Memory Register Stores, Accumulates
- Floating Decimal Entry to 6 Places, Fixed 0-6 Place Result

Nicely-styled, full-feature calculator has 12-digit capacity and display, M+, M-, RM, CM direct access memory which stores and accumulates sub-totals in separate register, constant for multiplication and division functions. Reverse key for > and ÷ functions, bright ¾" display, overflow, credit balance, memory indicators. 7½ x 9½ x 2½". UL listed. For 117 VAC, 60 Hz. Imported. 15 F 10577L Shpg. wt. 5 lbs. . . . . Net 74.95

## 5 Brother Heavy-Duty XL-1010 Portable

- 88-Character Keyboard • Large Pica Type

Has big-machine features at a small price—great for high school and college students, home or light-duty office use. 88-character office keyboard, easy-to-use tabulator, 3-position touch control, half-space ratchet and jam-release key. Two-color ribbon with stencil position. With lid cover carrying case. 15 F 17200W Imported. Shpg. wt. 14 lbs. . . . . Net 59.95

## 6 Brother Electric with Power Carriage Return

- Extra-Wide 12" Carriage • Electric Shift Key

Outstanding pica-type electric for home or office. 88-character keyboard, 6 repeat characters, 3 repeat keys, tabulator, automatic repeat spacer, touch control, 2-color ribbon with stencil. Contour-shaped, molded carrying case. For 117 VAC, 60 Hz. 15 F 17176W Imported. Shpg. wt. 30 lbs. . . . . Net 159.95

## 7 Smith-Corona "Super 12" Electric Portable

- Exclusive Coronamatic Ribbon Change Cartridge

Change your typewriter ribbon with a flick of the wrist! Simply pull out one cartridge, insert the other. Has power-return carriage, full-length tab, repeat action for space bar, ., -, ×, underline. Touch and impression controls, vinyl-clad steel case. 88-character keyboard. Pica type. For 117 VAC, 60 Hz. 15 F 40210W Shpg. wt. 30 lbs. . . . . Net 219.95

15 F 40228 Carbon Cartridge Ribbon. Shpg. wt. 4 oz. . . . . Net 1.95

Charge It with Your BankAmericard or Master Charge.



**Unitrex**  
All Add, Subtract, Multiply  
and Divide



**Unisonic.**  
Stylish Large-Capacity  
Calculators—Portable  
or Desk Models

**Student, Business, Home  
Portable Typewriters**

# Thinking, Writing, Drawing Tools from Lafayette



13 1/4" "Vectorlog"® Slide Rule

- For Engineers and Physicists
- Laminated Bamboo Construction
- 5 Log Log Scales Plus a Voltage dB Scale
- Complete with Belt Carrying Loop-Leather Case

All scales are specially designed for easy, quick manipulation. Twenty-seven scales cover many problems used in Electrical Engineering and Physics. Unique P, P' and Q scales allow direct right angle vector addition, does not require the usual several settings. Adjustable screws allow variable tension on the slide. Scales include (Front) Tr-1, Tr-2, P, P', Q, ST, Sr, S-θ, C, D, LL03, LL02, LL01, LL1', (Rear) Sh-1, Sh-2, DF, A, B, CF, Th, Cl, C, D, LL3, LL2, dB. With instructions, carrying case.

99 F 71029 Imported. Shpg. wt. 1 1/4 lbs. Net 21.95

13 3/4" Deluxe Log Log Dupli Decimal Trigonometric Slide Rule

- Laminated Bamboo—Won't Shrink or Distort
- Extra P Scale Simplifies Computations
- Two Color Scales • 8 Log Log Scales

A log log dupli decimal trigonometric slide rule that contains 25 scales including 8 log log scales. Extension of C & D scales eliminates end-for-end resetting. Extra feature is a P scale which enables direct readout of cosine value. Scales: (Front), LL-1, LL-2, LL-3, DF, CF, C1F, C1, C, D, LL3, LL2, LL1; (Rear), LLo, L, K, A, B, S, ST, T, C, D, D1, P, and LLO. With instructions and handy case, belt clip. Imported.

99 F 70559 Shpg. wt. 1 1/2 lbs. Net 22.95

Decimalog™ 6 1/2" Log Log Dupli

- P Scale Permits Direct "Readout" of Cosine Values

Pocket version of the 13 3/4" log log dupli decimal trigonometric slide rule. Contains all the scales of the 13 3/4" rule except the "ST" scale. Two color scales—positioned for ease in use and rapid calculations. Laminated bamboo. Instruction booklet, leatherette case.

99 F 70997 Imported. Shpg. wt. 8 oz. Net 10.95

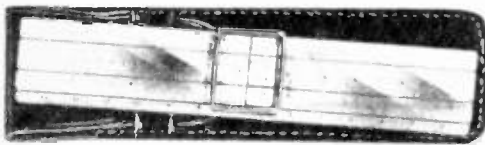

5" Pocket Slide Rule

- Very Accurate
- With S, L and T Scales

Portable, pocket-size slide rule made of select bamboo. A, B, C1, C, D and K scales engraved on easy-read surface. Reverse side has standard S, L & T scales. Will not warp or shrink under normal use.

99 F 70302 Imported. Shpg. wt. 6 oz. Net 5.95



Decorative 2-Drawer Desk

\$34<sup>95</sup>

Chair Optional

- Walnut Permaneer Finish • Very Attractive—Practical

Sleek, modern desk fits in any decor, home or office. Two storage drawers and a large, extended desk top provide large work area. Durable pressed-wood Permaneer, walnut-finished, wood-like surface is heat-, scratch- and stain-resistant. Easy to clean with a damp cloth, no polishing necessary. 29" high, desk is 48" wide x 20" deep. Assemble with a screwdriver. Optional chair has matching finish.

20 F 16020WX Shpg. wt. 53 1/2 lbs. Net 34.95

Optional Chair. Fully-padded, black vinyl seat with contour back.

20 F 23059W Shpg. wt. 9 3/4 lbs. Net 13.50

Automatic Electric Pencil Sharpener

Have a sharp point at all times! For standard graphite or colored crayon pencils. Stops when sharpening is done. For businessmen, secretaries, students. Good-looking for any decor. 117 VAC, 60 Hz.

15 F 17192 Imported. Wt. 4 lbs. Net 17.95

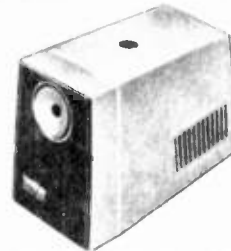

Lettering Guide Set



Use with sharp pencil or ink. Complete alphabet, numbers and commonly used signs. Set has six guides. Sizes: 1/8, 3/16, 1/4, 5/16, 3/8 and 1/2". Made of clear plastic.

15 F 14322 Shpg. wt. 1 lb. Net 4.95

Rubber Type Set



Full kit with 14-pt. 1/8" rubber type, 22 numerals, over 100 capital letters, punctuation marks, ink pad and tweezers. Base-lock for perfect alignment. Neat, clear printing. Instructions included.

15 F 60010 Shpg. wt. 3/4 lbs. Net 3.95

Electronic Drafting Template



Very accurate because it meets J.I.C. standards. 7x5". Covers all symbols. Shows all elements of electronic and CR tubes. Thickness .030".

15 F 43016 Shpg. wt. 4 oz. Net 2.99

Draftette Portable Drafting Machine \$16<sup>95</sup>

- Precision Instrument

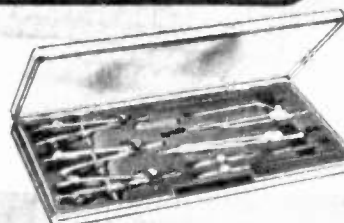
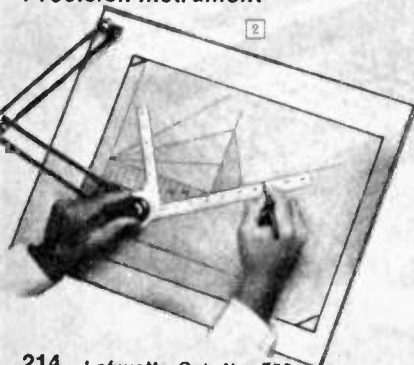

\$14<sup>95</sup> Utility Drafting Set

- Made in West Germany
- Nickel-Plated Brass
- Professional Quality

1 5 1/4" compass with pen and pencil parts, lengthening bar, 5/4" divider, 5/4" ruling pen and pencil. Three side wheel 3 1/2" bow Instruments—divider, pencil and pen, all with reversible needles. Extra handle. Capsule with extra lead. Imported.

15 F 64178 Shpg. wt. 1 lb. Net 14.95

2 Model 9-B. Design, draw, draft, sketch like a pro. T-square, triangle, and protractor all in one. Ready to use, mounted on 16 x 21" drawboard.

15 F 74011 Wt. 5 1/2 lbs. Net 16.95

\$13<sup>95</sup> Precision Drawing Set

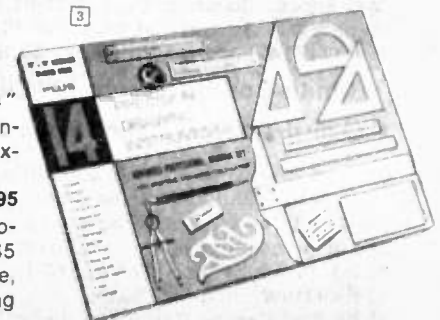

3 13x19" board, T square, protractor, french curve, 30, 60, 45 and 90° triangles, slide rule, bow, compass, 12" ruler, erasing shield, much more.

15 F 14504 Wt. 3 3/4 lbs. Net 13.95



# Cameras, Strobes, Accessories For The Hobbyist



**POCKET CAMERA OUTFITS**  
**\$32<sup>95</sup>**



**argus** Pocket Camera and Strobe Outfit  
**\$39<sup>95</sup>**

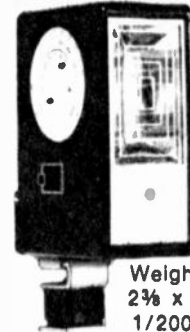

**LAFAYETTE Electronic Strobe Flash**  
**\$13<sup>95</sup>**

- Fully Transistorized
- Use Horizontally or Vertically

Weights under 7 oz., only 3¼ x 2¾ x 1¾". Color temp., 6000°K. 1/2000 sec. flash.

Guide No. 28 (ASA 25). Hot shoe or PC cord. Recycle time: 7 to 10 sec. Imported. 99 F 71128 Shpg. wt. ¾ lb. . . . . Net 13.95  
99 F 63828 Alk. Batts. (2 req.) Net ea. .45

## Pocket Instamatic Camera Outfits

- Fits in Pocket for Easy Use
- Easy-Load C-110 Cartridge

**Model 20 Outfit.** Features double-exp. safety, f/9.5 color-corrected lumenized lens, Speeds: 1/100-1/40 sec. With strap, film, Magicube, extender. 2½ x 5 x 1"  
15 F 26391L Shpg. wt. 5.6 oz. . . . Net 32.95

**\$52<sup>50</sup>** **Model 30 outfit.** Above, but with electronic eye, shutter speeds of 1/160-5 sec. Wt. 6.2 oz.  
15 F 26409L . . . . . Net 52.50

## Strobe Adapter for Instamatic Pocket Cameras



**\$4<sup>95</sup>**

Adapts Kodak Pocket Instamatic cameras for use with any electronic flash. Fits Instamatic models 20, 30, and 40 by just snapping into flashcube socket. Imported.

15 F 37778 Wt. 8 oz. . Net 4.95

## TIFFEN Pocket Strobe

**\$18<sup>95</sup>**



For Kodak Instamatic cameras. Never buy flashcubes again! Gives

up to 200 flashes, simple slip-on design. Uses 2 AA batteries. Imported. 1 lb.

15 F 36853 For Models 20, 30, 40 Net 18.95  
15 F 36903 For Model 50, 60 . . . . Net 19.95  
99 F 63828 Alkaline Batteries .Net ea. .45

## Argus Carefree Camera Strobe/Outfit

• Instant-Load Pocket Camera  
• 80 Flashes from 2 "AA" Cells

Outfit includes Model 110 Carefree camera with f/9.5 3-element lens, double exp. safety. Strobe, case, wrist strap, 2 "AA" batteries, film. Imported.

15 F 34593L Shpg. wt. 2 lbs. . . . . Net 39.95

**\$19<sup>95</sup>** Argus Carefree Camera Outfit includes 110 camera, Magicube, film. Imported.

15 F 34601L Shpg. wt. 1¾ lbs. . . Net 19.95

## Developer/Enlarger Kit

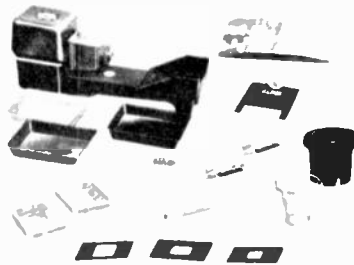

**\$22<sup>95</sup>**

Photo and enlarging kit has everything you need to develop and enlarge black and white 126, 127 and 35mm film to 3¼ x 5" prints. Kit contains developing tank, 2 clips, 25 sheets of glossy paper, 3 trays, 1 orange safety light (7½ watts), 2 Kodak TriChem packs. UL and CSA listed enlarger, print masks, negative carriers, graduate, thermometer and detailed instruction booklet are included with the complete outfit.

15 F 36937W Wt. 5 lbs. . . . . Net 22.95

## BAUER Autoblitz Electronic Flash Guns

**\$19<sup>95</sup>**



**\$44<sup>95</sup>**



## Model E18A Automatic Flash Gun

Hot shoe or PC cord electronic flash unit has computerized output range of 1½-13 ft. at 1600 BCPS automatically. Automatic current control powered by rechargeable batteries or 120-220 VAC. Guide No.: 45 for Kodak II ASA 25. Flash duration: 1/1400-1/2500 sec. 1½ x 2¾ x 3". With NiCad rechargeable batteries, AC adapter/charger, sync cord.

15 F 37786 Imported. Wt. 1 lb. . . . Net 44.95

Model E18. Above, but non-auto. 40 ASA 25.

15 F 37794 . . . . . Net 29.95

## KAKO 818 Electronic Flash

Hot shoe, PC cord unit operates on 2 "AA" batteries or AC. Only 3¼ x 1¼ x 2½". Positive click-stop shoe for vertical or horizontal operation. Guide number 34 (ASA 25). Recycle time: 7-10 sec. on battery, 3-6 sec. AC. Uses 2 "AA" batteries or 110-120 or 220-240 VAC, 60 Hz. With AC cord.

15 F 36895 Shpg. wt. 1 lb. . . . . Net 19.95

99 F 63828 Alk. Batts. (2 req.) Net ea. .45

## Deluxe CdS Exposure Meter

**\$26<sup>95</sup>** • Measures Moonlight, Candlelight  
• With Vinyl Carrying Case, Battery

High quality light meter features full range of sought after characteristics. Sensitivity: Low range, 0.275 to 444 footcandles; High range, 444 to 36,674 footcandles. ASA range: 6-12,000. Din: 9-42. Stops: f/1 to f/32. Shutter speed: 1/8000-8 min. Movie scale: 8-128 fps. Much more. 3¼ x 2½ x ¼". Imported.

15 F 49641L Wt. 1 lb. . . . . Net 26.95



**\$10<sup>95</sup>**

## LAFAYETTE "35" Clip-On Exposure Meter

• Weighs 1 Oz. • ASA 10-1000

Exceptionally light weight meter features speeds of from 1/1000 sec to 1 sec. Lens aperture f/1.4 to f/22. Mounts on camera or may be hand held. Complete with leather case and instructions. Wt. ½ lb.

99 F 70344 . . . . . Net 10.95

# Cameras And Accessories For Novice Or Pro



## argus CAMERA KIT



Remote Control Projector

### CAMERA WITH CASE

**\$179<sup>95</sup>** Model STL 1018

### COMPLETE OUTFIT

**\$249<sup>95</sup>** With Complete Accessories

### Model 2670

**\$74<sup>95</sup>**

### Auto Focus Model 2690

**\$114<sup>95</sup>**

## ARGUS 35mm SLR Camera with Telephoto Lens, Flash

- Complete Kit: Camera, Case, Lens, Filter, Flash and More
- STL 1018 Camera with Full Range of Professional Features

A professional looking and performing SLR camera plus all the extras you'll need. Camera has cross-coupled CdS with match needle visible thru viewfinder. ASA-25 to 1600. 55mm auto f/1.8 lens. Self timer with 9 second delay. FP-X synch with 1/60 sec. X. Kit also includes ever-ready case, 135mm f/3.5 telephoto lens, filter, lens shade, hot shoe AC/DC electronic strobe flash and carry-all zipper bag. Imported.

15 F 34619L ..... Net 249.95  
15 F 34627L Camera with Everready case. 3 lbs. .... Net 179.95

## GAF 35mm Slide Projectors

- Features Full Remote Control to Make Slide Shows Easy
- Sharp 4" f/3.5 Lens for Extra Sharp Pictures

**Model 2670.** No more "whir" and "click" to spoil the show. Extra quiet operation. Remote control lets you run the show from 10 feet away. Has transparent lens protector. With 100 slide tray. Shpg. wt., 12 lbs.

15 F 78285W ..... Net 74.95

**Model 2690.** Similar to above, but with automatic focusing, auto slide changing timer, pop-up editor. With slide tray. Shpg. wt. 3 lbs.

15 F 78293W ..... Net 114.95

15 F 78301 100 Slide Tray. Shpg. wt. 1 lb. .... Net 2.75



**\$259<sup>95</sup>**

### 1 AUTO "SENSOREX EE" 35mm SLR

Automatic or manual camera has average or spot through the lens setting. 50mm f/1.8 lens. Variable delay self timer. FP and X synch hot shoe. Speeds 1-1/1000 sec. EE coupling: EV3-18, ASA-25-1600. With case. Imported. 4 lbs.

15 F 37588L ..... Net 259.95



**\$199<sup>95</sup>**

### 2 "SENSOREX II" 35mm SLR with Case

Matched needle CdS through the lens meter is fully coupled, has ASA range 25-1600 (EV 3-18). 50mm f/1.8 lens. FP and X synch, speeds 1-1/1000 sec. Variable speed self timer, instant return mirror, rapid film advance lever. Imported. 4 lbs.

15 F 37596L ..... Net 199.95



**\$299<sup>95</sup>**

### 3 SR-T 101 35mm SLR with Case

Thru-lens CdS metering system has match needles in viewfinder. Camera also features focal plane shutter with 1-1/1000 sec. speeds plus B, 55mm f/1.7 lens, FP & X synch, self timer, built-in accessory shoe. Imported. 4 1/4 lbs.

15 F 34551L ..... Net 299.95



**\$124<sup>95</sup>**

### 4 ELECTRO-35 GSN 35mm Camera

"Electronic brain" checks light and sets lens and shutter speed automatically. Coupled range/viewfinder. Built-in self timer. Speeds: 30-1/500 sec. Accessory hot shoe. ASA 12-500 X synch. 45mm f/1.7 lens. Imported. 3 lbs.

15 F 36754L ..... Net 124.95



### Soligor Telephoto, Wide-Angle Lenses, Tele-converters

Interchangeable lenses designed for use with SLR's. Each precision lens is hard-coated and fully color-corrected. Shipped prepaid from Factory. No COD. Send Full Remittance or Use Lafayette's Easy Pay Plan\*.

### SOLIGOR AUTOMATIC LENSES

Fully automatic lenses for many SLR cameras including Canon FL; Konica Auto Reflex "T"; Minolta SR series. SRT 101; Miranda F. F.V. G; Sensomat, Sensomat "RE," Sensorex, Sensorex II; Nikon; Pentax and Topcon. With click stops, depth of field scale and manual diaphragm control when needed. Specify make and model of camera.

Stock No.	Auto Lens	Closest Focus	Net
15 F 37281Z	28mm f/2.8 W.A.	18"	99.95
15 F 37489Z	35mm f/2.8 W.A.	2'	79.95
15 F 37299Z	135mm f/2.8 Tele	6'	93.50
15 F 37497Z	135mm f/3.5 Tele.	6'	76.95
15 F 37307Z	200mm f/3.5 Tele.	10'	113.95
15 F 37315Z	300mm f/5.5 Tele.	20'	126.95
15 F 37513Z	400mm f/6.3 Tele.	30'	160.00
15 F 37802Z	80-200mm f/3.5 Tele. Zoom 6'3"		209.95
15 F 37323Z	90-230mm f/4.5 Tele. Zoom 8'		198.95

### MIRANOX "SENSOREX EE" LENSES

Stock No.	Auto Lens	Closest Focus	Net
15 F 37703Z	28mm f/2.8 W.A.	18"	109.95
15 F 37729Z	135mm f/2.8 Tele.	6'	104.95

### SOLIGOR 2X TELE CONVERTERS

Does not change focusing range of original lens. Four-element, color-corrected, with coupling for shutter and metering system of camera. With leather case. Specify make and model of camera. 1 lb. 2X Tele Converter for Nikon, Minolta SRT-101, Sensomat, Sensomat "RE," Canon, Exakta.  
15 F 37752Z ..... Net 29.95  
2X for Konica, Autoreflex T, Sensorex, Sensorex II.  
15 F 37760Z ..... Net 29.95

No Money Down—See Page 4 for Lafayette's Easy-Credit Plan (Minimum Order \$30.00)

# Family Fun With Movie Cameras, Accessories



**\$119.95** With Variable Speed Slow Motion     **\$99.95** Dual 8mm Operation Plus Zoom

**\$199.95** Buy the Complete Outfit and Save Almost \$20.00

## DeJUR Deluxe Dual 8mm Zoom Projector for Super and Standard 8

**Eldorado 888AZ.** Movie projector with advanced features of variable speed control, true slow motion (shows individual frames as slides) and forward or reverse projection. 100% illumination for extended still projection and cool, quiet operation. Has sturdy die-cast aluminum case, 400' reel capacity, built-in automatic room light receptacle, auto threading, fast rewind, film trimmer, lifetime lubrication and self-enclosed carrying case with handle. Sharp f/1.5 zoom lens for excellent image. For 117 VAC, 60 Hz. Shpg. wt. 10 lbs.

**15 F 52140W** ..... Net 119.95  
**Citation 850AZ.** Above, less slow motion and light outlet. 10½ lbs.  
**15 F 52165W** ..... Net 99.95

## GAF Zoom Movie Outfit with Power Zoom Camera

Enjoy the convenience of taking movies anywhere without movie lights under most conditions. Reflex Zoom movie camera features 2.5:1 pushbutton power zoom with extra-fast f/1.1 lens. Automatic electric eye with over/under exposure warning assures perfect pictures. Handles high speed film, auto ASA range from 25/40 to 100/160. Model 2388Z projector features auto threading, rapid rewind, stop 'n glow bright still, and sharp f/1.5 zoom lens. Dual 8 operation. Outfit includes 400' reel, camera case, batteries, guidebook. 16 lbs.

**15 F 78319W** Complete Outfit. .... Net 199.95  
**15 F 78327L** XL-128 Camera Only. 3 lbs. .... Net 149.95  
**15 F 78335W** 2388Z Projector Only. 11 lbs. .... Net 69.95

## Kodak Film With Processing Included

You get 3½" square prints with C-126. 3½ x 4½" with C-110 and 3½ x 5" with C-135. Credit coupons for FREE film on pictures not developed. Save energy—send film by mail. Processed films return postpaid! DO NOT MAIL TO LAFAYETTE RADIO. Avg. shpg. wt. 8 oz.

### Movie Film For Super 8MM

**Kodachrome II KA-464, Indoor/Outdoor ASA40**  
**15 F 47058L** 50 feet ..... Net 4.95  
**Ectachrome-160, KLA-464, Indoor/Out. ASA160**  
**15 F 47355L** 50 feet ..... Net 5.50

### Kodachrome 35MM, Type X (ASA-64) Color Slides

**15 F 47082L** KM 135-20, 35mm, 20 Exp. Net 3.75  
**15 F 47090L** KM 135-36, 35mm, 36 Exp. Net 5.39  
**15 F 47108L** KR 126, Instamatic, 20 Exp. Net 3.75

### For Color Prints ASA-80

**15 F 47140L** C-126, Instamatic, 12 Exp. Net 3.99  
**15 F 47363L** C-110, Instamatic, 12 Exp. Net 4.19  
**15 F 47348L** C-135, 35mm, 20 Exp. Net 5.99

### Flashcubes

For standard cameras. Pkg. of 3 cubes. 3 oz.  
**15 F 26326L** ..... Net 1.29  
 Magicube Type X, for use with X cameras only. Pkg. of 3 cubes, 12 shots. Wt. 3 oz.  
**15 F 47330L** ..... Net 1.99

### GE or Sylvania Projector Lamps



We will fill your order with GE or Sylvania depending on stock. Imported. Shpg. wt. 6 oz

Stock No.	ASA Code	Net	Stock No.	ASA Code	Net
15 F 36564	CLS/CLG	4.95	15 F 36630	DEF	8.75
15 F 36572	CYC	5.05	15 F 36648	DEK/DFW	7.55
15 F 36580	CZA/CZB	7.55	15 F 36655	DFA	7.55
15 F 36739	CZX/DAB	8.00	15 F 36663	DFC/DFN	7.35
15 F 36598	DAK	6.80	15 F 36671	DFG	7.55
15 F 36606	DCA	7.55	99 F 71219	EDK	2.49
15 F 36614	DCH/DJA	7.35	15 F 36747	EGH/DYY	14.00
15 F 36622	DDB	8.35			

## GAF ST-602 Super-8 6:1 Power Zoom Movie Camera

1 Deluxe camera features pushbutton power zoom from 8mm to 48mm. Fast f/1.7 lens and automatic ASA speed range from 16-250. Three film speeds, 18, 24 and 48 fps thru-the-lens CdS electric eye with manual override, gives exposure reading plus over/under exposure warning. Thru-lens viewing. With batteries, lens shade. 3 lbs

**15 F 78343L** ..... Net 189.95

## BAIA Dual 8 Ultraviewer Editor

2 Offers giant 4½ x 6" fresnel screen with 27 square inch picture area. For use with all 8mm formats. Prismatic-type shutter allows flickerless viewing of film. Geared 3:1 for rapid rewind. Focusing and framing control plus film editing notcher and splicer. 400-ft. reel capacity. For 117 VAC, 60 Hz. Shpg. wt. 8 lbs.

**15 F 62024** ..... Net 29.95

## For Polaroid Camera Lens Set

3 Telephoto lens results in 3X area magnification. Wide angle lens increases subject area 75%. With slip-on adapter ring, viewfinder and case. Imported. Shpg. wt. 1¼ lbs. For Polaroid Models 100, 101, 103, 230, 240, 250, 340, 350, 360, and 400 series.

**15 F 49237** ..... Net 49.95

## Elevator Tripod

4 Three sections extend to 60" for still and movie camera applications. Quick column lift raises camera quickly, locks in positions. Aluminum tubular legs. Closed lgth.: 22". 3¾ lbs.

**15 F 68021** ..... Net 19.95



**\$189.95**

**\$29.95**

**\$49.95**

**\$19.95**

# Look! Fine Quality Telescopes and Binoculars

1 **\$89<sup>95</sup>**

264X with Optional Barlow Lens



5 **\$64<sup>95</sup>**

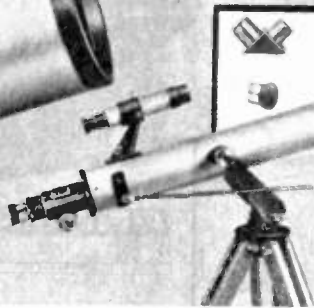

6 **\$34<sup>95</sup>**

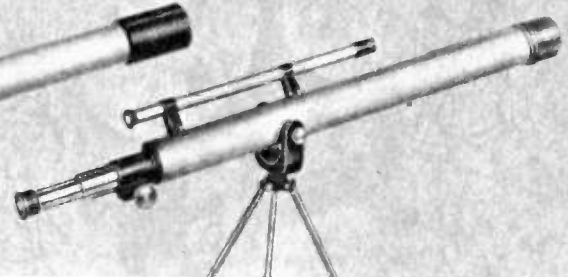

1 **\$54<sup>95</sup>**

## 1 Tru-Zoom 7-15X Binoculars

Sensational zoom action holds fast-moving objects in view. Sight-in subjects at 7-power, ZOOM to 15-power for close-up viewing! Has 40mm hard-coated achromatic objective lenses, prisms, clamped in shock-resistant mounts. Center focus, left eye adjust. Field of view is 300 ft. at 1000 yards. Alloy frame and body sealed against dust and moisture. With case, straps. Imported. 15 F 64160 Shpg. wt. 4¾ lbs. . . . . Net 54.95

## 2 7x35 Wide-Angle Binoculars

Multi-purpose binocular features wide-angle hard-coated prisms for excellent close-ups without sacrificing image, center focus and right-eye adjustment, collimated and sealed optics. Field of view at 1000 yards is 578 feet! Neck strap, storage case. Imported. 99 F 70195 Shpg. wt. 3 lbs. . . . . Net 39.95

## 3 Versatile All-Purpose Binoculars

Precision binoculars feature quality workmanship, hard-coated prisms clamped in lightweight alloy frame and body and fully sealed against dirt and moisture. Optics are properly collimated and aligned for long-term use. All below are center focus with adjustable right eyepiece, include hard-lined case and neck strap.

**Popular 7x35 Binocular.** Field of view, 367 feet at 1000 yards. Imported.

99 F 70187 Shpg. wt. 2¾ lbs. . . . . Net 26.50

**7x50 Navy-Style Night Glasses.** High light-gathering power. 372' at 1000 yds. Imported.

99 F 70161 Shpg. wt. 3¾ lbs. . . . . Net 39.95

**20x50 Long-Range Binoculars.** Great for hunters, climbers, etc. 157 feet at 1000 yards. Imported.

99 F 70203 Shpg. wt. 3¾ lbs. . . . . Net 44.95



2 **\$39<sup>95</sup>**



3 Low As **\$26<sup>50</sup>**



7 **\$24<sup>95</sup>**

## 7 6X-8X Mini-Scope

Pocket scope for 8-power viewing. Includes 6X super-wide angle objective, 24mm lens for 435' viewing area, 178mm lens for 575' at 1000 yards. With case, strap. Imported. 99 F 72159 Shpg. wt. 10 oz. . . . . Net 24.95

## 8 8-25X 30-mm Zoom Spotting Scope

Ideal for field and target use. Fingertip controls, built-in camera tripod socket, table-type tripod. Overall length, 12". Imported. 15 F 64160 Shpg. wt. 3 lbs. . . . . Net 29.95  
As above, except 13-40X. 40mm length 16". 15 F 64038 Shpg. wt. 2¾ lbs. . . . . Net 39.95



8 **\$29<sup>95</sup>**

## 4 Meteor 4" Reflector

Professionally-designed, 4" reflecting scope with achromatic optics for extremely low light loss. Aluminized and quartz overlaid primary mirror, adjustable wood 48" tripod with tray brace and optical sight, rack and pinion drive for smooth focusing. Mirror dia., 4". Focal length: 800 mm. 6, 12.5 and 25 mm Huygenian eyepieces for 32X, 64X and 132X. Resolving power: 1.4 seconds. With stand, sun filter, eyepieces. Imported.

99 F 72126W Shpg. wt. 10½ lbs. . . Net 89.95  
99 F 70542 2X Barlow Lens. 6 oz. Net 6.25

## 5 210X Astronomical Scope

60mm color-corrected lens system provides 65X to 210X magnifications with optional 1x5 erecting tube (below). Has big 5x20mm viewfinder, 800mm focal length, 65X, 90X and 140X eyepieces. Star diagonal for right-angle viewing, sun filter. Adjustable wood tripod has declination rod for vertical and fine adjustment. Resolving power, 1.93". Erecting tube (below) increases power by 50 percent and converts scope for terrestrial use. Imported.

15 F 64129W Shpg. wt. 12 lbs. . . . Net 64.95  
15 F 64137 Erecting Tube. ½ lb. . . . Net 4.95

## 6 45X Terrestrial Telescope

Easy-to-use scope for amateur astronomers, students, etc. Has fully-coated 40 mm objective lens for outstanding light-gathering power, adjustable focal length for 15X, 30X and 45X, built-in erecting system for fast and easy sighting of stars. Viewfinder for quick location, rack and pinion gear for smooth, easy focusing. Metal table tripod with rubber tips for easy placement anywhere. 27" long, 12" high. Imported.

15 F 21079 Shpg. wt. 4 lbs. . . . . Net 34.95



## 9 Pen-size Tele/Microscope

It's an 8-power telescope, a 30-power microscope! Extends to 8", collapses to 5½" and fits easily into pocket. Nickel-plate metal case. ⅝" dia. Imported.

99 F 71987L Shpg. wt. 5 oz. . . . . Net 4.79

## 10 2X Barlow Lens

Use with telescopes having eyepieces of 24.5mm (.97") O.D. and fits draw tubes of that type. Sharpens definition, reduces image distortion, provides 2X magnification. Imported.

99 F 70542 Shpg. wt. 6 oz. . . . . Net 6.25

# See? Lafayette Has Fine Optical Values!



1 \$16<sup>95</sup>



2 \$29<sup>95</sup>



4 \$29<sup>95</sup>

3 \$39<sup>95</sup>

1 **750X "Zoom" Microscope Set.** Great for students and hobbyists. Zoom action for vibration-free variable magnification without disturbing specimens, three objectives set in "click-stop" turret for 50X, 75X, 200X, 300X, 500X and 750X. Eyepiece zooms from 10X to 15X. Battery/AC Illuminator. With instructions, slides, 5-piece dissecting kit, wood carry case. Less batteries. Imported.

99 F 70450 Shpg. wt. 3 $\frac{3}{4}$  lbs. . . . Net 16.95  
99 F 62580 Battery. 2 req'd. . . Net ea. . .14

2 **Complete 900X "Zoom" Student Lab.** Features all you need to learn about fascinating microscopics. Deluxe scope zooms 50X to 900X with 3 objectives (5X, 20X and 45), and ocular (10X to 20X). Has optical condenser, plano mirror, light powered by AC or batteries. Includes tools, eyedropper, blank slides, 2 bottled specimens, slide preparation chemicals, lots more. In fitted carry case. Imported.

99 F 70252 Shpg. wt. 5 lbs. . . . . Net 29.95  
99 F 71060 Replacement Bulb. . . . . Net .25  
99 F 62580 Battery. 2 req'd. . . Net ea. . .14

3 **Complete 50X to 1200X "Zoom" Microscope Outfit.** Has zoom eyepiece for controlled detail magnification, dual knob rack and pinion coarse focus control plus fine focus, stage with optical condenser and aperture diaphragm. All-metal construction, built-in plano mirror and battery illuminator. With 2 prepared slides, 4 blank slides, spatula, scalpel, probe, scissors, tweezers and magnifying glass. Wood case with carrying handle. Less batteries.

99 F 70278 Imported. Wt. 5 lbs. . . Net 39.95  
99 F 62580 Battery. 2 req'd. . . Net ea. . .14

4 **"Micro-Dapter."** Lets you use just about any camera, even movie cameras, with telescopes and microscopes. NO NEED TO REMOVE CAMERA LENS. Image is automatically in focus for camera when viewed in focus through the Micro-Dapter. May be used with all microscopes, telescopes with up to 29mm (1 $\frac{1}{2}$ " ) eyepieces. Imported.

99 F 70807 Shpg. wt. 2 $\frac{1}{4}$  lbs. . . . Net 29.95  
"Hunting with Microscope" Book.  
10 F 60029 . . . . . Net 2.25  
10 F 60011 "How to Dissect" Bk. Net 2.25

5 **Lafayette Optical Micrometer.** Uses approx. 7-power triplet lens with etched glass reticle. Measures  $\frac{1}{2}$ -inch in 0.005" calibrations; 10mm (.2mm). Hole diameters from .005 to .05"; thickness from  $\frac{1}{8}$  to  $\frac{1}{4}$ ". Radii from  $\frac{1}{8}$  to  $\frac{3}{8}$ "; angles from 0-90°. Accurate to edge of 1" field. Adjustable focus. Leather case. Imported.

99 F 70757L Shpg. wt. 8 oz. . . . . Net 11.95

6 **Project-A-Scope.** Optical aid for students, lecturers, artists, etc. — projects large-size pictures in color or black-and-white. No film or negatives needed. Uses ordinary bulbs. 117 VAC. UL Listed.

15 F 50011 Shpg. wt. 2 $\frac{1}{2}$  lbs. . . . . Net 6.95

7 **Magni-Booster Scope/Binocular Converter.** Converts binoculars to high-powered scopes—magnifies power 2 $\frac{1}{2}$  times (7X becomes 17 $\frac{1}{2}$ X). Fits over front lens of binocular with proper locking adapter.

15 F 42018 Shpg. wt. 1 lb. . . . . Net 24.95  
Mounting Adapters for Magni-Booster. (For obj. rim dia.).  
15 F 42026 For 1 $\frac{3}{4}$ -2" O.D. 5 oz. . . Net 4.45  
15 F 42042 For 2 $\frac{3}{16}$ -2 $\frac{1}{8}$ " O.D. 6 oz. Net 4.45

## Sugar Refractometer



\$64<sup>95</sup>

• Measures % of Dissolved Sucrose in Solids

Great for wine-making, experimenting, chemistry and pathology uses; an excellent precision tool for sugar industry, canning, soft drinks, chocolate, breweries, etc. Modified abbe design — accurately measures % of dissolved sucrose in solids. Range of 0-30%. reads directly to 0.2%. Accuracy is 0.2%. With adjusting screwdriver, temperature correcting tables, leather carry case, straps. Imported.  
99 F 70369L Wt. 1 $\frac{1}{4}$  lbs. . . Net 64.95



5 \$11<sup>95</sup>



6 \$6<sup>95</sup>

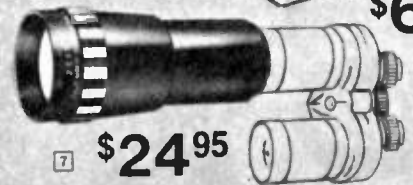

7 \$24<sup>95</sup>



Low As \$4<sup>95</sup>

**Magna-Sight-Master 3-D Magnifier.** Enables just about anyone to do close work and see it clearly. Leaves hands free, reduces eye-strain. Adjusts to any head size. Shpg. wt. 9 oz. W.D.—Working Distance.  
15 F 20055 1.75X, 14" W.D. . . . . Net 4.95  
15 F 20063 2.25X, 10" W.D. . . . . Net 4.95  
15 F 20071 2.75X, 8" W.D. . . . . Net 5.75  
15 F 20089 3.5X, 4" W.D. . . . . Net 6.50

\$13<sup>95</sup>

**Lafayette Binocular Magnifier.** Complete outfit for all kinds of close work. Three lenses provide 2X magnification for 9" working distance, 2.5X for 5 $\frac{1}{2}$ " working distance and 3X for 4 $\frac{1}{2}$ " working distance. Flip-up viewer may be worn over glasses. Imported.  
99 F 72068 Shpg. wt. 1 lb. . . . . Net 13.95



• With 3 Lenses

# Let Lafayette Lamps Shed the Light on You!



1  
**\$28<sup>95</sup>**

2  
**\$32<sup>95</sup>**

3  
**\$22<sup>95</sup>**

4  
**\$36<sup>95</sup>**

5  
**\$41<sup>95</sup>**

**Fluorescent Magnifying Lamp with 5" Diameter Glass**  
**Our Best-Selling Magnifier Lamp!**  
For precision work at home or office. Big 5" magnifier has 13" focus, 22-watt shadow-free fluorescent tube. Custom-engineered, spring-loaded arm for complete mobility, 45" reach. Good-looking desert tan finish. For 117 VAC, 60 Hz. Shpg. wt. 10 lbs.  
12 F 33543W Kit. Less Lamp . . . Net 29.95  
12 F 33550W Asmbld. Less Lamp Net 34.95  
12 F 75015 Cool White Lamp. 11 oz. Net 4.95

Kit	Assembled
<b>\$29<sup>95</sup></b>	<b>\$34<sup>95</sup></b>

1 **Fluorescent Desk Lamp**  
All-purpose lamp for drafting tables, factory benches, tables, etc. Clamps securely to surfaces up to 3" thick, spring-controlled swivel joints and double-arm action. Arm extends 36". Uses two T-18 15-watt lamps. Natural beige. For 117 VAC, 60 Hz. 7¾ lbs.  
12 F 10012W Less Lamps . . . . . Net 28.95  
12 F 10020 T8 15-W Lamp. 5 oz. Net ea. 1.75

2 **Deluxe Fluorescent Desk Lamp**  
Dual-light lamp has uniquely designed shade and inner reflector for maximum non-glare lighting, spring-balanced extension arms. Two-button starter switch, built-in AC outlet in base. 45" reach. Desert tan. With "C" clamp bracket. UL listed. Less bulbs. For 117 VAC, 60 Hz.  
12 F 33519W Shpg. wt. 10 lbs. . . Net 32.95  
12 F 10020 T8 15-W Lamp. 5 oz. Net ea. 1.75

3 **Deluxe Incandescent Lamp**  
Non-friction, spring-balanced design. Can be raised or lowered, swivels 360° and has 45" reach. Dual-shade construction reduces heat. Easily clamps on edge of table or desk. Desert tan. Accepts standard bulb.  
12 F 33527W UL listed. Wt. 5 lbs. Net 22.95

4 **Deluxe Incandescent/Fluorescent**  
For efficient office or home lighting. Separate switches control each light, spring-controlled, counterbalanced arms, AC outlet in base. Rotates 360°, extends 45". UL listed. Less bulbs.  
12 F 33535 Shpg. wt. 7¾ lbs. . . . Net 36.95  
12 F 75015 22-Watt Fluor. Lamp . Net 4.95

5 **Deluxe Fluorescent Magnifier**  
Specially designed for assembly and inspection of miniature parts, reading numbers and fine print. Spring-balanced, reaches 25 to 45", swivels 360°. 5" magnifier, uses 22-watt tube. With AC outlet in base, "C" clamp. Desert tan. UL listed. Less bulb.  
12 F 33568W Shpg. wt. 10 lbs. . . Net 41.95  
12 F 75015 22-Watt Fluor. Lamp . Net 4.95

**\$9<sup>95</sup>**

**All-Purpose Clamp-On Lamp**

- 18" Flexible "Gooseneck"
- 3-Way Mounting Clamp

Has parabolic shade, swivels a full 360°, lock nut maintains position. White enamel inside shade. For 60-watt lamps. 117 VAC, 60 Hz.  
12 F 10087 Wt. 2½ lbs. . Net 9.95

7  
**\$11<sup>95</sup>**

8  
**\$21<sup>95</sup>**

9  
**\$5<sup>95</sup>**

8  
**\$12<sup>95</sup>**

6 **Modern High-Intensity Lamp.** Has Hi-Lo selector, adj. arm. 12" high. With bulb. 117 VAC, 60 Hz. Imported.  
12 F 52527 Shpg. wt. 1½ lbs. . . . Net 5.95  
32 F 66848 Replacement Bulb . . . Net 48¢

7 **Fluorescent Desk Lamp.** Has metal base, pushbutton switch, gooseneck support. White plastic light diffuser. 11" high. With bulb. 117 VAC, 60 Hz. Imported.  
12 F 52535 Shpg. wt. 5¾ lbs. . . . Net 11.95

8 **High-Intensity Desk Lamp.** Has all-angle lamp head, spring control, extra-wide shade. Arm reach, 24". Chrome/black base. 117 VAC, 60 Hz.  
12 F 33501 Shpg. wt. 7¾ lbs. . . . Net 21.95  
12 F 75536 Replacement Bulb . . . Net 99¢

9 **Eagle Dial-a-Light High-Intensity Lamp.** Dials any degree of light from darkness to full brightness. Has telescoping arm, swivel shade, more. Folds to 3¼ x 9¼". For 117 VAC, 60 Hz. Includes bulb. UL listed.  
13 F 81318 Shpg. wt. 2½ lbs. . . . Net 12.95  
32 F 66475 Replacement Bulb . . . Net 48¢

**\$6<sup>95</sup>**

**Under-Cabinet Fluorescent Lamp**

- Has AC Outlet, Too

For shop, kitchen, etc. Has white plastic diffuser, pushbutton switch, cord and plug. With 15-watt bulb. 18¼ x 3¾ x 1¼". 117 VAC, 60 Hz.  
12 F 16050 Wt. 2¾ lbs. . . . Net 6.95  
12 F 10020 Repl. Bulb. 5 oz. Net 1.75

# Hearing Aids, Headphones and Accessories

## 1 Sub-miniature Hearing Aid

• 2½" L x 1½" W x ¼" D • Only 2 Ounces

Features an advanced 4-transistor circuit, wide-range volume control, crystal mike, magnetic earphone, and a 4-position tone converter control. With 3 tiny ear plugs, 3-ft. flexible cord, leather case, battery. Imported.  
 99 F 90680L Shpg. wt. ½ lb. . . . . Net 38.95  
 32 F 46754 Burgess N-Type Battery . . . . . Net .10  
 99 F 90696 Extra Plug-in Cord . . . . . Net .99  
 99 F 90706 Extra Earphone . . . . . Net 2.49

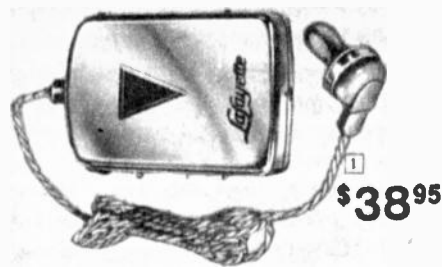

\$38.95

## 2 Behind-the-Ear Hearing Aid

• Self-Contained • Weighs Only ½ oz.

All components in flesh-colored, high-impact case, worn behind the ear. Independent on/off switch, volume control. Operates 8-10 hours on rechargeable nickel cadmium cell (2 included); 80-100 hours on mercury cell. With battery charger that works overnight. Imported.  
 99 F 90722L Shpg. wt. 9 oz. . . . . Net 79.95  
 32 F 47467 Nickel Cadmium Cell . . . . . Net 1.73  
 32 F 46863 Pkg. of 6 Mercury Cells . . . . . Net 2.34

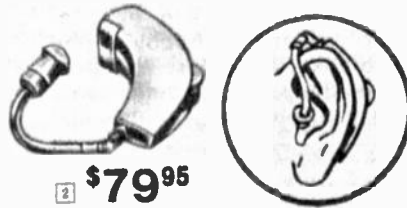

\$79.95



\$3.49

\$6.50

\$3.99

The Hearing Aids Shown Above (99 F 90680L and 99 F 90722L) are Available for Sale Only in Those States Where Licensing is Not Required by Law.

## 13 Private Radio-TV Listener

Installs easily, allowing normal use of TV or radio while adding controllable earphones or extension speakers up to 17 feet away. Imported.  
 99 F 91720 With 1 Earphone. Wt. 5 oz. Net 3.49  
 99 F 25466 Extra Earphone. Wt. 4 oz. . . . . Net .99  
 99 F 25496 10-Ft. Extension Cord. 3 oz. Net .99

## 14 Silent TV Viewing Remote Control

Control box has volume control, speaker on-off switch, 2 sets of jacks, 20-ft. cable. With earphone and its own 3-ft. cord. Only 3½"x2x1½".  
 13 F 09012 Shpg. wt. 1¼ lbs. . . . . Net 6.50  
 99 F 25488 Extra Earphone. Wt. 4 oz. . . . . Net .99

## 15 Unique Sound Shell Earphone

Wide-range (30-14,000 Hz) speaker in a specially designed sound shield. Fits comfortably. 8 ohms. 4½-ft. cord. ¼" dia. plug. Imported.  
 99 F 26146 Shpg. wt. ¼ lb. . . . . Net ea. 3.69

## 16 Quality Pillow Speaker

Outstanding tone for both music and speech reproduction. 2½" dia. round ivory plastic case is ⅝" thick. 8-ft. cord, ¼" plug and jack. 6 ohms. Plugs into radio or TV. Imported.  
 99 F 90128 Shpg. wt. 8 oz. . . . . Net 1.99  
 99 F 25496 10-ft. Extension. Wt. 3 oz. . . . . Net .99

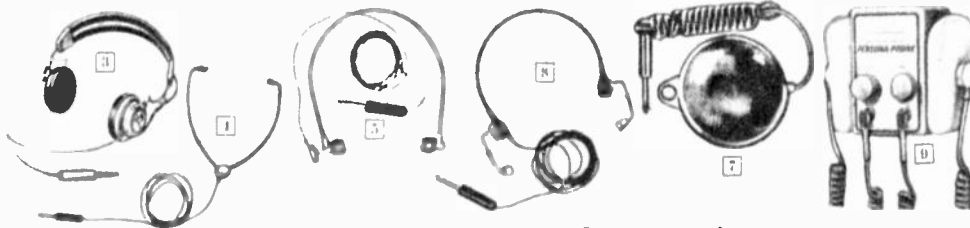

## Telex Headphones and Accessories

3 Telex Teleset. Lightweight (8 oz.) headset. 50-10,000 Hz. 5-ft. durable cord. Wt. 1 lb.  
 40 F 59010 Impedance: 2000 ohms. . . . . Net 19.45  
 40 F 59028 Impedance: 500-600 ohms Net 19.45

4 Telex Monoset. Under-chin headset. Adjustable arms. 50-5000 Hz. 5-ft. cord. Wt. 7 oz.  
 40 F 59044 125-Ohm Model HMV-2 . . . . . Net 10.25  
 40 F 59051 2000-Ohm Model MHY-2 . . . . . Net 10.25

1 Telex Dynaset. Versatile lightweight headset. Magnetic driver element. 5-ft. tubing with phone plug. 50-5000 Hz. Shpg. wt. 7 oz.  
 40 F 59069 Model HUP-01 . . . . . Net 13.30

5 Telex Twinset. No ear pressure. Only 1.6-oz. 5-ft. cord, standard phone plug. Shpg. wt. 7 oz.  
 40 F 59085 500-Ohm Model HTW-2 . . . . . Net 16.45

6 Telex Tele-Fi. One millsec. delay to ear opposite speaker creates depth. 5-ft. cord. 8 oz.  
 40 F 59101 15-Ohm Model HFR-91 . . . . . Net 6.55  
 40 F 59127 500-Ohm Model HFW-91 . . . . . Net 6.55  
 40 F 59143 2,300-Ohm Model HFY-91 . . . . . Net 6.55

7 Telex Dynamic Pillow Speaker. Safe, with no complicated wiring necessary. Stainless steel, moisture-proof housing. 3¾"D x 1½" max. thickness. 5-ft. cord, phone plug. Wt. 12 oz.  
 40 F 59200 3.2-Ohm Model SDN-2A . . . . . Net 6.85

8 Telex Persons-Phone. Private listening in churches, libraries, etc. Volume controls with 2 shell-type, 1½-oz. earsets. 5-ft. cords. May use with 70V, 25V or 8-ohm sound systems.  
 40 F 59507 Shpg. wt. 4 lbs. . . . . Net 35.70

## C.F. Cannon & Superex Headphones

9 C.F. Cannon "Cannon-Ball" Single Headset. Single efficient phone with spring steel headband, 4½-ft. cord, 1000 ohms DC. Wt. 6 oz.  
 40 F 81046 AM-15-1 . . . . . Net 1.75

10 C.F. Cannon Brandes "Admiral" Headphones. Large diaphragms, double coils, chrome steel magnets. Adjustable headband. 4½" cord.  
 40 F 81097 BA-5—5000 Ohms. ¼ lbs. . . . . Net 3.89

11 Replacement Cushions. Soft rubber cushion fits most standard headphones. Wt. 5 oz.  
 40 F 95325 . . . . . Net 90¢

12 Superex Sensiphones. Double alnico V magnetic coil assemblies for high sensitivity, clear response. Adjust. headband. 2000 ohms.  
 40 F 85023 Shpg. wt. 10 oz. . . . . Net 3.95



40 F 59291 Spade and pin tip . . . . . Net 90¢  
 40 F 59309 Pin tip both ends . . . . . Net 90¢  
 Heavy plated tips. Takes up to No. 18 wire.  
 32 F 85244 1"L, 2 oz. . . . . Pkg. of 10, Net 25¢

## Replacement Cords & Tips

Sturdy copper conductor replacement cords with cotton insulation; 4½ ft. long. Double phone cord. Shpg. wt. 3 oz.

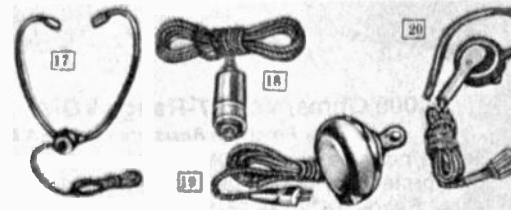

17 Crystal Headset. Lightweight, fits under the chin. High sensitivity and high impedance. With 3-ft. cord. Imported.  
 99 F 25504 Shpg. wt. 3 oz. . . . . Net 2.59

14 Extension Cord for Miniature Headphones. 10-ft. cord with ¼" dia. mini plug at one end, matching socket at other. Imported.  
 99 F 25496 Shpg. wt. 3 oz. . . . . Net .99

19 Earphone for Transistor Circuits. Powerful efficient magnet. AC Imp. 6700 ohms; DC resist. 3000 ohms. Ear plug. 3-ft. cord. ¼" dia. plug.  
 40 F 76010 Imported. Wt. 2 oz. . . . . Net 2.95

20 All-Purpose Dynamic Earphone. For radio & TV listening, etc. 6 ohms. 3-ft. cord. Imported.  
 99 F 25488 ½" dia. plug. Wt. 3 oz. . . . . Net .99  
 40 F 79018 ¾" dia. plug. Wt. 3 oz. . . . . Net .99

# Lafayette VOM's and Multitesters... Depend On Us!



Sure, accurate and easy-to-use testers for hobbyist and pro alike. All feature excellent sensitivity, most useful ranges, easy-to-read meters and scales. Bench, portable or pocket-size, there's one for your needs and budget!



**50,000 Ohms/Volt FET VOM—Our Best!**

**\$59<sup>95</sup>**

- Measures DC Volts, AC p-p and RMS Volts, DC Current, Ohms and dB
- 5½" Meter with Mirrored Scale

Has the high-impedance of a VTVM, the versatility and portability of a VOM. Low-voltage ranges for transistor work, high sensitivity (2500 mV full scale) for transistor bias measurements to 2000 meg. Overload protection, battery check, "zero center" for null measurements. ±2% DC, ±3% AC Accuracy. Reads DCV: 0.3-1.2-12-30-120-300-600. ACV: 0-3-30-120-600 (RMS), 0-8-80-320-1600 (P-P). DC Current: 0.12-1.2-12-120 mA—1.2A. Ohms: X1-X10-X100-X10k-X1 meg. —20 to +56 dB. With battery, leads, instructions. 4½ x 2 x 6¼". Imported.  
99 F 50833 Shpg. wt., 2½ lbs. . . . . Net 59.95

**50,000 Ohms/Volt VOM—Lab Quality!**

**\$44<sup>95</sup>**

- Measures AC and DC Volts, DC Current, Ohms and dB
- 5½" Meter with Color-Coded Scales

Precision multi-tester uses 1% resistors for outstanding accuracy of ±2% DC and ±3% AC. Has shielded meter movement, overload protection, polarity switch. Reads DCV: 0-0.25-2.5-10-50-250-1000 @ 25k ohms/volt; 0-0.125-1.25-5.0-25-125-500 @ 50k ohms/V. ACV: 0-3-10-50-250-1000 @ 2.5k ohm/V, 0-1.5-5.0-25-125-500 @ 5k ohms/volt. DC Current: 0-25µA-2.5-25-250mA-5A at 125 mV, 0-50µA-5-50-500mA-10A at 250 mV. Ohms: 0-2k-10k-100k-1-10 meg. —20 to +81.5 dB. 6½ x 2¾ x 5¼". With batteries and leads. Imported.  
99 F 50767 Shpg. wt., 3 lbs. . . . . Net 44.95



**\$32<sup>95</sup>**



**\$24<sup>95</sup>**



**\$19<sup>95</sup>**



**\$9<sup>95</sup>**

**1 30,000 Ohms/Volt 27-Range VOM**

- 1% Precision Resistors • 33-µA Movement

Deluxe portable bench VOM has 4" meter with mirrored scale, overload protection, low-voltage scale, special "buzzer" for fast short tests. Reads DCV: 0-.25-1-2.5-10-25-100-250-1000. ACV: 0-2.5-10-25-100-250-1000. DC Current: 0-0.05-5-50-500 mA, 0-12 A. Ohms: X1, 0-60k-6-60 meg. —20 to +56 dB. With leads, batteries. 4¼ x 6¾ x 2¾".  
99 F 50841 Shpg. wt., 2¼ lbs. . . . . Net 32.95  
38 F 01081 Carrying Case for Above. 5 oz. . . . . Net 2.95

**3 20,000 Ohms/Volt 17-Range Multitester**

- 1% Precision Resistors • 40-µA Movement

Handy tester has a large 2-color 3" meter, overload protection, 1% precision resistors. Reads DCV: 0-3-30-60-300-600-3000. ACV: 0-6-60-120-1200. DC Current: 0-60 µA, 0-12-300 mA. Ohms: 0-60k-6-60 meg.—20 to +63 dB. Has single function/range knob, uses 1% precision resistors. With battery, leads. 4¼ x 1 x 3¼". Imported.  
99 F 50726 Shpg. wt., 1 lb. . . . . Net 19.95  
38 F 01073 Carrying Case for Above. 5 oz. . . . . Net 2.95

**2 Deluxe 20,000 Ohms/Volt 21-Range Multitester**

- 1% Precision Resistors • 40-µA Movement

Has mirrored scale, most-needed ranges for fast checks of all types of equipment. Reads DCV: 0.6-6-30-120-600-1200. ACV: 0-6-30-120-600-1200. DC Current: 0-60 µA, 0-6-60-600 mA. Ohms: 0-10k-1000k-1M-10 meg.—20 to +63 dB. 200 mmF to 0.2 mfd capacity. Has overload protection, zero adjust more. With batteries, leads. 3¾ x 1¾ x 5½". Imported.  
99 F 50734 Shpg. wt., 1½ lbs. . . . . Net 24.95  
38 F 01073 Carrying Case for Above. 5 oz. . . . . Net 2.95

**4 Our "Super-Mini" VOM—2½ x 1½ x 3½"**

Handy little tester for hobbyists and hi-fi buffs. Has 10 ranges, easy-to-read meter with color-coded scales, 1% resistors for good accuracy. Perfect for testing electrical wiring and appliances, making quick checks on audio equipment, etc. Reads AC/DCV: 0-10-50-250-1000. 1-100 DC mA; ohms to 150k. With battery, leads. Imported.  
99 F 50957 Shpg. wt., 10 oz. . . . . Net 9.95  
99 F 50809 Carrying Case for Above. 5 oz. . . . . Net 2.95



# Our Best Name-Brand VOM's & Multitesters!

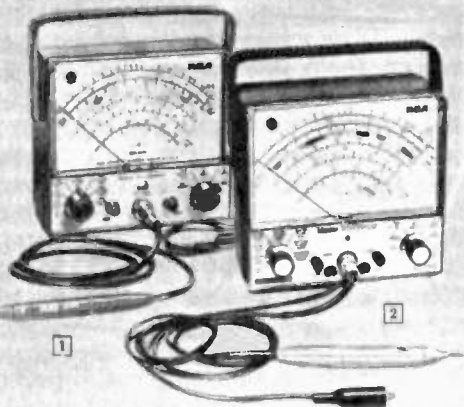

**1 RCA WV-98C Senior Voltohmmyst**  
**\$109<sup>00</sup>** • AC/DC Accuracy:  $\pm 3\%$   
 • Measure AC p-p Volts  
 • Precision 1% Resistors

Has 6½" meter with 200  $\mu$ A movement, burnout protection. Measures DCV to 1500; ACV rms to 1500; ACV p-p to 4200; ohms to 1000 meg. 11 meg DC input res. With switchable probe. 7 x 6½ x 3¾". For 117 VAC. 38 F 46102 Shpg. wt., 7¾ lbs. . Net 109.00

**2 RCA WV-510A Master Voltohmmyst**  
**\$139<sup>00</sup>** • Solid-State Circuit  
 • 0.01 DC Volt Range  
 for Transistor Work

Has 21-meg input resistance to minimize circuit loading,  $\pm 3\%$  AC/DC accuracy. Measures DC volts to 1500; DC current to 1.5 A; ACV rms to 1500; ACV p-p to 4200; ohms to 1000 meg. With probe, clip leads. 6¾ x 5¼ x 3¾". For 117 VAC. 38 F 46482W Shpg. wt., 7¼ lbs. . Net 139.00

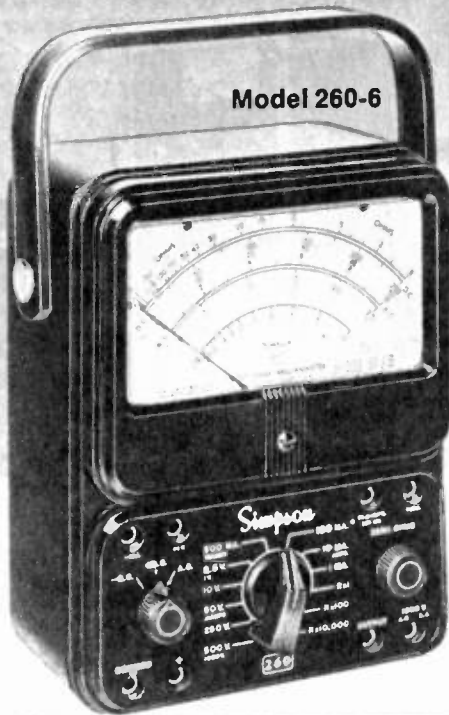

**ADD-A-TESTERS for 260 and 270 SERIES**  
 For AC/DC VOMs made since 1947 except ROLL TOP models. 2¾ lbs.

Stock No.	Model	Type	Net
38 F 48108	650	Transistor Tester	49.50
38 F 48124	652	Temperature Tester	55.00
38 F 48132	653	AC Ammeter	35.00
38 F 48140	654	Audio Wattmeter	37.50
38 F 48181	661	DC Ammeter	35.00

**ACCESSORIES for SIMPSON 260 & 270 VOMs**

Stock No.	Model	Description	Wt.	Net
38 F 48066	01818	Leather Case	1½	16.05
38 F 48074	07500	Leads†	½	3.90
38 F 48082	00509	50KV HV Probe	1	21.00

38 F 48611 SIMPSON 92-PAGE BOOK: "1001"  
 USES OF THE 260 SERIES VOM . . . . Net 1.00

## Simpson AC/DC VOM

Low As **\$74<sup>50</sup>**

- 20,000 Ohms/VDC, 5000 Ohms/VAC Sensitivity
- Accuracy:  $\pm 2\%$  DC,  $\pm 3\%$  AC
- 50  $\mu$ A Self-Shielding and Shockproof Movement

Features 0-1 volt DC range, 0-500 volt AC and DC ranges, external access battery and fuse compartment, DC polarity switch, full wave bridge rectifier for fast readings. Ranges: DC mV, 0-250; AC and DC volts, 0-1, 2.5-10-50-250-500-1000; AF output V., 0-2.5-10-50-250; DC  $\mu$ A, 0-50; DC mA, 0-1-10-100-500; DC amps., 0-10; dB, -20 to +50 in 4 ranges; Resistance, 0-20 megs in 3 ranges. Housed in bakelite case, 5¼ x 7 x 3¾". With battery and test leads. 38 F 48710 Shpg. wt., 4½ lbs. . . . Net 74.50

**Simpson MODEL 260-6P** — Same as Model 260-6, but has special sensor circuit to prevent burnouts. 38 F 48702 Shpg. wt., 4 lbs. . . . Net 112.00

**Simpson MODEL 260-6PRT** — Same as above, but with "roll top" safety case. 38 F 48728 Shpg. wt., 7¾ lbs. . . Net 120.50

**Simpson MODEL 270-4** — Same as Model 260-6, but with mirror scale, knife edge pointer, self-shielded annular meter. Accuracy:  $\pm 1.25\%$ ,  $\pm 3\%$  AC. 5¼ x 7 x 3¾". 38 F 48736 Shpg. wt., 4½ lbs. . . Net 93.00

**Simpson MODEL 270-4RT** — Same as Model 270-4 but with "roll top" case. 38 F 48744 Shpg. wt., 7¾ lbs. . . Net 101.50

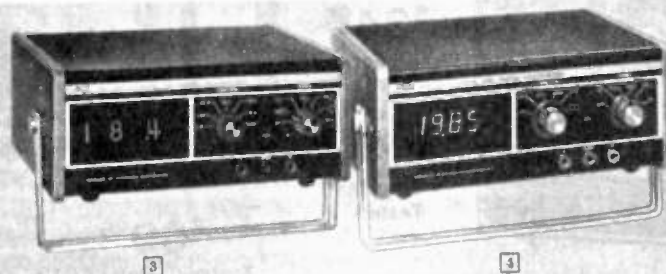

**3 B&K Model 281 2½-Digit Display Multimeter.** High-accuracy VOM has polarity reversal switch, 10 megohm input impedance, positive over-range indication, bench-type case with handle/stand.  $\pm 1\%$  accuracy on DC volts. 32 ranges. Reads DCV to 1500; DC current to 1 A (1.5% acc.); AC rms volts to 1000 (1500 peak); ohms to 10 meg. 3½ x 7 x 9". With leads and probe. For 117 VAC. 38 F 17384W Shpg. wt., 5 lbs. . . . . Net 169.95

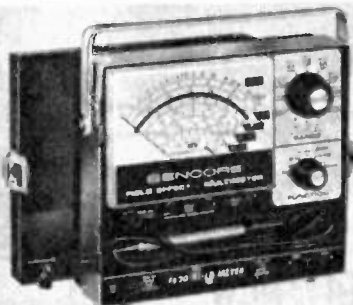

**4 B&K Model 282 3½-Digit Display Multimeter.** High resolution digital VOM features 0.25% accuracy on DC volts; 100% over-range capability on all ranges, automatic polarity and decimal positioning. Reads DCV to 1000; ACV rms to 1000; DC current to 1 A; AC current to 1 A; ohms to 10 meg. PR-21 probe has switchable 100k resistor. 10 meg. input impedance. With case, leads. 3½ x 7 x 9". For 117 VAC. 38 F 17467W Shpg. wt., 4 lbs. . . . . Net 199.95

**5 Sencore FE-20 Hi-Lo FET Multimeter.** Has 15 meg input resistance on DC, 12 meg on AC. 9 DC zero center ranges (.05 to 500 V) for transistor bias; AC rms ranges from 1/10 to 1000 V. 1.5% DC, 3% AC accuracy. Low-voltage DC ranges from 1/10th V to 1000; high ranges at 3, 10 and 30 kV. Reads ohms to 1000 meg; DC current to 1 A; Has battery test; overload protection. With HV probe, ess batteries. 9½ x 7¾ x 3¾". 38 F 53371W Shpg. wt., 9 lbs. . . Net 150.00  
 99 F 63687 Batteries. Use 7 . . . Net ea. .25

**6 Mercury Model 4000 FET VOM.** Combines the best features of a VOM and a VTVM— isolation from AC line, no warm-up time, no drift. Wide visibility meter, burnout protection. 27 ranges. Reads DC volts to 1000; AC volts to 1000 (10 Hz to 1 MHz,  $\pm 1$  dB). Ohms to 1000 meg; DC current to 1 A. DC accuracy,  $\pm 3\%$  full-scale; AC,  $\pm 5\%$ . DC input resistance, 11 meg. Operates on 117 VAC or 9-volt battery for more effective isolation if needed. With probe, leads. 7½ x 6½ x 4". 38 F 37234 Shpg. wt., 5 lbs. . . . . Net 89.95

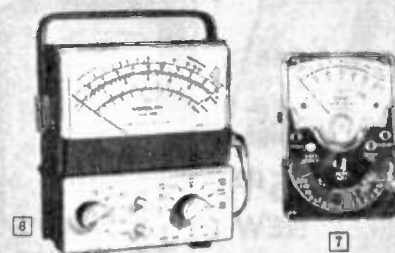

**7 Triplet Model 310 Pocket VOM.** "Pro"-quality for easy in-the-field checks. Has 10 meg DC input resistance, zero center for null measurements, high sensitivity for transistor bias checks. 3% DC, 4% AC accuracy. Polarity reverse. Reads DCV, 0.3-600; ACV, 3-600; 0-50 meg; 0.2 to 1.2 DC mA at 300 mV. With leads, battery. 00x00x00". 38 F 72009 Shpg. wt., 1 lb. . . . . Net 82.00  
 38 F 73072 Add-on Ammeter for above. Reads to 300 Amps. Wt., 1 lb. . . . Net 22.00  
 38 F 73080 Case for 310/10. 12 oz. Net 10.20

# Look to Lafayette for Value-Proven Test Equipment

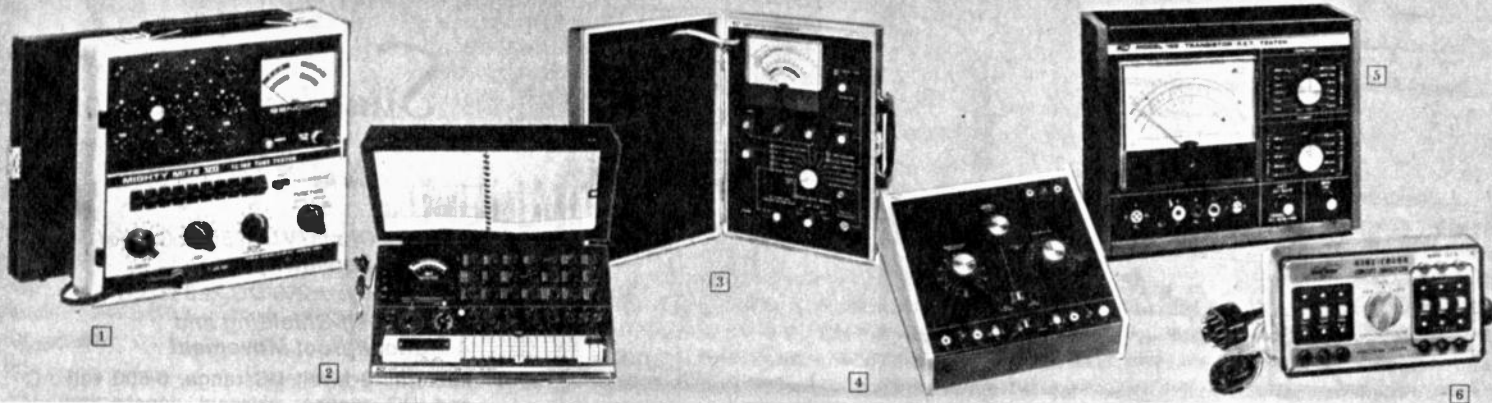

## 1 Sencore Mighty Mite Tube Tester

**\$120<sup>00</sup>** • Tests Over 3,000 Tubes  
• Stethoscope Shorts Tests

TC162. Solid-state unit with FET's tests virtually every tube type, with pin elimination switches. Checks for shorts, grid emission, gas, leakage to 100 megs. 115 VAC. 10 x 9 x 3½".  
38 F 53348W Shpg. wt. 10 lbs. . . . . Net 120.00

## 2 B&K Dynamic Gm Tube Tester

**\$259<sup>95</sup>** • Tests All Tubes with True Dynamic Mutual Conductance

727B. Has "Jet-Check" section for popular tube types; programmed section for less popular types. Checks shorts, leakage, emission, gas, life expectancy. Solid-state. 5¼ x 20½ x 11½".  
38 F 17491WX Shpg. wt. 12 lbs. . . . . Net 259.95

## 3 B&K CRT Tester/Rejuvenator

**\$139<sup>95</sup>** • Checks and Rejuvenates CRT's In the TV Set

466. Checks color or B&W CRT's for leakage, shorts, opens, emission. Rejuvenates virtually all CRT's with "monitored rejuvenation." Has "Super-Rejuvenate." 115 VAC. 13¼ x 9½ x 5¾".  
38 F 17327WX Shpg. wt. 8 lbs. . . . . Net 139.95

## 5 B&K Transistor/FET Tester

**\$109<sup>95</sup>** • Read Beta, Gm and Leakage Directly on 4½" Meter

162. Tests transistors and FET's in-circuit and out-of-circuit. Go-No Test tells instantly if device is defective. Checks diodes, unijunctions, SCR's, etc. With batteries. 7¼ x 9 x 4".  
38 F 17483W Shpg. wt. 7¼ lbs. . . . . Net 109.95

## 4 B&K Semiconductor Curve Tracer

**\$139<sup>95</sup>** • Compatible with All Scopes  
• Includes Probe, Cables

501-A. Makes fast analysis of semiconductor condition by displacing its curve on the screen of an auxiliary scope. Measures gain (beta), leakage, breakdown voltage, etc. 4 x 10 x 9½".  
38 F 17376WX Shpg. wt. 6 lbs. . . . . Net 139.95

## 6 Color CRT and Circuit Analyzer

**\$19<sup>95</sup>** • Instant Hook-up for Analyzing, Testing and Adjusting

Hooks up instantly to test CRT and associated circuitry under actual operating conditions. Each color gun has its own switch. Pin jacks for voltage, current tests. 6¼ x 3¾ x 2".  
38 F 14019 Shpg. wt. 1¼ lbs. . . . . Net 19.95



**\$135<sup>00</sup>**  
**NEW**

## 7 Hickok 215 Pocket Semiconductor Tester

• Easy to Use and Carry  
• Instant Good/Bad Analysis

Fast and easy to use—no need to look in the book to find emitter, base or collector leads. Just connect it to leads in any order, in or out of circuit. The 215 instantly and automatically determines the lead configuration and indicates Good or Bad in bright LED display. If Good, it identifies which lead is the base, and whether device is PNP or NPN. Also tests SCR's and unijunctions. Uses 9V battery (not incl.). With test leads.  
38 F 36103L Wt. 1 lb. . . . . Net 135.00  
224 Lafayette Cat. No. 750

**\$14<sup>75</sup>** NEW

**\$54<sup>95</sup>** NEW

## 8 Mercury 1750 AC VTVM

• Measures Audio Circuits, Low-Level AC

High-sensitivity VTVM will check or measure audio circuits and low-level AC voltages. Considerable negative feedback assures stabilized operation. Ten ranges, from 0-0.1 to 0-300 V rms; dBm, -40 to +50. Calibrated to 0 dB = 1V and 0 dB = 1 mW = 0.775V across 600 ohms.  
38 F 37259 Shpg. wt. 7 lbs. . . . . Net 54.95

## 9 RCA Transistor/Diode Checker

• Checks In-Circuit or Out-of-Circuit  
• Connects to General-Purpose Scope

WC-528B. Fast way to check transistors and diodes—even resistors and capacitors. Distinctive Quicktracer waveform indicates at a glance whether the component is functioning properly. Connects easily to scope. Detailed application manual. 4 x 2¾ x 1¾".  
38 F 46516 Shpg. wt. 1 lb. . . . . Net 14.75

## Tube & Transistor Checker

**\$34<sup>95</sup>**  
Kit Form

**\$49<sup>95</sup>**  
Wired and Tested



**\$39<sup>95</sup>**

Tests 90° Color CRT's

## 10 Lafayette Tube/Transistor Checker

• Easy-to-Build Kit—Or Wired and Tested

Easy, step-by-step wiring and assembly instructions. Tests compactrons, novistors, novars and 10-pin tubes in addition to standard types. Checks shorts, leakage, intermittent; quality check on 3-color meter. With batteries, ring-bound manual. 110 VAC. 8½ x 7½ x 4".  
38 F 01123W Kit Form. Shpg. wt. 4½ lbs. . . . . Net 34.95  
38 F 01131 Wired and Tested . . . . . Net 49.95

## 11 "Pix-Mate" CRT Tube Tester

• Quickly Checks All 90° Color CRT's

Features: emission test for each gun; test for leakage and shorts; easy-to-read 3-color scale; positive fast readings; line adjustment. 110 VAC. 8¼ x 5 x 4".  
38 F 29009 Shpg. wt. 4 lbs. . . . . Net 39.95  
CR-90/70 Adapter for testing 70° color CRT's.  
38 F 29017 Shpg. wt. 8 oz. . . . . Net 4.95

No Money Down—See Page 4 for Lafayette's Easy-Credit Plan (Minimum Order \$30.00)

# Signal Generators and Scopes for TV Servicing

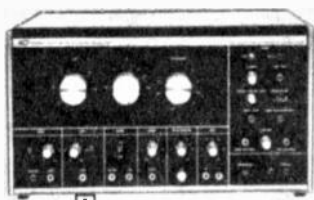

1 \$454<sup>00</sup>

**1 B&K MODEL 1077B COLOR AND B&W TV ANALYST.** Lets you inject your own signals at any stage in the TV set, and watch the generated pattern on the picture tube. Eight VHF RF channels, UHF, 20-45 MHz IF, audio, video sync, 3 color adjustment patterns, AGC keying pulse. 105-125 VAC. With leads. 17 x 10 1/4 x 10".

38 F 17301WX Shpg. wt. 31 lbs. ....Net 454.00

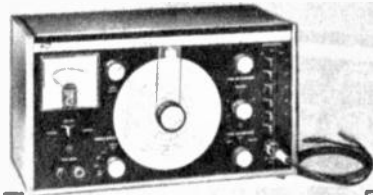

2 \$229<sup>00</sup>

**2 DELUXE B&K MODEL 200D SOLID-STATE RF GENERATOR.** Range: 100 kHz to 54 MHz on fundamentals, 54-216 MHz on harmonics. Built-in crystal calibration. Easy-set 2-color 5" vernier dial. Accuracy better than 0.1%. 110-130 VAC, 50/60 Hz. 12 3/4 x 7 1/4 x 8"D.

38 F 17319WX Shpg. wt. 16 lbs. ....Net 229.00

**3 RCA MODEL WR-50B RF SIGNAL GENERATOR.** Provides tunable RF output from 85 kHz to 40 MHz in 6 ranges on fundamentals; CW or modul. RF. 400 Hz oscillator; sweep output; 2% dial accuracy. 105-130 VAC. 5 1/2 x 7 3/4 x 4 3/4".

38 F 46318 Shpg. wt. 7 1/4 lbs. ....Net 89.90



4 \$89<sup>90</sup>

**4 LEADER MODEL L8G-15 RF WIDEBAND SIGNAL GENERATOR.** Quickly locates problems in tuner, IF, video and color circuits. Uses FET's for ultra-stable performance. Range: 120 kHz to 150 MHz; up to 450 MHz on harmonics. Accurately calibrated dial. Internal 400 Hz/1 kHz modulation; up to 1V output for audio test. Crystal oscillator for 1-15 MHz (crystal not included). Output: 100,000  $\mu$ V approx. with fine attenuator and high-low switch. Also functions as marker generator. RF cable. 7 x 11 1/2 x 5 1/2".

38 F 40089 Shpg. wt. 5 lbs. ....Net 109.95

**5 LEADER MODEL LAG-25 SINE/SQUARE WAVE GENERATOR.** Perfect for testing sensitive hi-fi equipment. Offers low-distortion sine wave and fast-rise square wave; plus complex wave output for I-M distortion checks. Range: 2 Hz to 200 kHz in 4 decade bands. Calibration accuracy:  $\pm$ 3% (+2 Hz). Drift: less than 1% for 5% change in line voltage. Can synchronize from ext. source. 115 VAC. 7 x 11 1/2 x 5 1/2".

38 F 40097 Shpg. wt. 5 lbs. ....Net 129.95



4 \$109<sup>95</sup> NEW

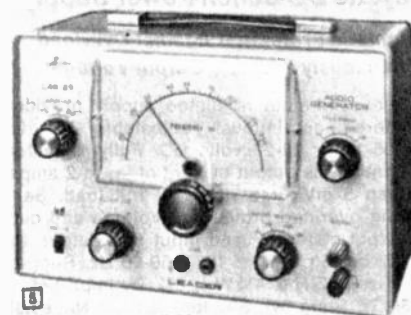

5 \$129<sup>95</sup> NEW

## Color TV Signal Generators



Pocket Size  
4

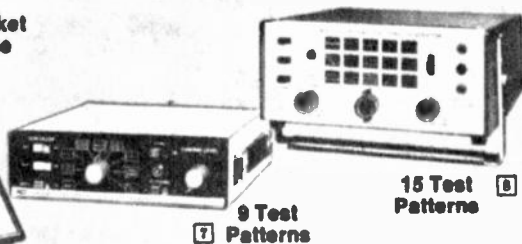

7 9 Test Patterns

8 15 Test Patterns

**4 NEW! Hickok 239 Pocket Color Bar Generator**

\$115<sup>00</sup>

- Only Two Matrix Switches to Select 9 Patterns
- Pocket Size—Only 5 1/4 x 3 3/4 x 1 1/2"

Battery-operated, with crystal-controlled RF and chroma oscillators. Chroma level adjustable from 0-150%. RF adjustable from Chs. 2 thru 4. Exclusive MOS/LSI circuit chip for stability, reliability. Adjustable RF: channels 2-4. Shpg. wt. 1 lb.

38 F 36111 .....Net 115.00  
99 F 63729 9V Battery for above (2 required) .....Net ea. .49

**7 B&K 1246 I.C. Digital Color Generator**

\$156<sup>00</sup>

- Produces 9 Testing Patterns
- Red, Blue and Green Gun Killers

Checks convergence, color, linearity, size, focus. RF output: crystal-controlled Ch. 3 (61.25 MHz) and Ch. 4 (67.25 MHz), both  $\pm$ .005%. Line width: 54  $\mu$ s horiz., vertical preset to .25  $\mu$ s. 117 VAC. 2 1/4 x 7 x 10 3/4".

38 F 17428W Shpg. wt. 5 lbs. ....Net 156.00

**8 Leader LCG-388 Color Bar Pattern Generator**

\$199<sup>95</sup>

- Produces 15 Patterns Including Single Dot and Single Cross

Trigger pulses to sync. scope; composite video signals. Gun killers for purity, convergence adjustments. Chroma level: 0-200% adjustable. Outputs: RF chans. 5 & 6; color bars; gated, R-Y, B-Y, —(R-Y) rainbow; dots; single dot; crosshatch; single cross; line. 105-125 VAC. 3 1/2 x 7 3/4 x 7 3/4".

38 F 40006WX Shpg. wt. 6 1/2 lbs. ....Net 199.95

Lafayette—Your "Single-Trip" Source for Everything in Electronics

## Precision Oscilloscopes

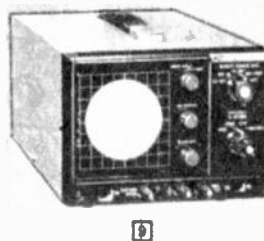

9



10

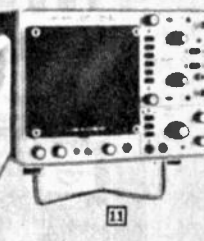

11

**9 B&K Model 1403 Solid-State 3" Scope**

\$189<sup>95</sup>

- Ultra-Compact, Lightweight—5 1/4 x 7 3/4 x 11 1/2"
- For Field Service, Production, Schools

Rugged "mini-scope" has smoked acrylic graticule for sharp trace. DC to 2 MHz bandwidth. Vertical amp: 20 mV/cm or better sensitivity. Horiz. amp: 500 mV/cm or better, DC to 250 kHz. 117-234 VAC, 50/60 Hz. With leads.

38 F 17459W Shpg. wt. 10 lbs. ....Net 189.95

**10 B&K 1460 Triggered Sweep 5" Oscilloscope**

\$450<sup>00</sup>

- 19 Sweep Positions Plus TV-H and TV-V
- DC to 10 MHz Bandwidth • Solid-State

Vertical amp: 10-20 mV/cm in 11 ranges DC to 10 MHz. Horizontal amp: 300 mV/cm; DC to 600 kHz (—3 dB). Sweep: 0.5  $\mu$ s/cm to 0.5 sec/cm in 19 ranges. With tilt stand, mylar overlay. 117-234 VAC, 50/60 Hz. 9 x 10 x 7".

38 F 17434WX Shpg. wt. 25 lbs. ....Net 450.00

38 F 17442 PR-20 10:1 Probe with clip-on tip .....Net 19.95

**11 Leader LBO-505 Solid-State Dual-Trace 5" Scope**

\$669<sup>95</sup>

- With 2 Direct Lo/Cap Probes, 2 Terminal Adapters, One Set of Test Leads

For the demanding technician. Triggered/automatic sweep. DC to 15 MHz bandwidth, 4 cm deflection; 10 mV p-p/cm vert. sensitivity. 10X magnification. Separate or simultaneous sweep display. 115-230 VAC. 7 1/2 x 9 1/2 x 15".

38 F 40071XY Shpg. wt. 17 1/2 lbs. ....Net 669.95

Lafayette Cat. No. 750 225

# DC Power Supplies and Test Equipment



**\$69<sup>95</sup>**  
Lafayette



**\$175<sup>00</sup>**

**Regulated DC Power Supplies**

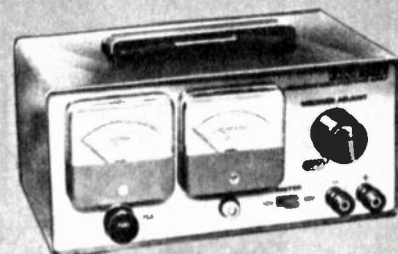

EICO KIT **\$49<sup>95</sup>**

## Lafayette DC Bench Power Supply

- Automatic Protection Against Overload
- Continuously Variable Output Voltage

Lab-type solid-state regulated supply provides well-filtered, continuously adjustable DC output of 5-13 or 12-20 volts DC. Fully-regulated with continuous output current of up to 2 amps, less than 5 mV RMS ripple at full load. Self-restoring overload protection. Voltage and current output meters. Fused input and output. Input: 115 or 230 VAC  $\pm$  10%, 50-60 Hz. Rugged steel case, 6 1/2" H x 4 1/2" W x 8 3/4" D. Imported.

99 F 50775 Shpg. wt. 8 1/2 lbs. .... Net 69.95

## B&K Deluxe Regulated DC Supply

- Continuously Variable, 0-50 VDC
- 0-2 Amps—Fully Regulated Output

Model 1801. Versatile supply features simplified current limit setting—does not require application of short circuit to output terminals. Fail-safe overload protection; Set/Reset combination Current Limit pushbutton; Standby switch. Output Voltage: 0-50 VDC in two ranges. Output Current: 0-2 amps in four ranges. Load Regulation: .05% to 0.1%; typical 0.7%. Ripple: 5 mV peak-to-peak. 1 1/4" x 3 3/4" x 10".

38 F 17418W Shpg. wt. 12 lbs. .... Net 175.00

## EICO Regulated Power Supply Kit

- Line and Load Regulation
- 0-30 Volts Continuous Output

Model 1032. Solid-state, low-ripple supply is ideal for testing portable radios, tape recorders, hearing aids. Milliammeter is fused to prevent burnout. Output Voltage: 0-30 V regulated. Output Current: 0-500 mA. Regulation: 0.2 V change from 0 to maximum load with 105-135 V line. Ripple: less than 2.5 mV p-p. Dual meters. 117 VAC, 60 Hz. 3 3/4" x 8" x 4 1/4".

38 F 27581 Kit. Shpg. wt. 7 lbs. .... Net 49.95

38 F 27599 Factory Wired, Tested ... Net 64.95

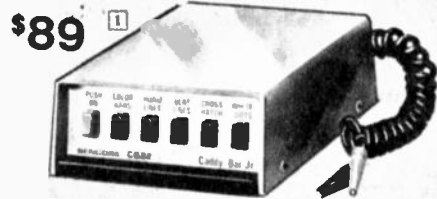

**\$89**



**\$29<sup>95</sup>** KIT



**\$59<sup>95</sup>** KIT



**\$64<sup>95</sup>** KIT



**\$44<sup>95</sup>** KIT

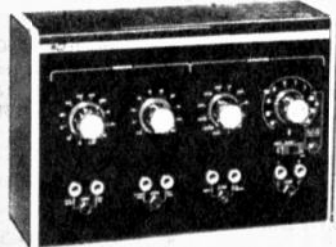

**\$77**

**2 SPRAGUE TO-6A TELOHMIKE CAPACITOR ANALYZER.** Complete analysis of all types of capacitors, including low-voltage types, at accuracy of  $\pm$ 3% up to 200  $\mu$ F,  $\pm$ 5% for 200  $\mu$ F and up. Measures capacity in 5 ranges from 1 pF to 2000  $\mu$ F. Indicates power factor, leakage current, insulation resistance. Safety switch. 110-120 VAC, 50-60 Hz. 8 7/8" x 14 3/4" x 6 1/2".

38 F 70011W Shpg. wt. 18 lbs. .... Net 158.25

**3 B&K 2902 R/C SUBSTITUTION MASTER.** Provides 76 values of carbon resistors, power resistors, disc/tubular capacitors, electrolytic capacitors. Selects up to 5 components for simultaneous substitution. Surge protection circuit. Size: 10 3/4" x 7 1/4" x 3 3/8".

38 F 17392 Shpg. wt. 4 lbs. .... Net 77.00

**4 EICO 1020K TRANSISTOR DC POWER AND BIAS SUPPLY.** Continuously variable output to 30 volts, monitored by dual-range voltmeter. Max. continuous output: 150 mA from 0-12 V, 200 mA from 12-24 V, 300 mA from 24-30 V. Full-wave silicon-diode rectifier circuit. Fused. Rugged steel case. For 105-125 VAC, 60 Hz.

38 F 26955 Kit. Shpg. wt. 4 1/2 lbs. .... Net 29.95

38 F 28963 Factory Wired, Tested ... Net 44.95

**5 EICO 1064S BATTERY ELIMINATOR/CHARGER KIT.** Two DC voltage ranges: 6 or 12 VDC; up to 10 amps continuous; 0.3% ripple at 2 A. 105-125 VAC, 50-60 Hz. 8 1/2" x 5 3/4" x 7 1/2".

38 F 27300 Kit. Shpg. wt. 16 1/2 lbs. .... Net 64.95

38 F 27318 Factory Wired, Tested ... Net 64.95

**6 EICO 1060S BATTERY ELIMINATOR/CHARGER KIT.** For servicing transistor equipment. Variable continuous voltage adjustment in two ranges: 0-16 (6 amps cont.) and 0-8 V (10 amps cont.). 105-125 VAC. 8 3/4" x 10 1/2" x 7 3/4".

38 F 27284 Kit. Shpg. wt. 17 1/4 lbs. .... Net 59.95

38 F 27292 Factory Wired, Tested ... Net 79.95

**7 LAFAYETTE SOLID-STATE DC POWER SUPPLY/BATTERY ELIMINATOR.** Highly filtered. Four output voltages: 4.5, 6, 9 and 12V; to 140 mA. 117 VAC, 60 Hz. 5 1/2" x 2 3/4" x 2 1/2". Imported.

99 F 50742 Shpg. wt. 1 1/4 lbs. .... Net 9.95

**8 EICO 1080 220-WATT INVERTER/CHARGER.** Connects to 12-volt battery; provides 220 watts at 115 VAC rms. Charger rated 5 amps; automatically tapers current. 4 x 6 x 5 3/4".

38 F 27755 Kit. Shpg. wt. 7 lbs. .... Net 44.95

38 F 27763 Factory Wired, Tested ... Net 59.95

**1 SENCORE CG-22 PORTABLE COLOR BAR GENERATOR.** Compact, battery-powered unit has 5 function pushbuttons to produce 10 standard color bars, crosshatch and dots, plus individual vertical and horizontal bars. Perma-Lock circuitry for stability; preheater for instant operation. Exclusive FET computer memory timing circuit automatically shuts unit off in 15 minutes if you should forget. Adjustable RF channels. Less batteries. 2 x 4 x 6".

38 F 53389 Shpg. wt. 2 lbs. .... Net 89.00

Type E164 5-6-Volt Battery for CG-22.

32 F 47681 (2 required) .... Net ea. 1.80

226 Lafayette Cat. No. 750

Lafayette—Over 55 Years of Electronics Leadership

# Test Instruments, Leads, Probes, Accessories



## Amprobe Clamp-On Volt-Ammeters

Measure AC current by snapping trigger-operated jaws around single conductor; measure AC voltage with safety test leads. Accuracy  $\pm 3\%$  FS. RS models feature pointer lock, rotary scale; jaws accept  $1\frac{1}{8}$ " dia. conductors,  $1\frac{1}{8}$ " x  $\frac{1}{2}$ " bus bars. For 60 Hz. RS-1. Ranges: 0-6/15/40/100 A AC, 0-150/600 VAC. 38 F 13011 Shpg. wt. 1 1/2 lbs. Net 48.85  
 Deluxe RS-3. Ranges: 0-6/15/40/100/300 Amps AC, 0-150/300/600 VAC 25-ohm midscale ohmmeter. 38 F 13037 Shpg. wt. 1 3/4 lbs. Net 63.25  
 RS-1000. Ranges 0-15/40/100 300/1000 Amps AC, 0-150/300/600 VAC 25-ohm midscale ohmmeter. 38 F 13185 Shpg. wt. 2 lbs. Net 84.85  
 Amprobe Juniors. Takes 1/2" conductors. Wt. 3/4 lb.

Stock No.	Mod.	AC Amps	AC Volts	Net
38 F 13052	Y25	0-25	0-125-250	26.85
38 F 13094	Y550	0-50	0-150-600	26.85
38 F 13102	Y500	0-100	0-150-600	26.85
38 F 13128	P1 Carrying Case;		1/4 lb.	3.75



## Amprobe Voltprobe Voltage Testers

- Illuminated Voltage Indicator Permits Easy Reading Even in Dim Light

Small enough to fit in a shirt pocket for easy voltage readings anywhere, anytime. "Thermometer Style" illuminated windows indicate AC or DC voltage levels. Includes one push-up captive probe, and one removable probe with attached coil cord, for measurement of points over 50" apart. 117 VAC receptacle check chart permits inspection of outlets for proper wiring. Both models indicate 115 220 277/440/550 VAC and 115/220 400 600 750 VDC; accurate over 25-800 Hz range. Model VT-100 has DC polarity indication. Model VT-124 has additional ranges of 24 and 48 VAC. Size: 6 x 2 1/4 x 3/4". Shpg. wt. 1/2 lb.  
 38 F 13138 Model VT-100 Net 9.85  
 38 F 13144 Model VT-124 Net 15.50  
 38 F 13177 Carrying Case Net 2.95



## Amprobe Line-Probe 5-in-1 Tester

- Lets One Man Trace and Identify Up to 10 Separate Circuits

Pocket-size tester will trace up to 10 separate pairs of conductors at one time... and it's a snap-around volt-ammeter/ohmmeter and continuity checker, too. Eliminates groping—each test either indicates a conductor or locates a short or open. Instantaneous conductor identification: touch a conductor and needle swings to number on scale corresponding to the marker number at other end. Shows voltage on two calibrated scales. Voltage/current readings within  $\pm 3\%$  FS. Ranges: 0-150/500 VAC, 0-100 amps, 1000 ohms midscale. 2 1/2 x 4 3/4". With 10 station markers, leads. Needs Eveready 912 battery.  
 38 F 13169 Shpg. wt. 2 lbs. Net 49.50  
 32 F 48655 Battery (1 required) Net 16¢

## Test Leads, Probes and Accessories

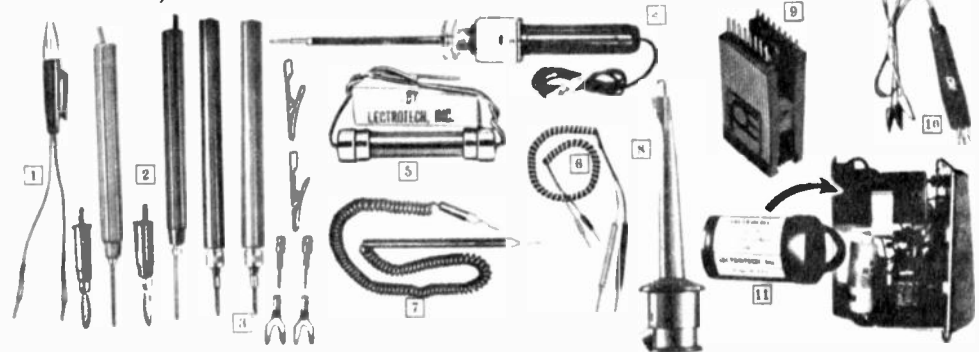

- NEON CIRCUIT TESTER.** Simple, safe for voltages from 60 to 550 VAC or VDC. Imported. 99 F 80715 Shpg. wt. 2 oz. Net 75¢
- STANDARD TEST LEADS.** With plastic prods and pin plugs which withstand chipping or breaking. Extra-flexible kinkless vinyl-covered 60" leads. Prods are 4" long x 3/4" diameter. Supplied in pair of one red and one black. Shpg. wt. 8 oz. Imported. 99 F 50015 With Banana Plugs Net 99¢  
 99 F 50023 With Pin Plugs Net 99¢
- UNIVERSAL TEST LEAD KIT.** Consists of: pair of red and black 4 3/4 x 3/4" plastic handle pin prods with 30" insulated leads. 2 x 3/4" banana plugs; pair of spade lugs; pair of phone tips; pair of red and black insulated alligator clips. 38 F 34009 Shpg. wt. 7 oz. Net 2.39
- CRT 36 kV TEST PROBE.** Self-contained, with built-in voltmeter. Needs no batteries or external power source. 36,000 VDC range; 20,000 ohms, V sensitivity; accuracy of  $\pm 3\%$ . Overall length only 14 3/4". With ground wire and clip. 38 F 12013 Shpg. wt. 12 oz. Net 24.95
- VOM AND VTVM METERGARD.** Protects any meter against overloads. No more bent pointers, damaged pivots, burnt-out coils. Easily installed—allows meter to withstand up to 10,000% overload. 38 F 88015 Shpg. wt. 2 oz. Net 2.95
- 8-FT. COIL CORD TEST LEADS.** Color-coded twin leads with 5/8" test prods on one end, pin plugs on other. Vinyl-clad wire. Imported. 99 F 50783 Shpg. wt. 5 oz. Net 2.19
- STRETCH-TYPE TEST LEADS.** Cannot kink or tangle. 16" coil extends to 9 ft. Red and black plastic handles on each end. 6 1/2" probes. Imported. 99 F 50239 Shpg. wt. 6 oz. Net 3.19
- MINI "GRABBER" CLAMP-ON CONTACT HOOK.** Build your own "clamp-on" test leads. Plunger action between thumb and two fingers. Shpg. wt. 2 oz. 38 F 12021 Black Net 85¢  
 38 F 12047 Red Net 85¢
- IC TEST CLIP.** For "hands-free" testing of 14- or 18-lead DIP's. Spring-loaded wiping action of contact pins gives good electrical connection. 38 F 12039 Shpg. wt. 2 oz. Net 5.75
- B&K FPS 3-POINT PROBE.** Easy one-hand way to check transistors, diodes and components in printed circuit boards. Spring-loaded needle tips. Color-coded leads with insulated alligator clips. 38 F 17269 Shpg. wt. 8 oz. Net 9.95
- LECTROCELL DC POWER SUPPLY FOR VTVM's.** Quickly replaces 1 1/2-volt battery used in VTVM's for resistance measurements. 38 F 68023 Shpg. wt. 1/2 lb. Net 3.95

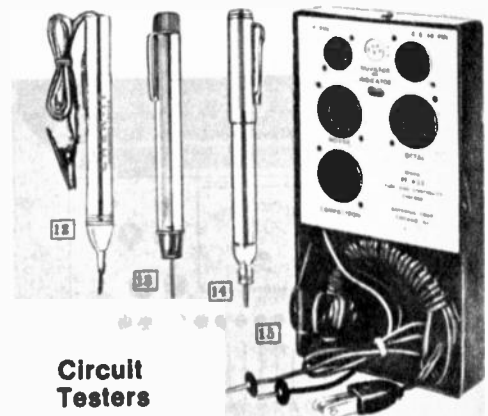

## Circuit Testers

- CHEK-IT ELECTRICAL CIRCUIT TESTER.** Handy pocket-size tester checks electrical continuity of line cords, switches, coils and fuses. Ideal for checking out buzzers, chimes and various other appliances. Uses 2 penlights (not included). Net 2.55  
 38 F 79087 Shpg. wt. 3 oz. Net 2.55  
 99 F 62580 Batteries (2 required) Net ea. 14¢
- SIGNAL TRACER.** Pocket-size device allows easy servicing of transistor radios, amplifiers, TV, etc. Generates 1 kHz signal containing harmonics useable to 160 MHz, at output voltage of .55 volts. In tracing the circuit, a 1-kHz tone will sound. Circuits can be traced from speaker back to RF section. Pilot light. With instructions, battery. 38 F 44008 Shpg. wt. 6 oz. Net 5.25
- BOSCO "MOSQUITO" SIGNAL INJECTOR.** Transistorized, pocket-size, cordless. Oscillates at 1 kHz with harmonics to 30 MHz. Can be coupled into magnetic circuits and pickups without leads. Output: 50V p-p. Impedance: 10k. DC input voltage: 600V max. Size: 5 3/4" L x 1 1/2" O.D. Less battery. 38 F 22103 Shpg. wt. 6 oz. Net 14.95  
 32 F 48655 "AAA" Battery Net ea. 16¢
- FILAMENT/CONTINUITY CHECKER.** Tests filaments of 7-pin, 9-pin, 10-pin and octal tubes, plus Nuviators, Novars and Compactrons. Also checks continuity. Size: 6 3/8 x 3 3/8 x 1 1/8". 38 F 14036 Shpg. wt. 1 1/2 lbs. Net 3.45

# EICO Test Equipment—Kit or Factory Wired



1 \$49<sup>95</sup>

2 \$89<sup>95</sup>

3 \$74<sup>95</sup>

5 \$69<sup>95</sup>

4 \$44<sup>95</sup>

6 \$119<sup>95</sup>

7 \$26<sup>95</sup>

8 \$59<sup>95</sup>

9 \$119<sup>95</sup>

10 \$129<sup>95</sup>

## EICO Probes

Low As  
\$5<sup>95</sup>  
Kit

- PST-2 Signal Tracer Probe.** Usable bandwidth 50 Hz-200 MHz. 1 "AA" batt. 6 $\frac{3}{4}$ " lg. 38 F 27730 Kit. Shpg. wt. 8 oz. . . . .Net 19.95  
38 F 27748 Factory Wired . . . . .Net 29.95
- HVP-2 Hi-Voltage Probe.** 30,000-volt. 38 F 26344 Factory Wired.  $\frac{1}{2}$  lb. . . . .Net 10.95
- PRF-11K RF Probe.** 11-meg; for VTVM's. 38 F 26286 Kit. Shpg. wt.  $\frac{1}{2}$  lb. . . . .Net 5.95  
38 F 26294 Factory Wired . . . . .Net 7.95

**1 MODEL 239K FET VOM KIT.** Battery operated. Checks semiconductor and vacuum tube circuits. 11-megohm DC input impedance. 4 $\frac{1}{2}$ " meter. Peak-to-peak AC volts: 0-2.8, 8.5, 28, 85, 280, 850, 2800. AC RMS/DC volts: 0-1, 3, 10, 30, 100, 300, 1000. Resistance: 0.2 ohms to 1000 meg-ohms in seven ranges. Includes Uni-Probe. Operates on 3 "AA" and 1 "D" batteries. 8 $\frac{1}{2}$  x 5 $\frac{1}{4}$  x 5". Shpg. wt. 4 $\frac{3}{4}$  lbs.

38 F 27672 Kit . . . . .Net 49.95  
38 F 27664 Factory Wired . . . . .Net 79.95

**2 DELUXE MODEL 242K FET VOM KIT.** Includes single Uni-Probe for DC/AC-ohms-mA measurements. 6 $\frac{1}{2}$ " meter. 1V scale for accurate readings as low as 0.05 V. Ranges: AC p-p—0-2.8, 8.5, 28, 85, 280, 850, 2800 volts and mA; AC RMS/DC—0-1, 3, 10, 30, 100, 300, 1000 volts and mA. Input impedance: DC—11 meg, AC—1 meg. Resistance: 0.2 ohms to 1000 megs in 7 ranges. For 105-132 VAC or battery operation. 7 $\frac{1}{2}$  x 8 $\frac{1}{2}$  x 5". Shpg. wt. 9 lbs.

38 F 27482 Kit . . . . .Net 89.95  
38 F 27508 Factory Wired . . . . .Net 129.95

**3 MODEL 235K PROFESSIONAL VTVM KIT.** Features 6" 200- $\mu$ A meter.  $\frac{1}{2}$ -volt full-scale DC range for transistor servicing. AC/DC "Uni-Probe" and 1% resistors. Ranges: AC/DC volts—0-0.5, 1.5, 5, 15, 50, 150, 500, 1500; p-p volts—0-4, 14, 42, 140, 1400, 4200; resistance—0.2 ohms to 1000 megs in 7 ranges. Accuracy: 3%. 11-meg DC input. Resp.: 3 Hz-3 MHz. 117 VAC. 8 $\frac{1}{2}$  x 7 $\frac{1}{2}$  x 5". Shpg. wt. 8 $\frac{3}{4}$  lbs.

38 F 27169 Kit . . . . .Net 74.95  
38 F 27177 Factory Wired . . . . .Net 99.95

**4 MODEL 232K PEAK-TO-PEAK VTVM KIT.** 11-meg input impedance; 1% resistors. P-p volts: 0-4, 14, 42, 140, 420, 1400, 4200. DC/RMS volts: 0-1.5, 5, 15, 50, 150, 500, 1500. Resis.: 0.2 ohms to 1000 megs. 4 $\frac{1}{2}$ " meter. AC. 8 $\frac{1}{2}$  x 5 x 5".

38 F 28179 Kit. Shpg. wt. 5 lbs. . . . .Net 44.95  
38 F 28187 Factory Wired . . . . .Net 69.95

**5 MODEL 635K PORTABLE TUBE TESTER KIT.** Tests new Decals, Magnovals, Novars, 10-pin, etc.; all popular TV picture tubes. Checks dynamic cathode emission, shorts, leakage, gas. Tube chart. 8 $\frac{1}{2}$  x 11 $\frac{1}{4}$  x 3 $\frac{1}{4}$ ".

38 F 27383 Kit. Shpg. wt. 7 $\frac{1}{4}$  lbs. . . . .Net 69.95  
38 F 27391 Factory Wired . . . . .Net 99.95

**6 MODEL 685K DYNAMIC SEMICONDUCTOR CIRCUIT ANALYZER.** Tests FET, bipolar and unijunction transistors. SCR's, power rectifiers, signal diodes, zeners. Tests transconductance and beta—in or out of circuit. Built-in voltmeter and ohmmeter. 120 VAC. 12 $\frac{1}{2}$  x 8 $\frac{1}{2}$  x 6".

38 F 27623 Kit. Shpg. wt. 13 $\frac{3}{4}$  lbs. . . . .Net 119.95  
38 F 27631W Factory Wired . . . . .Net 189.95

**7 MODEL 566K VOM KIT.** 4 $\frac{1}{2}$ " meter; 1000 ohms/V 38 ranges. AC/DC volts: 0-1-5-10-500-5000. Current: 0-1-10 mA. 0-0-1-1 A. Ohms: 0-5k-100k-1 meg. —20 to +68 dB. 6 $\frac{3}{4}$  x 5 $\frac{1}{4}$  x 3".

38 F 26013 Kit. Shpg. wt. 3 $\frac{1}{4}$  lbs. . . . .Net 26.95

Model 558K. As above, with 1% resistors.

38 F 26039 Kit. Shpg. wt. 3 $\frac{1}{4}$  lbs. . . . .Net 29.95

38 F 26047 Factory Wired . . . . .Net 39.95

Model 536K VOM (not illus.). 3" meter. 1000 ohms/V sensitivity. 31 ranges. 6 $\frac{1}{2}$  x 3 $\frac{3}{4}$  x 2 $\frac{3}{4}$ ".

38 F 26054 Kit. Shpg. wt. 2 $\frac{1}{2}$  lbs. . . . .Net 26.95

38 F 28062 Factory Wired . . . . .Net 34.95

**8 MODEL 680K TRANSISTOR AND CIRCUIT TESTER KIT.** Measures transistor ICBO, ICEO, DC Beta, simulated AC Beta. 20,000 ohm/V meter. Five current ranges. 2 voltage ranges, 3 resistance ranges. With batteries. 6 x 5 x 3".

38 F 26856 Kit. Shpg. wt. 3 $\frac{1}{4}$  lbs. . . . .Net 59.95

38 F 26864 Factory Wired . . . . .Net 74.95

**9 MODEL 633K CRT TESTER AND REJUVENATOR KIT.** Tests, repairs, rejuvenates color or BW CRT's. 4 $\frac{1}{2}$ " meter shows grid cut-off voltage, filament voltage, beam current on Good-Bad scale. Short-open test. Luggage case; 5-socket cable. 105-130 VAC. 12 x 9 $\frac{1}{4}$  x 5".

38 F 27367 Kit. Shpg. wt. 11 $\frac{1}{4}$  lbs. . . . .Net 119.95

38 F 27375W Factory Wired . . . . .Net 159.95

**10 MODEL 667K DYNAMIC CONDUCTANCE TUBE & TRANSISTOR TESTER KIT.** Combines mutual conductance test with peak emission test to give a single quality reading. Checks transistors for leakage and Beta. Tests all new tube types. 4 $\frac{1}{2}$ " meter roll chart. Separate plate, screen, grid switches. AC. 12 x 15 x 4 $\frac{1}{2}$ ".

38 F 26526W Kit. Shpg. wt. 20 $\frac{3}{4}$  lbs. . . . .Net 129.95

38 F 26534W Factory Wired . . . . .Net 189.95

# EICO Generators and Scopes—Kit or Wired



\$89<sup>95</sup> Kit



\$89<sup>95</sup> Kit



\$69<sup>95</sup> Kit

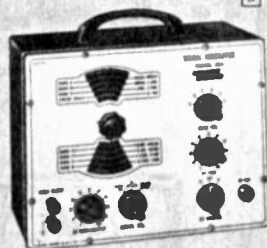

\$59<sup>95</sup> Kit

\$159<sup>95</sup> Kit



\$79<sup>95</sup> Kit



\$59<sup>95</sup> Kit



\$69<sup>95</sup> Kit



\$89<sup>95</sup> Kit

**MODEL 385K SOLID-STATE COLOR BAR GENERATOR KIT.** Crystal-controlled, portable unit feeds directly into TV antenna terminals. Produces 10-bar color display plus dot and crosshatch. Gun killer. 117 VAC. 2½ x 8½ x 8". Shpg. wt. 7 lbs.  
 38 F 27441 Kit ..... Net 89.95  
 38 F 27458 Factory Wired ..... Net 129.95  
 99 F 62572 "C" Batt. (6 req.) Net ea. 19¢



\$159<sup>95</sup> Kit

**1 MODEL 379K SOLID-STATE SINE/SQUARE WAVE GENERATOR KIT.** Sine wave—20 Hz to 2 2 MHz; 0-7.5 V rms into hi-impedance output, 0-6.5 V into 600 ohms. Square wave—20 Hz to 200 kHz; 1-10 V p-p into hi-impedance. Accuracy: 3%. For 105-132 VAC, 50-60 Hz. 7½ x 8½ x 8½". Shpg. wt. 11¼ lbs.  
 38 F 27532 Kit ..... Net 89.95  
 38 F 27540 Factory Wired ..... Net 129.95

**2 DELUXE 378K AUDIO GENERATOR KIT.** Switch selectable output from 1 Hz to 110 kHz in 1 Hz, 10 Hz, 100 Hz and 1 kHz steps. 5% accuracy. Distortion less than 0.1%, 20 Hz-20 kHz. Metered voltage. 120 VAC. 8½ x 12½ x 9".  
 38 F 27706W Kit. Shpg. wt. 16 lbs. ... Net 89.95  
 38 F 27714W Factory Wired ..... Net 129.95

**3 MODEL 377K AUDIO GENERATOR KIT.** R-C (Wien Bridge) oscillator with 1% resistors. Sine wave—20-20,000 Hz in 4 bands; square wave—60-50,000 Hz. Distortion less than 1%. Accuracy 3%. 117 VAC, 60 Hz. 7½ x 11½ x 7½".  
 38 F 26633 Kit. Shpg. wt. 14¾ lbs. ... Net 69.95  
 38 F 26641 Factory Wired ..... Net 89.95

**4 MODEL 369K TV-FM SWEEP MARKER GENERATOR KIT.** Sweep generator is independent of marker generator. feeds sweep signal only to IF strip being aligned. Five ranges from 3.5 MHz to 220 MHz. Variable freq. marker: 4 ranges, 2-75 MHz on fundamentals. to 220 MHz on harmonics. Fixed freq. marker: 4.5 MHz (crystal included). 105-125 VAC, 60 Hz. 12½ x 8½ x 7".  
 38 F 26674W Kit. Shpg. wt. 17¾ lbs. ... Net 159.95  
 38 F 26682WX Factory Wired ..... Net 219.95

**5 MODEL 324K RF SIGNAL GENERATOR KIT.** Range: 150 kHz-145 MHz on fundamentals; 111-435 MHz on calibrated harmonics. 1.5% frequency accuracy. 50 ohms. 105-125 VAC. 8 x 10 x 4¾". Shpg. wt. 9¼ lbs.  
 38 F 26591 Kit ..... Net 59.95  
 38 F 26609 Factory Wired ..... Net 79.95

**6 MODEL 330K SOLID-STATE RF SIGNAL GENERATOR KIT.** Modulated and unmodulated output. 100 kHz to 54 MHz in 5 bands. 3-step coarse, 0-100% fine attenuation. AC. 7½ x 8½ x 5". Shpg. wt. 8¼ lbs.  
 38 F 27656 Kit ..... Net 79.95  
 38 F 27649 Factory Wired ..... Net 119.95

**7 MODEL 147K DELUXE SIGNAL TRACER KIT.** High-gain RF and low-gain audio channels. Visual and aural monitors. With shielded RF crystal demodulator variable noise locator circuit, calibrated wattmeter, substitute test speaker, amplifier and output transformer. VTVM/scope output. 105-125 VAC. 8 x 10 x 4¾".  
 38 F 26666 Kit. Shpg. wt. 11 lbs. .... Net 59.95  
 38 F 26625 Factory Wired ..... Net 79.95

**8 MODEL 150K SOLID-STATE SIGNAL TRACER KIT.** Provides component substitution of output transformer and speaker. Independent RF and audio outputs. With hi-frequency RF point contact crystal demodulator probe and direct audio probe. 400 mW output. Speaker and calibrated meter. 105-132 VAC. 7½ x 8½ x 5".  
 38 F 27516 Kit. Shpg. wt. 8¾ lbs. .... Net 69.95  
 38 F 27524 Factory Wired ..... Net 99.95

**9 MODEL 435K 3" WIDEBAND DC SCOPE KIT.** Push-pull vertical amplifier offers direct or capacitive inputs. Response flat from DC to 4.5 MHz; sensitivity 18 mV/cm. Horizontal flat, 1 Hz to 500 kHz; sensitivity, 0.7 V/cm. Sweeps from 10 Hz to 100 kHz in 4 ranges plus TV-V and TV-H. 105-125 VAC. 5¾ x 8½ x 12¾".  
 38 F 26377WX Kit. Shpg. wt. 17 lbs. ... Net 159.95  
 38 F 26385WX Factory Wired ..... Net 219.95

**10 DELUXE 460K 5" WIDEBAND DC SCOPE KIT.** Push-pull direct coupled vertical amplifier with 25 mV/in sensitivity; response flat from DC to 4.5 MHz. Ideal for 3.58 MHz color TV sync burst. Sweep: 10-100 Hz with external capacitor for lo-freq. Preset TV-V and TV-H sweep positions. 105-125 VAC. 13 x 8½ x 16".  
 38 F 26435W Kit. Shpg. wt. 28¼ lbs. ... Net 139.95  
 38 F 26443W Factory Wired ..... Net 189.95

**11 MODEL 465K PROFESSIONAL 5" OSCILLOSCOPE-VECTORSCOPE.** Zener diode voltage calibrator; distortionless V and H trace expansion; drift-free positioning. Vertical response, DC to 8 MHz (+1, -5 dB); sensitivity, 12 mV/cm rms. Horizontal, DC to 1 MHz (+1, -3 dB); 17 mV/cm rms. 117 VAC. 12¾ x 8½ x 17½".  
 38 F 27425W Kit. Shpg. wt. 34¼ lbs. ... Net 219.95  
 38 F 27433W Factory Wired ..... Net 299.95



\$139<sup>95</sup> Kit



\$219<sup>95</sup> Kit

**MODEL PSI SIGNAL INJECTOR PROBE KIT.** Pocket-size, cordless, pen-type instrument generates and injects a signal covering the audio, IF and RF spectrum. Solid-state oscillator is powered by two 1½-volt penlight cells. Can be coupled into magnetic pickups and circuits without leads. 1000 kHz; harmonics to 30 MHz. 5¾" long.  
 38 F 27359 Kit. 4 oz. ... Net 6.45  
 38 F 27342 Fact. Wired Net 10.95



\$6<sup>45</sup> Kit

# EICO Test Instruments—Kit or Wired

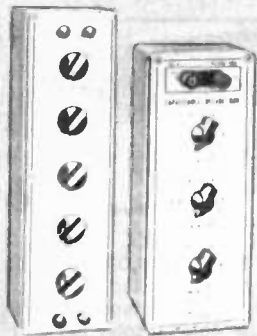

1 Kit \$29<sup>95</sup>



2 Kit \$24<sup>95</sup>

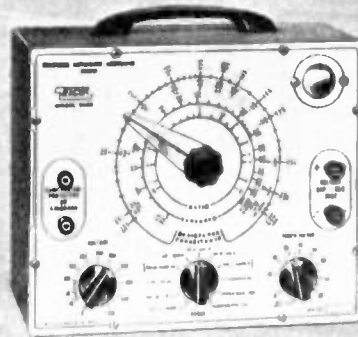

3 Kit \$49<sup>95</sup>



\$49<sup>95</sup>  
4 Kit

1 1180K CAPACITANCE DECADE KIT. 100 pF to 0.111  $\mu$ F in 100 pF increments. 9 x 3 $\frac{1}{2}$  x 3 $\frac{1}{2}$ ". 38 F 26799 Kit. Shpg. wt. 2 $\frac{3}{4}$  lbs. ....Net 29.95  
38 F 26807 Factory Wired .....Net 39.95  
1171K Resistance Decade Kit. Range: 0 to 99,999 ohms in 1-ohm steps. 12 x 3 $\frac{1}{2}$  x 3". 38 F 26773 Kit. Shpg. wt. 3 $\frac{1}{4}$  lbs. ....Net 34.95  
38 F 26781 Factory Wired .....Net 49.95

2 1140K SERIES/PARALLEL RC SUBSTITUTION BOX KIT. Select R alone, C alone, 1350 combinations. 10% accuracy. 6 $\frac{3}{4}$  x 5 $\frac{1}{4}$  x 2 $\frac{3}{8}$ ". 38 F 26872 Kit. Shpg. wt. 3 lbs. ....Net 24.95  
38 F 26880 Factory Wired .....Net 34.95

3 950K R-C BRIDGE AND RCL COMPARATOR KIT. Direct reading ratio scale for comparison with "standard" component. 8 x 10 x 4 $\frac{3}{4}$ ". 38 F 26898 Kit. Shpg. wt. 8 lbs. ....Net 49.95  
38 F 26906 Factory Wired .....Net 69.95

4 955K IN-CIRCUIT CAPACITOR TESTER KIT. Tests capacitors for opens, shorts; in or out of circuit. Wien bridge measures capacitance, 0.1-50  $\mu$ F. 105-130 VAC. 8 $\frac{1}{2}$  x 5 $\frac{3}{4}$  x 6". 38 F 26914 Kit. Shpg. wt. 6 $\frac{3}{4}$  lbs. ....Net 49.95  
38 F 26922 Factory Wired .....Net 69.95

5 944K FLYBACK TRANSFORMER AND YOKE TESTER KIT. Separate calibration for air- and iron-core. Test in or out of circuit. 7 x 5 x 4". 38 F 27011 Kit. Shpg. wt. 5 $\frac{3}{4}$  lbs. ....Net 49.95  
38 F 27029 Factory Wired .....Net 69.95

6 540K APPLIANCE/CAR TESTER. Multi-range AC/DC voltmeter, ammeter, ohmmeter, wattmeter, leakage checker. Finds defects in irons, fans, heaters, TV and radio tubes, batteries ignition coils, etc. With leads. 6 $\frac{1}{2}$  x 3 $\frac{3}{8}$  x 3 $\frac{1}{2}$ ". 38 F 26245 Kit. Shpg. wt. 3 lbs. ....Net 21.95  
38 F 26252 Factory Wired .....Net 29.95



3 Kit \$49<sup>95</sup>



8 \$21<sup>95</sup>

## Oscilloscope Accessory Probes

38 F 26450 PSD-K Demodulator Probe Kit. Shpg. wt.  $\frac{1}{2}$  lb. ....Net 5.95  
38 F 26468 PSD as above, but factory wired. Shpg. wt.  $\frac{1}{2}$  lb. ....Net 7.95  
38 F 26476 PD-K Direct Probe Kit. Shpg. wt.  $\frac{1}{2}$  lb. ....Net 4.95  
38 F 26484 PD as above, but factory wired. Shpg. wt.  $\frac{1}{2}$  lb. ....Net 5.95  
38 F 26492 PLC-K Low-Capacity Probe Kit. Shpg. wt.  $\frac{1}{2}$  lb. ....Net 5.95  
38 F 26518 PLC as above, but factory wired. Shpg. wt.  $\frac{1}{2}$  lb. ....Net 7.95



7 Kit \$17<sup>95</sup>

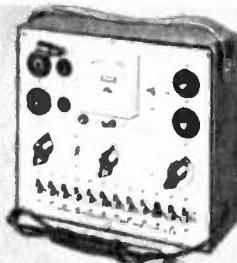

8 Kit \$27<sup>50</sup>



9 Kit \$35<sup>50</sup>



10 Kit \$38<sup>50</sup>

## EMC Test Equipment—Kit and Wired

7 MODEL 212 TRANSISTOR ANALYZER KIT. Battery powered; checks transistors for beta in 3 ranges to 200; leakage on 3-color scale. Tests transistors in circuit. Signal traces AF, IF or RF circuits. Measures battery voltage on 0-12V peak, DC current drain. With leads. 38 F 24018 Kit. Shpg. wt. 5 lbs. ....Net 17.95  
38 F 24026 Factory Wired .....Net 26.95

8 MODEL 213 TUBE TESTER KIT. Checks new Compactrons, Nuvistors, Novars and 10-pin tubes in addition to octals, loctals, miniatures, 9-pin. Tests for shorts, leakage, Intermittents, quality. Chart manual. 8 $\frac{1}{2}$  x 7 $\frac{1}{2}$  x 4". 38 F 24034 Kit. Shpg. wt. 4 $\frac{1}{2}$  lbs. ....Net 27.50  
38 F 24042 Factory Wired .....Net 42.50

9 MODEL 801 RESISTANCE-CAPACITANCE COMPARATOR AND CAPACITY CHECKER KIT. Measures capacitors for actual value, leakage and power factor. Detects in-circuits opens, shorts. Checks capacity in 4 ranges, 10-500 pF; resistance 5 ohm to 500 megs. 10 x 7 x 5". 38 F 24059 Kit. Shpg. wt. 8 $\frac{1}{4}$  lbs. ....Net 35.50  
38 F 24067 Factory Wired .....Net 56.50

10 MODEL 802 SIGNAL TRACER AND GENERATOR KIT. Generates its own signal for audio, IF or RF testing. Noise locator circuit. Audio freq., 400 Hz; IF, 455 kHz (Mod). With demodulator and audio probes. 10 x 7 x 5". 38 F 24075 Kit. Shpg. wt. 9 $\frac{1}{4}$  lbs. ....Net 38.50  
38 F 24083 Factory Wired .....Net 60.95

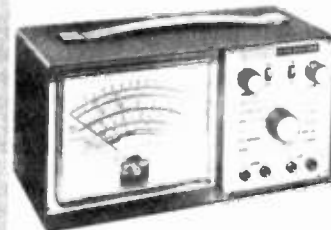

Wired \$99<sup>95</sup>  
Kit \$69<sup>95</sup>

## 888K Deluxe Solid-State Engine Analyzer Kit

- For 6- or 12-Volt, Positive or Negative Ground Systems
- 4-, 6- or 8-Cylinder Engines
- Large 6" D'Arsonval 2-Color Meter

Combines seven professional engine and ignition testers in one—helps you keep your car in tune all year 'round for good starting, better fuel economy, BETTER performance! Determines condition of battery (0-3.2 and 0-16 V), starter, Ignition coil, distributor, alternator or generator, regulator. Has 0-20k ohms scale for general continuity, separate dwell and rpm readings for 4-, 6-, 8-cyl. engines. Uses 4 "D" cells, order below. 11 $\frac{1}{2}$  x 6 x 5". 38 F 27227 Kit. Shpg. wt. 9 lbs. Net 69.95  
38 F 27235 Factory Wired ....Net 99.95  
99 F 62564 "D" Battery ....Net ea. 19<sup>95</sup>



# See Lafayette for Precise Meters and Monitors

## RCA WV-120B Power Line Monitor

Installs between AC line and unit to be monitored—lets you know voltage fluctuations, "brown-out" patterns, when to turn off equipment that may burn out due to low power line voltage. Features fast meter action to reveal "bounces," true rms reading even on distorted sine waves. Reads 100-140 volts, frequency range, 25 Hz to 400 Hz, 5 x 3 3/4" x 3 3/4". With three-wire power cord.  
38 F 46532 Wt. 1 1/2 lbs. ... Net 27.00



\$27.00

## RCA Sound Level Meter

Portable sound level meter that complies with ANSI specification S1.4, 1971 for performance and accuracy. Measures sound levels in factories, construction sites, auto and truck traffic, etc. Shows sound limits specified by OSHA. Easy to operate—simply press the "On" switch and read the meter. Reads 70-110 dBA with "A" weighted response. Ceramic omnidirectional mike element. Uses four 1.5-volt "AA" cells. 3 x 6 1/2" x 1 1/4".  
38 F 46524L Shpg. wt. 1 lb. ... Net 90.00  
"AA" Long Life Cells.  
99 F 63760 4 in pkg. .... Net 80¢



\$90

## Shurite Panel Meters

1. ±5% Accuracy 2. Zero Adjust

All require 2 1/2" hole. Model 850: clear plastic meters with 2 1/2" x 2 3/4" crystal polystyrene front. Model 950: Metal case, glass front with flange mount. Avg. shpg. wt. 6 oz.



DC VOLTMETERS				DC VOLTMETERS			
Range	Type 950	Net Each	Type 850	Net Each	Range	Type 950	Net Each
0-1	38 F 60840	4.25	—	—	0-25H	38 F 60285	4.75
0-3	38 F 60857	4.25	38 F 61499	4.40	0-50	38 F 60293	4.45
3-0-3	38 F 60655	4.35	—	—	0-100	38 F 60327	5.00
0-5	38 F 60673	4.25	38 F 61507	4.40	0-150H	38 F 60343	4.65
0-10	38 F 60707	4.35	38 F 61523	4.50	0-150H	38 F 60350	5.00
0-15	38 F 60715	4.35	38 F 61531	4.50	0-300H	38 F 60368	5.15
0-25	38 F 60731	4.50	38 F 61556	4.60	0-500H	38 F 60376	5.25
<b>DC MILLIAMPERES</b>				<b>DC MILLIAMPERES</b>			
0-1	—	—	38 F 60087	5.75	0-100	38 F 60897	4.25
0-3	38 F 60822	4.55	38 F 60095	4.65	0-150	38 F 60905	4.25
0-5	38 F 60848	4.20	38 F 60111	4.35	0-200	38 F 60913	4.35
0-10	38 F 60855	4.10	38 F 60129	4.25	0-300	38 F 60921	4.35
0-50	38 F 60898	4.25	38 F 60152	4.40	0-500	38 F 60947	4.35
<b>DC AMPMETERS</b>				<b>DC AMPMETERS</b>			
0-1	38 F 60954	4.25	38 F 60228	4.40	0-25	38 F 60558	4.60
0-5	38 F 60517	4.25	38 F 60244	4.40	0-50	38 F 60566	4.80
0-10	38 F 60533	4.25	38 F 60251	4.40	20-0-20	38 F 60616	4.60
0-15	38 F 60541	4.35	38 F 60269	4.50	50-0-50	38 F 60632	4.80
<b>OHMMETER</b>				<b>DC MICROAMMETER</b>			
10,000	38 F 60392	4.65	38 F 61630	4.80	0-500	38 F 61671	5.70

### TYPE 850 AC METERS

Volts			Amps			Volts			Amps		
Range	Stock No.	Net	Range	Stock No.	Net	Range	Stock No.	Net	Range	Stock No.	Net
0-10	38 F 59303	5.65	0-1-38	F 59238	5.50	0-50	38 F 59337	5.75	0-15	38 F 59279	5.50
0-15	38 F 59311	5.65	0-5-38	F 59253	5.50	0-150	38 F 59345	5.90	0-30	38 F 59287	5.85
0-25	38 F 59329	5.75	0-10-38	F 59281	5.50	0-300	38 F 59352	6.10	0-50	38 F 59295	5.90

## Emico Panel Meters

All models pre-calibrated and accurate within 5%. Styled to enhance appearance of electrical equipment. Meter movements: DC meters—"HI-TORK" magnetic and AC meters—moving iron type. Model 13, 3/4" x 1 1/4" x 1/2" all-plastic design. Screw terminals with soldering lugs. Supplied with all mounting hardware. Avg. shpg. wt. 4 oz.



DC AMPMETERS			DC VOLTMETERS			DC MILLIAMPERES		
Stock No.	Range	Net	Stock No.	Range	Net	Stock No.	Range	Net
38 F 31773	0-10	3.30	38 F 32037	0-3	3.30	38 F 31377	0-1	4.40
38 F 31781	0-15	3.30	38 F 32045	0-10	3.30	38 F 31385	0-5	3.55
38 F 31799	0-30	3.30	38 F 32052	0-15	3.30	38 F 31393	0-10	3.40
38 F 31807	30-0-30	3.30	38 F 32060	0-20	3.30	38 F 31401	0-20	3.30
<b>AC VOLTMETERS</b>			<b>AC VOLTMETERS</b>			<b>AC VOLTMETERS</b>		
38 F 31542	0-150	5.05	38 F 32078	0-20	3.30	38 F 31419	0-30	3.30
38 F 31559	0-300	5.35	38 F 32086	0-50	3.30	38 F 31427	0-50	3.30
<b>AC MILLIAMMETERS</b>			<b>AC AMPMETER</b>			<b>AC AMPMETER</b>		
38 F 32227	0-500	4.50	38 F 32185	0.5	4.50	38 F 31435	0-100	3.30
						38 F 31443 0-150 3.30		
						38 F 31450 0-200 3.30		
						38 F 31488 0-300 3.30		
						38 F 31476 0-500 3.30		

## SHURITE AC-DC LINE VOLTAGE TESTER

Type 5406-LT. Sturdy, pocket-sized tester has a range of 0-150 volts AC/DC. Plug into any wall outlet and read the voltage, then plug in the appliance(s) and note the new reading. Find (and demonstrate) voltage drops. Shpg. wt. 6 oz.  
38 F 61697 ..... Net 5.80



## MINIATURE FM TUNING METERS

FM Tuning Meter. Only 3/4" sq., 1" deep. Can be connected between radio detector and AF amplifier. The indicator will rest in the center when station is tuned in. Current sensitivity ±100 microamps on both sides DC. Internal resistance about 1200 ohms. Imported.  
99 F 50262 Shpg. wt. 2 oz. .... Net 3.50



## METER RECTIFIER

A full-wave economical meter rectifier of exceptionally linear characteristics. Universal electrical replacement for most multimeters, such as Lafayette's miniature VOMs. Single screw mount. Long terminals.  
99 F 62077 Imported. Shpg. wt. 2 oz. .... Net 98¢



## Panel Meters with D'Arsonval Movements

- 1 3 1/4" Square
- 2 3 1/2" Square
- 3 1 1/2" Square

2% full-scale accuracy, jeweled bearings. Four threaded mounting studs in corners, zero adjust screw and clear plastic fronts except (2) which has black bakelite. Volume level indicator calibrated in standard -20 to +3 VU and 0-100% ranges. Dimensions: (1), 2 3/4" square, 2 3/4" x 1 1/4" dial faces, 1 1/4" overall depth, 1 1/4" behind panel including terminals. Miniature meters (Fig. 3) with silver dials, black pointers, 1 1/2" square fronts. 1 1/2" overall front to back with 1/4" behind panel including 1/4" terminals. Panel mtg. hole requirements: Fig. (1), 2 3/4"; Fig. (2), 2 1/4"; Fig. (3), 1 1/2". Supplied with mounting screws. Imported. Average shpg. wt. 3/4 lb.

Stock No.	Fig.	Range	Net
99 F 50832	1	V.U. Meter	10.95
99 F 50824	3	V.U. Meter	7.49
99 F 50858	2	0-50 DC Microamp.	10.85
99 F 50874	2	0-1 DC Milliamper.	10.85
99 F 50882	3	0-1 DC Milliamper.	7.50
99 F 50890	3	0-100 DC Milliamper.	6.95
99 F 50866	3	0-50 DC Microamp.	7.95
99 F 50908	3	0-15 DC Volt	6.95
99 F 50916	3	0-150 AC Volt	7.95

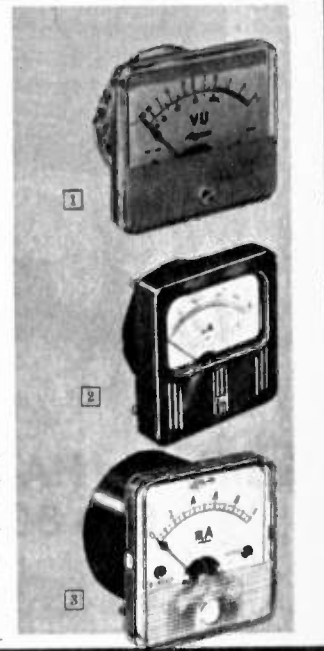

## LAFAYETTE EDGE-WISE BALANCE AND TUNING PANEL METER

Use as stereo balance indicators or as tuning indicators for FM tuners. Pointer at center of the scale indicates zero or null position. Current Sensitivity: ±100 µA on both sides. Complete with installation schematics. Clear plastic case. Meter body: 1 1/4" L x 1/2" W x 3/4" D. Depth behind panel: 1".  
99 F 50346 Imported. Shpg. wt. 3 oz. .... Net 3.95



## MINIATURE ILLUMINATED "S" METER

2% full-scale accuracy. Zero adjustment jeweled bearing movement. Calibrated in "S" units from 0.9 with the scale terminating in +10 and +30 calibrations. Silvered dials, black numerals and pointers. Illuminating lamp for 6- or 12-volt operation. 1 1/4" dial face 1 1/4" behind panel. With mounting screws. Imported.  
99 F 26270 Shpg. wt. 1/2 lb. .... Net 6.95



## MINIATURE ILLUMINATED MODULATION "S" METER

Front panel zero adjustment. Calibrated scales (1 mA full scale), 0 to 100% modulation, "S" units 0-9, also +10 and +30. Linear full-scale markings of 0 to 5. Dimensions: dial face, 1 1/4" depth, 1 1/4" overall. Supplied with 4 mounting screws and lugs. For 6 or 12 volts. Dust-resistant case.  
99 F 26262 Imported. Shpg. wt. 1/2 lb. .... Net 6.95



## Specialty Meters by JBT



### ELAPSED TIME METER

Model 31-EXW-5

Records operating time of AC equipment. Registers in 1/10th hour steps to 9,999.9 hours, then automatically resets. 3 1/2" flange. Mts. in 2 1/4" hole, overall depth 3 3/4". For 110-120 VAC, 60 Hz.  
38 F 67058 Shpg. wt. 1 lb. .... Net 19.15



### AC FREQUENCY METER

Model 34-FX

56-64 Hz. Vibrating reed meters for measuring frequency of AC power sources in 1 Hz steps ±0.3% at 77". Flange 3 1/2", mounts in 2 1/4" hole, overall depth 3 3/4". For 100-130 volts.  
38 F 67025 Shpg. wt. 1 lb. .... Net 33.20

## Lafayette HA-600A 5-Band AM/CW/SSB Solid-State Amateur and Shortwave Receiver

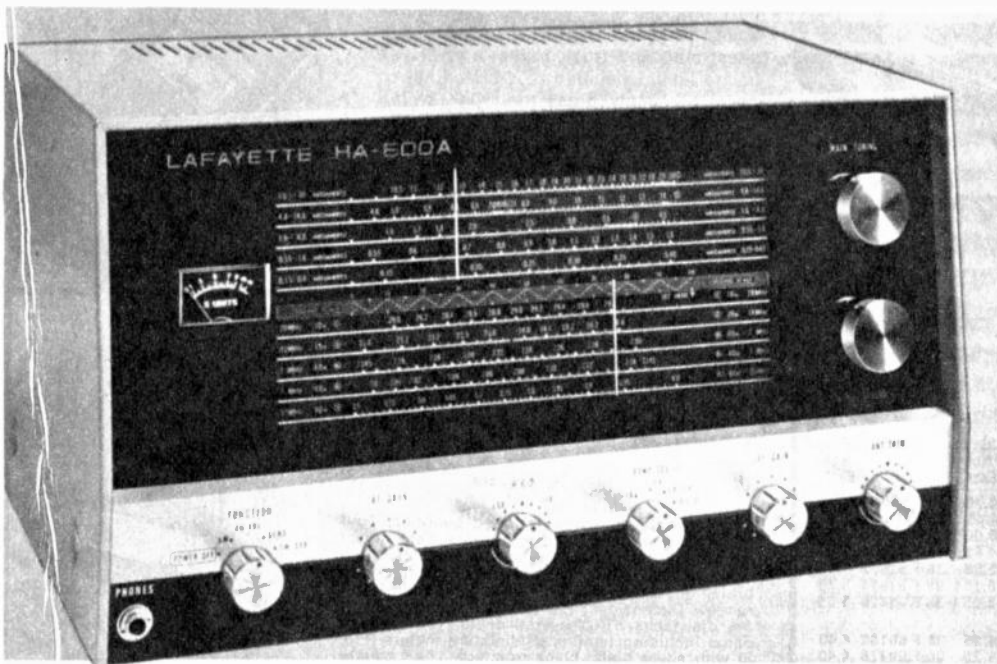

## Lafayette Amateur Receivers

Lafayette Model HA-600A

ONLY **\$169<sup>95</sup>**

- Product Detector for SSB/CW
- Super-Selective Mechanical Filter
- Huge Edge-Lit Slide-Rule Dial
- 117 VAC and 12 VDC Operation
- 24½" Bandsread on 10-80 Meters
- Series-Gate Noise Limiter
- Front Panel Headphone Jack
- All Solid-State • "S" Meter

General coverage receiver combines the latest solid-state electronics with sleek, modern appearance. Advanced circuitry uses two FET's in the front end to assure high sensitivity with low noise factor. Series-Gate noise limiter; AVC. Variable BFO permits clear reception of code and SSB signals. 455 kHz mechanical filter assures superior selectivity. Slide-rule dial with main tuning, logging and bandsread scales. Electrical bandsread has wide calibration for easy tuning of crowded ham bands. Sensitivity: 1  $\mu$ V at 10 dB S/N. Selectivity:  $\pm 6$  kHz at  $-60$  dB,  $\pm 2$  kHz at  $-6$  dB. Speaker impedance: 4, 8 and 500 ohms (use optional HE-48C speaker listed below). Frequency Range: 150-400 kHz, 550-1600 kHz, 1.6-4.8 MHz, 4.8-14.6 MHz, 10.5-30 MHz. 15 x 9¼ x 8¼". Imported.

99 F 25991W Shpg. wt. 25¼ lbs. . Net 169.95

## Lafayette HA-800B Solid-State SSB/AM/CW 6 to 80 Meter Amateur Receiver

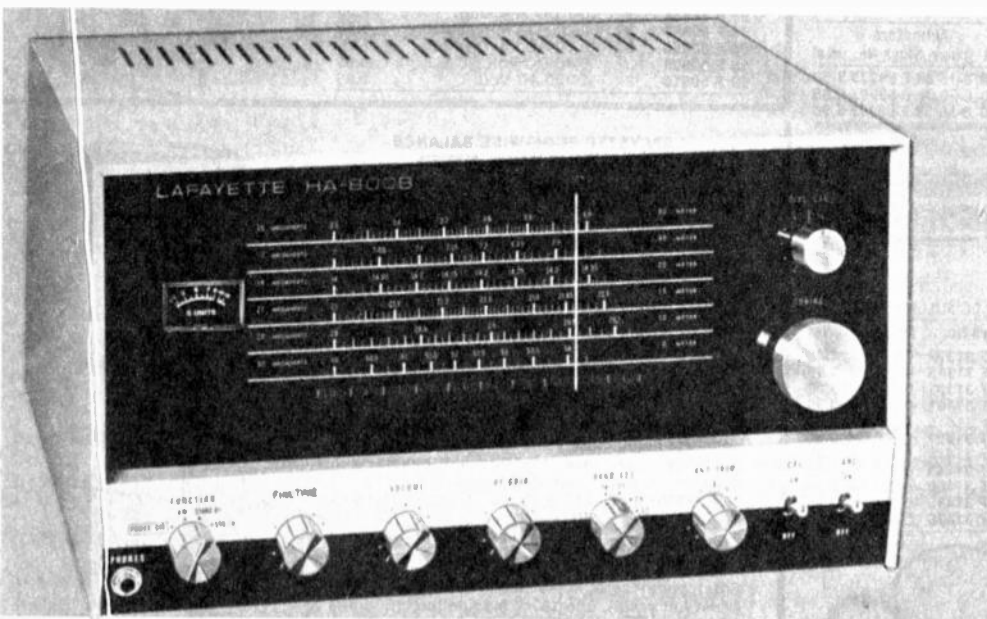

Lafayette Model HA-800B

ONLY **\$129<sup>95</sup>**

- Product Detector for SSB/CW
- Varactor Fine Tuning & Callibrator
- Two 455 kHz Mechanical Filters
- Zener-Regulated Power Supply—12 VDC or 117 VAC Operation
- Series-Gate ANL • "S" Meter
- FET Front End Attenuates Overload
- Dual Conversion • Xtal Calibrator

Covers the 80 through 6 meter Ham bands—AM, CW and SSB—with superb reception. Tuned RF, mixer and oscillator stages use FET's for outstanding selectivity and sensitivity. Built-in 100 Hz crystal calibrator (less crystal). Tape output jack, headphone jack. Sensitivity: better than 1  $\mu$ V. Selectivity: 60 dB down at  $\pm 6$  kHz. Size: 8¼ H x 15W x 9¼" D. Speaker not included (order HE-48C at left). Imported.

99 F 26155W Shpg. wt. 24¼ lbs. . Net 129.95

100 kHz Calibrator Crystal for above.

40 F 09015L Shpg. wt. 3 oz. . . . Net 6.95

### Lafayette Model HE-48C Matching Amateur Speaker

- For HA-600A, HA-800B or Other Receivers

Tough 3x5" permanent magnet speaker in a handsome cabinet. Provides clean, crisp and clear audio response—even during SSB reception. Mates beautifully with Lafayette's HA-600A and HA-800B, or other manufacturer's receivers which need an external speaker. 8-ohm impedance. Size: 7¼ H x 3½ W x 5" D. Imported.

99 F 25397 Shpg. wt. 2½ lbs. . . . . Net 11.95

**\$11<sup>95</sup>**

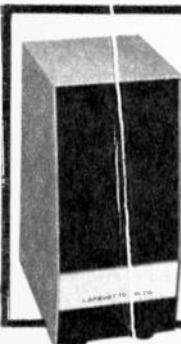

# The Rig the 2-Meter Hams have been waiting for!

## Lafayette Model HA-146 25-Watt, 12-Channel Solid-State 2-Meter Mobile VHF-FM Transceiver



ONLY  
**\$279<sup>95</sup>**  
No Money Down\*

A real powerhouse in the 2-meter FM spectrum! Crystal-controlled dual conversion superhet receiver offers sensitivity of less than 0.5  $\mu$ V for 20 dB quieting; adjacent channel rejection of -60 dB; 4-watt audio output into built-in 4-ohm speaker. Frequency stability of  $\pm$ .001% from -20° to +60°C. Encoded input jack permits connecting optional tone encoder to activate external repeater for much greater range. Adjustable squelch; tape recorder jack. Includes 4 sets of crystals (8 total): Channel A, 146.94 MHz Receive and Transmit; Channel B, 146.76

MHz Receive, 146.34 MHz Transmit; Channel C, 146.76 MHz Receive and Transmit; Channel D, 146.94 MHz Receive, 146.34 MHz Transmit. Built-in 12 VDC power supply for negative ground, with polarity protection. Hand-held plug-in dynamic microphone, mobile mounting bracket, DC power cable, SO-239 antenna connector, ext. speaker jack. 8 x 2½ x 9". Imported.  
**99 F 26239W** Shpg. wt. 10 lbs. . . Net 279.95  
Crystal Certificate for 2-meter transceiver. Fill out and send to crystal mfr.  
**40 F 69233Y** . . . . . Net ea. 4.95

- **Switchable High (25-watt) and Low (1-watt) Outputs**
- **For 12 VDC Mobile Operation**
- **Priority Switch for Automatic Selection of Favorite Channel**
- **Frequency Range: 144-148 MHz**
- **All-Solid-State Circuitry**
- **Supplied with 4 Sets of Transmit & Receive Crystals**
- **Repeater Encoder Input Jack**

## Lafayette HA-270 100-Watt Mobile Linear Amplifier

**\$139<sup>95</sup>**

Boost your flea power rig up to high power for extended range and better readability! Mobile amplifier provides up to 100 watts PEP (50 watts DC) input into a 50-ohm load (with 10 watts RF drive). Unique sensing circuit automatically switches in the linear when transmitter is activated—no external switching needed. Built-in relay connects antenna to input SO-239 socket when receiving. No internal connections required to your existing equipment. Broadband circuitry—only one tune-up is usually necessary on any band. Illuminated meter indicates relative RF strength of linear or exciter output. Self-contained power supply uses a high efficiency toroid power transformer. Requires RF drive of ½ to 10 watts. With manual, fused DC cable, mounting bracket. For 12 VDC negative ground. 9 x 2 x 7". Imported. Shpg. wt. 7 lbs. 12 oz.

**99 F 26304W** . . . . . Net 139.95  
**Model PS-55 AC Power Supply**. For 117 VAC, 50/60 Hz operation of HA-270. Size: 9W x 7D x 5"H. Imported.  
**99 F 26312W** Shpg. wt. 11 lbs. . . . Net 59.95



- **Covers 20-54 MHz . . . 6, 10, 11 and 15 Meters (not permitted on 11-meter CB in U.S.A.)**
- **Self-Contained 12-Volt Power Supply**
- **Operates on 117 VAC with Optional Supply**
- **No External Switching Required**
- **Amplifies AM, FM, CW, DSB, SSB Signals**



No Money Down—See Page 4 for Lafayette's Easy-Credit Plan (Minimum Order \$30.00)

# Ham Communications Gear and Code Equipment

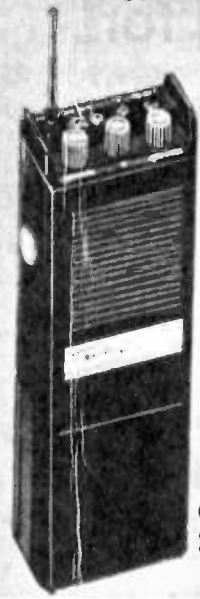

(1)  
**\$229<sup>00</sup>**



(2)  
**\$229<sup>00</sup>**

(1) **REGENCY HRT-2 5-CHANNEL 2-METER NBFM HAND-HELD TRANSCEIVER.** Compact transceiver goes anywhere—gives 2 watts output. Double conversion superhet receiver has two ceramic filters for great selectivity. Efficient bandpass circuitry across the 144-148 MHz band. Squelch control. High-Low power switch. Removable telescoping antenna. Includes NiCad battery, transmit and receive crystals for 146.94 MHz. Size: 3½ x 1¼ x 9¾".  
40 F 60448 Shpg. wt. 2½ lbs. . . . . Net 229.00  
40 F 60455 BC-101 Battery Charger, Shpg. wt. ¾ lb. . . . . Net 29.95  
40 F 60463 MA-29 Cigarette Lighter Power Cord, Shpg. wt. 6 oz. . . . . Net 3.50

(2) **REGENCY HR-2B 12-CHANNEL 2-METER MOBILE FM TRANSCEIVER.** Double conversion receiver with 0.35 µV sensitivity for 20 dB quieting. Sharp selectivity of 6 dB ± 7 kHz and 50 dB ± 20 kHz. Squelch circuit has variable noise compensation. Phase-modulated transmitter with automatic deviation limiting. VSWR bridge-limiting circuit. Delivers 15 watts output. Individual trimmer capacitors for frequency netting. Power drain: 3 amps max. at 13.8 VDC. With crystals for 146.94 MHz, PTT mike, mounting bracket. 2¼ x 5½ x 7½".  
40 F 60323W Shpg. wt. 5½ lbs. . . . . Net 229.00  
40 F 82129Y Transmit Crystal—specify frequency . . . . . Net 6.50  
40 F 82137Y Receive Crystal—specify frequency . . . . . Net 4.95

**REGENCY HR-220 12-CHANNEL 220 MHz FM TRANSCEIVER.** Identical to HR-2B above, but for 200-225 MHz range. Sensitivity, 0.4 µV for 20 dB quieting. Power output 10 watts. With crystals for 223.50 MHz.  
40 F 60471W Shpg. wt. 5½ lbs. . . . . Net 239.00  
40 F 60489Y Transmit Crystal—specify frequency, 200-225 MHz . . . . . Net 6.50  
40 F 60497Y Receive Crystal—specify frequency, 200-225 MHz . . . . . Net 4.95



(3)

(3) **DELUXE DRAKE R-4C TRIPLE CONVERSION RECEIVER.** Covers 80, 40, 20 and 15 meters completely and the 28.5-29 MHz segment of 10 meters with crystals furnished. 15 accessory crystal sockets for any additional 500 kHz ranges from 1.5 to 30 kHz (with the exception of 5.0-6.0 MHz). 0.25 µV sensitivity. Pass-band tuning, tunable notch filter. 25 kHz crystal calibrator. Noise blanker on CW, SSB, AM. Solid-state linear permeability tuned VFO. S-meter. 120-240 VAC. 50-60 Hz. 5½ x 10¼ x 11¾".  
40 F 65538W Less speaker. Wt. 19 lbs. . . . . Net 549.00  
40 F 65041 MS-4 Speaker. Wt. 9½ lbs. . . . . Net 22.00



(4)

(4) **DRAKE MODEL TR-4C SSB/AM/CW TRANSCEIVER.** Features VOX and PTT on SSB and AM, automatic T/R switching on CW. Sensitivity less than ½ µV for 10 dB S/N. Full frequency coverage, 15-80 meters, plus 10 meter crystals for 28.5-29.1 MHz. CW sidetone oscillator; adjustable pi-network; solid-state VFO; 100 kHz crystal calibrator. Selectivity: 2.1 kHz at 6 dB, 7.5 kHz at 60 dB. Input power: 300W PEP (SSB), 260W AM/CW. 10¼ x 8½ x 14¾". Less power supply, speaker.  
40 F 65520WX Shpg. wt. 20½ lbs. . . . . Net 599.95  
34 PNB Plug-In Noise Blanker.  
40 F 65470 Shpg. wt. 1 lb. . . . . Net 100.00  
40 F 65041 MS-4 Speaker. Wt. 9½ lbs. . . . . Net 22.00  
40 F 65249W AC Power Supply. 19½ lbs. . . . . Net 120.00  
40 F 65397W DC Power Supply. 9 lbs. . . . . Net 135.00

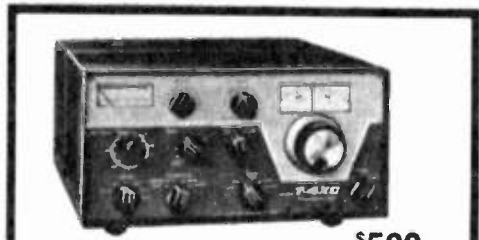

**\$580**

**DRAKE MODEL T-4XC SSB/AM/CW TRANSMITTER.** Covers 160-10 meters in 6 bands. Permeability tuned solid-state VFO has calibration accuracy of better than 1 kHz. Rated 200 watts PEP on SSB and AM, 200 watts CW. Controlled carrier AM modulation is compatible with SSB linear amplifiers. Two 8-pole crystal lattice filters for sideband selection. Plate current/relative output meter. Automatic T/R switching on CW, VOX or PTT on SSB/AM. AGC on SSB. 5½H x 11¼D x 10¼W. Less power supply.  
40 F 65546W Shpg. w. 18 lbs. . . . . Net 580.00  
AC-4 117 VAC Power Supply for above.  
40 F 65249W Shpg. wt. 19½ lbs. . . . . Net 120.00

## Code Keys and Oscillators

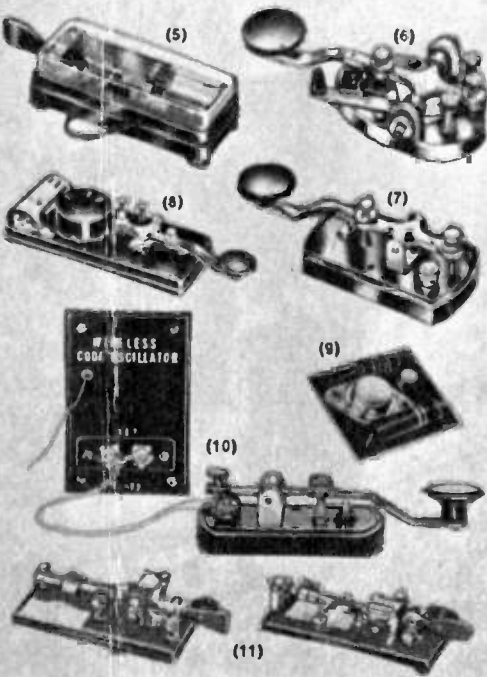

(5) **LAFAYETTE SEMI-AUTOMATIC "BUG."** Seven adjustments for speed and comfort. Nickel-plated brass and stainless steel operating parts. Imported.  
99 F 25520 Shpg. wt. 3¼ lbs. . . . . Net 17.95

(6) **LAFAYETTE "BRASS-POUNDER'S" KEY.** Spring tension and contact clearance adjustments ¼" silver contacts. 3 x 2". Imported.  
99 F 25553 Shpg. wt. ½ lb. . . . . Net 2.99

(7) **LAFAYETTE BEGINNER'S KEY.** Chrome- and nickel-plated metal parts. 5" long. Imported.  
99 F 25546 Shpg. wt. ½ lb. . . . . Net 1.29

(8) **LAFAYETTE CODE PRACTICE SET.** Key has adjustable tension, contacts. High frequency buzzer has frequency and tension adjustment. Imported.  
99 F 25538 Shpg. wt. ½ lb. . . . . Net 2.79  
99 F 62564 "D" Battery (1 required) . . . . . Net ea. 19¢  
99 F 25504 Stethoscope Headset . . . . . Net 2.59

(9) **MINIATURE CODE OSCILLATOR MODULE.** Connects to telegraph key, 1½- to 8-volt battery and PM speaker. Simple instructions included.  
19 F 15131 Shpg. wt. 3 oz. . . . . Net 98¢

(10) **LAFAYETTE SOLID-STATE WIRELESS CODE PRACTICE OSCILLATOR SET.** Just place oscillator antenna next to AM radio, turn radio on and you're ready to practice. With battery. Imported.  
99 F 26080 Shpg. wt. ½ lb. . . . . Net 5.50  
99 F 80212 Extra 9V Battery . . . . . Net ea. 39¢

(11) **VIBROPLEX SEMI-AUTOMATIC KEYS.** Super Deluxe "Presentation." Jewel movement, super speed control. 24K gold-plated base top.  
40 F 88084 Shpg. wt. 5 lbs. . . . . Net 57.45

"Champion." Chromed top parts gray crystal base.  
40 F 88019 Shpg. wt. 3¼ lbs. . . . . Net 27.50

"Original." Cast iron base; chromed mechanism.  
40 F 88027 Shpg. wt. 4¾ lbs. . . . . Net 34.50

Deluxe "Original." Jeweled bearings; chrome base.  
40 F 88035 Shpg. wt. 5 lbs. . . . . Net 44.75

Vibro-Keyer. Keying mechanism for electronic transmitting unit. Smooth, easy-operating trunion lever. Large contacts. 3½ x 4½".  
40 F 88068 Shpg. wt. 3¾ lbs. . . . . Net 28.75



**\$10<sup>95</sup>**

**LAFAYETTE CODE PRACTICE OSCILLATOR.** Three-way operation—light indicator, variable pitch tone, or light-tone combined. Built-in speaker. Terminals for key, earphone. Low-drain battery-operated transistor oscillator. 6¼ x 3¾ x 2". Imported.  
99 F 25603 Shpg. wt. 1¼ lbs. . . . . Net 10.95  
99 F 62572 Extra "C" Cell (2 required) . . . . . Net ea. 19¢  
99 F 25504 Crystal Headset. Imported. 3 oz. Net 2.59

# Ham Radio Equipment and Accessories

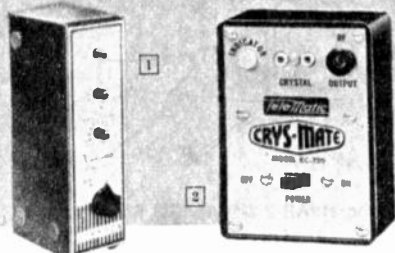

**1 NYE VIKING 250-46 PHONE PATCH.** Compact, automatic, hybrid-transformer-type patch accepts PTT, manual, or VOX keying. Separate receiver and transmitter gain controls. 2 x 6 x 2 1/2".  
40 F 46231 Shpg. wt. 2 1/2 lbs. ....Net 36.50

**2 TELEMATIC CRYSTAL CHECKER AND FREQUENCY STANDARD.** Checks crystals with GO-NO GO indicator light; generates fundamental frequencies for calibrating, etc. 4 x 3 x 1 3/4". Less battery.  
40 F 62006 Shpg. wt. 1 1/2 lbs. ....Net 18.95  
32 F 48077 9-Volt Battery (1 req.) ....Net ea. 54¢



\$289.95

**HY-GAIN 300-WATT LINEAR AMPLIFIER.** For amateur 10-meter band (illegal for use on CB) Amplifies AM, FM, SSB and DSB signals. Automatic antenna changeover relay. Power Output: 150 watts carrier, 300 watts peak. Max. Drive: 5 watts (unmodulated carrier & FM), 3.5 watts (AM carrier), 14 watts PEP (AM peak), 50 ohms, input/output. 117 VAC, 60 Hz. 5 1/8" x 14 x 11 1/2".  
40 F 31399W Shpg. wt. 15 lbs. ....Net 289.95



**3 B&W MODEL 331A LITTLE DIPPER.** Highly sensitive, accurately calibrated, battery operated, transistorized instrument acts as RF signal generator, auxiliary generator, absorption wavemeter; also measures capacitance, inductance and "Q." Continuous 2-230 MHz coverage with 7 overlapping plug-in coils (supplied). Frequency Accuracy: ±3%. With 9-volt battery. Stainless steel case. 7 x 2 1/2 x 2 1/2".  
40 F 16390 Shpg. wt. 3 1/2 lbs. ....Net 99.95  
99 F 60212 Extra 9V Battery ....Net ea. 39¢

**6 EICO 710 GRID DIP METER.** Extremely stable; frequency range of 400 kHz to 250 MHz. Use to tune transmitters, trim antennas, locate parasitics; measures resonance, capacitance, "Q," inductance. Uses 8 plug-in coils. 115 VAC. 2 1/4 x 2 1/8 x 6 3/8".  
40 F 74258 Kit Form. Shpg. wt. 4 lbs. ....Net 59.95  
40 F 74266 Factory Wired and Tested ....Net 79.95

**7 HY-GAIN POWER METER.** Accurate power readings to 150 MHz (10-, 100-, 500-watt scales). Also shows stable SWR and % modulation. With cables.  
40 F 31407 Shpg. wt. 3 1/2 lbs. ....Net 59.95

**4 LAFAYETTE SWR BRIDGE AND RF POWER METER.** Measures standing wave ratio in transmission line, and up to 20-watt output into a built-in dummy load at up to 50 MHz. VSWR from 1:1 to 10:1 and input power up to 1 kW from 2-30 MHz. May be permanently inserted in transmission line for SWR/relative power monitoring. For 52-ohm lines. 0-100 DC µA meter is calibrated in watts and SWR. 3 1/2 x 7 1/2 x 2 3/8" Imported.  
99 F 26338 Shpg. wt. 2 3/4 lbs. ....Net 20.95

**8 1000-WATT IN-LINE WATTMETER.** Continuously monitors radiated power. Ranges: 0-10, 0-100 and 0-1000 watts full scale. Covers 2-30 MHz. VSWR measurements can be determined by a nomogram (supplied). 50 ohms. Vinyl-clad metal/wood case. 4 1/4 x 9 x 4".  
40 F 24030 Shpg. wt. 2 lbs. ....Net 49.95

**9 R.L. DRAKE W-4 RF WATTMETER.** Reads forward and reflected power directly in watts (VSWR from nomogram). Two scales in each direction: 200 and 2000 watts full scale. Freq. coverage 1.8-54 MHz. Accuracy: ± (5% of reading + 2 watts) on 200-watt scale; ± (5% + 20 watts) on 2000W. 5 1/2 x 3 3/4 x 4".  
40 F 65371 Shpg. wt. 2 1/4 lbs. ....Net 61.95

**5 MINIATURE ILLUMINATED "S" METER.** Has wrap-around plastic front panel for wide-angle readability. Zero adjustment screw on front panel. Jeweled bearing D Arsonval movement. Accuracy: 2% of full scale. Silvered dial; black numerals and pointer. Illuminating lamp for 6-12-volt operation. 1 1/2" dial face; 1 1/4" behind panel. With mounting screws.  
99 F 26270 Imported. Shpg. wt. 1/2 lb. ....Net 6.95

**10 LAFAYETTE SWR & FIELD STRENGTH METER.** Measures SWR, relative forward and reflected power to 1 kW; reads field strength. Can be left continuously in the circuit. SWR, 1:1 to 3:1. Accuracy: ±5 dB. 2-30 MHz. Impedance: 52 ohms. 5-section antenna. Sensitive 100 µA meter; 2-color dial. 1 1/8 x 5 1/8 x 2 3/8". Imported.  
99 F 25835 Shpg. wt. 1 1/2 lbs. ....Net 15.95

**MINIATURE MODULATION/"S" METER.** Same as above, but shows "S" units, percentage modulation, and RF power output. Illuminated; for 6 or 12 volts. With 4 mounting screws. Imported.  
99 F 26262 Shpg. wt. 1/2 lb. ....Net 6.95



**11 CODE COURSES ON CASSETTE TAPE.** Each includes 20-page course.  
**Basic Course.** 10 lessons; brings speed up to 15 wpm.  
40 F 71007 Wt. 1/2 lb. ....Net 4.95  
**Advanced Course.** 12 lessons; covers 16 to 25 wpm.  
40 F 71015 Wt. 1/2 lb. ....Net 4.95

**12 AMECO RECORD CODE COURSES.** Fast, accurate method for learning code. Courses include one 33 1/3 RPM record (Senior has 2 records) and 32-page manual with FCC-type exam. Avg. shpg. wt. 1 lb.

Stock No.	Course	WPM	Net
40 F 13058	Junior	0-7 1/2	3.95
40 F 13074	Senior	0-18	7.50
40 F 13090	Advanced	8 1/2-18	3.95
40 F 10518	Extra Class	13-22	3.95
40 F 10526	Supplementary General	12-15	3.95
40 F 10534	Supplementary Extra	19-24	3.95



**13 W2AU "Balun 1" BROAD-BAND BALUN.** 1:1 model matches 50- or 75-ohm unbalanced to 50- or 75-ohm balanced load. Handles 1 kW AM/CW, 2 kW PEP.  
40 F 47023 Shpg. wt. 3/4 lb. ....Net 12.95  
**Balun II.** 4:1 model matches 50- or 75-ohm unbalanced coax line to 200- or 300-ohm balanced load.  
40 F 47031 Shpg. wt. 3/4 lb. ....Net 12.95

**14 B&W 425 LOW-PASS FILTER.** Handles 1 kW. 85 dB attenuation. For 52-ohm coax.  
40 F 16085 Shpg. wt. 2 lbs. ....Net 27.75

**15 B&W 377 ANTENNA T/R CHANGEOVER RELAY.** 2 kW PEP (1 kW CW), up to 150 MHz. 40-130 VAC.  
40 F 16408 Shpg. wt. 1 1/2 lbs. ....Net 13.50

**16 AMECO HP-45 HIGH-PASS FILTER.** 40 dB attenuation at 14 MHz. 20 dB at 28 MHz. 300 ohms.  
40 F 10054 Shpg. wt. 3 oz. ....Net 14.95

**17 LAFAYETTE 5-POSITION COAXIAL SWITCH.** Selects 1 of 5 transmitters, antennas, etc., with 52-75-ohm line. Single gang, single pole; grounded. 1 kW AM to 50 MHz. Shpg. wt. 3/4 lb.  
40 F 01228 ....Net 14.95

**18 DRAKE TV-42-LP LOW-PASS FILTER.** 100 watts, 160-10 meters includes CB. 50 ohms. Two SO-239's.  
40 F 65132 Shpg. wt. 2 lbs. ....Net 8.95  
Drake TV-1000-LP. 1 kW on 160 to 10 meters.  
40 F 65140 Shpg. wt. 2 lbs. ....Net 18.75

**19 SUPEREX AMATEUR HEADPHONES.** Removable vinyl foam cushions. Dual imped.: 600 and 4-10 ohm.  
40 F 85015 Shpg. wt. 2 1/2 lbs. ....Net 25.95

**20 VHF & SHORTWAVE ANTENNA TUNER.** Installs in any SW/Ham/monitor receiver in minutes.  
42 F 21073 Shpg. wt. 1/2 lb. ....Net 12.95

**21 HUSTLER MOBILE "MONITOR-MATCH" BOX.** Lets you use AM or FM radio and up to 3 monitors with your regular car antenna. Separate outputs for AM/FM, 300-500 MHz, 140-175 MHz, and 25-50 MHz.  
40 F 55158 With cables. Shpg. wt. 1 lb. ....Net 15.95

**22 NYE VIKING ANTENNA COUPLER.** For 80, 40, 20, 15, 10 meters. Matches balanced 25-1500 ohms, unbalanced 25 to 3000. Reads SWR. 750W PEP TR relay. Shpg. wt. 9 3/4 lbs.  
40 F 46082 ....Net 139.50

# Amateur/Shortwave Antennas and Accessories

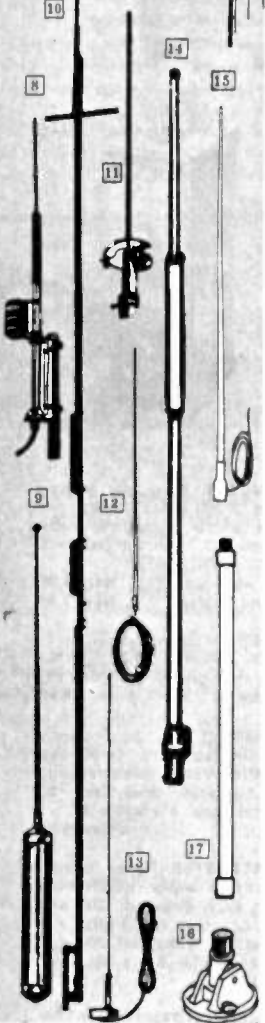
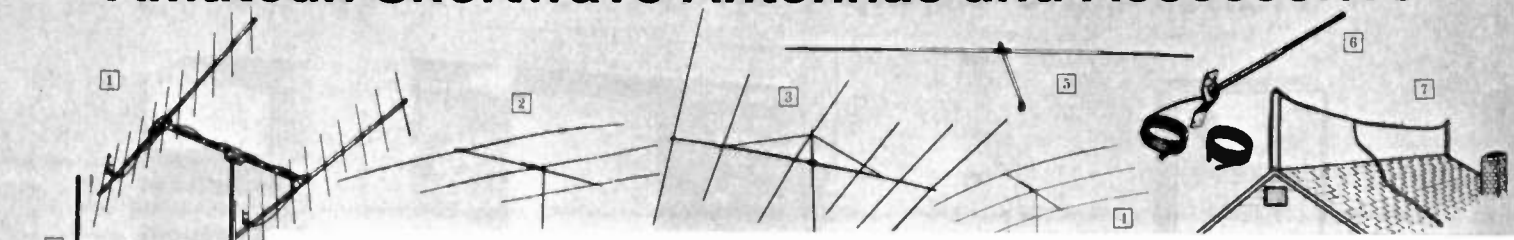

**1 Cushcraft "Power Pack" 2-Meter Beam Antenna.** Uses 2 A147-11 yagls with horizontal mounting boom. Gain, 16 dB, F/B 24 dB, 1/2-power bandwidth 42°. 144 x 80 x 40", 60" turn radius. 52 ohms. Takes PL-259. 1000 watts. With coax harness, hardware.  
**40 F 19630W** Shpg. wt. 14 lbs. .Net 62.50  
**Model A-144-7.** Similar to above, 7 elements, 98" beam, 11 dB gain, 26 dB F/B.  
**40 F 19139W** Shpg. wt. 4 lbs. .Net 17.95  
**Model A-147-11.** 2-meter, 11-element. 13.2 dB gain, 20 dB F/B. 144" boom. 7-ft. turn radius. Shpg. wt. 6 lbs.  
**40 F 19287W** .Net 21.95  
**Hy-Gain Tribander Beam Antennas.** For 10, 15, 20 meters. Separate Hy-Q traps for each band, SWR less than 2:1 on all bands. Taper swaged, slotted tubing, tiltable boom to mast clamp. 52 ohms —Beta matched.

**2 Model TH3Mk3.** 8 dB gain, 25 dB F/B. 3 elements. Maximum legal power.  
**40 F 31449WX** Wt. 40 lbs. .Net 189.95  
**3 Model TH6DXX Super Thunderbird.** 9.5 dB gain, 25 dB F/B, 6 elements, less than 1.5:1 SWR. Shpg. wt. 64 lbs.  
**40 F 31456WX** .Net 224.95  
**4 Model TH3JR Thunderbird Junior.** 8 dB gain, 25 dB F/B, 3 elements. 300 W AM, 600 W PEP. Shpg. wt. 20 1/2 lbs.  
**40 F 31464WX** .Net 139.95  
**5 Cushcraft "Trik-Stik" Antenna.** For vertical or horizontal mounting, Amateur, SWL, TV, FM, Business Band, VHF high and low, Aircraft reception. Two 54" elements, two 51" element inserts, 23" support boom. With hardware, instructions  
**40 F 19188W** Shpg. wt. 3 lbs. .Net 11.95  
**6 Hy-Gain SW-9 Shortwave Window Antenna.** Broadband performance. Single 9-ft. aluminum tubular element, universal window mounting bracket.  
**40 F 31183** Shpg. wt. 3 1/4 lbs. .Net 13.95

**7 Hy-Gain SW-6 Shortwave Antenna.** For 1.8 to 30 MHz coverage. Flat top design for pole-to-pole, pole-to-tree, attic, etc. 50-ft. copper wire, low-loss insulators with 15-ft. rope, lead-in.  
**40 F 31175** Shpg. wt. 2 lbs. .Net 10.95

**8 Lafayette 10-80-Meter Vertical Antenna.** Tunable, irridite-treated to MIL specs. 18-ft., knocks down to 5-ft. 1000 watts AM or CW, 2 kW PEP. Omnidirectional. 3 1/2" air-wound coil. 52 ohms.  
**40 F 01046W** Shpg. wt. 4 1/2 lbs. Net 29.95

**9 New-Tronics "Hustler" Mobile CB Antennas.** Buy just one mast, select resonator for particular bands. Feature SWR less than 2 to 1. Heat-treated 1/2" aluminum masts. AM, 75 watts. SSB, to 400 watts PEP. Masts have 3/8"-24 base stud for all mounts. 52 ohms.

Stock No.	Mod.	Description	Lbs.	Net
40 F 55018W	MO-1	54" Fender Mast	2	15.95
40 F 55026W	MO-2	54" Bump. Mast	2 1/4	15.95
40 F 55034	RM-10	10M Resonator	1	10.75
40 F 55042	RM-15	15M Resonator	1	11.75
40 F 55059	RM-20	20M Resonator	1	12.75
40 F 55067	RM-40	40M Resonator	1 1/4	15.95
40 F 55075	RM-75	75M Resonator	1 1/4	16.95

**10 Hy-Gain 18 AVT/WB 10-80 Meter Wide-Band Vertical Antenna.** 5-band capability with automatic switching, true 1/4-wave resonance on all bands. Low radiation angle. SWR 2:1 or less. 25' high.  
**40 F 31290** Shpg. wt. 10 3/4 lbs. Net 97.00

**10 Model 14 AVQ/WB 10-40 Meter Antenna.** Above, 10-40 meters, 18 ft. high, 12" grip mast bracket.  
**40 F 31308W** Shpg. wt. 8 1/4 lbs. .Net 67.00

**Roof Mount Kit for 14 AVQ/WB.** 5' mast, wires, insulators, all necessary hardware.  
**40 F 31050** Shpg. wt. 6 1/4 lbs. .Net 19.95

**11 Cushcraft AR-2 2-Meter FM Ringo Antenna.** Power ring tuning, 52-ohm coax feed. 3.75 dB gain, direct DC ground. For up to 1 1/2" masts. 100 watts 135-170 MHz.  
**40 F 19253W** Shpg. wt. 3 lbs. .Net 15.50  
**ARX-2 Ringo Ranger Antenna.** Omnidirectional, 4.5 to 6 dB gain. 135-170 MHz.  
**40 F 19345W** Shpg. wt. 4 lbs. .Net 24.50  
**ARX-2K.** Converts AR-2 Ringo to Ranger.  
**40 F 19352** Shpg. wt. 3 lbs. .Net 9.95  
**AR-6 6-Meter Ringo**  
**40 F 19303W** Shpg. wt. 4 lbs. .Net 21.50

**12 Shakespeare 2-Meter Fiberglass Antenna.** 3/8-wave, 100 watts. 3 dB gain, SWR 1.3:1, 50 ohms impedance. 47" long, 3/4" mounting hole. With 18 ft. of RG58/U. PL-259. Mobile.  
**40 F 27082W** Shpg. wt. 1 lb. .Net 19.85  
**40 F 27074** Trunk Mount. 6 oz. .Net 5.25

**13 Lafayette 2-Meter Mobile Power Gain Antenna.** 51" 3/4-wavelength 2-meter antenna has 3.4 dB gain. SWR of better than 1.5:1, power rating of 100 watts FM. 17-ft. cable PL-259 Trunk mount.  
**40 F 01236W** Shpg. wt. 2 lbs. .Net 27.95

**14 Mosley SWV-7 Fixed Vertical SW Antenna.** 11, 13, 16, 19, 25, 31 and 49 meters. Has six trap assemblies, weather-proof phenolic casing, molded plastic element cap. 13' 3 3/8" high. Needs grd.  
**40 F 58095W** Shpg. wt. 8 lbs. .Net 46.25

**15 Shakespeare FM Marine Fiberglass Antenna.** 8 ft. high, 5dB gain. White molded fittings, needs no ground plates. Use with extension below to form 12-ft. self-supporting antenna. 52 ohms. With 20' cable.  
**40 F 27090W** Shpg. wt. 3 lbs. .Net 65.95

**16 White Molded Deck Mount for Above.** Levelling plate, self-support for antennas to 12 feet. Shpg. wt. 1/2 lb.  
**40 F 27108** .Net 13.25

**17 Five-Foot Extension Rod for Above.**  
**40 F 27116W** Shpg. wt. 4 lbs. .Net 32.95

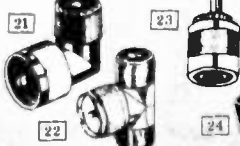
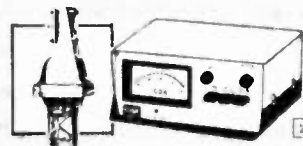
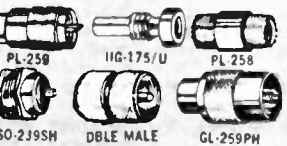
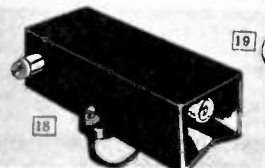

**18 Hy-Gain BN-86 Broad-Band Ferrite Balun.** For 10-to-80-meter beams, antennas and doublets. Provides maximum power to both sides on doublets. Weatherproof construction. VSWR/Impedance: 1:1 at 52 ohms. W/mtg. brackets.  
**40 F 31282** Shpg. wt. 1 1/4 lbs. .Net 15.95  
**19 Coaxial Connectors.** Shpg. wt. 3 oz. PL-259 Connector.  
**42 F 69031** .Net 69¢  
**UG-175/U Reducer.** Adapts PL-259 to RG58/U.  
**42 F 69049** .Net 25¢  
**PL-258.** Accepts PL-259 both ends.  
**42 F 69056** .Net 79¢  
**UHF Double Male.** Free turning nuts.  
**42 F 69064** .Net 1.40  
**SO-239SH Single-Hole Chassis Mount.**  
**42 F 69072** .Net 69¢  
**GL-259PH.** PL-259. For on-off without threading.  
**42 F 69080** .Net 1.09  
**SO-239 (not shown).** SO-239 w/panel mt. flange.  
**42 F 69148** .Net 69¢

**20 Cornell Dubilier Heavy-Duty Antenna Rotors.** Feature time-tested bell-shaped rotors, unique new direction control. Rotator has 50 heavy-duty bearings, two 6 1/2" ball races. 800 in.-lbs. brake torque. Control unit has clockwise, counterclockwise switches, 2% accuracy, lighted meter for antenna position. 8 1/2 x 8 1/4 x 4 1/8". For 115-220 VAC, 50-60 Hz.  
**Model CD-44.** For light arrays with 2.5 sq. ft. wind area. For masts 1 3/8 to 2 1/8" O.D.  
**40 F 83036W** Shpg. wt. 22 lbs. .Net 99.95  
**Model Ham II.** Heavy-duty for up to 7.5 sq. ft. wind area. For masts 1 3/8 to 2 1/8" O.D.  
**40 F 83044W** Shpg. wt. 29 lbs. .Net 149.95  
**100 Ft. of 8-Cond. Rotor Cable.**  
**32 F 14574** Shpg. wt. 5 1/4 lbs. .Net 12.25

**21 Coax Cable Adapter.** Right angle "L" connector adapts PL-259 to SO-239.  
**42 F 69155** Shpg. wt. 4 oz. .Net 1.79

**22 "T" Connector.** Adapts 2 PL-259 connectors to SO-239 input.  
**42 F 69163** Shpg. wt. 4 oz. .Net 2.99  
**23 Semi-Solderless PL-259 Connectors.** Pkg. of 2 PL-259 coaxial connectors for RG8/U or RG11/U cables. No internal soldering to shield.  
**40 F 21028** Shpg. wt. 6 oz. .Net 1.59  
**40 F 21036** Above, for RG58/U .Net 1.59  
**40 F 21044** Above, for RG59/U .Net 1.59  
**40 F 21051** For 82-Channel TV .Net 1.59  
**24 Dummy Antenna Load.** Rated 100 watts continuous. 1250 watts with fan cooling. 52-ohm non-inductive load for easy RF power checks. 0-100 MHz range. VSWR: 1.1:1 at 50 MHz, 1.3:1 at 160 MHz; 1.7:1 at 220 MHz. 7 x 2 x 1 1/8".  
**42 F 21164** Shpg. wt. 1 lb. .Net 22.95  
**25 Marine Electronics Handbook.** By Leo G. Sands. Covers high-band FM, single sideband, low-band AM, radio-telephones, etc. Clear.  
**10 F 41920** 5 1/2 x 8 1/2". Wt. 1 lb. .Net 4.95

# Hear It as It Happens...AUTOMATICALLY!

## Police-Fire Calls



**\$149<sup>95</sup>**

**NEW!**

Delivery November 1, 1974

### Lafayette Monitorscan DB-8 2-BAND High/Low VHF 8-Channel Scanning Monitor

Offers ENTIRE FREQUENCY COVERAGE of both the high VHF (150-170 MHz) and low VHF (30-50 MHz) police/public service radio bands—not simply portions of these bands as in most other dual-band monitors! Lets you monitor ANY COMBINATION of both bands, too—not 4 plus 4 like many others. Has switchable automatic scan delay to prevent missed calls, built-in whip antenna for high-VHF reception, tape recorder and external speaker jacks, volume and squelch controls, more. Special flush-mount crystal door makes crystal changing a breeze. Regulated power supply for both 117 VAC and 12 VDC negative ground operation. 8 1/4 x 2 3/4 x 8 1/2". Imported. Less crystals, order certificates below.

- Automatic Monitoring of 8 Programmed High-Band and Low-Band VHF Frequencies
- Self-Tuning RF Circuitry for Highly Sensitive Full-Range Reception on Both Bands
- 8 Front Panel LED's Flash for Visual Indication of Channel Scanning
- Built-in Whip Antenna for VHF High-Band
- Dual Conversion Superheterodyne Receiver for Outstanding 1 μV Sensitivity on Both Bands
- Scanning Delay Switch

99 F 26320W Shpg. wt. 9 lbs. . . . . Net 149.95  
 Crystal Certificates. Fill out and send to mfr. Mfr. sends crystals post-paid. Use one for each VHF frequency you wish to monitor.  
 40 F 82145Y . . . . . Net ea. 4.95

### Lafayette Monitorscan-8™ 8-Channel High-Band VHF Scanner

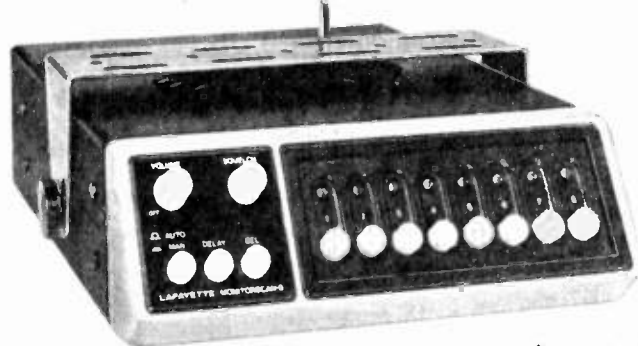

**\$119<sup>95</sup>**

- LED Front Panel Indicators
- Built-in Telescoping Antenna
- Front Panel Lockout Buttons
- Automatic Scan Delay Switch
- 117 VAC or 12 VDC Mobile Operation

Great way for housewives, businessmen, shop owners, etc., to stay tuned to the police, fire and public service news that affects them as they work in their neighborhoods. Automatic monitor covers eight crystal-controlled frequencies (crystals extra)—scans each frequency and stops when a signal is received—continues scan when signal is no longer present. Has volume and squelch controls, lockout buttons, LED indicator lights. Two models: each covers a separate 10-MHz portion of the 150-170 MHz VHF police/public service band. With telescoping antenna, external antenna connector, AC and DC line cords. 8 1/4 x 2 3/4 x 8 1/2". Imported. Shpg. wt. 9 lbs. Less crystals.  
 99 F 26288W For 150-160 MHz . . . . . Net 119.95  
 99 F 26296W For 160-170 MHz . . . . . Net 119.95  
 40 F 82145Y Crystal Certificate. See above . . . . . Net 4.95  
 No Money Down—See Page 4 for Lafayette's Easy-Credit Plan (Minimum Order \$30.00)

### Lafayette 4-Channel FM/VHF Pocket Scanning Monitor

- Listen to Police/Fire/Civil Defense/Marine/Weather, Etc.
- Automatic Scanning on Any 4 VHF High-Band Channels
- Pushbutton "Priority" Switch
- Dual Conversion Superhet Receiver for Maximum Selectivity and Adjacent Channel Rejection



**PORTASCAN-4™**  
**\$99<sup>95</sup>**

Has many of the features of the BIG SETS, including LED channel indicators, volume and squelch controls, pushbutton priority and manual selector switches, built-in antenna, jacks for external antenna and earphone. With clip for carrying monitor on belt. Requires 4 "AA" penlight cells, crystal for each VHF frequency you wish to monitor. 2 7/8 x 6 5/8 x 1 1/2". Shpg. wt. 3/4 lb. Imported.  
 99 F 26247L For 150-160 MHz . . . . . Net 99.95  
 99 F 26254L For 160-170 MHz . . . . . Net 99.95  
 99 F 63828 Batteries. Use 4. Imported. Shpg. wt. 4 oz. . . . . Net ea. .45  
 32 F 47400 Alternate Rechargeable Batteries. Use 4. . . . . Net ea. 1.89  
 99 F 25488 Earphone. Imported. Shpg. wt. 4 oz. . . . . Net .99  
 99 F 31007 NiCad Battery Charger. Shpg. wt. 1 1/4 lbs. . . . . Net 15.95  
 40 F 82145Y VHF Crystal Certificate. See above . . . . . Net 4.95

# HEAR IT HAPPEN with These Popular Regency Monitors

These Brand-Name VHF and UHF Monitors Bring You Local News and Action While It Happens—For Drama, Excitement and Information You Won't Find On Any TV!

*Regency*

## 10-Channel 3-Band Scanning Monitor

Model ACT-R 10H/L/U. Get the information you need on three popular police/public service bands. Fully programmable scanning monitor covers any 10 crystal-controlled channels in the 30-50, 148-174 MHz VHF and 450-470 MHz UHF bands. Has squelch control, channel lock-out buttons, automatic or manual scanning, lighted channel indicators. For 117 VAC, 60 Hz or 12 VDC neg. gnd. With AC/DC power cords, mobile mtg. bracket, built-in 4" speaker. Less crystals. 6 1/2 x 2 1/2 x 9 3/4".  
40 F 60331W Wt. 8 lbs. . Net 169.00

Crystal Certificates for Regency Monitors. Good for 1 crystal  
40 F 82145Y . . . . . Net 4.95

NOTE: Crystals selected for 148-174 MHz and 450-470 MHz should not exceed 8 MHz spread within each band.

\$169<sup>00</sup>

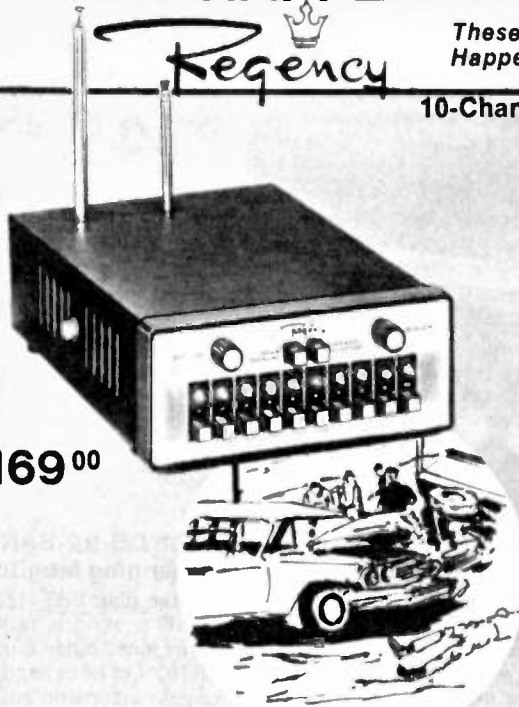

## New 8-Channel 2-Band Scanning Monitor

Model ACT-M 8H/L. Deluxe scanner for areas where UHF is not presently in use. Monitors any combination of low 30-50 or high 148-174 MHz VHF for police, fire, civil defense, etc. Has channel lights, slide squelch and volume controls, manual pushbutton channel selection too. 117 VAC, 60 Hz base or 12 VDC negative ground mobile operation. With mobile mounting bracket, removable telescoping antenna, built-in speaker. 10 x 4 x 8 1/2".  
40 F 60356W Wt. 8 lbs. . Net 159.00 • Telescoping Antenna

\$159<sup>00</sup>

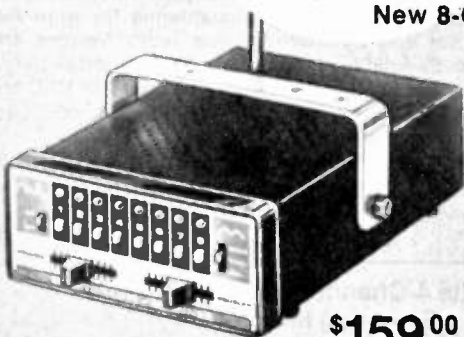

**NEW!**

Choice of 3 Bands!

\$89<sup>95</sup>

Desk Type Base

4-Channel Scanning Monitor

Nicely styled desk-type monitor keeps you in touch at home or office. Has automatic or manual scan pushbuttons, volume and squelch, ABS plastic case with telescoping antenna and door for crystals. 117 VAC, 60 Hz. 7x7x2". Wt. 2 lbs.  
40 F 60364W ACT-C 4L. 30-50 MHz. . Net 89.95  
40 F 60372W ACT-C 4H. 148-174 MHz. . Net 89.95  
40 F 60380W ACT-C 4U. 450-470 MHz. . Net 89.95



\$119<sup>00</sup>

## Hand-Held 4-Channel Scanning Monitor

Portable, fast and slow scan monitor has volume, squelch, earphone jack, jack for optional DC power. 3 1/4 x 6 3/4 x 1 1/4". Less batteries & crystals.  
ACT-P 4H. For 150-175 MHz.  
40 F 60398 1 1/4 lbs. Net 119.00  
ACT-P 4LL. For 30-40 MHz.  
40 F 60408 1 1/4 lbs. Net 119.00  
ACT-P 4LM. For 40-50 MHz.  
40 F 60414 1 1/4 lbs. Net 119.00  
MA-72 NiCad Battery Pack.  
40 F 60422 Wt. 6 oz. Net 27.50  
BC-102 Battery Charger.  
40 F 60430 Wt. 1 lb. Net 14.95



# Famous Bearcat Full-Spread Scanning Monitors

Offer Complete Band Coverage without the Usual Spread Limits

*Electra*

## Bearcat III 8-Channel 2-Band Scanners

Versatile monitor scans up to 8 fixed frequencies in either of two police/public service bands (choice of bands below). Feature quartz crystal IF filters for outstanding selectivity, squelch control, automatic or manual scan, 8 channel lockout switches (to bypass unused channels). Sensitivity: 0.7  $\mu$ V for each band. With telescoping antenna, mobile mounting bracket, 117 VAC 60 Hz and 12 VDC neg. gnd. power cables. 9x3 3/4 x 6 1/4". Less crystals. Shpg. wt. 6 lbs.  
40 F 17067W BC3-L/H. 30-50/150-174 MHz. . 159.95  
40 F 17075W BC3-L/U. 30-50/450-470 MHz. . 159.95  
40 F 17133W BC3-L/T. 30-50/470-512 MHz. . 159.95  
40 F 17083W BC3-H/U. 150-174/450-470 MHz. 159.95  
40 F 17141W BC3-H/T. 150-174/470-512 MHz. 159.95

\$159<sup>95</sup>

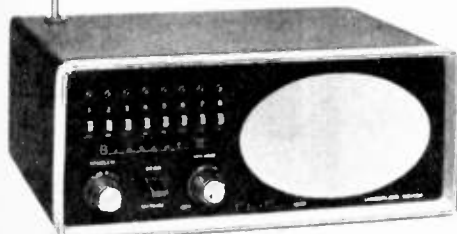

**NEW!**

\$179<sup>95</sup>



## Electra Bearcat IV All-Band Scanning Monitor

Similar to Bearcat III above, but scans any combination of all frequency bands now in use—30-50, 150-174, 450-470 and 470-512 MHz without affecting receiver sensitivity! 9 x 3 3/4 x 6 1/2". Less crystals. Shpg. wt. 6 lbs.  
40 F 17158W BC-4. . . . . Net 179.95  
Crystals for Electra Monitors. Order one certificate for each frequency.  
40 F 82145Y . . . . . Net ea. 4.95

## "Jolly Roger" AM/Monitor



\$79<sup>95</sup>

It's an AM radio, it's a 2-channel monitor that operates 3 ways to keep you in touch and in tune. Operates Channel A or Channel B only with automatic switch to AM radio, Channel A or B only, AM only, Channel A and B only. Includes earphone, telescoping antenna, LED indicators. Operates on 4 "D" batteries or 117 VAC, 60 Hz. 6 x 8 x 3 1/2". Less batteries, crystals. Full spread except 12 MHz on JR-1H.  
40 F 17059 JR-1H. 150-174 MHz. . . . . Net 79.95  
40 F 17042 JR-1U. 450-470 MHz. . . . . Net 79.95  
99 F 63661 "D" Cells. Use 4. . . . . Net ea. 28¢



# Monitor Antennas and Accessories

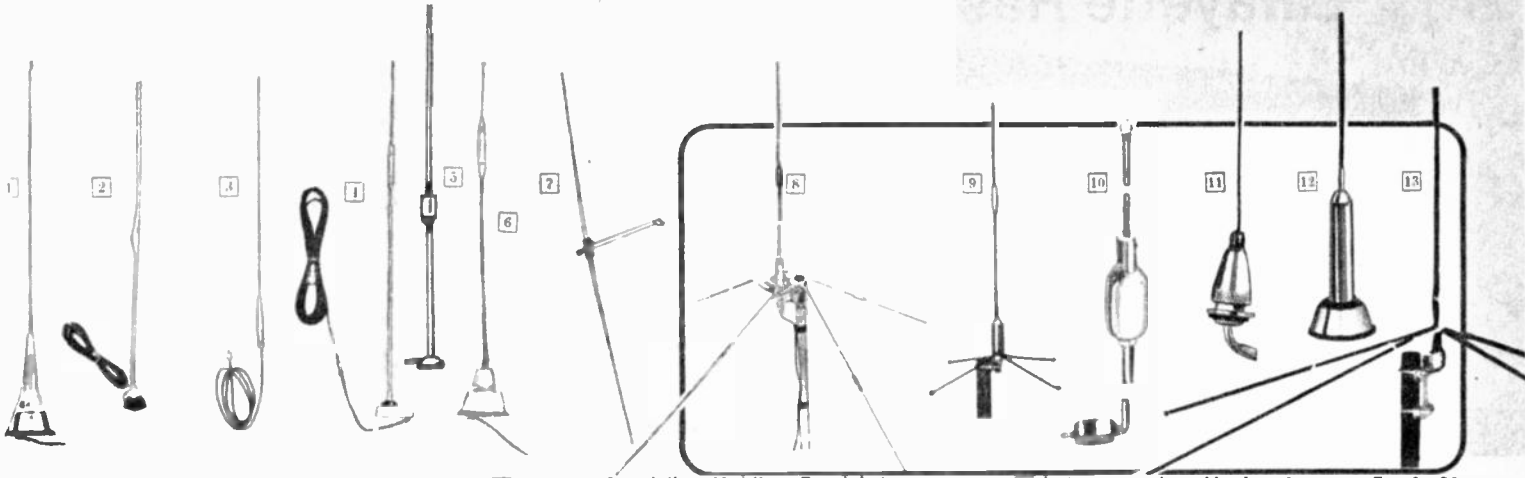

**1** Antenna Specialists High-Band Mobile Antenna. Covers 150-174 MHz, has 3 dB gain. "Quick-Grip" trunk mount, stainless steel whip and spring. With 17-ft., 50-ohm coax cable. con. 40 F 13330W Shpg. wt. 2 1/2 lbs. . . . . Net 24.80

**2** Hy-Gain UHF 450-470 MHz Monitor Mobile Antenna. Trunk-lip-mount antenna offers 5 dB gain, has 17-7 stainless steel whip, chrome-plated fittings, cyclac base. With coax connector and adapter. 40 F 31431 Shpg. wt. 2 lbs. . . . . Net 26.95

**3** Shakespeare Low/High Band Fiberglass Monitor Antenna. For 25-50, 148-174 MHz VHF bands. Mounts in 3/4" hole, 47" long, 18-ft. cable with Motorola phono plugs. 40 F 27066 Shpg. wt. 1 1/2 lbs. . . . . Net 19.85

40 F 27074 No-Hole Tnk. Mt. for above Net 5.25  
40 F 27058 Gutter Mount for above . . . . . Net 4.00  
40 F 22014 Motorola/SO-239 Adapter Net 1.59

**4** New-Tronics Hi/Lo Mobile Monitor Antenna. For 25-50, 140-174 MHz VHF. Trunk lip mount—no holes to drill. Waterproof loading coil. With 17-ft cable, connector 40 F 55166 Shpg. wt. 2 lbs., 5 oz. . . . . Net 21.45

**5** Hy-Gain Tri-Band Monitor Antenna. For 25-50, 130-174 MHz VHF, 450-470 MHz UHF. Centerloading coil, plugs directly into monitor. 40 F 31316 Shpg. wt. 1 lb. . . . . Net 10.95

**6** Antenna Specialists Mobile 3-Band Antenna. 30-50, 150-174 MHz VHF, 450-470 MHz UHF. "Quick-Grip" trunk mount, no holes required. Stainless steel whip, weatherproof phasing coil. Low profile base Only 21" high. With 17-ft. cable and connector. 40 F 13348 Shpg. wt. 1 1/2 lbs. . . . . Net 21.55

**7** Cushcraft 3-Band Monitor Stick. Use with any coax input, any monitor VHF or UHF. Universal support for mounting on mast, tower, window, etc. 12-ft., 24" boom. For 72 ohms or 52 ohms. PL-259 conn. 40 F 19246W Shpg. wt. 4 lbs. . . . . Net 21.50

**8** Lafayette "Range-Boost" Ground Plane Antenna. For 30-50, 130-174 MHz. Has 4 drooping radials, vertical radiator with transformer, coilinear collector. Heavy-duty aluminum alloy and stainless steel For 1" pipe, 1 1/4" tubing. 40 F 01053W Shpg. wt. 5 1/4 lbs. . . . . Net 22.95

**9** Lafayette UHF "Range-Boost" Antenna. Offers 4 dB gain over standard 1/4-waves, clamps on masts to 1 1/2" dia. Two 1/2 wavelengths, with high-Q phasing coils, shunt-fed DC grounding. Power rating: 100 watts, 50 ohms imp. Less coax conn. 40 F 01202W Shpg. wt. 1 lb. . . . . Net 24.95

**10** Lafayette Indoor Monitor Antenna. For 30-50 and 130-174 MHz VHF. Mounts directly to receiver. Two-section stainless steel whip, center-loaded coils. 48" length. PL-259 plug. 99 F 26205 Imported Shpg. wt. 1 lb. . . . . Net 10.95

**11** Lafayette Mobile FM-VHF Antenna. Roof/trunk deck mount antenna for 130-174 and 450-470 MHz. Has 3/8" bolt, whip with screw adapter, 12-ft. cable with PL-259 connector. 40 F 01137 Shpg. wt. 1 3/4 lbs. . . . . Net 7.95

**12** Lafayette Low-Band Mobile Antennas. Rapid-Grip trunk lip mount, omnidirectional pickup. Stainless steel whip, waterproof phasing transformer. Length, 43". Shpg. wt. 2 lbs.

40 F 01145W For 30-36 MHz . . . . . Net 15.95  
40 F 01152W For 36-42 MHz . . . . . Net 15.95  
40 F 01129W For 42-50 MHz . . . . . Net 15.95

20-ft. Coax Cable Assembly for Above. 40 F 70021 Shpg. wt. 11 oz. . . . . Net 3.69  
**13** Lafayette LR-145 FM-VHF Ground Plane Monitor Antenna. Omnidirectional, 4 stainless steel radials, chrome-plated brass radiator. Coax fitting for PL-259. For 1 1/8" dia. masts. For 130-174 and 450-470 MHz. 40 F 01160W Shpg. wt. 2 lbs. . . . . Net 8.95  
Model LR-40, Above, for 25-50 MHz. 40 F 01178W Shpg. wt. 4 lbs. . . . . Net 10.50

## "Mini" Pocket AM-VHF Aircraft Monitor

• With Earphone and Batteries **\$19.95**

Listen to aircraft in flight, local control towers up to 10 miles away. Solid-state, has variable tuning, whip antenna imported. 40 F 21002L Wt. 1/2 lb. . . . . Net 19.95  
Pkg. of 6 Extra Batteries. 32 F 46931 Wt. 1/2 lb. . . . . Net 2.34



**\$49.95**



Low As **\$32.35**

## RG-58/U Coax Cable Assemblies

With PL-259 connectors on both ends. 42 F 09243 50-ft. Length . . . . . Net 7.50  
42 F 09250 100-ft. Length . . . . . Net 11.95

## Coax Connector Adapters

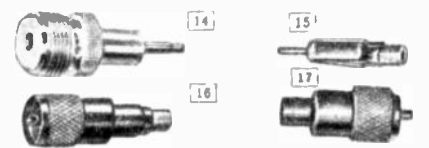

Stock No.	Fig.	Description	Net
42 F 69171	14	PL-259 to Min. Ph. Plug	2.95
42 F 69189	15	Phono Plug to Mot. Pin	.90
42 F 69197	16	Phono Plug to PL-259	1.69
42 F 22014	17	Mot. Pin Plug to PL-259	1.59

## Antenna Specialists Monitor Preamp

• For 30-50, 144-175, 450-475 MHz  
• 12 to 14 dB Gain on All Bands  
Increases gain and signal-pulling capacity of all VHF and UHF monitors and receivers. Great for apartment dwellers, anywhere outdoor antennas cannot be used. Smartly-styled cabinet. Has pilot lamp, on-off control, built-in antennas. For 117 VAC, 60 Hz 5 x 5 x 4 1/4". (Not for use with multiband portable radios.) 40 F 13322 Shpg. wt. 2 1/2 lbs. . . . . Net 49.95

## Antenna Specialists Monitor Preamps

• Increase Signal Levels Up to 10 Times  
Brings weak signals up to useable levels—up to 20 dB amplification on any band! Operates on 9-volt battery (order below) or 117 VAC, 60 Hz with optional adapter. With mobile bracket, cable with plug. 2 x 3 3/4 x 4 3/4".  
40 F 13298 148-174 MHz VHF . . . . . Net 32.35  
40 F 13306 30-50, 148-174 MHz VHF . . . . . Net 43.15  
40 F 13314 450-470 MHz UHF . . . . . Net 32.35  
99 F 60212 Battery for above . . . . . Net 3.95  
99 F 90151 AC Adapter for above . . . . . Net 4.50

**Police Call Police, Fire and Emergency Radio Directory**  
Lists frequencies, call letters and number of base and mobile stations in specified areas. Latest 1974-1975 Edition Shpg. wt. 1 lb.

Stock No.	Vol.	For States	Net
10 F 14505	1	Conn., Maine, Mass., N.H., N.Y., R.I., Vt.	3.95
10 F 14513	2	Delaware, Maryland, New Jersey, Pennsylvania	3.95
10 F 14521	3	Ohio, Michigan	3.95
10 F 14539	4	Illinois, Indiana, Kentucky, Wisconsin	3.95
10 F 14547	5	Iowa, Kan., Minn., Mo., Neb., N.D., S.D.	3.95
10 F 14554	6	D.C., Fla., Ga., N.C., S.C., Va., W. Va.	3.95
10 F 14562	7	Ala., Ark., La., Miss., Okla., Tenn., Texas	3.95
10 F 14570	8	Ariz., Colo., Idaho, Mont., N.M., Nev., Utah, Wyo.	3.95
10 F 14588	9	California, Oregon, Washington	3.95



# Lafayette Has Everything in CB Accessories



Hy-Gain \$64<sup>95</sup>

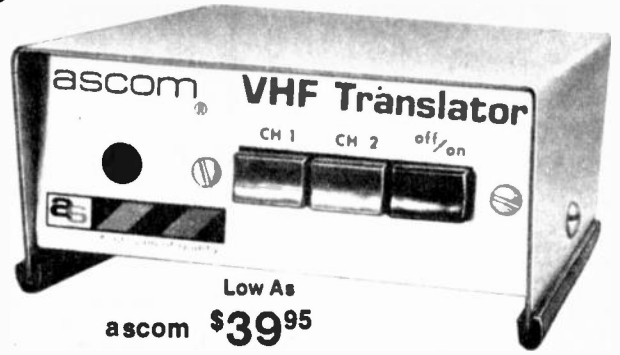

Low As  
ascom \$39<sup>95</sup>

## Hy-Gain 422 Base or Mobile CB Receiver Preamp

- 20 dB Gain on All 23 Channels
- Switches In- and Out-of-Circuit
- Illuminated On-the-Air Sign

Really boosts those weak signals! Provides up to 20 dB gain for all tunable CB receivers. Has on-the-air indicator light, in/out-of-circuit switch, SSB/AM switch, illuminated on-the-air sign. Automatic delay circuit prevents annoying chatter. Operates on 12 volts DC or 117 VAC, 60 Hz. Good-looking metal cabinet, 7½ x 3 x 6". THE aid for the CB enthusiast.

42 F 35263 Shpg. wt. 4 lbs. . . . . Net 64.95

## Ascom Solid-State Mobile CB to Police Converters

- Converts CB Radio to VHF-FM Monitor
- Includes Mobile Bracket, Hardware

Installs in antenna circuit, converts any mobile CB radio to an FM monitor for police and fire calls, civil defense, etc. Works thru Ch. 9, does not interfere with normal CB operation when off. Crystal-controlled, order crystals below. 12 VDC. 4 x 1¼ x 4¼".

42 F 10712 For 30-50 MHz. 2 lbs. . Net 39.95  
 42 F 10720 For 148-174 MHz. 2 lbs. Net 39.95  
 42 F 10738 For 450-470 MHz. 2 lbs. Net 44.95  
 Crystal Certificate. Good for one crystal.  
 40 F 82145Y Spec. Exact Freq. Net ea. 4.95



\$22<sup>95</sup>

\$14<sup>95</sup>

**1 E.F. Johnson Solid-State In-Converter.** Converts 6-12, 6-18 and 12-24 VDC, negative or positive ground. 3¼ x 5¼ x 2½". 42 F 39190 Shpg. wt. 2¼ lbs. . . . Net 22.95

**2 6/12 V Power Inverter.** Converts 6-volt negative or 12 V positive ground to 12-volt negative ground. Fused line cord. 3 amps continuous, 10-amp surge. 3 x 2½ x 5". 42 F 50502 Shpg. wt. 2½ lbs. . . . Net 16.95

## Antenna Accessories

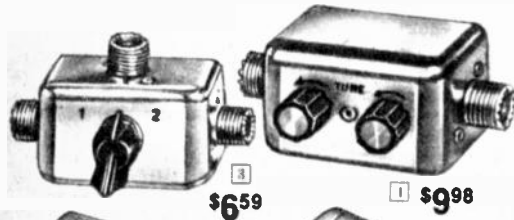

\$6<sup>59</sup>

\$9<sup>98</sup>

**3 2-Position Antenna Coax Switch.** Rated at 1 kW AM, 2kW PEP SSB. Instantly changes from one antenna to another. 2½ x 1¼". 42 F 21024 Shpg. wt. 6 oz. . . . . Net 6.59

**4 CB Antenna Match.** Provides antenna/line match with 1.1:1 VSWR. Installs between antenna and lead-in. Tuning knobs. 42 F 21032 Shpg. wt. 6 oz. . . . . Net 9.98



\$7<sup>15</sup>

\$10<sup>59</sup>

**5 Low-Pass Filter.** Reduces TVI from your rig to nearby TV sets. Rated 100 watts. Installs directly in line. 42 F 21123 Shpg. wt. 6 oz. . . . . Net 7.15

**6 Twin-Rig Coupler.** Monitor two CB transceivers from a single antenna. Transmit up to 5 watts, too. 2.5-220 MHz operation. Less than ½ dB insertion loss. 42 F 21107 Shpg. wt. 6 oz. . . . . Net 10.59

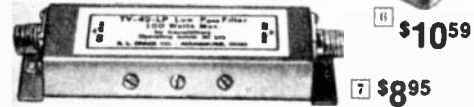

\$8<sup>95</sup>

**7 Drake TV42LP Low-Pass Filter.** Four-section, with 43.2 MHz cutoff—reduces interference to TV's. 100 watts. 40 F 65132 Shpg. wt. ¾ lb. . . . . Net 8.95



\$15<sup>95</sup>

**8 E.F. Johnson CB Matchbox.** Provides maximum energy transfer to antenna system, 1.1:1 VSWR. 4x3¼ x 2¾". Inserts in line. 42 F 39141 Shpg. wt. 1½ lbs. . . . Net 15.95

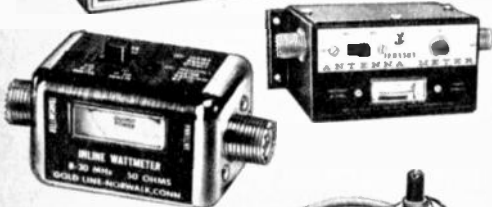

\$14<sup>95</sup>

**9 E.F. Johnson Antenna Meter.** Minimizes power loss, measures VSWR up to 10:1 on signals up to 50 watts. 4½ x 2¾ x 2½". 42 F 39133 Shpg. wt. 14 oz. . . . Net 14.95



\$16<sup>49</sup>

\$15<sup>95</sup>

**10 CB Inline Wattmeter.** Reads 0-5 and 0-50 watts. Operates 8-30 MHz. Negligible insertion loss. Can be kept in line. 40 F 24055 Shpg. wt. 8 oz. . . . . Net 16.49

**11 CB Phone Patch.** Use with high-impedance mike input and 3-16-ohm speaker—connect your telephone to your CB rig. 42 F 21180 Shpg. wt. 1 lb. . . . . Net 15.95

## Mobile Accessories

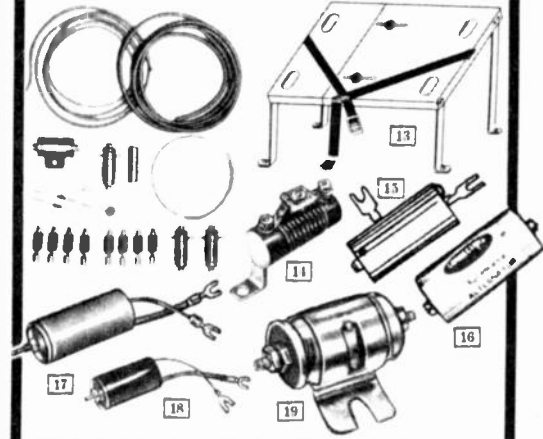

**12 Lafayette Auto-Marine Engine Noise Suppressor Kit.** With all hardware, full instructions. Really effective! 42 F 09052 Shpg. wt. 1¼ lbs. . . . . Net 16.95

**13 Mobile Mount.** Adjustable for all CB transceivers. All steel, 1" strap. 42 F 68009W Shpg. wt. 4¾ lbs. . . . . Net 8.95

**14 Generator Noise Filter.** 3-30 MHz. 99 F 60188 Imported. Shpg. wt. 5 oz. . . Net 3.95

**15 Voltage Regulator Filter.** For all frequencies. 6-12-24-32 V systems. 42 F 89013 Shpg. wt. 5 oz. . . . . Net 3.95

**16 Alternator Noise Filter.** To 50 dB. 42 F 49009 Shpg. wt. 4 oz. . . . . Net 3.49

**17 60-Amp Alternator/Gen. Filter.** 2.2 to 400 MHz range. No tuning needed. 42 F 21131 Shpg. wt. 1 lb. . . . . Net 8.25

**18 100-Amp Alternator/Generator Filter.** 42 F 21172 Shpg. wt. 1½ lbs. . . . . Net 12.95

**19 Feed-Thru Suppressor Filters.** For above 2 MHz. Rated at 5 µF, 50 WVDC. Shpg. wt. 6 oz.

42 F 21149 40 Amps . . . . . Net 2.99  
 42 F 21156 60 Amps . . . . . Net 3.99

# Lafayette CB Microphones, Crystals, Accessories



**1 Dynamic Microphone.** For solid-state, low-impedance transceivers. Fits in palm of hand, high-impact plastic case. Three-cond. coiled cord, 4-prong miniature plug. Wired for relay switching. Mates directly with Lafayette HB-500, A, 555, 525 series, 625A, HB-23, A, HE-20T, A, Telsat SSB-50A, HE-20D, HB-600, A, Telsat 23. 3 3/8" x 2 3/8" x 1 1/4". **99 F 46187 Imported.** Wt. 3/4 lb. . . . . Net 12.95

**2 Noise-Cancelling Mike.** High output (-48 dB) ceramic mike for base or mobile. Cardioid pattern minimizes noise pickup, high-impact Cyclac case. 3-cond. coiled cord, hang-up clip. For FET & tube-type equip. **44 F 45011 Shpg. wt. 3/4 lb. . . . . Net 10.95**

**3 "Mity-Mite" Hand-Held Ceramic Mike.** Has 3-cond. cord with shield for electronic switching (has instr. for relay switching). For high-impedance (tube-type) units. 1 x 1 1/4 x 3 1/4". Imported. Used in Lafayette Comstat 25 and 35 series. **99 F 45791 Shpg. wt. 9 oz. . . . . Net 8.95**

**4 CB Cradle Handset.** Telephone-style handset for base or mobile units. Automatically disconnects speaker when handset is lifted. Push-bar talk switch. Minimizes noise. **42 F 65039 Shpg. wt. 2 lbs. . . . . Net 32.50**  
**Miniature 1/8" Speaker Plug.** Imported. **99 F 62101 Shpg. wt. 3 oz. . . . . Net 39¢**  
**Standard 1/4" Speaker Plug.** Imported. **99 F 62218 Shpg. wt. 3 oz. . . . . Net 45¢**

**5 Base Station Dynamic Desk Mike.** For solid-state transceivers requiring relay/elect. switching. Has push-to-talk bar, lock lever, 3-cond. shielded coiled cable. With instructions for use with Lafayette and with over 100 other popular transceivers. 300-3,000 Hz response. **42 F 01695 Shpg. wt. 4 lbs. . . . . Net 21.95**

**6 Dynamic Mobile Mike.** Top-performing dynamic microphone for Lafayette Micro 723, 923, Telsat 1023 and other popular solid-state CB transceivers. Universally-wired for electronic switching of Micro 723 and relay switching of Micro 923 and Telsat 1023. With retractable coiled cord and 5-pin DIN connector. Imported. **99 F 46716 Shpg. wt. 3/4 lb. . . . . Net 11.95**  
**34 F 31038 Repl. DIN Plug. 2 oz. . . . . Net 1.16**

**7 "Range-Boost" Pre-Amplified Dynamic Desk Mike with Modulation Guard.** Has a compression amplifier circuit which guards against overmodulation, 300-3,000 Hz response for excellent voice transmission, volume control, touch-to-talk front bar, slide-lock for extended transmission. -23 dB output. With self-contained battery, 3-cond. (1 shielded cord), wiring instructions for relay or electronic switching for Lafayette and other popular transceivers. **42 F 01703 Shpg. wt. 4 lbs. . . . . Net 39.95**  
**99 F 63729 9-V Repl. Battery . . . . . Net 49¢**

## Lafayette Precision CB Crystals for Current Lafayette CB Units

For: Micro 66, HA-120, HA-73B, HE-411, HA-420, Dyna-Com 3B and Dyna-Com 12A.  
**46 F 10\*\* Receive Crystal . . . . . Net 2.25**  
**46 F 15\*\* Transmit Crystal . . . . . Net 2.25**  
**\*\*How to Order:** State appropriate Stock No. (transmit or receive), add two digits to represent the desired CB channel, i.e., 46 F 1009 (receive crystal for Ch. 9) 46 F 1521 (transmit crystal for Ch. 21), etc.

**CB Crystals for standard brand and other Lafayette Models:** Specify Mfr., Model No., Transmit or Receive and Channel No. (Not applicable for crystals used in synthesis circuitry). Send filled-out certificate to mfr.; mfr. will send crystal, postpaid, within 30 days.  
**46 F 09004Y Crystal Certificate Net ea. 2.25**  
**All crystals are extremely accurate "3rd Overtone," meet or exceed FCC tolerance requirements of .005%.**

## CB and Microphone Accessories

**8 Microphone Mounting Clip.** For stud mount CB and Ham mikes. Attaches with two screws (supplied). **99 F 31841 Imported.** Shpg. wt. 3 oz. . . . . Net 79¢

**9 Magnetic Mike Holder.** Clips to mike or attaches to any metal surface. Fits most CB, Ham, commercial radio mikes. Imported. **99 F 45585 Shpg. wt. 4 oz. . . . . Net 1.09**

**10 Mike Plug for CB and Amateur Mikes.** For 4-cond. (3-cond. with shield). 1 1/4 x 1 1/2". Used with mikes in Comstat 23, MKV, MKVI, 25, 25A, 25B, 35; HB-444, 444/25, 444/25A, Comstat 19. Imported. **99 F 62630 Shpg. wt. 3 oz. . . . . Net 1.95**

**11 Mike Chassis Socket.** Mates with above. Requires 5/8" mounting hole. 3/8 x 3/8" dia. Imported. **99 F 62648 Shpg. wt. 3 oz. . . . . Net 1.25**

**12 Microphone Plug.** For Lafayette HB-555, 600, 600A; HA-650, HE-20D, HB-525 series, HB-625, A, HE-20T, A, HB-23, A, HA-750, Telsat 23, 150, 50, SSB-50A, 1023; Micro 12. 1 1/2 x 1/2" diameter. Imported. **99 F 62838 Shpg. wt. 4 oz. . . . . Net 1.95**

**13 Mike Chassis Socket.** Mates with above. Imp. **99 F 63646 Shpg. wt. 2 oz. . . . . Net 1.79**

**14 Cable Assemblies.** For Comstat 23, 25, 25A, 25B, 35—dual power plug and B-prong octal socket. Imp. **99 F 32401 AC, 5 3/4 ft. Shpg. wt. 5 oz. . . . . Net 2.99**  
**4 1/2-ft. Fused DC Cable.** Tinned end to octal socket. **99 F 31825 Imported.** Shpg. wt. 5 oz. . . . . Net 4.49

**15 12 VDC Power Cable.** 6 feet long. For HB-500, 500A, 555, 525 series; 625, A, 23, A, Telsat 50, 150, HA-750, PB-50, PB-150, HA-39, 42, 45, 46, 153, 155, HA-159. Fuse protected. Imported. **99 F 31106 Shpg. wt. 4 oz. . . . . Net 3.99**

**16 Heavy-Duty Mike Cable.** 3-cond. plus shield. Extends to 5 feet, retracts to 10 inches. For HB500, A, 525 series, 625, A, HB23, A, Telsat 23, 50, 150, SSB-50A, Micro 12, etc. Imported. **99 F 63620 Shpg. wt. 4 oz. . . . . Net 4.99**

**17 CB Connector/Adapter.** Accepts Motorola plug, plugs into SO-239 socket. **44 F 22014 Shpg. wt. 4 oz. . . . . Net 1.59**

**18 CB Connector Adapter.** Accepts PL-259 plug, plugs into Motorola antenna socket. **44 F 22022 Shpg. wt. 4 oz. . . . . Net 1.35**

**19 Lighted Pilot Lamps.** "S" meter lamp. For 6V AC or DC. For Comstat 23, MKV, MKVI, 25, 25A, 25B, 35, HB-444/25A. Imported. **99 F 62622 Shpg. wt. 3 oz. . . . . Net 49¢**

**19 Channel Selector Indicator Lamp.** For all Lafayette solid-state CB transceivers and VHF monitors. **99 F 63612 Shpg. wt. 2 oz. Imported. . . . . Net 53¢**

**20 Knurled Screw.** For mobile mounting brackets on HB-525 series, 555, 625, 625A, 23, A, 750, Telsat 50, 150, PB-50, PB-150, Micro 12. Imported. **99 F 63604 Shpg. wt. 3 oz. . . . . Net 79¢**  
**For Comstat 23, MKV, MKVI, 25, 25A, 25B, 35, HB-44/25. Imported.**  
**99 F 31833 Shpg. wt. 2 oz. . . . . Net 59¢**

**21 DC Power Chassis Jack.** Mounts on rear of chassis, accepts 99-31106 cable (15) above. **99 F 63638 Imported.** Shpg. wt. 2 oz. . . . . Net 99¢

**22 Mobile Mounting Bracket.** Adj. side mtg. holes for knurled screws. For HB-525 series, 625, A, HA-750, PB-50, PB-150, Telsat 50 and 150. 6 3/4 x 2 x 3/4". **99 F 63588 Imported.** Shpg. wt. 5 oz. . . . . Net 1.59  
**For HB-555, 23, A, HA-39, 42, 45, 46, 153, 155, 159. 6 1/4 x 2 1/4 x 3/4". Imported.**  
**99 F 63596 Shpg. wt. 4 oz. . . . . Net 1.59**



# Lafayette Heavy-Duty Mobile CB Antennas

Rugged Citizens Band Antennas help you get your message across.  
Easy to install on your car, truck, trailer or camper.

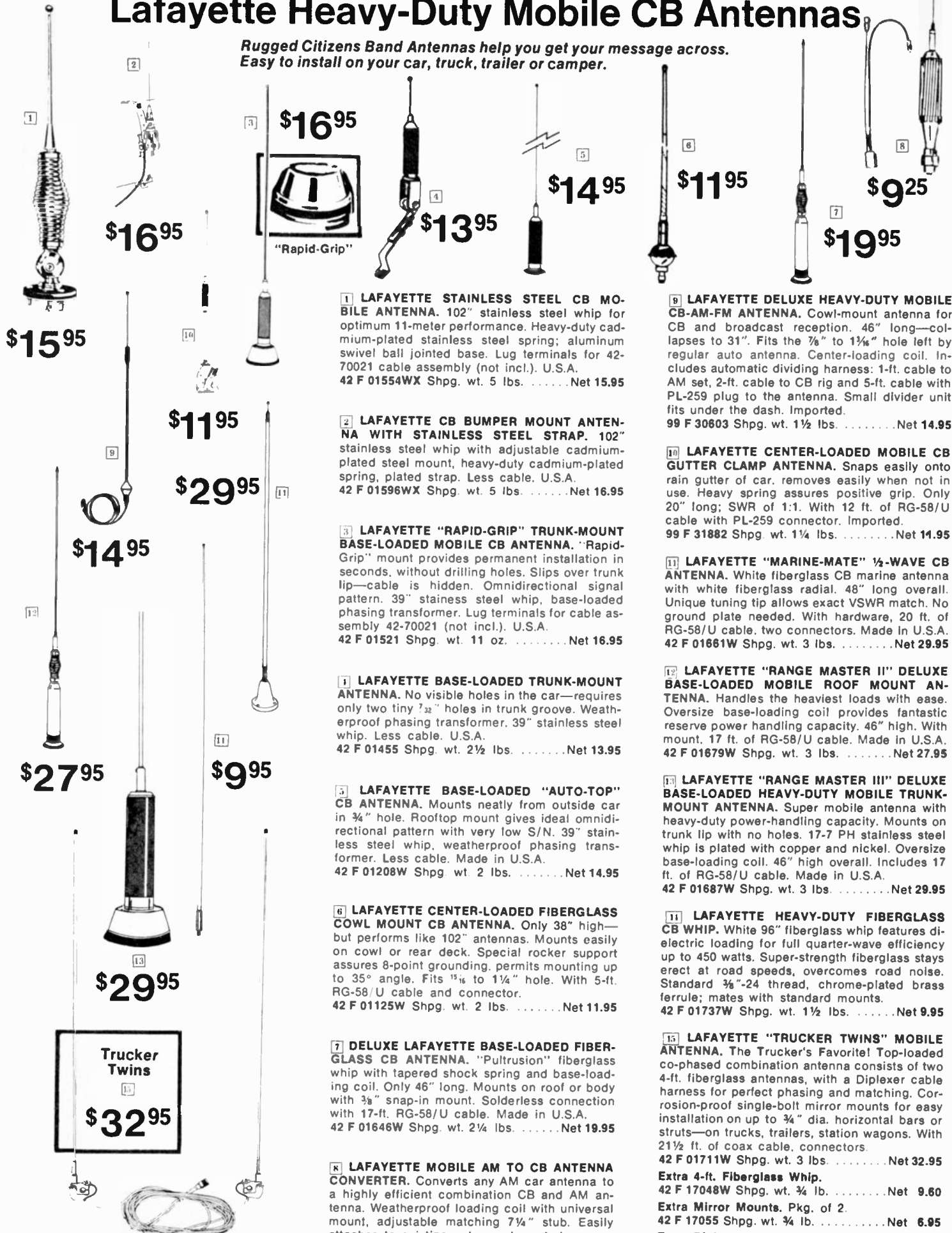

**1 LAFAYETTE STAINLESS STEEL CB MOBILE ANTENNA.** 102" stainless steel whip for optimum 11-meter performance. Heavy-duty cadmium-plated stainless steel spring; aluminum swivel ball jointed base. Lug terminals for 42-70021 cable assembly (not incl.). U.S.A. 42 F 01554WX Shpg. wt. 5 lbs. . . . .Net 15.95

**2 LAFAYETTE CB BUMPER MOUNT ANTENNA WITH STAINLESS STEEL STRAP.** 102" stainless steel whip with adjustable cadmium-plated steel mount, heavy-duty cadmium-plated spring, plated strap. Less cable. U.S.A. 42 F 01596WX Shpg. wt. 5 lbs. . . . .Net 16.95

**3 LAFAYETTE "RAPID-GRIP" TRUNK-MOUNT BASE-LOADED MOBILE CB ANTENNA.** "Rapid-Grip" mount provides permanent installation in seconds, without drilling holes. Slips over trunk lip—cable is hidden. Omnidirectional signal pattern. 39" stainless steel whip, base-loaded phasing transformer. Lug terminals for cable assembly 42-70021 (not incl.). U.S.A. 42 F 01521 Shpg. wt. 11 oz. . . . .Net 16.95

**4 LAFAYETTE BASE-LOADED TRUNK-MOUNT ANTENNA.** No visible holes in the car—requires only two tiny  $\frac{7}{32}$ " holes in trunk groove. Weatherproof phasing transformer. 39" stainless steel whip. Less cable. U.S.A. 42 F 01455 Shpg. wt. 2½ lbs. . . . .Net 13.95

**5 LAFAYETTE BASE-LOADED "AUTO-TOP" CB ANTENNA.** Mounts neatly from outside car in  $\frac{3}{4}$ " hole. Rooftop mount gives ideal omnidirectional pattern with very low S/N. 39" stainless steel whip, weatherproof phasing transformer. Less cable. Made in U.S.A. 42 F 01208W Shpg. wt. 2 lbs. . . . .Net 14.95

**6 LAFAYETTE CENTER-LOADED FIBERGLASS COWL MOUNT CB ANTENNA.** Only 38" high—but performs like 102" antennas. Mounts easily on cowl or rear deck. Special rocker support assures 8-point grounding, permits mounting up to 35° angle. Fits  $\frac{13}{16}$  to  $1\frac{1}{4}$ " hole. With 5-ft. RG-58/U cable and connector. 42 F 01125W Shpg. wt. 2 lbs. . . . .Net 11.95

**7 DELUXE LAFAYETTE BASE-LOADED FIBERGLASS CB ANTENNA.** "Pultrusion" fiberglass whip with tapered shock spring and base-loading coil. Only 46" long. Mounts on roof or body with  $\frac{3}{8}$ " snap-in mount. Solderless connection with 17-ft. RG-58/U cable. Made in U.S.A. 42 F 01646W Shpg. wt. 2¼ lbs. . . . .Net 19.95

**8 LAFAYETTE MOBILE AM TO CB ANTENNA CONVERTER.** Converts any AM car antenna to a highly efficient combination CB and AM antenna. Weatherproof loading coil with universal mount, adjustable matching  $7\frac{1}{4}$ " stub. Easily attaches to existing antenna. Imported. 99 F 31163 Shpg. wt.  $\frac{3}{4}$  lb. . . . .Net 9.25

**9 LAFAYETTE DELUXE HEAVY-DUTY MOBILE CB-AM-FM ANTENNA.** Cowl-mount antenna for CB and broadcast reception. 46" long—collapses to 31". Fits the  $\frac{7}{8}$ " to  $1\frac{1}{8}$ " hole left by regular auto antenna. Center-loading coil. Includes automatic dividing harness: 1-ft. cable to AM set, 2-ft. cable to CB rig and 5-ft. cable with PL-259 plug to the antenna. Small divider unit fits under the dash. Imported. 99 F 30603 Shpg. wt. 1½ lbs. . . . .Net 14.95

**10 LAFAYETTE CENTER-LOADED MOBILE CB GUTTER CLAMP ANTENNA.** Snaps easily onto rain gutter of car, removes easily when not in use. Heavy spring assures positive grip. Only 20" long; SWR of 1:1. With 12 ft. of RG-58/U cable with PL-259 connector. Imported. 99 F 31882 Shpg. wt. 1¼ lbs. . . . .Net 14.95

**11 LAFAYETTE "MARINE-MATE" ½-WAVE CB ANTENNA.** White fiberglass CB marine antenna with white fiberglass radial. 48" long overall. Unique tuning tip allows exact VSWR match. No ground plate needed. With hardware, 20 ft. of RG-58/U cable, two connectors. Made in U.S.A. 42 F 01661W Shpg. wt. 3 lbs. . . . .Net 29.95

**12 LAFAYETTE "RANGE MASTER II" DELUXE BASE-LOADED MOBILE ROOF MOUNT ANTENNA.** Handles the heaviest loads with ease. Oversize base-loading coil provides fantastic reserve power handling capacity. 46" high. With mount, 17 ft. of RG-58/U cable. Made in U.S.A. 42 F 01679W Shpg. wt. 3 lbs. . . . .Net 27.95

**13 LAFAYETTE "RANGE MASTER III" DELUXE BASE-LOADED HEAVY-DUTY MOBILE TRUNK-MOUNT ANTENNA.** Super mobile antenna with heavy-duty power-handling capacity. Mounts on trunk lip with no holes. 17-7 PH stainless steel whip is plated with copper and nickel. Oversize base-loading coil. 46" high overall. Includes 17 ft. of RG-58/U cable. Made in U.S.A. 42 F 01687W Shpg. wt. 3 lbs. . . . .Net 29.95

**14 LAFAYETTE HEAVY-DUTY FIBERGLASS CB WHIP.** White 96" fiberglass whip features dielectric loading for full quarter-wave efficiency up to 450 watts. Super-strength fiberglass stays erect at road speeds, overcomes road noise. Standard  $\frac{3}{8}$ "-24 thread, chrome-plated brass ferrule; mates with standard mounts. 42 F 01737W Shpg. wt. 1½ lbs. . . . .Net 9.95

**15 LAFAYETTE "TRUCKER TWINS" MOBILE ANTENNA.** The Trucker's Favorite! Top-loaded co-phased combination antenna consists of two 4-ft. fiberglass antennas, with a Diplexer cable harness for perfect phasing and matching. Corrosion-proof single-bolt mirror mounts for easy installation on up to  $\frac{3}{4}$ " dia. horizontal bars or struts—on trucks, trailers, station wagons. With 21½ ft. of coax cable, connectors. 42 F 01711W Shpg. wt. 3 lbs. . . . .Net 32.95

**Extra 4-ft. Fiberglass Whip.**  
42 F 17048W Shpg. wt.  $\frac{3}{4}$  lb. . . . .Net 9.60  
**Extra Mirror Mounts, Pkg. of 2.**  
42 F 17055 Shpg. wt.  $\frac{3}{4}$  lb. . . . .Net 6.95  
**Extra Diplexer Cable Harness.**  
42 F 17063 Shpg. wt. 2 lbs. . . . .Net 9.95

# Lafayette Heavy-Duty CB Base Station Antennas

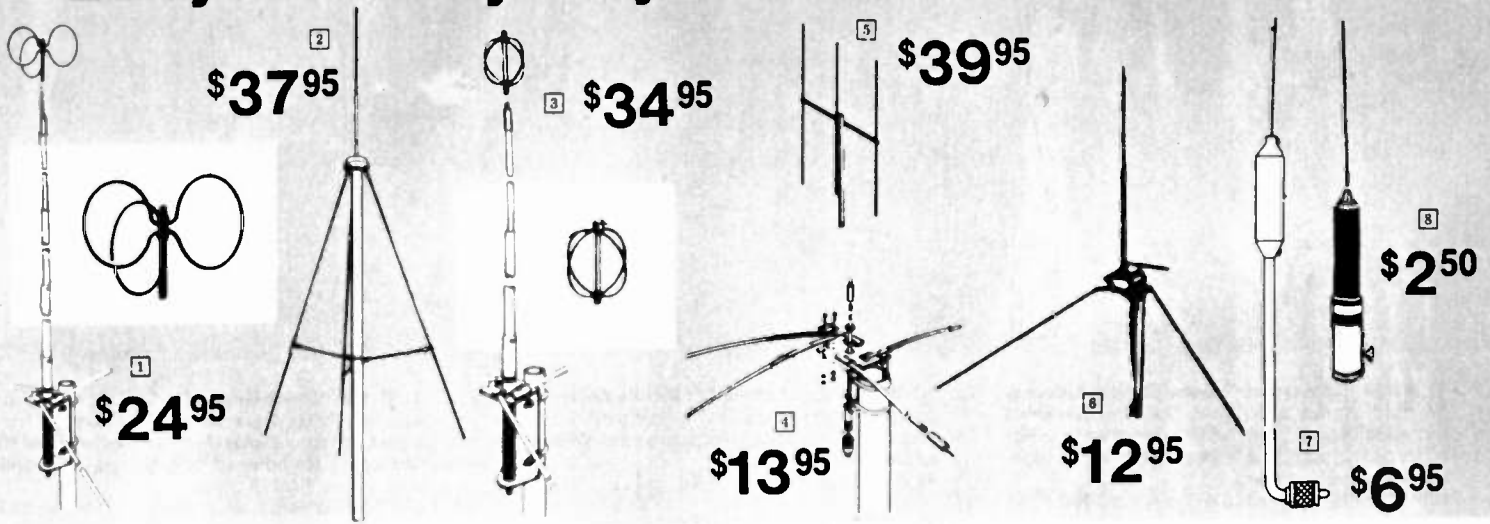

**1 LAFAYETTE "RANGE BOOST II"™ END-FED 1/2-WAVE CB ANTENNA.** Anti-static clover-leaf ball drastically reduces receiver noise. Offers 3.75 dB true omnidirectional gain, signal-to-noise improvement of 6-20 dB, VSWR of 1.5:1 or less. Vertical radiator consists of three seamless aluminum tube sections, topped by 108" top section. Three 54" radials. Heavy-duty mounting bracket, rubber-covered phasing transformer, 17.6" overall length. Accepts masts to 1 1/2" diameter and PL-259. Less cable. USA. 42 F 01448W Shpg. wt. 6 lbs. . . . . Net 24.95

**2 DELUXE LAFAYETTE "RANGE-MASTER I" OMNIDIRECTIONAL CB ANTENNA.** Half-wave dipole in fullaperturic design gives 5 dB gain, VSWR of 1.5:1. No coils or matching stubs. 100-mph wind survival. Has 8 10" radials. Mounts on 1 1/4" mast. SO-239. 17 ft. high. Less cable. USA. 42 F 01653W Shpg. wt. 4 lbs. . . . . Net 37.95

**3 DELUXE LAFAYETTE SUPER RANGE-BOOST II™ OMNIDIRECTIONAL BASE ANTENNA.** Half-wave end-fed antenna offers 4 dB gain, delivering 13 watts effective radiated power. Hi-Q phasing coil optimizes impedance match. VSWR of 1.4:1 or less. Seamless aircraft tubing and corrosion-proof steel. 4-element static ball. Loaded ground radials. Overall height, 18 feet. Takes mast to 1 1/2". Less mast and coax. USA. 42 F 01604W Shpg. wt. 8 1/2 lbs. . . . . Net 34.95

**4 DELUXE LAFAYETTE HEAVY-DUTY 4-ELEMENT GROUND PLANE.** Solid aluminum 108" heat-treated radials and radiator. Radial droop for 50-ohm match. Accepts 1 1/4" mast and PL-259 connector. Less mast, coax. USA. 42 F 01562W Shpg. wt. 4 1/2 lbs. . . . . Net 13.95

**5 LAFAYETTE 3-ELEMENT VERTICAL BEAM CB ANTENNA.** Develops forward gain of 8 dB; front-to-back ratio is 25 dB. Precision tuned. Iridite-treated steel hardware. 8-ft boom of 1 1/4" O.D. aluminum. 16 1/2-ft elements. Accepts mast up to 1 1/2". Less cable. USA. 42 F 01133W Shpg. wt. 7 3/4 lbs. . . . . Net 39.95

**6 LAFAYETTE 1/4-WAVE GROUND PLANE.** Unity gain, omnidirectional antenna of heavy-wall 1/2" and 3/8" O.D. aluminum tubing. Sturdy mount takes masts to 1 5/8". Less cable. USA. 42 F 01620W Shpg. wt. 3 3/4 lbs. . . . . Net 12.95

**7 LAFAYETTE CENTER-LOADED CB WHIP ANTENNA.** Chrome-plated whip for base or portable use. Adjustable whip is 11 7/8" long; additional stub, 12 7/8" total length. Terminates in PL-259 Weatherproof. Imported. 99 F 31890 Shpg. wt. 1/2 lb. . . . . Net 6.95

**8 LAFAYETTE UNIVERSAL BASE-LOADED WALKIE-TALKIE ANTENNA.** Replaces broken or existing recessed antenna. 16" long. Imported. 99 F 32187 Shpg. wt. 1/4 lb. . . . . Net 2.50

**9 MOSLEY WEATHER-GUARD ANTENNA COAT.** Protects against corrosive action of salt, water, etc. Applies easily with a brush. 42 F 51112 Shpg. wt. 1 lb. . . . . Net 2.25

**10 "DUMMY" ANTENNA LOAD FOR CB TRANSCEIVERS.** Non-inductive 52-ohm load for testing, tuning. In PL-259 coax plug. 42 F 09029 Shpg. wt. 3 oz. . . . . Net 1.95

**11 LAFAYETTE LIGHTNING PROTECTOR.** Eliminates static build-up on coax cables. One PL-259 plug and one DKCB connector. 42 F 20018 Shpg. wt. 1/4 lb. . . . . Net 3.95

**12 MOBILE/BASE COAXIAL CABLE ASSEMBLY—Type A.** Consists of 20-ft. RG-58/U cable with PL-259 and UG-175/U on both ends. 42 F 70013 Shpg. wt. 12 oz. . . . . Net 3.98

**13 COAXIAL CABLE ASSEMBLY—Type B.** Same as (12) except one end is terminated with PL-259 and UG-175/U; other end with universal-type terminal lugs for mobile antenna. 42 F 70021 Shpg. wt. 11 oz. . . . . Net 3.69

**POLYFOAM RG-8/U COAX ASSEMBLY FOR BASE STATIONS.** Polyfoam dielectric for low line loss. PL-259 connectors both ends. 42 F 09102 50-ft. Shpg. wt. 5 lbs. . . . . Net 13.95  
42 F 09110 100-ft. Shpg. wt. 9 3/4 lbs. . . . . Net 22.95

**14 LAFAYETTE CB WALKIE-TALKIE ANTENNA REPLACEMENTS.** For Lafayette and other Walke-Talkies. 3/8" base. \* 5/16". 1/2 lb. Imported.

Stock No.	Sec-tions lapped	Col-lgth	Ex-tended Lgth	For Lafayette Models	Net
99 F 31122*	8	5 7/8	36 1/2	HA-70B, C, D	1.95
99 F 32039	9	7 3/8	55	HA-73A, HA-73B	4.95
99 F 32047	11	6	49	HA-73, HA-305, HE-210A, HA-62, HA-310, HA-310A, HE-410, HE-411, HA-420	3.95
99 F 32054	10	7	55	Dyna-com 2, 2A, 3, 3A, 3B	4.95
99 F 32070	10	8 3/8	67 1/2	Dyna-com 5, 5A, 6, 12, 12A, 23	4.95

**15 CORNELL-DUBILIER AR-22L HEAVY-DUTY AUTOMATIC ROTOR.** Handles antennas up to 150 lbs. Simply set control unit pointer to desired direction—antenna automatically rotates within accuracy of ±2%. Reversible clamps take masts from 7/8" to 2 1/8" O.D. Uses 4-conductor cable. For 115 VAC. U.L. listed. 42 F 86076W Shpg. wt. 1 1/4 lbs. . . . . Net 49.95

**MODEL AR-40 ROTOR.** Includes same rotor as above, but with solid-state control unit for silent, automatic positioning of antenna within ±1%. Uses 5-wire cable. For 115 VAC. 42 F 86118W Shpg. wt. 14 lbs. . . . . Net 54.95  
100-foot coils of rotor cable.  
32 F 89105 4-cond. Shpg. wt. 2 1/2 lbs. . . . . Net 6.18  
32 F 36312 5-cond Shpg wt 2 3/4 lbs. . . . . Net 6.65

## CB ACCESSORIES

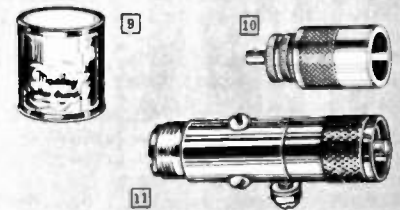

## Mobile Accessories

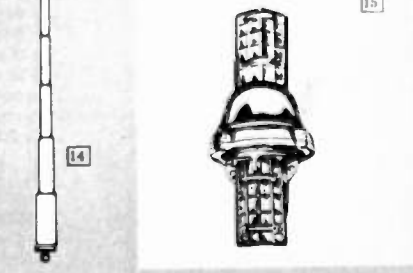
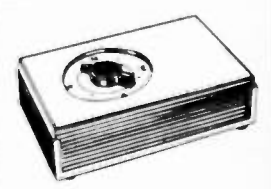

# Antenna Specialists CB Antennas

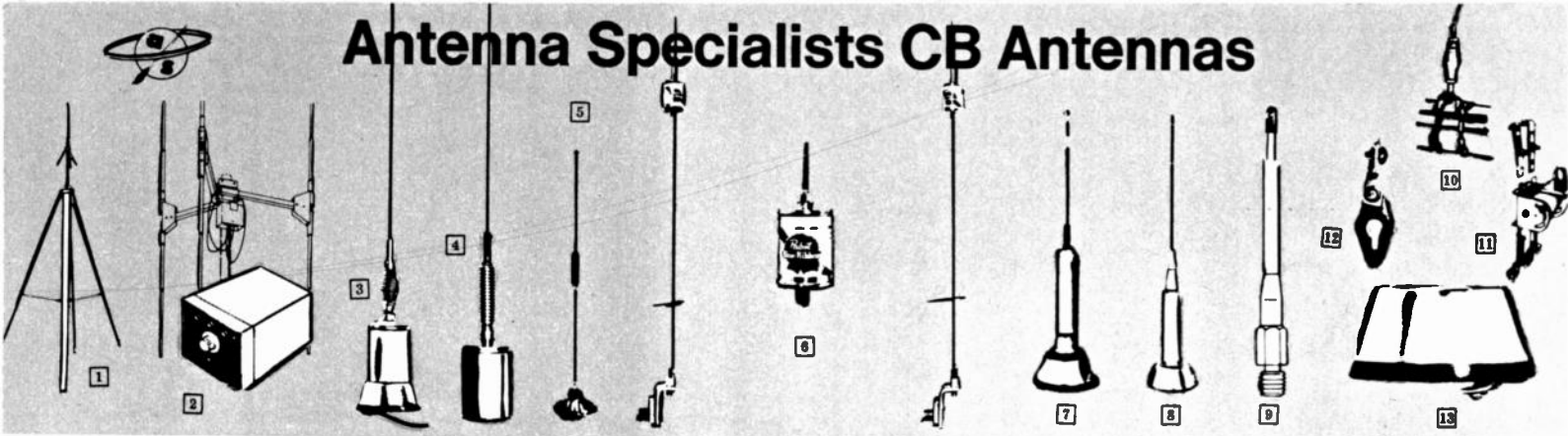

**1 M-400 "Star Duster" Base Station Antenna.** Omnidirectional. 5 dB gain. Die-cast aluminum and seamless aircraft tubing construction. For 1" threaded pipe, 1 1/4" steel mast. 18 ft. high. Parcel Post Shippable.

42 F 10688W Shpg. wt. 5 1/2 lbs. . . . . Net 43.15

**2 MS-119 "Super Scanner" Rotatable Base Station Antenna.** Electronically scans 360°. 4.75 dB omni, 8.75 dB directional gain. Three 17 1/2-ft. vertical elements, separate scan control. Accepts masts from 1 1/2 to 2". Requires 4-cond. rotor cable.

42 F 10696W Shpg. wt. 20 lbs. . . . . Net 113.35  
32 F 69105 100' 4-Cond. Cable . . . . Net 3.65

**3 M-410 "Big Momma" Mobile Antenna.** Has professional 1 3/4" loading coil, VSWR of 1.5 to 1, 49" overall height. With quick-grip mount, cable and connector. 50 ohms.

42 F 10670W Shpg. wt. 2 lbs. . . . . Net 34.50

**4 M-412 "Big Momma III" Mobile Antenna.** For roof, truck or van top. 3/4" hole mount. Fully waterproof, even goes thru a carwash. With cable and connector.

42 F 10761W Shpg. wt. 2 lbs. . . . . Net 34.50

**5 M-168 Mobile "Grip-Stick" Magnetic Antenna.** No installation—simply place it on rooftop or back deck, run cable thru window or trunk to CB unit. VSWR: less than 1.5 to 1. With coax cable and connector.

42 F 10480W Shpg. wt. 2 lbs. . . . . Net 21.55

**6 MR-415 "Super Cans" Dual Truck Antenna.** Burnout-proof "Big Momma" coils, adjustable chrome-plated collet, phasing harness large enough for the biggest rigs. Rugged mounts take vibration and strain without slipping. For any west coast mirror mount.

42 F 10779W Shpg. wt. 10 lbs. . . . . Net 59.95

**7 M-175 "Quick-Grip" Mobile Antenna.** Stainless steel whip, base loaded, "quick-grip" trunk mount. Whip adapter for 1 1/4" adjustment for fine tuning. No holes to drill, mounts in seconds. 16-ft. cable, PL-259 plug.

42 F 10498W Shpg. wt. 2 lbs. . . . . Net 23.25

**8 M-304 "Quick-Grip" Mobile Antenna.** As above, with fiberglass whip. Tapered stainless steel slim-line shock spring. Extra resistance to rust and corrosion. With 17-ft. cable, connector.

42 F 10613W Shpg. wt. 1 3/4 lbs. . . . . Net 28.05

**9 M-90 96" Fiberglass Whip Mobile Antenna.** Has mounting adapter with chrome-plated brass ferrule, 3/8"-24 male thread for standard base or spring.

42 F 10217WX Shpg. wt. 1 1/4 lbs. . . . . Net 12.90

**Model M-38 Stainless Steel 102" Whip.**

42 F 10255WX Shpg. wt. 2 lbs. . . . . Net 7.50

## Antenna Mounts

**10 M-91 Double-Chain Bumper Mount.** Accepts 3/8"-24 thread spring or whip.

42 F 10163 Shpg. wt. 2 3/4 lbs. . . . . Net 12.90

**11 M-147 Stainless Steel Bumper Strap Mount.** No hole mounting.

42 F 10399 Shpg. wt. 2 1/4 lbs. . . . . Net 15.05

**12 M-115 Whip Hold-Down Clip.**

42 F 10191 Shpg. wt. 3 oz. . . . . Net 1.60

**13 M-161 Quick-Grip Mount.** For 3/8" antennas.

42 F 10472 Shpg. wt. 1 lb. . . . . Net 5.85

## Other Best-Selling Antenna Specialists Antennas

**M-227 "Mighty Magnum III" 1/2-Wave Omnidirectional Base Station Antenna.** "Power Tip" Radials, more. Parcel Post Shippable.

42 F 10563W Wt. 10 lbs. Net 42.10

**M-180 Adjustable Gutter Clamp Mobile Antenna.** Adjusts to five positions from inside your vehicle. With 12' coax cable. Wt. 2 lbs.

42 F 10522W . . . . . Net 22.70

**M-178 "Stick Shift" Mobile Magnet Antenna.** Powerful magnet means no installation, easy to transfer from vehicles, etc. With cable.

42 F 10530W Wt. 2 lbs. Net 21.10

## CB Antennas

## from Shakespeare, Newtronics, Avanti, Hy-Gain, Cushcraft

**14 Shakespeare 484 Co-Phased Mobile Antenna Array.** Dual 1/4-wave top-loaded fiberglass antennas boost signal. Mount easily on both sides of trunk on cars, etc. SWR, 1.5-1. With 21-ft. 6" coax harness, PL-259 connector. 4-ft. antennas.

42 F 17030W Shpg. wt. 3 lbs. Net 35.95

**15 Shakespeare "Big Stick" 176 CB Base Station Antenna.** Half-wave fiberglass antenna is totally weather resistant. Omnidirectional, does not require radials. Low SWR. Includes U-bolts for 1 1/4"-1 1/2" mast. Two sections form 18 1/2-ft. length. SO-239 connector.

42 F 17014W Wt. 7 1/2 lbs. . . . Net 38.50

**16 Newtronics "Hustler" HTM Twin Mobile CB Truck Antenna.** Mounts on side-view mirror supports, provides superior signal radiation. Has 2 twin white fiberglass antennas with stainless steel adjustable tip rods, oversize resonators. 17-ft. dual co-phasing coax harness.

42 F 37053W Wt. 4 lbs. . . . . Net 39.95

**17 Shakespeare "Seabee" 388 CB Marine Antenna.** 7-ft. 1/2-wave fiberglass whip with sealed center-loading coil. Self-supporting mount with levelling plate. No grounding needed. Includes 6-ft. cable, PL-259 connector.

42 F 17022W Wt. 2 lbs. . . . . Net 31.75

**18 Avanti "Moonraker" Base Station Antenna.** Combines 1/2-wave dipole elements with patented PDL UNQUAD reflector for interference-free communications. 14.4 dB gain, 1.2:1 VSWR. 38 dB vertical to horiz. separation. With 15-ft. boom, less mast.

42 F 34068WXY Wt. 27 lbs. Net 157.95

**19 Avanti "Astro-Plane" Base Station Antenna.** Combines full omnidirectional design with signal power concentrated on top for maximum efficiency. SWR: less than 1.4-1, power gain, 4 dB. 12 ft. long. Mounts on masts to 1 1/2".

42 F 34019W Wt. 4 3/4 lbs. . . . Net 38.95

**20 Hy-Gain CLR/II Base Station Antenna.** 300 watts power capability, delivers 8 dB circuit gain. 3/4-wave length radiator develops 4 dB in measured field strength intensity, plus improved S/N. SWR: less than 1.2-1. For 1 1/2" masts.

42 F 35016W Wt. 8 1/4 lbs. . . . Net 39.95

**21 Cushcraft "Ringo" 1/2-Wave Vertical Fixed Antenna.** Offers 3.75 dB gain, VSWR of 1.1-1 on all 23 CB channels. Overall height, 17'10", .049" wall aluminum tubing. Direct DC ground. Solid-hold telescope clamps.

42 F 20026W Wt. 5 lbs. . . . . Net 24.50

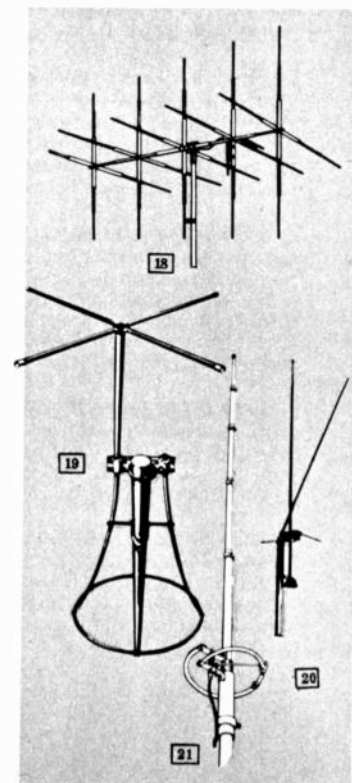
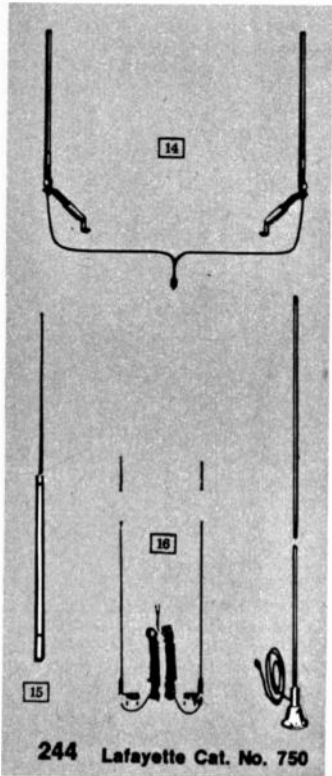

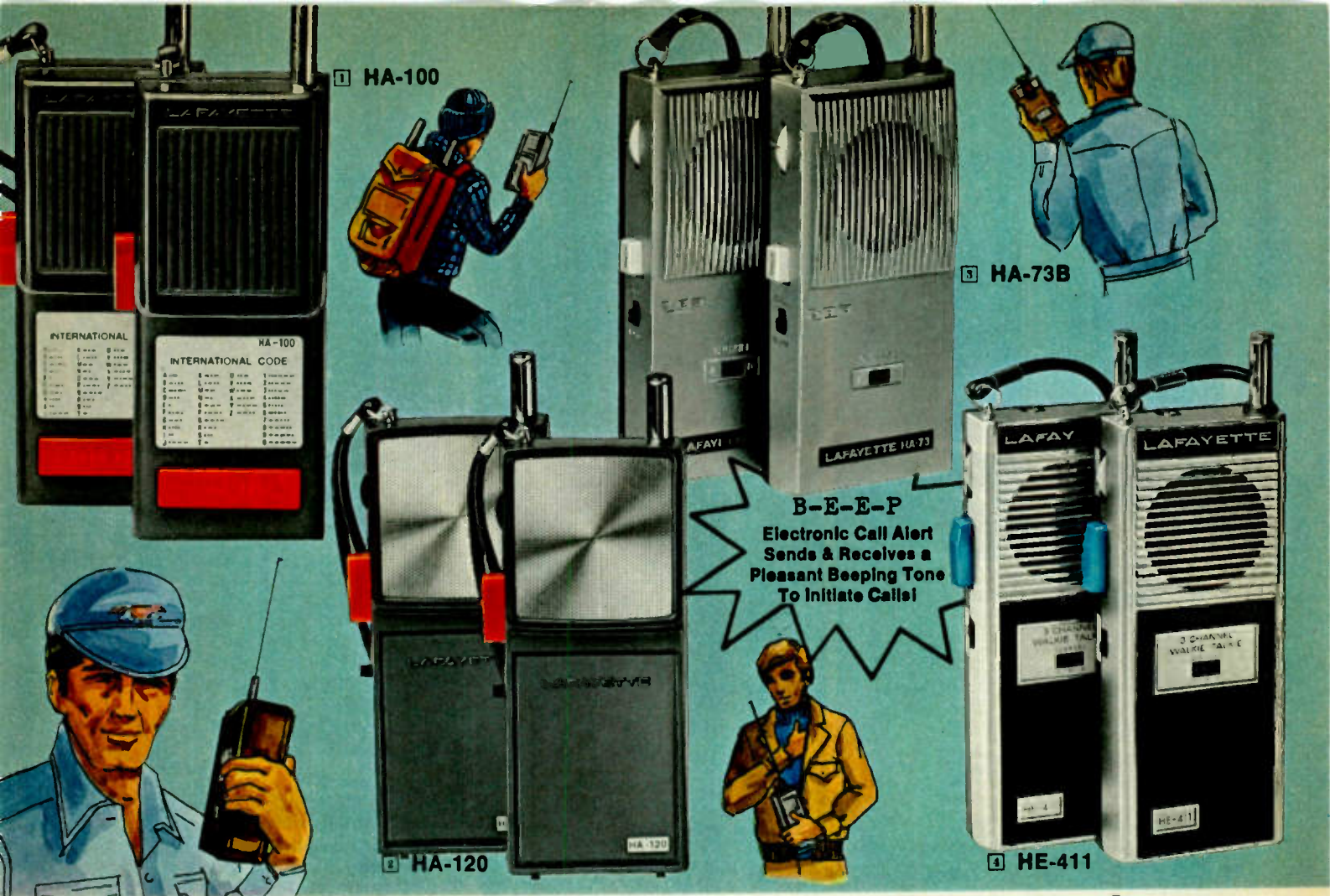

# Lafayette Walkie-Talkies Get Your Message Across

**For Sound Performance and Value, Lafayette Walkie-Talkies Come Over Loud and Clear!**

**1 HA-100 3-IN-1 Walkie-Talkie** No FCC License Required

**\$8<sup>95</sup> EACH**

- A 100 MW Walkie-Talkie
- A Code Message Transmitter
- A Morse Code Practice Oscillator

With the International Morse Code on the front panel and a special code key, the HA-100 not only transmits and receives voice and code messages, but also teaches Morse Code! You can even listen to your own signal while practicing. With crystal-controlled transmitter, sensitive super-regenerative receiver, volume control and speaker/mike combination. Includes Channel 14 crystal, telescoping antenna and carry strap. Size: 6H (less antenna) x 1 3/4 D x 2 3/4 W. Less battery. 99 F 32815L Shpg. wt. 1 1/4 lbs. Imported. Net ea. 8.95 99 F 60212 9V Battery. Imported. Shpg. wt. 4 oz. Net .39

**2 HA-120 6-Transistor Walkie-Talkie**

**\$19<sup>95</sup> EACH**

- Sends and Receives Alert Tone
- Superhet Circuit for Superior Sensitivity and Selectivity

This dependable 6-transistor 100 mw walkie-talkie is made for important messages. It features a sensitive superheterodyne receive circuit and a pleasant sounding, attention-getting call alert system for initiating calls. Includes volume control, wrist carrying strap, telescoping antenna, and plug-in crystals for Channel 12. (Replacement crystals right.) Size: 6 1/4 H x 2 3/4 W x 1 1/2 D. Imported. Less battery. 99 F 32831L Shpg. wt. 1 1/2 lbs. Net ea. 19.95 99 F 60212 9V Battery. Imported. Shpg. wt. 4 oz. Net .39

Lafayette Has Over 500 Stores from Coast to Coast

**3 HA-73B 2-Channel, 7-Transistor Walkie-Talkie**

**\$24<sup>95</sup> EACH**

- All Silicon Transistors
- Powerful Push-Pull Audio
- Built-In Call Alert

Sensitive superhet receiver and extended range Pi-network output. 2-channel operation for greater flexibility. Beeping call alert to initiate call. Impressive die-cast front panel. Wrist strap, telescoping antenna, and plug-in crystals for Channel 15. (Additional crystals below.) 5 7/8 x 1 1/4 x 2 3/4". Imported. Less battery.

99 F 32542L Shpg. wt. 1 3/4 lbs. Net ea. 24.95  
99 F 60212 9V Battery. Imported. Wt. 4 oz. Net .39

**4 HE-411 3-Channel, 10 Transistor Walkie-Talkie**

**\$34<sup>95</sup> EACH**

- "Range Boost" for More Effective Talk Power
- 10 Silicon Transistors
- Built-In Call Alert

3-channels! "Range Boost" transmit, efficient superhet receive. Antenna, and Channel 10 crystals (others below). Lightweight metal case: 5 7/8 x 1 1/4 x 2 3/4". Imported. Less battery.

99 F 32708L Shpg. wt. 2 1/4 lbs. Net ea. 34.95  
Dry Cell Batteries (6 required). Imported.  
99 F 62580 Shpg. wt. ea. 3 oz. Net ea. .14  
Alternate Alkaline Batteries (6 required). Imported.  
99 F 63828 Shpg. wt. ea. 3 oz. Net ea. .45  
99 F 31429 Battery Eliminator. Imported. Wt. 7 oz. Net 4.95

## REPLACEMENT AND ADDITIONAL CRYSTALS for HA-120, HA-73B and HE-411

46 F 15 Transmit. Shpg. wt. ea. 2 oz. Net ea. 2.25  
46 F 10 Receive. Shpg. wt. ea. 2 oz. Net ea. 2.25  
Use stock number indicated followed by channel number desired: i.e., Channel 1 transmit crystal, 46 F 1501; Channel 23, 46 F 1523.



1.5 WATTS  
3 CHANNELS  
**\$49<sup>95</sup>** Each

FCC Type Accepted  
D.O.C. Approved

3 WATTS!  
3 CHANNELS!  
**\$74<sup>95</sup>** Each

FCC Type Accepted (26-28 MHz)  
Parts 95 (CB), 91 (Industrial),  
93 (Transportation). D.O.C. Approved

# Lafayette Walkie-Talkies Come Over Loud & Clear!

## HA-420 1.5 Watt Walkie-Talkie with Range-Boost™

- 3 Crystal-Controlled Channels • Superhet Receiver
- Jack for Internal Charging • Battery Condition Meter
- Push-Pull Modulation • Antenna, Earphone, Charger Jacks

A fine "traveling companion" for most any outdoor use. Its 1.5 watt power is enough for plenty of range over most areas, its 3-channel operation is ideal for "net" setups, even monitoring at home. Has a 13 transistor, 4 diode circuit with RF amplifier for sensitivity of better than 1 μV, RANGE BOOST for more effective range, squelch and automatic noise limiting, telescoping antenna. With CB crystals for Ch. 10. Less batteries. 3 x 8 1/8 x 1 1/8". Imported. Order additional 46-10 and 46-15 crystals, page 245.

- 99 F 32674L Shpg. wt. 2 3/4 lbs. . . . . Net 49.95
- 99 F 63828 Batteries, 8 Req'd. Wt. ea. 2 oz. . . . . Net ea. 45¢
- 99 F 35081 117 VAC Battery Eliminator/Charger. 3 1/2 lbs. . . . . Net 24.95
- 99 F 25488 Earphone. Shpg. wt. 3 oz. . . . . Net 99¢

## Dyna-Com 3b with 7-Stage Transmitter

- 3 Crystal-Controlled Channels • Superhet Receiver
- External Mike/Speaker Jack • Ceramic IF Filter
- Combination Battery/RF Power and Signal-Strength Meter

The full-feature, medium-power Dyna-Com 3b is an excellent choice for warehouse communications setups, crowd control at ballgames, keeping in touch with home base on camping trips, etc. Has a 12-transistor, 7-diode solid-state circuit with an RF amplifier and ceramic IF filter for excellent transmission, reception and adjacent channel rejection, automatic gain control, automatic noise limiting, volume and squelch controls, telescoping antenna. External antenna, earphone and battery charger jacks. With carrying strap and Ch. 10 crystals. Less Batteries. 3 3/4 x 8 5/8 x 1 1/8". Imported. Crystals, page 245.

- 99 F 32450L Shpg. wt. 4 1/4 lbs. . . . . Net 74.95
- 99 F 25488 Earphone. Shpg. wt. 3 oz. . . . . Net 99¢
- 99 F 63828 Heavy Duty Alkaline Batteries (10 req.) 2 oz. Net ea. 45¢

Dyna-Com 3b Special Frequency Modifications		Indust./Trans. (FCC Parts 91 & 93).	
26.620 MHz C.A.P. . . . .	27.575 MHz U.S. Gov't. . . . .	99 F 32617YL 27.235 MHz. Net 84.95	99 F 32633YL 27.255 MHz. Net 84.95
99 F 32583YL . . . . . Net 84.95	99 F 32591YL . . . . . Net 84.95	99 F 32625YL 27.245 MHz. Net 84.95	99 F 32641YL 27.265 MHz. Net 84.95
27.585 MHz U.S. Gov't. . . . .		99 F 32658YL 27.275 MHz. Net 84.95	
99 F 32609YL . . . . . Net 84.95			

## Dyna-Com Optional Accessories



- 1 Battery Eliminator/Charger.** Use Dyna-Coms 3b, 12A and 23 from 117 VAC outlet, charges NiCads internally or externally. Imported. Wt., 5 1/4 lbs. 99 F 32872 Model PS-53. . . . . Net 44.95
- 2 Dyna-Charge.** Charges from 8 to 15 NiCad "AA" cells. 3 3/4 x 2 3/4 x 2". 99 F 31007 Imported. 1 1/4 lbs. Net 15.95
- 3 Miniature Top-Loaded Antenna.** Coil loaded 18" antenna mounts on top of collapsed telescoping antenna. 99 F 31437 Imported. 1/2 lb. . . . . Net 8.95
- 4 Remote Mike/Speaker.** For Dyna-Coms 3b, 12a and 23. Requires push-to-talk switch on unit for transmission. 99 F 32500 Imported. 1 lb. . . . . Net 8.95
- 5 Antenna Adapter Cable.** Adapts PL-259 plug to external antenna jack on Dyna-Coms. Imported. 99 F 32478 Shpg. wt. 8 oz. . . . . Net 3.95
- NiCad Rechargeable Batteries.** 12 for Dyna-Com 12a, 23; 10 for 3b. 32 F 47400 Ea. 3 oz. . . . . Net ea. 1.89 10 or more Net ea. 1.75
- Cases.** Top Grain Leather. 12 oz. 42 F 28110 For Dyna-Com 12a Net 6.95 42 F 28136 For Dyna-Com 23 Net 6.95 42 F 28128 For Dyna-Com 3b Net 6.95
- Mobile Lighter Cable.** Use Dyna-Coms from 12 VDC car lighter socket. 99 F 46054 Imported. 7 oz. . . . . Net 4.95





5 WATTS!  
12 CHANNELS!  
**\$109<sup>95</sup>** Each

FCC Type Accepted  
D.O.C. Approved



5 WATTS!  
23 CHANNELS!  
**\$159<sup>95</sup>** Each



FCC Type Accepted

## Lafayette Walkie-Talkies—Hand Held Powerhouses!

**Dyna-Com 12A—Hand-Held Powerhouse with a Full 5 Watts—12-Channel Operation!**

- Excellent 0.7  $\mu$ V Sensitivity for 10 dB S/N
- Public Address/External Speaker Jack
- TVI Trap to Minimize Interference to TV's
- Jack for External Base or Mobile Antennas
- Combination Battery/RF Power and "S" Meter
- External Microphone-Speaker Jack
- Automatic Compressor RANGE-BOOST™ Circuit

*Ideal for Industry, Public Safety, Farm, Marine, Sports, Etc.*

The full power and 12-channel versatility of the Dyna-Com 12A make it ideal for most business and commercial uses, a really rugged performer for outdoors or warehouse, a fine unit for sports and general-purpose uses. Solid-state circuit uses 13 transistors, 7 diodes, 1 thermistor and 1 resistor for excellent performance characteristics. Has mechanical filter for adjacent channel rejection, variable squelch and automatic noise limiting, telescoping antenna, superhet receiver with RF stage. Operates on 12 NiCad rechargeable batteries, or 10 alkaline or dry cell batteries. Includes shoulder carrying strap, crystals for Ch. 10, FCC license application. 3¼ x 9½ x 2⅝". Imported. Less batteries.

Order additional 46-10 and 46-15 crystals, page 245.

99 F 32484L Shpg. wt. 3¾ lbs. . . . . Net 109.95  
99 F 25488 Earphone for Above. Shpg. wt. 5 oz. . . . . Net 99¢  
99 F 63828 Heavy Duty Alkaline Batteries. (10 req.) 2 oz. Net ea. 45¢

See Page 246 for Dyna-Com Accessories.

**Dyna-Com 23 . . . Our Finest Walkie-Talkie—Full 5-Watt 23-Channel Hand-Held CB Two-Way Radio**

- Frequency Synthesis for 23-Channel Crystal Control
- Automatic Compression Range Boost for Greater Talk Power
- 455 kHz Mechanical Filter for Excellent Selectivity
- Jack for External Base Station or Mobile Antennas
- Combination Battery/RF Output and "S" Meter
- Variable Squelch Control Plus Automatic Noise Limiting
- External Microphone-Speaker Jack

**The ONLY Walkie-Talkie You'll EVER Need! Has All the Features of Full 23-Channel Base or Mobile CB Rigs!**

As good a walkie-talkie as you'll find for this price, the Dyna-Com 23 is fully compatible with and has all the sock of the finest base and mobile CB rigs. It features a dual conversion receiver with RF overload protection and push-pull audio, full 5 watt maximum allowable transmit input power, and synthesis circuitry for complete 23-channel crystal control with ALL CRYSTALS SUPPLIED! Has a public address/external speaker jack with PA switch, volume and squelch controls, telescoping antenna, input jacks for external battery source, mobile battery, and battery charger/eliminator. There's a lighted channel indicator for easy operation in dimly lit areas, a TVI trap to minimize TV interference, and lots more. Operates on either 12 NiCad rechargeable batteries, 10 alkaline or dry cell batteries. With all crystals, shoulder carrying strap, FCC license application. 3¼ x 9½ x 2⅝". Imported. Less batteries.

99 F 32567L Shpg. wt. 3¾ lbs. . . . . Net 159.95  
99 F 25488 Earphone for Above. Shpg. wt. 5 oz. . . . . Net 99¢  
99 F 63828 Heavy Duty Alkaline Batteries. (10 req.) 2 oz. Net ea. 45¢

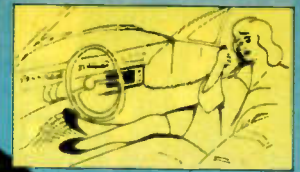
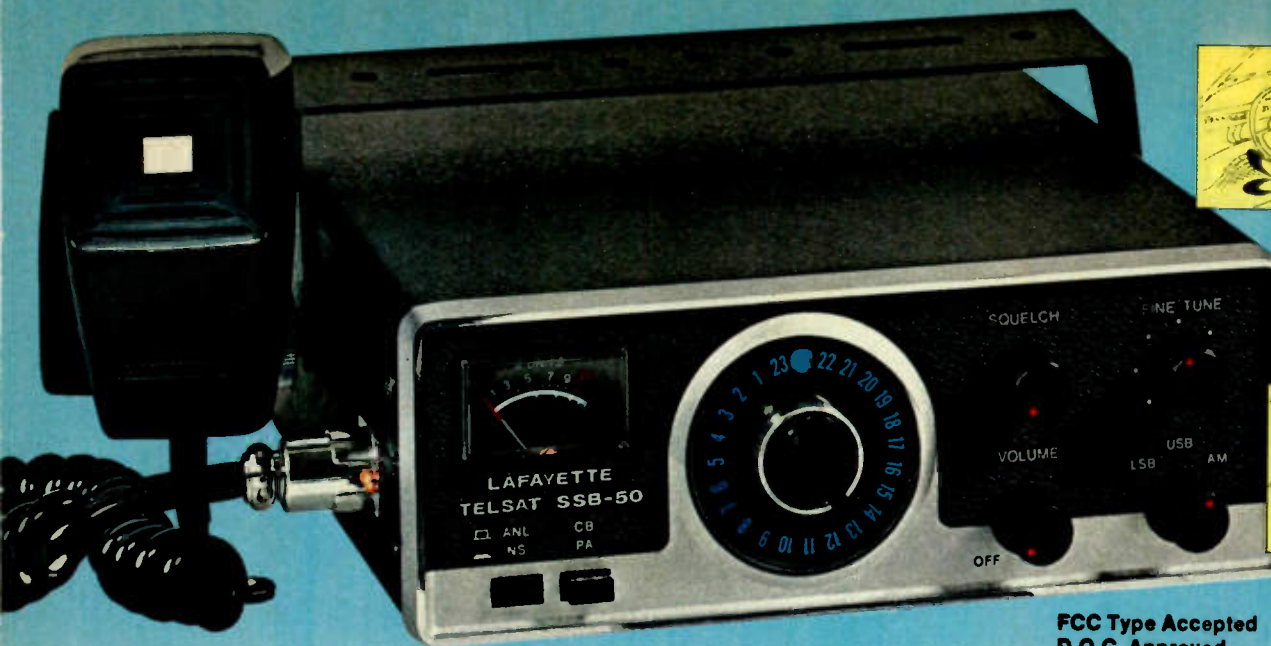

**GREAT FOR CAR!**



**GREAT FOR BOAT!**

FCC Type Accepted  
D.O.C. Approved

## “Go the Distance” with This Superb Lafayette CB Rig

**Lafayette Telsat SSB-50A SSB/AM CB Two-Way Radio**

**23 Channels AM, 23 Upper Sideband, 23 Lower Sideband  
—Communicate with ANY Other CB Rigs!**

One of the finest mobile CB units you can buy . . . now with variable fine tuning on BOTH TRANSMIT AND RECEIVE for “right on” signals!

**\$329<sup>95</sup>**

- Suppressed Sideband Carrier Offers Great Effective Range and Talk Power
- “Range Boost” Circuit and Automatic Modulation Control for 100% Power
- Dual Conversion Superhet Receiver
- Product Detector for Fine SSB Reception
- Multi-Stage RF Noise Silencing

- Illuminated Front Panel “S”/PRF Meter
- Output for Remote PA Speaker
- Input for Tuner, Tape Player, Etc.
- Includes Heavy-Duty Dynamic Mike
- Rugged Under-Dash Mounting Bracket
- 12 VDC Negative or Positive Ground

Drive and talk with the best of 'em with this truly outstanding mobile CB radio. Has “total crystal control” on all AM and SSB channels for precise, accurate transmission and reception; full FCC maximum allowable transmitter input and SSB output power. Its “True” single sideband transmitter develops 100% talk power, the adjustable antenna loading and special RANGE-BOOST circuit provide maximum RF output. Variable fine tuning allows “sliding” the transmitter within FCC tolerances—perfect for “net” setups, working weak or unsteady signals. The dual conversion superhet receiver features a crystal lattice filter and built-in product detector for sensitive, sure

SSB and AM reception. The multi-stage RF noise silencer minimizes ignition-type interference. Its compact size and long-life construction make it ideal for any 12 VDC vehicle—car, boat, tractor or truck. Has lighted channel indicator, variable squelch, audio input jack and PA output. With PTT dynamic mike, mobile mounting bracket, DC power cable and FCC license application. 7 $\frac{1}{8}$  x 2 $\frac{1}{8}$  x 9 $\frac{1}{8}$ ”. Imported.  
99 F 32849W Shpg. wt. 12 $\frac{1}{4}$  lbs. . Net 329.95

**Model PS-50 AC Power Supply for Above.** Use the Telsat SSB-50A as a first class base station. For 117 VAC.  
99 F 32682 Shpg. wt. 7 $\frac{1}{2}$  lbs. . . Net 37.95

## SAVE on Telsat SSB-50A Base and Mobile Systems

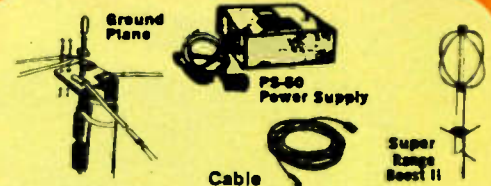

**Base Station Systems**

**SAVE \$19.85**  
**\$375<sup>95</sup>**  
If Bought Separately \$395.80

Includes Telsat SSB-50A SSB/AM 2-Way Radio; PS-50 AC Power Supply; heavy-duty ground plane Base Station Antenna, 50-ft. RG-8/U Cable Assembly. Shpg. wt. 30 $\frac{1}{4}$  lbs.  
42 F 92777WM . . . Net 375.95  
System as above, with “Super Range Boost II” deluxe  $\frac{1}{2}$ -wave end-fed ground plane antenna. Shpg. wt. 34 $\frac{3}{4}$  lbs.  
42 F 92785WM . . . Net 395.95

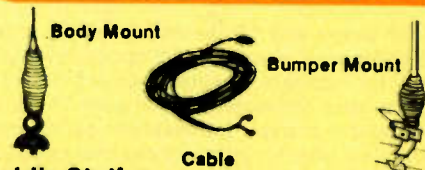

**Mobile Station Systems**

**SAVE \$17.64**  
**\$331<sup>95</sup>**  
If Bought Separately \$349.59

Includes Telsat SSB-50A 2-Way Radio, long-life stainless steel body mount mobile CB Antenna, and 20-ft. RG-58/U Coax Cable Assy. 16 $\frac{3}{4}$  lbs.  
42 F 92793WM . . . Net 331.95  
System as above, with deluxe Bumper Mount Mobile CB Antenna for fast and easy setup. Shpg. wt. 15 $\frac{1}{4}$  lbs.  
42 F 92801WM . . . Net 332.95



FCC TYPE ACCEPTED  
DOC APPROVED



**Money-saving Lafayette Telsat 925  
CB/Emergency Base Station Systems**

**SAVE \$293<sup>50</sup>**  
**15.35** If Bought Separately,  
\$308.85

**Range-Boost II System**

Excellent system consists of Telsat 925 CB/Emergency 2-Way Radio; "Range Boost II" 1/2-wave end fed ground plane Antenna and 50-ft. RG-8/U low-loss Coax Cable Assembly. Wt. 26 1/2 lbs.

42 F 92538WM ..... Net 293.50

Same system as above, but with 100-ft. RG-8/U Coax Assembly and PL-259 connectors. Shpg. wt. 31 1/4 lbs.

42 F 92546WM ..... Net 301.95

Total Reg. Price \$317.85 **Save \$15.90**



**SAVE \$302<sup>95</sup>**  
**\$15.90** If Bought Separately,  
\$318.85

**Super Range Boost II System**

Deluxe long-range system includes the Telsat 925 CB/Emergency 2-Way Radio; our best "Super Range Boost II" 1/2-wave end fed ground plane antenna; 50-ft. RG-8/U low-loss Coax Cable Assembly. Shpg. wt. 29 lbs.

42 F 92553WM ..... Net 302.95

Same system as above, with 100-ft. RG-8/U Coax Cable Assembly with PL-259 connectors. Shpg. wt. 33 1/4 lbs.

42 F 92561WM ..... Net 311.50

If Bought Separately, \$327.85 **Save \$16.35**

## Our Best Lafayette CB Base Station Could Be a Lifesaver!

**Lafayette Telsat 925 23-Channel CB Two-Way Radio with Separate Built-in Channel 9 (HELP) Emergency Receiver**

**23 Channels, All Crystals Supplied, \$269<sup>95</sup>**  
**Full 5-Watt Input for Real "Talk-Power"**

- Dual Conversion Receiver
- 3-Position Crystal Delta-Tune
- "Range-Boost" for Greater Range
- Emergency Channel 9 Indicator
- Illuminated S/PRF Meter
- Transmit, "On-Air" and Receive Lights

If you're a serious CB'er, this is one of the most important radios you can own. Offers EVERY fine feature for dependable CB two-way communications on all 23 CB channels, plus a built-in Channel 9 emergency receiver. Features a digital alarm for pre-setting operating times, transmitter section with full allowable input power, dual conversion main receiver with 0.7  $\mu$ V sensitivity and mechanical filter for adjacent channel rejection. Volume control, separate variable squelch for both receiver sections, tape recorder output, and separate power on-off switch. Has output for PA external speaker and headphones. With dynamic push-to-talk plug-in microphone, built-in 117 VAC, 60 Hz power supply, all CB crystals, and FCC license application. Handsome cabinet with walnut-finish wood sides, 15 1/4 x 4 7/8 x 9 1/8". Imported.

99 F 32856W Shpg. wt. 18 lbs. Net 269.95

**Base Station Desk-Type Dynamic Mike.**

42 F 01695 Shpg. wt. 4 lbs. ... Net 21.95

**Microphone Plug for Above.**

99 F 62838 Shpg. wt. 1/4 lb. ... Net 1.95

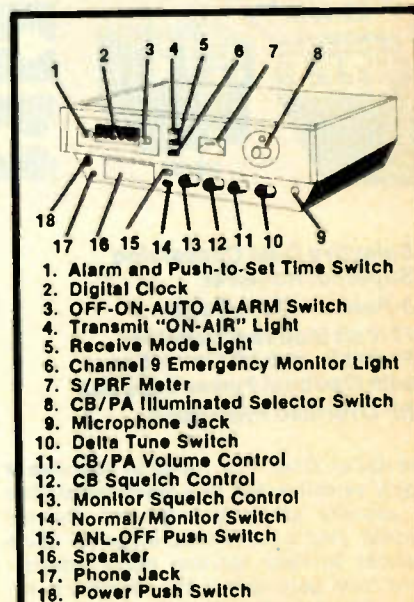

1. Alarm and Push-to-Set Time Switch
2. Digital Clock
3. OFF-ON-AUTO ALARM Switch
4. Transmit "ON-AIR" Light
5. Receive Mode Light
6. Channel 9 Emergency Monitor Light
7. S/PRF Meter
8. CB/PA Illuminated Selector Switch
9. Microphone Jack
10. Delta Tune Switch
11. CB/PA Volume Control
12. CB Squelch Control
13. Monitor Squelch Control
14. Normal/Monitor Switch
15. ANL-OFF Push Switch
16. Speaker
17. Phone Jack
18. Power Push Switch

The radio you **NEED** for effective CB, emergency use too. Separate receiver section monitors Channel 9 (H.E.L.P.) and flashes to indicate signals. You could be of invaluable assistance during an emergency!



FCC Type Accepted  
D.O.C. Approved

## Lafayette HB-625A Comes Through Loud and Clear!

*Deluxe Mobile 2-Way CB Radio has a built-in Multi-Stage RF Ignition Noise Silencer*

Transmits and Receives on 23  
Crystal-Controlled Channels ...  
**ALL CRYSTALS SUPPLIED!**

**\$199<sup>95</sup>**

**Unique RF Noise Silencer**  
Super-quiet RF Noise Silencer uses a revolutionary integrated circuit that actually silences the receiver for the brief duration of each noise impulse — eliminates it before it reaches the audio stages! You get spectacular reduction of ignition noise without distortion, audible holes or volume reduction.

- Selective Dual Conversion Superhet Receiver
- 3-Position Delta Tune
- 12-Volt Mobile Operation; Portable and AC Operation with Optional Power Supplies
- RF Overload Protection

- Mechanical Filter for Superior Selectivity
- Front Panel Transmit Mode Indicator Light
- Range Boost Circuitry For Added Talk Power
- Built-in PA Facilities

The Quiet One! The HB-625A features a highly selective 455 kHz mechanical filter to virtually eliminate adjacent channel splatter. And it has a multi-stage RF noise silencer to keep ignition noise interference from getting into the receiver's audio, without cutting the incoming signal strength. Variable squelch and standard ANL combine with the noise silencer for really quiet, sensitive reception. Range Boost audio system uses revolutionary IC microcircuits for increased effective talk power. Public address jack for optional external PA speaker. Operates instantaneously from 12 volts DC, negative or positive ground, with low battery drain. With 250 Lafayette Cat. No. 750

mounting bracket, power cord, push-to-talk dynamic mike with coiled cord, and FCC license application. Size: 2 3/4" x 5 1/4" x 8". Imported.

**99 F 32468W** Shpg. wt. 7 1/2 lbs. Net **199.95**

**Model PS-52 AC Power Supply and Nicad Battery Charger.** Imported.

**99 F 32864W** Shpg. wt. 5 lbs. . . Net **39.95**

**Model HB-506A Portable DC Power Pack.** Attaches to HB-625A for portable operation. Includes battery pack (less batteries), telescoping antenna, strap. Imported.

**99 F 32336W** Shpg. wt. 3 1/2 lbs. .Net **29.95**

**Batts. for HB-506A.** "C" Alkaline (8 req.).

**99 F 63802** Shpg. wt. 4 oz. ea. Net ea. .52

### SAVE on Complete HB-625A Base or Mobile Systems

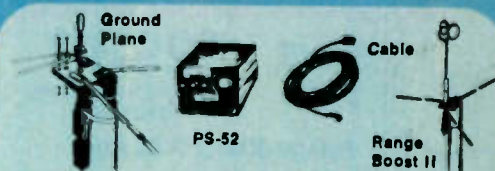

**SAVE \$13.30**

**\$254<sup>50</sup>**

If Bought Separately \$267.80

#### Base Station Systems

Consists of: HB-625A 23-channel CB Transceiver; PS-52 AC Power Supply; heavy-duty Ground Plane Antenna; 50' RG-8/U low-loss Cable Assembly. 21 1/4 lbs. 42 F 92819WM . . . . . Net 254.50

Same as above except with "Range Boost II" deluxe 1/2-wave end-fed antenna. Wt. 23 lbs. 42 F 92827WM . . . . . Net 264.95 Save 13.85 from separate prices!

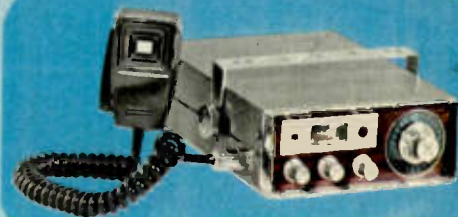

**SAVE \$10.64**

**\$208<sup>95</sup>**

If Bought Separately \$219.59

#### Mobile Systems

Consists of: HB-625A 23-channel CB Transceiver; stainless steel Body Mount Antenna; 20' RG-58/U Coax Assembly. 13 1/4 lbs. 42 F 92439WM . . . . . Net 208.95

Same system as above but with Bumper Mount. Wt. 13 1/4 lbs. 42 F 92447WM . . . . . Net 209.95



Optional  
"Range Boost"  
Desk  
Mike



### SAVE on Comstat 35 23-Channel Economy CB 2-Way Radio Systems

**SAVE \$11.90** **\$226<sup>95</sup>**

If Bought Separately 238.85 **Complete No Money Down\***



Antenna

Consists of: Lafayette COMSTAT 35 23-Channel CB 2-Way Radio; Lafayette "Range Boost II" half-wave end-fed Antenna; 50' RG-8/U low-loss Coaxial Cable Assembly with PL-259 connectors. Shpg. wt. 27 lbs.

42 F 92835WM ..... Net 226.95

Same system as above except with 100' RG-8/U low-loss coaxial cable assembly. Shpg. wt. 31 3/4 lbs.

42 F 92843WM ..... Net 235.50  
Save \$12.35 from separate prices!



Cable



**SAVE \$12.35** **\$236<sup>50</sup>**

If Bought Separately 248.85 **Complete**



Antenna

Deluxe system consists of: COMSTAT 35 23-channel CB 2-Way Radio; Lafayette "Super Range Boost II" deluxe extra efficient half-wave end-fed Antenna; 50' RG-8/U low-loss Coax Cable Assembly. Shpg. wt. 29 1/2 lbs.

42 F 92850WM ..... Net 236.50

Same system as above, but with 100' RG-8/U cable. Shpg. wt. 34 1/4 lbs.

42 F 92868WM ..... Net 245.50



Cable

No Money Down—See Page 4 for Lafayette's Easy-Credit Plan (Minimum Order \$30.00)

## Lafayette COMSTAT 35 CB Radio...a worthy successor to the Famous COMSTAT 25B

23-Channel CB Two-Way Radio...  
**ALL CRYSTALS SUPPLIED!**

**\$199<sup>95</sup>**

No Money Down\*

### FEATURES

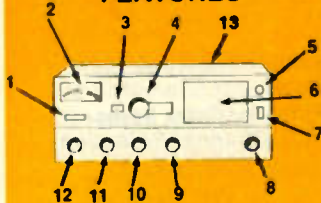

1. Range Boost Switch
2. Illuminated "S/PRF" Meter
3. Illuminated Channel Indicator
4. Single-Knob Channel Selector
5. Modulation Indicator Light
6. Front Panel PM Speaker
7. CB/Public Address Switch
8. Headphone/External Speaker Jack
9. Positive-Lock Mike Connector
10. 2.5 kHz Fine Tuning Vernier
11. Volume Control/Power Switch
12. Adjustable Squelch/Standby Switch
13. T.V. Interference Trap (rear)

- Dual Conversion Receiver with 0.8  $\mu$ V Sensitivity
- Pi Network and Low Pass Filter for Maximum Power Output
- Range Boost for More Talk Power

- 11 Tubes, 2 Transistors, 11 Diodes
- Built-in 117 VAC, 12 VDC Power Supplies for Base and Mobile Operation
- FCC Type Accepted
- Transmit Modulation Indicator

A fine 23-channel Transceiver that delivers outstanding performance—and outstanding value! Incorporates high performance circuitry for dependable base station and mobile operation. Crystal frequency synthesizer permits operation on all 23 CB channels with crystals supplied—no extra crystals are needed! Highly selective receiver circuits minimize adjacent channel interference (-45 dB). Variable squelch quiets receiver between calls. And a 2.5 kHz total spread fine tuning vernier facilitates precise reception. Front panel switch converts transceiver to a handy 4.5-watt public address amplifier. Has convenient front panel jack for optional headphones or optional external extension speaker. Built-in dual power supply for 117 VAC

base station and 12 VDC mobile operation. Handsome black and aluminum front panel has complementary multi-colored "S/PRF" meter and attractive control knobs. The Comstat 35 also features ultra-reliable push-to-talk relay switching and a plug-in ceramic microphone with convenient coiled cord. Less mobile accessories below. Size: 12 x 5 x 8 1/2". Imported.

99 F 32971W Shpg. wt. 16 lbs. .Net 199.95  
Mobile Mounting Bracket, DC Cable and Hardware. Imported.

99 F 63851 Shpg. wt. 3 1/2 lbs. .Net 8.95

Optional "Range Boost" Desk-Type Base Station Microphone. Less connector.

42 F 01703 Shpg. wt. 4 lbs. .Net 39.95  
Microphone Connector.

99 F 62630 Shpg. wt. 3 oz. .Net 1.95

Lafayette Cat. No. 750 251

# Lafayette Micro-Size Powerhouse... a Natural for Mobile CB!

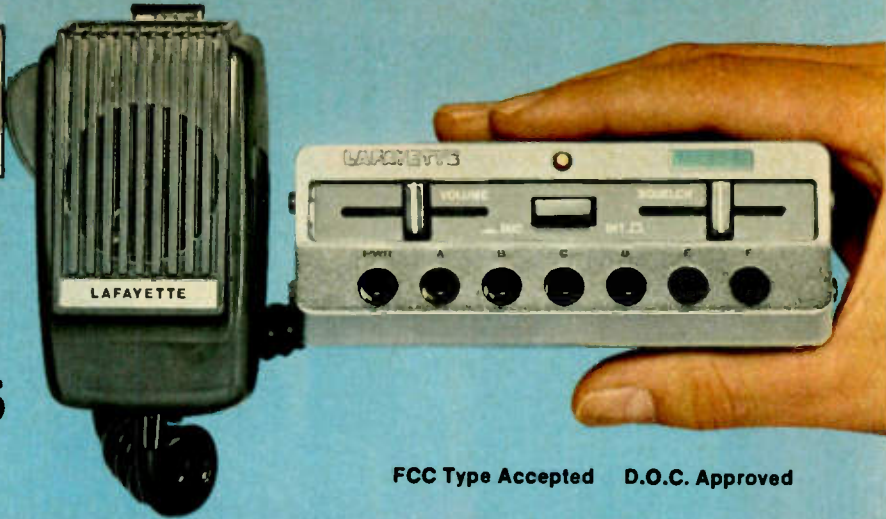
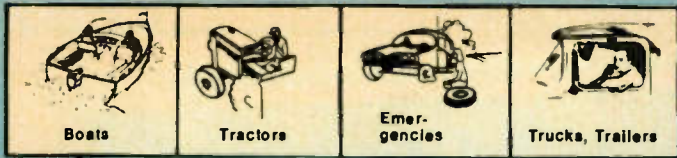

## Lafayette Micro 66 5-Watt 6-Channel Mobile 2-Way Radio

Includes  
Channel 10  
Crystals **\$79<sup>95</sup>**

FCC Type Accepted D.O.C. Approved

Micro 66  
with PS-57

Micro 66  
with PS-54

- Only 1-15/16 x 5-3/16 x 6-13/16"
- 5-Watt Maximum Legal Input Power
- Less Than 1  $\mu$ V Sensitivity for 10 dB Signal-to-Noise Ratio
- Ceramic IF Filter
- Slide-Lever Volume, Squelch Controls
- Pushbutton Selection of Built-in Speaker or Speaker-Microphone
- "Range Boost" Circuitry
- 12 VDC Negative or Positive Ground
- Pushbutton Channel Selection

A superb value in 5-watt mobile communications, the Micro 66 is built for extra-reliable mobile performance. Its 3-stage transmitter has "Range Boost" circuitry for high average modulation and greater effective range, an antenna tuning adjustment, and a TVI filter. Highly sensitive superhet receiver has tuned RF stage, ANL, AGC, mechanical IF filter for excellent selectivity and adjacent channel rejection. Pushbutton selection of internal speaker, or external dynamic push-to-talk speaker-microphone (included). CB/PA slide switch; PA speaker jack. With mobile mounting bracket, channel 10 crystals, DC power cable, FCC form 505. Size: 1 $\frac{1}{4}$ "H x 5 $\frac{3}{8}$ "W x 6 $\frac{1}{4}$ "D. Imported. Shpg. wt. 6 lbs.  
99 F 32716W ..... Net 79.95

### Extra Crystals for Micro 66.

- 48 F 15f Transmit Crystal ..... Net ea. 2.25
- 48 F 10t Receive Crystal ..... Net ea. 2.25
- †See page 245 for How to Order Crystals.
- PS-54 AC Power Supply. For 117 VAC base operation. Charges PS-57 Nicad Batteries.  
99 F 32922 Wt. 5 lbs. Imported..... Net 27.95
- PS-57 Portable Battery Pack. Adapts Micro 66 for portable operation. Shoulder strap, antenna, meter. Less batteries. Imported.  
99 F 32765W Shpg. wt. 3 $\frac{1}{2}$  lbs. .... Net 34.95
- Alkaline Battery for PS-57 (8 req.). Imported.  
99 F 63802 Shpg. wt. 4 oz. .... Net ea. .52
- Nicad Battery (alternate) for PS-57 (10 req.).  
32 F 48887 Shpg. wt. 5 oz. .... Net ea. 4.68

# Economy Plus Reliability... a Lafayette Exclusive!

## HB-23A 23-Channel Crystal-Controlled Mobile CB 2-Way Radio

With Crystals for Channels 9, 13, 19

FCC Type Accepted **\$139<sup>95</sup>**  
D.O.C. Approved

- Full 5-Watt Legal Input Power
- Full 23-Channel Capability
- "Range Boost" for Greater Range
- For 12 VDC Neg. or Pos. Ground
- With RF Overload Protection

Ultra-compact synthesis transceiver has 455 kHz mechanical filter for razor-sharp selectivity; dual conversion receiver with RF stage for 0.7  $\mu$ V sensitivity; ANL; variable squelch; push-pull audio. Transmitter provides 5-watt input power with "Range Boost" circuitry. Illuminated "S" PRF meter. PA speaker/earphone jack. With push-to-talk mike, mobile mtg. bracket, fixed crystals for channels 9, 13 and 19, FCC Form 505. Size: 6W x 8D x 2"H. Imported. Wt. 6 $\frac{1}{4}$  lbs.  
99 F 32351W ..... Net 139.95

- Package of 10 Plug-In Crystals. Converts HB-23A to full 23-channel operation. Imported.  
99 F 31742 Shpg. wt. 1 lb., 2 oz. .... Net 22.95
- PS-52 AC Power Supply/Charger for HB-23A.  
99 F 32864W Imported. Wt. 5 lbs. .... Net 39.95
- HB-507 Portable Battery Pack. Adapts HB-23A for portable use. Less batteries. Imported.  
99 F 31551 Shpg. wt. 3 $\frac{1}{4}$  lbs. .... Net 29.95
- Alkaline "C" Battery for HB-507 (8 required).  
99 F 63802 Shpg. wt. 5 oz. .... Net ea. .52
- Nicad Batteries for HB-507 (alternate) (10 req.).  
32 F 48887 Shpg. wt. 5 oz. .... Net ea. 4.68

2 More Channels with Each Extra Plug-in Crystal You Buy!

### Individual Plug-In Crystals

Each crystal adds 2 operating channels, inserts into specified socket. Shpg. wt. 2 oz.  
99 F 31635 Channels 1 and 5; socket A  
99 F 31643 Channels 2 and 6; socket B  
99 F 31650 Channels 3 and 7; socket C  
99 F 31668 Channels 4 and 8; socket D  
99 F 31684 Channels 10 and 14; socket F  
99 F 31692 Channels 11 and 15; socket G  
99 F 31700 Channels 12 and 16; socket H  
99 F 31718 Channels 17 and 21; socket I  
99 F 31726 Channels 18 and 22; socket J  
99 F 31734 Channels 20 and 23; socket L  
Any Crystal Above ..... Net each 3.95

### HB-23A Base Station with PS-52 AC Supply



Portable HB-23A  
with HB-507  
Power Pack



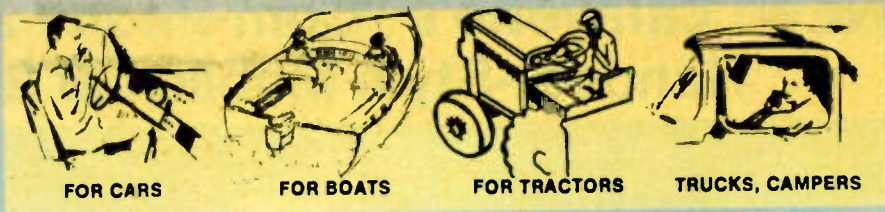

FOR CARS

FOR BOATS

FOR TRACTORS

TRUCKS, CAMPERS

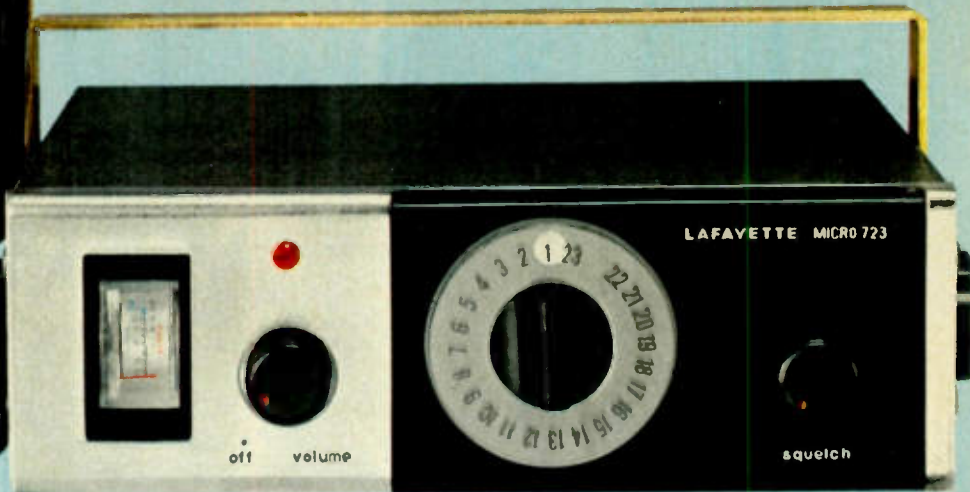

## Great Little Champion... for Personal, Business and Emergency Communications

### Lafayette Micro 723 Miniature 23-Channel Mobile CB 2-Way Radio

**5-Watt Input Power on All 23 Channels— ALL CRYSTALS SUPPLIED!**

**\$119<sup>95</sup>**  
 FCC Type Accepted  
 D.O.C. Approved

- **Highly Sensitive Dual Conversion Receiver**
- **Powerful 5-Watt "Range Boost" Transmitter**
- **Front Panel "S"/PRF Meter**
- **Variable Squelch Control**

- **Miniature Size—Only 1-15/16H x 6-1/8W x 7-1/16"D**
- **For 12 Volts DC, Negative or Positive Ground**
- **117 VAC Base Operation with Optional AC Power Supply**

Lafayette brings you another great winner with the Micro 723 23-channel CB transceiver—a truly sensational low price! It's carefully designed with all the features you need for dependable communications. Has excellent sensitivity, automatic gain control and battery-saving low current drain. Transmitter provides full 5-watt input power (the FCC maximum allowable), with "Range Boost" circuitry for greater average modulation and range, a TVI network, and transmit indicator light. Dual conversion superhet receiver offers 1  $\mu$ V sensitivity for 10 dB S/N; variable squelch and automatic noise limiting; push-pull audio; and 455 kHz mechanical filter for excellent selectivity and adjacent channel rejection. External speaker jack.

Includes dynamic push-to-talk microphone, mobile mounting bracket, DC power cable, all crystals, FCC license application. Imported. Wt. 6 1/4 lbs.  
**99 F 32807W** ..... Net **119.95**  
**PS-52 AC Power Supply.** For 117 VAC operation of Micro 723; also charges Nicad batteries for PS-58. Imp. 60 Hz.  
**99 F 32864** Wt. 5 lbs. .... Net **39.95**  
**PS-58 Portable Battery Pack.** Adapts Micro 723 for portable use. Shoulder strap, separate antenna, battery indicator. Less batteries. Imported.  
**99 F 32799** Wt. 3 1/4 lbs. .... Net **37.95**  
**Alkaline Battery** for PS-58 (8 required). Imported.  
**99 F 63802** Wt. 4 oz. ... Net ea. **.52**  
**Nicad Battery (Alt.) for PS-58** (10 req.)  
**32 F 48887** Wt. 5 oz. ... Net ea. **4.68**

### Micro 723 2-Way Radio Systems

**SAVE \$6.64**  
**\$132<sup>95</sup>**

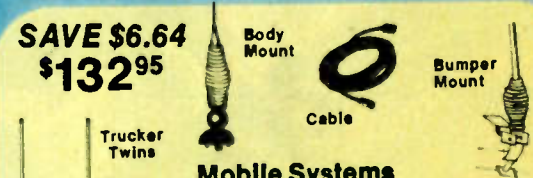

#### Mobile Systems

Consists of: Lafayette Micro 723 CB Transceiver, stainless steel Body Mount Antenna; and 20' RG-58/U Coax Cable Assembly..Shpg. wt. 12 lbs.  
**42 F 92694WM** ..... Net **132.95**  
 As above, but Bumper Mt. antenna.  
**42 F 92702WM** Wt. 11 lbs. . Net **133.95**

#### Truck/Trailer/Camper System

Consists of: Lafayette Micro 723 Transceiver plus "Trucker Twins" top-loaded co-phased combo antenna—two 4' fiberglass antennas with efficient harness.  
**42 F 01729WM** Shpg. wt. 3 1/4 lbs. .... Net **145.50**  
 SAVE \$7.40 from separate prices!

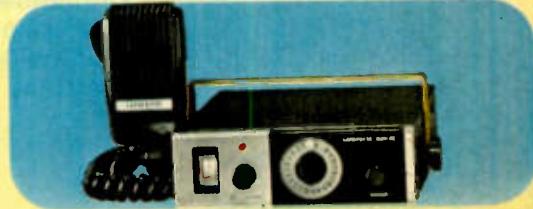

#### Base Station Systems

**SAVE \$9.30**  
**\$178<sup>50</sup>**

Consists of: Lafayette Micro 723 23-channel CB Transceiver; PS-52 AC Power Supply; heavy-duty Ground Plane Antenna; and 50' RG-8/U Coax Cable Assembly. Shpg. wt. 20 lbs.  
**42 F 92710WM** ..... Net **178.50**  
 Same as above but with "Range Boost II" half-wave end-fed antenna.  
**42 F 92728WM** Wt. 22 lbs. . Net **188.95**  
 SAVE \$9.85 from separate prices!

# NEW! Lafayette's "Com-Phone 23" 23-Channel Handset-Style Mobile CB 2-Way Radio



Lets You Hear the Message Loud and Clear, Even Under the Noisiest Conditions!

ONLY  
**\$189<sup>95</sup>**

Delivery Oct. 1, 1974

- Full 23-Channel Operation—ALL Crystals Supplied!
- Mounts Practically Anywhere—in Car, Truck, Motorhome or Boat
- Handsome Design
- Great Performance
- All-Solid-State
- 12 VDC Negative Operation (Adaptable to Positive Ground)



## LOADED WITH FEATURES FOR GREAT CB PERFORMANCE

- Superior Reception Clarity, Especially in Noisy Traffic
- Handset/Speaker Switch Permits Private Listening
- "Range Boost" Circuitry for Greater Transmitting Range
- Dual Conversion Receiver for Super Sensitivity
- Mechanical Filter for Good Adjacent Channel Rejection
- Transmit Modulation Indicator • PA Switch
- Variable Squelch and Automatic Noise Limiting
- Universal Mounting Bracket—for Installation Anywhere

SAVE on a Complete Com-Phone 23 CB Mobile System

Choice of 4!

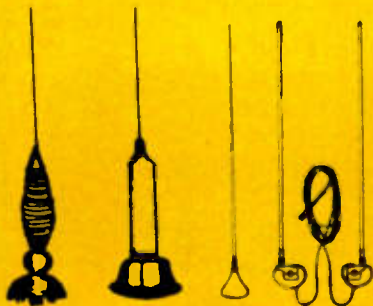

Body Mount    Trunk Mount    Marine-Mate    Trucker Twins

**Mobile System with Body Mount Antenna.** Consists of Lafayette Com-Phone 23 handset CB 2-way radio, Body Mount antenna, stainless steel whip, 20-ft. RG-58/U cable. Save \$10.09! 42 F 92942WM Shpg. wt. 11½ lbs. . . . . Net 199.50

**Mobile System with Trunk Mount Antenna.** As above, but with "Rapid Grip" trunk mount antenna. Save \$10.09! 42 F 92959WM Shpg. wt. 8¼ lbs. . . . . Net 200.50

**Marine Mobile System.** As above, with "Marine-Mate" ½-wave 48" fiberglass antenna that needs no ground plate. Save \$10.95! 42 F 92967WM Shpg. wt. 10 lbs. . . . . Net 208.95

**"Trucker Twins" System.** Includes Com-Phone 23, dual mobile truck antenna with coax phasing harness assy. Save \$10.95! 42 F 92975WM Shpg. wt. 10 lbs. . . . . Net 211.95

Lafayette's new "Com-Phone 23"—the latest in convenience and dependability for the mobile CB enthusiast. Handset-style CB 2-way radio is as easy to use as your telephone . . . and it lets you hear through the heavy background noises of mobile traffic. You hear all the incoming signals with ease—and you can listen in privacy whenever you desire, without disturbing other passengers in the vehicle. Dramatically-styled transceiver comes with a universal mounting bracket for easy installation anywhere in the car, truck, boat or motorhome. Transmits and receives on all 23 CB channels—with All Crystals Supplied! "Range Boost" circuitry gives greater "talk power" and transmitter range. Has illuminated channel selector; variable squelch control; PA switch; speaker/handset switch; private listening feature; modulation indicator. All-solid-state circuitry for reliable performance. Three-way listening: with handset only, built-in speaker only, or both together. For 12 volts negative ground, adaptable for positive ground. 4H x 5W x 9½" D. 99 F 33011W Shpg. wt. 7 lbs. . . . . Net 189.95

Charge It with Your BankAmericard or Master Charge.





# Car Stereo Tape Players—"Moving" Music Makers



**\$99<sup>95</sup>**  
Less Speakers

### Auto-Reverse Stereo Cassette Player

- Plays Both "Sides" of a Cassette Without Bothering Removal and Reloading
- Includes Mounting Bracket and All Hardware

**Model FT453M.** Good-looking and fine-sounding car stereo tape player makes motoring a musical treat. Plays all pre-recorded stereo cassettes with excellent fidelity—features slide-type volume, tone and balance controls, fast forward and rewind for easy location of selections, manual eject button for any point on the tape. Has lighted tape direction indicators, easy pop-in cassette loading, more. Includes hardware for easy under-dash installation. 7 3/4" x 3 3/4" x 9 1/2". For 12 VDC neg. gnd. Imported.  
17 F 59125W Shpg. wt. 8 lbs. . . . . Net 99.95



**\$179<sup>95</sup>**  
Less Speakers

### Stereo FM/FM/AM Radio/Cassette Recorder/Player

- Matrix Circuit for 4-Dimensional Sound with 4 Speakers
- Includes Microphone with Remote On-Off
- Includes Under-Dash Bracket, Hardware

**Model FT433M.** ALL THE CAR STEREO ENTERTAINMENT YOU'LL EVER NEED! Listen to your favorite stereo FM and AM radio programs, RECORD YOUR OWN STEREO CASSETTES, make "live" mono recordings with the remote mike. Has volume, tone, balance controls, pushbutton cueing, automatic eject, fast forward, automatic stop at end of cassette. Pause control stops tape for commercial-free recording. Radio has cylindrical tuning dial, stereo light, more. 8 1/2" x 3 x 9". For 12 VDC neg. gnd. Imported.  
17 F 59133W Shpg. wt. 9 lbs. . . . . Net 179.95

## These Sanyo Car Tape Players Are Performance-Engineered to Bring You the Best in 8-Track & Cassette Stereo Listening

(See Page 71 for a complete selection of car speakers.)



**\$49<sup>95</sup>**  
Less Speakers

### Compact Stereo 8-Track Player

- Fits in Many Glove Boxes
- Program Repeat Pushbutton
- Fast Forward Pushbutton

**Model FT883.** Plays pre-recorded 8-track stereo cartridges with excellent fidelity, has a fast-forward button for easy location of selections, repeat button for instant repeat of any program; volume, tone and balance controls, program lights, more. With bracket, hardware. 5 1/4" x 8 x 3". For 12 VDC neg. gnd. Imported.  
17 F 59216W Shpg. wt. 7 lbs. . . . . Net 49.95



**\$99<sup>95</sup>**  
Less Speakers

### 8-Track Player/Stereo FM Radio

- Matrix Circuit for 4-Dimensional Sound with 4 Speakers
- Automatic/Manual Program Selection

**Model FT865.** Nicely-styled and versatile 8-track cartridge player/stereo FM radio is a worthwhile entertainer for any car. Has thumbwheel volume and tone controls, balance, 8-track program indicator lights, lighted radio dial, stereo light. With easy-to-install under-dash mounting bracket, all hardware. 4 3/4" x 3 x 7 1/2". For 12 VDC negative ground. Imported.  
17 F 59224W Shpg. wt. 5 lbs. . . . . Net 99.95



**\$159<sup>95</sup>**  
Less Speakers

### In-Dash 8-Track Player Stereo FM/FM/AM Radio

- With Universal Mount for "In-Dash" Custom Installation in Many Cars
- 4-Dimensional Speaker Matrix Circuit

**Model FT-868.** A superb stereo combination unit with adjustable shafts that mounts "in-dash" in most vehicles for a custom factory-installed look at about half the cost. Has 8-track stereo cartridge player with program lights, automatic or manual program change; radio with lighted dial, stereo FM light. 7 1/2" x 2 x 6". 12 VDC neg. gnd. Imported.  
17 F 59232W Shpg. wt. 5 lbs. . . . . Net 159.95

Prices and Specifications are Subject to Change Without Notice.

# TDK "Total Performance" Recording Tape— THE Tape for the Serious Home Recordist

When you invest in a tape recorder, you buy a fine piece of precision electronics equipment—BUT ITS RECORDING CAPABILITIES CAN BE LOST WITH INFERIOR OR LOW-GRADE TAPE. TDK is committed to the proposition that its tape be the equal of even professional recording machines—it offers great dynamic range, extremely wide response—magnificent sound reproduction!



## The AUDUA Series Reel-to-Reel Tape

Equal to the finest reel-to-reel tape available to the consumer today! Provides higher output and lower noise levels than even TDK's famous SD reel-to-reel tape. Features ultra-fine particle coating with a length-to-width ratio of 10 to 1, and extremely dense packing along the entire tape. Provides significantly better high-end response, broader dynamic range, higher S/N, lower hiss noise than random particle tapes. THE tape to use for serious home recordings!

Stock No.	Type	Reel Size	Shpg. Wt.	Net Each	
				1-9	10-Up
28 F 24589	L-1200	7"	1 lb.	6.49	5.84
28 F 24597	L-1800	7"	1 lb.	8.49	7.64
28 F 24605	L-3600	10½"	2½	25.19	22.67

See Page 75 for TDK 8-Track Cartridges, Endless Cassettes and Accessories.



## Full-Range Cassettes for Every Recording Need

**ED-Series.** For recordists who demand the finest—an entire NEW recording experience.

Stock No.	Model	Playing Time	Shpg. Wt.	Net Each	
				1-9	10-Up
28 F 24613	ED-C45	45 min.	4 oz.	2.69	2.42
28 F 24621	ED-C60	60 min.	4 oz.	2.99	2.69
28 F 24639	ED-C90	90 min.	4 oz.	4.49	4.04

**SD-Series.** The ORIGINAL HIGH-FIDELITY CASSETTE—for recordists who are really serious about fine sound reproduction.

Stock No.	Model	Playing Time	Shpg. Wt.	Net Each	
				1-9	10-Up
28 F 24647	SD-C45	45 min.	4 oz.	2.19	1.97
28 F 24654	SD-C60	60 min.	4 oz.	2.39	2.15
28 F 24662	SD-C90	90 min.	4 oz.	3.59	3.23
28 F 24670	SD-C120	120 min.	4 oz.	4.79	4.31

**DYNAMIC "D" SERIES.** Performance equal to or better than the premiums—TDK quality at a lower cost! Includes TDK's exclusive 180-minute cassette.

Stock No.	Model	Playing Time	Shpg. Wt.	Net Each	
				1-9	10-Up
28 F 24688	D-C45	45 min.	4 oz.	1.79	1.61
28 F 24696	D-C60	60 min.	4 oz.	1.99	1.79
28 F 24704	D-C90	90 min.	4 oz.	2.99	2.69
28 F 24712	D-C120	120 min.	4 oz.	3.99	3.59
28 F 24522	D-C180	180 min.	4 oz.	5.49	4.94

**KR-Series.** TDK's famous quality in the chromium dioxide cassette. For those who prefer the chromium dioxide performance and have the equipment to use it.

Stock No.	Model	Playing Time	Shpg. Wt.	Net Each	
				1-9	10-Up
28 F 24720	KR-C60	60 min.	4 oz.	2.99	2.69
28 F 24738	KR-C90	90 min.	4 oz.	4.49	4.04

## LAFAYETTE RADIO ELECTRONICS

111 JERICHO TURNPIKE, SYOSSET, L.I., N.Y. 11791