

CORRECTIONS AND CHANGES



Prices and specifications in this catalog are subject to change without notice. We aim, however, to keep our customers informed of all important changes. The following changes have been noted since publication. Please enter these in your copy of Catalog R.

Inside Front Cover: SALES ENGINEERING OFFICES — Since publication we have added two more Sales Engineering Offices:

OFFICE	SALES AREA	TELEPHONE AND TWX	STAFF
CLEVELAND 5579 Pearl Road Cleveland, Ohio, 44129	Ohio Kentucky Western Pa.	216 886-0150 TWX: 216 888-0716	Leroy C. (Tom) Fricke, Manager Danny L. Woodward, Engineer
MONTREAL Office 395 1225 Laird Blvd. Town of Mount Royal Quebec, Canada	Ottawa Montreal Maritimes	514 737-3673 -3674	Richard J. Provan, Engineer

- Page i. Contents — Add: STROBOSCOPES page 168.
- Page 4. TYPE 1551-C SOUND-LEVEL METER — Specifications — **Sound-Level Indication**, line 4: 0.002 should be 0.0002. Correct figure is given under **Sound-Level Range**.
- Page 5. TYPE 1560-P3 PZT MICROPHONE — Specifications, **Temperature Coefficient of Sensitivity**: Approximately -0.01 db/°C. **Internal Impedance**: . . . varying from 445 to 510. . . .
- Page 7. TYPE 1560-P11B VIBRATION PICKUP SYSTEM — Minimum displacement should be 30 microinches; velocity, 1000 microinches per second; acceleration, 0.1 in. sec/sec.
- Pages 14 and 15. TYPE 1900-A WAVE ANALYZER — Specifications, **Range**: Upper frequency limit has been increased to 54,000 cps. **Accuracy of Calibration** is $\pm 1\%$ beyond 50,000 cps. **Voltage Accuracy**: After calibration by internal source, the accuracy up to 50 kc is $\pm (3\%$ of indicated value + 2% full of scale) except for the effects of internal noise when the attenuator knob is in the maximum-sensitivity position. In that position the internal noise is about 5% of full scale for the 3- and 10-cycle bands and 10% of full scale for the 50-cycle band. From 50 to 54 kc, the above 3% error becomes 6%.
- Pages 16 and 17. TYPE 1564-A SOUND AND VIBRATION ANALYZER — Specifications, **Filter Characteristics**, add: Ultimate attenuation is greater than 70 db for both characteristics; change: Peak response is uniform ± 1 db from 5 cps to 10 kc and ± 1.5 db from 2.5 cps to 25 kc. **Accessories Available**: Add TYPE 1560-P3 PZT Microphone. Band-Pass Characteristics of the Analyzer: Legends on curves are transposed; the 1/10th-octave curve is the narrower of the two.
- Page 23. TYPE 1233-A POWER AMPLIFIER — Pulse-response oscillograms: Pulse length is omitted. From left, 0.2, 1, and 2 μ sec, respectively.
- Pages 27 and 29. BRIDGE TABULATIONS. Range of 1650 is 1 m Ω to 11 M Ω .
- Page 35. TYPE 1650-A IMPEDANCE BRIDGE — Price is \$475 as announced prior to publication of Catalog R. Price of TYPE 1650-P1 is \$20.
- Page 37. TYPE 1615-A CAPACITANCE BRIDGE — Specifications, **Accuracy**: Capacitance — Direct-reading, internal standard: At 1 kc, $\pm (0.01\% + 0.00003$ pf). Additional error at higher frequencies and with high capacitance, $\pm 2 \times 10^{-5} f_{kc}^2\%$ + $2 \times 10^{-3} C_{\mu f} f_{kc}^2\%$. At lower frequencies and with small capacitance, accuracy may be limited by bridge sensitivity. Dissipation Factor: Direct reading, $\pm (0.1\%$ of measured value + 0.00001).
- Page 39. TYPE 716-CS1 CAPACITANCE BRIDGE — Specifications, **Accessories Required**: change last sentence to read "For operation at frequencies other than 1 Mc, use the Type 1232-A Tuned Amplifier and Null Detector, with the Type 1232-A Mixer, and a local oscillator."
- Page 48. TYPE 1862-C MEGOHMMETER — Specifications, **Dimensions**: Panel height for relay rack model is 10 $\frac{1}{2}$ inches.
- Page 64. TYPE 874 ADAPTORS — Adaptor table, TO TYPE 274, last column, should read "shown on page 209."
- Page 70. TYPE 874-W100, -W200 TERMINATIONS — Frequency scale is omitted from plots of vswr. Curves cover from 100 to 2000 Mc, as in Catalog Q. Types 874-R20A and -R22A — vswr plot: Dashed curve is for R20A.
- Page 77. Price List — Code Number for TYPE 900-L10 should be 0900-9605.
- Page 78. Sensitivity-frequency curves — Curve for 1212-A, -P3 should start 2 decades higher, at 30 Mc.
- Page 90. TYPE 1103-B SYNCHRONOMETER® TIME COMPARATOR — Specifications, **Input**: 1-kc sine wave, one volt into 10 kilohms; 1-kc sawtooth, 30 volts, peak-to-peak, into 100 kilohms.
- Page 100. TYPE 1137 DATA PRINTER — Price list: 230-volt models are for 50 cps only.
- Page 107. TYPE 1304-B BEAT-FREQUENCY AUDIO GENERATOR. The two captions at the foot of the page are interchanged.

Page 108. TYPE 1308-A AUDIO OSCILLATOR AND POWER AMPLIFIER — Specifications, **Voltage and Current Ranges**, add: in any combination up to 200 volt-amperes. **Optimum Load Impedance**: 0.8, 2.5, 8, 80, 800 ohms.

Page 113. SUMMARY OF POWER-SUPPLY CHARACTERISTICS. TYPE 1203-B Unit Power Supply (Page 173) can also be used.

Pages 114 and 115. UHF, VHF OSCILLATORS. Output into 50 ohms, guaranteed:

Osc. Type	With Type 1269-A or Type 1203-B Power Supply	With Type 1267-A, Type 1264-A, or Type 1201-B Power Supply
	1208-C	240 mw, 65 to 250 Mc 80 mw, 250 to 500 Mc
1209-CL	320 mw, 180 to 500 Mc 240 mw, 500 to 600 Mc	270 mw, 180 to 500 Mc 200 mw, 500 to 600 Mc
1209-C	150 mw	120 mw
1215-C	120 mw, 50 to 215 Mc 70 mw, 215 to 250 Mc	90 mw, 50 to 215 Mc 50 mw, 215 to 250 Mc

For typical output-vs-frequency curves, see the *GR Experimenter* for August, 1963.

Page 117. TYPE 1360-A MICROWAVE OSCILLATOR — Specifications, **Output, Power**: Individual instruments may show variations of 2:1 from typical curve. New output specification (guaranteed) is "At least 20 mw from 1.7 to 2.1 Gc; at least 50 mw from 2.1 to 4.1 Gc".

Page 118. TYPE 1220-A KLYSTRON OSCILLATOR — **Dimensions**: Width, $10\frac{3}{4}$ (275 mm).

Page 123. TYPE 1001-A STANDARD-SIGNAL GENERATOR — Specifications, **Voltage Accuracy**: "At frequencies below 10 Mc" should read "From 150 kc to 10 Mc."

Page 125. TYPE 1000-P5 VHF TRANSFORMER — Line 5: "... measurement of fm and television receivers."

Page 128. TYPE 1025-A STANDARD SWEEP-FREQUENCY GENERATOR — Features, line 9: "... to counter accuracy without disturbance. ..."

Page 142. TYPE 1806-A ELECTRONIC VOLTMETER — Specifications, **Accuracy**, second line: " $\pm 0.2\%$ of full scale from one-tenth. ..."

Page 150. TYPE 1401-D STANDARD AIR CAPACITOR — Dissipation factor is 20×10^{-6} .

Page 151. TYPE 1403-G STANDARD AIR CAPACITOR — Dissipation factor is 30×10^{-6} ; TYPES 1403-A, -D, -K, -N, -R, -V, dissipation factor is 20×10^{-6} .

Page 151. TYPE 1404-A REFERENCE STANDARD CAPACITOR — Specifications, Replace **Certificate** with: **Calibration**: A certificate of calibration is supplied with each capacitor giving the measured direct parallel capacitance at 1 kc and at 23 ± 1 C. The measured value is obtained by a comparison to a precision better than ± 1 ppm with working standards whose absolute values are known to an accuracy of ± 20 ppm, determined and maintained in terms of reference standards periodically measured by the National Bureau of Standards.

TYPE 1404-B — A 100-pf model, TYPE 1404-B, is now available — Price \$225.00.

Page 154. TYPE 1424-A STANDARD POLYSTYRENE DECADE CAPACITOR — Specifications, **Frequency**: Change last sentence to: At higher frequencies, terminal capacitance rises as resonant frequency, f_0 , is approached. The increase can be calculated from $\Delta C/C = (f/f_0)^2$, and f_0 varies from about 525 kc at 1 μ f to 235 kc at 10 μ f.

Page 157. TYPE 1419-A DECADE CAPACITOR — Capacitance per Step, A-decade, is 0.1 μ f.

TYPE 1419-M DECADE CAPACITOR — Specifications, **Dimensions**: $13\frac{3}{4}$ by 4-5/16 by 5 inches (350 by 110 by 130 mm).

Page 170. TYPE 1531-P3 SURFACE-SPEED WHEEL — Additional new specification, **Over-all Accuracy, including Strobotac**: $\pm 1.5\%$.

Page 174. TYPE 1263-B AMPLITUDE-REGULATING POWER SUPPLY — Specifications, **RF Output Voltage**: Change last sentence to read "With 1-kc square-wave modulation, 0.2 to 1.0 volt average value of the rms carrier level behind 50 ohms." **Output Voltmeter**: Add: "Meter reads average value of the rms carrier level."

Page 176. TYPE 1116-B EMERGENCY POWER SUPPLY — Continuous rating is 150 watts.

TYPE 1268-A AUTOMATIC BATTERY CHARGER — This device should be used only with nickel-cadmium batteries, TYPE 1268-9602 or equivalent.

Page 203. POTENTIOMETERS — Dimensions given are in inches.

Page 207. TYPE 274-DB, -MB, -NK PLUGS — Dimensions are in inches.

Page 211. Column 1, last line — Reference to page 116 should read page 113.

We have available a list of references to original descriptions in the *General Radio Experimenter* covering all major items in Catalog R. Free on request.

GENERAL RADIO COMPANY

WEST CONCORD, MASSACHUSETTS, USA

General Radio Company (Overseas), Zurich, Switzerland
Representatives in Principal Overseas Countries

ELECTRONIC INSTRUMENTS AND STANDARDS



CATALOG R

GENERAL RADIO COMPANY

WEST CONCORD • MASSACHUSETTS • U S A

GENERAL RADIO COMPANY

MAIN OFFICE AND PLANT: WEST CONCORD, MASSACHUSETTS

TELEPHONE: (CONCORD) 617 369-4400
(FROM BOSTON AREA) 646-7400

TWX NO. 617 369-5708

CABLE ADDRESS: GENRADCO CONCORD (MASS.)

SALES ENGINEERING OFFICES

General Radio Sales Engineering Offices are maintained in the following areas in the United States and Canada. These offices are staffed by competent factory-trained engineers. We invite your inquiries for technical, commercial, and service information.

OFFICE	SALES AREA	TELEPHONE AND TWX	STAFF
*NEW ENGLAND 22 Baker Avenue West Concord, Massachusetts	Mass., R.I., Conn., Me., N.H., Vt.	617 369-4400 (Boston area) 646-7400 TWX: 617 369-5708	Robert B. Richmond, Manager Ralph K. Peterson, Engineer Stuart P. Roberts, Engineer Richard G. Rogers, Engineer Howard H. Dawes, Service Manager
*METROPOLITAN NEW YORK Broad Avenue at Linden Ridgefield, New Jersey	N.Y. City and vic., Long Island, No. N.J.	(N.Y.) 212 964-2722 (N.J.) 201 943-3140 TWX: 201 943-8249	George G. Ross, Manager Peter Bishop, Engineer J. Peter Eadie, Engineer Richard K. Eskeland, Engineer Raymond J. Jones, Service Supervisor
SYRACUSE Pickard Building East Molloy Road Syracuse 11, New York	Upstate N.Y.	315 454-9323 TWX: 315 477-1265	Leo J. Chamberlain, Manager Crawford E. Law, Engineer
PHILADELPHIA 1150 York Road Abington, Pennsylvania	Penn., So. N.J., Del.	(Phil.) 215 424-7419 (local) 215 887-8486 TWX: 215 887-0147	John E. Snook, Manager Carl W. Alsen, Engineer
*WASHINGTON and BALTIMORE Rockville Pike at Wall Lane Rockville, Maryland	D.C., Md., Va., W.Va., N.C., S.C., Tenn., Ga., Ala.	301 946-1600 TWX: 301 949-6787	C. William Harrison, Manager James L. Lanphear, Engineer Gerald L. Lett, Engineer Donald W. Brown, Service Supervisor
ORLANDO 113 East Colonial Drive Orlando, Florida	Florida	305 425-4671 TWX: 305 275-1668	John C. Held, Manager
*CHICAGO 6605 West North Avenue Oak Park, Illinois	Ill., Ind., Iowa, Kan., Ky., Mich., Minn., Mo., Ohio, Wis.	312 848-9400 TWX: 312 383-3091	William M. Ihde, Manager Leroy C. (Tom) Fricke, Engineer Robert P. Delzell, Engineer Lane W. Gorton, Engineer George R. Hanson, Service Supervisor
DALLAS 2501-A West Mockingbird Lane Dallas 35, Texas	Texas, La., Okla., Ark., Miss., Colo.	214 Fleetwood 7-4031 TWX: 214 899-9065	Edward F. Sutherland, Manager
*LOS ANGELES 1000 North Seward Street Los Angeles 38, California	So. Calif., Ariz., N. Mex.	213 469-6201 TWX: 213 876-4083	Frank J. Thoma, Manager Kenneth J. Castle, Engineer John R. Ross, Engineer Harold Stevens, Engineer Alfred J. Guay, Service Supervisor
SAN FRANCISCO 1186 Los Altos Avenue Los Altos, California	No. Calif., Ore., Wash., Utah, Nev., Idaho	415 948-8233 TWX: 415 949-7964	James G. Hussey, Manager Donald M. Vogelaar, Engineer
*TORONTO 99 Floral Parkway Toronto 15, Ontario, Canada	Canada	416 247-2171	Arthur Kingsnorth, Manager Richard J. Provan, Engineer Ronald F. Mossman, Engineer Walter Otelinger, Service Supervisor

* SERVICE, INCLUDING REPAIRS, CALIBRATION, AND SPARE PARTS STOCK, AVAILABLE AT THESE OFFICES.

OVERSEAS REPRESENTATIVES

For a list of representatives in other countries, see inside back cover.

EXPORT SALES AND SERVICE

GENERAL RADIO COMPANY

EXPORT SALES ENGINEERING

WEST CONCORD, MASSACHUSETTS, USA

Telephone: 369-4400 (Code 617) Cable Address: GENRADCO BOSTON

Stephen W. DeBlois, Export Manager

J. (Fritz) Pfaffmann

Ian H. Sichel

REPRESENTATIVES

AUSTRALIA

WARBURTON FRANKI INDUSTRIES PTY. LTD.
Instruments Division
307-315 Kent Street
Sydney, N.S.W., Australia
Tel: 29 1111, Cable: BOOSTER-SYDNEY
Offices: Melbourne, Brisbane, Adelaide

CANADA

(See inside front cover)

INDIA

MOTWANE PRIVATE LIMITED
127 Mahatma Gandhi Road
P. O. Box 1312, Fort
Bombay 1, India
Tel: 252337, Cable: CHIPHONE-BOMBAY
Branches in: Calcutta, Lucknow, Kanpur, New Delhi,
Madras, and Bangalore

INDONESIA

HADI TRADING & INDUSTRIAL CORP.
P. O. Box 2437
Djakarta, Indonesia
Cable: HADINDUSTRY-DJAKARTA

JAPAN

MIDORIYA ELECTRIC CO., LTD.
3, 2-Chome, Kyobashi
Chuo-ku, Tokyo, Japan
Tel: 561-9256, Cable: MIDRIYAELC-TOKYO

LATIN AMERICA

AD. AURIEMA, INC.
85 Broad Street
New York 4, New York
Tel: BOwling Green 9-7750
Cable: AURIEMA-NEW YORK, Telex: 2791 NEW YORK
Resident representatives in principal cities of South
America, Central America, Mexico, and the
Caribbean Area

NEW ZEALAND

W. & K. McLEAN LTD.
7 Anzac Avenue
P. O. Box 3097
Auckland, New Zealand
Tel: 34-541, Cable: KOSFY-AUCKLAND

REPUBLIC OF SOUTH AFRICA

ROGERS-JENKINS AND CO. (PTY.) LTD.
251 Main Street
P. O. Box 654
Johannesburg, Republic of South Africa
Tel: 23-1541, Cable: ROGJENKINS-JOHANNESBURG
Telex: JX7453

SPAIN and PORTUGAL

AD. AURIEMA, INC.
85 Broad Street
New York 4, New York
Tel: BOwling Green 9-7750
Cable: AURIEMA-NEW YORK, Telex: 2791 NEW YORK
Resident representatives in Madrid and Lisbon

TURKEY

MEHMET VASFI MÜESSESİ
Galata, Bankalar Cad. 71-73
P. O. Box 143
Istanbul, Turkey
Tel: 447590, Cable: VASFI-ISTANBUL

GENERAL RADIO COMPANY (OVERSEAS)

(A wholly owned subsidiary of General Radio Company)

HELENASTRASSE 3, ZURICH 8, SWITZERLAND

Telephone: 47 70 20 (Code 051) TELEX: GENRAOVER ZCH 53638

Peter J. Macalka, Manager

REPRESENTATIVES

BELGIUM

S. A. MULTITECHNIC
30, Place Saintelette
Bruxelles 1, Belgique
Tel: 02/25.16.36, Cable: MULTITECHNIC-BRUXELLES

BRITISH ISLES

CLAUDE LYONS LTD.
Valley Works
Hoddesdon, Herts, England
Tel: 4541-6, Cable: MINMETKEM HODDESDON TELEX
Telex: 22724

CLAUDE LYONS LTD.
76 Old Hall Street
Liverpool 3, England

DENMARK

SEMLER & MATTHIASSEN
1, Aabelsgade
P. O. Box 879
København Ø, Denmark
Tel: (01) 29 03 11, Cable: SEMMATT-KØBENHAVEN

FINLAND

K. L. NYMAN
11 Meritullinkatu
Helsinki, Finland
Tel: 66 39 09, Cable: KLNMYMAN-HELSINKI

FRANCE

ETS RADIOPHON
148, Avenue Malakoff
Paris 16^e, France
Tel: Kleber 32 50, Cable: RADIOPHON-PARIS

RADIOPHON CORPORATION
509 Madison Avenue
New York 22, New York
Tel: Eldorado 5-5198

GERMANY

DR.-ING. GÜNTER NÜSSLEIN
Rissener Strasse 102
2 Wedel bei Hamburg
West Germany
Tel: Wedel 3842

GREECE

K. KARAYANNIS
Karitsi Square
Athens 124, Greece
Tel: 230.301, Cable: RAKAR-ATHENS

ISRAEL

EASTRONICS LTD.
22 Maze Street
P. O. Box 2554
Tel Aviv, Israel
Tel: 66890, Cable: EASTLAND-TEL AVIV

ITALY

ING. S. & DR. GUIDO BELOTTI
Piazza Trento 8
Milano (718), Italia
Tel: 54.20.51, Cable: INGBELOTTI-MILAN
Uffici: Genova, Roma, Napoli

NETHERLANDS

TECHNISCH VERKOOPKANTOOR GROENPOL
13-15 Prinsengracht
Postbus 1188
Amsterdam, Holland
Tel: 64474, Cable: GROENPOL-AMSTERDAM
Telex: 11177

NORWAY

MASKIN-AKTIESELSKAPET ZETA
Drammensvaen 39
Postboks 7553 SV
Oslo, Norway
Tel: 44 79/10, Cable: MASKINZETA-OSLO
Telex: 1157

SWEDEN

JOHN C. LAGERCRANTZ
Värtavägen 57
Stockholm, Sweden
Tel: 63 07 90, Cable: FIVESSVEE-STOCKHOLM

SWITZERLAND

SEYFFER & COMPANY, INC.
Badenerstrasse 265
Zurich, Schweiz
Tel: (051) 25 54 11, Cable: RADIOSEYFFER-ZURICH

CATALOG **R**

GENERAL RADIO COMPANY

WEST CONCORD, MASSACHUSETTS

NEW YORK • PHILADELPHIA • SYRACUSE • WASHINGTON • CLEVELAND
ORLANDO • CHICAGO • DALLAS • LOS ANGELES • SAN FRANCISCO • TORONTO

(See Inside Cover)

GENERAL RADIO COMPANY (OVERSEAS)

ZURICH, SWITZERLAND

REPRESENTATIVES IN PRINCIPAL COUNTRIES

(See Inside Back Cover)



CONTENTS

MAY 1963

C A T A L O G

R

Since 1915 —
manufacturers of electronic apparatus
for science and industry

GENERAL RADIO COMPANY

WEST CONCORD, MASSACHUSETTS

NEW YORK • PHILADELPHIA • WASHINGTON • SYRACUSE • DALLAS
ORLANDO • CHICAGO • LOS ANGELES • SAN FRANCISCO • TORONTO

Copyright, 1963, by General Radio Company, West Concord, Mass., U.S.A.

INSTRUMENTS

ACOUSTICAL	1
ANALYZERS	13
AMPLIFIERS	22
ATTENUATORS	24
BRIDGES	27
COAXIAL EQUIPMENT	59
DETECTORS	78
FREQUENCY STANDARDS AND METERS	83
GENERATORS (AF, RF, STANDARD-SIGNAL, SWEEP, NOISE, PULSE)	102
METERS (VOLTAGE, CURRENT, POWER)	139
RECORDER	144
STANDARDS (CAPACITANCE, RESISTANCE, INDUCTANCE)	146
POWER EQUIPMENT	172
POWER SUPPLIES	173
REGULATORS	178
SPEED CONTROLS	180
VARIAC® AUTOTRANSFORMERS	183
PARTS & ACCESSORIES	201
APPENDIX (CABINETS, REACTANCE CHARTS, SYMBOLS AND ABBREVIATIONS, DB TABLES)	210
INDEX	220



COME VISIT US

We are always glad to see our customers at our home plant as well as at our Sales Engineering Offices. We can welcome you best between 10AM and 4PM any day except Saturdays, Sundays, and legal holidays in Massachusetts.

Our plant is located in West Concord, at 22 Baker Avenue. This is near the intersection of State Routes 2 and 62, and the accompanying map shows routes from Boston and vicinity. The Maynard bus (Middlesex and Boston Street Railway Company) from Harvard Square, Cambridge, serves West Concord. Also, the Boston and Maine Railroad provides service from Boston's North Station.

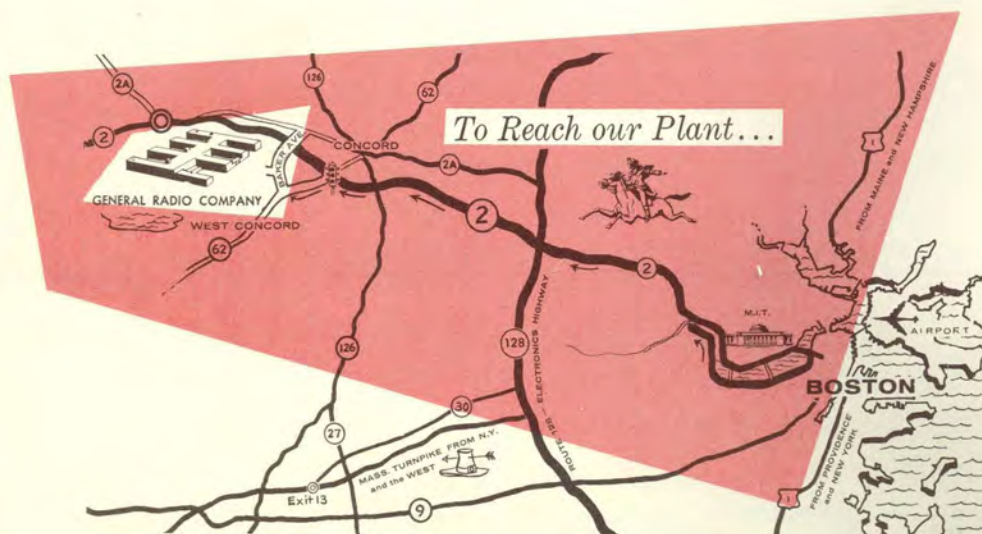



OUR COMPANY

General Radio, an employee-owned company, was founded in 1915. Our principal business has always been the manufacture of measuring instruments for science and industry. Our administrative offices and all manufacturing operations are at our new plant in West Concord, Massachusetts. Our sales engineering and service network includes offices in 11 metropolitan areas in North America and a wholly owned subsidiary, General Radio Company (Overseas), in Zurich, Switzerland.

General Radio sells standard, proprietary, off-the-shelf products, listed in this catalog. It does not sell consulting services, patents, or proprietary rights or processes.

COMPETENCE IN ENGINEERING

General Radio has furthered the science of electrical measurement for almost 50 years. GR contributions have been many: The heterodyne wave analyzer, the electronic stroboscope, the adjustable autotransformer, the RC oscillator, the butterfly circuit, and the coaxial admittance meter are a few of the devices either invented or first introduced commercially by General Radio. Today, to answer the needs of new technology, our rate of new instrument development is at an all-time high; in this catalog are 26 major instruments, plus many standards, connectors, parts, and accessories, that have been introduced since our last general catalog was published two years ago.

The rich experience and high competence of General Radio's engineering staff, many of whom are leading authorities in their fields, are available to our customers in the form of advice on measurement problems as well as in the superior design of our products.





OUR PRODUCTS

Two unwritten specifications for every GR instrument are reliable performance and long life. These are part of every engineering and manufacturing decision; they are evident in the design, layout, materials, components, wiring, and finishes of our instruments. Every step has been refined by an instrument-manufacturing experience unequaled in the electronics industry.

Our panels and cabinets are of especially heavy-gauge aluminum so that they will not hum, dent, buckle, or rattle. We either paint or plate all outside aluminum surfaces. We plate all brass parts. Our instruments would operate as well — for a while — with less plating, painting, and finishing, but we'd rather give them the protection they deserve.

We use only the best components in our instruments, and this often means designing and making our own. For instance, when we needed a binding post with high dielectric strength, high leakage resistance, low capacitance, and low loss, we designed our own jack-top binding post, which soon became a popular (and widely copied) GR product in its own right. Our coaxial connectors and double banana plug are other GR-designed components now used throughout the electronics industry.

Components are only as reliable as the leads connecting them. At GR, we terminate all shielded leads with crimped ferrules, for connections that *stay* connected. We use Z-wire connections to join components on opposite sides of etched boards, and we nylon-braid our own cables by a GR-designed cable-braiding machine. The cables, etched boards, components — the vital organs of a GR instrument — look as if they are solidly in place. They are.

Our old friends will notice that the traditional black crackle and square cabinets have given way to soft grays and smart styling. We are proud of the new GR look, just as we are proud that we are old enough to be able to *have* a new look.

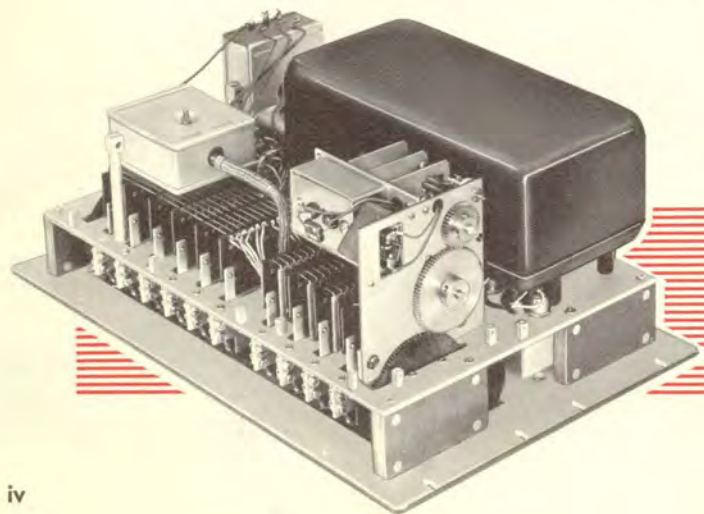
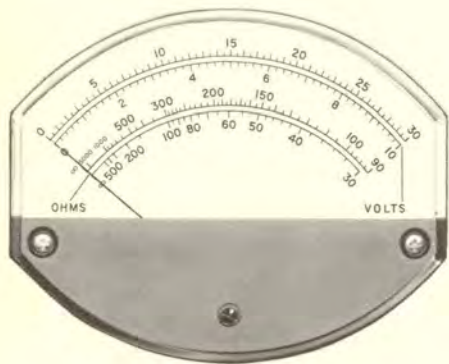



We feel that correct functional design is the key to a good-looking instrument. Take GR's proprietary new meter design. It is aesthetically pleasing because it looks *right*. You wonder, in fact, why *all* meters don't look like that. But here the primary design objective was, not styling, but maximum scale length per unit of panel area and the most readable scales possible. The good looks were the inevitable reward for proper design.

GR instruments are assembled by what is sometimes called the "artisan" method. This means that one man assembles a group of instruments, in contrast with the assembly-line method, where many people assemble each instrument. There are no assembly lines at General Radio.

The artisan system places high demands on the assemblers, and a major factor in the quality of our instruments is the caliber and experience of these men. Three quarters of them have been assembling GR instruments for over 10 years, and better than one in four is a 20-year man.

These are a few of the reasons why we can guarantee performance to published specifications for two years, and why many of our instruments manufactured over a quarter century ago are still working perfectly. Another reason is GR's conservative approach to instrument specifications. Every instrument passing through our test and calibration laboratory must exceed published specifications by a comfortable margin. Because of this margin, you can have confidence in the specifications in this catalog.

Over the past half century General Radio instruments have won an enviable reputation for quality. We never rest on this reputation, but constantly strengthen it and add to it. The results are shown in this catalog: the best instruments we have ever made.

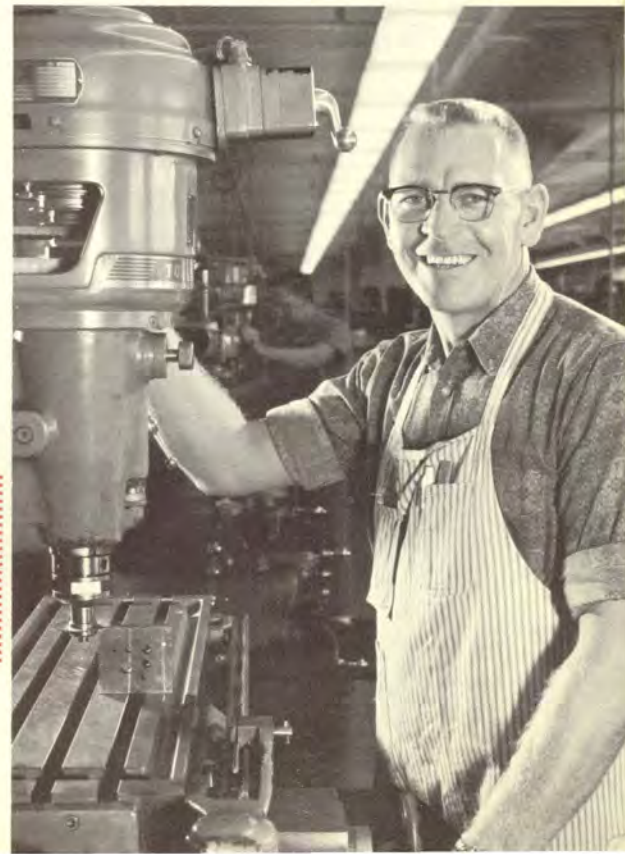

SALES, SHIPPING, AND SERVICE INFORMATION



WE SELL DIRECT

We have long believed that we serve our domestic customers best by serving them directly. The men who sell GR instruments are *sales engineers*, in the strictest sense. They are also General Radio employees, paid salaries, not commissions. They make up the best qualified team of electrical measurement consultants to be found anywhere, and their advice is yours for the asking. Overseas, carefully selected representatives offer our many friends abroad the same competent service.

Another GR sales policy of long standing is the single price to all. We have no patience (nor have our customers) for prices that are so variable that they cannot be advertised. The price of a product, we have always felt, is just as much a part of specifications as is the technical description. Moreover, we feel that there is no more place for fiction in prices than in voltage ratings. The prices given in this catalog are what we charge for our products, and you may be sure that you are not carrying the load for somebody else's discount.

(Variac® autotransformers are sold in the U. S. both direct and through distributors, either way at the same advertised prices.)

HOW TO ORDER

An item is fully identified by the type number given in this catalog. For protection against typographical or reading errors, however, we recommend that you also give the name of the instrument and, where applicable, the measurement range or other significant specifications. Be sure to include orders for any accessories desired or for calibrations that are to be made before shipment.

SHIPPING INSTRUCTIONS

Unless specific instructions accompany the order, we shall use our judgment as to the best method of shipment. Repair parts or other items needed quickly will be shipped by air if requested. The following table shows approximate

U. S.	2 POUNDS				5 POUNDS				25 POUNDS				40 POUNDS			
	Air Freight	Air Express	Air Parcel Post	REA	Air Freight	Air Express	Air Parcel Post	REA	Air Freight	Air Express	Truck*	REA	Air Freight	Air Express	Truck*	REA
ATLANTA	\$12.10	\$6.50	\$1.26	\$2.65	\$12.10	\$6.50	\$2.94	\$2.97	\$12.10	\$12.15	\$ 6.46	\$5.06	\$12.10	\$16.41	\$ 6.46	\$ 6.61
BUFFALO	11.20	6.50	1.15	2.89	11.20	6.50	2.65	3.10	11.20	8.15	5.40	4.51	11.20	10.01	5.40	5.57
CHICAGO	13.25	6.50	1.26	2.96	13.25	6.50	2.94	3.30	13.25	12.15	6.22	5.47	13.25	16.41	6.22	7.09
CLEVELAND	11.45	6.50	1.15	2.92	11.45	6.50	2.65	3.17	11.45	9.75	6.23	4.86	11.45	12.57	6.23	6.12
DALLAS	16.90	6.50	1.47	2.75	16.90	7.49	3.63	3.10	16.90	17.75	9.48	6.22	16.90	25.37	9.48	8.46
DETROIT	11.35	6.50	1.15	2.87	11.35	6.50	2.65	3.23	11.35	9.75	6.39	5.12	11.35	12.57	6.39	6.54
HOUSTON	16.90	6.50	1.47	2.75	16.90	7.49	3.63	3.22	16.90	17.75	9.48	6.29	16.90	25.37	9.48	8.60
LOS ANGELES	24.75	6.51	1.60	2.90	24.75	8.77	4.00	3.55	24.75	24.15	11.81	7.98	24.75	35.61	11.81	11.29
ST. LOUIS	13.75	6.50	1.39	2.99	13.75	6.53	3.31	3.35	13.75	12.95	6.77	5.79	13.75	17.69	6.77	7.63
SEATTLE	22.15	6.51	1.60	2.88	22.15	8.77	4.00	3.54	22.15	24.15	11.81	7.92	22.15	35.61	11.81	11.20
CANADA**	Air Freight	Air Express	Airmail	REA	Air Freight	Air Express	Airmail	REA	Air Freight	Air Express	Truck*	REA	Air Freight	Air Express	Truck*	REA
CALGARY	\$12.55	\$7.00	\$2.56	\$4.16	\$12.55	\$9.30	\$6.40	\$4.16	\$12.55	\$26.80	\$10.52	\$7.97	\$18.30	\$39.85	\$10.52	\$10.83
MONTREAL	7.50	7.00	2.56	3.47	7.50	7.00	6.40	3.47	7.50	7.80	5.50	4.53	9.10	9.45	5.50	5.58
OTTAWA	7.50	7.00	2.56	3.49	7.50	7.00	6.40	3.49	7.50	7.80	5.55	4.67	9.50	9.45	5.55	5.56
QUEBEC	7.50	7.00	2.56	3.49	7.50	7.00	6.40	3.49	7.50	8.80	5.50	4.67	9.10	11.05	5.50	5.56
TORONTO	8.00	7.00	2.56	3.56	8.00	7.00	6.40	3.56	8.00	9.80	6.42	4.97	10.70	12.65	6.42	6.04
VANCOUVER	14.00	7.00	2.56	4.30	14.00	9.70	6.40	4.30	14.00	28.80	11.81	8.69	20.30	43.05	11.81	13.06
WINNIPEG	10.50	7.00	2.56	3.87	10.50	7.90	6.40	3.87	10.50	19.80	11.71	6.62	14.70	28.65	11.71	8.65

U. S.	75 POUNDS				100 POUNDS				200 POUNDS				400 POUNDS			
	Air Freight	Air Express	Truck*	REA	Air Freight	Air Express	Truck*	REA	Air Freight	Air Express	Truck*	REA	Air Freight	Air Express	Truck*	REA
ATLANTA	\$15.60	\$32.00	\$ 6.46	\$10.26	\$17.00	\$34.15	\$ 6.46	\$12.87	\$28.90	\$ 65.02	\$11.80	\$25.34	\$ 55.80	\$129.60	\$23.60	\$50.38
BUFFALO	11.20	15.00	5.40	8.06	11.20	18.15	5.40	9.82	17.20	33.02	8.02	19.34	32.40	65.60	16.04	38.38
CHICAGO	17.00	27.00	6.22	10.89	17.00	34.15	6.22	13.59	28.25	65.02	11.04	26.58	55.60	129.60	22.08	53.46
CLEVELAND	12.95	19.80	6.23	9.09	12.95	24.55	6.23	11.20	20.45	45.82	8.88	22.10	39.60	91.20	17.76	41.90
DALLAS	22.00	43.80	9.48	13.74	22.00	56.55	9.48	17.52	39.10	109.82	16.26	34.74	76.80	219.20	32.52	69.18
DETROIT	13.50	19.80	6.39	9.85	13.50	24.55	6.39	12.22	21.65	45.82	9.34	24.14	41.80	91.20	18.68	47.98
HOUSTON	22.55	43.80	9.48	13.99	22.55	56.55	9.48	17.83	40.20	109.82	16.26	35.36	79.00	219.20	32.52	70.42
LOS ANGELES	31.70	63.00	11.81	24.55	31.70	82.15	11.81	24.55	58.20	161.02	23.62	48.80	115.60	321.60	47.24	97.30
ST. LOUIS	17.35	29.40	6.77	11.91	17.35	37.35	6.77	14.96	29.50	71.42	12.28	29.62	58.20	142.40	24.56	58.94
SEATTLE	37.56	63.00	11.81	18.86	37.56	82.15	11.81	24.33	69.97	161.02	23.62	48.36	138.24	321.60	47.24	96.42
CANADA**	Air Freight	Air Express	Truck*	REA	Air Freight	Air Express	Truck*	REA	Air Freight	Air Express	Truck*	REA	Air Freight	Air Express	Truck*	REA
CALGARY	\$31.25	\$70.95	\$10.52	\$17.51	\$32.85	\$92.75	\$10.52	\$22.28	\$62.20	\$182.22	\$23.44	\$44.56	\$123.60	\$364.00	\$46.88	\$89.12
MONTREAL	13.45	13.95	5.50	7.19	13.45	16.75	5.50	8.23	23.40	30.22	6.56	16.46	53.00	60.00	13.12	32.92
OTTAWA	14.35	13.95	5.55	7.63	14.35	16.75	5.55	9.10	25.20	30.22	7.40	18.20	49.60	60.00	14.80	36.40
QUEBEC	12.95	16.95	5.50	7.63	12.95	20.75	5.50	9.10	22.40	38.22	7.00	18.20	44.00	76.00	14.00	36.40
TORONTO	16.75	19.95	6.42	8.54	16.75	24.75	6.42	10.32	30.00	46.22	8.56	20.64	59.20	92.00	17.12	41.28
VANCOUVER	35.00	76.95	11.81	19.62	36.75	100.75	11.81	25.10	70.00	198.22	23.62	50.20	139.20	396.00	47.24	100.40
WINNIPEG	24.50	49.95	11.87	13.44	25.15	64.75	12.38	16.84	46.80	126.22	17.41	33.68	92.80	252.00	35.68	67.36

* Or rail freight forwarder.
 ** Canadian rates do not include handling or brokerage fees, duties, or any other taxes.

cost of four different methods of shipment to major cities in the United States and Canada, door-to-door.

There is no charge for our domestic packing or for regular export packing and no charge for shipping containers or cases. Cases are not returnable.

OUR ADDRESS

Communications may be addressed to General Radio Company, West Concord, Massachusetts, to one of the Sales Engineering Offices listed on the inside front cover of this catalog, or to the appropriate export representative.

Customers may call on whichever Sales Engineering Office is most convenient for them. Areas regularly served by the various offices are listed on the inside front cover. States not listed are covered by the Sales Engineering Department at West Concord.

We have direct teleprinter connections with both Western Union and Bell System TWX. Our cable address is GENRADCO CONCORD (MASS), and our TWX call numbers are 617-369-5708. Complete addresses and telephone numbers for our Sales Engineering Offices are listed on the inside front cover.

PRICES

All prices given in this catalog are established on a direct-to-customer basis, with no discounts other than the quantity discounts noted below. Prices are f.o.b. our plant, West Concord, Massachusetts, and are exclusive of all taxes now in effect or that may be imposed hereafter by Federal, State, or local governments. Prices given are subject to change without notice. Formal price quotations remain in effect for 30 days in the U.S.A. and Canada, 60 days in other areas.

Canadian customers may obtain prices f.o.b. Toronto from our Toronto Office.

Customers outside the U. S. and Canada may obtain delivered prices from the General Radio representatives listed inside the rear cover of this catalog.

QUANTITY DISCOUNTS

Quantity discounts apply only to Variac® autotransformers and to parts, not to instruments. When 10 or more identical parts or autotransformers are ordered at the same time for single shipment to the same place, with ultimate destination in the continental United States (not including the Canal Zone) or Canada, the following quantity discounts are allowed, except where otherwise noted:

<i>Quantity</i>	<i>Discount</i>
10 through 19	5 percent
20 through 99	10 percent
100 or more	15 percent

MINIMUM BILLING

The minimum billing per order is \$10.00. This applies to all purchases except repair parts and cash-with-order transactions.

SOURCE INSPECTION SURCHARGE

A surcharge of 1 percent (\$2.50 minimum) applies on all orders requiring inspection at our plant either by one of the Government services or by the customer's own inspection department or other private agency. The inspection surcharge applies on each shipment inspected.

CONDITIONS OF SALE

Determination of prices, terms, and conditions of sale, and final acceptance of orders are made only at our plant, West Concord, Massachusetts.

For customers in the United States and Canada, terms are net 30 days if credit has been arranged; otherwise, unless payment is received before shipment, shipment will be made COD.

When full payment accompanies an order, except for repairs, we pay transportation charges to any point in the continental United States (not including Alaska and the Canal Zone) on carrier of our choice.

WARRANTY

We warrant that each new instrument sold by us is free from defects in material and workmanship and that, properly used, it will perform in full accordance with applicable specifications for a period of two years after original shipment. Any instrument or component that is found within the two-year period not to meet these standards, after examination by our factory, district offices, or authorized repair agency personnel, will be repaired or, at our option, replaced without charge, except for tubes or batteries that have given normal service.

SERVICE AND REPAIR

Repair service is available from our plant at West Concord, Massachusetts, or from our field service facilities (see inside front cover).

Before returning an instrument for repair, please write to us, requesting a Returned Material Tag, which includes shipping instructions. Also state the type and serial numbers of the instrument, date of purchase, and details concerning the difficulty.

Repair parts may be obtained from our home plant or Sales Engineering Offices. When ordering repair parts, please specify the part number and description of the item and the type and serial numbers of the instrument in which it is used.



EXPORT ORDERS

Customers outside the United States and Canada are served by General Radio and its wholly owned subsidiary, General Radio (Overseas), through the export representatives listed inside the rear cover of this catalog. All communications should be directed to the appropriate export representative. For countries not listed, inquiries should be addressed either to General Radio Company, West Concord, Massachusetts, U.S.A., or, for customers in Europe, to General Radio Company (Overseas), Helenastrasse 3, Zurich 8, Switzerland.

Prices to overseas destinations are available from export representatives on request. Estimated prices, C.I.F., will

be quoted by General Radio Company, West Concord, Massachusetts, U.S.A., or by General Radio Company (Overseas) on request.

Determination of export prices, terms, and conditions of sale are made at General Radio Company, West Concord, Massachusetts, U.S.A., or General Radio Company (Overseas), Zurich, Switzerland.

Export terms are full payment in advance of shipment or by sight draft against an irrevocable letter of credit at a New York or Boston bank, or as previously arranged with General Radio or General Radio (Overseas).

**PUBLICATIONS**

A monthly publication, the *General Radio Experimenter*, features new products developed by General Radio as well as general technical information. Sent free on request, this periodical is distributed to over 100,000 readers throughout the world.

Other publications available from General Radio include the *Handbook of Noise Measurement*, *Primer of Noise Measurement*, *Handbook of Voltage Control*, *Handbook of High-Speed Photography*, and instrument notes, booklets, and reprinted articles on a wide range of technical subjects.

PATENTS

Many of our products are manufactured and sold under United States Letters Patent owned by the General Radio Company or under license grants from other companies. To simplify the listing of these patents they are given here in a single list and referred to at each instrument only by appropriate reference number.

1. "Certain vacuum-tube amplifier devices, electric wave filters, vacuum-tube oscillators, and sound-level meters are licensed by Western Electric Company, Inc., under all United States Letters Patent owned or controlled by American Telephone and Telegraph Company, or Western Electric Company, Inc., and any or all other United States patents with respect to which Western Electric Company, Inc., has the right to grant a license, solely for utilization in research, investigation, measurement, testing, instruction and development work in pure and applied science, including engineering and industrial fields."

2. "This apparatus uses inventions of United States Patents licensed by Radio Corporation of America. Patent numbers supplied upon request. Licensed only for use in measuring or testing electronic devices, electron tube cir-

cuits, parts of such devices and circuits, and elements for use in such devices and circuits."

3. Patent D 161,030.
4. Patent 2,548,457.
5. Patent 2,802,907.
6. Licensed under designs, patents and patent applications of Edgerton, Germeshausen and Grier.
7. Patent 2,949,592.
8. Patent Applied For.
9. Patent Re 24,204.
10. Patent 3,050,685.
11. Patent 3,022,944.
12. Patent 3,012,197.
13. Patent 2,977,540.
14. Patent 2,763,733.
15. Patent D 187,740.
16. Patent 2,970,258.
17. Patent 2,538,122.
18. Patent 2,581,133.
19. Patent 2,872,639.
20. Patent 2,943,277.
21. Patent 2,942,172.
22. Patent 2,966,257.

CORRECTIONS AND CHANGES



Prices and specifications in this catalog are subject to change without notice. We aim, however, to keep our customers informed of all important changes. The following changes have been noted since publication. Please enter these in your copy of Catalog R.

Inside Front Cover: SALES ENGINEERING OFFICES — Since publication we have added two more Sales Engineering Offices:

OFFICE	SALES AREA	TELEPHONE AND TWX	STAFF
CLEVELAND 5579 Pearl Road Cleveland, Ohio, 44129	Ohio Kentucky Western Pa.	216 886-0150 TWX: 216 888-0716	Leroy C. (Tom) Fricke, Manager Danny L. Woodward, Engineer
MONTREAL Office 395 1225 Laird Blvd. Town of Mount Royal Quebec, Canada	Ottawa Montreal Maritimes	514 737-3673 -3674	Richard J. Provan, Engineer

- Page i. Contents — Add: STROBOSCOPES page 168.
- Page 4. TYPE 1551-C SOUND-LEVEL METER — Specifications — **Sound-Level Indication**, line 4: 0.002 should be 0.0002. Correct figure is given under **Sound-Level Range**.
- Page 5. TYPE 1560-P3 PZT MICROPHONE — Specifications, **Temperature Coefficient of Sensitivity**: Approximately -0.01 db/°C. **Internal Impedance**: . . . varying from 445 to 510. . . .
- Page 7. TYPE 1560-P11B VIBRATION PICKUP SYSTEM — Minimum displacement should be 30 micrometers; velocity, 1000 micrometers per second; acceleration, 0.1 in. sec/sec.
- Pages 14 and 15. TYPE 1900-A WAVE ANALYZER — Specifications, **Range**: Upper frequency limit has been increased to 54,000 cps. **Accuracy of Calibration** is $\pm 1\%$ beyond 50,000 cps. **Voltage Accuracy**: After calibration by internal source, the accuracy up to 50 kc is $\pm (3\%$ of indicated value + 2% full of scale) except for the effects of internal noise when the attenuator knob is in the maximum-sensitivity position. In that position the internal noise is about 5% of full scale for the 3- and 10-cycle bands and 10% of full scale for the 50-cycle band. From 50 to 54 kc, the above 3% error becomes 6%.
- Pages 16 and 17. TYPE 1564-A SOUND AND VIBRATION ANALYZER — Specifications, **Filter Characteristics**, add: Ultimate attenuation is greater than 70 db for both characteristics; change: Peak response is uniform ± 1 db from 5 cps to 10 kc and ± 1.5 db from 2.5 cps to 25 kc. **Accessories Available**: Add TYPE 1560-P3 PZT Microphone. Band-Pass Characteristics of the Analyzer: Legends on curves are transposed; the 1/10th-octave curve is the narrower of the two.
- Page 23. TYPE 1233-A POWER AMPLIFIER — Pulse-response oscillograms: Pulse length is omitted. From left, 0.2, 1, and 2 μ sec, respectively.
- Pages 27 and 29. BRIDGE TABULATIONS. Range of 1650 is 1 m Ω to 11 M Ω .
- Page 35. TYPE 1650-A IMPEDANCE BRIDGE — Price is \$475 as announced prior to publication of Catalog R. Price of TYPE 1650-P1 is \$20.
- Page 37. TYPE 1615-A CAPACITANCE BRIDGE — Specifications, **Accuracy**: Capacitance — Direct-reading, internal standard: At 1 kc, $\pm (0.01\% + 0.00003$ pf). Additional error at higher frequencies and with high capacitance, $\pm 2 \times 10^{-5} f^2_{kc} \%$ + $2 \times 10^{-3} C_{\mu f} f^2_{kc} \%$. At lower frequencies and with small capacitance, accuracy may be limited by bridge sensitivity. Dissipation Factor: Direct reading, $\pm (0.1\%$ of measured value + 0.00001). **Maximum Safe Generator Voltage**: 30 f_{kc} volts. 300 volts maximum. If generator and detector connections are interchanged, 150 to 500 volts can be applied, depending on switch settings.
- Page 39. TYPE 716-CS1 CAPACITANCE BRIDGE — Specifications, **Accessories Required**: change last sentence to read "For operation at frequencies other than 1 Mc, use the Type 1232-A Tuned Amplifier and Null Detector, with the Type 1232-A Mixer, and a local oscillator."
- Page 48. TYPE 1862-C MEGOHMMETER — Specifications, **Dimensions**: Panel height for relay rack model is 10 $\frac{1}{2}$ inches.
- Page 64. TYPE 874 ADAPTORS — Adaptor table, TO TYPE 274, last column, should read "shown on page 209."
- Page 70. TYPE 874-W100, -W200 TERMINATIONS — Frequency scale is omitted from plots of vswr. Curves cover from 100 to 2000 Mc, as in Catalog Q. Types 874-R20A and -R22A — vswr plot: Dashed curve is for R20A.
- Page 77. Price List — Code Number for TYPE 900-L10 should be 0900-9605.
- Page 78. Sensitivity-frequency curves — Curve for 1212-A, -P3 should start 2 decades higher, at 30 Mc.
- Page 90. TYPE 1103-B SYNCHRONOMETER® TIME COMPARATOR — Specifications, **Input**: 1-kc sine wave, one volt into 10 kilohms; 1-kc sawtooth, 30 volts, peak-to-peak, into 100 kilohms.
- Page 100. TYPE 1137 DATA PRINTER — Price list: 230-volt models are for 50 cps only.
- Page 107. TYPE 1304-B BEAT-FREQUENCY AUDIO GENERATOR. The two captions at the foot of the page are interchanged.

Page 108. TYPE 1308-A AUDIO OSCILLATOR AND POWER AMPLIFIER — Specifications, **Voltage and Current Ranges**, add: in any combination up to 200 volt-amperes. **Optimum Load Impedance**: 0.8, 2.5, 8, 80, 800 ohms.

Page 113. SUMMARY OF POWER-SUPPLY CHARACTERISTICS. TYPE 1203-B Unit Power Supply (Page 173) can also be used.

Pages 114 and 115. UHF, VHF OSCILLATORS. Output into 50 ohms, guaranteed:

Osc. Type	With Type 1269-A or Type 1203-B Power Supply	With Type 1267-A, Type 1264-A, or Type 1201-B Power Supply
	1208-C	240 mw, 65 to 250 Mc 80 mw, 250 to 500 Mc
1209-CL	320 mw, 180 to 500 Mc 240 mw, 500 to 600 Mc	270 mw, 180 to 500 Mc 200 mw, 500 to 600 Mc
1209-C	150 mw	120 mw
1215-C	120 mw, 50 to 215 Mc 70 mw, 215 to 250 Mc	90 mw, 50 to 215 Mc 50 mw, 215 to 250 Mc

For typical output-vs-frequency curves, see the *GR Experimenter* for August, 1963.

Page 117. TYPE 1360-A MICROWAVE OSCILLATOR — Specifications, **Output, Power**: Individual instruments may show variations of 2:1 from typical curve. New output specification (guaranteed) is "At least 20 mw from 1.7 to 2.1 Gc; at least 50 mw from 2.1 to 4.1 Gc".

Page 118. TYPE 1220-A KLYSTRON OSCILLATOR — **Dimensions**: Width, $10\frac{3}{4}$ (275 mm).

Page 123. TYPE 1001-A STANDARD-SIGNAL GENERATOR — Specifications, **Voltage Accuracy**: "At frequencies below 10 Mc" should read "From 150 kc to 10 Mc."

Page 125. TYPE 1000-P5 VHF TRANSFORMER — Line 5: "... measurement of fm and television receivers."

Page 128. TYPE 1025-A STANDARD SWEEP-FREQUENCY GENERATOR — Features, line 9: "... to counter accuracy without disturbance. ..."

Page 142. TYPE 1806-A ELECTRONIC VOLTMETER — Specifications, **Accuracy**, second line: " $\pm 0.2\%$ of full scale from one-tenth. ..."

Page 150. TYPE 1401-D STANDARD AIR CAPACITOR — Dissipation factor is 20×10^{-6} .

Page 151. TYPE 1403-G STANDARD AIR CAPACITOR — Dissipation factor is 30×10^{-6} ; TYPES 1403-A, -D, -K, -N, -R, -V, dissipation factor is 20×10^{-6} .

Page 151. TYPE 1404-A REFERENCE STANDARD CAPACITOR — Specifications, Replace **Certificate** with: **Calibration**: A certificate of calibration is supplied with each capacitor giving the measured direct parallel capacitance at 1 kc and at 23 ± 1 C. The measured value is obtained by a comparison to a precision better than ± 1 ppm with working standards whose absolute values are known to an accuracy of ± 20 ppm, determined and maintained in terms of reference standards periodically measured by the National Bureau of Standards.

TYPE 1404-B — A 100-pf model, TYPE 1404-B, is now available — Price \$225.00.

Page 154. TYPE 1424-A STANDARD POLYSTYRENE DECADE CAPACITOR — Specifications, **Frequency**: Change last sentence to: At higher frequencies, terminal capacitance rises as resonant frequency, f_0 , is approached. The increase can be calculated from $\Delta C/C = (f/f_0)^2$, and f_0 varies from about 525 kc at 1 μ f to 235 kc at 10 μ f.

Page 157. TYPE 1419-A DECADE CAPACITOR — Capacitance per Step, A-decade, is 0.1 μ f.

TYPE 1419-M DECADE CAPACITOR — Specifications, **Dimensions**: $13\frac{3}{4}$ by 4-5/16 by 5 inches (350 by 110 by 130 mm).

Page 170. TYPE 1531-P3 SURFACE-SPEED WHEEL — Additional new specification, **Over-all Accuracy, including Strobosc**: $\pm 1.5\%$.

Page 174. TYPE 1263-B AMPLITUDE-REGULATING POWER SUPPLY — Specifications, **RF Output Voltage**: Change last sentence to read "With 1-ke square-wave modulation, 0.2 to 1.0 volt average value of the rms carrier level behind 50 ohms." **Output Voltmeter**: Add: "Meter reads average value of the rms carrier level."

Page 176. TYPE 1116-B EMERGENCY POWER SUPPLY — Continuous rating is 150 watts.

TYPE 1268-A AUTOMATIC BATTERY CHARGER — This device should be used only with nickel-cadmium batteries, TYPE 1268-9602 or equivalent.

Page 203. POTENTIOMETERS — Dimensions given are in inches.

Page 207. TYPE 274-DB, -MB, -NK PLUGS — Dimensions are in inches.

Page 211. Column 1, last line — Reference to page 116 should read page 113.

We have available a list of references to original descriptions in the *General Radio Experimenter* covering all major items in Catalog R. Free on request.

GENERAL RADIO COMPANY

WEST CONCORD, MASSACHUSETTS, USA

General Radio Company (Overseas), Zurich, Switzerland
Representatives in Principal Overseas Countries

ACOUSTICAL INSTRUMENTS



General Radio's comprehensive line of acoustical and audio-frequency instruments provides the essential elements for the efficient evaluation of noise and vibration and for the measurement of other acoustical phenomena. The basic instruments described in this section comprise a sound-level meter, a vibration meter, and a variety of transducers and calibrators, for the quantitative measurement of both air-borne and solid-borne vibrations.

These are supplemented by:

- (1) A group of analyzers, described in the section following, which operate from the electrical output of the sound-level meter* to measure the amplitude and frequency of the components of the sound or vibration spectrum. These include narrow-band, $\frac{1}{3}$ -octave, and octave-band instruments, as well as a peak-reading device for evaluating impact-type sounds.
- (2) Audio-frequency oscillators, a random-noise generator, and pulse generators for exciting acoustical and electrical systems under test.
- (3) A graphic level recorder for automatic spectrum analysis, reverberation-time measurements, and permanent records of measurements.
- (4) Stroboscopes for visual analysis of vibrating phenomena.
- (5) Impedance bridges for determining the characteristics of transducers and other acoustical devices.
- (6) Auxiliary equipment, such as frequency meters and amplifiers.

SOUND-LEVEL MEASUREMENTS

The standard sound-level meter is the basic sound-measuring instrument and has been improved in each successive model in performance, in convenience, and in versatility, culminating in the TYPE 1551-C Sound-Level Meter, which meets the requirements of the current American Standard Specification for General-Purpose Sound Level Meter.†

An excellent, general-purpose pzt microphone is now supplied as standard equipment. This stable and rugged microphone has a smooth frequency response and is relatively unaffected by normal temperature changes. It can be mounted directly on the instrument or separately with connection by extension cable when it is necessary to avoid the effects of the observer on the acoustical measurement. For broad-band measurements the TYPE 1551-P1 Condenser Microphone System is available.

The TYPE 1555-A Sound-Survey Meter is a simplified version of the sound-level meter, particularly designed for convenience in use, small size, and low cost.

Either of these instruments can be used to measure over-all level, the first important measure of a noise. A frequency analysis is also often desirable to estimate the effects of the noise, to track down the source, and to determine efficient control measures.

OCTAVE-BAND AND NARROWER-BAND MEASUREMENTS — SPECTRUM ANALYSIS

The TYPES 1558-A and 1558-AP Octave-Band Noise Analyzers and TYPE 1564-A Sound and Vibration Analyzer can be used directly with the pzt microphone to measure octave-band, or $\frac{1}{3}$ -octave and $\frac{1}{10}$ -octave band, sound-pressure levels in the range from 44 to 150 db, which is often all that is necessary to check against hearing-damage criteria or compliance with test codes or noise ordinances. When even lower band levels must be measured, the electrical output of the TYPE 1551-C Sound-Level Meter can be analyzed. This output is the amplified electrical replica of the acoustic signal at the microphone, and it has a wide dynamic range. Its frequency spectrum can be analyzed by the broad-band TYPE 1558 Octave-Band Noise Analyzers, the TYPE 1564-A Sound and Vibration Analyzer with both $\frac{1}{10}$ -octave and $\frac{1}{3}$ -octave bandwidths, and the TYPE 1900-A Wave Analyzer with 3-, 10-, and 50-cycle bandwidths.

IMPACT NOISE

The measurement of impact noise, which has previously required extensive instrumentation including an oscilloscope, is now possible with a simple setup consisting of the TYPE 1551-C Sound-Level Meter and the TYPE 1556-B Impact-Noise Analyzer. This analyzer is also used to measure electrical noise peaks in communication circuits.

CALIBRATION

Satisfactory noise measurements depend upon measuring equipment that is kept in proper operating condition. Although the instruments are inherently reliable and stable, after long periods of use their performance may change. In order to ensure that important changes will be discovered and corrected, the TYPE 1552-B Sound-Level Calibrator has been developed. It provides an over-all calibration of the system at 400 cps. When driven by a 400-cycle oscillator at a 2-volt level, it supplies a known acoustic signal to the microphone. The TYPE 1307-A Transistor Oscillator is a convenient 400-cycle source.

Where greatest accuracy is desired, the TYPE 1559-A Microphone Reciprocity Calibrator should be used. This new device, which uses the closed-coupler reciprocity method of calibration, will determine the sensitivity of the TYPE 1560-P3 and -P4 PZT Microphones over a frequency range of 20 to 8000 cps. It is also a precision acoustic source, as well as a sound-level calibrator.

With these instruments, one can make the measurements necessary for evaluating practically any industrial noise problem. They can be used by nontechnical personnel and are designed for long life and trouble-free operation. The use of these and other noise-measuring instruments is discussed thoroughly in the *Handbook of Noise Measurement*, published by General Radio Company, and available at one dollar a copy, postpaid. A *Primer of Noise Measurement*, an elementary treatise, is free on request.

* The TYPE 1564-A Sound and Vibration Analyzer and the TYPE 1558-A Octave-Band Analyzer can also be operated directly from a microphone.

† ASA S1.4 — 1961.

VIBRATION MEASUREMENTS

Vibration-measuring equipment includes the TYPE 1553 Vibration Meters to measure the acceleration, velocity, displacement, and jerk of a vibrating element; the TYPE 1564-A Sound and Vibration Analyzer or TYPE 1900-A Wave Analyzer to analyze the vibration; and the TYPE 1560-P11B Vibration Pickup System to convert the sound-level meter to a vibration meter. The TYPE 1558 Octave-Band Noise Analyzers and the TYPE 1564-A Sound and Vibration Analyzer can also be operated directly from the output of a vibration pickup. Calibration of these instruments is easily checked by the TYPE 1557-A Vibration Calibrator, a self-contained electromagnetic shaker.

Another important group of vibration instruments are stroboscopes (see page 195), which permit vibrating objects to be viewed intermittently and produce the optical effect of slowing down or stopping a periodic vibration.

GRAPHIC LEVEL RECORDER

The TYPE 1521-A Graphic Level Recorder can record the level and spectral distribution of sound and vibration, operating from the output of the sound-level meter, the TYPE 1553 Vibration Meter, or one of the analyzers. The frequency dials of the TYPE 1564-A Sound and Vibration Analyzer and the TYPE 1900-A Wave Analyzer can be driven by the recorder for automatic plotting of the spec-

trum. Reverberation measurements can also be made with this recorder.

MEASUREMENT POWER SOURCES

The TYPE 1304-B Beat-Frequency Audio Generator can drive transducers for observing the vibratory or acoustical response of various systems. If the response is recorded on the TYPE 1521-A Graphic Level Recorder, a plot of the transfer response level in decibels versus frequency on a standard logarithmic scale is obtained. An output of the TYPE 1900-A Wave Analyzer can also be used to drive transducers or networks; the response can be detected by the TYPE 1900-A Wave Analyzer and plotted automatically on the TYPE 1521-A Graphic Level Recorder. When higher power is needed, the TYPE 1308-A Audio Oscillator and Power Amplifier is recommended.

Another useful source is the TYPE 1390-B Random-Noise Generator, which can supply a broad-band noise. When its output is fed to one of the General Radio analyzers, the analyzer output is a band of noise that is tunable over the range of the analyzer. Such a signal has many applications in acoustical testing, particularly in architectural acoustics and psychoacoustics. For transient-response measurements, square-wave and pulse generators can provide steep-wavefront signals.

The accompanying diagram shows the functional relations among these various instruments, which collectively make up the General Radio Sound-Measuring System.

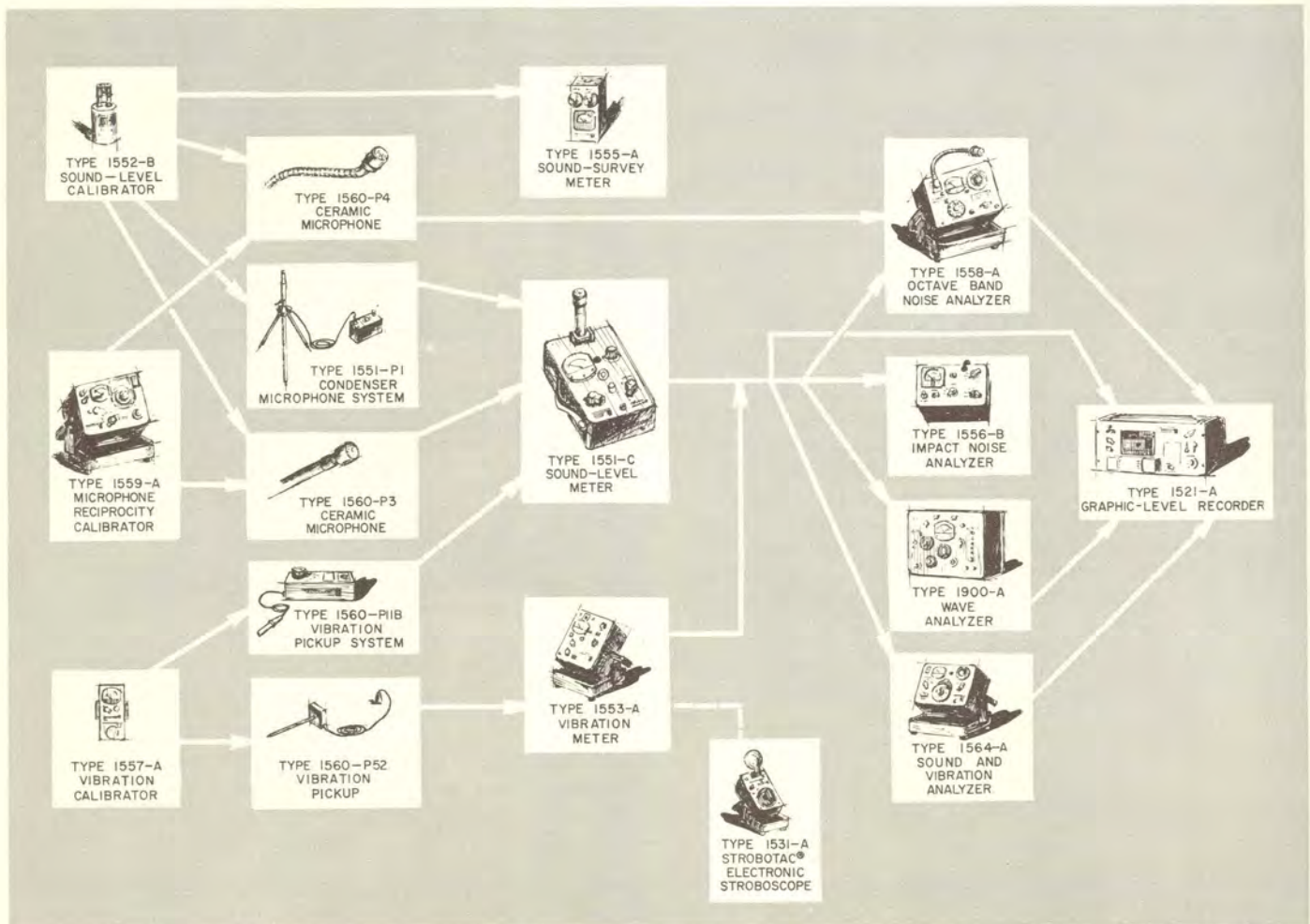



Type 1555-A SOUND-SURVEY METER

FEATURES:

- ◆ Small enough to fit in pocket.
- ◆ Can be used set on a table, mounted on a tripod, or held in the hand.
- ◆ Miniature in size, yet uses standard and well-tested components.

The TYPE 1555-A Sound-Survey Meter is an inexpensive, pocket-sized instrument for use in general survey measurements. Some of the many uses of this versatile meter are:

Measurement of noise levels in homes, offices, factories, and outdoor locations.

Measurement of noise levels produced by appliances, office equipment, and machinery.

Measurement of sirens and other warning systems.

Measurement of level and dispersion pattern of reproduced sound from public address systems, theaters, and home sound systems.

Field surveys for acoustic material companies.

Acoustical experiments in physics classes.

Measurements of cross-over characteristics and dynamic range of high-fidelity music-reproducing systems.

Frequency-response measurements on loudspeakers and rooms.

Loudness checks on speakers and singers, at rehearsals and in classes.

DESCRIPTION: The TYPE 1555-A Sound-Survey Meter consists of a nondirectional microphone, a continuously adjustable, calibrated attenuator, a stable amplifier with three weighting networks, and an easily read indicating meter. The entire assembly, including microphone and batteries, is housed in a rugged, two-piece aluminum case. The attenuator and weighting-network selector are fingertip-operated, permitting operation of the instrument with one hand. No provision is made for connection of an analyzer, but, by comparing measurements in different weighting positions, one can estimate the relative importance of low-frequency components in the sound being measured.

For more accurate measurements and when an output for frequency analysis is required, the TYPE 1551-C Sound-Level Meter (page 4) is recommended.

SPECIFICATIONS

Range: 40 to 136 db (re 0.0002 μ bar).

Frequency Characteristics: Any one of three different frequency characteristics can be selected by the FUNCTION switch. For c weighting, the frequency response is substantially flat from 40 to 8000 cps. The A- and B-weighting positions follow, respectively, the 40- and 70-db contours used as the weighting for sound-level meters.

Accuracy: The gain of the amplifier is so set that the sensitivity of the instrument is correct at 400 cps within ± 1 db.

Stability: The amplifier is stabilized by feedback to minimize the effect of changes in battery voltage. Temperature and humidity changes over the normal range of room conditions have no noticeable effect. The temperature coefficient of the sound-level indication is low, in the order of 0.03 db/ $^{\circ}$ F.

Operating Limits: The maximum safe operating temperature of the instrument is 115 F. Temperatures above 130 F will permanently damage the Rochelle-salt crystal in the microphone.

Microphone: A crystal-diaphragm-type microphone is mounted at the top of the instrument.

Batteries: One 1 $\frac{1}{2}$ -volt size C flashlight battery (Rayovac 1LP or equivalent) and one 30-volt hearing-aid battery (Eveready 413E or equivalent) are supplied.

Cabinet: Aluminum, finished in crackle, with a standard $\frac{1}{4}$ -20 threaded tripod mount. A leather "ever-ready" carrying case (not supplied with the sound-survey meter, but available separately) permits operation of the instrument without removal from the case.

Dimensions: Width 3 $\frac{1}{8}$, height 6, depth 2 $\frac{1}{2}$ inches (80 by 155 by 65 mm), over-all.

Net Weight: 2 pounds (0.9 kg) with batteries.

Shipping Weight: 2 $\frac{3}{4}$ pounds (1.3 kg); case, $\frac{3}{8}$ pound (0.3 kg).

The Primer of Noise Measurement, free on request, discusses sound and noise measurements possible with this instrument.

Type		Code Number	Price
1555-A	Sound-Survey Meter	1555-9701	\$185.00
	Set of Replacement Batteries		1.95
1555-P2	Leather Carrying Case	1555-9602	10.00





Type 1551-C SOUND-LEVEL METER

USES:

The TYPE 1551-C Sound-Level Meter is an accurate, portable instrument designed to meet American Standards Association specifications. In its primary function as a noise meter, this is the accepted instrument for the measurement of both product noise and environmental noise by industry, laboratories, regulatory bodies, and noise-abatement groups.

Typical users include:

MACHINE AND APPLIANCE MANUFACTURERS, in industrial and development laboratories as well as on the production line. The sound-level meter provides a means of establishing noise standards and of accepting or rejecting products on the basis of noise tests.

ACOUSTICAL ENGINEERS AND PHYSICISTS, for the measurement of machinery noise and for determining the acoustical properties of buildings, vehicles, and materials.

INDUSTRIAL HYGIENISTS AND PSYCHOLOGISTS, in surveys of the psychological and physiological effects of noise and for the determination of satisfactory noise environments in factories and offices.

In addition to its primary use as a self-contained sound-level meter, the TYPE 1551-C is the heart of a complete sound-measuring system, which includes spectrum analyzers, special-purpose microphones, calibrators, and vibration pickups. Many other accessories, such as graphic level recorders and tape recorders, can also be operated from the sound-level-meter output.

This sound-level meter can also be used as a portable amplifier, attenuator, and voltmeter for laboratory measurements in the audio-frequency range.

Its many applications are described in detail in the *Handbook of Noise Measurement*, a copy of which is available to each user.

DESCRIPTION: The TYPE 1551-C Sound-Level Meter consists of a nondirectional microphone, a calibrated attenuator, an amplifier, standard weighting networks, and an indicating meter. The complete instrument, including batteries, is mounted in an aluminum case. The microphone can be used in either a vertical or a horizontal position and, when not in use, folds down into a storage position, automatically disconnecting batteries. An ac power-supply unit is available.

FEATURES:

- ♦ Small, compact, and portable — weighs less than 8 pounds with batteries.
- ♦ Simple to operate.
- ♦ Meets requirements of ASA S1.4-1961 and IEC Publication 123, 1961.
- ♦ Wide dynamic range.
- ♦ Two-speed meter movement permits measurement of either steady or fluctuating sound.
- ♦ Wide sound-level range — from 24 to 150 db.
- ♦ Uses readily available batteries.
- ♦ Wide frequency response of amplifiers and panel meter — from 20 cps to 20 kc.
- ♦ Low internal noise level.
- ♦ Internal calibration system for standardizing gain.
- ♦ Quasi-rms meter; indication is essentially rms for all waveforms except short impact pulses.

SPECIFICATIONS

Sound-Level Range: From 24 to 150 db (re 0.0002 μ bar).

Frequency Characteristics: Any one of four response characteristics, A, B, C, or 20 kc, can be selected by a panel switch.

The A-, B-, and C-weighting positions are in accordance with ASA S1.4-1961.

Frequency response for the 20-kc position is flat from 20 cps to 20 kc, so that complete use can be made of wide-range microphones such as the TYPE 1551-P1 Condenser Microphone Systems.

Microphone: The microphone is a highly stable pZr ceramic type. A condenser microphone is available as an accessory. See page 6.

Sound-Level Indication: Sound level is indicated by the sum of the meter and attenuator readings. The clearly marked, open-scale meter covers a span of 16 db with calibration from -6 to 10 db. The attenuator is calibrated in 10-db steps from 30 to 140 db above 0.002 μ bar.

Output: An output of 1 volt across 20,000 ohms (when the panel meter is at full scale) is available at an output jack. The output can be used to drive frequency analyzers, recorders, and oscilloscopes.

Input Impedance: 25 megohms in parallel with 50 pf.

Output Impedance: 7000 ohms.

Meter Damping: The panel meter has two different damping characteristics; either FAST or SLOW response can be selected by a panel switch. The meter ballistics comply with current ASA standards.

Calibration: Built-in calibration circuit standardizes the sensitivity of the electrical circuits in the sound-level meter within ± 1 db at 400 cps, as specified in ASA standards. The TYPE 1552-B Sound-Level





The Type 1551-C Sound-Level Meter with the microphone in the storage position and batteries automatically disconnected.



The sound-level meter is here operated while in its leather carrying case, with the microphone in the horizontal operating position.



The Type 1551-C Sound-Level Meter can be ac-operated by means of the Type 1262-B Power Supply, which plugs directly into the base of the sound-level meter.

Calibrator (page 8) is available for making periodic acoustical checks on the over-all calibration, including microphone. The PZT microphone can be accurately calibrated with the TYPE 1559-A Microphone Reciprocity Calibrator, which can also be used for over-all acoustical checks of the sound-level meter.

Environmental Effects: Readings are independent (within 1 db) of temperature and humidity over normal ranges of room conditions.

Power Supply: Two 1½-volt size D flashlight cells (Rayovac 2LP or equivalent) and one 67½-volt battery (Burgess XX45 or equivalent) are supplied. An ac power supply, the TYPE 1262-B, is available.

Accessories Supplied: Telephone plug.

Accessories Available: TYPE 1551-P2 Leather Case, which permits

operation of the instrument without removal from the case. TYPE 1560-P95 Adaptor Cable Assembly, for connecting output to TYPE 1521-A Graphic Level Recorder. For other accessories, including analyzers, see pages 6 to 21.

Cabinet: Shielded aluminum, finished in gray crackle.

Dimensions: Width 7¼, height 9¼, depth 6½ inches (185 by 235 by 160 mm), over-all.

Net Weight: 7¾ pounds (3.5 kg) with batteries; 9¾ pounds (4.4 kg), including leather case.

Shipping Weight: 9 pounds (4.1 kg) with batteries; 11½ pounds (5.3 kg), including leather case.

See also *General Radio Experimenter*, 35, 8, August, 1961.

Type		Code Number	Price
1551-C	Sound-Level Meter	1551-9703	\$450.00
1262-B	Power Supply (see page 176)	1262-9702	95.00
	Set of Replacement Batteries		3.90
1551-P2	Leather Carrying Case	1551-9602	25.00
1560-P95	Connecting Cable	1560-9695	3.00

PATENT NOTICE. See Note 12, page viii.

MILITARY SPECIFICATIONS: We can supply TYPE 1551-C Sound-Level Meters to meet the specifications of MIL-STD-740. Price and details on request.



Type 1560-P3 PZT MICROPHONE

This microphone, which is used in the TYPE 1551-C Sound-Level Meter, is a PZT piezoelectric ceramic type, whose characteristics approach those of condenser microphones used as laboratory standards. It requires no polarizing voltage, however, and its impedance is lower by an order of magnitude. Thus, leakage due to high humidity is less of a problem than with the condenser type, and the microphone can be more readily used at the end of a cable.

SPECIFICATIONS

Frequency Response: Typical response is shown in the accompanying plot. Deviations of individual units are approximately ±0.3 db from 20 to 1000 cps and ±1 db up to about 8000 cps.

Sensitivity: -60 db re 1 volt/μbar.

Temperature Coefficient of Sensitivity: Approximately 0.01 db/°C.

Internal Impedance: Capacitive; 475 pf at 25 C, varying from 445 to 475 over a temperature range of 0 to 50 C.

Directivity: See frequency characteristic plot.

Environmental Effects: The microphone is not damaged by temperatures from -30 C to +95 C and relative humidities of 0 to 100%.

Terminal: Microphone fits Cannon XLR-3-11C cable connector.

Dimensions: Length 2¾ inches (70 mm), maximum diameter 1½ inches (29 mm).

Net Weight: ¼ pound (115 grams).

Type		Code Number	Price
1560-P3	PZT Microphone	1560-9603	\$80.00

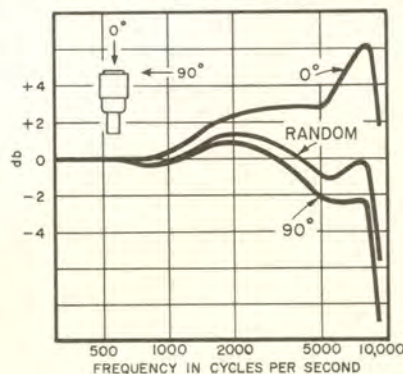



Type 1551-P1 CONDENSER MICROPHONE SYSTEM

USES:

The TYPES 1551-P1L (for normal-level measurement) and 1551-P1H (for high-level measurement) Condenser Microphone Systems are designed for use with the TYPE 1551-C Sound-Level Meter for measuring sound levels over wide frequency ranges. These microphones are not damaged by high sound levels or by high temperatures.

Applications include:

Measurement of high-frequency and high-level noises produced by such noise sources as air streams, wood-working and metalworking machinery, turbines, and jet engines.

General-purpose sound-level measurements where ambient temperature and sound level are high.

Measurements on high-fidelity sound systems over the full audio spectrum.

SPECIFICATIONS

Frequency Response: 20 cps to 18 kc with either microphone. Typical response curves are shown at right.

Calibration: The output level as a function of frequency is measured in our laboratory by comparison with a standard microphone. The measured level at 400 cps is supplied, and a calibration curve is included with each instrument.

Output Impedance: 6500 ohms (typical).

Direct Use with Analyzers: These assemblies can supply a signal directly to either the TYPE 1558 Octave-Band Noise Analyzer or the TYPE 1564-A Sound and Vibration Analyzer, provided that the levels of the measured components are above the following indicated values:

	1551-P1H	1551-P1L
TYPE 1558-A, -AK	85 db	70 db
TYPE 1564-A	65 db	50 db

A TYPE 1552-B Sound-Level Calibrator is necessary for absolute level calibration.

Maximum Sound-Pressure Level:

For the TYPE 1551-P1L Condenser Microphone Assembly, non-linear distortion is below 1% at levels up to 135 db, and below 10% at 155 db.

For the TYPE 1551-P1H Condenser Microphone Assembly, non-linear distortion is below 1% up to 150 db and below 10% up to 170 db.

Minimum Measurable Sound-Pressure Level:

- TYPE 1551-P1L — 50 db (re 0.0002 μ bar)
- TYPE 1551-P1H — 65 db (re 0.0002 μ bar)

DESCRIPTION: The TYPE 1551-P1L Condenser Microphone System uses an Altec 21-BR-150 microphone and measures sound-pressure levels up to 155 db; the TYPE 1551-P1H, which uses a 21-BR-180 microphone, measures levels up to 170 db.

The microphone base houses a subminiature pre-amplifier tube. A battery-operated power supply provides preamplifier filament and plate power and a polarizing voltage for the microphone. An extension cable, a tripod, and a leather carrying case are supplied.

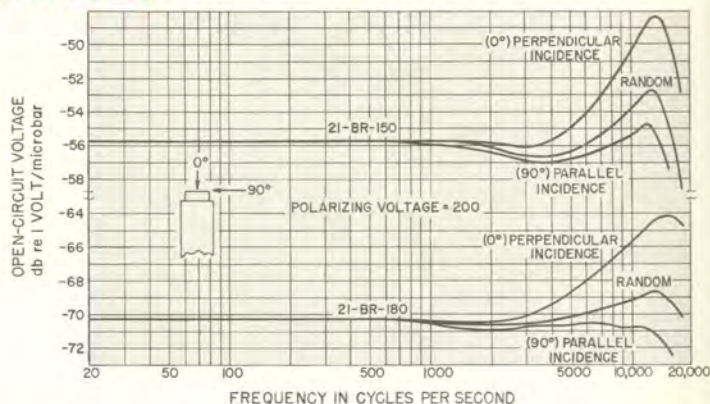

Temperature and Humidity: Maximum recommended operating temperature of the microphone in its probe is 100 C. The microphone is not damaged by exposure to high humidity, but prolonged exposure may cause electrical leakage and render it temporarily inoperative.

Batteries: One 1½-volt size D flashlight cell (Rayovac 2LP or equivalent) and one 300-volt B battery (Eveready 493, Burgess V-200 or equivalent) are supplied. Batteries should last at least 150 hours under normal use.

Mounting: The microphone on its base plugs into one end of a 10-foot cable and will slip into a receptacle on the tripod. The other end of the cable is connected to the power-supply unit, which fastens to one end of the sound-level meter.

Components and Accessories Supplied: Microphone base assembly, cable assembly, power supply, microphone, microphone cap, carrying case, and tripod.

Dimensions: Leather carrying case is approximately 7 by 5½ by 8½ inches (180 by 140 by 220 mm).

Net Weight: Complete in carrying case, 7¼ lb (3.3 kg).

Shipping Weight: 10¾ pounds (4.9 kg).

Type		Code Number	Price
1551-P1L	Condenser Microphone System (Normal Level)	1551-9866	\$475.00
	Condenser Microphone System (High Level)	1551-9865	475.00
	Set of Replacement Batteries		11.20

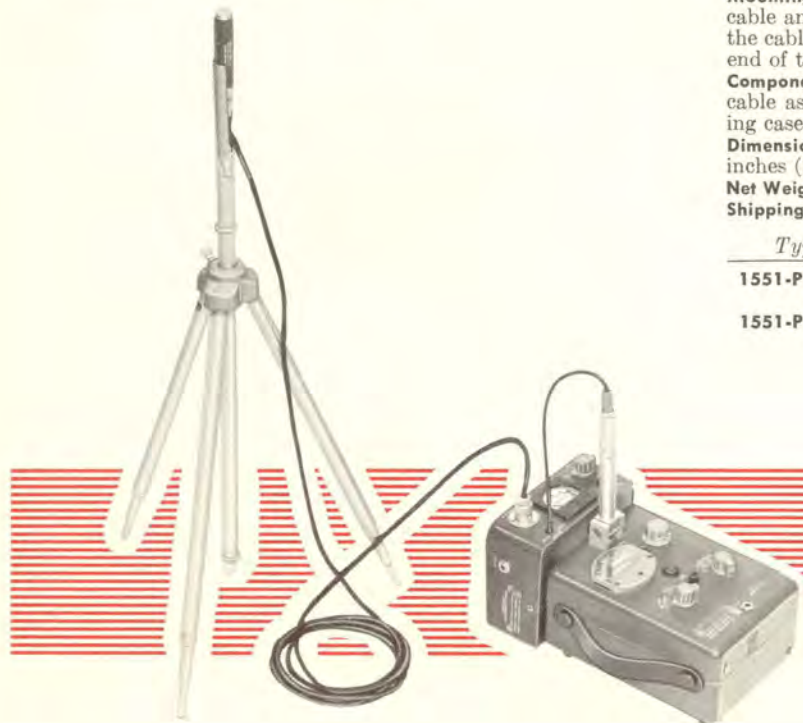

STANDARD ACCESSORIES FOR THE SOUND-LEVEL METER

The following accessories are available for use with the TYPE 1551-C Sound-Level Meter to increase its field of application and to adapt it for specialized types of measurement. These accessories can also be used with our older Sound-Level Meters, the TYPES 1551-B and 1551-A. An adaptor is required for the TYPE 1551-A.

Type 1560-P11B VIBRATION PICKUP SYSTEM

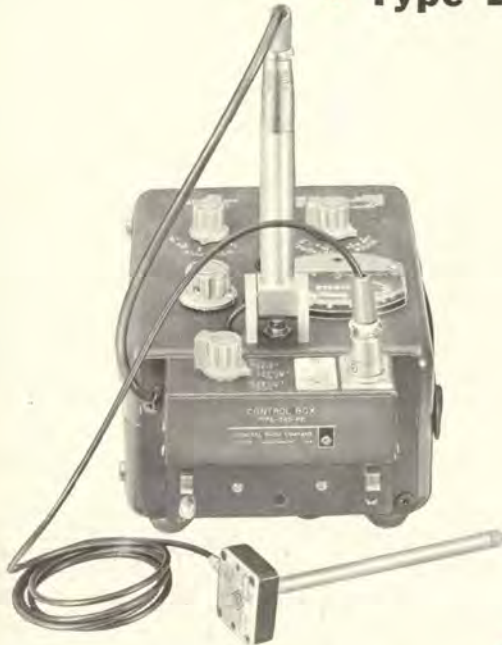

The TYPE 1560-P11B Vibration Pickup System consists of a TYPE 1560-P52 Vibration Pickup (with removable probe and probe tips), a TYPE 1560-P21B Control Box, and a 5-foot cable. The vibration pickup is an inertia-operated, lead-zirconate-titanate ceramic device which generates a voltage proportional to the acceleration of the vibrating body. By means of integrating networks in the control box, voltages proportional to velocity and displacement can also be delivered to the sound-level meter. The desired response is selected by means of a three-position switch on the control box. This pickup is also used on the TYPE 1553 Vibration Meter (page 10).

The TYPE 1560-P11S2 Vibration Pickup System, consisting of Endeveco Model 2217 Vibration Pickup with TYPE 1560-P21S1 Control Box, meets the requirements of MIL-STD-740 (Ships) and is available on special order. Write for details.

SPECIFICATIONS

SYSTEM

Calibration: The db readings on the sound-level meter can be converted into absolute values of displacement, velocity, or acceleration by means of calibration data supplied.

Range: The range of measurement of the pickup and control box when used with the TYPE 1551-C or 1551-B Sound-Level Meter is approximately as follows:

Rms Displacement, 100 microinches, minimum.

Rms Velocity, 3000 microinches per second, minimum. The upper limit of velocity and displacement measurements depends on frequency, and is determined by the maximum acceleration permissible before nonlinearity occurs (100 g).

Rms Acceleration, 0.3 to 39,000 in/sec/sec (100 g).

PICKUP

Sensitivity	75 mv/g
Resonant Frequency	3200 cps
Capacitance	0.01 μ f
Temperature Coefficient of Sensitivity	<0.01 db/°F
Temperature Range	-30 to +200 F
Relative Humidity Range	0 to 100%
Cable Length	5 feet (1.55 m)
Dimensions	1 5/8 × 1 7/16 × 9/16 in. (42 × 37 × 15 mm)
Net Weight	1.6 oz (45 grams)

Net Weight: 1 3/4 pounds (0.8 kg).

Shipping Weight: 3 pounds (1.4 kg).

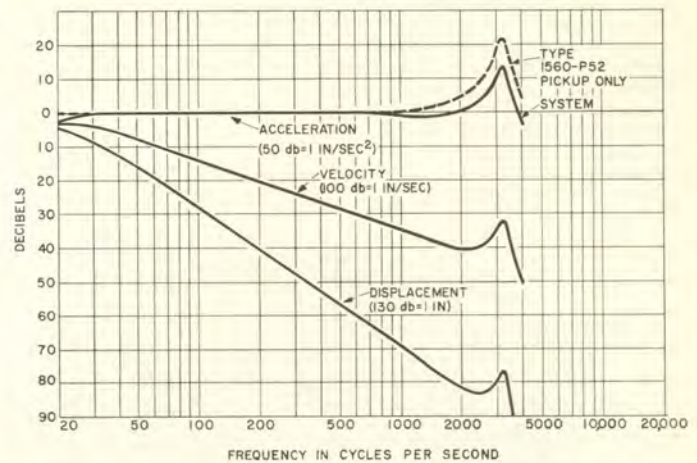

Frequency-response characteristics of the Type 1560-P11B Vibration Pickup System for constant applied acceleration.

Type		Code Number	Price
1560-P11B	Vibration Pickup System	1560-9922	\$160.00
1560-P52	Vibration Pickup only	1560-9652	100.00

TRIPOD AND EXTENSION CABLE

A 25-foot extension cable (TYPE 1560-P73) and tripod (TYPE 1560-P32) for mounting the TYPE 1560-P3 PZT Microphone (supplied with the TYPE 1551-C Sound-Level Meter) are available as the TYPE 1560-P34 Tripod and Extension Cable. A 100-foot cable is also available.

Net Weight: 5 1/2 pounds (2.5 kg).
Shipping Weight: 8 pounds (3.7 kg).

Type		Code Number	Price
1560-P34	Tripod and Extension Cable	1560-9634	\$45.00
1560-P73B	100-ft Extension Cable	1560-9982	29.00

Type 1552-B SOUND-LEVEL CALIBRATOR

USES:

The TYPE 1552-B Sound-Level Calibrator supplies an acoustic signal of known sound-pressure level for checking the over-all performance of a sound-level meter, including its microphone.

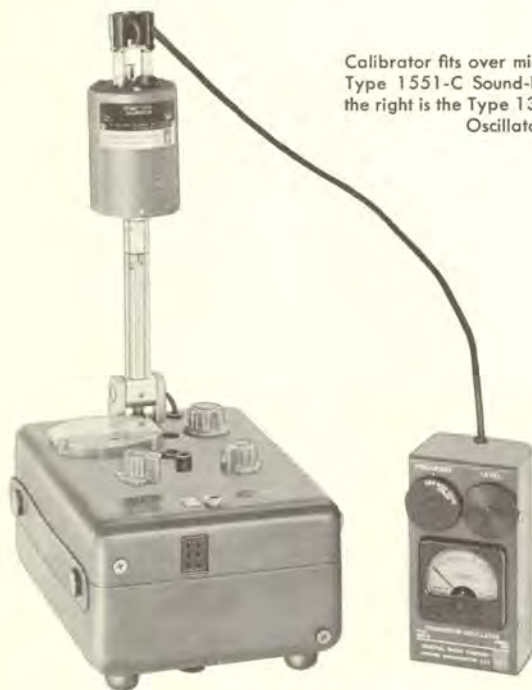

Calibrator fits over microphone of the Type 1551-C Sound-Level Meter. At the right is the Type 1307-A Transistor Oscillator.

It can be used to calibrate not only the TYPE 1551-C Sound-Level Meter and the TYPE 1555-A Sound-Survey Meter but also the TYPE 1558 Octave-Band Noise Analyzers and TYPE 1564-A Sound and Vibration Analyzer when they are used directly with the microphones listed in the specifications, below. The calibrator can also be used to supply an acoustic reference level for audio systems.

The TYPE 1307-A Transistor Oscillator serves as both power source and level indicator when used with the sound-level calibrator.

DESCRIPTION: A small, stable loudspeaker is mounted in one end of a cylindrical enclosure. The other end of the enclosure fits over the microphone. Acoustic coupling between the speaker and microphone is fixed by chamber and microphone dimensions. The calibrator provides acoustic shielding and a high test level to reduce effects of ambient noise during calibration. Calibration checks under these conditions are accurate and readily repeatable.

FEATURES:

- ♦ Good accuracy — ± 1 db at 400 cps. Very stable, low temperature coefficient and long-term stability.
- ♦ Easily portable — calibrator and battery-powered TYPE 1307-A Oscillator together weigh under 3 pounds.
- ♦ Fits many microphones.

SPECIFICATIONS

Accuracy of Calibration: ± 1 db at 400 cps.

Microphones: The calibrator can be used on the following microphones without the need of special adaptors:

Current types

Shure Brothers 98108 (General Radio TYPES 1560-P3, -P4)
General Radio TYPE 1551-P1H, -P1L Condenser Microphone Systems

General Radio TYPE 1555-A Sound-Survey Meter

Western Electric 640-AA

Kellogg Microphone

Discontinued types

Shure Brothers 98B99 (General Radio TYPE 1551-B Sound-Level Meter)

Shure Brothers 9898 (General Radio TYPE 759-B and TYPE 1551-A Sound-Level Meters)

Terminals: Input terminals are TYPE 938 Binding Posts, spaced $\frac{3}{4}$ inch to fit TYPE 274-MB Double Plug.

Accessory Required: A 400-cycle source, with output control and voltmeter. The TYPE 1307-A Transistor Oscillator, a battery-operated instrument with self-contained voltmeter, is recommended (see below).

Accessory Available: TYPE 1560-P31 Leather Carrying Case, for both calibrator and TYPE 1307-A Oscillator.

Dimensions: Length $4\frac{1}{2}$, diameter $2\frac{1}{2}$ inches (115 by 64 mm), over-all.

Net Weight: 14 ounces (0.4 kg).

Shipping Weight: $1\frac{1}{8}$ pounds (0.6 kg).



Type 1307-A TRANSISTOR OSCILLATOR

Recommended as a power source for the sound-level calibrator, this oscillator is a convenient 400- and 1000-cycle source for general testing at audio frequencies. Output voltage is indicated by a voltmeter, and a finger-tip output control facilitates setting the output level.

SPECIFICATIONS

Frequency: 400 and 1000 cps.

Frequency Accuracy: $\pm 3\%$ at 2 volts output into 600-ohm resistive load.

Output: Adjustable to a maximum of at least 2 volts into a 600-ohm load.

Distortion: Less than 5% at 400 cps and less than 6% at 1000 cps with 2 volts across a resistive 600-ohm load.

Voltmeter: Calibrated in volts, with 3 volts full scale.

Output Circuit: Output cable (20 inches) terminated in TYPE 274-MB Double Plug.

Batteries: Three mercury A batteries (Mallory RM-1 or equivalent) are supplied. Battery life is about 100 hours for 8 hours use per day.

Cabinet: Aluminum, with aluminum panel.

Carrying Case: Leather case with a strap is available for holding both oscillator and sound-level calibrator.

Dimensions: Width $3\frac{1}{8}$, height 6, depth $2\frac{1}{2}$ inches (79 by 153 by 64 mm), over-all.

Net Weight: $1\frac{3}{4}$ pounds (0.8 kg) with batteries.

Shipping Weight: $2\frac{1}{2}$ pounds (1.2 kg).

Type		Code Number	Price
1552-B	Sound-Level Calibrator	1552-9702	\$52.50
1307-A	Transistor Oscillator	1307-9701	97.00
1560-P31	Leather Carrying Case, for both calibrator and oscillator	1560-9631	15.00

PATENT NOTICE. See Note 1, page viii.

See also the Type 1559-A Microphone Reciprocity Calibrator, described on page 9.



Type 1559-A MICROPHONE RECIPROCIDY CALIBRATOR

- USES:**
- ♦ Primary calibrator for pzt microphones (TYPE 1560-P3 and TYPE 1560-P4).
 - ♦ Precision acoustical source.
 - ♦ Sound-level calibrator.

This instrument employs the closed-coupler (cylindrical cavity), reciprocity calibration procedure, the recognized method of performing the absolute calibration of laboratory standard microphones. Without calculations, one can rapidly determine the sensitivity of a microphone in db *re* 1 volt/ μ bar.

As a sound-level calibrator of constant acoustic output, it covers a wide frequency range, for rapid check on microphones and sound-level meters or for setting the reference levels in analyzing systems.

DESCRIPTION: This instrument provides the circuit and the structure required for closed-coupler reciprocity calibrations of General Radio TYPE 1560-P3 and 1560-P4 PZT Microphones. An audio oscillator and a detector are also needed. All calculations are automatically performed by an analog computer, and microphone sensitivity is read from a dial.

The necessary reversible transducer is the cartridge of a TYPE 1560-P3 PZT Microphone, which is built into the coupler; and the auxiliary transducer is a pzt cylinder that forms the cylindrical wall of the coupler. The symmetry

that results from the use of a reversible transducer identical with the microphone being measured and an auxiliary transducer in the form of an encompassing cylinder makes the coupler usable over a wide frequency range without the necessity of removal and replacement of transducers during the course of the measurement.

A single switch controls simultaneously the calibration operations and the analog computer. The detector characteristics and the magnitude of the applied voltage do not influence the result.

The pzt cylinder used in the reciprocity calibration also serves as a stable acoustical source for the sound-level-calibrator applications of the instrument. The sound-pressure level produced is indicated on a meter, which is actuated by the signal applied to the pzt cylinder.

FEATURES:

- ♦ Rapid and simple operation.
- ♦ High accuracy.
- ♦ Direct readout — answers available with no calculations.
- ♦ Useful for daily verification of calibrations.
- ♦ Portable or relay-rack mounting.

SPECIFICATIONS

MICROPHONE CALIBRATOR

Range: Direct reading for microphone sensitivities between -55 db and -65 db *re* 1 volt/ μ bar.

Frequency Range: 20 to 8000 cps.

Accuracy: ± 0.2 db $\pm (0.1$ db \times frequency in kc) up to 2.5 kc, ± 0.7 db above 2.5 kc to 7 kc, when reference is set to actual barometric pressure.

PRECISION ACOUSTICAL SOURCE

Frequency Range: 20 to 8000 cps.

Output: 92 db *re* 0.0002 μ bar for excitation of 50 volts.

Accuracy: At 92 db, ± 0.1 db + error in determining microphone sensitivity.

SOUND-LEVEL CALIBRATOR

Frequency Range: 20 to 2000 cps.

Output: 92 db *re* 0.0002 μ bar for excitation of 50 volts.

Accuracy: ± 0.7 db at standard atmospheric pressure.

GENERAL

Maximum Safe Input Voltage: 50 volts behind 600 ohms.

Accessories Required: Generator and detector. Generator to supply 5 volts or more into a 2000-pf load, and 2.5 volts or more into a 600-ohm load. Lower voltage can be used, with a resultant lowering of signal-to-ambient-noise ratio. The TYPE 1304-B Beat-Frequency Audio Generator, the TYPE 1210-C Unit R-C Oscillator, and the TYPE 1311-A Audio Oscillator are recommended. The TYPE 1551-B or -C Sound-Level Meter is recommended for the detector.

Accessories Supplied: TYPE 274-NP Patch Cord and an extension cable, for connection to generator and detector.

Cabinet: Flip-Tilt; relay-rack model also is available. (See page 210.)

Dimensions: Portable model, case closed — width 10, height 8, depth 7½ inches (255 by 205 by 190 mm), over-all; rack model — panel 19 by 10½ inches (485 by 270 mm), depth behind panel 5 inches (130 mm).

Net Weight: Portable model, 13 pounds (6 kg); rack model, 14 pounds (6.5 kg).

Shipping Weight: Portable model, 22 pounds (10 kg); rack model, 29 pounds (13.5 kg).

Type		Code Number	Price
1559-A	Microphone Reciprocity Calibrator, Portable Model	1559-9701	\$475.00
1559-9820	Microphone Reciprocity Calibrator, Rack Model	1559-9820	475.00

PATENT NOTICE. See Note 22, page viii.

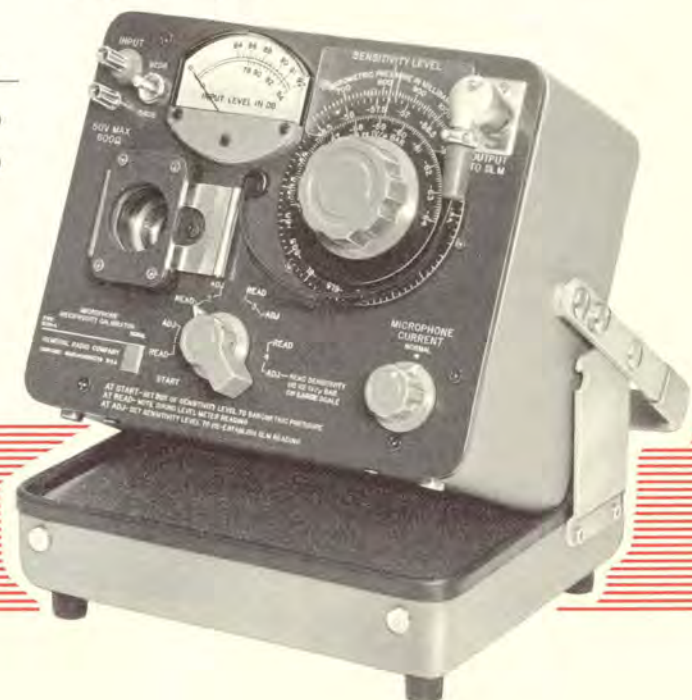

Type 1553 VIBRATION METER

USES:

Vibrations in machines and structures can be measured quickly and easily with this instrument. For the manufacturer of machinery and equipment, the TYPE 1553 Vibration Meter is extremely useful in research, design, and production testing.

Maintenance engineers will find it useful for checking the operating condition of bearings, gear trains, and other mechanisms. Excessive vibrations due to improper adjustment or to structural resonances can be located and measured.

Its excellent low-frequency response permits the study of the operation of belt drives and of the effectiveness of mountings designed to reduce vibrations in adjacent structures.

A frequency analysis of the measured vibration can be made with the TYPE 1564-A Sound and Vibration Analyzer or the TYPE 1900-A Wave Analyzer, page 14.

DESCRIPTION: The TYPE 1553 Vibration Meter consists of an inertia-operated, lead-zirconate-titanate ceramic pickup, which delivers a voltage proportional to the acceleration of the vibratory motion; an adjustable attenuator; an amplifier; and an indicating meter. Integrating networks can be switched to convert the output of the vibration pickup to a voltage proportional to either displacement or velocity.

A differentiating network can be switched in to convert the output of the vibration pickup to a voltage proportional to time rate of change of acceleration, or jerk.

The TYPE 1553-A Vibration Meter indicates directly in peak-to-peak, peak, or average inches, inches per second; inches per second², or inches per second³. The TYPE 1553-AK indication is in metric units: millimeters, meters/sec, meters/sec², and meters/sec³.

Filter jacks on the panel allow the use of external high-pass filters where it is desired to eliminate the frequency components below 30 or 70 cps.

The vibration meter is portable and is mounted in a Flip-Tilt cabinet, which serves as protective cover and case in transit, and as a base on which the instrument can be operated in almost any position from vertical to horizontal. The instrument is powered by readily available batteries and is equipped with a built-in calibrating circuit. A relay-rack model is also available.

Accessories include various tips and a metal probe for the pickup to facilitate measurements in normally inaccessible places. Available at additional cost is the TYPE 1560-P35 Permanent-Magnet Clamp, which replaces the probe or tip when measurements are made under conditions where hand-held operation would not be satisfactory.

FEATURES:

- ◆ Portable and self-contained.
- ◆ Easy to operate.
- ◆ Direct read-out includes units being measured.
- ◆ Low-frequency response down to 2 cycles per second.
- ◆ Meter indication independent of load connected to output jack.
- ◆ Meter is true peak, peak-to-peak, or average indicator.
- ◆ 20-cycle cutoff position on function switch increases displacement sensitivity by a factor of 100 over that obtainable with a 2-cycle cutoff.
- ◆ Measures jerk as well as conventional vibration parameters.
- ◆ Can be used to measure acceleration with a suitable pickup over the full range (2-20,000 cps) of the amplifier.
- ◆ Panel jacks provided for addition of external filters.

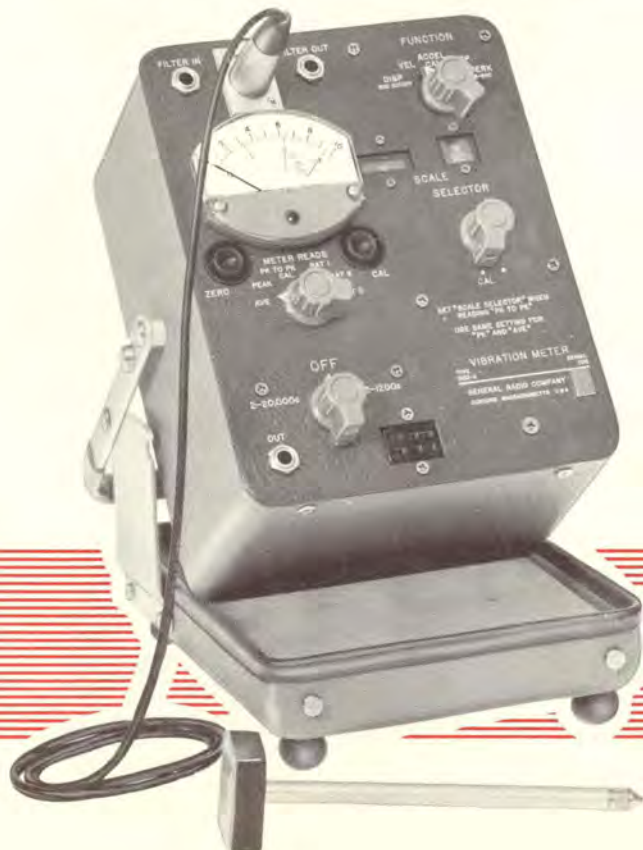

The Type 1553 Vibration Meter can be furnished with calibration in either English or metric units. The portable model in the convenient Flip-Tilt case is shown here. A rack-mount model is also available, as listed on the opposite page.

SPECIFICATIONS

Ranges of Measurement:

Type No.	Quantity	Peak to Peak		Average		Units	Frequency Range (cps)
		Min	Max	Min	Max		
1553-A	Acceleration	0.3	300,000	0.1	100,000	in/sec ²	2-2000
1553-AK	Acceleration	0.01	10,000	0.003	3,000	m/sec ²	2-2000
1553-A	Velocity	0.03	30,000	0.01	10,000	in/sec	2-2000
1553-AK	Velocity	0.001	1,000	0.0003	300	m/sec	2-2000
1553-A	Displacement	3	300,000	1	300,000	mils	2-2000
1553-AK	Displacement	0.1	10,000	0.03	10,000	mm	2-2000
1553-A	Displacement	0.03	30,000	0.01	10,000	mils	20-2000
1553-AK	Displacement	0.001	1,000	0.0003	300	mm	20-2000
1553-A	Jerk	30	300,000	10	300,000	in/sec ³	2-20
1553-AK	Jerk	1	10,000	0.3	10,000	m/sec ³	2-20

Accuracy: ±10% of full scale.

Input Impedance: 25 megohms.

Voltage at Output Jack: 5 volts rms behind 75 kilohms for full-scale deflection.

Attenuators: A 10-step attenuator changes the meter scale range by a factor of 100,000 to 1. Window readout indicates full-scale values and units.

Calibration: Internal.

Allowable Pickup Sensitivity for Direct Reading: 30 to 150 mv/g.

Terminals: A panel jack is provided for plugging in earphones, TYPE 1564-A Sound and Vibration Analyzer, TYPE 1556-B Impact-Noise Analyzer, TYPE 1531-A STROBOTAC® electronic stroboscope, TYPE 1900-A Wave Analyzer, or an oscilloscope.

Batteries: 3 size D cells and one 67½-volt battery (Burgess Type XX45 or equivalent) supplied. Typical battery life, 7 days at 8 hours per day.

Accessory Supplied: TYPE 1560-P52 Vibration Pickup.

Other Accessories Available: TYPE 1560-P35 Permanent-Magnet Clamp; TYPE 1557-A Vibration Calibrator, page 12.

Cabinet: Flip-Tilt; relay-rack models also are available. (See page 210.)

Dimensions: Portable model, case closed — width 8, height 9¼, depth 7½ inches (205 by 235 by 190 mm), over-all; rack model — panel 19 by 10½ inches (485 by 270 mm), depth behind panel 5 inches (130 mm).

Net Weight: Portable model, 10½ pounds (4.8 kg); rack model, 11 pounds (5 kg).

Shipping Weight: Portable model, 14½ pounds (7 kg); rack model, 21½ pounds (10 kg).



(Left) Vibration pickup with permanent-magnet clamp. (Right) Vibration pickup with probe and tips.

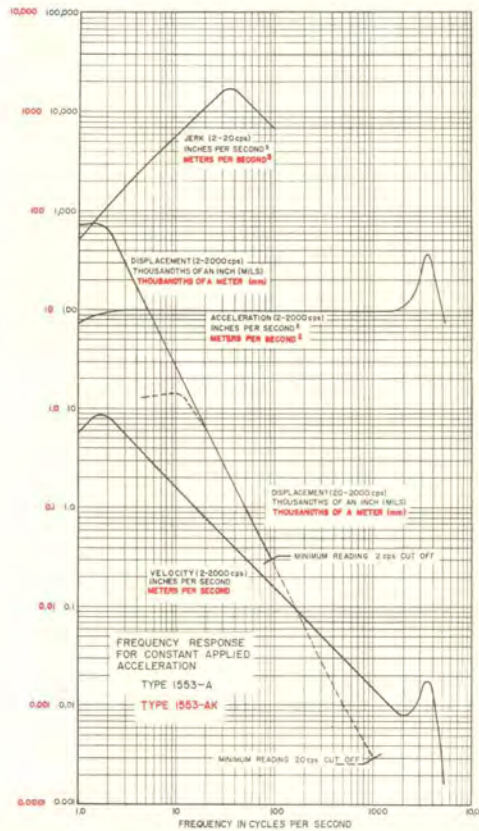

The TYPE 1553 Vibration Meters can be supplied on special order with a wide-range accelerometer, 20 - 20,000 cps (Endevco model 2217). Write for details.

Type		Code Number	Price
1553-A	Vibration Meter (English Units), Portable Model	1553-9701	\$775.00
1553-9820	Vibration Meter (English Units), Rack Model	1553-9820	775.00
1553-AK	Vibration Meter (Metric Units), Portable Model	1553-9819	775.00
1553-9840	Vibration Meter (Metric Units), Rack Model	1553-9840	775.00
1560-P52	Replacement Pickup*	1560-9652	100.00
	Set of Replacement Batteries		4.10
1560-P35	Permanent-Magnet Clamp	1560-9635	6.50

* Give instrument and serial number when ordering.
PATENT NOTICE. See Note 12, page viii.



Type 1557-A VIBRATION CALIBRATOR

USES:

This vibration calibrator is a convenient device for calibrating vibration pickups, accelerometers, vibration meters, and other vibration-measuring systems that use small, piezoelectric accelerometers as the sensing elements.



The calibrator provides a single-frequency (100 cps), single-level (1 g) check on the TYPE 1560-P52 Vibration Pickup (part of the TYPE 1560-P11B Vibration Pickup System), the TYPE 1553 Vibration Meter, or any pickup whose total mass is 300 grams or less. It can provide

SPECIFICATIONS

OUTPUT

Acceleration: 1 g rms \pm 10%.

Velocity: 0.614 in/sec (15.6 mm/sec), rms.

Displacement: 0.000978 inch (0.0248 mm), rms; 0.00277 inch (0.0704 mm), peak-to-peak.

Frequency: 100 cps \pm 1% for 50-gram load; 100 cps + 0, -2% for 300-gram load.

GENERAL

Batteries: Four RM-4 (or equivalent) mercury cells. Battery life is 100 hours of continuous operation. (Dry cells optional; please specify.)

Accessory Supplied: Leather carrying case.

Dimensions: Width 4, height 8, depth 4 inches (105 by 205 by 105 mm), over-all.

Net Weight: 3¼ pounds (1.5 kg), including case.

Shipping Weight: 5¼ pounds (2.4 kg).

on-the-spot calibration of vibration-measuring systems immediately before and after important measurements and can also be used to compare transducers or to calibrate working transducers against a standard transducer.

DESCRIPTION: The TYPE 1557-A Vibration Calibrator is a small, battery-operated unit consisting of a transistorized electromechanical oscillator and a cylindrical shaker. The acceleration output of the calibrator appears at two pillbox-shaped, 50-gram disks mounted on an internal cylinder that projects through the sides of the instrument.

Operation of the calibrator is simple. A pickup of known mass is attached to the shaker, either in place of one of the removable 50-gram disks or to one of the disks by double-faced, pressure-sensitive tape. The user adjusts the LEVEL control until the panel meter, calibrated in grams, indicates the mass of the pickup. The pickup will then be automatically subjected to an acceleration of 1 g at 100 cps. The only other control on the instrument is a combination of on-off switch and battery checker.

Life tests on the calibrator indicate that it will operate continuously for over 1000 hours. Since normal operation will usually be below the maximum and will not be continuous, the calibrator should give trouble-free service for many years.

FEATURES:

- ♦ Completely portable, with long-life mercury batteries.
- ♦ Accommodates most of the accelerometers and vibration pickups in use today.
- ♦ Weighs less than four pounds, with leather carrying case.

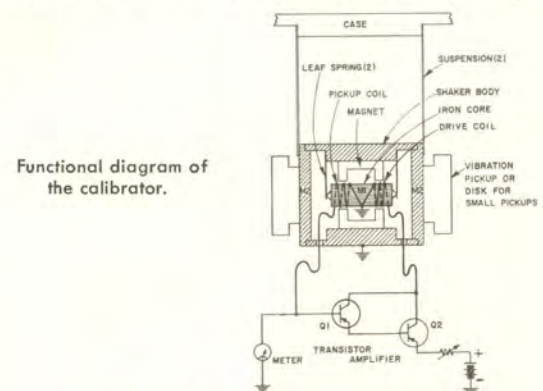

Functional diagram of the calibrator.

Type	Code Number	Price
1557-A	1557-9701	\$225.00

Vibration Calibrator

HANDBOOKS

The *Handbook on Noise Measurement*, published by General Radio Company, covers thoroughly the subject of noise and vibration measurement. Authors are Dr. A. P. G. Peterson and Ervin E. Gross, Jr., of the General Radio Engineering Staff. Copies of this handbook are available from General Radio at a price of \$1.00 each, postpaid, in the United States and Canada.

A *Primer of Noise Measurement* presents an elementary discussion of sound measurements, written for those with little or no background in the field. Copies are available free on request.



ANALYZERS



The instruments described in this section are used to determine the components and the wave shape of complex electrical signals, acoustic noise, or mechanical vibrations. The choice of an instrument for evaluating the individual components of such a signal depends upon the character of the signal, the information that is needed, and how the results are to be used.

HETERODYNE ANALYZER — FIXED BANDWIDTH

If, for example, the signal is a periodic one that is reasonably stable in frequency, each individual component is readily measured with the TYPE 1900-A Wave Analyzer. The very high selectivity of this analyzer, with its bandwidths of 3, 10, and 50 cps, is independent of the frequency to which the analyzer is tuned. These selectivity characteristics, which are obtained through the use of quartz-crystal filters, are invaluable in the measurement of intermodulation distortion of amplifiers and other audio equipment. When this analyzer is used as an electronic voltmeter in the measurement of the transmission characteristics of electrical wave filters and as a null detector for impedance bridges, the excellent selectivity is of particular value in avoiding the effects of interfering signals, hum, noise, and distortion products. When used as a bridge detector it will also supply the generator signal for operating the bridge, with identical generator and detector frequencies. The 50-cycle bandwidth of this analyzer is very useful in the measurement of noise, particularly when the spectrum is automatically plotted.

CONSTANT-PERCENTAGE BANDWIDTH ANALYZER

The TYPE 1564-A Sound and Vibration Analyzer finds its greatest use in the measurement of the components of noise, either electrical or acoustical, when the bandwidth of the TYPE 1900-A Wave Analyzer is too narrow for rapid analysis, and in the measurement of noises and complex waveforms whose frequency components fluctuate. It provides two bandwidths which are constant percentages of the center frequency: 1/3 octave (23%) and 1/10 octave (7%).

Although its tuning is continuous, if one assumes that the analyzer separates its range from 2.5 to 25,000 cps into contiguous bands, according to its effective bandwidth, it will have about 135 bands without appreciable overlap for the 1/10-octave bandwidth and about 41 bands for the 1/3-octave bandwidth. This contrasts with approximately 16,600, 5000, and 1000 bands for the 3-, 10-, and 50-cycle bandwidths, respectively, of the wave analyzer, whose frequency coverage is 20 cps to 50 kc.

RECORDING ANALYZERS

Either of the above-mentioned analyzers can be combined with the TYPE 1521-A Graphic Level Recorder to form a recording analyzer. The analyzer dial is driven automatically by the recorder, and chart paper is available to fit the scale of each type of analyzer. These combinations are illustrated on pages 15 and 17. With such a combination, complex spectra can be plotted automatically over the complete frequency range of the analyzer.

TUNED AMPLIFIER

Approximate magnitudes of spectrum components can be determined by measurement with the TYPE 1232-A Tuned Amplifier and Null Detector (page 79). This highly sensitive instrument has a bandwidth of about 5% and is tunable from 20 cps to 20 kc.

OCTAVE-BAND ANALYZER

For many noise measurements a simpler division of the spectrum is desired than that provided by either the TYPE 1564-A Sound and Vibration Analyzer or the TYPE 1900-A Wave Analyzer. Much time can be saved in the evaluation of the general spectral distribution of a noise through the use of an octave-band analyzer such as the TYPES 1558-A and 1558-AP Octave-Band Analyzers. These divide the audio spectrum into ten bands. Like the more selective analyzers, the octave-band analyzer can also be used as a selective voltmeter when it is desired to exclude certain bands of frequencies or individual frequencies from a signal.

DISTORTION METER

The TYPE 1932-A Distortion and Noise Meter is a specialized yet versatile device for the measurement of distortion into audio-frequency systems. Here the complete signal is used as a reference value, the fundamental component is suppressed; the remainder, which includes distortion components, hum, and noise, is then measured to give a single-number distortion rating. When used with a cathode-ray oscilloscope, it is a versatile testing tool, indicating immediately optimum conditions whenever adjustments are made that affect distortion and noise.

STEEP WAVEFRONTS

With impact-type acoustical noise and electrical noise, which have extremely steep wavefronts, a frequency analysis is usually of little value. The important characteristics of such signals are the peak amplitude and the duration or decay time. To evaluate these quantities, the TYPE 1556-B Impact-Noise Analyzer is used.

Type 1900-A WAVE ANALYZER

FEATURES:

- ♦ Wide frequency range — 20 to 50,000 cps.
- ♦ Three bandwidths — 3, 10, and 50 cps.
- ♦ Outputs for dc recorder and graphic level recorder.
- ♦ Tunable filter — output at selected frequency is provided.
- ♦ Tracking analyzer — analyzer can be used as both source and detector.
- ♦ Self-contained voltage-calibrating system.
- ♦ 30 microvolts to 300 volts, full scale.
- ♦ Input impedance of one megohm.
- ♦ Three meter speeds for easier noise analysis.
- ♦ Linear frequency scale for optimum tuning characteristics over full range.
- ♦ AFC holds analyzer in tune despite small drifts in input frequency.

USES: The wave analyzer is used for measuring the components of or analyzing the spectrum of complex electrical signals, including those which are replicas of acoustic noise or mechanical vibrations.

Individual components of periodic complex waveforms such as harmonic or intermodulation distortion are readily separated and measured, owing to the excellent selectivity available.

This analyzer is particularly suited for analyzing noise, because its bandwidth in cycles per second is independent of the center frequency. The required averaging time is, therefore, constant, and the calculation of spectrum level is simple. Furthermore, when the 50-cycle bandwidth is used, the averaging time required is reasonably short.

The analyzer can also be used as a tunable filter, so that the individual components of a complex input signal can be used to drive other instruments, such as frequency counters, when a highly accurate measure of the component frequencies is desired, or to drive earphones. When a wide-band noise generator drives the analyzer, the output is a tunable narrow band of noise. Such a signal is useful in a number of psychological and architectural-acoustics tests.

In the "tracking analyzer" mode of operation the output is a sine-wave signal tunable over the 50-ke range and

always in tune with the analyzer. When this signal is used to drive a bridge or other network, the output can be measured by the analyzer, whose selectivity reduces the interference from extraneous noise, hum, and distortion.

For automatic waveform analysis, outputs are provided for driving the TYPE 1521-A Graphic Level Recorder as well as dc recorders.

DESCRIPTION: The TYPE 1900-A Wave Analyzer is a heterodyne type of voltmeter. The intermediate-frequency amplifier at 100 kc includes a highly selective quartz-crystal filter whose bandwidth can be switched to 3, 10, and 50 cps. The use of a heterodyne system makes it possible to vary the response frequency although the filter frequency is fixed. The 100-ke output of the filter is indicated on a meter and is also available at the panel. In one mode of operation the output is also heterodyned back to the original frequency. In another mode the local oscillator beats with a 100-ke quartz-crystal oscillator to function as a beat-frequency oscillator. These two outputs are also available at panel terminals as FILTERED INPUT COMPONENT and INDICATED FREQUENCY, respectively. The block diagram shows how the elements of the analyzer operate to produce the several outputs.

SPECIFICATIONS

FREQUENCY

Range: 20 to 50,000 cps. The frequency is indicated on a counter and a dial with a linear graduation, 1 division/10 cps.

Accuracy of Calibration: $\pm(1/2\% + 5 \text{ cps})$.

Incremental-Frequency Dial (ΔF): ± 100 cps. Accuracy is ± 2 cps below 2 ke, ± 5 cps up to 50 ke.

Automatic Frequency Control: Range of frequency lock is ± 200 cps for 50-cycle band, ± 50 cps for 10-cycle band.

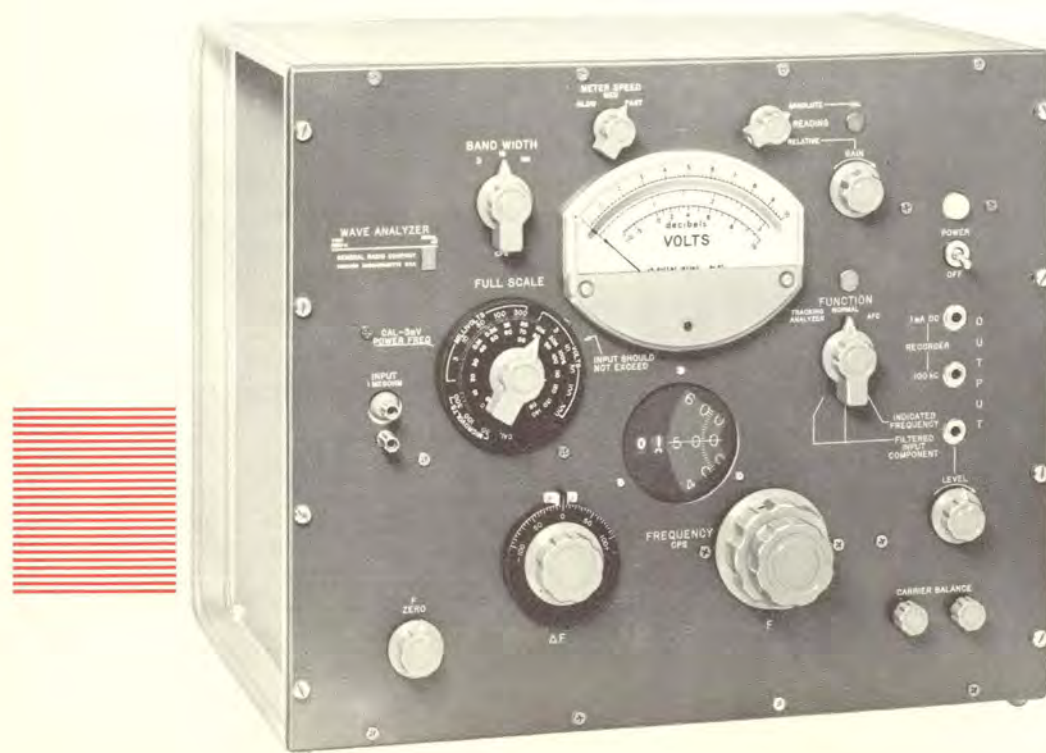

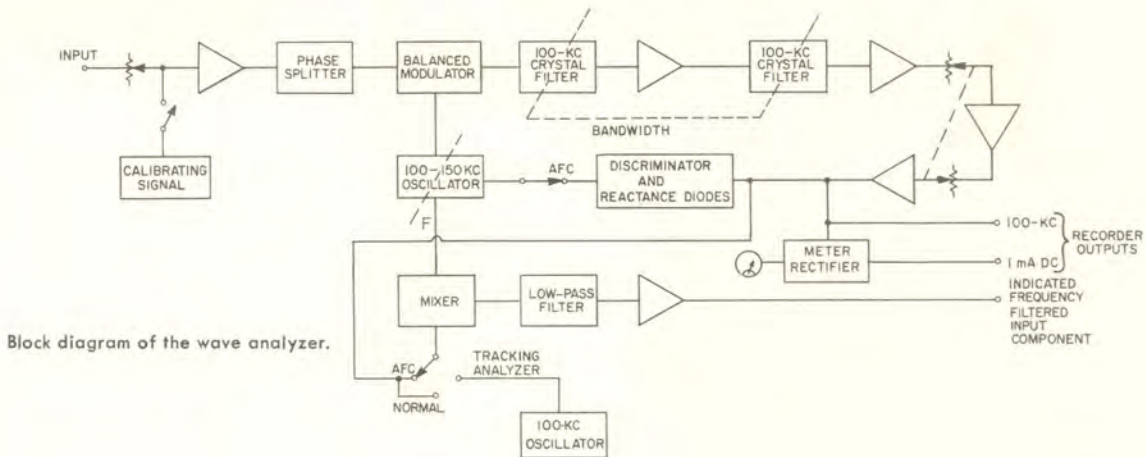

Block diagram of the wave analyzer.

SELECTIVITY: Three bandwidths (3, 10, and 50 cps) selected by switch.

3-Cycle Band: At least 30 db down at ± 6 cps from center frequency, at least 60 db down at ± 15 cps, at least 80 db down at ± 25 cps and beyond.

10-Cycle Band: At least 30 db down at ± 20 cps, at least 60 db down at ± 45 cps, at least 80 db down at ± 80 cps and beyond.

50-Cycle Band: At least 30 db down at ± 100 cps, at least 60 db down at ± 250 cps, at least 80 db down at ± 500 cps and beyond.

Effective bandwidth for noise equal to nominal bandwidth within $\pm 10\%$ for 10- and 50-cycle bands and $\pm 20\%$ for 3-cycle band.

INPUT

Impedance: One megohm on all ranges.

Voltage Range: 30 microvolts to 300 volts full scale in 3, 10 series. A decibel scale is also provided.

Voltage Accuracy: $\pm (3\%$ of indicated value $+ 2\%$ of full scale $+ 3$ microvolts). On the most sensitive range, a small residual error, due to internal noise, occurs.

OUTPUT

100-kc Output: Amplitude is proportional to amplitude of selected component in analyzer input signal. With the TYPE 1521-A Graphic Level Recorder connected through the adaptor cable supplied, at full-scale meter deflection output is at least 3 volts. Dynamic range is approximately 80 db.

Recording Analyzer: The analyzer in combination with the TYPE 1521-A Graphic Level Recorder produces continuous, convenient

records of frequency spectra over the complete range of the analyzer. The end frames of the bench models can be bolted together to form a rigid assembly. The recorder is described on page 144. Use chart paper 1521-9464 or 1521-9465.

DC Output: One milliamper in 1500 ohms for full-scale meter deflection.

Filtered Input Component: Output at least 1 volt across 600-ohm load for full-scale meter deflection with output control at maximum.

Tracking Analyzer (Indicated Frequency): 20 cps to 50 kc; output is at least 2 volts across 600-ohm load with output control at maximum.

GENERAL

Residual Modulation Products and Hum: At least 75 db down.

Terminals: Input, TYPE 938 Binding Posts; output, telephone jacks.

Power Requirements: 105 to 125 (or 210 to 250) volts, 50 to 60 cps, approximately 40 watts.

Accessories Supplied: TYPE 1560-P95 Adaptor Cable Assembly, phone plug, TYPE CAP-22 Power Cord, spare fuses.

Other Accessories Available: TYPE 1900-P1 Link Unit for coupling to TYPE 1521-A Graphic Level Recorder.

Cabinet: Rack-bench (see page 210).

Dimensions: Bench model — width 19, height 16 $\frac{1}{4}$, depth 15 $\frac{1}{4}$ inches (485 by 415 by 390 mm), over-all; rack model — panel 19 by 15 $\frac{3}{4}$ inches (485 by 400 mm), depth behind panel 13 $\frac{1}{4}$ inches (340 mm).

Net Weight: 56 pounds (26 kg).

Shipping Weight: 84 pounds (39 kg).

Type		Code Number	Price
1900-AM	Wave Analyzer, Bench Model	1900-9801	\$2150.00
1900-AR	Wave Analyzer, Rack Model	1900-9811	2150.00

A recording-analyzer assembly can be made up of the wave analyzer and the Type 1521-A Graphic Level Recorder for the automatic recording of complete spectra. A Type 1521-P10 Drive Unit and a Type 1900-P1 Link Unit are also required. See pages 144 and 145 for a description of the recorder and listing of chart paper to fit the analyzer dial.

Either rack-mount or bench-mount models can be used for this combination. Bench-mount units are furnished with end frames, which can be bolted together to form a rigid assembly without the use of a rack.

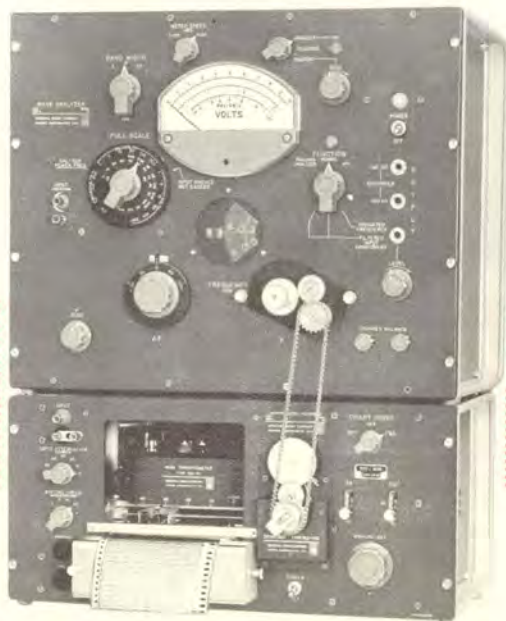

Type 1564-A SOUND AND VIBRATION ANALYZER

FEATURES:

- ♦ Wide frequency range — 2.5 cps — 25 kc.
- ♦ High input impedance — 25 megohms in parallel with 80 pf.
- ♦ High sensitivity — 0.3 millivolt full scale.
- ♦ Direct reading in either volts or, when used with microphone, in db *re* 0.0002 μ bar.
- ♦ Operates from either power line or rechargeable battery.
- ♦ Internal amplitude calibration system.
- ♦ Quasi-rms detector with three averaging times.
- ♦ Completely transistorized.
- ♦ Detent at ASA preferred frequencies can be engaged with panel control.

USES: The TYPE 1564-A Sound and Vibration Analyzer is designed primarily for measuring the amplitude and frequency of the components of complex sound and vibration spectra. Its 1/3-octave (23%) and 1/10-octave (7.1%) noise bandwidths provide the flexibility needed for analysis of both line (single frequency) and continuous spectra. The high input impedance of the analyzer permits direct connection of piezoelectric transducers for measuring sound pressures from 44 to 150 db *re* 0.0002 μ bar and acceleration from 0.0005 g to 100 g.

Automatic range switching is provided so that the TYPE 1521-A Graphic Level Recorder can record automatically the spectrum of the signal under analysis.

The analyzer can be used in conjunction with the TYPE 1390-B Random-Noise Generator for transfer and

reverberation measurements using 1/3- or 1/10-octave bands of random noise.

High sensitivity, wide amplitude and frequency ranges, and high input impedance make the TYPE 1564-A a very useful tuned voltmeter or general-purpose wave analyzer at audio and subaudio frequencies.

The TYPE 1560-P41 Audio-Frequency Voltage Probe is available for convenient connection to an electrical circuit.

DESCRIPTION: The TYPE 1564-A Sound and Vibration Analyzer consists of a high impedance preamplifier, a continuously tunable filter having a noise bandwidth of either 1/3 or 1/10 octave, an output amplifier, and an indicator. The center frequency of the filter is continuously adjustable. An all-pass, or flat, characteristic permits measurement of the over-all signal amplitude.

SPECIFICATIONS

FREQUENCY

Range: From 2.5 cps to 25 kc in four decade ranges.

Dial Calibration: Logarithmic.

Accuracy of Calibration: $\pm 2\%$ of frequency-dial setting.

Filter Characteristics: Noise bandwidth is either 1/3 octave or 1/10 octave.

One-third-octave characteristic has at least 30-db attenuation at one-half and twice the selected frequency (see plot). One-tenth-octave characteristic has at least 40-db attenuation at one-half and twice the selected frequency.

For both characteristics peak response is flat ± 1 db over the entire tuning range.

All-pass response is flat ± 1 db from 2.5 cps to 25 kc.

INPUT

Impedance: 25 megohms in parallel with 80 pf (independent of attenuator setting).

Voltage Range: 0.3 millivolt to 30 volts full scale in 10-db steps.

Microphone: TYPE 1560-P4 PZT Microphone Assembly is recommended.



1/3- and 1/10-OCTAVE BANDWIDTHS
2.5 cps to 25 kc

OPERATES FROM SOUND-LEVEL METER
OR DIRECTLY FROM MICROPHONE

This combination of the Type 1564-9820 Sound and Vibration Analyzer and the Type 1521-AR Graphic Level Recorder forms a rack-mount recording analyzer, for the automatic plotting of complete spectra. The recorder is described on page 144. Chart paper specifically designed for the sound and vibration analyzer is listed on page 145.



OUTPUT

Voltage: 1.2 volts open circuit when meter reads full scale.

Impedance: 6000 ohms. Any load can be connected.

Meter: Three scales, 0 - 3 volts; 0 - 10 volts; -6 to +10 db.

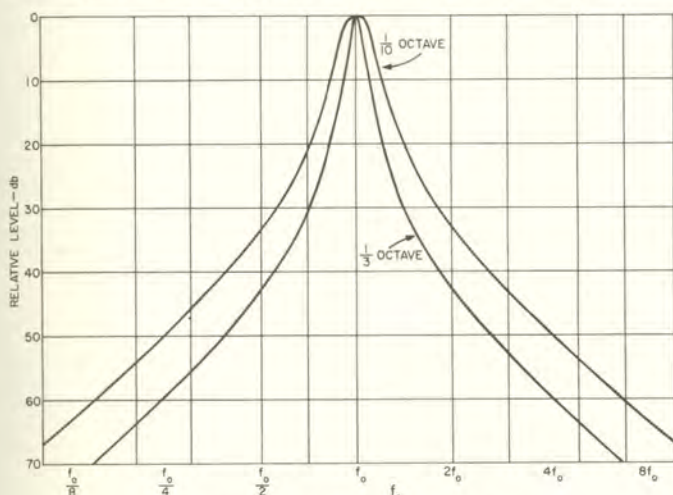

Band-pass characteristics of the analyzer.

Recording Analyzer: Automatic range switching at the end of each frequency decade allows convenient continuous recording of spectra with the TYPE 1521-A Graphic Level Recorder. See page 144 for a description of the TYPE 1521-A Recorder. Use TYPE 1521-P14 Link Unit and chart paper 1521-9493.

GENERAL

Amplitude Calibration: Built-in, feedback-type calibration system permits amplitude calibration at any frequency.

Detector: Quasi-rms with three averaging times. Fastest speed conforms with ASA standard for sound-level meters.

Power Requirements: Operates from 115 (or 230) volts, 50-60 cps, or from nickel-cadmium battery supplied. Battery provides 25 hours of operation when fully charged and requires 14 hours for charging.

Accessories Supplied: TYPE CAP-22 Power Cord, shielded cable, and TYPE 1564-2020 Detented Knob and Dial Assembly.

Accessories Available: TYPE 1560-P4 PZT Microphone Assembly for direct acoustic pickup (page 19); TYPE 1560-P52 Vibration Pickup for solid-borne vibrations (page 7); TYPE 1560-P41 Audio-Frequency Voltage Probe for voltage measurements (see below).

Cabinet: Flip-Tilt; relay-rack model also is available. (See page 210.)

Dimensions: Portable model, case closed — width 10¼, height 8⅞, depth 8 inches (260 by 210 by 205 mm), over-all; rack model — panel 19 by 10½ inches (485 by 270 mm), depth behind panel 6 inches (155 mm).

Net Weight: Portable model, 14½ pounds (7 kg); rack model, 15½ pounds (7.5 kg).

Shipping Weight: Portable model, 23 pounds (10.5 kg); rack model, 30 pounds (14 kg).

Type		Code Number	Price
1564-A	Sound and Vibration Analyzer, Portable Model	1564-9701	\$1150.00
1564-9820	Sound and Vibration Analyzer, Rack Model	1564-9820	1150.00

PATENT NOTICE. See Notes 12, 15, and 22, page viii.

TEST PROBE FOR VOLTAGE MEASUREMENT WITH THE ANALYZER

The TYPE 1560-P41 Audio-Frequency Voltage Probe consists of a 10:1 RC divider. It presents a high impedance to the circuit under test and connects to the analyzer with a 4-foot cable. It is supplied with a variety of probe tips, including plugs, to fit jack-top binding posts on ¾-inch centers.

Input Impedance: 25 megohms in parallel with 20 pf.

Net Weight: ¼ pound (115 grams).



Type		Code Number	Price
1560-P41	Audio-Frequency Voltage Probe	1560-9641	\$45.00



Type 1558 OCTAVE-BAND NOISE ANALYZER

ANALYZERS
OCTAVE-BAND

USES:

The TYPE 1558 Octave-Band Noise Analyzer is used for the rapid analysis of broadband noises, where a knowledge of individual frequency components is not required. For the measurement of octave-band sound-pressure levels above 44 db *re* 0.0002 μ bar, the analyzer can be used directly with a piezoelectric microphone. For lower levels, it can be operated from the output of the TYPE 1551-C Sound-Level Meter.

It is particularly useful for:

- Measurement of aircraft, vehicle, and machinery noise.
- Measurement of environmental noise, as in offices and factories, where speech-interference level is important.
- Studies of environmental noise as related to hearing damage.
- Production testing and noise-level acceptance tests.
- Loudness determinations.
- Acoustical studies of rooms and materials.

DESCRIPTION: Two models of the octave-band noise analyzer are available. The TYPE 1558-A has bands as specified by the ASA Standard for Octave-Band Filters, Z 24.10-1953. In the TYPE 1558-AP, the bands are centered at the ASA Preferred Frequencies for Acoustical Measurements, ASA S 1.6-1960.* In addition, the -A model has band-pass filters that extend the range at both ends beyond the range specified in the standard.

Essentially, the analyzer consists of a high-impedance preamplifier, a filter, an output amplifier, and a meter. The preamplifier frequency response can be set to be either flat or c-weighted. A built-in reference allows calibration for microphones ranging in sensitivity from -52 to -62 db *re* 1 volt/ μ bar. RC active filters are used, resulting in small size, light weight, and lack of interference from stray magnetic fields. The high input impedance and preamplification permit the use of piezoelectric microphones and vibration pickups. The analyzer is portable and powered by rechargeable nickel-cadmium batteries.

FEATURES:

- Small, compact, and portable — weighs less than 9 pounds.
- Measures level in 10 octave bands.
- Direct use with piezoelectric microphones for levels in the range from 44 to 150 db.
- Uses rechargeable nickel-cadmium battery.
- Fully transistorized.
- Internal calibration system.
- Quasi-rms meter; indication is essentially rms for all waveforms except short impact pulses.
- Load impedance has no effect on meter indication.
- c or 20-ke preamplifier weighting can be selected by means of an internal switch.

ACCESSORY MICROPHONE

The TYPE 1560-P4 PZT Microphone Assembly consists of a TYPE 1560-P3 ceramic microphone unit attached to a short length of flexible conduit, which in turn mounts on a swivel base. The assembly plugs into the MIKE input connector on the panel of the octave-band analyzer.

It has a flat response to sounds of random incidence from 20 cps to 8 kc. It will withstand temperatures from -30 to 200 F and relative humidity from 0 to 100%. It shows little change in sensitivity and internal impedance with temperature. See also page 5.

* Also specified by ISO Recommendation 402 and German Standard DIN45-401.

SPECIFICATIONS

Filter Characteristics†: Level at center frequency in bands from 37.5 to 9600 cps is uniform within 1 db. Maximum deviation from ALL PASS level at center frequency in any band is 1 db. For bands from 37.5 to 9600 response at nominal cutoff frequency is (3.5 ± 1) db below response at center frequency. Attenuation is at least 30 db at

† Measured with signal applied at INPUT(SLM) terminals.

one-half the lower nominal cutoff frequency and twice the upper nominal cutoff frequency for all octave bands. Attenuation is at least 50 db at one-fourth the lower nominal cutoff frequency and four times the upper nominal cutoff frequency for all octave bands. The 75-cycle low-pass filter has at least 30-db attenuation at 200 cps and at least 50-db attenuation at 400 cps.

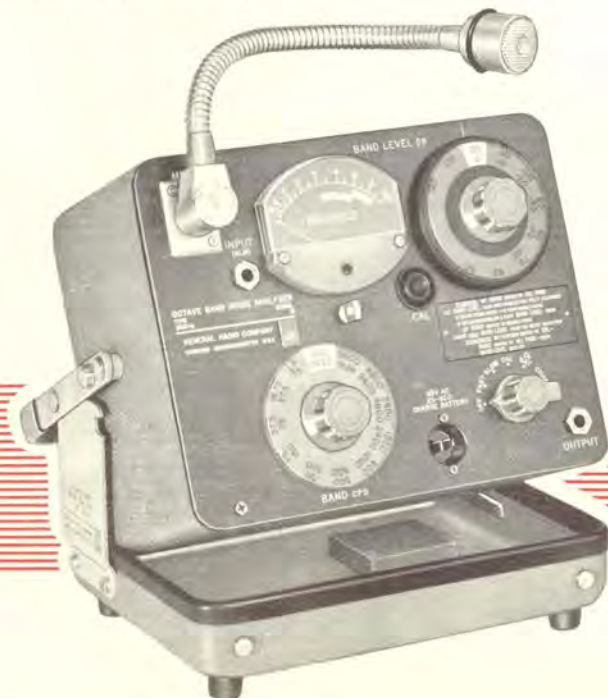

The Type 1558-A Octave-Band Noise Analyzer with the Type 1560-P4 PZT Microphone Assembly.

Bands:	Type 1558-A	
Lower Cutoff Frequency — cps	Upper Cutoff Frequency — cps	Center Frequency* cps
18.75	37.5	26.5†
37.5	75.0	53.0†
75.0	150	106
150	300	212
300	600	424
600	1200	849
1200	2400	1700
2400	4800	3390
4800	9600	6790
9600	19,200	13,590†
LP	75	

ALL PASS

* Geometric mean.

† These bands are not required by Z24.10.

FOR TYPE 1558-AP, center frequencies are 31.5, 63, 125, 250, 500, 1000, 2000, 4000, 8000, 16,000.

Sound-Pressure Level Range: 44 to 150 db above 0.0002 μ bar in any band when TYPE 1560-P4 PZT Microphone Assembly is used.

Input: Impedance at MIKE terminals is approximately 50 pf in parallel with 50 megohms. It is intended for use with high-impedance transducers such as the TYPE 1560-P4 PZT Microphone Assembly.

Impedance at INPUT (SLM) terminals is approximately 100 kilohms. Maximum input is 3 volts. Low-input terminal is connected to case. This input is intended for connection to the output of a sound-level meter.

Preamplifier Frequency Characteristic: Can be set to be either c weighting, which is specified by the American Standards Association (ASA S1.4-1961 SLM), or 20 kc, an essentially flat response.

Output: Open-circuit output is at least 1 volt for full-scale meter indication. Output impedance is 6000 ohms. Any load can be connected across the output terminals.

Meter Response: FAST or SLOW meter response is selected by panel control. These characteristics are as specified in the American Standard Specifications for General Purpose Sound Level Meters, ASA S1.4-1961. Meter indication is closely rms for most waveforms.

Internal Calibration: A built-in reference allows the gain of the analyzer to be calibrated for use with piezoelectric microphones having sensi-



Relay-rack model, Type 1558-9820 (or Type 1558-9822), is adapted from portable model; see page 210.

tivities from -52 to -62 db re 1 volt/ μ bar. The absolute accuracy for ALL PASS is then within 1 db over a wide range of atmospheric conditions.

Batteries: Two 9.6-volt rechargeable nickel-cadmium batteries (Gould Type 9.6V/450B) give 30 hours operation. They are recharged by connection to a 115-volt (or 230-volt), 25- to 60-cycle power line. Full charge takes about 14 hours.

Accessories Supplied: Carrying strap, power cord for charging battery, shielded cable assembly for connection to sound-level meter.

Accessories Available: TYPE 1560-P4 PZT Microphone Assembly.

Cabinet: Flip-Tilt; relay-rack models also are available. (See page 210.)

Dimensions: Portable model — width 10 $\frac{1}{4}$, height 9 $\frac{1}{4}$, depth 7 $\frac{1}{4}$ inches (260 by 235 by 185 mm), over-all, including handle; rack model — panel 19 by 8 $\frac{3}{4}$ inches (485 by 225 mm); depth behind panel 5 inches (130 mm).

Net Weight: Portable models, 8 $\frac{3}{4}$ pounds (4 kg); rack models, 9 pounds (4.1 kg).

Shipping Weight: Portable models, 17 $\frac{3}{4}$ pounds (8.1 kg); rack models, 24 pounds (11 kg).

Type		Code Number	Price
1558-A	Octave-Band Noise Analyzer (ASA Standard), Portable Model	1558-9701	\$770.00
1558-9820	Octave-Band Noise Analyzer (ASA Standard), Rack Model	1558-9820	770.00
1558-AP	Octave-Band Noise Analyzer (ASA Preferred Frequencies), Portable Model	1558-9829	770.00
1558-9822	Octave-Band Noise Analyzer (ASA Preferred Frequencies), Rack Model	1558-9822	770.00
1560-P4	PZT Microphone Assembly	1560-9604	80.00

PATENT NOTICE. See Note 12, page viii.

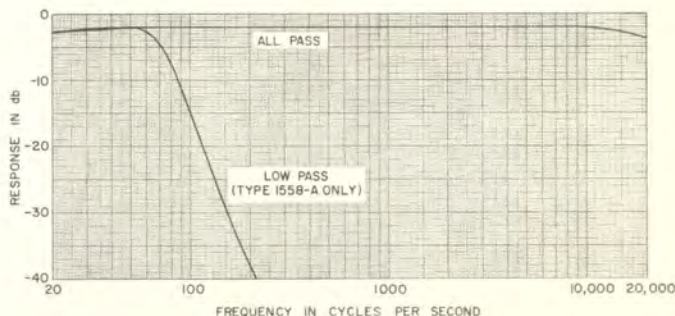
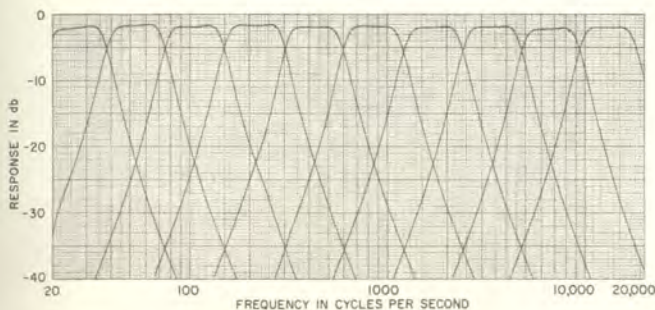

(Left) Filter characteristics of the Type 1558-A. The Type 1558-AP characteristics are similar, except that the center frequencies are changed, as specified in the data above. (Right) Lowpass and allpass characteristics of the Type 1558.



Type 1556-B IMPACT-NOISE ANALYZER

ANALYZERS
IMPACT NOISE

This device measures the characteristics of impact-type sounds and electrical noise impulses, which cannot be satisfactorily measured with conventional noise-measuring equipment.

IMPACT NOISES

include those produced by punch presses, forging hammers, fire alarms, pile drivers, office machinery, and similar equipment. From the standpoint of hearing damage, some of these sounds constitute a serious problem for industry. They have hitherto been measurable only by complicated methods employing oscilloscopes.

The two characteristics of impact sounds that seem most significant are the peak amplitude and the duration, or decay time. This analyzer measures both of these quantities and also a quasi-peak value that is useful in determining the variation among repetitive peak values.

Peak value is the maximum sound-pressure level reached by the noise; quasi-peak is a continuously indicating measure of the high sound-pressure levels reached just before the time of indication; time-average is a measure of the average level over a predetermined period of time, which, when subtracted from peak level, is a measure of the time duration of the sound.

For these applications, the TYPE 1556-B Impact-Noise Analyzer operates from the output of a TYPE 1551 Sound-Level Meter and, when a vibration pickup is used in place of the microphone on the sound-level meter, will measure

vibration impacts. It will also operate from octave-band analyzers, tape recorders, and vibration meters.

ELECTRICAL NOISE PEAKS

in a wire communication circuit can be measured with this instrument as one of the tests to determine the adequacy of the circuit for transmitting data pulses to and from computers and other business machines. In such measurements, many peaks may be measured in a short time, and, after each peak, the stored signal must be erased before the next pulse occurs. To facilitate this, to reduce operator fatigue, and to minimize acoustic noise from the switching process, a RESET pushbutton is provided, which can also be operated by an ordinary camera cable release.

CIRCUIT

A battery-operated, degenerative, transistor amplifier simultaneously drives three ac voltmeter circuits, which comprise rectifiers, storage capacitors, and a dc electronic voltmeter. The electrical storage system (a capacitor charged by a rectifier) makes it possible to measure three characteristics — peak, quasi-peak, and time-average — of an impulse with a single indicating meter.

SPECIFICATIONS

Input: Any voltage from 1 to 10 volts for normal range. Inputs below 1 volt reduce the range of reading.

Input Impedance: Between 25,000 and 100,000 ohms, depending on the setting of the LEVEL control.

Frequency Range: 5 cps to 20 kc.

Level Indication: Meter calibrated in db from -10 to +10. Attenuator switch increases range by 10 db.

Peak Reading: Rise time is less than 50 microseconds for a value within 1 db of peak value (for rectangular pulses). Storage time at normal room temperature is greater than 10 seconds for a 1-db change in value.

Quasi-Peak Reading: Rise time of less than 1/4 millisecond and decay time of 600 ± 120 milliseconds for rectifier circuit.

Time-Average Reading: Charge time of rectifier circuit selected by seven-position switch, having times of 0.002, 0.005, 0.01, 0.02, 0.05, 0.1, and 0.2 second for the resistance-capacitance time constant. Storage time at normal room temperature is greater than 1 minute for a 1-db change in value.

Accessories Required: A sound-level meter or frequency analyzer to supply the analyzer input if it is to be used for acoustical measurements.

Input Terminals: Cord with phone plug at one end.

Batteries: One 1 1/2-volt size D flashlight cell (Rayovac 2LP or equivalent) and one 45-volt B battery (Burgess XX30 or equivalent) are supplied. Typical battery life is 100 hours.

Cabinet: Aluminum; carrying case supplied. Cabinet can be fastened directly to one end of a TYPE 1551 Sound-Level Meter.



The Type 1556-B Impact-Noise Analyzer with the Type 1551-C Sound-Level Meter.

Dimensions: Width 7 1/2, height 6 1/2, depth 4 1/4 inches (190 by 170 by 110 mm), over-all.

Net Weight: 4 1/2 pounds (2.1 kg); carrying case, 1 pound (0.5 kg).

Shipping Weight: 7 1/4 pounds (3.3 kg), in case.

Type	Code Number	Price
1556-B Impact-Noise Analyzer	1556-9702	\$240.00

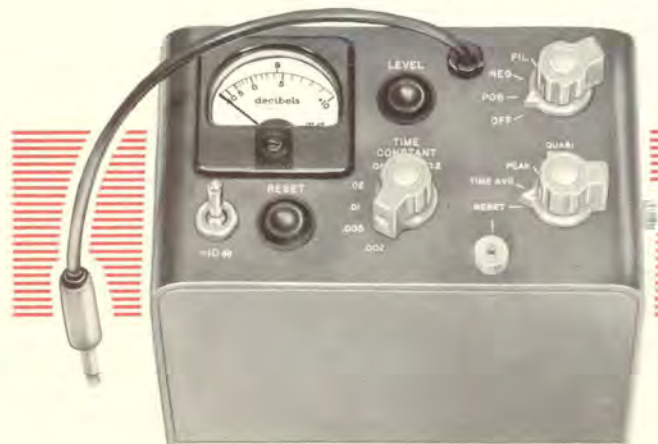

MEASURES BOTH ELECTRICAL AND ACOUSTICAL NOISE PEAKS



Type 1932-A DISTORTION AND NOISE METER

USES:

The TYPE 1932-A Distortion and Noise Meter measures distortion, noise, and hum level in audio-frequency circuits. In conjunction with the TYPE 1931-B Modulation Monitor*, it can be used to measure these quantities in the output of radio broadcasting transmitters.

It finds many uses in the electronics laboratory and in the production testing of radio receivers as a wide-range, highly sensitive voltmeter for such measurements as signal-to-noise ratio, AVC characteristics, and hum level. With the aid of an oscilloscope, individual hum and distortion components can be identified.

DESCRIPTION: The principal elements of the unit are a high-gain amplifier with an RC interstage coupling unit that balances to a sharp null, a calibrated attenuator for adjusting the sensitivity, and a vacuum-tube voltmeter. Degeneration maintains stability in amplifier gain and a flat transmission characteristic, except within an octave of the null frequency. The null frequency is continuously variable. The null network eliminates the fundamental of the audio-frequency signal, leaving only the distortion

products, which are indicated directly on the panel meter.

The null network is switched out of the circuit for noise and hum measurements, and the instrument then operates as a highly sensitive voltmeter. Two input circuits are provided: (1) a transformer for bridging a 600-ohm line; and (2) a direct connection to the 100,000-ohm gain control.

FEATURES:

- ◆ Continuous adjustment of frequency over the entire audio range is provided.
- ◆ Quick frequency selection.
- ◆ Frequencies up to 55,000 cps are passed by the amplifier circuits, so that distortion measurements can be made on fundamental frequencies up to 18,000 cps.
- ◆ Distortion as low as 0.1% can be measured.

* Price and specifications on request.

SPECIFICATIONS

RANGES OF MEASUREMENT

Distortion: Full-scale deflection for 0.3%, 1%, 3%, 10%, or 30% distortion.

Frequency: 50 to 18,000 cps fundamental; with bridging-transformer input, harmonics up to 30 kc; with 100,000-ohm input, harmonics up to 55 kc.

Noise: 80 db below reference calibration level, or 80 db below an audio-frequency signal of zero dbm level, at maximum sensitivity.

ACCURACY

Distortion: ±5% of full scale, ± residual distortion, where distortion is defined as the ratio of harmonics-plus-noise to total input signal.

Noise, dbm: ±5% of full scale for specified bandwidths.

Residual Distortion and Hum Level: 50 to 150 cps, 0.07%. 150 to 5000 cps, 0.02%. 5000 to 18,000 cps, 0.10%.†

Residual Noise Level: At least 80 db down.

INPUT

Impedance: 100,000 ohms, unbalanced, and 600-ohm bridging input (10,000 ohms), balanced or unbalanced.

GENERAL

Meter: Scale is calibrated in percentage and db. The ballistic characteristic is similar to that of a VU meter.

†Can be reduced to 0.02% by use of low-level calibration techniques.

Accessories Supplied: TYPE CAP-22 Power Cord, cable for connecting to the TYPE 1931-B Modulation Monitor, spare fuses.

Other Accessories Required: For measuring the distortion in oscillators and other audio-frequency sources, no additional equipment is required. For measurements on amplifiers, lines, and other communications networks, a low-distortion oscillator is required. When the modulated output of a radio transmitter is to be measured, a linear demodulator having minimum undistorted output of 1.5 volts rms can be used.

Terminals: Terminals are provided at the rear for permanent wiring connections. A Western Electric jack is provided at the panel also, as an auxiliary input circuit. Plugging into this jack automatically disconnects the rear connectors.

Power Requirements: 105 to 125 (or 210 to 250) volts, 50 to 60 cps. The line input power is 65 watts.

Mounting: Relay-rack panel. End frames are available for bench use. (See price list below.)

Panel Finishes: Standard General Radio gray crackle. Certain standard finishes which can be processed in quantity can be supplied.

Dimensions: Width 19, height 7, depth 13 inches (485 by 180 by 330 mm) over-all; depth behind panel, 12 inches (305 mm).

Net Weight: 35½ pounds (16.5 kg).

Shipping Weight: 41 pounds (19 kg).

Type		Code Number	Price
1932-A	Distortion and Noise Meter Aluminum End Frames	1932-9701	\$795.00
FRI-412-2		5310-9478	15.00 Pair

FOR DISTORTION AND NOISE-LEVEL MEASUREMENTS ON AUDIO EQUIPMENT AND CIRCUITS



AMPLIFIERS

The two amplifiers listed in this section are broadband instruments, adaptable to a variety of applications encountered in the electronics laboratory. The TYPE 1206-B Unit Amplifier, with 3 watts output, covers audio, sub-audio, and ultrasonic frequencies. The TYPE 1233-A Power Amplifier, a 15-watt instrument, operates well up into the rf range.

Other amplifiers, with many applications in addition to those for which they are primarily designed, are listed in other sections of the catalog. Among them are:



Type 1206-B UNIT AMPLIFIER

This well-designed, high-quality, compact amplifier delivers 3 watts at audio and ultrasonic frequencies. It has many uses in the laboratory — as a bridge amplifier, as a driver for low-power electronic and electro-acoustical devices, and as an amplifier for use with the TYPE 1210-C Unit R-C Oscillator. Single-ended, push-pull circuit* produces excellent low-frequency response.

* Arnold Peterson and Donald B. Sinclair, "A Single-Ended Push-Pull Audio Amplifier," *Proceedings of the Institute of Radio Engineers*, January 1952.

INPUT

Voltage: Less than 1 volt for full power output.

Impedance: 100,000 ohms in parallel with 35 pf.

OUTPUT

Power: With 300-volt plate supply, 600-ohm load: 3 watts from 10 cps to 50 kc; 1.5 watts from 5 cps to 100 kc; 0.5 watt at 250 kc.

Load Impedance: 600 ohms optimum. Blocking capacitor is 100 μ f. (Internal impedance about 100 ohms.)

Distortion: Less than 1% harmonic distortion with 2 watts output (2% with 3 watts) into 600 ohms from 20 cps to 40 kc.

AC Hum in Output: Less than 15 millivolts, rms, with TYPE 1203-B Unit Power Supply; less than 3 millivolts, rms, with TYPE 1201-B Unit Regulated Power Supply.

GENERAL

Voltage Gain: Continuously adjustable. Maximum gain is 50 to 1 (34 db), with no load; 42.5 to 1 (32.6 db) into 600 ohms.

Frequency Response: (See curve above.) Down less than 3 db at 2 cps and 500 kc at 10 volts (or less) output, with gain control set at maximum. See also power output specification.

Power Requirements: 6.3 volts, 2.7 amperes; 300 volts, 50 milliamperes. TYPE 1203-B Unit Power Supply or TYPE 1201-B Unit Regulated

Tuned Amplifier, TYPE 1232-A, page 79, is a selective amplifier, tunable continuously from 20 cps to 20 kc, and at 50 kc and 100 kc; it also has a broadband characteristic, 20 cps to 100 kc.

DC Amplifier, TYPE 1230-A, page 140, amplifies weak voltages and currents to operate a recorder.

High-gain Logarithmic Amplifier, TYPE 1551-C Sound-Level Meter, page 4, has a full-scale sensitivity of 20 microvolts and a range of 126 db.

See also the section on DETECTORS, page 78.

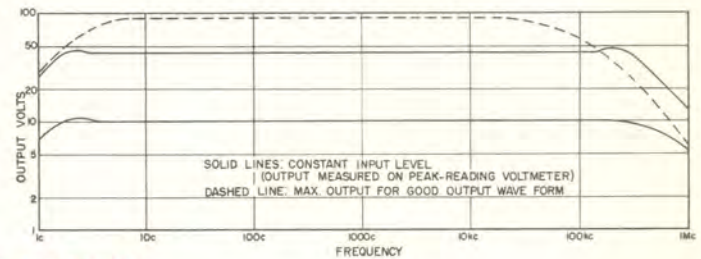

SPECIFICATIONS

Power Supply is recommended. The amplifier plugs directly into a Unit Power Supply (page 173). It can be rigidly attached, with locking strips supplied, to form a complete assembly. The combination will operate satisfactorily from a 400-cycle supply.

Pulse Response:	NO LOAD	600 Ω
Drop in 30-cycle square wave	15%	20%
Approx rise time: 50 v peak-to-peak	1 μ sec	2 μ sec
100 v peak-to-peak	2 μ sec	4 μ sec
Max output, peak-to-peak magnitude	260 v	120 v

Accessories Supplied: Two multipoint connectors.

Terminals: Jack-top binding posts with $\frac{3}{4}$ -inch spacing.

Cabinet: Unit Instrument (see page 210).

Dimensions: Width 10 $\frac{1}{4}$, height 5 $\frac{3}{4}$, depth 6 $\frac{1}{4}$ inches (260 by 145 by 160 mm), over-all. As shown here, including power supply, 15 by 5 $\frac{3}{4}$ by 6 $\frac{1}{4}$ inches (380 by 145 by 160 mm), over-all. Relay-rack adaptor set listed below mounts both instrument and power supply (panel 19 by 7 inches).

Net Weight: 4 pounds (1.9 kg).

Shipping Weight: 14 pounds (6.5 kg).

Type		Code Number	Price
1206-B	Unit Amplifier	1206-9702	\$95.00
1203-B	Unit Power Supply (for 115-volt line)	1203-9702	55.00
480-P4U3	Relay-Rack Adaptor Panel (for Amplifier and Power Supply)	0480-9986	12.00

PATENT NOTICE. See Notes 5, 9, and 14, page viii.



Type 1206-B Unit Amplifier
with Type 1203-B Unit Power
Supply.



Type 1233-A POWER AMPLIFIER

AMPLIFIERS
POWER AND RF

USES: The wide frequency range and high power output of this amplifier make it adaptable to many uses in electronic and electro-acoustical laboratories. Typical uses are:
♦ Exciting antennas for radiation-pattern and impedance measurements.

- ♦ Driving acoustical generators.
- ♦ Amplifying received signals for operating remote modulation and frequency monitors.
- ♦ Amplifying weak signals for oscilloscope deflection.

DESCRIPTION: The excellent frequency response of this amplifier is obtained in three push-pull, broadband circuits with series-peaked interstage couplings. The two power ranges use toroidal output transformers; the voltage-amplification range uses a series-peaked video-output network with gradual roll-off above 3 Mc. Ranges are selected by panel switch. Meter reads output volts and can be switched to read plate current of output tubes.



Output pulse waveforms 20-cps to 3-Mc range; input-pulse rise time, 0.03 μ sec; three pulse lengths shown.

SPECIFICATIONS

Input Voltage: Less than 0.2 volt for full output.
Input Impedance: 100,000 ohms in parallel with 37 pf (grounded).
Power Requirements: 105 to 125 (or 210 to 250) volts, 40 to 60 cps; 120 watts at zero output; 140 watts maximum.
 Instrument will operate with a maximum output of 10 watts on power-supply frequencies up to 400 cps.
Voltmeter: Full-wave-average type; 150, 50, and 15 volts, full scale; accuracy $\pm 10\%$, compensated to 3 Mc.
Terminals: Input and output, TYPE 874 Coaxial Connectors with

ground post for double-plug connection; TYPE 938 Binding Posts for balanced output.
Accessories Supplied: Two TYPE 274-MB Double Plugs, two TYPE 874-C58A Cable Connectors, TYPE CAP-22 Power Cord, spare fuses.
Cabinet: Relay-rack panel with end frames supplied for bench use.
Dimensions: Width 19 $\frac{1}{2}$, height 7 $\frac{1}{2}$, depth 15 $\frac{1}{2}$ inches (495 by 190 by 395 mm) over-all.
Net Weight: 46 $\frac{1}{2}$ pounds (21.5 kg).
Shipping Weight: 56 pounds (26 kg).

Range Switch Position	Operating Freq Range	Power*	Output Voltage	Optimum Load Impedance	Rise Time	Distortion at Rated Output	Noise Level
20 c to 20 kc	20 cps — 20 kc 50 cps — 15 kc	8 watts 15 watts	150 volts, peak-to-peak, bal; 50 volts grounded	600 or 150 Ω	0.1 μ sec.	4%	60 db below 15 watts or equivalent to 200 μ v input.
20 kc to 1.5 Mc	20 kc — 1.5 Mc 20 kc — 0.5 Mc	8 watts 15 watts		50 Ω grounded		4%	70 db below 15 watts or equivalent to 63 μ v input.
20 c to 3 Mc	20 cps — 3 Mc			CRO deflection plates; 1 M Ω , 36" leads		4%	Less than 0.6 v, peak-to- peak, bal, or equivalent to 600 μ v peak-to-peak input.

Disconnected Any single frequency, 20 cps to 5 Mc; 15 watts, with external tuned output transformer

* Rated output is obtainable at 105-volt line; output is greater for higher line voltages.

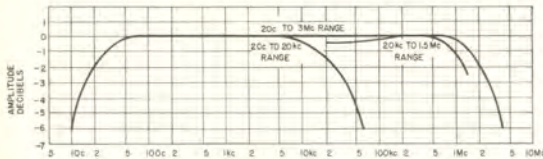

Typical response curves for the three amplifier ranges. The 20-cps to 3-Mc range is given a smooth roll-off at the high end to assure good transient response.

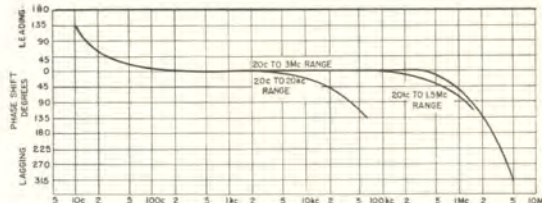

Phase shift versus frequency for Type 1233-A Power Amplifier.

Type	Code Number	Price
1233-A Power Amplifier	1233-9701	\$690.00

PATENT NOTICE. See Note 4, page viii.

- 20 cps to 20 kc
- 20 kc to 1.5 Mc
- 20 cps to 3 Mc



ATTENUATORS

Calibrated attenuators are basic instruments for measurement of voltage ratios, linearity, circuit gain or loss, transmission efficiency, and for the calibration of meters and other measuring devices. Described in this

section are resistive decade attenuators and precise voltage dividers, and also an audio-frequency Microvoltage* for use with an audio oscillator to standardize low output voltages.



Type 546-C AUDIO-FREQUENCY MICROVOLTAGE

FEATURES:

- ◆ An excellent frequency characteristic, extending from very low frequencies up to 100,000 cps. Converts an audio oscillator to an audio signal generator.
- ◆ Excellent accuracy for absolute voltage levels as well as for voltage ratios in gain or loss measurements.
- ◆ Both decibel and voltage scales are provided.

DESCRIPTION: This instrument consists, essentially, of a constant-impedance attenuator and a voltmeter which standardizes the input to the attenuator. A switch controls the output voltage in decade steps, while an individually calibrated dial provides continuous control over each decade.

USE: The TYPE 546-C Audio-Frequency Microvoltage used in conjunction with an oscillator is a useful source of small, known audio-frequency voltages for response measurements of amplifiers, transformers, and other audio equipment. The Microvoltage can also be used to measure small voltages by substitution methods.

SPECIFICATIONS

Output-Voltage Range: From 0.5 microvolt to 1.0 volt open circuit, when the input voltage is set to the standardized reference value (2.2 volts).

Accuracy: For open-circuit output voltages the calibration is accurate within $\pm(3\% + 0.5 \text{ microvolt})$ for output settings above 1 microvolt and for all frequencies between 20 and 20,000 cps. For higher frequencies up to 100 kc the calibration is accurate within $\pm 5\%$ for output settings above 100 microvolts. These specifications apply only where waveform and temperature errors are negligible (see below).

For the determination of ratios of output voltages at a given frequency, the accuracy of any given reading can be assumed to be within $\pm(2\% + 0.5 \text{ microvolt})$, at frequencies up to 100,000 cps. At frequencies above 20 kc this accuracy applies only at levels above 100 microvolts.

The microvoltage can be used on dc with an external dc meter. Internal meter can be calibrated for dc.

Output Impedance: Approximately 600 ohms, constant with setting within $\pm 5\%$. No correction of the output voltage is necessary for load impedances of the order of 100,000 ohms and greater.

Input Impedance: Approximately 600 ohms, substantially independent of output setting on all but the highest multiplier position.

Waveform Error: When this instrument is used as a calibrated attenuator or voltage divider, its accuracy is independent of waveform. Absolute accuracy of the output-voltage calibration depends on the characteristics of the input copper-oxide rectifier voltmeter, which has a small waveform error that depends on both the phase and the magnitude of harmonics in the input. This error in the voltmeter can, in general, be neglected when the microvoltage is used with ordinary

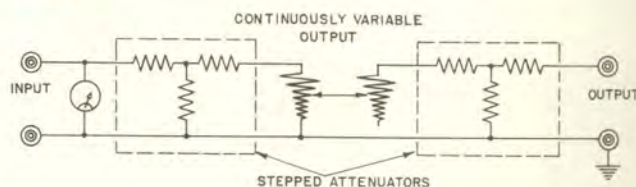

laboratory oscillators. The rectifier-type voltmeter itself introduces some distortion unless the source impedance is very low. With a 600-ohm source the distortion introduced is about 0.2%.

Temperature Error: Accuracy of the calibration is independent of temperature when the microvoltage is used as an attenuator or voltage divider. Absolute accuracy is affected slightly by temperature because of change in the voltmeter characteristics. The necessary correction for temperatures from 65 to 95 F is furnished with the instrument. The effects of humidity are negligible.

Input Requirements: About 2.2 volts across 600 ohms, or approximately 8 milliwatts.

Terminals: Jack-top binding posts are mounted on standard $\frac{3}{4}$ -inch spacing.

Cabinet: Lab bench (see page 210).

Dimensions: Width 10, height $7\frac{1}{4}$, depth $6\frac{1}{4}$ inches (255 by 185 by 160 mm), over-all.

Net Weight: $6\frac{1}{2}$ pounds (3 kg).

Shipping Weight: 13 pounds (6 kg).

Type	Code Number	Price
546-C	0546-9703	\$180.00

Audio-Frequency Microvoltage*

* Reg. U.S. Pat. Off.

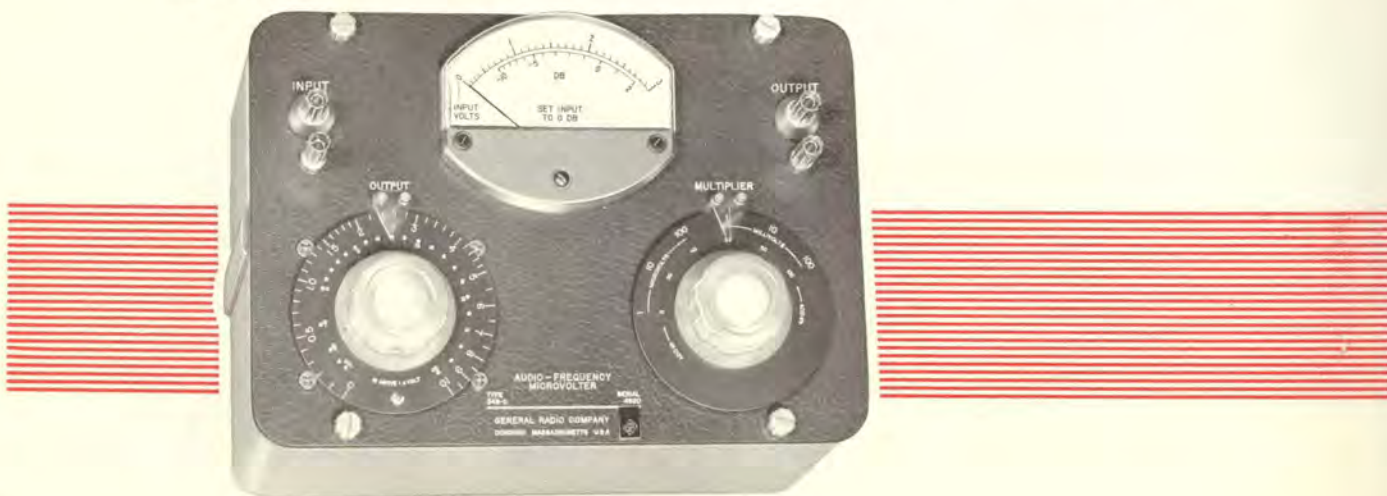



Type 1450 PRECISION DECADE ATTENUATOR

FEATURES:

- ♦ Wide range of attenuation values in small steps.
- ♦ Accuracy is maintained even at low radio frequencies.
- ♦ Convenient, decade-type switches are arranged for break-before-make operation to prevent "blasting" and meter damage. They can be adjusted for make-before-break operation if requested at time of ordering.
- ♦ An etched plate is attached to the case, indicating mismatch loss for terminations other than 600 ohms.

USES: The Type 1450 Decade Attenuator is useful in power-level measurements, transmission-efficiency tests, and in gain or loss measurements on transistors, filters, amplifiers, and similar equipment. It can also be used as a power-level control in circuits not equipped with other volume controls.

DESCRIPTION: The resistors used in each decade are mounted in compartments in an aluminum housing, which is completely shielded by the addition of aluminum covers.

SPECIFICATIONS

Attenuation Range: 110 or 111 decibels in steps of 1 or 0.1 decibel, respectively.

Terminal Impedance: 600 ohms in either direction. An etched plate on the cabinet indicates the mismatch loss for other than 600-ohm circuits.

Accuracy: Each individual resistor is adjusted within $\pm 0.25\%$ of its correct value. The low-frequency error in attenuation is less than ± 0.02 db $\pm 0.25\%$ of indicated db setting plus a switch-resistance error of 0.003 db (for -TA) or 0.005 db (for -TB), when the attenuator is terminated at both ends in a pure resistance of 600 ohms. For differences in attenuation between any two settings, the switch-resistance error virtually disappears. To maintain accuracy at high attenuations, special wiring methods are employed to the "low" INPUT post.

Frequency Discrimination (with low terminal at panel potential): Less than 0.1 db $\pm 1\%$ of the indicated value at frequencies below 200 kc. For increments in attenuation, the 1% tolerance extends to approximately 1 Mc.

Maximum Input Power: 1 watt.

Switches: Cam-type switches are used with twelve positions covering 360°. The dials are numbered from 0 to 10 inclusive, and the twelfth point is also connected to 0. Stops are provided in the switch mechanism for the 100-db decade. No stops are provided to prevent com-

plete rotation of the 10- and 1-db decades, but spacers, which are provided, can be used under the mounting screws to act as stops for the knob, if desired.

Characteristic Impedance: 600 ohms both directions. One end must be terminated in 600 ohms.

Terminals: Jack-top binding posts with $\frac{3}{4}$ -inch spacing; common terminal insulated from chassis; ground terminal provided.

Cabinet: Lab bench (see page 210). Each decade is individually shielded, and all shields are connected to the panel, to which the "G" post is also connected. Both "high" and "low" sides are connected to insulated binding posts, the "low" ones being connected together. The user is thus given free choice of grounding point for the "low" side, including connection to the panel post by the link provided. Relay rack mounting is available on special order at an additional charge (see below).

Dimensions: TYPE 1450-TA—width 10, height 5 $\frac{3}{4}$, depth 12 $\frac{1}{4}$ inches (255 by 145 by 315 mm) over-all; TYPE 1450-TB—width 12, height 5 $\frac{3}{4}$, depth 12 $\frac{1}{4}$ inches (305 by 145 by 315 mm), over-all.

Net Weight: TYPE 1450-TA, 10 $\frac{3}{4}$ pounds (4.9 kg); TYPE 1450-TB, 14 $\frac{1}{2}$ pounds (7 kg).

Shipping Weight: TYPE 1450-TA, 18 pounds (8.5 kg); TYPE 1450-TB, 23 pounds (10.5 kg).

Type	Range	Impedance	Type of Section	Code Number	Price
1450-TA	110 db in steps of 1 db	600 ohms	T	1450-9891	\$285.00
1450-TB	111 db in steps of 0.1 db	600 ohms	T	1450-9893	390.00

For 19-inch relay-rack mounting add \$10.00 to price and add R to type number (TYPE 1450-TAR, -TBR).



Type 1450-TB

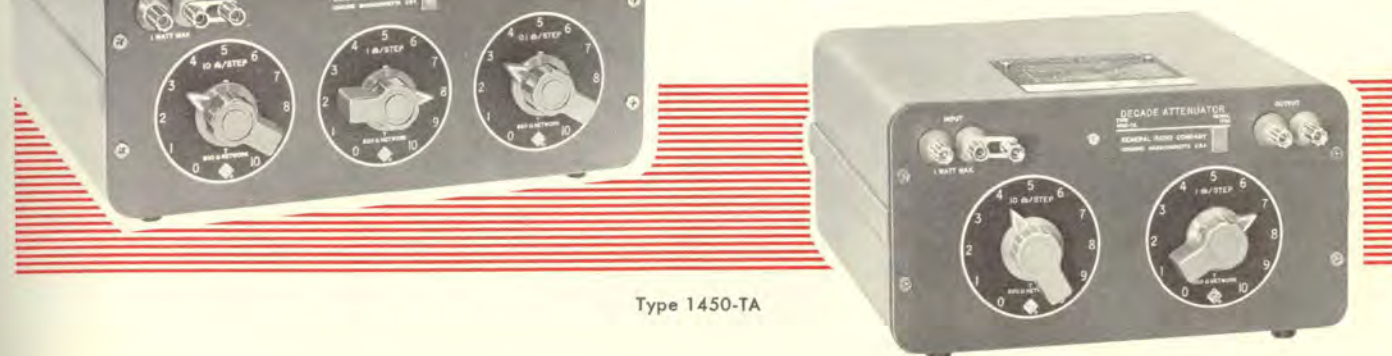

Type 1450-TA



Type 1454 DECADE VOLTAGE DIVIDER

ATTENUATORS
VOLTAGE DIVIDER

FEATURES:

- ◆ Two models, 10,000 ohms and 100,000 ohms.
- ◆ High accuracy, 0.04% of indicated ratio.
- ◆ Constant input resistance.
- ◆ Low thermal emf. ◆ Complete shielding.

USES: The TYPE 1454 Decade Voltage Divider provides accurately known voltage ratios from 0.0001 to 1.0000 for use in determining voltage transmission ratios by direct comparison or by null methods.

They are particularly valuable in linearity measurements and meter calibration.

Their high input impedance, high resolution, and high accuracy make them widely used laboratory accessories

for both dc and audio-frequency measurements.

DESCRIPTION: Four decade resistors of the 510-type are connected in a Kelvin-Varley circuit. The voltage drop in switches and wiring is compensated by a resistor so that accuracy is maintained down to the lowest settings. The case provides an electrostatic shield, to which the separate ground terminal is connected. The divider circuit can be used either grounded or floating, as desired.

SPECIFICATIONS

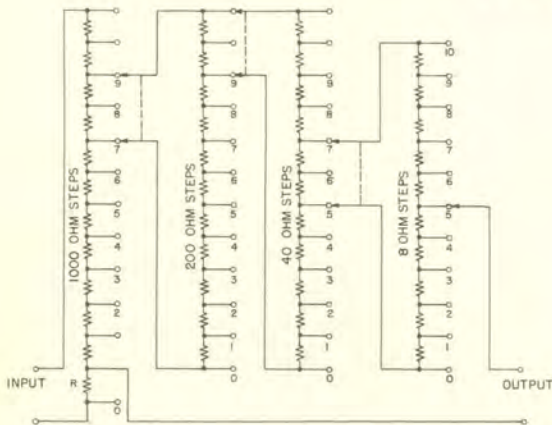

Voltage Ratio: 0.0001 to 1.0000 in steps of 0.0001.

Accuracy: $\pm 0.04\%$ of indicated ratio for input voltages below 120 volts on the 10,000-ohm model, TYPE 1454-A, and below 350 volts on the 100,000-ohm model, TYPE 1454-AH.

Linearity: Better than $\pm 0.02\%$ of full-scale setting for any decade.

Frequency Characteristics: If the external capacitance across the output terminals of the TYPE 1454-A is less than 50 pf, the frequency error is less than 0.1% to 20 kc for any setting. For the TYPE 1454-AH, the frequency limit is 2 kc for the same capacitance.

Input Resistance: TYPE 1454-A, 10,000 ohms. TYPE 1454-AH, 100,000 ohms.

Maximum Input Voltage: For TYPE 1454-A, 230 volts rms (or dc) for 40 C rise of resistors of the input decade. Input voltage should be limited to 120 for maximum accuracy. At maximum rated voltage the total error can approach $\pm 0.1\%$. For TYPE 1454-AH, 700 volts rms, limited to 350 volts for maximum accuracy.

Resistance Units: TYPE 510 Decade Resistors.

Temperature Coefficient: Of each resistor, less than $\pm 0.002\%$ per degree C. Since the voltage ratios are determined by resistors of similar construction, ambient temperature effects are very small.

Terminals: Jack-top binding posts with standard $\frac{3}{4}$ -inch spacing at input and output. A separate ground post is provided, so that the divider circuit can be used grounded or ungrounded, with the shield grounded.

Output Resistance: Varies with output setting, from zero to approximately 2700 ohms for the TYPE 1454-A, from zero to approximately 27,000 ohms for the TYPE 1454-AH, depending primarily on the setting of the highest decade in use. Directions for accurate calculation of the output resistance are given in the instruction manual. Approximate values can be determined by interpolation from the following table. The figures given in the table apply to the 10,000-ohm model, TYPE 1454-A; for the 100,000-ohm model, TYPE 1454-AH, multiply the values by 10.

TABLE I

	0.00	0.01	0.02	0.03	0.04	0.05	0.06	0.07	0.08	0.09
0	0	189	356	501	624	725	804	861	896	909
0.1	900	1069	1216	1341	1444	1525	1584	1621	1636	1629
0.2	1600	1749	1876	1981	2064	2125	2164	2181	2176	2149
0.3	2100	2229	2336	2421	2484	2525	2544	2541	2516	2469
0.4	2400	2509	2596	2661	2704	2725	2724	2701	2656	2589
0.5	2500	2589	2656	2701	2724	2725	2704	2661	2596	2509
0.6	2400	2469	2516	2541	2544	2525	2484	2421	2336	2229
0.7	2100	2149	2176	2181	2164	2125	2064	1981	1876	1749
0.8	1600	1629	1636	1621	1584	1525	1444	1341	1216	1069
0.9	900	909	896	861	804	725	624	501	356	189

Cabinet: Lab bench (see page 210).

Dimensions: Width $15\frac{3}{4}$, height 5, depth $5\frac{1}{4}$ inches (400 by 130 by 135 mm), over-all.

Net Weight: $7\frac{1}{4}$ pounds (3.3 kg).

Shipping Weight: 13 pounds (6 kg).

Type		Code Number	Price
1454-A	Decade Voltage Divider (10,000 ohms)	1454-9701	\$160.00
1454-AH	Decade Voltage Divider (100,000 ohms)	1454-9817	160.00

Potentiometer voltage dividers are described on page 202.





Type 1615-A CAPACITANCE BRIDGE

FEATURES:

- ◆ 0.01% direct-reading accuracy; comparison accuracy, one ppm.
- ◆ 6-figure resolution for capacitance; one ppm for dissipation factor.
- ◆ Wide capacitance range — 10^{-5} pf to $11 \mu\text{f}$.
- ◆ Loss can be measured as either dissipation factor or conductance.
- ◆ Lever-type balance controls.
- ◆ In-line readout in C , D , and G with automatically positioned decimal point.
- ◆ Makes both 2- and 3-terminal measurements.
- ◆ Low terminal at ground for 2-terminal measurements.

USES: Intercomparison of capacitance standards to 1 part in 10^6 . Standards differing in magnitude by as much as 10,000:1 can easily be compared.

Accurate and precise measurements of capacitance and dissipation factor.

Measurement of circuit capacitances.

Dielectric measurements.

DESCRIPTION: This bridge improves the accuracy of capacitance measurements by an order of magnitude over what has previously been available. This accuracy is achieved through the use of precisely wound transformer ratio arms and highly stable standards, fabricated from Invar and hermetically sealed in nitrogen. Eight standard capacitors are used, in decade values from 1000 pf to 0.00001 pf. Each of the internal standards can be easily compared with one another.

The circuit, shown here in elementary form, is also clearly delineated on the panel. Changes in connections and grounds are also indicated as the terminals are switched for different measurement conditions.

The loss balance can be made in terms of either dissipation factor or conductance.

The bridge has six-figure resolution for capacitance from

$1 \mu\text{f}$ to 1 pf and a direct-reading accuracy of 0.01% over this capacitance range and over most of the frequency range from 50 cps to 10 kc. The minimum detectable capacitance is 10 af (10^{-17} farad) and an auxiliary capacitor is available to extend the range to $11.11110 \mu\text{f}$. The impedance of the transformer ratio arms has been kept very low, so that accurate three-terminal measurements can be made even in the presence of capacitances to ground as large as $1 \mu\text{f}$. Accurate measurements thus can be made with the unknown connected by means of long cables. The bridge also has the necessary internal shielding to permit one terminal of the unknown to be directly grounded, so that both true two-terminal and three-terminal measurements can be made over the whole capacitance range.

For both capacitance and dissipation factor, the balance controls are smoothly operating, lever-type switches. The readout is digital, and the decimal point is automatically positioned. Each capacitance decade has a -1 position to facilitate rapid balancing.

These features and many others result in a capacitance bridge that brings to the measurement of capacitance, to the intercomparison of standards, and to the measurement of dielectric properties an unusual degree of accuracy, precision, range, and convenience.

SPECIFICATIONS

RANGES OF MEASUREMENT

Capacitance (6 ranges): 10^{-17} to 10^{-6} farad ($10 \mu\text{pf}$ to $1.11110 \mu\text{f}$), direct reading; 6-figure resolution, smallest division 10^{-17} farad. With TYPE 1615-P1 Range-Extension Capacitor, upper limit can be extended to $11.11110 \mu\text{f}$.

Dissipation-Factor (3 ranges): 0.000001 to 1 at 1 kc, direct reading.

Directly proportional to frequency at other frequencies. Four-figure resolution; smallest division, 0.000001.

Conductance (2 ranges +; 2 ranges -): $10^{-6} \mu\text{mho}$ to $100 \mu\text{mho}$; 4-figure resolution, smallest division $10^{-6} \mu\text{mho}$; independent of frequency; varies with C range.

Frequency: Approximately 50 cps to 10 kc, useful with reduced accuracy to 100 kc.



BRIDGES AND IMPEDANCE-MEASURING INSTRUMENTS



For the measurement of all types of impedance, resistive or reactive, inductive or capacitive, at frequencies well up into the uhf band, null methods have proved to be the most acceptable on grounds of both precision and convenience. While most of the null circuits used from dc to about 100 Mc are adaptations of the fundamental Wheatstone bridge circuit, many other types of networks that can be adjusted to give zero transmission are also used. Still other systems, such as resonant circuits using deflection-type instruments, have advantages for certain applications.

At very-high and ultra-high frequencies, where impedances can no longer be treated as lumped elements, null circuits based on coaxial-line techniques have been developed in the General Radio laboratories.

DIRECT-CURRENT BRIDGES

The so-called Wheatstone bridge, Figure 1, has been used for over a century for the measurement of direct-current resistance and is still considered the fundamental circuit for the purpose. It measures an unknown resistance in terms of calibrated standards of resistance from the relationship:

$$\frac{R_A}{R_B} = \frac{R_N}{R_P} \quad (1)$$

which is satisfied when the voltage across the detector terminals is zero.

ALTERNATING-CURRENT BRIDGES

The basic circuit of Figure 1 is also applicable to alternating-current measurement.* With complex impedances, two conditions of balance must be satisfied, one for the resistive component and one for the reactive component. At balance:

$$\begin{aligned} Z_P &= R_P + jX_P = Y_A Z_B Z_N & (2) \\ \text{or } Y_P &= G_P + jB_P = Z_A Y_B Y_N & (3) \end{aligned}$$

Equation (2) expresses the unknown in terms of its impedance components, while Equation (3) expresses the unknown in terms of its admittance components. To satisfy these equations, at least one of the three arms A, N, or B must be complex.

The reactance X_P can be measured in terms of a similar reactance in an adjacent arm or an unlike reactance in the opposite arm, as indicated in Figure 2.

*B. Hague, "Alternating-Current Bridge Methods," Sir Isaac Pitman & Sons, Ltd., London, 1957.



Figure 1. The general Wheatstone bridge circuit.

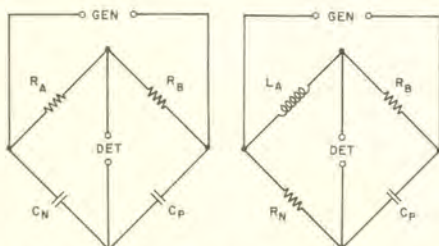

Figure 2. Circuits for capacitance bridges in which like reactances, C_N and C_P , or unlike reactances, L_A and C_P , are compared.

Phase Balance The complex arm required to satisfy the balance conditions of (2) or (3) is a combination of a resistance and a reactance, either in series or in parallel. With a series combination in an arm adjacent to the unknown or a parallel combination in the arm opposite to the unknown, the bridge will measure the equivalent series components of the unknown, while, conversely, with an adjacent parallel or an opposite series combination, the bridge will measure the equivalent parallel components. Examples of various combinations as used in the TYPE 1608-A Impedance Bridge are shown on page 33.

If the two components in this complex arm are both adjustable, the bridge will have independent and orthogonal balances for the real and imaginary parts of the unknown. If only one of the components in the complex arm is adjustable, this component will be proportional to either the D or Q of the unknown impedance, which is a measure of the loss of a reactive component or the reactance of a resistor (see below). If this adjustable component is the more prominent of the two, as it is when very-low- Q inductors are measured, the bridge balance convergence is slow, if not impossible. The TYPE 1650-A Impedance Bridge uses a mechanical ganging of the bridge controls (ORTHONULL® balance finder) to facilitate the convergence (see page 34).

Dissipation Factor and Storage Factor An important characteristic of an inductor or a capacitor, and often even a resistor, is the ratio of resistance to reactance or of conductance to susceptance. This ratio

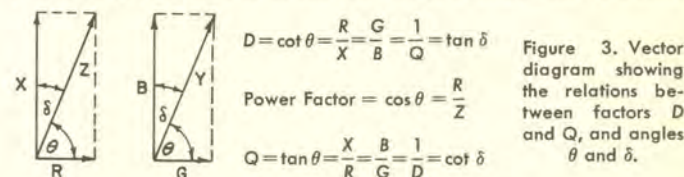

Figure 3. Vector diagram showing the relations between factors D and Q , and angles θ and δ .

is termed dissipation factor, D , and its reciprocal is storage factor, Q . These ratios are defined in Figure 3 in terms of phase angle θ and loss angle δ . Dissipation factor is directly proportional to the energy dissipated, and storage factor to the energy stored, per cycle. Power factor is defined as

$$PF = \cos \theta = \sin \delta$$

and differs from dissipation factor by less than 1% when their magnitudes are less than 0.1.

In Figure 3, R and X are the series resistance and reactance, and G and B are the parallel conductance and susceptance, of the impedance or admittance involved.

Dissipation factor, which varies directly with the power loss, is commonly used for capacitors and, to a lesser extent, for inductors. Its reciprocal, storage factor, Q , is more often used for inductors, because it is a measure of the voltage step-up in a tuned circuit. Q is also used for resistors, in which case it is usually very small.

Series and Parallel Components Every impedance can be expressed in terms of either series or parallel components. The choice is a matter of convenience for the problem at hand. One cannot tell from a single measurement whether a combination of a resistive and a reactive element is actually parallel or series, and, regardless of the physical configuration, the resistive and reactive components can be measured

The General Radio Company manufactures four instruments incorporating dc Wheatstone bridges:

Type	Name	Range of Measurement	Nominal Accuracy	Remarks	See Page
1650-A	Impedance Bridge	1 mΩ to 1 MΩ	±1%	Also measures ac R, L, C	34
1608-A	Impedance Bridge	0.5 mΩ to 1.1 MΩ	±0.1%	Also measures ac R, G, L, C	32
1652-A	Resistance Limit Bridge	1 Ω to 1 MΩ	0.5% as limit bridge 0.25% by null method	Equally useful as production or laboratory bridge	49
544-B	Megohm Bridge	0.1 MΩ to 1 MMΩ	3% up to 1000 MΩ	Excellent for measuring insulation resistance	47

Two deflection-type instruments for the measurement of dc resistance are also listed: the TYPE 1862-C Megohmmeter (page 48) and the TYPE 1230-A Electrometer (page 140).

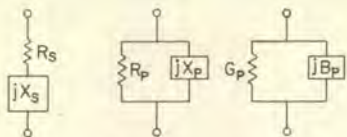

Figure 4. Series and parallel components of impedance.

as, and expressed as, (1) series impedance components, (2) parallel impedance components, or (3) admittance components.

The relations between these various systems (see Figure 4) are:

$$R_P = \frac{1}{G_P} = \frac{R_S^2 + X_S^2}{R_S} = R_S(1 + Q^2)$$

$$X_P = \frac{1}{B_P} = \frac{R_S^2 + X_S^2}{X_S} = X_S(1 + D^2)$$

So that:

$$C_P = C_S \left(\frac{1}{1 + D^2} \right); C_S = C_P(1 + D^2)$$

$$L_P = L_S \left(1 + \frac{1}{Q^2} \right); L_S = L_P \left(\frac{Q^2}{1 + Q^2} \right)$$

Where:

$$Q = \frac{X_S}{R_S} = \frac{R_P}{X_P} = \frac{B_P}{G_P} \quad D = \frac{1}{Q} = \frac{R_S}{X_S} = \frac{X_P}{R_P} = \frac{G_P}{B_P}$$

In terms of inductance and capacitance

$$Q = \frac{\omega L_S}{R_S} = \frac{R_P}{\omega L_P} = \frac{1}{D} \quad D = \omega R_S C_S = \frac{1}{\omega R_P C_P} = \frac{1}{Q}$$

Only for values of Q below 10 (or D greater than 0.1) does the difference between X_S and X_P exceed 1%. For very low Q 's, however, the difference is marked: when $Q = 1$, X_P is twice X_S . If there were no losses in the reactive elements (i.e., $Q = \infty$), X_S and X_P would be equal.

Substitution Methods Substitution methods of measurement can often be used to advantage in many ac bridges. The unknown component is put either in series with or in parallel with the main adjustable component, and balances are made before and after the unknown is connected. The magnitude of the unknown is then equal to the change made in the adjustable component, since, for both balances, the total impedance of that bridge arm must be constant. The accuracy of measurement is improved, because it is dependent only on the calibration of the adjustable arm and not upon the other bridge arms as long as they are constant. (The D or Q balance, however, will generally depend on the other bridge arms.)

Parallel substitution is often used with the TYPE 716-C Capacitance Bridge, and series substitution is used in the TYPE 1606-A and the TYPE 916-AL Radio-Frequency Bridges (see page 52).

BRIDGES WITH ACTIVE ELEMENTS

A recent development* in bridge circuits is the use of amplifiers as bridge elements. These are used with potentiometers to form variable-voltage sources. They permit the use of fixed capacitance and conductance standards, whose currents are adjusted by variation of applied voltage rather than by variation of impedance magnitude. This arrangement has many advantages, particularly in the measurement of nonlinear elements, such as inductors with ferromagnetic cores. The TYPE 1633-A Incremental-Inductance Bridge uses this type of circuit (see page 44).

TRANSFORMER-RATIO-ARM BRIDGES†

Inductively coupled, or transformer, ratio arms are used in some of the newest bridges. First introduced nearly a century ago, they have received increased attention in the last few years because, for some uses, they possess outstanding advantages. Accuracies of a few parts per million can be obtained, even for ratios as great as 1000:1, and these ratios are essentially unaffected by age, temperature, or voltage. The low impedance of the transformer ratio arm also makes it easy to measure a wide range of impedances in a three-terminal measurement without the use of guard circuits and auxiliary balances.

Figure 5 shows a transformer bridge in elementary form. The balance condition for capacitance is

$$\frac{C_X}{C_N} = \frac{N_N}{N_X}$$

* H. P. Hall, R. G. Fulks, "The Use of Active Devices in Precision Bridges," *Electrical Engineering*, May, 1962.

† For a more complete discussion of transformer-ratio-arm bridges, see John F. Hersh, "Accuracy, Precision, and Convenience for Capacitance Measurements," *General Radio Experimenter*, 36, 8 & 9, August-September, 1962.

Note that the terminal capacitances to ground from both the standard capacitor, C_N , and the unknown, C_X , can have very little effect on the measurement. Capacitances from the H terminals appear across the low-impedance transformer winding, while those from the L terminals are across the detector, where they do not enter the balance expression, although they can reduce the detector sensitivity. Because this type of bridge can tolerate relatively large capacitances from both sides of the unknown to the guard point, long cables with guard shields may be used for remote measurement, and circuit capacitances can be measured *in situ*.

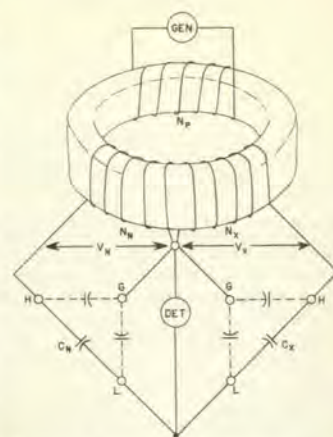

Figure 5. A capacitance bridge with transformer ratio arms.

Transformer ratio arms are used in the highly accurate TYPE 1615-A Capacitance Bridge, the TYPE 1613-A Capacitance Bridge, and the TYPE 1605-A Impedance Comparator. The use of transformer windings for two arms of the bridge leaves only one internal arm for the two balance adjustments.

THREE-TERMINAL MEASUREMENTS — GUARD CIRCUIT

Three-terminal measurements can be made on conventional bridges (though not so easily as on transformer bridges) if the stray impedances are negligible compared to the bridge arm being shunted or if a guard circuit is used. For capacitance measurements on the TYPES 1650-A and 1608-A Impedance Bridges, stray capacitance to ground shunts a standard capacitor of 0.1 μf or larger, so that considerable stray capacitance can be tolerated without appreciable error. Similarly, on the TYPE 544-B Megohm Bridge, a relatively low leakage resistance can be tolerated across a resistive arm.

Three-terminal measurements can be made on the TYPE 716-C Capacitance Bridge if a TYPE 716-P4 Guard Circuit is used. This circuit provides adjustable components forming a fifth bridge node, which is used as the guard point (see Figure 6a). It can be shown that the bridge is in balance if either of the following conditions is met:

$$\frac{A}{N} = \frac{B}{P} = \frac{F}{H} \quad \text{or} \quad \frac{A}{B} = \frac{N}{P} = \frac{S}{T}$$

Obviously, these conditions include the ordinary balance equation for the four-arm network $A-B-N-P$. The actual circuit for the TYPE 716-P4 Guard Circuit is shown in Figure 6b. An auxiliary balance is made with the internal arms, so that the stray capacitance to the guard point does not affect the final bridge balance.

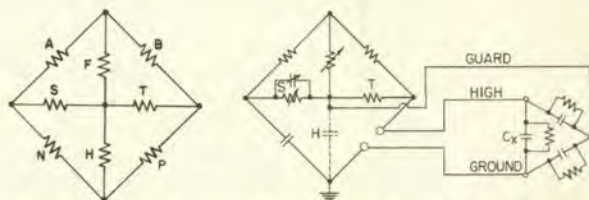

(Left) Figure 6a. General bridge network with guard circuit and unknown three-terminal impedance. (Right) Figure 6b. Schematic for bridge and guard circuit.

LIMIT BRIDGES AND COMPARATORS

In limit testing, the unbalance voltage of the bridge is used to actuate meters, which indicate the degree of deviation of one impedance from another. In the TYPE 1652-A Resistance Limit Bridge an adjustable resistance standard is included, and the instrument is thus a complete system for limit testing of resistors over a wide range of values. Also, the operation can be inverted, i.e., the bridge balanced as in a conventional bridge, and the answer read on the dials of the internal standards.

The TYPE 1605-A Impedance Comparator is an ac bridge with transformer ratio arms. It uses a phase-selective voltage-measuring system, and the magnitude and phase of the difference between the unknown and an external standard impedance are displayed independently on two meters.

AC BRIDGES

Type	Name	Measures	Nominal Accuracy	Frequency	Remarks	See Page
Power-Frequency Bridges						
1611-B	Capacitance-Test Bridge	C 0 to 11,000 μ f D 0 to 60%	$\pm 1\%$ $\pm 2\%$	60, 120 cps (with Type 1214 Unit Oscillator)	For testing insulators, bushings, capacitors, cables, and polarized electrolytic capacitors. Measures grounded capacitors.	42
Audio-Frequency Bridges						
1650-A	Impedance Bridge	R 1 m Ω to 1 M Ω C 1 pf to 1000 μ f L 1 μ h to 1000 h Also D and Q	$\pm 1\%$ $\pm 1\%$ $\pm 1\%$ $\pm 5\%$	dc, 1 kc 20 cps to 20 kc with external generator	Completely self-contained, general-purpose, laboratory and production bridge. Belongs in every laboratory and electronic plant.	34
1608-A	Impedance Bridge	R 0.05 m Ω to 1.1 M Ω C 0.05 pf to 1100 μ f L 0.05 μ h to 1100 h G 0.05 n Ω to 1.1 Ω Also D and Q	0.1% 0.1% 0.1% 0.1% $\pm 5\%$, $\pm 2\%$	dc, 1 kc 20 cps to 20 kc with external generator	For precise sorting, accurate component selection, laboratory measurement.	32
1603-A	Z-Y Bridge	R, X 0 to 1000 Ω G, B 0 to 1000 μ mho	$\pm 1\%$ $\pm 1\%$	20 cps to 20 kc	Will balance for any impedance from 0 to ∞ . Ideal for measuring audio-frequency transducers.	31
1615-A	Capacitance Bridge	C 10^{-17} to 10^{-6} f D 10^{-6} to 1 G 10^{-6} to 100 μ i Ω	$\pm 0.01\%$ $\pm 0.1\%$ $\pm 1\%$	20 cps to 20 kc	For highly accurate measurements, comparison of standards, measurements of very small capacitances, etc.	36
716-C	Capacitance Bridge	C 100 pf to 1 μ f C 100 to 1000 pf C 0.1 to 1000 pf D 0.00002 to 0.56	$\pm 0.1\%$ $\pm 0.1\%$ $\pm 0.2\%$ $\pm 2\%$	1 kc 30 cps to 300 kc 30 cps to 300 kc 30 cps to 300 kc	Direct reading. Direct reading. Substitution method.	38
1613-A	Capacitance Bridge	C 5 pf to 0.011 μ f D 0 to 0.11	$\pm 0.1\%$ $\pm 2\%$	400 cps	Measures 3-terminal capacitors.	43
1632-A	Inductance Bridge	L 0.001 μ h to 1111 h G 0.01 μ mho to 1111 mho	$\pm 0.1\%$ $\pm 1\%$	1 kc	Six-figure resolution for comparison of standard inductors.	46
1633-A	Incremental-Inductance Bridge	L 0.2 μ h to 1000 h R 10 m Ω to 1 M Ω Q ∞ to 1	$\pm 1\%$ $\pm 2\%$ $\pm 2\%$	direct reading at nine frequencies, 50 cps to 15.75 kc	For measurements of iron-core coils at high levels of dc and ac excitation. Has own internal detector.	44
1605-A	Impedance Comparator	ΔZ $\pm 0.01\%$ to $\pm 10\%$ $\Delta \theta$ ± 0.001 to ± 0.1 radian	$\pm 0.01\%$	0.1, 1, 10, 100 kc	Direct indication on meters, no balancing. Guard circuit included.	50
Radio-Frequency Bridges						
716-CS1	Capacitance Bridge	C 0.1 to 1100 pf D 0.00002 to 0.56	$\pm 0.1\%$ $\pm 2\%$	0.5 to 3 Mc	High-frequency model of Type 716-C.	39
916-AL	RF Bridge	X $\pm 11,000 \Omega$ at 100 kc R 0 to 1000 Ω	$\pm 2\%$ $\pm 1\%$	50 kc to 5 Mc	Measures antennas, lines, components.	53
1606-A	RF Bridge	X $\pm 5000 \Omega$ at 1 Mc R 0 to 1000 Ω	$\pm 2\%$ $\pm 1\%$	0.4 to 60 Mc	Measures antennas, lines, components.	52

COAXIAL-LINE INSTRUMENTS

The Admittance Meter The upper-frequency limit of conventional bridge circuits using lumped-parameter elements is determined by the magnitude of the residual impedances of the elements and leads. The corrections for these usually become unmanageable at frequencies higher than a few hundred megacycles per second, and circuits based on coaxial-line techniques are more satisfactory.

The TYPE 1602-B UHF Admittance Meter (see page 54) is a null device based on these techniques. Through adjustable loops, it samples the currents flowing in three coaxial lines fed from a common source at a common junction point and terminated, respectively, in the unknown element, a standard conductance, and a standard susceptance. The outputs of the loops are combined, and, when the loops are properly oriented, the combined output becomes zero, so that a null balance is produced. Scales associated with the three loops give the value of the unknown admittance directly. The loops in the standard lines are basically a means of varying the effective magnitudes of conductance and susceptance, although the standards themselves are fixed. Similarly, the loop in the unknown line provides a multiplying factor.

The Transfer-Function and Imittance Bridge Like the Admittance Meter, the TYPE 1607-A Transfer-Function and Imittance Bridge is a null instrument using coaxial lines and adjustable coupling loops. A schematic is shown on page 57. This instrument can measure four-

terminal functions, such as forward and reverse transconductance and transsusceptance, transimpedance, input-output ratios of voltage and current, and output-input ratios, as well as the two-terminal functions of admittance and impedance.

It is particularly useful for evaluating the transfer functions of vacuum tubes and transistors in the vhf and uhf ranges, and the two-terminal parameters of diodes.

The Slotted Line One of the basic methods of determining impedance of a coaxial device is the measurement of the standing-wave ratio it introduces into a uniform line. The measurement is made by means of a coaxial line in whose outer conductor is a longitudinal slot. An electrostatic probe enters the line through this slot and can be moved along the line to sample the electric field between the inner and outer conductors. From the voltage maximum and minimum, and their location with respect to the unknown, the impedance can be calculated. This instrument is one of few in which the impedance standard is inherently part of the instrument and can be determined in absolute terms, from physical dimensions.

The TYPE 874-LBA Slotted Line for general impedance measurement is described on page 65.

A precision slotted line for highly accurate measurements of standing-wave ratio is available as the TYPE 900-LB and, in combination with the TYPE 1521-A Graphic Level Recorder, as the TYPE 1640-A Slotted-Line Recorder System. See page 76.

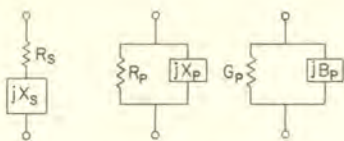

Figure 4. Series and parallel components of impedance.

as, and expressed as, (1) series impedance components, (2) parallel impedance components, or (3) admittance components.

The relations between these various systems (see Figure 4) are:

$$R_P = \frac{1}{G_P} = \frac{R_S^2 + X_S^2}{R_S} = R_S(1 + Q^2)$$

$$X_P = \frac{1}{B_P} = \frac{R_S^2 + X_S^2}{X_S} = X_S(1 + D^2)$$

So that:

$$C_P = C_S \left(\frac{1}{1 + D^2} \right); C_S = C_P(1 + D^2)$$

$$L_P = L_S \left(1 + \frac{1}{Q^2} \right); L_S = L_P \left(\frac{Q^2}{1 + Q^2} \right)$$

Where:

$$Q = \frac{X_S}{R_S} = \frac{R_P}{X_P} = \frac{B_P}{G_P} \quad D = \frac{1}{Q} = \frac{R_S}{X_S} = \frac{X_P}{R_P} = \frac{G_P}{B_P}$$

In terms of inductance and capacitance

$$Q = \frac{\omega L_S}{R_S} = \frac{R_P}{\omega L_P} = \frac{1}{D} \quad D = \omega R_S C_S = \frac{1}{\omega R_P C_P} = \frac{1}{Q}$$

Only for values of Q below 10 (or D greater than 0.1) does the difference between X_S and X_P exceed 1%. For very low Q 's, however, the difference is marked: when $Q = 1$, X_P is twice X_S . If there were no losses in the reactive elements (i.e., $Q = \infty$), X_S and X_P would be equal.

Substitution Methods Substitution methods of measurement can often be used to advantage in many ac bridges. The unknown component is put either in series with or in parallel with the main adjustable component, and balances are made before and after the unknown is connected. The magnitude of the unknown is then equal to the change made in the adjustable component, since, for both balances, the total impedance of that bridge arm must be constant. The accuracy of measurement is improved, because it is dependent only on the calibration of the adjustable arm and not upon the other bridge arms as long as they are constant. (The D or Q balance, however, will generally depend on the other bridge arms.)

Parallel substitution is often used with the TYPE 716-C Capacitance Bridge, and series substitution is used in the TYPE 1606-A and the TYPE 916-AL Radio-Frequency Bridges (see page 52).

BRIDGES WITH ACTIVE ELEMENTS

A recent development* in bridge circuits is the use of amplifiers as bridge elements. These are used with potentiometers to form variable-voltage sources. They permit the use of fixed capacitance and conductance standards, whose currents are adjusted by variation of applied voltage rather than by variation of impedance magnitude. This arrangement has many advantages, particularly in the measurement of nonlinear elements, such as inductors with ferromagnetic cores. The TYPE 1633-A Incremental-Inductance Bridge uses this type of circuit (see page 44).

TRANSFORMER-RATIO-ARM BRIDGES†

Inductively coupled, or transformer, ratio arms are used in some of the newest bridges. First introduced nearly a century ago, they have received increased attention in the last few years because, for some uses, they possess outstanding advantages. Accuracies of a few parts per million can be obtained, even for ratios as great as 1000:1, and these ratios are essentially unaffected by age, temperature, or voltage. The low impedance of the transformer ratio arm also makes it easy to measure a wide range of impedances in a three-terminal measurement without the use of guard circuits and auxiliary balances.

Figure 5 shows a transformer bridge in elementary form. The balance condition for capacitance is

$$\frac{C_X}{C_N} = \frac{N_N}{N_X}$$

* H. P. Hall, R. G. Fulks, "The Use of Active Devices in Precision Bridges," *Electrical Engineering*, May, 1962.

† For a more complete discussion of transformer-ratio-arm bridges, see John F. Hersh, "Accuracy, Precision, and Convenience for Capacitance Measurements," *General Radio Experimenter*, 36, 8 & 9, August-September, 1962.

Note that the terminal capacitances to ground from both the standard capacitor, C_N , and the unknown, C_X , can have very little effect on the measurement. Capacitances from the H terminals appear across the low-impedance transformer winding, while those from the L terminals are across the detector, where they do not enter the balance expression, although they can reduce the detector sensitivity. Because this type of bridge can tolerate relatively large capacitances from both sides of the unknown to the guard point, long cables with guard shields may be used for remote measurement, and circuit capacitances can be measured *in situ*.

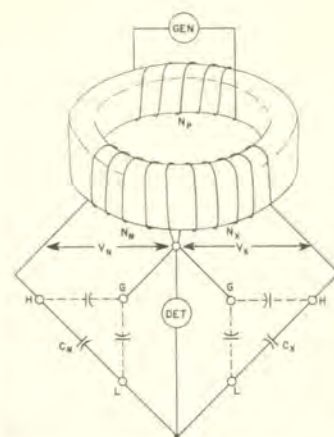

Figure 5. A capacitance bridge with transformer ratio arms.

Transformer ratio arms are used in the highly accurate TYPE 1615-A Capacitance Bridge, the TYPE 1613-A Capacitance Bridge, and the TYPE 1605-A Impedance Comparator. The use of transformer windings for two arms of the bridge leaves only one internal arm for the two balance adjustments.

THREE-TERMINAL MEASUREMENTS — GUARD CIRCUIT

Three-terminal measurements can be made on conventional bridges (though not so easily as on transformer bridges) if the stray impedances are negligible compared to the bridge arm being shunted or if a guard circuit is used. For capacitance measurements on the TYPES 1650-A and 1608-A Impedance Bridges, stray capacitance to ground shunts a standard capacitor of 0.1 μ f or larger, so that considerable stray capacitance can be tolerated without appreciable error. Similarly, on the TYPE 544-B Megohm Bridge, a relatively low leakage resistance can be tolerated across a resistive arm.

Three-terminal measurements can be made on the TYPE 716-C Capacitance Bridge if a TYPE 716-P4 Guard Circuit is used. This circuit provides adjustable components forming a fifth bridge node, which is used as the guard point (see Figure 6a). It can be shown that the bridge is in balance if either of the following conditions is met:

$$\frac{A}{N} = \frac{B}{P} = \frac{F}{H} \quad \text{or} \quad \frac{A}{B} = \frac{N}{P} = \frac{S}{T}$$

Obviously, these conditions include the ordinary balance equation for the four-arm network $A-B-N-P$. The actual circuit for the TYPE 716-P4 Guard Circuit is shown in Figure 6b. An auxiliary balance is made with the internal arms, so that the stray capacitance to the guard point does not affect the final bridge balance.

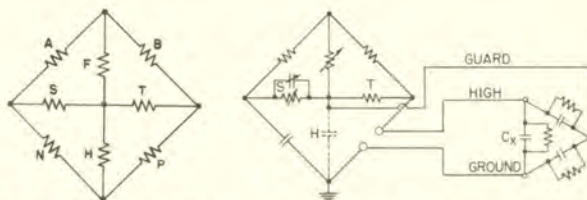

(Left) Figure 6a. General bridge network with guard circuit and unknown three-terminal impedance. (Right) Figure 6b. Schematic for bridge and guard circuit.

LIMIT BRIDGES AND COMPARATORS

In limit testing, the unbalance voltage of the bridge is used to actuate meters, which indicate the degree of deviation of one impedance from another. In the TYPE 1652-A Resistance Limit Bridge an adjustable resistance standard is included, and the instrument is thus a complete system for limit testing of resistors over a wide range of values. Also, the operation can be inverted, i.e., the bridge balanced as in a conventional bridge, and the answer read on the dials of the internal standards.

The TYPE 1605-A Impedance Comparator is an ac bridge with transformer ratio arms. It uses a phase-selective voltage-measuring system, and the magnitude and phase of the difference between the unknown and an external standard impedance are displayed independently on two meters.

COAXIAL-LINE INSTRUMENTS

Type	Name	Measures	Nominal Accuracy	Frequency	Remarks	See Page
1602-B	UHF Admittance Meter	B, G 0.01 to 10,000 mmhos X, R 0.1 to 100,000 ohms	$\pm 3\%$	20 to 1500 Mc	For admittance, impedance, and VSWR measurements on coaxial lines, antennas, networks, components.	54
1607-A	Transfer-Function and Imittance Bridge	Z_{21} 0 to 1500 ohms Y_{21} 0 to 600 mmhos V_2/V_1 0 to 30 I_2/I_1 0 to 30 B, G 0 to 400 mmhos X, R 0 to 1000 ohms	$\pm 5\%$	25 to 1500 Mc	Measures four-terminal transfer functions of tubes, transistors, and networks; also 2-terminal functions, impedance, and admittance.	56
874-LBA	Slotted Line	VSWR	Better than 2.5% at 300 Mc 10.0% at 5000 Mc	300 to 5000 Mc	Standard instrument for uhf impedance and VSWR measurement.	65
900-LB	Slotted Line	VSWR	Better than 0.13% at 300 Mc, 1.0% at 9000 Mc	300 to 9000 Mc	Precision line for best accuracy.	76
1640-A	Slotted-Line Recorder System	VSWR		300 to 9000 Mc	Type 900-LB with recorder.	76

DETECTORS

(See also the discussion of detectors on page 78.)

For maximum precision of balance with any bridge or null-balance circuit, it is necessary to obtain a virtually complete null balance. With modern amplifiers, however, sufficient sensitivity can be obtained to utilize all the potential precision of any null-balance network, even with relatively low applied bridge voltage.

The desirable characteristics of a bridge detector are:

- (1) High sensitivity, preferably the ability to detect a few microvolts.
- (2) High selectivity, to reject harmonics, noise, or other interfering signals. This is particularly important in measuring iron-core coils and other nonlinear elements.
- (3) Quasi-logarithmic response, to obviate the necessity of gain adjustments during the balancing procedure.
- (4) Good shielding, to prevent errors from extraneous pickup.

These requirements are best met by some combination of amplifier, filter, and null indicator.

20 cps to 5 Mc At audio frequencies, a tuned amplifier with meter or earphones is satisfactory. The TYPE 1232-A Null Detector is a high-sensitivity device of this type. The TYPE 1212-A Unit Null Detector, which has a wide-band amplifier and meter, can be used at frequencies up to several megacycles per second.

100 kc to 60 Mc Crystal mixers are available for both of the above detectors, to extend their usable ranges up to about 60 Mc. In this application the signal is heterodyned against a local oscillator, and the detector unit is used as an i-f amplifier. Well-shielded radio receivers of the communications type are also satisfactory detectors for the range from a few hundred kc to some 40 Mc.

40 Mc to 5 Gc At very-high and ultra-high frequencies, the heterodyne detector is preferred, owing to its wide frequency range and excellent shielding. The TYPE DNT Detectors, consisting of the TYPE 1216-A Unit I-F Amplifier, a Unit Oscillator for heterodyning, and a crystal mixer, are excellent detectors for this frequency range. Commercial receivers in this range are also satisfactory.

GENERATORS

The important considerations in the selection of a power source for ac bridge measurements are good frequency stability, adequate power output, and low harmonic content. For those General Radio bridges that require external generators, a wide choice is available (see pages 102 to 118).

For single-frequency measurements at 400 or 100 cps, the TYPE 1214-A Unit Oscillator is satisfactory. For measurements at several fixed frequencies in the audio range, the TYPE 1311-A Audio Oscillator, a high-performance, compact, transistor oscillator, is recommended. For continuous coverage over a range of frequencies, recommended oscillators are the TYPES 1304-B, 1210-C, and 1302-A at low and audio frequencies; the TYPES 1330-A and 1211-C at medium frequencies; and, from 0.5 Mc to 2 Gc, the various vhf and uhf Unit Oscillators and the TYPE 1361-A UHF Oscillator. Frequencies from 2 to 4.1 Gc are covered by the TYPE 1360-A Microwave Oscillator or the TYPE 1220-A Unit Klystron Oscillator.

CONNECTIONS — SHIELDING

Adequate ground connection and shielded generator and detector leads are necessary precautions in any bridge measurements, but are particularly important at high frequencies. At audio and low-radio frequencies, electrostatic shielding of the leads is usually all that is necessary; above a few Mc, coaxial leads must be used, and these must be securely grounded to the detector, generator, and bridge shields to provide a completely shielded system, and to eliminate common impedances between generator and detector.

The widespread use of three-wire power cords with a grounded lead in ac-operated devices has introduced unwanted ground-loop currents into many types of measurements. Only by careful elimination of multiple paths to ground for the measurement signal can serious errors be avoided.

SPECIALIZED MEASUREMENTS

Vacuum Tubes and Transistors No single device will measure all the desired characteristics of tubes and transistors, nor will it measure any one property at all frequencies. The fundamental vacuum-tube parameters — plate resistance, amplification coefficient, and transconductance — are measured easily and accurately at low frequencies by the TYPE 1661-B Vacuum-Tube Bridge. Of transistors, it will measure the short-circuit conductance parameter, including the h_i hybrid parameter, and the forward and reverse voltage ratios, including the h_r hybrid parameter. The h_f , α , and β factors, as well as other open-circuit parameters, can be calculated from these measurements.

At very-high and ultra-high frequencies the TYPE 1607-A Transfer-Function and Imittance Bridge measures important parameters of both tubes and transistors. For transistors, these include short-circuit current gain, open-circuit voltage-feedback factor, hybrid input impedance, and hybrid output admittance. For tubes, they include open-circuit voltage gain, transadmittance, feedback admittance, and input and output admittances. These last two quantities can be measured at low frequencies by the TYPE 1603-A Z-Y Bridge.

The equivalent-circuit parameters of tunnel diodes at high frequencies can also be measured on the Transfer-Function and Imittance Bridge.

Small capacitances, such as the collector-to-base capacitance of a transistor, are easily measured at production-line speeds with the TYPE 1605-A Impedance Comparator. A similar method of measurement is used to determine the small phase angles of high resistances.

Dielectric Measurements For the measurement of the dielectric constant and dissipation factor of insulating materials, the TYPE 1615-A Capacitance Bridge is recommended for the audio-frequency range. For wider frequency coverage, the TYPE 716-C Capacitance Bridge is useful up to 300 kc and the TYPE 716-CS1 from 300 kc to 5 Mc. With these bridges, the TYPE 1690-A Dielectric Sample Holder is useful in two-terminal measurements.

When the sample is in a conditioning chamber, a three-terminal measurement must be used. The TYPE 1615-A Capacitance Bridge and the TYPE 1605-A Impedance Comparator (which is well suited to environmental tests) have built-in guard facilities. With the TYPE 716-C Capacitance Bridge, the TYPE 716-P4 Guard Circuit provides the third-terminal connection.

Type 1603-A Z-Y BRIDGE

Z-Y BRIDGES

- FEATURES:**
- ◆ Balances for any unknown impedance 0 to ∞ .
 - ◆ Covers entire audio-frequency range.
 - ◆ 1% accuracy to 7 kc (to 20 kc for resistance and conductance).
 - ◆ Fast, convenient operation.
 - ◆ Can measure grounded, direct, or balanced impedances.

USES: This remarkable bridge can easily be balanced for any impedance connected to its terminals. For example, it can be used to measure:

- R , L , and C components, or any combinations of them.
- Impedances (including negative resistance) of active networks.
- Complex impedance characteristics of transformers, transducers, transmission networks, and transistors.
- Frequency characteristics of components, such as electrolytic capacitors and sonar elements.

DESCRIPTION: The basic circuit is a resistance-capacitance bridge, and a substitution method of measurement is used. Low impedances are measured directly in terms of R and X , and high impedances (low admittances) are measured directly in terms of G and B . R and G readings are independent of frequency. X and B are direct reading at 100 cps, 1 kc, and 10 kc.

By selection of detector connections, one can measure (1) the grounded impedance, (2) the direct impedance, or (3) the impedance of the equivalent delta circuit, balanced or unbalanced, of the unknown element.

SPECIFICATIONS

RANGES OF MEASUREMENT

Frequency: 20 cps to 20 kc.

Impedance and Admittance: $-\infty$ to $+\infty$.

The unknown is measured as an impedance if the absolute resistance is less than 1000 ohms and the absolute reactance is less than 1000 (f_0/f) ohms.

The unknown is measured as an admittance if the absolute conductance is less than 1000 micromhos and the absolute susceptance is less than 1000 (f/f_0) micromhos.

ACCURACY (with unknown grounded)

- R:** $\pm 1\% \pm (2 \text{ ohms on main R dial or } 0.2 \text{ ohm on } \Delta R \text{ dial}) \pm 0.0002f_{kc}X$
- G:** $\pm 1\% \pm (2 \text{ } \mu\text{mhos on main G dial or } 0.2 \text{ } \mu\text{mho on } \Delta G \text{ dial}) \pm 0.0002f_{kc}B$

- X:** $\pm 1\% \pm (2f_0/f \text{ ohms on main X dial or } 0.2 f_0/f \text{ ohm on } \Delta X \text{ dial}) \pm 0.0002f_{kc}R$
- B:** $\pm 1\% \pm (2f/f_0 \text{ } \mu\text{mhos on main B dial or } 0.2 f/f_0 \text{ } \mu\text{mho on } \Delta B \text{ dial}) \pm 0.0002f_{kc}G$

These expressions are valid for R and G up to 20 kc; for X and B the 1% term is valid up to 7 kc; above 7 kc it becomes 2%, above 15 kc, 3%. There are slightly larger errors at high frequencies for direct or delta measurements.

GENERAL

Maximum Applied Voltage: 130 volts, rms, on bridge, giving less than 32 volts on unknown.

Accessories Required: Calibrated oscillator or suitable generator and detector. The TYPE 1210-C Unit R-C Oscillator (page 105) and the TYPE 1232-A Null Detector (page 79) are recommended.

Accessories Supplied: One TYPE 274-NP and one TYPE 874-R34 Patch Cord.

Cabinet: Lab bench (see page 210).

Dimensions: Width 12½, height 13½, depth 8½ inches (320 by 345 by 220 mm), over-all.

Net Weight: 21½ pounds (10 kg).

Shipping Weight: 31 pounds (14.5 kg).

For a more complete description of this instrument send for the General Radio Reprint No. E-102.

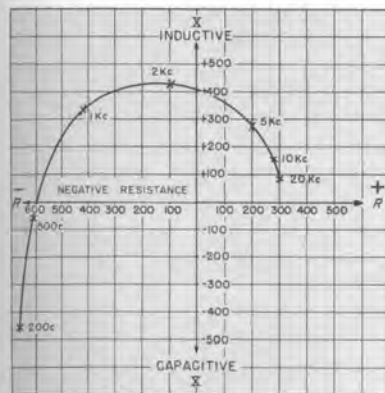

Input impedance of a feedback circuit; data taken with Type 1603-A Z-Y Bridge.

Type	Code Number	Price
1603-A	Z-Y Bridge	1603-9701 \$475.00

A UNIVERSAL AUDIO-FREQUENCY
IMPEDANCE-MEASURING INSTRUMENT



Type 1608-A IMPEDANCE BRIDGE

FEATURES:

- ◆ 0.1% basic accuracy for C , R , L , and G .
- ◆ Digital readout for C , R , L , and G ; decimal point and unit indicated — no multiplying factors.
- ◆ High-phase accuracy — measures D to 0.0005, Q to 2000.
- ◆ Measures impedances of any phase angle including reactive resistors and high-loss reactances.
- ◆ Rapid balancing made possible by concentric balance control having only coarse and fine balances.
- ◆ Appropriate D and Q scales illuminated automatically — no multiplying factors to remember.
- ◆ Self-contained oscillator, selective detector, three dc supplies, and sensitive null meter.

USES: This precision bridge is intended for general-purpose impedance measurements on modern precision components requiring an accuracy of 0.1%. It will measure capacitance, inductance, and ac resistance and conductance, as well as dc resistance. The digital display, including decimal point and unit indication, provides an almost error-free readout system, which, with the rapid-balancing coaxial adjustment, makes laboratory or production testing quick and sure. The six ac bridges provide complete phase coverage of the passive impedance plane so that "black boxes" such as filters, transducers, equalizers, or other networks can be measured regardless of phase angle.

The ac-resistance and -conductance bridge circuits make possible the measurement of resistors at 1000 cps; they include a Q adjustment for precise balance, which provides phase information useful in predicting their high-frequency performance. These bridges are also useful for measuring high-loss reactances, such as rf chokes, without a sliding null. The high-phase precision of ± 0.0005 radian makes D or Q measurements meaningful on low-loss reactances, which must often have tight D or Q tolerances, for use in precision networks.

Other uses include the dc measurement of a wide range of resistors at EIA specified voltages, the measurement of

three-terminal capacitors and small capacitors remotely located, measurements on voltage-biased capacitors or current-biased inductors or resistors, and the measurement of impedances over the audio-frequency range.

The ability to measure small capacitances in a three-terminal connection makes possible the measurement of the capacitance between components, wires, or mounting structures. It is possible, for instance, to measure such quantities as the capacitance between any two conductors on an etched-board pattern with the other elements grounded. Furthermore, long shielded cables can be used to connect remote or otherwise inaccessible components without significantly affecting the accuracy of the measurement.

For production testing of components a test jig can be used. The TYPE 1650-P1 Test Jig is recommended.

DESCRIPTION: This self-contained bridge-measurement system includes six bridges, along with suitable ac and dc sources and detectors. The bridges include the familiar series and parallel capacitance- and inductance-measuring circuits, plus a series-resistance bridge and a parallel-conductance bridge, both having phase (Q) adjustments. The bridge elements are precision units. The wire-wound



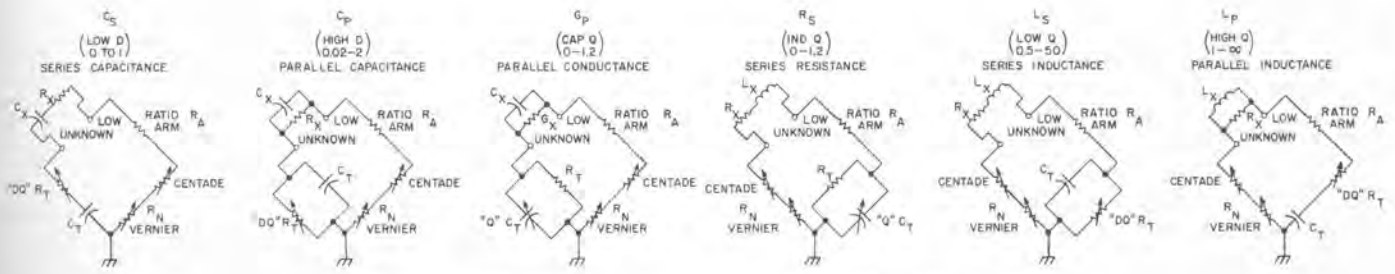

Elementary schematics of the capacitance, conductance, resistance, and reactance bridges.

resistors are similar to those used in General Radio decade resistance boxes, and the standard capacitor is a special, combination silver-mica and stabilized-polystyrene capacitor, with a low temperature coefficient.

The readout system is digital for C , R , L , and G , as well as for the Q of resistors. The D and Q readings for capacitors and inductors are directly read from a dial with the correct scale illuminated. Decimal points and units are indicated where necessary, and there are no multiplying factors for any quantity indicated at 1 kc or dc.

The main readout has both coarse and fine adjustments

controlled by concentric knobs. The fine control is a compensated, wire-wound rheostat. The coarse control, which yields approximately 100 fixed unit steps of resistance, uses only 40 individual resistors combined in an ingenious switching system called a centade.

The 1-kc frequency-selective networks for the internal oscillator and tuned detector are on a plug-in module, which can be easily replaced with modules available for other internal test frequencies. Provision is made for use with an external oscillator. Three dc supplies are included to obtain good dc sensitivity over a wide range of resistance.

SPECIFICATIONS

RANGES

- Capacitance:** 0.05 pf to 1100 μ f in seven ranges, series or parallel.
- Inductance:** 0.05 μ h to 1100 h in seven ranges, series or parallel.
- Resistance:** (series) 0.05 milliohm to 1.1 megohms, ac or dc.
- Conductance:** (parallel) 0.05 nanomhos to 1.1 mhos, ac or dc (20,000 megohms to 0.9 ohm).
- D:** (of series capacitance) — 0.0005 to 1 at 1 kc.
(of parallel capacitance) — 0.02 to 2 at 1 kc.
- Q:** (of series inductance) — 0.5 to 50 at 1 kc.
(of parallel inductance) — 1 to 2000 at 1 kc.
(of series resistance) — 0.0005 to 1.2 inductive at 1 kc.
(of parallel conductance) — 0.0005 to 1.2 capacitive at 1 kc.
- Frequency:** 1 kc with internal oscillator module supplied; 20 cps to 20 kc with external oscillator.

ACCURACY

- C, G, R, L**
- At 1 kc: $\pm 0.1\% \pm 0.005\%$ of full scale except on lowest R and L ranges and highest C and G ranges, where it is $\pm 0.2\% \pm 0.005\%$ of full scale.
- Additional % error terms for high frequency and large phase angle:**
- C and L:** $(\pm 0.001f_{kc}^2 \pm 0.1Df_{kc} \pm 0.5D^2)\%$ of measured quantity.
- R and G:** $(\pm 0.002f_{kc}^2 \pm 0.000001f_{kc}^4 \pm 0.1Q)\%$ of measured quantity.
- Residual Terminal Impedance:** $R \approx 0.001$ ohm, $L \approx 0.15$ μ h, $C \approx 0.25$ pf.
- DC Resistance and Conductance:** Same as for 1-kc measurement, except that accuracy is limited by sensitivity at the range extremes. Balances to 0.1% are possible from 1 ohm to 1 megohm with the internal supply and detector.
- D (or $\frac{1}{Q}$) of C or L:** $\pm 0.0005 \pm 5\%$ at 1 kc or lower.
 $\pm 0.0005f_{kc} \pm 5\%$ above 1 kc.
- Q of R or G:** $\pm 0.0005f_{kc} \pm 2\%$.

GENERATOR AND DETECTOR

- Internal Oscillator:** 1 kc $\pm 1\%$ normally supplied. Plug-in modules for other frequencies available on request. Level control provided.
- Internal AC Detector:** Can be used either flat or selective at frequency of plug-in module (normally 1 kc). Second-harmonic rejection approximately 25 db; sensitivity control provided.
- Internal DC Supplies:** 3.5 volts, 35 volts, 350 volts, adjustable, and power limited to less than $\frac{1}{3}$ watt.
- External Oscillator and Detector:** For measurement at other frequencies from 20 cps to 20 kc, TYPE 1210-C Unit R-C Oscillator (page 105), the TYPE 1311-A Audio Oscillator (page 109), and TYPE 1232-A Tuned Amplifier and Null Detector (page 79) are recommended.
- DC Bias:** Provision is made for biasing capacitors to 500 volts with external supplies, and for biasing current in inductors.

GENERAL

- Accessories Supplied:** TYPE CAP-22 Power Cord, spare fuses, spare indicator lamps.
- Accessories Available:** TYPE 1650-P1 Test Jig (page 35); external generator and detector, if used, as listed above.
- Power Requirements:** 105 to 125 (or 210 to 250) volts, 50 to 60 cps, 10 watts.
- Cabinet:** Rack-bench (see page 210).
- Dimensions:** Bench model — width 19, height 12 $\frac{1}{2}$, depth 11 $\frac{1}{2}$ inches (485 by 320 by 295 mm), over-all; rack model — panel, 19 by 12 $\frac{1}{4}$ inches (485 by 315 mm), depth behind panel 10 inches (255 mm).
- Net Weight:** Bench model, 36 $\frac{3}{4}$ pounds (17 kg); rack model, 34 $\frac{3}{4}$ pounds (15.8 kg).
- Shipping Weight:** Bench model, 50 pounds (22.7 kg); rack model, 48 pounds (22 kg).

For a complete description, see *General Radio Experimenter*, 36, 3, March, 1962.

Type		Code Number	Price
1608-AM	Impedance Bridge, Bench Model	1608-9801	\$1300.00
1608-AR	Impedance Bridge, Rack Model	1608-9811	1300.00



Type 1650-A IMPEDANCE BRIDGE

BRIDGES — IMPEDANCE
UNIVERSAL (1%)

FEATURES:

- ♦ Completely self-contained and portable.
- ♦ Wide impedance range, covering all commonly used components.
- ♦ ORTHONULL[®] balance finder to facilitate low-*Q* balances. ♦ Visual null indicator.
- ♦ Transistor oscillator and detector powered by commonly available "D" cells.
- ♦ Provision for applying dc bias. ♦ Easy-to-read dials.
- ♦ Very small residual errors. ♦ Long battery life; easy replacement.

USES: The TYPE 1650-A Impedance Bridge will measure the inductance and storage factor, *Q*, of inductors,* the capacitance and dissipation factor, *D*, of capacitors, and the ac and dc resistance of all types of resistors.

In the laboratory it is extremely useful for measuring the circuit constants in experimental equipment, testing preliminary samples, and identifying unlabeled parts. In the shop and on the test bench it has many applications for testing and component sorting.

Three-terminal measurements can be made in the presence of considerable stray capacitance to ground.

DESCRIPTION: This bridge is a completely self-contained and portable instrument. Five separate bridge circuits are included to give flexibility and wide range. Battery-powered, low-drain transistor oscillator and detector are included. The panel meter indicates both dc and ac bridge

* Including such low-*Q* inductors as rf coils measured at 1 kc.

unbalances, and, therefore, earphones are not required.

The measured quantities, *R*, *L*, *C*, *D*, and *Q*, are indicated directly on dials with logarithmic scales. No multiplier is necessary for the *D* and *Q* indications, and the *C*, *R*, or *L* multiplier and the units of measurement are indicated by the range switch setting.

The bridge circuits are made up of high-quality, stable components to give accuracy for many years under a wide range of conditions. The ORTHONULL balance finder, a patented mechanical-ganging device, is used to make low-*Q* (high-*D*) balances possible without a "sliding null." This mechanism, which may be switched in or out as desired, adds accuracy as well as convenience and makes easy many low-*Q* measurements that are practically impossible on other impedance bridges.

The Flip-Tilt case provides a handle and a captive, protective cover and allows the bridge panel to be tilted and held firmly at any angle.

SPECIFICATIONS

RANGES OF MEASUREMENT

Resistance: 1 milliohm to 11 megohms, eight ranges, ac or dc.

Capacitance: 1 pf to 1100 μ f, seven ranges, series or parallel.

Inductance: 1 μ h to 1100 h, seven ranges, series or parallel.

D: (of series capacitance) — 0.001 to 1 at 1 kc.
(of parallel capacitance) — 0.1 to 50 at 1 kc.
($C_s = C_p$ within 1% if $D < 0.1$.)

Q: (of series inductance) — 0.02 to 10 at 1 kc.
(of parallel inductance) — 1 to 1000 at 1 kc.
($L_s = L_p$ within 1% if $Q > 10$.)

ACCURACY

AC Resistance: $\pm 1\% \pm 1$ milliohm (residual $R = 1$ milliohm).

DC Resistance: 1% from 1 ohm to 100 kilohms. An external dc supply is required for 1% accuracy above 100 kilohms.

Capacitance: $\pm 1\% \pm 1$ pf (residual $C = 0.5$ pf).

Inductance: $\pm 1\% \pm 1$ μ h (residual $L < 0.2$ μ h).

D: $\pm 5\% \pm 0.001$ at 1 kc or lower.

1/Q: $\pm 5\% \pm 0.001$ at 1 kc or lower.

Frequency: (1 kc supplied internally)

1% accuracy for *R*, 20 cps to 5 kc; for *L* and *C*, 20 cps to 20 kc. *D* and *Q* ranges are functions of frequency. With reduced accuracy, measurements can be made up to 100 kc.

GENERATOR AND DETECTOR

Internal Oscillator Frequency (external ac and dc sources can also be used): 1 kc $\pm 2\%$.



COMPLETELY SELF-CONTAINED
UNIVERSAL BRIDGE

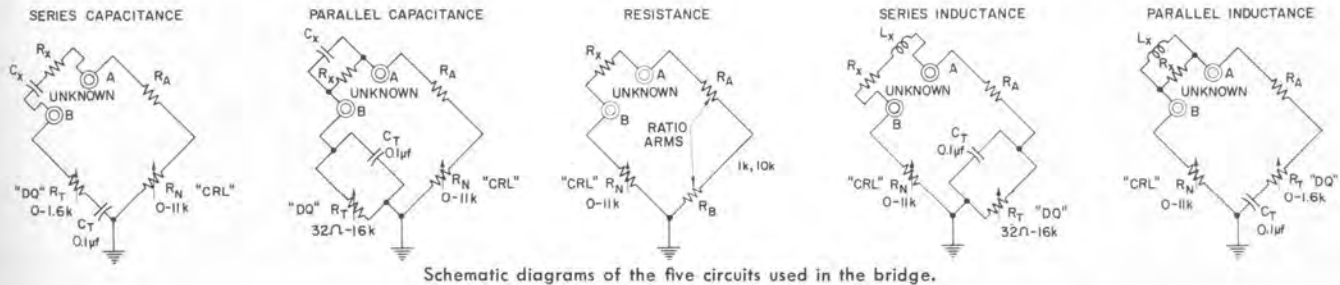

Schematic diagrams of the five circuits used in the bridge.

Internal Detector: Response, flat or selective at 1 kc; sensitivity control provided.

Internal DC Supply: 6 volts, 60 milliamperes, maximum.

Power Requirements: 4 D cells, supplied. Current drain (ac measurements) 10 milliamperes.

External Oscillator and Detector: TYPE 1210-C Unit R-C Oscillator (page 105), TYPE 1311-A Audio Oscillator, and TYPE 1232-A Null Detector (page 79) are recommended for audio measurements at frequencies other than 1 kc.

DC Polarization: 600 volts may be applied (from external source) for series capacitance measurements.

GENERAL

Accessories Available: TYPE 1650-P1 Test Jig.

Other Accessories Required: None. Earphones can be used for high precision at the extremes of the bridge ranges.

Cabinet: Flip-Tilt; relay-rack model also available (see page 210).

Dimensions: Portable model, case closed — width 12 3/4, height 12 1/2, depth 7 3/4 inches (325 by 320 by 200 mm), over-all; rack model — panel 19 by 12 1/4 inches (485 by 315 mm); depth behind panel 5 inches (130 mm).

Net Weight: Portable model, 17 pounds (8 kg); rack model, 18 pounds (8.5 kg).

Shipping Weight: Portable model, 28 pounds (12.8 kg); rack model, 30 pounds (13.6 kg).

For a more complete description of this instrument send for General Radio Reprint No. E-108.



Flip-Tilt cabinet holds bridge firmly tilted at almost any angle and provides protection when bridge is not in use.

Type 1650-9820 Impedance Bridge, for relay-rack mounting.

Type		Code Number	Price
1650-A	Impedance Bridge, Portable Model	1650-9701	\$460.00
1650-9820	Impedance Bridge, Rack Model	1650-9820	460.00

PATENT NOTICE. See Notes 1, 15, 19, and 22, page viii.

Type 1650-P1 TEST JIG

This test-jig adaptor provides a way to connect components quickly to a pair of terminals, which can be placed on the bench directly in front of the operator. Thus, the test jig and TYPE 1650-A Impedance Bridge make a rapid and efficient component sorting device when the panel meter of the bridge is used as a limit indicator.

The test jig makes a three-terminal connection to the bridge, so that the residual zero capacitance is negligible. The lead resistance (0.08 ohm total) has effect only when very low impedances are measured, and the lead capacitance affects only the measurement of the *Q* of inductors, introducing a small error in *D* (or $\frac{1}{Q}$) of less than 0.007.

Net Weight: 10 ounces (285 grams).

Shipping Weight: 2 1/2 pounds (1.2 kg).

MINIMIZES EFFECTS OF
LEAD CAPACITANCE



Type		Code Number	Price
1650-P1	Test Jig	1650-9601	\$19.00

ACCURACY

Capacitance — direct-reading, internal standard: $\pm 0.01\%$, from 1 pf to 1 μf . At high capacitances and high end of frequency range, error is $+0.002\% C\mu\text{f} \left(\frac{f}{1000}\right)^2$. At low capacitance and low frequency, accuracy may be limited by bridge sensitivity.

Capacitance — comparison with external standard: approximately 1 ppm.

Conductance: $\pm (1\% + 0.00001 \mu\text{mho})$.

Dissipation Factor: Direct reading, $\pm (0.1\% \text{ of measured value}) + 0.00001$.

GENERAL

Temperature Coefficients of Internal Standards: Less than 5 ppm/ $^{\circ}\text{C}$ for the 1000-, 100-, and 10-pf units; slightly greater for the smaller capacitance units.

Maximum Safe Generator Voltage: 30 volts at 1 kc. Proportional to frequency. If generator and detector connections are interchanged, 300 volts can be applied.

Accessories Required: Generator and detector; the TYPE 1311-A Audio Oscillator and the TYPE 1232-A Tuned Amplifier and Null Detector are recommended. See below for complete assembly.

Accessories Supplied: TYPE 874-WO Open-Circuit Termination, TYPE 874-R22A Patch Cord, and TYPE 274-NL Patch Cord.

Cabinet: Rack-bench (see page 210).

Dimensions: Bench model — width 19, height $12\frac{3}{4}$, depth $10\frac{1}{2}$ inches (485 by 325 by 270 mm), over-all; rack model — panel 19 by $12\frac{1}{4}$ inches (485 by 315 mm), depth behind panel $8\frac{1}{2}$ inches (220 mm).

Net Weight: $38\frac{1}{2}$ pounds (17.5 kg).

Shipping Weight: 58 pounds (27 kg).

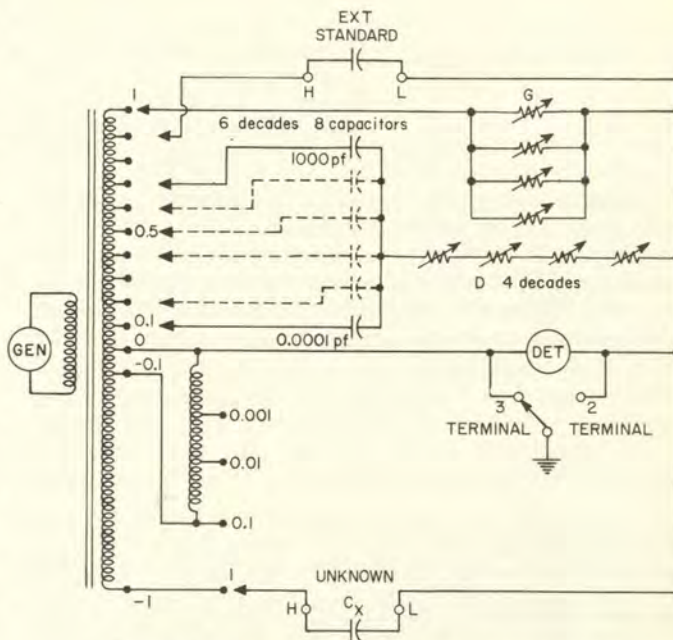

Elementary schematic diagram of the capacitance bridge.

Type		Code Number	Price
1615-AM	Capacitance Bridge, Bench Model	1615-9801	\$1475.00
1615-AR	Capacitance Bridge, Rack Model	1615-9811	1475.00
1615-P1	Range-Extension Capacitor	1615-9601	35.00

PATENT NOTICE. See Note 4, page viii.

Type 1620-A CAPACITANCE-MEASURING ASSEMBLY

The TYPE 1620-A Capacitance-Measuring Assembly consists of the TYPE 1615-AM Capacitance Bridge with the TYPE 1311-A Audio Oscillator and the TYPE 1232-A Tuned Amplifier and Null Detector, thus providing a complete system for the precise measurement of capacitance over the range of 10 μpf to 1 μf (10^{-17} to 10^{-6} farad). Frequency range is approximately 50 cps to 10 kc. The system has sufficient sensitivity to realize the full six-place resolution of the bridge for all measurements except for very small capacitances at the lower frequencies.

Oscillator and detector are mounted side by side as shown in the photograph. The end frames are bolted together to make a rigid assembly without the use of a relay rack. Connection cables are supplied.

The oscillator operates from the power line, the detector from internal batteries.

Type		Code Number	Price
1620-A	Capacitance-Measuring Assembly	1620-9701	\$2065.00

View of the Type 1620-A Capacitance-Measuring Assembly.





Type 716-C CAPACITANCE BRIDGE

USES:

At frequencies from 30 cps to 300 kc, this direct-reading bridge measures capacitance and dissipation factor by either direct or substitution methods.

Designed to measure 2-terminal capacitance, it can be adapted for 3-terminal measurement by addition of a guard circuit.

It is well suited to the measurement of the dielectric properties of insulating materials — dielectric constant, dissipation factor, loss factor, phase angle — and their change with frequency, temperature, and humidity.

Capacitors beyond the range of the internal standards can be measured by substitution methods.

Other possible substitution measurements are the inductance and Q of large inductors, the inductance and resistance of cables, the resistance and parallel capacitance of high-valued resistors, and conductance and parallel resistance of electrolytes.

DESCRIPTION: The TYPE 716-C Capacitance Bridge is a modified Schering bridge. To obtain a wide and direct-reading capacitance range at 1 kc, the ratio arms are switched to give decade multipliers of 1 to 1000. At other

frequencies, the maximum direct-reading capacitance is that of the internal standard, which is a worm-driven, precision, variable capacitor. Careful shielding to eliminate the effects of stray capacitance permits a direct-reading accuracy of 0.1%.

FEATURES:

- ♦ Wide frequency range, 30 cps to 300 kc.
- ♦ Direct-reading dials.
- ♦ Convenient to operate.
- ♦ Flexible in application.

SPECIFICATIONS

RANGES OF MEASUREMENT

Capacitance, direct-reading: 100 pf to 1.1 μ f at 1 kc; 100 pf to 1150 pf at 100 cps, 10 kc, and 100 kc.

Capacitance, substitution: 0.1 pf to 1050 pf with the internal standard. 0.1 pf up to value of available standard with external standard.

Dissipation Factor, direct-reading: 0.00002 to 0.56.

Dissipation Factor, substitution: $0.00002 \text{ to } 0.56 \times \frac{C_{\text{standard}}}{C_{\text{unknown}}}$

Frequency: 30 cps to 300 kc.

ACCURACY

Capacitance, direct-reading: $\pm 0.1\% \pm (0.6 \text{ pf} \times \text{capacitance multiplier setting})$ when $D < 0.01$.

Capacitance, substitution: $\pm 1.2 \text{ pf}$.

A correction chart for the precision capacitor is supplied, which allows a substitution measurement accuracy of $\pm 0.05\%$ or $\pm 0.6 \text{ pf}$.

A 100-point calibration of the standard capacitor is available, at extra charge, which allows substitution measurements to be made with an accuracy of $\pm 0.05\%$ or $\pm 0.2 \text{ pf}$.

Dissipation Factor, direct-reading: ± 0.0005 or $\pm 2\%$ of dial reading, whichever is larger.

Dissipation Factor, substitution: ± 0.00005 or $\pm 2\%$ for the change in D when the change is less than 0.06.

Formulae are supplied for making corrections when D is greater than these limits.

Zero Capacitance Across the Unknown Terminals: Approximately 1 pf (negligible in substitution measurements or direct measurements with the multiplier at 10 or higher).

Temperature and Humidity: Variations of temperature from 65 to 95 F have no significant effect on the accuracy of the bridge. Precise measurements of dissipation factor should not be attempted when the bridge has been exposed to abnormally high relative humidity, unless it is first dried by heat or a desiccant.

Power Input: 1 watt, maximum, at GENERATOR terminals, which allows a maximum of 200 volts at 1 kc, or 50 volts at 60 cps. If the generator and detector connections are interchanged, 700 volts can be applied at 1 kc and lower.

Accessories Supplied: One TYPE 274-NL Shielded Patch Cord and one TYPE 874-R34 Patch Cord.

Accessories Required: Oscillator, high-impedance detector, and, for substitution measurements, a balancing capacitor. The TYPE 1311-A Audio Oscillator (page 109) or the TYPE 1210-C Unit R-C Oscillator (page 105) and the TYPE 1232-A Null Detector (page 79) are recommended. The TYPE 1422 Precision Capacitor and the TYPES 505, 1409, and 1401 Fixed Capacitors are recommended for use as balancing capacitors. For dielectric measurements, the TYPE 1690-A Dielectric Sample Holder can be used.

Mounting: Relay-rack or hardwood cabinet.

Dimensions: Rack model—width 19, height 14 inches (485 by 360 mm), depth behind panel 9 inches (230 mm); cabinet model—width 21 $\frac{3}{4}$, height 14 $\frac{1}{4}$, depth 11 $\frac{1}{4}$ inches (555 by 365 by 290 mm), over-all.

Net Weight: Rack model, 30 $\frac{1}{2}$ pounds (14 kg); cabinet model, 40 $\frac{1}{2}$ pounds (17 kg).

Shipping Weight: Rack model, 45 pounds (20.3 kg); cabinet model, 55 pounds (25 kg).

Type		Code Number	Price
716-CM	Capacitance Bridge, Cabinet Model	0716-9803	\$825.00
716-CR	Capacitance Bridge, Rack Model	0716-9813	785.00
	100-Point Calibration for Internal Precision Capacitor	0716-9728	50.00

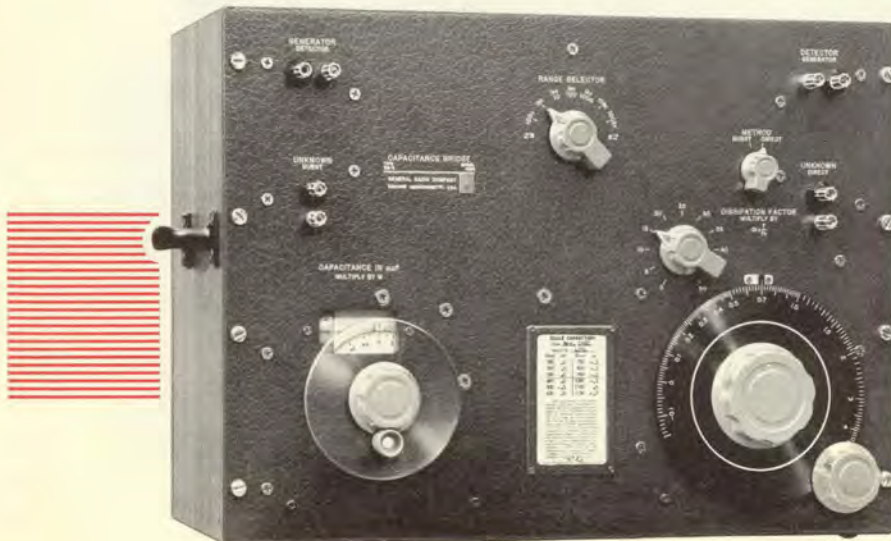



Type 716-CS1 CAPACITANCE BRIDGE

BRIDGES — CAPACITANCE
WIDE-RANGE



FOR CAPACITANCE MEASUREMENTS
UP TO 1150 pf AT 1 Mc

Both commercial and military specifications for capacitors of 1000 pf and less call for measurements of capacitance and dissipation factor at a frequency of 1 Mc. The TYPE 716-CS1 Capacitance Bridge has been designed specifically for these measurements. It is also satisfactory for measuring dielectrics with the TYPE 1690-A Dielectric Sample Holder at the ASTM test frequency of 1 Mc.

This bridge, a modification of the standard TYPE 716-C model, has a single capacitance range and a more limited frequency range.

SPECIFICATIONS

RANGE AND ACCURACY

Range and accuracy specifications are identical with those of TYPE 716-C Capacitance Bridge, except that the direct-reading capacitance range is 100 to 1150 pf.

The stated accuracy is for 1-Mc measurements. The same accuracy can be obtained from 0.1 Mc to 3 Mc if corrections are made for the effects of residual impedances and if adequate selectivity is provided by the null detector. With decreased accuracy, measurements up to 5 Mc can be made.

Accessories Required: Generator and detector. For measurement at 1 Mc only, the TYPE 1214-M Unit Oscillator (page 110) is the recommended generator; for measurements over the range of 0.5 to 3 Mc, the TYPE 1211-C Unit Oscillator with Unit Power Supply (page 114). For measurements at 1 Mc only, a convenient detector is the TYPE

1212-A Unit Null Detector (page 80) with TYPE 1212-P2 1-Mc Filter. For operation at frequencies other than 1 Mc, this null detector, with the TYPE 1212-P3 Mixer and a heterodyning local oscillator, can be used.

For substitution measurements, a balancing capacitor is needed. This may be a fixed TYPE 505, 1409, or 1401 Capacitor or a variable TYPE 1422 Precision Capacitor (pages 148-157).

Accessories Supplied: Two TYPE 874-R34 Patch Cords, to fit the above generators and detectors.

Other Accessories Available: For measurements on unguarded dielectric specimens, the TYPE 1690-A Dielectric Sample Holder (page 41).

Other specifications are the same as those for the standard TYPE 716-C.

Type	Code Number	Price
716-CMS1	Capacitance Bridge, Cabinet Model	0716-9843 \$750.00
716-CRS1	Capacitance Bridge, Rack Model	0716-9846 710.00
	100-Point Calibration for Internal Precision Capacitor	0716-9728 50.00

PATENT NOTE. See Note 4, page viii.



Type 716-P4 GUARD CIRCUIT

The guard circuit facilitates three-terminal measurements such as guarded dielectric samples at frequencies up to 300 kc. It is particularly useful in the measurement of components and materials over wide ranges of frequency,

temperature, and humidity, because it eliminates from the measurement the effects of the leads from the bridge to the sample in its conditioning apparatus. A schematic circuit is shown on page 29.

SPECIFICATIONS

Capacitance Range: Designed for use with the 1-multiplier range, 100-1150 pf, of the TYPE 716-C Capacitance Bridge. The range can be extended by the addition of external capacitance to the standard arm of the bridge.

Frequency Range: 30 cps to 300 kc.

Guard Balance Capacitor: Any value of capacitance up to 1000 pf between the guard point and the high measuring terminal can be balanced out.

Accessories Supplied: One TYPE 874-Q2 Coaxial Adaptor and one TYPE 838-B Alligator Clip.

Mounting: Relay-rack or hardwood cabinet.

Dimensions: Width 19, height 9 1/8, depth 8 3/4 inches (485 by 225 mm), over-all.

Net Weight: Rack model, 17 pounds (8 kg); cabinet model, 23 pounds (10.5 kg).

Shipping Weight: Rack model, 29 pounds (13.5 kg); cabinet model, 37 pounds (17 kg).

Type	Code Number	Price
716-P4M	Guard Circuit, Cabinet	0716-9943 \$350.00
716-P4R	Guard Circuit, Rack Model	0716-9945 330.00

PATENT NOTICE. See Note 4, page viii.



COMPLETE MEASURING SYSTEMS — See next page for complete, rack-mounted assemblies.



Type 1610 CAPACITANCE-MEASURING ASSEMBLIES

USES: Each TYPE 1610 Capacitance-Measuring Assembly is a complete system for the measurement of capacitance and dissipation factor. Measurements can be made by either direct or substitution methods.

DESCRIPTION: The TYPE 1610-B Capacitance-Measuring Assembly, which includes a guard circuit, makes both 2-terminal and 3-terminal measurements over the frequency range of 20 cps to 100 kc. Thus it is well suited for studies of the frequency characteristics of dielectric samples and components in conditioning chambers.

When only 2-terminal measurements are to be made, the guard circuit is unnecessary, and the TYPE 1610-B2 Capacitance-Measuring

Assembly, which covers the same frequency range, is used.

The TYPE 1610-AH Capacitance-Measuring Assembly is used for 2-terminal measurements at 1 Mc. The Dielectric Sample Holder, TYPE 1690-A (page 41), is recommended for use with any of these assemblies in the measurement of solid-dielectric specimens. All assemblies include cabinet rack, rack adaptor panels, connecting cables, spare fuses, and power cord.

SPECIFICATIONS

RANGES OF MEASUREMENT		Type 1610-B	Type 1610-B2	Type 1610-AH
Frequency		20 cps to 20 kc, 50 kc, 100 kc		
C	Direct, 2-terminal	100 pf to 1.1 μ f	100 pf to 1.1 μ f	100 pf to 1150 pf
	Substitution, 2-terminal	0.1 pf to 1050 pf	0.1 pf to 1050 pf	0.1 pf to 1050 pf
	Direct, 3-terminal	100 pf to 1150 pf		
	Substitution, 3-terminal	0.1 pf to 1050 pf		
D	Direct	0.0002 to 0.56		
	Substitution	0.0002 to 0.56 multiplied by C_{STD}/C_{UNK}		

ACCURACY, NOMINAL

Capacitance: $\pm 0.1\%$. Dissipation Factor: $\pm 2\%$ of dial. For complete statement, see bridge specifications.

GENERAL

	105 to 125 volts,† 50 to 60 cps*		
	50 watts	50 watts	100 watts
Dimensions	Width 22½, height 43, depth 20 inches (570 by 1090 by 510 mm), over-all		
Net Weight	203 pounds (93 kg)	180 pounds (83 kg)	150 pounds (69 kg)
Shipping Weight	305 pounds (140 kg)	280 pounds (129 kg)	241 pounds (111 kg)
Code Number	1610-9702	1610-9481	1610-9817
Price	\$2000.00	\$1650.00	\$1250.00

* Assembly will operate satisfactorily at power-supply frequencies up to 400 cps, provided that supply voltage is at least 115 volts.

† TYPE 1610-BQ18 for 210- to 250-volt, 50- to 60-cycle supply. Code Number: 1610-9818. Price: \$2010.00.

TYPE 1610-B2Q18 for 210- to 250-volt, 50- to 60-cycle supply. Code Number: 1610-9482. Price: \$1660.00.

PATENT NOTICE. See Notes 4 and 15, page viii.

TYPE
1610-B

Type 716-C Capacitance Bridge
Type 716-P4 Guard Circuit
Type 1210-C Unit R-C Oscillator
Type 1203-B Unit Power Supply
Type 1232-A Null Detector

TYPE
1610-B2

Type 716-C Capacitance Bridge
Type 1210-C Unit R-C Oscillator
Type 1203-B Unit Power Supply
Type 1232-A Null Detector

TYPE
1610-AH

Type 716-CS1 Capacitance Bridge
Type 1214-M Unit Oscillator
Type 1212-A Unit Null Detector
Type 1212-P2 1-Mc Filter
Type 1203-B Unit Power Supply

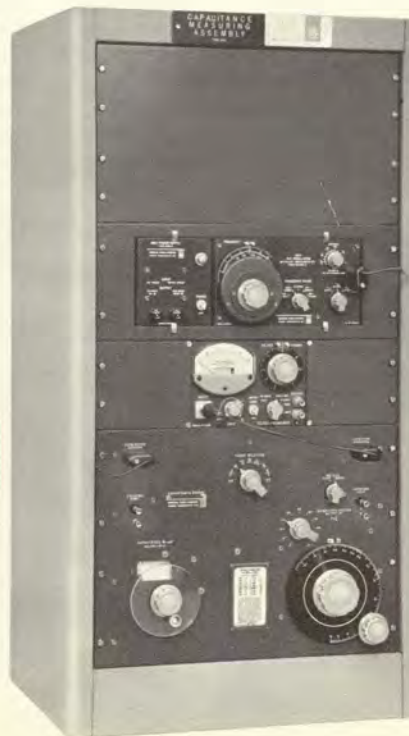



Type 1690-A DIELECTRIC SAMPLE HOLDER

FEATURES:

- ◆ Specimens can be measured over a wide range of frequencies with the same holder in different measuring circuits.
- ◆ Precision calibration provided for each holder.
- ◆ Calibration takes account of corrections for edge fringing and stray capacitance.
- ◆ Rigid casting supports entire structure. ◆ Complete shielding.
- ◆ Large, easily read dials.
- ◆ "Floating" electrode protects precision drive.

USES: The TYPE 1690-A Dielectric Sample Holder is a micrometer-driven sample holder of the Hartshorn type,* used for the measurement of dielectric constant and dissipation factors of specimens of dielectric materials in the form of standard ASTM 2-inch diameter disks. It is suitable for any flat sample whose largest dimension is not over 2 inches and whose thickness is not over 0.3 inch.

* L. Hartshorn and W. H. Ward, *Proceedings of the Institution of Electrical Engineers*, Vol. 79, pp 597-609 (1936).

It can be used, for example, with resonant circuits for susceptance-variation or frequency-variation measurements, with the TYPES 1615-A, 716-C and 716-CS1 Capacitance Bridges, the TYPES 874-LBA and 900-LB Slotted Lines, and the TYPE 1602-B UHF Admittance Meter.

A precision micrometer screw, M, with large instrument knob, K, drives the movable grounded electrode, L, with respect to a fixed, insulated electrode, H. An accurately divided drum, D, indicates the electrode spacing. The micrometer screw is electrically shunted by a metal bellows, S, to assure a positive, low-resistance connection. A release mechanism automatically disengages the drive to prevent damage from excessive mechanical pressure when the electrodes are in contact. The movable electrode adjusts itself to the plane of the specimen surface.

A cylindrical vernier capacitor with micrometer screw, V, is provided for use in the susceptance-variation method of measurement.

The assembly is mounted in a rugged aluminum casting, B, which shields it on four sides. The shielding is completed by two removable cover plates, which permit access to the electrodes. The holder can be mounted on either horizontal or vertical panels.

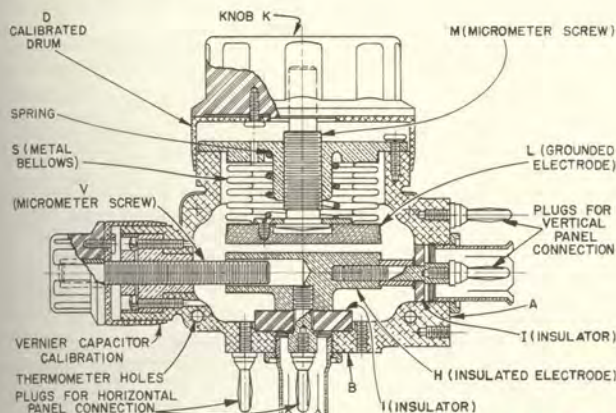

SPECIFICATIONS

Electrodes: Diameter, 2.000 inches \pm 0.0025 inch. Surfaces are ground optically flat within a few wavelengths.

Electrode Spacing: Adjustable from zero to 0.3 inch, indicated by the micrometer reading in mils.

Vernier: Incremental capacitance is 5 pf, nominal.

Calibration: For the main capacitor, a chart gives the calculated air capacitance as a function of spacing. A correction curve gives the measured deviations from calculated values over the range from 300 mils to 10 mils spacing. In accordance with recommended ASTM practice, this calibration is referred to the calculated geometric value at a spacing of 100 mils. Accuracy is $\pm 0.2\%$ \pm 0.1 mil.

For the vernier capacitor, a correction chart is provided, from which capacitance differences can be determined to an accuracy of ± 0.004 pf.

Zero Capacitance: Approximately 11 pf.

Operating Temperature: Up to 150 C.

Frequency: No significant error occurs at frequencies below 100 Mc.

Accessories Supplied: TYPE 1690-P1 Adaptor Assembly for mounting to the TYPES 1615-A, 716-C and -CS1 Capacitance Bridges; hardware for mounting sample holder on TYPES 1611-B and 544-B Bridges and TYPE 1862-C Megohmmeter.

Accessories Available: TYPE 1690-P2 Adaptor Assembly to TYPE 874-LBA Slotted Line or TYPE 1602-B UHF Admittance Meter.

Mounting: Wooden carrying case supplied, which provides storage for hardware and calibration charts.

Dimensions: Mounted on adaptor—6¼ by 5¾ by 4½ inches (160 by 150 by 115 mm), over-all.

Net Weight: 3¾ pounds (1.8 kg), excluding carrying case.

Shipping Weight: 13 pounds (6 kg), including carrying case.

For a more complete description of this instrument refer to the *General Radio Experimenter*, 26, 3, August, 1951.

Type		Code Number	Price
1690-A	Dielectric Sample Holder	1690-9701	\$435.00
1690-P2	Adaptor Assembly (for connection to coaxial equipment)	1690-9602	20.00

PATENT NOTICE. See Note 4, page viii.

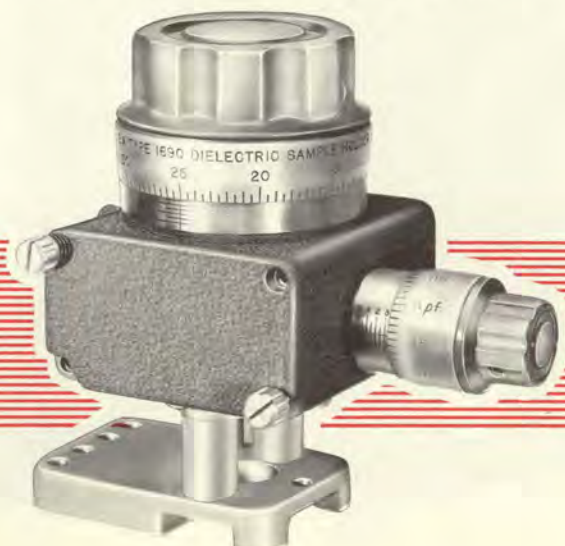

◆ Type 1611-B CAPACITANCE TEST BRIDGE

FEATURES:

- ◆ Wide range — 0 to 11,000 μ f.
- ◆ Measures both 2- and 3-terminal capacitors.
- ◆ Visual null indicator.
- ◆ External polarizing voltage can be applied.
- ◆ Measures polarized electrolytics under conditions of actual use — with 120-cycle ripple.
- ◆ Measurements are unaffected by moderate electrostatic fields.

USES: Capacitance and dissipation-factor measurements can be made quickly and conveniently with this bridge. Among its uses in shop and laboratory are the measurement and test of:

- Paper and mica capacitors.
- Polarized electrolytic capacitors (also tantalytics) at 60 cps without external generator (50 cps for TYPE 1611-BQ1).
- Dielectric properties of solid insulation and transformer oil.
- Cables — testing and fault location.

Insulators and insulation — bushings, transformers, rotating machines.

- Capacitance components for electric equipment.
- Transformer interwinding and intershield capacitance.

DESCRIPTION: The series-resistance capacitance bridge circuit is used. A shield terminal is provided for 3-terminal measurements. The null detector consists of a tuned amplifier and electron-ray tube. Measurements are made at the power-line frequency. External generator can be connected for 120 cps and other frequencies.

SPECIFICATIONS

RANGES OF MEASUREMENT

Capacitance: 0 to 11,000 μ f at 60 cps; 1 μ f to 11,000 μ f at 120 cps and other externally supplied frequencies.

Dissipation Factor: TYPE 1611-B, 0 to 60% at 60 cps; TYPE 1611-BQ1, 0 to 50% at 50 cps. Range is proportional to frequency (0 to 120% at 120 cps).

ACCURACY

Capacitance: $\pm(1\% + 1 \text{ pf})$.

Dissipation Factor: $\pm(2\% \text{ of dial reading} + 0.05\% \times \frac{f}{60^*})$.

VOLTAGE

AC Voltage on Capacitor under Test: Varies from a maximum of approximately 125 volts at 100 pf to less than 1 volt at 10,000 μ f. A maximum of one voltampere of reactive power is delivered to the sample. Voltage can be reduced by an external rheostat on the four highest ranges for measurement of tantalum capacitors.

Polarizing Voltage: A dc polarizing voltage of up to 500 volts can be applied externally for measurements on capacitors of 1 to 11,000 μ f.

GENERAL

Sensitivity: Capacitances from 100 pf to 10,000 μ f can be balanced to a precision of at least 0.1%.

* $\frac{f}{50}$ for TYPE 1611-BQ1.

Selectivity: Detector filter is tuned to power-line frequency or 120 cps, selected by switch. External filter can be connected at panel jack for other frequencies.

External Fields: For bushing testing, the fields usually encountered in shop and laboratory, even up to several thousand volts, will not affect the accuracy. For measurements in locations where the overhead voltages are very high, the unknown should be shielded.

External Generator: Required for frequencies other than 60 cps. TYPE 1214-D Unit Oscillator (page 110) is recommended for 120-cycle measurements.

Environmental Effects: The readings of the bridge are unaffected by temperature and humidity variations over the range of room conditions normally encountered (18 to 35 C, 0 to 90% RH).

Power Requirements: 105 to 125 (or 210 to 250) volts, 60 cps for TYPE 1611-B, 50 cps for TYPE 1611-BQ1. Power input is 15 watts.

Accessories Supplied: TYPE CAP-22 Power Cord and spare fuses.

Accessories Required: 120-cycle oscillator, if 120-cycle measurements are to be made. TYPE 1214-D Unit Oscillator is recommended.

Cabinet: Luggage-type, completely shielded to ensure freedom from electrostatic pickup.

Dimensions: Width 14 $\frac{1}{4}$, height 16, depth 10 inches (370 by 410 by 255 mm), over-all.

Net Weight: 30 $\frac{1}{2}$ pounds (14 kg).

Shipping Weight: 37 pounds (17 kg).



Type		Code Number	Price
1611-B	Capacitance Test Bridge	1611-9702	\$665.00
1611-BQ1	Capacitance Test Bridge, for 50-cycle supply	1611-9914	700.00
1214-D	120-cycle oscillator (including power supply)	1214-9704	115.00

WIDE-RANGE TEST BRIDGE FOR SHOP, FIELD, OR LABORATORY



Type 1613-A CAPACITANCE BRIDGE

BRIDGES — 400
CAPACITANCE

USES:

Test Set, Capacitance Bridge, TTU 24/E, Precision, Three-Terminal, Depot. Meets the essential requirements of MIL-T-4778 (USAF) for calibration of capacitive fuel-gage testers.* Also an excellent general-purpose bridge for 3-terminal capacitance measurements to 0.1%.

DESCRIPTION: The circuit is a transformer-ratio-arm bridge, direct reading in capacitance and dissipation factor at 400 cps. The direct impedance of the T network used in the standard side of the bridge balances the direct impedance of the unknown. The standard capacitor consists of a 50- to 1100-pf precision variable air unit and a 1000- to 10,000-pf decade of silvered-mica capacitors. Voltage on the unknown capacitor remains constant at 25 volts as the bridge ratio is changed. Generator frequency is practically independent of tube parameter changes. Frequency-determining components are GR

precision resistors and capacitors. A buffer cathode-follower amplifier prevents external loading from affecting the frequency.

FEATURES:

- ♦ Direct reading.
- ♦ Easy to operate — few balance controls; panel lights indicate direction of unbalance.
- ♦ No guard circuit necessary.
- ♦ Internal generator and detector.
- ♦ High detector selectivity.

* See page 155.

SPECIFICATIONS

RANGES OF MEASUREMENT

Capacitance: 5 to 11,000 pf.

Dissipation Factor: 0 to 0.11.

ACCURACY

Capacitance: $\pm 0.1\%$ from 11,000 to 40 pf, rising to 0.8% at 5 pf.

Dissipation Factor: $\pm 2\%$ of reading ± 0.0002 .

Internal-Oscillator Frequency: 400 cps — 25 volts, nominal output. 1000-cycle model can be supplied on special order.

DETECTOR

Sensitivity: 1-MULTIPLIER — 10% deflection for 0.05 pf ΔC . 1/10-MULTIPLIER — 10% deflection for 0.005 pf ΔC .

Selectivity: Down 44 db at 800 cps, down 72 db at 60 cps.

GENERAL

Effect of Impedance to Third Terminal (Chassis): Impedance from unshielded lead to chassis causes no bridge error. The output voltage is reduced approximately 50% by shunt impedance of 5 kilohms or 0.1 μf . On the 1-MULTIPLIER position, impedance of 1 kilohm or 0.1 μf from coaxial lead to chassis has a negligible effect. On the 1/10-MULTIPLIER, there is negligible effect from 10 kilohms or 0.01 μf .

Accessories Supplied: For connection to TYPE 1429-A Fuel-Gage Tester, two unshielded cable assemblies and one common shielded assembly; for connection to TYPE 03 Fuel-Gage Tester, one cable harness, including termination-unit assembly; for general-purpose three-terminal measurements, one coaxial and one unshielded cable

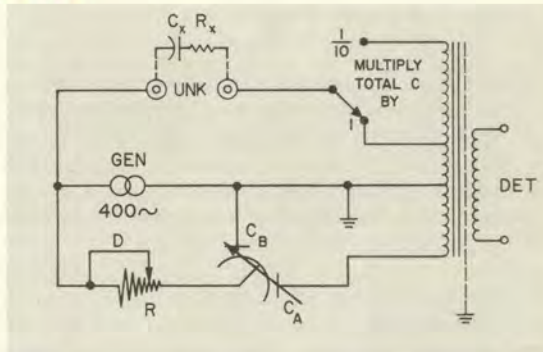

assembly, with TYPE 874 Connectors; desiccant; power cord. **Power Requirements:** 105 to 125 (or 210 to 250) volts, 50 to 60 cps. 30 watts input at 115-volt line. **Cabinet:** Steel, with detachable cover. **Dimensions:** Width 22½, height 14, depth 12¾ inches (575 by 360 by 325 mm), over-all, including cover. **Net Weight:** 55 pounds (25 kg). **Shipping Weight:** 67 pounds (30 kg).

Type	Code Number	Price	
1613-A	Capacitance Bridge	1613-9701	\$2175.00
	100-point Calibration for precision capacitor	1613-9728	50.00

PATENT NOTICE. See Note 4, page viii.





Type 1633-A INCREMENTAL-INDUCTANCE BRIDGE

BRIDGES—INDUCTANCE INCREMENTAL

FEATURES:

- ♦ Measures L and R or Q directly at nine frequencies. ♦ Wide ranges of measurement.
- ♦ High ac and dc power-handling capacity — up to 1250 volts and 50 amperes.
- ♦ Dc and ac can be impressed simultaneously on the coil being measured.
- ♦ Known induction levels can be set and maintained through a test procedure.
- ♦ No sliding balance. ♦ Both generator and detector can be grounded.
- ♦ Extensive safety precautions have been taken to avoid shock hazard to the operator and damage to the equipment.

USES: The measurement of incremental inductance, or the inductance of a coil under different conditions of dc and ac excitation, is important to both manufacturers and users of silicon steel and other magnetic alloys, ferrites, chokes, transformers, and filters. Such measurements can be made accurately and conveniently with the TYPE 1633-A Incremental-Inductance Bridge. It can also be used to measure nonlinear resistors and the ac impedance, with dc superposed, of rectifiers, Zener diodes, thermistors, and other semiconductor devices. Complete assemblies of bridge and power supplies are listed on the next page.

DESCRIPTION: This bridge uses a new circuit, which includes active elements,* in order to obtain wide operating ranges of inductance and current without the use of excessive numbers of resistance and capacitance decades. For each range a simple fixed capacitor and a single resistor are used, and the effect of changing magnitudes is simulated by changes in the applied voltage.

The active elements are three multistage, transistor, feedback amplifiers, designed to have parameters at least an order of magnitude more stable than is required for the desired bridge accuracy. Two are used for isolation, and, with their associated potentiometers, they form variable-voltage sources, with low output impedance, to simulate changes in magnitude of the fixed standards, C_s and G_s . The third amplifier is a phase inverter.

At balance, $I_1 + I_2 + I_3 + I_4 = 0$, and

$$L_x \sim \alpha R_B C_s, \quad R_x \sim \beta R_B G_s, \quad Q \sim \frac{\omega C_s}{\beta G_s}$$

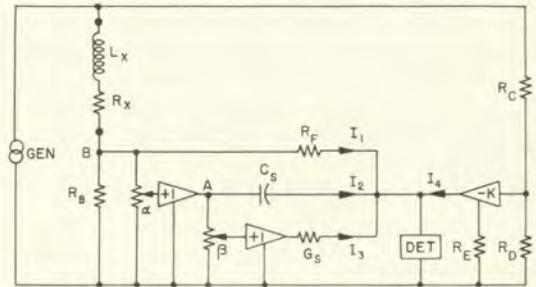

Where α and β = fractions of potentiometer voltage applied to the isolation amplifiers,
 R_B = ratio-arm resistance,
 C_s and G_s = capacitance and conductance standards.

Up to 7 amperes, rms (combined ac and dc), at up to 1250 volts, can be impressed on the sample, and, with a TYPE 1633-P1 Range-Extension Unit, up to 50 amperes. Three power supplies are available, a dc supply, a line-frequency supply, and a variable-frequency oscillator, which are designed specifically for use with the bridge. Most conventional power supplies are not suitable. See *Accessories Required* in Specifications.

The internal detector is highly selective at nine frequencies between 50 cps and 15.75 kc. Owing to high detector sensitivity and low noise, measurements can be made at excitation levels below one volt on the highest inductance ranges and 10 millivolts in the lowest range.

* H. P. Hall, R. G. Fulks, "The Use of Active Devices in Precision Bridges," *Electrical Engineering*, May 1962.



SPECIFICATIONS

RANGES OF MEASUREMENT

	Frequency	Full-Scale Ranges					Smallest Division	
		a	b	c	d	e		f
L	50, 60, 100, 120 cps	10 mh	100 mh	1 h	10 h	100 h	1000 h	20 μ h
	400, 800 cps, 1 kc	1 mh	10 mh	100 mh	1 h	10 h	100 h	2 μ h
	10 kc, 15.75 kc	100 μ h	1 mh	10 mh	100 mh	1 h	10 h	0.2 μ h
R	all	10 Ω	100 Ω	1 k Ω	10 k Ω	100 k Ω	1 M Ω	10 m Ω
Q	all	$\infty - 1$ Direct Reading at Above Frequencies					Q = 1000	
Max rms volts		12.5	125	1250	1250	1250	1250	
Max rms amp*†		7	7	7	2	0.7	0.2	

*Maximum rms current = $\sqrt{I_{dc}^2 + I_{ac}^2}$

† For those applications requiring more than 7 amperes, the TYPE 1633-P1 Range-Extension Unit, which contains a 0.1-ohm resistor, can be externally connected to shunt R_B on the three lowest bridge ranges; the inductance and resistance values are then reduced by a factor of 10. With this resistor, measurements up to 50 amperes, ac or dc, are possible.

ACCURACY

Inductance: $\pm 1\%$ of reading or 0.1% of full scale, $\pm \left(\frac{2\pi}{100} \times \frac{f_{kc}}{Q_x} \right) \%$.

Resistance: $\pm 2\%$ of reading or 0.1% of full scale, $\pm \frac{Q_x f_{kc}}{2\pi} \%$.

$\frac{1}{Q}$: $\pm 2\% \pm 0.001 \pm 0.0001 f_{kc}$.

INTERNAL DETECTOR

Frequency: Selective at any one of nine specific frequencies, accurate to $\pm 1\%$, 50, 60, 100, 120, 400, and 800 cps, and 1, 10, and 15.75 kc. (Can be used with external detector from 20 cps to 20 kc.)

Second-Harmonic Response: Approximately 60 db below fundamental.

GENERAL

Power Requirements: 105 to 125 (or 210 to 250) volts, 50 to 60 cps; approximately 6 watts.

Accessories Supplied: One TYPE CAP-22 Power Cord, spare fuses.

Accessories Required: Generator to cover desired ranges of frequency and power, and a source of dc bias current (if desired). For optimum

performance when dc bias is used, the ac supply must be capable of withstanding large dc currents in the output circuit, and the dc supply large ac currents. The following are recommended: TYPE 1265-A Adjustable DC Power Supply, 200 watts (page 177); TYPE 1266-A Adjustable AC Power Source, 200 voltamperes (page 177), for 60-cycle ac measurements; and TYPE 1308-A Audio Oscillator and Power Amplifier, 200 voltamperes (page 108) for measurements at the above nine frequencies and, with the TYPE 1232-A Null Detector (page 79), continuously over the audio-frequency range.

Accessories Available: TYPE 1633-P1 Range-Extension Unit.

Cabinet: Rack-bench (see page 210).

Dimensions: Bench model—width 19, height 12 $\frac{3}{4}$, depth 10 $\frac{1}{4}$ inches (485 by 325 by 260 mm), over-all; rack model—panel 19 by 12 $\frac{1}{4}$ inches (485 by 315 mm), depth behind panel 8 $\frac{3}{4}$ inches (225 mm).

Net Weight: Bench model, 31 pounds (14.5 kg); rack model, 29 pounds (13.2 kg).

Shipping Weight: Bench model, 50 pounds (22.8 kg); rack model, 48 pounds (21.8 kg).

For a complete description, with examples of measurements, see *General Radio Experimenter*, 36, 5, May, 1962.

Type		Code Number	Price
1633-AM	Incremental-Inductance Bridge, Bench Model	1633-9801	\$1050.00
1633-AR	Incremental-Inductance Bridge, Rack Model	1633-9811	1050.00
1633-P1	Range-Extension Unit (50 amperes)	1633-9601	125.00

PATENT NOTICE. See Notes 1 and 15, page viii.

View of the Type 1630-AV Inductance-Measuring Assembly. Space is provided at the top of the rack for the addition of an oscilloscope, which permits the current waveform or the hysteresis loop to be viewed during the measurements.



Type 1630 INDUCTANCE-MEASURING ASSEMBLIES

The TYPE 1630 Inductance-Measuring Assemblies are complete systems for the measurement of the inductance and loss of coils with ferromagnetic cores at high dc and ac excitation levels. Each assembly consists of the bridge and two 200-voltampere power supplies (one dc and one ac), a cabinet-type rack, as shown, and the necessary connecting cables. Two models are available:

Type 1630-AL
For 60-cycle measurements

Type 1633-A Incremental-Inductance Bridge
Type 1265-A Adjustable DC Power Supply
Type 1266-A Adjustable AC Power Source

Type 1630-AV
For measurements at 9 frequencies
from 50 cps to 15.75 kc

Type 1633-A Incremental-Inductance Bridge
Type 1265-A Adjustable DC Power Supply
Type 1308-A Audio Oscillator and Power Amplifier

The power supplies will produce 200-voltampere outputs into a wide range of load impedances and are designed to pass the large dc and ac currents required. Although these power supplies do not cover the full power capabilities of the bridge, they are adequate for all except extreme power ranges.

Type		Code Number	Price
1630-AL	Inductance-Measuring Assembly	1630-9831	\$2440.00
1630-AV	Inductance-Measuring Assembly	1630-9827	3230.00

PATENT NOTICE. See Notes 1, 7, and 15, page viii.



Type 1632-A INDUCTANCE BRIDGE

- FEATURES:**
- ♦ Wide range, 0.0001 μ h to 1111 h. ♦ $\pm 0.1\%$ direct-reading accuracy.
 - ♦ Six-figure resolution. ♦ Will detect 0.1 millimicrohenry.
 - ♦ Easy, fool-proof readout with in-line decade readings and indicated decimal points.
 - ♦ No sliding balance. ♦ Measures series or parallel inductance.
 - ♦ Circuits and instructions engraved on the panel.

USES: This bridge measures the series and the parallel components of two-terminal grounded inductors, at audio frequencies. Its high accuracy makes it suitable for standardization measurements, while its convenient in-line readout feature and the absence of a sliding balance make possible rapid, highly precise measurements.

DESCRIPTION: The bridge circuit is shown schematically on the panel. The standard reactance is a capacitor, which, owing to its very low residual impedances, exhibits a negligible change in its effective capacitance over the audio range. The Owen circuit also makes possible the use of the high accuracy of decade resistors for the inductance balance. The bridge can be made direct reading in either

series or parallel components of the unknown inductor.

Inductance is indicated by the setting of a six-decade control; conductance by the setting of four decades and a variable air capacitor. The inductance dials, which show only the pertinent digit of each decade, indicate directly either series or parallel inductance. Resistance, either series or parallel, is the reciprocal of the conductance setting. An eight-position multiplier automatically indicates both the decimal point and the units of measurement.

To obtain maximum accuracy for the measurement of both large and small values of inductance, the residual impedances associated with the "unknown" terminals have been minimized.

SPECIFICATIONS

Ranges of Measurement:

Inductance — 0.0001 μ h to 1111 h.

Conductance — 0.0001 micromho to 1111 mhos.

Frequency: Designed primarily for precise and accurate measurements at 1 kc and lower. Usable to at least 10 kc with some decrease in accuracy (see below).

Accuracy:

Inductance — $\pm 0.1\%$, direct reading, except at the extremes of the inductance, Q , and frequency ranges; $\pm 1\%$ on the lowest inductance range (0.0001 to 111 μ h).

When Q is less than unity, the accuracy is reduced to $(+0.05 - Q_B)\%/Q_X$. Values of Q_B at 1 kc are:

Range	a, b, c	d-Low Z	d-High Z e-Low Z	e-High Z f-Low Z	f-High Z g	h
R_B	1 Ω	10 Ω	100 Ω	1 k Ω	10 k Ω	100 k Ω
Q_B at 1 kc	$\pm 0.03\%$	$\pm 0.005\%$	$\pm 0.002\%$	$\pm 0.002\%$	$\pm 0.02\%$	$\pm 0.1\%$

For frequencies higher than 1 kc, multiply the Q_B values by f , the frequency in kilocycles. There is an additional error of $0.1 \times 10^{-8} f^2\%$ on the lowest inductance range and of $4 \times 10^{-8} f^2\%$ on the highest range.

Two nearly equal inductors can be intercompared to a precision of one part in 10^5 or better.

The bridge adds approximately 1 pf to the capacitance across the inductor.

Conductance — $\pm 1\%$ direct-reading accuracy, reduced at the extremes of the L and G decades, of Q , and of frequency. The C_N capacitor decades are adjusted within $\pm 1\% + 2$ pf.

When Q is greater than 10, the error, in either series resistance or parallel conductance, is increased to $Q_X (+0.05 \pm Q_B)\%$. See the table above for values of Q_B at 1 kc.

Above 1 kc, the value of Q_B is multiplied by f in kilocycles.

When the bridge reads series resistance with the L decades set at one-tenth full scale ($R_N = 10$ k Ω), there is an additional error of 0.15 $Q_X\%$ at 1 kc, which is proportional to frequency (with constant Q_X) and approximately proportional to the resistance (R_N) of the L decades.

Maximum Measurable Q: Series connection, proportional to frequency, 60 at 100 cps; parallel connection, 80 at 100 cps and R_N of 100,000 ohms, inversely proportional to frequency and to R_N .

Maximum Safe Bridge Input Voltage: One volt on low-inductance ranges to 100 volts on high ranges. Values engraved on panel.

Accessories Required: Generator — the TYPE 1311-A Audio Oscillator (page 109), the TYPE 1304-B Beat-Frequency Audio Generator (page 106), or the TYPE 1210-C Unit R-C Oscillator (page 105); detector — the TYPE 1232-A Null Detector (page 79).

Accessories Supplied: TYPE 274-NL Shielded Patch Cord and TYPE 874-R34 Patch Cord for generator and detector connection. TYPE 1632-P1 Transformer to match low bridge-input impedances to 600-ohm generators.

Cabinet: Aluminum, with aluminum panel. End frames can be removed for relay-rack mounting.

Dimensions: Width 19½, height 16, depth 10½ inches (495 by 410 by 270 mm), over-all; depth behind panel 8½ inches (230 mm).

Net Weight: 40 pounds (18½ kg).

Shipping Weight: 53 pounds (24.5 kg).

For a more complete description of this instrument refer to the *General Radio Experimenter*, 33, 11, November, 1959.



Type	1632-A
Inductance Bridge	

Code Number	1632-9701
Price	\$950.00



Type 544-B MEGOHM BRIDGE

FEATURES:

- ◆ Direct measurement to 10^{12} ohms.
- ◆ Approximately logarithmic scale.
- ◆ Constant voltage on unknown, independent of resistance magnitude.
- ◆ Voltage stabilization prevents surges in charging current.
- ◆ Safety features — insulated terminals and current limiters.

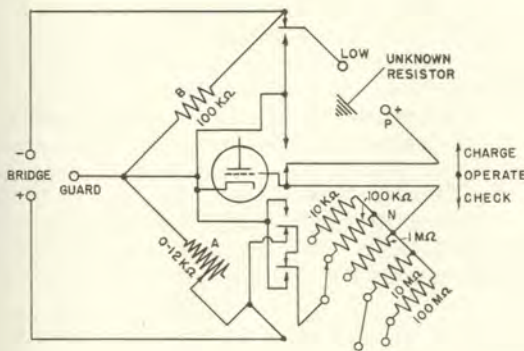

USES: The TYPE 544-B Megohm Bridge measures all types of resistances in the megohm ranges. These include composition, film, and carbon resistors, and the insulation resistance of electrical machinery, appliances, cables, and capacitors. Among other measurements are those of the volume resistivity of insulating materials, of dielectric absorption effects in the insulation of electrical machines, and, with an external decade resistor, the intercomparison of high-resistance standards.

DESCRIPTION: The circuit is a conventional Wheatstone bridge with a vacuum-tube voltmeter to indicate the null. Switching is included to check the meter zero and to charge capacitors quickly to full voltage before measurement.

SPECIFICATIONS

Range: 0.1 megohm to 1,000,000 megohms, covered by a dial and a 5-position multiplier switch. A resistance of 1,000,000 megohms can be distinguished from infinity.

Accuracy: $\pm 3\%$ on the 0.1, 1, and 10 multipliers; $\pm 4\%$ on the 100 and 1000 multipliers. Above 10,000 megohms, the accuracy is essentially that with which the scale on the MEGOHMS dial can be read.

Power Supply: Two types of power supply are available — (1) an ac-operated unit delivering dc test voltages of 500 and 100 volts to the bridge, and (2) a battery power supply of 90 volts. The ac unit operates from a 105- to 125-volt (or 210- to 250-volt), 40- to 60-cycle line. It will also operate from a 400-cycle supply. The battery power supply consists of one No. 6 dry cell and three 45-volt batteries. This supplies 45 volts for the tube anode and 90 volts for the test voltage.

External Bridge Voltage: Up to 500 volts can be applied from an external source.

Power Requirements: 60 watts at 115 volts, 60 cps; with battery supply, approximately current requirements are 60 milliamperes for cathode heaters and 7.5 milliamperes for anode.

Accessories Supplied: Test probe. With ac power supply, a TYPE CAP-22 Power Cord, spare fuses, spare neon ballast tube. Batteries are supplied with the battery-operated model.

Cabinet: Shielded, oak, with cover.

Dimensions: Width $8\frac{1}{2}$, height $22\frac{1}{2}$, depth 8 inches (220 by 575 by 215 mm), over-all, with cover closed.

Net Weight: With battery power supply, $29\frac{1}{2}$ pounds (13.5 kg); with ac power supply, $26\frac{1}{2}$ pounds (12 kg); TYPE 544-P10, $14\frac{1}{2}$ pounds (6.5 kg); TYPE 544-P3, $11\frac{1}{4}$ pounds (5.2 kg).

Shipping Weight: 35 pounds (15.9 kg); TYPE 544-P10, 22 pounds (10 mm); TYPE 544-P3, 19 pounds (9 mm).

Type	Code Number	Price
544-BA Megohm Bridge, with AC Power Supply	0544-9807	\$450.00
544-BB Megohm Bridge, Battery Operated (Including Batteries)	0544-9808	315.00
544-P3 AC Power Supply Unit Only	0544-9603	180.00
544-P10 Battery Power Supply Unit Only	0544-9610	45.00

FOR MEASUREMENT OF INSULATION RESISTANCE,
RESISTIVITY, DIELECTRIC ABSORPTION



GA Type 1862-C MEGOHMMETER

FEATURES:

- ◆ Direct reading and simple to operate.
- ◆ Test voltages of 100 and 500 permit approximate measurement of voltage coefficient.
- ◆ Voltage can be removed from UNKNOWN terminals by setting of either switch to DISCHARGE position, thus permitting connections to be made without danger of shock.
- ◆ Panel light indicates when voltage applied to terminals.
- ◆ Guard and ground terminals provided.

USES: Rugged, versatile, and safe, this megohmmeter rapidly measures wide ranges of resistance at either of two test voltages. The 100-volt level is the EIA standard for measurement of composition, film, and wire-wound resistors above 100 kilohms. The 500-volt level is a standard value in the measurement of the insulation resistance of rotating machinery, transformers, cables, capacitors, appliances, and other electrical equipment.

Regulated power supply and charging circuit permit

rapid and accurate measurement of the leakage resistance of capacitors.

Guard and ground terminals permit measurement of grounded or ungrounded two- or three-terminal resistors.

DESCRIPTION: The megohmmeter consists of a regulated power supply, a complement of resistance standards, and an indicating meter. The indicator is a balanced, dc, vacuum-tube voltmeter that has a very high input resistance.

SPECIFICATIONS

Range: 0.5 to 2,000,000 megohms at 500 volts and to 200,000 megohms at 100 volts. There are six decade steps selected by a multiplier switch.

Scale: Each resistance scale up to 500,000 megohms utilizes 90% of the meter scale. Center-scale values are 1, 10, 100, 1000, 10,000, and 100,000 megohms for 500-volt operation.

Accuracy: From $\pm 3\%$ at the low-resistance end of each decade to $\pm 12\%$ (accuracy to which the scale can be read) at the high-resistance end up to 50,000 megohms. There can be an additional $\pm 2\%$ error at the top decade.

Voltage on Unknown: 100 or 500 volts, as selected by switch on front panel. Indicator lamp is lighted when voltage is applied. Current available limited to safe value. Voltage across unknown is 500 volts ± 10 volts, or it is 100 volts ± 4 volts. This voltage source is regulated for operation from 105- to 125- (or 210- to 250-) volt lines.

Terminals: Unknown, ground, and guard terminals. All but the ground terminals are insulated. The voltage is removed from the terminals in the DISCHARGE position of either switch.

Calibration: Switch position is provided for standardizing the calibration at 500 volts.

Power Requirements: 105 to 125 (or 210 to 250) volts, 40 to 60 cps, 25 watts. Instrument will operate satisfactorily on power-supply frequencies up to 400 cps.

Accessories Supplied: Spare fuses, two color-coded test leads.

Cabinet: Flip-Tilt; relay-rack model also is available. (See page 210.)

Dimensions: Portable model, case closed — width 11½, height 8¼, depth 7½ inches (295 by 210 by 190 mm), over-all; rack model — panel 19 by 5¼ inches (485 by 135 mm); depth behind panel 5 inches (130 mm).

Net Weight: Portable model, 9 pounds (4.1 kg); rack model, 10 pounds (4.6 kg).

Shipping Weight: Portable model, 16 pounds (7.5 kg); rack model, 23 pounds (10.5 kg).

Type		Code Number	Price
1862-C	Megohmmeter, Portable Model	1862-9703	\$310.00
1862-9844	Megohmmeter, Rack Model	1862-9844	310.00

MEGOHM BRIDGE: The Type 544-B Megohm Bridge, a bridge for resistance measurements in the megohm range, is described on page 47.

ELECTROMETER: The Type 1230-A Electrometer and D-C Amplifier, described on page 140, measures resistances as high as 5×10^{14} ohms as well as very low voltages and currents.





Type 1652-A RESISTANCE LIMIT BRIDGE

FEATURES:

- ♦ Rapid, accurate for limit tests. ♦ Equally useful for null measurements.
- ♦ Large, open-scale meter, color coded. ♦ Wide range — one ohm to one megohm.
- ♦ AC-operated — no batteries needed.

USES: This resistance limit bridge is intended for the production testing of resistors at dc. It can be used:

- To indicate deviation from nominal value.
- To match pairs of resistors.
- To compare resistors to a standard sample.
- To measure resistance by the null method.

For manufacturers and users of resistors, this bridge is a rapid and accurate means for sorting into tolerance classifications, for selection to close tolerances, and for matching pairs of resistors for balanced circuits.

In the laboratory, its accuracy is adequate for all but the most exacting requirements, and it will measure resistors up to one megohm.

For automatic sorting, a relay and amplifier can be connected to actuate a selector mechanism.

DESCRIPTION: The circuit is a conventional equal-arm Wheatstone bridge, supplied from a constant-voltage dc source. The meter indicates percentage deviation directly. The internal standard consists of seven TYPE 510 Decade-Resistance Units and is adjustable in 0.1-ohm steps from one ohm to 1,111,111 ohms.

For limit testing, the standard is set to the desired nominal value, and the percentage deviation is read from the meter. Terminals are provided for connection of a test jig such as the TYPE 1650-P1 (page 35).

For matching pairs, the resistor to be matched is substituted for the internal standard.

For null measurements, the internal standard is adjusted to equality with the unknown resistor.

SPECIFICATIONS

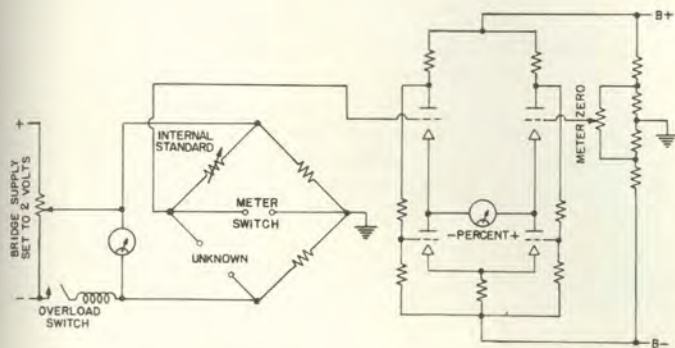

Schematic circuit diagram of the Type 1652-A Resistance Limit Bridge.

Resistance Range: As a limit bridge, 1 ohm to 1,111,111 ohms with internal standard; for null measurement, 1 ohm to 1,111,111 ohms with internal standard; 1 ohm to 2 megohms with external standard.

Limit Range: Meter reads from -20% to $+20\%$, with the standard EIA (RETMA) tolerance range of $\pm 5\%$ and $\pm 10\%$ clearly indicated by gold and silver coloring, respectively.

Accuracy: As a limit bridge, $\pm 0.5\%$ or better; for matching, $\pm 0.2\%$; for null measurement, with internal standard, $\pm 0.25\%$ above 10 ohms and $\pm 0.4\%$ between 1 ohm and 10 ohms; with an external standard, from 1 ohm to 2 megohms $\pm (0.2\% + \text{accuracy of standard})$.

Voltage Applied to Unknown: One volt when the meter indication is zero; 0.9 volt at -20% ; 1.1 volts at $+20\%$.

Power Requirements: 105 to 125 (or 210 to 250) volts, 60 cps. The power input is approximately 30 watts.

Accessories Supplied: TYPE CAP-22 Power Cord, spare fuses.

Cabinet: Rack-bench (see page 210).

Dimensions: Bench model — width 19, height $8\frac{3}{4}$, depth $12\frac{1}{4}$ inches (485 by 225 by 315 mm), over-all; rack model — panel 19 by $8\frac{3}{4}$ inches (485 by 225 mm), depth behind panel 11 inches (280 mm).

Net Weight: 29 pounds (13.5 kg).

Shipping Weight: 43 pounds (19.6 kg).

Type		Code Number	Price
1652-AM	Resistance Limit Bridge, Bench Model	1652-9801	\$600.00
1652-AR	Resistance Limit Bridge, Rack Model	1652-9811	600.00
1652-AMQ1	Resistance Limit Bridge (50 cps), Bench Model	1652-9495	725.00
1652-ARQ1	Resistance Limit Bridge (50 cps), Rack Model	1652-9496	725.00



Type 1605-A IMPEDANCE COMPARATOR

FEATURES:

- ♦ High-speed meter indication — no balancing operation required.
- ♦ Wide frequency range — 100 cps to 100 kc.
- ♦ High accuracy.
- ♦ Four internal frequencies — 100 cps, 1 kc, 10 kc, and 100 kc.
- ♦ Versatile — compares impedances of any phase angle.
- ♦ Wide impedance range — 2 ohms to 20 megohms.
- ♦ Compares both magnitude and phase angle simultaneously and indicates direction of unbalance.
- ♦ Guard point available.
- ♦ Completely self-contained.
- ♦ Terminals are brought out at rear for operation of automatic selection devices, oscilloscope, or recorder.
- ♦ Meters are protected from off-scale damage.

USES: Typical uses for this highly precise instrument include:

Rapid testing, sorting, and matching of precision components, etched boards, subassemblies and complex networks, either manually or in combination with automatic sorting equipment.

Measuring the effects of time, temperature, humidity, and pressure on components, with high precision and continuous indication.

Rapid test for tracking of ganged potentiometers and variable capacitors.

Frequency characteristics of components.

Easy comparison of quantities usually requiring laboratory techniques, such as:

Small impedance differences.

D of low-loss dielectric materials.

$D \left(= \frac{1}{Q} \right)$ of inductors.

Q or phase angle of wire-wound resistors or potentiometers.

Balance of transformer windings.

Semiconductor capacitances.

Can also be used as a null bridge with the addition of an adjustable standard.

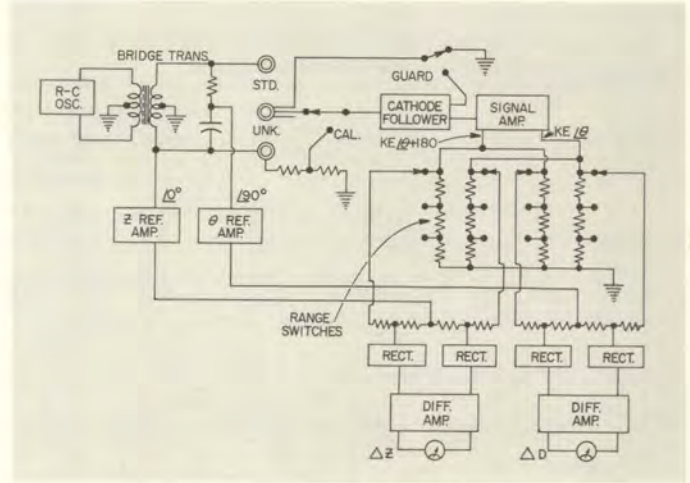

Block schematic of the Type 1605-A Impedance Comparator.

DESCRIPTION: This completely self-contained impedance comparator indicates directly on two panel meters the difference in impedance and phase angle between two elements connected to its terminals. Three highly de-

ACCURATE AND VERSATILE ON THE PRODUCTION LINE AND IN THE LABORATORY



sirable characteristics not usually obtained together are combined in this unique instrument:

- high accuracy
- high speed
- wide ranges of impedance and frequency.

As a result, not only does it bring laboratory accuracy to production-line inspection, but, conversely, it brings the speed of the production test to measurements in the laboratory.

The basic circuit of the comparator is a bridge circuit, with the unknown and standard impedances serving as two of the bridge arms and the halves of a center-tapped transformer secondary winding serving as the other two arms. An internal rc oscillator driving the transformer primary winding provides frequencies at 100 cps, 1 kc, 10 kc, and 100 kc. The bridge unbalance voltage, resulting from inequality of standard and unknown impedances, is separated into in-phase and out-of-phase components, which are amplified and indicated directly by two meters

reading, respectively, impedance magnitude difference in percent and phase-angle difference in radians.

The transformer is especially designed to have as high a degree of coupling as possible between the two halves of its secondary winding. The coefficient of coupling achieved is greater than 0.9997, and the open-circuit voltages of the two halves are balanced to within 1 part in 10^6 . This makes possible measurement of differences as low as 0.01% on the TYPE 1605-A and 0.003% on the TYPE 1605-AH and minimizes the loading effect of external impedances on the bridge transformer.

An unusual type of cathode-follower circuit provides a very high input impedance for the bridge detector and also a guard terminal. This shield makes possible the measurement of high impedances at a distance from the instrument, as in an environmental test chamber.

For operating external selector circuits, meter voltages are available at the rear of the instrument; a plug connector is supplied.

Calibration can quickly be checked at any time by means of a simple built-in network.

SPECIFICATIONS

RANGES OF MEASUREMENT

	R or Z	C	L
1605-A	2Ω to 20 MΩ	40 pf to 800 μf*	20 μh to 10,000 h
1605-AH	20Ω to 20 MΩ	40 pf to 80 μf	200 μh to 10,000 h

* To 0.1 pf with reduced accuracy.

Frequency: 100 cps, 1 kc, 10 kc, 100 kc, all $\pm 3\%$, from internal generator.

METER RANGES

Type 1605-AM, -AR:

Impedance-Magnitude Difference — $\pm 0.3\%$, $\pm 1\%$, $\pm 3\%$, $\pm 10\%$, full scale. (Can be adjusted for maximum of 50%.)

Phase-Angle Difference — ± 0.003 , ± 0.01 , ± 0.03 , ± 0.1 radian, full scale. The phase-angle difference is very nearly equal to the D difference for capacitors or inductors, or the Q difference for resistors, as long as the D or Q is less than 0.1.

Type 1605-AHM, -AHR:

Impedance-Magnitude Difference — $\pm 0.1\%$, $\pm 0.3\%$, $\pm 1\%$, $\pm 3\%$, full scale.

Phase-Angle Difference — ± 0.001 , ± 0.003 , ± 0.01 , ± 0.03 radian, full scale.

ACCURACY

Difference Readings: 3% of full scale; i.e., for the $\pm 0.3\%$ impedance-difference scale, accuracy is 0.009% of the impedance magnitude being measured.

GENERAL

Voltage Across Standard and Unknown: TYPE 1605-A, approximately 0.3 volt; TYPE 1605-AH, 1 volt.

Power Requirements: 105 to 125 (or 210 to 250) volts, 50 to 60 cps; about 100 watts input at 115 volts. Instrument will operate satisfactorily on power-supply frequencies up to 400 cps, provided that the supply voltage is at least 115 volts.

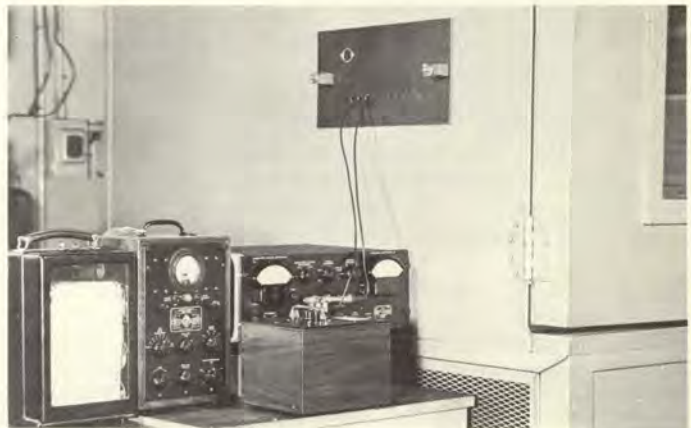

Long leads from capacitor in conditioning chamber, as shown here, have a negligible effect on measurement accuracy. Bridge output can also operate a recorder to give a continuous record of environmental tests.

Accessories Supplied: TYPE CAP-22 Power Cord, telephone plug, external-meter plug, adaptor plate assembly (fits panel terminals), spare fuses.

Cabinet: Rack-bench (see page 210).

Dimensions: Bench model — width 19, height 7, depth 13½ inches (485 by 180 by 345 mm), over-all; rack model — panel 19 by 7 inches, depth behind panel 12 inches (305 mm).

Net Weight: 29½ pounds (13.5 kg).

Shipping Weight: 46 pounds (21 kg).

For a more complete description of this instrument send for General Radio Reprint No. E-103.

Type		Code Number	Price
1605-AM	Impedance Comparator, Bench Model	1605-9801	\$875.00
1605-AR	Impedance Comparator, Rack Model	1605-9811	875.00
1605-AHM	Impedance Comparator, Bench Model	1605-9951	925.00
1605-AHR	Impedance Comparator, Rack Model	1605-9961	925.00

PATENT NOTICE. See Notes 4 and 5, page viii. Models with other meter ranges or other frequencies are available on special order.

Type 1606-A RADIO-FREQUENCY BRIDGE

FEATURES:

- ♦ Wide frequency range — 400 kc to 60 Mc. ♦ Direct reading in ohms.
- ♦ Fast, simple operation. ♦ Accurate, reliable measurements.
- ♦ Small, light, and rugged — suitable for field or laboratory.

USES: The TYPE 1606-A Radio-Frequency Bridge measures impedances simply and accurately at frequencies from 400 kc to 60 Mc. It measures directly the resistance and reactance of antennas, transmission lines, networks, and components. Although the bridge is designed primarily for measuring the low values of impedance most often encountered in rf devices, its range can be extended by means of an external parallel capacitor so as to measure high impedances, such as tuned circuits.

DESCRIPTION: Measurements are made by a series-substitution method in which the bridge is first balanced by means of capacitors C_P and C_A (see schematic diagram) with a short-circuit across the unknown terminals. The short is then removed, the unknown impedance connected, and the bridge rebalanced.

The resistance is then given by $R_X = R_B \frac{(C_{A2} - C_{A1})}{C_N}$

and the reactance by $X_X = \frac{1}{\omega} \left(\frac{1}{C_{P2}} - \frac{1}{C_{P1}} \right)$

where the subscripts 1 and 2 denote the dial readings for the initial and final balances respectively.

The unknown reactance at 1 Mc is read directly in ohms from the dial of C_P , and the unknown resistance in ohms from the dial of C_A .

The resistive component is measured in terms of a fixed resistor (R_B), a fixed capacitor (C_N), and a variable capacitor (C_A). This feature is an important factor in the high-frequency performance of the bridge because residual parameters can be made much smaller in a fixed resistor and a variable capacitor than in a variable resistor.

SPECIFICATIONS

RANGES

Frequency: 400 kc to 60 Mc.

Reactance: ± 5000 ohms at 1 Mc. This range varies inversely as the frequency; at other frequencies the dial reading must be divided by the frequency in Mc.

Resistance: 0 to 1000 ohms.

ACCURACY

Reactance: At frequencies up to 50 Mc, $\pm (2\% + 1 \text{ ohm} + 0.0008 Rf)$ where R is the measured resistance in ohms and f is the frequency in Mc.

The TYPE 1606-A Bridge incorporates several important features in bridge design. A single, internal transformer, used to couple an external generator to the bridge circuit, covers the entire 150:1 frequency range of the instrument, while its triple shielding keeps undesired couplings to an insignificant level.

A special type of variable air capacitor, having very low losses and inductance, is used for the reactance balances and the initial resistance balance. In this capacitor the complete rotor and stator sections are milled out of solid blocks of aluminum, a construction that avoids losses at the joints between plates and spacers and provides the utmost stability.

Finally, the entire mechanical design is such that the instrument can operate under difficult environmental conditions similar to those specified for testing military electronics equipment, which makes the TYPE 1606-A Bridge an excellent instrument for portable field use.

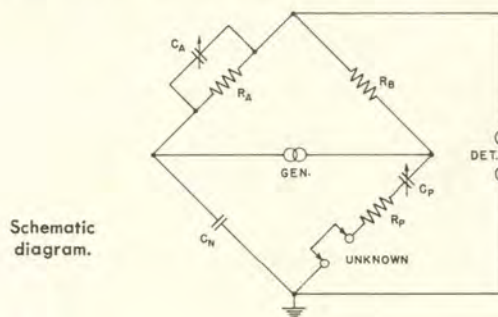

Schematic diagram.

Resistance: At frequencies up to 50 Mc,

$$\pm \left[1\% + 0.0024f^2 \left(1 + \frac{R}{1000} \right) \% \pm \frac{10^{-4} X}{f} \Omega + 0.1\Omega \right]$$

subject to correction for residual parameters. X is the measured reactance in ohms. At high frequencies, the correction depends upon the frequency and magnitude of the unknown resistance component. A chart from which the correction can be determined is given in the instruction book supplied with the bridge.

Satisfactory but somewhat less accurate operation can be obtained at frequencies as low as 100 kc and somewhat above 60 Mc. The f^2



FOR THE MEASUREMENT
OF ANTENNAS, LINES,
NETWORKS, AND COMPONENTS FROM
400 kc TO 60 Mc

term is important only at frequencies above 10 Mc. The $1/f$ term is important only at very low frequencies when the resistance of a high-reactance, low-loss capacitor is measured.

GENERAL

Terminals: Generator and detector terminals are locking TYPE 874 Coaxial Connectors. This instrument can be equipped with type N, BNC, TNC, SC, C, or UHF connectors through the use of locking adaptors, listed on page 64.

Accessories Supplied: Two leads of different lengths for connecting the unknown impedance to the bridge terminals; one 1/2-inch spacer and one 3/4-inch, 6-32 screw for mounting components to be measured directly on the bridge terminals; two TYPE 874-R22A Patch Cords for connecting the generator and detector; and one TYPE 874-PB58A Panel Connector.

Other Accessories Required: Generator and detector. The TYPE 1330-A Bridge Oscillator and the TYPE 1211-C Unit Oscillator are satisfactory generators, as are the TYPE 1001-A and the TYPE 805-D Standard-Signal Generators. At frequencies above 50-Mc, a TYPE 1215-C Unit Oscillator or a TYPE 1021-AV Standard-Signal Generator is

recommended. (See pages 114 to 125.)

A heterodyne-type detector, consisting of the TYPE 1232-A Tuned Amplifier and Null Detector, a local oscillator, and the TYPE 1232-P1 Mixer (page 79), is recommended for use up to 10 Mc. If measurements are to be made above 3 Mc only, the TYPE 1212-A Unit Null Detector and the TYPE 1212-P3 Mixer can be used. A well-shielded communications receiver covering the desired frequency range also makes a satisfactory detector. It is recommended that the receiver be fitted with the TYPE 874-PB58A Panel Connector or other coaxial connector to avoid leakage at the input connection.

Cabinet: Welded aluminum. A luggage-type carrying case is available separately.

Dimensions: Width 12 1/2, height 9 1/2, depth 10 1/4 inches (320 by 245 by 260 mm), over-all.

Net Weight: 23 pounds (10.5 kg) without carrying case; 29 pounds (13.5 kg) with carrying case.

Shipping Weight: 30 pounds (13 kg).

For a more complete description of this instrument refer to the *General Radio Experimenter*, 30, 1, June, 1955.

Type	Code Number	Price
1606-A	1606-9701	\$750.00
1606-P1	1606-9601	25.00

PATENT NOTICE. See Note 4, page viii.



Type 916-AL RADIO-FREQUENCY BRIDGE

The TYPE 916-AL Radio-Frequency Bridge uses the same series-substitution circuit as the TYPE 1606-A to cover the low and medium frequencies between 50 kc and 5 Mc.

An important feature is the ΔX dial, which greatly facilitates the measurement of large capacitances and small inductances.

RANGES

Frequency: 50 kc to 5 Mc. Satisfactory operation for many measurements can be obtained at frequencies as low as 15 kc.

Reactance: $\pm 11,000$ ohms at 100 kc. This range varies inversely as the frequency; at other frequencies the dial readings must be divided by the frequency in hundreds of kc. To facilitate the measurement of small reactances, the instrument is provided with an incremental reactance dial which has a range of 100 ohms at 100 kc.

Resistance: 0 to 1000 ohms.

ACCURACY

Reactance: Below 3 Mc, $\pm(2\% + 0.2 \times \frac{100}{f_{kc}} \Omega + 3.5f_{kc}^2 R \times 10^{-10})$, where R is the measured resistance in ohms and f_{kc} is the frequency in kc. The errors increase at frequencies above 3 Mc; at 5 Mc, the accuracy is $\pm(2\% + 0.01\Omega + 2.3R^{1.4} \times 10^{-3}\Omega)$.

Resistance: Below 5 Mc, $\pm(1\% + 0.1\Omega)$, subject to correction for residual parameters at low frequencies. The correction depends upon the frequency and upon the magnitude of the unknown reactance component.

GENERAL

Terminals: Generator and detector terminals are locking TYPE 874 Coaxial Connectors. This instrument can be equipped with type N, BNC, TNC, SC, C, or UHF connectors through the use of locking adaptors, listed on page 64.

Accessories Supplied: Two input transformers, one covering the lower portion of the frequency range, the other the higher portion; two

leads of different lengths (for connecting the unknown impedance); two TYPE 874-R22A Patch Cords for connecting generator and detector; one TYPE 874-PB58A Panel Connector.

Other Accessories Required: Generator and detector. The TYPE 1330-A Bridge Oscillator (page 111) and the TYPE 1211-C Unit Oscillator (page 114) are satisfactory generators, as are the TYPE 1001-A and the TYPE 805-D Standard-Signal Generators (pages 122 and 124). A heterodyne-type detector, consisting of the TYPE 1232-A Tuned Amplifier and Null Detector (page 79), a local oscillator, and the TYPE 1232-P1 Mixer, is recommended. A well-shielded radio receiver covering the desired frequency range also makes a satisfactory detector. It is recommended that the receiver be fitted with the TYPE 874-PB58A Panel Connector to avoid leakage at the input connection.

Cabinet: Luggage-type. Both input transformers are stored inside the case.

Dimensions: Width 13 1/2, height 17, depth 11 1/4 inches (345 by 435 by 290 mm), over-all.

Net Weight: 34 1/2 pounds (16 kg).

Shipping Weight: 45 pounds (20.5 kg).

Type	Code Number	Price
916-AL	0916-9831	\$825.00

PATENT NOTICE. See Note 4, page viii.

50 kc to 5 Mc





Type 1602-B UHF ADMITTANCE METER

FEATURES:

- ◆ Direct reading in admittance components — conductance and susceptance — independent of frequency.
- ◆ With line stretcher, can indicate impedance directly.
- ◆ Can measure vswr directly, with TYPE DNT Detector or any other linear detector.
- ◆ No sliding balance — resistive and reactive adjustments are independent.
- ◆ Wide frequency range — direct reading from 40 to 1500 Mc.
- ◆ Accurate, rapid, easy to use.

USES: This null-type impedance-measuring instrument is particularly useful for measurements on coaxial systems: antennas, lines, coaxial components.

It can be used as an indicator for adjusting a network to a predetermined admittance or for matching one network to another, and is particularly useful in matching antennas and other networks to 50-ohm circuits.

As a comparator, the Admittance Meter can be used to determine impedance magnitude, reflection-coefficient magnitude, and voltage standing-wave ratio. Direct-reading measurements of vswr can be made when a linear detector is used.

The usefulness of the Admittance Meter is greatly enhanced by the many accessories available for use with it. Among these are:

The TYPE 874-LK20L Constant-Impedance Adjustable Line, which can be set to one-half wavelength to eliminate corrections for the length of transmission line between the unknown and the measuring point. When the line is set to one-quarter wavelength, the Admittance Meter dials read directly in impedance parameters, i.e., the series resistance and reactance of the unknown.

The TYPE 874-UBL Balun, for use in measuring balanced impedances.

The TYPE 874-ML Component Mount, which provides a convenient means of connecting lumped elements (resistors, capacitors, or inductors) to the Admittance Meter for measurement.

Low-vswr adaptors (which can be locked in place) for most types of military connectors and (nonlocking) for

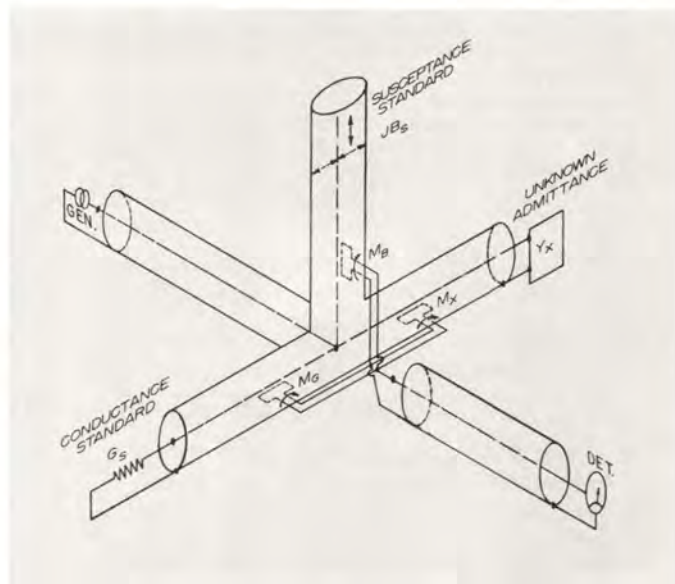

Schematic diagram of admittance-meter circuit, with standards, generator, and null detector connected for admittance measurements.

rigid vhf and uhf transmission lines used with tv transmitting antennas. With these adaptors and the adjustable line mentioned above, the over-all accuracy of measurement is more than adequate for measurements in the design, test, and installation of antennas.



A UNIQUE INSTRUMENT FOR UHF-VHF ADMITTANCE, IMPEDANCE, AND VSWR MEASUREMENT FROM 40 TO 1500 Mc



DESCRIPTION: The TYPE 1602-B UHF Admittance Meter comprises a coaxial line to which the unknown is connected, a shielded pickup loop to sample the current, a second line and loop terminated in a pure resistance, and a third line and loop terminated in a pure reactance. All are fed from the same voltage source, so that their input voltages are in phase, and the current in each line is proportional to the admittance. The voltage induced in each loop is proportional to the current in the corresponding line and is dependent upon the orientation of the loop, which is adjustable.

The three loops are connected in parallel, and the voltage from the loop in the unknown line is canceled by adjustment of the loops coupled to the standard lines until a null is reached. The conductance and susceptance of the unknown are read directly from the scales of the standard loops, while the scale of the loop in the unknown line indicates the multiplying factor.

This arrangement produces the effect of continuously variable elements by using known fractions of the currents in fixed elements.

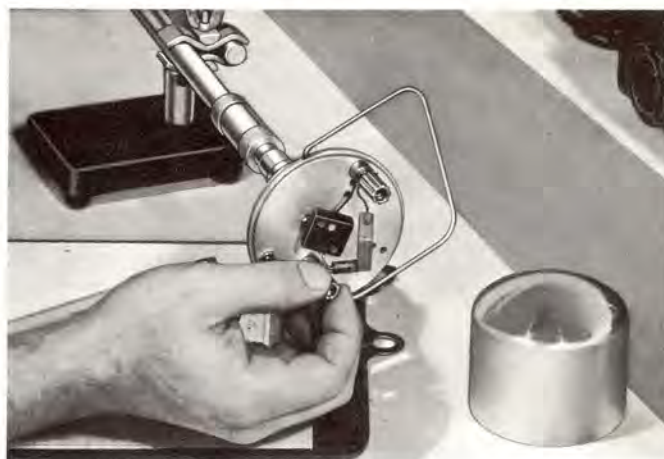

The Type 874-ML Component Mount is shown here attached to the Type 874-LK20L Constant-Impedance Adjustable Line. These useful accessories plug easily into the Admittance Meter. Also shown is the Type 874-Z Stand, which provides support.

SPECIFICATIONS

RANGES OF MEASUREMENT

Admittance: Theoretically, zero to infinity; practically, the lower limit is determined by the smallest readable increment on the scale, which is 100 micromhos (0.1 millimho). The scale upper limit is about 1000 millimhos. With the 0.1 multiplier plate, the smallest readable increment is 0.01 millimho; the upper limit is about 10,000 millimhos. Range is the same for both conductance and susceptance, but susceptance can be either positive or negative, i.e., the susceptance dial is calibrated from -20 to +20 millimhos. Scale-multiplying factors from 1 to 20 are provided on the dial, and, with the 10:1 multiplier plate, the limit is extended to 200.

Standing-wave ratios of less than 1.2 can be measured by a direct-reading method; the standing-wave ratio is read directly from the meter of a TYPE DNT Detector (or equivalent) without adjustment of the Admittance Meter controls. *v*swr as high as 10 can be readily measured by a voltage-ratio method.

Frequency: 40 to 1500 Mc, direct reading. Range can be extended downward to 20 Mc, if a frequency correction is applied to the susceptance reading.

Accuracy (for both conductance and susceptance):

Up to 1000 Mc,

from 0 to 20 millimhos, $\pm (3\% + 0.2 \text{ millimho})$

from 20 to ∞ millimhos, $\pm (3\sqrt{M}\% + 0.2 \text{ millimho})$ where *M* is the scale-multiplying factor.

Above 1000 Mc, errors increase slightly, and, at 1500 Mc, the basic figure of 3% in the expression above becomes 5%. For matching impedances to 50 ohms, the accuracy is 3% up to 1500 Mc. When the multiplier plates are used, the fixed error of 0.2 millimho is reduced to approximately 0.04 millimho.

GENERAL

Accessories Supplied: Two TYPE 1602-P4 50- Ω Terminations, for use as conductance standards, and one TYPE 1602-P1 Adjustable Stub and one TYPE 1602-P3 Variable Air Capacitor, for susceptance standards; two TYPE 874-R22LA Patch Cords for connections to generator and detector; and one TYPE 874-PB58A Panel Connector for installation on detector, if needed; TYPE 1602-P10 and -P11 Multiplier Plates. A wooden storage case is furnished.

Other Accessories Required: Generator and detector. Generator should cover desired frequency range and deliver between 1 volt and 10 volts. TYPE 1208-C (65 to 500 Mc), TYPE 1215-C (50 to 250 Mc), TYPE 1209-C (250 to 920 Mc) and TYPE 1218-A (900 to 2000 Mc) Unit Oscillators and the TYPE 1361-A UHF Oscillator (500 to 1000 Mc) (pages 114-117) are recommended. The TYPE 1021-AU and -AV Standard-Signal Generators are also satisfactory.

Detector sensitivity should be better than 10 microvolts. TYPE DNT Detectors (page 81) are recommended.

Other Accessories Available: Coaxial adaptors (page 64); line stretcher (page 71); balun (page 73); and component mount (page 72); Smith charts (page 65).

Terminals: All terminals are TYPE 874 Coaxial Connectors and are locking-type, except for the detector terminal. Adaptors to other types of coaxial connectors (page 64) can be used on the generator and detector terminals.

Dimensions: Width 5½, height 7½, depth 5½ inches (140 by 195 by 140 mm), without standards or unknown.

Net Weight: 8¼ pounds (3.8 kg).

Shipping Weight: 18 pounds (8.5 kg).

Type		Code Number	Price
1602-B	UHF Admittance Meter	1602-9702	\$325.00
874-LK20L	Constant-Impedance Adjustable Line	0874-9631	42.00
874-ML	Component Mount	0874-9663	29.50

PATENT NOTICE. See Note 4, page viii.

OTHER COAXIAL IMPEDANCE-MEASURING DEVICES: *Type 1607-A Transfer-Function and Immittance Bridge (page 56), Types 874-LBA and 900-LB Slotted Lines (pages 65 and 76).*



Type 1607-A TRANSFER-FUNCTION AND IMMITTANCE BRIDGE

FEATURES:

- ◆ Simple to operate. Suitable for both laboratory and routine production measurements.
- ◆ Measures effective network parameters of transistors, diodes, tubes, and two-terminal and four-terminal networks, active and passive.
- ◆ Wide frequency range — 25 to 1500 Mc. ◆ Direct reading.
- ◆ Component mounts available for commonly used transistors and tubes.
- ◆ Built-in provisions for dc biasing.

USES: The Transfer-Function and Immittance* Bridge is a null-type instrument for vhf and uhf measurements of the forward and reverse complex transfer functions and the input and output impedances and admittances of four-terminal electrical networks, either active or passive. The complex impedance or admittance of two-terminal circuits or components can also be measured easily.

A few examples of the measurements that can be made with this bridge are:

Transistors — α , β , h_f , h_r , h_i , h_o .

Tunnel Diodes — Equivalent circuit parameters.

Vacuum Tubes — μ , Y_{21} and Y_{12} , Y_{11} and Y_{22} .

General two-terminal or four-terminal networks —

Z_{11} , Z_{22} , Z_{21} , Z_{12} .

Y_{11} , Y_{22} , Y_{21} , Y_{12} .

I_2/I_1 , I_1/I_2 and E_2/E_1 , E_1/E_2 .

Ungrounded components —

Inductors — inductance and self-resonance.

Capacitors — capacitance and resonances.

Resistors — resistance and shunt capacitance.

Components, Coaxial Lines, and Other Grounded

Elements — Z , Y , $|\rho|$, $VSWR$.

* Immittance = impedance and/or admittance.



Type 1607-P101
Transistor Mount



Type 1607-P201
Tube Mount



Type 1607-P401
Tetrode Transistor Mount

DESCRIPTION: The TYPE 1607-A Transfer-Function and Immittance Bridge comprises three identical loops, fed from a common source and magnetically coupled to three coaxial lines. One of these lines is terminated with a resistance standard, one with a reactance standard, and one with the network to be tested. The coupling of each loop is adjusted until a null is obtained on an external detector in which the three lines are terminated. Each loop has a calibrated scale and the settings at null condition indicate the value of the unknown.

Two interchangeable loop-and-scale assemblies (Transfer-Function Indicator and Immittance Indicator, respectively) allow either four-terminal or two-terminal networks to be measured with equal ease.

Two constant-impedance, adjustable-length lines are built into the instrument to eliminate the need for lead corrections.

FOR TRANSFER-FUNCTION, IMPEDANCE,
AND ADMITTANCE MEASUREMENTS FROM
25 TO 1500 Mc

Instrument with Transfer-Function Indicator mounted in place.

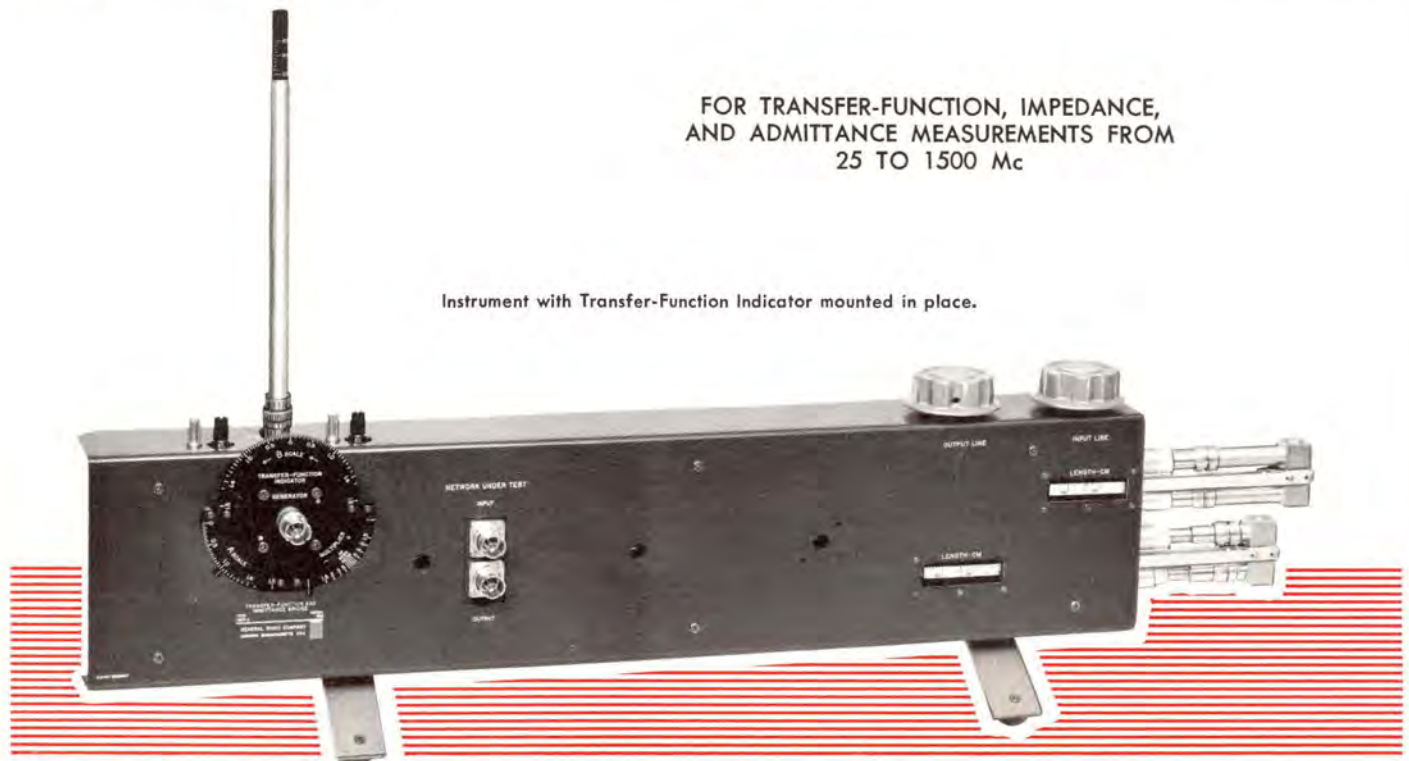

Accessories and storage box for the Transfer-Function and Imittance Bridge.

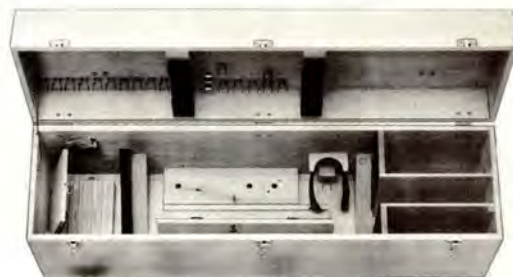
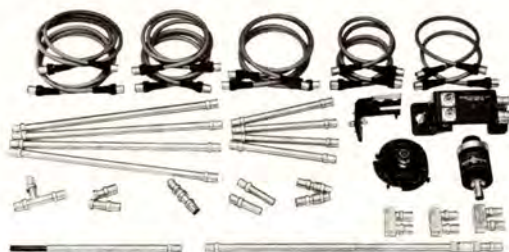

SPECIFICATIONS

Frequency Range: 25 to 1500 Mc, with reduced accuracy above 1000 Mc and when flexible cable is used in the lines. The use of this cable is required at frequencies below 150 Mc and is optional at other frequencies.

Measurement Range: Voltage and Current Ratios (R) 0-30
Accuracy: (up to 1000 Mc) $2.5(1 + \sqrt{R})\% + 0.025^*$

Transimpedance (Z_{21}) 0-1500 ohms $2.5 \left(1 + \sqrt{\frac{Z_{21}}{50}} \right) \% + 1.25 \text{ ohms}^*$

Transadmittance (Y_{21}) 0-600 mmhos $2.5 \left(1 + \sqrt{\frac{Y_{21}}{20}} \right) \% + 0.5 \text{ mmho}^*$

Impedance (Z_{11}) 0-1000 ohms $2.0 \left(1 + \sqrt{\frac{Z_{11}}{50}} \right) \% + 1.0 \text{ ohm}^*$

Admittance (Y_{11}) 0-400 mmhos $2.0 \left(1 + \sqrt{\frac{Y_{11}}{20}} \right) \% + 0.4 \text{ mmho}^*$

*When the 0.1 multiplier plate is used, these residual errors are significantly reduced.

DC Bias: Terminals are provided for introducing dc bias from external sources. Maximum bias current, 2.5 amperes, continuous; higher currents are permissible for short periods; maximum bias voltage, 400 volts.

Accessories Supplied: Range-Extension Unit; Transfer-Function Indicator; Imittance Indicator; 6 terminations (open, short, matched, etc.); standards; 10-db attenuator; 8 air lines (21.5 and 43 cm); 3 U-line sections; constant-impedance adjustable line; a special tee; two 0.1 multiplier plates; 10 patch cords; carrying case with storage space for instrument and accessories.

Accessories Required: Generator, detector, and mount for unknown device. Unit Oscillators (page 112) and TYPE DNT Detectors (page 81) are recommended. For coaxial adaptors, see page 64. See below for mounts available.

Other Accessories Available: Four transistor mounts, ungrounded component mount, and tube mounts listed in the price table below.

Dimensions: Case, 11 1/4 by 14 1/2 by 40 inches (290 by 370 by 1020 mm), over-all.

Net Weight: 63 pounds (29 kg).

Shipping Weight: 132 pounds (61 kg).

For a more complete description of this instrument, refer to the *General Radio Experimenter*, 32, 10, March, 1958, and 33, 5, May, 1959.

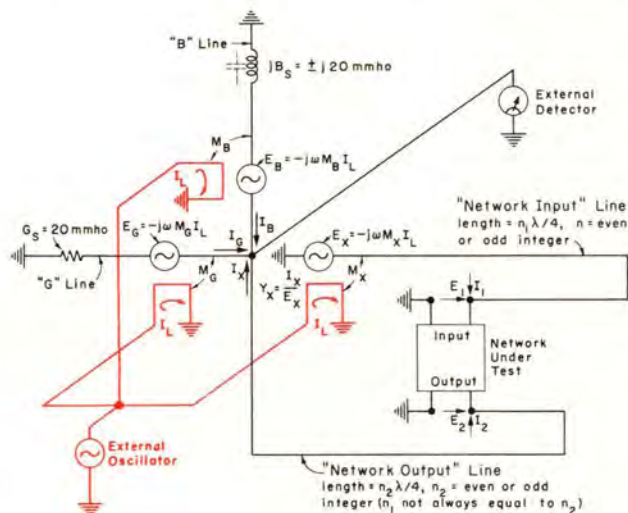

Schematic diagram of rf circuits of the Transfer-Function and Imittance Bridge.

Type		Code Number	Price
1607-A	Transfer-Function and Imittance Bridge	1607-9701	\$1775.00
1607-P101	Transistor Mount (JETEC-30, 0.200 in. D pin circle, for TO-5, -9, -11, -39 and similar packages)	1607-9992	60.00
1607-P102	Transistor Mount (JETEC-30, 0.200 in. D pin circle, grounded emitter, for TO-5, 9-, -11, -39, and similar packages)	1607-9993	60.00
1607-P111	Transistor Mount (0.100 in. D pin circle, grounded base, for TO-1, -18, -23, -24, and similar packages)	1607-9994	65.00
1607-P201	Tube Mount (7-pin miniature, grounded cathode, for Type 6AN4 and similarly based tubes)	1607-9995	75.00
1607-P401	Tetrode Transistor Mount (0.200 in. D pin circle, grounded base, for TO-12 and similar packages)	1607-9996	65.00
1607-P601	Ungrounded Component Mount	1607-9997	25.00

PATENT NOTICE. See Note 4, page viii.

Type 1661-B VACUUM-TUBE BRIDGE

USES: The TYPE 1661-B Vacuum-Tube Bridge measures the low-frequency dynamic coefficients of electron tubes and transistors over wide ranges and under a wide variety of conditions. It is suitable for research, development, and production measurements.

For electron tubes, independent, direct-reading measurements of voltage-amplification factor, resistance, and transconductance can be made quickly and easily. Voltage and current ratings permit many transmitting tubes to be tested. The bridge meets the requirements of IEC Document 39 (Secretariat 111).

For transistors, the short-circuit conductance parameters g_i , g_o , g_r , and g_f , and the h_r and h_i parameters can be determined directly. With external shielding some open-circuit parameters can be measured. The h_{fb} (α) and h_{fe} (β) parameters and open-circuit impedance parameters can be calculated from short-circuit conductance measurements.

SPECIFICATIONS

Range: Amplification factor (μ), 0.001 to 10,000.

Dynamic internal plate resistance (r_p), 50 ohms to 20 megohms.

Transconductance (g_m), 0.02 to 50,000 micromhos.

The various parameters can also be measured with respect to different electrodes, such as screen grids, etc.

Accuracy: Within $\pm 2\%$ for resistances (r_p switch position) from 1000 ohms to 1 megohm. At lower and higher values the error increases.

The expression $\mu = r_p g_m$ will check to $\pm 2\%$ when the quantities are all measured by the bridge, and when r_p is between 1000 ohms and 1 megohm.

Frequency: 270 to 400 cps, or 1000 cps.

Tube and Transistor Mounts: Adaptors are provided for 3- and 4-lead transistors and for tubes of 4-pin, 5-pin, 6-pin, small 7-pin, large 7-pin, octal, loctal, miniature button 7-pin, miniature button 9-pin (noval), acorn (5- and 7-pin), flat-press subminiature up to 7 wires, and 8-wire subminiature. In addition, a universal adaptor, with nine soldering lugs, is provided for unbased transistors, unmounted tubes, or tubes with nonstandard bases. For short-lead subminiature tubes, for Nuvistors, and for transistors, sockets are supplied which can be mounted on the universal adaptor. The panel jack plate and the adaptors are made of low-loss (natural) phenolic, reducing to a minimum the shunting effect of dielectric losses on the dynamic resistance being measured.

Current and Voltage Ratings: Maximum allowable plate current, 400 milliamperes; maximum plate voltage, 1500 volts.

Electrode Voltage Supply: Batteries or other suitable power supplies are necessary for providing the various voltages required by the device under test.

Bridge Source: TYPE 1214-A Oscillator (page 110) or TYPE 1311-A Audio Oscillator (page 109) is recommended.

DESCRIPTION: In this ac null method of measurement, each of the three coefficients is obtained in terms of the ratio of two alternating test voltages. Resistance, voltage ratio, and transconductance parameters can be measured with reference to any pair of electrodes. Connections are made with coaxial patch cords. Each section of two-section tubes can be tested independently.

FEATURES:

- ◆ Simple to operate.
- ◆ Measures both positive and negative values of tube parameters.
- ◆ Switch provides for both static and dynamic measurements on one- or two-section tubes.

Simplified diagram of the circuit employed for the measurement of transconductance with the Type 1661-B Vacuum-Tube Bridge. The points of introduction of the test voltages e_1 and e_2 are changed by a switch when the other coefficients are measured. Another switch reverses the polarity of e_1 when negative values of the coefficients are to be measured.

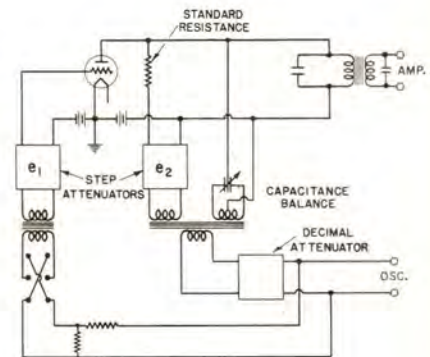

Null Detector: The TYPE 1232-A Tuned Amplifier and Null Detector (page 79) and the TYPE 1212-A Unit Null Detector (page 80) are recommended.

Accessories Supplied: Adaptors and sockets as listed above, all necessary plug-in leads and shielded patch cords for connecting generator and detector, adaptor case.

Cabinet: The instrument is mounted in a hardwood cabinet. A wooden storage case is provided for the adaptors and leads. Storage space is provided for a spare universal adaptor, on which any type of socket can be permanently mounted.

Dimensions: Panel, 15 3/4 by 20 inches (400 by 510 mm); height above bench, 11 inches (280 mm).

Net Weight: 54 pounds (24.5 kg) with accessories.

Shipping Weight: 90 pounds (41 kg).

Type	Code Number	Price
1661-B Vacuum-Tube Bridge	1661-9702	\$1100.00

FOR MEASUREMENTS OF
OPERATING PARAMETERS OF
VACUUM TUBES AND TRANSISTORS

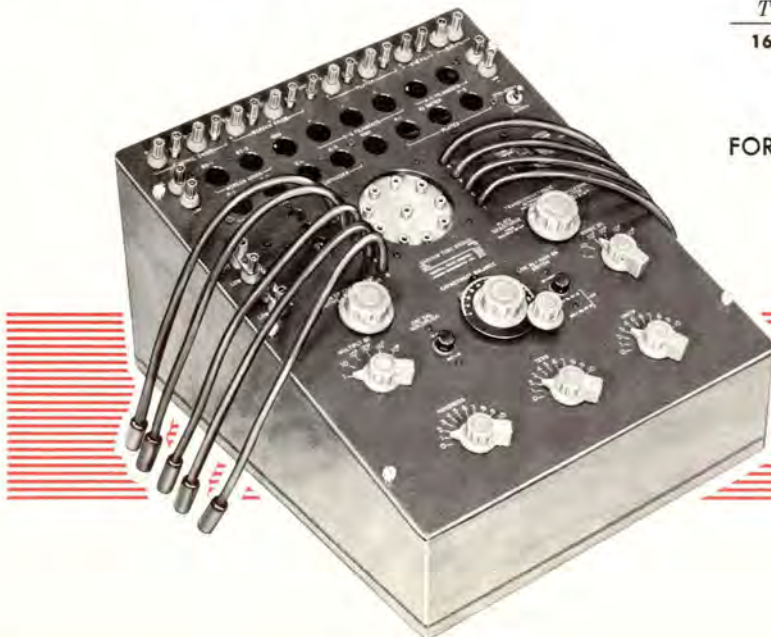

COAXIAL INSTRUMENTS AND COMPONENTS

DC TO MICROWAVE



The inductance, capacitance, and radiation of ordinary wire leads make them unsuitable for most circuit applications at vhf and above. When they are arranged as concentric lines with uniform spacing, lead radiation and stray-field effects are eliminated, and inductance and capacitance are distributed uniformly. This coaxial-line arrangement also ideally has a constant value of characteristic impedance due to the uniform distribution of inductance and capacitance. One value of characteristic impedance — 50 ohms — has been widely adopted.

General Radio coaxial components are built around a standard $\frac{9}{16}$ -inch-diameter rigid air line with a characteristic impedance of 50 ohms. While rigid line closely approximates the ideal, flexible coaxial cable (with solid dielectric between the conductors) is required for a variety of practical situations. Connectors compatible with a broad range of flexible cable sizes are available to supplement the basic air-line components.

Measurements at these frequencies pose special problems which are most readily overcome by use of coaxial techniques; the basic general-purpose coaxial instrument is the slotted line (see page 65). Bridge-type circuits built in coaxial-line form are also used for measurements at very-high and ultra-high frequencies. Instruments of this type are the Admittance Meter and the Transfer-Function and Immittance Bridge (see pages 54–57).

In coaxial measurements, even minor variations in the characteristic impedance anywhere in the system introduce reflections of incident energy and set up voltage standing-wave (vswr) patterns, which reduce system precision

and increase frequency sensitivity. Careful design, close-tolerance production, and exacting quality control are required to achieve the consistently low vswr that is characteristic of General Radio coaxial components.

Since coaxial instruments are no better than the connectors used with them, the core element of any family of coaxial devices is the connector. It must combine repeatable, low-reflection performance with ruggedness and ease of use. Fifteen years ago General Radio developed the TYPE 874 connector series, which uniquely meets those requirements in *general* laboratory use. Through the years the TYPE 874 design has undergone many refinements and has been extended to a host of new applications. In that time it has become standard on all GR instruments requiring a coaxial terminal and has been the basis for the development of a broad line of coaxial instruments and accessories of ever-increasing accuracy.

To meet the growing need of standards laboratories for even higher accuracy, General Radio has developed a practical, *ultra-precision*, coaxial connector and associated instruments and accessories. This new line (see page 74) is based on the TYPE 900-BT Precision Coaxial Connector.

For maximum utilization of instruments and for the construction of developmental and measurement circuits, many different types of coaxial elements are required. The General Radio line of coaxial connectors, adaptors, terminations, filters, attenuators, isolators, detectors, fixed and adjustable air lines, tees, elbows, and other accessories includes most types of commonly used coaxial-circuit components.

INDEX TO TYPE 874

See also type number index at the back of this catalog

Component	Page	Component	Page	Component	Page
Accessories, Slotted-Line	66	Flexible Line	66	Rectifier, Voltmeter	67
Adaptors	64	Indicator, Voltmeter	67	Rotary Joint	72
Adjustable Lines	71	Inductor, Series	68	Series Inductor	68
Air Lines	71	Insertion Unit	72	Short-Circuit Terminations	70
Attenuators	69	Isolators	68	Slotted Line	65
Balun	73	Kit, Cable Measurement	66	Slotted-Line Accessories	66
Cable	66	Kit, Slotted-Line	66	Smith Charts	65
Cable Connectors	63	Lines	71	Stand	73
Capacitor, Coupling	72	Adjustable	71	Standard Terminations	70
Capacitor, Variable	68	Constant-Impedance	71	Stubs	68
Clamps	73	Radiating	72	Tee	72
Cliplock	72	Rigid	71	Terminal Pad	73
Component Mount	72	Trombone	71	Terminal Unit	73
Connectors	63	Low-Pass Filters	68	Terminations	70
Constant-Impedance Line	71	Micrometer Vernier	65	Tool Kit	63
Coupling Elements	72	Mixer Rectifier	67	Trombone Line	71
Coupling Probe	72	Mount, Component	72	Tuning Elements	68
Crimping Tools	63	Open-Circuit Termination	70	Variable Capacitor	68
Detectors	67	Panel Connectors	63	Vernier, Micrometer	65
Ell	72	Patch Cords	70	Voltmeter Detector	67
Filters, Low-Pass	68	Probe, Coupling	72	Voltmeter Indicator	67
Fixed Attenuators	69	Radiating Line	72	Voltmeter Rectifier	67

Precision coaxial components in the Type 900 series are described on pages 74–77.

Type 874 SERIES COMPONENTS

A comprehensive line of coaxial components and instruments for general laboratory use comprises the General Radio TYPE 874 series. All elements have a characteristic impedance of 50 ohms, and most have a low vswr from dc through 7 Gc. By virtue of its broad line of connectors and low-reflection adaptors, the TYPE 874 series can be combined with most representative military-type coaxial-cable and -connector series and with larger air lines. Power-handling and peak-voltage capabilities for the entire line appear in the adjacent figure and the chart below.

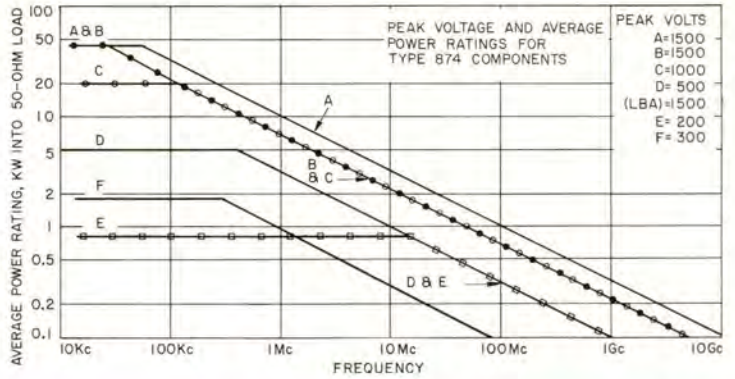

See Curve	Category	Applicable Type 874 Units	Peak Volts
A	Connectors Air Lines Elements Adaptors	-B, -BL, -PLT, -PRLT, -PFL -L10, -L10L, -L20, -L20L, -L30, -L30L -EL, -EL-L, -T, -TL -QHJA, -QHPA, -QLJA, -QLPA, -QLTJ, -QLTP, -QU1A, -QU2A, -QU3A	1500
B	Adjustable Air Lines	-LAL, -LK10L, -LK20L	1500
C	Connectors Adaptors Patch Cords	-CA, -CLA, -C8A, -CL8A, -PBA, -PB8A, -PLA, -PL8A, -PRLA, -PRL8A -QCP, -QCJA, -QCJL, -QNP, -QNJA, -QNJL, -QSCP, -QSCJ, -QSCJL -R20A, -R20LA	1000
D	Connectors Adaptors Elements Patch Cords	-C58A, -CL58A, -C62A, -CL62A, -PB58A, -PB62A, -PL58A, -PL62A, -PRL58A, -PRL62A -QBJA, -QBJL, -QBPA, -QTNJ, -QTNJL, -QTNP, -QUJ, -QUJL, -QUP -K, -KL -R22A, -R22LA	500
	Slotted Line	-LBA	1500
E	Filters	-F185L, -F500L, -F1000L, F2000L, -F4000L	200
F	Connectors Adaptors	-C174A, -CL174A, -PB174A, -PL174A, -PRL174A -QMDJ, -QMDJL, -QMDP	300

Type 874 COAXIAL CONNECTOR*

Since a coaxial connector is very much a part of a transmission line, it must not significantly add to the vswr of the line. The General Radio TYPE 874 Coaxial Connector, designed primarily for use in measurement systems, offers excellent performance in this respect as well as unmatched mechanical convenience. It possesses the lowest reflection characteristics of any standard, general-purpose, 50-ohm coaxial connector in its frequency range. Typically, its vswr performance is superior to that of the most highly regarded military-type connector in common laboratory use, as is demonstrated by the curves given in the adjacent figure.

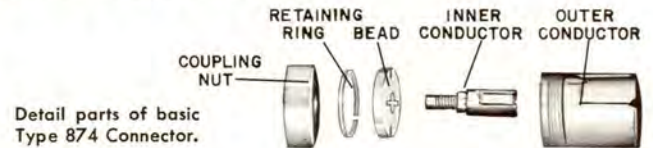

(on patch cords or panel mounted), with single-wire solder terminals, and as panel feedthroughs.

The basic elements of the TYPE 874 Coaxial Connector, as shown in the exploded view, are an inner conductor, an outer conductor, a supporting polystyrene bead, a phosphor-bronze retaining ring, and a threaded coupling nut. All metal parts are machined and formed to extremely close tolerance from hard-drawn brass, except for the center conductor, which is made of heat-treated beryllium copper to ensure good gripping capability and wear. An Albaloy finish on all surfaces produces high-conductivity for low loss and gives long-lasting tarnish resistance and durability.

Inner and outer conductors are similar in principle; each is essentially a tube with four longitudinal slots in one end, with two opposite quadrants displaced inward. When two connectors are joined, the undisplaced quadrants of one overlap the displaced quadrants of the other and form circular inner and outer surfaces. The overlapping, as well as the circularity of the joined connectors, can be seen in the cutaway view.

* PATENT NOTICE. See Note 4, page viii.

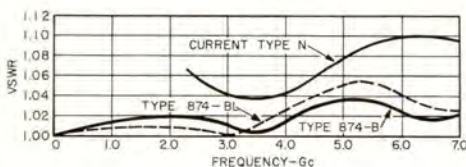

A unique mechanical advantage is that any two of these connectors, although identical, can be plugged together, eliminating the inconvenience so often encountered with the usual plug-jack type connectors. This hermaphrodite feature, plus the fact that TYPE 874 connectors merely plug together without twisting, makes them the easiest-to-use coaxial connectors available. These connectors can be used with air lines, with most types of coaxial cables

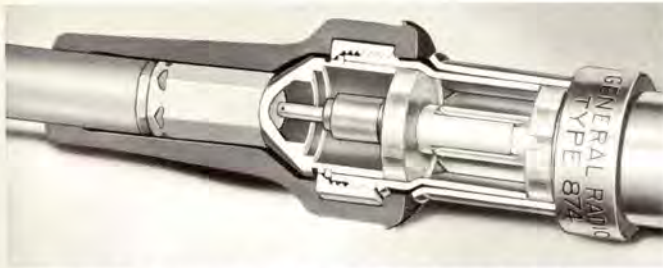

Basic Type 874 Connector (right) mated with Type 874 Cable Connector.

For applications requiring a semipermanent connection, or minimal leakage, locking versions of all connector types are offered. As with regular TYPE 874 connectors, the locking type is hermaphrodite, any two making a pair. Moreover, locking and nonlocking connectors are fully compatible. In addition, two locking connectors can be joined without locking, retaining the speed and convenience advantages of the regular connectors. Locking connectors, besides furnishing a strong mechanical connection, provide optimal leakage reduction. A comparison of leakage results of mated pairs of TYPE 874 locking connectors with pairs of other leading types is shown below.

In the locking version, the basic connector is equipped with a nickel-chrome-finished locking nut, threaded on the inside and knurled on the outside, and a threaded coupling nut. When two locking connectors are joined (refer to the section view), the locking nut of the second connector is backed off and not used. The locking nut draws the two connectors together until the two coupling nuts come in contact. In this position, the mating elements of the connector are engaged, but are not bottomed. Bottoming is avoided to prevent damage to the connector and to preserve a low vswr.

Virtually all coaxial components in the TYPE 874 series are available with either locking or nonlocking connectors; all coaxial instruments are equipped with locking connectors. In most instances, other General Radio instruments fitted with TYPE 874 connectors are furnished with the locking panel-mounted version. An attractive variant of the panel locking connector is the recessed version, which provides a coaxial terminal flush with the front of the panel.

An increasing number of electronic-instrument manufacturers, requiring a high-performance coaxial connector

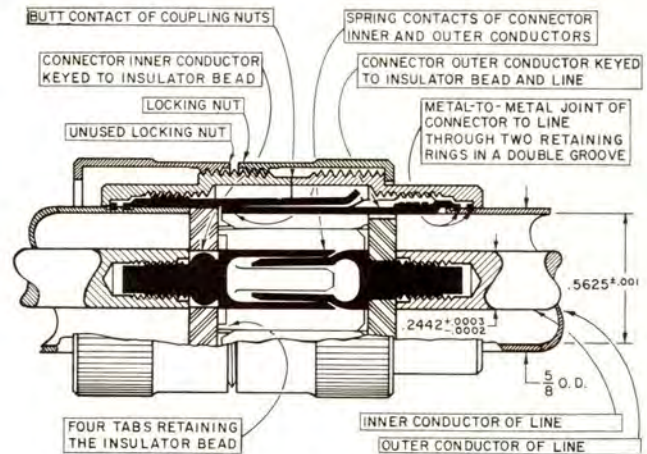

Section view of Type 874 locking connectors.

and recognizing the simplicity, convenience, and adaptability of the TYPE 874 series, are incorporating this versatile connector in their advanced equipment designs. Its unexcelled ability to handle fractional-nanosecond-rise-time pulses is but one feature that has attracted attention. Inquiries from interested OEM users are invited.

TYPE 874 CONNECTOR GROUPINGS

The TYPE 874 coaxial-connector line includes 30 different kinds. A complete listing appears on page 63.

Air Line Connectors The TYPE 874-B and -BL Basic Connectors, regular and locking versions respectively, are for use on rigid, 50-ohm, air lines made from 5/8-inch-OD, 9/16-inch-ID tubing and 0.244-inch-diameter rod.

Cable Connectors There are five kinds of TYPE 874 Cable Connector, each of which is available in locking and nonlocking versions. They fit a wide variety of common coaxial-cable sizes, including miniature. In addition to the General Radio TYPE 874-A2 and -A3 Cables, these connectors fit more than 40 different RG- types (see the table on page 63) and should be selected on the basis of cable type. The cable connectors consist of a basic connector plus inner and outer transition pieces, a soft-copper ferrule, a heat disk, and a flexible cable guard. The cylindrical transition pieces maintain the 50-ohm characteristic impedance of the connector throughout the reduction to the cable diameter. The cable inner conductor is soldered to the inner transition piece, and the cable braid and jacket are crimp-fastened to the outer transition by the ferrule. The Neoprene cable guard provides a protective handle which enhances the exclusive fast-connection properties of the TYPE 874 design.

The improved "A-suffix" cable connectors, here catalogued for the first time, offer vswr performance superior to that of any cable with which they can be used. In fact, performance is commensurate with that of rigid-line connectors. And the new connectors are even easier to assemble, thus minimizing unit-to-unit vswr changes resulting from assembly variations. Average vswr curves are given on the next page.

Highlights of the improved design are a change from a smooth taper to a stepped transition, the addition of the Teflon heat shield to prevent cable dielectric distortion, and the introduction of a longer, perforated ferrule, which secures both cable braid and jacket. The new ferrule thus prevents the braid from working loose and causing reflections and leakage. The opening in the gray cable guard

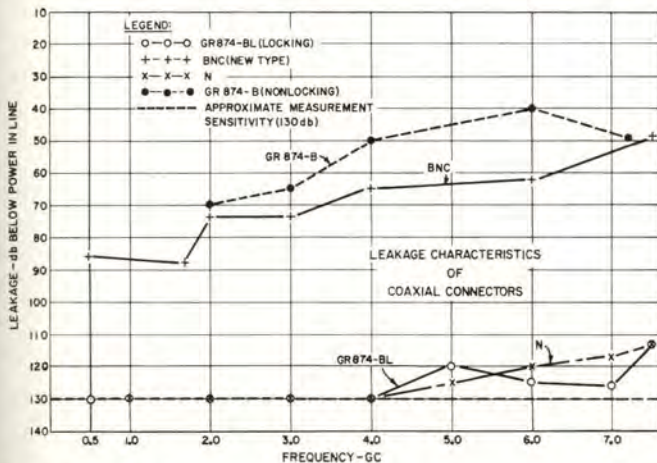

Typical leakage characteristics of Type 874 Connectors compared with other types.

(which identifies the new series) is now sized to grip the cable securely without compressing it, precluding impedance variations from that source.

Panel Connectors Six panel-connector configurations are available. There are three versions for each of the five cable-connector groupings. Basically, they are identical to the cable connectors, except that the cable guard is replaced by complete mounting hardware. The three panel-mounting types, designed for use with cable, are: (1) *Flanged*, nonlocking, mounts either side of panel; (2) *Panel Locking*, mounts with four screws; (3) *Recessed Panel Locking*, mounts with four screws, protrusion in front of panel limited to $\frac{1}{8}$ inch to save space and present a neat appearance. *Terminal Locking* and *Recessed Terminal Locking* Panel Connectors, to join single-wire leads (via a solder terminal) to TYPE 874 connectors, are also available.

A recent innovation is the TYPE 874-PFL, Panel Feed-through Locking Connector. A short section of air line with a locking connector at each end, it is useful for joining TYPE 874 cable connectors directly through a panel, thus avoiding awkward patch-cord runs on instrument racks. It is supplied with hardware for mounting either as an ordinary or a recessed panel-locking connector.

Type 874 Adaptors More than 30 different low-reflection adaptors are offered to permit use of TYPE 874 connectors with common military and commercial coaxial connectors, including high-power types for television broadcast use. They are available both in regular, quick connect/disconnect, and locking versions. TYPE 874 adaptors can convert any instrument fitted with TYPE 874 connectors for use with connectors of almost any type.

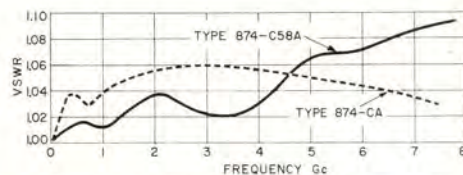

Typically, the vswr of the converted TYPE 874 connector is comparable to the vswr of the other connector by itself. The TYPE 874 locking adaptor offers a low-leakage connection that can be wrench-tightened, yet one that can be quickly removed if a change of connector is desired. When a TYPE 874-PRL Locking Recessed Panel Connector is used, the adaptor extends less than an inch in front of the instrument panel surface.

These uniform 50-ohm adaptors offer electrical performance to match their convenience. In nearly every instance, design improvements in the "other-series" connector raise its vswr performance closer to that of the TYPE 874 connector to which it is joined. For example, the nominal dimensions of adaptors to various military series are refined, and the tolerances maintained exceed military specifications. vswr plots for pairs of many of these adaptors are given on page 64. Photos below show three principal applications of TYPE 874 adaptors to General Radio instruments and illustrate their neat and unobtrusive appearance.

Because any two TYPE 874 adaptors mate, a few TYPE 874 adaptors can perform a cross-connection job that would otherwise require a costly quantity of direct adaptors. For instance, interconnection of all possible combinations of types N, C, BNC, TNC, UHF, and Microdot plugs and jacks would require 72 adaptors, while only 12 TYPE 874 adaptors will perform the job.

Now

most types of connectors can be used with GR instruments

TYPE 874 ADAPTORS PROVIDE THE LINK



unit oscillator output connector adapted to type BNC with Type 874-QBJL



locking Type 874 panel connector adapted to type N with Type 874-QNJL



recessed Type 874 panel connector adapted to type TNC with Type 874-QTNJL











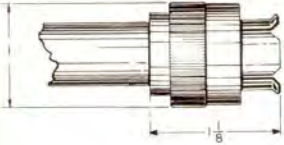



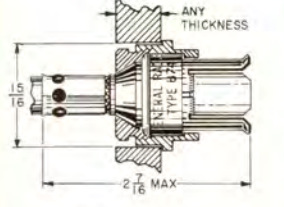

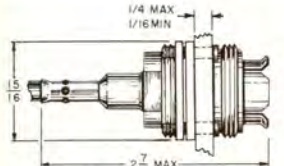

Type 874 COAXIAL CONNECTORS

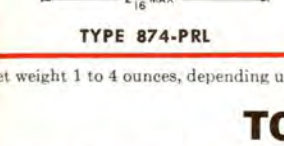
CONNECTORS

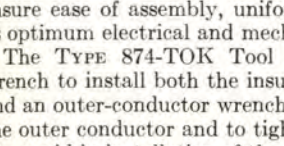
SEE PAGE 60 FOR POWER AND VOLTAGE RATINGS

	Group	Type	Fits	Code Number	Price*	
 <p>TYPE 874-BL</p>	Basic Connectors	874-B	50-ohm Rigid Air Line	0874-9400	\$2.25	
		874-BL	50-ohm Rigid Air Line	0874-9401	3.25	
 <p>TYPE 874-CL</p>	Cable Connectors	874-CA	(50-ohm) 874-A2 Cable	0874-9410	3.00	
		874-C8A	(50-ohm) RG-8A/U, -9B/U, -10A/U, -87A/U, -116/U, -156/U, -165/U, -166/U, -213/U, -214/U, -215/U, -225/U, -227/U; (non-50-ohm) RG-11A/U, -12A/U, -13A/U, -63B/U, -79B/U, -89/U, -144/U, -146/U, -149/U, -216/U Cables	0874-9412	3.00	
		874-C58A	(50-ohm) 874-A3, RG-29/U, -55/U (series), -58/U (series), -141A/U, -142A/U, -159/U, -223/U Cables	0874-9414	3.00	
		874-C62A	(non-50-ohm) RG-59/U, -62/U (series), -71B/U, -140/U, -210/U Cables	0874-9416	3.00	
		874-C174A	(50-ohm) RG-174/U, -188/U, -316/U; (non-50-ohm) RG-161/U, -179/U Cables	0874-9418	4.50	
 <p>TYPE 874-PB</p>	Cable Connectors — Locking	874-CLA	Same as Type 874-CA.	0874-9411	4.00	
		874-CL8A	Same as Type 874-C8A.	0874-9413	4.00	
		874-CL58A	Same as Type 874-C58A.	0874-9415	4.00	
		874-CL62A	Same as Type 874-C62A.	0874-9417	4.00	
		874-CL174A	Same as Type 874-C174A.	0874-9419	5.50	
 <p>TYPE 874-PBA</p>	Panel Connectors — Flanged	874-PBA	Same as Type 874-CA.	0874-9440	4.00	
		874-PB8A	Same as Type 874-C8A.	0874-9442	4.00	
		874-PB58A	Same as Type 874-C58A.	0874-9444	4.00	
		874-PB62A	Same as Type 874-C62A.	0874-9446	4.00	
		874-PB174A	Same as Type 874-C174A.	0874-9448	5.00	
 <p>TYPE 874-PLA</p>	Panel Connectors — Locking	874-PLA	Same as Type 874-CA.	0874-9441	4.00	
		874-PL8A	Same as Type 874-C8A.	0874-9443	4.00	
		874-PL58A	Same as Type 874-C58A.	0874-9445	4.00	
		874-PL62A	Same as Type 874-C62A.	0874-9447	4.00	
		874-PLT	Wire Lead.	0974-9459	4.00	
874-PL174A	Same as Type 874-C174A.	0874-9449	5.00			
 <p>TYPE 874-PRL</p>	Panel Connectors — Locking Recessed	874-PRLA	Same as Type 874-CA.	0874-9461	4.00	
		874-PRL8A	Same as Type 874-C8A.	0874-9463	4.00	
		874-PRL58A	Same as Type 874-C58A.	0874-9465	4.00	
		874-PRL62A	Same as Type 874-C62A.	0874-9467	4.00	
		874-PRLT	Wire Lead.	0874-9479	4.00	
874-PRL174A	Same as Type 874-C174A.	0874-9469	5.00			
 <p>TYPE 874-PFL</p>	Panel Connector — Locking Feedthrough	874-PFL	Mates any pair of Type 874 Connectors directly through a panel or wall.	0874-9451	9.50	

Net weight 1 to 4 ounces, depending upon item.

* For quantities of 1 to 99; prices for larger quantities on request.

TOOLS

Although TYPE 874 connectors can be assembled with ordinary pliers and wrenches, use of special tools is recommended. The tools ensure ease of assembly, uniformity, and good appearance, as well as optimum electrical and mechanical characteristics.

The TYPE 874-TOK Tool Kit consists of an inner-conductor wrench to install both the insulating bead and the inner conductor, and an outer-conductor wrench and a coupling-nut wrench to install the outer conductor and to tighten the coupling nut. The remaining pieces aid in installation of the retaining ring.

When a TYPE 874 connector is installed on cable, the ferrule must be crimped to secure the cable to the connector. Pliers can be used to crimp the ferrule, but where many connectors are to be installed, or where the neatest possible crimp is desired, use of the TYPE 874-TO58 or -TO8 Crimping Tool is recommended.

TYPE 874-TOK TOOL KIT



1. Outer-conductor wrench
2. Inner-conductor wrench
3. Coupling-nut wrench
4. Front-ring expander (red)
5. Keeper for ring expanders
6. Back-ring expander (green)
7. Ring pusher

CRIMPING TOOLS



874-TO58 874-TO8

Type		Net Weight	Code Number	Price
874-TOK	Tool Kit	1 lb (0.5 kg)	0874-9902	\$25.00
874-TP58	Crimping Tool	1 3/4 lb (0.8 kg)	0874-9901	85.00
874-TO8	Crimping Tool	1 3/4 lb (0.8 kg)	0874-9900	75.00

Use on Cable Connector

874-CA, -CLA, -C58A, -CL58A, -C62A, -CL62A, -C174A, -CL174A, -PBA, -PLA, -PRLA, -PB58A, -PL58A, -PRL58A, -PB62A, -PL62A, -PRL62A, -PB174A, -PL174A, -PRL174A

874-C8A, -CL8A, -PB8A, -PL8A, -PRL8A

Crimping Tool Type

874-TO58

874-TO8



ADAPTORS

COAXIAL
ADAPTORS

In ordering adaptors by type number, note that the P or J suffix letter identifies the connector on the adaptor, and not the connector that the adaptor fits. (For instance, the J in TYPE 874-QNJ indicates that the adaptor *contains* a type-N jack, and therefore *fits* a type-N plug.) A final L in the type designation indicates a locking adaptor,

that is, one that contains a locking TYPE 874 Connector. TYPE 874-QU1A, -QU2, and -QU3A Adaptors are used to connect the rigid lines in television transmitting antenna systems to instruments or components fitted with TYPE 874 connectors, as, for instance, the TYPE 1602-B UHF Admittance Meter and the TYPE 874-LBA Slotted Line.

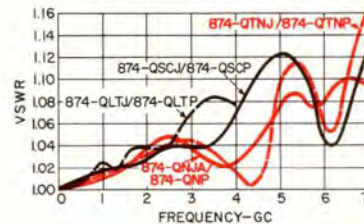
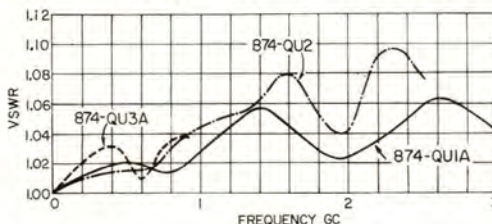
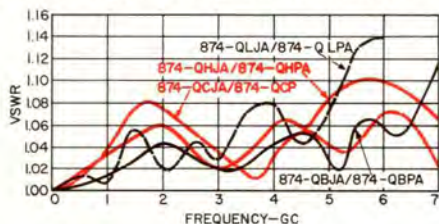

Typical VSWR introduced in line by pairs of Type 874 Adaptors plugged together.

ADAPTORS

SEE PAGE 60 FOR POWER AND VOLTAGE RATINGS

	Type*	Fig Ref	Contains 874 and . . .	Connects Type 874 to . . .	Net Wt**	Code Number	Price	Nonlocking Adaptors
TO TYPE BNC	874-QBJA	A	BNC Jack	BNC Plug	1 oz	0874-9700	\$ 4.75	
	874-QBJL		BNC Jack	BNC Plug	1 1/2 oz	0874-9701	5.75	
	874-QBPA	B	BNC Plug	BNC Jack	1 1/2 oz	0874-9800	6.00	
TO TYPE C	874-QCJA	C	C Jack	C Plug	1 oz	0874-9702	6.00	
	874-QCJL		C Jack	C Plug	2 oz	0874-9703	7.00	
	874-QCP	D	C Plug	C Jack	2 oz	0874-9802	6.25	
TO TYPE HN	874-QHJA	E	HN Jack	HN Plug	1 1/2 oz	0874-9704	6.00	
	874-QHPA	F	HN Plug	HN Jack	2 1/2 oz	0874-9804	7.50	
TO TYPE LC	874-QLJA	G	LC Jack	LC Plug	5 oz	0874-9706	6.00	
	874-QLPA	H	LC Plug	LC Jack	7 1/2 oz	0874-9806	16.00	
TO TYPE LT	874-QLTJ	I	LT Jack	LT Plug	4 3/4 oz	0874-9708	10.00	
	874-QLTP	J	LT Plug	LT Jack	7 oz	0874-9808	20.00	
TO TYPE MICRODOT	874-QMDJ	K	Microdot Jack	Microdot Plug	1 oz	0874-9720	9.50	
	874-QMDJL		Microdot Jack	Microdot Plug	1 1/2 oz	0874-9721	10.50	
	874-QMDP	L	Microdot Plug	Microdot Jack	1 oz	0874-9820	9.50	
TO TYPE N	874-QNJA	M	N Jack	N Plug	1 1/2 oz	0874-9710	5.00	
	874-QNJL		N Jack	N Plug	2 oz	0874-9711	6.00	
	874-QNP	N	N Plug	N Jack	1 3/4 oz	0874-9810	5.00	
TO TYPE SC	874-QSCJ	O	SC Jack	SC Plug (Sandia)	1 3/8 oz	0874-9712	9.00	
	874-QSCJL		SC Jack	SC Plug (Sandia)	2 oz	0874-9713	10.00	
	874-QSCP	P	SC Plug	SC Jack (Sandia)	1 3/8 oz	0874-9812	9.00	
TO TYPE TNC	874-QTNJ	Q	TNC Jack	TNC Plug (Sandia)	1 oz	0874-9716	6.50	
	874-QTNJL		TNC Jack	TNC Plug (Sandia)	1 1/2 oz	0874-9717	7.50	
	874-QTNP	R	TNC Plug	TNC Jack (Sandia)	1 1/4 oz	0874-9816	6.50	
TO TYPE UHF	874-QUJ	S	UHF Jack	UHF Plug	1 oz	0874-9718	5.00	
	874-QUJL		UHF Jack	UHF Plug	2 oz	0874-9719	6.00	
	874-QUP	T	UHF Plug	UHF Jack	1 1/2 oz	0874-9818	5.00	
TO TYPE 274	874-Q2		274 Plug/Jack	274 Plug or Jack	2 oz	0874-9870	5.50	Shown on page 208
	874-Q9		938 Jack	938 Binding Posts	3 oz	0874-9874	6.00	
TO UHF RIGID LINE 50-OHM	874-QU1A 874-QU2 874-QU3A	U		3/8-in., RG-155/U (EIA TR-134) 1 5/8-in., RG-153/U (EIA TR-134) 3 1/8-in., RG-154/U (EIA TR-134)	7 oz 1 1/4 lb 5 1/4 lb	0874-9770 0874-9772 0874-9774	35.00 80.00 240.00	

* L-suffix denotes locking TYPE 874 connector — see photos, page 62.

** To convert ounces to grams, multiply by 28; to convert pounds to kilograms, divide by 2.2.



Type 874-LBA SLOTTED LINE

COAXIAL
SLOTTED LINE

FEATURES:

- ◆ Highly accurate but reasonably priced.
- ◆ Rugged enough for production use.
- ◆ Integral probe and crystal.
- ◆ Wide frequency range, 300 Mc to 5 Gc.
- ◆ Wide variety of accessories available.
- ◆ Low-reflection adaptors available to connect to most coaxial-connector series.

USES: One of the most important basic measuring instruments used at uhf and above is the slotted line. With it, vswr, phase of the reflected wave, impedance or admittance of the load, wavelength of the rf signal, losses in attached elements, degree of mismatch between load and line, and other characteristics of antennas, components, coaxial elements, and networks can be determined.

The TYPE 874-LBA is ideally suited for general-purpose measurements where accuracies of a few percent are sufficient. The TYPE 900-LB Precision Slotted Line (page 76) is available for users requiring accuracies of a few tenths percent.

Measurements can be made on balanced lines and components with the aid of a TYPE 874-UBL Balun (page 73).

DESCRIPTION: The TYPE 874-LBA Slotted Line is a 50-ohm air-dielectric, coaxial line whose electric field is sampled by an integral probe that projects through a longitudinal slot in the line. Probe coupling is adjustable. The probe carriage is driven by a pulley-and-cord arrangement conveniently operated from one end of the line, and can be precisely set. A source of about one milliwatt rf power is adequate for most measurements; suitable generators are listed on the next page. A crystal rectifier is built into the carriage and can be tuned to the operating frequency by means of an adjustable stub. Three suitable types of detector are described on the next page.

SPECIFICATIONS

Characteristic Impedance: 50 ohms \pm 0.5%.

Probe Travel: 50 cm. Scale in centimeters; each division is 1 mm.

Scale Accuracy: \pm (0.1 mm + 0.05%).

Frequency Range: 300 Mc to 5 Gc. At 300 Mc, the slotted line covers a half wavelength. Operation below 300 Mc is possible with slightly reduced accuracy by use of lengths of TYPE 874 Air Lines (page 71).

Constancy of Probe Pickup: \pm 1.5%.

Residual VSWR: Less than 1.025 at 1 Gc, 1.04 at 2 Gc, 1.055 at 3 Gc, 1.07 at 4 Gc, 1.1 at 5 Gc.

Accessories Supplied: Storage box and spare drive cable.

Accessories Required: Adjustable Stub (TYPE 874-D20L) for tuning the crystal rectifier when audio-frequency detector or microammeter is used; suitable detector and generator; one each, TYPE 874-R22LA

and TYPE 874-R22A Patch Cords, for generator and detector connections.

Accessories Available: A complete slotted-line kit is described on page 66. For measurement of vswr greater than 10, a TYPE 874-LV Micrometer Vernier is recommended. Smith Charts are listed below. Adaptors are listed on page 64.

Dimensions: 26 by 4½ by 3½ inches (660 by 115 by 89 mm).

Net Weight: 8½ pounds (3.9 kg).

Shipping Weight: 23 pounds (10.5 kg).

Type		Code Number	Price
874-LBA	Slotted Line	0874-9650	\$255.00
874-LV	Micrometer Vernier	0874-9652	37.50

Type 874-LV MICROMETER VERNIER

For precise measurements of large vswr by the width-of-minimum method, and for precise phase measurements. Consists of a micrometer head calibrated in centimeters (calibrated to 0.001 cm), mounted on an arm that can be attached to the rear base rod of the slotted line. One turn of the micrometer barrel advances the head by 0.5 mm. Maximum range is 2.5 cm. Can be read to \pm 0.002 mm.

Net Weight: 8 ounces (230 grams).

SMITH CHARTS

The Smith Chart facilitates measurements made with the TYPE 874-LBA Slotted Line. It can be used to determine the impedance corresponding to any vswr and to convert from impedance to admittance, and vice versa. Four forms of Smith Chart are available; see below. Those with normalized coordinates are for use with lines of any impedance. The 50-ohm characteristic impedance (20-mmho characteristic admittance) is common to all General Radio coaxial equipment. Charts are 8½ by 11 inches.

	Code Number	Quantity	Price
Smith Chart — Admittance Coordinates (20-mmho characteristic admittance)	5301-7568Y	50*	\$ 2.00
Smith Chart — Impedance Coordinates (50-ohm characteristic impedance)	5301-7569Z	100	3.75
Smith Chart — Normalized Coordinates	5301-7560N	200	7.00
Smith Chart — Normalized Expanded Coordinates	5301-7561NE	500	14.00
		1000	25.00

* Minimum quantity sold.

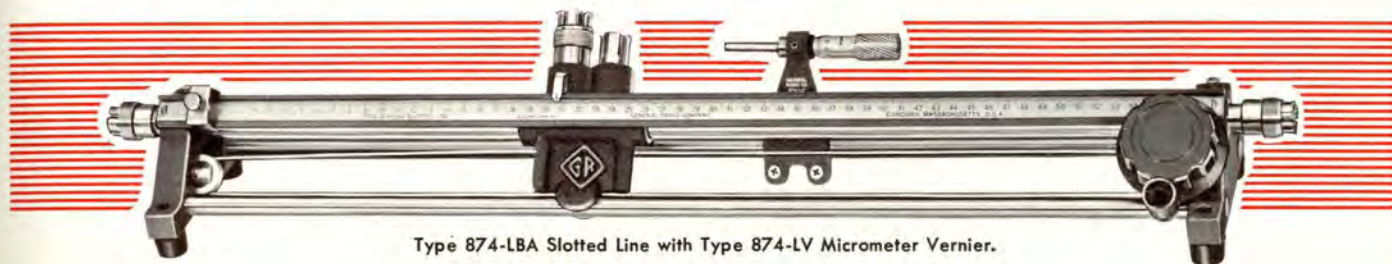

Type 874-LBA Slotted Line with Type 874-LV Micrometer Vernier.

GP SLOTTED-LINE ACCESSORIES

GENERATORS

Oscillators covering the frequency range of the slotted line are described on pages 112 to 118. They can be square-wave modulated at 1 kc with the TYPE 1264-A Modulating Power Supply. For use at the higher frequencies, both the TYPE 1220-A Unit Klystron Oscillator and the TYPE 1360-A Microwave Oscillator have internal 1-kc square-wave modulation. Where a calibrated output is desired, a standard-signal generator (such as the TYPE 1021-AU, page 124) can be used. To modulate any of these generators at frequencies other than 1 kc, the TYPE 1210-C Unit R-C Oscillator (page 105) is recommended.

DETECTORS

Any one of three types of detector can be used with the slotted line. The heterodyne detector is an excellent general-purpose instrument. The General Radio TYPE DNT Detectors cover the frequency range from 40 to 2030 Mc (up to 5 Gc by the use of harmonics).

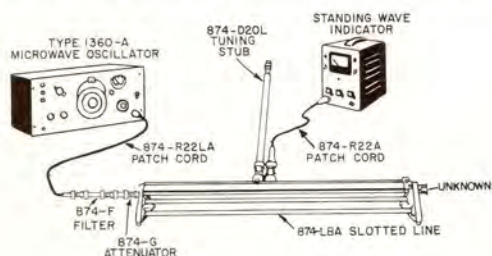

Typical measurement setups showing use of slotted line, VSWR indicator (left), and heterodyne detector (right).

Each TYPE DNT system includes local oscillator, i-f amplifier, mixer, filter, attenuator pad, and ell (see page 81).

The simplest suitable detector is a microammeter used with the slotted line's built-in crystal. Its sensitivity is low, but satisfactory with high-power oscillators. Excellent results can be obtained with a 50-microampere meter and oscillator power levels between 100 milliwatts and 20 watts, for vswr between 1 and 5. A TYPE 874-D20L 20-centimeter Tuning Stub is required. A meter-sensitivity control, consisting of a 10-kilohm variable shunt resistor, is recommended.

Most popular vswr indicators will serve as satisfactory detectors with the TYPE 874-LBA. Use of such a detector requires that the generator be modulated at 1 kc. Also, a TYPE 874-D20L 20-centimeter Stub is required for tuning.

FILTERS AND ISOLATORS

A low-pass coaxial filter should be used between generator and slotted line to eliminate harmonics of the signal source. An isolator prevents load-generator interaction. See page 68 for complete specifications.

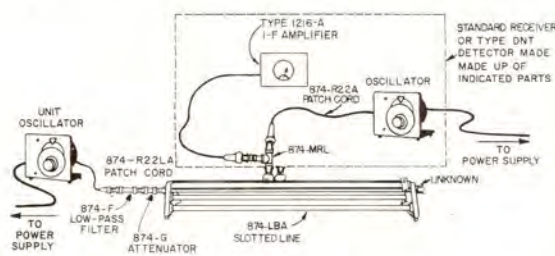

GP COAXIAL KITS

TYPE 874-EKA BASIC SLOTTED-LINE KIT

For impedance and vswr measurements with the slotted line, a group of coaxial elements is available as the TYPE 874-EKA Basic Slotted-Line Kit. The TYPE 874-LBA Slotted Line is included in the kit, but the generator and detector are not.

Shipping Weight: 38 pounds (17.5 kg).

Type		Quantity	Price
874-A2	Coaxial Cable	25 ft	\$10.00
874-A3	Coaxial Cable	25 ft	5.00
874-BL	Basic Connector, Locking	2	6.50
874-B	Basic Connector	2	4.50
874-CA	Cable Connector	2	6.00
874-C8A	Cable Connector	2	6.00
874-CLA	Cable Connector, Locking	2	8.00
874-C58A	Cable Connector	2	6.00
874-CL58A	Cable Connector, Locking	2	8.00
874-D20L	Adjustable Stub	1	16.00
874-D50L	Adjustable Stub	1	19.00
874-LAL	Adjustable Line	1	27.00
874-LBA	Slotted Line	1	255.00
874-PL58A	Panel Connector, Locking	1	4.00
874PRL58A	Panel Connector, Locking Recessed	1	4.00
874-QBJL	Adaptor, Locking, Connects to type BNC Plug	1	5.75

Type		Quantity	Price
874-QNJL	Adaptor, Locking, Connects to type N Plug	1	\$6.00
874-QNP	Adaptor, Connects to type N Jack	1	5.00
874-R22A	Patch Cord	1	10.00
874-R22LA	Patch Cord, Locking	1	12.00
874-R34	Patch Cord	1	6.00
874-TL	Tee, Locking	1	15.00
874-W50	50-ohm Termination	1	18.50
874-WN	Short-Circuit Termination	1	3.50
874-WO	Open-Circuit Termination	1	2.50
874-TOK	Tool Kit	1	25.00
874-Z	Stand	1	19.50

Type		Code Number	Price
874-EKA	Basic Slotted-Line Kit	(0874-9521)	\$513.75

KITS FOR CABLE MEASUREMENTS

Various combinations of TYPE 874 coaxial elements can be used very effectively with Unit Instruments and associated equipment to measure attenuation, characteristic impedance, velocity of propagation, and capacitance of both coaxial and twin-conductor cables.

For convenience in ordering, the necessary equipment is offered in assemblies for specific types of measurement. These kits and their use are described in Reprint E-104, "The Measurement of Cable Characteristics," available on request.

GP COAXIAL CABLES

TYPE 874-A2 COAXIAL CABLE Flexible, double-shielded, bulk cable. Consists of No. 14 stranded inner conductor separated from the two tinned-copper braids by 0.250-inch of polyethylene dielectric and a 0.365-inch of gray polyvinyl-chloride jacket.

Characteristic Impedance: 50 ohms \pm 5%.

Nominal Capacitance: 29 pf per foot.

Attenuation: 2.6 db per 100 feet at 100 Mc; 10.5 db per 100 feet at 1 Gc.

Propagation Velocity Factor: 66%.

Net Weight: 2 $\frac{3}{4}$ pounds (1.3 kg) per 25 feet.

TYPE 874-A3 COAXIAL CABLE Same as TYPE 874-A2 except inner conductor is 19 strands of 0.0066-inch tinned, soft-copper wire, separated from the double braid by 0.116-inch of polyethylene dielectric, and a 0.206-inch of black polyvinyl-chloride jacket. More

flexible than the TYPE 874-A2, but losses are higher. Recommended for most general-purpose applications.

Characteristic Impedance: 50 ohms \pm 5%.

Nominal Capacitance: 29 pf per foot.

Attenuation: 5.3 db per 100 feet at 100 Mc; 22 db per 100 feet at 1 Gc; 45 db per 100 feet at 3 Gc.

Propagation Velocity Factor: 66%.

Net Weight: 1 pound (0.45 kg) per 25 feet.

Type		Code Number	Price
874-A2	Coaxial Cable	0874-9500	\$0.60/ft (0.40/ft in lengths of 25 ft or more)
874-A3	Coaxial Cable	0874-9501	0.35/ft (0.20/ft in lengths of 25 ft or more)



COAXIAL DETECTOR, VOLTMETER, AND MIXER

Type 874-VQ VOLTMETER DETECTOR

Can be used with TYPE 874-VI (see below) for voltage measurement, with a tuned audio amplifier such as the TYPE 1232-A Tuned Amplifier as a sensitive detector (approximately 100 microvolts) of modulated signals, or with a microammeter as an rf detector. It introduces no appreciable discontinuity when inserted in a 50-ohm coaxial line. With the TYPE 874-W50 50-ohm Termination, it can be used as a matched detector to terminate a line. TYPE 874-VQL has locking connectors.

Frequency Range as Matched Detector: 0.5 Mc to 2 Gc. Usable from 60 cps to 7 Gc.

Resonant Frequency: Approximately 5.4 Gc; correction curve supplied.

Maximum Voltage: 2 volts.

VSWR: Less than 1.1 at 1 Gc, 1.2 at 2 Gc.

Crystal: 1N23B.

Bypass Capacitance: Approximately 300 pf.

Dimensions: Length 3¾, height 2½ inches (96 by 64 mm).

Net Weight: TYPE 874-VQ, 5 ounces (140 grams); TYPE 874-VQL, 6 ounces (170 grams).

Typical VSWR and correction factor for Types 874-VQ and 874-VR.

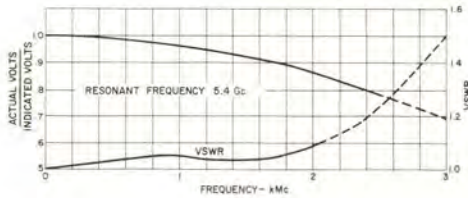

Type 874-VR VOLTMETER RECTIFIER

In conjunction with the TYPE 874-VI (see below), can be used to measure, or to monitor, the voltage in coaxial systems. It contains a 50-ohm resistor in series with the output line, and thus can be used to measure the voltage behind a 50-ohm impedance. The unit, when used with a signal source, will simulate a 50-ohm generator with a known, equivalent, open-circuit voltage. In addition, it is a good general-purpose detector and can be used with a microammeter or, when high sensitivity is desired (approximately 100 microvolts), with modulated signals and a tuned audio amplifier such as the TYPE 1232-A. With the TYPE 1263-B Amplitude-Regulating Power Supply, it provides an effective oscillator amplitude-leveling system. The TYPE 874-VRL has locking connectors.

Frequency Range as Calibrated Voltmeter: 15 Mc to 2.5 Gc.

Resonant Frequency: Approximately 5.4 Gc; correction curve supplied.

Maximum Voltage: 2 volts.

Crystal: 1N23B.

Bypass Capacitance: Approximately 300 pf.

Dimensions: Length 3¾, height 2½ inches (96 by 64 mm).

Net Weight: TYPE 874-VR, 5 ounces (140 grams); TYPE 874-VRL, 6 ounces (170 grams).

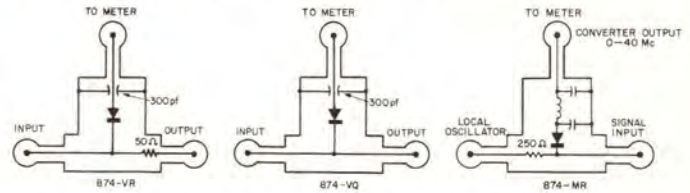

Schematic diagram of Types 874-VR, 874-VQ, and 874-MR.

Type 874-VI VOLTMETER INDICATOR

Measures dc output of either TYPE 874-VQ or TYPE 874-VR at any level between 0.1 and 2 volts. A built-in 60-cycle calibration system eliminates errors arising from differences in crystal rectification efficiencies.

Range and Accuracy of Calibrating Voltage: 0.1 to 2 volts, ±0.05 volt.

Crystal Current for Full-Scale Indication: 200 microamperes.

Power Supply: 105 to 125 (or 210 to 250) volts, 50 to 60 cps.

Input Resistance: 600 ohms minimum, 10,000 ohms maximum.

Accessory Supplied: TYPE CAP-22 Power Cord.

Accessory Required: One TYPE 874-R34 Patch Cord (page 70).

Dimensions: 5½ by 5½ by 4½ inches (140 by 140 by 115 mm), over-all.

Net Weight: 3 pounds (1.4 kg).

Shipping Weight: 5 pounds (2.3 kg).

Type 874-MR MIXER RECTIFIER

The TYPE 874-MR Mixer Rectifier is a broadband rf mixer. With a TYPE 1216-A Unit I-F Amplifier, it forms a heterodyne detector having a 30-Mc difference frequency. The output circuit contains a low-pass filter having a cut-off frequency of 40 Mc. A 250-ohm series resistor isolates the signal circuit from the local-oscillator circuit. TYPE 874-MRL has locking connectors.

Operating Frequency Range: 40 Mc to 5 Gc; at lower and higher frequencies with decreased sensitivity.

Crystal: 1N21B.

Crystal Current: 5 ma (maximum), 0.2 ma (minimum).

Maximum Input from Local Oscillator: 2 volts.

Cutoff Frequency of Output Filter: 40 Mc.

Output Impedance: Approximately 400 ohms.

Accessories Required: For complete detector assembly, see page 81.

Dimensions: Length 3¾, height 3½ inches (96 by 89 mm).

Net Weight: 874-MR — 7 ounces (200 grams); 874-MRL — 8 ounces (230 grams).

Type		Code Number	Price
874-VQ	Voltmeter Detector	0874-9940	\$30.00
874-VQL	Voltmeter Detector (locking connectors)	0874-9941	32.00
874-VR	Voltmeter Rectifier	0874-9942	30.00
874-VRL	Voltmeter Rectifier (locking connectors)	0874-9943	32.00
874-MR	Mixer Rectifier	0874-9944	32.50
874-MRL	Mixer Rectifier (locking connectors)	0874-9945	34.50
874-VI	Voltmeter Indicator	0874-9936	95.00



COAXIAL DETECTOR, VOLTMETER, MIXER

GP FILTERS

COAXIAL
FILTERS, STUBS, ISOLATORS

TYPE 874-F LOW-PASS FILTERS Recommended for any immittance- or voltage-measurement system to reduce harmonics, especially with systems containing nonlinear elements, or sections that might resonate at a harmonic. Also useful if high standing-wave ratios are to be measured by means of a slotted line. The TYPE 874-F Low-Pass Filters are Tschebyscheff type, which produce a very steep cutoff characteristic at the expense of passband flatness. Spurious responses in the stop band are very small. Equipped with locking connectors on both ends.

Accuracy of Cutoff Frequencies: -0%, +10%.

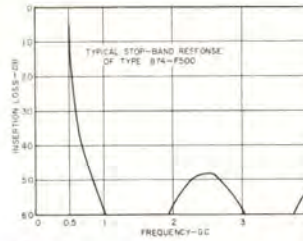

Typical stop-band response of Type 874-F500L Low-Pass Filter.

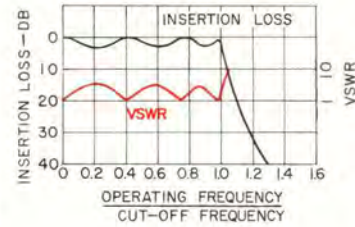

Typical insertion loss and VSWR, Type 874-F Filters.



Type 874-F2000L

Type	Physical Length	Net Wt	Code Number	Price
874-F185L	185-Mc Low-Pass Filter	17 3/8 in.	0874-9533	\$32.00
874-F500L	500-Mc Low-Pass Filter	10 3/16 in.	0874-9537	26.00
874-F1000L	1000-Mc Low-Pass Filter	7 7/8 in.	0874-9541	24.00
874-F2000L	2000-Mc Low-Pass Filter	4 3/8 in.	0874-9545	24.00
874-F4000L	4000-Mc Low-Pass Filter	2 7/8 in.	0874-9549	24.00

GP TUNING ELEMENTS

TYPE 874-D20L AND -D50L ADJUSTABLE STUBS For matching or tuning, for use as adjustable short-circuit terminations, and for use as reactive elements. With an external indicator, functions as a reaction-type wavemeter. Consists of a coaxial line with a sliding short circuit of the multiple-spring-finger type. The 20-centimeter stub is calibrated in electrical length. The 50-centimeter stub is not calibrated but has an adjustable reference marker. Each is equipped with a locking connector.

Characteristic Impedance: 50 ohms.

Maximum Travel: TYPE 874-D20L, 20 cm; TYPE 874-D50L, 50 cm.

Physical Length: TYPE 874-D20L, 28 cm (min) to 48 cm (max); TYPE 874-D50L, 58 cm (min) to 109 cm (max).

TYPE 874-VCL VARIABLE CAPACITOR Tuning element for resonant-line circuits, matching transformers, and baluns at low frequencies where line-type elements are

awkward to use. Well-shielded, high-temperature polystyrene insulation, precision ball bearings, locking connector.

Scale: 0 - 100.

Capacitance Range: Low frequencies, 14 to 70 pf at connector, 16.5 to 72.5 pf at T-junction.

Capacitance Variation: Linear.

Dimensions: Diameter 2 1/2, height 5 1/4 inches (64 by 135 mm).

TYPE 874-XL SERIES INDUCTOR Used as a general-purpose tuning element in resonant-line circuits, matching transformers, and baluns at low frequencies.

Series Inductance: 0.226 μ h \pm 5% at 1 kc.

Type	Net Wt*	Code Number	Price	
874-D20L	20-cm Adjustable Stub	7 oz	0874-9511	\$16.00
874-D50L	50-cm Adjustable Stub	13 oz	0874-9513	19.00
874-VCL	Variable Capacitor	12 1/2 oz	0874-9931	61.00
874-XL	Series Inductor	3 1/2 oz	0874-9998	15.00

* To convert ounces to grams, multiply by 28.

GP ISOLATORS

TYPES 874-H500L, -H1000L, and -H2000L ISOLATORS These are compact, broadband, one-way transmission devices. They consist of a section of 50-ohm coaxial line

surrounded by a permanent magnet and loaded internally with ferrite material. They have very low insertion loss in one direction and high attenuation in the reverse direction. Thus, they efficiently eliminate interactions between elements in a coaxial-measurement setup. They are particularly useful for isolating a generator from the effects of load changes and for matching a generator to a 50-ohm load. All have TYPE 874 locking connectors at both ends.



Type 874-D20L

Type 874-VCL



Type 874-XL



Type 874-H1000L

Type	Freq Range Gc	VSWR Max	Max Power Watts	Isolation db-Min	Insertion Loss db-Max	Length Inches	mm
874-H500L	0.5-1	1.20	5	10	1.5	10 3/4	275
874-H1000L	1-2	1.15	5	10	1.0	7 3/4	200
874-H2000L	2-4	1.18	5	20	1.0	8 1/4	210

Type	Net Weight Pounds	kg	Code Number	Price	
874-H500L	Isolator	4	1.9	0874-9581	\$550.00
874-H1000L	Isolator	1 1/2	0.7	0874-9583	325.00
874-H2000L	Isolator	2	1	0874-9585	275.00



Type 874-GAL ADJUSTABLE ATTENUATOR

A waveguide-below-cutoff type, useful as a calibrated attenuator or as a sampling device. It is calibrated in decibels on a micrometer-type scale. Absolute attenuation is the sum of insertion loss and scale reading. The main line is a short coaxial section with locking connectors, one end for source and the other for load. It introduces minimum discontinuity when inserted in a 50-ohm line. The loop output is brought out through three feet of 50-ohm cable.

Can be used with TYPE 874-VR/VRL Voltmeter Rectifier and TYPE 874-VI Voltmeter Indicator to convert a Unit Oscillator (pages 112 to 118) into a signal generator.

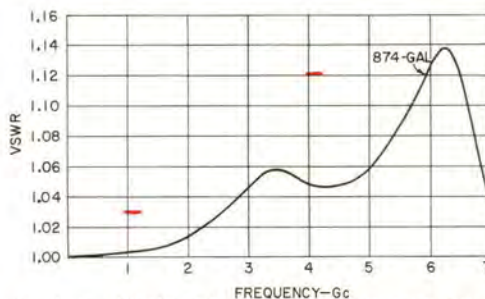

Typical main-line VSWR of Type 874-GAL Adjustable Attenuator. (Specifications in red.)

SPECIFICATIONS

Calibrated Range: 120 db (relative attenuation) with input line terminated in 50 ohms; 129 db with input line terminated in adjustable stub to minimize the electric field at the coupling point (scale reads -9 to 120 db).

Insertion Loss (from input connector to end of output cable at 1 Gc, when signal source impedance is 50 ohms):

With input line terminated in 50 ohms, and scale set at 0 db, 33 ± 2 db; set at -9 db, 18 ± 2 db (settings below 0 are not accurate).

With input line terminated in adjustable stub (which extends the range over which the calibration is accurate to the -9 db scale setting), 20 ± 2 db minimum.

(Insertion loss is approximately inversely proportional to frequency up to 1 Gc.)

Insertion Loss Directly Through Tee: Negligible.

Accuracy of Attenuation:

Stub-terminated input, $\pm(0.01$ times difference in attenuation reading +0.2) db, direct reading.

50-ohm terminated input, $\pm(0.015$ times difference in attenuation reading + 0.2) db, when corrected. Correction chart supplied.

VSWR Introduced into Line: Less than 1.03 at 1 Gc; less than 1.12 between 1 and 4 Gc.

VSWR of Output: Less than 4 at 1 Gc, less than 5 to 4 Gc.

Maximum Power: Input power inversely proportional to square root of frequency, and should not exceed 300 watts at 1 Gc. Output power should not exceed $\frac{1}{2}$ watt.

Frequency Range: 100 Mc to 4 Gc.



Type 874-G FIXED ATTENUATORS

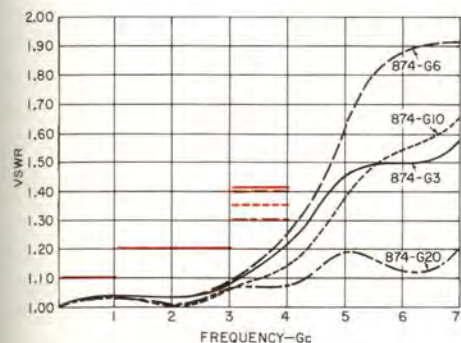

Typical VSWR of Type 874-G Attenuators. (Specifications in red.)

Single-section, T-type resistance pads, for adding fixed attenuation in 50-ohm systems and for matching to 50 ohms over a broad frequency range. Consist of one disk and two cylindrical resistors, as shunt and series elements, respectively. Available with regular or locking TYPE 874 connectors.

SPECIFICATIONS

DC Resistance: 50 ohms $\pm 1\%$ when terminated in 50 ohms.

VSWR: Less than 1.1 to 1 Gc, 1.2 to 3 Gc for all units; to 4 Gc, less than 1.3 for -G20, 1.35 for -G10, and 1.4 for -G3 and -G6.

Accuracy in 50-ohm System: $\pm 1.5\%$ of nominal at dc; ± 0.2 db from value indicated on curve to 1 Gc, ± 0.4 db to 2 Gc, ± 0.6 db to 4 Gc.

Temperature Coefficient: Less than 0.0003 db/ $^{\circ}$ C/db.

Maximum Power: CW - 1 watt; pulse - 3000 watts peak, 1 watt average.

Physical Length: $3\frac{1}{2}$ inches (90 mm), over-all.

Type		Net Weight	Code Number	Price
874-GAL	Adjustable Attenuator	1 $\frac{1}{4}$ lb (0.6 kg)	0874-9577	\$67.00
874-G3	Fixed Attenuator (3 db)	3 oz (85 grams)	0874-9564	36.00
874-G3L	Fixed Attenuator (3 db), locking connectors	4 oz (115 grams)	0874-9565	38.00
874-G6	Fixed Attenuator (6 db)	3 oz (85 grams)	0874-9568	30.00
874-G6L	Fixed Attenuator (6 db), locking connectors	4 oz (115 grams)	0874-9569	32.00
874-G10	Fixed Attenuator (10 db)	3 oz (85 grams)	0874-9570	30.00
874-G10L	Fixed Attenuator (10 db), locking connectors	4 oz (115 grams)	0874-9571	32.00
874-G20	Fixed Attenuator (20 db)	3 oz (85 grams)	0874-9572	30.00
874-G20L	Fixed Attenuator (20 db), locking connectors	4 oz (115 grams)	0874-9573	32.00

Type 874-G3L

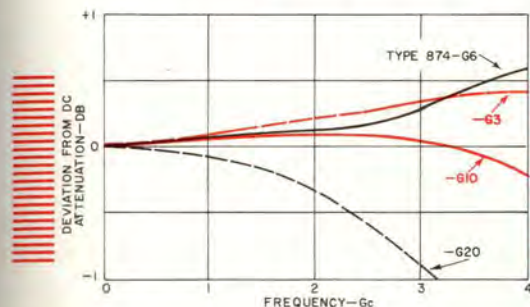

Type 874-GAL

STANDARD TERMINATIONS

TYPE 874-W50 50-OHM TERMINATION A 50-ohm cylindrical resistor mounted in a tapered coaxial holder, useful for impedance matching, establishment of reference conditions, and terminations. Locking- and nonlocking-connector versions available.

DC Resistance: 50 ohms \pm 0.5%.

Maximum Power: 2 watts continuous.

VSWR: Less than 1.06 at 4 Gc; see curve.

TYPE 874-WN SHORT-CIRCUIT TERMINATION A fixed shorting strap mounted in a connector, for establishing reference conditions on coaxial lines and for use in substitution measurements.

TYPE 874-WN3 SHORT-CIRCUIT TERMINATION Used same as TYPE 874-WN. The short circuit is at a point 3 cm (3.2-cm electrical distance) beyond the face of the bead in the TYPE 874 connector. This distance corresponds to the distance between the bead and the ground plane of the TYPE 874-ML Component Mount (see page 72) and the effective distance between the bead and the balanced terminals in the TYPE 874-UBL Balun (see page 73).

TYPE 874-WO OPEN-CIRCUIT TERMINATION A shielding cap for open-circuited lines, for establishing reference conditions on coaxial lines, and for use in substitution measurements. Produces an open circuit at same point in line that TYPE 874-WN produces a short circuit.

VSWR of Type 874-W50.

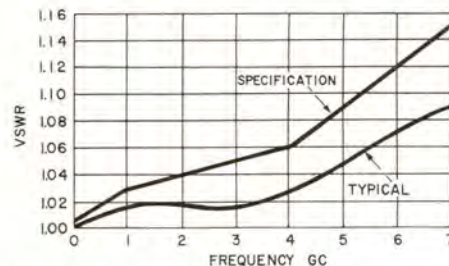

TYPE 874-WO3 OPEN-CIRCUIT TERMINATION Same as TYPE 874-WO, except that position of open circuit corresponds to position of short circuit in TYPE 874-WN3.

TYPE 874-W100 100-OHM COAXIAL STANDARD Produces known resistive termination at specific locations on coaxial lines. Useful for checking accuracy of directional couplers, bridges, and admittance meters. The known location of the purely resistive termination permits the production of many known complex impedances through the addition of sections of TYPE 874-L Air Line (page 71).

DC Resistance: 100 ohms \pm 1%.

Maximum Power: 1/3 watt continuous, 150 watts peak.

TYPE 874-W200 200-OHM COAXIAL STANDARD Same as TYPE 874-W100 except standard resistance is 200 ohms.

DC Resistance: 200 ohms \pm 1%.

Maximum Power: 1/4 watt continuous, 50 watts peak.

Type		Net Wt*	Code Number	Price
874-W50	50-ohm Termination	2 1/2 oz	0874-9952	\$18.50
874-W50L	50-ohm Termination, locking	3 oz	0874-9953	19.50
874-WN	Short-Circuit Termination	1 oz	0874-9970	3.50
874-WN3	Short-Circuit Termination	1 1/2 oz	0874-9972	5.50
874-WO	Open-Circuit Termination	1 oz	0874-9980	2.50
874-WO3	Open-Circuit Termination	1 1/2 oz	0874-9982	4.00
874-W100	100-ohm Coaxial Standard	3 oz	0874-9956	35.00
874-W200	200-ohm Coaxial Standard	3 oz	0874-9958	35.00

* To convert ounces to grams, multiply by 28.

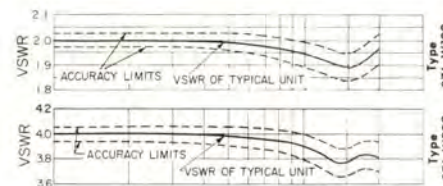

Typical VSWR of Types 874-W100 and -W200.

PATCH CORDS

These coaxial patch cords meet the need for flexible connections in measurements work. All are 3 feet long and are terminated in representative General Radio con-

nectors. The TYPES 874-R20A and -R22A Patch Cords have very low vswr characteristics (see curves) and are available with either locking or nonlocking connectors.

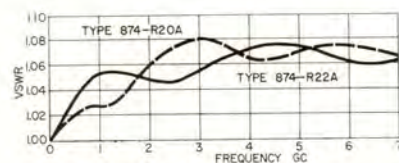

Average VSWR of Types 874-R20A and -R22A.

Type	Cable Type	Connectors Used	Braid	Length (Feet)	Freq Range	Net Wt*	Code Number	Price
874-R20A	874-A2	874-CA	Double	3	1 - 7 Gc	7 oz	0874-9680	\$11.00
874-R20LA	874-A2	874-CLA	Double	3	1 - 7 Gc	9 oz	0874-9681	13.00
874-R22A	874-A3	874-C58A	Double	3	1 - 7 Gc	4 oz	0874-9682	10.00
874-R22LA	874-A3	874-CL58A	Double	3	1 - 7 Gc	6 oz	0874-9683	12.00
874-R33	Coaxial	874-C58A & 274-NO	Single	3	—	2 1/2 oz	0874-9690	6.00
874-R34	Coaxial	874-C58A & 274-NK	Single	3	—	3 1/2 oz	0874-9692	6.00

* To convert ounces to grams, multiply by 28.

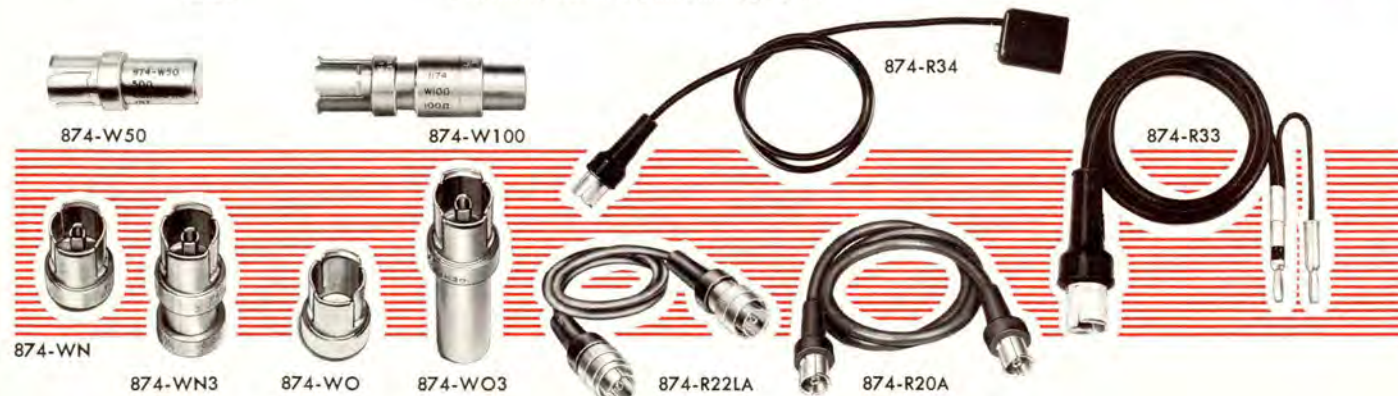



FIXED AND ADJUSTABLE AIR LINES

AIR LINES

TYPE 874-L RIGID AIR LINES For spacing stubs or other elements of a coaxial system; also useful as time-delay elements. Each air line consists of a length (10, 20, or 30 cm) of 50-ohm, air-dielectric coaxial line with a TYPE 874 coaxial connector, either regular or locking, at each end.

TYPE 874-LAL ADJUSTABLE LINE An air-dielectric coaxial line that can be telescoped to change its length. Used in matching networks, as a phase shifter, and as a variable time-delay element. Contacts are made by multiple-spring fingers. Connectors are locking TYPE 874.

Characteristic Impedance: Not constant — approximately 50 ohms when fully collapsed, approximately 57 ohms when fully extended.
Adjustment Range: 25 cm.
Physical Length: 33 cm (minimum) to 58 cm (maximum).

TYPE 874-LK CONSTANT-IMPEDANCE ADJUSTABLE LINES A line stretcher with a very low *v*SWR and a uniform characteristic impedance of 50 ohms. Especially useful for eliminating the usual Smith-chart corrections for length of line between unknown and impedance-measuring device. These lines are useful as impedance-matching transformers and phase-adjustment elements in coaxial systems. Thus the TYPE 1602-B UHF Admittance Meter can be made to read impedance by adjustment of the over-all line length to an odd multiple of a quarter wavelength. Locking TYPE 874 connectors on both ends.

Characteristic Impedance: 50 ohms.
Adjustment Range: TYPE 874-LK10L — 10 cm (half wavelength at 1.5 Gc); TYPE 874-LK20L — 22 cm (half wavelength at 680 Mc).
Physical Length: TYPE 874-LK10L — 35 cm (minimum) to 45 cm (maximum); TYPE 874-LK20L — 58 cm (minimum) to 80 cm (maximum).
VSWR: TYPE 874-LK20L — Less than 1.03 at 500 Mc, less than 1.06 at 1 Gc, less than 1.08 at 1.5 Gc, less than 1.10 at 2 Gc. TYPE 874-LK10L — same as TYPE 874-LK20L to 2 Gc, less than 1.15 at 3 Gc, less than 1.2 at 4 Gc, less than 1.25 at 5 Gc.

Typical VSWR of Types 874-LAL and -LK10L. (Specifications are shown in red for Type 874-LK10L.)

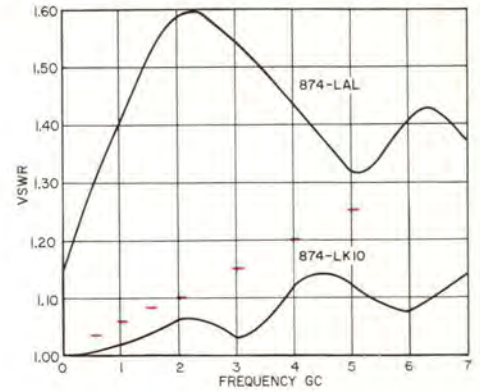

TYPE 874-LTL TROMBONE CONSTANT-IMPEDANCE ADJUSTABLE LINE With this line stretcher, built like a trombone slide, the user can vary the length of a 50-ohm transmission line between two fixed terminals without moving the terminals or using flexible cable. Consists of two TYPE 874-LK20L Adjustable Lines mounted in parallel and joined at one end by a U-shaped section to form a rigid assembly. Can be plugged into two adjacent TYPE 874 coaxial connectors or inserted in a line by means of two ells (not included) when installed vertically to save bench space. Low *v*SWR. An excellent phase shifter.

Characteristic Impedance: 50 ohms.
Frequency Range: DC to 2 Gc (TYPE 874-LK10L is recommended above 2 Gc).
Adjustment Range: 44 cm (half wave at 340 Mc).
Physical Length: 61 cm (minimum) to 83 cm (maximum).
Spacing: 1 3/8 inch between centers.
VSWR: Less than 1.10 to 1 Gc, and 1.25 to 2 Gc.

Type		Net Wt*	Code Number	Price
874-L10	10-cm Air Line	2 1/2 oz	0874-9604	\$ 8.50
874-L10L	10-cm Air Line, locking connectors	3 1/2 oz	0874-9605	10.50
874-L20	20-cm Air Line	4 1/2 oz	0874-9608	9.00
874-L20L	20-cm Air Line, locking connectors	5 1/2 oz	0874-9609	11.00
874-L30	30-cm Air Line	6 1/2 oz	0874-9612	9.75
874-L30L	30-cm Air Line, locking connectors	7 1/2 oz	0874-9613	11.75
874-LAL	Adjustable Line	10 oz	0874-9621	27.00
874-LK10L	10-cm Constant-Impedance Adjustable Line	9 oz	0874-9627	42.00
874-LK20L	22-cm Constant-Impedance Adjustable Line	15 oz	0874-9631	42.00
874-LTL	Constant-Impedance Trombone Line	2 1/4 lb	0874-9645	97.00

* To convert ounces to grams, multiply by 28; to convert pounds to kilograms, divide by 2.2.

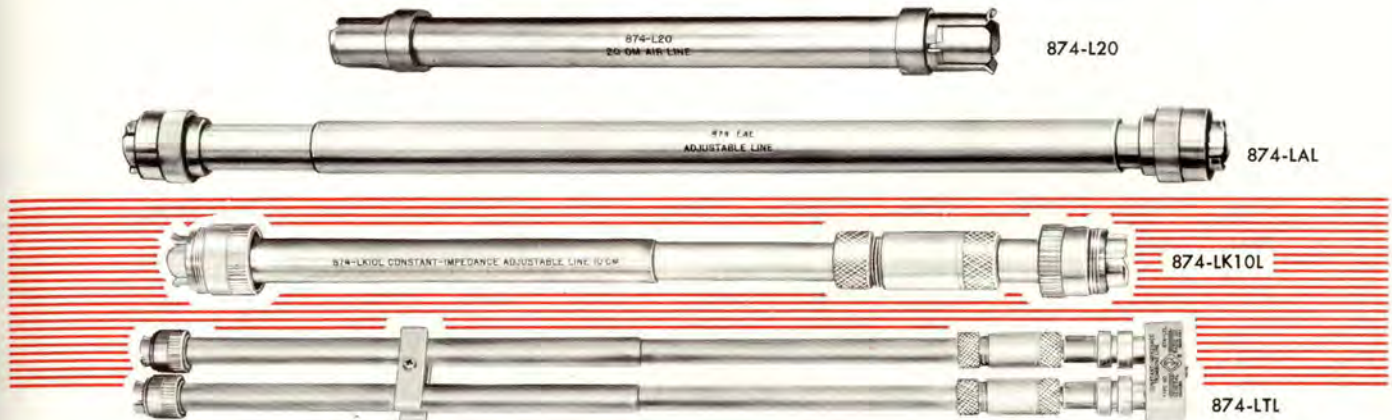



COUPLING ELEMENTS

COAXIAL
COUPLING ELEMENTS

TYPE 874-K COUPLING CAPACITOR (DC Block) A short length of coaxial line having a disk capacitor in series with the inner conductor. High frequencies are transmitted with small reflections, but dc and low audio frequencies are blocked. Available with regular or locking connectors.

Coupling Capacitance: 4700 pf - 20% + 50%.
VSWR: Less than 1.06 at 1 Gc, 1.15 at 2 Gc, 1.3 from 2 to 4 Gc.
Voltage Rating: 500 volts.
Length: 3 inches (77 mm).

TYPE 874-LR RADIATING LINE Leakage coupler for fields within a coaxial system. Short coaxial line with opening in outer conductor that can be partly or completely covered by a rotatable sleeve.

VSWR: Closed, less than 1.10 at 1 Gc, less than 1.4 at 3 Gc, and less than 1.35 at 4 Gc.
Length: 4 3/8 inches (112 mm).

TYPE 874-MB COUPLING PROBE Electrostatic probe consisting of a binding post mounted on a TYPE 874 coaxial connector.

Over-all Length: 3 inches (77 mm).

TYPE 874-EL 90° ELL Convenient right-angle line section with TYPE 874 coaxial connector at each end. Available with either regular or locking connectors.

Characteristic Impedance: 50 ohms.
Electrical Length: Approximately 7 cm.
VSWR: Less than 1.06 at 2 Gc; less than 1.15 at 4 Gc.
Dimension: 2 1/4 inches (57 mm) on a side.

TYPE 874-JR ROTARY JOINT Used when one part of a coaxial system must be rotated with respect to another part. Not for motor-driven applications.

VSWR: Less than 1.06 at 1 Gc; less than 1.3 at 4 Gc.
Length: 2 1/2 inches (64 mm).

TYPE 874-T TEE For connecting stubs and other elements in shunt with a coaxial line. Available with regular or locking TYPE 874 connectors.

Dimensions: 3 3/8 by 2 1/4 inches (86 by 58 mm).

TYPE 874-X INSERTION UNIT A hollow cylinder fitted with a TYPE 874 connector at each end and with a sleeve that slides back to provide access to a space about 2 inches

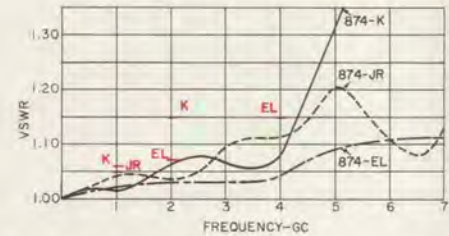

Typical VSWR of Types 874-K, -EL, and -JR. (Specifications are shown in red.)

long and 9/16 inch in diameter. In this space may be mounted arrangements of small components, such as resistors, capacitors, or inductors. The insertion unit can be used as a shielded housing for impedance-matching networks, attenuator pads, vhf transformers, filters, and many other networks. It offers excellent shielding, minimal discontinuity in the line, and convenience.

Length: 4 3/8 inches (115 mm).

TYPE 874-Y CLIPLOCK A cylindrical spring that can be slipped over nonlocking TYPE 874 connectors to provide a secure lock, preventing accidental disconnection.

TYPE 874-ML COMPONENT MOUNT A shielded enclosure with jack-top binding posts inside, a locking TYPE 874 coaxial connector outside, for convenient mounting of small components being measured. Use of mount minimizes lead reactance and stray capacitance in impedance measurements of circuit elements and networks from dc to 5 Gc. Connects directly to TYPE 874-LBA Slotted Line, TYPE 1602-B UHF Admittance Meter, TYPE 1607-A Transfer Function and Immittance Bridge, TYPE 874-LK Adjustable Lines, and all GR coaxial elements.

Supplied with the mount are short- and open-circuit terminations to simplify determination of corrections for length of line between measuring point and component being measured.

Frequency Range: DC to 5 Gc.

Accessories Supplied: One TYPE 874-WN3 Short-Circuit Termination, one TYPE 874-WO3 Open-Circuit Termination.

Accessory Recommended: One TYPE 874-LK20L Constant-Impedance Adjustable Line (page 71) for use with TYPE 1602-B UHF Admittance Meter.

Dimensions: Diameter 3 inches (77 mm); height of shield can, 2 5/8 inches (67 mm).

Type		Net Wt*	Code Number	Price
874-K	Coupling Capacitor	2 oz	0874-9596	\$10.50
874-KL	Coupling Capacitor, locking connectors	3 oz	0874-9597	12.50
874-LR	Radiating Line	4 oz	0874-9660	12.00
874-MB	Coupling Probe	1 oz	0874-9666	5.00
874-EL	90° Ell	2 1/2 oz	0874-9526	9.50
874-EL-L	90° Ell, locking connectors	3 oz	0874-9527	11.50
874-JR	Rotary Joint	3 oz	0874-9590	16.00
874-T	Tee	4 oz	0874-9910	12.00
874-TL	Tee, locking connectors	5 oz	0874-9911	15.00
874-X	Insertion Unit	3 oz	0874-9990	13.00
874-Y	Cliplock	1 oz/10	0874-9992	10 for 2.50
874-ML	Component Mount	10 1/2 oz	0874-9663	29.50

* To convert ounces to grams, multiply by 28.

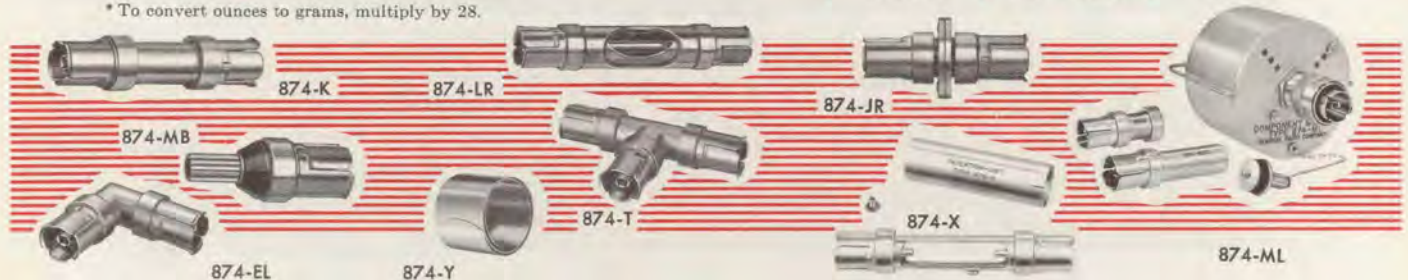



Type 874-UBL BALUN

The TYPE 874-UBL Balun is a tuned coaxial transformer with a 4:1 ratio that permits measurements on balanced devices with generally available coaxial and grounded measuring equipment. The balun converts 50-ohm coaxial line to 200-ohm balanced line. Thus, the 200-ohm balanced line can be treated as an extension of the 50-ohm line of the measuring device. Used with the TYPE 874-LBA Slotted Line, the TYPE 1602-B UHF Admittance Meter, or the TYPE 1607-A Transfer-Function and Immittance Bridge, it permits measurements on balanced components from 54 Mc to 1 Gc without appreciable insertion loss or transformation error. When the balun is used with the admittance meter and a TYPE 874-LK Constant-Impedance Adjustable Line, the admittance meter reads balanced impedance.

The balun converts from unbalanced to balanced by using an artificial half-wave line, adjusted for operation at a particular frequency by means of shunt tuning elements. These elements, listed below and described on page 68, are not supplied with the balun but should be ordered separately.

Frequency Range Mc	Tuning Elements Required	Page Ref
54 - 88	2 Type 874-VCL and 2 Type 874-XL	68
88 - 140	2 Type 874-VCL and 2 Type 874-L30	68, 71
140 - 174	2 Type 874-VCL and 2 Type 874-L20	68, 71
174 - 216	2 Type 874-VCL and 2 Type 874-L10	68, 71
170 - 280	2 Type 874-D50L and 2 Type 874-L30	68, 71
225 - 280	2 Type 874-D20L and 2 Type 874-L30	68, 71
275 - 380	2 Type 874-D20L and 2 Type 874-L20	68, 71
350 - 525	2 Type 874-D20L and 2 Type 874-L10	68, 71
470 - 1000	2 Type 874-D20L	68

Frequency Range: 54 Mc to 1 Gc with accessory elements as listed above.

Dimensions: 3 1/8 by 3 3/8 by 2 3/8 inches (79 by 81 by 60 mm), over-all per assembly.

Accessories Supplied: One TYPE 874-UB-P1 300-ohm Terminal, one TYPE 874-WN3 Short-Circuit Termination, one TYPE 874-WO3 Open-Circuit Termination.

Other Accessories Recommended: One TYPE 874-LK20L Adjustable Line (for use with the TYPE 1602-B UHF Admittance Meter), one TYPE 874-Z Stand, and tuning elements listed above.

TYPE 874-BM 300-OHM BALANCED TERMINATION

Termination for 300-ohm lines under test.

DC Resistance: 300 ohms \pm 5%. **Frequency Range:** DC to 1 Gc. **VSWR:** 1.2 to 900 Mc.

Dimensions: 2 by 2 by 2 1/2 inches (51 by 51 by 64 mm), over-all.

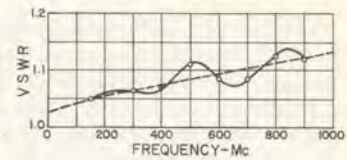
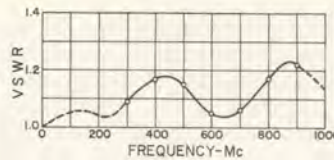

Typical VSWR of Type 874-UB-P3 (left) and Type 874-BM (right).

TYPE 874-UB-P2 200-OHM TERMINAL UNIT Connects the balun directly to 200-ohm transmission line or balanced components via screw terminals.

Characteristic Impedance: 200 ohms.

Frequency Range: DC to 1 Gc.

Recommended Transmission Line: RG-86/U.

VSWR: 1.2 to 300 Mc, 1.3 to 1 Gc.

Dimensions: 1 by 1 3/4 by 1 7/8 inches (25 by 44 by 48 mm), over-all.

TYPE 874-UB-P3 300-OHM TERMINAL PAD Converts to 300 ohms the 200-ohm balanced output impedance produced by the balun from a 50-ohm unbalanced source. This pad facilitates power and voltage measurements on balanced 300-ohm systems with signal generators and detectors designed for use with 50-ohm coaxial circuits.

TYPE 874-UB-P4 ADAPTOR Provides a reliable, shielded connection between the balun and TYPE RG-22/U (small-size twinax) cable. Adaptor includes UG-422/U twinax connector, which connects to UG-421/U cable connector.

Type 874-Z STAND

A stable support for components of coaxial systems. Consists of a heavy cast-iron base with rubber feet, 22-inch and 8-inch stainless-steel rods, and three universal clamps. The vertical rod can be used to hold long tuning stubs. The horizontal rod can be moved longitudinally or can be interchanged with the vertical rod to provide support where needed. Two bases can be used with one 22-inch rod between them to support a long horizontal run of coaxial parts. Clamps will fit a range of diameters and will join any two rods. Any desired arrangement can be set up quickly. Base (3 1/2 by 4 7/16 inches) can be bolted to bench top.

Type		Net Wt*	Code Number	Price
874-UBL	Balun	1 1/4 lb	0874-9921	\$78.00
874-BM	300-ohm Balanced Termination	1 1/2 oz	0874-9928	15.00
874-UB-P2	200-ohm Terminal Unit	1 oz	0874-9923	9.00
874-UB-P3	300-ohm Terminal Pad	1 oz	0874-9924	22.00
874-UB-P4	Adaptor (Balun to Twinax)	4 1/2 oz	0874-9925	60.00
874-Z	Stand	5 1/2 lb	0874-9996	19.50
874-ZC	Extra Clamp	3 oz	0874-9997	2.25

* To convert ounces to grams, multiply by 28; to convert pounds to kg, divide by 2.2.

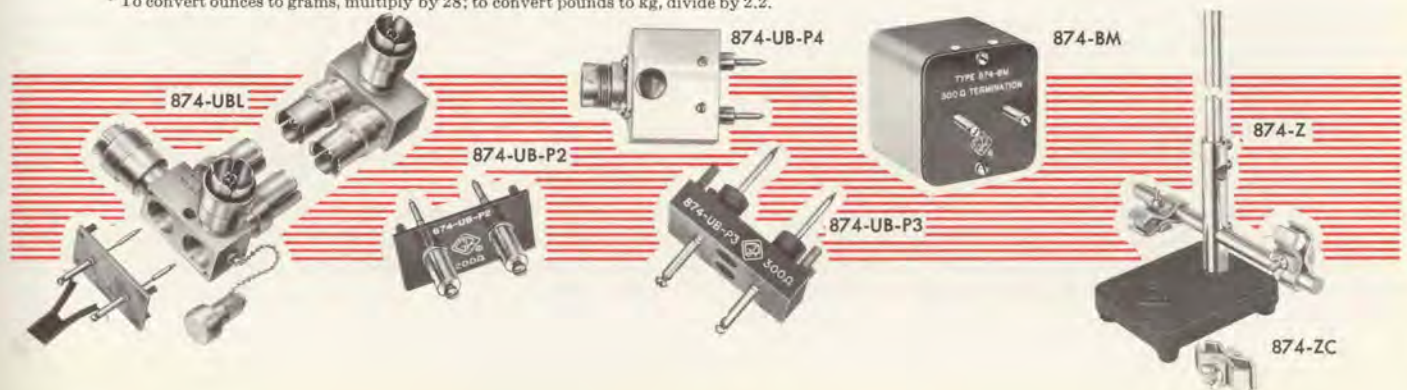

GP Type 900 PRECISION COAXIAL COMPONENTS

The TYPE 900 coaxial measuring equipment introduces a new class of coaxial elements characterized by ultra-precise physical dimensions, by outstanding stability, and especially by superior electrical performance. The TYPE 900 components for the first time permit vswr measurements to an accuracy of a few *tenths* of one percent. They are, therefore, particularly suited for standards applications, for performing absolute calibrations, and for low-vswr component design, as well as for general-purpose high-frequency measurements.

The principal factor in this substantial improvement is the TYPE 900-BT Precision Coaxial Connector*, which possesses excellent repeatability and a vswr below 1.002 to 1 Gc and below 1.01 to 9 Gc. Prior to this, highly accurate coaxial measuring equipment was not only impossible to design, but also not worth designing, since any improvements would be obscured by the connector deficiencies. While the TYPE 874 connector (page 63) is an excellent, low-vswr unit for low-cost, general-purpose applications, it and other popular connectors lack sufficient precision to meet all present needs of government and industrial laboratories. The TYPE 900-BT connector, on the other hand, provides the precision needed.

An important practical requirement of a precision connector is that it be adaptable to other connector types in common use without having its performance degraded significantly below that of the other series. To satisfy this requirement, the TYPE 900-Q874, a precision adaptor to the TYPE 874 connector, is available, as are the TYPES 900-QNJ and -QNP, low-reflection adaptors to connect the TYPE 900 connector to type-N plugs and jacks. As a result, precision test equipment, e.g., bridges, slotted lines, and reflectometers, fitted with TYPE 900-BT connectors, can be used to make measurements in other coaxial series that are limited only by the accuracy of the lower-precision connectors themselves. Moreover, instruments equipped with TYPE 900 connectors may be calibrated at the TYPE 900-BT connector reference plane to an order-of-magnitude better than has been previously possible.

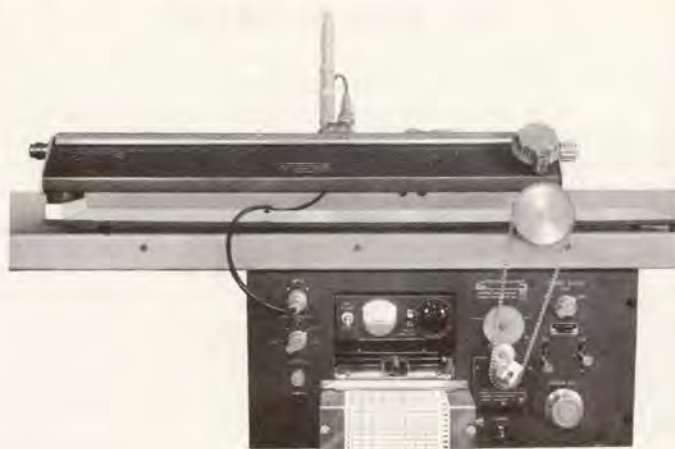

Type 1640-A Slotted Line Recorder System. See page 76 for description.

General Radio has developed a comprehensive line of ultraprecise coaxial measuring equipment around the TYPE 900-BT connector, the principal instrument being the TYPE 900-LB Precision Slotted Line, described on page 76. Supplementing it, in addition to the items previously mentioned, are standard air lines, a matched 50-ohm termination, and short- and open-circuit terminations. The TYPE 1640-A Slotted Line Recorder System offers a new capability in precision coaxial instrumentation, maximizing the utility of the TYPE 900 components. This complete system combines the TYPE 900-LB Precision Slotted Line with a TYPE 1521-SL Graphic Level Recorder (see page 76), and makes convenient the measurement of vswr's as low as 1.001 on a continuous, permanent record.

The specifications given in the following pages for the TYPE 900 components apply under ordinary laboratory conditions at 23 C, at sea level.

*For a detailed description of the TYPE 900-BT Precision Coaxial Connector, see A. E. Sanderson, "A Radically New Coaxial Connector for High-Precision Measurements," *General Radio Experimenter*, 37, 2, February-March, 1963.

GP Type 900-BT PRECISION COAXIAL CONNECTOR



FEATURES:

- ◆ One-piece design — no loose parts.
- ◆ VSWR less than 1.002 to 1 Gc, 1.01 to 9 Gc.
- ◆ Excellent repeatability of vswr, within 0.05%.
- ◆ Convenient and well-defined reference plane.
- ◆ Low loss and low dc contact resistance.
- ◆ Low leakage, better than 130 db below signal.
- ◆ Negligible change in characteristics with time.
- ◆ Compact, versatile, easy to use.

CHARACTERISTICS: An important characteristic of a precision connector is its vswr, that is, the extent to which it introduces reflections into an otherwise matched transmission line. The graph on page 75 shows the vswr test specification for a pair of connectors ($1.001 + 0.001 \times f_{Gc}$), as well as the average vswr for a production lot. Since it is impossible to say how much each connector contributes to the vswr of the pair, the test limits for the pair are used as the guaranteed specification for a single connector.

Another important characteristic of a precision connector is repeatability, that is, the consistency of measured

value as the connection is broken and remade in different orientations. The connection of a pair of TYPE 900-BT connectors under these conditions typically repeats to within 0.03% up to 9 Gc, far better than lower-precision connectors. The leakage of the TYPE 900-BT connector (see graph) is lower than that of any other commonly used coaxial connector, better than 130 db below the signal level. This is due to the triple shielding action of (1) the butt contact of the outer conductors, (2) the interlocking and overlapping of the centering gear rings, and (3) the outer locking nut.

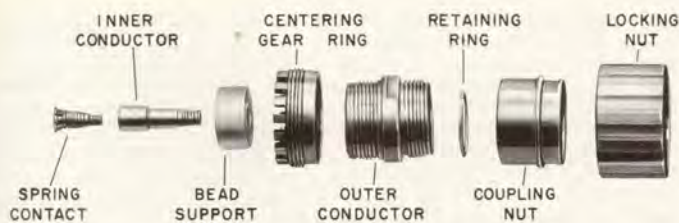

Type 900-BT Precision Coaxial Connector.

The insertion loss, or attenuation, of the TYPE 900-BT connector is extremely small. It has been minimized by the use of Teflon for the bead and solid-silver alloys for both the inner and outer conductors, and by use of a special contact design.

The electrical length of a pair of TYPE 900-BT connectors is 3.50 cm and is virtually independent of frequency. The dc resistance of a mated pair is typically 0.4 milliohm for the inner conductors, and 0.04 milliohm for the outer conductors.

DESCRIPTION: The TYPE 900-BT is a sexless connector intended for use on rigid, air-dielectric, 9/16-inch, 50-ohm, coaxial transmission line (principal dimensions: 0.5625 inch and 0.24425 inch). The connector (see exploded view) consists of a solid silver-alloy inner conductor and spring contact, a solid coin-silver outer conductor, stainless-steel centering-gear ring, chrome-plated brass locking nut, and a solid Teflon bead support. The connector is attached to the air line by a coupling nut and retaining ring on the line's outer conductor; the inner conductor is threaded into the

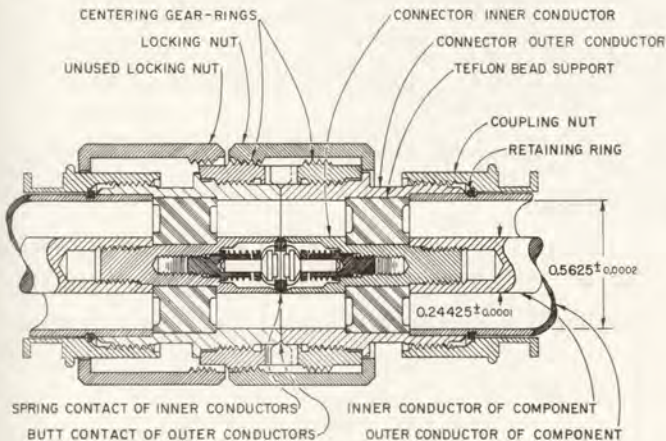

Mated pair of Type 900-BT Precision Coaxial Connectors.

SPECIFICATIONS

Frequency Range: DC to 9 Gc.

Characteristic Impedance: 50 ohms \pm 0.1% at frequencies where skin depth is insignificant.

VSWR: Less than $1.001 + 0.001 \times f_{Gc}$ per connector. (Connectors are tested by pairs, conservatively using the above limit for a pair of connectors.)

Repeatability: Within 0.05% or 0.0005 in vswr.

Leakage: Better than 130 db below signal.

center conductor of the air line and has no loose parts, such as "bullets." All silver parts are plated with a few micro-inches of gold to keep them from tarnishing.

When two of these connectors are mated, the centering gear rings interlock and overlap, in order to center each of the connectors with respect to the other, and also to provide indexing in one of 16 possible positions (see the sectional view). The outer conductors have flange-type surfaces butted tightly together by the pressure of the locking nut. Only one of the locking nuts is necessary for a connection; the unused nut is backed off into a storage position. The over-all diameter of the mated pair is only $1\frac{1}{16}$ inches.

The front surfaces of the inner conductors are recessed by 0.001 inch, with respect to the surfaces of the outer conductors. Inner-conductor contact is made by a spring-

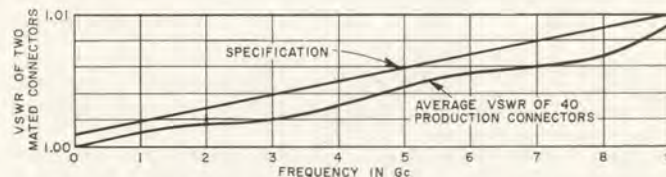

VSWR of mated pairs of Type 900-BT Precision Coaxial Connectors.

contact assembly, which projects slightly beyond the surface of the outer conductors until the connector is mated. The spring-contact assembly consists of six solid silver-alloy segments, independently sprung. Upon mating, these contacts are forced back and spread, making wiping contact both with one another and with the inside surface of the inner conductor. This method avoids the reflections caused by slots in the inner and outer conductors, and eliminates changes in the electrical diameter due to wear. Only one spring contact is necessary for a good electrical connection; the spring contact will mate just as well with any flat surface.

When two connectors are mated, the conductors meet in the center of the connection, and this feature very conveniently provides the electrical reference plane.

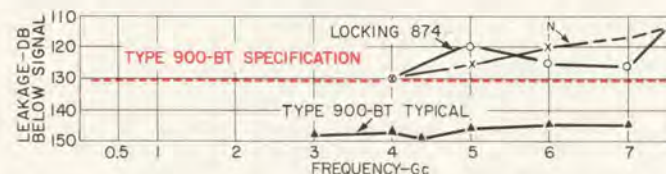

Typical leakage curve of mated pair of Type 900-BT Precision Coaxial Connectors compared with other leading types.

Insertion Loss: Less than $0.003 \sqrt{f_{Gc}}$ db per pair.

Voltage: 3000 volts (peak).

Power: 20 kilowatts up to 1 Mc; 20 kw/ $\sqrt{f_{Mc}}$ above 1 Mc.

Electrical Length: 3.500 ± 0.005 cm per pair.

DC Contact Resistance: Inner conductor, less than 0.5 milliohm; outer conductor, less than 0.07 milliohm.

Dimensions: Length of one connector, $1\frac{3}{16}$ inches (31 mm); maximum diameter, $1\frac{1}{16}$ inches (27 mm).

Type	Net Weight	Code Number	Price
900-BT Precision Coaxial Connector	2 oz (60 grams)	0900-9405	\$35.00*

* Subject to quantity discount.

GR Type 900-LB PRECISION SLOTTED LINE

The basic instrument for the most precise measurements of impedance and vswr at high frequencies is the slotted line. The TYPE 900-LB Precision Slotted Line design takes full advantage of the accuracy of the TYPE 900-BT connector; as a result, the vswr specification of the slotted line is identical to that of the connector. The line is useful for the most precise calibration and comparison of rf standard impedances and mismatches, as well as for the design of components of the lowest possible vswr. The accuracy of this slotted line eliminates the tedious, time-consuming calibration procedures required with less accurate instruments. With a TYPE 900-QNJ or -QNP Adaptor, it can be simply converted to a type-N slotted line with a vswr less than $1.005 + 0.005 \times f_{Gc}$.

The TYPE 900-LB is a slotted section of precision coaxial transmission line whose characteristic impedance is very accurately known (50.0 ohms \pm 0.1%). The outer conductor is precision-forged brass tubing lined with pure silver for low loss. The inner conductor, a steel tube with a layer of silver, is precision-machined. The load end of the line has a TYPE 900-BT Precision Coaxial Connector, and the generator end has a locking TYPE 874 connector.

The probe is mounted in a movable carriage which also contains a

crystal detector, a tuning stub, and a TYPE 874 audio output jack. The removable, barrel-type tuning stub supplied has a vernier drive for stability, smooth rotary action, and easy settability, and a tuning range from 300 Mc to 9 Gc. Probe penetration is adjustable by means of a knob (calibrated in thousandths of an inch) at the top of the stub. For measurement of width-of-minima, a micrometer carriage drive, which can be read to 0.002 mm, is also supplied. For applications requiring a direct rf output, an rf probe accessory is provided; terminated with a TYPE 874-BL connector, this unit replaces the tuning stub.

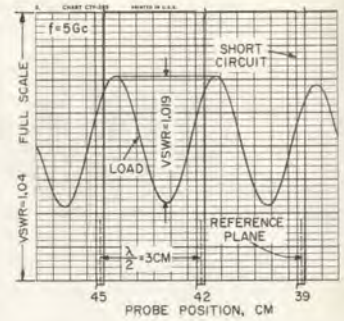

Typical readout of Type 1640-A Slotted Line Recorder System (described below and shown on page 74).

SPECIFICATIONS

- Characteristic Impedance:** 50.0 ohms \pm 0.1%.
- Probe Travel:** 50 cm. Scale calibrated in centimeters from the reference plane. Attached vernier scale can be read to 0.1 mm.
- Scale Accuracy:** \pm (0.1 mm + 0.05%).
- Frequency Range:** 300 Mc to 9 Gc. At 300 Mc, covers a half wavelength. Operates below 300 Mc with TYPE 900 Precision Air Line.
- Constancy of Probe Pickup:** \pm 0.5%.
- Residual VSWR:** Less than $1.001 + 0.001 \times f_{Gc}$ (e.g., 1.002 at 1 Gc).
- Accessories Supplied:** TYPE 874-R22A Patch Cord; TYPE 900-WN Precision Short-Circuit; TYPE 900-WO Precision Open-Circuit; tuning stub-probe assembly (including 1N21C and 1N23C crystals);

rf probe assembly (with TYPE 874-BL connector); micrometer carriage drive (accurate to 0.01 mm); spare drive cable; storage box, Smith charts.

Accessories Required: Generator and detector (see page 66).

Dimensions: Width 27½, height 10, depth 4¾ inches (700 by 255 by 125 mm).

Net Weight: 10¾ pounds (4.9 kg).

Shipping Weight: 27 pounds (12.5 kg).

Type	Code Number	Price
900-LB	Precision Slotted Line	0900-9651 \$575.00

GR Type 1640-A SLOTTED LINE RECORDER SYSTEM

This system automatically plots the standing-wave pattern in the TYPE 900-LB Precision Slotted Line. vswr's from 1.001 to 1.20 can be measured conveniently and accurately. The positions of minima, with a short circuit at the reference plane, can also be plotted automatically (see sample strip chart above). In substitution measurements*, several curves may be plotted on the same record, to facilitate measurement of vswr differences directly and cancel the effect of nonconstant probe pickup.

The TYPE 1640-A system includes a TYPE 900-LB Precision Slotted Line, a TYPE 1521-SL Slotted-Line Recorder, similar to the TYPE 1521-A Graphic Level Recorder (page 144), and an adjustable

mechanical-linkage unit through which the recorder drives the carriage of the slotted line. The audio output from the carriage drives the pen of the completely transistorized recorder, which has a variable expanded-scale vswr presentation. Horizontal scale can be either 1 cm/div or 0.5 cm/div, with the two sprockets provided. Audio input-signal levels from 0.05 to 2 millivolts can be accommodated, thus permitting operation at the signal level producing the best signal-to-noise ratio.

*A. E. Sanderson, "An Accurate Substitution Method of Measuring the vswr of Coaxial Connectors," *The Microwave Journal*, January, 1962, Vol 5, No. 1, pp 69-73.

SPECIFICATIONS

- Sensitivity:** Continuously variable from 0.05 to 2.0 mv (on-scale).
- Frequency:** 1 kc \pm 3%; 3 db bandwidth — 50 \pm 10 cps.
- Chart:** 4-inch recording width with 8 major, total of 40, divisions. Horizontal divisions, ¼ inch.
- VSWR Range:** Continuously variable from 1.008 (0.8%) to 1.20 (20%) full scale; accurate to within one minor division at any setting.
- Noise Level (referred to input):** Short-circuit, less than 0.1 microvolt; open-circuit, less than 4.0 picoamperes. Noise figure less than 5 db at the optimum source resistance (about 25 kilohms).
- Power Requirements:** 105 to 125 (or 210 to 250) volts, 60 cps, 35 watts; 50-cycle models are available; see price list below.
- Dimensions:** Width 19, height 9, depth 14¼ inches (485 by 229 by 362 mm) — TYPE 1521-SL only. See above for TYPE 900-LB.
- Net Weight:** 67 pounds (30 kg).
- Shipping Weight:** 100 pounds (46 kg).

Type	Code Number	Price
1640-A	Slotted Line Recorder System (60 cps)	1640-9701 \$1875.00
1640-AQ1	Slotted Line Recorder System (50 cps)	1640-9494 1875.00

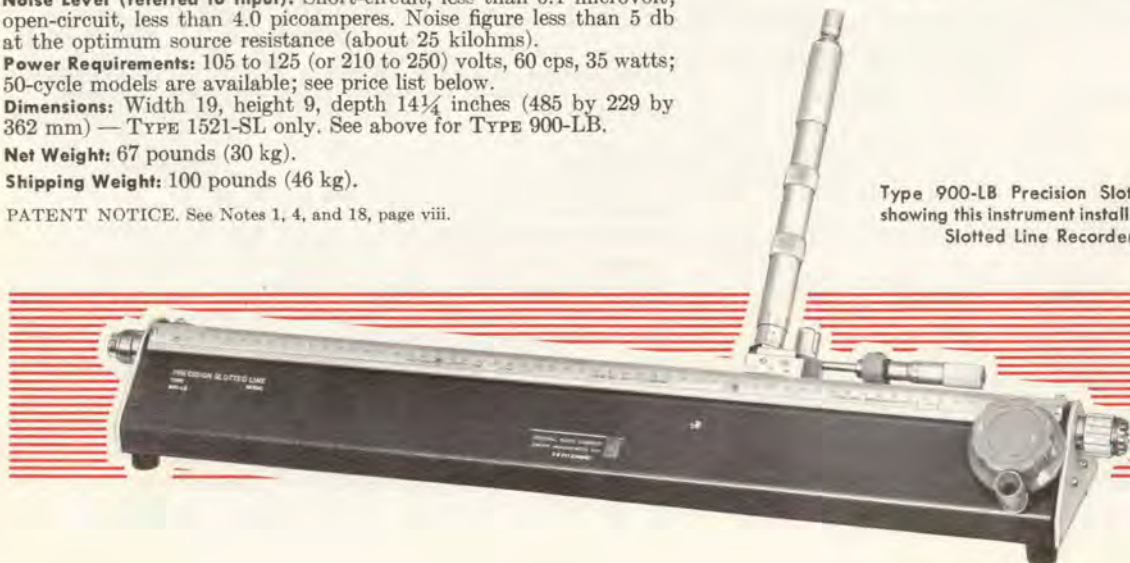

Type 900-LB Precision Slotted Line. For a photograph showing this instrument installed as part of the Type 1640-A Slotted Line Recorder System, see page 74.



PRECISION COAXIAL ELEMENTS

COAXIAL
PRECISION COAXIAL ELEMENTS

TYPE 900-W50 50-OHM STANDARD TERMINATION A precision, low-vswr standard, designed around a highly stable, deposited-metal-film resistor, with TYPE 900-BT connector. Excellent as 50-ohm standard for calibration of bridges, slotted lines, and impedance plotters. The combination of a TYPE 900-W50 termination plus a TYPE 900-QNJ or -QNP adaptor has lower vswr than generally available 50-ohm series-N terminations *alone*.

VSWR: Less than $1.005 + 0.005 \times f_{Gc}$, up to 9 Gc.

DC Resistance: 50 ohms $\pm 0.3\%$.

Maximum Power: 1 watt with negligible change; 5 watts without damage.

Temperature Coefficient: 150 ppm/ $^{\circ}$ C.

TYPE 900-L10, -L15, -L30 PRECISION AIR LINES Short sections (10, 15, and 30 cm) of precision, 50-ohm air line with a TYPE 900-BT connector on each end. Conducting surfaces of inner and outer conductors are of pure silver for low loss. Used as low-reflection line extenders, as an aid in checking the vswr of precision connectors, and as 50-ohm-impedance standards at frequencies for which the electrical length is an odd multiple of $\lambda/4$, for example, in calibrating a slotted line and termination.

VSWR: Less than $1.0013 + 0.0013 \times f_{Gc}$, up to 9 Gc.

Characteristic Impedance: 50 ohms $\pm 0.1\%$.

Electrical Length: TYPE 900-L10 — 10.00 ± 0.02 cm; TYPE 900-L15 — 15.00 ± 0.02 cm; TYPE 900-L30 — 30.00 ± 0.02 cm.

TYPE 900-WN PRECISION SHORT-CIRCUIT TERMINATION A precision-machined, silver-plated body, mounted in a centering gear ring and locking-nut assembly, which short-circuits the face of a TYPE 900-BT connector. For establishing reference planes and for use in loss measurements. Reflection coefficient > 0.9995 .

TYPE 900-WO PRECISION OPEN-CIRCUIT TERMINATION A shield-body mounted in a centering ring and locking-nut assembly. Establishes a well-shielded open circuit 2.6 ± 0.2 mm beyond the face of a TYPE 900-BT connector. For establishing a reference plane and for use in loss measurements. Reflection coefficient > 0.9995 .

TYPES 900-QNJ, -QNP ADAPTORS Low-reflection adaptors from TYPE 900-BT Precision Coaxial Connector to type-N connector. TYPE 900-QNJ contains an improved type-N jack and mates with a standard type-N plug. TYPE 900-QNP contains an improved type-N plug and mates with a standard type-N jack.

VSWR: Less than $1.004 + 0.004 \times f_{Gc}$, up to 9 Gc, either unit.

Electrical Length: TYPE 900-QNP — 5.50 ± 0.03 cm to end of male outer conductor. TYPE 900-QNJ — 5.00 ± 0.03 cm to end of female inner conductor.

TYPE 900-Q874 ADAPTOR Low-reflection adaptor between TYPE 900-BT Precision Coaxial Connector and any TYPE 874 connector (see page 63). Contains the new TYPE 874-BL Locking Connector.

VSWR: Less than $1.00 + 0.015 \times f_{Gc}$ to 1 Gc; $1.01 + 0.005 \times f_{Gc}$ from 1 to 7 Gc.

Electrical Length: 6.50 ± 0.04 cm to front face of mated nonlocking TYPE 874 connector bead.

TYPE 900-TOK TOOL KIT Nine-piece tool kit in fitted case for convenient installation of TYPE 900-BT Precision Coaxial Connector on suitable air line or component. Complete instructions for use of tools are supplied with each connector to simplify assembly and ensure precision results.

1. Open-End Wrench
2. Coupling-Nut Torque Wrench
3. Inner-Conductor Torque Wrench
4. Gear Wrench
5. Inner-Conductor Plier
6. Bead Pusher
7. Inner-Conductor Injector
8. Bead Compression Sleeve
9. Spring-Contact Wrench



PRECISION ROD AND TUBING Used in fabrication of custom air lines and components employing TYPE 900-BT Precision Coaxial Connectors. Diameters are specified at a temperature of 23 C. Both rod and tubing have been stress-relieved.

PRECISION INNER-CONDUCTOR ROD (0900-9508) Precision, centerless-ground, silver-layered brass rod stock with a nominal 0.24425-inch diameter.

Length: 27 inches (710 mm).

Diameter Accuracy: ± 65 microinches.

Uniformity of Diameter: ± 25 microinches.

Surface Finish: 20 microinches, max.

Straightness: 0.002 inch per foot.

PRECISION OUTER-CONDUCTOR TUBE (0900-9509) Precision-forged, silver-lined brass tubing with a nominal OD of 0.830 inch and a nominal ID of 0.5625 ($\frac{9}{16}$) inch. Nominal wall is 0.134 inch.

Inner Diameter Accuracy: ± 140 microinches.

Inner Surface Finish: 30 microinches, max.

Straightness of ID: 0.005 inch per foot.

Length: 27 inches (710 mm).

ADAPTOR FLANGE (0900-9782) A flange which threads onto the TYPE 900-BT connector, in place of the gear ring and locking nut, to connect the TYPE 900 components to coaxial systems that terminate in a flat-plane surface, or to other flange-type connectors.

Mounting Holes: 0.157 ± 0.005 inch dia, $120^{\circ} \pm 0.5^{\circ}$ apart on a radius of 0.812 ± 0.003 inch.

Type		Length inches	Net Weight*	Code Number	Price
900-L10	Precision Air Line (10 cm)	4	6 1/2 oz	0900-9603	\$ 85.00
900-L15	Precision Air Line (15 cm)	6	10 oz	0900-9607	90.00
900-L30	Precision Air Line (30 cm)	12	15 oz	0900-9613	100.00
900-Q874	Adaptor to Type 874	2 3/8	3 1/2 oz	0900-9883	45.00
900-QNJ	Adaptor (contains type-N Jack)	2 1/4	3 1/2 oz	0900-9711	50.00
900-QNP	Adaptor (contains type-N Plug)	2 3/8	4 oz	0900-9811	50.00
900-TOK	Tool Kit	—	2 lb	0900-9902	95.00
900-WN	Short-Circuit Termination	1 1/8	2 1/2 oz	0900-9971	9.00
900-WO	Open-Circuit Termination	1 1/8	2 oz	0900-9981	9.00
900-W50	50-Ohm Termination	2	3 1/2 oz	0900-9953	60.00
0900-9508	Precision Inner-Conductor Rod	27	7 oz	0900-9508	25.00
0900-9509	Precision Outer-Conductor Tube	27	2 1/2 lb	0900-9509	35.00
0900-9782	Adaptor Flange	—	3 oz	0900-9782	3.50

*To convert ounces to grams, multiply by 28; pounds to kg, divide by 2.2.



DETECTORS



In practically all types of electrical measurements, a means must be provided for aural or visual indication of the desired measurement condition. For bridge measurements, some degree of selectivity in the indicator or detector is useful to eliminate spurious signals, noise, and harmonics of the desired signal. For voltage-amplitude measurements, a wide linear range is desirable, and in modulation measurements the output signal should be a faithful reproduction of the modulation envelope.

For these applications, a number of detectors are in common use:

1. Amplifier followed by a meter or earphones.
2. Simple rectifier to convert an ac signal to dc or to demodulate an rf signal.
3. Simple rectifier followed by a high-gain amplifier with an aural or visual indicator.
4. Mixer in which the signal to be measured is heterodyned with a signal of a different frequency from an oscillator and the difference frequency amplified in a fixed-frequency, band-pass, high-gain amplifier.

An amplifier with meter or earphones is commonly used in the frequency range between a few cycles and several megacycles. The TYPE 1232-A Tuned Amplifier and Null Detector is an instrument of this type, tunable over the audio-frequency range, with two additional operating fre-

quencies at 50 and 100 kc. Its unusually high sensitivity, low noise level, excellent selectivity, and high gain make it suitable for the most exacting bridge-measurement requirements. With the TYPE 1232-P1 RF Mixer, it can be used as the i-f amplifier in a heterodyne-detector system at frequencies up to 10 Mc.

The TYPE 1212-A Unit Null Detector is an untuned detector, which covers a wide frequency range and uses limiting amplifiers to produce a nonlinear compression of the meter scale of at least 100 db, thus eliminating the need for amplifier gain adjustments during bridge-balancing operations.

For maximum effective sensitivity, one of the accessory filters should be used at the input: the TYPE 1212-P1, for eliminating pickup at the power-line frequency in measurements above 10 kc; and the TYPE 1212-P2, for maximum sensitivity and selectivity at 1 Mc. The TYPE 1212-P3 RF Mixer is also available for this instrument, extending its frequency coverage to 60 Mc or more.

Simple rectifiers are often used at the high frequencies. The TYPE 874-VQ Voltmeter Detector and TYPE 874-VR Voltmeter Rectifier cover a very wide frequency range, as indicated on the chart. When one of these is used directly with a meter or earphones, the sensitivity is low. Used with an audio amplifier, such as the TYPE 1232-A, they are sensitive detectors of modulated signals.

At very-high and ultra-high frequencies, the heterodyne method of detection has many advantages. It can have high sensitivity, a wide frequency range, any amount of selectivity, and excellent linearity. In the TYPE DNT Detectors, the signal is heterodyned in a TYPE 874-MRL Mixer Rectifier with a signal from a Unit Oscillator. The 30-Mc beat frequency is amplified and detected by a TYPE 1216-A Unit I-F Amplifier. Various local oscillators can be used to cover the very extensive frequency range shown in the chart, and harmonic operation can be used to extend the range of any oscillator. The 80-db linear range is also useful in relative voltage-level measurement.

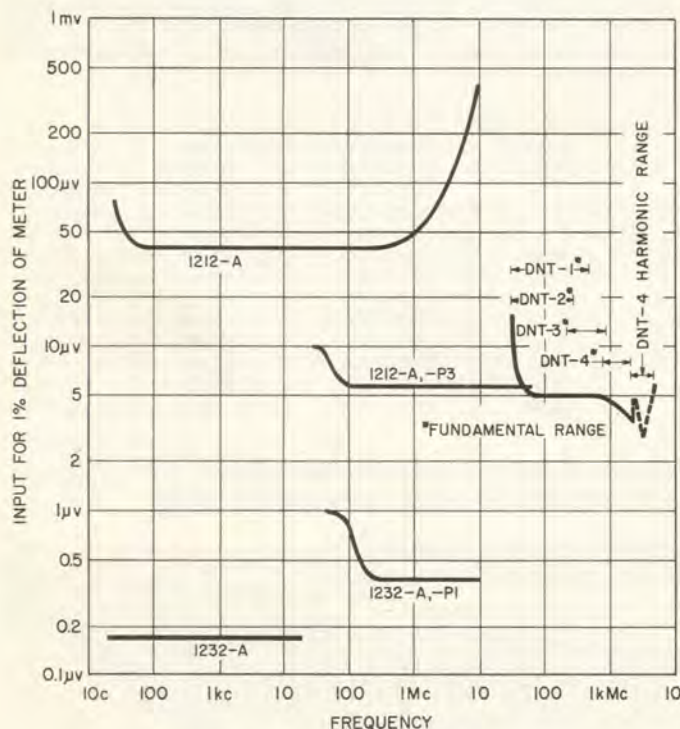

Sensitivity and frequency range of various detectors.

Type	Class	See Page
1232-A	High-Gain Tuned Amplifier	79
1212-A	Broadband Logarithmic Amplifier	80
DNT	Heterodyne with I-F Amplifier	81
874-VQ, -VR	Crystal Rectifier	67

OTHER INSTRUMENTS SUITABLE AS DETECTORS

Other general-purpose and special-purpose amplifiers such as the TYPE 1206-B Unit Amplifier and the TYPE 1551-C Sound-Level Meter can also be used in detection systems over their respective frequency ranges.

Type	Name	See Page
1206-B	Unit Amplifier	22
1551-C	Sound-Level Meter	4



Type 1232-A TUNED AMPLIFIER AND NULL DETECTOR

DETECTORS
NULL, TUNED

FEATURES:

- ◆ High sensitivity — typically, 0.3 microvolt at 1 kc. ◆ 120-db gain.
- ◆ High selectivity — approximately 5% bandwidth.
- ◆ Very low noise level — generally below 0.1 microvolt.
- ◆ Continuous, single-control tuning — 20 cps to 20 kc.

USES: Bridge detector for audio frequencies.

Audio-frequency preamplifier for oscilloscopes, microphones, vibration pickups, and other transducers.

General-purpose, tunable, or broadband audio amplifier (± 3 db from 20 cps to 20 kc plus spot frequencies at 50 kc and 100 kc).

Audio wave analyzer (for approximate measurements) with a sensitivity of a fraction of a microvolt.

Detector for modulated frequencies from 500 kc to 5000 Mc, with the TYPE 874-VQ Voltmeter Detector.

Extremely sensitive, heterodyne, rf null detector when used as a 20-kc and 100-kc i-f amplifier with the TYPE 1232-P1 RF Mixer and appropriate local oscillator.

DESCRIPTION: The circuit consists of a low-noise pre-amplifier, followed by a frequency selective stage, and an amplifier-compressor stage. Transistors are used throughout. Tuning is accomplished by the single-control rc network in a negative-feedback loop.

The meter scale can be either compressed or linear, as selected by a panel switch.

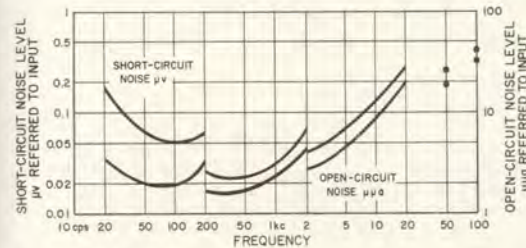

SPECIFICATIONS

(Left) Typical noise levels as a function of frequency. (Right) Minimum input for full-scale meter deflection as a function of frequency.

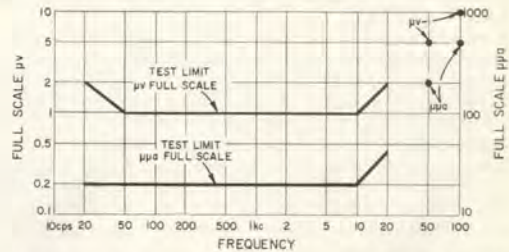

Frequency Response:

Tunable Filters — 20 cps to 20 kc in 3 ranges; 5% bandwidth; 2nd harmonic at least 34 db down from peak, 3rd at least 40 db down; rejection filter on two highest ranges reduces 60-cycle level to at least 60 db below peak (50 db at 50 cps). Dial accuracy is $\pm 3\%$.

50- and 100-kc Filters — 2nd harmonic 44 and 53 db down, respectively.

Flat Response — ± 3 db 20 cps to 100 kc.

Sensitivity: See plot. Typically 0.1 microvolt over most of the frequency range ($\frac{S}{N} = 1$). See also noise-level plot.

Noise Level Referred to Input: See plot. Noise figure at 1 kc is less than 2 db at an optimum source impedance of 27 kilohms.

Noise Level Referred to Output: Less than 30 millivolts on flat position and at minimum gain setting.

Input Impedance: Approximately 50 kilohms at maximum gain, varies inversely with gain to one megohm at minimum gain.

Maximum Safe Input Voltage: 200 volts ac or 400 volts dc.

Gain: 120 db on the tunable ranges; 100 db, flat range; 106 db at 50 kc; 100 db at 100-kc position.

Output: 1 volt into 10,000 ohms. Internal impedance is 3000 ohms.

Meter Linearity: Db differences on scale are accurate to $\pm 5\%$ for input of less than 0.3 volt.

Compression (on LOG position): Reduces full-scale sensitivity by 40 db. Does not affect bottom 20% of scale.

Distortion (in FLAT position): Less than 5% (from meter rectifiers).

Power Supply: 12 volts dc, from 9 mercury (M72) cells in series. Estimated battery life is 1500 hours.

Accessories Supplied: TYPE 874-C58A Cable Connector.

Cabinet: Convertible bench (see page 210).

Dimensions: Width 8, height 6, depth 7½ inches (205 by 150 by 190 mm), over-all. Panel adaptor sets are available for 19-inch relay-rack mounting (panel height 5½ inches).

Net Weight: 5¼ lb (2.6 kg).

Shipping Weight: 12 lb (5.5 kg).

Type	Code Number	Price
1232-A Tuned Amplifier and Null Detector	1232-9701	\$360.00
480-P308 Relay-Rack Adaptor Set	0480-9638	7.00

PATENT NOTICE: See Notes 4 and 15, page viii.



Type 1232-P1 RF MIXER

This well-shielded RF mixer, with the null detector and a local oscillator, becomes a sensitive heterodyne detector with a high degree of harmonic rejection. When the frequency of the local oscillator is swept, the combination can be used for approximate spectrum analysis with an oscilloscope. It can also be used as a sensitive level indicator in attenuation measurements. The circuit comprises a semiconductor diode, tuned i-f output transformer, crystal-current meter, and associated components.

SPECIFICATIONS

Frequency Range: 70 kc to 10 Mc. (Can be used up to 60 Mc, with care in the selection and identification of local-oscillator frequencies.)

I-F Output Frequencies: Switch-selected to 20 kc or 100 kc.

Bandwidth: 0.8 kc in 20-kc position, 10 kc in 100-kc position with a 20-kilohm output load (TYPE 1232-P1 RF Mixer alone).

Sensitivity: (Open-circuit voltage from 50-ohm source, equivalent

to noise level.) Typically 1 microvolt from 70 kc to 150 kc; 0.4 microvolt from 150 kc to 10 Mc.

Input Impedance: Approximately 200 ohms.

Output Impedance: Approximately 20,000 ohms.

Dimensions: Diameter 2¼, length 6¾ inches (58 by 175 mm).

Net Weight: 1 pound (0.5 kg). **Shipping Weight:** 2 pounds (1 kg).

Type	Code Number	Price
1232-P1 RF Mixer	1232-9601	\$105.00



(Right) Type 1232-A Tuned Amplifier and Null Detector.
(Left) Type 1232-P1 RF Mixer.





Type 1212-A UNIT NULL DETECTOR

DETECTORS
NULL, BROADBAND

FEATURES:

- ◆ 50 cps to 5 Mc. ◆ Quasi-logarithmic response.
- ◆ On-scale range of approximately 120 db.
- ◆ Meter sensitivity control provided for setting of voltage range desired.
- ◆ Sensitivity increases as balance is approached, thus increasing speed and precision.
- ◆ Regulated tube voltages and balanced meter circuit maintain stability.

USES: This unit null detector is an inexpensive, broadband balance indicator for ac bridge measurements from 50 cps to 5 Mc. With the TYPE 1212-P3 RF Mixer and a local oscillator, its range can be extended to 60 Mc as a heterodyne detector.

DESCRIPTION: The instrument consists of a three-stage, broadband amplifier with series-peaking compensation. Germanium-diode clippers are used between stages to obtain the quasi-logarithmic response. The output meter has a linear scale. Earphone terminals are provided.

SPECIFICATIONS

Frequency Response: See plot.

Sensitivity: Less than 40 μ v at 1 kc for 1% of full scale.

Power Supply: TYPE 1203-B is recommended (see page 173). Power supply can be attached to detector to form a rigid unit (locking strips supplied).

Hum and Noise Level: Hum, 20 μ v; broadband noise, 30 μ v.

Input Terminal: Locking TYPE 874 Coaxial Connector.

Accessories Supplied: Power-supply plug, TYPE 874 Cable Connector.

Accessory Equipment Available: TYPES 1212-P1 and -P2 Filters, TYPE 1212-P3 RF Mixer. (See below.)

Cabinet: Unit Instrument (see page 210).

Dimensions: Width 10 $\frac{3}{4}$, height 5 $\frac{3}{4}$, depth 6 $\frac{1}{4}$ inches (275 by 150 by 160 mm), over-all. As shown here, including power supply, 15 by 5 $\frac{3}{4}$ by 6 $\frac{1}{4}$ inches (385 by 150 by 160 mm), over-all. Relay-rack adaptor set listed below mounts both instrument and power supply (panel 19 by 7 inches).

Frequency response characteristic of the Type 1212-A Unit Null Detector.

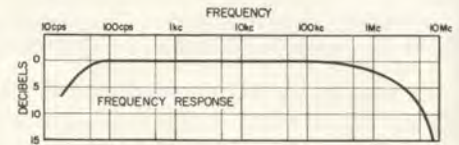

Net Weight: 4 $\frac{3}{4}$ pounds (2.2 kg).

Shipping Weight: 12 pounds (5.5 kg).

Type	Code Number	Price
1212-A Unit Null Detector	1212-9701	\$185.00
1203-B Unit Power Supply (115-v line†)	1203-9702	55.00
480-P4U3 Relay-Rack Adaptor Set	0480-9986	12.00

PATENT NOTICE. See Notes 4 and 15, page viii.

† See page 173 for 230-volt supply.

Type 1212-P1 HIGH-PASS FILTER

This shielded RC filter provides about 50-db attenuation at 60 cps. Plugs into detector input connector.

Nominal Load Impedance: 1 megohm.

Input Voltage Limit: 150 volts maximum.

Terminals: TYPE 874 Coaxial Connector at each end.

Dimensions: Diameter $\frac{7}{8}$, length 4 $\frac{3}{4}$ inches (25 by 110 mm).

Net Weight: 3 ounces (0.1 kg).

Shipping Weight: 1 pound (0.5 kg).

Type 1212-P2 1-Mc FILTER

This shielded, tuned LC filter provides insertion gain at 1 Mc and attenuates higher and lower frequencies. Plugs into detector connector.

Insertion Gain: Between 22 db and 32 db at 1 Mc.

Second-Harmonic Rejection: At least 39 db.

Maximum Input Voltage: 200 volts.

Terminals: TYPE 874 Coaxial Connector at each end.

Dimensions: Diameter 2, length 5 inches (50 by 130 mm).

Net Weight: 9 ounces (255 grams). **Shipping Weight:** 1 pound (0.5 kg).

Type 1212-P3 RF MIXER

The TYPE 1212-P3 RF Mixer, which is similar to the TYPE 1232-P1, combines with the TYPE 1212-A Unit Null Detector to form a sensitive heterodyne null detector from 3 Mc to 60 Mc.

This combination may also be used as a receiver, spectrum analyzer, and sensitive level indicator throughout its frequency range.

Frequency Range: 3 Mc to 60 Mc. (Can be used up to 150 Mc if care is taken in the selection and identification of local-oscillator frequency.)

Sensitivity: (Open-circuit voltage from 50-ohm source, equivalent to noise level) 10 μ v from 3 Mc to 5 Mc, 6 μ v to 60 Mc (typical).

I-F Output Frequency: 1 Mc.

Bandwidth: 25 kc with TYPE 1212-A Unit Null Detector.

Input Impedance: 200 ohms (approximately).

Output Impedance: 50 kilohms (approximately).

Terminals: TYPE 874 Coaxial Connector at end of cable.

Dimensions: Diameter 2 $\frac{1}{4}$, length 6 $\frac{3}{4}$ inches (58 by 175 mm).

Net Weight: 1 pound (0.5 kg). **Shipping Weight:** 2 pounds (1 kg).

Type	Code Number	Price
1212-P1 High-Pass Filter	1212-9601	\$15.00
1212-P2 1-Mc Filter	1212-9602	35.00
1212-P3 RF Mixer	1212-9603	105.00

PATENT NOTICE. See Note 4, page viii.

Type 1212-A Unit Null Detector with Type 1203-B Unit Power Supply

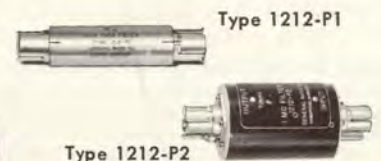



Type DNT HETERODYNE DETECTORS

UHF — VHF
DETECTORS

FEATURES:

- ♦ Wide frequency ranges. ♦ High sensitivity.
- ♦ Excellent shielding. ♦ AVC for null-detector use.
- ♦ Broad bandwidth with good selectivity. ♦ Wide-range calibrated attenuator.

USES: This is a general-purpose, well-shielded, high-frequency heterodyne detector. It can be used as a high-sensitivity, high-frequency voltmeter for relative signal levels, as a standing-wave indicator, and as a null detector.

The system is extremely well shielded and is, therefore, suitable for low-level measurements in the presence of high-level external fields.

As an indicator of relative signal levels, it can be used to measure the insertion loss and attenuation of filters, attenuators, and cables; crosstalk in multi-terminal devices such as switches; to calibrate attenuators; as a field-strength indicator; to measure antenna gain and radiation patterns; and as a general-purpose high-frequency receiver.

Since the mixer is linear over a wide range of input voltages, the built-in step attenuator makes possible the direct measurement of signal levels over an 80-db range. With the use of external TYPE 874-G20L Attenuators, this range can usually be extended to about 110 db.

When standardized at one signal level in terms of an rf voltage standard, as, for instance, a standard-signal generator, the TYPE DNT Detector can be used to measure rf voltage as low as 10 microvolts with a reasonable degree of accuracy.

This detector is recommended for use as a standing-wave indicator with the TYPE 874-LBA Slotted Line. It is particularly useful for measurements on nonlinear elements, where a high degree of harmonic rejection and small operating signal level are required.

As a null detector, it is recommended for use with the

TYPE 1602-B UHF Admittance Meter and the TYPE 1607-A Transfer-Function and Immittance Bridge.

Individual assemblies for various frequency ranges are listed below.

DESCRIPTION: Each assembly comprises one TYPE 874-MRL Mixer Rectifier, one TYPE 1216-A Unit I-F Amplifier, one TYPE 874-G10L 10-db Pad, one TYPE 874-EL-L 90° Ell, plus one unit oscillator and one filter, both depending on the frequency range desired (see price table). For maximum shielding, components are equipped with locking TYPE 874 Coaxial Connectors, which can be used interchangeably with the nonlocking type.

The incoming signal and the signal from the unit oscillator are heterodyned in the mixer rectifier to obtain a 30-Mc difference frequency, which is amplified and indicated on the meter of the TYPE 1216-A Unit I-F Amplifier.

Higher-frequency operation is obtainable with oscillator harmonics, but sensitivity is decreased, and care must be taken to avoid ambiguous beats. Effective harmonic ranges (i.e., without overlap), as well as fundamental, are shown in the curves. The lowest harmonic covering the desired frequency should be used.

When wide ranges of frequency are to be covered, however, it is recommended that one complete DNT detector be purchased, plus the necessary oscillators and filters for the additional frequency ranges desired. For instance, to cover the range from 40 to 950 Mc, one would order a TYPE DNT-2 Detector, plus one TYPE 1209-C Unit Oscillator and one TYPE 874-F1000L Filter.

SPECIFICATIONS

Frequency Range: See sensitivity curves; also price table.

Sensitivity: Typically 5 microvolts; see accompanying curves.

Mixer: TYPE 874-MRL Mixer Rectifier (page 67).

Local Oscillator: See pages 112 to 115 for specifications.

Input Terminal: Mixer input terminal is TYPE 874 Coaxial Connector.

For connection to other types of coaxial connectors, see TYPE 874 Coaxial Adaptors, page 64. The TYPE 874-R22LA Patch Cord (page 71) is also a convenient accessory.

Rack-Mount: Relay-rack adaptor panels are available for both oscillator and i-f amplifier. (See below and page 116.)

(Specifications continued on page 82)

Type DNT-4 Heterodyne Detector.



SPECIFICATIONS (Cont)

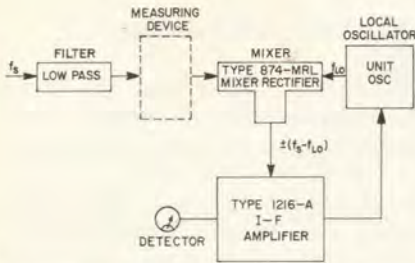

(Right) Frequency range and sensitivity of Type DNT Detectors for both fundamental and harmonic operation.

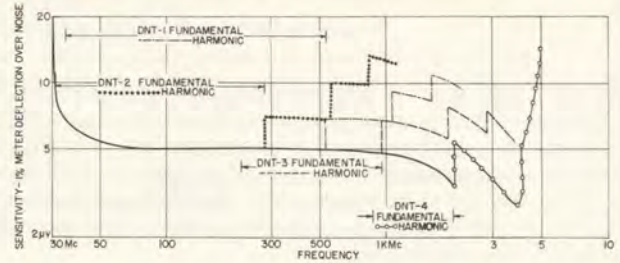

Type	Frequency Range — Mc				Local Oscillator Supplied	Filter Supplied	Code Number	Price
	Fundamental	2nd Harmonic*	3rd Harmonic*	4th Harmonic*				
DNT-1	40†-530	100-1030	165-1530	230-2030	1208-C	874-F500L	1235-9601	\$714.00
DNT-2	40†-280	70-530	120-780	170-1030	1215-C	874-F500L	1235-9602	674.00
DNT-3	220-950	470-1870	720-2790	970-3710	1209-C	874-F1000L	1235-9603	747.00
DNT-4	870-2030	1770-4030	2670-6030	Not recommended	1218-A	874-F2000L	1235-9604	927.00

* For harmonic operation, the appropriate low-pass filter must be used. PATENT NOTICE. See Note 4, page viii.

† 40 Mc is the practical low-frequency limit.



Type 1216-A UNIT I-F AMPLIFIER

The basic element of the TYPE DNT Detector is the TYPE 1216-A Unit I-F Amplifier. It consists of four tuned i-f amplifier stages, a detector, a video amplifier stage, an accurate rf attenuator, and two power supplies. It is designed to operate from the 400-ohm nominal output impedance of the TYPE 874-MRL Mixer Rectifier.

Automatic volume control is provided to facilitate bridge balancing and other null-type measurements. The AVC can be switched out for voltage level measurements.

A built-in, precision, film-type-resistor, step attenuator

is included to make possible accurate measurements of relative signal levels. The indicating meter is calibrated in db, as well as in linear units, for convenient interpolation between the 10-db attenuator steps.

Provision is made for measuring crystal-mixer current.

One of the internal power supplies operates the amplifier circuits; the other supplies heater and plate power to the heterodyning unit oscillator.

Modulation on the input frequency is amplified by a cathode follower and is available at the output terminals.

SPECIFICATIONS

- Center Frequency:** 30 Mc.
- Bandwidth:** Greater than 0.5 Mc at 3 db down; 9.5 Mc at 60 db down.
- Sensitivity:** From a 400-ohm source, 2-microvolt input required for 1% meter deflection (above noise); 50-microvolt input for full-scale meter deflection. These are open-circuit source voltages.
- Noise Figure:** Approximately 5 db.
- Attenuator Range:** 0 to 70 db in 10-db steps.
- Attenuator Accuracy:** ± (0.3 db + 1%).
- Output-Circuit Bandwidth (Modulation):** 0.4 Mc.
- Output Impedance:** 600 ohms.
- Maximum Output Voltage:** 2 volts open circuit.
- Terminals:** Input, TYPE 874 Connector on 2-foot cable; output, 3/4-inch-spaced TYPE 938 Binding Posts.
- Supplementary Power Supply Output:** 300 volts dc at 30 milliamperes; 6.3 volts ac at 1 ampere. With this power supply, full output will

not be obtained from a unit oscillator, but output is ample for heterodyne use.

Power Requirements: 105 to 125 (or 210 to 250) volts, 50 to 60 cps. Power input, 45 watts at full load. Can also be operated at 400 cps where line voltage does not drop below 110 volts.

Accessories Supplied: Spare fuses.

Cabinet: Unit Instrument (see page 210). Relay-rack adaptor panel listed below (panel 19 by 7 inches).

Dimensions: Width 10 1/4, height 5 3/4, depth 6 1/4 inches (260 by 150 by 160 mm), over-all.

Net Weight: 8 1/4 pounds (3.8 kg).

Shipping Weight: 14 pounds (6.5 kg).

Type	Code Number	Price
1216-A	Unit I-F Amplifier	1216-9701 \$360.00
480-P4U2	Relay-Rack Adaptor Panel	0480-9985 11.00

PATENT NOTICE. See Notes 4 and 15, page viii.



FREQUENCY AND TIME



The determination of frequency directly in terms of time is a fundamental measurement, since frequency is the *time* rate of recurrence of a cyclical phenomenon, and, conversely, the time interval required for the occurrence of a given number of events of a fixed frequency is a constant quantity.

Axiomatically, the basis of frequency measurement is time measurement. All frequency measurements are specified in terms of events per unit time, usually in cycles per second. The development of atomic and molecular frequency standards, of presumably ultimate stability, has provided new means for calibrating standard frequencies and time intervals. International agreement has been obtained for Ephemeris Time (E.T.) as the basic constant-time scale for scientific measurements. The Ephemeris second is defined as $1/31,556,925,975$ of the tropical year 1900 (the tropical year is the time between successive vernal equinoxes). The Ephemeris Time scale is tentatively standardized with respect to the resonance frequency of the cesium atom at 9,192,631,770 cycles per second. However, Universal Time, also known as Greenwich Mean Time, based on the rate of rotation of the earth, is used for navigation and daily living. Hence, radio time signals and standard frequency broadcasts are now made on

a time scale related to Ephemeris Time, but offset by an amount which produces approximate agreement with Universal Time. This offset has been -130×10^{-10} in 1962 and 1963.

The principal types of frequency and time standards have been discussed in a paper by Lewis,¹ which references original work.

Time Calibration

Astronomical time observations are carried out by national observatories throughout the world. Their measurements are made available to users through radio time-signal transmissions and by telegraph in their respective countries. In the United States, the U. S. Naval Observatory transmits time signals by radio through the facilities of the U. S. Naval Radio Service. Standard time signals monitored by the Naval Observatory are also broadcast continuously by the standard-frequency transmitters of WWV, operated by the National Bureau of Standards. A similar service is provided in Canada by the Dominion Observatory.

The user of a frequency standard equipped with means for measurement of the time of arrival of a radio time signal can then calibrate the frequency of the standard directly in terms of time. For a precise result, the errors of the transmitted time signal must be taken into account. Correction data for this purpose may be obtained from the Superintendent, U. S. Naval Observatory, Washington 25, D.C. In addition, calibration accuracy depends on stability of propagation time from the transmitter to the receiving location. The variation in *high-frequency* propagation time is usually not less than ± 0.1 millisecond and may be greater. Hence, for a precision of calibration of $\pm 1 \times 10^{-9}$, a time interval longer than one day ($1 \text{ day} = 8.64 \times 10^7$ milliseconds) is necessary between observations even if no additional instrumental errors are introduced. With the General Radio equipment described herewith, a time interval of two days should be adequate to obtain a calibration accurate to approximately $\pm 1 \times 10^{-9}$. Calibration to an accuracy of $\pm 1 \times 10^{-10}$ will require several time determinations over a period of 15 to 20 days.

Frequency Calibration

The "working" clocks used at the Naval Observatory are timed by piezoelectric oscillators of the type used in stable frequency standards. These oscillators are checked against astronomical observations and also against atomic frequency standards (whence derives Atomic Time, A1). Through close cooperation between the National Bureau of Standards and the U. S. Naval Observatory, the time signals radiated by WWV and WWVH have been closely synchronized with the time signals transmitted by NBA on 18 kc. International agreement with Great Britain has likewise synchronized time and frequency broadcasts in the United Kingdom and the United States. Since the time signals are derived from the stable oscillators controlling the carrier frequencies of these stations, their standard-frequency values are similarly in agreement.

Standard-frequency broadcasts in the United States are primarily the responsibility of the National Bureau of Standards. Transmissions are made in the hf bands by stations WWV (Washington, D.C.) and WWVH (Hawaii), in the lf by WWVB, and in the vlf by WWVL (Boulder, Colorado). These transmissions are of the greatest possible stability and accuracy and represent a high-precision standard service wherever they can be received. It is important to note that WWVB (60 kc) and, especially, WWVL (20 kc) are intended to make use of the stable propaga-

¹F. D. Lewis, "Frequency and Time Standards," *Proc IRE*, September, 1955, pp 1046-1069.

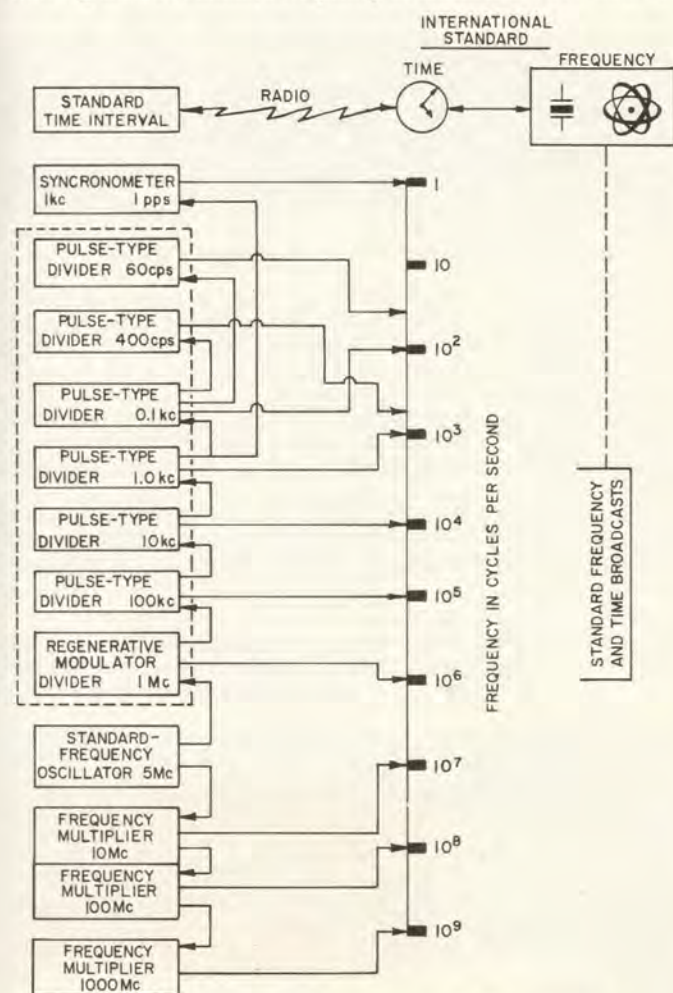

Figure 1. Block diagram of frequency standardization system.

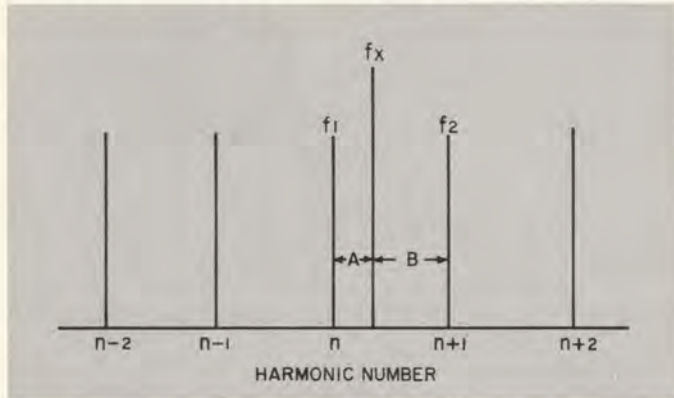

Figure 2. Relation between an unknown frequency and a series of standard-frequency harmonics.

tion conditions at low frequencies. For information and schedules of transmission of standard frequencies, apply to the Radio Standards Laboratory, National Bureau of Standards, Department of Commerce, Boulder, Colorado.

The U. S. Naval Radio Station NBA (Panama Canal Zone) on 18 kc also radiates on a standardized carrier frequency. The excellent geographic position of this station makes vlf standard time and frequency signals available over a large portion of the world.

Methods of utilizing vlf transmission for the calibration of local standards have been discussed by Pierce² and Lewis.³

Frequency Measurement

An unknown frequency is measured by comparison with a known standard frequency. The standard of comparison may be remote, for direct measurements with a calibrated device such as an analog frequency meter, or a component part of the measuring instrument, as with a digital counter. In general, it is desirable to make use of a standard frequency that lies close to the unknown frequency and to measure the difference between the unknown and the standard frequency by an interpolation device. The relation between the standard and unknown frequencies is shown in Figure 2. The heterodyne, analog, and digital interpolation systems are outlined in Figure 3. The heterodyne method is often used for the measurement of noisy, keyed, or remotely originating signals when monitoring of the signal is necessary to avoid incorrect measurements. Since the human ear serves as a monitor, the calibrated audio oscillator need cover only up to a few kilocycles of range.

The analog frequency meter is direct reading in frequency, covering well beyond the audible range of beat frequencies. It can be used for direct measurement of frequencies up to 1.5 Mc,

² J. A. Pierce, "Intercontinental Frequency Comparison by VLF Radio Transmission," *Proc IRE*, June, 1957, pp 794-803.

³ F. D. Lewis, "VLF Standard-Frequency Calibration," *General Radio Experimenter*, June, 1962.

as well as for interpolating between standard frequencies. It is well suited to such applications as the measurement of oscillator drift or other frequency data that can be recorded on a pen recorder.

The digital-counter frequency meter has a wide basic range, covering essentially zero to several tens of megacycles per second. Hence, the counter may be used directly for measuring frequencies up to its maximum without requiring auxiliary equipment if the signal is of adequate strength and purity. The counter requires a time base derived from a frequency standard. Measurement of stable signals near zero beat with the reference frequency may be carried out either by the use of the digital counter as a period-measuring device, or by the observation or recording of the current in a phase-sensitive detector versus time. The digital counter affords the highest resolution with a continuous signal of adequate amplitude and a relatively clean spectrum. The digital counter serves also as an automatic interpolator when used with suitable converter units to extend its range above its direct resolution limit. Stable tunable oscillators, with provisions for synchronizing to external signals, may be used as transfer oscillators for the measurement of intermittent signals, and, through the use of harmonics, of signals above the normal frequency range of the measurement system.

Maintenance of Frequency Standards

Any measurement of frequency depends for its accuracy upon the accuracy of the frequency standard used, which depends, in turn, upon both the accuracy of calibration and the stability of the local standard. The most widely used, and the most useful, laboratory frequency standards are quartz-crystal-controlled oscillators with appropriate dividers and multipliers attached.

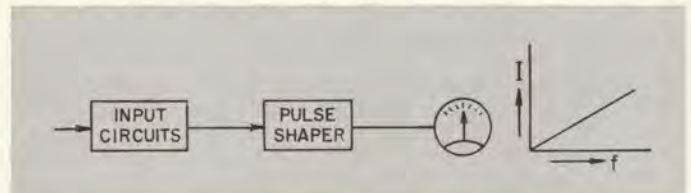

Figure 4. Elementary block diagram of an analog frequency meter.

Calibration of a quartz-crystal oscillator is necessary because the crystal resonator has no intrinsic calibration. However, the stability of a quartz-crystal frequency standard can be entirely adequate for use as a transfer standard, and, in fact, is considerably better than most impedance (R, L, C), mass, or length transfer standards. For applications where no recalibration is possible, atomic standards provide the most stable references, but the operating cost of atomic standards is high, as is also the initial cost.

For most laboratory applications it is almost essential to have two, and preferably three, frequency standards to ensure continuity of operation and to provide assurance of continued

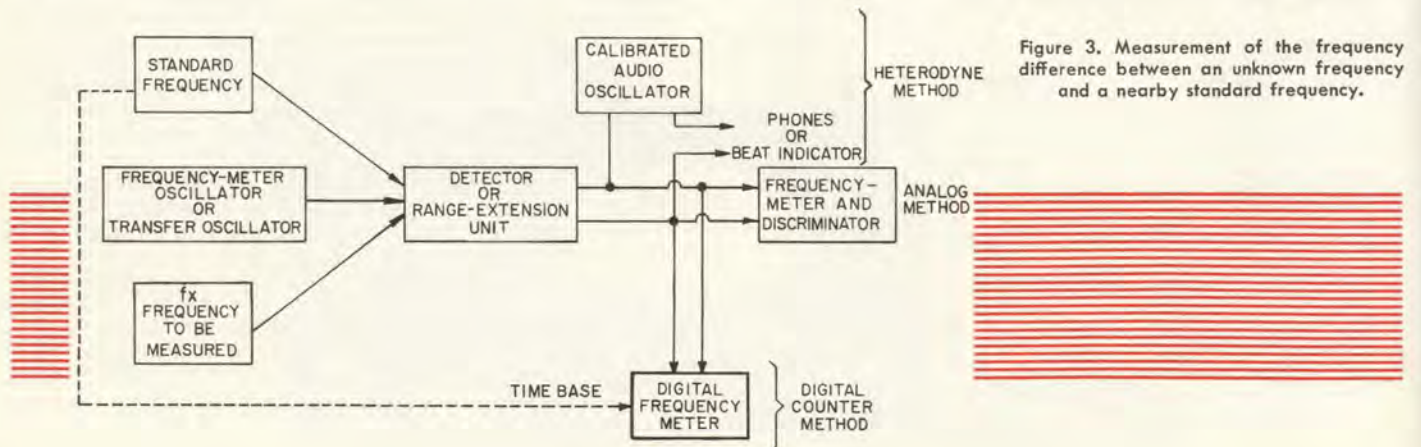

Figure 3. Measurement of the frequency difference between an unknown frequency and a nearby standard frequency.

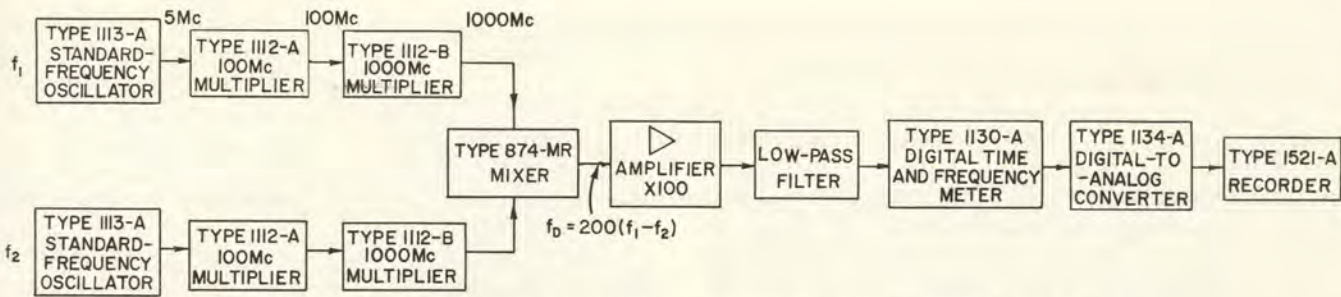

Figure 6. System for intercomparison of two standard-frequency oscillators, by means of a digital frequency meter, to a resolution of $\pm 1 \times 10^{-11}$.

satisfactory performance by means of local comparisons of frequency, in addition to routine calibration with respect to recognized standards. It is possible to provide a frequency standard, with two or three local quartz-crystal oscillators, a comparison system, and a calibration system, that can furnish frequency-calibration data of accuracy equivalent to that of all but the most expensive atomic frequency standards. In many cases, multiple atomic standards will not improve ultimate accuracy, and resort must be had to calibration with respect to the nationally recognized standards. It is also worthy of note that all atomic or molecular frequency standards include quartz-crystal standards, with the exception of the ammonia and hydrogen masers, which are not presently commercially available. On the other hand, the standard-frequency and -time signals broadcast by the National Bureau of Standards, U. S. Navy, and the appropriate agencies of other governments enable adequate calibrations to be performed at low cost to the user.

General Radio frequency-standard equipment is specifically designed to facilitate establishment of a two- or three-oscillator frequency standard. The TYPE 1113-A Standard-Frequency Oscillator does not contain expensive frequency-divider elements that must be purchased if only the oscillator is desired. The TYPE 1114-A Frequency Divider can be easily transferred from one oscillator to another if, for any reason, it is desired to use the alternate source of driving signals. Intercomparison equipment for the checking and recording of standard-frequency oscillator performance is described below. Combinations other than those illustrated are available and can be arranged to suit individual needs.

For the highest resolution intercomparison, two oscillators are put through separate multiplier chains, which produce output frequencies of 1 Gc. The output of each multiplier is applied to a common mixer. The beat frequency, which is produced when one oscillator frequency is slightly offset from the other, is amplified and applied to a digital period counter through a low-pass filter. The output of the digital counter is applied to a digital-to-analog converter, which selects the three most sensitive digits of the indication and supplies the required drive to a graphic recorder. Figure 6 is a block diagram of this system. The resolution of this system is approximately $\pm 1 \times 10^{-11}$, with a sampling time of approximately one-tenth second. In addition to the intercomparison feature, this assembly provides output signals up to 1 Gc.

An intercomparison system of less resolution and lower cost is shown in block diagram form in Figure 7. It is useful for averaging times of 5 seconds or longer. The use of multiplier chains pro-

ducing 100-Mc output frequencies, together with the frequency meter-discriminator in its most sensitive operating range, i.e., the interpolation mode, produces a resolution of approximately ± 0.1 cycle per second, or $\pm 1 \times 10^{-9}$ at 100 Mc. If a second frequency multiplier unit to 1000 Mc is added in each leg, the resolution can be increased to $\pm 1 \times 10^{-10}$.

Described in this section of the catalog are instruments, singly and in combination, to perform the functions described above:

	Page
Frequency Standards ($\pm 5 \times 10^{-10}$)	86
Frequency Standards ($\pm 5 \times 10^{-7}$)	92
Standard-Frequency Oscillator	88
Frequency Divider	88
Time Comparator	90
Heterodyne Interpolation Assembly	93
Digital Frequency Meters (Counters)	94-97
Digital-to-Analog Converters	99
Data Printers	100
Analog Frequency Meter	101

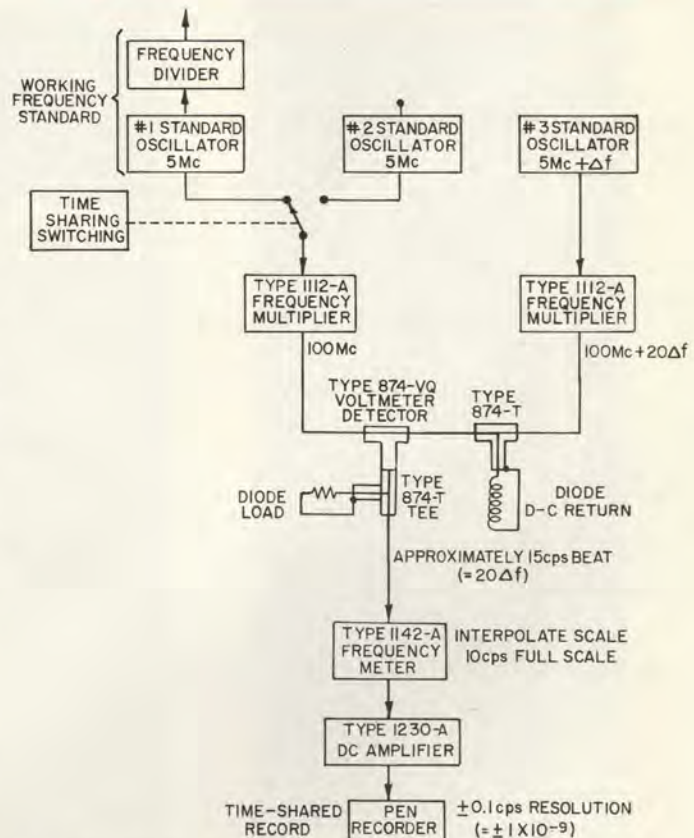

Figure 7. Alternate intercomparison system with analog frequency meter. Resolution is $\pm 1 \times 10^{-9}$ as shown in this figure.

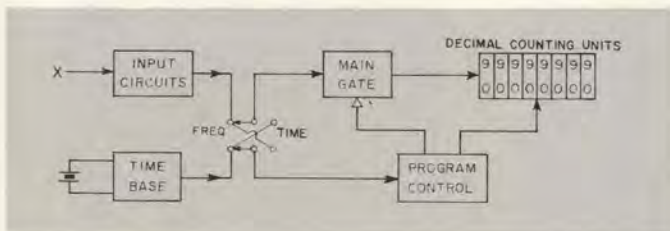

Figure 5. Elementary block diagram of a digital frequency meter (counter).



Type 1120 FREQUENCY STANDARDS

FEATURES:

- ◆ Excellent long-term and instantaneous stabilities.
- ◆ High spectral purity.
- ◆ Reliability — available with emergency power supply.
- ◆ Wide range of output frequencies — up to 1000 Mc.

In the electronics plant, the frequency standard has many uses. It supplies standard frequencies both for laboratory measurements and for production testing; for standardizing digital counters (either as a source for routine accuracy checks or directly as a counter time base); and for measuring received signals in conjunction with frequency meters and other comparison equipment.

The TYPE 1120 Frequency Standards are highly stable sources of standard-frequency signals at decade intervals from 100 cps to 1 Gc, as well as at 5 Mc, 60 cps, and 400 cps. The standard-frequency oscillator operates at 5 Mc, using a high-Q, fifth-overtone-mode quartz crystal. A frequency-

divider chain provides lower frequencies through a series of cascaded divider circuits.

In the TYPE 1120-AH model, frequencies above 5 Mc are produced in low-noise phase-locked-oscillator frequency-multiplier units. These standards offer the highest quality, low-noise, standard-frequency signals for uhf and microwave applications. The vhf and uhf signals are essentially free from submultiple output frequencies.

The SYNCHRONOMETER® time comparator integrates the oscillator frequency and provides a time indication. By means of the built-in, precisely adjustable microdial contactor, the frequency of the oscillator can be compared with

TYPE 1120-A

TYPE 1120-AH

TYPE 1120-AB

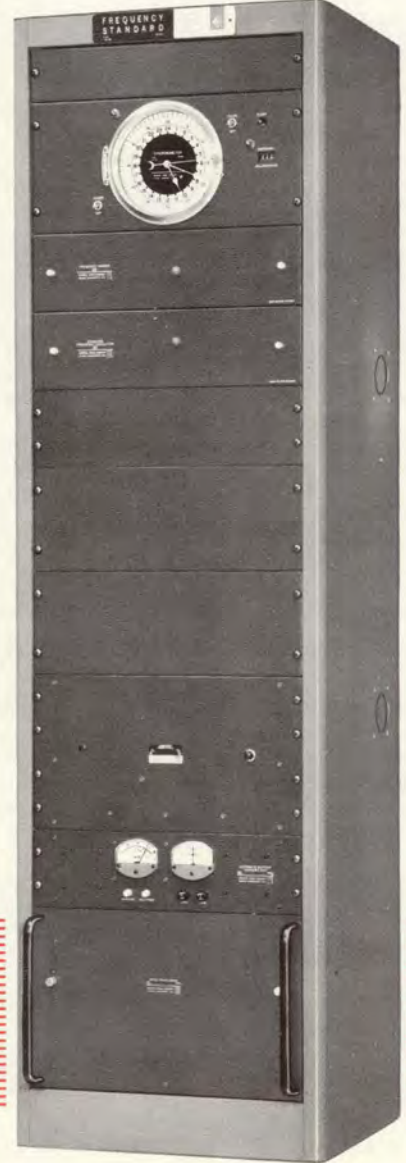
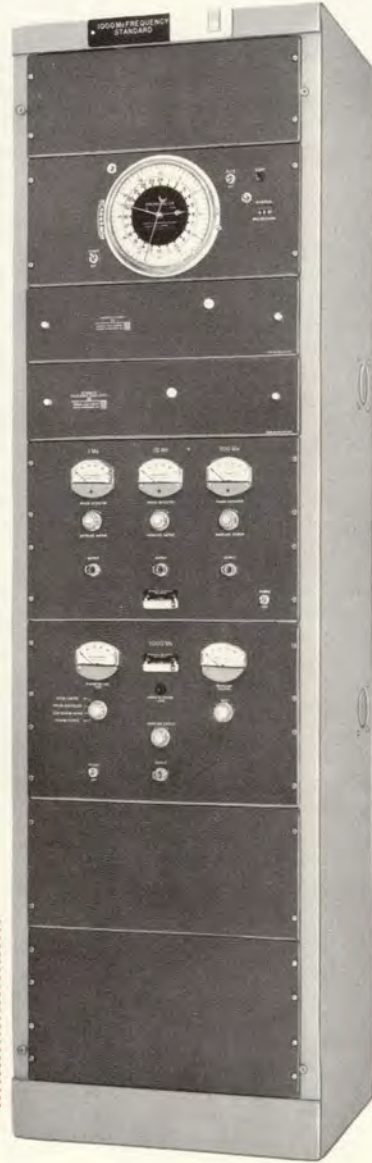

standard-time signals to approximately 0.1 millisecond. The standard can also be calibrated by comparison with standard-frequency broadcasts.

General Radio frequency standards are known the world over for reliability and stability. They are used by governmental agencies, industrial plants, research laboratories, and military services. They are excellent national standards of time and frequency for communications ministries. They are useful as frequency monitoring and measuring systems for checking the frequencies of radio transmitters. The high stability and low aging rate of the 5-Mc oscillator make it suitable for use as an observatory clock, along with the frequency divider and SYNCHRONOMETER time comparator.

Three assemblies are listed:

TYPE 1120-A, a basic frequency standard supplying output frequencies up to 5 Mc.

TYPE 1120-AH, consisting of the TYPE 1120-A plus frequency multipliers producing 10, 100, and 1000 Mc.

TYPE 1120-AB, which is the TYPE 1120-A plus emergency power-supply equipment.

Other systems can be assembled to meet specific needs. For instance, the SYNCHRONOMETER time comparator can be omitted from any of the assemblies and the emergency power equipment can be added to the TYPE 1120-AH. Our engineers will gladly assist in the selection of equipment to meet specific requirements.

The individual components of the standard are available for special applications. Since the 5-Mc reference oscillator is a self-contained unit, it is possible to operate several oscillators for intercomparison checking without the purchase of unnecessary frequency dividers or other auxiliary equipment with each oscillator. The separate frequency-divider and frequency-multiplier units may be purchased as required. It is a simple matter to provide multiple standard-frequency work areas by this means. Space is available in the racks for additional units, as listed below. Blank panels are supplied to fill unused rack space.

For a detailed description of the TYPE 1120 Frequency Standards, see R. W. Frank, F. D. Lewis, and H. P. Stratemeyer, "A Stable and Reliable Frequency Standard," *General Radio Experimenter*, 35, 4, April, 1961.

SPECIFICATIONS

The performance specifications of these frequency standards are listed under the descriptions of the component units described in the following pages.

TYPE 1120-A FREQUENCY STANDARD

Components:

- TYPE 1113-A Standard-Frequency Oscillator.
- TYPE 1114-A Frequency Divider.
- TYPE 1103-B Synchronometer® time comparator.
- Floor-type relay rack.
- Blank panels to fill rack.
- Connection cables.

Output Frequencies: 5 Mc, 1 Mc, 100 kc, 10 kc, 1 kc, 100 cps. Plug-in

units for 400 cps and 60 cps are also available. See TYPE 1114-A Frequency Divider, page 89.

Power Requirements: 140 watts, maximum, at 105 to 125 (or 210 to 250) volts, 50 to 60 cps.

Dimensions: Width 22, height 76½, depth 18½ inches (560 by 1950 by 470 mm), over-all.

Net Weight: 275 pounds (125 kg).

Shipping Weight: 485 pounds (225 kg).

TYPE 1120-AH 1000-MEGACYCLE FREQUENCY STANDARD

Components:

- TYPE 1113-A Standard-Frequency Oscillator.
- TYPE 1114-A Frequency Divider.
- TYPE 1103-B Synchronometer® time comparator.
- TYPE 1112-A Frequency Multiplier.
- TYPE 1112-B Frequency Multiplier.
- Floor-type relay rack.
- Blank panels to fill rack.
- Connection cables.

Output Frequencies: 1000 Mc, 100 Mc, 10 Mc, 5 Mc, 1 Mc, 100 kc, 10 kc, 1 kc, 100 cps; optionally 60 cps and 400 cps (see page 89).

Power Requirements: 375 watts, maximum at 105 to 125 (or 210 to 250) volts, 50 to 60 cps.

Dimensions: Width 22, height 76½, depth 18½ inches (560 by 1950 by 470 mm), over-all.

Net Weight: 325 pounds (150 kg).

Shipping Weight: 575 pounds (265 kg).

TYPE 1120-AB FREQUENCY STANDARD

Components:

- TYPE 1113-A Standard-Frequency Oscillator.
- TYPE 1114-A Frequency Divider.
- TYPE 1103-B Synchronometer® time comparator.
- TYPE 1116-B Emergency Power Supply.
- TYPE 1268-A Automatic Battery Charger.
- TYPE 1268-P1 Battery Drawer.
- TYPE 1268-9602 Battery.
- Floor-type relay rack.
- Blank panels to fill rack.
- Connection cables.

Output Frequencies: 5 Mc, 1 Mc, 100 kc, 10 kc, 1 kc, 100 cps. Plug-in units for 400 cps and 60 cps are also available. See TYPE 1114-A Frequency Divider, page 89.

Power Requirements: 370 watts, maximum at 105 to 125 (or 210 to 250) volts, 50 to 60 cps.

Dimensions: Width 22, height 76½, depth 18½ inches (560 by 1950 by 470 mm), over-all.

Net Weight: 475 pounds (220 kg).

Shipping Weight: 645 pounds (300 kg), less battery; battery shipped direct from supplier.

Type	Code Number	Price
1120-A Frequency Standard	1120-9701	\$3715.00
1120-AH 1000-Megacycle Frequency Standard	1120-9817	6525.00
1120-AB Frequency Standard	1120-9430	5200.00

PATENT NOTICE. See Notes 1, 4, and 8, page viii.

Type 1113-A STANDARD-FREQUENCY OSCILLATOR

- FEATURES:**
- ◆ Excellent short- and long-term stability.
 - ◆ DC on tube heaters for lowest possible fm.
 - ◆ Frequency can be set to 1 part in 10^{-10} .
 - ◆ Five-point meter circuit to check all important operating characteristics.

This high-stability oscillator uses a 5-Mc, fifth-overtone, AT-cut crystal in a modified Gouriet-Clapp circuit. The block diagram shows the functional arrangement of the circuit. The drive level is held constant by the automatic gain control. In addition, negative feedback is used to hold the drive-level variation to less than 10% for 2:1 changes in tube transconductance.

A two-stage oven holds crystal and critical oscillator

components at constant temperature. The outer stage operates at approximately 57 C, the inner stage at the temperature at which the crystal has zero temperature-coefficient. This temperature varies between units and is between 70 and 80 C.

Both plate and heater voltage are regulated. Long-life, premium-quality tubes are used in both the oscillator and the amplifier.

Typical frequency drift of Type 1113-A Standard-Frequency Oscillator.

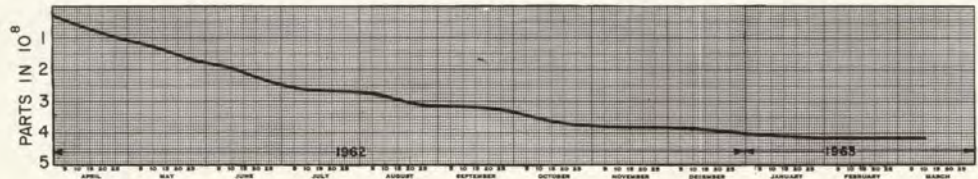

SPECIFICATIONS

FREQUENCY STABILITY

Aging: Less than $\pm 5 \times 10^{-10}$ per day, averaged over 10 days, after 60 days of operation. After one year of operation, typical drift is less than $\pm 2 \times 10^{-10}$ per day.

Short-Term: Better than 1×10^{-10} per minute, as measured with one-second samples. See also spectrum plot at 23,900 Mc.

Oven Cycling: Less than 1×10^{-10} , peak-to-peak.

Ambient: Less than $1 \times 10^{-10}/^{\circ}\text{C}$ (5×10^{-9} for 0 to 50 C).

Line: Less than 1×10^{-10} for 105 to 130 volts.

Loading: Less than $\pm 2 \times 10^{-10}$ for 50 ohms $\pm 20\%$.

FREQUENCY ADJUSTMENTS

Coarse: Approximately 500×10^{-9} .

Fine: $\pm 5 \times 10^{-9}$ in divisions of 5×10^{-10} .

Settability: To 1×10^{-10} .

OUTPUTS 1 volt, rms, into 50 ohms at 5 Mc. 0.4 volt, rms, for General Radio TYPE 1112-A Frequency Multiplier.

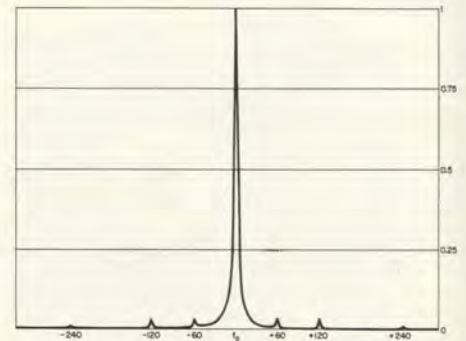

Spectrum of Type 1113-A Standard-Frequency Oscillator as measured at 23,900 Mc by the National Bureau of Standards.

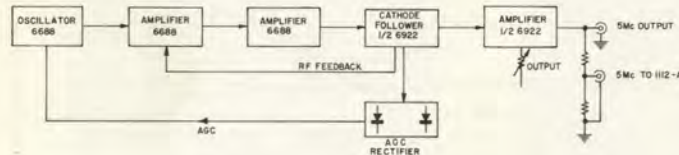

GENERAL

Power Requirements: 102 to 125 (or 210 to 250) volts, 50 to 60 cps, 100 watts, maximum.

Cabinet: Rack bench (see page 210).

Dimensions: Width 19, height $5\frac{1}{4}$, depth $16\frac{3}{4}$ inches (485 by 135 by 425 mm); over-all; rack model—panel 19 by $5\frac{1}{4}$ inches (485 by 135 mm); depth behind panel 16 inches (410 mm).

Net Weight: 30 pounds (14 kg). **Shipping Weight:** 40 pounds (18.5 kg).

Type		Code Number	Price
1113-AM	Standard-Frequency Oscillator, Bench Model	1113-9801	\$1550.00
1113-AR	Standard-Frequency Oscillator, Rack Model	1113-9811	1550.00

PATENT NOTICE. See Notes 1 and 4, page viii.



View of Type 1113-A Standard-Frequency Oscillator control panel. The front panel is held in place with two catches, and is easily removed for adjustment of controls or observation of oven performance.



Type 1114-A FREQUENCY DIVIDER

FREQUENCY MEASUREMENTS
FREQUENCY STANDARD

FEATURES:

- ♦ Wide range of output frequencies.
- ♦ Fail-safe operation.
- ♦ Very low jitter.

The frequency divider operates from the 5-Mc output of the standard-frequency oscillator to produce output frequencies of 1 Mc, 100 kc, 10 kc, 1 kc, and 100 cps; optionally, outputs of 400 cps and 60 cps are also available. The 5-Mc to 1-Mc divider is a regenerative type; all others are switching types. *All circuits are "fail-safe." There is no output when the input signal is absent.* Output of all divider stages is sine wave, with square waves also available at 10 kc and 100 kc. All divider units are plug-in modules.



SPECIFICATIONS

Input: 5 Mc, 1 Mc, 100 kc, 50 ohms, 1 volt \pm 50%.

Output (with 5-Mc input):

- Sine Waves** —
- 1 Mc } 1 volt $\left\{ \begin{array}{l} +50\% \\ -10\% \end{array} \right\}$ into 50 ohms
 - 100 kc }
 - 10 kc } 1 volt $\left\{ \begin{array}{l} +50\% \\ -10\% \end{array} \right\}$ into 600 ohms
 - 1 kc }
 - 100 cps }
 - *400 cps } 1 volt $\left\{ \begin{array}{l} +50\% \\ -10\% \end{array} \right\}$ into 600 ohms
 - *60 cps }
- Square Waves** —
- 100 kc } Approximately 7 volts peak-to-peak
 - 10 kc } open circuit

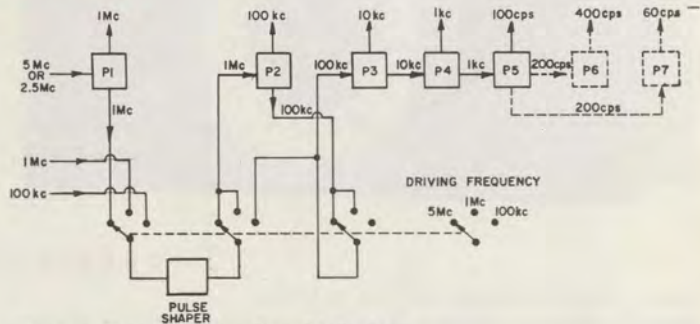

Spurious Signals: Better than 34 db down.

Jitter: Less than 0.5 nsec for 100-cycle output with respect to 5-Mc input.

Additional Frequencies Available: 400 cps; 60 cps. See price table below.

Power Input: 105 to 130 (or 210 to 260) volts, 50 to 400 cps; approximately 7 watts.

Cabinet: Rack-bench (see page 210).

Dimensions: Width 19, height 5 1/4, depth 11 1/2 inches (485 by 135 by 295 mm), over-all; rack model—panel 19 by 5 1/4 inches (485 by 135 mm); depth behind panel 11 inches (280 mm).

Net Weight: 15 pounds (7 kg).

Shipping Weight: 22 pounds (10 kg).

*Optional accessories.

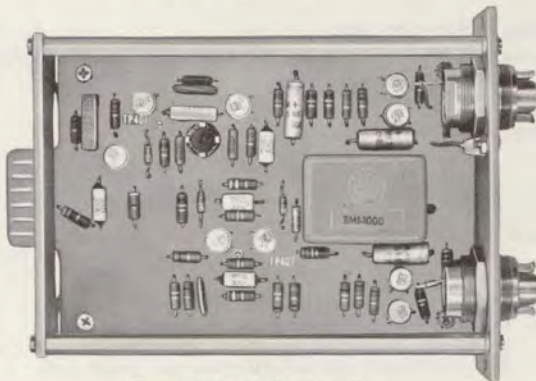

View of typical plug-in unit.

Type		Code Number	Price
1114-AM	Frequency Divider, Bench Model	1114-9801	\$950.00
1114-AR	Frequency Divider, Rack Model	1114-9811	950.00
1114-P6	400-cycle Plug-in Unit	1114-9606	115.00
1114-P7	60-cycle Plug-in Unit	1114-9607	130.00

PATENT NOTICE. See Notes 1 and 4, page viii.

Rear view of the frequency divider, showing the plug-in units.



Type 1103-B SYNCHRONOMETER® TIME COMPARATOR

FEATURES:

- ◆ Time-of-arrival readings can be made without disturbance of the indicated time on the clock.
- ◆ The 1000-cycle synchronous motor is started from the front panel through pushbutton control of the power-frequency starting motor.

The TYPE 1103-B Synchronometer® time comparator is a precision clock with a 24-hour dial for the calibration of frequency and time standards. The 100-tooth phonic-wheel motor is driven by a 1-ke standard-frequency signal at 10 revolutions per second. A worm-and-gear reduces this to one revolution per second at a shaft which carries



a cam operating a phaseable contactor. The contactor operating time, or phase, is adjustable to any time setting within the second (one revolution). The contactor setting is indicated by a three-wheel digital microdial indicator reading directly in milliseconds with graduations at 0.2-millisecond intervals, which can be read accurately to ± 0.1 millisecond. The stability of the closing time of the contactor is ± 0.1 millisecond. The variation in time of arrival of time signals in the hf band is generally of comparable magnitude. Time comparison by this method can yield a frequency-calibration accuracy of $\pm 1 \times 10^{-9}$ over a 48-hour interval.

The SYNCHRONOMETER time comparator is a constant monitor of the continuity of operation of the frequency standard, as well as of the proper functioning of the divider chain. If the clock driving signal is interrupted or changes frequency momentarily, or if the power supply fails, the clock stops and requires restarting. The entire mechanism is simple and reliable, and will give years of service with minimum maintenance.

SPECIFICATIONS

Input: 1-ke sine wave, one volt into 50 kilohms.

Microdial Contactor Stability: Maximum contact-closing-time deviation at any microdial setting is ± 0.1 millisecond.

Calibration Errors: The maximum deviation between the indicated microdial setting and the actual contactor closing time varies sinusoidally from 0 to ± 1 millisecond (maximum) over the 1000-millisecond range.

Accuracy of Time Increments: The maximum error over a time interval of 25 milliseconds is $\pm 2\% \pm 0.1$ millisecond.

Power Requirements: 105 to 125 (or 210 to 250) volts, 50 to 60 cps; 22 watts, continuous; 10 watts additional for starting motor.

Mounting: Relay-rack panel.

Dimensions: Panel 19 by $8\frac{3}{4}$ inches (485 by 225 mm); depth behind panel 11 inches (280 mm).

Net Weight: 35 pounds (16.0 kg).

Shipping Weight: 46 pounds (21 kg).

Type	Code Number	Price
1103-B	Synchronometer® time comparator 1103-9702	\$975.00

EMERGENCY POWER EQUIPMENT

- TYPE 1116-B EMERGENCY POWER SUPPLY
- TYPE 1268-A AUTOMATIC BATTERY CHARGER
- TYPE 1268-P1 BATTERY DRAWER
- TYPE 1268-9602 BATTERY

This emergency power-supply equipment will maintain continuous operation of a frequency standard comprising an oscillator, frequency divider, and clock unit. It furnishes ac power from storage batteries, the switchover being accomplished automatically in less than two cycles of the supply frequency upon failure of the main ac supply. The transition to battery supply occurs without interruption of the continuous operation of the oscillator and timing system, so that calibration procedure involving time integration can be fully relied upon.

While the design of the TYPE 1113-A Standard-Frequency Oscillator prevents the possibility of permanent damage in the event of power failure, a period of hours or even days may be necessary for the standard to recover equilibrium after a temporary unsettlement caused by power failure.

The emergency power supply is, therefore, a recommended accessory for the frequency standard, with the addition of the TYPE 1268-A Automatic Battery Charger, TYPE 1268-P1 Battery Drawer, and battery.

For complete specifications, see page 176.



Type	Code Number	Price
1116-B	Emergency Power Supply 1116-9702	\$450.00
1268-A	Automatic Battery Charger 1268-9701	450.00
1268-P1	Battery Drawer (less battery) 1268-9601	195.00
1268-9602	Battery 1268-9602	250.00



Type 1112 STANDARD-FREQUENCY MULTIPLIERS

FEATURES:

- ◆ Provides microwave-range standard frequencies — 20-milliwatt output (50 milliwatts at 1000 Mc).
- ◆ Excellent phase stability.
- ◆ Extremely low noise.

USES: The TYPE 1112 Standard-Frequency Multipliers generate sine-wave signals of 1, 10, 100, and 1000 Mc when driven from a 100-kc or 1-Mc source, or, when driven from a 1-, 2.5-, or 5-Mc source, outputs of 10, 100, and 1000 Mc.

The output provides standard frequencies in the microwave region for precise frequency measurements. The unusually low noise and excellent phase stability of output signals permit intercomparison of lower-frequency, standard-frequency oscillators and comparison of crystal with atomic standards.

DESCRIPTION: The phase stability and low noise of the multiplier outputs result from the use of a narrow-band

filter, which selects only the desired harmonic at each output frequency.

In the TYPE 1112-A Multiplier, the 100-kc input signal is multiplied to 1, 10, and 100 Mc. Quartz-crystal filters are used, each in an oscillator circuit whose frequency is phase-locked to the desired harmonic frequency.

In the TYPE 1112-B Multiplier, which operates from a separate 100-Mc output of the TYPE 1112-A, a phase-locked klystron oscillator is used as a selective filter. Phase-modulation noise inherent in klystrons is minimized by negative feedback. The reference standard is the multiplied harmonic of the crystal-controlled 100-Mc driving signal.

SPECIFICATIONS

Type	Input		Residual FM Noise	Locking Range	Bandwidth† Decade cps	Output Power	Open-Circuit Output Volts
	Freq in Mc	Volts					
1112-A	0.1	1	$< \pm 1 \times 10^{-9}$	± 15 in 10^6	0.1-1 Mc 50 1-10 Mc 500 10-100 Mc 5000	20 mw into 50Ω 4 channels: 1 at 1 Mc 1 at 10 Mc 2 at 100 Mc	2
	1	1.5					
	2.5	0.4					
	5	0.4					
1112-B	100	20 mw* (50Ω)	$< \pm 1 \times 10^{-9}$	± 100 kc‡	100 kc‡	1000 Mc 50 mw 50Ω Sine wave	> 3

* From TYPE 1112-A. † Expressed as allowable frequency deviation rate.

‡ At input frequency.

Spurious Signals: At least 100 db below output level.

Terminals: Locking TYPE 874 Coaxial Connectors; adaptors (page 64) are available to all commonly used types.

Accessories Supplied: TYPE 1112-A — TYPE CAP-22 Power Cord, TYPE 874-R22A Patch Cord, two TYPE 874-C58A Cable Connectors, spare fuses; TYPE 1112-B — TYPE CAP-22 Power Cord, two TYPE 874-R22A Patch Cords, one TYPE 874-C58A Cable Connector, spare fuses.

Power Supply: 105 to 125 (or 210 to 250) volts, 50 to 60 cps. TYPE 1112-A, 110 watts; TYPE 1112-B, 125 watts.

Dimensions: Relay-rack panel, 19 by 12¼ inches (485 by 330 mm); depth behind panel, 11 inches (280 mm).

Net Weight: TYPE 1112-A, 25 pounds (11.5 kg); TYPE 1112-B, 35 pounds (16 kg).

Shipping Weight: TYPE 1112-A, 50 pounds (23 kg); TYPE 1112-B, 60 pounds (28 kg).

Type	Code Number	Price
1112-A Standard-Frequency Multiplier	1112-9701	\$1450.00
1112-B Standard-Frequency Multiplier	1112-9702	1360.00

PATENT NOTICE. See Notes 4 and 15, page viii.

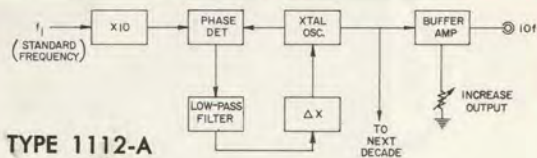
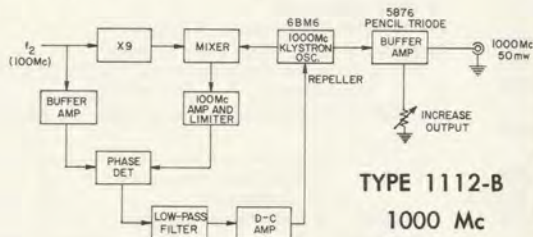

TYPE 1112-A
1, 10, 100 Mc

Type 1213-D UNIT TIME/FREQUENCY CALIBRATOR

- FEATURES:**
- ♦ High accuracy — a few parts in 10^7 .
 - ♦ Wide range of output frequencies.
 - ♦ Easily adjusted to zero beat with wv standard-frequency transmissions.
 - ♦ Accurate timing source for oscilloscopes.
 - ♦ Internal mixer for maximum utility.

USES: The TYPE 1213-D Unit Time/Frequency Calibrator is a compact frequency standard comprising all the circuits necessary for calibration operations that have hitherto required several instruments. These circuits include: (1) a crystal-controlled source of harmonics at multiples of 10 Mc, 1 Mc, 100 kc, and 10 kc, (2) mixer and beat amplifier, and (3) a pulse amplifier.

The self-contained mixer and audio amplifier permit frequency calibration of oscillators and signal generators without requiring additional equipment. The standard-frequency harmonics are useful for receiver calibration and for frequency measurement with external detectors and interpolating equipment.

With auxiliary Unit Oscillators for interpolation and an oscilloscope for zero-beat indications, this calibrator can measure accurately all the frequencies of radio broadcast and television transmitters.*

The output of the cathode-follower pulse amplifier can be used directly or differentiated in the TYPE 1213-P1 Differentiator to provide pulses at intervals of 0.1 μ sec, 1.0 μ sec, 10 μ sec, and 100 μ sec for time markers in swept-frequency applications and for calibrating variable time-delay units and oscilloscopes.

The amplitude of the pulses is sufficient to trigger pulse-generating equipment and oscilloscope sweeps.

The crystal oscillator can be standardized against standard-frequency radio transmissions.

DESCRIPTION: The block diagram shows the functional arrangement of circuits. The crystal oscillator uses a 5-Mc AT-cut, hermetically sealed quartz plate of exceptionally small temperature coefficient at room temperatures. The multivibrator outputs can be switched to drive either a video amplifier to supply frequency markers and timing pulses or a harmonic generator and mixer for frequency calibrations, with the video amplifier automatically switched to act as a high-gain audio amplifier.

A narrow-range frequency adjustment is provided, and also a touch-button deviator for establishing "sense" in low beat frequencies.

* Described in Technical Publication B10; copy free on request.

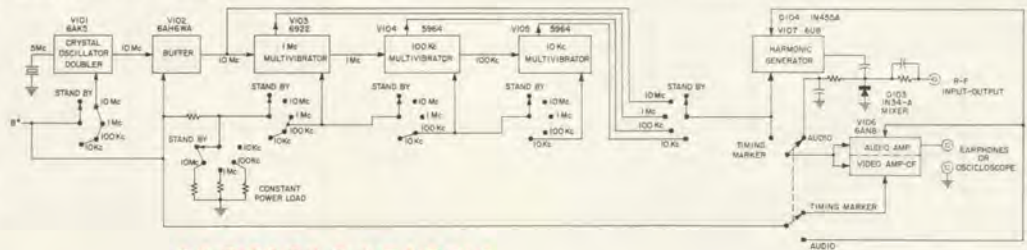

SPECIFICATIONS

OUTPUT

Frequencies: 10 Mc, 1 Mc, 100 kc, 10 kc.

Frequency Adjustment: ± 5 ppm.

Amplitude: 10 Mc — 5 volts, peak-to-peak; 30 volts, peak-to-peak, at lower output frequencies from pulse amplifier; rf harmonics usable to 1000 Mc from 10-Mc output, to 500 Mc from 1-Mc output, to 100 Mc from 100-kc output, and to 10 Mc from 1-kc output.

Impedance: Video cathode-follower, 300 ohms; rf output obtained from crystal-diode harmonic generator.

Terminal: Locking TYPE 874 Coaxial Connector. This instrument can be equipped with type N, BNC, TNC, SC, C, or UHF connectors through the use of locking adaptors, listed on page 64.

FREQUENCY STABILITY

Warmup Drift: Not more than $-2 \times 10^{-7}/^{\circ}\text{C}$ for ambient temperatures of 25 C, or over. With ambient 0 to 10 C crystal may not operate until operating temperature is reached. Minimum operating ambient, 0 C.

Temperature: Between $-1 \times 10^{-7}/^{\circ}\text{C}$ and $+2 \times 10^{-7}/^{\circ}\text{C}$ in ambient range 20 to 40 C.

Line-Voltage: Momentary changes of $\pm 10\%$ affect frequency by less than 5×10^{-8} . Changing line voltage will affect frequency per temperature specification above ($\pm 10\%$ line will change temperature ± 4 C).

Switching and Loading: Over-all, less than 1×10^{-7} .

GENERAL

Sensitivity: Usable beats can be produced with 50 millivolts input to mixer over the harmonic ranges listed above.

Power Requirements: TYPE 1203-B Unit Power Supply is recommended.

Accessories Supplied: TYPE 1213-P1 Differentiator, TYPE 874 Coaxial Connector, and multipoint connector.

Cabinet: Unit Instrument (see page 210).

Dimensions: Width 10 1/2, height 5 3/4, depth 7 inches (270 by 150 by 180 mm), over-all. As shown here, including power supply, 14 3/4 by 5 3/4 by 7 inches (375 by 150 by 180 mm), over-all. Relay-rack adaptor set listed below mounts both instrument and power supply (panel 19 by 5 1/4 inches).

Net Weight: 4 3/4 pounds (2.2 kg).

Shipping Weight: 12 pounds (5.5 kg).

For a detailed description of the calibrator, see R. W. Frank and H. P. Stratemeyer, "A Time/Frequency Calibrator of Improved Stability," *General Radio Experimenter*, 30, 10, October, 1959.

Type	Code Number	Price
1213-D Unit Time/Frequency Calibrator	1213-9704	\$310.00
1203-B Unit Power Supply	1203-9702	55.00
480-P4U3 Relay-Rack Adaptor Panel	0480-9986	12.00

PATENT NOTICE. See Note 4, page viii.

Type 1213-D Unit Time/Frequency Calibrator with Type 1203-B Unit Power Supply.





Type 1105-B FREQUENCY-MEASURING EQUIPMENT

FREQUENCY MEASUREMENTS
HETERODYNE

FEATURES:

- ♦ Can be used to measure intermittent or fading signals.
- ♦ Can generate a precisely known frequency between 100 kc and 200 Mc.

The TYPE 1105-B Frequency-Measuring Equipment is a heterodyne-method frequency measurement system. The method of operation is based on the principles set forth in Figure 2 and Figure 3 on page 83. Harmonics of the 10-kc and 100-kc standard frequencies are generated by a newly developed avalanche-transistor pulse generator, which produces strong harmonics to 100 Mc and beyond. It is thus possible to make direct measurement of frequencies up to 100 Mc using the TYPE 1107-A Interpolation Oscillator and the TYPE 1109-B Comparison Oscilloscope as the beat-frequency interpolator to measure frequency difference "A" in Figure 2. Each TYPE 1106 Frequency-Transfer Unit contains a regenerative detector and calibrated transfer oscillator covering a portion of the spectrum. They are interconnected with the unknown signal and the frequency standard through the TYPE 1108-B Coupling Panel, which contains the transistor pulse generators for producing the standard-frequency harmonics.

In the frequency range from 100 kc to 100 Mc, the

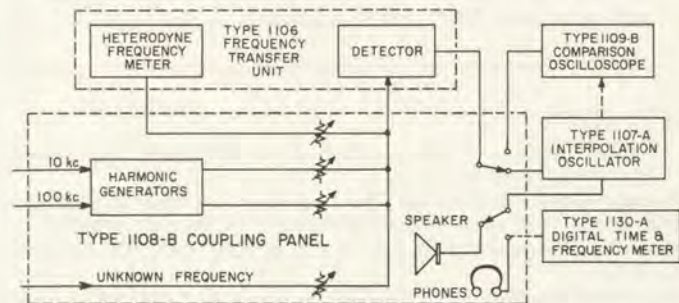

Block diagram of the Type 1105-B Frequency-Measuring Equipment.

SPECIFICATIONS

Specifications and prices of the component instruments will be furnished on request. All items are available individually. For specifications for TYPE 1107-A Interpolation Oscillator, see page 110.

Terminals and Cables: All units are equipped with TYPE 874 Coaxial Connectors at the rear. Suitable connection cables are furnished.

Power Requirements: 105 to 125 (or 210 to 250) volts, 50 to 60 cps, 200 watts.

Dimensions: Width 22, height 76 $\frac{1}{8}$, depth 20 $\frac{1}{2}$ inches (560 by 1940 by 520 mm), over-all.

Net Weight: 370 pounds (168 kg).

Shipping Weight: 560 pounds (258 kg).

Type	Code Number	Price
1105-B Frequency-Measuring Equipment	1105-9702	\$5900.00

PATENT NOTICE. See Note 4, page viii.

TYPE 1107-A INTERPOLATION OSCILLATOR

This unit is a linear-scale, direct-reading, audio-frequency oscillator covering frequencies from 0 to 5000 cps. It is used to measure the audio-frequency difference between the unknown frequency and a standard 10-kc harmonic. A meter indicates output voltage and can be used as a beat indicator for matching the interpolator and unknown frequencies. See also page 110. **\$1250.00**

TYPE 480-MA RELAY RACK

The individual units are mounted in the Type 480-MA Relay Rack. At the base of the rack is mounted a Type 1105-P1 Speaker for audible monitoring of beat tones.

All connections between standard and measuring assembly are made by means of patch cords, which are supplied.

approximate frequency is read from the dial of the detector, a more exact value from the heterodyne-frequency-meter (transfer oscillator) scale; and the beat between the unknown signal and the standard-frequency harmonic is measured by setting the direct-reading dial of the audio interpolation oscillator to produce a stationary pattern on the oscilloscope. The availability of the transfer oscillators in the same units as the detectors makes it possible to generate precisely known frequencies between 100 kc and 100 Mc. The oscillators cover fundamental frequency ranges from 100 to 200 kc ((1106-A), 1 to 2 Mc (1106-B), and 10 to 20 Mc (1106-C), other frequencies being generated as harmonics of those fundamental ranges.

Provision is made for use of an external radio receiver to receive signals for which either the sensitivity or selectivity of the heterodyne detector units is not considered adequate, or to cover the frequency range above 100 Mc. The standard-frequency harmonics extend beyond 100 Mc with adequate amplitude for use with sensitive receivers up to approximately 150 Mc.

TYPE 1109-B COMPARISON OSCILLOSCOPE

Includes cathode-ray oscilloscope, with power supply; selecting, smoothing, and phase-shifting networks for circular sweeps at line frequency, 0.1-, 1- and 10-kc standard frequencies, and at a variable frequency obtained from the interpolation oscillator; and all necessary switching. Most patterns are presented on a circular sweep by radial deflection. **\$600.00**

TYPE 1106-A, -B, -C FREQUENCY-TRANSFER UNITS

(3 panels)

Each of these units contains a heterodyne frequency meter and heterodyne detector, with direct-reading scales. Ranges are as follows:

Type 1106-A 100 kc to 2000 kc
Type 1106-B 1 Mc to 10 Mc
Type 1106-C 10 Mc to 100 Mc

The harmonic output of the frequency meter is used at frequencies higher than those covered by the dial ranges. The output of the frequency meter and the regeneration of the heterodyne detector are adjustable.

Each model, **\$1050.00**

TYPE 1108-B COUPLING PANEL

This unit is the centralized control point at which all necessary switching and level adjustments can be easily and quickly carried out. Also generates harmonics from the standard-frequency inputs of 10 and 100 kc. **\$510.00**





Type 1150-A DIGITAL FREQUENCY METER

FEATURES:

- ◆ Bright-light Numerik in-line display.
- ◆ Compact size — less than 4 inches high.
- ◆ High accuracy — stable, temperature-controlled crystal time base.
- ◆ Reliability — ring counting circuits noncritical enough to operate with wide range of transistor characteristics.

USES: The TYPE 1150-A Digital Frequency Meter is a basic general-purpose counter for laboratory and industrial use. Covering the frequency range from 10 cps to 300 kc, it can be used to calibrate oscillators, to monitor frequencies, and to make high-resolution measurements on precision filters and other frequency-selective devices.

With appropriate transducers, the counter can be used to measure pressure, temperature, strain, weight, production-line output, number of particles in liquids, and other quantities or events that may or may not be periodic. Used with the TYPE 1536-A Photoelectric Pickoff (page 170), the counter easily measures high rotational speeds.

DESCRIPTION: This instrument counts the number of cycles of the input signal occurring in a precise time interval of 0.1, 1, or 10 seconds. This interval is established by a stable, temperature-controlled 100-kc quartz-crystal oscillator. The counting circuits are simple but unconventional ring-of-ten counting units, which allow wide variations in transistor characteristics and which are directly adaptable

to the ten-lamp Numerik indicator (the collector currents of the counting transistors are used to light the incandescent lamps in the indicators).

The counter is available with or without output provision for use with the TYPE 1136-A Digital-to-Analog Converter (see page 99) and the TYPE 1137-A Data Printer (see page 100).

THE NUMERIK INDICATOR

The Numerik indicator used in the TYPES 1150-A and 1151-A counters is available as a general-purpose digital indicator, which can be used in the readouts of counters, computers, digital voltmeters, annunciators, and indicator boards. Two models are available: the TYPE IND-0300, with 10 digits, 0 through 9, and the TYPE IND-1801, with the 10 digits plus a comma on the right-hand side and a decimal point on the left-hand side. For further information, see page 201.

SPECIFICATIONS

Frequency Range: 10 cps to 300 kc.

Input Impedance: AC-coupled; approximately 0.5 megohm shunted by less than 100 pf.

Sensitivity: Better than 1 volt, peak-to-peak; for pulse input, duty ratio should be between 0.2 and 0.8. For input pulses of higher than minimum amplitude, duty ratio becomes less important.

Display: 5-digit, in-line Numerik register, incandescent-lamp operated.

Display Time: Adjustable from 0.5 to 5 seconds, or infinity.

Counting Interval: 0.1, 1, or 10 seconds, or can be set manually.

Accuracy: ± 1 count \pm crystal-oscillator stability.

Crystal-Oscillator Stability

Short-Term: Better than $\frac{1}{2}$ part per million.

Cycling: Less than counter resolution.

Temperature Effects: Less than $2\frac{1}{2}$ parts per million for rise of 0 to 50 C ambient.

Warmup: Within 1 part per million after 15 minutes.

Agging: Less than 1 part per million per week after four weeks, decreasing thereafter.

Crystal-Frequency Adjustment: The frequency is within 10 parts per million of 100 kc when shipped. Frequency adjustment provided.

Power Requirements: 105 to 125 (or 210 to 250) volts, 50 to 60 cps, 45 watts.

Accessories Supplied: TYPE CAP-22 Power Cord, eight replacement incandescent lamps, spare fuses.

Accessories Available: TYPE 1136-A Digital-to-Analog Converter (page 99) and TYPE 1137-A Data Printer (page 100) operate from output of TYPE 1150-AP model.

Cabinet: Rack-bench (see page 210).

Dimensions: Bench model — width 19, height $3\frac{7}{8}$, depth $12\frac{1}{2}$ inches (485 by 99 by 320 mm), over-all; rack model — panel 19 by $3\frac{1}{2}$ inches (485 by 90 mm); depth behind panel $12\frac{3}{4}$ inches (325 mm).

Net Weight: $17\frac{1}{2}$ pounds (8 kg).

Shipping Weight: 20 pounds (9.5 kg).

Type		Code Number	Price
1150-AM	Digital Frequency Meter, Bench Model	1150-9801	\$ 995.00
1150-AR	Digital Frequency Meter, Rack Model	1150-9811	995.00
1150-APM	Digital Frequency Meter (with output for printer or D/A converter), Bench Model	1150-9871	1050.00
1150-APR	Digital Frequency Meter (with output for printer or D/A converter), Rack Model	1150-9981	1050.00





Type 1151-A DIGITAL TIME AND FREQUENCY METER

FEATURES:

- ♦ Front-panel control of trigger level, slope, ac or dc coupling.
- ♦ Measures frequency, period, and frequency ratio. ♦ In-line Numerik display.
- ♦ Ability to trade input impedance for added sensitivity.

USES: The TYPE 1151-A is, like the TYPE 1150-A, a general-purpose counter for the laboratory or production line, but with a full complement of input controls and with the switching program needed for period, multiple-period, and ratio measurements.

DESCRIPTION: The TYPE 1151-A Digital Time and Frequency Meter is a versatile, accurate, general-purpose counter for the measurement of frequency from a fraction of a cycle per second to 300 kc, and for accurate measurement of single or multiple periods. The ability to make period measurements up to 1000 periods is especially useful for fast, accurate measurement of very low frequencies.

The input circuits provide a choice between ac or dc coupling and between negative- or positive-going slope. A third input control offers the choice between two sensitivities: 1 volt with an input impedance of 1 megohm, or 0.1 volt at 100 kilohms.

For frequency measurement, the main gate is opened and closed by a 100-kc crystal oscillator signal divided down to 0.1, 1, 10, or 100 cps. Two flip-flop aperiodic

dividers are used: the first divides by 1000, and the second divides by 10, 100, or 1000, or is bypassed.

For period measurement, the main gate is opened and closed by the signal of unknown frequency, either fed straight through for single-period measurements or divided by 10, 100, or 1000 for multiple-period measurements. The "clock" pulses are supplied by the 100-kc crystal oscillator.

The counter can also be used to measure frequency ratio. For ratio measurement, the counter is programmed as for period measurement, except that the internally generated 100-kc "clock" signal is replaced by the signal from an input channel. Frequency response for this channel (labeled B on the panel) is from dc to over 300 kc. Ratio measurements can be made over the full frequency-resolution range of the counter.

The counter is available with or without output provision for use with the TYPE 1136-A Digital-to-Analog Converter (see page 99) and the TYPE 1137-A Data Printer (see page 100).

SPECIFICATIONS

Frequency Measurement:

Range — DC to 300 kc.

Sensitivity — 0.1 volt, peak-to-peak, at 100 kilohms or 1 volt, peak-to-peak, at 1 megohm (1 microampere), switch-selected.

Counting Interval — 10 milliseconds to 10 seconds, extendible by multiplier switch.

Accuracy — ± 1 count \pm crystal-oscillator stability.

Period Measurement:

Range — DC to 20 kc.

Number of Periods — 1, 10, 100, or 1000.

Sensitivity — 0.1 volt at 100 kilohms or 1 volt, peak-to-peak, at 1 megohm (1 microampere), switch-selected.

Accuracy — ± 1 count \pm time base accuracy \pm noise errors.

Input Noise — 5 millivolts equivalent open-circuit input noise.

Counted Frequency — 100 kc.

Ratio Measurement:

Range — B/A, 10 B/A, 100 B/A, or 1000 B/A.

Frequency Range — A input, dc to 20 kc; B input, dc to 300 kc.

B Input — 1 volt peak-to-peak, 100 kilohms.

Display: 5-digit, in-line Numerik register, incandescent-lamp operated.

Display Time: 0.16, 0.32, 0.64, 1.28, 2.56, 5.12, or 10.24 seconds, switch-selected.

Input Impedance: 1 megohm shunted by 50 pf or 100 kilohms shunted by 500 pf, switch-selected.

Input Trigger Level: ± 1 volt at 0.1-volt sensitivity; ± 10 volts at 1-volt sensitivity.

Input Trigger Slope: AC or dc coupled, positive- or negative-going.

Crystal-Oscillator Stability:

Short-Term — Better than $\frac{1}{2}$ part per million.

Cycling — Less than counter resolution.

Temperature Effects — Less than $2\frac{1}{2}$ parts per million for rise of 0 to 50 C ambient.

Warmup — Within 1 part per million after 15 minutes.

Aging — Less than 1 part per million per week after four weeks, decreasing thereafter.

Crystal Frequency Accuracy: The frequency is within 10 parts per million when shipped. Frequency adjustment is provided.

Power Requirements: 105 to 125 (or 210 to 250) volts, 50 to 60 cps, 50 watts.

Accessories Supplied: TYPE CAP-22 Power Cord, eight replacement incandescent lamps, spare fuses.

Accessories Available: TYPE 1136-A Digital-to-Analog Converter (page 99) and TYPE 1137-A Data Printer (page 100) operate from output of TYPE 1151-AP model.

Cabinet: Rack-bench (see page 210).

Dimensions: Bench model — width 19, height $3\frac{7}{8}$, depth $12\frac{1}{2}$ inches (485 by 99 by 320 mm), over-all; rack model — panel 19 by $3\frac{1}{2}$ inches (485 by 90 mm), depth behind panel $12\frac{3}{4}$ inches (325 mm).

Net Weight: 19 pounds (9 kg). **Shipping Weight:** 22 pounds (10 kg)

Type		Code Number	Price
1151-AM	Digital Time and Frequency Meter, Bench Model	1151-9801	\$1195.00
1151-AR	Digital Time and Frequency Meter, Rack Model	1151-9811	1195.00
1151-APM	Digital Time and Frequency Meter (with output for printer or D/A converter), Bench Model	1151-9871	1250.00
1151-APR	Digital Time and Frequency Meter (with output for printer or D/A converter), Rack Model	1151-9981	1250.00



GP Type 1130-A DIGITAL TIME AND FREQUENCY METER

FEATURES:

- ♦ Designed-in reliability. ♦ Modular construction — easy to service.
- ♦ Continuous display — no blinking lights. ♦ Simple graphic recording.
- ♦ Versatile input circuits — high sensitivity, high impedance, wide dynamic range, adjustable trigger level.
- ♦ 500-Mc range (with external frequency converter).

USES: The Digital Time and Frequency Meter is an automatic instrument for the precise measurement of frequency, period, and time intervals. It can also count random events, measure frequency ratios, compute phase shift, and measure characteristics of pulse waveforms.

This counter is especially well-suited for applications demanding long-time trouble-free operation.

DESCRIPTION: The counter contains five basic circuit blocks: the input circuits, the time base, the main gate, the program control, and the decimal counting units. A detailed description of the individual circuits and their operation has been published.* Of particular interest are the following features:

1. The decimal counting units use a noncritical 1-2-4-2 weighting, rather than the customary 1-2-2-4, to minimize the effects of changes in operating voltages and tube characteristics.

2. Computer-type design and premium components are used throughout.

3. All tube circuits are on plug-in boards, easily detached for service or replacement.

4. Time-base units also plug in. Four different types are available. A monitor lamp indicates loss of standard-frequency drive or any failure of the time base.

5. The measurement display consists of digital neon-lamp columns. The operator can choose either an eight-digit intermittent or sequential display, or a four-digit continuous display. Any four consecutive digits can be selected for continuous display. An illuminated decimal point is automatically positioned for each measurement, and the units of measurement are clearly indicated.

6. Controls are logically placed and clearly marked — easily operated by unskilled personnel.

The matching TYPE 1133-A Frequency Converter (see page 98) extends the frequency range to 500 Mc.

* R. W. Frank and H. T. McAleer, "A Frequency Counter with a Memory and with Built-In Reliability," *General Radio Experimenter*, 35, 5, May, 1961. Reprints available.

SPECIFICATIONS

FREQUENCY MEASUREMENT

Range: DC to 10 Mc. Companion instrument, TYPE 1133-A Frequency Converter, extends range to 500 Mc (see page 98).

Sensitivity: 0.25 volt, rms, for sine waves, more sensitive at low frequencies; 0.4 volt, peak-to-peak, for typical pulse waveforms.

Counting Interval: 1 millisecond to 10 seconds, extendible by MULTIPLE INTERVAL switch or external connections.†

Accuracy: ± 1 count \pm time-base oscillator accuracy.

PERIOD MEASUREMENT

Range: 10 microseconds to 10^7 seconds (dc to 100 kc) for single-period measurement. 400 microseconds to 10^7 seconds (dc to 25 kc) for ten-period measurement.

Sensitivity: 0.1 volt, rms, for sine waves; 0.3 volt, peak-to-peak, for typical pulse waveforms.

Counting Interval: 1 period, 10 periods, extendible by MULTIPLE INTERVAL switch or external connections.†

Counted Frequency: 10 Mc, 100 kc, 1 kc, 10 cps or external (6 volts, rms, sine waves or -10-volt peak pulses, 100 cps to 10 Mc).

Accuracy: $\pm 0.1\%$ at 1 volt, rms, for single-period measurement; better for higher voltage level and good signal-to-noise ratio. $\pm 0.01\%$ at 1 volt, rms, for 10-period measurements; better for higher voltage level and good signal-to-noise ratio.

TIME-INTERVAL MEASUREMENT

Range: 1 microsecond to 10^7 seconds.

Sensitivity: 0.3 volt, peak-to-peak.

Counted Frequency: 10 Mc, 100 kc, 1 kc, 10 cps, or external (6 volts, rms, sine waves, or -10-volt peak pulses, 100 cps to 10 Mc).

Accuracy: Dependent on slope of input signals at trigger point. For steep slopes (e.g., pulses) — ± 1 period of frequency counted \pm accuracy of frequency counted.

† Instruments for automatic multiple-interval measurements are available on special order. Write for further information.



COUNT MEASUREMENT

Rate: DC to 10 Mc.
Sensitivity: 0.25 volt, rms, for sine waves, more sensitive at low frequencies; 0.4 volt, peak-to-peak, for typical pulse waveforms. Typically 100 millivolts up to 3 Mc.
Capacity: 10⁸ counts.

GENERAL

Display: Neon-lamp columns — eight digits intermittent, four digits continuous.
Display Time: Adjustable, 0.1 to 10 seconds, infinite, or continuous display.
Input Impedance: 1 megohm shunted by 40 pf.
Input Attenuator: ×1 or ×10.
Check: 10 cps, 1 kc, 100 kc, or 10 Mc can be counted for 1 millisecond to 10 seconds.
Monitor: Flashing lamp indicates lack of time-base drive signal or improper operation of frequency dividers.
Input Trigger Level: Adjustable ±10 volts.
Input Trigger Slope: Positive-going or negative-going, ac or dc coupling.
External Outputs, Front Panel: GATE signal (coincides with the counting interval); SYNC pulses (at start of internal program cycle); 10 cps to 10 Mc (except 1 Mc) standard frequencies from EXT connector, depending on settings of MEASUREMENT, FREQUENCY, and TIME controls.

External Outputs, at Rear: MULTIPLE-INTERVAL and RESET connections, carry output pulse; eight four-line, binary-coded-decimal digits (1-2-4-2) ("0" = 185 volts, "1" = 65 volts — 0.5-megohm source impedance — minimum load impedance 1.8 megohms).

Time-Base Drive Required: 5 Mc, 1 volt, rms, into 50 ohms (supplied by TYPES 1130-P2, -P3, -P4, and 1113-A).

Power Requirements: 105 to 125 (or 210 to 250) volts, 50 to 60 cps, 400 watts.

Ambient Temperature Range: 0 to 50 C.

Accessories Supplied: TYPE CAP-22 Power Cord, spare fuses, four TYPE 874-C62A Cable Connectors, TYPE 1130-47 Plug.

Accessories Available: Additional time-base units; TYPE 1137-A Data Printer (page 100); TYPE 1133-A Frequency Converter (page 98); TYPE 1134-A Digital-to-Analog Converter (page 99); TYPE 1130-P5 Servicing Accessory for operating any one of the etched-board assemblies outside the cabinet.

Cabinet: Rack-bench (see page 210).

Dimensions: Bench model — width 19, height 16¼, depth 19½ inches (485 by 415 by 495 mm), over-all; rack model — panel 19 by 15¼ inches (485 by 400 mm); depth behind panel 17 inches (435 mm).

Net Weight: 85 pounds (39 kg).

Shipping Weight: 155 pounds (71 kg).

Type		Mounting	Time Base Included	Code Number	Price
1130-AM1	Digital Time and Frequency Meter	Bench	1130-P1	1130-9401	\$2585.00
1130-AR1	Digital Time and Frequency Meter	Rack	1130-P1	1130-9405	2585.00
1130-AM2	Digital Time and Frequency Meter	Bench	1130-P2	1130-9402	2750.00
1130-AR2	Digital Time and Frequency Meter	Rack	1130-P2	1130-9406	2750.00
1130-AM3	Digital Time and Frequency Meter	Bench	1130-P3	1130-9403	2670.00
1130-AR3	Digital Time and Frequency Meter	Rack	1130-P3	1130-9407	2670.00
1130-AM4	Digital Time and Frequency Meter	Bench	1130-P4	1130-9404	2950.00
1130-AR4	Digital Time and Frequency Meter	Rack	1130-P4	1130-9408	2950.00

PATENT NOTICE. See notes 4, 8, 11, 13, and 17, page viii.

TYPE 1130-P TIME-BASE PLUG-IN UNITS

Four time-base units are available for use with the TYPE 1130-A Digital Time and Frequency Meter. Each of the combinations listed above includes one such unit. In addition, these plug-in units are available separately for those who wish to use more than one type of time base. All can be used with 5-Mc external drive.

TYPE 1130-P4 PRECISION TIME-BASE OSCILLATOR

This unit contains an accurate and stable crystal oscillator, but can also be used to couple to an external 5-Mc standard-frequency oscillator.

External Drive Requirements: 5 Mc, 1 volt, rms, into 50 ohms.

Internal Oscillator: A vacuum-sealed, 5-Mc crystal and solid-state circuit in a constant-temperature, proportional-control oven. Operates directly from the power-line connection of the TYPE 1130-A Digital Time and Frequency Meter.

Long-Term Drift: Less than 3×10^{-8} per week after 60 days of operation. After one year of operation, typically less than 1×10^{-8} per week. Fluctuations over any 24-hour period are less than 5×10^{-9} .

Short-Term Stability: Less than 1×10^{-9} per minute (one-second sampling time).

Temperature Coefficient: Less than 3×10^{-10} per degree C from 0 to 50 C.

Line-Voltage Effects: Less than 2×10^{-9} for ±10% voltage change.
Power Requirement: 7 watts.

TYPE 1130-P2 TIME-BASE OSCILLATOR/MULTIPLIER

This unit can be used with external frequency input of 5 Mc, 1 Mc, or 100 kc, or with internal crystal oscillator.

External-Drive Requirements:

5 Mc — 1 volt, rms, into 50 ohms.

1 Mc — 2 volts, rms, into 1 kilohm.

100 kc — 1 volt, rms, into 100 kilohms.

Internal Oscillator: 5-Mc crystal operating at room temperature.

Stability — Long-term drift, less than 10×10^{-6} in six months; short-term drift, less than 2×10^{-7} per week, less than 1×10^{-8} per minute.

Temperature Coefficient — less than 2×10^{-7} per degree C.

TYPE 1130-P3 TIME-BASE OSCILLATOR

For use with external 5-Mc standard-frequency input or with internal crystal oscillator.

External-Drive Requirements: 5 Mc, 1 volt, rms, into 50 ohms.

Internal Oscillator: Same as in TYPE 1130-P2.

TYPE 1130-P1 COUPLING UNIT

For use with external 5-Mc oscillator only. Input requirements are 1 volt, rms, into 50 ohms. This unit provides an inexpensive means of using a highly stable oscillator, such as the TYPE 1113-A (page 88), as a time base for the counter.

Type		Code Number	Price
1130-P4	Precision Time-Base Oscillator	1130-9604	\$400.00
1130-P3	Time-Base Oscillator	1130-9603	120.00
1130-P2	Time-Base Oscillator/ Multiplier	1130-9602	200.00
1130-P1	Coupling Unit	1130-9601	35.00
1130-P5	Servicing Accessory*	1130-9605	30.00

* Permits operation of any one of the eleven decade counter boards clear of the instrument for operational trouble shooting.

PATENT NOTICE. See Note 4, page viii.

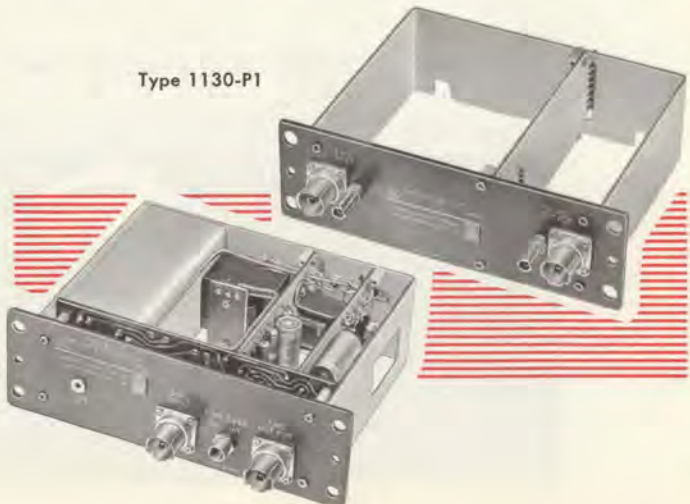

Type 1130-P4



Type 1133-A FREQUENCY CONVERTER

FEATURES:

- ♦ Wide frequency range — 100 kc to 500 Mc.
- ♦ High sensitivity. ♦ Tuned amplifier provides selectivity.
- ♦ Easy to use; in-line digital readout.

USES: This converter extends the frequency range of the TYPE 1130-A Digital Time and Frequency Meter up to 500 Mc, and also increases the counter sensitivity to about 10 millivolts in the range below 10 Mc. The converter can be used with any other 10-Mc counter, if a 5-Mc source is available as a reference frequency.

DESCRIPTION: In normal operation, the converter heterodynes the unknown input frequency between 10 and 500 Mc against a 10-Mc multiple of a standard frequency,

derived from the 5-Mc time base of the counter, and applies the difference frequency to the counter. The unknown frequency is indicated by the sum of the counter display and the in-line readout on the converter.

Use of linear mixing circuits in the converter results in high signal-to-noise ratio under a wide range of measurement conditions. The tuned amplifier in the converter can be switched in for measurement of low-level or noisy signals, or out for simplified wide-band operation.

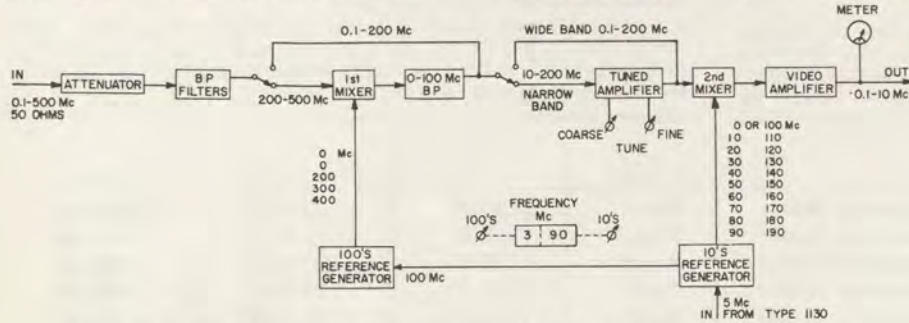

Block diagram. A single-conversion system is used below 200 Mc, a double-conversion system from 200 to 500 Mc.

Typical over-all sensitivity of converter and counter for 10.1-Mc counter indication. This is worst case. Sensitivity is better for lower converter output frequencies.

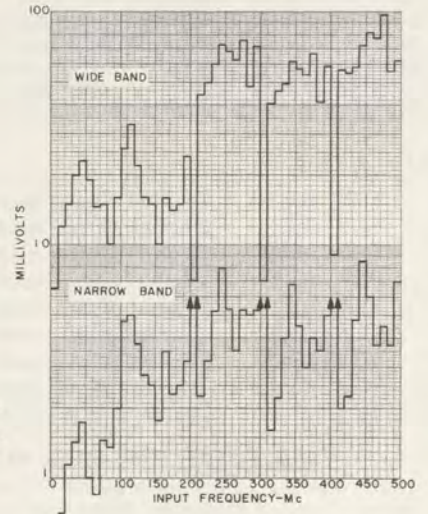

SPECIFICATIONS

INPUT

Frequency Range: 100 kc to 500 Mc.
Sensitivity (with TYPE 1130-A counter): Better than 10 millivolts on narrow band; better than 100 millivolts on wide band. See plot above.
Impedance: 50 ohms.
Reference Frequency Required: 5 Mc, 0.1 volt, rms, into 50 ohms (normally supplied from 5-Mc output connector on TYPE 1130-A).

OUTPUT

Frequency: 100 kc to 10.1 Mc.
Amplitude: 0.25 to 1 volt, approximately.
Impedance: 100 ohms, approximately.
Noise and Harmonics: Narrow-band operation provides filtering to reduce noise and extraneous signals. Linear mixer preserves signal-to-noise ratio during conversion.

GENERAL

Power Requirements: 105 to 125 (or 210 to 250) volts, 50 to 60 cps, 70 watts.
Accessories Supplied: Two coaxial patch cords (TYPES 874-4220 and 874-9912) for connection to counter; one TYPE 874-C58A Cable Connector; one TYPE CAP-22 Power Cord; spare fuses.
Cabinet: Rack-bench (see page 210).
Dimensions: Bench model — width 19, height 7½, depth 17¾ inches (485 by 190 by 450 mm), over-all; rack model — panel 19 by 7 inches (485 by 180 mm); depth behind panel 15 inches (380 mm).
Net Weight: 34 pounds (15.5 kg).
Shipping Weight: 50 pounds (23 kg).

Type		Code Number	Price
1133-AM	Frequency Converter, Bench Model	1133-9801	\$1250.00
1133-AR	Frequency Converter, Rack Model	1133-9811	1250.00

PATENT NOTICE. See Note 4, page viii.

FOR USE WITH TYPE 1130-A DIGITAL TIME AND FREQUENCY METER





Type 1136-A DIGITAL-TO-ANALOG CONVERTER

WITH HIGH-SPEED STORAGE SYSTEM

The TYPE 1136-A Digital-to-Analog Converter translates the digital output from a solid-state counter into a dc voltage or current for analog recording. When the converter is used with the TYPE 1150-AP Digital Frequency Meter or the TYPE 1151-AP Digital Time and Frequency Meter, the TYPE 1136-P1 Cable must also be used. This cable translates the 10-line information from the counter into a 4-line BCD input.

The converter is designed for 1-2-4-2 or 1-2-2-4 BCD input, but is easily modified for 1-2-4-8 coding.

Storage circuits in the converter permit use with intermittent as well as continuous BCD inputs.

The converter selects any three consecutive, or the last two, columns from an input of up to nine columns. A "command pulse" from the data source transfers the input data into the storage circuits of the converter. "Jam" transfer into storage is used so that the analog output changes only when the input data changes (no zero-set between transfers). The high-precision output is obtained from pairs of inverted transistors.

SPECIFICATIONS

Data Input: BCD weighted 1-2-4-2 or 1-2-2-4. Minor modification adapts for 1-2-4-8 input. Binary 1 at least 6 volts positive with respect to binary 0. Input impedance 50 kilohms. Binary 0 can be offset from ground by ± 150 volts. Switch selects any adjacent three or the last two digits of up to nine-decade input.

Conversion Rate: Up to 10,000 conversions per second (controlled by digital-measuring instrument).

Over-all Accuracy: $\pm 0.1\%$ of full scale (includes repeatability, long-term stability, linearity, $\pm 10\%$ line variation, and ± 15 C ambient-temperature variations around normal 25 C).

Storage Transfer: 50- μ sec transfer time.

Storage Command Pulse: 5 μ sec, ± 6 volts minimum into 10 kilohms, rise and fall times less than 1 μ sec.

Output: 1 milliamperere with 15-kilohm source impedance, or 100 millivolts with 100-ohm source impedance. Negative side grounded if binary 0 or input not more than 20 volts from ground. Output floating if offset voltage larger than 20 volts.

Load: 2000 ohms maximum for 1 milliamperere output. 1000 ohms minimum for 100 millivolts output.

Linearity: $\pm 0.05\%$ of full scale.

Stability: $\pm 0.02\%$ for $\pm 10\%$ line voltage; $\pm 0.003\%$ of full scale per degree C.

Accessories Supplied: TYPE CAP-22 Power Cord, spare fuses.

Accessory Available: TYPE 1136-P1 Cable with diode-matrix, required for use with 10-line decimal data from General Radio counters of the 1150 series.

Power Requirements: 105 to 125 (or 210 to 250) volts, 50 to 400 cps, 7 watts.

Cabinet: Rack-bench (see page 210).

Dimensions: Bench model — width 19, height $3\frac{1}{2}$, depth 12 inches (485 by 89 by 305 mm), over-all; rack model — panel 19 by $3\frac{1}{2}$ inches (485 by 89 mm), depth behind panel 11 inches (280 mm).

Net Weight: 13 pounds (6 kg). **Shipping Weight:** 17 pounds (8 kg).

Type		Code Number	Price
1136-AM	Digital-to-Analog Converter, Bench Model	1136-9801	\$650.00
1136-AR	Digital-to-Analog Converter, Rack Model	1136-9811	650.00
1136-P1	Cable (for connection to Type 1150-AP or 1151-AP)	1136-9601	160.00



Type 1134-A DIGITAL-TO-ANALOG CONVERTER

The TYPE 1134-A Digital-to-Analog Converter converts digital information from the TYPE 1130-A Digital Time and Frequency Meter into an accurate analog signal for graphic recording. The converter is designed to operate from either 1-2-4-2 or 1-2-2-4 BCD codes, and will operate with any digital equipment using these codes and supplying the required voltage levels. The converter is fully electronic, using transistors to switch in weighting resistors that translate the binary input into an output voltage or current. Thus the response speed is not limited by moving parts. The rise and fall times of the analog output are less than 1 millisecond. Either galvanometer- or potentiometer-type recorders can be used.

Full-scale output can be adjusted to compensate for recorder impedance. Critical components are housed in a constant-temperature oven for $\pm 0.1\%$ over-all stability and accuracy.

SPECIFICATIONS

Data Input: BCD, weighted 1-2-4-2 or 1-2-2-4. Binary 1, 90 volts maximum; binary 0, 150 volts minimum. Source impedance, 500 kil-

ohms. Input impedance, 1 megohm. Digit selector switch selects any adjacent three, or the last two, digits of a four-digit input.

Output: 1 milliamperere with 30-kilohm source impedance or 100 millivolts with 100-ohm source impedance. Positive side grounded.

Load Impedance: 2000 ohms maximum for 1 milliamperere; 2000 ohms minimum for 100 millivolts.

Linearity: $\pm 0.05\%$ of full scale.

Stability: $\pm 0.02\%$ for $\pm 15\%$ line. $\pm 0.03\%$ for ambient temperatures from 0 to 50 C. Warmup drift is less than 0.5% of full scale. Thermal equilibrium is achieved in 30 minutes.

Accessories Supplied: TYPE CAP-22 Power Cord, spare fuses, TYPE 1134-0211 Cable for connection to TYPE 1130-A.

Power Requirement: 100 to 130 (or 200 to 260) volts, 50 to 400 cps, 30 watts.

Cabinet: Rack-bench (see page 210).

Dimensions: Bench model — width 19, height $3\frac{1}{2}$, depth $13\frac{1}{2}$ inches (485 by 89 by 345 mm), over-all; rack model — panel 19 by $3\frac{1}{2}$ inches (485 by 89 mm), depth behind panel $12\frac{1}{2}$ inches (320 mm).

Net Weight: $16\frac{1}{4}$ pounds (7.5 kg).

Shipping Weight: 20 pounds (9.5 kg).

Type		Code Number	Price
1134-AM	Digital-to-Analog Converter, Bench Model	1134-9801	\$595.00
1134-AR	Digital-to-Analog Converter, Rack Model	1134-9811	595.00

Type 1134-A for use with Type 1130-A Digital Time and Frequency Meter.



Type 1136-A (for use with Types 1150-AP and 1151-AP counters).





Type 1137-A DATA PRINTER

FOR USE WITH ALL GENERAL RADIO COUNTERS

The TYPE 1137-A Data Printer is manufactured for General Radio Company by Beckman Instruments, Richmond, California, especially for use with General Radio digital equipment. The printer provides a precise, compact, and economical means of converting decimal-coded information into permanent, printed form.

The printer is equipped with plug-in code modules, which accept 10-line data or four-line 1-2-2-4, 1-2-4-8, or 1-2-4-2 BCD inputs. A two-color ribbon can be electrically or manually controlled to print red or black on standard 2¼-inch paper.

By fast, parallel entry of four-line BCD or 10-line inputs, the printer can operate at a rate of three prints per second, with up to 12 digits per print. The printing mechanism is a reliable Burroughs 10-key tabulator with Beckman stop-pawls and electromagnets. The use of solid-state circuits and the absence of power-consuming keyboard actuators keep power requirements to a minimum.

Since the capacity of the printer is 12 columns, additional plug-in modules are available for printing other data.

A cable is supplied with the printer for direct connection to the companion instrument.

SPECIFICATIONS

Capacity: 12 columns.

Digits: 0 through 9 or blank (column suppression).

Printing Rate: 3 lines per second maximum.

Accuracy: Identical to input.

Input:

Logic Levels — Source Resistance	Binary 0	Binary 1
100 kilohms	-8 to -50 v	0 to +50 v
2 megohms	-12 to -50 v	0 to +50 v

Code — 10-line code (one wire is binary 1, eight wires binary 0) or four-line BCD (1-2-2-4, 1-2-4-8, or 1-2-4-2) input.

Resistance — Approximately 10 megohms for minus input, 200 kilohms for plus input.

Internal Ground: Isolated from chassis. May be biased to ±100 volts.

Color-Control:

Manual — Two-position lever selects red or black print-out.

Remote — Red, binary 1 or open circuit; black, binary 0. Input resistance approximately 2 megohms.

Column Suppression: Single line grounded for each column suppressed (3 milliamperes maximum, +10 volts open circuit).

Print Command: Change from binary 1 to binary 0. Binary 0, 100 milliseconds minimum after print command; binary 1, 15 milliseconds

minimum before next print command. Source resistance 1 megohm maximum.

Inhibit Reset Output: Occurs within 50 milliseconds after print command; 200 milliseconds maximum duration.

Printing Ribbon: 7/16-inch two-color adding-machine ribbon.

Paper: Standard 2¼-inch roll tape.

Power Requirements: TYPES 1137-9731, 1137-9732, 1137-9735, and 1137-9736 — 115 volts, 60 cps, 45 watts. TYPES 1137-9733, 1137-9734, 1137-9737, and 1137-9738 — 230 volts, 50 cps, 45 watts.

Accessories Supplied: Cable assembly for connection to counter, spare fuses.

Accessory Available: TYPES 1137-9604 and 1137-9605 Plug-In Code Modules.

Cabinet: Rack and portable models available.

Dimensions: Rack model — width 19, height 8¾, depth 15¼ inches (485 by 225 by 390 mm), over-all; portable model — width 9, height 10, depth 16½ inches (230 by 255 by 420 mm), over-all.

Net Weight: Rack model, 45 pounds (20.5 kg); portable model, 35 pounds (16.0 kg).

Shipping Weight: Rack model, 55 pounds (25.0 kg); portable model, 45 pounds (20.5 kg).

	Type		Code Number	Price†
For use with Type 1130-A Counter*	1137-9731	Data Printer, Portable Model (115 v, 60 cps)	1137-9731	\$1675.00
	1137-9732	Data Printer, Rack Model (115 v, 60 cps)	1137-9732	1725.00
	1137-9733	Data Printer, Portable Model (230 v, 50-60 cps)	1137-9733	1700.00
	1137-9734	Data Printer, Rack Model (230 v, 50-60 cps)	1137-9734	1750.00
For use with Types 1150-AP and 1151-AP Counters	1137-9735	Data Printer, Portable Model (115 v, 60 cps)	1137-9735	1350.00
	1137-9736	Data Printer, Rack Model (115 v, 60 cps)	1137-9736	1400.00
	1137-9737	Data Printer, Portable Model (230 v, 50-60 cps)	1137-9737	1375.00
	1137-9738	Data Printer, Rack Model (230 v, 50-60 cps)	1137-9738	1425.00
	1137-9604	Plug-In Four-Line Code Module	1137-9604	55.00
	1137-9605	Plug-In 10-Line Code Module	1137-9605	75.00

* TYPE 1130-A counters shipped before February 1963 require minor modification. A modification kit is included with these printers.
† Prices applicable for sales in U. S. A. and Canada only.

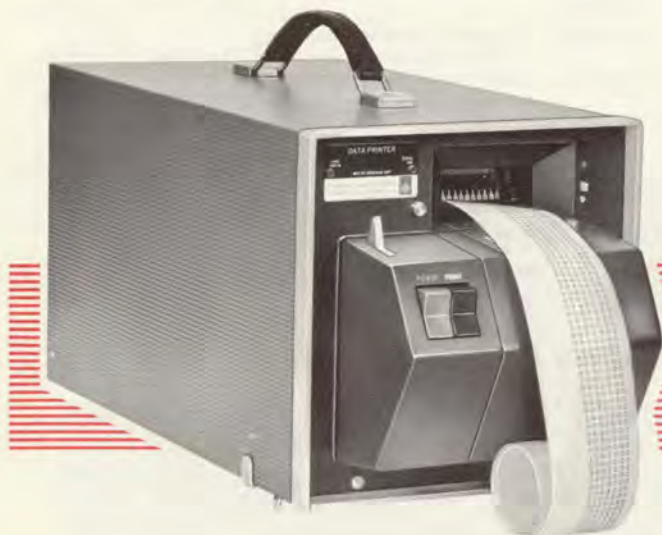

Type 1137-A Data Printer, Rack Mounted



Type 1142-A FREQUENCY METER AND DISCRIMINATOR

- FEATURES:** ♦ Wide frequency range. ♦ High sensitivity.
♦ High accuracy. ♦ Recorder output.

USES: This analog-type frequency meter measures frequencies from 3 cps to 1.5 Mc with an over-all accuracy of $\pm 0.2\%$, and can be used with a recorder to produce time records of frequency change or drift. Its highly linear discriminator, when used with an external voltmeter, can measure fm deviation. With a wave analyzer, this frequency meter can measure individual components of incidental fm.

The usable frequency range, particularly for frequency drift and incidental fm measurements, can be extended upwards to thousands of megacycles per second if the unknown frequency is heterodyned against a stable frequency. This gives a proportionate increase in resolution. At 100 Mc, frequency drift and incidental fm can be measured to at least one part in 10^9 .

DESCRIPTION: This instrument operates as a pulse-count discriminator. The input signal is clipped and amplified.

SPECIFICATIONS

Frequency Range: 3 cps to 1.5 Mc in five decade ranges. Full-scale values are 150 cps, 1.5 kc, 15 kc, 150 kc, and 1.5 Mc. A calibrated interpolation feature effectively expands the meter scale by a factor of 10, so that 1/10 of any range covers the full scale.

Accuracy of Recorder Output Current: Below 15 kc, 0.05% of full scale $\pm 0.05\%$ of reading; above 15 kc, 0.1% of full scale $\pm 0.1\%$ of reading.

Over-all Accuracy:

Over-all accuracy is the sum of recorder output current error (see above) and any of the following errors that are applicable.

Meter Accuracy — Direct reading, 1% of reading above 10% of full scale (0.1% of full scale below 10% of full scale). Interpolating, 0.1% of full scale (range switch setting).

Line-Voltage Effect — $\pm 10\%$ change produces approximately $\pm 0.2\%$ change in reading ($\pm 0.5\%$ on 1.5-Mc range).

Warmup Drift — Less than 0.2% of reading after a few minutes, substantially complete within 30 minutes.

Ambient-Temperature Effect — Output current changes less than 0.01%/°C (0.02%/°C on 1.5-Mc range).

Calibration: Internal calibration at twice line frequency to standardize output current.

Input Sensitivity: 20 millivolts, rms, between 20 cps and 150 kc, rising to 200 millivolts at 3 cps and 1.5 Mc. Peak-to-peak voltage requirements for pulse and sine-wave inputs are approximately equal, except for very short pulses. Input pulses on the order of 1 nanosecond may require up to 5 volts.

Maximum Input Voltage: 300 volts peak up to 150 kc; 70 volts peak above 150 kc.

Input Impedance: 100 kilohms, dropping to a minimum of 5000 ohms above 500 kc.

The resulting rectangular waveform triggers a Schmitt circuit, which, in turn, triggers a monostable multivibrator to produce a pulse of constant amplitude and duration for each input cycle.

The average dc component for this pulse train actuates the meter. For a constant-frequency input, these pulses are equally spaced in time. When frequency modulation is present, the time spacing varies, and the resulting additional ac component is a faithful reproduction of the modulating frequency; its amplitude is a measure of the modulation deviation.

The precision six-inch meter is accurate to 1% of indication down to 10% of full scale. A calibrated interpolation technique effectively expands the meter scale by a factor of 10, providing a readout accuracy of 0.1%.

Output is available for driving conventional 1- to 5-milliamperere recorders. An interpolation output is provided for higher resolution.

Discriminator Characteristics:

Output Voltage — 15 volts dc full scale (1.5) on all ranges.

Residual FM Noise — At input frequencies below 1 Mc, noise is more than 100 db below full output. (With 400-cycle power, noise is 90 db down.) Narrow-band residual noise at frequencies other than 60 or 120 cps is more than 120 db down from full output.

Linearity — Below 15 kc, 0.05% of full scale (15 volts) $\pm 0.05\%$ of output voltage; above 15 kc, 0.1% of full scale (15 volts) $\pm 0.1\%$ of output voltage.

Recorder Output:

Direct — Output current adjustable to drive recorders from 1 milliamperere (2700 ohms maximum) to 5 milliampereres (190 ohms maximum).

Interpolate — Full scale, 0.64 volt behind 4800 ohms.

Power Requirements: 105 to 125 (or 210 to 250) volts, 50 to 60 and 400 cps, 85 watts.

Accessories Supplied: TYPE CAP-22 Power Cord, spare fuses.

Cabinet: Convertible bench (see page 210).

Dimensions: Width 12, height 5 $\frac{7}{8}$, depth 12 inches (305 by 150 by 305 mm), over-all. Panel adaptor sets are available for 19-inch relay-rack mounting (panel height 5 $\frac{1}{4}$ inches).

Net Weight: 16 pounds (7.5 kg).

Shipping Weight: 22 pounds (10 kg).

Type		Code Number	Price
1142-A	Frequency Meter and Discriminator	1142-9701	\$525.00
480-P312	Relay-Rack Adaptor Set	0480-9632	6.50

PATENT NOTICE: See Notes 15 and 16, page viii.



GENERATORS—SIGNAL SOURCES



A signal source is essential in any electrical measuring system since it provides the stimulus that, in turn, creates the response to be measured. This source is generally an oscillator or standard-signal generator of known characteristics, which can be adjusted to establish a known set of conditions. These characteristics comprise the output voltage and impedance, the carrier-signal waveform, which may typically be sine-wave, square-wave, pulse or random noise, and the modulation, which carries the system information through variation of phase, frequency, amplitude, or timing of the carrier waveform.

Signal sources can be classified functionally as to whether they yield information that is readily usable in frequency-domain or time-domain analysis. Sine-wave techniques form the basis of power-generation and transmission systems and most communication systems, leading to ready frequency-domain analysis. Many of the newer developments in information transmission and data handling, however, such as radar systems, digital computers, telemetry, and even the more venerable wire telegraphy, are based upon pulse techniques, which yield most easily to time-domain analysis.

Common to all these systems are ultimate performance limitations determined by system bandwidths and noise. Bandwidth and transient performance are the two sides of a coin; they convert one into the other, and can be measured as phenomena in either the frequency or the time domain, at the convenience of the analyst. Noise is most easily measured by comparison with a noise source having known characteristics.

OSCILLATORS

The sine-wave oscillator is the basic general-purpose signal source. Its output voltage is closely sinusoidal, and its frequency is usually adjustable over a wide range. It is therefore eminently suited to making a series of measurements at uniquely specified frequencies, which can be combined to specify performance in the frequency domain. These measurements may be made by manual settings, point by point, or by a frequency swept automatically over the desired range to display the system response on a recorder or cathode-ray oscilloscope. As the increasing sophistication of communications and data-processing systems demands more and more measurements of this nature, the value of automatic measuring systems in lightening routine work loads becomes more and more evident.

The sine-wave oscillators whose characteristics are summarized on the page opposite are of four types: LC, RC, beat-frequency and klystron.

The LC oscillator, oldest of the four types, because of its stability, good waveform, and efficiency, finds many uses at both audio and radio frequencies.

At radio frequencies where tuning can be accomplished by air capacitors, the LC circuit is the best and most economical frequency-determining system. The TYPE 1330-A Bridge Oscillator uses tuned circuits to cover a frequency range of 10,000:1. The TYPES 1211, 1208, 1215, and 1209 Unit Oscillators, together with the TYPE 1361-A UHF Oscillator, cover a wide range of frequencies from the standard radio broadcast band up through the uhf television band. All of these employ unique tuned circuits, in which the inductance and capacitance are varied simultaneously. Many of them use the General-Radio-developed butterfly circuit,¹ which has no sliding or wiping contacts.

At frequencies above about 1000 Mc, circuits with distributed constants are used. The TYPE 1218-A Unit Oscillator covers a frequency range from 900 to 2000 Mc with ganged quarter-wave lines. In RC oscillators the frequency is determined by resistive and capacitive elements.²

The RC degenerative type, of which the TYPE 1311-A is one

example, is an original, patented, General Radio development. It uses a Wien-bridge network as its tuning element, as does the TYPE 1210-C, a small, versatile instrument, which produces either sine-wave or square-wave output over a wide frequency range. The TYPE 1305-A, a phase-shift oscillator, generates frequencies as low as 0.01 cps, with single-phase, three-phase, and four-phase output as well as an output continuously variable in phase over 360°.

Early mention of the *beat-frequency oscillator* is made by Van der Bijl.³ In this oscillator, the output frequency is the difference between the frequencies of a variable and a fixed oscillator of higher frequencies. Thus several decades of frequency can be covered in one band with a single control.

The first commercial beat-frequency oscillator was produced by General Radio in the middle 1920's. As the development of tubes and circuits has progressed, increasingly better models have been developed, culminating in the present TYPE 1304-B Beat-Frequency Audio Generator, whose logarithmic scale greatly facilitates frequency-response measurements, and which can be driven by the TYPE 1521-A Graphic Level Recorder for automatic plotting.

A still more versatile instrument is the TYPE 1300-A Beat-Frequency Video Generator, which can test circuits and networks by four methods: point-by-point, square-wave, sweep-frequency, and automatic plotting.

In *klystron oscillators*, first described by the Varians,⁴ the frequency is determined by a velocity-modulated electron stream, which excites a resonant cavity. The TYPE 1360-A Microwave Oscillator uses a reflex klystron in a coaxial cavity with a non-contacting plunger to cover frequencies from 1.7 to 4.1 Gc. Internal square-wave and frequency modulation are provided.

The TYPE 1220-A Unit Klystron Oscillator is a klystron power supply which covers frequencies from 2700 to 7425 Mc with plug-in klystron tubes, each of which operates at a single output frequency or is adjustable over a limited band of frequencies.

MODULATION

The rf oscillators can all be amplitude modulated with sine waves, and the TYPE 1218-A, TYPE 1361-A, and TYPE 1220-A can be directly square-wave and pulse modulated as well.

The Unit Oscillators operating above 50 Mc can be pulse or square-wave modulated by the TYPE 1264-A Modulating Power Supply, and can be held to a constant output amplitude vs frequency with the TYPE 1263 Amplitude-Regulating Power Supply.

SWEEPING FREQUENCY

Specific provision for automatic display is incorporated in many General Radio sources.⁵ Electronic sweeping systems are particularly suited to microwave sources and are incorporated in the TYPE 1220-A Unit Klystron Oscillator (page 118) and the TYPE 1360-A Microwave Oscillator (page 117) to cover frequencies from 2 Gc to 7 Gc. The TYPE 1300-A Beat-Frequency Video Generator is also swept electronically.

To convert to automatic operation the many existing manually operated devices that have given, and are still giving, good service, the TYPE 1750-A Sweep Drive (page 127) provides a

¹ Eduard Karplus, "Wide-Range Tuned Circuits and Oscillators for High Frequencies," *Proceedings of the Institute of Radio Engineers*, July, 1945.

² Eduard Karplus, "The Butterfly Circuit," *General Radio Experimenter*, 19, 5, October, 1944.

³ First described by Nichols in 1921; see U. S. Patent 1,442,781.

⁴ H. J. Van der Bijl, "Thermionic Vacuum Tube," McGraw-Hill Book Co., 1920 (first edition), p. 377.

⁵ Russell H. and Sigurd F. Varian, "A High-Frequency Oscillator and Amplifier," *Journal of Applied Physics*, May, 1939, p. 321.

⁶ See also the TYPE 1025-A Standard Sweep-Frequency Generator, which has the accurately calibrated output and other features of the standard-signal generator.

mechanical hand that will grasp and rotate knobs and dials of assorted sizes and varieties and provide dc voltages that define their angular positions. The TYPE 908-P and 908-R Dial Drives (page 127) perform similar functions for instruments using General Radio TYPE 907 and 908 Dials.

PULSE AND TIME-DELAY GENERATORS

(Pages 134 to 137)

The TYPE 1217-B Unit Pulse Generator, through the use of electron-tube circuits, achieves a level of performance that is not possible with solid-state circuitry. This outstanding performance is combined with low cost, resulting in today's best buy in pulse generators. Its popularity attests its wide application in the development laboratory, on the test bench, and in the educational laboratory.

The TYPE 1391-B Pulse, Sweep and Time-Delay Generator is our most versatile pulse instrument. Also using electron tubes, it has a wide range of pulse durations, with no duty-ratio restrictions, at an equally wide range of prf's. It also includes a wide-range, precision time-delay generator, as well as a generator of

linear sweep voltages. A variety of switching and external connection possibilities make this instrument applicable to almost any conceivable laboratory application where pulses and time delays are required.

Its precise time-delay circuits are also available separately in the TYPE 1392-A Time-Delay Generator.

SIGNAL GENERATORS

Standard-signal and sweeping-signal generators are discussed on page 119.

RANDOM-NOISE GENERATOR

(Page 133)

The concepts of stochastic processes, probabilistic vs deterministic performance, and quantized information that characterize modern information theory have led to widespread use of sources with substantially gaussian energy distributions.

The TYPE 1390-B Random-Noise Generator, described on page 133, is a well-designed noise source covering frequencies between 20 cps and 5 Mc.

OSCILLATORS

	Type	Name	Class	Frequency Range	Maximum Output	Open-Circuit Volts	Nominal Load Impedance	Harmonic Distortion	Power Supply	See Page
Audio and Sub-Audio Frequency	1305-A	Low-Frequency Oscillator	RC	0.01 to 1000 cps	170 mw per phase	10	600 ohms	<2%	AC Line	104
	1214-D	Unit Oscillator	Tuned Circuit	120 cps	400 mw	45	1, 10, 100, 1000 ohms	<3%	AC Line	110
	1307-A	Transistor Oscillator	Tuned Circuit	400 and 1000 cps	6 mw	2	600 ohms	<5%	Mercury Cells	8
	1214-A	Unit Oscillator	Tuned Circuit	400 and 1000 cps	200 mw	60	8000 ohms	<3%	AC Line	110
	1304-B	Beat-Frequency Audio Generator	Beat-Frequency	20-20,000 cps 20,000-40,000 cps	1 w	50	600 ohms	<1%	AC Line	106
	1210-C	Unit R-C Oscillator	RC	20 cps-0.5 Mc	80 mw 40 mw	7 45 30	>500 ohms >10,000 ohms >1000 ohms	<1.5% <5% Square Wave	Unit Power Supply	105
	1311-A	Audio Oscillator	RC	11 fixed frequencies 50-10,000 cps	1 w	1, 3, 10, 30, 100	0.1 ohm to 10 kilohms	<0.5%	AC Line	109
	1308-A	Audio Oscillator and Power Amplifier	RC	20 cps-10 kc	200 w	4, 12.5, 40, 125, 400	8, 80, 800 ohms	1% to 2%	AC Line	108
	1107-A	Interpolation Oscillator	Beat-Frequency	0-5000 cps		14	600 ohms		AC Line	110
1300-A	Beat-Frequency Video Generator	Beat-Frequency (also Sweep)	20 cps-20 kc 20 kc-12 Mc 20 cps-20 kc 20 kc-12 Mc	30, 3 mw 30, 3 mw	10, 1 10, 1 10 10	820, 75 ohms 820, 75 ohms 75 ohms 75 ohms	<1% <4% Square-Wave Square-Wave	AC Line	130	
Medium and High Frequency	1214-M	Unit Oscillator	Tuned Circuit	1 Mc	300 mw	7	50 ohms	<3.5%	AC Line	110
	1330-A	Bridge Oscillator	Tuned Circuit	60, 400, 1000 cps 5 kc-50 Mc	0.75 w 1 w	12 10	50 ohms 20-80 ohms	<5%	AC Line	111
	1211-C	Unit Oscillator	Tuned Circuit	0.5-5 Mc 5-50 Mc	1 w 200 mw		50 ohms		Unit Power Supply	114
	1215-C	Unit Oscillator	Semi-Butterfly	50-250 Mc	80 mw		50 ohms		Unit Power Supply	114
VHF and UHF	1208-C	Unit Oscillator	Sliding-Contact Tuned Circuit	65-500 Mc	100 mw		50 ohms		Unit Power Supply	114
	1209-CL	Unit Oscillator	Butterfly Tuned Circuit	180-600 Mc	300 mw		50 ohms		Unit Power Supply	114
	1209-C	Unit Oscillator	Butterfly Tuned Circuit	250-920 Mc	200 mw		50 ohms		Unit Power Supply	114
	1361-A	UHF Oscillator	Butterfly Tuned Circuit	450-1050 Mc	150 mw		50 ohms		Unit Power Supply	114
	1218-A	Unit Oscillator	Coaxial-Line Tuned Circuit	900-2000 Mc	140 mw		50 ohms		Unit Power Supply	114
SHF	1220-A	Unit Klystron Oscillator	Velocity-Modulated	2700-3275 Mc 3400-4910 Mc 5100-5900 Mc 5925-7425 Mc	75-100 mw		50 ohms		Unit Power Supply	118
	1360-A	Microwave Oscillator	Velocity-Modulated	1.7-4.1 Gc	100 mw		50 ohms		AC Line	117

Type 1305-A LOW-FREQUENCY OSCILLATOR

- FEATURES:**
- ♦ Low-frequency output, 0.01 to 1000 cps.
 - ♦ Logarithmic frequency scale.
 - ♦ Known output levels over 80-db range.
 - ♦ Excellent amplitude stability.
 - ♦ Low distortion.
 - ♦ Low ripple in direct-reading output voltmeter.

USES: This generator of subaudible and low audio frequencies has many uses in the development and testing of servomechanisms, low-frequency amplifiers, recorders, geophysical equipment, medical instruments, and electrical analogs of mechanical systems. With suitable amplifiers it can serve as a variable-frequency drive for low-power, two-phase or three-phase machines.

In addition to its three-phase output (0°, 120°, 240°), any phase of which can be used singly, an adaptor produces four-phase output at 0°, 90°, 180°, 270°, independent of frequency, providing quadrature signals for such applications as component resolution and circular oscilloscope sweeps.

Another output, continuously variable in phase from 0° to 360°, is useful for phase measurements with Lissajous-pattern techniques, gain and phase-shift measurements of

four-terminal devices, and transfer characteristics of amplifiers and servomechanisms.

DESCRIPTION: Three independent, RC phase-shift networks, connected as low-pass filters, are used in a direct-coupled, phase-shift oscillator circuit. Miller-effect amplifiers increase the effective size of the polystyrene capacitors for operation at the lowest frequencies. The amplitude regulator provides an extremely high degree of amplitude stability, independent of frequency. Cathode-follower circuits provide low-distortion, low-impedance outputs. The output meter and attenuator indicate output voltage directly over an 80-db range.

The phase-shifter resistive network produces an output signal that is constant in amplitude and continuously variable in phase, independent of frequency.

SPECIFICATIONS

FREQUENCY

Range: 0.01 to 1000 cps in five decade ranges.

Accuracy: ±2%.

Stability: Warmup drift is less than 1% in the first ten minutes, less than 0.2% in the next hour.

THREE-PHASE OUTPUT

Maximum Amplitude: At least 10 volts, rms, open circuit, line to neutral, behind 600 ohms in each phase, constant with frequency to ±5%. Phase voltages are equal to each other within ±2%.

Impedance: 75 ohms per phase at DIRECT position of OUTPUT ATTENUATOR switch.

Phase Accuracy: Phase difference between adjacent phases is 120° ± 2°.

Maximum Power: 167 milliwatts per phase into 600-ohm wye.

Harmonic Distortion: Less than 2% for all loads at all frequencies, except at DIRECT output, where it is less than 2% for loads of more than 600 ohms per phase (wye) or 1800 ohms (delta).

Output Meter: Six-phase rectifier minimizes ripple; fluctuations in indication are between +5% and -10% of true rms at lowest output frequencies.

FOUR-PHASE OUTPUT (from plug-in adaptor)

Maximum Amplitude: At least 5 volts, rms, line to neutral.

Impedance: 600 ohms. **Phase Accuracy:** ±3°.

VARIABLE-PHASE OUTPUT

Range: 360°. **Phase Accuracy:** ±3°.

Maximum Amplitude: Approximately 0.8 volt, rms, constant to ±5% with phase setting.

Impedance: Variable; 15,000 ohms maximum. **Distortion:** Less than 5%.

GENERAL

AC Hum: More than 60 db down from output signal when OUTPUT AMPLITUDE control is at maximum.

Power Requirements: 105 to 125 (or 210 to 250) volts, 50 to 60 cps. Total power consumption is 165 watts.

Accessories Supplied: TYPE 1305-P1 Four-Phase Output Adaptor, TYPE CAP-22 Power Cord, three TYPE 274-MB Double Plugs, spare fuses.

Cabinet: Rack-bench (see page 210).

Dimensions: Bench model—width 19, height 7³/₈, depth 15¹/₂ inches (485 by 190 by 395 mm), over-all; rack model—panel 19 by 7 inches (485 by 180 mm), depth behind panel 13¹/₂ inches (345 mm).

Net Weight: Bench model, 35 pounds (16 kg); rack model, 33 pounds (15 kg).

Shipping Weight: Bench model, 47 pounds (21.5 kg); rack model, 46 pounds (21 kg).

Type		Code Number	Price
1305-AM	Low-Frequency Oscillator, Bench Model	1305-9801	\$940.00
1305-AR	Low-Frequency Oscillator, Rack Model	1305-9811	940.00

PATENT NOTICE. See Note 15, page viii.



SINGLE-PHASE OR
POLYPHASE OUTPUT
0.01 TO 1000 CPS



Type 1210-C UNIT R-C OSCILLATOR

FEATURES:

- ♦ Very wide frequency range — audio, supersonic, and radio frequencies.
- ♦ Sine- and square-wave outputs. ♦ High output voltage.
- ♦ Small size — inexpensive — compact and rugged.
- ♦ Sweepable, with dial drive. ♦ Precision frequency-control dial.
- ♦ Fast-responding AVC system. ♦ Output constant with frequency.

USES: This compact, inexpensive oscillator offers outstanding performance per dollar and per cubic inch of space. It can be used as:

A sine-wave source for measurements at audio, ultrasonic, and low radio frequencies.

A square-wave source for network steady-state and transient response measurements at audio, ultrasonic, and low radio frequencies.

A sine-wave or square-wave modulator for rf oscillators and standard-signal generators.

A square-wave trigger for pulse generators.

A swept oscillator for displaying amplitude-frequency characteristics (with the TYPE 907-R144 Dial Drive) on a graphic recorder.

A 3-watt oscillator, when combined with the TYPE 1206-B Unit Amplifier.

DESCRIPTION: The frequency of the oscillator is determined by an RC network. A fast-response AVC system holds the amplitude of oscillation constant in spite of changes in frequency or line voltage.

The oscillator provides three different outputs that contribute to its versatility and usefulness:

1. A low-impedance, low-voltage, low-distortion output from a cathode-follower amplifier.

2. A high-impedance, high-voltage output from a cathode-follower amplifier. Output impedance is constant, regardless of attenuator setting.

3. A square-wave output of 30 volts peak-to-peak, (open-circuit) with $\frac{1}{3}$ - μ sec rise time.

The oscillator can be clamped to its external power supply to form a single, rigid unit, as shown below.

SPECIFICATIONS

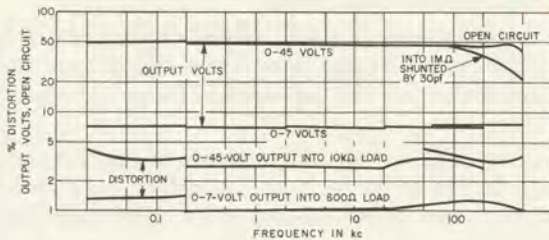

Typical output and harmonic distortion characteristics of the Type 1210-C Unit R-C Oscillator as functions of frequency and load.

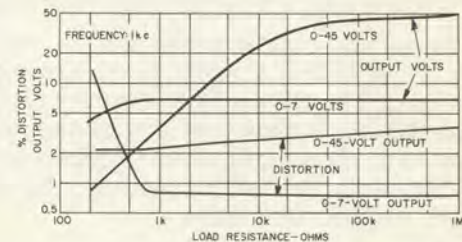

FREQUENCY

Range: 20-500,000 cps in five ranges: 20-200, 200-2000, 2000-20,000, 20,000-200,000, and 50,000-500,000 cps.

Controls: Range selection switch and TYPE 907 Precision Dial. Dial has two scales and covers each decade in about $4\frac{1}{2}$ turns.

Accuracy: $\pm 3\%$.

Stability: Warmup drift is less than 1%, complete in 1 to 2 hours.

OUTPUT

Control: Logarithmic, calibrated 0-50 db.

Low-impedance: (for loads of 500 ohms and higher) 0-7 volts, open circuit, constant within ± 1 db up to 200 kc; internal output impedance 50 ohms at full output, 1250 ohms at half output; no-load distortion less than 1% from 200 cps to 10 kc, less than 1.5% over entire frequency range. Attenuator calibration is reliable for loads of 12,000 ohms and above. Hum at least 60 db below output level.

High-impedance: (for loads of 10,000 ohms and higher) 0-45 volts, open circuit, constant within ± 1 db from 200 cps to 150 kc; distortion less than 5% from 200 cps to 200 kc, no load (reduced under load). Internal output impedance 14,000 ohms regardless of attenuator setting. Hum at least 50 db below maximum output level.

Square-Wave: 0-30 volts, peak-to-peak, open circuit; rise time approximately $\frac{1}{3}$ μ sec (decreases to about 0.15 μ sec with load of

1000 ohms); overshoot approximately 1%; hum at least 60 db below output voltage level; internal output impedance 2500 ohms.

Terminals: Two TYPE 938 Binding Posts, one grounded to panel.

GENERAL

Power Supply Recommended: TYPE 1203-B Unit Power Supply for operation from 115 volts, 50 to 400 cps.

Accessories Available: For higher output (3 watts) use TYPE 1206-B Unit Amplifier (page 22); for graphic recording, TYPE 907-R144 Dial Drive (page 127).

Cabinet: Unit Instrument (see page 210).

Dimensions: Width $10\frac{3}{4}$, height $5\frac{3}{4}$, depth 7 inches (275 by 150 by 180 mm), over-all. As shown here, including power supply, 15 by $5\frac{3}{4}$ by 7 inches (385 by 150 by 180 mm), over-all. Relay-rack adaptor set listed below mounts both instrument and power supply (panel 19 by 7 inches).

Net Weight: $5\frac{1}{2}$ pounds (2.5 kg). **Shipping Weight:** 12 pounds (5.5 kg).

Type	Code Number	Price
1210-C Unit R-C Oscillator	1210-9703	\$185.00
1203-B Unit Power Supply (115-v line*)	1203-9702	55.00
480-P4U3 Relay-Rack Adaptor Panel	0480-9986	12.00

* See page 173 for 230-volt supply.

Type 1210-C Unit R-C Oscillator with Type 1203-B Unit Power Supply.





Type 1304-B BEAT-FREQUENCY AUDIO GENERATOR

FEATURES:

- ◆ Logarithmic frequency scale — covers audio range in one sweep of dial.
- ◆ Linear frequency-increment dial.
- ◆ Constant output voltage.
- ◆ Low distortion and hum level.
- ◆ Known output over 80-db range.
- ◆ Additional 20- to 40-ke range.
- ◆ Can be coupled to level recorder or motor driven for xy recorder.

USES: For amplitude-frequency tests on audio-frequency equipment — lines, amplifiers, filters, equalizers, transducers, and other networks — this beat-frequency generator is an excellent test-signal source. Its especial fitness for these applications lies in five of the characteristics mentioned above. These are:

- (1) Its frequency scale is logarithmic;
- (2) It covers the entire audio range in one sweep of the dial;
- (3) Its output voltage is constant with frequency;
- (4) Its distortion is extremely low;
- (5) It is adapted to automatic recording.

Frequency characteristics can be recorded by either the TYPE 1521-A Graphic Level Recorder or by an xy recorder. The graphic level recorder drives the oscillator dial through a chain-and-gear system, and the curve is plotted on chart paper whose frequency scale matches that of the oscillator. For xy plotting, the drive can be the TYPE 908-R96 Dial Drive.

This general-purpose audio generator finds constant use in the electronics laboratory, as a power source for bridge measurements, as a modulator for rf signal generators, and as a power source for acoustical tests at both audio and ultrasonic frequencies.

DESCRIPTION: This instrument has a number of unusual design features that contribute to superior performance

and ease of operation. Two radio-frequency oscillators, one fixed and one variable, feed a pentagrid converter through buffer amplifiers. The resulting difference frequency, after passing through a low-pass filter, is amplified in a degenerative amplifier. The output stage of this amplifier is the unique, low-distortion, single-ended, push-pull circuit.*

The oscillator output level is continuously adjustable, and the output can be connected for either balanced or unbalanced use. The unbalanced circuit contains a three-step attenuator. The output voltmeter is calibrated in dbm and open-circuit output volts.

The output voltmeter is used to standardize the frequency calibration of the oscillator when the output frequency is set either to the power-line frequency or to zero beat.

The frequency dial carries a logarithmic frequency scale for the range 20 cps to 20 kc, and it is driven by a slow-motion gear-reduction drive, essentially free from backlash.

Rotation is continuous over 360°, to facilitate automatic recording. A cycles-increment dial varies the frequency over a range of ± 50 cps at any setting of the main dial and can be swept by the TYPE 1750-A Sweep Drive.

The 20- to 40-ke range is selected by a single panel switch.

* A. P. G. Peterson and D. B. Sinclair, "A Single-Ended Push-Pull Audio Amplifier," Proc IRE, vol 40, pp 7-11, January, 1952.



SPECIFICATIONS

FREQUENCY

Range: 20 cps to 40 kc in two ranges, 20 cps to 20 kc and 20 kc to 40 kc.

Controls: Main dial has precision 10:1 reduction gear drive, and can be rotated continuously for automatic drive. Frequency-increment dial is direct manual drive. Two-position switch changes frequency range.

Calibration: Main scale is logarithmic from 20 cps to 20 kc, covering a rotational angle of 240°, or 80° per decade. High-range position of switch adds 20 kc to main scale calibration. Frequency-increment dial is linear, -50 to +50 cps.

Accuracy: Main dial, $\pm(1\% + 0.5 \text{ cps})$ after standardization by zero-beat or line-frequency setting. The 20-kc increment for the high range is accurate to $\pm 0.5\%$. Accuracy of frequency-increment dial is $\pm 1 \text{ cps}$.

Stability: At zero beat, the drift from a cold start is less than 7 cps in the first hour and is essentially completed within two hours.

OUTPUT

Voltage: Continuously variable from below 5 millivolts to 50 volts, open circuit. Full-scale, open-circuit output voltages of 50 millivolts, 500 millivolts, 5 volts, and 50 volts are provided.

Frequency Characteristic: For a 600-ohm resistive load the variation of output voltage with frequency is as follows:

- NORMAL range, 20 to 20,000 cps $\pm 0.25 \text{ db}$;
- ADD 20 KC range, 20-30 kc, $\pm 0.5 \text{ db}$;
- 30-40 kc, $\pm 1.0 \text{ db}$.

The open-circuit output voltage rises considerably at the higher frequencies.

Impedance: 600 ohms, resistive, within $\pm 2\%$. At +20 dbm setting of the output attenuator, the output may be used either balanced or with one side grounded. With one side of the output grounded, the attenuator can be used throughout its entire range.

Power: 1 watt, maximum, into a 600-ohm resistive load.

Distortion: Less than 0.25% from 100 to 10,000 cps. Below 100 cps the harmonic content increases and may reach 0.5% at 50 cps. Above 10,000 cps the harmonic content is less than 1%.

AC Hum: Less than 0.1% of the output voltage for output-voltmeter readings above 10% of full scale.

Voltmeter: Calibrated in volts output at open circuit, and in dbm. Above 10% of full scale, the calibration is accurate within $\pm 5\%$ of the reading.

Attenuator: Used only with single-ended output; has three steps of 20 db each, with an accuracy of $\pm 1\%$ of the nominal attenuation.

Control: For each step of the attenuator, the output voltage can be varied continuously from zero to the maximum voltage.

Zero-Beat Indicator: The output voltmeter is used to indicate zero beat.

GENERAL

Terminals: TYPE 938 Binding Posts and standard Western Electric double output jack on panel; a standard four-terminal socket at the rear.

Power Requirements: 105 to 125 (or 210 to 250) volts, 50 to 60 cps. Power consumption is about 100 watts.

Accessories Supplied: TYPE CAP-22 Power Cord, four-terminal plug, and spare fuses.

Cabinet: Rack-bench (see page 210).

Dimensions: Bench model — width 19, height 7½, depth 15¼ inches (485 by 190 by 390 mm), over-all; rack model — panel 19 by 7 inches (485 by 180 mm), depth behind panel 13¼ inches (340 mm).

Net Weight: 39 pounds (18 kg).

Shipping Weight: 51 pounds (23.2 kg).

Type		Code Number	Price
1304-BM	Beat-Frequency Audio Generator, Bench Model	1304-9802	\$795.00
1304-BR	Beat-Frequency Audio Generator, Rack Model	1304-9812	795.00

PATENT NOTICE. See Notes 5, 9, 14, and 15, page viii.

OTHER BEAT-FREQUENCY OSCILLATORS: *The Type 1107-A Interpolation Oscillator (page 110) has a linear scale from 0 to 5000 cps. The Type 1300-A Beat-Frequency Video Generator (page 130) covers frequencies from 20 cps to 20 kc and 20 kc to 12 Mc.*



Type 1304-B Beat-Frequency Audio Generator driven by a Type 1521-A Graphic Level Recorder.

Type 1304-B Beat-Frequency Audio Generator driven by a Type 908-R96 Dial Drive, for use with an XY plotter.



Type 1308-A AUDIO OSCILLATOR AND POWER AMPLIFIER

FEATURES:

- ♦ Low dynamic output impedance provides low-distortion signal to nonlinear loads.
- ♦ 200 voltamperes into a reactive load — 200 watts into resistive load.
- ♦ Low distortion — wide frequency range — 20 cps to 20 kc.
- ♦ All-solid-state circuitry.
- ♦ Can be used separately as an audio-frequency power amplifier.
- ♦ Matches wide range of loads. Delivers up to 5 amperes, 400 volts.
- ♦ Output transformer will pass dc.

USES: The TYPE 1308-A Audio Oscillator and Power Amplifier is an ac power source whose frequency can be varied over the entire audio range. Because its output circuit will handle dc currents equal to the ac rating, it is an excellent power source for the TYPE 1633-A Incremental-Inductance Bridge. Its low dynamic output impedance enhances its usefulness as a power source for testing other devices over a wide range of supply frequencies. It will provide a low-distortion signal (not clipped) to nonlinear loads, such as capacitor-input rectifier systems. Its high power output makes it useful for driving shake tables and other vibration equipment. It can also be used to isolate sensitive equipment from power-line transients.

This instrument also finds many uses as a general-purpose, audio-frequency power amplifier, operating from an external input.

DESCRIPTION: This instrument combines a capacitor-tuned, Wien-bridge oscillator, a low-distortion power amplifier, and a tapped output transformer.

Solid-state circuitry is used throughout. The power amplifier can be easily disconnected from the oscillator for use with an external signal source.

Output-voltage and current meters are provided. The output is monitored by an overload circuit, which turns off the output when it exceeds safe limits.

SPECIFICATIONS

OUTPUT

Power: 200 voltamperes, 50 cps to 1 kc. See curves below.

Voltage and Current Ranges: 0 to 4, 12.5, 40, 125, 400 volts, rms.
0 to 5, 1.6, 0.5 amperes, rms.

Optimum Load Impedance: 8, 80, 800 ohms. Will operate satisfactorily with higher-impedance or nonlinear loads. Output transformer will pass dc equal to rated ac.

Regulation and Response Time: (See curves.) Less than 20% no load to full load — 20 cps to 1 kc. (Bandwidth greater than 10 kc provides essentially instantaneous regulation.)

Frequency: Internal oscillator covers 20–20,000 cps continuously.

Harmonic Distortion at Rated Output: (See curves.) 1% 100 cps–10 kc
2% 50–100 cps

Hum: More than 50 db below maximum output.

GENERAL

Overload Protection: Electronic overload circuit trips at approximately 1½ full-scale current (manual reset); thermal protection on transistor heat sink (automatic reset).

Load Power Factor:

Any at full ratings — continuous operation to 30 C ambient.

Any at full ratings — intermittent operation to 50 C ambient.

0.7 to 1.0 at full ratings — continuous operation to 50 C ambient.

Meters: 0 to 5, 15, 50, 150, 500 volts.

0 to 0.05, 0.16, 0.5, 1.6, 5 amperes.

Power Requirements: 105 to 125 (or 210 to 250) volts, 50 to 60 cps, 70 to 500 watts, depending on load. For 50-cycle supply, maximum output must be reduced 20%

Amplifier:

Input Impedance — 10 kilohms.

Sensitivity — Approximately 2 volts needed for full output.

Terminals: Binding posts and 4-terminal connector at rear.

Cabinet: Rack-bench (see page 210).

Dimensions: Bench model — width 19, height 7, depth 16¼ (485 by 180 by 414 mm), over-all; rack model — panel 19 by 7 inches (485 by 180 mm), depth behind panel 15 inches (385 mm).

Net Weight: 91 pounds (42 kg).

Shipping Weight: 105 pounds (48 kg).

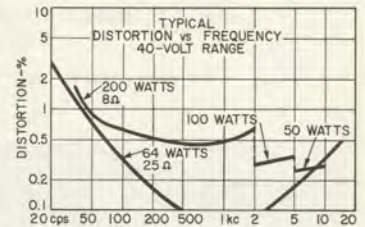
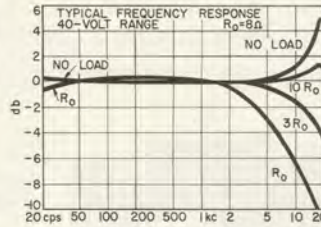
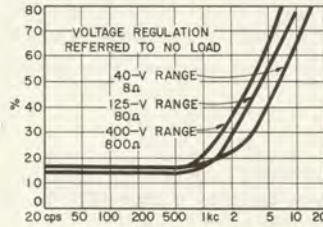
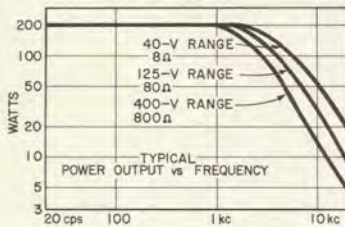

Type	Code Number	Price
1308-AM Audio Oscillator and Power Amplifier, Bench Model	1308-9801	\$1150.00
1308-AR Audio Oscillator and Power Amplifier, Rack Model	1308-9811	1150.00





Type 1311-A AUDIO OSCILLATOR

GENERATORS
AUDIO OSCILLATOR

FEATURES:

- ◆ One-watt output at 11 audio frequencies.
- ◆ Output currents up to 4 amperes, voltages to 100 volts.
- ◆ Low distortion, even on short circuit. ◆ Low noise.
- ◆ Drives balanced or grounded circuits. ◆ Solid-state circuitry.
- ◆ Excellent frequency and amplitude stability.
- ◆ Can be synchronized with external signal.

USES: Although the TYPE 1311-A Audio Oscillator was designed primarily for use as a generator for bridge measurements, its superior performance and many features make it well suited to almost any application where a high-quality audio oscillator is needed.

For bridge measurements, the shielded output-transformer secondary minimizes circulating ground currents and matches loads over a wide impedance range. The frequency can be synchronized with that of an external standard for precise measurement of frequency-sensitive parameters.

In such applications as the calibration of high-speed level recorders and digital-to-analog converters, its short-term stability of both amplitude and frequency is advantageous.

Its ability to drive any load impedance with low waveform distortion greatly enhances its usefulness as a general-purpose laboratory oscillator.

DESCRIPTION: The oscillator uses the RC-degenerative circuit, in which the frequency is determined by a Wien-bridge network in the positive feedback path. The multi-stage, Class-B, six-transistor circuit provides the one-watt output without additional amplification. A tapped output transformer makes available a wide range of voltages and short-circuit currents. Feedback around the whole amplifier makes the distortion practically independent of load impedance, even under short-circuit conditions.

The convenient convertible bench-type cabinet can be easily mounted in a relay rack by means of adaptor panels.

SPECIFICATIONS

FREQUENCY

Range: 11 fixed frequencies from 50 to 10,000 cps.
Control: 50, 60, 100, 120, 200, 400, 500, 1000, 2000, 5000, 10,000 cps selected by rotary switch. A vernier provides a $\pm 2\%$ adjustment. One additional frequency in this range can be added by the installation of two resistors at an unused switch position.
Accuracy: $\pm 1\%$ when ΔF control is at zero.

OUTPUT

Power: One watt into matched load. (Taps provide at least 0.5 watt into any resistive load between 80 milliohms and 8 kilohms.)

Voltage: Continuously adjustable from 0 to 1, 3, 10, 30, or 100 volts, open circuit.

Current: Continuously adjustable from 0 to 40, 130, 400, 1300, 4000 milliamperes, short circuit (approximately).

Impedance: Between one and two times matched load, depending on control setting. Output circuit is isolated from ground and, hence, can be used to drive balanced circuits.

Stability (Typical, after warmup): Amplitude, long term, better than 1%; short term, better than 0.01%. Frequency, long term, better than 0.1%.

DISTORTION AND NOISE LEVEL

Distortion: Less than 0.5% under any load condition. Typically less than 0.1% over much of range. Oscillator will drive a short circuit without waveform clipping.

AC Hum: Typically less than 0.003% of output voltage.

GENERAL

Synchronization: A locking voltage from an external reference frequency can be introduced at a telephone jack. Locking range is approximately $\pm 3\%$ for 1-volt reference signal. The ΔF control can be used for phase adjustment. When reference signal is sinusoidal, distortion in the output will not exceed the specification for a free-running oscillator.

Terminals: Jack-top TYPE 938 Binding Posts with standard $\frac{3}{4}$ -inch spacing. Separate ground terminal holds TYPE 938-L Shorting Link, which can be used to ground adjacent OUTPUT binding posts.

Power Requirements: 105 to 125 (or 210 to 250) volts, 50 to 400 cps. Total power input varies between 7 and 22 watts, depending on load.

Accessories Supplied: TYPE CAP-22 Power Cord, spare fuses.

Cabinet: Convertible bench (see page 210).

Dimensions: Width 8, height 6, depth $7\frac{3}{4}$ inches (205 by 155 by 200 mm), over-all. Panel adaptor sets are available for 19-inch relay-rack mounting (panel height $5\frac{1}{4}$ inches).

Net Weight: 6 lbs. (2.8 kg).

Shipping Weight: 11 lbs. (5 kg).

For a more complete description of this oscillator, see *General Radio Experimenter*, 36, 8 & 9, August-September, 1962.

Type		Code Number	Price
1311-A	Audio Oscillator	1311-9701	\$190.00
480-P308	Relay-Rack Adaptor Set (for oscillator only)	0480-9638	7.00

PATENT NOTICE. See Note 1, page viii.



Type 1214 UNIT OSCILLATORS



The TYPE 1214 Unit Oscillators are compact and inexpensive oscillators generating fixed frequencies. The TYPE 1214-A and -D Unit Oscillators are convenient modulators for the high-frequency Unit Oscillators and power sources for bridge measurements. The output can be isolated from ground for use of the oscillator as a modulator in the plate circuit of a high-frequency oscillator. Power supply is built in. The TYPE 1214-D includes an impedance-matching transformer (8000 to 1, 10, 100, or 1000 ohms) which can be used with an external oscillator as well.

SPECIFICATIONS

TYPE	1214-A	1214-D	1214-M
Frequency	400 and 1000 cps	120 cps	1 Mc
Accuracy	±2%	±5%	±1%
Maximum Output *	200 mw into 8000 ohms	400 mw into 1, 10, 100, 1000 ohms	300 mw into 50 ohms
Distortion	3% into 8000 ohms	3% into matched load	3.5% into 50 ohms
Open-Circuit Output Voltage *	0 to 60 v	45, 13, 4.5, or 1.3 v	0 to 7 v
Dimensions	Panel width 4 3/4, height 5 1/4, depth 6 inches (120 by 135 by 155 mm)		
Net Weight	4 1/2 pounds (2.1 kg)	4 1/2 pounds (2.1 kg)	2 3/4 pounds (1.3 kg)
Shipping Weight	9 pounds (4.1 kg)	9 pounds (4.1 kg)	8 pounds (3.7 kg)
Code Number	1214-9701	1214-9704	1214-9713
Price	\$85.00	\$115.00	\$75.00

* Output voltage changes by about 12% per 10% change in line voltage. Power and voltage values given are for 115-volt input.

Power Requirements: 105 to 125 volts, 50 to 60 cps, 15 watts. Can also operate on frequencies up to 400 cps.

Accessories Supplied: Spare fuses.

Cabinet: Unit Instrument (see page 210). TYPE 480-P4U1 Relay-Rack Adaptor Panel Set available to mount oscillator (panel 19 by 7 inches); code number: 0480-9984; price: \$11.00.



Type 1107-A INTERPOLATION OSCILLATOR

FEATURES:

- ♦ Linear frequency scale, 0 to 5000 cps.
- ♦ Excellent frequency stability.
- ♦ Precision worm-and-gear drive.
- ♦ Mixer circuit included, for frequency comparison.

USES: This beat-frequency oscillator was originally designed as an interpolation device between 10-kc harmonics in a wide-range frequency-measuring system. It has many other applications where accurate frequency increments and a linear scale are needed.

DESCRIPTION: The oscillator circuits are designed for

exceptional stability of frequency against changes in supply voltage and tube capacitance.

The variable oscillator frequency is controlled by a precision variable air capacitor, the fixed oscillator frequency by a fixed air capacitor. The inductors are wound on ceramic forms and are shielded, effectively eliminating unwanted coupling and reducing the effects of changes in ambient temperature.

Although the oscillator has a single frequency range of 0 to 5000 cps, two scales are provided, reading 0 to 5000 and 5000 to 10,000. The second scale is for use in frequency interpolation and can be ignored for other uses.

Incremental-frequency dials (±10 cps) are provided for setting small increments.

SPECIFICATIONS

Frequency Range: 0 to 5000 cps.

Dial Calibrations: DIRECT — 0-5000, with the oscillator frequency increasing from 0 to 5000 cps. REVERSE — 5000-10,000, with the oscillator frequency decreasing from 5000 cps to zero. Δf REVERSE and Δf DIRECT — ±10 cps.

Accuracy: Main scales, ±2 cps; Δf scales, ±0.3 cps.

Output Voltage: 0 to 14 volts, essentially constant with frequency.

Output Impedance: Approximately 600 ohms.

Mixer: A mixer circuit, with volume control, is provided for the injection of a frequency to be measured into the output amplifier circuit. Beats may be observed on the output meter, or by means of earphones or speaker.

Power Requirements: 105 to 125 (or 210 to 250) volts, 50 to 60 cps, 55 watts.

Terminals: On panel and at rear for mixer input and oscillator output. Panel terminals will accept both TYPE 274-MB Double Plug and TYPE 874 Coaxial Connector; rear terminals are TYPE 874.

Accessories Supplied: TYPE CAP-22 Power Cord, four TYPE 874-C62A Cable Connectors, spare fuses.

Mounting: Standard 19-inch relay-rack.

Dimensions: Panel — width 19 by height 12 1/4 inches (485 by 315 mm); depth behind panel 12 inches (305 mm).

Net Weight: 41 1/2 pounds (19 kg).

Shipping Weight: 55 pounds (25 kg).

Type	Code Number	Price
1107-A Interpolation Oscillator	1107-9701	\$1250.00

PATENT NOTICE. See Note 4, page viii.



PORTABLE TRANSISTOR OSCILLATOR: The Type 1307-A Transistor Oscillator, a compact battery-operated test-signal source of 400 and 1000 cps, is described on page 8.



Type 1330-A BRIDGE OSCILLATOR

FEATURES:

- ♦ Wide frequency range.
- ♦ Internal modulation available.
- ♦ Good frequency stability.
- ♦ One-watt output over much of the radio-frequency range.
- ♦ Excellent shielding.
- ♦ Good bandspread on all ranges.
- ♦ Rugged and compact construction.

USES: The TYPE 1330-A Bridge Oscillator is an economical, general-purpose laboratory source, of maximum utility and adaptability. It covers the major part of the frequency range of the TYPE 1606-A and TYPE 916-AL Radio-Frequency Bridges and the TYPE 716-CS1 Capacitance Bridge. It also supplies 400 and 1000 cps for bridge measurements. Its power output of about one watt is adequate for most direct-deflection-type measurements with resonant circuits.

By means of adaptors (page 64) its coaxial output connectors can be made to fit all commonly used types.

DESCRIPTION: The circuit and the mechanical construction of this oscillator are similar to those used in the TYPE 1001-A Standard-Signal Generator (page 122), but a higher-power oscillator tube is used, and the aperiodic output stage has been omitted. Tuning capacitor and inductors are ruggedly constructed to assure frequency stability, the oscillator circuits are doubly shielded to minimize stray fields, and a modulating circuit of unusual design provides excellent modulation characteristics over the radio-frequency range.

Modulation is available at two audio frequencies and at two levels, selected by switches.

SPECIFICATIONS

FREQUENCY

Range: Three fixed frequencies — 1000 cps, 400 cps, and the power-line frequency; 5 kc to 50 Mc, continuous.

Calibration: Direct reading for eight 3:1 ranges. Calibration is logarithmic and vernier dial indicates increments of 0.1% per division from 5 kc to 15 Mc.

Accuracy: 400 and 1000 cps, $\pm 5\%$; frequencies below 150 kc, $\pm 3\%$; above 150 kc, $\pm 2\%$, all at no load. Frequency shift with 50-ohm load, 5% at low carrier frequencies; above 150 kc, less than 1%.

OUTPUT

Voltage: Open-circuit audio, 12 volts; rf, adjustable, approximately 10 volts over the mid-frequency range, less at ends of range.

Power: Into 50-ohm load, audio, approximately $\frac{3}{4}$ watt; rf, 1 watt, over most of range.

Impedance: Audio jack, 50 ohms; rf, 20 to 80 ohms, depending upon frequency, when output control is at maximum setting.

GENERAL

RF Distortion: With maximum output into 50 ohms, about 3.5%, except at the lower frequencies, where it is 7%.

Audio Distortion: 5%.

Leakage: Stray fields are less than 50 microvolts per meter at two feet from the oscillator.

Modulation: Internal only, at 400 and 1000 cps, 25% and 50%.

Envelope Distortion: Less than 6% at 50% modulation; less than 4% at 25% modulation.

Power Requirements: 105 to 125 (or 210 to 250) volts, 50 to 60 cps; 30 watts, approximately.

Terminals: Locking TYPE 874 Coaxial Connectors.

Accessories Supplied: TYPE 874-R22A Coaxial Cable, TYPE 874-Q2 Adaptor, TYPE 874-C58A Cable Connector, TYPE TO-44 Adjustment Tool (mounted on rf shield cover), TYPE CAP-22 Power Cord, and spare fuses.

Cabinet: Lab bench (see page 210). Cabinet can be removed for rack mounting.

Dimensions: Width 21 $\frac{3}{4}$, height 7 $\frac{1}{2}$, depth 11 $\frac{1}{4}$ inches (555 by 190 by 285 mm), over-all; panel 19 by 7 inches (485 by 435 mm).

Net Weight: 37 $\frac{1}{2}$ pounds (17 kg).

Shipping Weight: 50 pounds (23 kg).

Type	Code Number	Price
1330-A Bridge Oscillator	1330-9701	\$690.00

PATENT NOTICE. See Note 4, page viii.



HF, VHF, AND UHF OSCILLATORS



0.5 - 2000 Mc

See pages 114 and 115 for individual listings

These compact, low-priced oscillators provide continuous coverage from 500 kc to 2000 Mc with single-dial control and output in the order of several hundred milliwatts. A complete listing of their characteristics will be found on pages 114 and 115. Additional coverage to 7425 Mc is provided by a group of microwave oscillators (see pages 117 and 118). In conjunction with one of the companion group of power supplies (see opposite page), any oscillator becomes a complete signal source with characteristics adapted to the customer's application. By appropriate

choice of power supply, the oscillator can deliver maximum power, optimum frequency stability with minimum residual fm and a-m, pulse and square-wave modulated output, amplitude-regulated output for sweeping applications, or can be incorporated into a heterodyne detector system (see page 81). Power supplies and oscillators are designed for semi-permanent attachment for bench use or relay-rack mounting. Accessories suitable for use with these oscillators are listed on page 116.

GENERAL RF OSCILLATOR SPECIFICATIONS

for 500-kc—2000-Mc Oscillators

Types 1211-C, 1215-C, 1208-C, 1209-CL, 1209-C, 1361-A, 1218-A

Frequency Control: TYPE 908 Gear-Drive Precision Dials (page 127) are used on all models, except the TYPE 1361-A which uses TYPE 907. Vernier drive ratio is 10:1.

Output Power: Output power listed is obtainable at any frequency within the range of the oscillator, with the TYPE 1269-A Power Supply. With Types 1267-A, 1201-B, and 1264-A, Power Supplies, multiply the listed power by approximately 0.6; with TYPE 1216-A Unit I-F Amplifier, multiply by about 0.4. With the TYPE 1263-B Amplitude-Regulating Power Supply, the maximum useful power output is 20 milliwatts. The available power is adequate for practically all laboratory measurements with bridges, slotted lines, admittance and transfer-function meters, tuned circuits, etc.

Output System: A short coaxial line brings the output from an adjustable coupling loop (in the TYPE 1211-C, from a fixed loop and potentiometer) to a locking TYPE 874 Coaxial Connector. The output connector is located at the rear of the oscillator except on the TYPE 1361-A, which has it on the front panel. Maximum power can be delivered to load impedances normally encountered in coaxial systems. Adaptors are available to convert the TYPE 874 Connector to any other common type (see page 64). These adaptors lock securely in place, yet are easily removed.

Power Supply: The external power supply should be chosen from the group listed in the *Summary of Power-Supply Characteristics*. Operation from 400-cycle lines is permissible with many of these power supplies with all oscillators except the TYPE 1208-C.

Modulation: Amplitude modulation over the audio range can be obtained by superimposing a modulating voltage on the plate supply. A jack is provided on all GR oscillators for this purpose. The audio source must be capable of carrying the dc plate current of the oscillator. The inexpensive TYPE 1214 fixed-frequency oscillators are recommended as modulators, and are usually used in conjunction with the TYPE 1269-A, 1201-B, or 1267-A Power Supplies. For 30% a-m, incidental fm in this system is of the order of 0.01% at the lower part of the tuning range, and increases to about 0.05% at the

high-frequency end. Approximately 40 volts across 8000 ohms is adequate to produce 30% modulation.

Square-wave or pulse modulation can be obtained on all oscillators, except the TYPE 1211-C and TYPE 1208-C, by use of the TYPE 1264-A Modulating Power Supply. All oscillators except the TYPE 1208-C can be square-wave modulated at 1 kc, supplied by the TYPE 1263-B Amplitude-Regulating Power Supply.

For video modulation up to 30% with 5-Mc bandwidth, the TYPE 1000-P6 Crystal-Diode Modulator can be used at carrier frequencies from 20 to 1000 Mc. No tuning adjustments are required. This low-level absorption modulator introduces negligible incidental fm, but the output capability is limited to approximately 10 millivolts, peak, into 50 ohms.

For 100% linear a-m free of incidental fm and for pulse modulation, the TYPE 1000-P7 Balanced Modulator should be used. It is suitable for use at carrier frequencies from 60 to 2300 Mc and has a video bandwidth of 20 Mc. The output capability is 10 millivolts, peak, into 50 ohms.

Sweep Applications: Mechanical sweep at speeds suitable for oscilloscopic display can be obtained by use of the TYPE 1750-A Sweep Drive. The Types 1208-C and 1218-A are not recommended for this service because of the sliding contacts in their tuned circuits.

Slower mechanical sweep for use with xy recorders is possible with the TYPE 907-R144 or 908-R96 Dial Drives. The TYPE 1218-A is not suitable for use with these drives, and the TYPE 1208-C should only be used for short periods with the TYPE 1750-A Sweep Drive.

The TYPE 1263-B Amplitude-Regulating Power Supply is recommended to hold the oscillator output constant as the frequency is varied, particularly when mechanical sweep is employed. It can be used with all these oscillators except the TYPE 1208-C.

Mounting:

Bench Use—Any of the oscillators can be used on the bench with any of the recommended power supplies; interconnecting cables are supplied. All oscillators except the TYPE 1218-A, and all power supplies except the TYPE 1201-B, are 7" high and can be attached to each other with the hardware supplied to form a rigid assembly.

Relay-Rack Use—Any oscillator except the TYPE 1218-A can be relay-rack mounted together with a TYPE 1263-B, 1264-A, 1267-A, or 1269-A Power Supply in a space 7" high. The TYPE 1218-A requires a space 12¼" high in addition to a space 7" high for the associated power supply. Accessories required for rack mounting are listed on page 116. When the TYPE 1201-B Power Supply is used, separate rack-adaptor panels are necessary.



A constant-amplitude sweeping system, consisting of a Unit Oscillator, sweep drive (page 127), amplitude-regulating power supply, voltmeter rectifier (page 67), patch cord (Type 874-R22A, page 71), and tee (page 72). When a 50-ohm system is being measured, use Type 874-VQ Voltmeter Detector and Type 874-W50 Matched Termination to rectify the output of the network under test and to provide vertical deflection voltage.

TYPICAL SIGNAL-SOURCE SYSTEMS

HF, VHF, AND UHF OSCILLATORS
POWER SUPPLIES

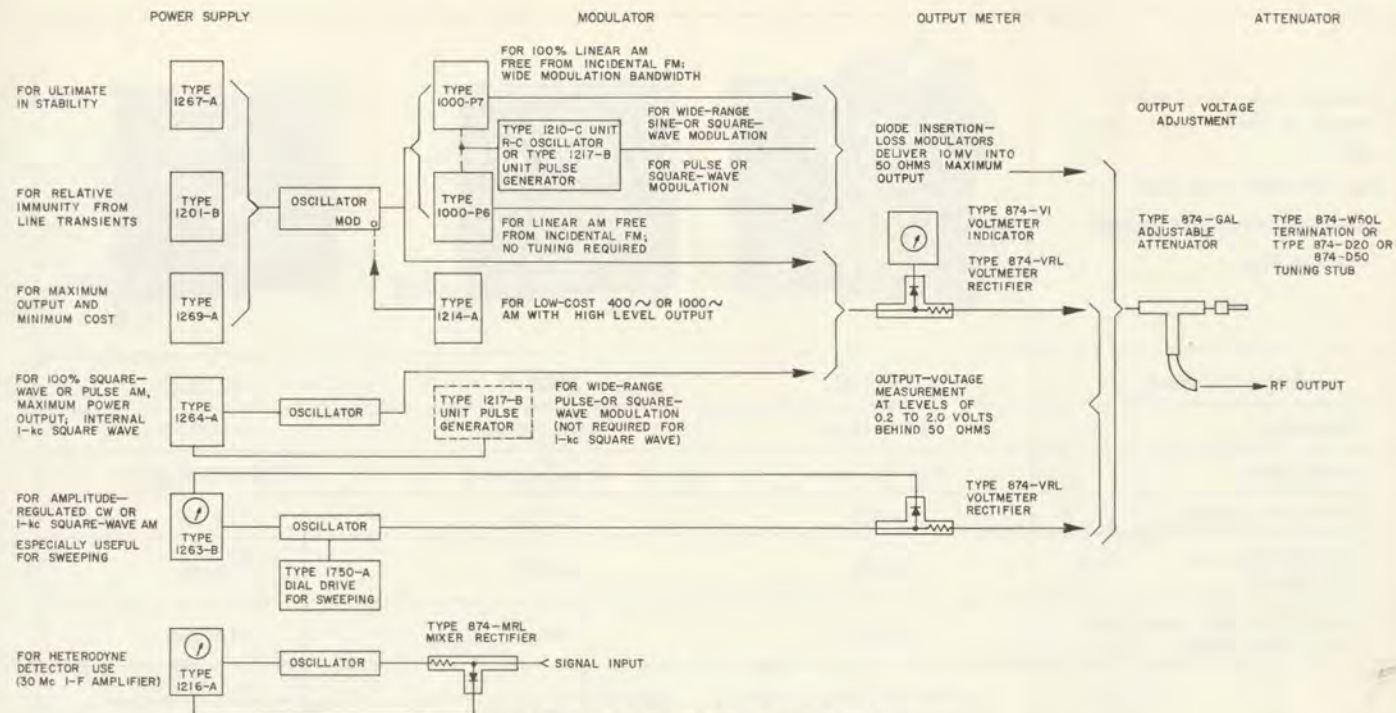

OSCILLATOR POWER SUPPLIES

Power-supply characteristics are frequently a determining factor in the performance of an oscillator. For such applications as parametric-amplifier pumps, oscillators must be stable against all power-line variations and free of modulation from power-supply ripple. For these extreme requirements, both plate and heater supplies should be regulated, well-filtered dc, as in the TYPE 1267-A Power Supply.

Where relative freedom from line transients is required without ultimate reduction in longer term drifts and hum modulation, regulated plate supply is desirable, but unregulated ac may be used for the heater supply. This need is met by the TYPE 1201-B Power Supply.

For many noncritical applications, unregulated dc plate and ac

heater supplies are entirely adequate and represent considerable economy. The TYPE 1269-A Power Supply is this type.

Other applications require power supplies in which the plate-supply voltage is controllable to modulate or to regulate the oscillator output. The TYPE 1264-A Modulating Power Supply provides 100% amplitude modulation at high level by square waves or pulses as well as cw operation. The TYPE 1263-B Amplitude-Regulating Power Supply includes a feedback loop to maintain constant oscillator output as the oscillator frequency is varied. Constant output not only speeds and simplifies measurements where the oscillator is tuned manually, but is essential when making sweep measurements. The TYPE 1263-B Amplitude-Regulating Power Supply has an internal 1-kc oscillator for square-wave modulation.

SUMMARY OF OSCILLATOR POWER-SUPPLY CHARACTERISTICS

Type	Applications	DC Plate Supply	Heater Supply	Panel Width	Page Ref	Price
1267-A ¹	Ultimate stability for cw	300 v @ 70 ma, regulated	6.3 v dc @ 1 amp, reg	4"	173	\$170.00
1201-B ¹	Relative freedom from line transients	300 v @ 70 ma, regulated	6.3 v ac @ 4 amp	*	173	95.00
1269-A ¹	Maximum output and minimum cost	380 v open circuit; 300 v @ 50 ma	6.3 v ac @ 3 amp	4"	173	70.00
1264-A ^{1, 2, 3}	100% square wave and pulse a-m	200-300 v @ 50 ma, reg.	6.3 v ac @ 2.1 amp	8"	175	285.00
1263-B ²	Amplitude-regulated cw or 1-kc square-wave output	0-300 v @ 30 ma	6.3 v dc @ 0.5 amp	8"	174	380.00
1216-A ¹	Heterodyne detector	300 v @ 30 ma	6.3 v ac @ 1 amp	*	82	360.00

¹Unit Instrument Cabinet; see page referenced.

²May be operated from 400-cycle supply, except with TYPE 1208-C Unit Oscillator.

³Not for use with TYPE 1208-C Unit Oscillator.

⁴Requires adaptor cable when used with TYPES 1215-C, 1209-CL, 1209-C, and 1218-A Unit Oscillators (see pages 114 and 115). Not recommended for use with TYPE 1211-C.



The Type 1361-A UHF Oscillator and Type 1264-A Modulating Power Supply assembled with Type 480-P416 Adaptor Plate Set for rack mounting.



Type 1211-C Unit Oscillator and Type 1269-A Power Supply assembled with Type 480-P412 Adaptor Plate Set for rack mounting.

HF, VHF, UHF OSCILLATORS

Supplied with each oscillator, except as noted under "Remarks":

Type 874-R22A Patch Cord

Type 874-C58A Cable Connector

Telephone Plug

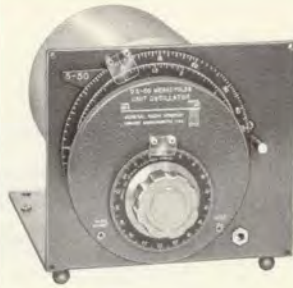





Type Number	1211-C	1208-C	1215-C
Frequency	0.5 to 50 Mc	65 to 500 Mc	50 to 250 Mc
Tuned Circuit	Variable L and C	Variable L and C	Semi-Butterfly
Calibration Accuracy	±2%	±2%	±1%
Warmup Frequency Drift (typical)	0.4%	0.5%	0.4%
Output into 50 ohms with Type 1269-A Supply	> 200 mw	80 mw	100 mw
Typical Output Characteristic with Type 1269-A Power Supply			
Cabinet (see page 210)	Unit	Unit	Unit
Panel Dimensions	8 × 7 in. (180 × 205 mm)	8 × 7 in. (180 × 205 mm)	8 × 7 in. (180 × 205 mm)
Depth Behind Panel	9 3/4 in. (250 mm)	7 3/8 in. (190 mm)	7 1/2 in. (190 mm)
Net Weight	11 1/2 pounds (5.3 kg)	6 pounds (2.8 kg)	7 1/4 pounds (3.3 kg)
Shipping Weight	19 pounds (9 kg)	12 pounds (5.5 kg)	15 pounds (7 kg)
Code Number	1211-9703	1208-9703	1215-9703
Price	\$325.00	\$250.00	\$210.00
ACCESSORIES AVAILABLE			
Modulating Power Supply See pages 113 and 175	No	No	Yes ¹
Amplitude-Regulating Power Supply See pages 113 and 174	Yes	No	Yes
Crystal-Diode Modulator See page 126	Yes, above 10 Mc	Yes	Yes
Balanced Modulator See page 126	No	Yes	Yes
Dial Drives (page 127)	Types 908-P1, -P2, -R96	Types 908-P1, -R96	Types 908-P1, -P2, -R96
Sweep Drive (page 127)	Yes	Not recommended	Yes
Relay-Rack Mount		See page 116	
Other Power Supplies		See page 113	
Remarks	Type 874-Q2 Adaptor supplied instead of cable connector	Sliding Contact	No Sliding Contact

¹Requires Adaptor Cable, TYPE 1264-P1 (see page 175).
²Requires Adaptor Cable, TYPE 1264-P2 (see page 175).

HF, VHF, UHF OSCILLATORS

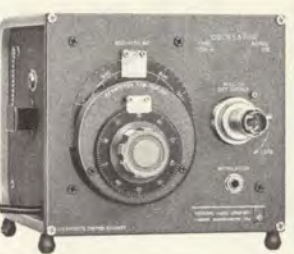
OSCILLATORS
HF, VHF, UHF

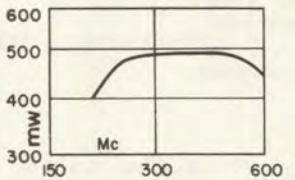
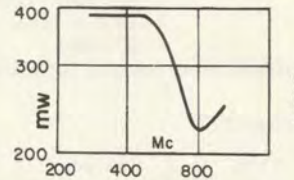
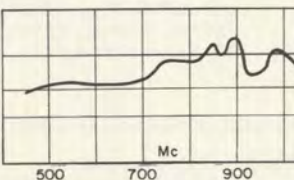
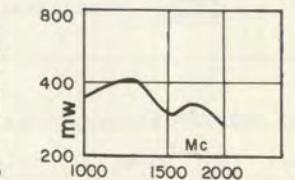
			
1209-CL	1209-C	1361-A	1218-A
180 to 600 Mc	250 to 960 Mc	450 to 1050 Mc	900 to 2000 Mc
Butterfly	Butterfly	Butterfly	Adjustable Lines
±1%	±1%	±1%	±1%
0.2%	0.2%	0.2%	0.1%
300 mw	150 mw	150 mw	150 mw
			
Unit	Unit	Convertible Bench	Unit
8 × 7 in. (180 × 205 mm)	8 × 7 in. (180 × 205 mm)	8 × 7 in. (180 × 205 mm)	12½ × 10½ in. (320 × 270 mm)
7⅝ in. (190 mm)	7⅝ in. (190 mm)	8¼ in. (210 mm)	7½ in. (190 mm)
6 pounds (2.8 kg)	6 pounds (2.8 kg)	7 pounds (3.2 kg)	14¾ pounds (6.7 kg)
13 pounds (6 kg)	13 pounds (6 kg)	13 pounds (6 kg)	26 pounds (12 kg)
1209-9933	1209-9703	1361-9701	1218-9701
\$285.00	\$285.00	\$285.00	\$465.00
ACCESSORIES AVAILABLE			
Yes ¹	Yes ¹	Yes	Yes ²
Yes	Yes	Yes	Yes
Yes	Yes	Yes	No
Yes	Yes	Yes	Yes
Types 908-P1, -P2, -R96	Types 908-P1, -P2, -R96	Types 908-P1, -P2, 907-R144	Not recommended
Yes	Yes	Yes	No
See page 116			
See page 113			
No Sliding Contact	No Sliding Contact	Logarithmic frequency scale. Low external field. Calibrated attenuator. No sliding contact.	Sliding Contacts

See page 112 for general specifications

RF OSCILLATOR ACCESSORIES

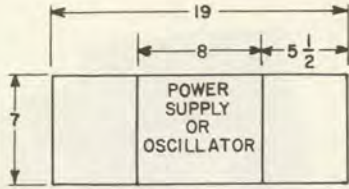

Adaptor Plate Set Type 480-P408 used to rack-mount a single 8"-wide power supply (Type 1263-B or 1264-A) or oscillator (Type 1208-C, 1209-C, 1209-CL, 1211-C, 1215-C, or 1361-A).

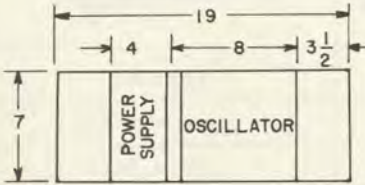

Adaptor Plate Set Type 480-P412 used to rack-mount an assembly of a 4"-wide power supply (Type 1267-A or 1269-A) and oscillator (Type 1208-C, 1209-C, 1209-CL, 1211-C, 1215-C, or 1361-A).

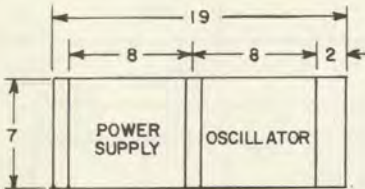

Adaptor Plate Set Type 480-P416 used to rack-mount an assembly of an 8"-wide power supply (Type 1263-B or 1264-A) and oscillator (Type 1208-C, 1209-C, 1209-CL, 1211-C, 1215-C or 1361-A).

RELAY-RACK MOUNT

The panel extensions listed below can be readily attached to any of the 7"-high oscillators, power supplies, or oscillator-power supply assemblies to permit mounting in a standard 19" relay rack. The relay-rack adaptor panel for the TYPE 1218-A Oscillator (900-2000 Mc) requires a space 12 1/4" high and, in addition, a space 7" high for power-supply mounting.

Type		Code Number	Price
480-P408	Adaptor Plate Set, for one 8"-wide instrument (7" high)	0480-9648	\$ 8.00
480-P412	Adaptor Plate Set, for assembly of one 8"- and one 4"-wide instrument (7" high)	0480-9642	7.00
480-P416	Adaptor Plate Set, for assembly of two 8"-wide instruments (7" high)	0480-9646	6.00
480-P7U1	Relay-Rack Adaptor Panel, for Type 1218-A Oscillator (12 1/4" high)¹	0480-9990	15.00
480-P4U1	Relay-Rack Adaptor Panel, for Type 1201-B or Type 1203-B Power Supply only (7" high)	0480-9984	11.00

¹Oscillator and power supply require separate panels.

DIAL DRIVES Descriptions and specifications will be found on page 127.

Type	Name	Primary Characteristics	Type	Name	Primary Characteristics
908-P1	Synchronous Dial Drive	will drive TYPES 1330-A, 1211-C, 1215-C, 1208-C, 1209-CL, 1209-C, 1361-A, 1360-A.	908-R96	Dial Drive	96° per minute; for use with 6" dials, 20-kilohm potentiometer; use with TYPES 1211-C, 1215-C, 1208-C, 1209-CL, 1209-C, 1330-A.
908-P2	Synchronous Dial Drive	will drive TYPES 1211-C, 1330-A, 1215-C, 1209-CL, -C, 1361-A, 1360-A.	1750-A	Sweep Drive	Sweep speed: 0.5-5 cps; sweep arc: 30-300°; sweep voltage output to oscilloscope: 2.5 v, peak-to-peak. Will drive any GR oscillator or signal generator.
907-R144	Dial Drive	144° per minute; for use with 4" dials; 20-kilohm potentiometer; use with TYPE 1361-A, 1360-A.			

Detailed descriptions, specifications, and prices of the following items commonly used in conjunction with rf oscillators and signal generators will be found on the pages indicated.

COAXIAL ELEMENTS

Name	Type Number	Page Ref	Name	Type Number	Page Ref
Adaptors, coaxial connector to type N, BNC, TNC, SC, C, or UHF connector.	874-Q-	64	Lines, air, fixed	874-L-	71
Attenuator, adjustable	874-GA	69	Mixer Rectifier (crystal)	874-MR	67
Attenuator, fixed pads	874-G-	69	Isolators	874-H-	68
Coaxial Cables	874-A2, A3	64	Stub, adjustable (tuning)	874-D-	68
Detector, voltmeter (crystal)	874-VQ	67	Terminations	874-W-	70
Balun	874-UB	73	Line Stretchers	874-LT	71
Filters	874-F-	68	Voltmeter	874-VI	67
			Patch Cords	874-R-	70

MODULATORS, OUTPUT ACCESSORIES

Type	Name	Primary Characteristics	Page Ref	Type	Name	Primary Characteristics	Page Ref
1000-P4	Dummy Antenna	Standard for test of a-m broadcast receivers, 550-1500 kc	123	1000-P5	VHF Transformer	50Ω unbalanced to 300Ω balanced; 50-200 Mc	125
1000-P10	Test Loop	For test of a-m broadcast receiver with loop antenna, 550-1500 kc	123	1000-P6	Crystal-Diode Modulator	30% linear a-m; carrier 20-1000 Mc, mod 0-5 Mc	126
				1000-P7	Balanced Modulator	100% linear a-m; carrier 60-2300 Mc; mod 0-20 Mc	126



Type 1360-A MICROWAVE OSCILLATOR

FEATURES:

- ◆ Excellent frequency stability.
- ◆ 100-milliwatt output over most of range.
- ◆ Output monitor permits maximum output setting for any frequency and load.
- ◆ Narrow-band linear sweep, with sync pulses.
- ◆ Db scale on attenuator is particularly useful at low output levels.
- ◆ Can be fm, pulse, or square-wave modulated; internal 1-kc square-wave provided.

USES: The TYPE 1360-A Microwave Oscillator is a general-purpose power source at frequencies between 1.7 and 4.1 Gc. It is useful as a driver for slotted lines and other measurement circuits, and as the local oscillator in a heterodyne detector. Its usefulness is enhanced by its variety of modulation capabilities.

DESCRIPTION: The oscillator uses a reflex klystron in a coaxial cavity with a non-contacting plunger. The frequency range is covered in two bands, 1.7-2.8 Gc and 2.6-4.1 Gc. Range switching is controlled automatically

by the main frequency dial. Scales for the two ranges are in different colors; a pilot light indicates the correct scale.

An adjustable output control is provided, with an output monitor to warn against over-coupling. The output connector is a locking TYPE 874 Coaxial Connector, to which an adaptor for any commonly used coaxial connector type can be attached and locked.

Cathode, repeller, and bias voltages are well regulated, and the klystron heater supply is dc.

Tube replacements, including the klystron, require no tools. Long-life Teflon bearings are used for the plunger.

SPECIFICATIONS

FREQUENCY

Range: 1.7 to 4.1 Gc in two ranges, 1.7 to 2.8 Gc and 2.6 to 4.1 Gc.

Fine Frequency Control (ΔF): Order of 1 Mc, but not functioning for square-wave modulation.

Accuracy: $\pm 1\%$.

Stability: Warmup drift is approximately 0.15% during the first hour, total drift approximately 0.25%. After warmup, frequency is stable within approximately 5 ppm.

Residual FM: Approximately 0.5 ppm in the lower frequency range and 0.2 ppm in the higher. Dominant frequencies are 60 and 120 cps (with 60-cycle line frequency).

OUTPUT

Power: Typically more than 100 milliwatts above 2 Gc.

Attenuator: Relative calibration

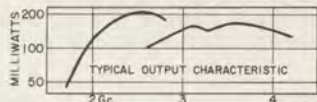

Terminal: TYPE 874 Coaxial Connector, recessed, locking. For connection to type N, BNC, TNC, SC, C, or UHF connector, use a locking adaptor (page 64), which locks securely in place, yet is easily removed. Panel connector is recessed, and adaptor projects only about an inch from panel.

INTERNAL MODULATION

Narrow-Band Sweep: 1 to 3 Mc maximum at 1 kc and power-line frequency. Negative trigger pulse supplied.

Square-Wave: 1 kc, adjustable approximately $\pm 5\%$.

EXTERNAL MODULATION

FM: Sensitivity approximately 0.2 Mc per volt, input impedance, 400 kilohms and 70 pf (ac only).

Square-Wave: 50 cps to 200 kc, 12 volts (rms) sine wave or 20 volts (peak-to-peak) square wave; 20% minimum duty cycle from external source. Input impedance greater than 100 kilohms.

Pulse: Rise and fall times approximately 0.2 μ sec, minimum length approximately 0.5 μ sec. Input impedance 100 kilohms; driving-pulse amplitude, 20 volts (peak-to-peak); maximum duty cycle 20%.

GENERAL

Power Requirements: 105 to 125 (or 210 to 250) volts, 50 to 60 cps, 85 watts. Instrument will operate satisfactorily (except for line-frequency sweep) at power-line frequencies up to 400 cps.

Accessories Supplied: TYPE 874-R22A Patch Cord, TYPE 874-C58A Cable Connector, TYPE CAP-22 Power Cord, spare fuses.

Cabinet: Rack-bench (see page 210).

Dimensions: Bench model — width 19, height 7 $\frac{1}{2}$, depth 15 $\frac{1}{2}$ inches (485 by 195 by 395 mm), over-all; rack model — panel 19 by 7 inches (485 by 180 mm), depth behind panel 13 inches (330 mm).

Net Weight: 38 pounds (17.5 kg).

Shipping Weight: 74 pounds (34 kg).

Type		Code Number	Price
1360-AM	Microwave Oscillator, Bench Model	1360-9801	\$1100.00
1360-AR	Microwave Oscillator, Rack Model	1360-9811	1100.00

PATENT NOTICE. See Note 4, page viiii.

1.7 to 4.1 Gc



KLYSTRON POWER SUPPLY



Type 1220-A UNIT KLYSTRON OSCILLATOR

FEATURES:

- ♦ Inexpensive, versatile, microwave power source.
- ♦ Wide range of frequencies and modulation capabilities.
- ♦ Small — compact — inexpensive.

USES: The Unit Klystron Oscillator generates frequencies between 2700 and 7425 Mc. It can generate fixed frequencies or swept frequencies and can be amplitude modulated with either square waves or pulses, with low incidental fm.

Because of its relatively high output, low cost, small size, and rugged construction, it is equally useful in the laboratory, on the production line, and in classroom demonstrations. It is an excellent source for slotted-line measurements of impedance and VSWR, measurements of bandwidth, and attenuation measurements on cables, lines, and pads.

DESCRIPTION: This instrument includes an adjustable, regulated source of repeller voltage, a Schmitt squaring circuit, a 1000-cycle RC oscillator, and a socket for a reflex klystron tube.

Eight plug-in klystrons cover the frequency range. The oscillator is listed with each single klystron; additional klystrons can be ordered as desired.

The frequency range listed for each klystron can be covered by screw adjustment at the rear of the instrument. With most of the klystrons listed, this can be accomplished without removal of shield.

SPECIFICATIONS

Frequency Range: Depends on klystron tube used (see table below); frequency range of any unit can be changed to that of any other by the insertion of the appropriate klystron tube.

Amplitude Modulation:

Internal: 1-kc square wave, adjustable ± 15 cps.
External: Square wave — 50 cps to 200 kc; sine or square-wave modulating signal of at least 15 volts, rms, required — TYPE 1210-C Unit R-C Oscillator recommended.

Pulse: 1- to 10,000- μ sec duration, less than 0.2- μ sec rise and fall times, 50-cycle to 200-kc repetition rate; at least 20-volt peak pulse voltage required — TYPE 1217-B Unit Pulse Generator recommended.

Frequency Modulation: At least 15-Mc excursion with less than 3-db change in output at 60 cps and rms-input of the order of 10 volts.

Output Terminal: Locking TYPE 874 Coaxial Connector. This instrument can be equipped with type N, BNC, TNC, SC, C, or UHF connectors through the use of locking adaptors, listed on page 64.

Power Requirements: An external Unit Power Supply as shown below

is required. AC line connection to the TYPE 1220-A instrument is made through this power supply. TYPE 1201-B Unit Regulated Power Supply is recommended for high stability and minimum incidental fm (page 173); normal power-line frequency is 50 to 60 cps, but can be 400 cps, provided that the line voltage is between 115 and 125 volts.

Accessories Recommended: Fixed attenuator pad for isolating oscillator from load (page 69); TYPE 874-VQ or -VR for facilitating tuning adjustments (page 67).

Cabinet: Unit Instrument (see page 210).

Dimensions: Width 15, height $5\frac{3}{4}$, depth $6\frac{1}{4}$ inches (380 by 145 by 160 mm), over-all. As shown here, including power supply, 15 by $5\frac{3}{4}$ by $6\frac{1}{4}$ inches (380 by 145 by 160 mm), over-all. Relay-rack adaptor panel listed below mounts both instrument and power supply (panel 19 by 7 inches).

Net Weight: 6 pounds (2.8 kg) with klystron (less power supply).

Shipping Weight: 14 pounds (6.5 kg).

Type	Nominal Output in Milliwatts	Code Number	Price	Tube only Type	Code Number	Price
Klystron Power Supply with Klystron, for						
1220-A1	2700-2960 Mc	1220-9411	\$385.00	726-C	8370-1800	\$ 65.00
1220-A2	2950-3275 Mc	1220-9412	395.00	6043	8380-6043	75.00
1220-A3	3400-3960 Mc	1220-9413	385.00	2K29	8320-0700	65.00
1220-A4	3840-4460 Mc	1220-9414	422.50	2K56	8320-0800	102.50
1220-A5	4240-4910 Mc	1220-9415	385.00	2K22	8320-0600	65.00
1220-A6	5100-5900 Mc	1220-9416	412.00	6115	8380-6115	92.00
1220-A7	5925-6450 Mc	1220-9417	388.00	QK404	8300-1200	68.00
1220-A8	6200-7425 Mc	1220-9418	388.00	5976	8380-5976	68.00
1220-A	Klystron Power Supply (without Tube)	1220-9701	320.00			
1201-B	Unit Regulated Power Supply (required)	1201-9702	95.00			
480-P4U3	Relay-Rack Adaptor Panel (holds both oscillator and power supply)	0480-9986	12.00			

All klystron tubes except the 6043 are designed for relatively infrequent tuning. The oscillator will also operate with the TYPE 2K25 (8550-9660 Mc) and TYPE 2K26 (6250-7060 Mc) Klystrons.

PATENT NOTICE. See Note 4, page viii.

Power for the klystron cathode and for the internal 1-kc modulator is furnished by an external Unit Power Supply, shown here with the oscillator.



STANDARD-SIGNAL GENERATORS



A standard-signal generator is a source of alternating-current energy of accurately known characteristics. The carrier, or center, frequency is indicated by a dial setting, the output voltage by a meter reading and associated attenuator setting, and the modulation by a meter reading set by appropriate control knobs. Common types of modulation signals are sine-wave, square-wave, and pulse; the output signal may be either frequency- or amplitude-modulated by these signals. When the frequency-modulation system produces a considerable excursion in frequency at a relatively low cyclical rate, the instrument is known as a sweep-frequency generator and is particularly useful for testing radio receivers, as voltage standards over the range from a few microvolts to about a volt, and generally as power sources in measurement of gain, bandwidth, signal-to-noise ratio, standing-wave ratio, and other circuit properties.

Amplitude-Modulated Signal Generators

The elements of an amplitude-modulated standard-signal generator are shown in Figure 1. An amplifier may be added readily at lower frequencies, as shown in Figure 2, to isolate the oscillator from the load and to minimize the incidental frequency modulation that usually results from amplitude modulation. The elements of a standard sweep-frequency generator are shown in Figure 3. For use as a standard-signal generator, the oscillator must be stable, have reasonably constant output over any one frequency range, have good waveform, and have no appreciable hum or noise modulation. Careful over-all shielding of the generator is essential in order to minimize stray fields.

The three General Radio amplitude-modulated standard-signal generators are general-purpose, wide-tuning-range instruments covering the range from 5 kc to 940 Mc. Amplitude modulation is provided in an internal, fixed-frequency, sine-wave generator, or from an external audio-frequency source. This provision is omitted for

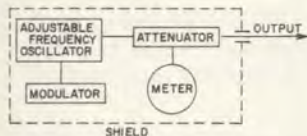

Figure 1. Elements of a standard-signal generator.

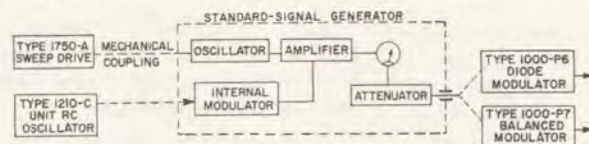

Figure 2. Modulation methods.

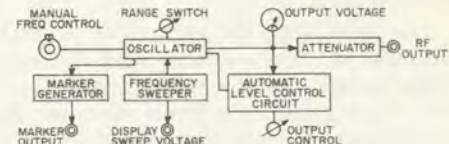

Figure 3. Elements of a standard sweep-frequency generator.

sweep-frequency generators. Amplitude modulation is generally accompanied by incidental frequency modulation. This can be minimized by an amplifier, as mentioned, or substantially eliminated (at some sacrifice in maximum available output) by the use of external crystal-diode absorption modulators, as shown in Figure 2. Such modulators also extend the range of modulation frequencies sufficiently to permit high-quality video and pulse modulation.

Sweep-Frequency Generators

The new TYPE 1025-A Standard Sweep-Frequency Generator covers the range from 700 kc to 230 Mc in ten octave bands and has in addition bandspread ranges at 450 kc and 10.7 Mc. This instrument employs a rotating tuning capacitor to bring the precision and stability of conventional, manually tuned signal generators to the field of sweep measurement. It sweeps 20 times per second over complete octave ranges, and is fast enough to eliminate flicker. This generator includes a very effective automatic level control so that the full advantage may be taken of the use of sweep techniques.

The TYPE 1300-A Beat-Frequency Video Generator provides swept-frequency voltages in the video range and at commonly used intermediate frequencies in addition to manually tunable audio and video sinusoidal and square-wave outputs. Sweeping in this instrument is accomplished electronically.

Sweep-Frequency Operation of Conventional Signal Generators

Conventional manual signal generators can also be swept over limited ranges through the use of the TYPE 1750-A Sweep Drive, which can impart reciprocating rotation up to 300 degrees at rates of 1 to 5 cps to the tuning control (see Figure 2). The corresponding frequency variation is listed in the specifications for the individual instruments.

STANDARD-SIGNAL GENERATORS

Type	Frequency Range	Open-Circuit Voltage	Output Impedance	Modulation %	Page
1001-A	5 kc-50 Mc	0.1 μ v-200 mv	10 Ω , 50 Ω	0-80%	122
805-D	16 kc-50 Mc	0.2 μ v-4 v	0.75, 7.1, 37.5, 50, 75 Ω	0-100%	120
1021-AV	40-250 Mc	0.5 μ v-1 v	50 Ω	0-50%	124
1021-AU	250-940 Mc	0.5 μ v-1 v	50 Ω	0-50%	124
STANDARD SWEEP-FREQUENCY GENERATOR					
1025-A	0.7 to 230 Mc 0.45 and 10.7 Mc	0.3 μ v-1 v	50 Ω	Sweep, all bands	128
SWEEP OSCILLATOR					
1300-A	20 cps-12 Mc 30-42 Mc	0-10 v 50 mv	820 Ω , 75 Ω 50 Ω	Sweep, 20 kc-12 Mc Sweep, 30-42 Mc	130
MODULATORS					
Type	Carrier Range	Modulation Frequency Range		Modulation %	Page
1000-P6	20-1000 Mc	0-5 Mc		0-30%	126
1000-P7	60-2300 Mc	0-20 Mc		0-100%	126
ACCESSORIES					
1000-P4	Dummy Antenna				123
1000-P5	VHF Transformer (50 ohms grounded to 300 ohms balanced)				124
1000-P10	Test Loop				123

Type 805-D STANDARD-SIGNAL GENERATOR

FEATURES:

- ◆ Output voltage continuously variable up to 2 volts across 37.5 ohms, 4 volts open circuit.
- ◆ Amplitude modulation up to approximately 100%.
- ◆ Exceptionally good frequency stability.
- ◆ Tuned amplifier minimizes reaction of output circuit on carrier frequency.
- ◆ Tuned circuit is heavily damped to prevent side-band clipping.
- ◆ Incremental-frequency dial with 0.01%-frequency change per division.
- ◆ Regulated power supply eliminates the effects of line-voltage fluctuations.
- ◆ Simplified controls, well suited to production-line testing by unskilled personnel.

USES: The TYPE 805-D Standard-Signal Generator is designed primarily as a precision laboratory instrument for rapid and accurate testing of radio receivers. Because of its accuracy, wide frequency range, and high voltage output, it is a valuable instrument for laboratories engaged in research and design on radio receivers and allied apparatus, while its speed and simplicity of operation make it well adapted to production testing.

It can be used for testing video i-f circuits by the addition of a TYPE 1000-P6 Crystal-Diode Modulator.

For intermittent sweep applications, the TYPE 1750-A Sweep Drive (page 127) can be used. The sweep range is $\pm 1\%$ of the operating frequency.

Owing to its excellent frequency stability, this generator is a suitable source of test voltage to display the response of narrow-band devices, such as crystal filters.

DESCRIPTION: Functionally this instrument consists of (1) a carrier-frequency oscillator, (2) a tuned radio-frequency amplifier, (3) a resistive output attenuator and a voltmeter to read the output level, (4) a modulating oscillator (400 cps and 1000 cps) with a voltmeter for reading percentage modulation, and (5) a well-regulated power supply.

The oscillator and amplifier assemblies are virtually identical in construction, and the coil-switching assemblies, as well as the tuning capacitors, are ganged and driven from common panel controls. Seven coils covering the frequency range from 16 kc to 50 Mc are carried on a rotary turret. An eighth coil position is provided for use

within this frequency range where bandspread use is desired, or to avoid awkward band-switching operations. The turret is driven from a panel knob through a gear mechanism, which also brings into panel view a frequency-range identification dial. As each coil is rotated into position, it is connected into circuit through silver-overlaid contact blades, which firmly engage silver-alloy brushes mounted on the tuning capacitor. The contacts are mounted on polystyrene strips, ensuring both low capacitance and low dielectric losses.

The main tuning capacitors are exceptionally rugged, with cast frames and ball bearings.

The output system consists of a vacuum-tube voltmeter, a resistive attenuator network, a 3-foot, 75-ohm output cable, and a TYPE 805-P1 Termination Unit. The effective output impedance at the panel terminals is nominally 75 ohms. The TYPE 805-P1 Unit permits a choice of three output impedances: 37.5, 7.1, or 0.75 ohm. The voltmeter reads the open-circuit output voltage directly for the 37.5-ohm termination. For the two lower impedances, the voltmeter reading is divided by 10 and 100 respectively. A standard broadcast-band dummy-antenna output is also provided.

The TYPE 805-P2 Termination Unit can be used to convert the 75-ohm output of the generator to an effective 50-ohm output. The TYPE 1000-P4 Dummy Antenna can then be used (page 123).

With either termination unit, the panel meter indicates the output voltage behind the effective impedance.

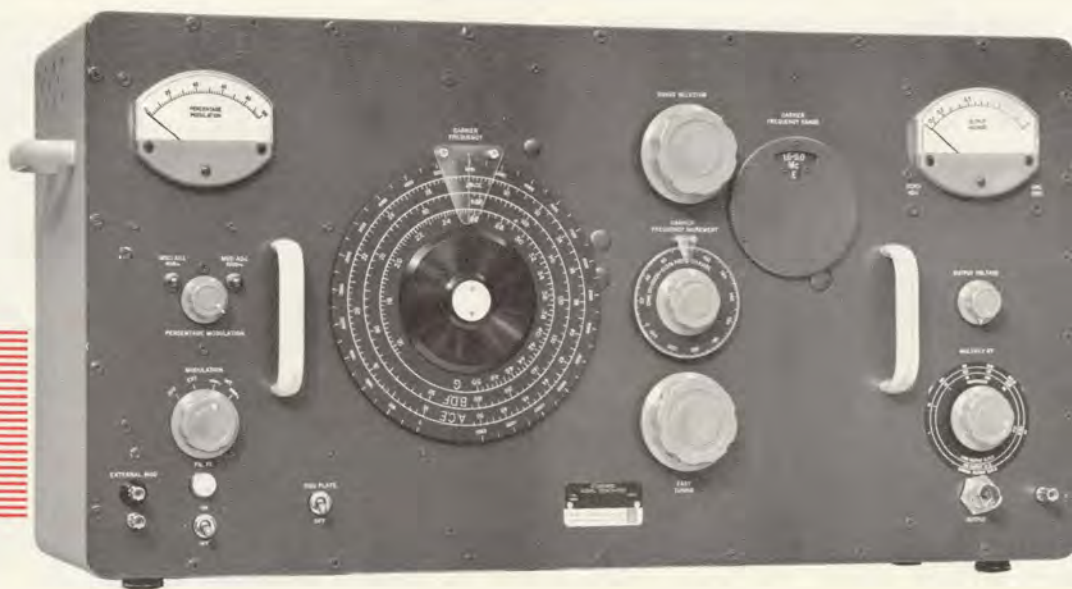

Typical frequency drift from cold start.

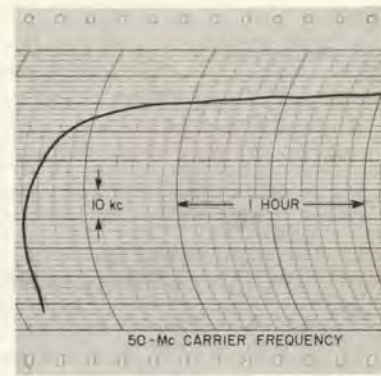
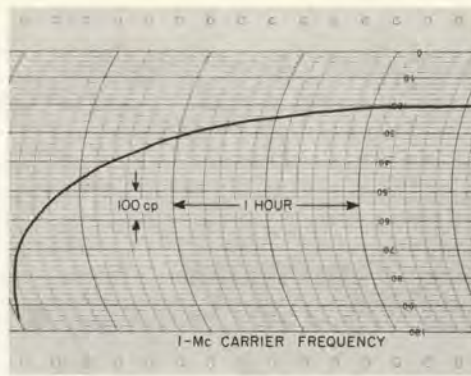
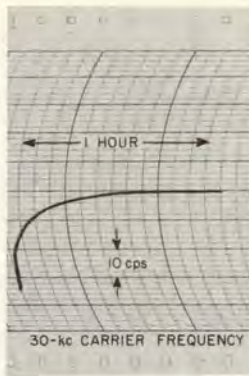

SPECIFICATIONS

CARRIER FREQUENCY

Range: 16 kc to 50 Mc, covered in seven direct-reading ranges: 16 to 50 kc, 50 to 160 kc, 160 to 500 kc, 0.5 to 1.6 Mc, 1.6 to 5.0 Mc, 5.0 to 16 Mc, 16 to 50 Mc.

Scale: Logarithmic.

Vernier Dial: A slow-motion vernier drive dial is provided, by means of which frequency increments as small as 0.01% may be obtained.

Accuracy: Each range is direct reading to an accuracy of $\pm 1\%$ of the indicated frequency.

Stability: Drift not greater than $\pm 0.1\%$ on any frequency range with continuous operation for five hours.

Sweep: Maximum sweep range with the TYPE 1750-A Sweep Drive is approximately 2%, i.e., $\pm 1\%$ of center frequency. Sweeping is not recommended for continuous or production-line use.

OUTPUT

Output Range: Continuously adjustable from 0.1 microvolt to 2 volts. The output voltage (at the termination of the 75-ohm output cable) is indicated by a panel meter and seven-point multiplier. Maximum open-circuit voltage with termination removed is 4 volts.

Voltage Accuracy: For multiplier settings below 1 volt the maximum error in output voltage is the sum of the attenuator and voltmeter errors listed below. Maximum voltmeter error, up to 25 Mc, is $\pm 5\%$ of indicated reading. Above 25 Mc an additional frequency error occurs, amounting to a total of $\pm 7\%$ at 50 Mc. At $1/10$ full scale and 50 Mc, there is also a transit-time error of -5% in the voltmeter tube. Maximum attenuator error is as follows:

- Below 3 Mc, $\pm (3\% + 0.1 \text{ microvolt})$
- 3 to 10 Mc, $\pm (5\% + 0.2 \text{ microvolt})$
- 10 to 30 Mc, $\pm (10\% + 0.4 \text{ microvolt})$
- 30 to 50 Mc, $\pm (15\% + 0.8 \text{ microvolt})$

There is no error for the 1-volt multiplier setting.

Impedance: The output impedance at the panel jack is 75 ohms resistive. A 75-ohm output cable is provided, together with a termination unit that furnishes constant output impedances of 37.5, 7.1, or 0.75 ohm. The calibration of the panel voltmeter-multiplier combination is in terms of the actual voltage across the 37.5-ohm output. When the 7.1- and 0.75-ohm positions are used, the indicated output voltage must be divided by 10 and 100, respectively. A standard dummy-antenna output is also available at the termination unit.

The TYPE 805-P2 Termination Unit can be used to convert the effective output impedance of the generator from 75 to 50 ohms. It also permits the use of 50-ohm accessory units (page 123).

Modulation: Continuously variable from 0 to approximately 100%. The percentage of modulation is indicated by a panel meter to an accuracy of $\pm 10\%$ of full scale up to 80%, for carrier frequencies below 16 Mc; $\pm 15\%$ for higher carrier frequencies.

Internal modulation is available at 400 cps and 1000 cps, accurate in frequency within $\pm 5\%$.

The generator can be modulated by an external oscillator. Approximately 10 volts across 500,000 ohms are required for 80% modulation. The over-all modulation frequency characteristic for constant audio input is as follows:

Carrier Frequency	Audio Range	Flatness
0.5 — 50 Mc	50 — 15,000 cps	$\pm 1 \text{ db}$
0.1 — 0.5 Mc	50 — 10,000 cps	$\pm 1.5 \text{ db}$
16 — 100 kc	50 cps — 10% of carrier frequency	$\pm 1.5 \text{ db}$

Incidental Frequency Modulation: On the highest carrier-frequency range the incidental frequency modulation is about 0.05% for 100% modulation, and 0.02% for 30% modulation. At lower carrier frequencies the frequency modulation is less than these percentages.

Above 20 Mc, for applications where incidental fm must be negligible or for wideband modulation, the TYPE 1000-P6 Crystal-Diode Modulator should be used.

Residual Frequency Modulation:

- Less than 2 cps for carrier frequencies below 5 Mc.
- Less than 30 cps for carrier frequencies below 16 Mc.
- Less than 75 cps for carrier frequencies below 50 Mc.

Distortion and Noise Level:

Envelope Distortion — Less than 5% at a modulation level of 80% with a carrier frequency of 1 Mc.

Carrier Noise Level — At least 40 db below 80% modulation.

Leakage: The magnetic induction leakage is less than 5 microvolts per meter at a distance of 2 feet from the generator. The 3-foot output cable permits the receiver under test to be kept beyond this limit. Radiation fields are negligible.

GENERAL

Terminal: A TYPE 874 Coaxial Connector. Adaptors to other commonly used coaxial types are listed on page 64.

Power Requirements: 105 to 125 (or 210 to 250) volts, 40 to 60 cps. An electronic voltage regulator compensates for line-voltage fluctuations from 105 to 125 volts (or from 210 to 250 volts). Maximum input power is 150 watts.

The instrument will operate satisfactorily on power-supply frequencies up to 400 cps, provided that the supply voltage is at least 115 volts.

Accessories Supplied: TYPE 805-P1 Termination Unit, shielded output cable, TYPE CAP-22 Power Cord, and spare fuses.

Other Accessories Available: TYPE 805-P2 Termination Unit, TYPE 1000-P Accessories (page 123) and TYPE 1750-A Sweep Drive (page 127).

Cabinet: Lab bench (see page 210).

Dimensions: Width 33, height 16, depth 13 inches (840 by 410 by 330 mm), over-all.

Net Weight: 118 pounds (54 kg).

Shipping Weight: 177 pounds (81 kg).

Type		Code Number	Price
805-D	Standard-Signal Generator Termination Unit	0805-9704	\$2250.00
805-P2		0805-9602	25.00

PATENT NOTICE. See Note 4, page viii.



Type 1001-A STANDARD-SIGNAL GENERATOR

FEATURES:

- ◆ Very low residual output and stray field.
- ◆ Excellent stability and low drift are assured by high-quality components, low power consumption, and regulated power supply.
- ◆ An aperiodic output amplifier avoids sideband clipping and minimizes reaction of attenuator setting or load on carrier frequency.
- ◆ Output cable termination can be removed for matching into a 50-ohm system.
- ◆ Simplicity of design and construction has resulted in an unusually sturdy instrument of small size, low weight, and long life.

USES: The TYPE 1001-A Standard-Signal Generator is a laboratory instrument for use in determining the performance of receivers and other equipment at ultrasonic and radio frequencies. Its sturdy construction and simplicity of operation make it suitable for production testing. Because of its small size, light weight, and low power consumption, it can be adapted for use in field-strength measurements.

At frequencies above 20 Mc, the TYPE 1000-P6 Crystal-Diode Modulator can be used to produce externally excited broadband amplitude modulation essentially free from incidental fm.

The frequency can be swept over a maximum range of 14% by the TYPE 1750-A Sweep Drive, which attaches to the slow-motion dial.

DESCRIPTION: The Hartley-type carrier-frequency oscillator covers the frequency spectrum from 5 kc to 50 Mc in eight ranges. The plates of the main tuning capacitor are shaped to give a logarithmic variation of frequency with angular rotation. The precision of frequency setting, therefore, is constant, and the vernier dial is calibrated directly in percentage frequency increments.

A buffer amplifier is used between the oscillator and the low-impedance output circuits. The amplifier is grid modulated to provide amplitude modulation from zero to 80%. Loose coupling between the oscillator and the amplifier minimizes incidental frequency modulation. The attenuator system and the output meter are coupled to the amplifier through a high-pass filter, which reduces voltages of the modulation frequency in the output.

The output voltage is determined by establishment of a fixed carrier level at the attenuator input and by the setting of two attenuator controls. The carrier level is set by adjustment of the plate-supply voltage of the oscillator and is indicated by a vacuum-tube voltmeter at the attenuator input. The attenuator system consists of a continuously adjustable L network controlled by the output dial and a decade ladder-network attenuator.

The modulation circuits include a 400-cycle RC oscillator for internal modulation and a germanium-crystal rectifier to determine modulation percentage. Percentage modulation is read on the same panel meter that indicates the carrier output level.

SPECIFICATIONS

CARRIER FREQUENCY

Range: 5 kc to 50 Mc covered in eight direct-reading ranges: 5 to 15 kc, 15 to 50 kc, 50 to 150 kc, 150 to 500 kc, 0.5 to 1.5 Mc, 1.5 to 5 Mc, 5 to 15 Mc, and 15 to 50 Mc.

Scale: Logarithmic up to 15 Mc, departing slightly from the logarithmic scale at higher frequencies.

Vernier Dial: Frequency increment is 0.1% per dial division at frequencies up to 15 Mc.



Accuracy: $\pm 1\%$.

Stability: Warmup drift is of the order of 0.25%. Half the maximum drift is reached in approximately $1\frac{1}{2}$ hours.

Sweep: Maximum sweep range with the TYPE 1750-A Sweep Drive is 14%.

OUTPUT

Voltage Range: Open-circuit output voltage at the attenuator jack is continuously adjustable from 0.1 microvolt to 200 millivolts. With output cable terminated at both ends, output voltage is continuously adjustable from 0.05 microvolt to 100 millivolts. Open-circuit output voltage at the 2 VOLTS panel jack is measured directly by the output meter and is 2 volts if the meter is set to the reference mark. This voltage is available up to at least 15 Mc.

Voltage Accuracy: At frequencies below 10 Mc, when the output dial is set near full scale or one-tenth full scale, the output voltage is correctly indicated to $\pm(6\% + 0.1 \mu v)$. With the output dial set in the mid-scale region, the error may be greater by 4%. At frequencies above 10 Mc, when the output dial is set near full scale, the output voltage is correctly indicated to an accuracy of $\pm(10\% + 0.3 \mu v)$, and the error may be as much as 10% larger or smaller at other output dial settings.

The accuracy of the open-circuit output voltages at the 2 VOLTS panel jack is $\pm 3\%$ at mid-frequencies.

Impedance: Output impedance at the attenuator jack is 10 ohms (50 ohms when the series unit is used) except for the highest output position of the attenuator, where it is 50 ohms.

Output impedance at the end of the terminated cable is 25 ohms. Output impedance at the 2 VOLTS panel jack is 300 ohms.

Use of the TYPE 1000-P4 Dummy Antenna provides a standard (IRE) test impedance. A known induction field is obtainable with the TYPE 1000-P10 Test Loop (for testing loop receivers).

Amplitude Modulation: Adjustable from zero to 80%. Modulation percentage is indicated on the panel meter and is accurate within $\pm 10\%$ of the indicated value, with a possible additional error of 2% modulation.

The internal modulation frequency is 400 cps $\pm 5\%$.

The external modulation characteristic is flat within ± 1 db from 20 cps to 15 kc. For 80% modulation, the external audio oscillator must supply 12 volts into a 4000-ohm load (36 milliwatts).

Incidental Frequency Modulation: At 80% amplitude modulation, the incidental frequency modulation varies from 30 to 300 parts per

million over each carrier-frequency range except for the highest range (15 to 50 Mc) where it may be three times as great. At lower modulation percentages, frequency modulation is approximately proportional to modulation percentage.

For applications above 20 Mc, where incidental frequency modulation must be very low, the use of the TYPE 1000-P6 Crystal-Diode Modulator (page 126) is recommended.

Distortion and Noise Level

Envelope Distortion: Less than 8% at 80% amplitude modulation.

Carrier Noise Level: Corresponds to about 0.1% modulation.

Carrier Distortion: Of the order of 7% on all except the lowest range, where it may increase to approximately 15%.

Leakage: Stray fields at 1 Mc are less than one microvolt per meter two feet from the generator.

Terminals: TYPE 874 Coaxial Connectors, recessed, locking. For connection to type N, BNC, TNC, SC, C, or UHF connector, use a locking adaptor (page 64), which locks securely in place, yet is easily removed. Panel connector is recessed, and adaptor projects only about an inch from panel.

GENERAL

Power Requirements: 105 to 125 (or 210 to 250) volts, 40 to 60 cps. Power input is approximately 65 watts.

This instrument will also operate satisfactorily on power-supply frequencies up to 400 cps, provided that the supply voltage is at least 115 volts.

Accessories Supplied: TYPE 874-R22A Coaxial Cable, TYPE 1000-P1 50-Ohm Termination Unit, TYPE 1000-P2 40-Ohm Series Unit, TYPE 874-Q2 Adaptor, TYPE TO-44 Adjustment Tool (stored in cabinet), TYPE 274-MB Plug, TYPE 874-C58A Cable Connector, TYPE CAP-22 Power Cord, and spare fuses.

Other Accessories Available: Not supplied but available on order are the TYPE 1000-P4 Standard Dummy Antenna, the TYPE 1000-P10 Test Loop, the TYPE 1000-P6 Crystal-Diode Modulator (pages 123 and 126), and the TYPE 1750-A Sweep Drive (page 127).

Cabinet: Lab bench (see page 210). A recessed compartment is built into the top of the cabinet for storing accessories.

Dimensions: Width $20\frac{1}{4}$, height $13\frac{3}{4}$, depth 11 inches (515 by 350 by 280 mm), over-all.

Net Weight: 54 pounds (25 kg).

Shipping Weight: 67 pounds (31 kg).

Type	Code Number	Price
1001-A Standard -Signal Generator	1001-9701	\$995.00

PATENT NOTICE. See Note 4, page viii.

Type 1000-P10 TEST LOOP

With this shielded test loop, radio receivers with loop antennas can be tested by the preferred method of the 1948 "Standards on Radio Receivers, Methods of Testing Amplitude-Modulation Broadcast Receivers," published by the Institute of Radio Engineers. The 3-turn loop is enclosed in aluminum tubing for electrostatic shielding. The field strength in volts per meter, at a distance of 19 inches from the loop, is equal to one-tenth the signal-generator output in volts, with a 50-ohm generator.

Maximum Frequency: 3 Mc.

Accuracy: $\pm 10\%$ ($\pm 5\%$ is typical); with TYPE 1001-A Standard-Signal Generator, $\pm 15\%$ ($\pm 10\%$ is typical).

Dimensions: Width $11\frac{3}{4}$, height $16\frac{1}{2}$, depth $3\frac{1}{2}$ inches (300 by 420 by 89 mm), over-all.

Net Weight: $4\frac{1}{2}$ pounds (2.1 kg).

Shipping Weight: 6 pounds (2.8 kg).

Type	Code Number	Price
1000-P4 Dummy Antenna	1000-9604	\$16.00
1000-P10 Test Loop	1000-9610	50.00

Type 1000-P4 DUMMY ANTENNA

Connected to the terminated output of a standard-signal generator of 50-ohm output impedance (25 ohms), this dummy antenna provides the output characteristics specified by the Institute of Radio Engineers in 1948 "Standards on Radio Receivers, Methods of Testing Amplitude-Modulation Broadcast Receivers."

Dimensions: Diameter $\frac{7}{8}$, length $4\frac{3}{8}$ inches (23 by 115 mm).

Net Weight: $3\frac{1}{4}$ ounces (0.1 kg). **Shipping Weight:** 2 pounds (1 kg).



Type 1021 STANDARD-SIGNAL GENERATOR

FEATURES:

- ♦ Wide frequency coverage in single dial range.
- ♦ Good frequency stability.
- ♦ Accurately known output voltage, frequency, and impedance.
- ♦ Auxiliary calibration in db below one milliwatt.
- ♦ High output. ♦ Excellent shielding.
- ♦ Readily interchangeable vhf and uhf oscillator units.
- ♦ A wide variety of coaxial accessories. ♦ Ease of operation.

USES: These standard-signal generators are as reliable and as convenient at very-high and ultra-high frequencies as conventional standard-signal generators are at much lower frequencies. They can be used to determine radio receiver and amplifier characteristics in the engineering laboratory and in production, as well as to supply power at vhf and uhf frequencies for bridges, slotted lines, and other measuring devices.

The simple TYPE 1000-P6 Crystal-Diode Modulator and a source of video signals, such as a standard television receiver tuned to a local television station, can be used to produce television picture modulation of the signal generator output on all vhf and uhf channels.

With the TYPE 1000-P7 Balanced Modulator, up to 100% amplitude modulation and pulsing with very low residual carrier level are possible at frequencies above 60 Mc.

The frequency can be swept over a range of about 10% by means of the TYPE 1750-A Sweep Drive, which can be attached to the slow-motion dial.

DESCRIPTION: Each TYPE 1021 Standard-Signal Generator is a compact instrument of simple, rugged, durable design. For flexibility and economy, each signal generator is made up of two units mounted in a single cabinet. The power supply, modulator, and metering system comprise one unit, and one of the readily interchangeable carrier-oscillators the other unit.

As noted in the price table, individual tuning units can be furnished for use with one common power supply and cabinet assembly. Power supply and cabinet assembly can also be purchased separately.

These generators have provisions for external and 1000-cycle sine-wave internal amplitude modulation.

The frequency-determining elements are butterfly circuits. A mutual-inductance-type attenuator, with a dial calibrated in both voltage and db below one milliwatt, is used.

The output voltmeter is connected across the output of the attenuator. The accuracy of the output voltage at the reference point is thus determined by the voltmeter alone and is unaffected by the length of cable between the pickup loop in the mutual-inductance-type attenuator and the point where the voltage is measured. The open-circuit output voltage is that indicated by the meter; the output impedance is 50 ohms (see diagram on facing page). Voltages between 0.5 and 2 volts are indicated directly on the meter. For lower voltages, the output is first set to 0.5 volt, and the movable attenuator index is set to the 0.5-volt point on the attenuator dial. Lower voltages are then indicated directly on the attenuator dial, as long as the load is unchanged. For ultra-high frequencies, this system gives more accurate output indications than the more common arrangement with the voltmeter at the attenuator input.

SPECIFICATIONS

TYPE 1021-AU UHF STANDARD-SIGNAL GENERATOR

CARRIER FREQUENCY

Range: 250 Mc to 940 Mc in one band.

Accuracy: Direct reading to $\pm 1\%$. Approximately 8 turns of the 100-division slow-motion dial cover the range of the main dial.

Sweep: The TYPE 1750-A Sweep Drive, attached to the slow-motion dial, will sweep the frequency approximately 5% and 15% at the low- and high-frequency ends of the range, respectively.

OUTPUT (1) As voltage generator with accurately known output

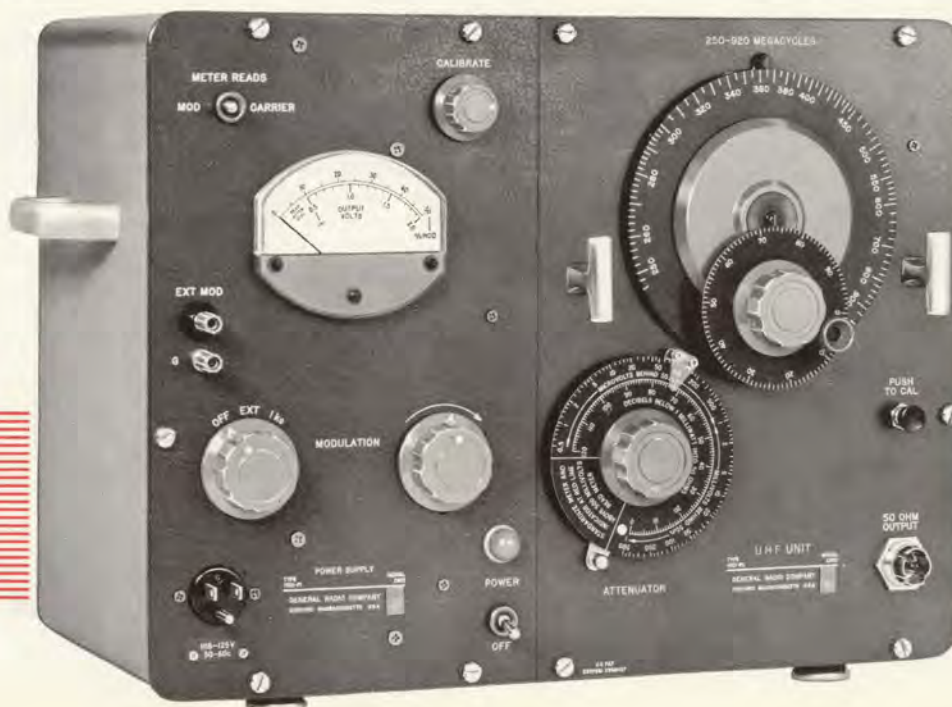

40 TO 940 Mc
IN TWO MODELS

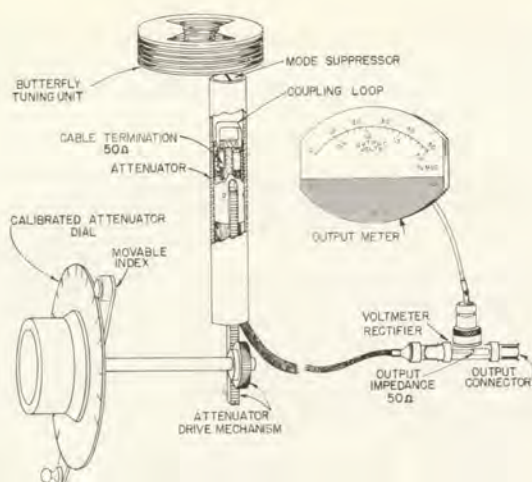

Functional diagram of output system.

impedance and (2) in terms of available power (db below one milliwatt).

Voltage Range: Continuously adjustable from 0.5 microvolt to 1 volt behind 50 ohms.

Voltage Accuracy: Over-all accuracy of output is better than ± 2 db. The accuracy of voltmeter calibration between 0.5 and 1.0 volt is better than ± 1 db. The accuracy of the attenuator-dial calibration for voltages between 1.0 microvolt and 0.1 volt is better than ± 0.5 db; from 0.1 volt to 0.5 volt, better than ± 1 db.

Impedance: 50 ohms $\pm 10\%$, following the output meter.

Power: Directly calibrated from 0 to 126 db below 1 milliwatt into 50 ohms.

Amplitude Modulation: Adjustable, 0 to 50%. Internal, 1000 cps $\pm 5\%$. External, flat within 3 db from 30 cps to 15 kc. For 50% modulation, external audio oscillator must supply 18 volts across a 100-kilohm load. The TYPE 1311-A Audio Oscillator or TYPE 1210-C Unit R-C Oscillator is recommended.

Incidental Frequency Modulation: For 50% amplitude modulation the incidental fm is approximately 100 parts per million for frequencies up to 400 Mc and is approximately 1000 parts per million at 920 Mc.

When lower values of incidental fm are required, the TYPE 1000-P6 Crystal-Diode Modulator or the TYPE 1000-P7 Balanced Modulator (page 126) is recommended.

Distortion and Noise Level:

Envelope Distortion: Approximately 5% at 50% modulation.

Carrier Noise Level: Corresponds to about 0.2% modulation.

Leakage: Stray fields and residual output voltage are sufficiently low for measurements on receivers of one-microvolt sensitivity.

Terminal: Locking TYPE 874 Coaxial Connector. This instrument can be equipped with type N, BNC, TNC, SC, C, or UHF connector through the use of locking adaptors, listed on page 64.

GENERAL

Power Requirements: 105 to 125 (or 210 to 250) volts, 50 to 60 cps. Power input is approximately 50 watts at 115 volts.

This instrument will operate satisfactorily on power-supply frequencies up to 400 cps, provided that the supply voltage is between 110 and 125 volts.

Accessories Supplied: TYPE 874-R22A Patch Cord, TYPE 874-C58A Cable Connector, TYPE CAP-22 Power Cord, and spare fuses.

Other Accessories Available: TYPE 874 Fixed Attenuators, TYPE 874 Coaxial Elements (pages 59 to 72), TYPE 1000-P6 Crystal-Diode Modulator, TYPE 1000-P7 Balanced Modulator (page 126).

Cabinet: Lab bench (see page 210). The left-hand side houses the TYPE 1021-P1 Power Supply; the right-hand side houses the TYPE 1021-P2 UHF Unit.

Dimensions: Width 20 1/4, height 13 1/2, depth 11 inches (515 by 345 by 280 mm), over-all.

Net Weight: 37 1/2 pounds (17.5 kg).

Shipping Weight: 50 pounds (23 kg).

TYPE 1021-AV VHF STANDARD-SIGNAL GENERATOR

Same as TYPE 1021-AU (above) except as noted

Carrier-Frequency Range: 40 to 250 Mc in two bands, 40 to 50 Mc and 50 to 250 Mc.

Sweep: The TYPE 1750-A Sweep Drive, attached to the slow-motion dial, will sweep the frequency approximately 4, 9, and 20% at 40, 50, and 250 Mc, respectively.

Incidental Frequency Modulation: For 50% amplitude modulation the incidental fm is approximately 100 parts per million for frequencies up to 100 Mc, and is approximately 500 parts per million at 250 Mc. When lower values of incidental fm are required, the TYPE 1000-P6 Crystal-Diode Modulator or the TYPE 1000-P7 Balanced Modulator (page 126) is recommended.

Cabinet: Same as for TYPE 1021-AU, above. Generator consists of the TYPE 1021-P1 Power Supply and TYPE 1021-P3B VHF Unit.

Type		Code Number	Price
1021-AU	UHF Standard-Signal Generator, 250-940 Mc	1021-9939	\$795.00
1021-AV	VHF Standard-Signal Generator, 40-250 Mc	1021-9827	795.00
1021-P2	UHF Oscillator Unit* only, 250-940 Mc	1021-9602	475.00
1021-P3B	VHF Oscillator Unit* only, 40-250 Mc	1021-9920	475.00
1021-P1	Power Supply (includes modulator unit and cabinet)	1021-9601	320.00

PATENT NOTICE. See Notes 4 and 10, page viii.

* Less power supply unit and cabinet. Can replace oscillator unit in signal generator listed above, to provide additional frequency range.



Type 1000-P5 VHF TRANSFORMER

50 Ohms, Grounded, to 300 Ohms, Balanced

The TYPE 1000-P5 VHF Transformer is designed to plug into a standard-signal generator having a 50-ohm grounded output and to produce an equal, balanced, open-circuit voltage behind a 300-ohm balanced impedance for measurements of fm and receivers.

One end of the transformer is terminated in a socket designed to receive the Alden TYPE HA902P Connector for standard 300-ohm open parallel-wire line; the other end has a TYPE 874 Coaxial Connector.

Dimensions: Diameter 7/8, length 4 3/8 inches (23 by 115 mm).

Net Weight: 3 1/2 ounces (0.1 kg). **Shipping Weight:** 2 pounds (1 kg).

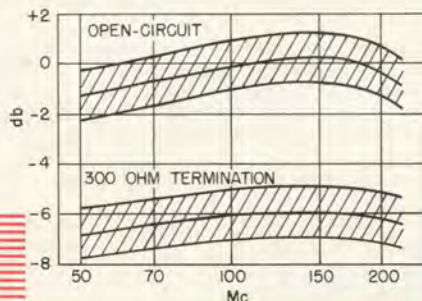

Type		Code Number	Price
1000-P5	VHF Transformer	1000-9605	\$27.50

GA Type 1000-P6 CRYSTAL-DIODE MODULATOR



This insertion-loss modulator is an inexpensive means of producing fm-free amplitude modulation. The diode resistance varies with the voltage across it and thus can be modulated by an ac voltage. Inserted between generator and load, the modulator produces variations in amplitude corresponding to the variations in resistance.

SPECIFICATIONS

Carrier-Frequency Range: 20 to 1000 Mc. The insertion loss increases 10 db at a carrier frequency of 10 Mc.

Modulation-Frequency Range: 0 to 5 Mc; about 2 db down at 5 Mc.

Impedance: For use with a 50-ohm source, 50-ohm load. Impedance at modulation terminals is approximately 600 ohms.

Modulation: With 50 millivolts rf input, 30% amplitude modulation is obtainable at carrier frequencies between 20 and 1000 Mc. For optimum sine-wave modulation, an average crystal requires 1.5 volts bias, and the insertion loss is about 12 db. Approximately 0.2 volt, rms, at modulation terminals will produce 30% modulation. Maximum percentage modulation at 1000 Mc is about 30%. Maximum peak-modulation voltage is 4 volts.

Terminals: The rf and modulating terminals are TYPE 874 Coaxial Connectors. Modulation terminals accept either a TYPE 874 Coaxial Connector or a TYPE 274-M Plug. Bias terminals are TYPE 938 Binding Posts.

Crystal Diode: 1N21B.

Accessories Supplied: One TYPE 274-MB Plug.

Other Accessories Required: Terminal adaptors (pages 64 and 208),

Typical modulation characteristics for the Type 1000-P6 Crystal-Diode Modulator at various carrier frequencies.

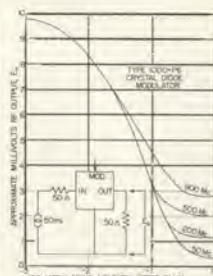

unless generator and load have TYPE 874 Coaxial Connectors; 1.5-volt battery for fixed bias, or a 3-volt battery and a 10,000-ohm rheostat for adjustable bias.

Accessories Available: TYPE 874 Fixed Attenuators, TYPE 874-R20A Patch Cord, TYPE 1000-P5 VHF Transformer, TYPE 874-Q Coaxial Adaptors.

Dimensions: Width 5, height 4, depth 1-1/16 inches (130 by 105 by 27 mm), over-all.

Net Weight: 1 pound (0.46 kg).

Shipping Weight: 5 pounds (2.3 kg).

Type	Code Number	Price
1000-P6 Crystal-Diode Modulator	1000-9606	\$45.00

PATENT NOTICE. See Note 4, page viii.

GA Type 1000-P7 BALANCED MODULATOR

USES: This instrument is an insertion-loss modulator for pulse and sine-wave modulating the output of generators over the carrier-frequency range of 60 to 2300 Mc. It is particularly useful for pulse modulation where a high degree of carrier suppression is desired with good rise-time characteristics and for linear-modulation systems where 100% modulation is required with modulating frequencies up to 20 Mc. It can be used for tests on television and radar receivers, microwave relay systems, telemetering circuits, and narrow-band systems where incidental fm must be negligible.

The balanced modulator is recommended for use with

the TYPE 1217-B Unit Pulse Generator or TYPE 1391-B Pulse, Sweep, and Time-Delay Generator for pulse-modulating output of TYPE 1021-A Standard-Signal Generator.

DESCRIPTION: Two crystal diodes are used in separate signal paths between input and output. In one path is a coaxial phasing line, set to an odd multiple of one-half wavelength at the carrier frequency. The output circuit includes a simple high-pass filter.

For small rf signals the impedances of the diodes can be controlled by variation of the applied bias.

Controls are provided for balancing out the carrier.

SPECIFICATIONS

Carrier-Frequency Range: 60 to 2300 Mc.

Modulation-Frequency Range: Flat, 0 to 20 Mc. For pulsing, rise-time is less than 0.02 microsecond.

Impedance: Input and output impedances are functions of bias and modulating voltages. Source and load impedances should be 50 ohms. Impedance at modulation input is 50 ohms \pm 5%. Where the attenuation can be tolerated, a TYPE 874-G20 (20-db) or a TYPE 874-G10 (10-db) Fixed Attenuator should be used at the input and output.

Modulation: Double-sideband, suppressed-carrier modulation, pulse modulation with 60-db carrier suppression between pulses, and 100% amplitude modulation throughout carrier-frequency range. One volt peak, at the modulation terminals, will produce full rf output from zero initial condition.

RF Output: 10 millivolts, maximum, into 50 ohms, on pulses or at modulation peaks, with a source of 50 millivolts behind 50 ohms.

Higher input and output voltages are permissible if bias and balance readjustments are made for each change in level. The rf source must not exceed 0.5 volt behind 50 ohms, or crystal diodes may be damaged.

Bias Supply: Self-contained battery of flashlight cells.

Terminals: TYPE 874 Coaxial Connectors. Adaptors are described on pages 64 and 208.

Crystal Diodes: Two TYPE 1N21-B.

Accessories Supplied: One 40-cm cable; one 80-cm cable; one TYPE 874-C58A Cable Connector.

Other Accessories Required: Suitable coaxial cable for connecting modulation source. TYPE 874-R33 (page 70) is recommended.

Accessories Available: TYPE 874-G Fixed Attenuators (page 69); TYPE 1000-P5 VHF transformer; TYPE 874-R Patch Cords (page 70).

Dimensions: (Fully extended) — width 30, height 3, depth 5 inches (765 by 77 by 130 mm), over-all. Length with line telescoped — 20 inches (510 mm).

Net Weight: 6 pounds (2.8 kg).

Shipping Weight: 13 pounds (6 kg).

Type	Code Number	Price
1000-P7 Balanced Modulator	1000-9607	\$245.00

PATENT NOTICE. See Note 4, page viii. All signal generators and accessories are equipped with TYPE 874 Coaxial Connectors.

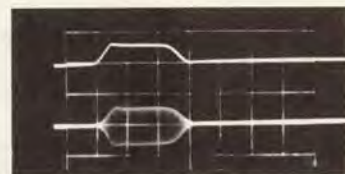
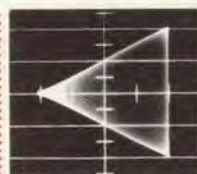

(Left) Amplitude-modulation characteristic at 900 Mc. Peak rf output is 10 millivolts; rf input, 50 millivolts. (Right) Oscillogram showing modulation pulse and rf output pulse. Pulse duration is 0.25 μ sec with 0.05- μ sec rise time. Carrier frequency is 60 Mc. Scale is 0.1 μ sec per horizontal division.

Type 907, 908 DIAL DRIVES

These dial drives are an inexpensive means for adapting manually operated equipment to sweep operation. They can be installed directly in place of the vernier knob on TYPE 908 and 907 Dials (page 206).

Each drive is powered by a synchronous motor. When the drive encounters a mechanical stop, the TYPE 908-P3 stops; the others reverse automatically. Adjustable stops that clamp on the dial are furnished; power switch and power cord are included.

TYPE 908-P SYNCHRONOUS DIAL DRIVES can be used on all TYPE 907 and 908 Precision Dials. The synchronous-motor drive supplies the equivalent of a horizontal time calibration.

Power Requirements: 105 to 125 volts, 50-60 cps, 3 watts.

TYPE 907-R AND 908-R DIAL DRIVES supply a sweep voltage proportional to angle of rotation. One knob engages or disengages the motor, and the second knob permits manual setting at any point and direct manual drive. A dc voltage, applied to an internal potentiometer, permits use with a wide range of dc output levels. Binding posts for the position-signal output are also provided.



(Left) Type 908-R96 Dial Drive installed on a Type 1215-C Unit Oscillator.

(Right) Type 908-P2.

Power Requirements: 105 to 125 volts, 50 to 60 cps, 3 watts.

Potentiometer: 20,000 ohms.

Maximum current: 10 ma.

Drive Type	Dial Type	Dial Speed °/min	Resolution	Recommended Display	Will Drive These Instruments	Dimensions	Net Weight	Code Number	Price				
908-P1	907	144		Graphic Recorder	1208-C, 1209-C, -CL, 1211-C, 1215-C, 1330-A, 1304-B, 1210-C, 1300-A, 1360-A, 1361-A	Depth 3, dia 3 3/8 in. (76 by 92 mm)	1 1/4 lb (0.6 kg)	0908-9601	\$40.00				
	908	96											
908-P2	907	1080		Oscilloscope	1209-C, -CL, 1211-C, 1215-C, 1304-B, 1300-A, 1360-A, 1361-A			Depth 3 3/8, dia 4 in. (100 by 105 mm)	1 3/4 lb (0.8 kg)	0908-9602	40.00		
	908	720		Oscilloscope									
908-P3		135		XY Recorder	1025-A					Depth 3 3/8, dia 5 3/8 in. (100 by 150 mm)	2 lb (0.9 kg)	0908-9603	40.00
907-R144	907	144	0.4°	XY Recorder	1210-C, 1564-A, 1360-A, 1361-A								
908-R96	908	96	0.2°	XY Recorder	1208-C, 1209-C, -CL, 1211-C, 1215-C, 1300-A, 1304-B, 1305-A, 1330-A								

Type 1750-A SWEEP DRIVE FOR WIDE-RANGE AUTOMATIC DATA DISPLAY

USES: The TYPE 1750-A Sweep Drive adapts manually operated equipment to sweep operation. It can be used in the display of any electrical quantity as a function of the shaft angle of the device being swept and can be adjusted to sweep, in reciprocating motion, any arc up to 300 degrees, speeds up to 5 cps. It attaches easily to any knob, dial, or shaft. In conjunction with Unit Oscillators, it makes available an extremely versatile system of swept signal sources covering a frequency span from 20 cps to 2000 Mc. For a constant output over the entire frequency range of any one of the Unit Oscillators, the TYPE 1263-B Amplitude-Regulating Power Supply is used (see page 112).

DESCRIPTION: The output shaft is driven through an adjustable rack and a differential. Sweep frequency, arc, and center position are all adjustable while the drive is in motion. An adjustable limit switch can be set to stop the drive when predetermined limits of motion of the driven shaft are exceeded.

An oscilloscope-deflection-voltage circuit provides a horizontal deflection voltage that is proportional to shaft angle. A blanking circuit is included to eliminate the oscilloscope return trace and to produce a base line.

SPECIFICATIONS

Reciprocating Output Shaft

Center Position: Adjustable over 9-turn range.

Sweep Arc: Adjustable 30 to 300 degrees.

Torque: Rated max 24 ounce-inches. Will drive TYPES 1209-C, 1209-CL, 1211-C, 1215-C Unit Oscillators, TYPE 1361-A UHF Oscillator, TYPE 1360-A Microwave Oscillator, TYPES 1300-A and 1304-B Beat-Frequency Oscillators, TYPES 1305-A and 1330-A Oscillators, TYPE 1564-A Sound and Vibration Analyzer, TYPES 805-D, 1001-A, and 1021-A Standard-Signal Generators.

Sweep Speed: Adjustable 0.5 to 5 cps. Moment of inertia determines upper speed limit.

Height of Shaft: Adjustable, 2 1/2 to 4 7/8 inches over bench.

Flexible Coupling: 5 3/4 inches long. Couples to 1/4- and 3/8-inch shafts; knobs and dials 1 to 4 inches in diameter.

Limit Switch: Adjustable within 9 turns.

Sweep Voltage: 2.5 volts, peak-to-peak, ungrounded.

Blanking: Shorting contact closed during clockwise rotation of driven shaft, ungrounded.

Accessories Supplied: Couplings, lubricant, spare fuses.

Power Requirements: 105 to 125 volts, 50 to 60 cps, 60 watts maximum. On 400-cycle supply, maximum sweep speed is reduced 25%. A 210- to 250-volt model also is available.

Dimensions: Width 17 1/2, height 9, depth 8 1/4 inches (445 by 230 by 210 mm), over-all.

Net Weight: 22 1/2 pounds (10.5 kg).

Shipping Weight: 33 pounds (15 kg).

Type		Code Number	Price
1750-A	Sweep Drive (115 volts, 50 to 60 cps)	1750-9701	\$550.00
1750-AQ18	Sweep Drive (230 volts, 50 to 60 cps)	1750-9911	\$65.00

OTHER SIGNAL-GENERATOR ACCESSORIES
Type 874 Coaxial Elements (pages 59 to 73).



GP Type 1025-A STANDARD SWEEP-FREQUENCY GENERATOR

FEATURES:

- ♦ Wide frequency range, 0.7 to 230 Mc, plus bandsread ranges for 450 kc and 10.7 Mc.
- ♦ Accurately calibrated rf output from 1 μ v to 1 v.
- ♦ Quiet, reliable motor-driven sweep provides drift-free display.
- ♦ Display can cover any portion of selected frequency range from 1/10 to full range.
- ♦ Single, continuously variable marker is accurately calibrated in both frequency and amplitude — does not interfere with displayed response.
- ♦ Converts quickly and conveniently from sweep to true cw operation for accurate point-by-point data gathering.
- ♦ Separate high-level output for frequency measurement to counter accuracy disturbance to rf output to device under test.
- ♦ Low leakage makes possible accurate measurements at low signal levels.

USES: The standard sweep-frequency generator is an accurately calibrated source for sweep-frequency measurements, in conjunction with a cathode-ray oscilloscope or recorder, on tuned circuits, filters, i-f amplifiers, and other networks. Amplitude and frequency data can be taken directly from the displayed response by use of the calibrated marker. By simple engagement of a front panel control, the instrument becomes a stable cw generator, and the response can be displayed point-by-point without changes in the test setup. In this mode a frequency counter can be connected to the separate high-level output.

DESCRIPTION: This generator extends the standard-signal generator concept to the sweep-frequency generator.

In this instrument, the frequency of the sinusoidal output is varied in a smooth, continuous manner over a frequency band in repetitive cycles by means of a motor-driven tuning capacitor. By this means, the amplitude response of a network or device as a function of frequency can be displayed automatically on an oscilloscope. A synchronously varying horizontal deflection is provided for the oscilloscope. The large dial on the instrument indicates the frequency of a manually positioned marker on the display. The amplitude of the marker is adjustable and is monitored by a panel meter, thus providing frequency

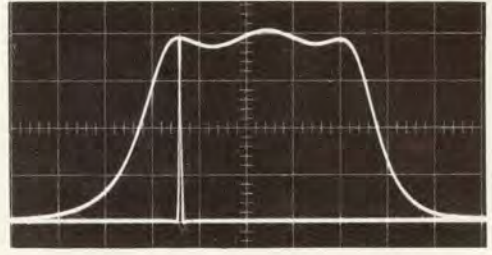

Marker is accurately calibrated in frequency and amplitude.

and amplitude calibration of the displayed response. The frequency range is covered in 10-step-switched octave bands plus 2 bandsread ranges.

The entire selected range is swept, but, by means of EXPAND DISPLAY and DISPLAY START controls, as little as one-tenth of any range can be set to occupy the full width of the oscilloscope screen.

Manual and slow-speed (with auxiliary dial drive) operation is also possible, for xy recording and point-by-point measurements. A detector probe is supplied, but the dc output of devices with built-in detectors can also be utilized.

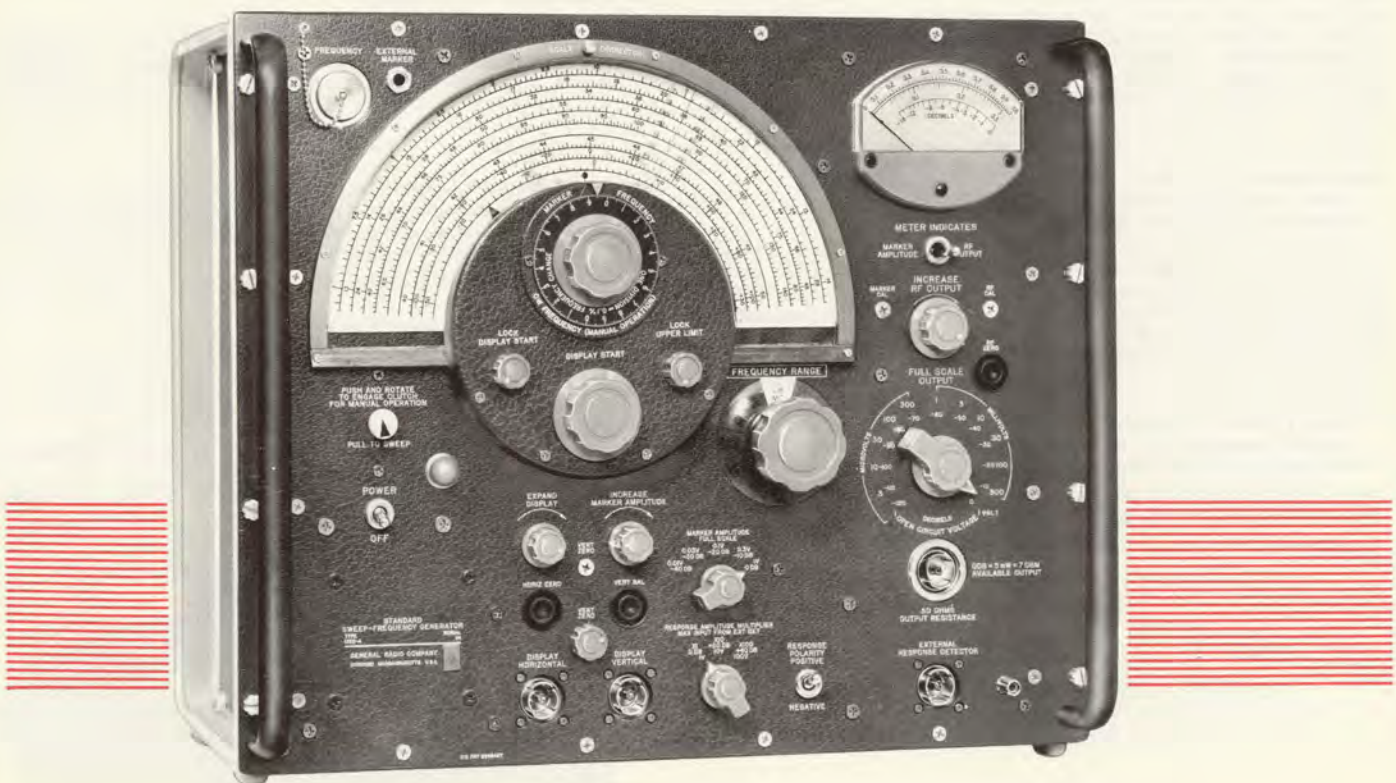

SPECIFICATIONS

FREQUENCY

Range: 0.7 to 230 Mc in 10 ranges (0.7 to 1.4, 1.3 to 2.6, 2.4 to 4.8, 4 to 8, 7 to 14, 13 to 26, 24 to 48, 40 to 80, 65 to 140, and 100 to 230 Mc) and bandspread ranges of 400 to 500 kc and 10.7 ± 0.3 Mc.

*Alternate range sectors can be substituted in the range-selector turret. Those presently available are: 0.4 to 0.8 Mc, 2 ± 0.1 Mc, 2.8 ± 0.1 Mc, 4 to 5 Mc, 16 ± 0.3 Mc, and 40 to 50 Mc. Special bandspread ranges can be provided according to the following schedule:

Specified Center Frequency	Bandwidth
Between 0.4 and 0.5 Mc	± 0.01 Mc
0.45 and 1.6 Mc	± 0.03 Mc
1.4 and 5 Mc	± 0.1 Mc
4.5 and 16 Mc	± 0.3 Mc

Control: 11-inch semicircular dial; scales are logarithmic for octave ranges up to 80 Mc, quasi-logarithmic between 65 and 230 Mc, essentially linear for all bandspread ranges. Slow-motion vernier drive dial is provided. One division on the vernier dial represents approximately 0.1% frequency difference on the octave frequency ranges.

Calibration Accuracy: At output voltages less than 0.3 volt, frequency is indicated to within $\pm 0.5\%$ when scale corrector is set to bring dial to index line. At output voltages above 0.3 volt, an external load on the output can produce frequency changes as large as $\pm 0.5\%$. With an external frequency meter, scale corrector can be used to bring dial into agreement, for frequency resolution within $\pm 0.1\%$.

Drift: Not greater than 0.3% for five hours after one-hour warmup.

Sweeping Rate: Frequency is swept from low-frequency end to high-frequency end of range in 22.2 milliseconds 20 times per second. Output is blanked off for return sweep.

Sawtooth Sweep Voltage: Adjustable in amplitude up to 100 volts, peak-to-peak. Also adjustable in starting point in the frequency range.

Marker: Internally generated marker of half-sinusoidal waveform is adjustable in amplitude from 3 millivolts to 1 volt and in frequency over the full sweep range; response amplitude multiplier effectively extends range up to 100 volts. Amplitude is indicated to an accuracy of $\pm 10\%$.

RF OUTPUT

Voltage: Adjustable from 0.3 microvolt to 1 volt behind 50 ohms (-123 to 7 dbm power into 50 ohms).

Over-all Voltage Accuracy: $\pm 14\%$ up to 100 Mc, due to maximum voltmeter and attenuator errors listed below. Above 100 Mc, harmonics may add additional error of $\pm 3\%$.

Voltmeter Error: $\pm 2\%$ ($+2\%$ of full scale reading).

Attenuator Error: 1% per step to maximum of 6%.

Stability: Output is held at preset level to within $\pm 1\%$ (0.1 db) up to 100 Mc and within $\pm 3\%$ (0.25 db) up to 230 Mc. Changes due to line-voltage variations and range switching will not exceed $\pm 3\%$ (0.25 db). A TYPE 874-R22A Patch Cord will reduce output 5% (0.4 db) at 230 Mc.

Impedance: 50 ohms resistive with a vswr of less than 1.01 at the panel jack. With a TYPE 874-R22A Patch Cord, vswr at the output of the cable will be less than 1.1 over the frequency range.

Leakage: External rf field produces negligible interference with measurements down to the lowest levels provided by the generator.

RESPONSE AMPLIFIER

Maximum Input Voltage: 1, 10, or 100 volts as selected by the response-amplifier multiplier switch. Noise level is less than 1 millivolt, peak-to-peak, referred to the input at the $\times 1$ (1 v) position of the multiplier switch, 10 millivolts at the $\times 10$ (10 v) position, and 100 millivolts at the $\times 100$ (100 v) position.

*Prices on request.

Input Impedance: 1 megohm in parallel with 30 to 45 pf.

Gain: Approximate dc amplification between external response input connector and vertical display output connector is $\times 8$ (18 db) at the $\times 1$ position of the multiplier, $\times 0.8$ at the $\times 10$ multiplier position, and $\times 0.08$ at the $\times 100$ multiplier position.

Bandwidth: Greater than 10 kc. Sufficient for passing all details of any response that can be resolved at the maximum sweep rate of the generator.

Polarity: A polarity-reversing switch is provided to give a positive display vertical output voltage with either positive or negative inputs from the external response detector.

DISPLAY OUTPUT VOLTAGES

Vertical: Up to +8 volts into 100-kilohm load, consisting of marker plus response to be displayed.

Horizontal: Up to +100 volts dc or sawtooth peak into 100-kilohm load.

GENERAL

Frequency Output Voltage: 0.1 to 0.3 volt behind 50 ohms for operating external frequency meter or external marker generator.

External Marker Input Voltage: 1 volt, peak-to-peak, into 50 kilohms. Birdie-type markers can be applied which are controlled in amplitude and added to the response displayed.

Power Requirements: 105 to 125 (or 210 to 250) volts, 60 (or 50) cps, as specified below. Maximum input power is 145 watts.

Terminals: Recessed TYPE 874 Locking Connectors, except for EXTERNAL MARKER input connector, which is a standard telephone jack. For connection to type N, BNC, TNC, SC, C, or UHF connector, use a locking adaptor (page 64), which locks securely in place, yet is easily removed. Panel connector is recessed, and adaptor projects only about an inch from panel. See also page 62.

Accessories Supplied: TYPE 1025-P1 Detector Probe, three TYPE 874-R22A Patch Cords, three TYPE 874-R33 Patch Cords, three TYPE 874-C58A Cable Connectors, six TYPE 838-B Alligator Clips, TYPE CAP-22 Power Cord, spare fuses.

Accessories Available: TYPE 874-VQ Voltmeter Detector, TYPE 874-WM 50-ohm Termination, TYPES 908-P2 and -P3 Synchronous Dial Drives.

Cabinet: Rack-bench (see page 210).

Dimensions: Bench model — width 19, height 16, depth $13\frac{3}{4}$ (485 by 410 by 350 mm), over-all; rack model — panel 19 by $15\frac{3}{4}$ inches (485 by 400 mm), depth behind panel $11\frac{1}{8}$ inches (290 mm).

Net Weight: 73 pounds (34 kg).

Shipping Weight: 108 pounds (50 kg), approximately.

Type 1025-P1 Detector Probe (supplied with instrument)

Input Impedance: 1.5 pf, in parallel with 25 kilohms up to 10 Mc decreasing to 6 kilohms at 250 Mc.

Maximum RF Voltage: 3 volts, rms.

Frequency Characteristic: Flat within 5% (0.4 db) from 0.4 to 250 Mc.

Output Polarity: Positive.

Transfer Characteristic: DC output voltage equals the rms rf voltage above 0.5-volt input; essentially square-law characteristic below 50 millivolts, rms, rf input.

Fall Time: Less than 150 μ sec, sufficiently short to follow all details of any response that can be resolved at the maximum sweep rate of the TYPE 1025-A.

For a more complete description of this instrument refer to the *General Radio Experimenter*, 37, 1, January, 1963.

<i>T</i> ype	Code Number	Price
1025-AM	Standard Sweep-Frequency Generator, Bench Model	1025-9801 \$3250.00
1025-AR	Standard Sweep-Frequency Generator, Rack Model	1025-9811 3250.00
1025-AMQ1	Standard Sweep-Frequency Generator (for 50-cycle supply), Bench Model	1025-9495 3300.00
1025-ARQ1	Standard Sweep-Frequency Generator (for 50-cycle supply), Rack Model	1025-9496 3300.00

PATENT NOTICE. See Note 4, page viii.



Type 1300-A BEAT-FREQUENCY VIDEO GENERATOR

FEATURES:

- ◆ Four major instruments in one assembly — audio beat-frequency oscillator, video beat-frequency oscillator, sweep oscillator, and square-wave generator.
- ◆ Either range, audio or video, is spanned by a single rotation of the dial.
- ◆ High resolution at any frequency is provided by the incremental-frequency dials.
- ◆ High output voltage, low distortion, excellent stability.
- ◆ Additional outputs in the 30- to 48-Mc range permit i-f circuit testing.

USES: The Beat-Frequency Video Generator provides four methods of circuit-response measurement at audio and video frequencies: point-to-point, square-wave, sweep-frequency for oscilloscope display, and automatic plotting with a graphic level recorder. Thus it has many applications, both in the laboratory and on the production line, in the testing of amplifiers, discriminators, filters, receivers,

and, in general, any networks in the range from 20 cps to 12 Mc, and, to a limited extent, from 30 to 48 Mc.

DESCRIPTION: This generator includes five internal oscillators to obtain the frequency ranges shown in the block diagram and in the specifications, two pairs to generate the two beat-frequency ranges, and a fifth, or sweep, oscillator, which replaces the high-frequency fixed oscillator for the video-sweep range. The frequency scale is logarithmic for the audio range and approximately logarithmic up to 5 Mc for the video range.

Buffer amplifiers are used between each oscillator and the pentagrid mixer to minimize coupling between the oscillators. The five-stage output amplifier uses high-transconductance tubes in a negative-feedback circuit to supply high output with low distortion and a flat frequency characteristic. A continuously adjustable level control is used at the amplifier input. The output attenuator has 10-db steps.

The square-wave generator is a Schmitt circuit driven from the output amplifier. A separate level control provides continuous adjustment of the output amplitude.

For narrow-band measurements, the frequency-increment dials can be swept by the TYPE 1750-A Sweep Drive. For xy plotting, a TYPE 908-R Dial Drive can be used.

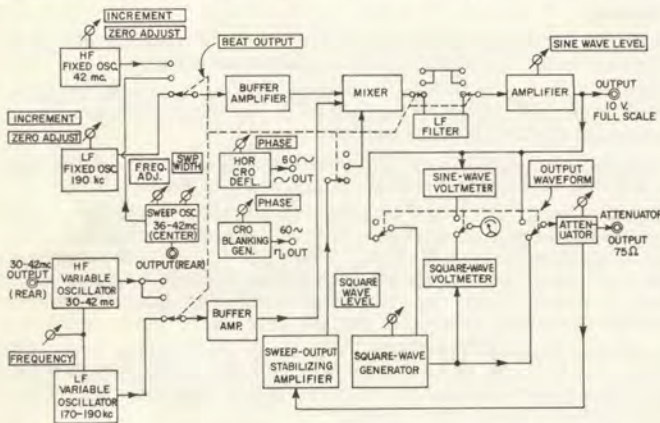

Block diagram of the Type 1300-A Beat-Frequency Video Generator.

FOUR MAJOR INSTRUMENTS IN A SINGLE PACKAGE



SPECIFICATIONS

OUTPUT

Frequency Range	Signal	Open-Circuit Amplitude	Tolerance	Impedance
20-20,000 cps	Sine Wave	0-10 v	< ±0.25 db	820 Ω ±2%
20-20,000 cps	Sine Wave	0-1 v	< ±0.25 db 40 cps-20 kc < ±0.75 db at 20 cps	75 Ω ±2% (Attenuator)
20-20,000 cps	Square Wave	0-10 v p-to-p (0-2.5 v p-to-p across 75 Ω)	< ±0.25 db	75 Ω ±2% (Attenuator)
20 kc-12 Mc	Sine Wave	0-10 v	±1 db	820 Ω ±2%
20 kc-12 Mc	Sine Wave	0-1 v	±1 db	75 Ω ±2% (Attenuator)
20 kc-2 Mc	Square Wave	0-10 v p-to-p (0-2.5 v p-to-p across 75 Ω)	±0.5 db	75 Ω ±2% (Attenuator)
20 kc-12 Mc Center Freq 0 to ±6 Mc Sweep	Sine-Wave Sweep*	0-10 v	±1 db (up to 12 Mc)	820 Ω ±2%
20 kc-12 Mc Center Freq 0 to ±6 Mc Sweep	Sine-Wave Sweep*	0-1 v	±1 db (up to 12 Mc)	75 Ω ±2% (Attenuator)
30-42 Mc	Sine Wave	Approx 50 mv	±1 db**	Approx 50 Ω
36-42 Mc Center Freq 0 to ±6 Mc Sweep	Sine-Wave Sweep*	Approx 100 mv	±2 db**	50 Ω or higher load recommended

* Sweep rate is at power-line frequency.

** Typical, not guaranteed.

FREQUENCY

Controls and Calibration: Main dial, inner scale, 20 cps to 20 kc, logarithmic, 80° per decade, scale length approximately 10 inches; outer scale, 20 kc to 12 Mc, approximately logarithmic up to 5 Mc, approaching linear distribution at high end, scale length approximately 12 inches.

Frequency-increment dials, audio -50 to +50 cps; video -20 to +20 kc.

Accuracy: Audio range, ±(1% + 1 cps) after zero-beat setting; video range, ±(1% + 1 kc) from 500 kc to 12 Mc, ±(2% + 1 kc) below 500 kc, after zero-beat setting. Frequency-increment dials, audio ±1 cps; video, ±0.5 kc. The frequency-increment dial does not operate on the video-sweep range.

STABILITY

Audio Range: The drift from a cold start is less than 20 cps in two hours.

Video Range: The drift from a cold start is less than 20 kilocycles in two hours.

Zero-Beat Indicator: Output voltmeter.

OUTPUT See table above.

Voltmeter: The panel meter indicates rms sine-wave voltage to ±3% and peak-to-peak square-wave voltage to ±5%. Auxiliary scale indicates 0- to 20-db value below full scale. The sine-wave voltmeter is connected in series with a 10-μf capacitor to the 10-volt output jack.

Attenuator: 75 ohms in eight steps of 10 db each, with an accuracy of ±1% of nominal. Sine-wave, full-scale, open-circuit voltages are 0.1 mv, 0.3 mv, 1 mv, 3 mv, 10 mv, 30 mv, 0.1 v, 0.3 v, and 1 v. Square-wave, full-scale, open-circuit voltages are 1 mv, 3 mv, 10 mv, 30 mv, 100 mv, 300 mv, 1 v, 3 v, and 10 v.

Horizontal Deflection Voltage: 4 volts at 60 cps (or power-line frequency) for horizontal deflection of a cathode-ray oscilloscope. Since both this voltage and the frequency distribution of the sweep output vary sinusoidally, the oscilloscope pattern is approximately linear. A blanking voltage (50-volt, peak-to-peak, square-wave) is also supplied.

Square-Wave Characteristics: At 60 cps, ramp-off is less than 2% of the peak-to-peak amplitude; at 20 cps, less than 5%. Rise time for frequencies from 300 kc to 2 Mc is less than 75 nanoseconds. At 20 kc the rise time is approximately 150 nanoseconds. Over-shoot is about 10% of the peak-to-peak output voltage.

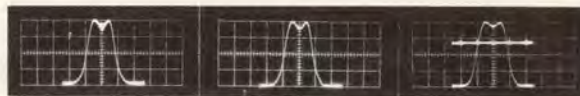

FM i-f characteristic of an fm-am tuner as measured with the beat-frequency video generator. Center frequency is 10.7 Mc; (left) with marker at 10.7 Mc; (center) same without marker; (right) with 100-kc markers from the Type 1213-D Unit Time/Frequency Calibrator. Scale, 100 kc/cm.

Harmonic Distortion: Sine-wave output, less than 1% of output on the 20-cps-to-20-kc range and less than 4% of output on the VIDEO SWEEP and 20-kc to 12-Mc ranges.

AC Hum: Less than 0.1% of the output for voltmeter readings above 10% of full scale.

Terminals: TYPE 874 Coaxial Connectors. Attenuator output has locking type, other output connectors are nonlocking. For adaptors to other types, see page 64.

GENERAL

Power Requirements: 105 to 125 (or 210 to 250) volts, 50 to 60 cps. Power input at 117 volts is approximately 175 watts, maximum. Instrument will operate normally, except for sweep output, at supply frequencies up to 400 cps.

Accessories Supplied: One TYPE CAP-22 Power Cord; two TYPE 874-R22A 50-ohm Patch Cords; one TYPE 874-413 75-ohm Patch Cord, one TYPE 874-Q2 Adaptor, three TYPE 874-C58A Cable Connectors, and spare fuses.

Other Accessories Available: TYPE 1521-A Graphic Level Recorder for automatic recording at audio frequencies; TYPE 1750-A Sweep Drive for slow-speed sweeping; TYPE 908-R Dial Drive for xy plots; TYPE 1213-D Unit Time/Frequency Calibrator for timing markers.

Cabinet: Rack-bench (see page 210).

Dimensions: Bench model—width 19, height 15¾, depth 14½ inches (485 by 400 by 370 mm), over-all; rack model—panel 19 by 15¾ inches (485 by 400 mm), depth behind panel 12¼ inches (315 mm).

Net Weight: Bench model, 64 pounds (29 kg); rack model, 61 pounds (28 kg).

Shipping Weight: Bench model, 120 pounds (55 kg); rack model, 117 pounds (54 kg).

Type		Code Number	Price
1300-AM	Beat-Frequency Video Generator, Bench Model	1300-9801	\$2450.00
1300-AR	Beat-Frequency Video Generator, Rack Model	1300-9811	2450.00

PATENT NOTICE. See Note 4, page viii.

Type 1390-B RANDOM-NOISE GENERATOR

FEATURES:

- ♦ Wide frequency range — 5 cps to 5 Mc.
- ♦ Uniform spectrum level over audio range.
- ♦ Output variable from 30 microvolts to 3 volts.
- ♦ Built-in precision attenuator.
- ♦ Low hum level by use of dc on heaters.
- ♦ Low external noise field.
- ♦ Regulated heater for gas tube, to stabilize output.

USES: This instrument generates wide-band noise of uniform spectrum level, particularly useful for noise and vibration testing in electrical and mechanical systems. Some of its many uses are:

as a broad-band signal source for

- ♦ frequency-response measurements. When the random-noise generator is used for frequency-response measurements, either the TYPE 1900-A Wave Analyzer or the TYPE 1564-A Sound and Vibration Analyzer is a satisfactory narrow-band detector. The one-third-octave band of the latter permits measurements to very low frequencies. With the TYPE 1521-A Graphic Level Recorder, continuous records of level *vs* frequency can be plotted from the output of the analyzer.
- ♦ intermodulation and cross-talk tests.
- ♦ simulation of telephone-line noise.
- ♦ measurements on servo amplifiers.
- ♦ noise interference tests on radar.
- ♦ determining meter response characteristics.
- ♦ setting transmission levels in communication circuits.

in acoustical measurements, to provide a signal for

- ♦ reverberation testing. The TYPE 1900-A Wave Analyzer and the TYPE 1564-A Sound and Vibration Analyzer can be used with this generator to produce narrow bands of noise, which are useful in acoustical measurements, especially reverberation testing.

- ♦ sound attenuation of ducts, walls, panels, or floors.
- ♦ acoustical properties of materials.
- ♦ room acoustical measurements.
- ♦ demonstrating noise properties in a classroom or laboratory.

with a suitable power amplifier to drive a loudspeaker to produce high-level acoustic noise for

- ♦ fatigue testing of structures or components.

and to drive a vibration shaker for

- ♦ structural tests of components or assemblies.

DESCRIPTION: A gas-discharge tube with a transverse magnetic field applied is used as a noise source in this instrument. The noise output of the tube is amplified in a two-stage amplifier. Between the two stages, the noise spectrum is shaped with low-pass filters to provide ranges to 20 kc, to 500 kc, and to 5 Mc.

The output system consists of a continuous attenuator control followed by a 4-step attenuator of 20 db per step. Metered levels from over 3 volts to below 30 microvolts are conveniently obtained. When the attenuator is used, the output impedance remains essentially constant as the level is varied by the continuous-output control.

The instrument cabinet is suitable for either bench or relay-rack mounting and has the added feature of extendible front legs to permit the instrument to be used in a tilted position for easier meter reading.

SPECIFICATIONS

Frequency Range: 5 cps to 5 Mc.

Output Voltage: Maximum open-circuit output is at least 3 volts for 20-kc range, 2 volts for 500-kc range, and 1 volt for 5-Mc range.

Output Impedance: Source impedance for maximum output is approximately 900 ohms. Output is taken from a 2500-ohm potentiometer. Source impedance for attenuated output is 200 ohms. One output terminal is grounded.

Typical Spectrum Level (with one-volt, rms, output): 20-kc band — 5 millivolts for 1-cps band. 500-kc band — 1.2 millivolts for 1-cps band. 5-Mc band — 0.6 millivolts for 1-cps band.

Spectrum-Level Uniformity: 20-kc range, within ± 1 db from 20 cps to 20 kc; 500-kc range, within ± 3 db from 20 cps to 500 kc; 5-Mc range, within about ± 8 db from 500 kc to 5 Mc. Noise energy is also present beyond these limits. The level is down 3 db at 5 cps. See plot.

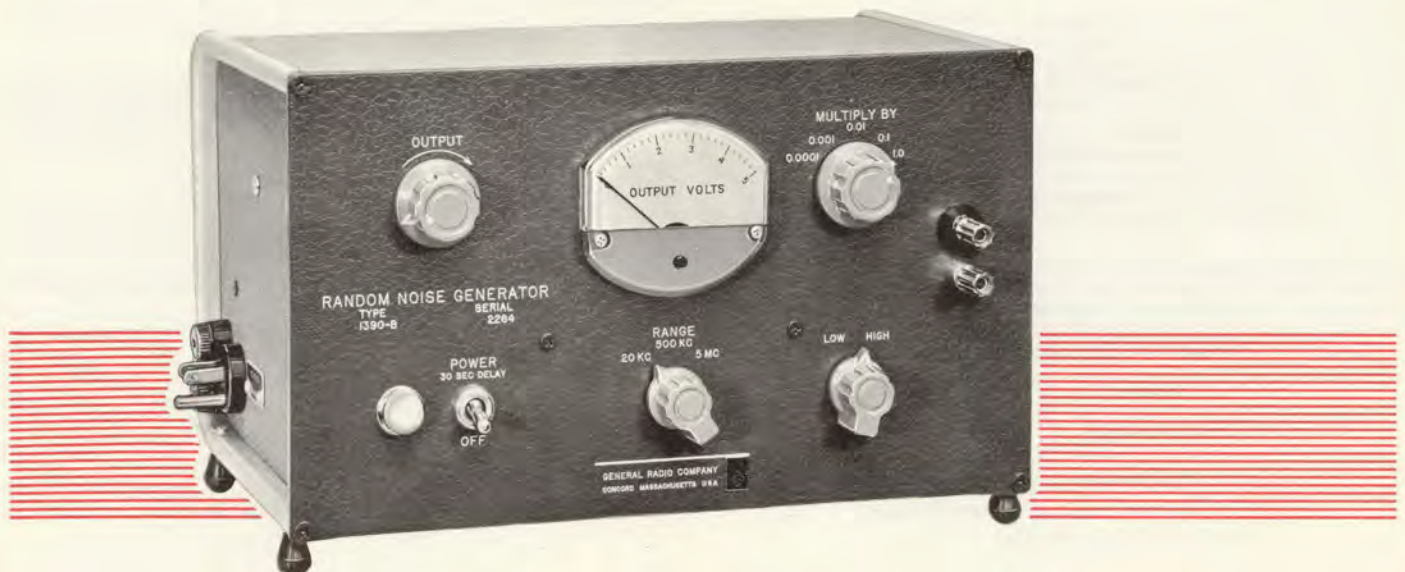

Elementary schematic of the generator.

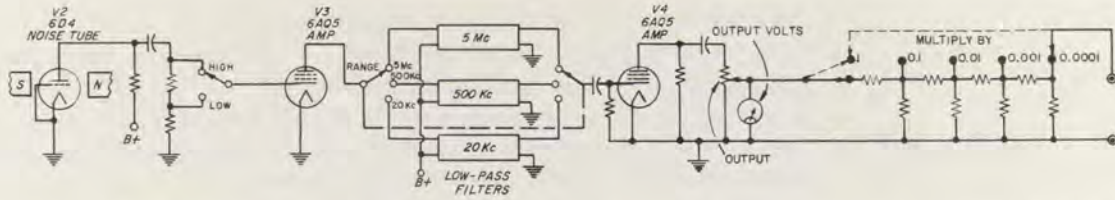

Waveform: Noise source is a gas tube that has good normal or Gaussian distribution of amplitudes for ranges of the frequency spectrum that are narrow compared to the band selected. Over wide ranges the distribution is less symmetrical because of dissymmetry introduced by the gas tube. Appreciable clipping occurs on the 500-kc and 5-Mc ranges.

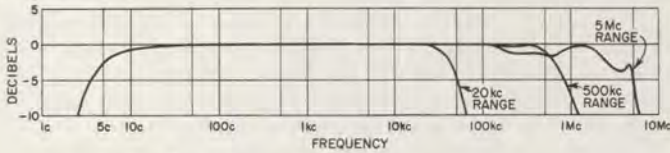

Typical spectrum-level characteristics.

Voltmeter: Rectifier-type averaging meter measures output. It is calibrated to read rms value of noise.

Attenuator: Multiplying factors of 1.0, 0.1, 0.01, 0.001, and 0.0001. Accurate to $\pm 3\%$ to 100 kc, within $\pm 10\%$ to 5 Mc.

Power Requirements: 105 to 125 (or 210 or 250) volts, 50 to 60 cps. Power input is approximately 50 watts. This generator will also operate satisfactorily on line frequencies up to 400 cps.

Accessories Supplied: TYPE CAP-22 Power Cord, spare fuses.

Cabinet: Convertible bench (see page 210).

Dimensions: Width 12 $\frac{3}{4}$, height 7 $\frac{1}{2}$, depth 9 $\frac{3}{4}$ inches (325 by 190 by 250 mm), over-all. Panel adaptor plate sets are available for 19-inch relay-rack mounting (panel height 7 inches).

Net Weight: 12 pounds (5.5 kg).

Shipping Weight: 28 pounds (12.8 kg).

For a more complete description, ask for Reprint E-110.

Type		Code Number	Price
1390-B	Random-Noise Generator Relay-Rack Adaptor Set	1390-9702	\$295.00
480-P412		0480-9642	7.00



Type 1390-P2 PINK-NOISE FILTER

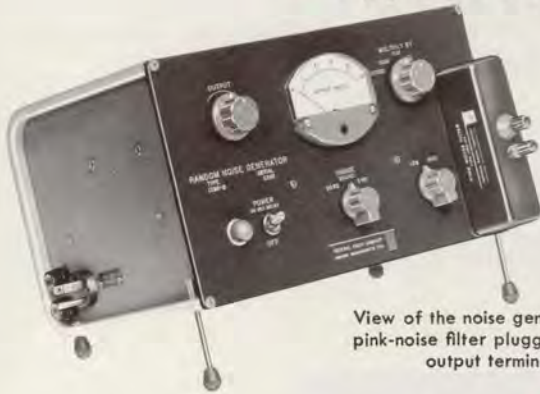

View of the noise generator with pink-noise filter plugged into the output terminals.

When white noise is used for frequency-response measurements in conjunction with a constant-percentage bandwidth analyzer, the amplitude-frequency characteristic of a "flat" system appears to slope upward with increasing frequency at a rate of 3 db per octave, owing to the constantly increasing bandwidth (in cycles) of the analyzer. The TYPE 1390-P2 Pink-Noise Filter converts the output of the random-noise generator in the audio-frequency range from "white" noise to "pink" noise, which has constant energy per octave. It plugs into the output terminals of the TYPE 1390-B Random-Noise Generator.

SPECIFICATIONS

Frequency Response: Sloping -3 db per octave from 20 cps to 20 kc, -6 db per octave above 20 kc. Output voltage is approximately -5 db with respect to the input voltage at 20 cps and -35 db at 20 kc. It lies within 1 db of the straight line connecting these two points on a graph of output in decibels vs log frequency.

Over-all Output Level: When the filter is used with the random-noise generator set for the 20-kc range, the output voltage of the filter is approximately 30 db below its input, and the voltage level in each one-third-octave band is approximately 17 db below that. Thus, when the output meter of the generator indicates 3 volts, the output of the filter is approximately 0.1 volt, and the level in each one-third-octave band is approximately 15 millivolts.

Input Impedance: The filter should be driven from a source whose impedance is 1 kilohm or less. Input impedance is variable from 6.5 kilohms + load resistance at zero frequency to 6.7 kilohms at high frequencies.

Output Impedance: The filter should not be operated into a load of less than 20 kilohms. Internal output impedance is variable from 6.5 kilohms + source resistance at low frequencies to approximately 200 ohms at high frequencies.

Input Voltage: 15 volts, rms, maximum.

Terminals: Input terminals are recessed banana pins on $\frac{3}{4}$ -inch spacing at rear of unit. Output terminals are jack-top binding posts with $\frac{3}{4}$ -inch spacing.

Response-frequency characteristic of the pink-noise filter.



Dimensions: Width 1 $\frac{3}{8}$, height 5, depth 2 $\frac{7}{8}$ inches (35 by 127 by 73 mm), over-all.

Net Weight: 6 ounces (0.2 kg).

Shipping Weight: 1 pound (0.5 kg).

Type		Code Number	Price
1390-P2	Pink-Noise Filter	1390-9602	\$45.00



Type 1391-B PULSE, SWEEP, AND TIME-DELAY GENERATOR

FEATURES:

- ♦ Complete versatility in one convenient package.
- ♦ Wide ranges of pulse duration and delay. ♦ No duty-ratio restrictions.
- ♦ Fast rise time. ♦ Low jitter — high accuracy.
- ♦ Pulse-forming and delay circuits stable against hum and line transients.
- ♦ Coincidence circuitry makes possible multiple pulsing and time selection, as well as generation of low-jitter delays and output pulses.
- ♦ Variable output impedance — 50 to 600 ohms.
- ♦ Pulse, sweep, and gate output, both positive and negative.
- ♦ Controls are logically arranged and easy to operate.

USES: The TYPE 1391-B Pulse, Sweep, and Time-Delay Generator is an unusually versatile instrument which produces:

- (1) Push-pull pulses of durations from 25 nanoseconds to 1.1 seconds at repetition rates to 250 kc;
- (2) Linear sweep voltages of durations from 3 μ sec to 0.12 sec;
- (3) Time delays from 1 μ sec to 1.1 sec;
- (4) Direct and delayed trigger pulses, which can be used externally or to delay the sweep and main pulse relative to the input signal.

This generator has many applications in measurements and testing of equipment for echo-ranging, navigation, television, computing, telemetering, and research.

DESCRIPTION: The system block diagram and the time diagram outline the operation of the generator.

Input circuits, when driven from an external signal of any wave shape, produce the direct synchronizing pulse. This pulse occurs at either a positive or negative zero

crossing, as determined by a switch setting. This signal is available at panel terminals.

The delay circuits produce a delayed synchronizing signal, which can start the pulse-generating circuits.

The coincidence circuit produces, optionally, multiple delayed trigger and synchronizing pulses from signals introduced at the coincidence drive terminals.

The sweep circuits, started by either direct or delayed trigger, produce

- (1) A positive and a negative linearly-rising voltage, adjustable in time, and
- (2) Positive and negative gate signals of the same duration as the sweep.

The pulse-timing circuits start and stop the output pulse. They operate from internal signals, external pulses, or a combination of the two, to produce multiple pulses.

The pulse-source circuits then produce push-pull output pulses of adjustable amplitude and output impedance.

Terminals are provided to facilitate any desired interconnection of these outputs.

SPECIFICATIONS

INPUT

Synchronizing Signal: May be any waveform; typical minimum amplitudes are 0.1 volt, rms, sine wave; 0.3 volt, peak-to-peak, square wave; 1 volt, peak-to-peak, positive or negative pulse.

Direct Synchronizing Pulse: Available at panel terminals; positive 75 volts up to 300 kc prf, 60 volts at 500 kc, 1 μ sec half-amplitude duration, 600 ohms.

TIME-DELAY CIRCUIT

Range: 1.0 μ sec to 1.1 sec in six ranges.

Delay Dial Resolution: 1 part in 8800.

Accuracy: Absolute, $\pm 2\%$ of full scale, or $\pm 3\%$ of scale reading $+0.05 \mu$ sec, whichever is larger; incremental delay, $\pm (1\% + 0.05 \mu$ sec).



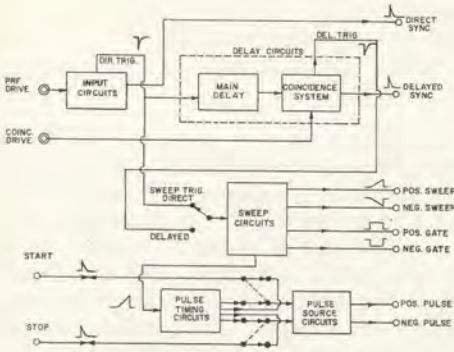

System block diagram showing major circuit groups and their interconnections.

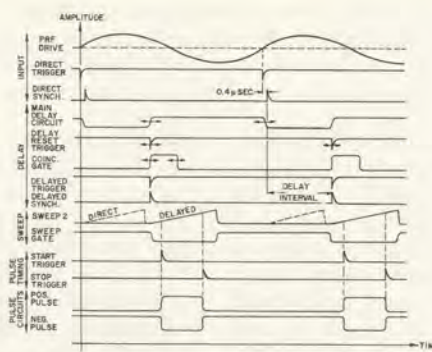

Timing diagram for the complete system.



View of generator and power supply.

Maximum PRF: 400 kc.
Duty-Ratio Effects: Less than 2% error in delay for duty ratios up to 60% at the low end, and up to 90% at the high end, of each range.
Delayed Synchronizing Pulse: Positive, 60 volts, 1.0- μ sec half-amplitude duration, 600-ohm cathode-follower output.

Stability:	Low End of Dial	High End of Dial
Time Jitter	1:10,000	1:50,000
10% Line Change	2:1000	2:10,000
Sudden 10% Line Transient	3:1000	3:10,000

COINCIDENCE CIRCUITS

Gate Duration: 3 to 1000 μ sec.
Gate Accuracy: $\pm 15\%$ or $\pm 1 \mu$ sec, whichever is larger.
 Coincidence driving circuit accepts either positive or negative input pulses. Source impedance should be low, have rise time less than 0.2 μ sec. Amplitudes between 5 and 20 volts for negative pulses and between 10 and 100 volts for positive pulses are acceptable.

SWEEP CIRCUIT

Sweep Duration: 3, 6, 12 μ sec with 5-decade multiplier.
Sweep Linearity: Determined by the accuracy of pulse timing. On longer ranges, where time-delay effects are absent, the linearity is better than 1%.
Sweep Amplitude: Push-pull, each phase, 135 volts, nominal.
Cathode-Follower Output: 1- μ f blocking capacitors.
Sweep-Gate Amplitude: Push-pull, each phase, 40 volts, nominal.
 Positive sweep gate is cathode-follower output circuit with a 1- μ f coupling capacitor. Negative gate is amplifier output with a 1- μ f blocking capacitor.
Duty-Ratio and Repetition-Rate Effects: Maximum repetition rate, 3- μ sec sweep, 250 kc:

Table of Maximum Frequency for 5% Error in Sweep Slope

Sweep Time	3 μ sec	6 μ sec	12 μ sec
$\times 1$	150 kc	100 kc	60 kc
$\times 10$	16 kc	12 kc	7 kc
$\times 10^2$	1.6 kc	1.2 kc	700 cps
$\times 10^3$	160 cps	120 cps	70 cps
$\times 10^4$	16 cps	12 cps	7 cps

PULSE-GENERATING CIRCUIT

Pulse Duration: (Timed by sweep) 0.025 to 2.5, 0.05 to 5.0, and 0.05 to 10.0 μ sec between half-amplitude points, with decade multipliers to a maximum of 100,000 μ sec. Pulse can be extended to 1.1 seconds if timed by delay circuit.
Pulse-Duration Accuracy: After full-scale calibration, $\pm 1\%$ of full scale.
Pulse-Delay Accuracy: $\pm (1\%$ of full scale + 0.5 μ sec).

Pulse Rise Time: Where the load $RLCs$ is negligible with respect to 15×10^{-9} sec, the rise time will be faster than 15 nsec. Higher load impedance or higher shunt Cs will result in increased rise time. Typical rise times (in nanoseconds) are as follows:

Load Impedance	Positive Pulse		Negative Pulse		overshoots approx 3%
	Rise	Decay	Rise	Decay	
50 Ω terminated	15	12	13	15	
600 Ω with 8-pf oscilloscope probe	40	40	38	38	

Pulse Shape: Overshoot is less than 3% of pulse amplitude when the generator is correctly terminated. Pulse ramp-off does not exist.
Pulse Duty Ratio: Unity duty ratio is possible.
Output Impedance: 50, 72, 94, 150, 600 ohms, all $\pm 10\%$.
Output Pulse Amplitude: 150-milliampere current source; voltage from each phase of push-pull channel, 0.15 $Z_o \pm 20\%$.
 Typical nominal amplitudes, 50 ohms, 7.5 v; 72 ohms, 10 v; 94 ohms, 14 v; 150 ohms, 22 v; 600 ohms, 90 v.

GENERAL

DC-Component Insertion: Terminals provided. DC can be moved ± 25 volts for all output impedances except 600 ohms.
Accessories Supplied: Power supply, 2 TYPE 874-C58A Cable Connectors, interconnecting cables, TYPE CAP-22 Power Cord, spare fuses.
Accessories Required: Trigger source; practically any laboratory oscillator is adequate; the TYPE 1210-C Unit R-C Oscillator is recommended.
Terminals: TYPE 874 Coaxial Connectors, recessed, locking. For connection to type N, BNC, TNC, SC, C, or UHF connector, use a locking adaptor (page 64), which locks securely in place, yet is easily removed. Panel connector is recessed, and adaptor projects only about an inch from panel.

Power Requirements: 105 to 125 (or 210 to 250) volts, 50 to 60 cps, 385 watts.

Cabinet: Rack-bench (see page 210).

Dimensions: Generator, bench model — width 19, height 14, depth 12 $\frac{1}{2}$ inches (485 by 355 by 320 mm), over-all; rack model — panel 19 by 14 inches (485 by 355 mm), depth behind panel 11 $\frac{1}{2}$ inches (295 mm). Power supply, bench model — width 19, height 8 $\frac{3}{4}$, depth 12 $\frac{1}{2}$ inches (485 by 225 by 320 mm), over-all; rack model — panel 19 by 8 $\frac{3}{4}$ inches (485 by 225 mm), depth behind panel 11 $\frac{1}{2}$ inches (295 mm).

Net Weight: Generator, 30 pounds (14 kg); power supply, 62 pounds (29 kg).

Shipping Weight: Generator, 88 pounds (40 kg); power supply, 106 pounds (50 kg).

Type		Code Number	Price
1391-BM	Pulse, Sweep, and Time-Delay Generator, Bench Model (Including Power Supply)	1391-9802	\$2025.00
1391-BR	Pulse, Sweep, and Time-Delay Generator, Rack Model (Including Power Supply)	1391-9812	2025.00

PATENT NOTICE. See Notes 4 and 8, page viii.

GR Type 1217-B UNIT PULSE GENERATOR

FEATURES:

- ♦ Fast rise and fall time — transitions average 12 nanoseconds.
- ♦ Duration adjustment over more than seven decades, 0.1 μ sec to 1.1 sec.
- ♦ Repetition rate from dc to 1 Mc, 3 cps to 500 kc, continuous, internal.
- ♦ 40-volt output pulses of either polarity simultaneously available.

USES: By virtue of its extreme simplicity and reliability the TYPE 1217-B is suitable for a great variety of applications in the laboratory and on the test bench. The wide range of pulse-duration adjustment, repetition rate, and output characteristics fit it for any application where a standard (non-sampling) oscilloscope can be used as an indicator. Applications therefore range from high-speed computing circuits through radar to geophysical and physiological pulse simulation. The versatility, reliability, simplicity, and low cost of this generator make it an excellent instrument for the student laboratory.

DESCRIPTION: The circuits are shown in functional form in the block diagram. The input circuits can be switched to act either as an aperiodic amplifier with adjustable sensitivity or as a stable RC oscillator for producing the prf internally. The pulse-timing circuits consist of a transistor bistable circuit, an RC integrator, and a Schmitt amplitude comparator. The bistable circuit switches a pair of pentode tubes in the output circuit. The pentode output stage is direct coupled to the output terminals so that the pulse dc component is retained. Efficient circuit design has resulted in a 40-ma output with only 55-ma total plate input.

SPECIFICATIONS

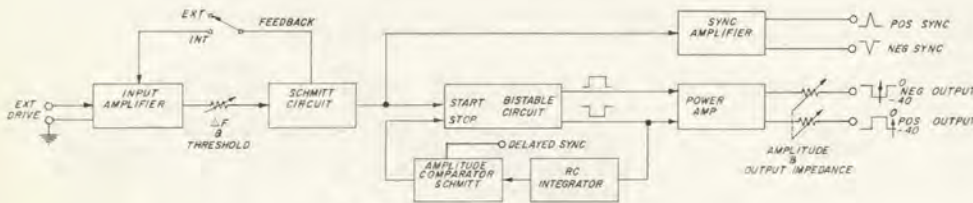

Block diagram of the circuit system.

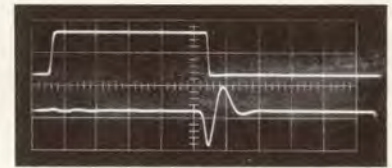

1- μ sec pulse into 50 ohms with delayed sync pulse.

PULSE REPETITION FREQUENCY

Internally Generated: 2.5 cps to 500 kc with calibrated points in a 1-3 sequence from 10 cps to 300 kc, and 500 kc, all $\pm 5\%$. Continuous coverage with an uncalibrated control.

Externally Controlled: Aperiodic, dc to 1 Mc with 1 v, rms, input (0.5 v at 500 kc and lower); input impedance, at 0.5 v, rms, approximately 100 kilohms shunted by 50 pf. Output pulse is started by the negative-going input transition.

OUTPUT-PULSE CHARACTERISTICS

Duration: 100 nsec to 1 sec in seven decade ranges, $\pm 5\%$ of reading or $\pm 2\%$ of full scale or ± 25 nsec, whichever is greater.

Rise and Fall Times: Into terminated 50- or 100-ohm cables all transitions will have rise times less than 20 nsec (typically 12 nsec). On high-voltage output (40 v at 1 kilohm) transition times are limited by load capacitance and are typically 60 nsec + 2 nsec/pf external load capacitance.

Voltage: Positive and negative 40-ma current pulses available simultaneously. DC coupled, with dc component negative with respect to ground. 40 v, peak, into 1-kilohm internal load impedance for both negative and positive pulses. Output control marked in approximate output impedance.

Overshoot: Overshoots and noise in pulse, less than 5% of amplitude with correct termination. **Ramp-off:** Less than 1% everywhere.

Synchronizing Pulses:

Pre-pulse: Positive and negative 10-v pulses of 150-nsec duration. If positive sync terminal is shorted, negative pulse can be increased to 50 v. Sync-pulse source impedance:

positive — approx 300 ohms; negative — approx 1 kilohm.

Delayed Sync Pulse: Consists of a negative-going transition of approximately 5 v and 100-nsec duration coincident with the late

edge of the main pulse. The duration control reads the time between the prepulse and the delayed sync pulse. This negative transition is immediately followed by a positive transition of approximately 5 v and 150 nsec to reset the input circuits of a following pulse generator. (See oscillogram.)

Stability: PRF and pulse-duration jitter are dependent on power-supply ripple and regulation. With TYPE 1201 Power Supply (recommended), input terminals short-circuited, prf jitter and pulse-duration jitter are each 0.01%. With TYPE 1203 Power Supply, they are 0.05% and 0.03%, respectively. (Jitter figures are typical, may vary somewhat with range switch settings, magnetic fields, etc.)

GENERAL

Power Requirements: 300 v at 55 ma, 6.3 v at 3 amp. TYPE 1201-B Unit Regulated Power Supply is recommended.

Accessories Available: TYPE 1217-P2 Single-Pulse Trigger.

Cabinet: Unit Instrument (see page 210).

Dimensions: Width 10 $\frac{3}{4}$ (15 with power supply), height 5 $\frac{3}{4}$, depth 6 $\frac{1}{2}$ inches (275 by 150 by 165 mm), over-all. Rack adaptor panel, 19 by 7 inches (485 by 180 mm).

Net Weight: 4 $\frac{1}{2}$ pounds (2.1 kg).

Shipping Weight: 12 pounds (5.5 kg).

For a more complete description of this instrument refer to the *General Radio Experimenter*, 36, 1 & 2, January-February, 1962.

Type		Code Number	Price
1217-B	Unit Pulse Generator	1217-9702	\$250.00
1217-P2	Single-Pulse Trigger	1217-9602	25.00
1201-B	Unit Power Supply	1201-9702	95.00
480-P4U3	Relay-Rack Adaptor Panel (for both generator and power supply)	0480-9986	12.00



Single-pulse trigger



Unit pulse generator with power supply.



Type 1392-A TIME-DELAY GENERATOR

FEATURES:

- ◆ Two stable delay outputs of high accuracy and resolution. ◆ Linear scales at all delays.
- ◆ Coincidence circuitry for calibrations and time selection.
- ◆ Wide range. ◆ Can be driven up to 300 kc.
- ◆ Passive electronic vernier with 4-nanosecond resolution.

USES: This instrument generates precise time intervals, which can be combined in several ways to produce analog timing signals for the measurement, test, and calibration of electronic equipment and systems.

Its two delay outputs have many applications in the design, test, and calibration of telemetry and pulse communication equipment; radar, sonar, and loran; computer systems; and in geophysical and physiological research.

In conjunction with a crystal-controlled time-mark generator, it is possible to establish delays with crystal-controlled precision in any time or time-equivalent unit.

DESCRIPTION: An external periodic signal of almost any wave-shape will set the prf. A direct synchronizing pulse of 0.1- μ sec duration is generated at this frequency and

becomes the time reference for two delays. The two delays can be operated in series (adding in delay times) or in parallel (two independent delays).

Delay No. 1 uses a passive, continuously variable delay line with a precisely-calibrated dial in 10-nsec divisions from 0 to 1 μ sec. A seven-position multiplier extends the range to 1.1 second.

Delay No. 2 provides the feature of time selection. Pulses from a timing comb coherent with the prf drive can be selected to provide precise delays independent of internal error or drift. The 0.5- μ sec minimum delay of Delay No. 2 permits the selection of a single 1- μ sec pulse from a 1-Mc train so that 1- μ sec steps of delay are provided. In addition, the coincidence feature provides for the production of bursts of pulses.

SPECIFICATIONS

INPUT SYSTEM

Voltage:

Sine wave, 0.1 volt, rms. Square wave, 0.3 volt, peak-to-peak. Pulse (negative or positive), 1 volt, peak, ac or dc, input trigger threshold control provided.

Frequency: DC to over 300 kc.

Time Delay (input to direct sync): $0.12 \pm 0.02 \mu$ sec.

Direct Sync Pulse:

Amplitude, 15 volts, or more, positive or negative.
Duration, $0.13 \pm 0.02 \mu$ sec. **Impedance,** 93 ohms or less.

DELAY NO. 1

Delay Range: 0 to 1.1 sec in seven ranges.

Accuracy: 1- μ sec to 1.1-sec range, $\pm 1\%$ of dial reading; 0 to 1- μ sec range, $\pm 0.01 \mu$ sec.

Stability: Jitter, 1:30,000 at worst.

Drift, 1:10,000 with 20% line voltage change.

Resolution: 0 to 1 μ sec, 0.004 μ sec; 1 μ sec to 1 sec, 1:8000.

Duty-Ratio Effects: Negligible to 60%; 5% at duty ratio of 80%.

DELAY NO. 1 SYNC

Duration: $0.1 \pm 0.02 \mu$ sec. **Impedance:** 93 ohms.

Amplitude: 25 volts or more, positive or negative.

Maximum PRF: 0 to 1- μ sec range, 300 kc;

1- μ sec to 1.1-sec range, 250 kc (at 1 μ sec).

DELAY NO. 2, OR COINCIDENCE CIRCUIT

Range: 0.5 μ sec to 0.5 sec (six decade ranges). **Resolution:** 1:2000.

Accuracy: $\pm 3\%$ of dial reading.

Stability: Jitter, 1:20,000.

Line Drift, 1:5000 for 20% line voltage change.

DELAY NO. 2 SYNC

Duration: 0.13μ sec $\pm 0.02 \mu$ sec. **Impedance:** 93 ohms.

Amplitude: 20 volts or more, positive or negative.

Duty-Ratio Effects: Full scale, less than dial accuracy at 60% duty ratio; bottom of scale, less than dial accuracy at 20% duty ratio. Maximum prf 300 kc.

Coincidence:

Input, positive or negative pulse, 5 volts or over.
Input frequency, 1 cps to 1.7 Mc (for single pulse selection).
Input-pulse rise time, 0.1 μ sec or less at 5 volts.

GENERAL

Power Requirements: 105 to 125 (or 210 to 250) volts, 50 to 60 cps, 180 watts at 115 volts.

Terminals: TYPE 874 Coaxial Connectors, recessed locking. For connection to type N, BNC, TNC, SC, C, or UHF connector, use a locking adaptor (page 64), which locks securely in place, yet is easily removed. Panel connector is recessed, and adaptor projects only about an inch from panel.

Accessories Supplied: TYPE CAP-22 Power Cord; spare fuses; test lead; four TYPE 874-C58A Cable Connectors.

Cabinet: Rack-bench (see page 210).

Dimensions: Bench model — width 19, height $8\frac{3}{4}$, depth $14\frac{1}{2}$ inches (485 by 225 by 370 mm), over-all; rack model — panel 19 by $8\frac{3}{4}$ inches (485 by 225 mm), depth behind panel $13\frac{1}{2}$ inches (325 mm).

Net Weight: 35 pounds (16 kg).

Shipping Weight: 49 pounds (24 kg).

Type		Code Number	Price
1392-AM	Time-Delay Generator, Bench Model	1392-9801	\$1095.00
1392-AR	Time-Delay Generator, Rack Model	1392-9811	1095.00

PATENT NOTICE. See Notes 8 and 20, page viii.



GP Type 314-S86 VARIABLE DELAY LINE

This variable delay line finds general application as a wide-band phase-shifting device, particularly when it is desired to delay a wide-band signal without the introduction of phase distortion.

Good transient response is obtained by a skewed-turn method of delay equalization.* The "baseline ripple,"

* See F. D. Lewis and R. M. Frazier, "A New and Better Variable Delay Line," *General Radio Experimenter*, 31, 7, October, 1956.

Delay Range: 0 to 0.5 μ sec.

Characteristic Impedance: 200 ohms \pm 15% up to 4.5 Mc.

DC Resistance: Not over 20 ohms.

Delay vs Frequency (with respect to delay at 1 Mc): \pm 1% at 10 Mc; \pm 2% at 15 Mc; \pm 4% at 20 Mc measured at maximum delay.

Amplitude Response vs Frequency: Loss at max delay, 9% (0.8 db) at dc; 30% (3 db) at 6 Mc; 60% (8 db) at 10 Mc; 90% (20 db) at 25 Mc.

Pulse and Step Response: See accompanying oscillograms.

Resolution: 1 nsec.

Voltage Rating: 1500 volts peak, winding to ground.

Dimensions: Diameter, including terminals, 3 $\frac{1}{4}$ inches (83 mm); depth 1 $\frac{1}{2}$ inches (39 mm), exclusive of shaft; shaft diameter $\frac{3}{8}$ inch (10 mm); shaft extends beyond body $\frac{3}{4}$ inch (20 mm). Knob is furnished.

Net Weight: 6 ounces (0.2 kg).

Shipping Weight: 1 pound (0.5 kg).

Type	Code Number	Price
314-S86 Variable Delay Line	0314-9917	\$60.00

PATENT NOTICE. See Note 20, page viii.

caused by variation in characteristic impedance along the line, has been reduced to 5% or less of the signal amplitude. End reflections have been minimized by the use of tapered capacitance elements at the ends of the winding. Materials are chosen for reliable operation under varying conditions of temperature and humidity.

There is no "ringing" or overshoot, and the delay is constant over a wide frequency range.

SPECIFICATIONS

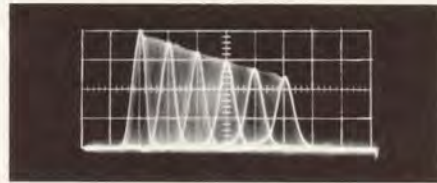

Oscilloscope showing pulse shape and amplitude as delay setting is varied. Tektronix 541 Oscilloscope, 53K/54K Pre-Amplifiers; sweep, 0.1 μ sec/cm.

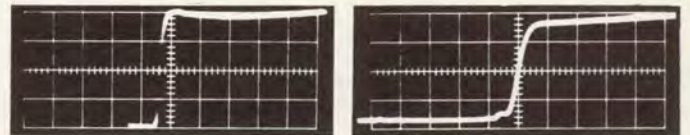

Step response of 0.5- μ sec, 200-ohm variable delay line with skewed winding; (left) step input, (right) step output at 0.5- μ sec delay. Scope photos taken on Tektronix 541 Oscilloscope, 0.1- μ sec/cm sweep.

GP Type 301-S104 VARIABLE DELAY LINE

The TYPE 301-S104 Variable Delay Line is a small distributed-winding unit with a sliding tap for adjustment of delay. Precious-metal wire is used in the winding to ensure reliable contact. Capacitive coupling between the terminals is minimized by shielding.

Applications for this line will be found in such fields as computers, nuclear physics, radar, and any place where an adjustable, linear phase shifter or wide-band, pulse-delay network is useful.

SPECIFICATIONS

Delay Range: 0 (approximately) to 25 nanoseconds (\pm 10%).

Resolution: 0.06 nsec.

Characteristic Impedance: 190 ohms \pm 15%.

Pulse Rise Time: 2.4 nanoseconds (approx) at maximum delay.

DC Resistance: 5.5 ohms (\pm 20%).

Voltage Rating: 1500 volts, peak, winding to ground.

Dimensions: Diameter, including terminals, 2 inches (51 mm); thickness, exclusive of shaft, 15/16 inch (24 mm); shaft diameter, $\frac{1}{4}$ inch (7 mm); shaft extension beyond body $\frac{3}{4}$ inch (20 mm).

Net Weight: 1 $\frac{1}{2}$ ounces (43 grams).

Shipping Weight: 1 pound (0.5 kg).

Type	Code Number	Price
301-S104 Variable Delay Line	0301-9489	\$48.00

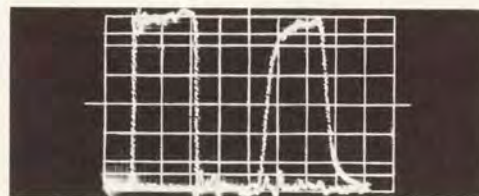

Photograph taken from the screen of a Lumatron 112 oscilloscope. The sweep speed is 5 nsec/cm. The photograph shows two sweeps superposed, the first with the delay line set for minimum delay, and the second trace with the line set for maximum delay. Delay, rise time, baseline ripple, and pulse distortion can be measured from the photograph. Attenuation may differ slightly among units.

TYPE 314-S86

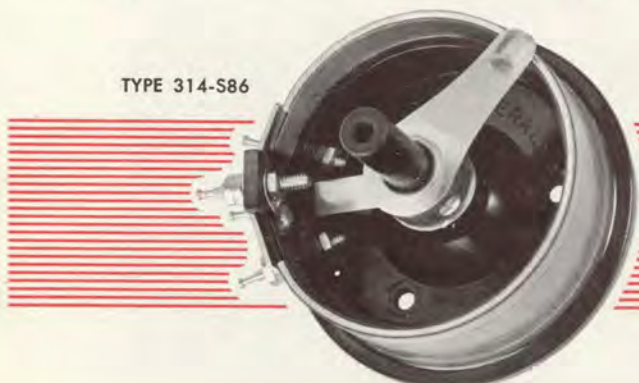

TYPE 301-S104

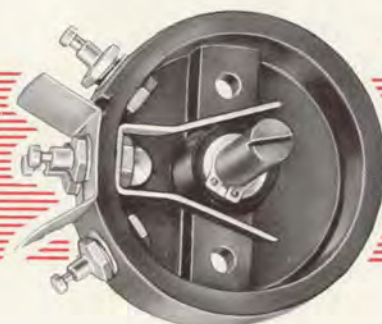

Type 1230-A ELECTROMETER AND DC AMPLIFIER

FEATURES:

- ♦ Extremely high input resistance, even in humid environment.
- ♦ High sensitivity and excellent stability.
- ♦ Shielded input circuits and component shield permit shielding to be extended to the unit under test.
- ♦ Guard terminals — the low-potential input terminal can be grounded or floating, as desired.
- ♦ Large meter with two voltage scales and two resistance scales.
- ♦ Output terminals for connecting an external meter, oscilloscope, or recorder.
- ♦ Amplifies weak dc voltages for recording and control.

USES: The Electrometer and DC Amplifier has a wide variety of applications in physics, chemistry, engineering, and industry. Typical uses include the measurement of

Currents: Ionization currents, photo currents, grid currents in electron tubes, leakage currents in semiconductors and insulators, and time-current curves of capacitors during charge and discharge.

Voltages: Piezoelectric potentials, bioelectric potentials, contact potentials, and electrostatic-field potentials, and pH indications.

Resistances: Back resistance of silicon-junction diodes, insulation resistance of electrical equipment, and voltage coefficient of resistance.

DESCRIPTION: The Electrometer and DC Amplifier is basically a millivoltmeter with a three-stage, direct-coupled amplifier that acts as a highly degenerated cathode follower with high over-all transconductance. It measures *voltage* (0.5 millivolt to 10 volts) directly; *current* (5×10^{-15} to 10^{-3} amperes) in terms of the voltage drop across a standard resistor; and *resistance* (3×10^5 to 5×10^{14} ohms) directly.

To achieve a high degree of stability, all power-supply voltages are stabilized, and all components are carefully selected and pre-aged. Chassis and subassemblies are shockmounted. See graph for typical drift characteristics.

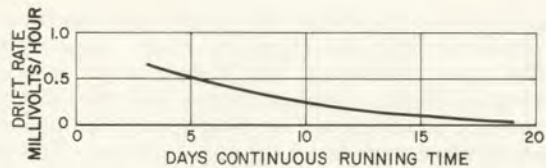

Typical drift after tubes are changed.

For high input resistance, unaffected by humidity, the input grid lead of the electrometer tube is enclosed in silicone-treated glass. The input-resistance selector has switch contacts that are mounted on individual Teflon bushings set in a metal base that connects to a guard point.

A completely shielded chamber, the TYPE 1230-P1 Component Shield, is available as an accessory within which the components to be measured can be conveniently connected.

The Esterline-Angus (or equivalent) 5-milliamperere graphic recorder is recommended. The TYPE 1230-AE model has a matching Esterline-Angus case. More sensitive recorders, such as the TYPE 1521-A Graphic Level Recorder, can be shunted for 5-milliamperere operation.



FOR VOLTAGE, CURRENT, AND
RESISTANCE MEASUREMENTS

METERS



DEFLECTION INSTRUMENTS FOR THE MEASUREMENT OF VOLTAGE, CURRENT, RESISTANCE, AND POWER

Described in this section are a new vacuum-tube voltmeter usable up into the gigacycle range, measuring also dc volts and resistance; an electrometer instrument measuring millivolts, femtoamperes, and teraohms; and a new output power meter for determining the power output and internal impedance of active devices. The ranges of these instruments, collectively, cover most of the magnitudes usually encountered in the laboratory.



Electronic Voltmeter,
Portable Model

VOLTMETER

The TYPE 1806-A Electronic Voltmeter extends to some 1500 Mc the frequency range for direct-indicating voltage measurements. Its 1500-volt range, ac and dc, and ohms scale up to 1000 megohms are additional features. Of particular importance, however, is its accuracy specification of $\pm 2\%$ of indication (not of full scale) for scale deflections above 0.15 volt dc, 1.5 volts ac.

The peak-indicating voltmeter¹ first became a practical, wide-range instrument with the introduction of the TYPE 726-A Vacuum-Tube Voltmeter in 1937.² This first combination of diode rectifier and degeneratively stabilized dc amplifier was followed in 1946 by the TYPE 1800-A,³ which improved the accuracy and frequency range by a factor of 2. Today's TYPE 1806-A represents a still further advance in accuracy, range, and convenience.

Electronic Voltmeter,
Rack Model



ELECTROMETER

The TYPE 1230-A Electrometer and DC Amplifier is a high-stability, direct-coupled, dc amplifier, which can be used not only for direct-reading measurements of small voltages and currents and high resistances, but also for amplifying weak currents and voltages to operate recorders, relays, and other equipment.



Electrometer

OUTPUT POWER METER

The output power meter, an original General Radio development,⁴ is now available for use over wider ranges than ever before — 0.2 ohm to 32 kilohms, 20 to 20,000 cps, 0.2 milliwatt to 20 watts. An indispensable laboratory and test-bench device, the new TYPE 1840-A Output Power Meter is available for bench or rack use.



Output Power
Meter

¹ C. H. Sharp and C. D. Doyle, "Crest Voltmeters," *Trans AIEE*, Vol 35, February, 1916, pp 99-107.

² W. N. Tuttle, "TYPE 726-A Vacuum-Tube Voltmeter," *General Radio Experimenter*, May, 1937.

³ C. A. Woodward, Jr., "A New Vacuum-Tube Voltmeter," *General Radio Experimenter*, September, 1946.

⁴ "A Direct-Reading Meter for Power and Impedance Measurements," *General Radio Experimenter*, November, 1932.

OTHER DEFLECTION-TYPE INSTRUMENTS

Additional meters, described in other sections of this catalog, are listed below.

Distortion The TYPE 1932-A Distortion and Noise Meter, for measurements of over-all harmonic distortion, noise, and hum, is described on page 21.

Wave Analyzers For amplitude and frequency measurements of the components of complex electrical waveforms, the TYPE 1900-A Wave Analyzer and TYPE 1564-A Sound and Vibration Analyzer are listed on pages 14 and 16, respectively.

High Resistance The TYPE 1862-C Megohmmeter, for measurements of insulation resistance, volume resistivity, and resistors in the megohm ranges, is described on page 48.

Microvolter Listed under ATTENUATORS, the TYPE 546-C Microvolter is a combination of voltmeter and attenuator for use with audio oscillators to deliver known output voltages in the microvolt range. See page 24.

Coaxial Voltmeter For voltage measurements in 50-ohm systems, see the TYPE 874-VR Voltmeter Rectifier and TYPE 874-VI Voltmeter Indicator, page 67.

SPECIFICATIONS

RANGES OF MEASUREMENT

Voltage: ± 30 , 100, and 300 millivolts, ± 1 , 3, and 10 volts, dc, full scale.

Current: ± 1 milliampere (10^{-3} ampere) dc, full scale, to ± 300 millimicroamperes (3×10^{-13} ampere) full scale.

Resistance: Direct reading from 300 kilohms to 10 megamegohms (10^{13} ohms) full scale (5×10^{14} ohms at smallest meter division). There are 16 ranges, two per decade. Voltage across the unknown resistance is 9.1 volts.

Extensions of Range: With batteries, or other suitable external supply, the resistance range can be extended, the voltage across the unknown can be increased, and the voltage coefficient of resistors can be measured.

With a 300-volt battery, the highest resistance range is 10^{15} ohms full scale (6×10^{16} ohms at the smallest meter division). The full battery voltage appears across the unknown resistance. The maximum permissible voltage is 600 volts if the external supply is grounded; somewhat greater if ungrounded.

ACCURACY

Voltage: $\pm 2\%$ of full scale on the five highest ranges, $\pm 4\%$ of full scale on the 30-millivolt range.

Current: $\pm 3\%$ of full scale from 10^{-3} to 10^{-9} ampere, $\pm 10\%$ of full scale from 3×10^{-10} to 3×10^{-13} ampere.

Resistance: $\pm 3\%$ from 3×10^5 to 10^{10} ohms at full scale (low-resistance end), $\pm 8\%$ from 3×10^{10} to 10^{13} ohms.

Resistance Standards: 10^4 , 10^5 , 10^6 , 10^7 , 10^8 , 10^9 , 10^{10} , and 10^{11} ohms. The switch also includes "zero" and "infinity" positions. The 10^4 - and 10^5 -ohm resistors are wire wound and are accurate to $\pm 0.25\%$. The 10^6 -, 10^7 -, and 10^8 -ohm resistors are of deposited-carbon construction and are accurate to $\pm 1\%$. The 10^9 -, 10^{10} -, and 10^{11} -ohm resistors are carbon, have been treated to prevent adverse humidity effects, and are accurate to $\pm 5\%$. A switch position permits quick checking of the higher-resistance standards in terms of the wire-wound units.

INPUT

Resistance: The input resistance is determined by the setting of the resistance standards switch. In the infinity position, it is approximately 10^{14} ohms.

Capacitance: Less than 35 pf.

Terminals: The input is connected through a TYPE 874 coaxial terminal assembly at the rear of the instrument. In addition, there are three "low" terminals to provide versatility in guard and ground

connections, as required, for example, in three-terminal network measurements.

Switch: A panel switch permits disconnection of the unknown without transient electrical disturbances in either the unknown or the measuring circuit.

Insulation: Entirely Teflon or silicone-treated glass.

OUTPUT

Indication: Voltage, current, and resistance are indicated on a panel meter.

Recorder: Terminals are available for connecting a recorder (such as the Esterline-Angus 5-ma or 1-ma graphic recorder).

AMPLIFIER CHARACTERISTICS

Maximum Transconductance: 167 millimhos (for 30-millivolt input, the output current is 5 milliamperes).

Output Load: Maximum allowable recorder resistance is 1500 ohms.

Drift: Less than 2 millivolts per hour after one-hour warmup.

FREQUENCY CHARACTERISTICS

With a 1500-ohm load at the output terminals, the frequency characteristic is flat within 5% from zero to 10, 30, 100, 300, 1000, and 3000 cps at the 30-, 100-, 300-millivolt, 1-, 3-, and 10-volt ranges, respectively.

GENERAL

Humidity, Line-Voltage Effects: Negligible.

Accessories Supplied: One TYPE 874-411 Adaptor, one TYPE 1230-P1-300 Panel Adaptor Assembly, one TYPE 274-SB Plug, TYPE CAP-22 Power Cord, and spare fuses.

Other Accessories Available: TYPE 1230-P1 Component Shield, TYPE 1521-A Graphic Level Recorder.

Power Requirements: 105 to 125 (or 210 to 250) volts, 50 to 60 cps, approximately 45 watts. Instrument will operate satisfactorily on power-supply frequencies up to 400 cps.

Cabinet: Lab bench (see page 210).

Dimensions: Width $7\frac{3}{8}$, height $13\frac{1}{4}$, depth 9 inches (195 by 340 by 230 mm), over-all.

Net Weight: $15\frac{1}{4}$ pounds (7 kg).

Shipping Weight: 24 pounds (11 kg).

For a more complete description of this instrument refer to the *General Radio Experimenter*, 30, 10, March, 1956.

Type		Code Number	Price
1230-A	Electrometer and DC Amplifier	1230-9701	\$460.00
1230-AE	Electrometer and DC Amplifier (in Esterline-Angus Case)	1230-9816	540.00
1230-P1	Component Shield	1230-9601	40.00

PATENT NOTICE. See Notes 4 and 15, page viii.

Type 1230-P1 Component Shield (with shield cover removed) plugged into the input terminal at the rear of the electrometer.

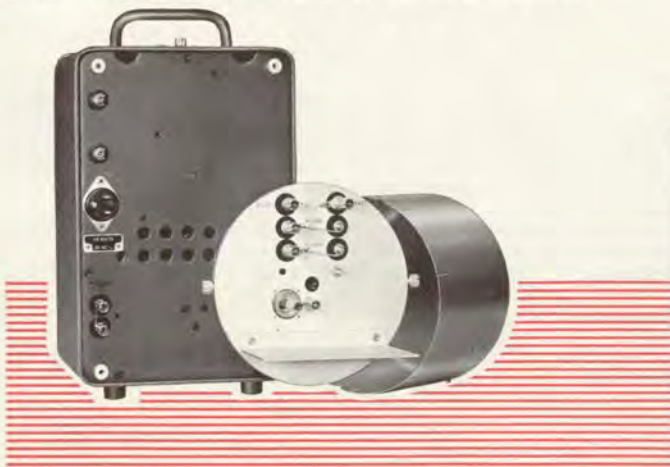

Type 1230-AE D-C Amplifier and Electrometer with a recorder.





Type 1806-A ELECTRONIC VOLTMETER

METERS
ELECTRONIC VOLTMETER

FEATURES:

- ◆ Measures ac and dc voltages, as well as resistances. ◆ Stable circuits — low drift.
- ◆ High accuracy: $\pm 2\%$ of indication over most of the range.
- ◆ Wide frequency range, within ± 3 db up to 1500 Mc.
- ◆ New, small-size probe for ready access to circuit points.
- ◆ Logarithmic meter scale for constant-percentage accuracy and maximum readability.
- ◆ Ohmmeter does not require full-scale adjustment.

USES: This versatile instrument meets practically all the voltage measurement needs of the modern electronics laboratory. It measures dc and ac voltages up to 1500 volts without the use of external multipliers. Its probe is capable of measuring voltage in closed coaxial systems up to 1500 Mc. As an ohmmeter, its range of 0.2 ohm to 1000 megohms further enhances its utility both in the laboratory and on the test bench.

DESCRIPTION: The heart of this instrument is a new highly stable tube-and-transistor dc amplifier. Its balanced circuit and regulated heater voltages provide zero stability. Calibration stability is excellent because there is so much feedback that changes in tube transconductance or transistor current gain have negligible effect. For measurement of ac voltages, a ceramic thermionic diode with



Rack Model, Type 1806-AR.

extremely short electron transit time is used in a small, convenient probe with a variety of connector accessories.

The small physical size and close spacing of the diode give it a high resonant frequency and low transit time, both of which contribute to the excellent high-frequency performance.

SPECIFICATIONS

DC VOLTMETER

Voltage Range: Four ranges, 1.5, 15, 150, and 1500 volts, full scale, positive or negative. Minimum reading is 0.005 volt.

Input Resistance: 100 megohms, $\pm 5\%$; also "open grid" on all but the 1500-volt range. Grid current is less than 10^{-10} amperes.

Accuracy: $\pm 2\%$ of indicated value from one-tenth of full scale to full scale; ± 0.2 of full scale from one-tenth of full scale to zero. Scale is logarithmic from one-tenth of full scale to full scale, permitting constant-percentage readability over that range.

AC VOLTMETER

Voltage Range: Four ranges, 1.5, 15, 150, and 1500 volts, full scale. Minimum reading on most sensitive range is 0.1 volt.

Input Impedance: Probe, approximately 25 megohms in parallel with 2 pf. Voltages above 150 use an internal voltage divider, and input impedance is 25 megohms in parallel with 30 pf.

Accuracy: At 400 cps, $\pm 2\%$ of indicated value from 1.5 volts to 1500 volts; $\pm 3\%$ of indicated value from 0.1 volt to 1.5 volts.

Waveform Error: On the higher ac-voltage ranges, the instrument operates as a peak voltmeter, calibrated to read rms values of a sine wave or 0.707 of the peak value of a complex wave. On distorted waveforms the percentage deviation of the reading from the rms

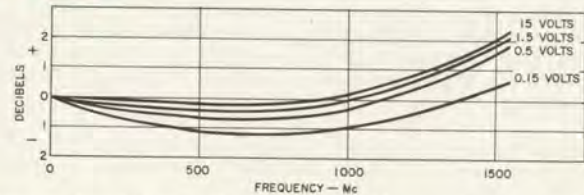

value may be as large as the percentage of harmonics present. On the lowest range the instrument approaches rms operation.

Frequency Range: Low-frequency roll-off is less than 3% at 20 cps. Probe resonant frequency is above 3000 Mc. Above several hundred megacycles per second, probe should be used in a 50-ohm coaxial system with the accessory tee connector. The error is then less than ± 3 db below 1500 Mc, and vswr of the tee connector and probe is less than 1.1 below 1000 Mc. Total error, which for low voltages is a function of the input voltage level because of transit-time effects, is shown in the accompanying plot. Above 150 volts with internal voltage divider there is an additional error of not more than $\pm 2\%$ for frequencies below 500 kc.

OHMMETER

Range: 0.2 ohm to 1000 megohms in four ranges with center scale values of 10 ohms, 1 kilohm, 100 kilohms, and 10 megohms.

Test Voltage: The dc test voltage is positive and never exceeds 1.5 volts. The maximum current (which is delivered to a short circuit on the lowest resistance range) is approximately 43 ma. The maximum available power from the ohmmeter circuit is 16 mw.

Accuracy: $\pm 5\%$ of indicated value from 1 to 10 on scale, approaching $\pm 10\%$ of indicated value at 100 on scale.

GENERAL

Power Requirements: 105 to 125 (or 210 to 250) volts, 50 to 400 cps, 20 watts, approximately. The case is grounded by the third wire in the power cord. The voltmeter circuit can be disconnected from the case and operated as much as 300 volts dc off ground. The low input terminal remains by-passed to the case.

Probe Storage: A socket and reel store both probe and cable.

Accessories Supplied: Spare fuses, CAP-22 Power Cord (on -AR only), an assortment of probe tips for various types of connections.

Cabinet: Portable model, Flip-Tilt case (see page 210). Rack model on 19-inch panel.

Dimensions: Portable model, case closed — $7\frac{1}{2}$ by $8\frac{1}{2}$ by $11\frac{1}{2}$ inches (190 by 220 by 295 mm), over-all; rack model — panel 19 by $5\frac{1}{4}$ inches (485 by 135 mm), depth behind panel $9\frac{1}{4}$ inches (235 mm).

Net Weight: Approximately 10 pounds (4.6 kg).

Shipping Weight: Approximately 16 pounds (7.5 kg).

Type		Code Number	Price
1806-A	Electronic Voltmeter, Portable Model	1806-9701	\$490.00
1806-AR	Electronic Voltmeter, Rack Model	1806-9811	490.00
1806-P1	Tea Connector	1806-9601	35.00





Type 1840-A OUTPUT POWER METER

FEATURES:

- ♦ Wide frequency response — 20 cps to 20 kc.
- ♦ Quasi-rms indication — reads rms with harmonics up to 20%.
- ♦ 48 different impedances — 0.6 ohm to 30 kilohms.
- ♦ Measures power from 0.1 milliwatt to 20 watts.

USES: The TYPE 1840-A Output Power Meter measures audio-frequency power into any desired load. Its important uses include the measurement of:

Power output of oscillators, amplifiers, preamplifiers, transformers, transducers, and low-frequency lines.

Output impedance, by adjustment of the load seen by the device under test to yield maximum power indication on the meter.

Frequency-response characteristics of amplifiers, transformers, and other audio-frequency devices.

DESCRIPTION: The TYPE 1840-A Output Power Meter is basically a multi-tapped audio-frequency transformer with a fixed secondary load.

The fixed secondary load is reflected to eight identical

primary windings. A front panel switch connects the eight primary coils in four different series and parallel combinations, and each primary combination is used with any one of six secondary taps, thus providing 24 different primary impedances. Each of these 24 impedances can in turn be multiplied by 250 with a second front panel switch. The end result is a total of 48 primary impedances.

The use of grain-oriented silicon steel in a laminated core yields a 20-watt rating with a relatively small core. The range can be extended to 200 watts for any particular impedance with the addition of a simple T-network attenuator. Details are given in the instruction book.

Interleaving of primary windings with secondary windings in two separate pi's permits measurements from 20 to 20,000 cps.

SPECIFICATIONS

Power Range: 0.1 milliwatt to 20 watts, except as noted on the accompanying derating curves and table. Auxiliary db scale reads from -15 to +43 db re 1 milliwatt.

Impedance Setting of Type 1840-A

Ohms	0.6	0.8	1	1.25	1.6	2
	2.5	3.12	4	5	6.4	8
	10	12.5	16	20	25	32
	40	50	64	80	100	128
Kilohms	0.15	0.2	0.25	0.312	0.4	0.5
	0.6	0.8	1	1.25	1.6	2
	2.5	3.12	4	5	6.4	8
	10	12.5	16	20	25	32
	A	B	C	D	E	F

(Refer to curves at right)

Impedance Range: 0.6 ohm to 32 kilohms in two ranges; yielding 48 individual impedances spaced approximately $\sqrt{4}$ apart.

ACCURACY

Power: At 1 kc, ± 0.3 db; from 50 to 6000 cps, ± 0.5 db; from 30 to 10,000 cps, ± 1 db; at 20 cps, -1.5 db max, -1 db average; at 20,000 cps, -5 db max, ± 1.5 db average.

Impedance: At 1 kc, $\pm 6\%$ max, -0.5% average; from 70 to 5000 cps, $\pm 7\%$ for values below 10,000 ohms (7% from 70 to 2500 cps for 10,000 ohms and above); at 20 cps, -15% max, -8% average; at 20,000 cps, $\pm 50\%$ max, $\pm 12\%$ average.

Waveform Error: A quasi-rms meter is used which will indicate true rms with as much as 20% second and third harmonics present in the input signal.

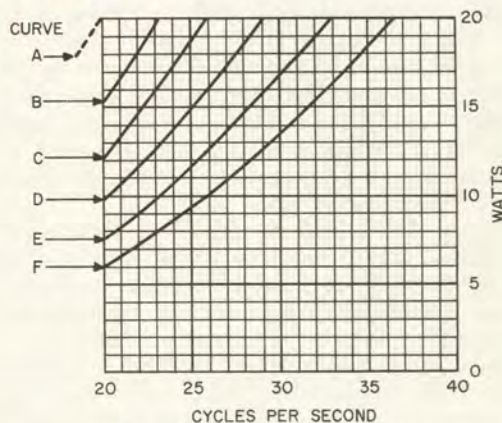

Derating vs impedance setting and frequency.

Cabinet: Convertible bench (see page 210).

Dimensions: Width 12, height 4, depth 8 inches (305 by 105 by 205 mm), over-all. Panel adaptor sets are available for 19-inch relay-rack mounting (panel height 3½ inches).

Net Weight: 10¾ pounds (4.9 kg).

Shipping Weight: 18 pounds (8.5 kg).

Type		Code Number	Price
1840-A	Output Power Meter	1840-9701	\$210.00
480-P212	Relay-Rack Adaptor Set	0480-9622	6.00





Type 1521-A GRAPHIC LEVEL RECORDER

FEATURES:

- ◆ Plots rms level of ac voltage, 20 cps to 200 kc. ◆ Completely transistorized.
- ◆ Fast writing speed with optimum ballistics.
- ◆ Calibrated in absolute level. ◆ Interchangeable logarithmic potentiometers.
- ◆ Mechanical coupling available for driving oscillator or analyzer.
- ◆ Simple to operate — three basic controls. ◆ Easily converted to dc linear recorder.

USES: The TYPE 1521-A Graphic Level Recorder has a wide variety of uses in electronics, acoustics, and other branches of physical science and engineering. It records linearly in decibels the rms magnitude of ac voltage from 20 cps to 200 kc. It produces permanent ink records of the response of electrical or electroacoustical devices and systems as a function of time or frequency. Owing to the high stability of its reference voltage and amplifier gain, it can be used as a recorder of absolute level.

Amplitude-Frequency Plotting. For frequency-characteristic measurements, the paper drive can be coupled by means of drive and link units to the frequency-control shaft of an oscillator or analyzer for completely automatic recording. The combination of the recorder and the TYPE 1304-B Beat-Frequency Audio Generator produces records having a true logarithmic frequency scale and is ideal for plotting frequency characteristics of analyzers, recording systems, networks, filters, and equalizers, as well as of loudspeakers, microphones, vibration pickups, and other transducers.

Acoustical Measurements. The combination of the recorder and either the TYPE 1564-A Sound and Vibration Analyzer or the TYPE 1900-A Wave Analyzer makes possible automatic analysis of sound spectra, and response measurements on devices excited by white noise.

Used with the TYPE 1551 Sound-Level Meter, the recorder can plot sound levels over a wide dynamic range. For measurements of level as a function of time, the writing speed is sufficiently high for the measurement of reverberation time and other transient phenomena.

The wide range of paper speed facilitates long-period studies of the noise produced by traffic, office machinery, industrial processes, and potential hearing-damage conditions, as well as of short-duration transients.

DESCRIPTION: The TYPE 1521-A Graphic Level Recorder is a completely transistorized, single-channel, servo-type recorder. It produces a strip-chart record with ink on white paper, suitable for reproduction. The pen is attached to a coil, which moves linearly over a 4-inch distance in a uniform magnetic field. A contact attached to the coil rides on a straight potentiometer, which is the balancing element for the servo. The position of the contact is determined by the input signal, and the exponential potentiometer characteristic produces a linear db scale.



Plot of frequency response of a public-address system made on the graphic level recorder driving the frequency dial of the beat-frequency audio generator.

The detector circuit response is, for all commonly encountered waveforms, very close to true rms.

The difference between the detector output and a one-volt reference is amplified and used to position the coil, which carries the potentiometer contact and pen. A velocity-feedback coil mounted on the drive-coil frame provides appropriate damping.

Careful design has made it possible to maintain both a high writing speed and the largest servo bandwidth consistent with a frequency response extending downward to 20 cps, without exceeding a 1-db overshoot. Writing speeds are selected by a single switch without auxiliary adjustment of low-frequency cutoff or damping.

Changes of range are easily accomplished by use of a 20-db or an 80-db potentiometer in place of the standard 40-db unit. With the 80-db unit, the maximum writing speed becomes 300 db/second, permitting measurement of reverberation times as short as 0.3 second. The slow writing speeds filter out abrupt level variations, yielding a smoothed plot without loss of accuracy.

For dc recording, a linear potentiometer provides a balancing voltage in series with the input voltage, and the combined voltage is balanced against the 1-volt reference. A single 0.8-volt range at a 1000-ohm input-impedance level makes the instrument interchangeable with the usual direct-writing strip-chart recorders.



SPECIFICATIONS

Dynamic Range: With potentiometer furnished, 0 to 40 db for level recording (20-db and 80-db potentiometers are also available); 0 to 0.8 volt (at 1000 ohms) full scale, for dc recording with zero input position adjustable over full scale.

Frequency Response

Level Recorder: 20 cps to 200 kc (within 3 db).

DC Recorder: 0 to 10 cps (peak-to-peak amplitude less than 25% of full scale).

Potentiometer Linearity

Level Recorder: $\pm 1\%$ of full-scale db value plus a frequency error of 0.5 db at 100 kc and 1.5 db at 200 kc.

DC Recorder: $\pm 1\%$ of full scale.

Resolution: $\pm 0.25\%$ of full scale.

Maximum Input Voltage: 100 volts, ac.

Input Attenuator: 60 db in 10-db steps.

Input Impedance: 10,000 ohms for ac level recorder; 1000 ohms for dc recorder.

Maximum Sensitivity: 1 millivolt at 0 db for level recording; 0.8 volt full scale for dc recording.

General

Paper Speeds: 2.5 inches per minute to 75 inches per minute. A slow-speed motor to provide speeds of 2.5 to 75 inches per hour is available as an alternate. See below.

Writing Speed: 1, 3, 10, or 20 inches per second (approximately), with overshoot less than 1 db.

Oscillator or Analyzer Drive: Order TYPE 1521-P10B Drive Unit and appropriate link unit.

External DC Reference: Internal terminals are provided for an external dc voltage, which can be substituted for the 1-volt internal dc reference. The recorder will operate properly over a 3:1 reference-voltage range (0.5 to 1.5 volts). If this reference voltage is derived from the source of energy in the system under test, variations of up to 3:1 in the source output can be eliminated from the recording.

Detector: Quasi-rms; within 0.25 db of rms for multiple sine waves, square waves, or noise. Detector operating level is 1 volt.

Chart Paper: 4-inch recording width on 5-inch paper. Charts have 8 major divisions, 40 total divisions on vertical scale, except 1521-9427, which has 80 total divisions, and 1521-9466, which has 50.

Accessories Supplied: 40-db potentiometer, 2 pens, 2-ounce bottle of red ink, 2-ounce bottle of green ink, bottle of potentiometer cleaner, 1 roll of 1521-9428 paper, droppers for filling pens, CAP-22 Power Cord, spare fuses, adaptor cable for connection to sound-measuring equipment and other devices having telephone jacks.

Accessories Available: Potentiometers, charts, ink, slow-speed motors, drive and link units, as listed in price table.

Power Requirements: 105 to 125 (or 210 to 250) volts, 60 cps, 35 watts. 50-cycle models are available; see price list below.

Cabinet: Rack-bench (see page 210).

Dimensions: Bench model — width 19, height 9, depth 13½ inches (485 by 230 by 350 mm), over-all; rack model — panel 19 by 8¾ inches (485 by 225 mm), depth behind panel 11¼ inches (290 mm).

Net Weight: 50 pounds (23 kg).

Shipping Weight: 64 pounds (29 kg).

POTENTIOMETERS

Type		Code Number	Price
1521-P1	20 db	1521-9601	\$ 55.00
1521-P2*	40 db	1521-9602	70.00
1521-P3	80 db	1521-9603	155.00
1521-P4	Linear (for dc)	1521-9604	55.00

* Supplied with recorder.

MOTORS FOR LOWER CHART SPEED††

1521-P20	(60 cps) for paper speeds of 2.5-75 inches/hour	1521-9620	\$ 52.50
1521-P22	(50 cps) for paper speeds of 2.5-75 inches/hour	1521-9622	65.00

†† Recorder can be supplied with low-speed motor installed, at same price as with standard motor.

Type	Mounting	Supply Frequency	Paper Speed	Code Number	Price
1521-AR	Rack	60 cps	2.5-75 in./min	1521-9811	\$995.00
1521-AM	Bench	60 cps	2.5-75 in./min	1521-9801	995.00
1521-ARQ1	Rack	50 cps	2.5-75 in./min	1521-9496	995.00
1521-AMQ1	Bench	50 cps	2.5-75 in./min	1521-9495	995.00

PATENT NOTICE. See Note 18, page viii.

CHART PAPER† — 100-FOOT ROLLS

Type		Code Number	Price
1521-9427	Calibrated 20 cps to 20 kc, logarithmic, 9 inches, repeating every 13½ inches; for use with Type 1304-B Beat-Frequency Audio Generator.	1521-9427	\$ 2.75
1521-9464	Calibrated 0 to 10 kc, linear, repeating every 20 inches; for use with Type 1900-A Wave Analyzer.	1521-9464	2.75
1521-9465	Calibrated 0 to 50 kc, linear, 10 inches, repeating every 16 inches; for use with Type 1900-A Wave Analyzer.	1521-9465	2.75
1521-9493	Calibrated 2.5 to 25 (normalized decades) for use with Type 1564-A Sound and Vibration Analyzer, 7½ inches per decade, repeating every 9 inches.	1521-9493	2.75
1521-9463	Calibrated 25 to 25,000 cps, repeating every 21 inches, for use with Type 1554-A Sound and Vibration Analyzer.	1521-9463	2.75
1521-9429	Calibrated 25 to 7500 cps in ⅓-decade segments 2¼ inches long, for use with Type 760-B Sound Analyzer.	1521-9429	2.75
1521-9428	Linear time base, 1 division = ¼ inch; for ac or dc records as a function of time.	1521-9428	2.75
1521-9466	Linear time base, 1 division = ⅓ inch; 10 major divisions, 50 total divisions. For use with Types 1134-A and 1136-A Digital-to-Analog Converters.	1521-9466	2.75

† Subject to quantity discounts.

INK

1521-4092	16-ounce bottle of red ink	1521-4092	\$ 5.50
1521-4093	16-ounce bottle of green ink (for ozalid copies)	1521-4093	5.50

DRIVE AND LINK UNITS FOR COUPLING TO OSCILLATOR AND ANALYZERS

1521-P10	Drive Unit to operate any link unit.	1521-9610	\$ 72.00
1521-P14	Link Unit for coupling to Type 1304-B Beat-Frequency Audio Generator above or below recorder, or to Type 1554-A or Type 1564-A Sound and Vibration Analyzer above recorder.	1521-9614	23.00
1900-P1	Link Unit for coupling to Type 1900-A Wave Analyzer.	1900-9601	35.00

STANDARD CAPACITORS



Choice of Capacitor Type

A properly designed air capacitor approaches the ideal standard reactance in that it has very low loss and very small changes with time, frequency, and environment. Capacitance changes with changes in atmospheric pressure (about 18 ppm per inch Hg) and in relative humidity (about 2 ppm per % RH) can be eliminated by hermetic sealing of the capacitor. Changes with temperature can be reduced to a few ppm per °C by the use of low-temperature-coefficient materials in the capacitor. The maximum capacitance for an air-dielectric unit of practical size is of the order of 1000 pf. (See TYPES 1404, 1401, 1403.)

For capacitance above 1000 pf, solid dielectrics are usually used. The preferred dielectric for standard capacitors is high-quality mica because of its dimensional stability, low loss, and high dielectric strength. The temperature coefficient of a mica capacitor is of the order of +35 ppm per °C. At dc or extremely low frequencies the mica dielectric has the disadvantage of relatively large change of capacitance with frequency. (See TYPES 1409, 1423.)

Polystyrene has a dielectric constant and dissipation factor very nearly constant with frequency, so that the capacitance change from dc to 1 kc is a small fraction of a percent instead of the 3% drop at 1 kc that is typical of mica. The temperature coefficient of a polystyrene capacitor is, however, of the order of -140 ppm per °C. (See TYPE 1424-A.)

Two-Terminal and Three-Terminal Connections

Most physical capacitors can be accurately represented by the three capacitances shown in Figure 1: the direct capacitance, C_{HL} , between the terminals H and L, capacitance between the plates of the capacitor, and the two terminal capacitances, C_{HG} and C_{LG} , are capacitances from the corresponding terminals and plates to the capacitor case, surrounding objects, and to ground (to which the case is connected either conductively or by its relatively high capacitance to ground).

Figure 1. Schematic diagram of a capacitor, showing the direct capacitance and its associated terminal capacitances.

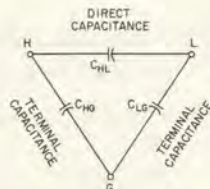

In the two-terminal connection, the capacitor has the L and G terminals connected together, i.e., the L terminal is connected to the case. The terminal capacitance, C_{LG} , is thus shorted, and the total capacitance is the sum of C_{HL} and C_{HG} . Since one component of the terminal capacitance C_{HG} is the capacitance between the terminal and surrounding objects, the total capacitance can be changed by changes in the environment of the capacitor and particularly by the introduction of the wires required to make connection to the capacitor.

The uncertainties in the calibrated value of a two-terminal capacitor can be of the order of tenths of a picofarad if the geometry, not only of the capacitor plates, but of the environment and of the connections is not defined and specified with

sufficient precision. For capacitors of 100 pf and more, the capacitance is usually adequately defined for an accuracy of a few hundredths percent if the terminals and method of connection used for calibration are specified. For smaller capacitances or for higher accuracy, the two-terminal capacitor is seldom practical and the three-terminal arrangement is preferred.*

A three-terminal capacitor has connected to the G terminal a shield which completely surrounds at least one of the terminals (H), its connecting wires, and its plates except for the area that produces the desired direct capacitance to the other terminal (L). Changes in the environment and the connections can vary the terminal capacitances, C_{HG} and C_{LG} , but the direct capacitance C_{HL} —usually referred to simply as the capacitance of the three-terminal capacitor—is determined only by the internal geometry.

This direct capacitance can be calibrated by three-terminal measurement methods, such as guard circuits or transformer-ratio-arm bridges, which exclude the terminal capacitances.

The direct capacitance can be made as small as desired, since the shield between terminals can be complete except for a suitably small aperture. The losses in the direct capacitance can also be made very low because the dielectric losses in the insulating materials can be made a part of the terminal impedances. When the three-terminal capacitor is connected as a two-terminal, the two-terminal capacitance will exceed the calibrated three-terminal value (C_{HL}) by at least the terminal capacitance C_{HG} .

Frequency Characteristics

Although the characteristics of the high-quality capacitors used as standards closely approach those of the ideal capacitor, the small deviations from ideal performance must be examined and evaluated to obtain high accuracy. The residual parameters which cause such deviations are shown in the lumped-constant, two-terminal equivalent circuit of Figure 2. R represents the

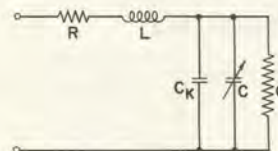

Figure 2. The equivalent circuit of a capacitor.

metallic resistance in the leads, supports and plates; L , the series inductance of the leads and plates; C , the capacitance between the plates; C_k the capacitance of the supporting structure. The conductance, G , represents the dielectric losses in the supporting insulators, the losses in the air or solid dielectric between capacitor plates, and the dc leakage conductance.

The effective terminal capacitance C_e of the capacitor becomes greater than the electrostatic or zero-frequency capacitance C_o as the frequency increases because of the inductance L . When the frequency, f , is well below the resonance frequency f_o (defined by $\omega_o^2 LC_o = 1$), the fractional increase in capacitance is approximately

$$\frac{\Delta C}{C_o} = \omega^2 LC_o = \left(\frac{f}{f_o}\right)^2 \quad (1)$$

* John F. Hersh, "A Close Look at Connection Errors in Capacitance Measurements," *General Radio Experimenter*, 33, 7, July, 1959.

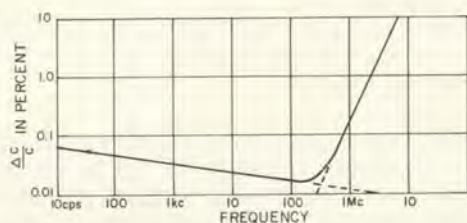
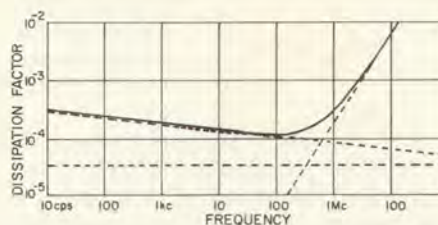

Figure 3. Variation with frequency of capacitance and dissipation factor for a mica capacitor.



This change in capacitance with frequency for the capacitors described on the following pages is given either as a plot on logarithmic co-ordinates of the percent increase, $\Delta C/C$, versus frequency or as a tabulation of the values of L or f_0 . Since the inductance is largely concentrated in the leads and supports, it is nearly independent of the setting of a variable capacitor. With this information, the increase in capacitance at, for example, a frequency of 1 Mc can be computed from the calibrated value at 1 kc with high accuracy. For small increases, the accuracy may be greater than that of a measurement at 1 Mc because of the difficulties in determining the measurement errors produced by residuals in the connecting leads outside the capacitor.

The three-terminal capacitor has a similar increase in capacitance produced by inductance. The lowest resonance is determined not solely by the calibrated direct capacitance but also by the terminal capacitances, which may be much larger than the direct capacitances (see equivalent circuit of TYPE 1403 Capacitors, page 150).

When the capacitor has a solid dielectric, such as mica, there is another source of capacitance change with frequency. The capacitance increases at low frequencies as the result of dielectric absorption caused by interfacial polarization in the dielectric. The change in capacitance with frequency of a 1000-pf capacitor with mica dielectric is shown in Figure 3. The dotted line slanting downward to the right represents the change in the dielectric constant of mica resulting from interfacial polarization; that slanting upward to the right shows the change in effective capacitance resulting from series inductance. The magnitude of the change at low frequencies depends upon the dielectric material and is, for example, much smaller for polystyrene than for mica.

Dissipation Factor

The dissipation factor of a capacitor (defined on page 27) is determined by the losses represented in Figure 2 by R and G . The resistance R is not usually significant until the frequency is high enough for the skin effect to be essentially complete. At such frequencies the resistance varies as the square root of frequency and may be expressed as $R_1\sqrt{f}$, where R_1 is the resistance at one megacycle and f is the frequency in megacycles. The total dissipation factor at high frequencies is then

$$D = \frac{G}{\omega C} + R_1\sqrt{f}\omega C \quad (2)$$

At low frequencies only the losses represented by G are important. The leakage conductance component is negligible at frequencies above a few cycles per second and is important only when the capacitor is used at dc for charge storage. The dominant components at audio frequencies are the dielectric losses in the insulating structure and in the dielectric material between the plates.

In the air capacitor the losses in the air dielectric and on the plate surfaces are negligible under conditions of moderate humidity and temperature. The loss is, therefore, largely in the insulating supports. When good-quality, low-loss materials, such as quartz, ceramics, and polystyrene, are used for insulation, the conductance varies approximately linearly with frequency and the dissipation factor, D_k , of the supports is nearly constant with frequency. The total dissipation factor of an air capacitor, whose equivalent circuit is that of Figure 2, may be expressed at low frequencies as

$$D = \frac{G}{\omega(C + C_k)} = \frac{D_k C_k}{C + C_k} \quad (3)$$

When the capacitance C is variable, this D is then inversely proportional to the total terminal capacitance. Since the quantity $D_k C_k$ is nearly independent of both frequency and capacitance setting, it is a convenient figure of merit for a variable capacitor.

In a capacitor with a solid dielectric the dominant component of the conductance G is the loss in the dielectric, which varies with frequency. The resulting variation of D with frequency, shown for a mica capacitor in Figure 3, is the sum of three principal components: a constant dissipation factor caused by residual polarizations and shown by the horizontal dotted line; a loss produced by interfacial polarizations, which contributes the D shown by the dotted line slanting downward to the right; and an ohmic loss in the leads and plates, which results in a D proportional to the $3/2$ power of frequency and is shown as the dotted line slanting upward to the right. The total dissipation factor has a minimum value at a frequency that varies inversely with capacitance and which ranges from 1 kc to 1 Mc for capacitance values from 1 μ f to 100 pf.

The capacitors described in these pages include air-dielectric reference standards, both fixed and variable, both fixed and decade mica-dielectric, and other decades with polystyrene, mica, and paper dielectric.

Type	Name	Capacitance	Page
1422	Precision Capacitor (Two- and three-terminal, variable)	7 models, 1.1 to 1150 pf, full scale	148
1401	Standard Air Capacitor (Two-terminal, fixed)	100, 200, 500, 1000 pf	150
1403	Standard Air Capacitor (Three-terminal, fixed)	0.01, 0.1, 1, 10, 100, 1000 pf	150
1404	Reference Standard Capacitor (Three-terminal, fixed)	1000 pf	151
1409	Standard Capacitor (Fixed, mica)	0.001 to 1 μ f in 10 models	152
1423	Standard Decade Capacitor	100 pf to 1.111 μ f	154
1424	Standard Polystyrene Decade Capacitor (Single decade)	10 μ f, full scale	154
1419	Decade Capacitor (3- and 4-dial boxes)	1 μ f, full scale	156
980	Decade Capacitor Unit	0.001, 0.01, 0.1, and 1 μ f, full scale	156
505	Capacitor (Fixed, mica)	100 pf to 0.5 μ f in 12 models	153
1429	Fuel-Gage Tester	20 to 6220 pf	155

Type 1422 PRECISION CAPACITOR

FEATURES:

- ◆ High stability. ◆ High accuracy. ◆ Low backlash.
- ◆ High precision of setting — one part in 25,000 of full scale; total scale length is 20 feet.
- ◆ Low temperature coefficient of capacitance. ◆ Low dielectric losses.
- ◆ Large transparent knob skirt to facilitate fine setting.

USES: The TYPE 1422 Precision Capacitor is a stable and precise variable air capacitor intended for use as a continuously adjustable standard of capacitance.

One of its most important applications is in ac bridge measurements, either as a built-in standard or as an external standard for substitution measurements. Because of its excellent accuracy and stability, it is the standard of the industry.

Both two-terminal and three-terminal models are available.

DESCRIPTION: The capacitor assembly is mounted in a cast frame, which gives the unit rigidity. The frame, spacers, stator rods, and rotor shaft are made of selected alloys of aluminum, which combine the high mechanical strength of brass with the low weight of aluminum. The plates of most models are also of aluminum, so that all parts have the same temperature coefficient of linear expansion.

A worm drive is used to obtain the desired high precision of setting. In order to avoid the slight eccentricity that may occur when a worm is mounted on a shaft, the shaft and the worm are accurately machined as one piece. The worm and worm wheel are also lapped into each other to improve smoothness. The dial end of the worm shaft runs in a self-aligning ball bearing, while the other end is supported by an adjustable spring mounting. This spring mounting gives positive longitudinal anchoring to the worm shaft through the use of a pair of sealed, self-lubricating, preloaded ball bearings. Similar pairs of preloaded ball bearings, one pair clamped to the casting at the worm end, provide positive and invariant axial location for the main or rotor shaft. Electrical connection to the rotor is made by means of a silver-alloy brush bearing on a silver-overlay drum to assure a low-noise electrical contact.

Stator insulation in all models is a cross-linked thermo-setting modified polystyrene having very low dielectric losses and very high insulation resistance. In the TYPES 1422-CC and -CD the insulation is in the form of plain

and shouldered washers separating the nickel-plated brass stator plates. In all other models the insulation between the stator stack and the casting consists of washers or buttons having one flat and one spherical surface, the latter mating with a spherically counterbored hole in the casting or separate support piece. Rotor insulation, when used (TYPES 1422-CB and -N), is grade L-4 steatite, silicone treated.

TYPE 1422-D is a two-section, two-terminal capacitor with a scale which is direct reading in total capacitance at the terminals.

TYPE 1422-N is similar to the TYPE 1422-D high section but is intended for use at higher frequencies. To minimize residual inductance and resistance, the connections are made through ribbon leads to the center of the stator and to the center of the rotor through silver-alloy brushes bearing on a silver-overlay disk.

TYPES 1422-MD and -ME are two-section, two-terminal capacitors with scales reading the capacitance removed, i.e., the capacitance is maximum at the zero reading. This scale is particularly convenient for substitution measurements.

TYPES 1422-CB, -CC, and -CD are three-terminal capacitors with shielded coaxial terminals for use in three-terminal measurements where a calibrated direct capacitance independent of terminal capacitances to ground and with very low losses is needed or where an accurate variable capacitance of very small magnitude can be used. The TYPE 1422-CB is similar in construction to the -D, but the -CC and -CD differ radically from the conventional construction. In the latter units, two sets of brass stator plates are interleaved and insulated from each other and from ground. The capacitance between these two stator stacks is varied by a set of grounded rotor plates, with 180° annular windows, interposed between the stators. The direct capacitance between stator stacks is directly proportional to the effective area exposed through the annular opening and, hence, to the angle of rotation of the rotor. This construction yields extremely low losses and a high degree of linearity.

SPECIFICATIONS

Accuracy: See table. The errors tabulated are possible errors, i.e., the sum of error contributions from setting, stability, adjustment, calibration, interpolation, and standards. The actual errors are almost always smaller. The accuracy is improved when the readings are corrected using the ten calibrated values of capacitance given on the

correction chart on the capacitor panel and interpolating linearly between calibrated points. Better accuracy can be obtained from a precision calibration of approximately 100 points on the capacitor dial, which permits correction for slight residual eccentricities of the worm drive and requires interpolation over only short intervals. This



Panel and interior views of Type 1422-D Precision Capacitor.

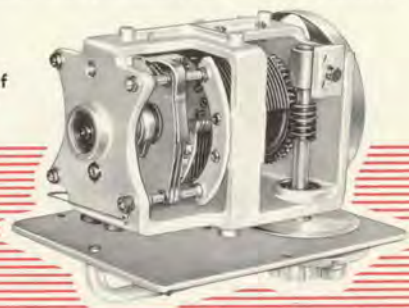

precision calibration is available for all models at an extra charge listed below. A plastic-enclosed certificate of calibration is supplied, giving corrections to one more figure than the tabulated accuracy.

Calibration: The measured values are obtained by comparison at 1 kc, to a precision better than $\pm(0.01\% + 0.00001 \text{ pf})$, with working standards whose absolute values are known to an accuracy typically $\pm 0.01\%$, determined and maintained in terms of reference standards periodically certified by the National Bureau of Standards.

The indicated value of total capacitance of a two-terminal capacitor is the capacitance added when the TYPE 1422 Capacitor is plugged into a TYPE 874-Q9 Adaptor. The uncertainty of this method of connection is approximately $\pm 0.03 \text{ pf}$.

Resolution: The dial can easily be read and set to 1/5 of a small division.

The backlash is less than 1/5 small division, corresponding to 0.004% of full-scale value. If the desired setting is always approached in the direction of increasing scale reading, no error from this cause will result.

Temperature Coefficient: Approximately $+20 \text{ ppm per degree Centigrade}$, for small temperature changes.

Residual Parameters: See table. The series resistance varies as the square root of the frequency above 100 kc. Its effect is negligible below this frequency.

Frequency Characteristic: See plots above, for two-terminal models. The resonance frequency for the -CB and -CC models is approximately 20 Mc; for the -CD model, 60 Mc for each section.

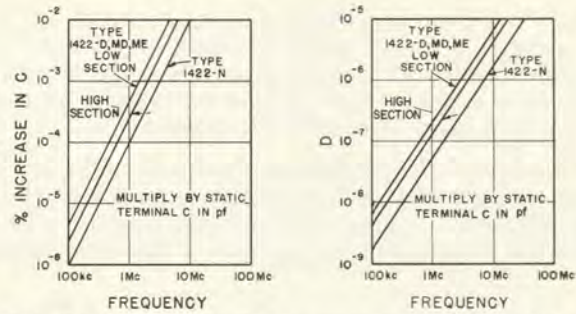

Variation with frequency of effective capacitance and dissipation factor per pf of capacitance for two-terminal Type 1422 Precision Capacitors.

Dissipation Factor: The losses in the two-terminal capacitors are primarily in the stator supports, which are of low-loss polystyrene ($DC = 0.01 \times 10^{-12}$).

The very small dissipation factor of the direct capacitance of the three-terminal capacitors is difficult to measure and is estimated to be not greater than 20×10^{-6} for -CB, and 10×10^{-6} for -CC, -CD.

†John F. Hersh, "A Close Look at Connection Errors in Capacitance Measurements," *General Radio Experimenter*, 33, 7, July, 1959.

TYPE 1422		Two-Terminal								Three-Terminal			
		-D		-N	Reads Capacitance Removed				-CB				-CC
				RF									
CAPACITANCE		Min	100	35	100	0	0	0	0	50	5	0.5	0.05
RANGE, pf:		Max	1150	115	1150	1050	105	105	10.5	1100	110	11	1.1
SCALE, pf/Division:			0.2	0.02	0.2	0.2	0.2	0.02	0.002	0.2	0.02	0.002	0.0002
ACCURACY: \pm Picofarads listed below or $\pm .03\%$, whichever is greater													
Direct-Reading (Adjustment):													
Total Capacitance		0.6*	0.1*	0.6*	Differences from Zero				0.6	0.15	0.04	0.008	
Capacitance Difference		1.2	0.2	1.2	1	0.2	0.2	0.05	1.2	0.3	0.08	0.016	
With Corrections from Calibration Chart (supplied):													
Total Capacitance		0.3*	0.04*	0.3*					0.3	0.04	0.01	0.002	
Capacitance Difference†		0.6	0.08	0.6	0.6	0.08	0.08	0.02	0.6	0.08	0.02	0.004	
With Corrections from Precision Calibration (extra charge):													
Total Capacitance		0.1*	0.01*	0.1*					0.1	0.01	0.001	0.0002	
Capacitance Difference †		0.2	0.02	0.2	0.2	0.02	0.02	0.004	0.2	0.02	0.002	0.0004	
STABILITY: Capacitance change per year not greater than 1 scale division													
RESIDUALS (typical values):													
Series Inductance, μh		0.06	0.10	0.024	0.06	0.10	0.06	0.10	0.14	0.17	0.17	0.17	
Series Resistance, ohms at 1 Mc		0.02	0.03	0.008	0.02	0.03	0.02	0.03	0.1				
Terminal Capacitances, pf:		high terminal to case							min scale	20	850	98	25
									max scale	20	560	74	23
		low terminal to case							min scale	36	920	117	115
									max scale	33	600	92	93
Capacitance at Zero Scale Setting, pf:					1140	135	145	35					

* Total capacitance is the capacitance added when the capacitor is plugged into a TYPE 874-Q9 Adaptor. † Divide error by 2 when one setting is made at a calibrated point.

Insulation Resistance: Under standard conditions (23 C, less than 50% RH), greater than 10^{12} ohms.

Maximum Voltage: All models, 1000 volts, peak.

Terminals: Jack-top binding posts are provided on 2-terminal models; standard 3/4-inch spacing is used. The rotor terminal is connected to the panel and shield. Locking TYPE 874 Coaxial Connectors are used on three-terminal models.

Accessories Supplied: Two TYPE 874-CL58A Cable Connectors with all three-terminal models.

Accessories Available: TYPE 874-Q9 Adaptor.

Cabinet: Lab bench (see page 210).

Dimensions: Width 9 1/2, height 7, depth 8 1/2 inches (245 by 180 by 220 mm), over-all.

Type		Net Weight		Shipping Weight		Code Number	Price	Additional Price for Precision Calibration**
		pounds	kg	pounds	kg			
1422-D	Precision Capacitor	11 1/4	5.1	19	9	1422-9704	\$325.00	\$ 90.00
1422-MD	Precision Capacitor	11	5	19	9	1422-9854	325.00	90.00
1422-ME	Precision Capacitor	10 1/2	4.8	19	9	1422-9855	310.00	110.00
1422-N	Precision Capacitor	10 3/4	4.9	19	9	1422-9714	300.00	50.00
1422-CB	Precision Capacitor	10 3/4	4.9	19	9	1422-9916	300.00	55.00
1422-CC	Precision Capacitor	12 1/2	5.7	19	9	1422-9809	300.00	55.00
1422-CD	Precision Capacitor	11	5	19	9	1422-9823	300.00	165.00

PATENT NOTICE. See Note 4, page viii.

**Add "P" to type number.

GP Type 1401 STANDARD AIR CAPACITOR (TWO-TERMINAL)

USES: The TYPE 1401 Standard Air Capacitors are accurate and stable two-terminal capacitors for laboratory use as reference or working standards. They supplement the TYPE 1409 series of fixed mica capacitors by providing standards of lower loss and lower capacitance.

DESCRIPTION: The aluminum plate assemblies are supported by a low-loss (96% quartz) mounting plate attached to an aluminum casting. This casting, together with the cylindrical aluminum case, provides a dust-free enclosure

and a complete shield. The low, or ground, terminal of the capacitor is connected to this shield. Three supporting rods are used for each of the plate assemblies, ensuring a high degree of rigidity and stability, and all plates, rods, and spacers are aluminum, to minimize thermal stresses. Terminals are insulated by polystyrene bushings.

FEATURES:

- ◆ High accuracy and stability.
- ◆ Low losses.
- ◆ Low temperature coefficient.
- ◆ Convenient size.

SPECIFICATIONS

Calibration: A certificate of calibration is supplied with each unit giving the measured capacitance at 1 kc and at a specified temperature. The measured capacitance is the capacitance added when the standard is plugged directly into General Radio binding posts. This value is obtained by comparison, to a precision better than $\pm 0.01\%$, with working standards whose absolute values are known to an accuracy typically $\pm 0.01\%$, determined and maintained in terms of reference standards periodically certified by the National Bureau of Standards.

Stability: Capacitance change is less than 0.05% per year.

Residual Impedances: The series inductance of all units is approximately 0.05 μ h. See plot.

The metallic resistance of all units is approximately 0.027 ohm at 1 Mc. The series resistance varies as the square root of frequency above about 100 kc.

Temperature Coefficient of Capacitance: $+20 \pm 5$ ppm per degree Centigrade between 20 and 70 C.

Terminals: TYPE 274 Plugs, spaced $\frac{3}{4}$ inch on centers, to plug into TYPE 938 Binding Posts.

Mounting: Aluminum panel and cylindrical case.

Change (percent) in effective terminal capacitance, with frequency, produced by residual inductance.

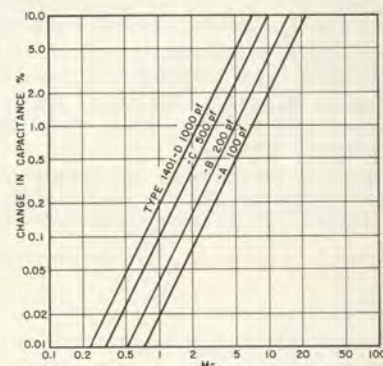

Dimensions: Diameter $3 \frac{1}{16}$ inches (78 mm), height $4 \frac{7}{8}$ inches (125 mm), over-all.

Net Weight: $1 \frac{1}{2}$ pounds (0.6 kg). **Shipping Weight:** 4 pounds (1.9 kg).

Type	Insertion Capacitance	Adjustment Accuracy	Peak Volts	Dissipation Factor	Code Number	Price
1401-A	100 pf	0.2%	1500	100×10^{-6}	1401-9701	\$50.00
1401-B	200 pf	0.15%	1200	50×10^{-6}	1401-9702	54.00
1401-C	500 pf	0.12%	900	20×10^{-6}	1401-9703	57.00
1401-D	1000 pf	0.1%	700	10×10^{-6}	1401-9704	65.00

GP Type 1403 STANDARD AIR CAPACITOR (THREE-TERMINAL)

USES: For measurement at 100 pf and below, a three-terminal connection increases the accuracy by eliminating the uncertainty in the measurement introduced by the capacitances between the capacitor terminals and ground. The TYPE 1403 Standard Air Capacitors are stable, three-terminal standards covering the same range as the TYPE 1401 and extending downward to 0.001 pf.

DESCRIPTION: The three largest sizes are similar in construction to the TYPE 1401, but have shielded termi-

nals, both of which are insulated from the case. The smaller-capacitance units are made up of two plates, with a grounded plate between them; an aperture in the grounded plate determines the magnitude of the direct capacitance. Dielectric losses are not detectable; there is no solid dielectric in the direct-capacitance field.

FEATURES:

- ◆ Provides standards down to 0.001 pf.
- ◆ Negligible dielectric loss.
- ◆ Low residual impedance.



SPECIFICATIONS

Calibration: A certificate of calibration is supplied with each unit giving the measured capacitance at 1 kc and at a specified temperature. The measured value is the direct capacitance between shielded terminals when the capacitor has at least one lead completely shielded and its case connected to a guard point. This value is obtained by comparison, to a precision better than $\pm(0.01\% + 0.00001 \text{ pf})$, with working standards whose absolute values are known to an accuracy typically $\pm 0.01\%$, determined and maintained in terms of reference standards periodically certified by the National Bureau of Standards.

Stability: Capacitance change is less than 0.05% per year.

Residual Impedances: See equivalent circuit and plot.

Temperature Coefficient of Direct Capacitance: $+30 \pm 10 \text{ ppm}$ per degree C between 20 and 70 C.

Terminals: TYPE 874 Coaxial Connectors, which provide complete shielding of the leads.

Mounting: Aluminum panel and cylindrical case.

Accessories Supplied: Two TYPE 874-C58A Cable Connectors.

Dimensions: Diameter $3 \frac{1}{16}$ inches (78 mm), height $4 \frac{7}{8}$ inches (125 mm), over-all.

Net Weight: 1 pound (0.5 kg). **Shipping Weight:** 4 pounds (1.9 kg).

Equivalent circuit showing direct capacitance, C_d , and average values of residual inductance, L , and terminal capacitances, C_a and C_b .

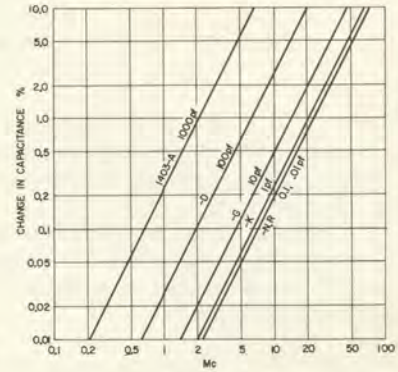
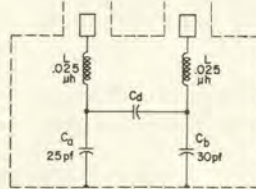

Change (percent) in effective direct capacitance, with frequency, produced by residual inductance.

Type	Nominal Capacitance	Adjustment Accuracy	Peak Volts	Dissipation Factor	Code Number	Price
1403-A	1000 pf	0.1%	700	20×10^{-6}	1403-9701	\$80.00
1403-D	100 pf	0.1%	1500	20×10^{-6}	1403-9704	65.00
1403-G	10 pf	0.1%	1500	30×10^{-6}	1403-9707	55.00
1403-K	1.0 pf	0.1%	1500	20×10^{-6}	1403-9711	45.00
1403-N	0.1 pf	0.1%	1500	20×10^{-6}	1403-9714	45.00
1403-R	0.01 pf	0.3%	1500	20×10^{-6}	1403-9718	45.00
1403-V	0.001 pf	1.0%	1500	20×10^{-6}	1403-9722	45.00

PATENT NOTICE. See Note 4, page viii.



Type 1404-A REFERENCE STANDARD CAPACITOR

USES: This capacitor has been designed as a primary reference standard of capacitance with which working standards can be compared. The TYPE 1615-A Capacitance Bridge (page 36) is particularly well suited for this purpose and can be conveniently used to calibrate accurately a wide range of working standards in terms of the TYPE 1404-A Reference Standard Capacitor. This single 1000-picofarad standard is also the only standard necessary to calibrate the bridge itself quickly and accurately.

DESCRIPTION: All critical parts of the plate assembly are made of Invar for stability and low temperature coefficient. After heat cycling and adjustment the assembly is mounted in a heavy brass container which, after evacuation, is filled with dry nitrogen under pressure slightly above atmospheric, and sealed. The container is mounted on an aluminum panel and placed in an outer aluminum case.

Two coaxial, locking, TYPE 874 Connectors are used as terminals. The outer shell of one is connected to the case but the outer shell of the other is left unconnected to permit the capacitor to be used with an external resistor as a dissipation-factor standard.

FEATURES:

- ◆ Excellent stability — better than 20 parts per million per year.
- ◆ Accurate adjustment — within ± 5 parts per million of nominal value.
- ◆ Low temperature coefficient.
- ◆ Hermetically sealed, with dry-nitrogen dielectric.
- ◆ Inner sealed container easily adaptable to oil immersion.
- ◆ Capacitance to ground less than 50 pf from either terminal.
- ◆ Can be easily used as a dissipation-factor standard.

SPECIFICATIONS

Capacitance: 1000 pf. Adjusted to within $\pm 5 \text{ ppm}$ of nominal value at 23 C and 1000 cps.

Certificate: A certificate is supplied certifying that the capacitor was adjusted at 23 C and 1000 cps by comparison, to a precision of ± 5 parts per million, with standards calibrated by the National Bureau of Standards to an accuracy of ± 50 parts per million.

Stability: Long-term drift is less than 20 parts per million per year. Maximum change with orientation is 10 ppm, and is completely reversible.

Temperature coefficient: $+2 \pm 2 \text{ ppm}/^\circ\text{C}$ from -20 C to $+65 \text{ C}$.

Temperature cycling: For temperature cycling over range from -20 C to $+65 \text{ C}$, hysteresis (retraceable) is less than 20 ppm at 23 C.

Dissipation Factor: Less than 10^{-5} at 1 kc.

Capacitance to ground: Less than 50 pf from either terminal to ground.

Maximum Voltage: 750 volts peak.

Accessories Supplied: Two TYPE 874-C58A Cable Connectors.

Cabinet: Sealed inner container mounted in outer lab-bench aluminum case. Easily adaptable to oil immersion of inner sealed container.

Terminals: Two coaxial, locking TYPE 874; easily convertible to other types of connectors by attachment of locking adaptors (see page 63). Outer shell of one connector is ungrounded to permit capacitor to be used with external resistor as a dissipation-factor standard.

Dimensions: Width $6 \frac{3}{4}$, height $6 \frac{5}{8}$, depth 8 inches (175 by 170 by 205 mm), over-all, including handle.

Net Weight: $8 \frac{1}{2}$ pounds (3.9 kg).

Shipping Weight: 12 pounds (5.5 kg).

Type	Code Number	Price
1404-A Reference Standard Capacitor	1404-9701	\$225.00

PATENT NOTICE. See Note 4, page viii.

Residuals ?



Type 1409 STANDARD CAPACITOR

CAPACITOR
STANDARD, MICA

FEATURES:

- ♦ Stable within $\pm 0.01\%$ per year.
- ♦ Calibrated for both two-terminal and three-terminal connections.
- ♦ Plug-in terminals permit several units to be stacked one upon the other without the use of leads and without cumulative error.

USES: The TYPE 1409 Standard Capacitors are fixed mica capacitors of very high accuracy and stability for use as two- or three-terminal reference or working standards in the laboratory.

A group of these capacitors, observed over more than five years, have shown random fluctuations of less than $\pm 0.01\%$ in measured capacitance with no evidence of systematic drift.

DESCRIPTION: These capacitor units consist of a silvered-mica and foil pile, spring-held in a heavy metal clamping

structure for mechanical stability. The units are selected for low dissipation factor and are stabilized by heat cycling. They are shielded from external fields and from humidity by being mounted, with silica gel to provide continuous desiccation, in cast aluminum cases, sealed with high-temperature potting wax. A well is provided in the wall of the case for the insertion of a dial-type bi-metallic thermometer. Three jack-top binding posts are provided on the top of the case and three removable plugs on the bottom, for convenient parallel connection without error.

SPECIFICATIONS

Accuracy of Adjustment: Within $\pm 0.05\%$ of the nominal capacitance value (two-terminal) marked on the case.

Calibration: A certificate of calibration is supplied with each unit, giving both two- and three-terminal measured capacitances at 1 kc and at a specified temperature. The measured value is the capacitance added when the standard is plugged directly into General Radio binding posts. This value is obtained by comparison, to a precision better than $\pm 0.01\%$, with working standards whose absolute values are known to an accuracy typically $\pm 0.01\%$, determined and maintained in terms of reference standards periodically certified by the National Bureau of Standards.

Stability: Capacitance change is less than 0.01% per year.

Temperature Coefficient of Capacitance: $+35 \pm 10$ ppm per degree Centigrade between 10 and 70 C.

Dissipation Factor: Less than 0.0003 at 1 kc and 23 C (see curves). Measured dissipation factor at 1000 cps is also given in the certificate to an accuracy of ± 0.00005 .

Frequency Characteristics: See typical curves on page 153. Values of series inductance and series resistance at 1 Mc are given in the table. This resistance varies as the square root of the frequency for frequencies above 100 kc.

Terminal Capacitance: The capacitance from the H terminal to the case (G) is of the order of 12-50 pf.

The capacitance from the L terminal (outside foils of capacitor) to the case is of the order of 300-1300 pf.

Leakage Resistance: 5000 ohm-farads or 100,000 megohms, whichever is the lesser.

Maximum Voltage: 500 volts peak at frequencies below the limiting frequencies tabulated below. At high frequencies the allowable voltage decreases and is inversely proportional to the frequency, approximately. These limits correspond to a temperature rise of 40 degrees Centigrade for power dissipations of 5, 6, and 7.5 watts for the small, medium, and large cases, respectively.

Terminals: Two insulated jack-top terminals, plus jack-top terminal and ground strap. Removable plugs screw into the terminal bottoms.

Mounting: Cast aluminum cases with rubber feet.

Dimensions: Small case, $3\frac{1}{4}$ by 4 by 2 inches (85 by 105 by 50 mm); medium case, $3\frac{1}{4}$ by 4 by 2 $\frac{11}{16}$ inches (85 by 105 by 70 mm); large case, $3\frac{1}{4}$ by 5 $\frac{5}{8}$ by 2 $\frac{11}{16}$ inches (85 by 145 by 70 mm) over-all.

Type	Nominal Capacitance μf	Maximum Peak Volts	Frequency Limit for Max Volts	Series Inductance μh	Resistance in Ohms at 1 Mc	Net Weight	Shipping Weight	Code Number	Price
1409-F	0.001	500	4.7 Mc	0.050	0.02	1 $\frac{1}{4}$ lb (0.6 kg)	3 lb (1.4 kg)	1409-9706	\$ 32.00
1409-G	0.002	500	2.7 Mc	0.050	0.02	1 $\frac{1}{4}$ lb (0.6 kg)	3 lb (1.4 kg)	1409-9707	32.00
1409-K	0.005	500	1.3 Mc	0.050	0.02	1 $\frac{1}{4}$ lb (0.6 kg)	3 lb (1.4 kg)	1409-9711	34.00
1409-L	0.01	500	750 kc	0.050	0.02	1 $\frac{1}{4}$ lb (0.6 kg)	3 lb (1.4 kg)	1409-9712	34.00
1409-M	0.02	500	430 kc	0.050	0.02	1 $\frac{1}{4}$ lb (0.6 kg)	3 lb (1.4 kg)	1409-9713	36.00
1409-R	0.05	500	210 kc	0.055	0.02	1 $\frac{1}{4}$ lb (0.6 kg)	3 lb (1.4 kg)	1409-9718	39.00
1409-T	0.1	500	120 kc	0.055	0.02	1 $\frac{1}{4}$ lb (0.6 kg)	3 lb (1.4 kg)	1409-9720	42.00
1409-U	0.2	500	70 kc	0.055	0.02	1 $\frac{1}{4}$ lb (0.6 kg)	3 lb (1.4 kg)	1409-9721	55.00
1409-X*	0.5	500	35 kc	0.055	0.02	1 $\frac{3}{4}$ lb (0.8 kg)	4 lb (1.9 kg)	1409-9724	105.00
1409-Y†	1.0	500	17 kc	0.070	0.03	2 $\frac{1}{2}$ lb (1.1 kg)	4 lb (1.9 kg)	1409-9725	175.00

* Mounted in medium case. † Mounted in large case.



GP Type 505 CAPACITOR

CAPACITORS
FIXED, MICA

- FEATURES:**
- ♦ Small, convenient, stable, and accurate.
 - ♦ Low-loss phenolic case to reduce dielectric loss and leakage conductance.
 - ♦ Low temperature coefficient of capacitance.

USES: The TYPE 505 Capacitors are stable, low-loss mica capacitors for use as high-quality circuit elements and as secondary standards where the higher accuracy, complete shielding, lower loss, and stacking connections of the TYPE 1409 Capacitors are not required.

DESCRIPTION: The TYPE 505 unit uses the same silvered-mica and foil pile used in the TYPE 1409 and has almost equally high stability. Each unit is sealed with wax in a low-loss phenolic case. Silica gel is included for continuous desiccation and granulated polyethylene is provided to absorb shock.

SPECIFICATIONS

Accuracy: At 1 kc, $\pm 0.5\%$ or ± 3 pf, whichever is the larger.

Temperature Coefficient: Approximately +35 ppm per degree Centigrade between 10 and 50 C. Calibration is made at 23 C, at a frequency of 1 kc.

Dissipation Factor: 0.0003 for 1000 pf and higher; 500 pf, 0.00035; 200 pf, 0.0004; 100 pf, 0.0006.

Frequency Characteristics: Similar to those for TYPE 1409. Series inductance is approximately $0.055 \mu\text{h}$ for units in small case and $0.085 \mu\text{h}$ for large case. Series resistance at 1 Mc is approximately 0.03 ohm for small case and 0.05 ohm for large case, varying as square root of frequency above 100 kc.

Leakage Resistance: Greater than 100,000 megohms, when measured at 500 volts, except for the TYPES 505-T, 505-U, and 505-X, for which it is greater than 50,000, 25,000, and 10,000 megohms, respectively.

Maximum Voltage: See table. At higher frequencies the allowable voltage decreases and is inversely proportional to the square root of the frequency. These limits correspond to a temperature rise of

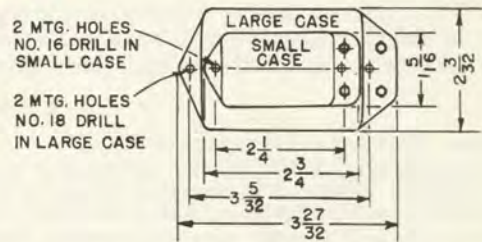

40 degrees Centigrade for a power dissipation of 1 watt for the small case and 2.5 watts for the large case.

Terminals: Two screw terminals spaced $\frac{3}{4}$ inch apart, with two removable plug bottoms, TYPE 274-P. High terminal (inside foil) is marked H.

Dimensions: See sketch; dimensions shown are in inches. Over-all height, $1\frac{5}{8}$ inches for large case, 1 inch for small case, exclusive of plugs. To convert inches to mm, multiply by 25.4.

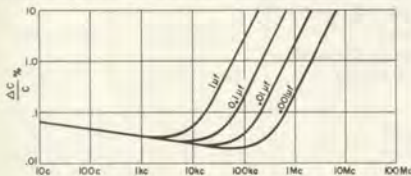

(Left) Change in capacitance as a function of frequency for typical Type 1409 Capacitors. The 1-kc value on the plot should be used as a basis of reference in estimating frequency errors. (Right) Dissipation factor as a function of frequency.

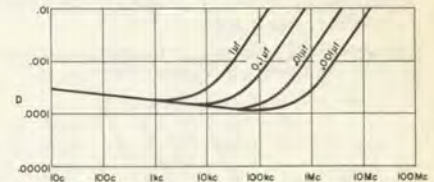

Type	Capacitance	Maximum Peak Volts	Frequency Limit For Max Volts	Net Weight	Shipping Weight	Code Number	Price
505-A	100 pf	700	10 Mc	4 oz (115 g)	8 oz (230 g)	0505-9701	\$10.00
505-B	200 pf	700	6 Mc	4 oz (115 g)	8 oz (230 g)	0505-9702	7.50
505-E	500 pf	500	4 Mc	4 oz (115 g)	8 oz (230 g)	0505-9705	7.50
505-F	0.001 μf	500	2.3 Mc	4 oz (115 g)	8 oz (230 g)	0505-9706	7.50
505-G	0.002 μf	500	1.3 Mc	5 oz (145 g)	8 oz (230 g)	0505-9707	7.50
505-K	0.005 μf	500	630 kc	5 oz (145 g)	8 oz (230 g)	0505-9711	7.50
505-L	0.01 μf	500	360 kc	5 oz (145 g)	8 oz (230 g)	0505-9712	9.00
505-M	0.02 μf	500	210 kc	6 oz (170 g)	8 oz (230 g)	0505-9713	11.50
*505-R	0.05 μf	500	100 kc	11 oz (315 g)	1 lb (0.5 kg)	0505-9718	15.50
*505-T	0.1 μf	500	50 kc	12 oz (340 g)	1 lb (0.5 kg)	0505-9720	22.00
*505-U	0.2 μf	500	20 kc	13 oz (370 g)	1 lb (0.5 kg)	0505-9721	35.00
*505-X	0.5 μf	500	10 kc	15 oz (425 g)	1 1/4 lb (0.6 kg)	0505-9724	75.00

* Mounted in large case.





Type 1423-A PRECISION DECADE CAPACITOR

USES: Any value of capacitance between 100 pf and 1.111 μf , in steps of 100 pf, can be set on the four decades and will be known to an accuracy of 0.05%. Thus a bridge can be standardized quickly to an accuracy that could be exceeded only by the use of individually certified laboratory standards of the highest available quality such as the TYPE 1404-A Reference Standard Capacitor.

In conjunction with a limit bridge, such as the TYPE 1605-A Impedance Comparator, production-line measurements of arbitrary values of capacitance (such as EIA preferred values) can be made rapidly and accurately, with a minimum of setup time.

DESCRIPTION: This is a doubly shielded decade capacitor consisting of four decades of high-quality silvered-mica capacitors. The two complete shields make the capacitance

at the terminals the same for either the two-terminal or the three-terminal method of connection, except for the external binding-post capacitance of about 1 pf added by the two-terminal connection. This external capacitance can be included in the two-terminal calibration by the adjustment of a single trimmer.

The terminal capacitance values are adjusted precisely to nominal value by independent means and can subsequently be readjusted at calibration intervals, if necessary, without disturbance of the main capacitors.

FEATURES:

- ◆ Direct-reading accuracy $\pm 0.05\%$.
- ◆ Long-term stability $\pm 0.01\%$ per year.
- ◆ Easily readjusted in terms of reference standards.
- ◆ Accurate for either two- or three-terminal use.

SPECIFICATIONS

Nominal Values: 100 pf to 1.111 μf in steps of 100 pf.

Accuracy of Adjustment: $\pm 0.05\%$ at 1 kc, calibrated in the three-terminal connection. Two-terminal connection (made by inserting the capacitor into TYPE 874-Q9 Adaptor) adds about 1.3 pf to reading.

Certificate: A certificate is supplied certifying that each component capacitor was adjusted by comparison, to a precision better than $\pm 0.01\%$, with working standards whose absolute values are known to an accuracy typically $\pm 0.01\%$, determined and maintained in terms of reference standards periodically certified by the National Bureau of Standards.

Frequency: Adjusted at 1 kc. The behavior of each individual capacitor is similar to that of a TYPE 505 Capacitor.

Dissipation Factor: Not greater than 0.001, 0.0005, and 0.0003 for capacitances of 100 pf to 1000 pf, 1100 pf to 2000 pf, and 2100 pf to 1.1110 μf , respectively.

Temperature Coefficient of Capacitance: Approximately +35 ppm per degree Centigrade between 10 and 50 C.

Insulation Resistance: Greater than 50,000 megohms to 0.1 μf and greater than 5000 megohms from 0.1 μf to 1.111 μf .

Maximum Voltage: 500 volts peak, up to 10 kc.

Accessories Supplied: Two TYPE 874-Q9 Adaptors.

Cabinet: Rack bench; rack model supplied without metal supports (see page 210).

Dimensions: Bench model — width 19, height 7 $\frac{1}{4}$, depth 10 $\frac{1}{2}$ inches (485 by 185 by 270 mm), over-all; rack model — panel 19 by 7 inches (485 by 180 mm), depth behind panel 8 $\frac{1}{2}$ inches (220 mm).

Net Weight: 26 pounds (11.8 kg).

Shipping Weight: 32 pounds (14.5 kg).

Type		Code Number	Price
1423-AM	Precision Decade Capacitor, Bench Model	1423-9801	\$695.00
1423-AR	Precision Decade Capacitor, Relay-Rack Model	1423-9811	695.00

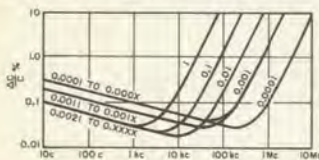

(Left) Change in capacitance as a function of frequency. These changes are referred to the values which the capacitors would have if there were neither interfacial polarization nor series inductance. The 1-kc value on the plot should be used as a basis of reference in estimating frequency errors.

(Right) Dissipation factor as a function of frequency.

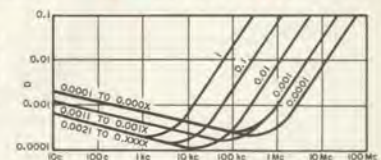

Type 1424-A STANDARD POLYSTYRENE DECADE CAPACITOR

USES: This single-decade capacitor extends to 10 μf the range of General Radio's accurate decade standards of capacitance. It provides ten individual standards, one at each integral microfarad value from 1 to 10.

DESCRIPTION: Twenty polystyrene capacitors are assembled to give ten 1- μf units. These are housed in two hermetically sealed non-ferrous metal cases with Teflon-insulated high terminals, the cases being the common (Low) terminal. The aluminum outer cabinet and panel are insulated from both capacitor terminals, so that either two- or three-terminal connections can be used.

Residual series inductance and resistance have been minimized by the use of current-sheet conductors, ribbon leads, and multiple switch contacts.

Leakage resistance is very high, corresponding to a time constant of 12 days, and a discharge position is provided on the switch to minimize the danger of electrical shock to the operator. To avoid damage to the capacitor, charging current is also limited by the switching arrangement.

FEATURES:

- ◆ High accuracy.
- ◆ High leakage resistance.
- ◆ Low series residuals and dissipation factor.

SPECIFICATIONS

Nominal Value: 0 to 10 microfarads, in steps of 1 microfarad.

Accuracy of Adjustment: $\pm 0.25\%$ at 1 kc.

Certificate: A certificate is supplied giving measured values obtained by comparison, to a precision better than $\pm 0.01\%$, with working standards whose absolute values are known to an accuracy typically $\pm 0.05\%$, determined and maintained in terms of reference standards periodically certified by the National Bureau of Standards.

Stability: Capacitance change is not greater than $\pm 0.05\%$ per year.

Frequency: Calibrated at 1 kc. Variation down to 60 cps is typically less than +0.02%. At higher frequencies, terminal capacitance rises as resonant frequency is approached (see curves).

Voltage Recovery: Less than 0.1% (see page 157).

Dissipation Factor: Less than 0.0002 at 1 kc. (See curves.)

Temperature Coefficient: Approximately -140 ppm per degree C.

Insulation Resistance: Approximately one million ohm-farads.

Maximum Voltage: 500 volts peak, up to 10 kc.

Terminals: Jack-top binding posts; ground terminal provided.

Cabinet: Lab bench (see page 210).

Dimensions: Width 9 $\frac{1}{2}$, height 7 $\frac{3}{4}$, depth 8 inches (245 by 195 by 205 mm), over-all.

Net Weight: 16 $\frac{1}{2}$ pounds (7.5 kg).

Shipping Weight: 24 pounds (11 kg).

0.003 on cert what curves



Type 1423-A



Type 1424-M

◆ Type 1424-M DECADE CAPACITOR

This capacitor is a 1-microfarad-per-step decade which has less rigorous performance specifications than the TYPE 1424-A and a correspondingly lower price. Sealed foil-paper capacitors of noninductive extended-foil construction are used with a viscous impregnant to improve stability.

SPECIFICATIONS

Nominal Value: 0 to 10 microfarads, in steps of 1 microfarad.

Accuracy of Adjustment: $\pm 1\%$ at 1 kc.

Stability: Capacitance change is not greater than $\pm 0.35\%$ per year.

Frequency: Adjusted at 1 kc. Variation down to 60 cps is typically less than $+0.7\%$. At higher frequencies, terminal capacitance rises as resonant frequency, f_0 , is approached. The increase is $\Delta C/C = (f/f_0)^2$, and f_0 varies from about 570 kc at 1 μf to 240 kc at 10 μf .

Voltage Recovery: Less than 5% (see page 157).

Dissipation Factor: Less than 0.005 at 1 kc.

Temperature Coefficient: Approximately $+180$ ppm per degree C.

Maximum Operating Temperature: 90 C.

Insulation Resistance: Greater than 10,000 ohm-farads.

Maximum Voltage: 500 volts peak, up to 2 kc.

Terminals: Jack-top binding posts; ground terminal provided.

Cabinet: Lab bench (see page 210).

Dimensions: Width $9\frac{1}{2}$, height 6, depth 8 inches (245 by 150 by 205 mm), over-all.

Net Weight: $7\frac{3}{4}$ pounds (3.5 kg). **Shipping Weight:** 24 pounds (11 kg).

Type		Code Number	Price
1424-A	Standard Polystyrene Decade Capacitor	1424-9701	\$325.00
1424-M	Decade Capacitor	1424-9713	195.00

◆ Type 1429-A FUEL-GAGE TESTER

USES: The TYPE 1429-A Fuel-Gage Tester meets the need for an accurate device for testing and calibrating modern capacitance-type fuel-gage systems in both reciprocating-engine and jet-engine planes.

DESCRIPTION: This tester fulfills the same function as the military MD-1 Tester, but has smaller dimensions and lower weight. It contains two 3-terminal, 200-pf ΔC air capacitors, one to simulate the jet fuel compensator, the other (with fixed capacitors) the main sensing capacitor of the fuel gage.

The main capacitor is extended in value to 6200 pf by two sets of switched, solder-sealed, precision, silvered-

mica, fixed capacitors, one having five steps of 200 pf, the other five steps of 1000 pf.

External connections are made through keyed coaxial connectors. Cables and adaptors as required by specification MIL-T-8579 (USAF) are supplied.

FEATURES:

- ◆ Protected from moisture and vibration.
- ◆ High precision of setting. ◆ High accuracy.
- ◆ Low temperature coefficient of capacitance.
- ◆ Low dielectric losses.
- ◆ Fulfills functions and environmental requirements of military MD-1 Tester.

SPECIFICATIONS

Capacitance Range: Main capacitor variable linearly from 20 to 220 pf, thence by switched steps of 200 pf to 6220 pf. Compensating capacitor variable linearly from 10 to 210 pf.

Accuracy: Main air capacitor within $\pm 0.5\%$ or ± 0.75 pf, whichever is greater. Compensating air capacitor within $\pm 1.5\%$ or ± 0.5 pf, whichever is greater. Switched capacitors within $\pm 0.5\%$.

Correction Chart: A correction chart, laminated between plastic sheets for protection, is supplied. When its corrections are applied, the capacitance is correct at 400 cps to $\pm 0.1\%$ or ± 0.15 pf, whichever is greater.

Maximum Voltage: 500 volts peak.

Dielectric Supports: Plates of low-loss steatite support the stator assembly, glass-bonded-mica washers the rotor.

Dielectric Losses: Almost negligible for the air capacitors. D not over 0.001 for the switched silvered-mica capacitors.

Temperature Coefficient of Capacitance: For small temperature changes, approximately $+0.002\%$ per degree Centigrade for air, and $+0.0035\%$ for mica capacitors.

Backlash: Less than one-third division (out of 2000), corresponding to 0.02% of full-scale value. If the desired setting is always approached in the direction of increasing scale reading, no error from this cause will result.

Terminals: Three special, keyed, coaxial connectors, the center one of which is connected to both rotors.

Cabinet: All capacitors and a renewable desiccant cartridge are mounted on an aluminum panel and enclosed in a moisture-sealed aluminum cabinet. The latter is shock-mounted in an aluminum transit case with a compartment to hold nine connecting cables and three tee adaptors.

Dimensions: Width $17\frac{1}{2}$, height $10\frac{1}{2}$, depth $10\frac{1}{2}$ inches (445 by 270 by 270 mm), over-all.

Net Weight: $28\frac{3}{4}$ pounds (13 kg). **Shipping Weight:** 35 pounds (16 kg).

Type		Code Number	Price
1429-A	Fuel-Gage Tester	1429-9701	\$975.00





Type 1419 DECADE CAPACITORS

Type 980 DECADE CAPACITOR UNITS

CAPACITORS
DECADE

FEATURES:

- ◆ Polystyrene decades have high insulation resistance, low dielectric absorption, and low losses.
- ◆ Mica decades available with 0.5% accuracy, low temperature coefficient, and higher permissible operating temperatures than polystyrene models.
- ◆ Three-terminal construction provided on all decades.

(Left) Typical plot of change in capacitance at maximum setting of each decade as a function of frequency. The capacitance curves are referred to the value the capacitor would have if there were no interfacial polarization and no series inductance. Since the capacitors are adjusted to their rated accuracy at 1 kc, the 1-kc value on the plots should be used as a basis of reference in estimating the frequency error. (Right) Typical plot of dissipation factor as a function of frequency.

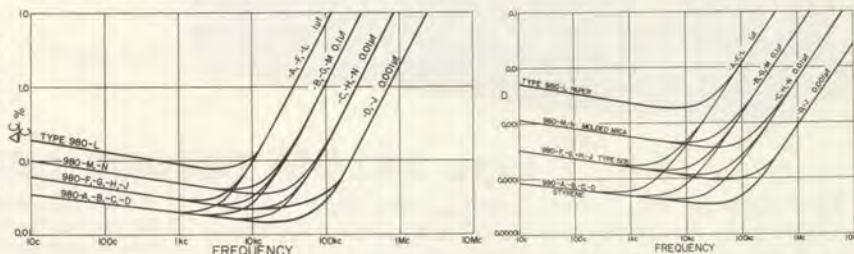

USES: General Radio decade capacitors have a multiplicity of uses in the electronics laboratory as circuit elements in resonant circuits, bridges, filters, oscillators, analyzers, equalizers and other networks. They are available as multi-decade units in shielded cabinets (TYPE 1419) for experimental laboratory use and as single decades (TYPE 980) for building into other equipment. Decades are available in three different dielectric materials: paper, for uses where dissipation factor is not critical; silvered mica, for better dissipation factor and use in higher ambient temperature; and polystyrene, for applications requiring very low dielectric absorption and constancy of both capacitance and dissipation factor with frequency.

DESCRIPTION: Each decade consists of four capacitors of magnitudes in the ratio of 1, 2, 2, 5. The switch selects parallel combinations to give all integral values between 1 and 10. Terminals are provided for both two-terminal and three-terminal connections on all decades and decade boxes.

The switch, which is designed for low capacitance and low losses, is rigidly constructed and includes a detent mechanism for positive location of position. The switch dielectric, including the shaft, is heat-resistant, cross-linked, modified polystyrene. Contacts are made by heavily silver-plated cams riding on tinned phosphor-bronze springs.

Units are furnished complete with knob, photo-etched dial plate, and switch stops.

Paper Dielectric Units (Type 980-L; used in Type 1419-M).

These units are highly stable, sealed, firecracker-shaped, foil-and-paper capacitors, with a viscous impregnant.

Polystyrene Decades (Types 980-A, B, C, D, and Types 1419-A and B).

The individual capacitor units are designed to be essentially non-inductive and are heat-stabilized, so that their long-time stability approaches that of the best silvered-mica capacitors.

The capacitors are wound in spool form from continuous interleaved tapes of polystyrene and metal foil, then flattened in heat treatment. The foils projecting at each end of the roll are soldered together to minimize inductance and series resistance.

The tape used for the dielectric is specially prepared of purified high-molecular-weight polystyrene, having very high resistance and freedom from interfacial polarization. Moisture sealing with Teflon feed-through insulators assures high performance even under adverse humidity conditions.

Silvered-Mica Decades (Types 980-F, G, H, and Type 1419-K).

The individual capacitors are General Radio TYPE 505 Capacitors (page 153), which are assembled from selected sheets of silvered mica. These units are accurate and stable, with low losses and low temperature coefficient.

Molded Units (Types 980-M, N; used in Type 1419-M).

These molded, silvered-mica units are EIA Characteristic-C types, offering excellent performance at low cost, for those applications where dissipation factor and stability are not critical.

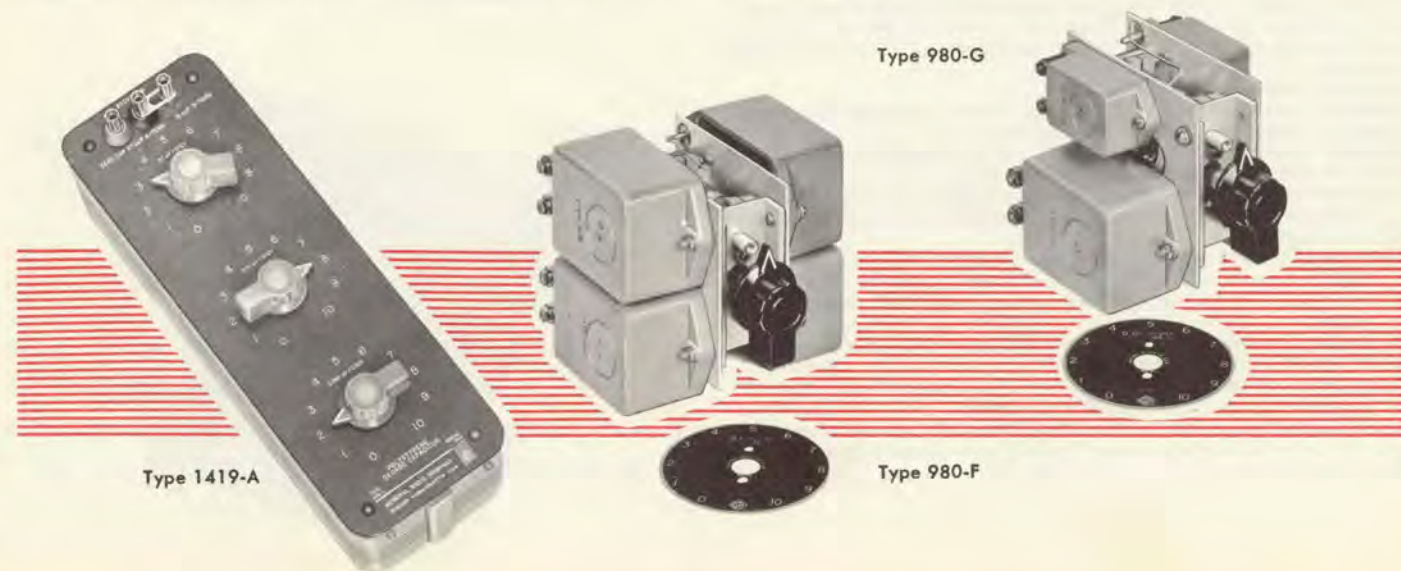

SPECIFICATIONS

Dielectric TYPE		Polystyrene				Silvered Mica — GR Type 505			Paper	Silvered Mica (Molded)	
		980-A	980-B	980-C	980-D	980-F	980-G	980-H	980-L	980-M	980-N
Maximum Capacitance (μf)		1.0	0.1	0.01	0.001	1.0	0.1	0.01	1.0	0.1	0.01
Capacitance per Step (μf)		0.1	0.01	0.001	0.0001	0.1	0.01	0.001	0.1	0.01	0.001
Zero Ca- pacitance	2-terminal connection	Approximately 11 pf									
	3-terminal connection	5 pf									
Accuracy ¹	2-terminal connection ²	±1%			±(1% +2 pf)	±0.5%			±1.5%	±1%	
	3-terminal connection	±1%	±1%	±1.5%	+1% -2% +4 pf)	±0.5%	±0.5%	±1%	±1.5%	±1%	±1%
Dissipation Factor		<0.0002				<0.0003			<0.005	<0.001	
Insulation Resistance at 100 v, 25 C, 50% RH (ohms)		10 ¹²				5 × 10 ⁹	25 × 10 ⁹	25 × 10 ⁹	10 ¹⁰	10 ⁹	10 ⁹
Temperature Coefficient of Capacitance ppm/°C		-140 nominal				+35 ± 10			+180 nominal	EIA Characteristic C	
Maximum Operating Voltage ³ (DC or peak)		500				500			500	500	
Frequency Limit for Maximum Voltage ³		35 kc	125 kc	800 kc	5 Mc	10 kc	100 kc	600 kc	1 kc	50 kc	400 kc
Frequency Characteristic		See Curves									
Maximum Operating Temperature (C)		65				90			90	90	
Dielectric Absorption		See Voltage Recovery									
Voltage Recovery ⁴		<0.1%				<3%			<5%	—	
Terminals		Bus wire				Flexible leads					
Mounting Hardware		Machine screws are furnished									
Width, height, depth behind panel — inches (multiply by 25.4 for mm)		3 7/8, 3 3/8, 3 1/8	2 3/4, 3 3/8, 3 1/4			4 7/8, 4 1/4, 4 1/8	4 1/4, 4, 4 1/8	3 3/8, 3 3/8, 4 1/8	2 3/4, 3 1/4, 3 1/2		
Net Weight		2 1/8 lb (1 kg)				3 3/4 lb (1.7 kg)	2 lb (0.9 kg)	1 1/2 lb (0.8 kg)	1 1/2 lb (0.8 kg)	1 1/2 lb (0.7 kg)	1 1/2 lb (0.7 kg)
Shipping weight		4 lb (1.9 kg)				6 lb (2.8 kg)	4 lb (1.9 kg)	4 lb (1.9 kg)	4 lb (1.9 kg)	4 lb (1.9 kg)	4 lb (1.9 kg)
Code Number		0980- 9701	0980- 9702	0980- 9703	0980- 9704	0980- 9706	0980- 9707	0980- 9708	0980- 9712	0980- 9713	0980- 9714
Price		\$66.00	\$51.00	\$57.00	\$57.00	\$180.00	\$65.00	\$50.00	\$45.00	\$50.00	\$34.00

TYPE NUMBER	1419-A									
	1419-B				1419-K			1419-M		
Type 980 Decades Used	A	B	C	D	F	G	H	L	M	N
Capacitance per Step (μf)	0.01	0.01	0.001	0.0001	0.1	0.01	0.001	0.1	0.01	0.001
Dielectric	Polystyrene				Mica			Paper	Mica	Mica
Maximum Capacitance of Box (μf)	1.110				1.110			1.110		
Zero Ca- pacitance (pf)	37		50		41			35		
	15		20		13			16		
Frequency Characteristic	Similar to those for the Type 980 Decade Capacitance Units, modified by the additional inductance and resistance at the box terminals and wiring.									
DC Cap/1-kc Cap	<1.001				Typically 1.03					
Terminals	Three Type 938 Binding Posts with grounding link									
Cabinet	Lab bench (see page 210)									
Over-all Dimensions	13 by 4 5/8 by 5 inches (330 by 110 by 130 mm)				14 1/8 by 5 1/2 by 6 inches (359 by 140 by 153 mm)			14 1/8 by 5 1/2 by 6 inches (359 by 140 by 153 mm)		
	16 5/8 by 4 5/8 by 5 inches (415 by 110 by 130 mm)									
Net Weight	8 3/8 lb (3.8 kg)			10 1/2 lb (4.8 kg)		11 1/4 lb (5.1 kg)			6 1/4 lb (2.9 kg)	
Shipping weight	10 lb (4.6 kg)			11 lb (5 kg)		12 lb (5.5 kg)			7 lb (3.2 kg)	
Code Number	1419-9701			1419-9702		1419-9711			1419-9713	
Price	\$205.00			\$262.00		\$330.00			\$156.00	

¹ Capacitance increments from zero position are within this percentage of the indicated value for any setting at 1 kc.

² Units are checked with switch mechanism high, electrically, and the common lead and case grounded.

³ At frequencies above the indicated maximum, the allowable voltage decreases and is (approximately) inversely proportional to frequency. These limits correspond to a temperature of 40 C.

⁴ Final % of original charging voltage after a charging period of one hour and a 10-second discharge through a resistance equal to one ohm per volt of charging.

Note: Decade Resistors and Decade Inductors are described on pages 160 and 166, respectively.

RESISTORS



Because of its accuracy of adjustment, long-term stability, low and uniform-temperature coefficient, and relative immunity to ambient humidity conditions, the wire-wound resistor is the most suitable type for use as a laboratory standard at audio and low radio frequencies, as well as at dc. In the resistance range from a fraction of an ohm to about one megohm, such resistors have been developed to a high state of refinement through improvements in design and manufacturing techniques.

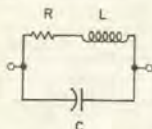

Figure 1.

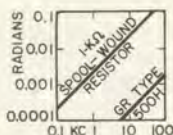

Figure 2.

Resistors designed for ac use differ from those intended for use only at direct current in that low series reactance and constancy of resistance as frequency is varied are important design objectives. Inevitably, resistors have residual capacitance and inductance associated with them, which become increasingly important as the frequency is raised, acting to change the terminal resistance from its low-frequency value.

For frequencies where the resistance and its associated residual reactances behave as lumped parameters, the equivalent circuit of a resistor can be represented as shown in Figure 1. The inductance, L , is the equivalent inductance in series with the resistance, while the capacitance, C , is the equivalent capacitance across the terminals of the resistor.

It is necessary to differentiate clearly between the concepts of equivalent series and equivalent parallel circuits. The two-terminal circuit of Figure 1 can be described as an impedance $R_s + jX_s$, or as an admittance $G + jB = \frac{1}{R_p} + \frac{1}{jX_p}$, wherein the parameters are a function of frequency. This distinction between series and parallel components is more than a mathematical exercise — the use to which the resistor is to be put will frequently determine which component is of principal interest.

The expression for the effective series impedance (Z) is:

$$Z_s = R_s + jX_s = \frac{R + j\omega \left[L \left(1 - \frac{\omega^2}{\omega_0^2} \right) - R^2 C \right]}{\left(1 - \frac{\omega^2}{\omega_0^2} \right)^2 + (\omega RC)^2}$$

where $\omega_0 = \frac{1}{\sqrt{LC}}$ and $\frac{\omega^2}{\omega_0^2} = \omega^2 LC$.

The effective parallel admittance is given by:

$$Y = G + jB = \frac{1}{R_p} + \frac{1}{jX_p} = \frac{\frac{1}{R} + j\omega \left[C - \frac{L}{R^2} \left(1 - \frac{\omega^2}{\omega_0^2} \right) \right]}{1 + \left(\frac{\omega L}{R} \right)^2}$$

At low frequencies where terms involving the square of frequency are negligible, the resistor may be represented by a two-element network consisting of the dc resistance, R , in series with an inductance equal to $L - R^2 C$ or in parallel with a capacitance equal to $C - L/R^2$. Because of the presence of the R^2 term in the equivalent reactive parameters, shunt capacitance is the dominating residual for high values of resistance, while for low values of resistance, the series inductance invariably predominates. Generally, individual wire-wound resistors above a few kilohms are capacitive, while decades, which have increased effective capacitance, are capacitive at somewhat lower values.

In the simplified circuit above, the effective parallel resistance of a high-valued resistor in which shunt capacitance dominates would be independent of frequency. Actually, other effects may cause the parallel resistance to decrease with frequency. For example, dielectric losses in the shunt capacitance, C , of Figure 1 are equivalent to a resistance

$$R_d = \frac{1}{D\omega C}$$

(where D is the dissipation factor of the distributed capacitance) which decreases with frequency and causes the effective parallel resistance to decrease rapidly beyond a certain frequency. In addition, distributed capacitance along the winding causes a similar rapid decrease in resistance even if its dielectric loss is negligible. The equations above indicate that the effective series resistance of low-valued resistors would be independent of frequency up to quite high frequencies. In practice, if the residual inductance and capacitance are kept small, skin effect becomes the main cause for departure from the low-frequency value of these resistors.

General Radio wire-wound resistance elements are designed to minimize inductance in low-resistance values and to minimize capacitance for high values of resistance. All units up through 200 ohms utilize an Ayrton-Perry winding, in which each resistor consists of two windings in opposite directions, such that their magnetic fields are opposed and largely cancel. For very low-valued units, the residual inductance of such a winding is of the order of 1% of that of a corresponding single winding.

Elements having 500-ohm resistance or higher are unifilar-wound on flat rectangular "cards," and have inherently less inductance than so-called "noninductive" spool-wound types because of the low cross-sectional area of the winding (refer to Figure 2). The capacitance of a card-type resistor is also much lower than that of a spool type because the turns of wire are not piled up but are evenly wound in one layer.

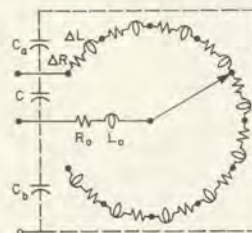

Figure 3. Equivalent circuit of a resistance decade, showing location and nature of residual impedances.

These wire-wound resistors exhibit a negligible frequency error in resistance up to about 500 kc for values up to 500 ohms, and only moderate errors at 1 Mc.

In decade boxes, the residual impedances of the switches, wiring, and cabinet are added to those of the resistors themselves. The equivalent circuit is then that of Figure 3, which represents a single TYPE 510 decade. For multiple-decade boxes, the series inductances are additive, but the capacitance is approximately that across the highest valued decade used (see specifications for each type).

The effect of the residual reactance depends greatly upon the way the resistor is connected in the circuit. For example, parallel capacitance can often be compensated for when the resistor is connected in parallel with a capacitor. For high-valued resistors, the upper frequency limit for a given error is some ten times higher in the effective parallel resistance than it is for the series connection.

General Radio decade boxes have a separate terminal for the case. With a three-terminal connection, the capacitance is reduced because capacitance from the resistor terminals to the case (C_a and C_b in Figure 3) are guarded and do not shunt the resistance. Moreover, this direct impedance will often appear slightly inductive due to distributed capacitance along the resistor to the case, as explained by the wye-delta transformation of Figure 4.

The resistance material used for most General Radio units is Evanohm, an alloy with excellent stability, very low and constant temperature coefficient, low thermal emf with copper, and high tensile strength. It is relatively insensitive to humidity and strain. For resistance units of less than 5 ohms, the older, well-known manganin alloy is used because its lower resistivity allows wire dimensions which are easier to work with and to adjust.

Figure 4. Equivalent wye and delta networks for a resistor with capacitance to shield.

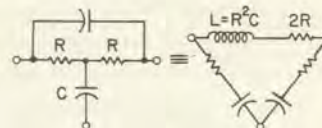

GP Type 500 RESISTOR

RESISTORS
FIXED

FEATURES:

- ◆ Convenient and accurate.
- ◆ Low thermal emf to copper.
- ◆ Low temperature coefficient of resistance.
- ◆ Excellent high-frequency characteristics.
- ◆ Standard plug-in terminals.

USES: The TYPE 500 Resistors are particularly recommended as resistance standards for use in impedance bridges and as secondary standards for laboratory use. The plug-type terminals make them readily interchangeable in experimental equipment. Screw terminals are also supplied for more permanent installations.

DESCRIPTION: This resistor is an accurately adjusted resistance unit wax-sealed in a phenolic case to exclude moisture and to provide protection from mechanical damage. The construction of individual units is similar to that used in the TYPE 510 Decade-Resistance Units (page 160).

SPECIFICATIONS

Accuracy of Adjustment: $\pm 0.05\%$ at the terminals, except for the 1-ohm unit, which is adjusted within $\pm 0.15\%$.

Frequency Characteristics: Similar to those of the TYPE 510 Decade-Resistance Units for resistance values up to 600 ohms; somewhat better for higher resistances, because of the relatively small shunt capacitance of an isolated resistor.

Maximum Power and Current: All units will dissipate one watt for a temperature rise of 40 degrees Centigrade. The value of current for this rise is given in the table below and is engraved on each unit.

Temperature Coefficient: Less than ± 20 ppm per degree Centigrade at normal room temperature.

Type of Winding: Less than 500 ohms, Ayrton-Perry; 500 ohms and higher, unifilar on thin mica cards. TYPES 500-V, W, and X are made up of multiple mica cards in series.

Terminals: Both terminal screws and plugs are supplied. Each terminal stud is recessed as a jack to accommodate a plug. Standard $\frac{3}{4}$ -inch spacing is used. High terminal is marked H.

Mounting: Black molded phenolic case is used for all units having a resistance of less than 1000 ohms. For units having a resistance value of 1000 ohms or higher, a low-loss mica-filled phenolic case is used.

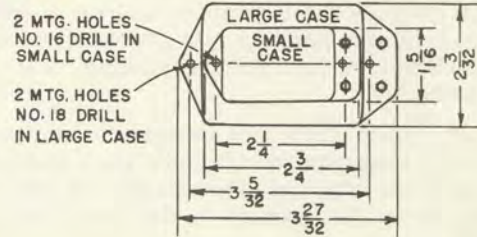

Both types are sealed with a high-melting-point wax. TYPES 500-A through -V are in small case; TYPES 500-W and -X in large case.

Dimensions: See sketch, dimensions are in inches. Over-all height, $1\frac{5}{8}$ inches for large case, 1 inch for small case, exclusive of plugs. To convert inches to mm, multiply by 25.4.

Net Weight: 2 ounces (60 g).

Shipping Weight: 8 ounces (230 g).

Type	Resistance in Ohms	Maximum Current	Code Number	Price
500-A	1	1.0 amp	0500-9701	\$6.00
500-B	10	310 ma	0500-9702	6.00
500-K	20	220 ma	0500-9711	6.00
500-C	50	140 ma	0500-9703	6.00
500-D	100	100 ma	0500-9704	6.00
500-E	200	70 ma	0500-9705	6.00
500-F	500	45 ma	0500-9706	6.00
500-G	600	40 ma	0500-9707	6.00
500-H	1000	30 ma	0500-9708	6.00
500-L	2000	22 ma	0500-9712	6.00
500-M	5000	14 ma	0500-9713	6.00
500-J	10,000	10 ma	0500-9710	6.00
500-R	20,000	7 ma	0500-9718	6.00
500-T	50,000	4.5 ma	0500-9720	6.00
500-U	100,000	3 ma	0500-9721	6.00
500-V	200,000	2.2 ma	0500-9722	8.50
500-W	500,000	1.4 ma	0500-9723	17.00
500-X	1 Megohm	1.0 ma	0500-9724	27.00

POTENTIOMETERS: General Radio 970-series potentiometers are listed on page 202.

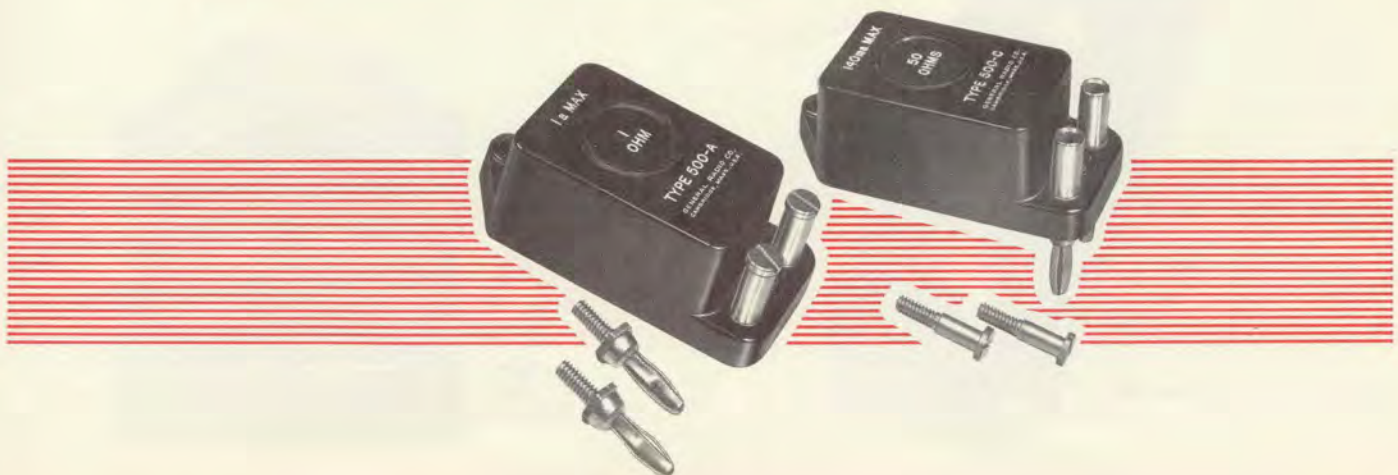



Type 1432 DECADE RESISTORS

Type 510 DECADE-RESISTANCE UNITS

USES: Decade resistors are used in circuits where a wide range of resistance values is required or where variable dummy generator and load resistances are needed. The accuracy of General Radio decade resistors easily meets the requirements of these applications and also permits them to be used as laboratory standards and as ratio arms for direct- and alternating-current bridges. Although designed primarily for direct-current and audio-frequency work, many of the models are useful well into the radio-frequency range.

These resistors are available as assemblies of 4, 5, or 6 decades in cabinets for laboratory use, or as shielded single-decade units for building into experimental equipment, production-test instruments, bridges, and other permanent assemblies.

DESCRIPTION: Each TYPE 510 Decade-Resistance Unit is enclosed in an aluminum shield, and a knob and etched-metal dial plate are supplied. The assembly is also available complete except for resistors, as the TYPE 510-P3 and -P3L Switches.

The TYPE 1432 Decade Resistor is an assembly of TYPE 510 Decade-Resistance Units in a single cabinet. Mechanical as well as electrical shielding of the units and switch contacts is provided by the attractive aluminum cabinet and panel. The resistance elements have no electrical connection to the cabinet and panel, for which a separate shield terminal is provided.

Accuracy of Adjustment: Each of the 10 resistors in each decade is adjusted to be accurate at its terminals within the tolerances given in the table. Resistance increments are accurate to this same tolerance.

Total Resistance: The resistance at the decade terminals is the sum of the switch resistance (see below) and that indicated by the switch-setting.

Maximum Current: See table. Maximum current is engraved on panels or dial plates.

Each decade has eleven contact studs and ten resistors, so that the dial values overlap. Positive detent mechanisms and bar-type knobs permit the operator to sense the position of the switches without looking at the panel. Each resistor is adjusted to be accurate within its specified tolerance at its terminals, so that resistance increments are accurate to that tolerance.

Winding methods are chosen to reduce the effects of residual reactances. The 1-ohm steps are Ayrton-Perry wound on molded phenolic forms especially shaped and heat treated to minimize aging effects. The 10- and 100-ohm steps are Ayrton-Perry wound on a form of silicone-fiber-glas laminate. The 0.01- and 0.1-ohm steps are straight wire and hairpin-shaped ribbon, respectively, while the 1000-, 10,000-, 100,000-, and 1,000,000-ohm steps are unifilar wound on thin mica cards.

FEATURES:

- ◆ Low zero resistance.
- ◆ High accuracy.
- ◆ Low temperature coefficient of resistance.
- ◆ Low thermal emf to copper.
- ◆ Resistors are adjusted so that resistance increments are always correctly indicated.
- ◆ Good frequency characteristics.
- ◆ Residual reactances are small and known.
- ◆ Excellent stability.
- ◆ Unaffected by high humidity.

SPECIFICATIONS

Frequency Characteristics: The accompanying plot shows the maximum percentage change in effective series resistance, as a function of frequency for the individual decade units. For low-resistance decades the error is due almost entirely to skin effect and is independent of switch setting, while for the high-resistance units the error is due almost entirely to the shunt capacitance and its losses and is approximately proportional to the square of the resistance setting.

The high-resistance decades (TYPES 510-E, -F, -G, and -H) are very commonly used as parallel resistance elements in resonant circuits, in which the shunt capacitance of the decades becomes part of the tuning capacitance. The parallel resistance changes by only a fraction, between a tenth and a hundredth, of the series-resistance change, depending on frequency and the insulating material in the switch.

Characteristics of the TYPE 1432 Decade Resistors are similar to those of the individual TYPE 510 units, modified by the increased series inductance, L_s , and shunt capacitance, C , due to the wiring and the presence of more than one decade in the assembly. At total resistance settings of approximately 1000 ohms or less, the frequency characteristic of any of these decade resistors is substantially the same as those shown for the TYPE 510 units. At higher settings, shunt capacitance becomes the controlling factor, and the effective value of this capacitance depends upon the settings of the individual decades.

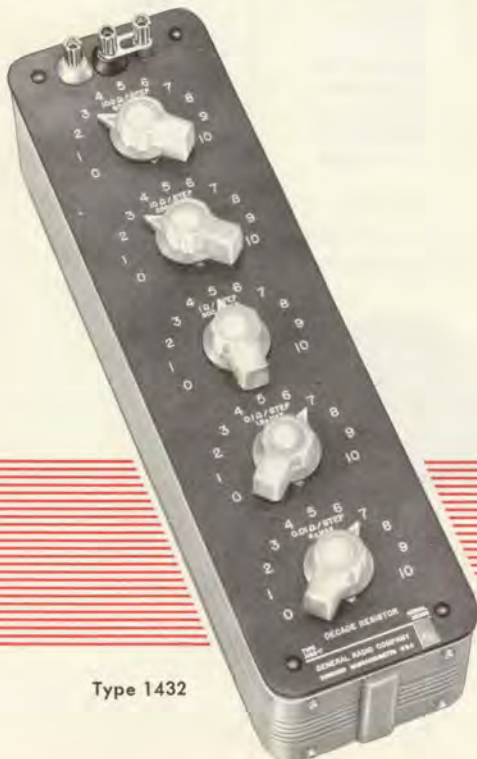

Type 1432



Type 510

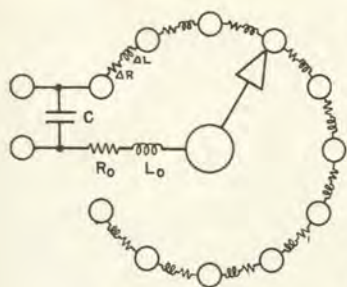

(Left) Equivalent circuit of a resistance decade, showing location and nature of residual impedances.

(Right) Maximum percentage change in series resistance as a function of frequency for Type 510 Decade-Resistance Units.

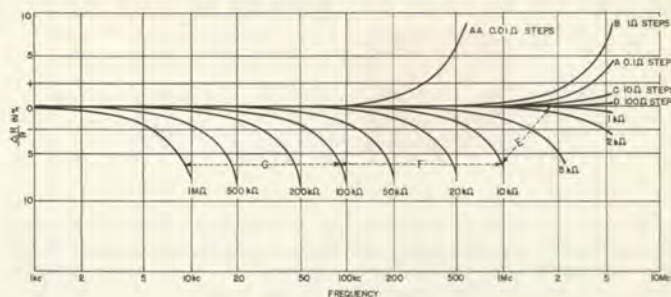

Typical Values of R_0 , L_0 , and C for the Decade Resistors:

Zero Resistance (R_0): 0.002 ohm or less per dial at dc (0.001-ohm switch resistance and 0.001-ohm lead resistance); 0.04 ohm per dial at 1 Mc; proportional to square root of frequency at all frequencies above 100 kc.

Zero Inductance (L_0): 0.10 μ h per dial.

Effective Shunt Capacitance (C): This value is determined largely by the highest decade in use. With the low terminal connected to shield, a value of 15 to 10 pf per decade may be assumed, counting decades down from the highest. Thus, if the third decade from the top is the highest resistance decade in circuit (i.e., not set at zero) the shunting terminal capacitance is 45 to 30 pf. If the highest decade in the assembly is in use, the effective capacitance is 15 to 10 pf, regardless of the settings of the lower-resistance decades.

Temperature Coefficient of Resistance: Less than ± 20 ppm per degree Centigrade at room temperatures for the TYPE 510 Decade-Resistance Units and for the TYPE 1432 Decade Resistors, except for the 0.1- and 0.01-ohm decades, where the box wiring will increase the over-all temperature coefficient.

Switches: Quadruple-leaf brushes bear on lubricated contact studs $\frac{3}{8}$ inch in diameter. Both brushes and studs are of copper alloy. These brushes are bent so as not to be tangent to the arc of travel, thus avoiding cutting and affording a good wiping action. A cam-

type detent is provided. There are eleven contact points (0 to 10 inclusive). The switch resistance is less than 0.001 ohm. The effective capacitance of the switch is of the order of 5 pf, with a dissipation factor of 0.06 at 1 kc for the standard cellulose-filled molded phenolic switch form and 0.01 for the mica-filled phenolic form used in the TYPE 510-G unit.

Terminals: For TYPE 1432, jack-top binding posts on standard $\frac{3}{4}$ -inch spacing. Shield terminal is provided. TYPE 510 units have soldering lugs.

Mounting: TYPE 1432, lab bench cabinet (see page 210); TYPE 510, complete with dial plate, knob, template, and mounting screws.

Dimensions: TYPE 1432 — width 4 $\frac{5}{16}$ inches (110 mm), height 4 $\frac{3}{4}$ inches (120 mm); length 13 inches (330 mm) for 4-dial, 15 $\frac{3}{4}$ inches (400 mm) for 5-dial, and 18 $\frac{1}{4}$ inches (470 mm) for 6-dial box. TYPE 510 — over-all diameter 3 $\frac{1}{16}$ inches (78 mm), depth behind panel 3 $\frac{5}{16}$ inches (85 mm).

Net Weight: TYPE 1432 — 5 pounds, 4 ounces (2.4 kg) for 4-dial; 6 pounds, 5 ounces (2.9 kg) for 5-dial; and 7 pounds, 8 ounces (3.4 kg) for 6-dial box. TYPE 510 units — 11 ounces (310 grams); TYPE 510-P switches — 9 $\frac{1}{2}$ ounces (270 grams).

Shipping Weight: TYPE 1432 — 7 pounds (3.2 kg) for 4- and 5-dial, 9 pounds (4.1 kg) for 6-dial box. TYPE 510 units and switches, 2 pounds (1.0 kg).

Type	Total	Multiple of	No. of Dials	Type 510 Decades Used	Code Number	Price
1432-U	111.1 ohms	0.01 ohm	4	AA, A, B, C	1432-9721	\$ 98.00
1432-K	1111	0.1	4	A, B, C, D	1432-9711	102.00
1432-J	11,110	1	4	B, C, D, E	1432-9710	110.00
1432-L	111,100	10	4	C, D, E, F	1432-9712	116.00
1432-Q	1,111,000	100	4	D, E, F, G	1432-9717	127.00
1432-T	1111.1	0.01	5	AA, A, B, C, D	1432-9720	124.00
1432-N	11,111	0.1	5	A, B, C, D, E	1432-9714	128.00
1432-M	111,110	1	5	B, C, D, E, F	1432-9713	139.00
1432-P	1,111,100	10	5	C, D, E, F, G	1432-9716	154.00
1432-Y	11,111,000	100	5	D, E, F, G, H	1432-9725	229.00
1432-X	111,111	0.1	6	A, B, C, D, E, F	1432-9724	165.00
1432-Z	11,111,100	10	6	C, D, E, F, G, H	1432-9726	262.00

Type	Total Resistance Ohms	Resistance Per Step (ΔR) Ohms	Accuracy of Resistance Increments	Maximum Current $40^\circ C$ Rise	Power Per Step Watts	ΔL μ h	C** pf	L_0 μ h	Code Number	Price
510-AA	0.1	0.01	$\pm 2\%$	4 amp	0.16	0.01	7.7-4.5	0.023	0510-9806	\$19.50
510-A	1	0.1	$\pm 0.5\%$	1.6 amp	0.25	0.014	7.7-4.5	0.023	0510-9701	15.00
510-B	10	1	$\pm 0.15\%$	800 ma	0.6	0.056	7.7-4.5	0.023	0510-9702	21.50
510-C	100	10	$\pm 0.05\%$	250 ma	0.6	0.11	7.7-4.5	0.023	0510-9703	23.50
510-D	1000	100	$\pm 0.05\%$	80 ma	0.6	0.29	7.7-4.5	0.023	0510-9704	24.00
510-E	10,000	1000	$\pm 0.05\%$	23 ma	0.5	3.3	7.7-4.5	0.023	0510-9705	24.00
510-F	100,000	10,000	$\pm 0.05\%$	7 ma	0.5	9.5	7.7-4.5	0.023	0510-9706	27.00
510-G	1,000,000	100,000	$\pm 0.05\%$	2.3 ma	0.5	—	7.7-4.5	0.023	0510-9707	35.00
510-H	10,000,000	1,000,000	$\pm 0.025\%$	0.7 *ma	0.5	—	13.5-5.0	0.023	0510-9708	98.00
510-P3	Switch only	(Black Phenolic Frame)							0510-9603	10.00
510-P3L	Switch only	(Low-Loss Phenolic Frame)							0510-9833	11.00

* Or a maximum of 4000 volts, peak.

** The larger capacitance occurs at the lowest setting of the decade. The values given are for units without the shield cans in place. With the shield cans in place, the shunt capacitance is from 10 to 20 pf greater than indicated here, depending on whether the shield is tied to the switch or to the zero end of the decade.

STANDARD INDUCTORS



An inductor used as a standard should have the smallest possible changes with time, frequency, current, temperature, external fields, or environment. The residual impedances should be as low as possible. For best accuracy, the connections to the inductor must not affect calibrated value.

Construction: For minimum generation of, or pickup from, external magnetic fields, the toroidal inductor is to be preferred to the solenoid. The symmetry of the toroid contributes both to stability and to a constant temperature coefficient.

An air core in the inductor results in the highest stability and a negligible variation of inductance with current, but at the expense of a relatively low Q . Because stability is the prime requirement in a laboratory standard, the TYPE 1482 Standard Inductors have air cores.

For a given volume, a larger inductance and Q can be obtained from a core of the high-permeability ferromagnetic materials, often termed "iron," although they usually are special alloys. Since the permeability of the material can change with age and particularly with current, the iron-core inductor is inherently less stable than the air-core type. Good stability can still be realized in iron-core inductors by proper design and choice of core materials, as in the TYPE 1481 Inductors.

Inductance Changes: The inductance depends not only upon the geometry and the permeability of the core, but upon the residual impedances, which are shown in the equivalent circuit of Figure 1. The largest changes of inductance with frequency are produced by the effective shunt capacitance, C_o , of the winding and the terminals. When the frequency, f , is well below the resonance frequency, f_o , the fractional increase in inductance is approximately

$$\frac{\Delta L}{L_o} \approx \omega^2 L_o C_o = \left(\frac{f}{f_o}\right)^2,$$

where L_o is the zero-frequency inductance.

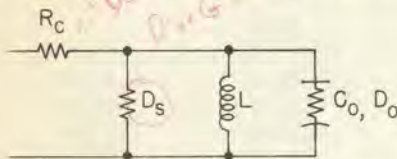

Figure 1. Equivalent circuit of an air-core inductor, L .

There is also a decrease in L with increasing frequency, produced by eddy currents in the winding and in ferromagnetic cores; this change can be kept relatively small by the use of stranded wire (Litzendraht) and of powdered core materials.

There is practically no change in inductance with current when the core is air, but ferromagnetic core materials have a permeability that changes with magnetizing force, and the change is usually appreciable. The curves shown on page 166 for the TYPES 1481 and 940 Inductors are typical. The increase is linear over a small region near zero current, increasing rapidly to a maximum followed by a sudden decrease as saturation is approached. To make these curves independent of the inductance magnitude, the current has been normalized to a value, I_1 , which is that current which produces an increase, $\Delta L/L_o$, of 0.25% when the core has a permeability of 125 and an increase of 0.1% when the permeability is 26.

Q Changes The storage factor, $Q = \omega L/R$, of an inductor is simply proportional to frequency when L and R are constant. But, as noted above, L can vary with frequency, and the losses are also functions of frequency. The components of loss are best described in terms of dissipation factor, $D = 1/Q$, since the total D is the sum of the component D 's and these can be plotted as straight lines in logarithmic co-ordinates, as shown in Figure 2.

In an air-core inductor, the losses (Figure 1) are

- D_c —from ohmic loss in the series resistance, R_c , which varies inversely with frequency.
- D_s —from eddy-current loss in the copper, directly proportional to frequency.
- D_d —from dielectric loss in the shunt capacitance; proportional to square of frequency in the range where its contribution to the total D is significant. Its value is D_o at f_o .

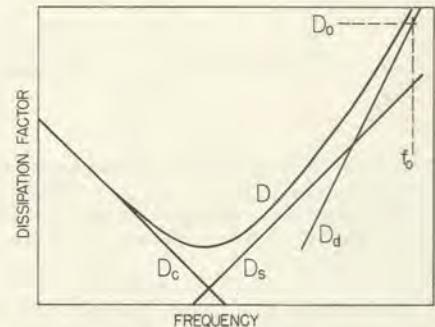

Figure 2. Dissipation factor variation with frequency showing the relative contributions of the several loss components for air-core inductors.

The total dissipation factor D (Figure 2) has a minimum value at a frequency usually below the resonance frequency f_o . At low frequencies the D or Q is determined by the series resistance; at high frequencies the eddy-current and dielectric losses predominate.

The higher permeability of an iron core makes possible lower values of D_c and D_s , while f_o is slightly reduced and D_o is not changed. The core adds three more components to the winding losses shown in Figure 2. Eddy currents in the core produce a component, D_e , which usually exceeds D_s and, like D_s , is proportional to frequency. The component D_h , from hysteresis loss in the core, is independent of frequency, and, since it is proportional to magnetizing force, it becomes negligible when the current approaches zero. A third component, D_r , from residual losses in the core, is also constant with frequency and is usually relatively small. The effects of these losses are shown on the following pages by plots of Q versus frequency for the various inductors.

Calibration The calibrated inductance of a standard inductor is the change in the measured inductance of a circuit when a portion of that circuit is removed and replaced by the inductor. This measured inductance includes small and variable mutual inductances between the inductor and the rest of the circuit, which are negligible when the calibrated inductance is larger than, say, 100 microhenrys, but which can introduce accuracy-limiting uncertainties into the calibration of smaller inductances. These uncertainties can be reduced to less than one nanohenry to permit accurate calibrations down to one microhenry, if the mutual components are made a definite part of the calibrated inductance. One method of achieving this, used in the TYPE 1482 Standard Inductors of 200 microhenrys and less, is to provide, on the inductor, a switching link, which connects either the inductor coil or a short circuit through internal leads to the external connection terminals. The calibrated inductance, which is the measured difference at the connection terminals when the switch is moved from coil to short, is to a high degree independent of the external connections or environment.*

Since the inductance usually varies with frequency, an accurate calibration requires that the frequency be specified. When, as in inductors with iron cores, the inductance also varies with current, the calibration must also specify a corresponding current or voltage. Since the frequency or current at which the inductor will be used is not usually known, a convenient reference level is zero frequency and zero current (initial permeability). For example, each TYPE 1481 Inductor is measured at a frequency considerably lower than its resonance frequency, and the measured value is corrected for the increase of L with frequency to obtain the value as frequency approaches zero; measurements are made at two currents within the linear range (less than I_1), and the measured values are extrapolated to obtain the inductance at zero current and initial permeability of the core material.

The inductors described in this section are intended for use in standards and measurement laboratories. They include highly stable air-core reference standards, fixed-value units with ferromagnetic cores, continuously variable (variometer) types, and decade assemblies.

* John F. Hersh, "Connection Errors in Inductance Measurement," *General Radio Experimenter*, 34, 10, October, 1960.



Type 1482 STANDARD INDUCTOR

STANDARDS
INDUCTANCE

USES: The TYPE 1482 Standard Inductor is an accurate, highly stable standard of self inductance for use as a low-frequency reference or working standard in the laboratory. Records extending over 11 years, and including inductors that traveled to national laboratories in several countries for calibration, show long-term stabilities well within $\pm 0.01\%$.

DESCRIPTION: Each inductor is a uniformly wound toroid on a ceramic core. It has a negligible external magnetic field and hence essentially no pickup from external fields. The inductor is resiliently supported in a mixture of ground cork and silica gel, after which the whole assembly is cast with a potting compound into a cubical aluminum case.

Sizes of 500 μh and above have three terminals, two for the inductor leads and the third connected to the case, to

provide either a two- or three-terminal standard. The 50-, 100-, and 200- μh sizes have three additional terminals for the switching used to minimize connection errors, as described on page 162.

For comparing other inductors with these standards, the TYPE 1632-A Inductance Bridge (page 46) is recommended.

FEATURES:

- ♦ Stable within $\pm 0.01\%$ per year.
- ♦ Precisely adjusted and accurately calibrated.
- ♦ Inductance independent of voltage.
- ♦ Connection errors minimized.
- ♦ Low external field.
- ♦ Low and known temperature coefficient.
- ♦ Free from humidity errors.

SPECIFICATIONS

Inductance Range: See table.

Accuracy of Adjustment: See table.

Calibration: A certificate of calibration is provided with each unit, giving measured values of inductance at 100, 200, 400, and 1000 cps, with temperature and method of measurement specified. These values are obtained by comparison, to a precision, typically, of better than $\pm 0.005\%$, with working standards whose absolute values, determined and maintained in terms of reference standards periodically certified by the National Bureau of Standards, are known to an accuracy typically $\pm (0.02\% + 0.1 \mu\text{h})$ at 100 cps.

Stability: Inductance change is less than $\pm 0.01\%$ per year.

DC Resistance: See table for representative values. A measured value of resistance at a specified temperature is given on the certificate of calibration.

Low-Frequency Storage Factor Q: See table for representative values of Q at 100 cps (essentially from dc resistance). An individual value of Q, calculated from the measured dc resistance, is given on each certificate of calibration.

Temperature Coefficient of Inductance: Approximately 30 ppm per degree Centigrade. Minute temperature corrections may be computed from dc resistance changes. A 1% increase in resistance, produced by a temperature increase of 2.54 degrees Centigrade, corresponds to 0.0076% increase in inductance.

Resonant Frequency: See table for representative values. A measured value is given on the certificate of calibration.

Maximum Input Power: For a rise of 20 degrees Centigrade, 3 watts; for precise work, a rise of 1.5 degrees Centigrade, 200 milliwatts. See table for corresponding current limits.

Terminals: Jack-top binding posts on $\frac{3}{4}$ -inch spacing with removable ground strap.

Cabinet: Aluminum lab bench cabinet with carrying handle and rubber feet.

Dimensions: 6 $\frac{1}{2}$ by 6 $\frac{1}{2}$ by 8 inches high (165 by 165 by 205 mm), over-all.

Net Weight: 11 $\frac{1}{2}$ pounds (5.5 kg).

Shipping Weight: 16 pounds (7.5 kg).

Hand-wound
6-term.
Duplex
Single
Litz
Single
wire

Type	Nominal Inductance	Adjustment Accuracy (Percent)	*Resonant Frequency (kc)	*DC Resistance (Ohms)	*Q at 100 cps	Milliamperes, rms, for		Code Number	Price
						200 mw	3 w		
1482-A	50 μh	± 0.5	3100	0.039	0.81	2260	8770	1482-9701	\$125.00
1482-B	100 μh	± 0.25	2250	0.083	0.76	1550	6010	1482-9702	125.00
1482-C	200 μh	± 0.25	1400	0.15	0.84	1150	4470	1482-9703	125.00
1482-D	500 μh	± 0.1	960	0.38	0.83	725	2810	1482-9704	125.00
1482-E	1 mh	± 0.1	800	0.84	0.75	490	1890	1482-9705	110.00
1482-F	2 mh	± 0.1	580	1.52	0.83	360	1400	1482-9706	110.00
1482-G	5 mh	± 0.1	320	3.8	0.83	230	890	1482-9707	110.00
1482-H	10 mh	± 0.1	220	8.2	0.77	156	600	1482-9708	110.00
1482-J	20 mh	± 0.1	145	14.5	0.87	117	450	1482-9710	110.00
1482-K	50 mh	± 0.1	84	36.8	0.85	74	280	1482-9711	110.00
1482-L	100 mh	± 0.1	71	81	0.78	50	192	1482-9712	110.00
1482-M	200 mh	± 0.1	39.0	109	1.15	43	166	1482-9713	110.00
1482-N	500 mh	± 0.1	24.5	280	1.12	27	103	1482-9714	110.00
1482-P	1 h	± 0.1	14.6	616	1.02	18	70	1482-9716	117.50
1482-Q	2 h	± 0.1	10.6	1125	1.12	13.3	52	1482-9717	140.00
1482-R	5 h	± 0.1	6.8	2920	1.08	8.3	32	1482-9718	170.00
1482-T	10 h	± 0.1	4.9	6400	0.98	5.6	22	1482-9720	225.00

* Representative values. Actual values given on certificate.



Type 107 VARIABLE INDUCTOR

FEATURES:

- ◆ Continuous variation of inductance over a 20-to-1 range.
- ◆ Separate terminals for rotor and stator permit either series or parallel connection.
- ◆ Calibrated in mutual as well as self inductance.
- ◆ Rotor and stator inductances are made closely equal, to minimize circulating currents in the parallel connection.

USES: The TYPE 107 Variable Inductors find their greatest uses in the laboratory as adjustable standards of moderate accuracy for measurements of self and mutual inductance, and as circuit elements in bridges, oscillators, and similar equipment.

DESCRIPTION: Rotor and stator coils are mounted concentrically. The effective inductance depends upon the

position of the rotor with respect to the stator.

In most models stranded wire is used, in which the separate strands are insulated from one another. The coils are impregnated and baked in a synthetic varnish before being securely mounted on the phenolic panel.

Dial is direct reading in inductance for the series connection of the coils. Inductance for the parallel connection is one-fourth the value shown by the dial.

SPECIFICATIONS

Inductance Ranges: See table below. Dial is direct reading in inductance for the series connection.

Accuracy: Series connection, $\pm 1\%$ of full scale at 1 kc. Inductance for parallel connection is one-fourth the series value within $\pm (1\% + 0.01 \mu\text{h})$ of the former. Mutual-inductance accuracy is $\pm 2.5\%$ of full-scale (mutual) value. The formula for mutual inductance is engraved on the nameplate.

Frequency Characteristics: The fractional increase in inductance with frequency will be f^2/f_0^2 where f is the operating frequency and f_0 the natural frequency, which can be calculated from $f_0 = \frac{1}{2\pi\sqrt{LC_0}}$. Values of C_0 are tabulated below. See plot for change in Q with frequency.

Maximum Power and Current: Current for 15 watts maximum dissipation, corresponding to a temperature rise of 40 degrees Centigrade, is given in the table below and is engraved on the nameplate.

DC Resistance: See table below. These series-connection values are engraved on the nameplate. For parallel connections the resistance is closely $\frac{1}{4}$ the tabulated values.

Terminals: Standard $\frac{3}{4}$ -inch spacing, jack-top binding posts provide separate connections to rotor and stator. Series and parallel connections are made by means of links.

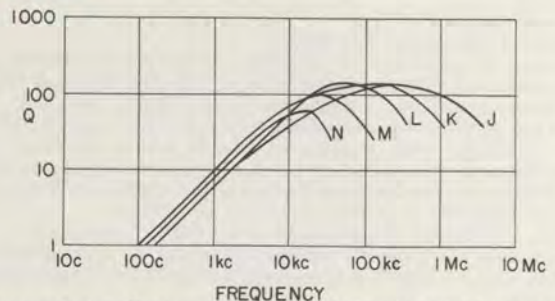

Storage factor, Q , versus frequency at full-scale series connection.

Cabinet: All units are mounted on phenolic panels and enclosed in unshielded hardwood cabinets.

Dimensions: $6\frac{1}{2}$ by $6\frac{1}{2}$ by $8\frac{3}{4}$ inches high, over-all (165 by 165 by 220 mm).

Net Weight: 5 pounds (2.3 kg), all ranges.

Shipping Weight: 12 pounds (5.5 kg).

Type	Self-Inductance		Mutual Inductance	Typical C_0 Values		DC Resistance ohms	Maximum Current amp	Code Number	Price
	Series	Parallel		Series	Parallel				
107-J	9-50 μh	2.25-12.5 μh	0-10.8 μh	35 pf	57 pf	0.05	16	0107-9710	\$110.00
107-K	90-500 μh	22.5-125 μh	0-110 μh	40 pf	72 pf	0.38	6	0107-9711	110.00
107-L	0.9-5 mh	0.225-1.25 mh	0-1.1 mh	39 pf	73 pf	5.0	1.7	0107-9712	110.00
107-M	9-50 mh	2.25-12.5 mh	0-11 mh	34 pf	41 pf	36	0.65	0107-9713	110.00
107-N	90-500 mh	22.5-125 mh	0-110 mh	34 pf	41 pf	450	0.17	0107-9714	110.00





Type 1481 INDUCTOR

FIXED INDUCTORS

USES: The TYPE 1481 Inductors have higher low-frequency values of storage factor Q than the TYPE 1482 Standard Inductors. They are useful at audio frequencies as working standards of self inductance, although their accuracy of adjustment and their stability are not so high as those of the TYPE 1482 Inductors, and, for some uses, allowance must be made for their current coefficient of inductance. For periodic checks of calibration, they can be compared with TYPE 1482 Standard Inductors on the TYPE 1632-A Inductance Bridge.

DESCRIPTION: These inductors are uniformly wound toroidal units on stabilized molybdenum-permalloy dust cores.

FEATURES:

- ◆ 16 values — 100 μ h to 10 h.
- ◆ High Q — between 200 and 500, maximum; greater than 1 down to 6 cps.
- ◆ Electrostatically shielded.
- ◆ Small in size, low in cost.

SPECIFICATIONS

Accuracy: See table below. Nominal inductance value, adjustment accuracy, and current for 0.25% or 0.1% change in inductance are engraved on the case.

Calibration is at initial permeability and zero frequency, i.e., the inductance, measured at a frequency much less than the resonant frequency and with a current no greater than I_1 , is extrapolated to zero current and zero frequency for the calibrated value.

Stability: The change in inductance is less than 0.25% per year when the inductors are adequately protected from extremes of current, temperature, and mechanical shock.

Storage Factor, Q : Figure 1 shows the variation of storage factor Q as a function of frequency for initial permeability, i.e., with no hysteresis loss.

Current Coefficient of Inductance: Percent change in inductance as a function of $\frac{I}{I_1}$ is given in Figure 1, page 166, where I is the rms operating current and I_1 the current that would produce a 0.25% or 0.1% linear increase in L .

Incremental Inductance: Direct-current bias will reduce the initial inductance as shown in Figure 1, page 166.

Temperature Coefficient of Inductance: Approximately -25 ppm per degree C, between 16 and 32 C.

Safe Operating Limits: (1) Maximum terminal voltage, 500 volts rms or (2) maximum rms current = 100 I_1 , whichever limit is lower.

Distributed Capacitance: Between 15 pf for the 100- μ h unit and 30 pf for the 10-h unit.

Terminals: Jack-top binding posts, one grounded to case. A pair of double-ended plugs is furnished, for connection to jack-top binding posts.

Mounting: Aluminum case.

Dimensions: Case, width 3 $\frac{1}{8}$, height 3 $\frac{5}{8}$, depth 1 $\frac{5}{8}$ inches (80 by 95 by 40 mm); over-all height, including terminals, 4 $\frac{5}{8}$ inches (120 mm).

Net Weight: $\frac{7}{8}$ pound (0.4 kg).

Shipping Weight: 3 pounds (1.4 kg).

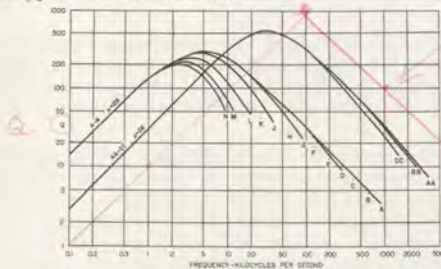

Figure 1. Q versus frequency for typical units.

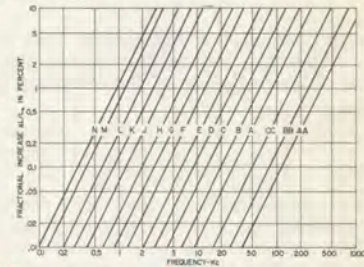

Figure 2. Percent increase in inductance versus frequency.

Type Inductor	Nominal Inductance L	Adjustment Accuracy (percent)	Rms Current, I_1 , for 0.25% Increase in L_0 (ma)	Resonant Frequency f_0 (kc)	Approx DC Resistance (ohms)	Code Number	Price
1481-AA	100 μ h	± 2.0	141*	3990	0.020	1481-9806	\$37.50
1481-BB	200 μ h	± 2.0	100*	2700	0.044	1481-9808	37.50
1481-CC	500 μ h	± 1.0	63*	1640	0.112	1481-9809	37.50
1481-A	1 mh	± 1.0	24	1100	0.043	1481-9701	37.50
1481-B	2 mh	± 1.0	17	770	0.098	1481-9702	37.50
1481-C	5 mh	± 1.0	11	490	0.25	1481-9703	37.50
1481-D	10 mh	± 0.6	7.6	310	0.44	1481-9704	37.50
1481-E	20 mh	± 0.6	5.4	220	0.95	1481-9705	37.50
1481-F	50 mh	± 0.6	3.4	135	2.3	1481-9706	37.50
1481-G	100 mh	± 0.4	2.4	94	4.3	1481-9707	40.00
1481-H	200 mh	± 0.4	1.7	66	7.2	1481-9708	40.00
1481-J	500 mh	± 0.4	1.1	41	22	1481-9710	40.00
1481-K	1 h	± 0.4	0.76	30	40	1481-9711	40.00
1481-L	2 h	± 0.4	0.54	21.8	91	1481-9712	42.50
1481-M	5 h	± 0.4	0.34	13.8	230	1481-9713	45.00
1481-N	10 h	± 0.4	0.24	9.5	416	1481-9714	50.00

* I_1 for 0.1% increase in L_0 .



Type 1490 DECADE INDUCTOR

Type 940 DECADE-INDUCTOR UNIT

FEATURES:

- ◆ High values of storage factor Q , with maximum values above 200.
- ◆ Toroidal construction minimizes external magnetic fields, so that the coils can be stacked without errors from mutual inductance. The toroids are nearly astatic to external magnetic fields.
- ◆ Aluminum covers provide electrostatic shielding and mechanical protection.
- ◆ Wax dipping keeps out moisture.
- ◆ The switch is inherently reliable in extensive use and should not require bothersome cleaning or adjustment in service.

USES: These inductance decades are convenient elements for use in wave filters, equalizers, and tuned circuits throughout the range of audio and low radio frequencies. As components in oscillators, analyzers, and similar equipment, they are especially useful during the preliminary design period, when the ability to vary circuit elements over relatively wide ranges is necessary to determine optimum operating values. As moderately precise standards of inductance they have values of low-frequency storage factor, Q , which are much larger than those of air-cored coils.

DESCRIPTION: Each TYPE 940 Decade-Inductor Unit is an assembly of four TYPE 1481 Inductors (relative values,

1, 2, 2, 5) wound on molybdenum-permalloy dust cores, which are combined by switching to give the eleven successive values from 0 to 10. The decade switch has high-quality ceramic stator-and-rotor members and utilizes a well-defined ball-and-socket detent. All contacts are made of a silver alloy and have a positive wiping action.

The TYPE 1490 Decade Inductor is an assembly of three or four TYPE 940 Decade-Inductor Units in a single metal cabinet. The units have no electrical connection to the panel, but a separate ground terminal is provided which can be connected to the adjacent low terminal, which leads to the smallest decade.

SPECIFICATIONS

Accuracy: Each unit is adjusted so that its inductance at zero frequency and initial permeability will be the nominal value within the accuracy tolerance given in the following table:

Inductance per step	100 μ h	1 mh	10 mh	100 mh	1 h
Accuracy	$\pm 2\%$	$\pm 2\%$	$\pm 1\%$	$\pm 0.6\%$	$\pm 0.6\%$

Frequency Characteristics: For any specific operating frequency, Figure 2 shows the percentage increase in effective series inductance (above the value when $f = 0$) which is encountered with the extreme settings of each of the five decade-inductor units when the chassis is floating. Interpolation may be used for intermediate settings.

For the TYPE 1490 Decade Inductors, the percentage increase in effective series inductance (above the zero frequency value, L_0) may be obtained by interpolation in Figure 3 for any setting of the highest-valued decade used, when the low terminal is grounded to the cabinet.

Change in Inductance with Current: Fractional change in initial inductance with ac current for each type of toroid is shown in the normal curves, Figure 1, in terms of the ratio of the operating current, I , to I_1 , the current for 0.25% change, solid line (0.1%, broken line). For ratios below unity, inductance change is directly proportional to current. Values of I_1 , listed below, are approximate and are based on the largest inductor in the circuit for each setting.

Incremental Inductance: DC bias current I_b will reduce the initial inductance as shown in the incremental curves, Figure 1.

Switch Setting	RMS I_1 (ma)				
	0.1% Increase	0.25% Increase			
		940-DD	940-E	940-F	940-G
1	141	24	7.6	2.4	0.76
2, 3, 4	100	17	5.4	1.7	0.54
5, 6, 7, 8, 9, 10	63	11	3.4	1.1	0.34



Type 1490-F

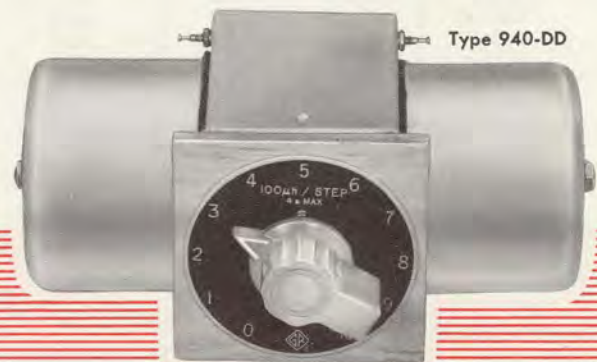

Type 940-DD

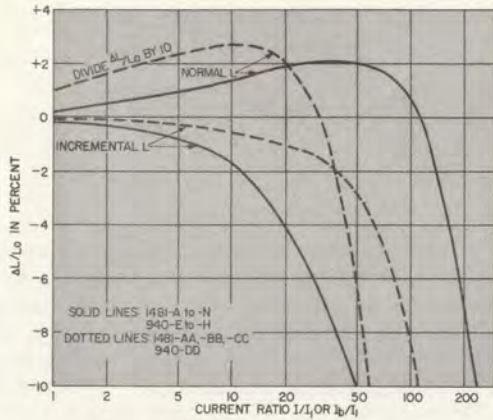

Figure 1. Percentage change in normal and incremental inductance with ac and bias current. Incremental curve is limited to an ac excitation less than I_1 .

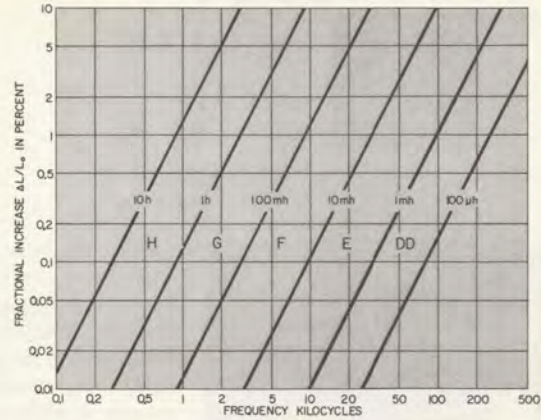

Figure 2. Change in effective inductance with frequency for the Type 940 Decade-Inductor Units.

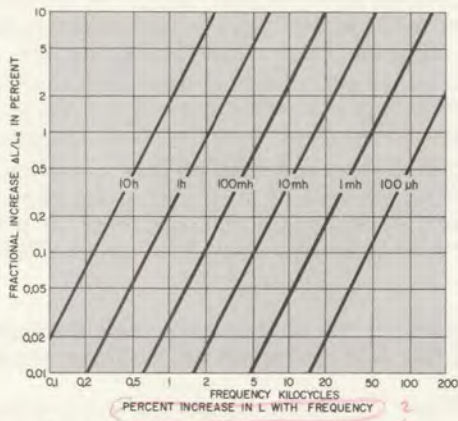

Figure 3. Variation of inductance with frequency, for the Type 1490 Decade Inductors.

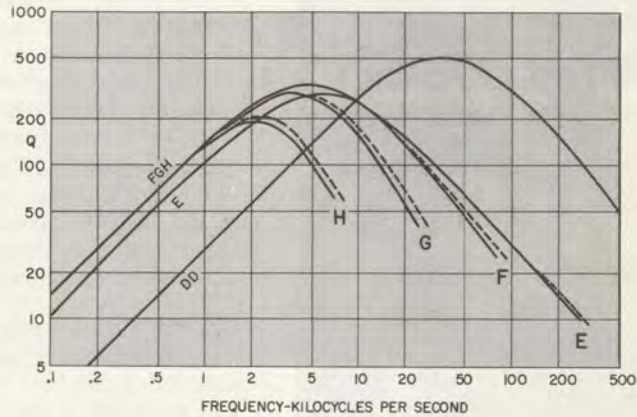

Figure 4. Variation of Q for the maximum inductance of each Type 940 Decade-Inductor Unit. Dashed curves correspond to use with chassis floating.

Zero Inductance: Approximately 1 μ h for the decade boxes.

Storage Factor, Q: See Figure 4.

DC Resistance: Approximately 45 ohms per henry.

Temperature Coefficient: Approximately -25 ppm per degree C between 16 and 32 C.

Maximum Voltage: 500 volts, rms. The switch will break the circuit at 500 volts if turned rapidly to the new setting, but voltages above 150 may cause destructive arcing if the switch is set between detent positions.

Maximum Safe Current: 100 times the pertinent I_1 value (30 times for the TYPE 940-DD).

Terminals: TYPE 1490, jack-top binding posts on standard $\frac{3}{4}$ -inch

spacing; separate ground terminal provided. TYPE 940 Units have soldering lugs. Circuit insulated from chassis.

Mounting: TYPE 1490, lab bench cabinet (see page 210); TYPE 940, complete with dial plate, knob, and mounting screws.

Dimensions: TYPE 940 — width 8, height $3\frac{1}{2}$, depth $4\frac{1}{4}$ inches (205 by 90 by 110 mm), over-all. TYPE 1490-C — width $8\frac{1}{2}$, height $12\frac{3}{4}$, depth $5\frac{1}{2}$ inches (215 by 325 by 140 mm), over-all; TYPES 1490-D and -F — width $8\frac{1}{2}$, height $16\frac{3}{4}$, depth $5\frac{1}{2}$ inches (215 by 425 by 140 mm), over-all.

Net Weight: TYPE 940 — $3\frac{1}{2}$ pounds (1.6 kg); TYPE 1490-C — $16\frac{3}{4}$ pounds (7.5 kg); TYPES 1490-D and -F — $21\frac{3}{4}$ pounds (10 kg).

Shipping Weight: TYPE 940 — 6 pounds (2.8 kg); TYPE 1490-C — 24 pounds (11 kg); TYPES 1490-D and -F — 29 pounds (13.5 kg).

Type	Inductance	No. of Dials	Code Number	Price
940-DD	1 mh; in 100- μ h steps		0940-9810	\$120.00
940-E	0.01 h; in 0.001-h steps		0940-9705	120.00
940-F	0.1 h; in 0.01-h steps		0940-9706	110.00
940-G	1 h; in 0.1-h steps		0940-9707	120.00
940-H	10 h; in 1-h steps		0940-9708	130.00
1490-C	1.11 h, total; in steps of 0.001 h	3	1490-9703	370.00
1490-D	11.11 h, total; in steps of 0.001 h	4	1490-9704	470.00
1490-F	1.111 h, total; in steps of 100 μ h	4	1490-9706	470.00

STROBOSCOPES



The stroboscope is basically a light that can be turned on and off at very high speeds to produce the optical effect of stopping motion. For instance, an electric fan revolving at 1800 rpm appears to be standing still if viewed under a light flashing 1800 times a minute. If the light flashes 1801 times a minute, the fan is illuminated at successively earlier parts of each revolution, and it appears to rotate backwards at 1 rpm. (The same principle explains the backward-spinning wagon wheels seen so often in Western movies.) If the light flashes 1799 times a minute, the fan appears to rotate forward at 1 rpm. Because the human eye retains images for an appreciable fraction of a second, no flicker is seen except at very low speeds. The apparent slow motion is an exact replica of the actual higher-speed motion, so that the motion of a high-speed machine can be analyzed with the machine in normal operation.

If the flashing rate of the stroboscope is adjustable, and if the control is calibrated in flashes per minute, the stroboscope becomes a highly precise tachometer. The flashing rate is simply adjusted until the moving object appears stationary, and the speed in revolutions per minute is read from the calibrated control. The stroboscope's great advantage over other types of tachometers is that it requires no mechanical attachment to the device whose speed is being measured.

The introduction of the electronic stroboscope, with its flash durations as brief as a millionth of a second, opened up the field of ultra-high-speed photography. This subject, of increasing interest to scientists and engineers as well as to photographers, is covered fully in the *Handbook of High-Speed Photography*, available free on request.

General Radio made its first stroboscope 30 years ago, and through a continuous development program in this field has produced the finest stroboscopic equipment available.

The keystone of the line is the TYPE 1531-A Strobotac® electronic stroboscope, a compact, portable instrument that operates from a 115-volt ac line. Its wide flashing range permits measurement of speeds up to a quarter of a million rpm with 1% accuracy. It is also widely used for slow-motion observations and, because of its bright, brief flash, for high-speed photography.

The usefulness of the STROBOTAC electronic stroboscope is greatly increased by the following accessory instruments:

The TYPE 1532-D Strobolume, a source of extremely bright light, can be triggered either by the electronic stroboscope or by an external contactor.

The TYPE 1536-A Photoelectric Pickoff and the TYPE 1531-P2 Flash Delay extend the stop-motion and slow-motion capabilities of the stroboscope to devices moving at nonconstant speeds.

The TYPE 1535-B Contactor is a mechanical coupling device, used to synchronize the stroboscopic flash with the rotation of a shaft.

With the TYPE 1531-P3 Surface-Speed Wheel, the stroboscope can be used for the accurate, direct measurement of surface speeds of belts, drums, wheels, rollers, and similar devices.





Type 1531-A STROBOTAC® ELECTRONIC STROBOSCOPE

FEATURES:

- ♦ High-intensity flash — up to 7 million beam candlepower (peak) for a single flash.
- ♦ High flashing rates — speed measurements to 250,000 rpm.
- ♦ Short flash duration — “stops” rapid motion and permits ultra-high-speed photography.
- ♦ High accuracy — rpm measurements can be made to $\pm 1\%$.
- ♦ Convenience — small Flip-Tilt case and swivel-mounted lamp provide maximum versatility.
- ♦ Simplicity — dials are easy to set and easy to read.

USES: The STROBOTAC® electronic stroboscope is a small portable flashing-light source used to measure the speed of fast-moving devices, or to produce the optical effect of stopping or slowing down high-speed motion for observation. A few of this instrument's many uses are:

- ♦ Observation and speed measurement of gears, cams, linkages, shuttles, spindles, motor rotors, and other machine elements.
- ♦ Observation of vibrating members, fuel-nozzle spray patterns, and vibrations of components under test in wind tunnels.
- ♦ High-speed photography of repetitive or nonrepetitive motion (see photos on page 168).
- ♦ Measurements and observations of any repetitive motion that is visible, even if inaccessible.

DESCRIPTION: The STROBOTAC electronic stroboscope includes a strobotron lamp and reflector assembly, an electronic pulse generator that controls the flashing rate, and a line-operated power supply.

The internal flashing-rate range of 110 to 25,000 flashes per minute is divided into three direct-reading ranges; to avoid reading errors, only the particular range in use is illuminated. The rpm control is concentric with the range

selector, and its large diameter provides precise control of the flashing rate.

External triggering of the flash lamp in order to “stop” motion that is not constant in speed or for photographic work can be introduced at a panel phone jack. External triggering can be achieved with a pulse of at least 6 volts peak-to-peak (or a 2-volt-rms sine wave). The combination of the TYPE 1531-P2 Flash Delay and the TYPE 1536-A Photoelectric Pickoff can be used as an external triggering source, which also provides a variable delay of the stroboscope flash with respect to the triggering pulse from the photoelectric pickoff. The TYPE 1535-B Contactor can also be used for triggering. These accessory instruments are described on page 170.

A built-in calibration system uses the power-line frequency for quick, easy checks on the accuracy of the flashing rate. Adjustment, if necessary, is made on the front panel.

The strobotron flash tube is mounted in a reflector housing that both pivots in a plane perpendicular to the panel and swivels 360 degrees on its own axis. The instrument can be operated while suspended by a neck strap, held in the hand, or set on a bench. Its Flip-Tilt case serves as a rugged carrying case for instrument and instruction manual, as a protective cover, and as a convenient base for the stroboscope during operation.

SPECIFICATIONS

Flashing-Rate Range: 110 to 25,000 flashes per minute in three direct-reading ranges: 110 to 690, 670 to 4170, and 4000 to 25,000. Speeds up to 250,000 rpm can be measured.

Accuracy: $\pm 1\%$ of dial reading after calibration on middle range.

Calibration: Two panel adjustments permit calibration against power-line frequency.

Flash Duration: Approximately 0.8, 1.2, and 3 microseconds for high-, medium-, and low-speed ranges, respectively, measured at 1/3 peak intensity.

Peak Light Intensity: Minimum on high-, medium-, and low-speed ranges, respectively, 0.21, 1.2, and 4.2 million beam candlepower (2.1×10^5 , 1.2×10^6 , and 4.2×10^6 lux measured at 1 meter distance at the center of the beam); for single flash, 7 million beam candlepower (7×10^6 lux measured at 1 meter distance at the center of the beam).

Reflector Beam Angle: 10 degrees at half-intensity points.

Output Trigger: 600- to 800-volt negative pulse available at panel jack.

External Triggering: The flash can be triggered with a mechanical contactor or 6-volt peak-to-peak signal (2-volt rms sine-wave signal down to 5 cps).

Power Requirements: 105 to 125 (or 210 to 250) volts, 50 to 60 or 400 cps. Maximum power input is 35 watts.

Accessories Supplied: Adjustable neck strap, plug to fit input and output jacks, spare fuses.

Accessories Available: TYPE 1531-P2 Flash Delay, TYPE 1536-A Photoelectric Pickoff, and TYPE 1532-D Strobolume (see pages 170 and 171).

Cabinet: Flip-Tilt (see page 210).

Dimensions: $10\frac{5}{8}$ by $6\frac{5}{8}$ by $6\frac{1}{8}$ inches (270 by 170 by 160 mm), over-all, including handle.

Net Weight: $7\frac{1}{8}$ pounds (3.2 kg).

Shipping Weight: 10 pounds (4.6 kg).

This instrument is listed by the CSA Testing Laboratories as approved.

Type		Code Number	Price
1531-A	Strobotac® electronic stroboscope	1531-9701	\$275.00
1531-P1	Replacement Strobotron Lamp	1531-9601	15.00

PATENT NOTICE. See Notes 6 and 22, page viii.





Type 1531-P2 FLASH DELAY

USES: The combination of flash delay, photoelectric pickoff, and electronic stroboscope is ideal for visual analysis over a complete cycle of repetitive motion whose period is not constant. In addition, these instruments can be used to provide precise synchronization of camera shutter, stroboscopic flash, and subject for high-speed photographs previously almost impossible to take because of variations in subject speed.

SPECIFICATIONS

Time-Delay Range: Approximately 100 microseconds to 0.8 second in three ranges.

Output Pulse: Better than 13 volts available for triggering the TYPE 1531-A Strobotac® electronic stroboscope.

Sensitivity: As little as 0.3-volt input will produce sufficient output to trigger the stroboscope.

Inputs: Phone jack for triggering; jack for camera synchronization.

Accessories Supplied: Trigger cable, phone-plug adaptor, and leather carrying case.

Accessories Available: TYPE 1536-A Photoelectric Pickoff.

DESCRIPTION: The TYPE 1531-P2 Flash Delay, when used with an external triggering device such as the TYPE 1536-A Photoelectric Pickoff, will provide a continuously adjustable time delay between the triggering pulse and the light flash. The external triggering device may be an oscillator, photocell, or other transducer. A jack is provided for camera shutter synchronization in single-flash photography.

Power Requirements: 105 to 125 (or 210 to 250) volts, 50 to 60 cps. 5 watts with TYPE 1536-A connected.

Mounting: Aluminum case with bracket which clips directly onto the STROBOTAC electronic stroboscope.

Dimensions: 5 $\frac{1}{8}$ by 3 $\frac{1}{8}$ by 3 $\frac{3}{4}$ inches (135 by 86 by 96 mm).

Net Weight: 2 pounds (1 kg).

Shipping Weight: 5 pounds (2.3 kg).

Type		Code Number	Price
1531-P2	Flash Delay	1531-9602	\$160.00



Type 1536-A PHOTOELECTRIC PICKOFF

FEATURES:

- ◆ Small size.
- ◆ Maneuverable double-jointed linkage.
- ◆ Firm mounting with C-clamp or magnet.
- ◆ High pulse rate — speeds up to 150,000 rpm.

USES: The TYPE 1536-A Photoelectric Pickoff is powered by the TYPE 1531-P2 Flash Delay, the TYPE 1150-A Digital Frequency Meter, or the TYPE 1151-A Digital Time and Frequency Meter. It produces a voltage pulse whenever its photocell senses a difference in reflected light. If a piece of reflective tape is attached to a moving object, the pickoff will produce a positive pulse whenever the tape passes by the pickoff. When used in combination with the TYPE 1531-P2 Flash Delay and the TYPE 1531-A Strobotac electronic stroboscope, the photoelectric pickoff will operate the stroboscope in synchronism with a rotating object but at a time, determined by the flash delay, after the synchronizing pulse from the photocell. This permits all phases of the motion to be studied.

For precise measurement of speed, the pulse from the photoelectric pickoff will operate the TYPES 1150-A or 1151-A Digital Meters. In combination with the TYPE 1531-P2 Flash Delay, the pickoff also permits continuous measurement or recording of speed with the TYPE 1142-A Frequency Meter and Discriminator.

DESCRIPTION: This photoelectric pickoff contains a light source, a concentrating lens, a photocell, an output cable, and an adjustable

mounting system. Light from the internal lamp is reflected from a rotating object back to the photocell.

SPECIFICATIONS

Maximum Pulse Rate: Approximately 2500 pulses per second as limited by the 200-microsecond time constant of the photocell and cable combination.

Power Requirements: 20 to 28 volts dc, 40 ma. Power is supplied by the TYPE 1531-P2 Flash Delay or the TYPE 1150-A (or TYPE 1151-A) Digital Frequency Meter.

Accessories Supplied: 10-ft roll of $\frac{3}{8}$ -inch black tape; 10-ft roll of $\frac{3}{8}$ -inch silver tape; carrying case.

Mounting: C-clamp (capacity 1-5/16 inches, flat or round) or 1 $\frac{1}{2}$ -inch magnet, both supplied.

Dimensions: Pickoff head, 11/16-inch diameter, 2 inches long. Linkage consists of two 5/16-inch-diameter stainless-steel rods, 6 and 6 $\frac{1}{4}$ inches long, and adjustable connecting clamp. Cable is 8 feet long, terminated in phone plug.

Net Weight: 18 ounces (0.6 kg).

Shipping Weight: 3 pounds (1.4 kg).

Type		Code Number	Price
1536-A	Photoelectric Pickoff	1536-9701	\$65.00



Type 1531-P3 SURFACE-SPEED WHEEL

USES: The TYPE 1531-P3 is used with the TYPE 1531-A Strobotac electronic stroboscope to make accurate measurements of the linear surface speed of belts, pulleys, wheels, drums, rollers, etc.

DESCRIPTION: Two black nylon wheels of different diameters are mounted on the ends of a sectioned steel rod. The selected wheel is held against the moving object and observed with the stroboscope to determine directly the surface speed.

SPECIFICATIONS

Speed Range: 10 to 2500 feet per minute with small wheel and 50 to 12,500 feet per minute with large wheel.

Dimensions: Wheels are 0.764 and 1.910 inches in diameter, respectively. Shaft totals 20 inches in length.

Net Weight: 8 ounces (0.3 kg). **Shipping Weight:** 2 pounds (1 kg).

Type		Code Number	Price
1531-P3	Surface-Speed Wheel	1531-9603	\$15.00

Flash Delay and Photoelectric Pickoff connected to a Strobotac electronic stroboscope.

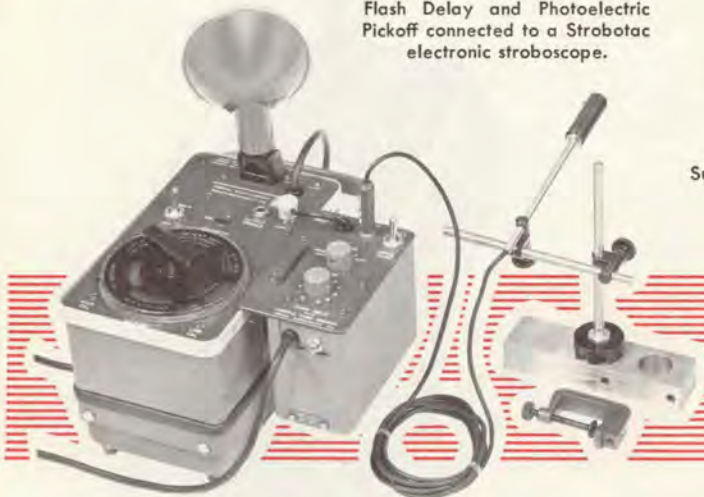

Surface-Speed Wheel



Contacting





Type 1535-B CONTACTOR

SPECIFICATIONS

FEATURES:

- ◆ Easily attached to or removed from machine in motion.
- ◆ Mounted permanently on machine.
- ◆ Ball bearings are used on rotating parts.
- ◆ Flexible drive coupling shaft can be bent through 90° angle for work in crowded locations.

USES: The TYPE 1535-B Contactor permits synchronization of a stroboscope with a rotating shaft, so that motion can be observed as a function of shaft angle. With the aid of the contactor, the stroboscope can be used in the observation of machines with varying speed.

DESCRIPTION: The electrical contact system consists of a rotating cam and a low-inertia breaker arm. The phasing control permits adjustment of the contact position with respect to the rotating shaft. The coupling system uses a powerful magnet with a centering device to ensure positive drive from a centered steel or iron shaft. Auxiliary devices are supplied for permanent coupling or for use as non-magnetic shafts.

Speed Range: 0 to 1000 rpm.

Contacts per Revolution: One.

Range of Phase Adjustment: 360°; scale graduated in 5-degree intervals.

Range of Height Adjustment: 6 inches to 4 feet.

Diameter of Base: 18 inches.

Accessories Supplied: Hex wrench, auxiliary coupling devices, and TYPE 1535-P5 Adaptor for connecting to TYPE 1531-A or TYPE 1532-D.

Net Weight: 19¾ pounds (9 kg).

Shipping Weight: 28 pounds (13 kg).

Type		Code Number	Price
1535-B	Contactor	1535-9702	\$170.00
1535-P5	Adaptor	1535-9605	5.00



Type 1532-D STROBOLUME

FEATURES:

- ◆ High-intensity short flash. ◆ Wide beam angle.
- ◆ Operates from STROBOTAC® electronic stroboscope or contactor.
- ◆ Compact, lightweight assembly.
- ◆ Lamp assembly is removable, with 14-foot extension cable.
- ◆ Lamp housing has socket with standard tripod thread.
- ◆ Long-life sealed-beam lamp.

USES: The Strobolume produces a brilliant white light flash useful for studying motions of machines operating at relatively low speeds. At low flashing rates the Strobolume's light is of a higher intensity than that of the STROBOTAC electronic stroboscope.

The Strobolume can be triggered by a spring-loaded toggle switch on the control panel, by an external contactor such as the TYPE 1535-B, or by the electronic stroboscope. It is a useful light source for single- and multiple-flash photography, when the motion of the subject is often too fast to be stopped by conventional strobe-lights.

DESCRIPTION: The Strobolume consists of a high-voltage transformer and rectifiers, a capacitor that is charged to about 2500 volts from the rectifiers, and a lamp through which the capacitor is discharged to produce the flash. The discharge is initiated by a special Strobotron tripped by an external impulse. Two ranges of intensity and flashing rate are provided.

SPECIFICATIONS

Flashing Speed Range:

High Intensity: Up to 60 flashes per minute continuous, up to 1200 per minute intermittent.

Low Intensity: Up to 3000 flashes per minute continuous.

Peak Light Intensity: 10 million beam candlepower (10⁷ lux measured at 1 meter distance at the center of the beam) from single flash to 60 flashes per minute; 0.14 million beam candlepower (1.4 × 10⁶ lux at 1 meter distance at the center of the beam) at 3000 flashes per minute.

Flash Duration: Approximately 30 microseconds at high intensity, 10 microseconds at low intensity.

Beam Width: 45 degrees at half-intensity points.

Guide Number: The guide number (distance in feet times aperture) for high intensity is approximately 25 with film speed of 100 (ASA).

Flashing Control: TYPE 1535-B Contactor, or TYPE 1531-A Strobotac electronic stroboscope with TYPE 1532-P3 Trigger Cable.

Accessories Supplied: TYPE CAP-22 Power Cable, TYPE 1532-2060 Contactor Cable Assembly, and plug for connection to contactor.

Other Accessories Required: None if lamp is to be flashed manually by pushbutton. For stroboscopic work a TYPE 1535-B Contactor, or a TYPE 1531-A Strobotac electronic stroboscope with TYPE 1532-P3 Trigger Cable, is needed. For use with older TYPE 631-BL Strobotac, a TYPE 1532-P2B Transformer Cable is required.

Cabinet: Metal case. Lamp assembly is removable. Storage space for lamp cable is provided in case. Lamp housing has ¼-20 threaded socket for tripod.

Power Requirements: 105 to 125 volts, 50 to 60 cps; 230-volt model TYPE 1532-DQ18, is available. Power consumption on high intensity is 105 watts at 60 flashes per minute, 500 watts at 1200 flashes per minute; at low intensity, 120 watts at 3000 flashes per minute.

Dimensions: Width 7½, height 11½, depth 13 inches (190 by 295 by 330 mm), over-all; lamp unit, 6 inches diameter by 5¾ inches (155 by 150 mm).

Net Weight: 18½ pounds (8.5 kg); lamp unit, 2 pounds (1 kg).

Shipping Weight: 26 pounds (12 kg).

Type		Code Number	Price
1532-D	Strobolume, 105-125 volts, 50-60 cps	1532-9704	\$350.00
1532-DQ18	Strobolume, 210-250 volts, 50-60 cps	1532-9825	360.00
1532-P1	Replacement Lamp	1532-9601	25.00
1532-P2B	Transformer Cable	1532-9941	17.00
1532-P3	Trigger Cable	1532-9603	15.00

PATENT NOTICE. See Note 6, page viii.

HIGH-INTENSITY STROBOSCOPE



POWER SUPPLIES



Although most General Radio instruments have their own self-contained power supplies, some have been designed for use with separate power supplies for versatility and economy. The different general- and special-purpose power supplies are described in this section.

The TYPE 1205-B Adjustable Regulated Power Supply is primarily a general-purpose instrument which provides a regulated output adjustable from 0 to 300 volts at a maximum current of 200 milliamperes.

The general-purpose TYPE 1203-B Unit Power Supply or the TYPE 1201-B Unit Regulated Power Supply can be used with any of the Unit Instruments and are recommended for the rectangular-case Unit Instruments. TYPE 1206-B Unit Amplifier, TYPE 1210-C Unit R-C Oscillator, TYPE 1212-A Unit Null Detector, TYPE 1213-D Unit Time/Frequency Calibrator, TYPE 1217-B Unit Pulse Generator, and TYPE 1220-A Unit Klystron Oscillator. With the rf, vhf, and uhf oscillators described on pages 112 to 115 one of the following four power supplies is recommended:

TYPE 1263-B Amplitude Regulating Power Supply for cw or 1-kc square-wave modulated output at a fixed level

adjustable between 0.1 and 2.0 volts behind 50 ohms.

TYPE 1264-A Modulating Power Supply for cw, 1-kc square-wave modulated, or pulse-modulated output adjustable over a wide range without auxiliary attenuators.

TYPE 1267-A Regulated Power Supply for cw operation with highest stability.

TYPE 1269-A Power Supply for cw operation with highest output at low cost.

Relay-rack adaptors are available for use with the above power supplies and associated instruments.

The TYPE 1265-A Adjustable DC Power Supply and the TYPE 1266-A Adjustable AC Power Supply have been designed primarily for use with the TYPE 1633-A Incremental-Inductance Bridge.

The TYPE 1116-B Emergency Power Supply, TYPE 1268-A Automatic Battery Charger, and TYPE 1268-P1 Battery Drawer are intended as standby power equipment for frequency standards. The TYPE 1262-B Power Supply is used for ac operation of the TYPE 1551-C Sound-Level Meter.

Type 1205-B ADJUSTABLE REGULATED POWER SUPPLY

FEATURES:

- ◆ Adjustable output voltage from 0 to 300 volts dc.
- ◆ Excellent regulation down to zero output.
- ◆ Low hum level.
- ◆ Small size — over-all volume is less than 1/5 that of conventional supplies.
- ◆ High power output — 120 watts.

DESCRIPTION: The TYPE 1205-B Adjustable Regulated Power Supply combines the features of a fast-acting series regulator which provides a low output impedance over a wide bandwidth, and a high-efficiency controlled rectifier which maintains constant voltage drop across the regulator. Thus the regulator always operates at the optimum point, and the power dissipation is held to the same minimum value for all output and line voltage values.

DC Output

Voltage: 0 to 300 volts continuously adjustable, at 200 milliamperes maximum.

Regulation: No load to full load, 0.1 volt; 0.75-volt change for $\pm 10\%$ change in line voltage.



SPECIFICATIONS

Bias Output

Voltage: -150 volts dc fixed, at 5 milliamperes maximum.

Regulation: No load to full load, 0.5 volt; 2-volt maximum change for $\pm 10\%$ change in line voltage.

Unregulated AC Voltage: 2 circuits, each 6.3 volts nominal, at 5 amperes, can be connected in series or parallel.

Meter Accuracy: Voltage, 2%; current, 5%.

120-cycle Ripple: Less than one millivolt.

Internal Impedance: Approximately 0.3 ohm + 2 μ h shunted by 4 μ f.

Power Input: 105 to 125 volts, 60 cps; 250 watts at full load.

Accessories Supplied: Adaptor plug, spare fuses.

Dimensions: Width 9 $\frac{1}{2}$, height 5 $\frac{1}{4}$ inches (245 by 135 mm); depth behind panel 8 $\frac{1}{4}$ inches (210 mm).

Net Weight: 15 pounds (7 kg).

Shipping Weight: 26 pounds (12 kg).

Type		Code Number	Price
1205-B	Adjustable Regulated Power Supply	1205-9702	\$325.00
480-P4U2	Relay-Rack Adaptor Panel	0480-9985	11.00

PATENT NOTICE. See Notes 15 and 21, page viii.

Type 1203-B UNIT POWER SUPPLY

Type 1201-B UNIT REGULATED POWER SUPPLY

These two supplies have been designed to provide plate and heater power for Unit Instruments. The TYPE 1203-B is a general-purpose, unregulated, 300-volt dc and 6.3-volt ac supply, while the TYPE 1201-B has a regulated plate voltage supply to minimize the

effects of line-voltage fluctuations on oscillator amplitude and frequency, amplifier hum level, or pulse-generator jitter. Both supplies are primarily for bench use but can be rack-mounted alone or with other Unit Instruments.

SPECIFICATIONS

TYPE 1203-B

Input: 105 to 125 volts (210 to 250 volts for TYPE 1203-BQ18), 50 to 60 cps, 50 watts full load at 115 volts. Can also be operated from 110- to 125-volt, 400-cycle supply for applications where a 400-cycle, 6.3-volt output can be tolerated.

Output: At 115-volt input — 300 volts dc ($\pm 5\%$) at 50 milliamperes; 6.3 volts ac at 3 amperes. (With ac load at 1.5 amperes or less, maximum dc load is 65 milliamperes, about 285 volts dc.)

Regulation: At no load, dc output is 380 volts.

Ripple: Less than 80 millivolts, rms, (120 cps) at full load.

Connectors: Three-wire line cord permanently attached. Standard four-terminal receptacle on cabinet side for convenient connection to Unit Instruments.

Accessories Supplied: Mating plug for equipment other than Unit Instruments.

Cabinet: Unit Instrument (see page 210).

Dimensions: Width 5, height $5\frac{3}{4}$, depth $6\frac{1}{4}$ inches (130 by 150 by 160 mm), over-all, not including power cord.

Net Weight: 5 pounds (2.3 kg).

Shipping Weight: 10 pounds (4.6 kg).

TYPE 1201-B

Input: 105 to 125 volts (210 to 250 volts for TYPE 1201-BQ18), 50 to 60 cps, 90 watts full load at 115 volts. Can also be operated from 110- to 125-volt, 400-cycle supply for applications where a 400-cycle, 6.3-volt output can be tolerated.

Output: 300 volts dc regulated to $\pm 0.25\%$, 70 milliamperes maximum; 6.3 volts ac unregulated at 4 amperes maximum.

Ripple: Less than 1 millivolt, rms, (120 cps) at full load.

Connectors: Three-wire line cord permanently attached. Standard four-terminal receptacle mounted on cabinet side for convenient connection to Unit Instruments.

Accessories Supplied: Mating plug for equipment other than Unit Instruments.

Cabinet: Unit Instrument (see page 210).

Dimensions: Width 5, height $5\frac{3}{4}$, depth $6\frac{1}{4}$ inches (130 by 150 by 160 mm), over-all, not including power cord.

Net Weight: 6 pounds (2.8 kg).

Shipping Weight: 11 pounds (5 kg).



Type	Code Number	Price
1203-B	1203-9702	\$ 55.00
1203-BQ18	1203-9818	60.00
1201-B	1201-9702	95.00
1201-BQ18	1201-9818	105.00
480-P4U1	0480-9984	11.00

Type 1203-B

Type 1201-B



Type 1269-A POWER SUPPLY

Type 1267-A REGULATED POWER SUPPLY

These two supplies have been designed primarily for use with the Unit RF Oscillators where the power supply and the oscillator are to be bolted together or mounted in a relay rack. The TYPE 1269-A is a general-purpose, unregulated, 300-volt dc and 6.3-volt ac supply. In the TYPE 1267-A, both heater and plate supplies are regulated to provide complete freedom from line-voltage variations and minimum residual modulation and frequency drift.

SPECIFICATIONS

TYPE 1269-A

Identical with TYPE 1203-B specifications, except for the following:
Input: 105 to 125 (or 210 to 250) volts, 50 to 60 cps, 50 watts full load at 115 (or 230) volts. Can also be operated from a 110- to 125-volt, 400-cycle supply for applications where a 400-cycle, 6.3-volt output can be tolerated.

Cabinet: Convertible bench (see page 210). See page 116 for relay-rack mounting with Unit Oscillators.

Dimensions: Width $4\frac{1}{4}$, height $7\frac{3}{8}$, depth $9\frac{1}{4}$ inches (110 by 195 by 235 mm), over-all, not including power cord.

Net Weight: $5\frac{3}{4}$ pounds (2.7 kg).

Shipping Weight: 8 pounds (3.7 kg).

TYPE 1267-A

Input: 105 to 125 (210 to 250 for TYPE 1267-AQ18) volts, 50 to 60 cps, 90 watts full load at 115 volts. Can also be operated from a 110- to 125-volt, 400-cycle supply.

Output: 300 volts dc 70 milliamperes, maximum; 6.3 volts dc at 1 ampere, maximum. Standby switch disconnects high-voltage output.

Ripple: Less than 1 millivolt, rms, (120 cps) at full load.

Line Regulation: $\pm 0.25\%$ for $\pm 10\%$ line change for both outputs.

Output Impedance: Approximate dc resistance 2 ohms (300 volts) and 35 milliohms (6.3 volts).

Cabinet: Convertible bench (see page 210). See page 116 for relay-rack mounting with Unit Oscillators.

Dimensions: Width $4\frac{1}{4}$, height $7\frac{3}{8}$, depth $9\frac{1}{4}$ inches (110 by 195 by 235 mm), over-all, not including power cord.

Connector: Standard four-terminal receptacle for convenient connection to Unit Instruments.

Accessories Supplied: Three-wire line cord; mating plug for equipment other than Unit Instruments.

Net Weight: $7\frac{3}{4}$ pounds (3.6 kg).

Shipping Weight: 10 pounds (4.6 kg).



Type	Code Number	Price
1269-A	1269-9701	\$ 70.00
1267-A	1267-9701	170.00
1267-AQ18	1267-9911	180.00

Type 1269-A

Type 1267-A





Type 1263-B AMPLITUDE-REGULATING POWER SUPPLY

FEATURES:

- ◆ Provides constant oscillator output up to 500 Mc (up to 2000 Mc with suitable low-pass filters), within $\pm 5\%$, with variations in frequency, load, and line voltage including effects of oscillator harmonics.
- ◆ Provides 1-kc square-wave modulation from an internal generator.
- ◆ The built-in, peak-responding meter, with an external TYPE 874-VR Voltmeter Rectifier, indicates rms oscillator output voltage.

USES: In most measurements using radio-frequency oscillators, it is desirable to maintain a constant applied voltage as the frequency is varied. The TYPE 1263-B Amplitude-Regulating Power Supply automatically maintains the output of General Radio vhf and uhf oscillators at a preset value in spite of incidental amplitude variations which occur both with supply-voltage variations and with changes in oscillator frequency.

With its very-high-speed response, the TYPE 1263-B is particularly useful when the oscillator dial is mechanically driven by a TYPE 1750-A Sweep Drive (see pages 112 and 127) for oscillographic display of amplitude-frequency characteristics.

This power supply will modulate a Unit Oscillator with 1-kc square waves, thus eliminating incidental frequency modulation, and permitting the use of an untuned detector with a sensitive audio amplifier. Regulation of

average output level is maintained in this mode of operation so that swept measurements at very low rf detector levels can be made.

DESCRIPTION: The TYPE 1263-B Amplitude-Regulating Power Supply compares the dc potential developed by the oscillator output rectifier with an adjustable dc reference potential in a feedback system. A rapid correction is applied to the plate-current supply of the oscillator to hold the oscillator output to a preset level. RF blanking can be accomplished by shorting of the reference potential with an external contactor.

For 1-kc modulation a multivibrator and rc low-pass input filter are switched into the power-supply circuit. The voltage regulated is then the average value of the square-wave envelope. An external synchronous detector, to maintain a high signal-to-noise ratio in low-level measurements, may be gated from a voltage provided.

SPECIFICATIONS

RF Output Voltage: 0.2 to 2.0 volts behind 50 ohms for any recommended oscillator (see below), with a TYPE 874-VR Voltmeter Rectifier. With 1-kc square-wave modulation, 0.2 to 1.0 volt behind 50 ohms.

RF Output Regulation: Below 500 Mc, rf output of recommended Unit Oscillators is held to within $\pm 5\%$ including the effects of harmonics. This regulation can be attained up to 2000 Mc if proper low-pass rf filters (see page 65) are used and a correction applied for the output-rectifier frequency characteristic.

Modulation:

Frequency: 1-kc square-wave, adjustable $\pm 5\%$, stable within 5 cps over the rated range of line voltage.

Duty Ratio: 0.5 to 0.53, adjustable to compensate for oscillator starting delay.

Rise and Decay Times: 50 μ sec each.

Overshoot: None.

Ramp-off: Less than 0.5%.

Gate Voltage: Synchronized with "off" interval of modulation, exceeds 1 volt into the recommended load of 30 kilohms shunted by 300 pf. Rise and decay times are less than 50 μ sec each. Gate output during "on" interval of modulation is less than 0.01 volt.

Plate Supply Output: 0 to 300 volts at 30 milliamperes.

Heater Supply Output: 6 volts $\pm 10\%$ at 0.5 ampere, 5.4 volts $\pm 10\%$ at 0.7 ampere.

Response Time: For a 2-to-1 step variation in oscillator output, correction is completed within 0.5 msec with cw operation, 50 msec with 1-kc modulation. Recovery time after blanking is less than 2 msec with cw operation, 200 msec with 1-kc square-wave modulation.

Hum and Noise: Peak residual hum and noise modulation is less than $\pm 0.3\%$ on cw; less than $\pm 3\%$ with 1-kc square-wave modulation.

Output Voltmeter: Internal standardizing circuit is provided. Accuracy after standardization is better than $\pm 10\%$ of indication when a correction is applied for rectifier characteristic at extremely high frequencies.

Power Input: 105 to 125 (or 210 to 250) volts, 50 to 60 cps, 55 watts maximum, at full load.

Accessories Supplied: TYPE CAP-22 Power Cord, connector cable for modulation jack on oscillator, spare fuses.

Other Accessories Required: TYPE 874-VR Voltmeter Rectifier (page 67), TYPE 874-R22A Patch Cord (page 70) for connecting output rectifier, and TYPE 874-T for monitoring oscilloscope connection in sweeping applications.

Recommended Oscillators (pages 112 to 115): TYPE 1215-C (50 to 250 Mc), TYPE 1209-CL (180 to 600 Mc), TYPE 1209-C (250 to 920 Mc), TYPE 1361-A (450 to 1050 Mc), TYPE 1218-A (900 to 2000 Mc), and for cw operation only, TYPE 1211-C (0.5 to 50 Mc).

Other Accessories Available: The TYPE 1750-A Sweep Drive (page 127) is recommended for automatic operation. Coaxial cables, connectors, attenuators, filters, and adaptors are listed on pages 63 to 70.

Cabinet: Convertible bench (see page 210).

Dimensions: Width 8, height 7, depth $9\frac{1}{4}$ inches (205 by 180 by 235 mm), over-all. Panel adaptor plate sets are available for 19-inch relay-rack mounting, panel height 7 inches (see page 116).

Net Weight: $14\frac{1}{2}$ pounds (7 kg).

Shipping Weight: 28 pounds (13 kg).



Type		Code Number	Price
1263-B	Amplitude-Regulating Power Supply	1263-9702	\$380.00
480-P408	Relay-Rack Adaptor Set (for power supply only)	0480-9648	8.00
480-P416	Relay-Rack Adaptor Set (for power supply and oscillator)	0480-9646	6.00



Type 1264-A MODULATING POWER SUPPLY

FEATURES:

- ◆ Clean, stable, high-level output pulses.
- ◆ Stable internal 1-kc square-wave generator.
- ◆ Synchronization to wide range of input signals.
- ◆ With an external pulse source, repetition rates from 20 cps to 100 kc are available.
- ◆ Adjustable well-regulated dc output for cw operation.
- ◆ Standby switch position cuts off oscillator output while keeping heater on.

USES: The TYPE 1264-A Modulating Power Supply is used primarily to produce 100% pulse and square-wave modulation of vhf and uhf Unit Oscillators. In addition to its use as a modulator, this power supply can be used as an adjustable regulated supply for the oscillator plate and a source of unregulated heater power.

Although the TYPE 1264-A was designed especially as a companion to the TYPE 1361-A UHF Oscillator (450 to 1050 Mc), accessory adaptor cables permit use of this power supply with many other General Radio oscillators (see specifications).

DESCRIPTION: The TYPE 1264-A comprises an electronically regulated, adjustable-output, high-voltage, dc supply, a dc-coupled, series-type power modulator driven by a Schmitt trigger circuit, and a 1-kc multivibrator. A switch permits selection of cw, standby (only heaters

energized), 1-kc square-wave modulated (internally generated), or externally modulated operation. Independent panel controls vary the regulated supply voltage for cw operation and the modulator amplitude for square-wave and pulse operation. Controls are also provided to adjust the frequency of the internal 1-kc multivibrator and the duty ratio to produce a true square wave.

The input trigger circuit accepts single or multiple positive pulses, which are reproduced at the modulator output. It also accepts square waves at rates up to 100 kc, or sine waves up to 50 kc, from any 20-volt source such as the TYPE 1217-B Unit Pulse Generator or the TYPE 1210-C Unit R-C Oscillator, and produces square waves at the modulator output. No adjustment of triggering is necessary. The stable 1-kc multivibrator provides ideal square-wave modulation for use with sharply selective amplifiers following the signal detector.

SPECIFICATIONS

Regulated DC Output (Unmodulated)

Voltage: Adjustable from 200 to 300 volts.

Current: 50 milliamperes maximum.

Stability: Output voltage at any rated load will change less than 0.5 volt for $\pm 10\%$ line-voltage change.

Ripple: Less than 1 millivolt, rms, with B- grounded; less than 5 millivolts, rms, with B+ grounded.

Heater Power Output (Unregulated)

Voltage: 6.3 volts ac.

Current: 2.1 amperes maximum.

Square-Wave Output (Internally Generated)

Amplitude: Adjustable from approximately 160 to 210 volts.

Frequency: Adjustable from 850 to 1150 cps.

Stability: Frequency will change less than 0.5% for $\pm 10\%$ line-voltage change.

Duty Ratio: 0.5, adjustable $\pm 5\%$.

Square-Wave Output (from External Sine-Wave Generator)

Amplitude: Adjustable from approximately 160 to 210 volts.

Driver Requirements: 20 to 50 volts, rms, 20 to 50,000 cps.

Pulse Output (Externally Generated)

Amplitude: Adjustable from approximately 160 to 210 volts.

Duration (between half-amplitude points): 1.5 μ sec to square waves; duration determined by external generator.

Rise and Decay Times (between 10% and 90% of maximum amplitude): Less than 1.5 μ sec when driving a load capacitance of 300 pf in shunt with a resistance of 15,000 ohms or less.

Ramp-off: None.

Driver Requirements: 20 to 50 volts peak, positive polarity, 20 to 100,000 pulses per second.

Power Requirements: 105 to 125 (or 210 to 250) volts, 50 to 1000 cps, 85 watts.

Accessories Supplied: TYPE CAP-22 Power Cord, connector plug.

Recommended Oscillators: TYPE 1361-A (450 to 1050 Mc); TYPES 1215-C (50 to 250 Mc), 1209-C (250 to 920 Mc), 1209-CL (180 to 600 Mc), and 1218-A (900 to 2000 Mc) (pages 112 to 115).

Other Accessories Available: TYPE 1264-P1 Adaptor Cable to connect to TYPES 1209-C, 1209-CL, and 1215-C Unit Oscillators; TYPE 1264-P2 Adaptor Cable to connect to TYPE 1218-A Unit Oscillator.

Cabinet: Convertible bench (see page 210).

Dimensions: Width 8, height 7, depth 9 $\frac{1}{4}$ inches (205 by 180 by 235 mm). Panel adaptor plate sets are available for 19-inch relay-rack mounting, panel height 7 inches (see page 116).

Net Weight: 12 pounds (5.5 kg).

Shipping Weight: 26 pounds (12 kg).

Type		Code Number	Price
1264-A	Modulating Power Supply	1264-9701	\$285.00
1264-P1	Adaptor Cable	1264-9601	15.00
1264-P2	Adaptor Cable	1264-9602	8.50
480-P408	Relay-Rack Adaptor Set (for power supply only)	0480-9648	8.00
480-P416	Relay-Rack Adaptor Set (for power supply and oscillator)	0480-9646	6.00





Type 1116-B EMERGENCY POWER SUPPLY

USES: The TYPE 1116-B Emergency Power Supply, powered by storage batteries, furnishes ac power to maintain uninterrupted operation of a frequency standard comprising an oscillator, frequency divider, and clock unit. The switchover to emergency power is accomplished automatically upon failure of the main ac supply. The transition to battery supply occurs within two cycles of the time the line voltage falls to 105 volts. There is no interruption of the continuous operation of the oscillator and timing system, so that calibration procedure involving time integration can be fully relied upon. Switchback does not occur until the line returns to 108 to 113 volts.

While the design of the TYPE 1113-A Standard-Frequency Oscillator prevents the possibility of permanent damage in the event of power failure, a period of hours or even days may be necessary for the standard to recover equilibrium after a temporary unsettlement caused by power failure. The emergency power supply is, therefore, a recommended accessory for the frequency standard.

SPECIFICATIONS

Input:

From Power Line — 115/230 volts, 50 to 60 cps.
From Battery (when operating Type 1120-A Frequency Standard) — 28 to 32 volts, 4.5 to 3.5 amperes.

From Battery (when operating Type 1100-A Frequency Standard) — 28 to 32 volts, 10 to 7.5 amperes.

Output: 115 volts, nominal, 60 cps, 180 watts continuous rating.

Operational Range: Battery cuts in when line voltage falls below 105 volts and cuts out when restored line voltage reaches a preset value between 108 and 113 volt ac.

Accessories Supplied: Two TYPE CAP-22 Power Cords, spare fuses.
Accessories Required: 2S-, 30-, or 32-volt battery and cables.

Accessories Available: TYPE 1268-A Automatic Battery Charger and TYPE 1268-P1 Battery Drawer.

Cabinet: Relay-rack (see page 210).

Dimensions: Width 19, height 10½ inches (485 by 270 mm), depth behind panel 13 inches (330 mm).

Net Weight: 58½ pounds (27 kg).

Shipping Weight: 77 pounds (35 kg).

Type	Code Number	Price
1116-B Emergency Power Supply	1116-9702	\$450.00



Type 1268-A AUTOMATIC BATTERY CHARGER

Type 1268-P1 BATTERY DRAWER

USES: The TYPE 1268-A Automatic Battery Charger is designed for use with the TYPE 1268-P1 Battery Drawer, which furnishes dc power to the TYPE 1116-B Emergency Power Supply

The TYPE 1268-P1 Battery Drawer is a relay-rack-mounted sliding drawer to accommodate 24 nickel-cadmium rechargeable cells.

DESCRIPTION: As soon as line voltage is restored after a power failure, a constant-current charge of about 4 amperes is applied to the battery cells by the charger. After 6 hours of this charge, a timer changes the operating mode to constant voltage. This "float" voltage automatically maintains the battery at optimum charge regardless of the current required.

SPECIFICATIONS

TYPE 1268-A Automatic Battery Charger

Constant-Current Charge: 6 hours at 4 amperes, nominal.

Trickle Charge: 33.8 volts ± 2% is maintained at the battery.

Power Required: 105 to 130 (or 210 to 260) volts, 60 cps, 240 watts maximum.

Ambient Temperature Range: 0 to 50 C.

Cabinet: Rack-bench (see page 210).

Dimensions: Bench model — width 19, height 5¼, depth 12 inches (485 by 135 by 305 mm), over-all; rack model — panel 19 by 5¼ inches (485 by 135 mm), depth behind panel 11½ inches (295 mm).

Net Weight: 29½ pounds (13.5 kg).

Shipping Weight: 50 pounds (23 kg).

TYPE 1268-P1 Battery Drawer and TYPE 1268-9602 Battery

Voltage: 28 volts dc, nominal.

Ampere-Hours: 15 ampere-hours. At 4.3 to 3.2 amperes required by TYPE 1116-B Emergency Power Supply, batteries will run at least 3½ hours.

Cabinet: Relay-rack (see page 210).

Dimensions: Width 19, height 12¼, depth 19 inches (485 by 315 by 485 mm), over-all.

Drawer Net Weight: 25 pounds (11.5 kg).

Drawer Shipping Weight: 35 pounds (16 kg).

Battery Net Weight: Approximately 90 pounds (41 kg). Battery shipped direct from supplier.

Type	Code Number	Price
1268-AM Automatic Battery Charger, Bench Model	1268-9801	\$450.00
1268-AR Automatic Battery Charger, Rack Model	1268-9811	450.00
1268-P1 Battery Drawer (less battery)	1268-9601	195.00
1268-9602 Battery	1268-9602	250.00



Type 1116-B



Type 1268-A



Type 1268-P1

Type 1262-B POWER SUPPLY

Attaches to the TYPE 1551-C Sound-Level Meter to provide plate and filament power for laboratory use.

Type	Volts	Frequency cps	Watts	Filament Supply		Plate Supply		Dimensions Inches*	Net Weight	Shipping Weight	Code Number	Price
				Volts	ma	Volts	ma					
1262-B or 210-250	105-125	50 to 400	2	#1	1.2	40	75	5 × 7¼ × 3¾	2½ lb (1.2 kg)	8 lb (3.7 kg)	1262-9702	\$95.00
				#2	1.2	20	55					



* To convert inches to mm, multiply by 25.4.



Type 1265-A ADJUSTABLE DC POWER SUPPLY

FEATURES:

- ◆ Continuously adjustable metered outputs up to 400 volts or 5 amperes.
- ◆ Low-impedance output circuit will pass high ac current.
- ◆ Current-regulated or voltage-regulated source.

USES: The TYPE 1265-A Adjustable DC Power Supply is primarily for use with the TYPE 1633-A Incremental-Inductance Bridge. The characteristics required for that use make the power supply useful for other applications and include wide ranges of current and voltage, a passive low-impedance output circuit that will pass high alternating currents, and a choice of voltage or current regulation.

DESCRIPTION: The instrument has four voltage ranges and four current ranges and will deliver its maximum rated power of 200 watts to 8, 80, or 800 ohms. Ranges are inter-

connected to prevent overloading. Damage to the instrument from accidental overloads is prevented by a trigger circuit.

Either the output voltage or current is sampled, amplified, and then used to control the conduction angle of two power-transistor trigger circuits used as controlled rectifiers. These rectifiers control the current into the output transformer whose several taps provide a choice of output voltages. The selected voltage is rectified and then filtered by components that are switched with both the voltage and current range adjustments to keep the output-circuit time constants independent of range.

SPECIFICATIONS

Full-Scale Output Ranges: 12.5, 40, 125, 400 volts, dc; 0.16, 0.5, 1.6, 5 amperes, dc; in any combination up to 200 watts.

Meters: Voltage and current; ranges switch with output ranges.

Overload Protection: Overload circuit trips at approximately 1½ times full-scale current.

Regulation (Voltage or Current): 0.2% for 10% line-voltage change; 1% for 100% load change.

Speed of Response: Approximately 0.1 second.

Hum Level (rms): Approximately 70 db below full-scale dc output (60 db on 12.5-volt, 5-ampere range).

Accessories Supplied: TYPE CAP-22 Power Cord and spare fuses.

Power Requirements: 105-125 (or 210-250) volts, 50-60 cps, 380 watts at rated load. (Specify if for 50 cps.)

Dimensions: Bench model—width 19, height 7½, depth 17¼ inches (485 by 190 by 440 mm), over-all; rack model—panel 19 by 7 inches (485 by 180 mm), depth behind panel 15 inches (385 mm).

Net Weight: 70 pounds (32 kg).

Shipping Weight: 140 pounds (64 kg).

Type		Code Number	Price
1265-AR	Adjustable DC Power Supply, Rack Model	1265-9811	\$875.00
1265-AM	Adjustable DC Power Supply, Bench Model	1265-9801	875.00

PATENT NOTICE. See Note 1, page viii.



Type 1266-A ADJUSTABLE AC POWER SOURCE

FEATURES:

- ◆ Continuously adjustable metered output up to 1250 volts or 5 amperes.
- ◆ Will tolerate dc current equivalent to maximum ac current in each range.

USES: The TYPE 1266-A Adjustable AC Power Source is compatible with the TYPE 1265-A Adjustable DC Power Supply for producing high-power composite waveforms for use in the TYPE 1633-A Incremental-Inductance Bridge.

It is also useful for other applications requiring a multi-range, high-power source of ac current and voltage.

DESCRIPTION: There are six voltage ranges and five

current ranges. These are selected by rotary panel switches which are mechanically interlocked to prevent any combination that might exceed the 200 voltampere capacity of the supply. Voltage, in each range, is continuously adjustable from zero to the maximum value selected, by means of a VARIAC® adjustable autotransformer. An automatic trip circuit, with manual reset, protects the source against unintentional overload.

SPECIFICATIONS

Frequency: Power-line frequency.

Full-Scale Output Ranges: 4, 12.5, 40, 125, 400, 1250 volts, rms; 0.05, 0.16, 0.5, 1.6, 5 amperes; in any combination up to 200 va. Dc currents up to the rated ac current may be superimposed on output from external source. Maximum voltage derated 20% at 50 cps.

Meters: Voltage and current; ranges switch with output ranges.

Overload Protection: Overload circuit trips at approximately 1½ times full scale of current meters; can be reset by panel switch.

Power Requirements: 50-60 cps, 105-125 (or 210-250) volts, 230 va.

Accessories Supplied: TYPE CAP-22 Power Cord and spare fuses.

Dimensions: Bench model—width 19, height 7½, depth 17¼ inches

(485 by 190 by 440 mm), over-all; rack model—panel 19 by 7 inches (485 by 180 mm), depth behind panel 15 inches (385 mm).

Net Weight: 46 pounds (21 kg).

Shipping Weight: 100 pounds (46 kg).

Type		Code Number	Price
1266-AR	Adjustable AC Power Source, Rack Model	1266-9811	\$360.00
1266-AM	Adjustable AC Power Source, Bench Model	1266-9801	360.00

PATENT NOTICE. See Note 7, page viii.

Type 1266-A



Type 1265-A



SP Type 1570-A AUTOMATIC VOLTAGE REGULATORS

FEATURES:

- ◆ No waveform distortion added.
- ◆ High accuracy.
- ◆ Output voltage independent of load.
- ◆ No power-factor restrictions.
- ◆ High response speed.
- ◆ Large power-handling capacity.
- ◆ Tolerates transient overloads up to ten times rated.

USES: The TYPE 1570-A Automatic Voltage Regulator is used to regulate ac line voltage. It supplies up to 6 kva continuously, adds no harmonic distortion, and has no power-factor restrictions. It combines high accuracy for laboratory use with large capacity for industrial installations. Typical uses include the regulation of line voltage for computers, transmitter supplies, carefully controlled industrial processes, and military equipment installations.

DESCRIPTION: The regulator comprises a motor-driven VARIAC® adjustable autotransformer, an auxiliary step-down transformer which multiplies the power rating of the autotransformer, and a control unit which automatically positions the autotransformer to hold the output voltage constant.

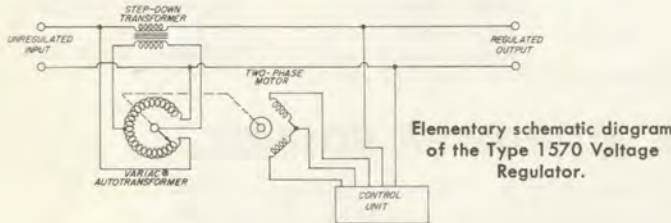

The output voltage is measured with an average-response detector and is compared to a reference voltage. The resultant error signal controls the phase angle of the voltage applied to the servo motor, providing a true proportional-control system, rather than an on-off circuit. The closed-loop phase and amplitude characteristics are

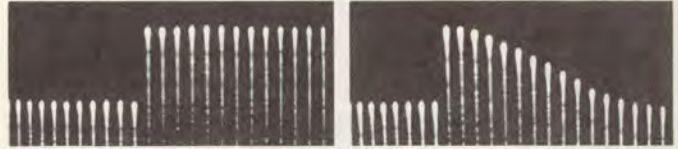

Expanded picture of line voltage peaks shows typical response of regulator. Left, 2% step change in input voltage; right, resulting output transient.

shaped with lead and lag networks to provide optimum transient response. The oscillograms shown above illustrate a typical response to a 2% step change in line voltage. The traces are greatly expanded and show only the ac voltage peaks.

The TYPE 1570-ALS15 is a militarized version of the standard TYPE 1570-A. It is designed to meet the requirements of MIL-E-4158B and MIL-E-16400C. For ease of maintenance, the control unit, containing the servo amplifier, has been separated from the regulator unit, consisting of the motor-driven VARIAC autotransformer and the buck-boost transformer. For servicing, only the control unit need be removed, permitting the regulator unit to supply continuous (but unregulated) power. The military model is particularly useful at high ambient temperatures or where mechanical shock or vibration is encountered.

In addition to the standard and military models listed in the table, special models are available for other current ratings, correction ranges, or frequencies.

SPECIFICATIONS

Input Voltage Range:

Frequency	Nominal Correction Range	Actual Input Voltage Range (% of Output Voltage)
60 cps	±10%	90% to 110%
	±20%	82% to 124%
50-cycle Models and 50- to 60-cycle Military Models	±10%	91% to 109%
	±20%	84% to 119%

Output Voltage: Adjustable over a range of ±10% from a base value of 115 volts (for TYPE 1570-AL) or 230 volts (for TYPE 1570-AH), determined by a screwdriver adjustment.

Frequency: Standard 50- and 60-cycle models operate from 45 to 55 cps and 55 to 65 cps, respectively. On military models, a switch permits operation from either 45 to 55 cps or 55 to 65 cps.

Waveform Distortion: None added.

Waveform Error: The voltage-sensing device responds to the average value of rectified output voltage, which is held constant. The rms



output voltage will also remain constant, regardless of the harmonic distortion present, if the phase and amplitude of the harmonics are constant. If the harmonic content changes, the rms value will change by an amount less than $\Delta R/n$, where ΔR is the change in the harmonic amplitude and n is the harmonic number.

Power Consumption: No load, 35 watts; full load, 100 watts.

Ambient Temperature: Standard models — full ratings apply up to 40 C. Militarized models — operating, -29 to +52 C; in storage, -54 to +85 C.

Mountings: Standard models — bench (-M), relay-rack (-R), or wall (-W). Militarized models — relay-rack only.

View of wall-mounted regulator. This model is used to regulate line voltages in the General Radio development and testing laboratories.



Nominal Output Voltage	Nominal Correction Range	Output Current (Amperes)	KVA	Maximum Response Speed* (Volts/Second)	Accuracy (% of Output Voltage)	Mounting	Type Number†	Code Number		Price
								60 cps	50 cps	
115 v Adjustable ±10%	±10%	50	5.8	12	0.25	Bench	1570-ALM	1570-9964	1570-9957	\$530.00
						Rack	1570-ALR	1570-9974	1570-9966	530.00
						Wall	1570-ALW	1570-9980	1570-9976	530.00
				Rack	1570-ALS15§	1570-9915		750.00		
				Bench	1570-ALMF	1570-9940	1570-9947	530.00		
				Rack	1570-ALRF	1570-9942	1570-9948	530.00		
	±20%	25	2.9	24	0.5	Wall	1570-ALWF	1570-9944	1570-9949	530.00
						Rack	1570-ALS15-F§	1570-9967		750.00
						Bench	1570-ALM2	1570-9901	1570-9932	530.00
				Rack	1570-ALR2	1570-9923	1570-9934	530.00		
				Wall	1570-ALW2	1570-9924	1570-9936	530.00		
				Rack	1570-ALS15-2§	1570-9963		750.00		
230 v Adjustable ±10%	±10%	20	4.6	24	0.25	Bench	1570-AHM	1570-9951	1570-9958	530.00
						Rack	1570-AHR	1570-9961	1570-9968	530.00
						Wall	1570-AHW	1570-9971	1570-9979	530.00
				Bench	1570-AHMF	1570-9779	1570-9783	530.00		
				Rack	1570-AHRF	1570-9780	1570-9784	530.00		
				Wall	1570-AHWF	1570-9781	1570-9785	530.00		
	±20%	10	2.3	48	0.5	Bench	1570-AHM2	1570-9771	1570-9775	530.00
						Rack	1570-AHR2	1570-9772	1570-9776	530.00
						Wall	1570-AHW2	1570-9773	1570-9777	530.00
				Bench	1570-AHMF2	1570-9787	1570-9791	530.00		
				Rack	1570-AHRF2	1570-9788	1570-9792	530.00		
				Wall	1570-AHRW2	1570-9789	1570-9793	530.00		

* Response speeds are 17% less for 50-cycle models.

** Somewhat less for an instantaneous increase in output voltage greater than 15%.

† For 50-cycle models, add "Q" to type number; e.g., TYPE 1570-ALWF2Q for TYPE 1570-ALWF2.

§ Militarized models.

Dimensions:

	STANDARD MODELS	
	Bench and Rack Models	Wall Models
Width	19 in. (485 mm)	13 1/2 in. (345 mm)
Height	7 in. (180 mm)	19 1/2 in. (495 mm)
Depth (over-all)	13 in. (330 mm)	8 1/4 in. (220 mm)
Depth (behind panel)	11 3/4 in. (300 mm)	
Net Weight	57 lb (26 kg)	64 lb (29 kg)

	MILITARIZED MODELS	
	Control Unit	Power Unit
Width	19 in. (485 mm)	19 in. (485 mm)
Height	3 1/2 in. (90 mm)	7 in. (180 mm)
Depth (over-all)	8 1/2 in. (220 mm)	11 1/4 in. (290 mm)
Depth (behind panel)	7 in. (180 mm)	9 5/8 in. (245 mm)
Net Weight	13 3/4 lb (6.3 kg)	50 lb (22.8 kg)

Shipping Weight: 108 pounds (50 kg).



output voltage will also remain constant, regardless of the harmonic distortion present, if the phase and amplitude of the harmonics are constant. If the harmonic content changes, the rms value will change by an amount less than $\Delta R/n$, where ΔR is the change in the harmonic amplitude and n is the harmonic number.

Power Consumption: No load, 35 watts; full load, 100 watts.

Ambient Temperature: Standard models — full ratings apply up to 40 C. Militarized models — operating, -29 to +52 C; in storage, -54 to +85 C.

Mountings: Standard models — bench (-M), relay-rack (-R), or wall (-W). Militarized models — relay-rack only.

View of wall-mounted regulator. This model is used to regulate line voltages in the General Radio development and testing laboratories.



Nominal Output Voltage	Nominal Correction Range	Output Current (Amperes)	KVA	Maximum Response Speed* (Volts/Second)	Accuracy (% of Output Voltage)	Mounting	Type Number†	Code Number		Price
								60 cps	50 cps	
115 v Adjustable ±10%	±10%	50	5.8	12	0.25	Bench	1570-ALM	1570-9964	1570-9957	\$530.00
						Rack	1570-ALR	1570-9974	1570-9966	530.00
						Wall	1570-ALW	1570-9980	1570-9976	530.00
				Rack	1570-ALS15§	1570-9915		750.00		
				Bench	1570-ALMF	1570-9940	1570-9947	530.00		
				Rack	1570-ALRF	1570-9942	1570-9948	530.00		
	Wall	1570-ALWF	1570-9944	1570-9949	530.00					
	Rack	1570-ALS15-F§	1570-9967		750.00					
	±20%	25	2.9	24	0.5	Bench	1570-ALM2	1570-9901	1570-9932	530.00
						Rack	1570-ALR2	1570-9923	1570-9934	530.00
						Wall	1570-ALW2	1570-9924	1570-9936	530.00
				Rack	1570-ALS15-2§	1570-9963		750.00		
Bench				1570-ALMF2	1570-9952	1570-9959	530.00			
Rack				1570-ALRF2	1570-9953	1570-9960	530.00			
Wall	1570-ALWF2	1570-9954	1570-9962	530.00						
Rack	1570-ALS15-F2§	1570-9970		750.00						
230 v Adjustable ±10%	±10%	20	4.6	24	0.25	Bench	1570-AHM	1570-9951	1570-9958	530.00
						Rack	1570-AHR	1570-9961	1570-9968	530.00
						Wall	1570-AHW	1570-9971	1570-9979	530.00
				Bench	1570-AHMF	1570-9779	1570-9783	530.00		
				Rack	1570-AHRF	1570-9780	1570-9784	530.00		
				Wall	1570-AHWF	1570-9781	1570-9785	530.00		
	Bench	1570-AHM2	1570-9771	1570-9775	530.00					
	Rack	1570-AHR2	1570-9772	1570-9776	530.00					
	Wall	1570-AHW2	1570-9773	1570-9777	530.00					
	Bench	1570-AHMF2	1570-9787	1570-9791	530.00					
	Rack	1570-AHRF2	1570-9788	1570-9792	530.00					
	Wall	1570-AHRW2	1570-9789	1570-9793	530.00					
±20%	10	2.3	48	0.5	Bench	1570-AHM2	1570-9771	1570-9775	530.00	
					Rack	1570-AHR2	1570-9772	1570-9776	530.00	
					Wall	1570-AHW2	1570-9773	1570-9777	530.00	
80**				1.0	Bench	1570-AHMF2	1570-9787	1570-9791	530.00	
					Rack	1570-AHRF2	1570-9788	1570-9792	530.00	
					Wall	1570-AHRW2	1570-9789	1570-9793	530.00	

* Response speeds are 17% less for 50-cycle models.

** Somewhat less for an instantaneous increase in output voltage greater than 15%.

† For 50-cycle models, add "Q" to type number; e.g., TYPE 1570-ALWF2Q for TYPE 1570-ALWF2.

§ Militarized models.

Dimensions:

	STANDARD MODELS	
	Bench and Rack Models	Wall Models
Width	19 in. (485 mm)	13 1/2 in. (345 mm)
Height	7 in. (180 mm)	19 1/2 in. (495 mm)
Depth (over-all)	13 in. (330 mm)	8 1/4 in. (220 mm)
Depth (behind panel)	11 3/4 in. (300 mm)	
Net Weight	57 lb (26 kg)	64 lb (29 kg)

	MILITARIZED MODELS	
	Control Unit	Power Unit
Width	19 in. (485 mm)	19 in. (485 mm)
Height	3 1/2 in. (90 mm)	7 in. (180 mm)
Depth (over-all)	8 1/2 in. (220 mm)	11 1/4 in. (290 mm)
Depth (behind panel)	7 in. (180 mm)	9 3/8 in. (245 mm)
Net Weight	13 3/4 lb (6.3 kg)	50 lb (22.8 kg)

Shipping Weight: 108 pounds (50 kg).

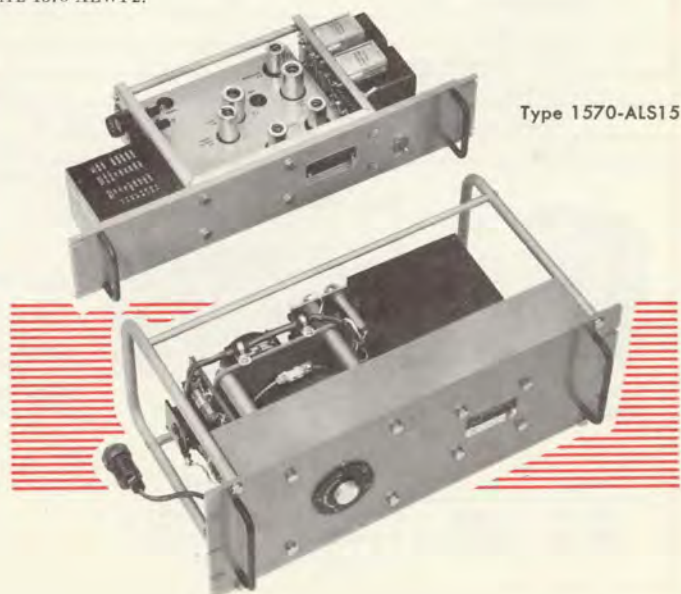

VARIAC® MOTOR SPEED CONTROLS

These speed controls are simple and rugged and have good regulation. They have given excellent performance in many types of industrial applications and are particularly well suited for use in the shop and the laboratory. See page 182 for general description and circuit.



Type 1701-AK
Complete Model
Two speed ranges

1/15 hp and less
for shunt motors



Type 1701-AKW
Basic Model



Type 1701-AU
Available only
in complete model

1/15 hp and less for
series or universal motors

Field and armature
leads must be
separate to provide
constant field
excitation

AC Input	Power supply single phase	Volts	115		115
		Full-load amps.	1.5		1.5
	Line voltage limits	at 60 cycles	105—125		105—125
		at 50 cycles	105—120		105—120
	Input power, watts	Full load	175		175
Stand-by		None		None	
DC Output	Armature	Amperes	0.8		0.8
		Volts	0—115		0—115
	Field	Amperes	0.2		1.25 or 1.0
		Volts	115 or 38		10 or 16
	Speed range	0 to rated or 0 to 2X rated		0 to rated or 0 to rated	
Model		Complete	Basic	Complete	
Dimensions (inches)	Cabinet (w x h x d)	5 7/8 x 6 3/4 x 3 3/4	6 1/8 x 9 x 2 3/4	5 7/8 x 6 3/4 x 3 3/4	
	Variac (w x h x d)	in cabinet		in cabinet	
Weight (pounds)	Net	6		6	
	Shipping	11		11	
Code Number		1701-9819	1701-9821	1701-9939	
Prices net F.O.B. factory	1-4	\$95.00		\$95.00	
	5-19	93.00		93.00	
	20 and up	91.00		91.00	

RECOMMENDED MOTORS FOR USE WITH ABOVE VARIAC® MOTOR SPEED CONTROLS

Motors not sold separately

Motor ratings: open, drip proof, electrically reversible, 40° C rise continuous, horizontal, rigid base. Any motor within control ratings can be used.	Shunt	Series or Universal
General Radio Code Number	5760-9621	5760-9604
Horsepower	1/15	1/15
Speed RPM	1725	8800
Frame Size	68	NSE-12
Leads (brought out separately)	4	4
Bearings	Ball	Sleeve
Weight	Net — 6 1/2 lb Shipping — 10 lb	Net — 3 1/2 lb Shipping — 7 lb
Price	\$38.00	\$21.50



Type 1702-P3

Type 1705-P1



Type 1702-P3 3-position Switch for use with Types 1700-CW, 1702-BW, and 1703-BW.

Type 1705-P1 drum-type Controller, especially suitable for machine-shop production work. For descriptions, refer to page 182.

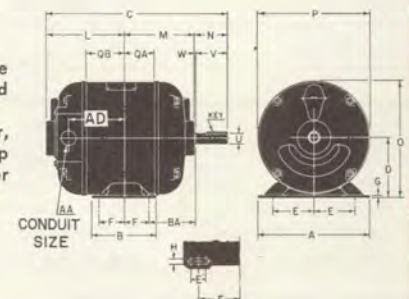





Type		Code Number	Price
1702-P3	Switch	1702-9603	\$11.00
1705-P1	Controller	1705-9601	30.00

SPECIFICATIONS AND PRICES

For description of these models, refer to page 182

VARIAC® AUTOTRANSFORMERS
SPEED CONTROLS

1/12 to 1/6 hp		1/4 and 1/3 hp		1/2 and 3/4 hp	
					
Type 1703-A Complete Model	Type 1703-BW Basic Model	Type 1700-B Complete Model	Type 1700-CW Basic Model	Type 1702-A Complete Model	Type 1702-BW Basic Model
115		115		115	
2.2		5		10	
105—125		105—125		105—125	
105—125		on Special Order only		on Special Order only	
325		560		1150	
30		38		65	
1.5		3.0		6.5	
0—115		0—115		0—115	
0.2		0.4		0.4	
115 or 66 or 48		115 or 75		115 or 75	
0 to rated or 0 to 1.25X or 0 to 1.5X rated		0 to rated or 0 to 1.15X rated		0 to rated or 0 to 1.15X rated	
Complete	Basic	Complete	Basic	Complete	Basic
7 1/8 x 7 3/4 x 4 3/4	6 7/8 x 10 1/8 x 3 1/2	12 7/8 x 9 1/8 x 4 5/8	12 1/2 x 9 3/16 x 4 7/8	13 1/2 x 14 7/8 x 5 1/8	15 3/16 x 10 11/16 x 5 13/16
in cabinet	3 1/4 x 3 11/16 x 4 3/8	in cabinet	4 1/2 x 4 15/16 x 5 1/2	in cabinet	5 3/4 x 6 1/4 x 5
9	8	23 1/2	23 1/2	41	38 3/4
13	15	34	40	55	51
1703-9701	1703-9826	1700-9702	1700-9828	1702-9701	1702-9826
\$110.00	\$90.00	\$180.00	\$155.00	\$255.00	\$215.00
107.00	87.50	176.00	151.50	245.00	206.00
104.00	85.00	172.00	148.00	235.00	197.00

RECOMMENDED MOTORS FOR USE WITH ABOVE VARIAC® MOTOR SPEED CONTROLS

Motors not sold separately

Compound with separate series - field leads		Compound with interpoles		Compound with interpoles	
5760-9611		5760-9603		5760-9625	
1/6		1/3		3/4	
1725		1725		1725	
G-56		G-56		J-56	
6		6		6	
Ball		Ball		Ball	
Net — 30 lb	Shipping — 34 1/2 lb	Net — 33 lb	Shipping — 36 lb	Net — 45 lb	Shipping — 48 1/2 lb
\$62.00		\$76.00		\$115.00	

DIMENSIONS OF MOTORS USED WITH VARIAC® MOTOR SPEED CONTROLS

General Radio Code Number	Frame Size	Dimensions (inches)													U		KEY		Other Dimensions					
		A	B	C	D	E	E'	F	G	H	L	M	N	O	P	Min.	Max.	Sq.	Lgt.	V	W	AA	AD	BA
5760-9603	G-56	6 5/8	4 1/8	10 3/4	3 1/2	2 7/16	3/8	1 1/2	1/4	1 1/2	4 13/32	4 13/32	1 5/16	6 31/32	6 15/16	.6245	.6250	3/16	1 1/4	1 7/8	1/16	1/2	3 3/32	2 3/4
5760-9604	NSE-12	3 9/16	2 1/4	5 11/16	2	1 15/32	7/16	5/8	..	1/4	2 3/8	2 3/8	1 5/16	3 21/32	3 21/64	.3119	.3122	1 3/4
5760-9611	G-56	6 5/8	3 7/8	10 3/4	3 1/2	2 7/16	7/8	1 1/2	1/4	1 1/2	4 13/32	4 13/32	1 5/16	6 31/32	6 1 5/16	.6245	.6250	3/16	1 1/4	1 7/8	1/16	1/2	3 5/16	2 3/4
5760-9621	68	4	5	7 3/4	2 1/2	1 9/32	9/32	1 19/32	1/8	9/32	3 7/16	3 3/8	1 5/16	3 31/32	4 1/4	.3120	.3125	1 1/4
5760-9625	J-56	6 5/8	4 1/8	12 1/2	3 1/2	2 7/16	3/8	1 1/2	1/4	1 1/2	6 1/4	4 1/4	1 5/16	6 31/32	6 15/16	.6245	.6250	3/16	1 1/4	1/2	5	2 3/4

VARIAC® SPEED CONTROLS



FOR OPERATING DC MOTORS FROM AC LINES

Refer to pages 180 and 181 for specifications and prices.

FEATURES:

- ◆ Smooth speed control — 10:1 for most applications; up to 100:1 or more with light loads.
- ◆ Full torque at any speed.
- ◆ Instant starting; quick reversing.
- ◆ Smooth controlled starting for delicate loads; fast high-torque starting for heavy loads.
- ◆ Dynamic braking in all models 1/6 hp and higher, to bring the armature to a quick stop.
- ◆ Economical, easy to install, require minimum of maintenance.

VARIAC® speed controls are compact, high-performance motor speed controls, designed to operate dc shunt, compound, or series motors from an ac line. The motors are operated with constant field excitation and adjustable armature voltage. A VARIAC® autotransformer, in the input to the armature-supply rectifier, provides smooth continuous adjustment of the armature voltage (and hence of the speed) from rated value down to zero. Regulation is 15 to 30 percent at base speed. A choke in the armature circuit minimizes ac ripple so the motor need not be derated for slow-speed operation. A resistor, connected across the armature when the switch is in the stop position, provides dynamic braking except on 1/15-hp models.

No electron tubes are used in these controls.

The basic circuit is shown in the diagram. Long-life selenium rectifiers are employed in both armature and field circuits. These are self-protecting against transient voltage surges. Armature overload protection is accomplished with slow-blow fuses in the 1/15- and 1/6-hp models, and with magnetic circuit breakers in the 1/3- and 3/4-hp models.

Curves of the speed-torque characteristics for a typical installation are shown in the diagram.

VARIAC speed controls are available in four power ratings: 1/15, 1/6, 1/3, or 3/4 horsepower. Each of these sizes can be ordered as either a complete, enclosed model, or as a basic model for assembly into other equipment (identified by the suffix W in the type number). These basic models include the basic components of the mounted

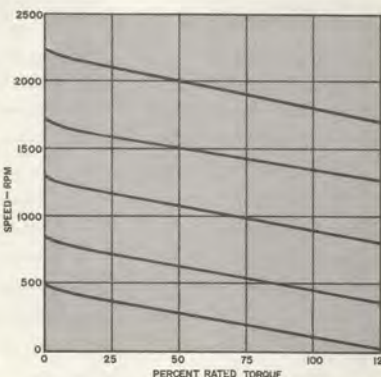

Speed-torque characteristics of a typical motor and speed control installation.

controls, with the VARIAC autotransformer supplied separately, to be mounted by the customer. No switches or overload protection are supplied with the basic models. A suitable switch or drum controller is available as a separate item (see below).

The table on the preceding pages gives the specifications and prices for both the complete and the basic models.

SWITCH AND CONTROLLER

for Use with 1/6-HP, 1/3-HP, and 3/4-HP Basic (W) Models

The TYPE 1702-P3 appliance-type switch, supplied with the complete models, is available for the W- models as a separate item. This switch is designed to break the ac and dc circuits simultaneously and handle reversing and dynamic braking. The escutcheon plate (supplied) is engraved FORWARD, STOP, and REVERSE.

A drum-type Controller, TYPE 1705-P1, is also available separately for use with the basic models in machine-shop production work (refer to page 180).

For prices of the switch and controller, refer to page 180.

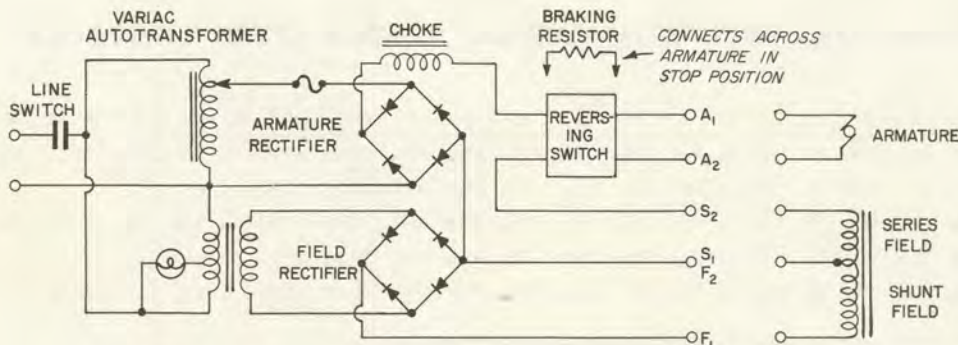

Circuit diagram of a Variac speed control.

VARIAC® AUTOTRANSFORMERS



Since General Radio introduced the first adjustable autotransformer 30 years ago and branded it "Variac,"* over a million of these units have seen service in virtually every industry. They control ac voltage, and thus anything in turn powered by ac voltage. Light, heat, motor speed — all are controlled smoothly, dependably, by VARIAC® autotransformers.

The autotransformer holds several big advantages over other methods of voltage control: It does not waste power by dissipating heat; it can withstand as high as 1000 percent short-term overload; and it does not affect waveform or power factor. To these basic advantages the VARIAC adds the value of 30 years of continuous refinement by General Radio and 30 years of proven performance in industry.

USES: Wherever ac voltage is to be adjusted, there is a place for the VARIAC autotransformer. Some typical applications are:

- ♦ Lighting control in theaters, auditoriums, photographic studios, and darkrooms.
- ♦ Control of electric heaters and ovens in laboratory, pilot plant, and production line.
- ♦ Motor-speed control (except induction motors).
- ♦ Control of ac voltage in test and development work.
- ♦ Overvoltage and undervoltage tests.
- ♦ Meter calibration by voltage control.

DESCRIPTION: The VARIAC autotransformer consists of a single-layer winding on a toroidal silicon-steel core. As the control knob is rotated, a carbon brush traverses the winding, tapping a portion of the total voltage across the winding. The brush is in continuous contact with the winding, and the voltage between turns is always less than 1 volt, even in the largest model; in the smallest model it is only about 0.3 volt. The brush always spans more than one turn, and the change in voltage as the brush moves is practically continuous. The brush is so designed that excessive heating cannot occur in the turns that it spans.

Duratrak®† All VARIAC autotransformers feature the DURATRACK contact surface, a uniform silver-alloy coating to prevent injurious high-temperature oxidation and resultant brush-track deterioration. The track shows no significant wear after 1,000,000 cycles of brush operation from zero to maximum and return. Because of DURATRACK contact surface, the life of a VARIAC autotransformer is essentially the same as that of a fixed-ratio power transformer.

* "Variac" is the registered trade name of the General Radio brand of adjustable autotransformers and associated control equipment in which these adjustable autotransformers are used.

† "Duratrak" is the registered trade name for the contact surface applied to the brush tracks of Variac autotransformers.

PATENT NOTICE. See Note 7, page viii.

FEATURES:

- ♦ **Regulation:** Output voltage is substantially independent of load.
- ♦ **Smooth Control:** Can be set very closely to any voltage in its range. Output voltage is continuously adjustable from zero to maximum.
- ♦ **Efficiency:** Low losses under all load conditions.
- ♦ **Long Life:** Life is essentially the same as that of a fixed-ratio transformer.
- ♦ **Linear Output Voltage:** Output voltage varies linearly with dial rotation.
- ♦ **Overvoltage:** Output voltage may be greater than input voltage.
- ♦ **Low Maintenance:** Occasional cleaning of the contact surface ensures long, trouble-free operation.

Models Available

There are two series of VARIAC autotransformers: the TYPE W, for 50- to 60-cycle service, and the TYPE M, for 350- to 1200-cycle service. The TYPE M series is described on page 194.

Type numbers for VARIAC autotransformers consist of a letter prefix (W for 50- to 60-cycle units, M for 350- to 1200-cycle models), a number, and a letter suffix that indicates exactly what elements are included in the assembly. The following is the legend for VARIAC type numbers:

- A — includes voltmeter and ammeter.
- BB — includes ball bearings.
- C — includes motor capacitor.
- D — motor-driven unit (number following indicates seconds for full traverse of 320°).
- G — ganged (digit following indicates number of units in gang).
- H — 240-volt (input) unit.
- K — includes Microswitches.
- L — higher than nominal current rating; no over-voltage connection; 60 cps only.
- M — cased unit.
- T — portable case with carrying handle and two-wire power cord.
- T3 — same as T, but three-wire cord.

For example, a TYPE W5HG3D16CKM is a motor-driven, three-gang, 240-volt W5 model, with motor capacitor, Microswitches, and case. The motor speed is such that a 320-degree traverse takes 16 seconds.

Left to right: W2M, W5M, W10M, W20M, W30M, and W50M Variac autotransformers.



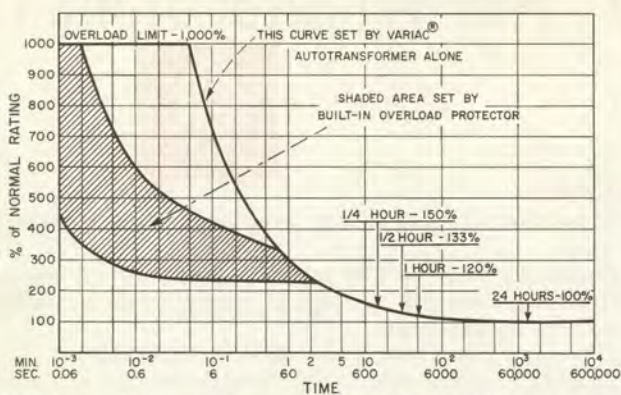

Short-time overload limits. For high initial surge current (as with motors, incandescent lamps, etc.) and other short-time overloads, the rated current may be exceeded as shown, when line-voltage connection is used.

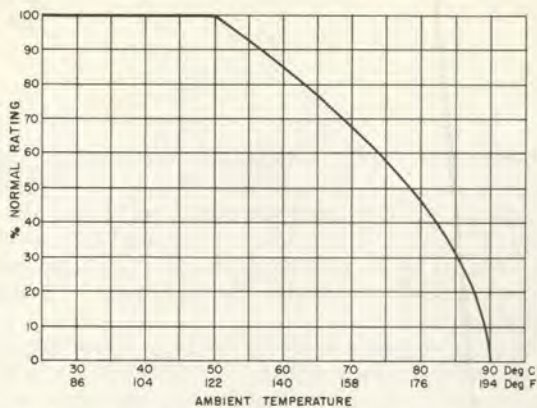

For ambient temperatures above 50 C, ratings should be decreased according to this curve.

GENERAL SPECIFICATIONS AND TERMINOLOGY

Frequency: W series, 50 to 60 cps; M series, 350 to 1200 cps, except as otherwise noted. Most W models can be operated at rated current and voltage at line frequencies of 50 to 400 cps. Models designed for 240-volt, 50- to 60-cycle service can be used on a 25-cycle supply at full current rating and one-half their voltage and kva ratings.

Overload Ratings: Rated currents can be safely exceeded with short-term overloads, as indicated by the curves above. The shaded area shows the limits for the models with built-in fuse-type protective devices.

Protective Devices: TYPES MT and MT3 have built-in circuit breakers with manual resets. TYPES W5L, W20H, W30, W30H, W50, and W50H have built-in fuse-type protectors. However, these should not be considered a substitute for normal fusing practices.

Temperature Effects: Ratings given are based on a temperature rise of not more than 50 C above ambient temperature. For operation in ambient temperatures above 50 C, see derating chart above.

Dials: Dial plates are reversible: 0 to 120 volts on one side, 0 to 140 volts on the other. Dials on H models are marked 0 to 240 and 0 to 280. Dials for ganged assemblies are marked 0 to 10.

Terminals: The following types have combination soldering and screw-type terminals: W2, W5, W5L, W8, W8L, W10, W10H, W30H, and W50H. The W30 and W50 models use clamp-type terminals to accommodate the larger conductors required.

Rated Current is that current which can be drawn at any position of the control knob.

Maximum Current is that current which can be drawn at maximum output voltage when the line-voltage connection is used.

Output Voltage Range is the range of voltage available at the output terminals when the given input voltage is applied to the input terminals.

Overvoltage Connection refers to that connection which gives an output voltage range of zero to 17 percent above input voltage.

Line-Voltage Connection refers to that connection which gives an output voltage range of zero to input (line) voltage.

KVA Load Rating is the maximum current multiplied by the nominal input line voltage. At any lower voltage setting, a Variac can handle a constant-impedance load that draws a current no greater than maximum current with rated input voltage.

No-Load Loss is the guaranteed maximum loss in watts at stated line voltage and frequency.

Driving Torque is the torque required to turn the shaft.

For a complete description of principles, circuits, and uses, refer to *The Handbook of Voltage Control with the Variac® Autotransformer*, available free on request from General Radio Company.

THE W SERIES VARIAC® AUTOTRANSFORMER



Shaft can be easily adjusted or replaced without disturbing other parts of the assembly.

There are seven basic sizes in the W series: W2, W5, W8, W10, W20, W30, and W50. (The numbers correspond approximately to rated current in amperes; for exact specifications, see the following pages.) All sizes except W8 are available in both 120- and 240-volt models. In addition, several mounting options are offered (uncased, cased, and portable), plus many optional features, such as ball bearings, motor drive, full 360-degree rotation, and two separate brush tracks.



Overload protector, an important feature on portable models, is quickly reset from front panel.

Uncased models have square mounting bases for convenient installation. On all models, wiring diagram and ratings are stamped on terminal plates.



Portable models have carrying handle, built-in overload protector, and either two- or three-wire power cord.

Cased models are totally enclosed, with easily removed covers. Power connections enter case through standard conduit knockouts.



DIMENSIONS† OF SINGLE UNIT W-SERIES VARIAC® ADJUSTABLE AUTOTRANSFORMERS

3 Mtg Holes 10-32 On
2 1/2" Bolt Circle
Uncased Model (1/8" Dia
Holes in Panel)

4 Mtg Holes, Clearance
For #10 Screw On Cased
Model (1/8" Dia Holes in Panel)

3 Dia Dial Plate
3/8" Dia Shaft

* For Cased Model

Panel Drilling
For Shaft And
Dial Plate

#31 Drill

Types W2 and W2M.

**Type W2
(uncased)
basic model.**

3 Mtg Holes 10-32 On
3 1/2" Bolt Circle For
Uncased Model (1/8" Dia
Holes in Panel)

4 Mtg Holes, Clearance
For #10 Screw On Cased
Model (1/8" Dia Holes in Panel)

4 Dia Dial Plate
3/8" Dia Shaft

* For Cased Model

Panel Drilling
For Shaft And
Dial Plate

#31 Drill

**Types W5, W5L, W5M, W5LM, W5MT,
W5MT3, W5LMT3, W5H, W5HM, and W5HMT.**

**Type W5M
(cased)
model.**

3 Mtg Holes 10-32 On
3 1/2" Bolt Circle (1/8" Dia
Holes in Panel)

4 Mtg Holes, Clearance
For 1/4" Dia Screw

4 Dia Dial Plate
3/8" Dia Shaft

#31 Drill

Panel Drilling
For Shaft And
Dial Plate

Engraving

Max Engraving

Types W8 and W8L.

**Type W8
(uncased)
model.**

3 Mtg Holes 1/4"-28
On 4 1/2" Bolt Circle
For Uncased Model

4 Mtg Holes, Clearance
For 1/4" Dia Screw On Cased
Model (1/8" Dia Holes in Panel)

5 1/2" Dia Dial Plate
1/2" Dia Shaft

* For Cased Model

Panel Drilling
For Shaft And
Dial Plate

#31 Drill

**Types W10, W10M, W10MT, W10MT3, W10H,
W10HM, W10HMT, and W10HMT3.**

**Type W10MT3,
portable model
with 3-wire cord.**

3 Mtg Holes 1/4"-28 On
6.000 Bolt Circle For
Uncased Model (1/8" Dia
Holes in Panel)

4 Mtg Holes, Clearance For
1/4" Dia Screw On Cased Model
(1/8" Dia Holes in Panel)

7 Dia Dial Plate
1/2" Dia Shaft

* For Cased Model

Panel Drilling
For Shaft And
Dial Plate

#31 Drill

**Types W20, W20M, W20MT3, W20H, W20HM,
and W20HMT3.**

**Type W20M
(cased)
model.**

3 Mtg Holes 1/4"-16 On
8.000 Bolt Circle For
Uncased Model (1/8" Dia
Holes in Panel)

4 Mtg Holes, Clearance For
1/4" Dia Screw On Cased Model
(1/8" Dia Holes in Panel)

7 Dia Dial Plate
1/2" Dia Shaft

* For Cased Model

Panel Drilling
For Shaft And
Dial Plate

#31 Drill

Types W30, W30M, W30H, and W30HM.

**Type W30
(uncased)
basic model.**

3 Mtg Holes 1/4"-16 On
9.000 Bolt Circle For
Uncased Model

4 Mtg Holes, Clearance
For 1/4" Dia Screw On Cased
Model (1/8" Dia Holes in Panel)

7 Dia Dial Plate
1/2" Dia Shaft

* For Cased Model

Panel Drilling
For Shaft And
Dial Plate

#31 Drill

Types W50, W50M, W50H, and W50HM.

**Type W50M
(cased)
model.**

† Given in inches; to convert to mm, multiply by 25.4.

RATINGS AND PRICES for 120-VOLT SINGLE-UNIT W-SERIES

VARIAC® ADJUSTABLE AUTOTRANSFORMERS

with DURATRAK® CONTACT SURFACE

This table lists commonly used single units and does not include all possible applications.
Dimensions for these models are given on page 185.

INPUT VOLTAGE	OUTPUT						TYPE	60-CYCLE NO-LOAD LOSS WATTS	DRIVING TORQUE OUNCE-INCHES	NET WEIGHT POUNDS	APPROXIMATE SHIPPING WEIGHT—POUNDS	CODE NUMBER	PRICE	REPLACEMENT BRUSH	ADD FOR BALL BEARINGS (NOTE E)
	Line-Voltage Connection				Overvoltage Connection										
	KVA LOAD RATING (SEE NOTE A)	VOLTAGE RANGE	RATED CURRENT AMPERES	MAXIMUM CURRENT AMPERES (SEE NOTE A)	VOLTAGE RANGE	RATED CURRENT AMPERES (SEE NOTE B)									
120	0.31	0-120	2.0	2.6	0-140	2.0	W2M† (With case)	3.5	5-10	4¼	9	3010-5111	\$21.50	Type VB1 80¢	\$8.00
120	0.37	0-120	2.4	3.1	0-140	2.4	W2† (Uncased)	3.5	5-10	3½	6	3010-5110	15.00		
120	See Note C				0-140	5	W5MT*† (Portable 2-wire)	9	10-20	8¼	15	3030-5118	31.50	Type VB2 80¢	\$8.00
120	See Note C				0-140	5	W5MT3*† (Portable 3-wire)	9	10-20	8¼	15	3030-5119	33.00		
120	0.78	0-120	5.0	6.5	0-140	5	W5M*† (With case)	9	10-20	7¼	13	3030-5111	26.00		
120	0.94	0-120	6.0	7.8	0-140	6	W5† (Uncased)	9	10-20	6½	12	3030-5110	18.00		
120	1.1	0-120	7.1	9.2	See Note D		W5LM (With case)	12	10-20	7¼	13	3050-5111	25.50		
120	1.1	0-120	7.1	9.2	See Note D		W5LMT3 (Portable 3-wire)	12	10-20	8½	15	3050-5119	32.50		
120	1.32	0-120	8.5	11	See Note D		W5L* (Uncased)	12	10-20	6¾	12	3050-5110	17.50		
120	1.32	0-120	8.5	11	0-140	8.5	W8 (Uncased)	12	10-20	8	15	3038-5110	21.00	Type VB3 90¢	\$8.00
120	1.56	0-120	10	13	See Note D		W8L (Uncased)	12	10-20	8¼	15	3058-5110	21.00		
120	1.56	0-120	10	13	0-140	10	W10*† (Uncased)	17	15-30	12½	18	3060-5110	33.00	Type VBT10 \$1.35	\$9.00
120	1.56	0-120	10	13	0-140	10	W10M*† (With case)	17	15-30	15½	21	3060-5111	46.00		
120	See Note C				0-140	10	W10MT† (Portable 2-wire)	17	15-30	16	24	3060-5118	56.00		
120	See Note C				0-140	10	W10MT3† (Portable 3-wire)	17	15-30	16	24	3060-5119	57.50		
120	3.12	0-120	20	26	0-140	20	W20*† (Uncased)	27	45-90	21½	27	3090-5110	48.00	Type VBT8 \$2.50	\$9.00
120	3.12	0-120	20	26	0-140	20	W20M† (With case)	27	45-90	24½	27	3090-5111	63.00		
120	See Note C				0-140	20	W20MT3† (Portable 3-wire)	27	45-90	28	38	3090-5119	96.00		
120	3.84	0-120	28	32	0-140	28	W30M (With case)	35	50-100	37	46	3120-5111	99.00	Type VBT13 \$4.00	\$12.00
120	4.32	0-120	30	36	0-140	30	W30 (Uncased)	35	50-100	30	36	3120-5110	81.00		
120	5.40	0-120	40	45	0-140	40	W50M*† (With case)	50	150-300	57	74	3150-5111	150.00	Type VBT6 \$7.50	\$12.00
120	6.00	0-120	50	50	0-140	50	W50*† (Uncased)	50	150-300	50	65	3150-5110	125.00		

See footnotes on following page.

RATINGS AND PRICES for 240-VOLT SINGLE-UNIT W-SERIES VARIAC® ADJUSTABLE AUTOTRANSFORMERS

with DURATRAK® CONTACT SURFACE

This table lists commonly used single units and does not include all possible applications.
Dimensions for these models are given on page 185.

INPUT VOLTAGE	OUTPUT					TYPE	60-CYCLE NO-LOAD LOSS WATTS	DRIVING TORQUE OUNCE-INCHES	NET WEIGHT POUNDS	APPROXIMATE SHIPPING WEIGHT—POUNDS	CODE NUMBER	PRICE	REPLACEMENT BRUSH	ADD FOR BALL BEARINGS (NOTE E)	
	Line-Voltage Connection				Overvoltage Connection										
	KVA LOAD RATING (SEE NOTE A)	VOLTAGE RANGE	RATED CURRENT AMPERES	MAXIMUM CURRENT AMPERES (SEE NOTE A)	VOLTAGE RANGE										RATED CURRENT AMPERES (SEE NOTE B)
240	See Note C				0-280	2	W5HMT† (Portable 2-wire)	9	10-20	8¼	15	3040-5118	\$35.00	Type VBT 80¢ \$8.00	
240 120	0.62 —	0-240 —	2.0 —	2.6 —	0-280 0-280	2 1	W5H† (Uncased)	9	10-20	6½	10	3040-5110	21.50		
240 120	0.62 —	0-240 —	2.0 —	2.6 —	0-280 0-280	2 1	W5HM† (Cased)	9	10-20	7¼	13	3040-5111	29.50		
240 120	1.25 —	0-240 —	4 —	5.2 —	0-280 0-280	4 2	W10H† (Uncased)	17	15-30	12	18	3070-5110	35.00	Type VBT11 \$1.35 \$9.00	
240 120	1.25 —	0-240 —	4 —	5.2 —	0-280 0-280	4 2	W10HM† (With Case)	17	15-30	14½	21	3070-5111	48.00		
240	See Note C				0-280	4	W10HMT (Portable 2-wire)	17	15-30	15½	24	3070-5118	58.00		
240	See Note C				0-280	4	W10HMT3† (Portable 3-wire)	17	15-30	15½	24	3070-5119	60.00		
240 120	2.50 —	0-240 —	8 —	10.4 —	0-280 0-280	8 4	W20H*† (Uncased)	27	45-90	20½	27	3100-5110	50.00	Type VBT12 \$3.00 \$9.00	
240 120	2.50 —	0-240 —	8 —	10.4 —	0-280 0-280	8 4	W20HM† (With case)	27	45-90	23½	31	3100-5111	65.00		
240	See Note C				0-280	8	W20HMT3† (Portable 3-wire)	27	45-90	27	35	3100-5119	98.00		
240 120	3.74 —	0-240 —	12 —	15.6 —	0-280 0-280	12 6	W30H (Uncased)	35	50-100	29	36	3130-5110	81.00	Type VBT14 \$4.00 \$12.00	
240 120	3.74 —	0-240 —	12 —	15.6 —	0-280 0-280	12 6	W30HM (With case)	35	50-100	36	46	3130-5111	99.00		
240 120	7.45 —	0-240 —	20 —	31 —	0-280 0-280	20 10	W50HM*† (With case)	50	150-300	60	76	3160-5111	150.00	Type VBT 7 \$7.50 \$12.00	
240 120	7.80 —	0-240 —	25 —	32.5 —	0-280 0-280	25 12.5	W50H*† (Uncased)	50	150-300	53	67	3160-5110	125.00		

NOTES

- A. Maximum current can be drawn at maximum voltage for the line-voltage connection only. Kva as listed = normal input line voltage times maximum current.
- B. Rated current should not be exceeded for the overvoltage connection. Output kva for overvoltage connection = output voltage times rated current.
- C. Type MT and MT3 models have overvoltage connections and corresponding dial scales but can be supplied on special order with line-voltage connections and dial scales.
- D. For 60-cycle use only; no overvoltage connection provided.
- E. When ordering a unit with ball bearings, add the suffix "BB" to the type number.

*Listed under the Re-examination Service of the Underwriters' Laboratories.

†Approved by the Canadian Standards Association.



METERED VARIAC® AUTOTRANSFORMERS

VARIAC® AUTOTRANSFORMERS

METERED

Metered VARIAC autotransformer assemblies are portable testing devices. Each consists of a VARIAC autotransformer and either a voltmeter, a voltmeter and an ammeter, a voltmeter and a wattmeter, or all three. Switching, fuses, and power cord are also provided. These handy, compact assemblies have many uses both in the laboratory and on the test bench, among them overvoltage and undervoltage tests, measurements of voltage, current, and power, and trouble shooting. The meter shielding reduces stray fields sufficiently to permit an over-all accuracy of 3% (full scale) with 2% meters. Connections are made through a three-wire cord (line) and a three-wire outlet (load). The output (load) circuit, containing the meters, is fused. A double-pole on-off switch disconnects both sides of the line. Make-

before-break range switches permit the dual-range meters to be switched under load. All meters have expanded scales for easier reading.

The TYPE W5MT3VM contains a voltmeter; two models include a voltmeter and an ammeter: TYPE W5MT3A (0-5 amperes) and TYPE W10MT3A (0-10 amperes); two models include a voltmeter and wattmeter: TYPE W5MT3W (0-750 watts) and TYPE W10MT3W (0-1500 watts); one model includes a voltmeter, ammeter, and wattmeter: TYPE W5MT3AW (0-5 amperes and 0-750 watts).

The metal case enclosing the metered units is finished to match the case used with the standard W-series VARIAC autotransformers. A convenient carrying handle assures ready portability.

RATINGS AND PRICES FOR METERED VARIAC® AUTOTRANSFORMERS

Type	Meters Included	Input Volts*	Output Voltage Range	Voltmeter Range	Ammeter Ranges	Wattmeter Ranges	60-Cycle No-Load Loss — Watts	Fusing Amperes		Weight Pounds		Dimensions Inches			Code Number	Price
								Low Range	High Range	Net	Shipping	Width	Height	Depth		
W5MT3VM†	V	120	0-140	0-150	—	—	9	—	—	8½	19	4¾	7½	6¼	3030-5015	\$ 60.00
W5MT3A	V, A	120	0-140	0-150	0-1, 0-5	—	9	1	5	11½	19	6¾	10	6½	3030-5012	93.00
W5MT3W	V, W	120	0-140	0-150	—	0-150, 0-750	9	2	5	11¾	19	6¾	10	6½	3030-5013	120.00
W5MT3AW	V, A, W	120	0-140	0-150	0-1, 0-5	0-150, 0-750	9	A = 1 W = 2	5	12½	20	12¾	9	6½	3030-5014	150.00
W10MT3A	V, A	120	0-140	0-150	0-2, 0-10	—	17	2	10	18¼	24	9¼	12	6½	3060-5012	110.00
W10MT3W	V, W	120	0-140	0-150	—	0-300, 0-1500	17	4	10	18¼	24	9¼	12	6½	3060-5013	145.00

V = Voltmeter A = Ammeter W = Wattmeter * 50 to 60 cps for all models. † Klixon-type overload protector.

TYPE W5MT3VM



TYPE W5MT3A



TYPE W5MT3AW



TYPE W10MT3W





GANGED VARIAC® ADJUSTABLE AUTOTRANSFORMER ASSEMBLIES

VARIAC® AUTOTRANSFORMERS
GANGED

The usefulness of the VARIAC autotransformer is greatly extended by means of multigang assemblies (two, three, four, or six). They can be used to control several circuits from a single knob and to control three-phase circuits, either wye- or delta-connected.

SINGLE-PHASE

PARALLEL COMBINATIONS

The larger models (TYPES W20, W30, and W50) can be operated in parallel if a TYPE 50-P1 Choke is used to limit circulating current, as shown in circuit (a). Load rating of two identical units in parallel is twice that of a single unit. Parallel operation is not usually recommended for smaller models, since the use of the next larger size is more economical. Where a load rating in excess of two TYPE W50 units is needed, a third unit can be added by use of a TYPE 50-P2 Choke, as shown in circuit (b). Four-gang and six-gang units can also be paralleled. See page 190 for prices of chokes and number required.

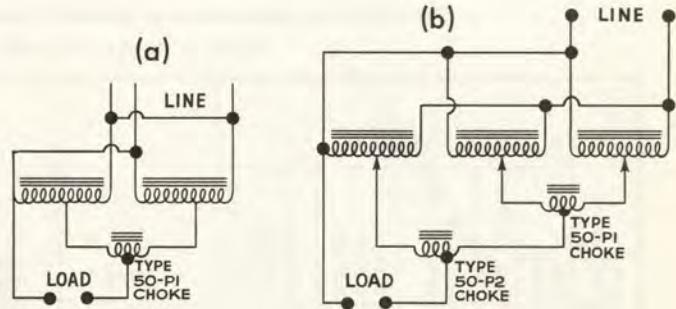

SERIES OPERATION

The series connection is useful in the operation of 120-volt units from 240-volt lines and 240-volt units from 480-volt lines. This circuit cannot be used, however, when a common connection between line and load is required, as, for instance, when the load is grounded.

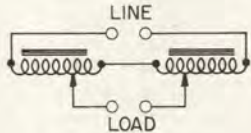

THREE-PHASE

OPEN-DELTA CONNECTION

With this connection, two VARIAC autotransformers will control a three-phase load from a three-phase source. Maximum output voltage can be either line voltage or 17 percent above line voltage. The load rating of a two-gang, open-delta circuit is 1.732 times that of a single unit. With 240-volt models, output voltages of more than double the supply voltage can be obtained, although current and power ratings are halved.

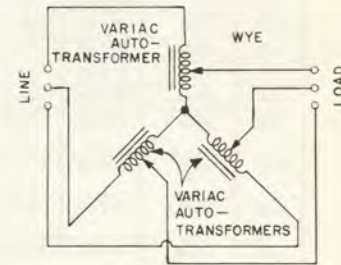
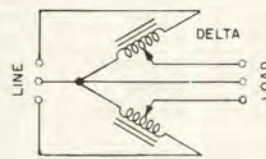

WYE CONNECTION

Wye-connected models can be operated from three-phase lines of twice the voltage rating. This is because the voltage across each leg of a wye-connected assembly equals line volts divided by $\sqrt{3}$, and because 120-volt models are wound for a maximum of 140 volts and 240-volt models for a maximum of 280 volts. With a wye connection, the voltage across a unit on a 480-volt line is 277 volts; on a 240-volt line, 138 volts. Although the overvoltage feature is sacrificed in this circuit, the kva rating is increased by the ratio 138:120. The load rating of a wye-connected assembly is 3.47 times that of a single unit.

PARALLEL OPERATION

As with single-phase assemblies, VARIAC autotransformers can also be paralleled on three-phase circuits. A 4-gang delta connection requires two TYPE 50-P1 Chokes and a 6-gang delta connection requires two TYPE 50-P1 and two TYPE 50-P2 Chokes. A 6-gang wye requires three TYPE 50-P1 Chokes.



Type 50-P1 Choke to limit circulating current in parallel combinations.



Type W2G2M (cased) 2-gang model.

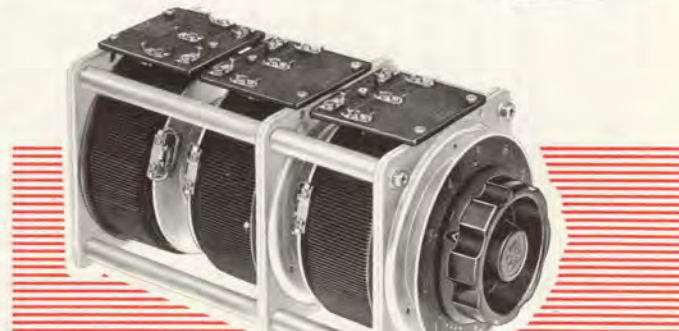

Type W20G3 (uncased) 3-gang model.

For ratings and prices of these assemblies, refer to pages 190 and 191. Dimensions will be found on pages 192 and 193.

RATINGS AND PRICES for SINGLE-PHASE W-SERIES GANGED VARIAC® AUTOTRANSFORMER ASSEMBLIES

with DURATRAK® CONTACT SURFACE

This table lists commonly used ganged assemblies and does not include all possible applications.
Refer to pages 192 and 193 for dimensions of these models.

INPUT VOLTAGE	OUTPUT				TYPE	DESCRIPTION (SEE NOTE B)	NUMBER OF CHOKES REQUIRED		NET WEIGHT POUNDS	APPROXIMATE SHIPPING WEIGHT—POUNDS	CODE NUMBER	PRICE	ADD FOR BALL BEARINGS (NOTE C)
	KVA LOAD RATING (SEE NOTE A)	VOLTAGE RANGE	RATED CURRENT AMPERES	MAXIMUM CURRENT AMPERES (SEE NOTE A)			TYPE 50-P1 \$16.00	TYPE 50-P2 \$16.00					
120	2.2	0-120	14.2	18.4	W5LG2M*	2-Gang, cased (P)	1		15 ¼	23	3050-5121	\$53.00	\$13.00
120	2.6	0-120	17.0	22.0	W5LG2*	2-Gang, uncased (P)	1		13 ¾	21	3050-5120	41.00	13.00
120	3.1	0-120	20.0	26.0	W8LG2	2-Gang, uncased (P)	1		16 ¾	25	3058-5120	48.00	13.00
120	3.3	0-120	21.3	27.6	W5LG3M*	3-Gang, cased (P)	1	1	22 ½	32	3050-5131	72.50	15.00
120	4.0	0-120	25.5	33.0	W5LG3*	3-Gang, uncased (P)	1	1	20 ½	30	3050-5130	59.50	15.00
120	4.7	0-120	30.0	39.0	W8LG3	3-Gang, uncased (P)	1	1	25 ¼	36	3058-5130	70.00	15.00
120	6.2	0-140	40.0	52.0	W20G2M	2-Gang, cased (P)	1		48	63	3090-5121	130.00	15.00
120	6.2	0-140	40.0	52.0	W20G2	2-Gang, uncased (P)	1		43 ½	57	3090-5120	106.00	15.00
120	7.7	0-140	56.0	64.0	W30G2M	2-Gang, cased (P)	1		67	83	3120-5121	210.00	18.00
120	8.6	0-140	60.0	72.0	W30G2	2-Gang, uncased (P)	1		61 ½	77	3120-5120	180.00	18.00
120	9.4	0-140	60.0	78.0	W20G3M	3-Gang, cased (P)	1	1	71	84	3090-5131	182.00	18.00
120	9.4	0-140	60.0	78.0	W20G3	3-Gang, uncased (P)	1	1	65	78	3090-5130	156.00	18.00
120	10.8	0-140	80.0	90.0	W50G2M	2-Gang, cased (P)	1		123	160	3150-5121	308.00	18.00
120	11.5	0-140	84.0	96.0	W30G3M	3-Gang, cased (P)	1	1	99	115	3120-5131	299.00	22.00
120	12.0	0-140	100.0	100.0	W50G2	2-Gang, uncased (P)	1		112	147	3150-5120	268.00	18.00
120	13.0	0-140	90.0	108.0	W30G3	3-Gang, uncased (P)	1	1	93	108	3120-5130	264.00	22.00
120	16.2	0-140	120.0	135.0	W50G3M	3-Gang, cased (P)	1	1	179	221	3150-5131	442.00	22.00
120	18.0	0-140	150.0	150.0	W50G3	3-Gang, uncased (P)	1	1	163	206	3150-5130	397.00	22.00
120	21.6	0-140	160.0	180.0	W50G4BBM	4-Gang, Ball Bearings, cased (P)	4		240	313	3150-5241	604.00	—
120	24.0	0-140	200.0	200.0	W50G4BB	4-Gang, Ball Bearings, uncased (P)	4		215	288	3150-5240	556.00	—
120	32.4	0-140	240.0	270.0	W50G6BBM	6-Gang, Ball Bearings, cased (P)	5	2	355	430	3150-5261	887.00	—
120	36.0	0-140	300.0	300.0	W50G6BB	6-Gang, Ball Bearings, uncased (P)	5	2	325	400	3150-5260	833.00	—
240	0.62	0-560	1.0	1.3	W5HG2	2-Gang, uncased (S)†			13 ¾	21	3040-5120	49.00	13.00
240	0.62	0-560	1.0	1.3	W5HG2M	2-Gang, cased (S)†			15	23	3040-5121	61.00	13.00
240	0.62	0-280	2.0	2.6	W2G2M	2-Gang, cased (S)†			8 ½	15	3010-5121	46.00	13.00
240	0.74	0-280	2.4	3.1	W2G2	2-Gang, uncased (S)†			7 ¼	14	3010-5120	36.00	13.00
240	1.56	0-280	5.0	6.5	W5G2M	2-Gang, cased (S)†			15	23	3030-5121	54.00	13.00
240	1.87	0-280	6.0	7.8	W5G2	2-Gang, uncased (S)†			13 ¾	21	3030-5120	42.00	13.00
240	2.64	0-280	8.5	11.0	W8G2	2-Gang, uncased (S)†			16 ¼	25	3038-5120	48.00	13.00
240	3.12	0-280	10.0	13.0	W10G2	2-Gang, uncased (S)†			25 ½	34	3060-5120	73.00	15.00
240	3.12	0-280	10.0	13.0	W10G2M	2-Gang, cased (S)†			29 ½	38	3060-5121	93.00	15.00
240	4.99	0-280	16.0	20.8	W20HG2	2-Gang, uncased (P)	1		41	55	3100-5120	110.00	15.00
240	4.99	0-280	16.0	20.8	W20HG2M	2-Gang, cased (P)	1		45	59	3100-5121	134.00	15.00
240	6.24	0-280	20.0	26.0	W20G2	2-Gang, uncased (S)†			44	57	3090-5120	106.00	15.00
240	6.24	0-280	20.0	26.0	W20G2M	2-Gang, cased (S)†			48	63	3090-5121	130.00	15.00
240	7.5	0-280	24.0	31.2	W30HG2	2-Gang, uncased (P)	1		59	75	3130-5120	180.00	18.00
240	7.5	0-280	24.0	31.2	W30HG2M	2-Gang, cased (P)	1		64 ½	81	3130-5121	210.00	18.00
240	7.7	0-280	28.0	32.0	W30G2M	2-Gang, cased (S)†			67	83	3120-5121	210.00	18.00
240	8.6	0-280	30.0	36.0	W30G2	2-Gang, uncased (S)†			61 ½	77	3120-5120	180.00	18.00
240	14.9	0-280	40.0	62.0	W50HG2M	2-Gang, cased (P)	1		126	165	3160-5121	308.00	18.00
240	15.6	0-280	50.0	65.0	W50HG2	2-Gang, uncased (P)	1		116	153	3160-5120	268.00	18.00
240	22.3	0-280	60.0	93.0	W50HG3M	3-Gang, cased (P)	1	1	183	230	3160-5131	442.00	22.00
240	23.4	0-280	75.0	97.5	W50HG3	3-Gang, uncased (P)	1	1	167	214	3160-5130	397.00	22.00
240	29.8	0-280	80.0	124.0	W50HG4BBM	4-Gang, Ball Bearings, cased (P)	3		255	328	3160-5241	604.00	—
240	31.2	0-280	100.0	130.0	W50HG4BB	4-Gang, Ball Bearings, uncased (P)	3		230	300	3160-5240	556.00	—
240	44.6	0-280	120.0	186.0	W50HG6BBM	6-Gang, Ball Bearings, cased (P)	4	1	385	458	3160-5261	887.00	—
240	46.8	0-280	150.0	195.0	W50HG6BB	6-Gang, Ball Bearings, uncased (P)	4	1	355	428	3160-5260	833.00	—

See footnotes on following page.

RATINGS AND PRICES for THREE-PHASE W-SERIES GANGED VARIAC[®] AUTOTRANSFORMER ASSEMBLIES

with DURATRAK[®] CONTACT SURFACE

VARIAC[®] AUTOTRANSFORMERS
THREE-PHASE GANGED

This table lists commonly used ganged assemblies and does not include all possible applications.
Refer to pages 192 and 193 for dimensions of these models.

INPUT VOLTAGE	OUTPUT				TYPE	DESCRIPTION	NUMBER OF CHOKES REQUIRED TYPE 50-P1 \$16.00	NET WEIGHT POUNDS	APPROXIMATE SHIPPING WEIGHT—POUNDS	CODE NUMBER	PRICE	ADD FOR BALL BEARINGS (NOTE C)
	KVA LOAD RATING (SEE NOTE A)	VOLTAGE RANGE	RATED CURRENT AMPERES	MAXIMUM CURRENT AMPERES (SEE NOTE A)								
208	3.31	0-208	7.1	9.2	W5LG3M*§	3-Gang, cased, Wye circuit		22½	32	3050-5131	\$72.50	\$15.00
208	3.96	0-208	8.5	11.0	W5LG3*§	3-Gang, uncased, Wye circuit		20½	30	3050-5130	59.50	15.00
208	4.68	0-208	10.0	13.0	W8LG3*§	3-Gang, uncased, Wye circuit		25¼	36	3058-5130	70.00	15.00
240	1.08	0-280	2.0	2.6	W5HG2	2-Gang, uncased, Open Delta		13½	21	3040-5120	49.00	13.00
240	1.08	0-280	2.0	2.6	W5HG2M	2-Gang, cased, Open Delta		14	23	3040-5121	61.00	13.00
240	1.08	0-240	2.0	2.6	W2G3M‡	3-Gang, cased, Wye circuit		12½	21	3010-5131	63.00	15.00
240	1.29	0-240	2.4	3.1	W2G3‡	3-Gang, uncased, Wye circuit		10¾	19	3010-5130	52.00	15.00
240	2.16	0-280	4.0	5.2	W10HG2	2-Gang, uncased, Open Delta		24½	33	3070-5120	77.00	15.00
240	2.16	0-280	4.0	5.2	W10HG2M	2-Gang, cased, Open Delta		29	37	3070-5121	97.00	15.00
240	2.70	0-240	5.0	6.5	W5G3M‡	3-Gang, cased, Wye circuit		22½	32	3030-5131	74.00	15.00
240	3.24	0-240	6.0	7.8	W5G3‡	3-Gang, uncased, Wye circuit		21	30	3030-5130	61.00	15.00
240	4.57	0-240	8.5	11.0	W8G3‡	3-Gang, uncased, Wye circuit		25½	36½	3038-5130	70.00	15.00
240	4.32	0-280	8.0	10.4	W20HG2	2-Gang, uncased, Open Delta		41	55	3100-5120	110.00	15.00
240	4.32	0-280	8.0	10.4	W20HG2M	2-Gang, cased, Open Delta		45	59	3100-5121	134.00	15.00
240	5.40	0-240	10.0	13.0	W10G3‡	3-Gang, uncased, Wye circuit		39	48	3060-5130	108.00	18.00
240	5.40	0-240	10.0	13.0	W10G3M‡	3-Gang, cased, Wye circuit		43	54	3060-5131	129.00	18.00
240	6.48	0-280	12.0	15.6	W30HG2	2-Gang, uncased, Open Delta		59	75	3130-5120	180.00	18.00
240	6.48	0-280	12.0	15.6	W30HG2M	2-Gang, cased, Open Delta		64½	81	3130-5121	210.00	18.00
240	10.8	0-240	20.0	26.0	W20G3‡	3-Gang, uncased, Wye circuit		65	78	3090-5130	156.00	18.00
240	10.8	0-240	20.0	26.0	W20G3M‡	3-Gang, cased, Wye circuit		71	84	3090-5131	182.00	18.00
240	12.9	0-280	20.0	31.0	W50HG2M	2-Gang, cased, Open Delta		126	165	3160-5121	308.00	18.00
240	13.3	0-240	28.0	32.0	W30G3M‡	3-Gang, cased, Wye circuit		99	115	3120-5131	299.00	22.00
240	13.5	0-280	25.0	32.5	W50HG2	2-Gang, uncased, Open Delta		116	153	3160-5120	268.00	18.00
240	15.0	0-240	30.0	36.0	W30G3‡	3-Gang, uncased, Wye circuit		93	108	3120-5130	264.00	22.00
240	18.7	0-240	40.0	45.0	W50G3M‡	3-Gang, cased, Wye circuit		179	221	3150-5131	442.00	22.00
240	20.8	0-240	50.0	50.0	W50G3‡	3-Gang, uncased, Wye circuit		163	206	3150-5130	397.00	22.00
240	25.8	0-280	40.0	62.0	W50HG4BBM	4-Gang, cased, Open Delta	2	255	328	3160-5241	604.00	—
240	27.0	0-280	50.0	65.0	W50HG4BB	4-Gang, uncased, Open Delta	2	230	300	3160-5240	556.00	—
240	37.4	0-240	80.0	90.0	W50G6BBM‡	6-Gang, cased, Wye circuit	3	355	430	3150-5261	887.00	—
240	41.6	0-240	100.0	100.0	W50G6BB‡	6-Gang, uncased, Wye circuit	3	325	400	3150-5260	833.00	—
480	2.16	0-480	2.0	2.6	W5HG3‡	3-Gang, uncased, Wye circuit		20½	29	3040-5130	71.50	15.00
480	2.16	0-480	2.0	2.6	W5HG3M‡	3-Gang, cased, Wye circuit		22	31	3040-5131	84.50	15.00
480	4.32	0-480	4.0	5.2	W10HG3‡	3-Gang, uncased, Wye circuit		36	46	3070-5130	114.00	18.00
480	4.32	0-480	4.0	5.2	W10HG3M‡	3-Gang, cased, Wye circuit		42	52	3070-5131	135.00	18.00
480	8.65	0-480	8.0	10.4	W20HG3‡	3-Gang, uncased, Wye circuit		61	73	3100-5130	162.00	18.00
480	8.65	0-480	8.0	10.4	W20HG3M‡	3-Gang, cased, Wye circuit		67	81	3100-5131	188.00	18.00
480	13.0	0-480	12.0	15.6	W30HG3‡	3-Gang, uncased, Wye circuit		90½	107	3130-5130	264.00	22.00
480	13.0	0-480	12.0	15.6	W30HG3M‡	3-Gang, cased, Wye circuit		97	113	3130-5131	299.00	22.00
480	25.8	0-480	20.0	31.0	W50HG3M‡	3-Gang, cased, Wye circuit		183	230	3160-5131	442.00	22.00
480	27.0	0-480	25.0	32.5	W50HG3‡	3-Gang, uncased, Wye circuit		167	214	3160-5130	397.00	22.00
480	51.5	0-480	40.0	62.0	W50G6BBM‡	6-Gang, cased, Wye circuit	3	385	458	3160-5261	887.00	—
480	54.0	0-480	50.0	65.0	W50G6BB‡	6-Gang, uncased, Wye circuit	3	355	428	3160-5260	833.00	—

NOTES

- A. Maximum current can be drawn at maximum voltage for the line-voltage connection only. Kva, as listed, = normal input line voltage times maximum current.
B. P = parallel windings; S = series windings.
C. When ordering a unit with ball bearings, add the suffix "BB" to the type number.

- *For 60-cycle use only; no overvoltage connection provided.
‡Do not use with grounded load.
‡Overvoltage connection not recommended.
§Can be used in wye connection on 208-volt, 60-cycle, 3-phase line.

DIMENSIONS† of W-SERIES GANGED VARIAC® AUTOTRANSFORMER ASSEMBLIES

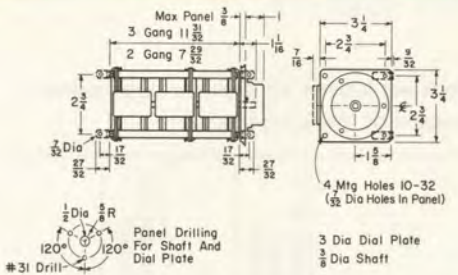
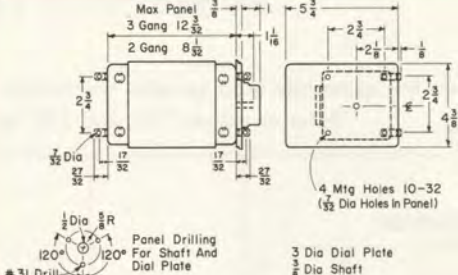
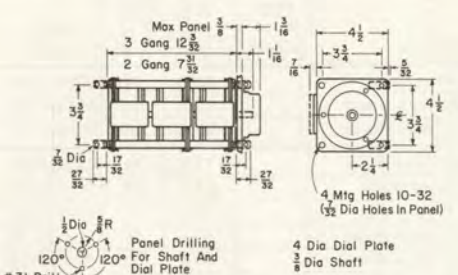
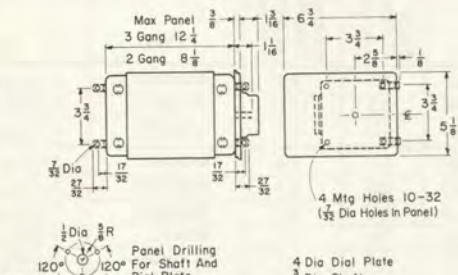
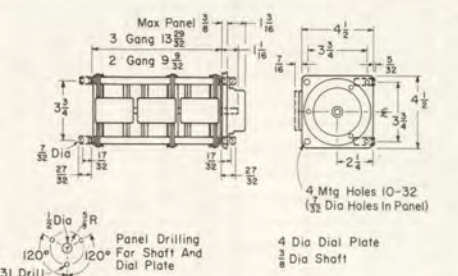
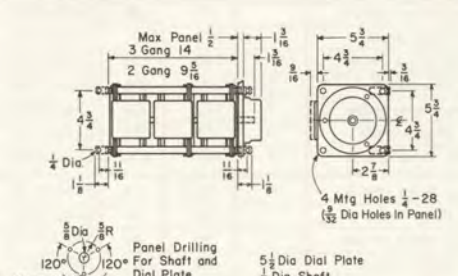
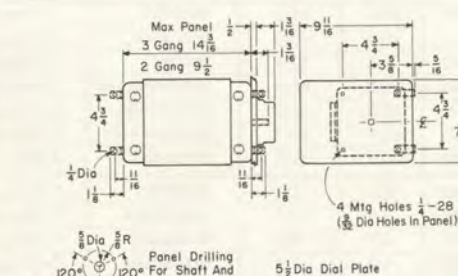
<p>W2</p> <p>Ganged Types W2G2, W2G3 (uncased).</p>  <p>Max Panel $3\frac{3}{8}$ 3 Gang $11\frac{31}{32}$ 2 Gang $7\frac{31}{32}$</p> <p>4 Mtg Holes 10-32 ($\frac{31}{32}$ Dia Holes In Panel)</p> <p>3 Dia Dial Plate $\frac{3}{8}$ Dia Shaft</p> <p>Panel Drilling For Shaft And Dial Plate #31 Drill</p>	<p>Ganged Types W2G2M, W2G3M (cased).</p>  <p>Max Panel $3\frac{3}{8}$ 3 Gang $12\frac{31}{32}$ 2 Gang $8\frac{31}{32}$</p> <p>4 Mtg Holes 10-32 ($\frac{31}{32}$ Dia Holes In Panel)</p> <p>3 Dia Dial Plate $\frac{3}{8}$ Dia Shaft</p> <p>Panel Drilling For Shaft And Dial Plate #31 Drill</p>
<p>W5</p> <p>Ganged Types W5G2, W5G3, W5HG2, W5HG3, W5LG2, W5LG3 (uncased).</p>  <p>Max Panel $3\frac{3}{8}$ 3 Gang $12\frac{31}{32}$ 2 Gang $7\frac{31}{32}$</p> <p>4 Mtg Holes 10-32 ($\frac{31}{32}$ Dia Holes In Panel)</p> <p>4 Dia Dial Plate $\frac{3}{8}$ Dia Shaft</p> <p>Panel Drilling For Shaft And Dial Plate #31 Drill</p>	<p>Ganged Types W5G2M, W5G3M, W5HG2M, W5HG3M, W5LG2M, W5LG3M (cased).</p>  <p>Max Panel $3\frac{3}{8}$ 3 Gang $12\frac{31}{32}$ 2 Gang $8\frac{31}{32}$</p> <p>4 Mtg Holes 10-32 ($\frac{31}{32}$ Dia Holes In Panel)</p> <p>4 Dia Dial Plate $\frac{3}{8}$ Dia Shaft</p> <p>Panel Drilling For Shaft And Dial Plate #31 Drill</p>
<p>W8</p> <p>Ganged Types W8G2, W8G3, W8LG2, W8LG3 (uncased).</p>  <p>Max Panel $3\frac{3}{8}$ 3 Gang $13\frac{31}{32}$ 2 Gang $9\frac{31}{32}$</p> <p>4 Mtg Holes 10-32 ($\frac{31}{32}$ Dia Holes In Panel)</p> <p>4 Dia Dial Plate $\frac{3}{8}$ Dia Shaft</p> <p>Panel Drilling For Shaft And Dial Plate #31 Drill</p>	<p>Types W8 and W8L Variac® autotransformers are available in uncased (basic) models only. They offer increased ratings over those of the Type W5 models, but occupy the same panel space, with a slight increase in depth behind panel.</p>
<p>W10</p> <p>Ganged Types W10G2, W10G3, W10HG2, W10HG3 (uncased).</p>  <p>Max Panel $3\frac{3}{8}$ 3 Gang $14\frac{31}{32}$ 2 Gang $9\frac{31}{32}$</p> <p>4 Mtg Holes $\frac{1}{4}$-28 ($\frac{31}{32}$ Dia Holes In Panel)</p> <p>$5\frac{1}{2}$ Dia Dial Plate $\frac{1}{2}$ Dia Shaft</p> <p>Panel Drilling For Shaft and Dial Plate #31 Drill</p>	<p>Ganged Types W10G2M, W10G3M, W10HG2M, W10HG3M (cased).</p>  <p>Max Panel $3\frac{3}{8}$ 3 Gang $14\frac{31}{32}$ 2 Gang $9\frac{31}{32}$</p> <p>4 Mtg Holes $\frac{1}{4}$-28 ($\frac{31}{32}$ Dia Holes In Panel)</p> <p>$5\frac{1}{2}$ Dia Dial Plate $\frac{1}{2}$ Dia Shaft</p> <p>Panel Drilling For Shaft and Dial Plate #31 Drill</p>

† Given in inches; to convert to mm, multiply by 25.4.

Type W2G3 (uncased)
3-gang model.

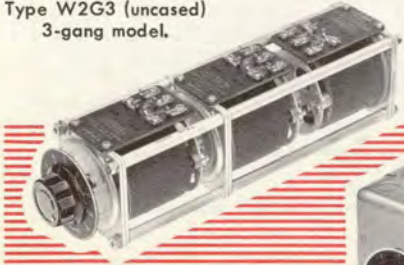

Type W10G3M (cased)
3-gang model.



Type W8G2 (uncased)
2-gang model.

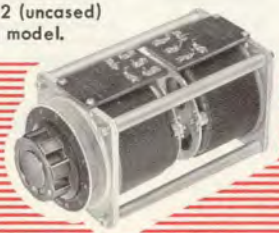

Type W5G2M (cased)
2-gang model.



DIMENSIONS† of W-SERIES

GANGED VARIAC® AUTOTRANSFORMER ASSEMBLIES

VARIAC® AUTOTRANSFORMERS
GANGS, DIMENSIONS

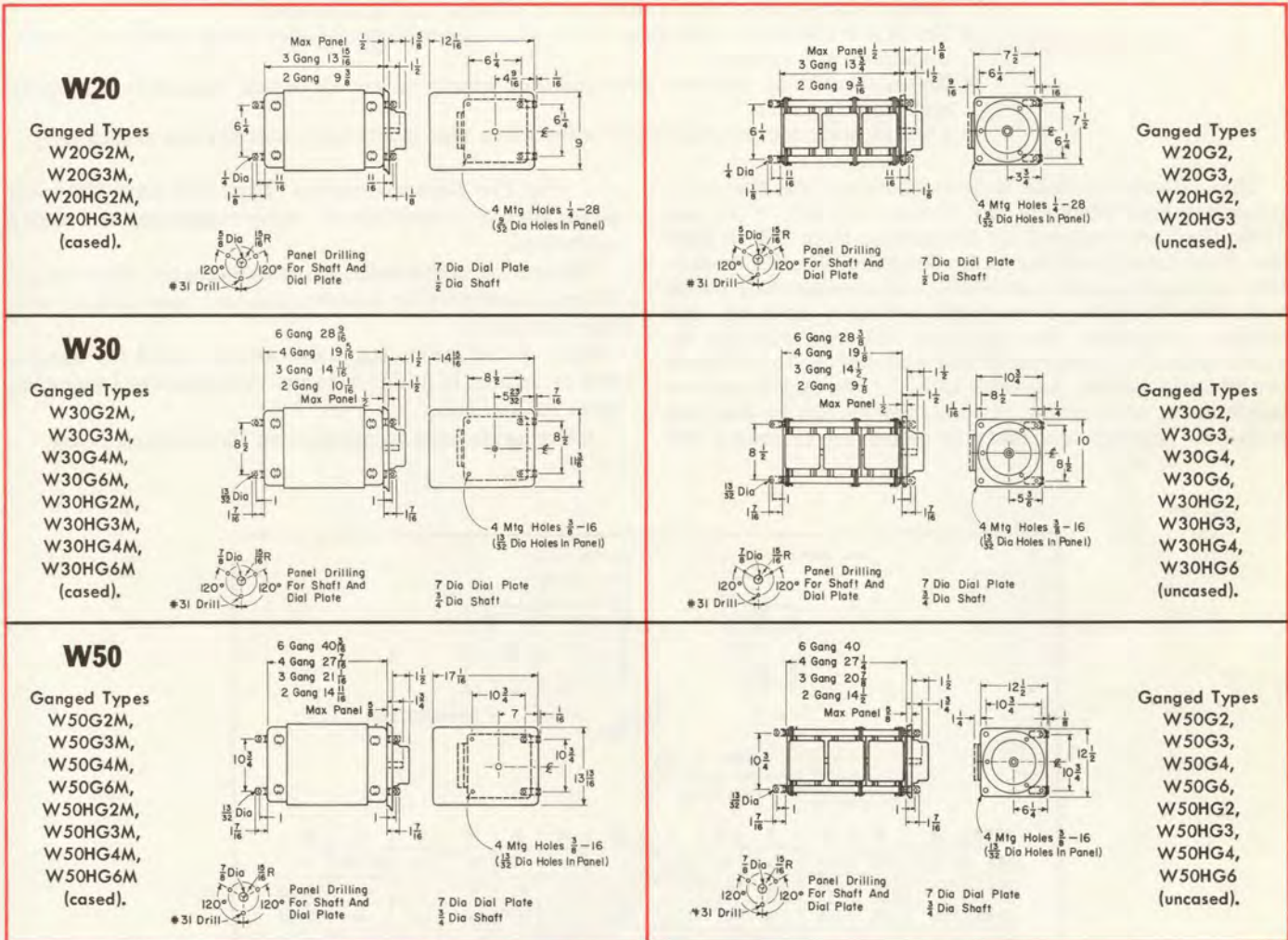

† Given in inches; to convert to mm, multiply by 25.4.

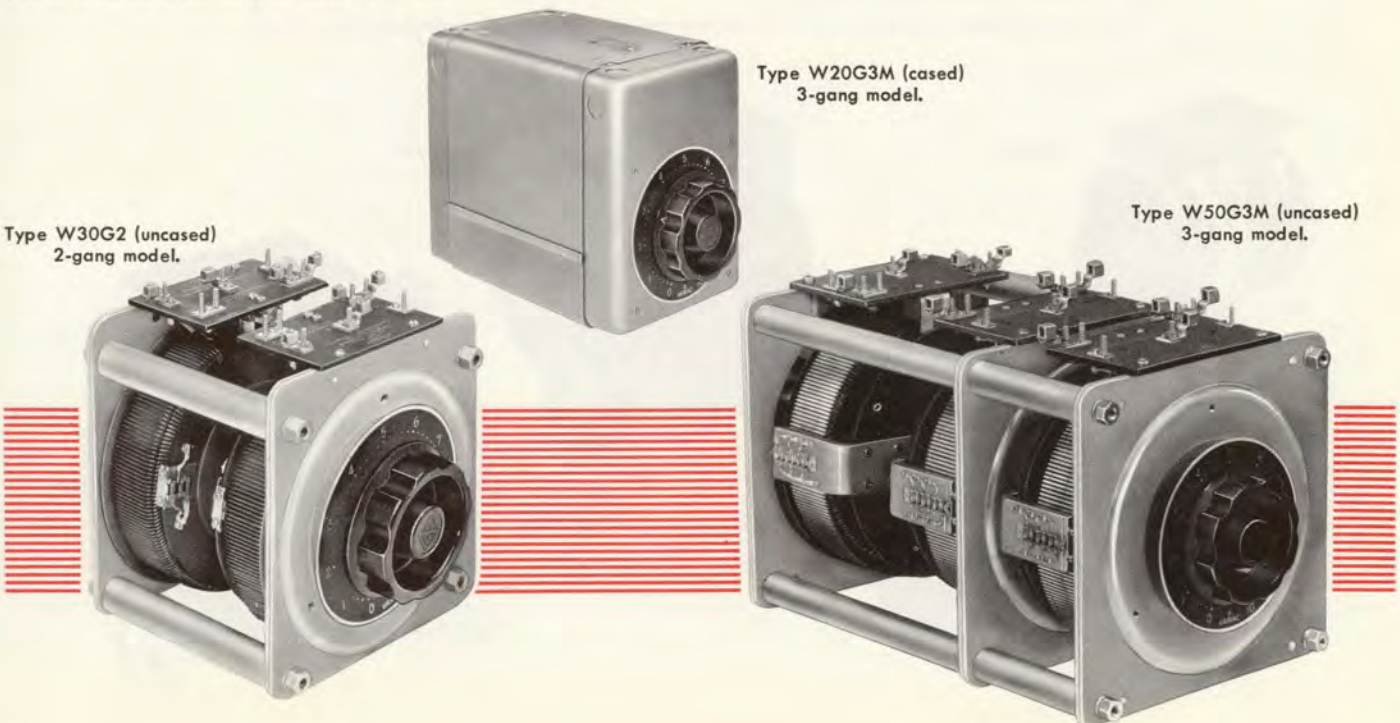

M-SERIES VARIAC® ADJUSTABLE AUTOTRANSFORMERS

VARIAC® AUTOTRANSFORMERS
M-SERIES

FOR 350- TO 1200-CYCLE SERVICE

FEATURES:

- ◆ Usable from 350 to 1200 cycles per second.
- ◆ DURATRAC® contact surface provides an extra factor of reliability under overloads. Instantaneous peaks of ten times rated current can be tolerated.
- ◆ Brush track shows no significant wear after one million cycles of brush operation (zero to maximum and return).
- ◆ Manufactured to conform with military specifications for shock, vibration, salt-spray, and tropicalization.
- ◆ Contain wide-temperature-range lubrication that meets most military specifications.

The M-series VARIAC autotransformers are the high-frequency equivalents of the TYPES W2, W5, W10, and W20; they are designed for frequencies from 350 to 1200 cps. Mechanically similar to the 60-cycle, W-series models, they are much smaller and lighter and are especially useful with the 400-cycle power supplies used in air-borne and marine equipment. The regulation obtained with the M-series models is considerably better at 400 cps than that of the 60-cycle models. Available in 2-, 5-, 10-, and 20-ampere single units, or in gangs, M-series models can be supplied with ball bearings and 60-cycle motor drives (pages 200

and 196). The 2-ampere models (TYPE M2) have 400 turns, giving adequate resolution for many computing and control operations.

The models in this series are designed to provide excellent thermal conductivity between coil and base and between base and panel.

Four corner mounting holes are provided for ganging and mounting, in addition to the three standard mounting holes (on radius).

A wiring diagram is stamped on the terminal board.

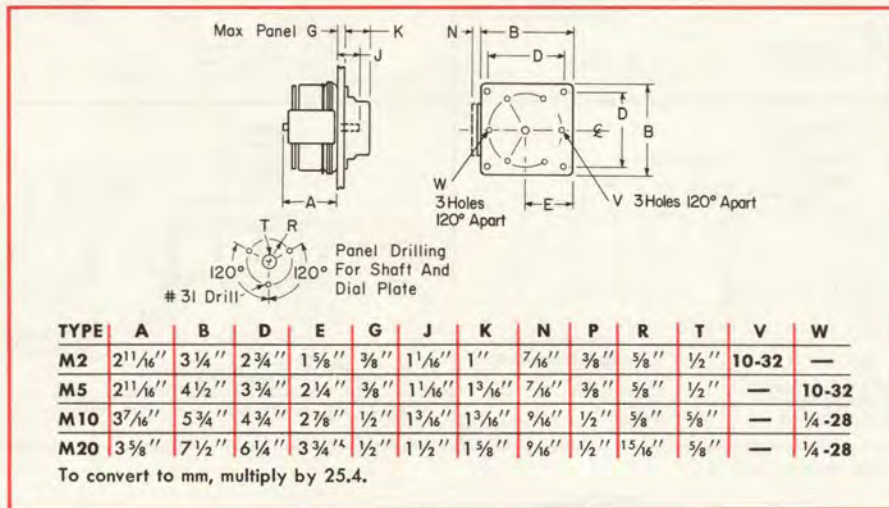

Type M2



Type M10



Type M5



Type M20



M-SERIES GANGED VARIAC® AUTOTRANSFORMER ASSEMBLIES

M-series models are available as two-gang assemblies for 120-volt, three-phase, open-delta connection (or for controlling two circuits from a single shaft) and as three-gang assemblies for 208- or 240-volt, three-phase, wye connection (or for controlling three circuits from a single shaft). Ganged assemblies are designed to occupy minimum volume.

A TYPE 50-P1 Choke is required when a two-gang unit is to be operated in parallel; for three-gang combinations, a TYPE 50-P2 Choke is required in addition to the TYPE 50-P1. Dials for ganged models are marked 0 to 10.

VARIAC® AUTOTRANSFORMERS
M-SERIES, UNCASSED, RATINGS

RATINGS AND PRICE LIST FOR M-SERIES SINGLE UNITS (UNCASSED)

Type	Rated Input Voltage	OUTPUT						400-Cycle No-Load Loss Watts	Driving Torque Ounce-Inches	Net Weight Pounds	Shipping Weight Pounds (Approx)	Code Number	Price	Add for Replacement Brush	Add for Ball Bearings*
		Line-Voltage Connection				Overvoltage Connection									
		Output KVA at Maximum Output Voltage (Note A)	Rated Output Current Amperes	Output Voltage Range	Maximum Output Current Amperes (Note A)	Output Voltage Range	Rated Current Amperes (Note B)								
M2†	120	0.37	2.4	0-120	3.1	0-140	2.4	3.5	5-10	2	4	3410-5110	\$15.50	VB1 80¢	\$8.00
M5†	120	0.94	6	0-120	7.8	0-140	6	9	10-20	3½	6	3430-5110	18.50	VB2 80¢	\$8.00
M10†	120	1.56	10	0-120	13	0-140	10	17	15-30	6½	11	3460-5110	35.00	VB110 \$1.35	\$9.00
M20†	120	3.12	20	0-120	26	0-140	20	27	45-90	13	18	3490-5110	54.00	VB18 \$2.50	\$9.00

A. Maximum current can be drawn at maximum voltage for the line-voltage connection only. Maximum output voltage = line input voltage. Kva as listed = normal input line voltage X maximum current.

B. Rated current should not be exceeded for the overvoltage connection. Output kva for overvoltage connection = output voltage X rated current.

* When ordering a unit with ball bearings, add the suffix "-BB" to the type number.

† Approved by Canadian Standards Association.

Type	A	B	D	E	G	J	K	N	P	R	T	X
M2G2	5 ¹³ / ₃₂ "	3 ¹ / ₄ "	2 ³ / ₄ "	1 ⁵ / ₈ "	3 ⁵ / ₈ "	1 ¹ / ₁₆ "	1"	7 ¹ / ₁₆ "	3 ⁵ / ₈ "	3 ⁵ / ₈ "	1 ¹ / ₂ "	10-32
M2G3	8 ⁷ / ₃₂ "	3 ¹ / ₄ "	2 ³ / ₄ "	1 ⁵ / ₈ "	3 ⁵ / ₈ "	1 ¹ / ₁₆ "	1"	7 ¹ / ₁₆ "	3 ⁵ / ₈ "	3 ⁵ / ₈ "	1 ¹ / ₂ "	10-32
M5G2	5 ¹⁵ / ₃₂ "	4 ¹ / ₂ "	3 ³ / ₄ "	2 ¹ / ₄ "	3 ⁵ / ₈ "	1 ¹ / ₁₆ "	1 ³ / ₁₆ "	7 ¹ / ₁₆ "	3 ⁵ / ₈ "	3 ⁵ / ₈ "	1 ¹ / ₂ "	10-32
M5G3	8 ¹¹ / ₃₂ "	4 ¹ / ₂ "	3 ³ / ₄ "	2 ¹ / ₄ "	3 ⁵ / ₈ "	1 ¹ / ₁₆ "	1 ³ / ₁₆ "	7 ¹ / ₁₆ "	3 ⁵ / ₈ "	3 ⁵ / ₈ "	1 ¹ / ₂ "	10-32
M10G2	6 ¹³ / ₁₆ "	5 ³ / ₄ "	4 ³ / ₄ "	2 ⁷ / ₈ "	1 ¹ / ₂ "	1 ³ / ₁₆ "	1 ³ / ₁₆ "	9 ¹ / ₁₆ "	1 ¹ / ₂ "	3 ⁵ / ₈ "	5 ⁵ / ₈ "	¼-28
M10G3	10 ¹ / ₄ "	5 ³ / ₄ "	4 ³ / ₄ "	2 ⁷ / ₈ "	1 ¹ / ₂ "	1 ³ / ₁₆ "	1 ³ / ₁₆ "	9 ¹ / ₁₆ "	1 ¹ / ₂ "	3 ⁵ / ₈ "	5 ⁵ / ₈ "	¼-28
M20G2	7 ³ / ₁₆ "	7 ¹ / ₂ "	6 ¹ / ₄ "	3 ³ / ₄ "	1 ¹ / ₂ "	1 ¹ / ₂ "	1 ⁵ / ₈ "	9 ¹ / ₁₆ "	1 ¹ / ₂ "	1 ⁵ / ₁₆ "	5 ⁵ / ₈ "	¼-28
M20G3	10 ³ / ₄ "	7 ¹ / ₂ "	6 ¹ / ₄ "	3 ³ / ₄ "	1 ¹ / ₂ "	1 ¹ / ₂ "	1 ⁵ / ₈ "	9 ¹ / ₁₆ "	1 ¹ / ₂ "	1 ⁵ / ₁₆ "	5 ⁵ / ₈ "	¼-28

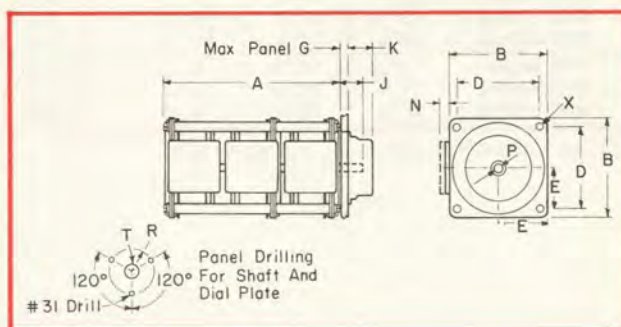

PRICE LIST FOR M-SERIES GANGED ASSEMBLIES (UNCASSED)

Type	Description	Driving Torque (Oz-In.)	Net Weight (Pounds)	Shipping Weight (Pounds)	Code Number	Price	Add for Ball Bearings*
M2G2	2-Gang M2	10-20	3¾	6	3410-5120	\$37.00	\$13.00
M2G3	3-Gang M2	15-30	5½	9	3410-5130	53.50	15.00
M5G2	2-Gang M5	20-40	6¾	12	3430-5120	43.00	13.00
M5G3	3-Gang M5	30-60	10¼	14	3430-5130	62.50	15.00
M10G2	2-Gang M10	30-60	12¼	18	3460-5120	77.00	15.00
M10G3	3-Gang M10	45-90	19	27	3460-5130	114.00	18.00
M20G2	2-Gang M20	90-180	26½	34	3490-5120	115.00	15.00
M20G3	3-Gang M20	135-270	38	48	3490-5130	171.00	18.00
Type 50-P1	Choke	—	1¼	1¾	0050-9601	16.00	—
Type 50-P2	Choke	—	1¼	1¾	0050-9602	16.00	—

* When ordering a unit with ball bearings, add the suffix "-BB" to the type number.

MOTOR-DRIVEN VARIAC® ADJUSTABLE AUTOTRANSFORMERS

All VARIAC autotransformers, both single and ganged models, can be furnished with motor drive. The motor mounting plate is attached to the base by four posts, and the motor is geared to the shaft. All motor-driven models are equipped with ball bearings.

Fully enclosed, two-phase, gear-reduction motors of the servo type, having very low moments of inertia, are used. Three basic speeds are available, which, together with a selection of stocked standard coupling gears, make possible the assembly of units having nominal full-traverse rates of 2, 4, 8, 16, 32, 64, or 128 seconds at 60 cps (approximately 20% slower at 50 cps). The 2- and 4-second models are intended for high-speed servo applications. Those with slower traverse speeds are primarily for remote positioning requirements, although they are often used for slower-speed servo work. Motors are 120-volt, 50/60-cycle units.

The two-phase motor supply may be derived from either (1) a servo amplifier or (2) the 120-volt line, with a capacitor (supplied) to produce the necessary phase shift.

Electrical limit switches are listed on all models to limit traverse to approximately 320°. However, they are not required on models with speeds of 2, 4, 8, or 16 seconds and they may be so ordered.*

Cased, motor-driven models are available in either single units or gangs and are similar to those used with W-series gangs.

In the tables on pages 198 and 199, available combinations are listed for each size. When less than 5 units are ordered, the setup charge must be included.

* If Microswitches are not desired, omit "K" from type number and subtract \$7.00 from listed price.

DIMENSIONS† OF MOTOR-DRIVEN MODELS (CASED)

	A	B	C	D	E	F	G	H	K	L	M	N	P
W2 Single	10 ¹ / ₂	11 ² / ₂	5/16	17/32	2 3/4	4 3/8	1/8	5 3/4	10-32	7/32 Drill	13/16	3/4	1/16
W2 2-Gang	13 ²³ / ₂	14 ²⁵ / ₂	5/16	17/32	2 3/4	4 3/8	1/8	5 3/4	10-32	7/32 Drill	13/16	3/4	1/16
W2 3-Gang	17 ²⁵ / ₂	18 ²⁷ / ₂	5/16	17/32	2 3/4	4 3/8	1/8	5 3/4	10-32	7/32 Drill	13/16	3/4	1/16
W5 Single	10 ²³ / ₂	11 ²⁵ / ₂	5/16	17/32	3 3/4	5 1/8	1/8	6 3/4	10-32	7/32 Drill	11/16	3/4	3/16
W5 2-Gang	13 ²⁷ / ₂	14 ²⁹ / ₂	5/16	17/32	3 3/4	5 1/8	1/8	6 3/4	10-32	7/32 Drill	11/16	3/4	3/16
W5 3-Gang	17 ³¹ / ₂	19 ¹ / ₂	5/16	17/32	3 3/4	5 1/8	1/8	6 3/4	10-32	7/32 Drill	11/16	3/4	3/16
W10 Single	12 ⁵ / ₁₆	13 ¹¹ / ₁₆	7/16	11/16	4 3/4	7 1/8	5/16	9 ¹¹ / ₁₆	1/4-28	9/32 Drill	13/16	1 1/4	5/16
W10 2-Gang	15 ³ / ₁₆	17 1/4	7/16	11/16	4 3/4	7 1/8	5/16	9 ¹¹ / ₁₆	1/4-28	9/32 Drill	13/16	1 1/4	5/16
W10 3-Gang	20 ⁷ / ₁₆	21 ¹⁵ / ₁₆	7/16	11/16	4 3/4	7 1/8	5/16	9 ¹¹ / ₁₆	1/4-28	9/32 Drill	13/16	1 1/4	5/16
W20 Single	12 ¹ / ₁₆	13 ⁷ / ₁₆	7/16	11/16	6 1/4	9	1/16	12 ¹ / ₁₆	1/4-28	9/32 Drill	1 3/8	1 3/8	1/8
W20 2-Gang	15 ³ / ₁₆	17	7/16	11/16	6 1/4	9	1/16	12 ¹ / ₁₆	1/4-28	9/32 Drill	1 3/8	1 3/8	1/8
W20 3-Gang	20 ³ / ₁₆	21 ⁹ / ₁₆	7/16	11/16	6 1/4	9	1/16	12 ¹ / ₁₆	1/4-28	9/32 Drill	1 3/8	1 3/8	1/8
W30 Single	12 ⁵ / ₁₆	14 ⁵ / ₁₆	7/16	1	8 1/2	11 3/8	3/16	14 ¹⁵ / ₁₆	3/8-16	13/32 Drill	17/16	1 1/2	1/4
W30 2-Gang	15 ¹⁵ / ₁₆	17 ¹⁵ / ₁₆	7/16	1	8 1/2	11 3/8	3/16	14 ¹⁵ / ₁₆	3/8-16	13/32 Drill	17/16	1 1/2	1/4
W30 3-Gang	20 ⁹ / ₁₆	22 ⁹ / ₁₆	7/16	1	8 1/2	11 3/8	3/16	14 ¹⁵ / ₁₆	3/8-16	13/32 Drill	17/16	1 1/2	1/4
W50 Single	14 ¹ / ₁₆	16 ¹¹ / ₁₆	7/16	1	10 3/4	13 ¹³ / ₁₆	1/4	17 ¹ / ₁₆	3/8-16	13/32 Drill	1 1/2	1 5/8	5/16
W50 2-Gang	21 ¹ / ₁₆	23 ¹ / ₁₆	7/16	1	10 3/4	13 ¹³ / ₁₆	1/4	17 ¹ / ₁₆	3/8-16	13/32 Drill	1 1/2	1 5/8	5/16
W50 3-Gang	27 ⁷ / ₁₆	29 ⁷ / ₁₆	7/16	1	10 3/4	13 ¹³ / ₁₆	1/4	17 ¹ / ₁₆	3/8-16	13/32 Drill	1 1/2	1 5/8	5/16

† Given in inches, to convert to mm, multiply by 25.4.

2-Gang W5 motor-driven model, with case.

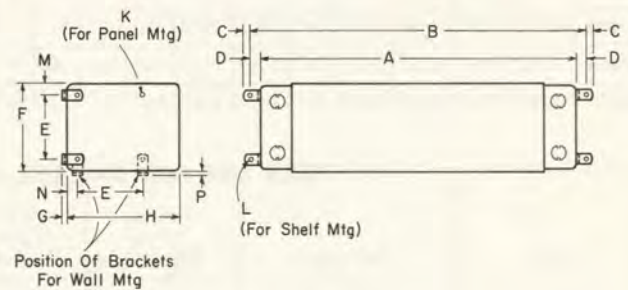
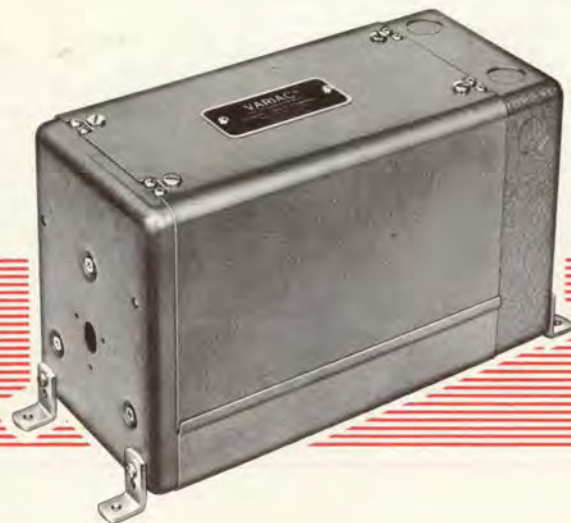

DIMENSIONS † OF MOTOR-DRIVEN UNCASSED MODELS

VARIAC® AUTOTRANSFORMERS
MOTOR-DRIVEN, UNCASSED

W-SERIES MODELS												
	A	B	C	D	E	F	G	H	J	K	L	M
W2 Single	9 ³ / ₈	6 ¹³ / ₁₆	5 ⁵ / ₁₆	17 ¹⁷ / ₃₂	2 ³ / ₄	3 ¹ / ₄	9 ¹ / ₃₂	3 ¹¹ / ₁₆	7 ⁷ / ₈	10-32	7 ⁷ / ₃₂ Drill	1 ¹ / ₄
W2 2-Gang	12 ¹ / ₂	9 ¹⁷ / ₃₂	5 ⁵ / ₁₆	17 ¹⁷ / ₃₂	2 ³ / ₄	3 ¹ / ₄	9 ¹ / ₃₂	3 ¹¹ / ₁₆	7 ⁷ / ₈	10-32	7 ⁷ / ₃₂ Drill	1 ¹ / ₄
W2 3-Gang	16 ⁵ / ₁₆	13 ¹⁹ / ₃₂	5 ⁵ / ₁₆	17 ¹⁷ / ₃₂	2 ³ / ₄	3 ¹ / ₄	9 ¹ / ₃₂	3 ¹¹ / ₁₆	7 ⁷ / ₈	10-32	7 ⁷ / ₃₂ Drill	1 ¹ / ₄
W5 Single	9 ⁷ / ₁₆	6 ¹⁵ / ₃₂	5 ⁵ / ₁₆	17 ¹⁷ / ₃₂	3 ³ / ₄	4 ¹ / ₂	5 ⁵ / ₃₂	4 ¹⁵ / ₁₆	—	10-32	7 ⁷ / ₃₂ Drill	3 ³ / ₈
W5 2-Gang	12 ⁹ / ₁₆	9 ¹⁹ / ₃₂	5 ⁵ / ₁₆	17 ¹⁷ / ₃₂	3 ³ / ₄	4 ¹ / ₂	5 ⁵ / ₃₂	4 ¹⁵ / ₁₆	—	10-32	7 ⁷ / ₃₂ Drill	3 ³ / ₈
W5 3-Gang	16 ¹¹ / ₁₆	13 ²³ / ₃₂	5 ⁵ / ₁₆	17 ¹⁷ / ₃₂	3 ³ / ₄	4 ¹ / ₂	5 ⁵ / ₃₂	4 ¹⁵ / ₁₆	—	10-32	7 ⁷ / ₃₂ Drill	3 ³ / ₈
W8 Single	9 ¹⁵ / ₁₆	6 ³¹ / ₃₂	5 ⁵ / ₁₆	17 ¹⁷ / ₃₂	3 ³ / ₄	4 ¹ / ₂	5 ⁵ / ₃₂	4 ¹⁵ / ₁₆	—	10-32	7 ⁷ / ₃₂ Drill	3 ³ / ₈
W8 2-Gang	13 ⁷ / ₈	10 ²⁹ / ₃₂	5 ⁵ / ₁₆	17 ¹⁷ / ₃₂	3 ³ / ₄	4 ¹ / ₂	5 ⁵ / ₃₂	4 ¹⁵ / ₁₆	—	10-32	7 ⁷ / ₃₂ Drill	3 ³ / ₈
W8 3-Gang	18 ¹ / ₂	15 ¹⁷ / ₃₂	5 ⁵ / ₁₆	17 ¹⁷ / ₃₂	3 ³ / ₄	4 ¹ / ₂	5 ⁵ / ₃₂	4 ¹⁵ / ₁₆	—	10-32	7 ⁷ / ₃₂ Drill	3 ³ / ₈
W10 Single	10 ⁹ / ₃₂	7 ⁷ / ₁₆	7 ⁷ / ₁₆	11 ¹¹ / ₁₆	4 ³ / ₄	5 ⁵ / ₄	3 ³ / ₁₆	6 ⁵ / ₁₆	—	¼-28	9 ⁹ / ₃₂ Drill	1 ¹ / ₂
W10 2-Gang	13 ²⁷ / ₃₂	11	7 ⁷ / ₁₆	11 ¹¹ / ₁₆	4 ³ / ₄	5 ⁵ / ₄	3 ³ / ₁₆	6 ⁵ / ₁₆	—	¼-28	9 ⁹ / ₃₂ Drill	1 ¹ / ₂
W10 3-Gang	18 ¹⁷ / ₃₂	15 ¹¹ / ₁₆	7 ⁷ / ₁₆	11 ¹¹ / ₁₆	4 ³ / ₄	5 ⁵ / ₄	3 ³ / ₁₆	6 ⁵ / ₁₆	—	¼-28	9 ⁹ / ₃₂ Drill	1 ¹ / ₂
W20 Single	10 ⁵ / ₃₂	7 ⁵ / ₁₆	7 ⁷ / ₁₆	11 ¹¹ / ₁₆	6 ¹ / ₄	7 ¹ / ₂	1 ¹ / ₁₆	8 ¹ / ₁₆	—	¼-28	9 ⁹ / ₃₂ Drill	5 ⁵ / ₈
W20 2-Gang	13 ²³ / ₃₂	10 ⁷ / ₈	7 ⁷ / ₁₆	11 ¹¹ / ₁₆	6 ¹ / ₄	7 ¹ / ₂	1 ¹ / ₁₆	8 ¹ / ₁₆	—	¼-28	9 ⁹ / ₃₂ Drill	5 ⁵ / ₈
W20 3-Gang	18 ⁵ / ₃₂	15 ⁷ / ₁₆	7 ⁷ / ₁₆	11 ¹¹ / ₁₆	6 ¹ / ₄	7 ¹ / ₂	1 ¹ / ₁₆	8 ¹ / ₁₆	—	¼-28	9 ⁹ / ₃₂ Drill	5 ⁵ / ₈
W30 Single	10 ³ / ₄	6 ¹ / ₄	7 ⁷ / ₁₆	1	8 ¹ / ₂	10	1 ¹ / ₈	11 ¹³ / ₁₆	—	3 ³ / ₈ -16	13 ¹³ / ₃₂ Drill	3 ³ / ₄
W30 2-Gang	14 ³ / ₈	9 ⁷ / ₈	7 ⁷ / ₁₆	1	8 ¹ / ₂	10	1 ¹ / ₈	11 ¹³ / ₁₆	—	3 ³ / ₈ -16	13 ¹³ / ₃₂ Drill	3 ³ / ₄
W30 3-Gang	19	14 ¹ / ₂	7 ⁷ / ₁₆	1	8 ¹ / ₂	10	1 ¹ / ₈	11 ¹³ / ₁₆	—	3 ³ / ₈ -16	13 ¹³ / ₃₂ Drill	3 ³ / ₄
W50 Single	12 ³ / ₈	8 ¹ / ₁₆	7 ⁷ / ₁₆	1	10 ³ / ₄	12 ¹ / ₂	1 ¹ / ₈	13 ³ / ₄	—	3 ³ / ₈ -16	13 ¹³ / ₃₂ Drill	7 ⁷ / ₈
W50 2-Gang	19 ¹ / ₁₆	14 ¹ / ₂	7 ⁷ / ₁₆	1	10 ³ / ₄	12 ¹ / ₂	1 ¹ / ₈	13 ³ / ₄	—	3 ³ / ₈ -16	13 ¹³ / ₃₂ Drill	7 ⁷ / ₈
W50 3-Gang	25 ⁷ / ₁₆	20 ⁷ / ₈	7 ⁷ / ₁₆	1	10 ³ / ₄	12 ¹ / ₂	1 ¹ / ₈	13 ³ / ₄	—	3 ³ / ₈ -16	13 ¹³ / ₃₂ Drill	7 ⁷ / ₈
M-SERIES MODELS												
M2 Single	8 ¹ / ₈	5 ⁵ / ₃₂	5 ⁵ / ₁₆	17 ¹⁷ / ₃₂	2 ³ / ₄	3 ¹ / ₄	9 ¹ / ₃₂	3 ¹¹ / ₁₆	7 ⁷ / ₈	10-32	7 ⁷ / ₃₂ Drill	1 ¹ / ₄
M2 2-Gang	10	7 ¹ / ₃₂	5 ⁵ / ₁₆	17 ¹⁷ / ₃₂	2 ³ / ₄	3 ¹ / ₄	9 ¹ / ₃₂	3 ¹¹ / ₁₆	7 ⁷ / ₈	10-32	7 ⁷ / ₃₂ Drill	1 ¹ / ₄
M2 3-Gang	12 ¹³ / ₁₆	9 ²⁷ / ₃₂	5 ⁵ / ₁₆	17 ¹⁷ / ₃₂	2 ³ / ₄	3 ¹ / ₄	9 ¹ / ₃₂	3 ¹¹ / ₁₆	7 ⁷ / ₈	10-32	7 ⁷ / ₃₂ Drill	1 ¹ / ₄
M5 Single	8 ³ / ₁₆	5 ⁷ / ₃₂	5 ⁵ / ₁₆	17 ¹⁷ / ₃₂	3 ³ / ₄	4 ¹ / ₂	5 ⁵ / ₃₂	4 ¹⁵ / ₁₆	—	10-32	7 ⁷ / ₃₂ Drill	3 ³ / ₈
M5 2-Gang	10 ¹ / ₁₆	7 ³ / ₃₂	5 ⁵ / ₁₆	17 ¹⁷ / ₃₂	3 ³ / ₄	4 ¹ / ₂	5 ⁵ / ₃₂	4 ¹⁵ / ₁₆	—	10-32	7 ⁷ / ₃₂ Drill	3 ³ / ₈
M5 3-Gang	12 ¹⁵ / ₁₆	9 ³¹ / ₃₂	5 ⁵ / ₁₆	17 ¹⁷ / ₃₂	3 ³ / ₄	4 ¹ / ₂	5 ⁵ / ₃₂	4 ¹⁵ / ₁₆	—	10-32	7 ⁷ / ₃₂ Drill	3 ³ / ₈
M10 Single	9 ¹ / ₃₂	6 ⁵ / ₁₆	7 ⁷ / ₁₆	11 ¹¹ / ₁₆	4 ³ / ₄	5 ⁵ / ₄	3 ³ / ₁₆	6 ⁵ / ₁₆	—	¼-28	9 ⁹ / ₃₂ Drill	1 ¹ / ₂
M10 2-Gang	11 ¹¹ / ₃₂	8 ¹ / ₂	7 ⁷ / ₁₆	11 ¹¹ / ₁₆	4 ³ / ₄	5 ⁵ / ₄	3 ³ / ₁₆	6 ⁵ / ₁₆	—	¼-28	9 ⁹ / ₃₂ Drill	1 ¹ / ₂
M10 3-Gang	14 ²³ / ₃₂	11 ¹⁵ / ₁₆	7 ⁷ / ₁₆	11 ¹¹ / ₁₆	4 ³ / ₄	5 ⁵ / ₄	3 ³ / ₁₆	6 ⁵ / ₁₆	—	¼-28	9 ⁹ / ₃₂ Drill	1 ¹ / ₂
M20 Single	9 ⁵ / ₃₂	6 ⁵ / ₁₆	7 ⁷ / ₁₆	11 ¹¹ / ₁₆	6 ¹ / ₄	7 ¹ / ₂	1 ¹ / ₁₆	8 ¹ / ₁₆	—	¼-28	9 ⁹ / ₃₂ Drill	5 ⁵ / ₈
M20 2-Gang	11 ²³ / ₃₂	8 ⁷ / ₈	7 ⁷ / ₁₆	11 ¹¹ / ₁₆	6 ¹ / ₄	7 ¹ / ₂	1 ¹ / ₁₆	8 ¹ / ₁₆	—	¼-28	9 ⁹ / ₃₂ Drill	5 ⁵ / ₈
M20 3-Gang	15 ⁹ / ₃₂	12 ⁷ / ₁₆	7 ⁷ / ₁₆	11 ¹¹ / ₁₆	6 ¹ / ₄	7 ¹ / ₂	1 ¹ / ₁₆	8 ¹ / ₁₆	—	¼-28	9 ⁹ / ₃₂ Drill	5 ⁵ / ₈

Refer to following pages for prices of motor-driven models.
† Given in inches; to convert to mm, multiply by 25.4.

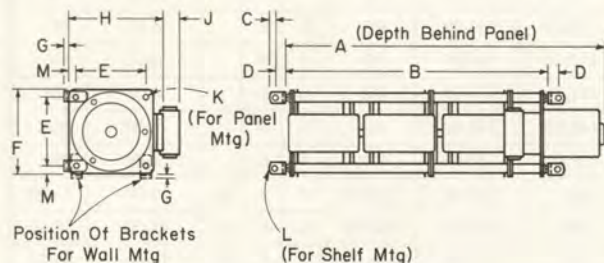

3-gang W20
motor-driven
model.

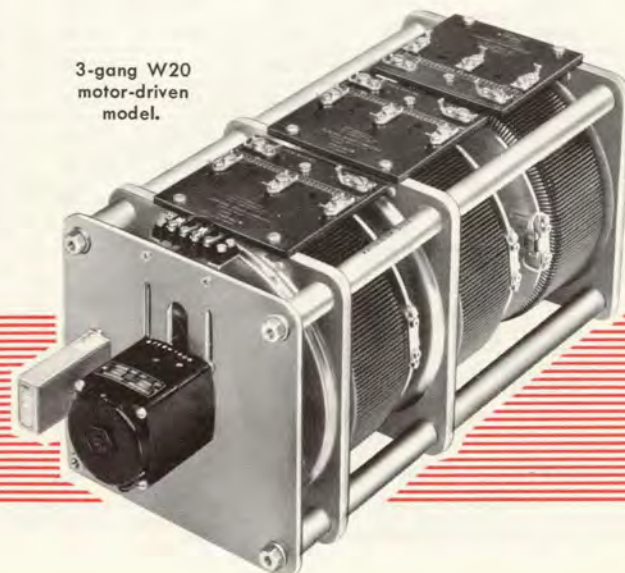

SPECIFICATIONS AND PRICES¹ FOR MOTOR-DRIVEN VARIAC® AUTOTRANSFORMERS

ALL MOTORS SHOWN ARE 60-CYCLE	MOTOR								STANDARD EXTERNAL GEAR RATIOS			ADD TO TYPE NUMBER ²			SET-UP CHARGE PRORATED 1-4 UNITS	ADD FOR CASE																					
	{	A	2:1		4:1							CAPACITOR	MICROSWITCH	CASED MODEL																							
		B	2:1		4:1		8:1																														
		C	2:1		4:1		8:1																														
SECONDS FOR 320° TRAVERSE ²	2	4	8	16	32	32	64	128																													
ADD TO TYPE NUMBER ³	D2	D4	D8	D16	D32	D32	D64	D128																													
TYPE ³	M2	M2G2	M2G3	M5	M5G2	M5G3	M10	M10G2	M10G3	M20	M20G2	M20G3	W2	W2G2	W2G3	W5	W5G2	W5G3	W5L	W5LG2	W5LG3	W5H	W5HG2	W5HG3	W8	W8G2	W8G3	W8L	W8LG2	W8LG3	W10	W10G2	W10G3	W10H	W10HG2	W10HG3	TORQUE — OUNCE-INCHES
	\$105.50	132.00	NA	108.50	138.00	NA	149.00	NA	NA	SO	SO	NA	105.00	131.00	NA	108.00	137.00	NA	107.50	136.00	NA	111.50	144.00	NA	111.00	143.00	NA	111.00	143.00	NA	139.00	NA	NA	141.00	NA	NA	30
	\$105.50	132.00	150.50	108.50	138.00	159.50	149.00	197.00	NA	173.00	SO	SO	299.00	105.00	131.00	149.00	137.00	158.00	107.50	136.00	156.50	111.50	144.00	168.50	111.00	143.00	167.00	111.00	143.00	167.00	139.00	185.00	NA	141.00	189.00	NA	60
	\$105.50	132.00	150.50	108.50	138.00	159.50	149.00	197.00	237.00	173.00	SO	SO	299.00	105.00	131.00	149.00	137.00	158.00	107.50	136.00	156.50	111.50	144.00	168.50	111.00	143.00	167.00	111.00	143.00	167.00	139.00	185.00	223.00	141.00	189.00	229.00	120
	NA	NA	NA	NA	NA	NA	\$149.00	197.00	237.00	173.00	240.00	299.00	NA	105.00	131.00	149.00	137.00	158.00	107.50	136.00	156.50	111.50	144.00	168.50	111.00	143.00	167.00	111.00	143.00	167.00	139.00	185.00	223.00	141.00	189.00	229.00	240
	NA	NA	NA	NA	NA	NA	NA	197.00	237.00	173.00	240.00	299.00	NA	105.00	131.00	149.00	137.00	158.00	107.50	136.00	156.50	111.50	144.00	168.50	111.00	143.00	167.00	111.00	143.00	167.00	139.00	185.00	223.00	141.00	189.00	229.00	480
	SO	SO	SO	SO	SO	SO	SO	SO	SO	SO	SO	SO	SO	SO	SO	SO	SO	SO	SO	SO	SO	SO	SO	SO	SO	SO	SO	SO	SO	SO	SO	SO	SO	SO	SO	SO	240
	NA	NA	NA	NA	NA	NA	NA	NA	NA	NA	NA	NA	NA	NA	NA	NA	NA	NA	NA	NA	NA	NA	NA	NA	NA	NA	NA	NA	NA	NA	NA	NA	NA	NA	NA	480	
	SO	SO	SO	SO	SO	SO	SO	SO	SO	SO	SO	SO	SO	SO	SO	SO	SO	SO	SO	SO	SO	SO	SO	SO	SO	SO	SO	SO	SO	SO	SO	SO	SO	SO	SO	960	
	NA	NA	NA	NA	NA	NA	NA	NA	NA	NA	NA	NA	NA	NA	NA	NA	NA	NA	NA	NA	NA	NA	NA	NA	NA	NA	NA	NA	NA	NA	NA	NA	NA	NA	NA	NA	

NA = not available. SO = available on special order only; prices on request.

Note: Microswitches, capacitors, and ball bearings are included in the above prices. If Microswitches are not desired, omit "K" from type number and subtract \$7.00 from listed price. Microswitches are mandatory with C motor.

NOTES

¹ Prices in table are for quantities of 5 or more. Add appropriate set-up charge for quantities of 1 to 4.

² Traverse speeds are nominal for 60-cycle supply. Actual speeds may vary ±15% from these values. Specify speed on order (e.g. D4, D32, etc.).

³ See page 183 for example of type numbers.

SPECIFICATIONS AND PRICES¹ FOR MOTOR-DRIVEN MODELS (cont)

MOTOR ALL MOTORS SHOWN ARE 60-CYCLE	STANDARD EXTERNAL GEAR RATIOS								ADD TO TYPE NUMBER ²			SET-UP CHARGE PRORATED 1-4 UNITS	ADD FOR CASE	
	A B C	2:1	4:1						CAPACITOR	MICROSWITCH	CASED MODEL			
			2:1	4:1	8:1		2:1	4:1						8:1
SECONDS FOR 320° TRAVERSE ²		2	4	8	16	32	32	64	128					
ADD TO TYPE NUMBER ³		D2	D4	D8	D16	D32		D64	D128					
TYPE ³														
W20	SO	\$159.00	\$159.00	\$159.00	\$159.00	NA	\$159.00	\$159.00	\$159.00	C	K	M	\$12.00	\$35.00
W20G2	SO	SO	223.00	223.00	223.00	NA	223.00	223.00	223.00	C	K	M	12.00	37.00
W20G3	NA	SO	276.00	276.00	276.00	NA	276.00	276.00	276.00	C	K	M	12.00	39.00
W20H	SO	161.00	161.00	161.00	161.00	NA	161.00	161.00	161.00	C	K	M	12.00	35.00
W20HG2	SO	SO	227.00	227.00	227.00	NA	227.00	227.00	227.00	C	K	M	12.00	37.00
W20HG3	NA	SO	282.00	282.00	282.00	NA	282.00	282.00	282.00	C	K	M	12.00	39.00
W30	SO	214.00	214.00	214.00	214.00	NA	214.00	214.00	214.00	C	K	M	12.00	49.00
W30G2	NA	SO	SO	311.00	311.00	NA	311.00	311.00	311.00	C	K	M	12.00	54.00
W30G3	NA	NA	SO	SO	395.50	NA	395.50	395.50	395.50	C	K	M	12.00	59.00
W30H	SO	214.00	214.00	214.00	214.00	NA	214.00	214.00	214.00	C	K	M	12.00	49.00
W30HG2	NA	SO	SO	311.00	311.00	NA	311.00	311.00	311.00	C	K	M	12.00	54.00
W30HG3	NA	NA	SO	SO	395.50	NA	395.50	395.50	395.50	C	K	M	12.00	59.00
W50	NA	SO	SO	262.00	262.00	NA	262.00	262.00	262.00	C	K	M	12.00	55.00
W50G2	NA	NA	SO	SO	396.00	NA	396.00	396.00	396.00	C	K	M	12.00	60.00
W50G3	NA	NA	SO	SO	529.00	NA	529.00	529.00	529.00	C	K	M	12.00	65.00
W50G4	NA	NA	NA	SO	SO	NA	SO	666.00	666.00	C	K	M	12.00	68.00
W50G6	NA	NA	NA	NA	SO	NA	SO	943.00	943.00	C	K	M	12.00	74.00
W50H	NA	SO	SO	262.00	262.00	NA	262.00	262.00	262.00	C	K	M	12.00	55.00
W50HG2	NA	NA	SO	SO	396.00	NA	396.00	396.00	396.00	C	K	M	12.00	60.00
W50HG3	NA	NA	SO	SO	529.00	NA	529.00	529.00	529.00	C	K	M	12.00	65.00
W50HG4	NA	NA	NA	SO	SO	NA	SO	666.00	666.00	C	K	M	12.00	68.00
W50HG6	NA	NA	NA	NA	SO	NA	SO	943.00	943.00	C	K	M	12.00	74.00
TORQUE — OUNCE-INCHES		30	60	120	240	480	240	480	960					

NOTES

NA = not available. SO = available on special order only; prices on request.

Note: Microswitches, capacitors, and ball bearings are included in the above prices. If Microswitches are not desired, omit "K" from type number and subtract \$7.00 from listed price. Microswitches are mandatory with C motor.

¹ Prices in table are for quantities of 5 or more. Add appropriate set-up charge for quantities of 1 to 4.

² Traverse speeds are nominal for 60-cycle supply. Actual speeds may vary $\pm 15\%$ from these values.

³ See page 183 for example of type numbers.

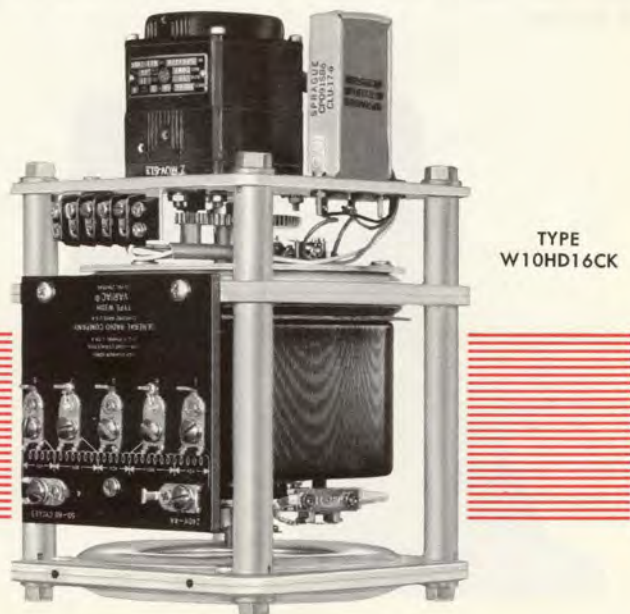

BALL BEARINGS

W-series and M-series models can be supplied with ball bearings, which provide more precise alignment with slightly lower and more nearly constant torque.

When ordering a single unit or gang equipped with ball

bearings, add the suffix "BB" to the type number, and add the price shown in the tables.

Ball bearings are standard equipment on all motor-driven units and on all 4- and 6-gang W30 and W50 models, and are included in the price.

SPECIAL VARIAC® AUTOTRANSFORMERS

Special models can be supplied to meet specific requirements, such as additional winding taps, fungicide treatment, special shaft lengths, or with voltage outputs or ranges differing from those of standard models. They can also be supplied on special order less knob, dial, etc., at lower net prices and with slightly extended delivery time.

The General Radio Company welcomes inquiries on special models, and is glad to furnish them when the quantities involved are sufficient to make production economically practicable.



Type
M2S16



Type 1590-A REMOTE CONTROL

The TYPE 1590-A Remote Control is a simple, accurate, servo control for the remote positioning of a motor-driven VARIAC® autotransformer. It can be set for any desired voltage from zero to 140 volts. The remote, motor-driven autotransformer will automatically position itself for the same voltage, indicated on an accurate quasi-rms panel meter.

Any change in output voltage due to VARIAC regulation is automatically corrected. The correction rate, up to 60 volts per second, depends on the size of the VARIAC autotransformer.

If a regulated line is available to supply up to 300 watts to operate the remote control, corrections can also be automatically obtained for fluctuations in line voltage at the remote autotransformer. This regulated line must have low impedance at 60 cps and must have the same phase angle as the unregulated line to the remote unit. This combination can provide large amounts of power at a regulated voltage, adjustable from zero to 140 volts.

If continuous control is not required, one TYPE 1590-A can be switched to control any number of remote units, one at a time.

To order the proper motor-driven VARIAC autotransformer, see the chart below and use the same type-numbering system as for our standard motor-driven units (page 183). Except for 64-second models, where Microswitches are mandatory, the motor capacitor and Microswitches, specified by C and K in the type numbers for standard units, are not used with the TYPE 1590-A. These letters should be omitted from the type numbers.

TRAVERSE TIME AND CORRECTION RATE FOR 2% POSITIONING ERROR

DRIVEN VARIAC AUTO- TRANS- FORMER MODEL	SINGLE UNIT		TWO-GANG (G2)		THREE-GANG (G3)	
	Traverse Time* (Sec- onds)	Approximate Correc- tion Rate (Volts/ sec)	Traverse Time* (Sec- onds)	Approximate Correc- tion Rate (Volts/ sec)	Traverse Time* (Sec- onds)	Approximate Correc- tion Rate (Volts/ sec)
W2	2	60	2	60	4	30
W5	2	60	4	30	8	15
W8	2	60	4	30	8	15
W10	4	30	8	15	16	8
W20	8	15	16	8	32	4
W30	16	8	32	4	32†	4
W50	32	4	64‡	2	64‡‡	2

* If half the positioning error is desired, the traverse time can be doubled, giving half the correction rate. Traverse times shorter than those listed or greater than 64 seconds should not be used.

† 3% positioning error.

‡ Exception: Microswitches are mandatory on 64-second models.

SPECIFICATIONS

Tracking Accuracy: $\pm 2\%$ of input line voltage, when used with motor speeds listed in the table. (Halving the speed increases the accuracy to $\pm 1\%$.)

Correction Rate: See table.

Power Requirements: 105 to 125 volts, 50 to 60 cps.

Accessories Required: Standard motor-driven VARIAC autotransformer less capacitor and Microswitches (Microswitches are mandatory on 64-second models).

Dimensions: Width $4\frac{7}{8}$, height $6\frac{5}{8}$, depth $5\frac{1}{4}$ inches (125 by 170 by 135 mm), over-all.

Net Weight: $6\frac{1}{2}$ pounds (3 kg).

Shipping Weight: $10\frac{1}{2}$ pounds (4.8 kg).



Type	Code Number	Price
1590-A Remote Control	1590-9701	\$95.00

PARTS AND ACCESSORIES



The General Radio Company has developed and is constantly improving a comprehensive line of parts for use in its laboratory and industrial instruments. Among the design objectives are maximum reliability, long life, convenience, attractive appearance, and known electrical characteristics. All General Radio parts are painstakingly designed, use the best available materials, and are produced by methods that yield reasonable prices. One important design consideration is to produce integrated groups of basic elements that fit together electrically and have a unity of appearance.

Described in this section are capacitors, potentiometers, transformers, knobs, dials, binding posts, plugs and jacks, and patch cords.

Additional parts will be found in other sections of this catalog. Decade capacitors, resistors, and inductors are listed in the section on standards, pages 157, 161, and 167, respectively, delay lines on page 138, and coaxial connectors and parts on pages 59 to 77.

All of these are high-quality parts, designed for instrument use and fabricated from materials with superior electrical and mechanical properties.

THE NUMERIK INDICATOR

The Numerik indicator used in the TYPES 1150-A and 1151-A counters (pages 94 and 95) is available as a general-purpose digital indicator, which can be used in the readouts of counters, computers, digital voltmeters, annunciators, and indicator boards. The Numerik indicator is manufactured for General Radio by KGM Electronics, under an agreement that makes General Radio the exclusive distributor for the United States and Canada.

As shown in the cross-section view, light is conducted from a bank of incandescent lamps to the front of the indicator through clear acrylic plates, with sheets of reflective

material sandwiched between plates to minimize cross-illumination and attenuation. The display arrangement is a stack of clear plastic strips, each one scribed with closely spaced dots in the form of a display character. A stack of 10 plates is just over 5/16 inch deep, so all symbols appear to be nearly in the same plane.

Two models are available: the TYPE IND-0300, with 10 digits, 0 through 9, and the TYPE IND-1801, with the 10 digits plus a comma on the right-hand side and a decimal point on the left-hand side.

SPECIFICATIONS

Lamps: 14-volt, 80-milliamper, 0.5 candlepower T-1 $\frac{3}{4}$ bulbs, No. 330. Any lamp with base and candlepower similar to No. 330 can be substituted. Working life approximately 5000 hours (switching with 10% duty ratio).

Viewing Angle: 120° horizontal, 60° vertical.

Lamp Holder Block: Solid aluminum heat sink with nylon-filled Bakelite backing block. Nickel-silver contact springs and 11 silver-plated terminals (14 for TYPE IND-1801), one for each lamp and common

Dimensions:

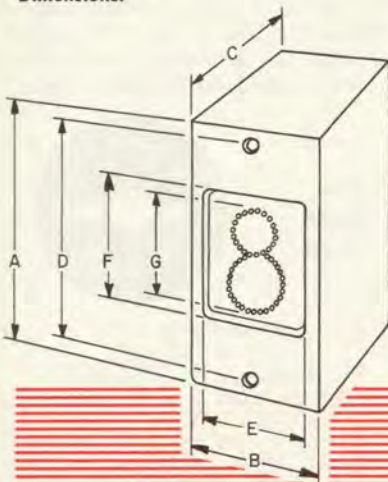

Type IND-0300

A	2 inches	(51 mm)
B	1 inch	(25 mm)
C	2½ inches	(58 mm)
D	1½ inches	(46 mm)
E	¾ inch	(19 mm)
F	1½ inches	(24 mm)
G	¾ inch	(19 mm)

Type IND-1801

A	2½ inches	(60 mm)
B	1 inch	(25 mm)
C	2¾ inches	(60 mm)
D	2½ inches	(55 mm)
E	¾ inch	(19 mm)
F	1½ inches	(27 mm)
G	1½ inches	(21 mm)

ground. Ground connection is to the case of the TYPE IND-0300; it is insulated from the case of the TYPE IND-1801.

Mounting: Back-of-panel by two No. 4-40 screws.

Dimensions: See illustration.

Net Weight: TYPE IND-0300, 4½ ounces (130 grams); TYPE IND-1801, 5 ounces (145 grams).

Prices:*

Quantity	TYPE IND-0300 (Code Number 5437-0300)	TYPE IND-1801 (Code Number 5437-1801)
1-19	\$32.20	\$33.60
20-49	30.60	32.00
50-99	28.60	30.00
100-299	27.20	28.60
300-999	24.70	26.10
1000-4999	22.00	23.20
5000-9999	18.40	18.40
10,000 up	16.90	16.90

*Prices applicable for sales in U.S.A. and Canada only.



970-SERIES POTENTIOMETERS

PARTS
POTENTIOMETERS

The 970-Series Potentiometers are moderately priced controls with high-quality performance. They can be used not only at dc but also throughout the audio- and ultrasonic-frequency ranges and, in many applications, at low radio frequencies.

DESCRIPTION: The materials used in the all-phenolic body (1), dust-proof cover (2), and glass-reinforced-polyester shaft (3) minimize the capacitance to ground. Low inductance results from the use of a thin winding form of phenolic laminate. A small-diameter brush (4) of precious-metal alloy assures high resolution. Brush arm and spring (5) are combined into a single stamping of spring-temper phosphor-bronze. The screw (6) that holds the cover to the base passes through a horseshoe-shaped slot in the brush arm to serve as a rotational stop that exerts no force on the brush. The brush rides with uniform pressure on the firmly anchored wires at the edge of the resistance winding (7). The combination of precious-metal contact, firm clean track, and uniform contact pressure minimizes electrical noise.

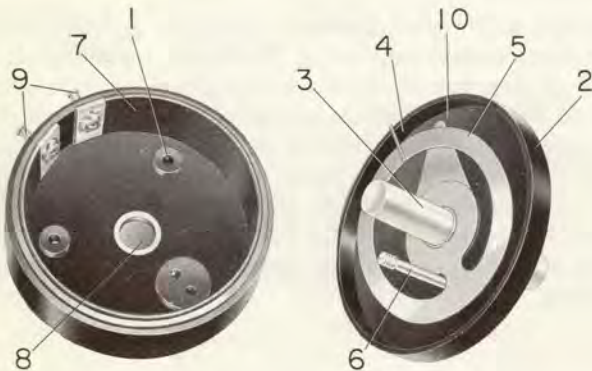

The projecting hub (11) permits adjustment of the shaft with respect to the contact brush while the case is closed. This hub rotates in a reamed brass insert molded into the cover to form a metal-to-metal main bearing close to the plane of the brush. The shaft is rigidly held by this hub, and a second bearing is provided by a stainless-steel insert to guide the shaft in the base. This arrangement provides stable, repeatable settings.

Resistance elements are wound of low-temperature-coefficient alloys. Linearity is assured by uniform turn spacing, on a mandrel that is firmly cemented into the cylindrical base molding.

The turret terminals (9) are both riveted to the end clamps and soldered to the ends of the winding (7) and to the silver-plated spring-bronze contact take-off in the

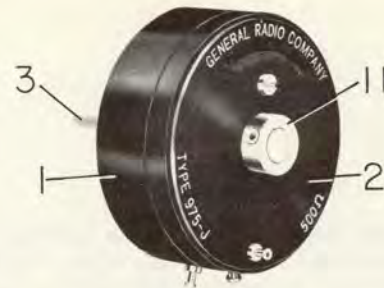

cover (10), so that none of the fixed internal connections depends upon pressure alone.

SPECIAL TYPES

Units in the 970 design can be made on special order with: 360° mechanical rotation, taps as close as 1/4 inch apart along the entire winding, resistance other than listed values, resistance tapers, resistance tolerance and linearity tolerances better than standard. For applications requiring maximum shaft rigidity, shafts of metal-cored phenolic or of metal can be supplied.

GANGING

When ganged, the 970-Series Potentiometers retain their low-capacitance characteristics. Units are designed to be nested with phenolic spacing rings stacked on a long shaft, and held together with thin metal clamping rings and tie rods. This assembly allows units to be set in any desired phase relationship. Inquiries are welcomed on a special-design basis.

KNOBS

Recommended knobs for these potentiometers are described on page 205. Use TYPES KNS-6 and KNSP-6 for TYPES 971, 972, 973, and 974; TYPES KNS-8 and KNSP-8 for TYPES 975 and 976.

DIAL PLATES

The TYPE 970-P1 (*below*) is a 2-inch dial plate for use with the TYPES 971, 972, 973, and 974 with a pointer-type knob. Scale covers 315°. The TYPE 970-P2 is a 2 3/4-inch reversible dial plate for use with the TYPES 975 and 976 with a pointer-type knob or attached to a knob. Scale covers 320°.



Type	Code Number	Price
970-P1	0970-9601	\$0.55
970-P2	0970-9602	0.55

Type	Approx Weight ounces	Effective Electrical Rotation	Total Mechanical Rotation	Standard Resistance Tolerance	Average Torque oz in.	Independent Linearity	Power Rating at 0 C ambient temp *	
							Mounted on Alum Panel	Suspended in Air
971	1/2	315° ± 5°	330° ± 5°	± 5%	1 3/4	± 2%	5.6	3.5
972	3/4	315° ± 5°	330° ± 5°	± 5%	1 3/4	± 2%	7.8	5.8
973	1	320° ± 5°	330° ± 5°	± 5%	2 1/2	± 1%	8.4	5.9
974	1 3/4	320° ± 5°	330° ± 5°	± 5%	2 1/2	± 1%	12.0	9.4
975	3	320° ± 2°	330° ± 5°	± 2%	4	± 0.5%	13.4	10.7
976	4	320° ± 2°	330° ± 5°	± 2%	4	± 0.5%	19.0	16.8

* Power rating in watts decreases linearly with rising ambient temperature to zero at 100 C.

POTENTIOMETER DIMENSIONS

Type	971	972	973	974	975	976
A	5/16	5/16	5/16	5/16	5/16	5/16
B	5/8	1 1/16	1 3/16	1 7/16	1 1/8	2
C	1	1	1	1	1	1
D	1/4	1/4	3/8	3/8	3/8	3/8
E	2 holes 4-40 tap	2 holes 4-40 tap	2 holes 6-32 tap	2 holes 6-32 tap	—	—
F	0.750	0.750	1.000	1.000	—	—
G	1 1/4	1 1/4	1 3/4	1 3/4	2 3/4	2 3/4
H	—	—	—	—	0.875R	0.875R
J	—	—	—	—	3 holes 6-32 tap	3 holes 6-32 tap

Type	Nominal Resistance Ohms	Temperature Coefficient of Resistance	Resolution	Code Number	Price
971	971-B 2	±0.07%	<1%	0971-9702	\$4.75
	971-C 5	±0.07%	<1%	0971-9703	4.75
	971-D 10	±0.002%	<1%	0971-9704	4.75
	971-E 20	±0.002%	<1%	0971-9705	4.75
	971-F 50	±0.002%	<0.5%	0971-9706	4.75
	971-G 100	±0.002%	<0.5%	0971-9707	4.25
	971-H 200	±0.002%	<0.5%	0971-9708	4.25
	971-I 500	±0.002%	<0.5%	0971-9710	4.25
	971-J 1000	±0.002%	<0.5%	0971-9711	4.25
	971-K 2000	±0.002%	<0.5%	0971-9712	4.25
	971-L 5000	±0.002%	<0.2%	0971-9713	4.25
	971-M 10,000	±0.002%	<0.2%	0971-9714	4.25
971-N 20,000	±0.002%	<0.2%	0971-9716	4.25	
972	972-F 50	±0.002%	<1%	0972-9706	\$4.75
	972-G 100	±0.002%	<0.5%	0972-9707	4.75
	972-H 200	±0.002%	<0.5%	0972-9708	4.75
	972-I 500	±0.002%	<0.5%	0972-9710	4.75
	972-J 1000	±0.002%	<0.5%	0972-9711	4.75
	972-K 2000	±0.002%	<0.5%	0972-9712	4.75
	972-L 5000	±0.002%	<0.5%	0972-9713	4.75
	972-M 10,000	±0.002%	<0.2%	0972-9714	4.75
	972-P 20,000	±0.002%	<0.2%	0972-9716	4.75
	972-Q 50,000	±0.002%	<0.2%	0972-9717	4.75
973	973-C 5	±0.07%	<0.5%	0973-9703	\$5.00
	973-D 10	±0.07%	<0.5%	0973-9704	5.00
	973-E 20	±0.002%	<0.5%	0973-9705	5.00
	973-F 50	±0.002%	<0.5%	0973-9706	5.00
	973-G 100	±0.002%	<0.5%	0973-9707	5.00
	973-H 200	±0.002%	<0.5%	0973-9708	5.00
	973-I 500	±0.002%	<0.2%	0973-9710	5.00
	973-J 1000	±0.002%	<0.2%	0973-9711	5.00
	973-K 2000	±0.002%	<0.2%	0973-9712	5.00
	973-L 5000	±0.002%	<0.2%	0973-9713	5.00

Type	Nominal Resistance Ohms	Temperature Coefficient of Resistance	Resolution	Code Number	Price	
973	973-N 10,000	±0.002%	<0.1%	0973-9714	\$5.00	
	973-P 20,000	±0.002%	<0.1%	0973-9716	5.00	
	973-Q 50,000	±0.002%	<0.1%	0973-9717	5.00	
974	974-D 10	±0.07%	<0.5%	0974-9704	\$5.50	
	974-E 20	+0.07%	<0.5%	0974-9705	5.50	
	974-F 50	±0.002%	<0.5%	0974-9706	5.50	
	974-G 100	±0.002%	<0.5%	0974-9707	5.50	
	974-H 200	±0.002%	<0.5%	0974-9708	5.50	
	974-I 500	±0.002%	<0.5%	0974-9710	5.50	
	974-K 1000	±0.002%	<0.2%	0974-9711	5.50	
	974-L 2000	±0.002%	<0.2%	0974-9712	5.50	
	974-M 5000	±0.002%	<0.2%	0974-9713	5.50	
	974-N 10,000	±0.002%	<0.2%	0974-9714	5.50	
	974-P 20,000	±0.002%	<0.1%	0974-9716	5.50	
	974-R 50,000	±0.002%	<0.1%	0974-9717	5.50	
975	975-J 500	±0.002%	<0.2%	0975-9710	\$5.50	
	975-K 1000	±0.002%	<0.2%	0975-9711	5.50	
	975-L 2000	±0.002%	<0.2%	0975-9712	5.50	
	975-M 5000	±0.002%	<0.2%	0975-9713	5.50	
	975-N 10,000	±0.002%	<0.1%	0975-9714	6.25	
	975-P 20,000	±0.002%	<0.1%	0975-9716	6.25	
	975-Q 50,000	±0.002%	<0.05%	0975-9717	6.25	
	975-R 100,000	±0.002%	<0.05%	0975-9718	6.25	
	976	976-K 1000	±0.002%	<0.2%	0976-9711	\$6.50
		976-L 2000	±0.002%	<0.2%	0976-9712	6.50
976-M 5000		±0.002%	<0.2%	0976-9713	6.50	
976-N 10,000		±0.002%	<0.2%	0976-9714	7.00	
976-P 20,000		±0.002%	<0.1%	0976-9716	7.00	
976-Q 50,000		±0.002%	<0.1%	0976-9717	7.00	
976-R 100,000		±0.002%	<0.05%	0976-9718	7.00	
976-T 200,000	±0.002%	<0.05%	0976-9720	7.50		

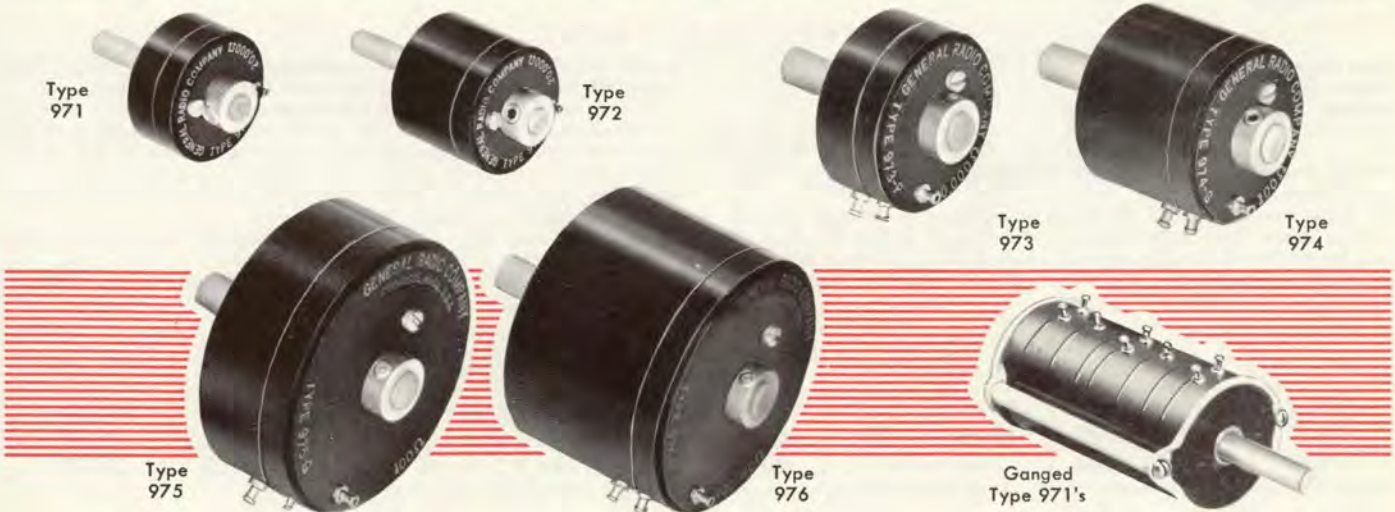

Types 1420 AND 1421 VARIABLE AIR CAPACITORS



Capacitance Range: See price table. The data in the price table are for the capacitor used as a two-terminal device, with rotor grounded. If the stator is grounded, maximum and minimum capacitance values will be decreased by about 1 pf. The rotor-to-ground capacitance is about 1 pf for the TYPE 1420 and about 2.5 pf for the TYPE 1421. The stator-to-ground capacitance is about 1.5 pf for the TYPE 1420, and 4 pf for TYPE 1421.

Linearity: The variation of capacitance with angle of rotation is guaranteed linear within $\pm 0.3\%$ of full scale. The angular range of linear variation is 160° .

Typical independent linearity is better than $\pm 0.2\%$.

Dielectric Losses: For the grounded-rotor connection, the dielectric losses correspond to a $D_o C_o$ product of less than 0.01×10^{-12} . The rotor-to-ground capacitance has a $D_o C_o$ product of 0.1×10^{-12} . This loss component is in parallel with the main capacitance only for the grounded-stator connection.

Inductance: Approximately 0.006 μ h.

Insulation Resistance: Greater than 10^{11} ohms under standard ASTM laboratory conditions (23 C, 50% RH).

Temperature Coefficient of Capacitance: Approximately $+0.003\%$ per degree C.

Shock and Vibration: The TYPE 1420 Capacitors will pass shock and vibration tests of MIL-T-945-A.

These capacitors were developed especially for use in laboratory instruments. The stator and insulated rotor are each machined from solid, shaped aluminum extrusions of identical alloy. Features include low dielectric losses, low inductance and resistance, good linearity, high mechanical and thermal stability, and sealed, long-life ball bearings.

SPECIFICATIONS

Maximum Voltage: 700 volts peak.

Torque: 2 ounce-inches maximum with shaft vertical.

Dimensions: See sketches below. To convert inches to mm, multiply by 25.4. Where dimensions are critical write for a copy of the latest drawings.

Net Weight: TYPE 1420-F, 4 oz (110 grams); TYPE 1420-G, $4\frac{1}{2}$ oz (125 grams); TYPE 1420-H, $5\frac{1}{2}$ oz (155 grams); TYPE 1421-J, $1\frac{1}{2}$ lb (0.7 kg); TYPE 1421-K, 2 lb (1 kg).

Shipping Weight: TYPES 1420-F, 1420-G, and 1420-H, 3 lb (1.4 kg); TYPES 1421-J and 1421-K, 5 lb (2.8 kg).

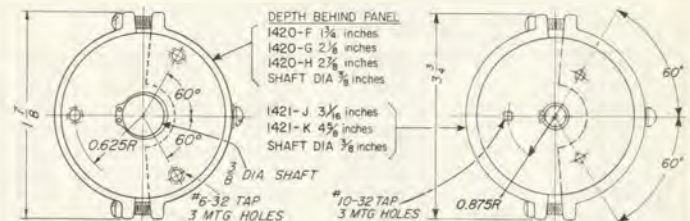

Type	Nominal Range		Range for Linear Variation	Code Number	Price
	Max	Min			
1420-F	70 pf	13 pf	54 ± 5 pf	1420-9706	\$30.00
1420-G	130 pf	14 pf	108 ± 5 pf	1420-9707	32.00
1420-H	250 pf	16 pf	216 ± 5 pf	1420-9708	33.00
1421-J	575 pf	22 pf	540 ± 20 pf	1421-9710	70.00
1421-K	1120 pf	29 pf	1025 ± 25 pf	1421-9711	70.00

See pages 205 and 206 for knobs and dials for Variable Air Capacitors.



Type 578 SHIELDED TRANSFORMER

This transformer is used in direct-reading ac bridges to isolate the bridge circuit from changes in electrostatic potential in the generator (or detector) circuit and to reduce the effect of the capacitance of the external circuit to ground. It can also be used to isolate any measuring circuit from the generator or detector, or to produce a balanced output from a grounded generator.

Three shields are used, one around each winding and a third to bring the core laminations to the potential of the case.

Grounded bridge supplied through a double-shielded transformer. When case is grounded, the capacitance placed across each capacitance arm is 40 pf. Note that the winding shield on the bridge side is not grounded, but is floating.

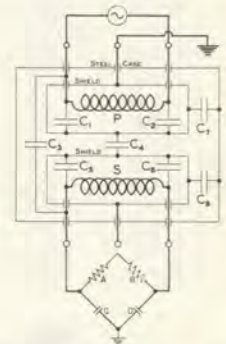

SPECIFICATIONS

Turns Ratio: 4 to 1 or 1 to 4.

Ranges: See price table.

Nominal Capacitances: See drawing.

C_1, C_2, C_5, C_6 each 200 pf C_4 30 pf
 C_3 0.3 pf C_7, C_8 each 70 pf

Winding Inductance: Turns squared (see table) multiplied by 3.5×10^{-6} henry, approx.

DC Resistance (in ohms): 30 times inductance in henrys, approx.

Voltage Limits: The high-impedance winding of TYPES 578-A or -B may be connected directly across a 115-volt 50- to 60-cycle line if the impedance connected to the other winding equals or exceeds the

lowest value given under "low impedance" in the table below. The TYPE 578-B may be used at 25 cps under the same conditions.

For TYPES 578-A or -B, the low-impedance winding may be connected directly to a 115-volt, 50- to 60-cycle line provided that the resistance across the high-impedance winding exceeds 10,000 ohms. The TYPE 578-B may be used at 25 cps under the same conditions.

Insulation: The insulation from winding to winding and from windings to case will withstand 1000 volts, peak.

Dimensions: Base, $3\frac{1}{8} \times 2\frac{1}{4}$ inches (80 by 70 mm); height, $4\frac{1}{8}$ inches (105 mm).

Net Weight: $2\frac{1}{2}$ pounds (1.2 kg). **Shipping Weight:** 4 pounds (1.9 kg).

Type	Turns	Frequency Range*	Impedance Range*		Code Number	Price
			Low-Impedance Winding	High-Impedance Winding		
578-A	600 to 2400	50 cps to 10 kc	50 Ω to 5 k Ω	1 k Ω to 100 k Ω	0578-9701	\$35.00
578-B	1000 to 4000	20 cps to 5 kc	60 Ω to 6 k Ω	1.2 k Ω to 120 k Ω	0578-9702	35.00
578-C	60 to 240	2 kc to 500 kc	20 Ω to 2 k Ω	0.4 k Ω to 40 k Ω	0578-9703	35.00

* These ranges are for transmission within 6 db. At extremes of both impedance and frequency ranges, the transmission may be down by 12 db.

Type KN FLUTED KNOBS

These black phenolic knobs are similar to those used on General Radio laboratory instruments. Each is molded with a brass insert bored for a $\frac{3}{8}$ -inch shaft except the TYPE KNSP-1, which is bored for a $\frac{1}{4}$ -inch shaft. A bushing is furnished with all $\frac{3}{8}$ -inch shaft types to adapt them to $\frac{1}{4}$ -inch shaft. The knob is clamped to the shaft by two

setscrews spaced 90° apart except in TYPES KNSP-6 and KNS-6, which have 135° spacing. TYPE KNB-1 has a single setscrew. TYPES KNS(P)-8, -10, and -12 have molded holes which can be drilled deeper to allow a dial plate to be attached to the knob.

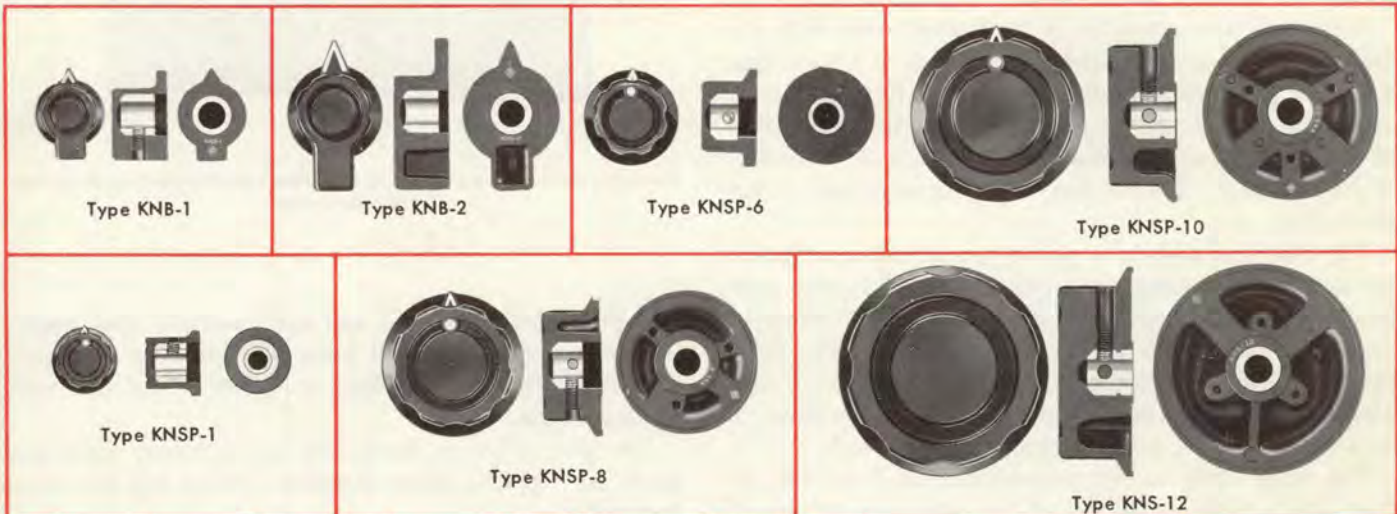

Type	Skirt Dia in Inches†	Total Depth in Inches‡		Net Wt for 5, in ounces§	Code Number	Unit Price† in Lots of				
						5*-19	20-199	200-399	400-1999	2000 up
KNB-1	1 $\frac{5}{16}$	$\frac{3}{4}$	Bar Type	3 $\frac{3}{4}$	5500-9601	\$0.90	\$0.80	\$0.75	\$0.70	\$0.67
KNB-2	1 $\frac{5}{16}$	$\frac{3}{4}$	Bar Type	6	5500-9602	0.95	0.84	0.79	0.73	0.70
KNSP-1	1 $\frac{5}{16}$	$\frac{3}{4}$	With Pointer	6	5530-9601	0.70	0.62	0.58	0.54	0.52
KNSP-6	1 $\frac{5}{16}$	$\frac{3}{4}$	With Pointer	5 $\frac{1}{2}$	5530-9606	0.80	0.72	0.68	0.64	0.62
KNS-6	1 $\frac{5}{16}$	$\frac{3}{4}$	Without Pointer	5 $\frac{1}{2}$	5520-9606	0.80	0.72	0.68	0.64	0.62
KNSP-8	1 $\frac{15}{16}$	1 $\frac{13}{16}$	With Pointer	8	5530-9608	0.90	0.82	0.78	0.74	0.72
KNS-8	1 $\frac{15}{16}$	1 $\frac{13}{16}$	Without Pointer	8	5520-9608	0.90	0.82	0.78	0.74	0.72
KNSP-10	2 $\frac{3}{8}$	2 $\frac{29}{32}$	With Pointer	12 $\frac{1}{2}$	5530-9610	1.30	1.17	1.11	1.03	1.00
KNS-10	2 $\frac{3}{8}$	2 $\frac{29}{32}$	Without Pointer	12 $\frac{1}{2}$	5520-9610	1.30	1.17	1.11	1.03	1.00
KNSP-12	2 $\frac{7}{8}$	1	With Pointer	17	5530-9612	1.40	1.27	1.21	1.13	1.10
KNS-12	2 $\frac{7}{8}$	1	Without Pointer	17	5520-9612	1.40	1.27	1.21	1.13	1.10

† Net. No further quantity discounts. ‡ To convert inches to mm, multiply by 25.4. § To convert ounces to grams, multiply by 28. * Minimum quantity sold.

Type 941-A TOROIDAL TRANSFORMER

FOR IMPEDANCE MATCHING OR BRIDGING IN LOW-LEVEL 600-OHM COMMUNICATION CIRCUITS

This transformer has highly astatic windings and tight coupling. The toroidal core is a spiral of high-permeability-alloy tape. Identical pairs of windings on each half of the toroid minimize pickup and induction field, while close coupling between inner and outer windings keeps leakage reactance low and extends high-frequency response.

SPECIFICATIONS

Frequency and Impedance Ranges:

Terminating Impedances	Frequency for 1-DB Drop	Flat Insertion Loss Less Than	
600Ω	9600Ω	80 cps—100 kc	0.3 db
600Ω	2400Ω	20 cps—135 kc	0.2 db
600Ω	2400Ω	80 cps—340 kc	0.2 db
600Ω	600Ω	20 cps—200 kc	0.1 db
150Ω	600Ω	5 cps—50 kc	0.7 db
150Ω	600Ω	20 cps—200 kc	0.2 db
37.5Ω	600Ω	5 cps—50 kc	0.8 db

Zero-Signal Inductance: Inner windings, in series, at least 5 henrys; outer windings, in series, at least 20 henrys.

Operating Level and Distortion:

Watts	DBM	RMS Distortion, 60 cps
1.26	31	<1%
1	30	<0.5%
0.5	27	<0.2%
0.032	15	<0.1%



Voltage Matching: Inner windings, 0.015% or better; outer windings, 0.08% or better.

Resistance: Inner windings, in series, 9 ohms; outer windings, in series, 34 ohms (approximately).

Dimensions: Aluminum case, 3 $\frac{5}{8}$ by 3 $\frac{1}{8}$ by 1 $\frac{5}{8}$ inches (95 by 80 by 40 mm). Mounting blocks project $\frac{1}{8}$ inch beyond case in 3 $\frac{1}{8}$ -inch dimension. Mounting holes are 3 $\frac{3}{8}$ inches on centers and are drilled for clearance with 10-32 machine screws.

Net Weight: 13 $\frac{3}{8}$ ounces (380 grams).

Shipping Weight: 4 pounds (1.9 kg).

Type	Code Number	Price
941-A	0941-9701	\$50.00



GEAR-DRIVE PRECISION DIALS

PARTS
DIALS

The TYPES 907 and 908 Gear-Drive Precision Dials have aluminum dial plates with black enamel finish. Scales are individually engraved on an automatic, self-indexing engraving machine. The fine, radial, accurately located lines divide the complete circumference into 360 divisions numbered from 0 to 360.

Settings can be consistently duplicated to one-fifth of a division, allowing a precision of resetting of better than 0.06% of full scale. Parallax is eliminated by the use of an indicator that always remains flush with the surface of the dial and, at the same time, through the flexibility of its mounting, absorbs any slight eccentricities of the main shaft.

The ring gear and drive pinion are precision-cut gears, spring-pressed to eliminate any backlash. The drive ratio is 10:1, and it is possible to use a calibrated vernier or increment dial on the pinion shaft if desired. The drive pinion is held in a stainless-steel collet, which runs in a phosphor-bronze bushing. The collet allows the drive to be adjusted for any panel thickness up to 5/16 inch.

The main dials are set permanently and securely to their shafts through the use of two setscrews 90° apart;



Motor drive attached to a Type 908 dial on the Type 1304-B Beat-Frequency Audio Generator.

this procedure eliminates any dial backlash that might otherwise occur. The dial hubs are bored to receive a 3/8-inch shaft, but a bushing is furnished for use with 1/4-inch shafts.

The dial indicator, knob, and all necessary mounting parts are supplied, as are complete drilling and mounting instructions.

MOTOR DRIVES The Types 907 and 908 Dial Drives for attachment to these dials are described on page 127. These drives can be installed directly in place of the knob.

4-INCH DIAMETER GEAR-DRIVE PRECISION DIALS

Type	Mounting	Dial		Max Panel Thickness	Total Panel Area*	Net Weight	Shipping Weight	Code Number	Price
		Arc	Divisions						
907-WA	Front-of-Panel	360°	360	—	4 × 5 inches	11 oz (0.4 kg)	3 pounds	0907-9857	\$12.00
907-WB	Back-of-Panel	360°	360	3/16 inch	4 × 5 inches	11 oz (0.4 kg)	(1.4 kg)	0907-9863	12.00

6-INCH DIAMETER GEAR-DRIVE PRECISION DIALS

Type	Mounting	Dial		Max Panel Thickness	Total Panel Area*	Net Weight	Shipping Weight	Code Number	Price
		Arc	Divisions						
908-WA	Front-of-Panel	360°	360	—	6 × 7 1/2 inches	21 oz (0.7 kg)	4 pounds	0908-9857	\$15.50
908-WB	Back-of-Panel	360°	360	3/16 inch	6 × 7 1/2 inches	19 oz (0.6 kg)	(1.9 kg)	0908-9863	15.50

* To convert inches to mm, multiply by 25.4.

Type 907-WA



Type 907-WB



TYPE 274 PLUGS AND JACKS, originated by General Radio in 1924, are widely used in electronics and communications laboratories for connecting equipment in temporary or semipermanent setups and for connecting plug-in elements. All TYPE 274 Plugs and Jacks are rated at 15 amperes. Plugs have nickel-plated brass studs and beryllium-copper springs. Jacks are nickel-plated brass. These plugs and jacks are designed for positive and reliable contact,

typically 1 milliohm. The plug seats firmly in the jack so that the plug springs are not depended upon for mechanical stability.

TYPE 938 JACKS also fit TYPE 274 Plugs. The TYPE 938-J Jack has a longer shank than the TYPE 274 Jack. The TYPE 938-X Jack Assembly consists of the TYPE 938-J Jack and TYPE 938-BB Insulators (page 208).

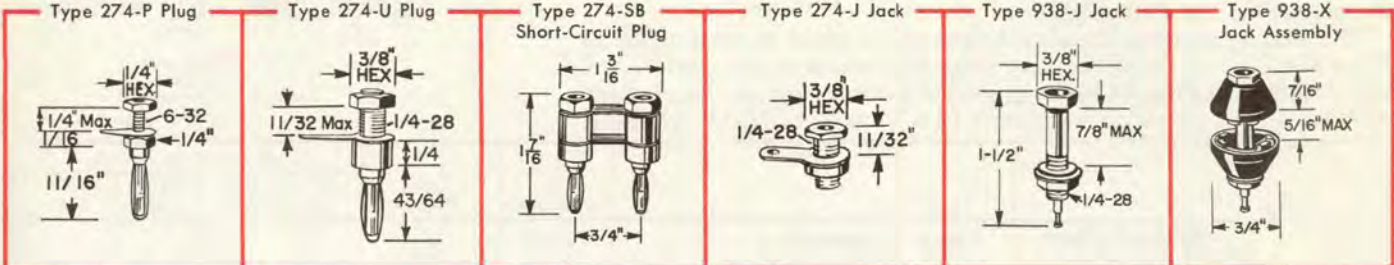

Type	Fits	Net Wt for Min Quan	Code Number	Unit Price† in Lots of				
				10*- 99	20*- 99	100- 999	1000- 1999	2000 up
274-P	Fits Type 274-J	2 oz (60 grams)	0274-9716		\$0.13	\$0.11	\$0.10	\$0.09
274-U	Fits Type 274-J Jack (1/4-28 threaded stud)	3 oz (85 grams)	0274-9721	\$0.20		0.18	0.17	0.16
274-SB	Two Type 274-U Plugs with metal links	1 oz (30 grams)	0274-9887	\$0.95				
274-J	Fits Type 274 Plugs	3 oz (85 grams)	0274-9710		0.10	0.09	0.08	0.07
938-J	Fits Type 274 Plugs	3 oz (85 grams)	0938-9710		0.32	0.27	0.25	0.22
938-XB	One Type 938-J and pair of black insulators	4 oz (115 grams)	0938-9868		0.52	0.39	0.36	0.32
938-XR	One Type 938-J and pair of red insulators	4 oz (115 grams)	0938-9869		0.52	0.39	0.36	0.32

† Net prices. No further quantity discounts. * Minimum quantity sold.

INSULATED PLUGS

TYPE 274-DB INSULATED SINGLE PLUG is a styrene-insulated plug with a jack top. A set-screw clamp is provided on the plug end.

TYPE 274-MB INSULATED DOUBLE PLUG is a molded-styrene double-plug assembly which fits TYPE 938 Binding Posts or TYPE 274 Jacks on standard 3/4-inch spacing. The jack top permits stacking for multiple connections. A cross hole through the center provides strain relief for attached cables up to 0.2-inch diameter. The plug is completely insulated.

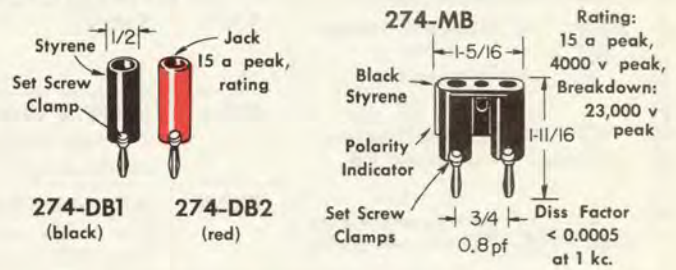

Type	Net Wt for Min Quan	Code Number	Unit Price† in Lots of				
			5*- 9	10- 99	100- 199	200- 999	1000 up
274-DB1 Black Insulated Single Plug	2 oz (60 grams)	0274-9454	\$0.50	\$0.43	\$0.40	\$0.36	\$0.34
274-DB2 Red Insulated Single Plug	2 oz (60 grams)	0274-9455	0.50	0.43	0.40	0.36	0.34
274-MB Insulated Double Plug	3 oz (85 grams)	0274-9875	0.65	0.57	0.54	0.49	0.47

† Net prices. No further quantity discounts. * Minimum quantity sold.

TYPE 274-NK SHIELDED DOUBLE PLUG is a double plug in an aluminum case with ceramic insulation for completely shielded connections to TYPE 938 Binding Posts. Strain relief for coaxial cable of 0.2 and 0.25 inch OD is provided. This plug terminates the TYPE 274-NL Patch Cord (page 209) and TYPE 874-R34 Patch Cord (page 70).

Type	Code Number	Net Wt	Price
274-NK Shielded Double Plug	0274-9877	2 oz (60 grams)	\$1.35

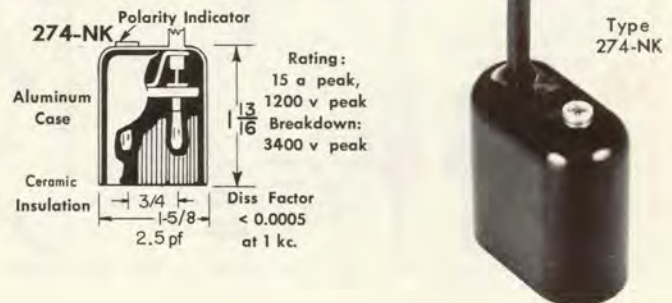



Type 938 BINDING POSTS

PARTS
BINDING POSTS

The excellent electrical properties and ingenious mechanical design of the TYPE 938 Binding Posts provide all the properties needed for modern electronic instruments. They are available with either metal or insulated tops. Nickel-plated brass is used for high conductivity. The styrene insulation has high insulation resistance and low dissipation factor and is available either red or black for color coding.

These binding posts can be mounted on metal or insulating panels, of a thickness from zero to 5/16 inch. Mechanical details and methods of connection are shown below.

The binding post has the same height above panel as the nonlocking TYPE 874 Coaxial Connector (see page 63), whose center contact will take a TYPE 274 Plug, so that a grounded binding post can be mounted adjacent to the coaxial connector to fit a TYPE 274-MB Double Plug.

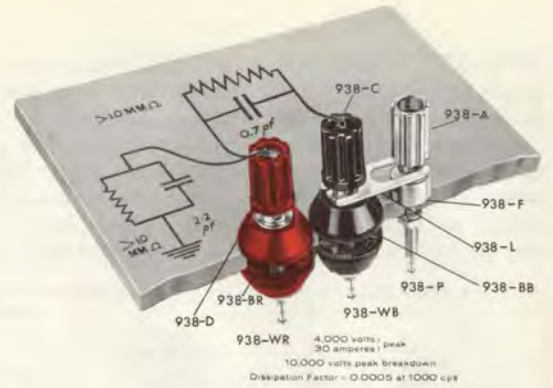

	Type	Description	Net Wt for Min Quan	Code Number	Unit Price† in Lots of			
					10*-99	100-999	1000-1999	2000 up
BINDING POSTS	938-A	Metal-Top Binding Post	4 oz (115 grams)	0938-9701	\$0.40	\$0.29	\$0.27	\$0.25
	938-C	Black-Top Binding Post	3 oz (85 grams)	0938-9703	0.55	0.40	0.38	0.35
	938-D	Red-Top Binding Post	3 oz (85 grams)	0938-9704	0.55	0.40	0.38	0.35
INSULATORS	938-BB	Black Insulators	1 oz (30 grams)	0938-9808	0.20	0.12	0.11	0.10
	938-BR	Red Insulators	1 oz (30 grams)	0938-9812	0.20	0.12	0.11	0.10
	938-YB	Double Insulators	2 oz (60 grams)	0938-9873	0.30	0.18	0.16	0.15
ACCESSORIES	938-F	Spacer	1 oz (30 grams)	0938-9706	0.12	0.09	0.09	0.09
	938-L	Shorting Link	1 oz (30 grams)	0938-9712	0.10	0.09	0.09	0.09
	838-B	Alligator Clip	2 oz (60 grams)	0838-9702	0.20	0.19	0.18	0.17

† Net prices. No further quantity discounts.

* Minimum quantity sold.

METHODS OF CONNECTION

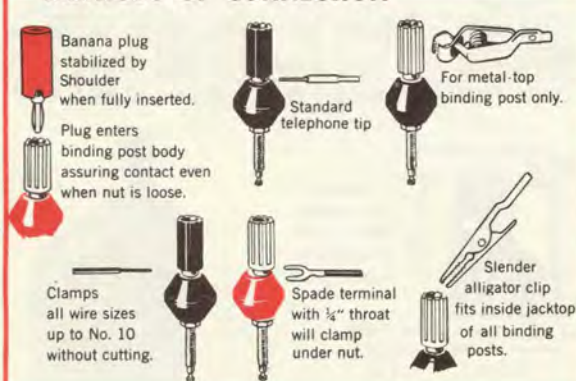

MECHANICAL DETAILS

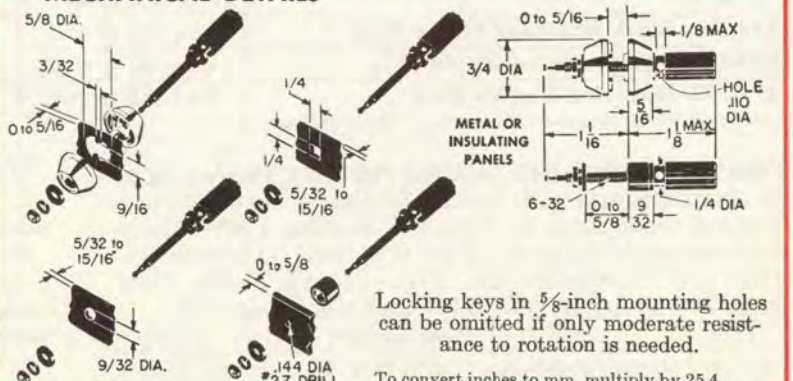

BINDING POST ASSEMBLIES

The following binding-post combinations are available. Listed prices are for shipment unassembled. When assembly and/or individual packaging before shipment is required, add 10¢ per binding post for assembly, 8¢ for packaging.

Type		Net Wt for Min Quan	Code Number	Unit Price† in Lots of			
				10*- 99	100- 999	1000- 1999	2000 up
938-P	938-A Metal-Top Post 938-F Spacer	5 oz (145 grams)	0938-9716	\$0.52	\$0.38	\$0.36	\$0.34
938-R	938-A Metal-Top Post 938-BR Red Insulators	5 oz (145 grams)	0938-9718	0.60	0.41	0.38	0.35
938-W	938-A Metal-Top Post 938-BB Black Insulators	5 oz (145 grams)	0938-9723	0.60	0.41	0.38	0.35
938-WB	938-C Black-Top Post 938-BB Black Insulators	4 oz (115 grams)	0938-9863	0.75	0.52	0.49	0.45
938-WR	938-D Red-Top Post 938-BR Red Insulators	4 oz (115 grams)	0938-9864	0.75	0.52	0.49	0.45

† Net prices. No further quantity discounts.

* Minimum quantity sold.

GP ADAPTORS AND CORDS

ADAPTORS

TYPE 274-QBJ ADAPTOR Shielded banana plugs provide connection from binding-post terminals to type BNC plug.

TYPE 874-Q2 ADAPTOR Provides connection from TYPE 274 Plugs to TYPE 874 Coaxial systems.

TYPE 874-Q9 ADAPTOR Provides connection from TYPE 938 Binding Posts to TYPE 874 Coaxial systems.

For a complete list of coaxial adaptors, refer to page 64.



Type	Adaptor	Net Weight	Code Number	Price
274-QBJ	Adaptor	2 oz (60 grams)	0274-9884	\$2.50
874-Q2	Adaptor	2 oz (60 grams)	0874-9870	5.50
874-Q9	Adaptor	2 oz (60 grams)	0874-9874	6.00

GP PATCH CORDS

TYPE 274-NP PATCH CORD is a three-foot shielded lead terminated with double plugs, which permit stacking for multiple connections.

TYPE 274-NL PATCH CORD is a three-foot shielded lead terminated with TYPE 274-NK Shielded Double Plugs (page 207).



Type	Patch Cord	Net Weight	Code Number	Price
274-NL	Patch Cord	4 oz (115 grams)	0274-9883	\$4.50
274-NP	Patch Cord	3 oz (85 grams)	0274-9880	3.50

GP POWER CORDS

These power cords are 7-foot rubber-covered No. 18 conductors. Plug and connector bodies are molded integrally with the cord and the hammerhead design permits stacking. The three-wire cord is supplied with General Radio ac-operated instruments.

TYPE CAP-22 3-WIRE POWER CORD Electrical ratings are 7 amperes and 230 volts. The connectors, designed for 125-volt operation, conform to the *American Standard for Grounding Type Attachment Plug Caps and Receptacles*, ASA C73-1-1957.

TYPE CAP-35 2-WIRE POWER CORD TYPE SJ cord rated by Underwriters Laboratories at 7 amperes and 300 volts, rms. Female connector fits either 2-wire or 3-wire plug.

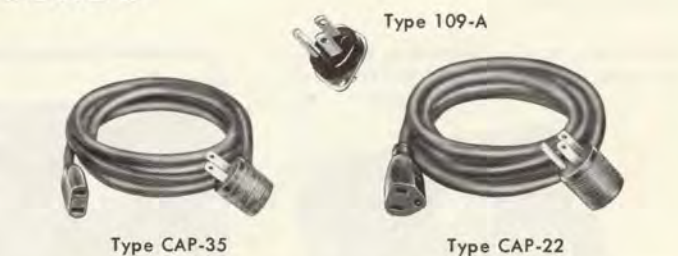

TYPE 109-A 3-WIRE RECEPTACLE Interchangeable with standard 2-wire receptacle to provide a 3-contact power-input receptacle which accepts either 2-wire or 3-wire power cords.

Type	Power Cord	Net Weight	Code Number	Price
CAP-22	3-Wire Power Cord	9 oz (255 grams)	4200-9622	\$2.50
CAP-35	2-Wire Power Cord	7 oz (200 grams)	4200-9635	1.75
109-A	3-Wire Receptacle	2 oz (60 grams)	0109-9701	1.25

INSTRUMENT CABINETS



General Radio instrument cabinets are rugged, attractive, and versatile. Heavy-gauge aluminum and tough wrinkle finishes combine to keep GR instruments operating and looking like new through many years of hard service.

We use five basic cabinet types: (1) "rack-bench" cabinets, with standard rack-width panels and optional bench or rack-mounting accessories, (2) "Flip-Tilt" cabinets, for portable instruments, (3) "convertible bench" cabinets, for smaller laboratory instruments, (4) "Unit" cabinets, for the GR line of general-purpose instruments and power supplies, and (5) "lab bench" cabinets, for laboratory standards, decade boxes, and other instruments that are seldom if ever mounted in relay racks.

RACK-BENCH CABINETS

A rack-bench cabinet consists of three major parts: a heavy-gauge aluminum cabinet comprising the top, bottom, sides, and rear of the instrument; a rack-width (19-inch) front panel, permanently attached to the instrument



For bench use, the rack-bench cabinet is equipped with aluminum end frames.

chassis; and either aluminum end frames, if the instrument is to be used on the bench, or two sheet-metal supports for rack mounting. The instrument is sold for one or the other type of mounting. Subsequent conversion is, however, quite simple.

Flip-Tilt cabinet in one of its many operating positions. Rubber gasket provides friction to allow almost any tilt angle.



Locked closed, with accessories and instruction manual inside, the Flip-Tilt instrument is well protected against damage.



Locked fully open, Flip-Tilt instrument is ready for either operation or transit.

Another of the many faces of the versatile Flip-Tilt, which here has traded cover and handle for a rack adaptor panel.



In bench models (identified by the type-number suffix "M"), the end frames serve several purposes. They allow instruments to be neatly stacked and, if desired, bolted together. They also serve as supporting feet, carrying handles, and protective bumpers.

In relay-rack models (identified by the type-number suffix "R"), the front panel and the two sheet-metal supports are attached by screws to the front of the relay rack, and the supports to the cabinet. The cabinet acts as a drawer slide, and the resulting installation offers easy accessibility to the interior of the instrument. The panel and chassis may be withdrawn from the front of the rack, with the cabinet left stationary. Or the cabinet may be removed from the rear of the rack, with panel and chassis left stationary.

FLIP-TILT CABINETS

One of the outstanding recent advances in instrument packaging is General Radio's patented Flip-Tilt cabinet, which offers the ultimate in protection, portability, and ease of use.

The Flip-Tilt cabinet includes three main parts: the instrument cabinet, a captive cover, and a carrying-handle and lever assembly. When the instrument is closed for storage or transit, the cover is locked in place over the front panel by means of slide-buttons and latches on the carrying handle. To open the cabinet, the user slides the buttons out of the latches and pushes down on the carrying handle. The lever action of the handle raises the cabinet from the cover. The cabinet is then easily flipped into position for operation. The operating position may be fully open and locked squarely in the cover or tilted at almost any angle. A rubber seal around the edge of the cover provides friction to hold the cabinet in the tilted position. When the instrument is closed, the same gasket provides a tight seal for the enclosure. Accessories and instruction

manual are conveniently stored in the Flip-Tilt cover.

Certain Flip-Tilt instruments are also available in standard relay-rack cabinets; such rack models are identified by the type suffix R (e.g., TYPE 1806-AR Electronic Voltmeter). Most other Flip-Tilt instruments are available adapted for rack mounting. In such adaptations, the Flip-Tilt cabinet (minus cover and handle) is neatly and securely mounted in a relay-rack adaptor panel. Such rack models are identified by four-digit numeral suffixes (e.g., TYPE 1650-9820 Impedance Bridge).

CONVERTIBLE BENCH CABINETS

Small and medium-sized instruments commonly used on the bench are housed in GR's unique "convertible bench" cabinet, designed primarily for the bench but offering quick relay-rack adaptability.

The convertible bench cabinet is made of sturdy aluminum finished in GR medium gray wrinkle. The U-shaped dust cover can be easily slipped off after removal of quick-action clamp fasteners. Instruments with panel meters can be tilted to the most convenient angle by means of extendible front legs.

Conversion for relay-rack mounting is easy: matching panel extensions are simply attached by means of screws to the instrument panel and to the relay rack.



Convertible bench instruments with meters tilt on extendible legs for easy viewing of front panel. Panel extensions are used for rack mount.

LAB BENCH AND UNIT CABINETS

Lab bench cabinets are simple enclosures used primarily for laboratory standards and decade boxes. Two U-shaped pieces of $\frac{1}{8}$ -inch extruded aluminum are strip-locked together to form the sides, and an aluminum bottom plate and $\frac{3}{16}$ -inch aluminum panel complete the enclosure. The result is a cabinet well shielded, structurally solid, and efficiently manufactured.

The Unit cabinet, used for General Radio's well-known line of general-purpose power supplies and other utility instruments, consists of two U-shaped aluminum pieces — one forming panel and sides and the other making up top, bottom, and rear of the instrument. The latter piece is a perforated dust cover that is easily withdrawn for access to the instrument chassis. High-frequency Unit oscillators use a simple L-bracket and cylindrical shield, compatible for relay-rack assembly with convertible-bench power supplies, as illustrated on page 116.



Two aluminum extrusions are strip-locked together to form the sides, heavy aluminum panel and bottom plate are added, and this precision capacitor is given the excellent shielding and trim appearance of the lab bench cabinet.

Unit instruments are specially designed for use with each other, and mating connectors permit the neat, compact assembly of power supply and driven instrument. Adaptor panels are available for rack-mounting Unit instruments.

OTHER CABINETS AND MODIFICATIONS

While most General Radio instruments are housed in the five cabinets described above, several other types of mounting are used to serve the special demands of various instruments. These range from the pocket-sized cases used for certain portable sound-measuring instruments to the specialized structures of a slotted line or an admittance meter. In the choice of mounting, the anticipated use of the instrument takes precedence over complete standardization of cabinets. This principle explains some variations in the five basic cabinet types, as well. Thus, the relay-rack version of the rack-bench cabinet does not include drawer slides where the instrument is a passive device whose withdrawal from the rack would rarely be necessary. Also, certain instruments (e.g., components of the frequency-measuring system) are designed solely for relay-rack mounting, and these are therefore not assigned the rack-bench optional end frames.

Accessory mounting hardware, such as end frames, relay-rack supports, and relay-rack adaptor panels, may be ordered separately by those customers wishing to convert from one type of mounting to another. Many of these accessories are listed along with the related instruments. Further information on such hardware, dimensions, etc., is available on request.



This Unit instrument and power supply make a neat combination, with no wasted space. Chassis-mounted multipoint power connectors mate, and locking strips are supplied to make the union permanent, if desired.

REACTANCE CHART

Always use corresponding scales

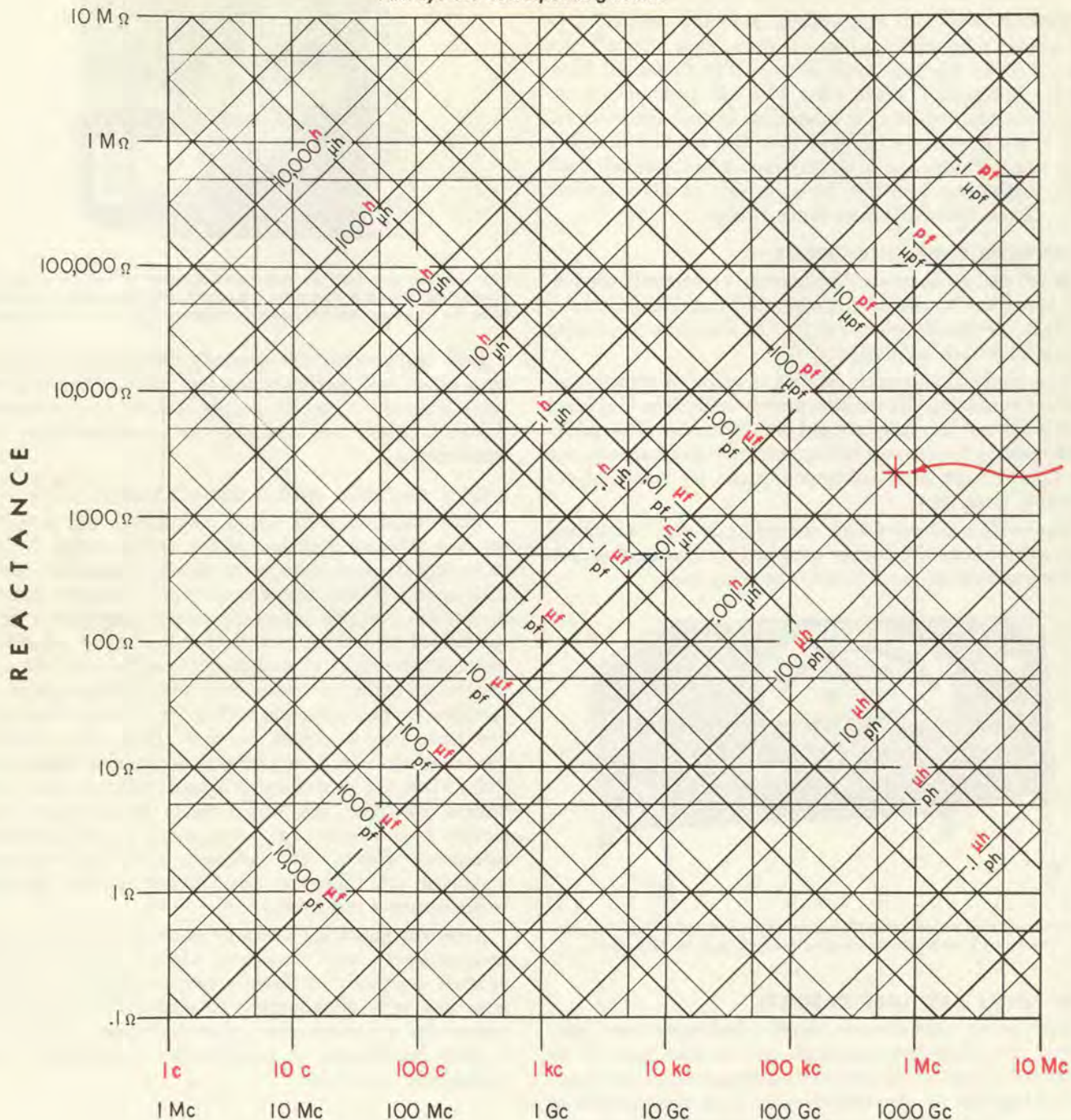

FIGURE 1

Figure 1 is the complete chart, used for rough calculations. Figure 2, which is a single decade of Figure 1 enlarged approximately 7 times, is used where two or three significant figures are to be determined.

TO FIND REACTANCE Enter the charts vertically from the bottom (FREQUENCY) and along the lines slanting upward to the left (CAPACITANCE) or to the right (INDUCT-

ANCE). Corresponding scales (red or black) must be used throughout. Project horizontally to the left from the intersection and read REACTANCE.

TO FIND RESONANT FREQUENCY Enter the slanting lines for the given inductance and capacitance. Project downward and read resonant frequency from the bottom scale. Corresponding scales (red or black) must be used throughout.

REACTANCE CHART

Always obtain approximate value from Figure 1 before using Figure 2

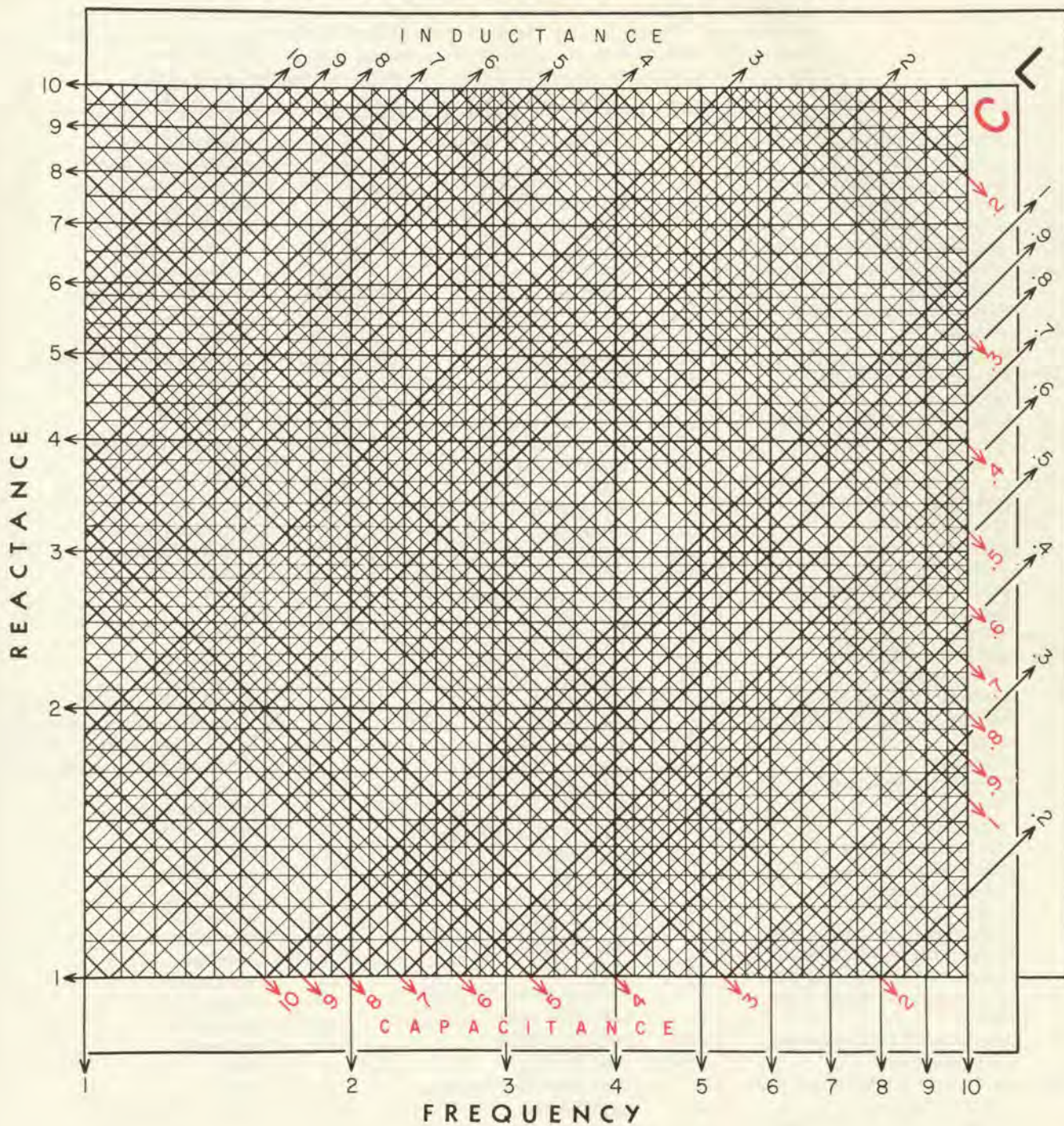

FIGURE 2

Example: The point indicated in Figure 1 corresponds to a frequency of about 700 kc and an inductance of 500 μ h, or a capacitance of 100 pf, giving in either case a reactance of about 2000 ohms. The resonant frequency of a circuit containing these values of inductance and capacitance is, of course, 700 kc, approximately.

USE OF FIGURE 2 Figure 2 gives additional precision but does not place the decimal point, which must be located from a preliminary entry on Figure 1. Since the

chart necessarily requires two logarithmic decades for inductance and capacitance for every single decade of frequency and reactance, unless the correct decade for L and C is chosen, the calculated values of reactance and frequency will be in error by a factor of 3.16. In Figure 2, the capacitance scale is red; inductance scale is black.

Example: (Continued) The reactance corresponding to 500 μ h or 100 pf is 2230 ohms at 712 kc, their resonant frequency.

ABBREVIATIONS, SYMBOLS, PREFIXES, AND CONVENTIONS

In this catalog, as in other General Radio publications, our use of symbols, prefixes, and abbreviations follows the recommendations of the American Standards Association, the International Committee on Weights and Measures, the International Electrotechnical Commission, and various scientific and engineering societies. Where there is not agreement among these groups, we generally choose the usage favored by the majority.

ABBREVIATIONS AND SYMBOLS

ac	alternating current	i-f	intermediate frequency	R	resistance
af	audio frequency	in.	inch	®	registered trademark
AFC	automatic frequency control	IRE	Institute of Radio Engineers	RC	resistance-capacitance
a-m	amplitude modulation	ISO	International Standards Organization	re	referred to
amp	ampere	<i>j</i>	$\sqrt{-1}$	rf	radio frequency
ASA	American Standards Association	k	kilo (10 ³)	RH	relative humidity
ASTM	American Society for Testing Materials	kg	kilogram	rms	root-mean-square
AVC	automatic volume control	kva	kilovolt ampere	rpm	revolutions per minute
ave	average	kw	kilowatt	<i>s</i>	series, as <i>L_s</i>
<i>B</i>	susceptance	<i>L</i>	inductance	sec	second
BCD	binary-coded decimal	lab	laboratory	sync	synchronous, synchronizing
<i>C</i>	capacitance	lb	pound	<i>T</i>	period
C	Centigrade, degrees Centigrade	LC	inductance-capacitance	<i>t</i>	temperature
C.I.F.	cost, insurance, freight	lf	low frequency	<i>t</i>	time
cm	centimeter	log	logarithm	uhf	ultra-high frequency
COD	cash on delivery	<i>m</i>	mass	<i>v</i>	velocity
cps	cycles per second	<i>m</i>	meter; milli (10 ⁻³)	<i>v</i>	volt
cw	continuous wave	ma	milliampere	va	voltampere
<i>D</i>	dissipation factor	max	maximum	vhf	very high frequency
db	decibel	mbar	millibar	vlf	very low frequency
dbm	decibel referred to one milliwatt	Mc	megacycles per second	vol	volume
dc	direct current	mh	millihenry	<i>vs</i>	versus
<i>E</i>	voltage	mil	0.001 inch	<i>w</i>	watt
EIA	Electronics Industries Association	min	minimum; minute	<i>X</i>	reactance
emf	electromotive force	mm	millimeter	<i>Y</i>	admittance
F	Fahrenheit, degrees Fahrenheit	mmho	millimho	<i>Z</i>	impedance
<i>f</i>	farad	mΩ	milliohm	α	short-circuit forward current-transfer ratio (common base)
<i>f</i>	frequency	MΩ	megohm	β	short-circuit forward current-transfer ratio (common emitter)
fm	frequency modulation	MMΩ	megamegohm	Γ	reflection coefficient
f.o.b.	free on board	mv	millivolt	Δ	increment
<i>G</i>	conductance	mw	milliwatt	δ	loss angle
<i>g</i>	gravitation constant	<i>n</i>	nano (10 ⁻⁹); any number	θ	phase angle
Gc	gigacycles per second	nsec	nanosecond	λ	wavelength
<i>g_m</i>	transconductance	nΩ	nanomho	μ	micro- (10 ⁻⁶)
<i>h</i>	henry	oz	ounce	μ a	microampere
<i>h_f</i>	forward current-transfer ratio	<i>p</i>	parallel, as <i>L_p</i>	μ bar	microbar
<i>h_i</i>	short-circuit input impedance	PF	power factor	μ f	microfarad
<i>h_o</i>	open-circuit output admittance	pf	picofarad	μ h	microhenry
<i>h_r</i>	reverse voltage-transfer ratio	PH	hydrogen in concentration	μ sec	microsecond
<i>I</i>	current	pp	push-pull; pages	μ v	microvolt
IEC	International Electrotechnical Commission	ppm	parts per million	Ω	ohm
IEEE	Institute of Electrical and Electronics Engineers	p-to-p	peak-to-peak	$\bar{\Omega}$	mho
		prf	pulse repetition frequency	<i>w</i>	angular velocity (2 π f)
		<i>Q</i>	quality factor		

PREFIXES

Orders of magnitude from 10¹² to 10⁻¹⁸ are designated by the following prefixes:

Order	Prefix	Symbol	Order	Prefix	Symbol
10 ¹²	tera	T	10 ⁻⁶	micro	μ
10 ⁹	giga	G	10 ⁻⁹	nano	n
10 ⁶	mega	M	10 ⁻¹²	pico	p
10 ³	kilo	k	10 ⁻¹⁵	femto	f
10 ²	hecto	h	10 ⁻¹⁸	atto	a
10	deka	da			
10 ⁻¹	deci	d			
10 ⁻²	centi	c			
10 ⁻³	milli	m			

CONVENTIONS

Dimensions and weights are rounded off to the next higher applicable fractional value. Shipping weights will necessarily vary with number of items shipped in one container, variations in packing methods, etc. Values given in specifications are approximate.

DECIBEL CONVERSION TABLES

In communications systems the ratio between any two amounts of electric or acoustic power is usually expressed in units on a logarithmic scale. The *decibel* (1/10th of the *bel*) on the briggisian or base-10 scale and the *neper* on the napierian or base-*e* scale are in almost universal use for this purpose.

Since voltage and current are related to power by impedance, both the *decibel* and the *neper* can be used to express voltage and current ratios, if care is taken to account for the impedances associated with them. In a similar manner the corresponding acoustical quantities can be compared.

From Table I and Table II on the following pages conversions can be made in either direction between the number of *decibels* and the corresponding power, voltage, and current ratios. Both tables can also be used for *nepers* by application of a conversion factor.

Decibel — The number of decibels N_{db} corresponding to the ratio between two amounts of power P_1 and P_2 is

$$N_{db} = 10 \log_{10} \frac{P_1}{P_2}$$

When two voltages E_1 and E_2 or two currents I_1 and I_2 operate in identical impedances,

$$N_{db} = 20 \log_{10} \frac{E_1}{E_2} \quad \text{and} \quad N_{db} = 20 \log_{10} \frac{I_1}{I_2}$$

If E_1 and E_2 or I_1 and I_2 operate in unequal impedances,

$$N_{db} = 20 \log_{10} \frac{E_1}{E_2} + 10 \log_{10} \frac{Z_2}{Z_1} + 10 \log_{10} \frac{k_1}{k_2}$$

and
$$N_{db} = 20 \log_{10} \frac{I_1}{I_2} + 10 \log_{10} \frac{Z_1}{Z_2} + 10 \log_{10} \frac{k_1}{k_2}$$

where Z_1 and Z_2 are the absolute magnitudes of the corresponding impedances and k_1 and k_2 are the values of power factor for the impedances. E_1 , E_2 , I_1 , and I_2 are also the absolute magnitudes of the corresponding quantities. Note that Table I and Table II can be used to evaluate the impedance and power factor terms, since both are similar to the expression for power ratio.

Neper — The number of nepers N_{nep} corresponding to a power ratio $\frac{P_1}{P_2}$ is

$$N_{nep} = \frac{1}{2} \log_e \frac{P_1}{P_2}$$

For voltage ratios $\frac{E_1}{E_2}$ or current ratios $\frac{I_1}{I_2}$ working in identical impedances,

$$N_{nep} = \log_e \frac{E_1}{E_2} \quad \text{and} \quad N_{nep} = \log_e \frac{I_1}{I_2}$$

Relations Between Decibels and Nepers

Multiply decibels by 0.1151 to find nepers
Multiply nepers by 8.686 to find decibels

TO FIND VALUES OUTSIDE THE RANGE OF CONVERSION TABLES

Table I: Decibels to Voltage and Power Ratios

Number of decibels positive (+): Subtract +20 decibels successively from the given number of decibels until the remainder falls within range of Table I. *To find the voltage ratio*, multiply the corresponding value from the right-hand voltage-ratio column by 10 for each time you subtracted 20 db. *To find the power ratio*, multiply the corresponding value from the right-hand power-ratio column by 100 for each time you subtracted 20 db.

Example — Given: 49.2 db.

$$49.2 \text{ db} - 20 \text{ db} - 20 \text{ db} = 9.2 \text{ db}$$

Voltage ratio: 9.2 db → 2.884

$$2.884 \times 10 \times 10 = 288.4$$

Power ratio: 9.2 db → 8.318

$$8.318 \times 100 \times 100 = 83180$$

Number of decibels negative (-): Add +20 decibels successively to the given number of decibels until the sum falls within the range of Table I. *For the voltage ratio*, divide the value from the left-hand voltage-ratio column by 10 for each time you added 20 db. *For the power ratio*, divide the value from the left-hand power-ratio column by 100 for each time you added 20 db.

Example — Given: -49.2 db

$$-49.2 \text{ db} + 20 \text{ db} + 20 \text{ db} = -9.2 \text{ db}$$

Voltage ratio: -9.2 db → 0.3467

$$0.3467 \times 1/10 \times 1/10 = 0.003467$$

Power ratio: -9.2 db → 0.1202

$$0.1202 \times 1/100 \times 1/100 = 0.0001202$$

Table II: Voltage Ratios to Decibels

For ratios smaller than those in table — Multiply the given ratio by 10 successively until the product can be found in the table. From the number of decibels thus found, subtract +20 decibels for each time you multiplied by 10.

Example — Given: Voltage ratio = 0.0131

$$0.0131 \times 10 \times 10 = 1.31$$

From Table II, 1.31 → 2.345 db

$$2.345 \text{ db} - 20 \text{ db} - 20 \text{ db} = -37.655 \text{ db}$$

For ratios greater than those in table — Divide the given ratio by 10 successively until the remainder can be found in the table. To the number of decibels thus found, add +20 db for each time you divided by 10.

Example — Given: Voltage ratio = 712

$$712 \times 1/10 \times 1/10 = 7.12$$

From Table II, 7.12 → 17.050 db

$$17.050 \text{ db} + 20 \text{ db} + 20 \text{ db} = 57.050 \text{ db}$$

TABLE I

GIVEN: Decibels

TO FIND: Power and $\left\{ \begin{matrix} \text{Voltage} \\ \text{Current} \end{matrix} \right\}$ Ratios

TO ACCOUNT FOR THE SIGN OF THE DECIBEL

For positive (+) values of the decibel — Both voltage and power ratios are greater than unity. Use the two right-hand columns.

For negative (-) values of the decibel — Both voltage and power ratios are less than unity. Use the two left-hand columns.

Example — Given: ± 9.1 db; Find:

	Power Ratio	Voltage Ratio
+9.1 db	8.128	2.851
-9.1 db	0.1230	0.3508

← -db+ →					← -db+ →				
Voltage Ratio	Power Ratio	db	Voltage Ratio	Power Ratio	Voltage Ratio	Power Ratio	db	Voltage Ratio	Power Ratio
1.0000	1.0000	0	1.000	1.000	.5623	.3162	5.0	1.778	3.162
.9886	.9772	.1	1.012	1.023	.5559	.3090	5.1	1.799	3.236
.9772	.9550	.2	1.023	1.047	.5495	.3020	5.2	1.820	3.311
.9661	.9333	.3	1.035	1.072	.5433	.2951	5.3	1.841	3.388
.9550	.9120	.4	1.047	1.096	.5370	.2884	5.4	1.862	3.467
.9441	.8913	.5	1.059	1.122	.5309	.2818	5.5	1.884	3.548
.9333	.8710	.6	1.072	1.148	.5248	.2754	5.6	1.905	3.631
.9226	.8511	.7	1.084	1.175	.5188	.2692	5.7	1.928	3.715
.9120	.8318	.8	1.096	1.202	.5129	.2630	5.8	1.950	3.802
.9016	.8128	.9	1.109	1.230	.5070	.2570	5.9	1.972	3.890
.8913	.7943	1.0	1.122	1.259	.5012	.2512	6.0	1.995	3.981
.8810	.7762	1.1	1.135	1.288	.4955	.2455	6.1	2.018	4.074
.8710	.7586	1.2	1.148	1.318	.4898	.2399	6.2	2.042	4.169
.8610	.7413	1.3	1.161	1.349	.4842	.2344	6.3	2.065	4.266
.8511	.7244	1.4	1.175	1.380	.4786	.2291	6.4	2.089	4.365
.8414	.7079	1.5	1.189	1.413	.4732	.2239	6.5	2.113	4.467
.8318	.6918	1.6	1.202	1.445	.4677	.2188	6.6	2.138	4.571
.8222	.6761	1.7	1.216	1.479	.4624	.2138	6.7	2.163	4.677
.8128	.6607	1.8	1.230	1.514	.4571	.2089	6.8	2.188	4.786
.8035	.6457	1.9	1.245	1.549	.4519	.2042	6.9	2.213	4.898
.7943	.6310	2.0	1.259	1.585	.4467	.1995	7.0	2.239	5.012
.7852	.6166	2.1	1.274	1.622	.4416	.1950	7.1	2.265	5.129
.7762	.6026	2.2	1.288	1.660	.4365	.1905	7.2	2.291	5.248
.7674	.5888	2.3	1.303	1.698	.4315	.1862	7.3	2.317	5.370
.7586	.5754	2.4	1.318	1.738	.4266	.1820	7.4	2.344	5.495
.7499	.5623	2.5	1.334	1.778	.4217	.1778	7.5	2.371	5.623
.7413	.5495	2.6	1.349	1.820	.4169	.1738	7.6	2.399	5.754
.7328	.5370	2.7	1.365	1.862	.4121	.1698	7.7	2.427	5.888
.7244	.5248	2.8	1.380	1.905	.4074	.1660	7.8	2.455	6.026
.7161	.5129	2.9	1.396	1.950	.4027	.1622	7.9	2.483	6.166
.7079	.5012	3.0	1.413	1.995	.3981	.1585	8.0	2.512	6.310
.6998	.4898	3.1	1.429	2.042	.3936	.1549	8.1	2.541	6.457
.6918	.4786	3.2	1.445	2.089	.3890	.1514	8.2	2.570	6.607
.6839	.4677	3.3	1.462	2.138	.3846	.1479	8.3	2.600	6.761
.6761	.4571	3.4	1.479	2.188	.3802	.1445	8.4	2.630	6.918
.6683	.4467	3.5	1.496	2.239	.3758	.1413	8.5	2.661	7.079
.6607	.4365	3.6	1.514	2.291	.3715	.1380	8.6	2.692	7.244
.6531	.4266	3.7	1.531	2.344	.3673	.1349	8.7	2.723	7.413
.6457	.4169	3.8	1.549	2.399	.3631	.1318	8.8	2.754	7.586
.6383	.4074	3.9	1.567	2.455	.3589	.1288	8.9	2.786	7.762
.6310	.3981	4.0	1.585	2.512	.3548	.1259	9.0	2.818	7.943
.6237	.3890	4.1	1.603	2.570	.3508	.1230	9.1	2.851	8.128
.6166	.3802	4.2	1.622	2.630	.3467	.1202	9.2	2.884	8.318
.6095	.3715	4.3	1.641	2.692	.3428	.1175	9.3	2.917	8.511
.6026	.3631	4.4	1.660	2.754	.3388	.1148	9.4	2.951	8.710
.5957	.3548	4.5	1.679	2.818	.3350	.1122	9.5	2.985	8.913
.5888	.3467	4.6	1.698	2.884	.3311	.1096	9.6	3.020	9.120
.5821	.3388	4.7	1.718	2.951	.3273	.1072	9.7	3.055	9.333
.5754	.3311	4.8	1.738	3.020	.3236	.1047	9.8	3.090	9.550
.5689	.3236	4.9	1.758	3.090	.3199	.1023	9.9	3.126	9.772

TABLE I (continued)

← -db+ →			← -db+ →						
Voltage Ratio	Power Ratio	db	Voltage Ratio	Power Ratio	Voltage Ratio	Power Ratio	db	Voltage Ratio	Power Ratio
.3162	.1000	10.0	3.162	10.000	.1585	.02512	16.0	6.310	39.81
.3126	.09772	10.1	3.199	10.23	.1567	.02455	16.1	6.383	40.74
.3090	.09550	10.2	3.236	10.47	.1549	.02399	16.2	6.457	41.69
.3055	.09333	10.3	3.273	10.72	.1531	.02344	16.3	6.531	42.66
.3020	.09120	10.4	3.311	10.96	.1514	.02291	16.4	6.607	43.65
.2985	.08913	10.5	3.350	11.22	.1496	.02239	16.5	6.683	44.67
.2951	.08710	10.6	3.388	11.48	.1479	.02188	16.6	6.761	45.71
.2917	.08511	10.7	3.428	11.75	.1462	.02138	16.7	6.839	46.77
.2884	.08318	10.8	3.467	12.02	.1445	.02089	16.8	6.918	47.86
.2851	.08128	10.9	3.508	12.30	.1429	.02042	16.9	6.998	48.98
.2818	.07943	11.0	3.548	12.59	.1413	.01995	17.0	7.079	50.12
.2786	.07762	11.1	3.589	12.88	.1396	.01950	17.1	7.161	51.29
.2754	.07586	11.2	3.631	13.18	.1380	.01905	17.2	7.244	52.48
.2723	.07413	11.3	3.673	13.49	.1365	.01862	17.3	7.328	53.70
.2692	.07244	11.4	3.715	13.80	.1349	.01820	17.4	7.413	54.95
.2661	.07079	11.5	3.758	14.13	.1334	.01778	17.5	7.499	56.23
.2630	.06918	11.6	3.802	14.45	.1318	.01738	17.6	7.586	57.54
.2600	.06761	11.7	3.846	14.79	.1303	.01698	17.7	7.674	58.88
.2570	.06607	11.8	3.890	15.14	.1288	.01660	17.8	7.762	60.26
.2541	.06457	11.9	3.936	15.49	.1274	.01622	17.9	7.852	61.66
.2512	.06310	12.0	3.981	15.85	.1259	.01585	18.0	7.943	63.10
.2483	.06166	12.1	4.027	16.22	.1245	.01549	18.1	8.035	64.57
.2455	.06026	12.2	4.074	16.60	.1230	.01514	18.2	8.128	66.07
.2427	.05888	12.3	4.121	16.98	.1216	.01479	18.3	8.222	67.61
.2399	.05754	12.4	4.169	17.38	.1202	.01445	18.4	8.318	69.18
.2371	.05623	12.5	4.217	17.78	.1189	.01413	18.5	8.414	70.79
.2344	.05495	12.6	4.266	18.20	.1175	.01380	18.6	8.511	72.44
.2317	.05370	12.7	4.315	18.62	.1161	.01349	18.7	8.610	74.13
.2291	.05248	12.8	4.365	19.05	.1148	.01318	18.8	8.710	75.86
.2265	.05129	12.9	4.416	19.50	.1135	.01288	18.9	8.811	77.62
.2239	.05012	13.0	4.467	19.95	.1122	.01259	19.0	8.913	79.43
.2213	.04898	13.1	4.519	20.42	.1109	.01230	19.1	9.016	81.28
.2188	.04786	13.2	4.571	20.89	.1096	.01202	19.2	9.120	83.18
.2163	.04677	13.3	4.624	21.38	.1084	.01175	19.3	9.226	85.11
.2138	.04571	13.4	4.677	21.88	.1072	.01148	19.4	9.333	87.10
.2113	.04467	13.5	4.732	22.39	.1059	.01122	19.5	9.441	89.13
.2089	.04365	13.6	4.786	22.91	.1047	.01096	19.6	9.550	91.20
.2065	.04266	13.7	4.842	23.44	.1035	.01072	19.7	9.661	93.33
.2042	.04169	13.8	4.898	23.99	.1023	.01047	19.8	9.772	95.50
.2018	.04074	13.9	4.955	24.55	.1012	.01023	19.9	9.886	97.72
.1995	.03981	14.0	5.012	25.12	.1000	.01000	20.0	10.000	100.00
.1972	.03890	14.1	5.070	25.70					
.1950	.03802	14.2	5.129	26.30					
.1928	.03715	14.3	5.188	26.92					
.1905	.03631	14.4	5.248	27.54					
.1884	.03548	14.5	5.309	28.18					
.1862	.03467	14.6	5.370	28.84					
.1841	.03388	14.7	5.433	29.51					
.1820	.03311	14.8	5.495	30.20					
.1799	.03236	14.9	5.559	30.90					
.1778	.03162	15.0	5.623	31.62					
.1758	.03090	15.1	5.689	32.36					
.1738	.03020	15.2	5.754	33.11					
.1718	.02951	15.3	5.821	33.88					
.1698	.02884	15.4	5.888	34.67					
.1679	.02818	15.5	5.957	35.48					
.1660	.02754	15.6	6.026	36.31					
.1641	.02692	15.7	6.095	37.15					
.1622	.02630	15.8	6.166	38.02					
.1603	.02570	15.9	6.237	38.90					

← -db+ →				
Voltage Ratio	Power Ratio	db	Voltage Ratio	Power Ratio
3.162×10^{-1}	10^{-1}	10	3.162	10
10^{-1}	10^{-2}	20	10	10^2
3.162×10^{-2}	10^{-3}	30	3.162×10	10^3
10^{-2}	10^{-4}	40	10^2	10^4
3.162×10^{-3}	10^{-5}	50	3.162×10^2	10^5
10^{-3}	10^{-6}	60	10^3	10^6
3.162×10^{-4}	10^{-7}	70	3.162×10^3	10^7
10^{-4}	10^{-8}	80	10^4	10^8
3.162×10^{-5}	10^{-9}	90	3.162×10^4	10^9
10^{-5}	10^{-10}	100	10^5	10^{10}

To find decibel values outside the range of this table, see page 215.

TABLE II

GIVEN: $\left\{ \begin{matrix} \text{Voltage} \\ \text{Current} \end{matrix} \right\}$ Ratio

TO FIND: Decibels

POWER RATIOS

To find the number of decibels corresponding to a given power ratio — Assume the given power ratio to be a voltage ratio and find the corresponding number of decibels from the table. The desired result is exactly one-half of the number of decibels thus found.

Example — Given: a power ratio of 3.41.

Find: 3.41 in the table:

$$3.41 \rightarrow 10.655 \text{ db (voltage)}$$

$$10.655 \text{ db} \times \frac{1}{2} = 5.328 \text{ db (power)}$$

Voltage Ratio	.00	.01	.02	.03	.04	.05	.06	.07	.08	.09
1.0	.000	.086	.172	.257	.341	.424	.506	.588	.668	.749
1.1	.828	.906	.984	1.062	1.138	1.214	1.289	1.364	1.438	1.511
1.2	1.584	1.656	1.727	1.798	1.868	1.938	2.007	2.076	2.144	2.212
1.3	2.279	2.345	2.411	2.477	2.542	2.607	2.671	2.734	2.798	2.860
1.4	2.923	2.984	3.046	3.107	3.167	3.227	3.287	3.346	3.405	3.464
1.5	3.522	3.580	3.637	3.694	3.750	3.807	3.862	3.918	3.973	4.028
1.6	4.082	4.137	4.190	4.244	4.297	4.350	4.402	4.454	4.506	4.558
1.7	4.609	4.660	4.711	4.761	4.811	4.861	4.910	4.959	5.008	5.057
1.8	5.105	5.154	5.201	5.249	5.296	5.343	5.390	5.437	5.483	5.529
1.9	5.575	5.621	5.666	5.711	5.756	5.801	5.845	5.889	5.933	5.977
2.0	6.021	6.064	6.107	6.150	6.193	6.235	6.277	6.319	6.361	6.403
2.1	6.444	6.486	6.527	6.568	6.608	6.649	6.689	6.729	6.769	6.809
2.2	6.848	6.888	6.927	6.966	7.008	7.044	7.082	7.121	7.159	7.197
2.3	7.235	7.272	7.310	7.347	7.384	7.421	7.458	7.495	7.532	7.568
2.4	7.604	7.640	7.676	7.712	7.748	7.783	7.819	7.854	7.889	7.924
2.5	7.959	7.993	8.028	8.062	8.097	8.131	8.165	8.199	8.232	8.266
2.6	8.299	8.333	8.366	8.399	8.432	8.465	8.498	8.530	8.563	8.595
2.7	8.627	8.659	8.691	8.723	8.755	8.787	8.818	8.850	8.881	8.912
2.8	8.943	8.974	9.005	9.036	9.066	9.097	9.127	9.158	9.188	9.218
2.9	9.248	9.278	9.308	9.337	9.367	9.396	9.426	9.455	9.484	9.513
3.0	9.542	9.571	9.600	9.629	9.657	9.686	9.714	9.743	9.771	9.799
3.1	9.827	9.855	9.883	9.911	9.939	9.966	9.994	10.021	10.049	10.076
3.2	10.103	10.130	10.157	10.184	10.211	10.238	10.264	10.291	10.317	10.344
3.3	10.370	10.397	10.423	10.449	10.475	10.501	10.527	10.553	10.578	10.604
3.4	10.630	10.655	10.681	10.706	10.731	10.756	10.782	10.807	10.832	10.857
3.5	10.881	10.906	10.931	10.955	10.980	11.005	11.029	11.053	11.078	11.102
3.6	11.126	11.150	11.174	11.198	11.222	11.246	11.270	11.293	11.317	11.341
3.7	11.364	11.387	11.411	11.434	11.457	11.481	11.504	11.527	11.550	11.573
3.8	11.596	11.618	11.641	11.664	11.687	11.709	11.732	11.754	11.777	11.799
3.9	11.821	11.844	11.866	11.888	11.910	11.932	11.954	11.976	11.998	12.019
4.0	12.041	12.063	12.085	12.106	12.128	12.149	12.171	12.192	12.213	12.234
4.1	12.256	12.277	12.298	12.319	12.340	12.361	12.382	12.403	12.424	12.444
4.2	12.465	12.486	12.506	12.527	12.547	12.568	12.588	12.609	12.629	12.649
4.3	12.669	12.690	12.710	12.730	12.750	12.770	12.790	12.810	12.829	12.849
4.4	12.869	12.889	12.908	12.928	12.948	12.967	12.987	13.006	13.026	13.045
4.5	13.064	13.084	13.103	13.122	13.141	13.160	13.179	13.198	13.217	13.236
4.6	13.255	13.274	13.293	13.312	13.330	13.349	13.368	13.386	13.405	13.423
4.7	13.442	13.460	13.479	13.497	13.516	13.534	13.552	13.570	13.589	13.607
4.8	13.625	13.643	13.661	13.679	13.697	13.715	13.733	13.751	13.768	13.786
4.9	13.804	13.822	13.839	13.857	13.875	13.892	13.910	13.927	13.945	13.962
5.0	13.979	13.997	14.014	14.031	14.049	14.066	14.083	14.100	14.117	14.134
5.1	14.151	14.168	14.185	14.202	14.219	14.236	14.253	14.270	14.287	14.303
5.2	14.320	14.337	14.353	14.370	14.387	14.403	14.420	14.436	14.453	14.469
5.3	14.486	14.502	14.518	14.535	14.551	14.567	14.583	14.599	14.616	14.632
5.4	14.648	14.664	14.680	14.696	14.712	14.728	14.744	14.760	14.776	14.791
5.5	14.807	14.823	14.839	14.855	14.870	14.886	14.902	14.917	14.933	14.948
5.6	14.964	14.979	14.995	15.010	15.026	15.041	15.056	15.072	15.087	15.102
5.7	15.117	15.133	15.148	15.163	15.178	15.193	15.208	15.224	15.239	15.254
5.8	15.269	15.284	15.298	15.313	15.328	15.343	15.358	15.373	15.388	15.402
5.9	15.417	15.432	15.446	15.461	15.476	15.490	15.505	15.519	15.534	15.549

TABLE II (continued)

Voltage Ratio	.00	.01	.02	.03	.04	.05	.06	.07	.08	.09
6.0	15.563	15.577	15.592	15.606	15.621	15.635	15.649	15.664	15.678	15.692
6.1	15.707	15.721	15.735	15.749	15.763	15.778	15.792	15.806	15.820	15.834
6.2	15.848	15.862	15.876	15.890	15.904	15.918	15.931	15.945	15.959	15.973
6.3	15.987	16.001	16.014	16.028	16.042	16.055	16.069	16.083	16.096	16.110
6.4	16.124	16.137	16.151	16.164	16.178	16.191	16.205	16.218	16.232	16.245
6.5	16.258	16.272	16.285	16.298	16.312	16.325	16.338	16.351	16.365	16.378
6.6	16.391	16.404	16.417	16.430	16.443	16.456	16.469	16.483	16.496	16.509
6.7	16.521	16.534	16.547	16.560	16.573	16.586	16.599	16.612	16.625	16.637
6.8	16.650	16.663	16.676	16.688	16.701	16.714	16.726	16.739	16.752	16.764
6.9	16.777	16.790	16.802	16.815	16.827	16.840	16.852	16.865	16.877	16.890
7.0	16.902	16.914	16.927	16.939	16.951	16.964	16.976	16.988	17.001	17.013
7.1	17.025	17.037	17.050	17.062	17.074	17.086	17.098	17.110	17.122	17.135
7.2	17.147	17.159	17.171	17.183	17.195	17.207	17.219	17.231	17.243	17.255
7.3	17.266	17.278	17.290	17.302	17.314	17.326	17.338	17.349	17.361	17.373
7.4	17.385	17.396	17.408	17.420	17.431	17.443	17.455	17.466	17.478	17.490
7.5	17.501	17.513	17.524	17.536	17.547	17.559	17.570	17.582	17.593	17.605
7.6	17.616	17.628	17.639	17.650	17.662	17.673	17.685	17.696	17.707	17.719
7.7	17.730	17.741	17.752	17.764	17.775	17.786	17.797	17.808	17.820	17.831
7.8	17.842	17.853	17.864	17.875	17.886	17.897	17.908	17.919	17.931	17.942
7.9	17.953	17.964	17.975	17.985	17.996	18.007	18.018	18.029	18.040	18.051
8.0	18.062	18.073	18.083	18.094	18.105	18.116	18.127	18.137	18.148	18.159
8.1	18.170	18.180	18.191	18.202	18.212	18.223	18.234	18.244	18.255	18.266
8.2	18.276	18.287	18.297	18.308	18.319	18.329	18.340	18.350	18.361	18.371
8.3	18.382	18.392	18.402	18.413	18.423	18.434	18.444	18.455	18.465	18.475
8.4	18.486	18.496	18.506	18.517	18.527	18.537	18.547	18.558	18.568	18.578
8.5	18.588	18.599	18.609	18.619	18.629	18.639	18.649	18.660	18.670	18.680
8.6	18.690	18.700	18.710	18.720	18.730	18.740	18.750	18.760	18.770	18.780
8.7	18.790	18.800	18.810	18.820	18.830	18.840	18.850	18.860	18.870	18.880
8.8	18.890	18.900	18.909	18.919	18.929	18.939	18.949	18.958	18.968	18.978
8.9	18.988	18.998	19.007	19.017	19.027	19.036	19.046	19.056	19.066	19.075
9.0	19.085	19.094	19.104	19.114	19.123	19.133	19.143	19.152	19.162	19.171
9.1	19.181	19.190	19.200	19.209	19.219	19.228	19.238	19.247	19.257	19.226
9.2	19.276	19.285	19.295	19.304	19.313	19.323	19.332	19.342	19.351	19.360
9.3	19.370	19.379	19.388	19.398	19.407	19.416	19.426	19.435	19.444	19.453
9.4	19.463	19.472	19.481	19.490	19.499	19.509	19.518	19.527	19.536	19.545
9.5	19.554	19.564	19.573	19.582	19.591	19.600	19.609	19.618	19.627	19.636
9.6	19.645	19.654	19.664	19.673	19.682	19.691	19.700	19.709	19.718	19.726
9.7	19.735	19.744	19.753	19.762	19.771	19.780	19.789	19.798	19.807	19.816
9.8	19.825	19.833	19.842	19.851	19.860	19.869	19.878	19.886	19.895	19.904
9.9	19.913	19.921	19.930	19.939	19.948	19.956	19.965	19.974	19.983	19.991

Voltage Ratio	0	1	2	3	4	5	6	7	8	9
10	20.000	20.828	21.584	22.279	22.923	23.522	24.082	24.609	25.105	25.575
20	26.021	26.444	26.848	27.235	27.604	27.959	28.299	28.627	28.943	29.248
30	29.542	29.827	30.103	30.370	30.630	30.881	31.126	31.364	31.596	31.821
40	32.041	32.256	32.465	32.669	32.869	33.064	33.255	33.442	33.625	33.804
50	33.979	34.151	34.320	34.486	34.648	34.807	34.964	35.117	35.269	35.417
60	35.563	35.707	35.848	35.987	36.124	36.258	36.391	36.521	36.650	36.777
70	36.902	37.025	37.147	37.266	37.385	37.501	37.616	37.730	37.842	37.953
80	38.062	38.170	38.276	38.382	38.486	38.588	38.690	38.790	38.890	38.988
90	39.085	39.181	39.276	39.370	39.463	39.554	39.645	39.735	39.825	39.913
100	40.000	—	—	—	—	—	—	—	—	—

To find ratios outside the range of this table, see page 215.

INDEX BY TYPE NUMBER

INDEX

TYPE NUMBER

Type	Name	Page	Type	Name	Page
CAP-22	Three-Wire Power Cord	209	874-B,-BL	Basic Connectors	63
CAP-35	Two-Wire Power Cord	209	874-BM	300-ohm Balanced Termination	73
DNT	Detectors	81	874-C,-CL	Cable Connectors	63
IND	Numerik Indicators	201	874-D20,-D20L, -D50,-D50L	Adjustable Stubs	68
KN	Knobs	205	874-EKA	Slotted-Line Kit	66
M2	Variac® adjustable autotransformers, High-Frequency		874-EL,-EL-L, -JR,-K,-LR, -MB,-ML, -T,-TL,-X,-Y	Coupling Elements	72
	Single Units	194	874-F185,-F500, -F1000, -F2000, -F4000	Filters	68
	Ganged Units	195	874-GA,-GAL, -G3,-G3L, -G6,-G6L, -G10,-G10L, -G20,-G20L	Attenuators	69
M5	Motor-Driven Units	197, 198	874-H500L, -H1000L, -H2000L	Isolators	68
M10	Variac® adjustable autotransformers, High-Frequency		874-L10,-L10L, -L20,-L20L, -L30,-L30L	Rigid Air Lines	71
	Single Units	194	874-LA,-LAL, -LK10, -LK10L, -LK20, -LK20L, -LT,-LTL	Adjustable Lines	71
	Ganged Units	195	874-LBA	Slotted Line	65
	Motor-Driven Units	197, 198	874-LV	Micrometer Vernier	65
M20	Variac® adjustable autotransformers, High-Frequency		874-MR,-MRL	Mixers	67
	Single Units	194	874-PB,-PL, -PRL	Panel Connectors	63
	Ganged Units	195	874-Q	Adaptors	64, 209
	Motor-Driven Units	197, 198	874-R20A, -R20LA, -R22A, -R22LA, -R33,-R34	Patch Cords	70
VB, VBT	Replacement Brushes	186, 187, 195	874-T08,-T058, -TOK	Tool Kits	63
W2	Variac® adjustable autotransformers		874-UBL	Balun and Accessories	73
	Single Units	183-187	874-VC,-VCL	Variable Air Capacitors	68
	Ganged Units	189-193	874-VI	Voltmeter Indicator	67
	Motor-Driven Units	196-199	874-VQ,-VQL	Voltmeter Detectors	67
W5	Variac® adjustable autotransformers		874-VR,-VRL	Voltmeter Rectifiers	67
	Single Units	183-187	874-W50, -W50L, -W100, -W200,-WN, -WN3,-WO, -WO3	Terminations	70
	Ganged Units	189-193	874-XL	Series Inductor	68
	Motor-Driven Units	196-199	874-Z	Stand	73
W8	Variac® adjustable autotransformers		874-ZC	Clamp	73
	Single Units	183-187	900-BT	Precision Connector	75
	Ganged Units	189-193	900-L10,-L15, -L30	Air Lines	77
	Motor-Driven Units	196-199	900-LB	Slotted Line	76
W10	Variac® adjustable autotransformers		900-Q	Adaptors	77
	Single Units	183-187	900-RL	Rigid Line Elements	77
	Ganged Units	189-193	900-TOK	Tool Kit	77
	Motor-Driven Units	196-199	900-W50,-WN, -WO	Terminations	77
W20	Variac® adjustable autotransformers		907	Dials	206
	Single Units	183-187	907-R144	Dial Drive	127
	Ganged Units	189-193	908	Dials	206
	Motor-Driven Units	196-199	908-P1,-P2,-P3, -R96	Dial Drives	127
W30	Variac® adjustable autotransformers		916-AL	RF Bridge	53
	Single Units	183-187	938-A,-C,-D,-P, -R,-W,-WB, -WR	Binding Posts	208
	Ganged Units	189-193	938-BB,-BR, -YB	Insulators	208
	Motor-Driven Units	196-199	938-F	Spacer	208
W50	Variac® adjustable autotransformers		938-J,-X	Jacks	207
	Single Units	183-187	938-L	Shorting Link	208
	Ganged Units	189-193			
	Motor-Driven Units	196-199			
50-P1,-P2	Power Chokes	189			
107	Variable Inductors	164			
109-A	Three-Wire Receptacle	209			
274-J	Jacks	207			
274-NK	Shielded Double Plug	207			
274-NL,-NP	Patch Cords	209			
274-P,-U,-DB, -MB,-SB	Plugs	207			
274-QBJ	Adaptor	209			
301-S104	Delay Line	138			
314-S86	Delay Line	138			
500	Resistors	159			
505	Capacitors	153			
510	Decade Resistance Units	160			
510-P3,-P3L	Switches	161			
544-B	Megohm Bridge	47			
544-P3,-P10	Power Supplies	47			
546-C	AF Microvolter	24			
578	Shielded Transformers	204			
716-C,-CS1	Capacitance Bridges	38, 39			
716-P4	Guard Circuit	39			
805-D	Standard-Signal Generator	120			
805-P2	Termination Unit	121			
838-B	Alligator Clip	208			
874-A2,-A3	Cable	66			

INDEX BY TYPE NUMBER (Cont)

INDEX
TYPE NUMBER

<i>Type</i>	<i>Name</i>	<i>Page</i>	<i>Type</i>	<i>Name</i>	<i>Page</i>
940	Decade Inductance Units	166	1361-A	UHF Oscillator	112-115
941-A	Toroidal Transformer	205	1390-B	Random-Noise Generator	132
970 Series	Potentiometers (Types 971-976)	202	1390-P2	Pink-Noise Filter	133
970-P1,-P2	Potentiometer Dial Plates	203	1391-B	Pulse, Sweep, and Time-Delay Generator	134
980	Decade Capacitance Units	156	1392-A	Time-Delay Generator	137
1000-P4	Dummy Antenna	123	1401	Standard Capacitors	150
1000-P5	VHF Transformer	125	1403	Standard Capacitors	150
1000-P6	Crystal-Diode Modulator	126	1404-A	Standard Capacitor	151
1000-P7	Balanced Modulator	126	1409	Standard Capacitors	152
1000-P10	Test Loop	123	1419	Decade Capacitors	156
1001-A	Standard-Signal Generator	122	1420	Variable Air Capacitors	204
1021-AU,-AV	Standard-Signal Generators	124	1421	Variable Air Capacitors	204
1021-P1	Power Supply and Cabinet	125	1422	Precision Capacitors	148
1021-P2	UHF Oscillator Unit	125	1423-A	Precision Decade Capacitor	154
1021-P3B	VHF Oscillator Unit	125	1424-A	Standard Polystyrene Decade Capacitor	154
1025-A	Standard Sweep-Frequency Generator	128	1424-M	1- μ f Decade Capacitor	155
1025-P1	Detector Probe	128	1429-A	Fuel-Gage Tester	155
1103-B	Synonometer [®] time comparator	90	1432	Decade Resistors	160
1105-B	Frequency-Measuring Assembly	93	1450-TA,-TB	Decade Attenuators	25
1106-A,-B,-C	Frequency-Transfer Units	93	1454-A,-AH	Decade Voltage Dividers	26
1107-A	Interpolation Oscillator	93, 110	1481	Inductors	165
1108-B	Coupling Panel	93	1482	Standard Inductors	163
1109-B	Comparison Oscilloscope	93	1490	Decade Inductors	166
1112-A,-B	Frequency Multipliers	91	1521-A	Graphic Level Recorder	144
1113-A	Standard-Frequency Oscillator	88	1521-P1,-P2,		
1114-A	Frequency Divider	89	-P3,-P4	Recorder Potentiometers	145
1114-P6,-P7	Plug-In Units	89	1521-P10B	Recorder Drive Unit	145
1116-B	Emergency Power Supply	90, 176	1521-P14	Recorder Link Unit	145
1120-A,-AB,-AH	Frequency Standards	86	1521-P20,-P22	Recorder Motors	145
1130-A	Digital Time and Frequency Meter	96	1521-4092,-4093	Recorder Ink	145
1130-P	Time-Base Plug-In Units	97	1521-9427 to		
1133-A	Frequency Converter	98	9493	Recorder Charts	145
1134-A	Digital-to-Analog Converter	99	1531-A	Strobotac [®] electronic stroboscope	169
1136-A	Digital-to-Analog Converter	99	1531-P1	Strobotron Lamp	169
1137-A	Printer	100	1531-P2	Flash Delay	170
1142-A	Frequency Meter and Discriminator	101	1531-P3	Surface-Speed Wheel	170
1150-A,-AP	Digital Frequency Meters	94	1532-D	Strobolume	171
1151-A,-AP	Digital Time and Frequency Meters	95	1532-P1	Replacement Lamp	171
1201-B	Unit Regulated Power Supply	173	1532-P2B	Transformer Cable	171
1203-B	Unit Power Supply	173	1532-P3	Trigger Cable	171
1205-B	Adjustable Regulated Power Supply	172	1535-B	Contactors	171
1206-B	Unit Amplifier	22	1535-P5	Adaptor	171
1208-C	Unit Oscillator	112-115	1536-A	Photoelectric Pickoff	170
1209-C,-CL	Unit Oscillators	112-115	1551-C	Sound-Level Meter	4
1210-C	Unit RC Oscillator	105	1551-P1H,-P1L	Condenser Microphone Systems	6
1211-C	Unit Oscillator	112-115	1551-P2	Carrying Case	4
1212-A	Unit Null Detector	80	1552-B	Sound-Level Calibrator	8
1212-P1,-P2	Filters	80	1553-A,-AK	Vibration Meters	10
1212-P3	Mixer	80	1555-A	Sound-Survey Meter	3
1213-D	Unit Time/Frequency Calibrator	92	1555-P2	Carrying Case	3
1214-A,-D,-M	Oscillators	110	1556-B	Impact-Noise Analyzer	20
1215-C	Unit Oscillator	112-115	1557-A	Vibration Calibrator	12
1216-A	Unit I-F Amplifier	82	1558-A,-AP	Octave-Band Noise Analyzers	18
1217-B	Unit Pulse Generator	136	1559-A	Microphone Reciprocity Calibrator	9
1217-P2	Single-Pulse Trigger	136	1560-P3	PZT Microphone	5
1218-A	Unit Oscillator	112-115	1560-P4	PZT Microphone Assembly	18
1220-A	Unit Klystron Oscillator	118	1560-P11B	Vibration Pickup System	7
1230-A,-AE	Electrometer and DC Amplifier	140	1560-P21B	Control Box	7
1230-P1	Component Shield	141	1560-P31	Carrying Case	8
1232-A	Tuned Amplifier and Null Detector	79	1560-P34	Tripod and Extension Cable	7
1232-P1	Mixer	79	1560-P35	Permanent-Magnet Clamp	10
1233-A	Power Amplifier	23	1560-P41	Audio-Frequency Voltage Probe	17
1262-B	Power Supply	177	1560-P52	Vibration Pickup	7
1263-B	Amplitude-Regulating Power Supply	174	1560-P73,-P73B	Extension Cables	7
1264-A	Modulating Power Supply	175	1560-P95	Connecting Cable	4
1264-P1,-P2	Adaptor Cables	175	1564-A	Sound and Vibration Analyzer	16
1265-A	DC Power Source	177	1570	Automatic Voltage Regulator	178
1266-A	AC Power Source	177	1590-A	Remote Control	200
1267-A	Unit Power Supply	173	1602-B	UHF Admittance Meter	54
1268-A	Automatic Battery Charger	176	1603-A	Z-Y Bridge	31
1268-P1	Battery Drawer	176	1605-A,-AH	Impedance Comparators	50
1268-9602	Battery	176	1606-A	RF Bridge	52
1269-A	Unit Regulated Power Supply	173	1606-P1	Carrying Case	53
1300-A	Beat-Frequency Video Generator	130	1607-A	Transfer-Function and Immittance Bridge	56
1304-B	Beat-Frequency Audio Generator	106	1607-P	Tube and Transistor Mounts	57
1305-A	Low-Frequency Oscillator	104	1608-A	Impedance Bridge	32
1307-A	Transistor Oscillator	8	1610-AH,-B,-B2	Capacitance-Measuring Assemblies	40
1308-A	Audio Oscillator and Power Amplifier	108	1611-B	Capacitance Test Bridge	42
1311-A	Audio Oscillator	109	1613-A	Capacitance Bridge	43
1330-A	Bridge Oscillator	111	1615-A	Capacitance Bridge	36
1360-A	Microwave Oscillator	117	1615-P1	Range-Extension Capacitor	37

INDEX BY TYPE NUMBER (Cont)

INDEX
SUBJECT AND TITLE

Type	Name	Page	Type	Name	Page
1620-A	Capacitance-Measuring Assembly	37	1700, 1701,		
1630-AL,-AV	Inductance-Measuring Assemblies	45	1702, 1703	Variac® motor-speed controls	180
1632-A	Inductance Bridge	46	1702-P3	Switch	180
1633-A	Incremental-Inductance Bridge	44	1705-P1	Drum Controller	180
1633-P1	Range-Extension Unit	44	1750-A	Sweep Drive	127
1640-A	Slotted Line Recorder System	76	1806-A	Electronic Voltmeter	142
1650-A	Impedance Bridge	34	1806-P1	Tee Connector	142
1650-P1	Test Jig	35	1840-A	Output Power Meter	143
1652-A	Resistance Limit Bridge	49	1862-C	Megohmmeter	48
1661-B	Vacuum-Tube Bridge	58	1900-A	Wave Analyzer	14
1690-A	Dielectric Sample Holder	41	1900-P1	Recorder Link Unit	15, 145
1690-P2	Adaptor Assembly	41	1932-A	Distortion and Noise Meter	21

INDEX BY SUBJECT AND TITLE

	Page		Page		Page
A bbreviations and Symbols	214	Banana Plugs	207	Capacitors, Air	148, 150, 204
Absorption Modulator	126	Bar Knobs	205	Decade	154, 156
AC Power Supplies	172-175	Basic Connector, Coaxial	63, 75	Fixed	152, 153
Acoustical Instruments	1-20	Basic Motor Speed Controls	180	Mica	152, 153
Adaptors, Binding Post	209	Battery Charger for Frequency Standard	90, 176	Paper	154, 156
Coaxial	64	Beat-Frequency Audio Generator	106	Polystyrene	154, 156
Precision Coaxial	77	Beat-Frequency Video Generator	130	Precision	148, 151
Adjustable, Attenuator, Coaxial	69	Binding Posts	208	Range-Extension	37
Adjustable autotransformers, Variac®	183-200	Binding-Post Adaptors	209	Standard	148-152
Adjustable Lines, Coaxial	71	Binding-Post Insulators	208	Three-Terminal	148, 151, 154-156
Adjustable Regulated Power Supply	172	Binding-Post Shorting Link	208	Two-Terminal	148, 150, 152-156
Adjustable Stubs, Coaxial	68	Binding-Post Spacer	208	Variable Air	68, 148, 204
Admittance Bridge, AF	31	Bridges, AC Limit	50	Variable, Coaxial	68
Admittance Meter, UHF	54, 56	Admittance	31, 54, 56	Charts, Reactance	212
Air Capacitors, Precision	148	Antenna-Measuring	52-57, 65, 76	Recorder	145
Standard, Fixed		Audio-Frequency	31-46	Smith	65
Three-Terminal	150, 151	Capacitance	36, 38, 42, 43	Choke, Power, Current Limiting	189
Two-Terminal	150, 151	Coaxial	54, 56	Clamp, Permanent-Magnet	10
Variable	68, 148, 204	Conductance, UHF	54, 56	Clamps, Universal, for Coaxial Systems	73
Air Lines, Coaxial	71	DC Limit	47, 49	Clip, Alligator	208
Precision Coaxial	77	High-Resistance	47	Cliplock, Coaxial	72
Airplane-Fuel-Gage Tester	154	Immittance	56	Clock, Synchronous Motor	90
Alligator Clip	208	Impedance	31, 32, 34	Coaxial Adaptors	64, 77
Amplifiers, Audio-Frequency	22, 23, 79	Impedance Comparator	50	Air Lines	71, 77
DC	140	Incremental-Inductance	44	Attenuators	69
Intermediate-Frequency	82	Inductance	44, 46	Balun	73
Power	23, 108	Insulation Resistance	47	Cable	66
Radio-Frequency	23	Megohm	47, 48	Connectors	63, 75
Tuned	79	Precision Inductance	46	Coupling Elements	72
Amplitude Modulators	126	Radio-Frequency	38, 52, 53	Filters	68
Amplitude-Regulating Power Supply	174	Reactance	31, 52, 53	Instruments	54, 56, 65, 76
Analog Frequency Meter	101	Resistance, dc, ac	32, 34, 47-49, 52	Isolators	68
Analyses, Continuous Spectrum	14, 16	Resistance-Limit	49	Mixers	67
Distortion	21	Susceptance	31, 54, 56	Patch Cords	70
Electric Wave	14	Transfer-Function	56	Slotted Lines	65, 76
Harmonic	14, 16	Transistor	56, 58	Stand	73
Impact-Noise	20	UHF	54, 56	Terminations	70, 77
Noise	14, 16, 18, 20	Universal	31-35	Tuning Elements	68
Octave-Band Noise	18	Vacuum-Tube	58	Voltmeters	67
One-Third Octave	16	VHF	54, 56	Comparator, Impedance	50
Sound and Vibration	16	Z-Y	31	Comparison Bridges	49, 50
Waveform	14	Bridge Detectors	79-82	Comparison Oscilloscope	93
Antenna, Dummy	123	Bridge Guard Circuit	39	Component Mounts, Coaxial	72
Antenna-Measuring Equipment	52-57, 65	Bridge Power Sources	102-118, 177	for Transfer-Function Bridge	57
Attenuators, Coaxial, Adjustable and Fixed	69	Bridge Transformer	204	Component Shield for Electrometer	141
Decade, Precision	25	Broad-Band Modulator	126	Condenser Microphone System	6
Microvolter	24	Brushes, Replacement, Variac®	183-200	Connectors, Coaxial	63, 75
Audio-Frequency Bridges	31-46	C abinets, Instrument	210	Contact, Stroboscopic	171
Audio-Frequency Microvolter	24	Cable, Coaxial	66	Control, Remote	200
Audio-Frequency Oscillators	104-110	Cable, Extension, and Tripod	7	Controls, Motor Speed	180
Audio-Frequency Voltage Probe	17	Cable Connectors, Coaxial	63	Conversion Tables, Decibel	215
Audio Generator, Beat-Frequency	106, 136	Calibrator, Frequency	92	Converters, Digital-to-Analog	99
Automatic Sweep Drive	127	Fuel-Gage	155	Frequency	98
Automatic Voltage Regulators	178	Fuel-Gage-Tester	43	Cords, Patch	70, 209
Autotransformers, adjustable, Variac®	183-200	Microphone Reciprocity	9	Power	209
B alanced-Line Terminations	73	Sound-Level	8	Counters, Frequency	94-97
Balanced Modulator	126	Time/Frequency	92	Coupling Capacitor, Coaxial	72
Balun, Coaxial	73	Vibration	12	Coupling Elements, Coaxial	72
Balun Accessories	73	Capacitance Bridges	36, 38, 42, 43	Coupling Panel	93
		Capacitance-Bridge Guard Circuit	38	Coupling Probe, Coaxial	72
		Capacitance-Measuring Assemblies	36, 40	Crystal-Diode Modulator	126
				Crystal Oscillators	88, 92

INDEX BY SUBJECT AND TITLE (Cont)

	Page		Page		Page
D ata Printer	100	Generators (Cont)		Metered Variac® autotransformers	188
DC Amplifier and Electrometer	140	Pulse	134, 136	Meters, Admittance, UHF	54, 56
DC Power Source for Inductance		Random-Noise	132	Digital Time and Frequency	94-97
Bridge	177	Sine-Wave	104-131	Frequency	94-97, 101
DC Recorder	144	Square-Wave	105, 134, 136	Megohm	48, 140
Decade Attenuator, Precision	25	Standard-Frequency	93	Millivolt	140
Decade Capacitors, Mica	154, 156	Standard-Signal	120-129	Noise and Distortion	21
Paper	155, 156	Sweep-Voltage	134	Output Power	143
Polystyrene	154, 156	Sweep-Frequency	128, 130	Sound-Level	4
Precision	154	Time-Delay	134, 137	Sound-Survey	3
Standard	154	Three-Phase	104	Teraohm	140
Three-Terminal	154-156	Video-Frequency	130	UHF Admittance	54
Two-Terminal	154-156	Graphic Level Recorder	144	Electronic Voltmeter	142
Decade Inductors	166	Guard Circuit for Capacitance Bridge	38	Vibration	10
Decade Resistors	160	H andbook of Noise Measurement	12	Micrometer Vernier	65
Decade Voltage Divider	26	Harmonic Analyzers	14, 16	Microphone Assembly, PZT	18
Decibel Conversion Tables	215	Heterodyne Detectors	79, 80, 81	Microphone Extension Cable and Tripod	7
Delay Generator, Time	134, 137	High-Intensity Stroboscope	171	Microphone Reciprocity Calibrator	9
Delay Lines, Variable	138	High-Level Microphone	6	Microphone, PZT	5, 18
Delay, Flash	170	High-Speed Light Sources	169, 171	Microphone System, Condenser	6
Detectors, Bridge	79-81	I mmittance and Transfer-Function		Microvolter, Audio-Frequency	24
Heterodyne	79-81	Bridge	56	Microwave Oscillators	114, 117, 118
Null	79, 80	Impact-Noise Analyzer	20	Militarized Voltage Regulator	178
Voltmeter	67	Impedance Bridges	27-57	Mixers, Coaxial	67
Dials, Gear-Drive, Precision	206	Impedance-Bridge Test Jig	35	Radio-Frequency	79, 80
Dial Drives	127	Impedance Comparator	50	Modulating Power Supply	175
Dial Plates, Potentiometer	202	Impedance-Matching Transformer	205	Modulators	110
Dielectric Measuring Bridges	36-40	Incremental-Inductance Bridge	44	Amplitude	126, 175
Dielectric Sample Holder	41	Indicators, Numerik	201	Balanced	126
Digital-to-Analog Converters	99	Inductance Bridges	44, 46	Crystal-Diode	126
Digital Frequency Meter	94	Inductance-Measuring Assembly	45	Pulse	126, 175
Digital Indicators, Numerik	201	Inductors, Decade	165, 166	Motor-Driven Variac® autotransformers	196-199
Digital Time and Frequency Meters	94-96	Fixed	163, 165	Motor Drives, Dial	127
Diode Modulator, Crystal	126	Series, Coaxial	68	Motor Speed Controls	180
Direct-Current Amplifier	140	Standard	163	Multipliers, Frequency	91
Discriminator and Frequency Meter	101	Variable	164	Mutual-Inductance Standard	164
Distortion Analyzer	14	Ink, for Recorder	145	N oise Analyzers	14, 16, 18, 20
Distortion and Noise Meter	21	Insertion-Loss Modulator	126	Noise and Distortion Meter	21
Dividers, Frequency	89	Insertion Unit, Coaxial	72	Noise Generator	132
Voltage	26	Instrument Cabinets	210	Null Detectors	79-81
Drives, Dial	127	Interpolation Oscillator	93, 110	Numerik Indicators	201
Drives, Sweep	127	Insulated Plugs	207	O ctave-Band Noise Analyzer	18
Drive Unit for Recorder	145	Insulators, Panel Terminal	208	Ohmmeter	142
Drum Controller for Motor Speed		Intermediate-Frequency Amplifier, Unit	82	Oscillators, Audio	105-110
Controls	180	Isolators, Coaxial	68	Beat-Frequency	106, 130
Dummy Antenna for Signal Generators	123	J acks and Plugs	207	Four-Phase	104
E lectrometer	140	Jig, Test, for Impedance Bridges	35	Interpolation	110
Electronic Voltmeter	142	K it, Slotted Line	65	Klystron	117, 118
EH, Coaxial	72	Tool, for Coaxial Connectors	63, 77	Low-Frequency	104
Emergency Power Supply	90, 176	Klystron Oscillator	117, 118	Microwave	115, 117, 118
Extension Cable and Tripod	7	Klystron Power Supply	118	Radio-Frequency	111-115
F emtoammeter	140	Klystron Tubes	118	Standard-Frequency	88
Filters, Coaxial	68	Knobs	205	Super-High-Frequency	118
Pink-Noise	133	L evel Recorder, Graphic	144	Three-Phase	104
Fixed Attenuators, Coaxial	69	Limit Bridges	49, 50	UHF	112-115, 117, 118
Flash Delay	170	Lines, Delay	138	Unit	105, 110, 112-115
Frequency Changer	108	Slotted	65, 76	Variable-Phase	104
Frequency Converter	98	Variable Delay	138	VHF	112-115
Coaxial	67	Line Elements, Coaxial	71, 77	Oscillator and Power Amplifier	108
Frequency Counters, Digital	94-97	Line Stretchers, Coaxial	71	Oscillator Relay-Rack Adaptor	
Frequency Divider	89	Line-Voltage Regulators	178	Panels	116
Frequency-Measuring Assembly	93	Link Units for Recorder	145	Oscillator Sweep Drive	127
Frequency Meter, Analog	101	Locking Connectors, Coaxial	63	Oscilloscope, Comparison	93
Digital	94-97	Loop, Test, for Signal Generators	123	Output Power Meter	143
Heterodyne	93	Low-Frequency Oscillator	104	P ads, Attenuator, Coaxial	69
Frequency Multipliers	91	Low-Pass Filters, Coaxial	68	Panel Connectors, Coaxial	63
Frequency Oscillator	88	M atched Terminations, Coaxial	70, 77	Panel Terminal Insulator	208
Frequency Standard	86, 92	Measuring Assemblies, Capacitance	37, 40	Parts and Accessories	201-209
Frequency-Transfer Units	93	Frequency	93	Patch Cords	70, 209
Fuel-Gage Tester	155	Inductance	45	Period Meters, Digital	95, 96
Fuel-Gage-Tester Calibrator	43	Mechanical Sweep Drives	127	Permanent-Magnet Clamp	10
G anged Variac® autotransformers	189-193	Megohm Bridge	47	Photoelectric Pickoff	170
Gear-Drive Precision Dials	206	Megohmmeter	48	Pickup System, Vibration	7
Generators, Audio	105-110			Pink-Noise Filter	133
Beat-Frequency	106, 130			Plugs and Jacks	207
				Polyethylene Cable	70

INDEX BY SUBJECT AND TITLE (Cont)

INDEX
SUBJECT AND TITLE

	Page		Page		Page
Polystyrene Decade Capacitor	154	Shield, Component, for Electrometer	141	Transformers (Cont.)	
Potentiometers	202	Shielded Transformer	204	Shielded	204
Potentiometer Dial Plates	202	Signal Generators, Standard	120-125	Toroidal	205
Power Amplifier	23, 108	Signal-Generator Dummy Antenna	123	VHF, for Signal Generators	125
Power Chokes for Variac® autotransformers	189	Signal-Generator Modulators	126	Trigger, Single-Pulse	136
Power Cords	209	Signal-Generator Test Loop	123	Tripod and Extension Cable	7
Power Meter, Output	143	Signal-Generator VHF Transformer	125	Tubes, Klystron	118
Power Pack for Sound-Level Meter	177	Single-Pulse Trigger	136	Tuned Amplifier and Null Detector	79
Power Supplies, Adjustable	172	Slotted Lines	65, 76	Tuning Elements, Coaxial	68
Amplitude-Regulating	174	Slotted-Line Accessories	66	Two-Terminal Capacitors	146-157
DC	172	Slotted Line Recorder System	76		
Emergency	90, 176	Smith Charts	65	UHF Admittance Meter	54
Frequency-Standard	90, 176	Sound and Vibration Analyzer	16	UHF Coaxial Equipment	54-57, 59-77
Klystron	118	Sound-Level Calibrator	8	UHF Oscillators	112-117
Megohm-Bridge	47	Sound-Level Meter	4	UHF Standard-Signal Generator	124
Modulating	175	Sound-Level-Meter Accessories	7	Unit Amplifier	22
Regulated	172, 173	Sound-Survey Meter	3	Unit Crystal Oscillator	92
Unit	173	Spectrum Analyzer	14	Unit I-F Amplifier	82
Precision Capacitors	148, 151	Speed Controls, Motor	180	Unit Instruments	22, 80, 82, 92, 105, 110, 112-115, 118, 136, 173
Precision Coaxial Adaptors	77	Square-Wave Generators	105, 134, 136	Unit Klystron Oscillator	118
Precision Coaxial Air Lines	77	Standards, Capacitors	150, 152, 154	Unit Null Detector	80
Precision Coaxial Connectors	75	Frequency	86, 92	Unit Oscillators	105, 110, 112-115
Precision Coaxial Slotted Line	76	Inductance	163	Unit RC Oscillator	105
Precision Coaxial Terminations	77	Mutual Inductance	164	Unit Power Supplies	173
Precision Decade Attenuator	25	Standard-Frequency Multipliers	91	Unit Pulse Generator	136
Precision Decade Capacitor	154	Standard-Frequency Oscillator	88	Unit Regulated Power Supplies	173
Precision Dials	206	Standard-Signal Generators	120-124	Universal Bridges	31, 32, 34
Precision Impedance Bridge	32	Standard Sweep-Frequency Generator	128		
Primary Frequency Standard	86	Strobolum	171	Vacuum-Tube Bridge	58
Primer of Noise Measurement	12	Stroboscope	169	Vacuum-Tube Voltmeter	142
Printer, Data	100	High-Intensity	171	Variable Air Capacitors	68, 148, 204
Probes, Audio-Frequency Voltage	17	Stroboscope Flash Delay	170	Variable Capacitor, Coaxial	68
Detector, for Sweep-Frequency		Stroboscope Photoelectric Pickoff	170	Variable Delay Lines	138
Generator	128	Stroboscope Surface-Speed Wheel	170	Variable Inductor	164
Pulse Generators	134, 136	Stroboscopic Contactor	171	Variable Power Supplies	172
Pulse Trigger	136	Strobotac® electronic stroboscope	169	Variable Resistors	202
PZT Microphone	5	Strobotron Lamp	169	Variac® adjustable	
PZT Microphone Assembly	18	Stub, Adjustable, Coaxial	68	autotransformers	183-200
Radiating Line, Coaxial	72	Surface-Speed Wheel	170	Ball Bearings	200
Radio-Frequency Bridges	52	Survey Meter, Sound	3	Ganged Models	189-193
Radio-Frequency Mixers	79, 80	Sweep Drive	127	Metered Models	188
Radio-Frequency Oscillators	111-115	Sweep-Frequency Generator, Standard	128	Motor-Driven Models	196-199
Random-Noise Generator	132	Sweep Generator, Voltage	130, 134	M-Series	194
Range-Extension Capacitor	37	Sweep Oscillator, Frequency	130	Power Chokes	189
Range-Extension Unit for Inductance Bridge	45	Switches, Decade-Resistor	160	Remote Control	200
RC Oscillator, Unit	105	Motor-Speed-Control	180	Replacement Brushes	186, 187, 195
Reactance Charts	212	Symbols and Abbreviations	214	Special Models	200
Receptacle, Three-Wire	209	Synchronous Dial Drives	127	Three-Phase	189
Reciprocity Calibrator	9	Synchronous Motor Clock	90	W-Series	183-187
Recorder Charts	145	Synonometer® time comparator	90	Variac® line-voltage regulators	178
Recorder, DC	144	Tables , Decibel Conversion	215	Variac® motor-speed controls	180
Graphic Level	144	Tachometer, Stroboscopic	169	Variometer	164
Recorder Drive Unit	145	Tee, Coaxial	72	Vernier, Micrometer, for Slotted Line	65
Recorder Ink	145	Teraohmmeter	140	VHF Coaxial Equipment	59-77
Recorder Link Units	145	Terminations, Balun	73	VHF Oscillators	112-115
Recorder Motors	145	Coaxial	70, 77	VHF Standard-Signal Generator	124
Recorder System, Slotted Line	76	Termination Unit for Standard-Signal Generator	121	VHF Transformer	125
Rectifiers, Mixer	67	Test Bridge, Capacitance	42	Vibration and Sound Analyzer	16
Voltmeter	67	Test Jig for Impedance Bridges	35	Vibration Calibrator	12
Regulated Power Supplies	172, 173	Test Loop for Signal Generators	123	Vibration Meter	10
Regulators, Line-Voltage	178	Tester, Fuel-Gage	155	Vibration Pickup	7
Military	178	Three-Terminal Capacitors	146-157	Video Generator, Beat-Frequency	130
Relay-Rack Adaptor Panels for Oscillators	116	Three-Wire Power Cord	209	Voltage Divider	25
Remote Control for Variac® autotransformers	200	Three-Wire Receptacle	209	Decade	26
Resistance Bridges	47, 49	Time-Base Plug-In Units	97	Rheostat	202
Resistance Meters, Megohm	48, 140	Time Comparator for Frequency Standard	90	Voltage Probe, Audio-Frequency	17
Resistors, Decade	160	Time-Delay Generators	134, 137	Voltage Regulators, Automatic	178
Fixed	159	Time/Frequency Calibrator	92	Military	178
Variable	202	Time and Frequency Meters, Digital	94-97	Voltmeter, AC	142
Rheostat	202	Tool Kits for Coaxial Connectors	63, 77	Coaxial	67
Voltage Divider, Decade	26	Toroidal Transformer	205	DC	142
Rigid-Line Adaptors, Coaxial	64	Tracking Analyzer	14	Electronic	142
Rotary Joint, Coaxial	72	Transfer-Function and Immittance Bridge	56	Vacuum-Tube	142
S ample Holder, Dielectric	41	Transformers, Adjustable	183-200	Voltmeter Detector, Coaxial	67
Secondary Frequency Standard	92	Bridge	204	Voltmeter Indicator	67
Series Inductor, Coaxial	68	Impedance-Matching	205	Voltmeter Rectifier, Coaxial	67
				Wave Analyzer	14
				Waveform-Measuring Instruments	14, 21
				Z-Y Bridge	31