

**OPERATING AND MAINTENANCE
INSTRUCTIONS**

**TYPE 650-A
IMPEDANCE BRIDGE
and
TYPE 650-P1
OSCILLATOR -AMPLIFIER**

Form 346-1
May, 1957

GENERAL RADIO COMPANY

**275 MASSACHUSETTS AVENUE
CAMBRIDGE 39 MASSACHUSETTS**

SALES ENGINEERING OFFICES

**NEW YORK: Broad Avenue at Linden
Ridgefield, New Jersey**

**CHICAGO: 920 South Michigan Avenue
Chicago 5, Illinois**

**PHILADELPHIA: 1150 York Road
Abington, Pennsylvania**

**WASHINGTON: 8055 13th Street
Silver Spring, Maryland**

**LOS ANGELES: 1000 North Seward Street
Los Angeles 38, California**

**SAN FRANCISCO: 1182 Los Altos Avenue
Los Altos, California**

REPAIR SERVICES

WEST COAST

**Western Instrument Company
826 North Victory Boulevard
Burbank, California**

EAST COAST

**General Radio Company
Service Department
275 Massachusetts Avenue
Cambridge 39, Massachusetts**

CANADA

**Bayly Engineering, Ltd.
First Street
Ajax, Ontario**

TABLE OF CONTENTS

	Page
Section 1.0 Introduction	1
1.1 General	1
Section 2.0 Installation	2
2.1 Accessories Supplied	2
2.2 Accessories Required	2
2.3 Power Supply	2
Section 3.0 Measurements in the Direct-Reading Range	2
3.1 Direct-Current Resistance Measurements	2
3.2 Alternating-Current Resistance Measurements	3
3.3 Capacitance Measurements	3
3.4 Inductance Measurements	4
3.5 Summary	5
Section 4.0 Other Measurements	5
4.1 Accessories	5
4.2 Voltage Limits	6
4.3 Ground-Capacitance Errors	8
4.4 Extension of Range	8
4.5 Special Applications	9
Section 5.0 Electrical Circuits	10
5.1 General	10
5.2 Resistance Measurements	11
5.3 Capacitance Measurements	11
5.4 Inductance Measurements	11
5.5 References	11
Section 6.0 Type 650-P1 Oscillator-Amplifier	11
6.1 General	11
6.2 Directions for Installation	11
6.3 Operating Instructions	12
Service and Maintenance Notes for the Type 650-A Impedance Bridge	13
Service and Maintenance Notes for the Type 650-P1 Oscillator-Amplifier	16
Vacuum-Tube Data	19
Wiring Diagram for the Type 650-P1	21
Wiring Diagram for the Type 650-A	25

View of the
 Type 650-P1 Oscillator-Amplifier
 Installed in the Battery
 Compartment of the
 Type 650-A Impedance Bridge

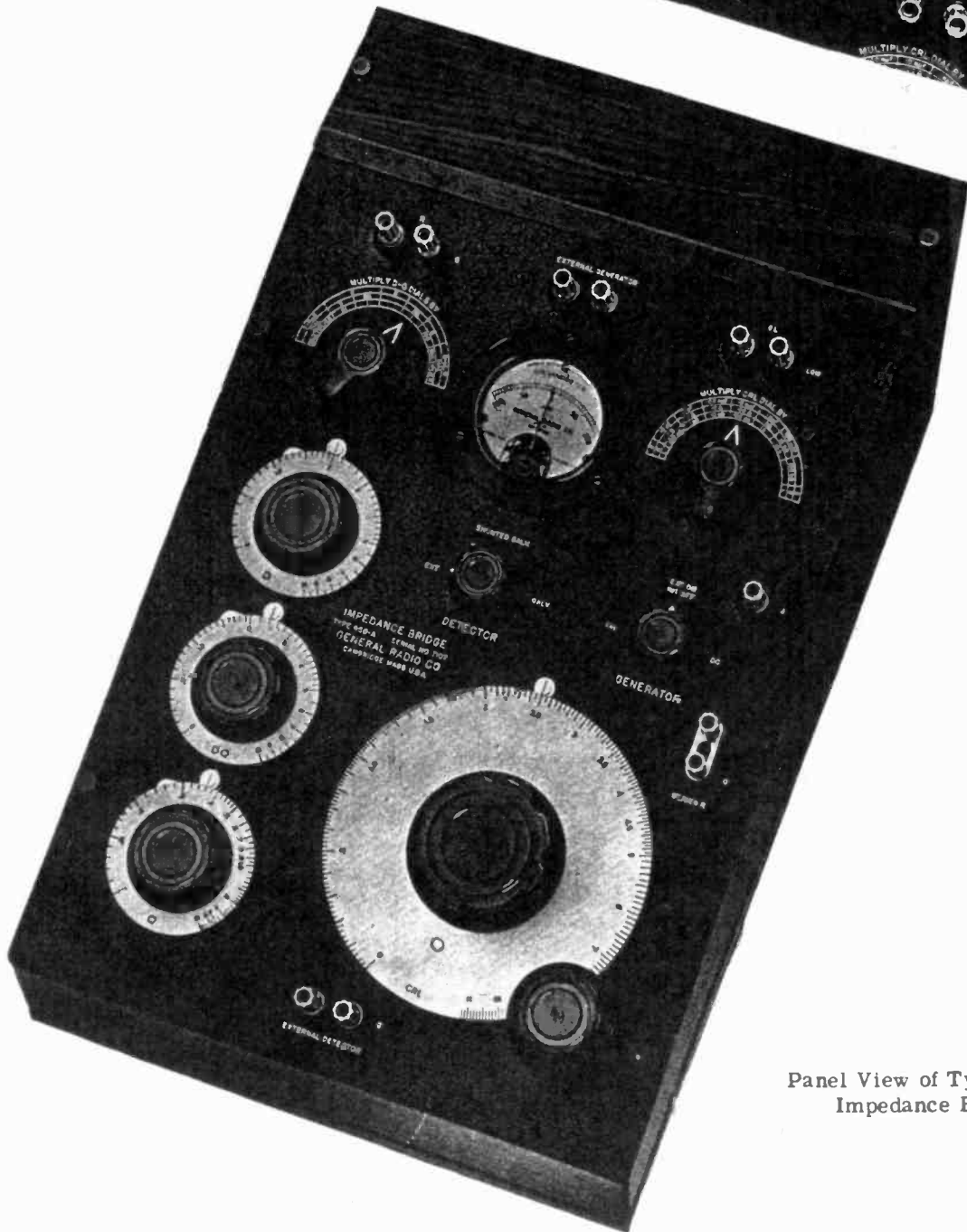
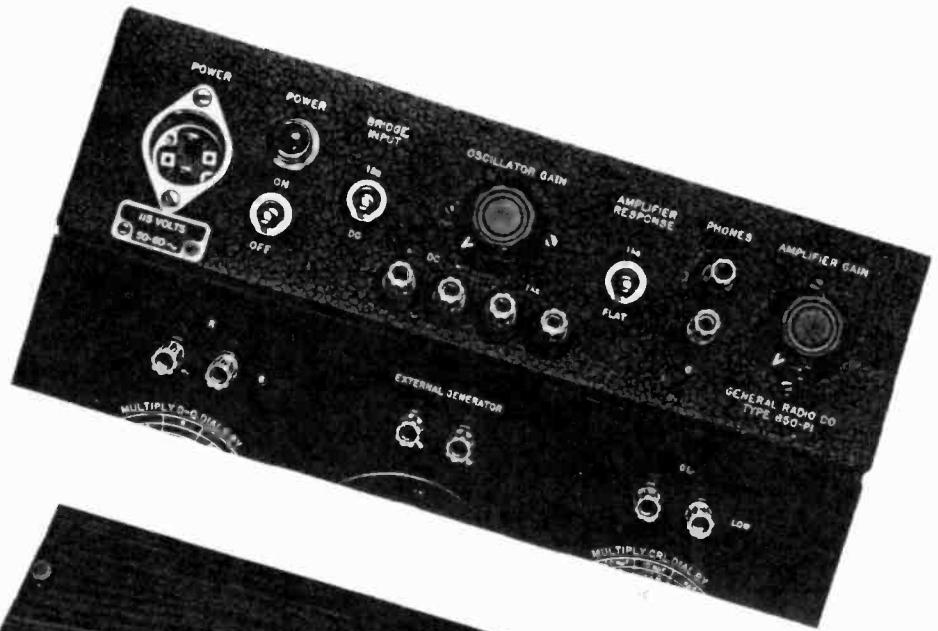

Panel View of Type 650-A
 Impedance Bridge

OPERATING INSTRUCTIONS

for

TYPE 650-A IMPEDANCE BRIDGE

and

TYPE 650-P1 OSCILLATOR - AMPLIFIER

SECTION 1.0 INTRODUCTION

1.1 GENERAL

The Type 650-A Impedance Bridge is a direct-reading, self-contained bridge for making the following types of measurements rapidly and conveniently:

- a) Resistors
 - 1. Direct-current resistance
 - 2. Alternating-current resistance at 1 kc
- b) Capacitors
 - 1. Capacitance at 1 kc
 - 2. Dissipation factor ($D = R\omega C$) at 1 kc
- c) Inductors
 - 1. Inductance at 1 kc
 - 2. Storage factor ($Q = \frac{\omega L}{R}$) at 1 kc

1.2 RANGE AND ACCURACY

The ranges over which measurements can be made with the accuracies that can be expected in normal use are summarized in Table I.

1.3 SYMBOLS AND ABBREVIATIONS

The following symbols and abbreviations used on the bridge and in this instruction book are those adopted

by the American Standards Association. Table II shows the significance of these symbols.

TABLE II
RESISTANCE

- 1 Ω = 1 ohm
- 1 $k\Omega$ = 1 kilohm = 1000 ohms = .001 $M\Omega$
- 1 $M\Omega$ = 1 megohm = 1,000,000 ohms = 1000 $k\Omega$
- 1 $m\Omega$ = 1 milliohm = 0.001 ohm

CAPACITANCE

- 1 μf = 1 microfarad
- 1 $m\mu f$ = 1 millimicrofarad = 0.001 μf = 1000 $\mu\mu f$
- 1 $\mu\mu f$ = 1 micromicrofarad = $1 \times 10^{-6} \mu f$ = 0.001 $m\mu f$

INDUCTANCE

- 1 h = 1 henry
- 1 mh = 1 millihenry = 0.001 henry = 1000 μh
- 1 μh = 1 microhenry = 0.001 mh

FREQUENCY

- 1 kc = 1 kilocycle per second = 1000 cycles

TABLE I

QUANTITY	RANGE		ERROR*	
	MINIMUM	MAXIMUM	MINIMUM	MAXIMUM
Resistance	1 $m\Omega$	1 $M\Omega$	1% or 2 $m\Omega$	2%
Capacitance	1 $\mu\mu f$	100 μf	1% or 2 $\mu\mu f$	2%
Dissipation Factor	.002	1	5% or .005	20% #
Inductance	1 μh	100 h	2% or 2 μh	10%
Storage Factor	.02	1000	5% or .5	20% #

* These values define the limits between which the error will lie. For a discussion of the accuracies obtainable under various conditions of measurement, see Section 3.0.

This value may be exceeded over a small portion of the range of the instrument. See Section 3.0.

GENERAL RADIO COMPANY

SECTION 2.0 INSTALLATION

2.1 ACCESSORIES SUPPLIED

The following accessories are supplied with each Type 650-A Impedance Bridge:

- 3 spade-tipped connectors for interconnecting dry cells
- 4 No. 6 dry cells

2.2 ACCESSORIES REQUIRED

The following accessories are required in order to operate the bridge:

1 pair head telephones for a-c measurements (Brush Model A or equivalent in sensitivity and resistance).

2.3 POWER SUPPLY

The bridge is designed for battery operation. For a-c operation, the Type 650-P1 Oscillator-Amplifier is available, which supplies either 1-kc or d-c power to the bridge circuit, and provides an amplifier of approximately 45 db gain for increasing the bridge sensitivity. The following instructions apply to the battery-

operated bridge and, in general, to the a-c operated combination. When the Type 650-P1 Oscillator-Amplifier is used, however, the instructions detailed in SECTION 6 should be followed.

2.31 Batteries: To install the four dry cells in the compartment at the back of the cabinet proceed as follows:

(1) Turn the GENERATOR switch to the EXT. ON INT. OFF position.

(2) Remove the cover.

(3) Install the four dry cells.

(4) Connect cells in series by means of the spade-tipped connectors and connect the terminals of the combination to the two spade-tipped leads. The red lead is positive, the black, negative.

(5) Replace cover.

The bridge is now ready for operation.

2.32 A-C Power Supply (Type 650-P1 Oscillator-Amplifier): See SECTION 6 for Installation.

SECTION 3.0

MEASUREMENTS IN THE DIRECT-READING RANGE (BATTERY OPERATION)*

3.1 DIRECT-CURRENT RESISTANCE MEASUREMENTS

3.11 Procedure: To make direct-current resistance measurements, proceed in the following manner:

(1) Check the zero of the galvanometer, setting the pointer exactly to zero by means of the zero adjusting screw.

(2) Set DETECTOR switch to SHUNTED GALV.

(3) Set GENERATOR switch on DC.*

(4) Set D-Q multiplier switch on R.

(5) Connect unknown resistance to R terminals.

(6) With the CRL dial set in the vicinity of 1.0, turn the CRL switch in the direction to bring the galvanometer to zero, choosing that position which leaves the pointer to the left of zero.

(7) Increase the setting of the CRL dial until the pointer is within one division of zero.

(8) Set DETECTOR switch to GALV. position.

(9) Rebalance by means of CRL dial, bringing galvanometer indication to zero.

(10) The reading of the CRL dial multiplied by the factor indicated by the CRL switch on the circular row R is the value of the resistance under measurement in the unit given.

EXAMPLE:

CRL dial	CRL switch	Resistance
2.67	10 Ω	26.7 Ω
2.67	10 k Ω	26700 Ω 26.7 k Ω

3.12 Accuracy: The accuracy of these readings is 1% between 1.2 Ω and 100 k Ω , increasing to 2% at 1 M Ω , when the CRL dial is set on its main decade between 1.0 and 10. The small decades below 1.0

are provided for convenience in obtaining an initial balance and to allow the measurement of small resistances. Their accuracy is determined by the spacing of their graduations. The zero resistance of the bridge may be measured by short-circuiting the R terminals. It is about 0.01 Ω . The short-circuiting bar should be a heavy copper wire securely clamped in the terminals. The resistance of the lead wires used in connecting an unknown resistor to the bridge may be measured by connecting their free ends together. By using such zero corrections resistances up to 0.2 Ω may be measured to 0.002 Ω and above 0.2 Ω to 1%.

3.13 Sensitivity - External Batteries: For resistances between 100 k Ω and 1000 k Ω the sensitivity of the galvanometer is not sufficient to allow the bridge to be balanced to 1%. The use of an external 45-volt dry battery will provide sufficient power to raise the accuracy of setting to 1%. Connect this battery to the EXTERNAL GENERATOR terminals in series with a 450-ohm, 5-watt resistor and set the GENERATOR switch to EXT. ON. The maximum voltage which may be safely applied to the bridge for each setting of the CRL switch and the fraction of this battery voltage placed across the unknown resistor at balance is given in Table IV, SECTION 4.

When the Type 650-P1 Oscillator-Amplifier is used, no separate protective resistor is needed.

*When the Type 650-P1 is used, the GENERATOR switch should always be in the EXT. ON - INT. OFF position. DETECTOR switch should always be in the EXT. position for a-c measurements, and in a GALV. position for d-c. See SECTION 6 for additional information.

TYPE 650-A IMPEDANCE BRIDGE

3.2 ALTERNATING-CURRENT RESISTANCE MEASUREMENTS

3.21 Procedure: To make 1-kc alternating-current resistance measurements, proceed in the following manner:

- (1) Set DETECTOR switch on EXT.
- (2) Connect unknown resistance to R terminals.
- (3) Set D-Q multiplier switch on R.
- (4) Set GENERATOR switch on 1 KC.* A faint 1-kc hum should be heard coming from the microphone hummer under the panel.
- (5) Connect a pair of head telephones to the EXTERNAL DETECTOR terminals. A loud 1-kc tone will be heard in the telephones.
- (6) With the CRL dial set in the vicinity of 1.0 turn the CRL switch in such a direction as to decrease the intensity of this tone, choosing that position which yields the least sound. Adjust the setting of the CRL dial until silence or minimum sound is obtained. If a balance cannot be obtained, change the setting of the CRL switch until a satisfactory balance is reached.
- (7) The resistance of the unknown resistor is the reading of the CRL dial multiplied by the factor indicated by the CRL switch on the circular row R.

3.22 Accuracy: The same accuracy statements that were given for direct-current measurement hold for this measurement except that the error for the 1-ohm setting of the CRL switch is 5%, increasing to 10% for the 0.1-ohm setting, when the internal generator is used.

A good null balance can be obtained only when the unknown resistance has a small reactance comparable to that of the various resistors which make up the remainder of the bridge circuit, because for this connection the bridge has only one control. The criterion of a good null balance is that as the CRL dial is moved off balance the passage of the sliding contact over the individual wires can be detected. In general, this condition limits this type of measurement to standard resistors and resistance boxes.

When the unknown resistor has considerable reactance, a balance can be obtained by connecting a capacitor across one of the bridge arms, as explained in SECTION 4.51, A-C Resistance with Reactance.

3.3 CAPACITANCE MEASUREMENTS

3.31 Procedure: To make alternating-current capacitance measurements at 1 kc, proceed as follows:

- (1) Connect the unknown capacitor to the CL terminals at the right with its shield (if any) connected to the LOW terminal.
- (2) Set the DQ switch on C-DQ and the DQ dial, which is then connected to the bridge, at 0.
- (3) Set the DETECTOR switch at EXT. and the GENERATOR switch at 1 KC.* A faint 1-kc hum should be heard coming from the microphone mounted below the panel. A loud 1-kc note will be heard in the telephones.
- (4) Ground the bridge at any terminal marked G.
- (5) With the CRL dial set in the vicinity of 1.0, turn the CRL switch in such a direction as to decrease

the intensity of this note, choosing that position which yields the least sound.

- (6) Turn the CRL dial until minimum sound is obtained.
- (7) Increase the setting of the DQ dial to obtain a better minimum.
- (8) Alternately adjust the CRL and DQ dials until the setting of each is unchanged on further adjustment of the other. When the final balance is obtained, it is possible to detect the passage of the sliding contact over the individual wires if either dial is moved off balance. This condition should always be attained for the CRL dial. It will be found that when the setting of the DQ dial is greater than 2 (a condition which seldom occurs), the successive settings of the CRL and DQ dials progress across the dials. This is because the two balances of the bridge are not independent. The number of successive settings which must be made before a good null balance is reached can be reduced by taking advantage of the orderly progression of the settings and slightly over-setting each one in the direction it will move the next time. When the true balance point is passed on one dial, the progression of the other dial in its next setting will be reversed.
- (9) The series capacitance of the unknown capacitor is then given by the reading of the CRL dial multiplied by the factor indicated by the CRL switch on the circular row C.** The parallel capacitance of the capacitor can be calculated from the formula

$$C_p = \frac{C_s}{1 + D^2} \quad (1)$$

- (10) The dissipation factor D of the unknown capacitor is the reading of the DQ dial multiplied by the factor indicated by the DQ switch on the circular row marked MULTIPLIER. If the setting of the DQ dial is less than one, greater accuracy can be attained by resetting the DQ switch to C-D and rebalancing the bridge by means of the D dial.

Dissipation factor is the ratio of series resistance to series reactance.

$$D = \frac{R}{X} = R\omega C \quad (2)$$

It may have any value from zero to infinity.

- (11) The series alternating-current resistance of the capacitor can be calculated from the expression

$$R = \frac{D}{\omega C} \quad (3)$$

The frequency of the microphone hummer is 1.00 ± 0.05 kc. The parallel resistance of the capacitor can be calculated from the formulae

$$R_p = \frac{1 + D^2}{D^2} R_s = \frac{1 + D^2}{D\omega C_s} = \frac{1}{D\omega C_p} \quad (4)$$

where: R_s = series resistance
 C_s = series capacitance
 C_p = parallel capacitance

*When the Type 650-P1 is used, see footnote on page 2 and SECTION 6.

**See also second paragraph of SECTION 4.57.

EXAMPLES:

CRL Dial	CRL Switch	Capacitance		
2.67	100 $\mu\mu f$	267 $\mu\mu f$.267 m μf	.000267 μf
2.67	1 m μf	2670 $\mu\mu f$	2.67 m μf	.00267 μf
2.67	100 m μf		267 m μf	.267 μf
2.67	10 μf			26.7 μf

DQ Dial	D Dial	D Switch	Dissipation Factor	
2.6		.1	.26	26%
	1.96	.01	.0196	1.96%

3.32 Accuracy: The accuracy of the capacitance readings is 1% between 1000 $\mu\mu f$ and 10 μf , increasing to 2% at 100 μf , when the CRL dial is set on its main decade between 1.0 and 10. The small decades below 1.0 are provided for convenience in obtaining an initial balance and to allow the measurement of small capacitances. Their accuracy is determined by the spacing of their graduations. The zero capacitance of the bridge can be measured by leaving the CL terminals open. It is about 10 $\mu\mu f$. The capacitance of the lead wires used in connecting the unknown capacitor to the bridge can be measured by disconnecting the lead running from the left CL terminal to the unshielded terminal of the capacitor at the capacitor, being careful not to alter the relative position of the leads. By using such zero corrections, capacitances up to 200 $\mu\mu f$ can be measured to 2 $\mu\mu f$ and above 200 $\mu\mu f$ to 1%.

The accuracy of the dissipation factor readings is 20% or 0.005, whichever is the larger for capacitances greater than 500 $\mu\mu f$. For capacitances less than 500 $\mu\mu f$, when measured on the 100 $\mu\mu f$ multiplier, the error increases as capacitance decreases, reaching 100% for 100 $\mu\mu f$. The largest source of error is the capacitances across the ratio arms, whose effects change with settings of the CRL switch. For values of dissipation factor greater than 0.05, the error is not greater than 10%. Another source of error is the zero capacitance C_0 and its dissipation factor D_0 .

The capacitance and dissipation factor D of the unknown capacitor are:

$$C = C_1 - C_0$$

$$D = \frac{D_1 C_1 - D_0 C_0}{C_1 - C_0} \quad (5)$$

where subscript '1' refers to the bridge readings with the unknown connected and subscript '0' to the readings with the unknown disconnected.

3.4 INDUCTANCE MEASUREMENTS

3.41 Procedure: To make alternating-current inductance measurements at 1 kc, proceed as follows:

(1) Connect the unknown inductor to the CL terminals at the right with the shield (if any) connected to the LOW terminal.

(2) Set the DQ switch at L-DQ and the DQ dial at 10.

(3) Set the DETECTOR and GENERATOR* switches

at the same points as for capacitance measurements (see above) and ground the bridge at any terminal marked G.

*When the Type 650-P1 is used, see footnote on page 2 and SECTION 6.

(4) With the CRL dial set in the vicinity of 1.0, turn the CRL switch in such a direction as to decrease the intensity of the tone heard in the telephones, choosing that position which yields the least sound.

(5) Turn the CRL dial until minimum sound is obtained.

(6) Decrease the setting of the DQ dial to obtain a better minimum. If it appears necessary to increase the setting of the DQ dial above 10, reset the DQ switch to L-Q and rebalance the bridge by means of the Q dial.

(7) Alternately adjust the CRL and DQ or Q dials until the setting of each is unchanged on further adjustment of the other. When the final balance is obtained, it is possible to detect the passage of the sliding contact over the individual wires if either dial is moved off balance. This condition should always be attained for the CRL dial. It will be found that when the setting of the DQ dial is less than five, the successive settings of the CRL and DQ dials progress across the dials as discussed in Capacitance Measurements, Section 3.31 (8).

(8) The inductance of the unknown inductor is the reading of the CRL dial multiplied by the factor indicated by the CRL switch on the circular row L. This inductance is series inductance when the DQ switch is set at L-DQ (Maxwell bridge) and parallel inductance when the DQ switch is set at L-Q (Hay bridge). The relation between series and parallel inductance is given by the equation:

$$L_p = \frac{1 + Q^2}{Q^2} L_s \quad (6)$$

(9) The storage factor Q of the unknown inductor is the reading of the DQ or Q dial multiplied by the factor indicated by the DQ switch on the circular row marked MULTIPLIER. Storage factor is the ratio of series reactance to series resistance and also the ratio of parallel resistance to parallel reactance:

$$Q = \frac{X_s}{R_s} = \frac{\omega L_s}{R_s} = \frac{R_p}{X_p} = \frac{R_p}{\omega L_p} = \frac{1}{D} \quad (7)$$

It may have any value from zero to infinity. It is the reciprocal of the dissipation factor D.

(10) The series and parallel alternating-current resistances of the inductor can be calculated from the formulae

$$R_s = \frac{\omega L_s}{Q} \quad R_p = Q \omega L_p \quad (8)$$

They are related by the expression

$$R_p = (1 + Q^2) R_s \quad (9)$$

where: R_s = series resistance R_p = parallel resistance
 L_s = series inductance L_p = parallel inductance

The frequency of the microphone hummer is 1.00 \pm 0.05kc.

TYPE 650-A IMPEDANCE BRIDGE

EXAMPLES:

CRL Dial	CRL Switch	Inductance		
2.67	100 μ h	267 μ h	.267 mh	.000267 h
2.67	1 mh	2670 μ h	2.67 mh	.00267 h
2.67	100 mh		267 mh	.267 h
2.67	10 h			26.7 h

3.42 Accuracy: The accuracy of the inductance readings is 2% between 100 μ h and 1 h, increasing to 5% at 10 h and 10% at 100 h, when the CRL dial is set on its main decade between 1.0 and 10. The small decades below 1.0 are provided for convenience in obtaining an initial balance and to allow the measurement of small inductances. Their accuracy is determined by the spacing of their graduations. The zero inductance of the bridge can be measured by short-circuiting the CL terminals. It is less than 2 μ h and is, generally, negligible. The inductance of the lead wires used in connecting the unknown inductor to the bridge can be measured by connecting the free ends together, being careful not to alter the relative position of the leads. By using this zero correction, inductances up to 100 μ h can be measured to 2 μ h and above 100 μ h to 2%. The increasing error appearing as the inductance increases is caused by the effect of the capacitance to ground of the various parts

of the bridge. These have a considerable effect when the reactance being measured is large.

DQ Dial	Q Dial	D-Q Switch	Storage Factor
2.6	.41	1 100	2.6 41

The accuracy of the storage factor readings is 20% up to a value of 40. For larger values the error is best expressed as being 0.005 for its reciprocal, dissipation factor D. The larger source of error is the shunt capacitances across the ratio arms, whose effects change with the settings of the CRL switch.

Errors may also be produced in both inductance and storage factor by the linking of the stray magnetic field of the microphone hummer with the inductor being measured. This inductor should be placed at least a foot away from the bridge.

3.5 SUMMARY

Table III below indicates the settings of the controls for the types of measurement just discussed.

TABLE III

Type of Measurement	BATTERY OPERATION			650-P1 OPERATION		
	Detector Switch	Generator Switch	CRL-Switch	D-Q Switch	Detector Switch	Generator Switch
D.C. Resistance	1. SHUNTED GALV. 2. GALV.	D.C.	As necessary for balance	R	1. SHUNTED GALV. 2. GALV.	EXT. ON INT. OFF
1-kc Resistance	EXT*	1 KC	As necessary for balance	R	EXT*	EXT. ON INT. OFF
Inductance	EXT*	1 KC	As necessary for balance	L (Q or DQ)	EXT*	EXT. ON INT. OFF
Capacitance	EXT*	1 KC	As necessary for balance	C (D or DQ)	EXT*	EXT. ON INT. OFF

*Connect a pair of earphones to the EXTERNAL DETECTOR terminals and balance for minimum sound.

*Connect a pair of earphones to the PHONES terminals and balance for minimum sound.

SECTION 4.0

OTHER MEASUREMENTS

4.1 ACCESSORIES

4.11 Amplifier: The self-contained power supply consisting of four 1.5-volt dry cells for d-c measurements and a Type 572-B Microphone Hummer for 1-kc a-c measurements is sufficient for the attainment of the accuracies mentioned in SECTION 1 except as noted in Part 3.13. For a-c measurements, the telephones

must be of good quality, equivalent in sensitivity and resistance to Brush Model A. For less sensitive telephones, for greater accuracy of setting, or for greater ease and convenience in obtaining a balance, an amplifier is very useful. The General Radio Type 1231 Amplifier and Null Detector is suitable. The Type 650-P1 Oscillator-Amplifier includes an amplifier for this purpose.

GENERAL RADIO COMPANY

TABLE IV

CRL Switch Row R	Arm B	Arm A	Ratio B/A	$\frac{B}{A+B}$	40°C Rise for A & B E Max.
0.1Ω	1 Ω	10 kΩ	0.0001	0.000100	71 volts
1 Ω	10 Ω	10 kΩ	0.001	0.000999	73 volts
10 Ω	100 Ω	10 kΩ	0.01	0.00990	78 volts
100 Ω	1 kΩ	10 kΩ	0.1	0.0909	93 volts
1 kΩ	10 kΩ	10 kΩ	1	0.5	141 volts
10 kΩ	100 kΩ	10 kΩ	10	0.909	200 volts
100 kΩ	100 kΩ	1 kΩ	100	0.990	200 volts

4.12 Filters: The harmonics introduced by high-loss capacitors, iron-cored inductors, and non-linear circuit elements such as copper-oxide rectifiers can be eliminated by the use of low-pass filters. Band-pass filters, obtainable as separate units or made up from low- and high-pass sections will also eliminate the 60-cycle alternating-current hum induced in iron-cored inductors and capacitors of large physical dimensions. Type 830-R, Type 1231-P2, P3, P5, and Type 1951-A Filters* are available for these purposes.

4.2 VOLTAGE LIMITS

4.21 D-C Resistance Measurements: An external battery can be used for direct-current measurements by connecting it to the EXTERNAL GENERATOR terminals and setting the GENERATOR switch at EXT. ON, as mentioned in Section 3.13. Care must be taken that the voltage applied to the bridge does not exceed the limits of safe operation for the bridge elements.

Figure 1a shows the bridge circuit used for resistance measurements. The battery voltage is applied across the ratio arms and across the unknown in series with the CRL rheostat. The safe operating limits for the ratio arms are given in Table IV, corresponding to a temperature rise of 40°C. Under these conditions 70 volts can be safely applied to the ratio arms. Two other conditions must also be met; first, the current through the CRL rheostat should not exceed 40 milliamperes, and second, the voltage across the unknown resistor should not exceed its rated operating value. Under some conditions, therefore, the voltage limit will depend on either or both of these factors.

A resistance of 60 ohms is connected in series with the bridge to protect the CRL rheostat when the zero resistance of the bridge is being determined.** This limits the current drawn from the 6-volt internal battery or a 6-volt external battery to 100 milliamperes.

Table IV gives the resistance values of the ratio arms for all multiplier settings. The ratio $\frac{B}{A+B}$, which, at balance, is the fraction of the total battery voltage appearing across the unknown resistor, is also given.

* Consult the General Radio catalog for data.

**This resistor is reduced to zero when the Type 650-P1 is used. See Section 6.2 (3).

4.22 A-C Resistance Measurements: An external oscillator can be used by connecting it to the EXTERNAL GENERATOR terminals and setting the GENERATOR switch at EXT. ON. The voltage applied to the bridge must not exceed the limits of safe operation for the bridge elements. These are the same as those described in Section 4.21, D-C Resistance Measurements. An oscillator having a maximum output of 0.5 watt can be used under all conditions.

4.23 Capacitance and Inductance Measurements: The maximum safe voltage for capacitance and inductance measurements is determined from a consideration of the bridge circuits used as shown in Figure 1b, for the former, and Figures 1c and 1d, for the latter. The voltage is applied across the ratio arm A or B in series with the unknown reactor, and also across the arm N containing the CRL rheostat in series with the standard capacitor and one of the D-Q rheostats. The maximum voltage for ratio arms A or B is given in Table V. The maximum voltage for the standard capacitors is 350 volts. The current ratings of the D-Q rheostats are given in Table VI. An oscillator having a maximum output of 0.5 watt can be used under all conditions.

TABLE V

CRL Switch C row	L	A for C B for L	E max	I max
10 μf	100 μh	1 Ω	0.7 volts	707 ma
1 μf	1 mh	10 Ω	2.2 volts	224 ma
100 mμf	10 mh	100 Ω	7.1 volts	71 ma
10 mμf	100 mh	1 kΩ	22.4 volts	22 ma
1 mμf	1 h	10 kΩ	71 volts	7 ma
100 μμf	10 h	100 kΩ	200 volts	2 ma

TABLE VI

Rheostat	R max	I max	R
CRL	11.5 kΩ	30 ma	reading (kΩ)
D	1.6 kΩ	60 ma	.1592 x reading (kΩ)
DQ	16 kΩ	20 ma	1.592 x reading (kΩ)
Q	.16 kΩ	200 ma	.01592 x reading (kΩ)

TYPE 650-A IMPEDANCE BRIDGE

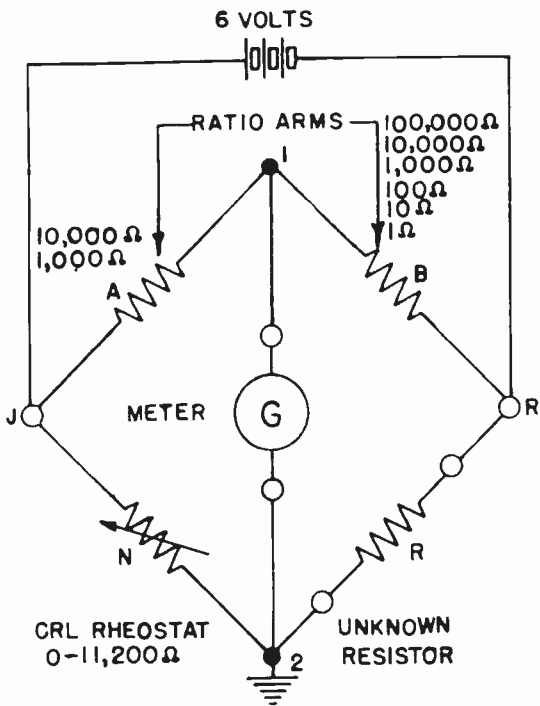

Figure 1a. R

$$R = \frac{B}{A} N$$

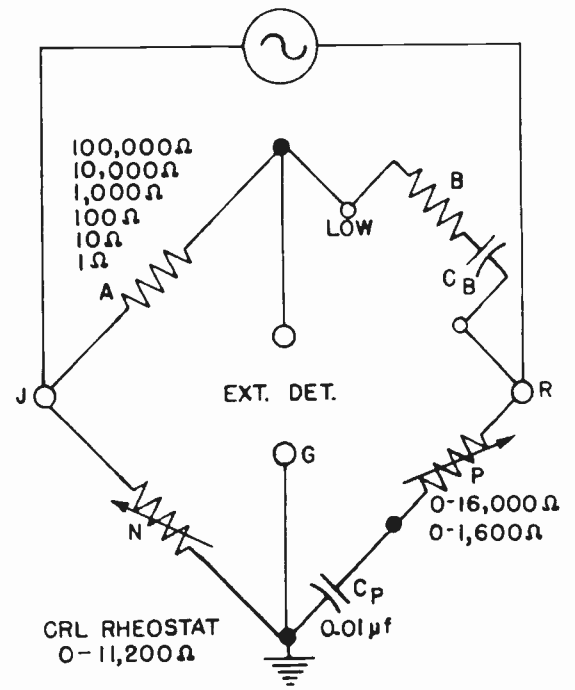
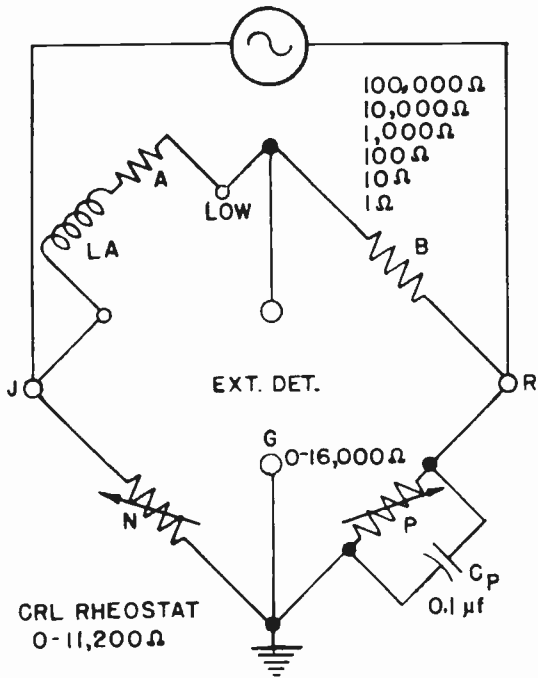

Figure 1b. C (D or DQ)

$$*(\text{Series}) \quad C_B = \frac{N}{A} C_P$$

$$D_B = D_P = P \omega C_P$$



$$*(\text{Series}) \quad L_A = BNC_P$$

$$Q_A = Q_P = P \omega C_P$$

Figure 1c. L(DQ) (MAXWELL BRIDGE)

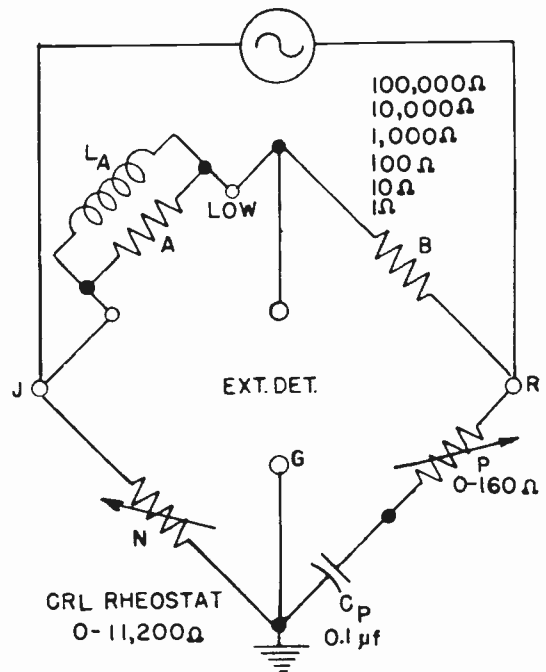

$$*(\text{Parallel}) \quad L_A = BNC_P$$

$$Q_A = Q_P = \frac{1}{P \omega C_P}$$

Figure 1d. L(Q) (HAY BRIDGE)

*See Section 3.31 (9) for relationship between series and parallel capacitance; and Section 3.41 (8) for inductance.

4.3 GROUND-CAPACITANCE ERRORS

4.31 Internal Generator: Ground capacitances appearing across the various arms of the bridge introduce errors in the reading of the D-Q dials when they are across resistances, and in the reading of the CRL dial when they are across the standard capacitor. When using the internal generator these errors are negligible for the CRL dial, but may amount to 10% or more for the D-Q dials, as stated in Sections 3.32 and 3.42 under Accuracy.

The error in dissipation factor or storage factor can be corrected by making the storage factors of the two ratio arms equal by adding capacitance across that arm having the lower storage factor. Since, however, one ratio arm is continuously variable, equality of storage factor may be obtained only for a particular setting. The correct value of this added capacitance can be found by measuring a standard reactor of known dissipation or storage factor.

Since the junction of the CRL rheostat and the standard capacitor is grounded, these ground capacitances are placed across this rheostat and the standard capacitor. This causes the bridge to read low on capacitance, inductance, and dissipation factor, and high on storage factor.

The fractional error in capacitance and inductance is the ratio of the ground capacitance placed across the standard capacitor to the capacitance of the standard capacitor. The error in dissipation factor and storage factor is the product $R\omega C$, where C is the ground capacitance placed across, and R is the resistance of, the CRL rheostat. The error in dissipation and storage factor caused by the presence of ground capacitance across the standard capacitor is usually negligible.

4.32 External Generator: An external generator always has a considerable ground capacitance. The division of capacitance between its terminals can be determined by the effect of the use of such an oscillator on the measurement of a capacitor which has been previously measured with the internal power supply.

When one terminal of the oscillator is grounded to its panel, almost the entire ground capacitance is associated with the ungrounded terminal and will affect only one arm of the bridge. Under these conditions, representative values of ground capacitance are 30 $\mu\mu\text{f}$ for a battery-operated oscillator and 300 $\mu\mu\text{f}$ for an a-c operated oscillator, the increase representing the interwinding capacitance of the power-supply transformer. In general, the oscillator should be so connected to the bridge that this capacitance is placed across the arm containing the standard capacitor. The errors introduced in the reading of the CRL dial range from 0.03% for a battery-operated oscillator and an inductance measurement to 3.0% for an a-c operated oscillator and a capacitance measurement.

* See General Radio catalog for data.

4.33 Shielded Transformer: The use of a shielded transformer between oscillator and bridge will suppress the effect of the ground capacitances of the oscillator, but will introduce similar effects on its own. The Type 578-A Shielded Transformer* is recommended for this use. Its terminal capacitances are equal and of about 35 $\mu\mu\text{f}$ each, or the whole capacitance of 70 $\mu\mu\text{f}$ can be associated with either terminal. The errors which it will introduce will be comparable with those of a battery-operated oscillator. For 60-cycle measurements the 2400-turn winding of this transformer can be connected directly to the 115-volt supply. Head telephones cannot be used at 60 cycles because of their lack of sensitivity. A Type 1231 Amplifier and Null Detector or a Type 1212-A Null Detector is recommended.

The Type 650-P1 Oscillator-Amplifier includes a shielded transformer.

4.4 EXTENSION OF RANGE

4.41 Frequency: The reading of the CRL dial is independent of frequency but, since both dissipation factor and storage factor depend upon frequency, multiplying factors must be applied to the readings of the D-Q dials. Dissipation factor at any frequency is the observed value of D multiplied by the frequency expressed in kilocycles. Storage factor at any frequency is the observed value as obtained from the DQ dial multiplied by, or the observed value as obtained from the Q dial divided by, the frequency expressed in kilocycles.

The accuracy of the resistance, capacitance, and inductance readings is independent of frequency from 60 cycles to 10 kc except for large inductors which are measured near their natural frequencies. The maximum error of 20% in dissipation factor and storage factor readings varies directly with frequency, as does also the average error of 5%, except that these errors will never be less than 3%, which is the error of adjustment of the D-Q dials.

The resistances used in the three D-Q rheostats are chosen to give the ranges stated in Table I at 1 kc. At lower frequencies the upper limit for dissipation factor will be less than unity, and for storage factor the DQ and Q dials will not overlap. At higher frequencies the ranges of all rheostats will be more than sufficient to overlap.

An additional rheostat can be placed in series with the D or DQ rheostat for the measurement of dissipation factor by connecting it to the SERIES RES terminals, the short-circuiting link being removed. The values needed in order to maintain the ranges of the D and DQ dials at different frequencies are given in Table VII. Dissipation factor is calculated from the expression $D = 0.0628 fR$ (kc, $k\Omega$). The readings of this added resistor and of the D or DQ dial are additive when expressed in the same units.

When the DQ and Q dials do not overlap for the determination of storage factor at frequencies lower than 1 kc, the DQ dial must be replaced by a resistor of

TYPE 650-A IMPEDANCE BRIDGE

more than 16 kΩ connected across the R terminals, the D-Q switch being turned to L-Q and the Q dial turned to maximum. Although, the switch is in the L-Q position the circuit is a Maxwell Bridge and thus measures series inductance. Storage factor is calculated from the expression $Q = 0.628 fR$ (kc, kΩ).

Under the same conditions the Q dial must be replaced by a resistor of more than 160Ω connected across the SERIES RES terminals. The circuit remains a Hay Bridge and measures parallel inductance. Storage factor is calculated from the expression:

$$Q = \frac{1.592}{fR} \quad (\text{kc, k}\Omega)$$

NOTE: See paragraph 3.41 (8) for the relation between series and parallel inductance especially when Q is small.

Type 214-A or 371-A Rheostats are recommended as these added resistors*.

TABLE VII

Values of Resistance needed for given values of D, Q, and f.

DIAL f	D		DQ		Q	
	D = 0.1	D = 1	DQ = 10	DQ = 10	Q = 10	Q = 10
0.01 kc	160 kΩ	1600 kΩ	1600 kΩ	1600 kΩ	16 kΩ	16 kΩ
0.02 kc	80 kΩ	800 kΩ	800 kΩ	800 kΩ	8 kΩ	8 kΩ
0.05 kc	32 kΩ	320 kΩ	320 kΩ	320 kΩ	3.2 kΩ	3.2 kΩ
0.1 kc	16 kΩ	160 kΩ	160 kΩ	160 kΩ	1.6 kΩ	1.6 kΩ
0.2 kc	8 kΩ	80 kΩ	80 kΩ	80 kΩ	.8 kΩ	.8 kΩ
0.5 kc	3.2 kΩ	32 kΩ	32 kΩ	32 kΩ	.32 kΩ	.32 kΩ
1 kc	1.6 kΩ	16 kΩ	16 kΩ	16 kΩ	.16 kΩ	.16 kΩ
2 kc	.8 kΩ	8 kΩ	8 kΩ	8 kΩ	.08 kΩ	.08 kΩ
5 kc	.32 kΩ	3.2 kΩ	3.2 kΩ	3.2 kΩ	.032 kΩ	.032 kΩ
10 kc	.16 kΩ	1.6 kΩ	1.6 kΩ	1.6 kΩ	.016 kΩ	.016 kΩ

4.5 SPECIAL APPLICATIONS

4.51 A-C Resistance with Reactance: A resistance having considerable reactance, such as a transmission line or electrolytic cell, can be measured by connecting it to the R terminals as described in Section 3.2. The resistance component is obtained from the reading of the CRL dial. The reactance component is balanced out by means of a capacitor placed across one of the bridge arms. Type 219 Decade Condensers and Type 1428-BM Variable Air Capacitor are recommended.* All four corners of the bridge are available, being brought out to the pairs of terminals, EXT DET high and G, R high and G, and the single terminal J, as shown in Figure 1. The storage factor of the unknown impedance is in all cases of the form $R\omega C$, where R is the resistance of the arm across which the capacitance C is placed. The kind of reactance which can be measured in this manner and the terminals across which the added capacitor is placed are shown in Table VIII. The resistances, as

* See General Radio catalog for data.

obtained from the reading of the CRL dial, are series for the capacitor across arm A and parallel for the other positions. The formulae given in Sections 3.31 (10) and (11) and 3.41 (8) and (9) can be used for calculating other resistances not obtained directly.

With the added capacitance placed across the B or N arms, the bridge is suitable for the measurement of the resistance of electrolytic cells.

When this capacitance is placed across the P arm, the bridge becomes a parallel resonance bridge, and when placed in series it becomes a series resonance bridge. In the two latter positions the P arm is made a pure resistance. The parallel or series inductance is calculated from the formula

$$L = \frac{1}{\omega^2 C}$$

TABLE VIII

Arm	Terminals	Resistance	Q	Reactance
A	EXT DET high & J	Series	$A\omega C_A$	+ or L
B	EXT DET high & R high	Parallel	$B\omega C_B$	- or C
N	EXT DET G & J	Parallel	$N\omega C_N$	- or C
P	R high & R G	Parallel	$P\omega C_P$	+ or L
P	In series	Series		+ or L

4.52 Natural Frequency: The natural frequency of a tuned circuit or inductor can be found by using an oscillator whose frequency is continuously variable, such as the Type 1304 Beat-Frequency Oscillator.* The unknown impedance is connected to the R terminals as described in Section 3.2. The bridge is balanced by means of the CRL switch and dial and by varying the oscillator frequency. This is best accomplished by using a Type 1231 Amplifier and Null Detector or the amplifier section of the 650-P1 Oscillator-Amplifier. The reading of the CRL dial gives the parallel resistance of the unknown impedance. Whatever capacitance exists across the R terminals due to the bridge wiring is added to that of the inductor being measured and lowers its natural frequency.

4.53 Parallel Inductance and Resistance: The parallel inductance and resistance of an unknown inductor, such as an iron-cored choke coil or transformer, can be found by setting the D-Q switch at L-Q, and the Q dial at infinity. An additional resistor is inserted at the SERIES RESISTANCE terminals. The parallel inductance is read directly from the CRL dial and switch in the usual manner. The parallel resistance is the ratio of the resistance of the ratio arm controlled by the CRL switch to the added resistance, multiplied by 1000 times the reading of the CRL dial. When the added resistance is less than 160 ohms, the Q rheostat itself can be used. Its resistance is given in Table VI. Type 214-A or 371-A Rheostats* are recommended as this added resistance.

4.54 Parallel Capacitance and Resistance: The parallel capacitance and resistance of an unknown capa-

capacitor can be found by setting the D-Q switch at either C-D or C-DQ and the D or DQ dials at zero. An additional resistor is connected across the R terminals. The parallel capacitance is read directly from the CRL dial and switch in the usual manner; and the parallel resistance is the value of the added resistance multiplied by the resistance of the ratio arm controlled by the CRL switch, as given in Table V, and divided by 1000 times the readings of the CRL dial. Type 214-A or 371-A Rheostats* are recommended as this added resistance.

4.55 D-C Polarizing Voltage for Capacitors: A d-c polarizing voltage can be applied to electrolytic capacitors in two ways, depending on whether the internal or an external power supply is used. For the internal microphone hummer, the polarizing battery must be connected in series with the capacitor being measured. It should be connected with its positive side to the right CL terminal marked LOW and its negative side to the negative terminal of the electrolytic capacitor. Not more than 200 volts should be used. The leakage current can be measured by a milliammeter connected between the battery and the LOW CL terminal. For an external oscillator, the direct-current polarizing battery can be placed as just described or in series with the oscillator. Its capacitance to ground is added to whichever side of the oscillator it is connected.

4.56 D-C Magnetizing Current for Iron-Cored Coils: A d-c magnetizing current can be obtained for an iron-cored choke coil by connecting a battery in series with a choke coil having a low direct-current resistance across the EXTERNAL DETECTOR terminals in parallel with the telephones. The magnetizing current can be read on an ammeter placed in series with the battery.

For the L-Q setting of the D-Q switch ($Q > 10$) all the battery current passes through the unknown inductor. For the L-DQ setting there is a second path through the ratio arm controlled by the CRL switch and the DQ rheostat. The resistance of this path will usually be high compared to that of the circuit through the unknown inductor and CRL rheostat. The actual resistances of these paths can be calculated from Table V and the settings of these rheostats. In case of doubt, the ammeter and, for that matter the battery, can be placed in series with the unknown inductor in the lead connected to the CL terminal marked LOW. Their resistance and inductance will be negligible compared to those of inductors being measured. The maximum magnetizing current is 40 ma.

4.57 Direct Capacitance: The direct capacitance* of a three-terminal capacitor can be measured by connecting the terminals of the direct capacitance desired across the CL terminals and the third terminal, usually the shield, to any terminal marked G. Of the other two direct capacitances in the network, one is placed across the detector and the other across the standard capacitor. The error thus introduced is usually negligible because of the size of the standard capacitor, 0.01 μf , being only 1% for 100 μf . A zero reading for the purpose of eliminating the zero capacitance across the CL terminals is taken by disconnecting the lead to the high CL terminal, leaving the other two leads connected.

Because neither of the CL terminals is grounded, every capacitance measured on the bridge is a direct capacitance in the sense that the capacitances of both terminals to ground are eliminated. It is, therefore, possible to measure the direct capacitance between two unshielded terminals, each having a capacitance to ground.

4.58 Terminal Capacitance: The terminal capacitances between the terminals of an inductor and its shield can be measured by connecting the terminal whose capacitance is desired to the CL terminal marked LOW, the other terminal to any terminal marked G and the shield to the high CL terminal. The other terminal capacitance and the ground capacitance of the shield are placed across the standard capacitor. The error thus introduced may amount to 5%, for terminal capacitances of 500 μf are not uncommon in shielded transformers. The reactance of the inductor is placed across the detector and must not be so low as to impair seriously the sensitivity of the bridge balance. The inductor must be placed at least a foot from the bridge to prevent an appreciable voltage being induced in it by the stray magnetic field of the internal microphone hummer. The second terminal capacitance can be measured by reversing the connections to the inductor. The capacitances thus measured are equal to the true terminal capacitances, which depend upon the relation of the shield potential to that of the terminals, only when they are concentrated at the terminals. This condition usually exists in multilayer coils because only the capacitances of the two end layers are effective.

*See General Radio catalog for data.

*Robert F. Field, "Direct Capacitance and its Measurement" General Radio EXPERIMENTER, VIII, November, 1933. Reprints are available.

SECTION 5

ELECTRICAL CIRCUITS

5.1 GENERAL

The Type 650-A Impedance Bridge uses conventional bridge circuits of various forms. All adjustable circuit elements are resistances which vary logarithmically with dial position. This gives a constant frac-

tional accuracy of reading and contributes a great deal to the ease of balancing.

Values of R, L, or C are read on the CRL dial and the CRL switch selects the desired ratio arms. The D-Q switch selects the proper D-Q rheostat and makes up the bridge circuit according to the diagrams of Figure 1.

TYPE 650-P1 OSCILLATOR-AMPLIFIER

5.2 RESISTANCE MEASUREMENTS

For both direct- and alternating-current resistance measurements, the Wheatstone bridge circuit of Figure 1a is used.

5.3 CAPACITANCE MEASUREMENTS

A Wheatstone bridge with two resistance arms and two capacitance arms, as shown in Figure 1b, is used for both C positions of the D-Q switch in the measurement of capacitance and dissipation factor.

5.4 INDUCTANCE MEASUREMENTS

For the L-DQ position of the D-Q switch, the circuit is arranged as a Maxwell bridge and for the L-Q position of the switch, a Hay bridge is used. These are shown in Figure 1c and Figure 1d respectively.

5.5 REFERENCES

All the above circuits are treated in detail in "Alternating-Current Bridge Methods", by B. Hague, published by Sir Isaac Pitman and Sons, Ltd., London, and in Henney's "Radio Engineering Handbook", Section 7, published by McGraw-Hill Book Company, New York.

SECTION 6

TYPE 650-P1 OSCILLATOR-AMPLIFIER

6.1 GENERAL

The Type 650-P1 Oscillator-Amplifier is designed especially for use with the Type 650-A Impedance Bridge. It replaces the four No. 6 dry cells and fits into the cabinet compartment which originally housed these cells. This unit operates from a single phase 40- to 60-cycle power line of either 115 or 230 volts (see wiring diagram for changing connections to power transformer).*

This auxiliary unit contains:

(1) A 1-kc vacuum-tube oscillator having a controllable voltage output, which replaces the microphone hummer and gives a distinctly better waveform than the latter. This oscillator is followed by a one-stage buffer amplifier which is connected to the bridge through a shielded transformer designed to minimize the bridge errors caused by terminal capacitances. The transformer contains separate electrostatic shields around the primary and secondary windings, with a substantial separation between them. The primary shield is grounded, while the secondary shield is connected to that secondary terminal which leads to the junction of the A and N arms of the bridge. This arrangement places a negligible capacitance of $9 \mu\text{mf}$ across the standard capacitor (0.01 or $0.1 \mu\text{f}$) bridge arm, and introduces a capacitance of less than $36 \mu\text{mf}$ ($4.4 \text{ M}\Omega$ reactance) across the CRL rheostat arm ($10 \text{ k}\Omega$ maximum) whence the error introduced is also negligible.

(2) A two-stage null-balance amplifier which can have a flat characteristic or which can be tuned to 1 kc, as selected by a panel switch. This amplifier has a sufficient and controllable gain to permit the capacitance and inductance bridge circuits of the Type 650-A to be balanced easily and precisely by the use of head telephones or by an external a-c voltmeter having a sensitivity of $10 \text{ k}\Omega$ per volt or better.

(3) A source of d-c voltage for energizing the Wheatstone bridge circuit for d-c measurements. This voltage

*The plate at the POWER receptacle is etched on both sides. If the power transformer connections are changed, the plate should be turned to show the correct voltage.

considerably exceeds the 6 volts originally available from the dry cells and permits a more accurate balance in measuring high resistance values up to one megohm, the limit of the bridge.

6.2 DIRECTIONS FOR INSTALLATION

(1) Remove the bridge from the cabinet.

(2) Cover each of the spade terminals on the extremities of the battery leads with any suitable insulating tape and wrap these leads out of the way, say, around the subpanel supporting post under the upper right-hand corner of the instrument panel. If subsequent use of batteries is not contemplated these leads may be cut off at the points where they are attached to the bridge circuits.

(3) A 60-ohm protective resistor card is mounted across two terminals on the rear of the GENERATOR switch of the bridge. When the Type 650-P1 unit is used with the bridge, this resistor is not required, and its presence, under certain conditions, will introduce errors in the bridge measurements. This resistance should, therefore, be reduced to zero, either by soldering a jumper wire directly across the leads to the card, or by cutting off the two leads close to the card and then bending and soldering these two leads together.**

(4) Remove the batteries from the instrument cabinet and pry off the sponge-rubber supporting pads.

(5) Remove the side panel of the oscillator-amplifier unit and pass the free end of the concentric cable stored in the oscillator compartment through the large hole in this panel. Ascertain that all three tubes are securely seated in their sockets and replace the side panel. This panel is fastened by three quarter-turn lock screws having vertical slots when secured.

(6) By pulling gently, ascertain that the shielded cable extends its full distance from the auxiliary unit. Insert the free end of this cable through the hole from

**This resistor should be replaced if the bridge is returned to battery operation.

the battery compartment into the bridge compartment of the cabinet. Lower the auxiliary unit into the battery compartment (with input socket on the left side) taking up slack in the shielded cable. Secure the unit with the two panel screws which originally mounted the battery cover.

(7) Support the bridge panel in a convenient inverted position. Without disturbing any of the present wiring, solder the short, insulated lead of the shielded cable from the auxiliary unit to the non-grounded EXTERNAL DETECTOR terminal of the Type 650-A Bridge. Attach the long, lug-tipped lead to the central (grounded) terminal of the CRL rheostat. The free extremity of the cable has been prepared to facilitate these internal soldered connections.

(8) Replace the bridge in the cabinet and fasten securely with the panel screws.

6.3 OPERATING INSTRUCTIONS

6.31 General: (1) Connect the recessed receptacle on the auxiliary unit to 50- to 60-cycle line by means of the cord provided. The applied voltage must be approximately the value specified on the receptacle label. Keep this power cord at a maximum distance from all bridge terminals and from the circuit element to be measured.

(2) Turn on the power switch of the auxiliary unit, which energizes the pilot light. There is a warm-up frequency rise of less than 20 cps.

(3) For all uses of the Type 650-A Bridge set the GENERATOR switch on the panel of this instrument in the middle position marked EXT. ON-INT. OFF. The DC and 1 KC positions of this switch are now inoperable.

(4) Avoid bodily contact with the idle EXTERNAL DETECTOR terminals on the 650-A panel while balancing any of the a-c bridges.

6.32 Measurement of D-C Resistance: (1) By means of the plug-terminated conductor provided, join the + and - DC terminals on the auxiliary panel to the EXTERNAL GENERATOR terminals on the bridge panel. Ascertain that this connection is the same as would be attained by non-crossing wires between these terminals. This will insure that the galvanometer needle moves in the same direction that the vernier control knob of the CRL dial is turned, a convenient operating feature. The d-c voltage thus applied to the bridge will vary according to the resistance values of the bridge arms. The regulation of this auxiliary unit is such that this voltage will exceed the 6-volt value formerly supplied by the dry-cells for the measurement of all resistors in excess of .08 ohm, but will remain at all times well within the maximum safe limits for the bridge arms. If desired, this bridge-terminal voltage may be reduced by connecting a suitable external resistor across the DC terminals in parallel with the internal 50 kΩ resistor. No harm will result from short-circuiting the DC terminals.

(2) Set the BRIDGE INPUT switch on the auxiliary

unit in the DC position. In so doing, both the oscillator and the amplifier are de-energized while the filtered output of the rectifier is applied (ungrounded) through an internal voltage divider to the DC terminals.

(3) Operate all other controls on the bridge panel as directed in the instructions for this instrument, using the galvanometer shunt (DETECTOR switch) in the proper manner.

6.33 Measurement of Inductance and Capacitance at a Frequency of 1 kc: (1) By means of the plug-terminated conductor provided, join the 1 KC terminals of the auxiliary unit to the EXTERNAL GENERATOR terminals on the bridge panel. Ascertain that this connection is the same as would be attained by non-crossing wires between these terminals.

(2) Set the BRIDGE INPUT and AMPLIFIER RESPONSE switches on the auxiliary panel in the 1 KC positions. All three switches are thus thrown in an "up" direction.

(3) Attach high impedance headphones or a suitable a-c galvanometer to the PHONES terminals on the auxiliary panel.

(4) Set the DETECTOR switch on the bridge panel in the EXT. position.

(5) Operate all other controls on the bridge panel as specified in the instructions for this instrument.

(6) Adjust the OSCILLATOR GAIN and AMPLIFIER GAIN controls on the auxiliary panel as desired. In general, the AMPLIFIER GAIN should be set at a maximum in the final balance of the bridge and the OSCILLATOR GAIN advanced only sufficiently to give a workable sensitivity. This will insure the maximum purity of waveform from the oscillator.

Reducing the OSCILLATOR GAIN to the lowest workable limit will permit iron-cored inductors to be measured as close to initial permeability as possible.

6.34 Measurement of Inductance and Capacitance at Other Frequencies: The 1-kc oscillator of the auxiliary unit may be replaced by any suitable external source of a-c voltage of the desired frequency while the amplifier in the auxiliary unit is used with headphones or an a-c galvanometer as the null detector.

(1) Remove the external connection between the panels of the bridge and the auxiliary unit.

(2) Connect the external generator to the EXTERNAL GENERATOR terminals of the bridge through a suitable shielded transformer (such as the Type 578-A). See Section 4.2 regarding this procedure and for safe limits of applied voltage.

(3) Turn on the auxiliary unit and set the BRIDGE INPUT switch in the 1 KC position (to energize the amplifier).

(4) Set the AMPLIFIER RESPONSE switch at the FLAT position, which provides greater sensitivity but which has no inherent selectivity. If needed, some selectivity and increase in gain may be given to the FLAT amplifier, when using telephones at frequencies below 1 kc, by adding an external adjustable capacitor in parallel across the PHONES terminals to resonate the inductive reactance of the phones at the frequency used. The

TYPE 650-P1 OSCILLATOR-AMPLIFIER

rectifier-type galvanometer cannot be tuned in this manner and should be used without added capacitance.

(5) Set the DETECTOR switch on the bridge panel in the EXT position.

(6) Operate the bridge-balancing controls in the normal manner, noting that a correction must be applied to either the D or Q dial used in accordance with the frequency of the a-c voltage employed, as described in Section 4.4.

6.35 Other Uses of the Auxiliary Unit: It will be evident that the auxiliary unit is a self-contained assembly comprising a 1-kc oscillator and a flat or a 1-kc amplifier which may be used, separately or jointly, in any suitable manner with other laboratory equipment. Likewise, this unit may serve as a source of limited d-c power, but not, simultaneously, as an amplifier or an oscillator.

To use the amplifier and/or oscillator separately, proceed as follows:

- (1) Remove all external connections to the 650-A panel.
- (2) Set the bridge GENERATOR switch in the DC position to minimize pickup on the GENERATOR terminals.
- (3) Set the bridge DETECTOR switch in the GALV. position to isolate the EXTERNAL DETECTOR terminals from the bridge circuits.
- (4) These EXTERNAL DETECTOR terminals then become the input of the auxiliary unit amplifier. Connections to them should be made through a concentric

shielded cable, preferably fitted with a shield cap such as the Type 274-NE Connector. The shield should, of course, be connected to the grounded EXTERNAL DETECTOR terminal.

(5) Energize the auxiliary unit and use either the FLAT or the tuned 1-kc amplifier as desired.

(6) The 1-kc oscillator is simultaneously in operation and may be used if desired. Neither terminal of the output transformer is internally grounded, but either may be grounded.

To use the d-c power supply unit separately, proceed as follows:

- (1) Energize the auxiliary unit.
- (2) Set the BRIDGE INPUT switch in the DC position.
- (3) Apply the external load across the DC terminals.

The regulation of this power supply is then very closely linear between the limits of 190 volts with zero load current, and zero volts with a maximum load current of 8 milliamperes when the load has essentially zero resistance.

If the desired terminal voltage for a given load current is less than the value specified by the equation

$$E(\text{volts}) = 190 - 22.6 I \text{ (ma)}$$

a suitable shunt resistor may be added externally across the DC terminals. This will, of course, improve the terminal voltage regulation for any given change in the resistance of the external load.

SERVICE AND MAINTENANCE INSTRUCTIONS

FOR THE

TYPE 650-A IMPEDANCE BRIDGE

1.0 FOREWORD

1.1 These Service Instructions together with the information given in the Operating Instructions should enable the user to locate and correct ordinary difficulties resulting from normal usage.

1.2 Most of the components mentioned in these notes can be located by referring to the photograph.

1.3 Major service problems should be referred to the Service Department which will cooperate as far as possible by furnishing information and instructions, as well as by shipping any replacement parts which may be required. If the instrument is more than one year old, a reasonable charge may be expected for replacement parts or for complete reconditioning if the bridge is returned.

1.4 Detailed facts giving type and serial numbers of the instrument and parts, as well as operating conditions, should always be included in your report to the Service Department.

2.0 GENERAL

2.1 If the bridge fails to function, check the position of the bridge controls and the condition of the sample under measurement before attempting to locate trouble in the bridge. Failure to obtain a balance may be due to reasons which lie outside the bridge, for instance an open circuited resistance sample. This situation can be checked by measuring a standard of the same order of magnitude which is known to be in good condition. Make certain that the magnitudes of impedances of the samples under test do not lie outside the range of the bridge.

2.2 From time to time all switch blades, contacts, and the contact surfaces of the four rheostats should be cleaned. A solution of half ether and half alcohol is recommended. A clean cloth may be used on exposed surfaces and stiff white paper where the cloth is inconvenient. No abrasives should be used on any contact surface. A thin coat of Lubriko MD grease or equivalent should be applied to all bearings and to switch contacts. No lubricant should be used on the rheostat contact surfaces.

GENERAL RADIO COMPANY

3.0 BRIDGE INOPERATIVE

- 3.1 D-C resistance measurements, refer to Section 4.0.
- 3.2 A-C resistance measurements, refer to Section 5.0.
- 3.3 Capacitance measurements, refer to Section 6.0.
- 3.4 Inductance measurements, refer to Section 7.0.
- 3.5 Calibration of dials, refer to Section 8.0.
- 3.6 Microphone hummer inoperative, refer to Section 9.0.

4.0 D-C RESISTANCE MEASUREMENTS

4.1 Refer to Figure A which shows components of bridge used with this circuit. External batteries can be used if required but their voltage should NEVER exceed the limits shown in Table IV of the Operating Instructions.

4.2 Test batteries for proper voltage. This should be done using a voltmeter.

4.21 Proper battery voltage under load is 6 volts, d.c.

4.22 Batteries can be checked as follows without removing battery compartment cover.

4.221 Turn switch S-6, DETECTOR, to EXT.

CAUTION: Do not turn DETECTOR switch during test or excessive current will flow through the galvanometer, causing damage to it.

4.222 Turn switch S-4, GENERATOR, to D-C.

4.223 Connect the positive lead of the voltmeter to the R (high) binding post, the negative lead to the J binding post.

4.3 Galvanometer will not come to zero.

4.31 Examine wiring to be sure that no short circuits are present or that wiring is not touching copper shielding of the cabinet.

4.4 Galvanometer is defective.

4.41 If the meter is defective, a replacement should be ordered from the Service Department. The General Radio Company cannot assume responsibility for any local repairs to the meter, although such repairs may be necessary in an emergency.

4.5 Check all switches for proper contacts and operation. Refer to Section 2.2.

4.6 Test resistors R-1 through R-10 and R-14 for open and short circuits and proper values.

4.61 Resistors R-1 through R-8, as well as S-1, can be conveniently checked from the panel of the bridge by setting DETECTOR switch to EXT, GENERATOR switch to EXT ON-INT OFF, D-Q MULTIPLIER switch

if Panel of P1 oscillator + Panel of 450A Bridge are touching (shorted) the meter will be shunted at all positions of galvan switch on DC Resistance readings. The meter will be insensitive on all positions

to R. An ohmmeter or Wheatstone bridge can then be connected to either the J or R (high) binding posts and the EXTERNAL DETECTOR (high) binding post and measurements made.

4.62 Test rheostat R-10 for continuity and proper resistance values corresponding to CRL dial settings.

4.621 R-10 can be checked from the panel by setting the DETECTOR switch to EXT, the GENERATOR switch to EXT ON-INT OFF and the D-Q MULTIPLIER switch to L. Connect a Wheatstone bridge from binding post J to one of the panel grounds. Resistance readings should be 1000 times the dial reading. If the dial calibration is incorrect, refer to Section 8.0.

5.0 A-C RESISTANCE MEASUREMENTS

5.1 Refer to Figure B which shows the components of the bridge used in this circuit. Circuit shown uses the internal 1-kc generator. An EXTERNAL GENERATOR can be used. (For switch S-4 settings see Figure D.)

CAUTION: Do not exceed the safe voltage limits given in Table V of the Operating Instructions.

5.2 Test batteries; refer to Section 4.2.

5.3 Check all switches for proper contacts and operation; refer to Section 2.2.

5.31 Switch S-3 is located on the shaft of the CRL-MULTIPLIER switch and changes the connections on the microphone hummer to keep the impedance matched. The cam should be set on the shaft so that the cam follower is down (toward the shaft) on the 0.1- and 1-ohm switch positions, and up (away from shaft) on all higher switch positions.

5.4 Test resistors R-1 through R-8 and R-10 for open and short circuits and proper values. Refer to Sections 4.61 and 4.62.

5.5 MICROPHONE HUMMER does not function properly. Refer to Section 9.0.

6.0 CAPACITANCE MEASUREMENTS

6.1 Refer to Figure C which shows the components of the bridge used in this circuit. Circuit shown uses the internal 1-kc generator. An EXTERNAL GENERATOR can be used. (For switch S-4 settings, see Figure D.)

CAUTION: Do not exceed the safe voltage limits given in Table V of the Operating Instructions.

6.2 Test batteries; refer to Section 4.2.

6.3 Check all switches for proper contacts and operation; refer to Section 2.2.

6.4 Test resistors R-1 through R-6 and resistors R-10, R-11, and R-13 for open and short circuits and proper values; refer to Sections 4.61 and 4.62.

TYPE 650-A IMPEDANCE BRIDGE

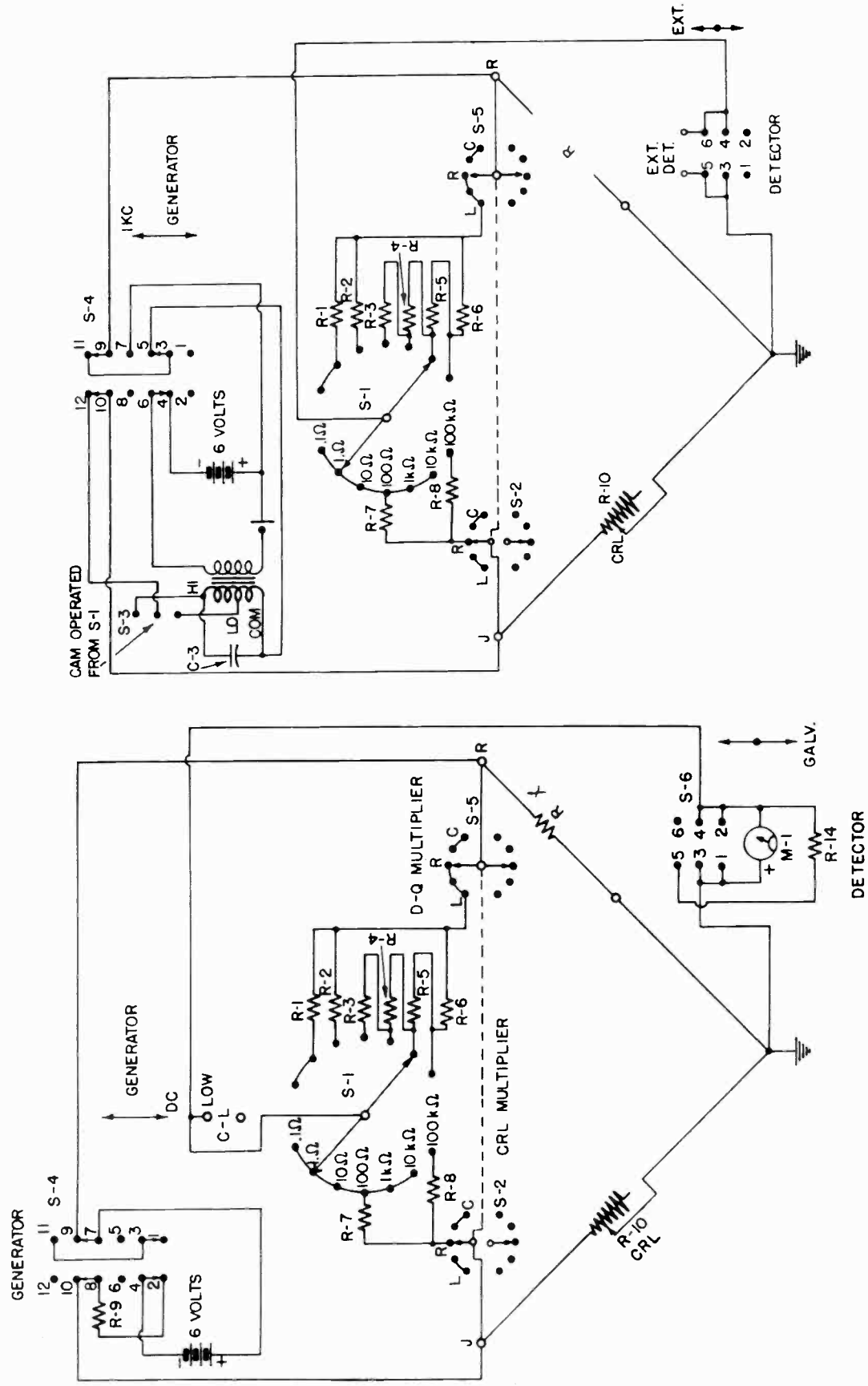

A.C. RESISTANCE - 1000~(INT)

Figure B.

D.C. RESISTANCE

Figure A.

GENERAL RADIO COMPANY

6.5 Test capacitor C-1 for an open or short circuit, leakage and proper value.

6.6 MICROPHONE HUMMER does not function properly; refer to Section 9.0.

7.0 INDUCTANCE MEASUREMENTS

7.1 Refer to Figure D which shows the components of the bridge used in this circuit with an external source of a-c voltage. The internal 1-kc generator can be used. (For switch S-4 settings see Figure C.)

CAUTION: Do not exceed the safe voltage limits given in Table V of the Operating Instructions.

7.2 Test batteries; refer to Section 4.2.

7.3 Check all switches for proper contacts and operation; refer to Section 2.2.

7.4 Test resistors R-1 through R-6, R-9 through R-12 for open and short circuits and proper values; refer to Sections 4.61 and 4.62.

7.5 Test capacitor C-2 for an open or short circuit, leakage and proper value.

7.6 MICROPHONE HUMMER does not function properly; refer to Section 9.0.

8.0 CALIBRATION OF DIALS

These calibrations must be made using a Wheatstone bridge accurate to at least $\pm 0.25\%$.

8.1 Main CRL dial.

8.11 Make certain that the rheostat, R-10, is clean, that the set screws are tight, and that the cam follower mechanism is operating freely.

8.12 Remove one connection to R-10, and connect the Wheatstone bridge to the rheostat. The resistance, in ohms, measured by the bridge should then be 1000 times the setting of the CRL dial.

8.13 Turn the main dial to a point near the center which brings the cam follower opposite one of the cam plate screws, and adjust the screw until the resistance in ohms is 1000 times the dial reading. Progress up the scale and then down the scale, adjusting each screw

in a similar manner. As a final check see that each main point on the dial and also points 0.5 and 0.1 check within 0.5% of the correct resistance value. If it is found that the whole cam plate is adjusted too high or too low, loosen the set screws in the dial, shift its position on the shaft, and start the cam plate adjustment over again.

8.2 D, D-Q, and Q Dials.

8.21 Calibration of these dials consists simply in setting a single point to the correct resistance. After the rheostats have been cleaned, set the D-Q MULTIPLIER switch at R and connect the Wheatstone bridge to the terminals of each rheostat in turn, setting the dials as shown below.

Dial	Dial Setting	Correct Resistance
D	2.5	398 ohms
D-Q	2.5	3980 ohms
Q	.5	31.8 ohms

If these resistance readings are not obtained, loosen the dial set screws and change the dial positions until they correspond to the correct resistance.

9.0 MICROPHONE HUMMER INOPERATIVE

9.1 Test batteries; refer to Section 4.2.

9.2 Check switch S-4 for proper connections and operation; refer to Section 2.2.

9.3 Test capacitor C-3 for a short circuit and leakage.

9.4 Test the coils of the hummer for open circuits or short circuits to ground.

9.5 If the hummer refuses to start when measuring samples of low inductance, the air gap of the reed can be decreased slightly by turning the adjusting screw in a clockwise direction. This tends to increase the harmonic output of the hummer which, if raised to too high a value, makes it difficult to detect the null balance and so is recommended only as an emergency measure.

9.6 If the hummer is completely inoperative, it should be removed from the bridge and returned to the factory for repair and reconditioning.

SERVICE AND MAINTENANCE INSTRUCTIONS FOR THE TYPE 650-P1 OSCILLATOR-AMPLIFIER

1.0 FOREWORD

1.1 These Service Instructions together with the information given in the Operating Instructions should enable the user to locate and correct ordinary difficulties resulting from normal usage.

1.2 Most of the components mentioned in these instructions can be located by referring to the photographs. Special instructions for disassembly of the instrument to replace component parts are given in Section 9.0.

1.3 Major service problems should be referred to the

TYPE 650-A IMPEDANCE BRIDGE

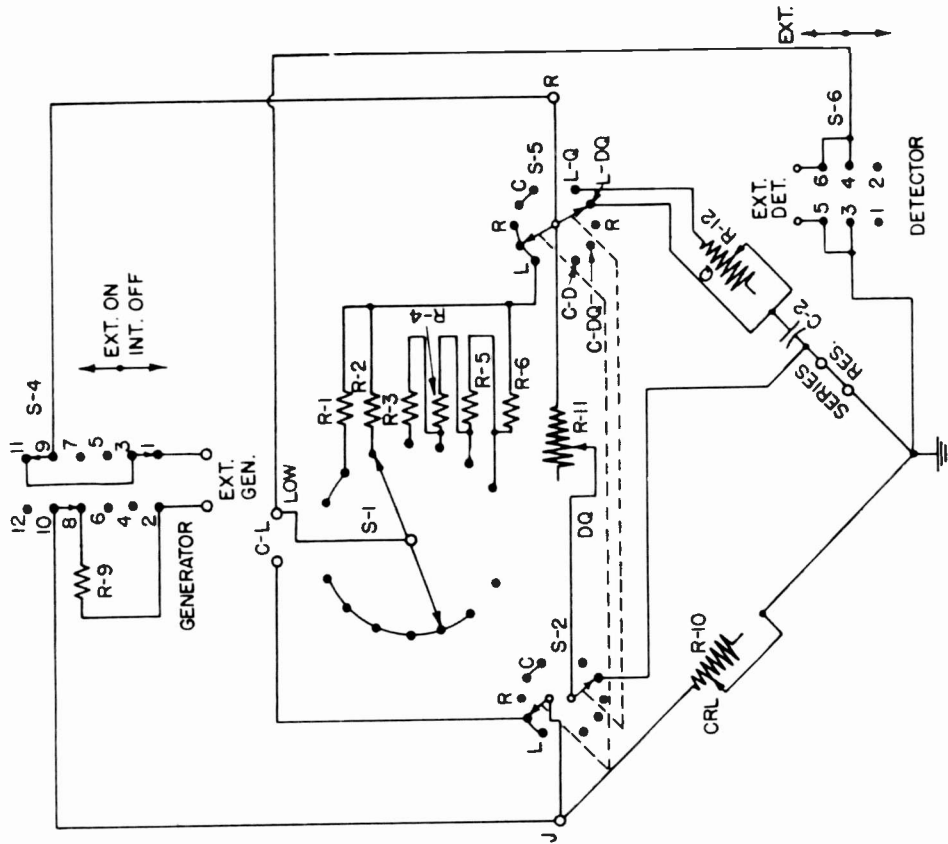

INDUCTANCE - EXT. GENERATOR

Figure D.

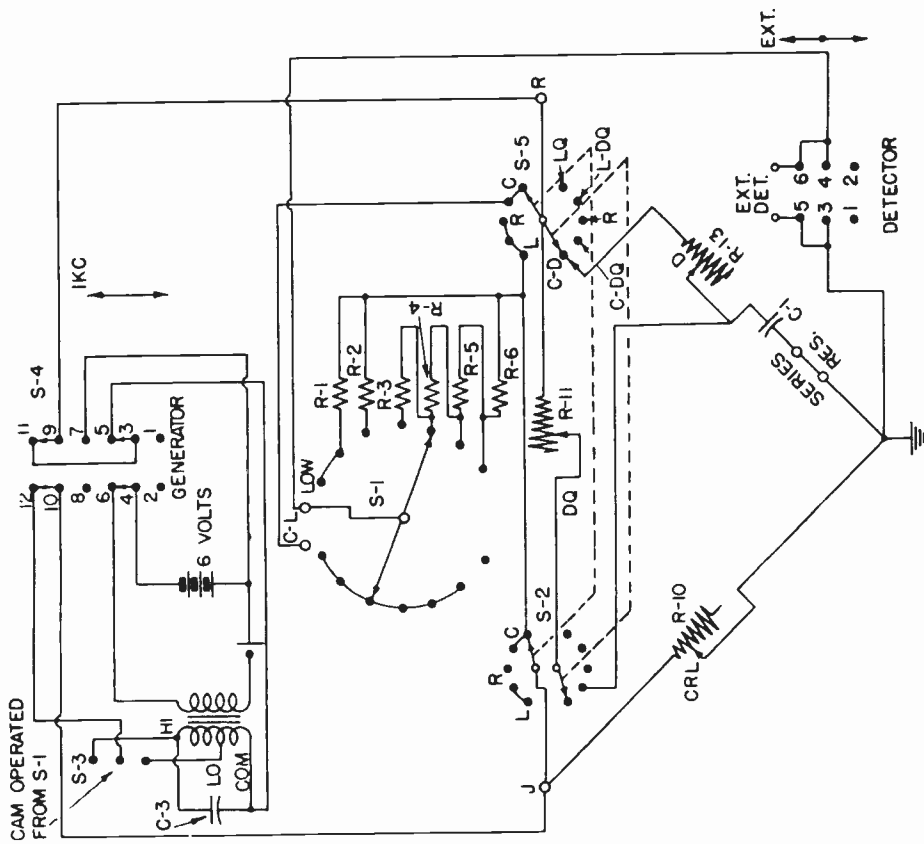

CAPACITANCE - 1000~(INT)

Figure C.

GENERAL RADIO COMPANY

Service Department which will cooperate as far as possible by furnishing information and instructions, as well as by shipping any replacement parts which may be required. If the instrument is more than one year old, a reasonable charge may be expected for replacement parts or for complete reconditioning if the unit is returned.

1.4 Detailed facts giving type and serial numbers of the instrument and parts, as well as operating conditions, should always be included in your report to the Service Department.

2.0 GENERAL

If the oscillator-amplifier becomes inoperative, a few simple checks should be made before removing the metal side panels.

2.1 Check the power line source.

2.2 Check the power supply cord for open circuits or poor contact in power outlet.

3.0 INSTRUMENT INOPERATIVE

3.1 See that all tube filaments are lighted.

3.2 If the pilot lamp does not light, see Section 4.0.

3.3 No d-c output at d-c terminals, see Section 5.0.

3.4 No output at 1-KC terminals, see Section 6.0.

3.5 No amplification, or low amplification, see Section 7.0.

4.0 PILOT LAMP DOES NOT LIGHT

4.1 Check bulb P-1.

4.2 Check R-26.

4.3 Check connections on transformer T-1.

5.0. NO D-C OUTPUT AT D-C TERMINALS

5.1 See that BRIDGE INPUT switch is set at D.C.

5.2 Test resistors R-2, R-3 and R-27 for open circuits and proper values.

5.3 Check BRIDGE INPUT switch, S-2, for loose or dirty contacts.

5.4 Check power supply; see Section 8.0.

6.0. NO OUTPUT AT 1-KC TERMINALS

6.1 See that BRIDGE INPUT switch is set at 1-KC.

6.2 Test tube V-2 and operating voltages. See Section 6.6.

6.3 Test transformer T-2 for open circuits and continuity.

6.4 Check resistors R-5 through R-15 and R-25 for open circuits and proper values.

6.5 Check capacitors C-5, C-6, C-8 through C-12 for open or short circuits and leakage.

6.6 When tube V-2 is replaced, the two internal adjustments R-14 and R-13 may, in rare instances, require readjustment. The side panels must be in place when these adjustments are made.

6.61 Line voltage should be 115 or 230 volts A.C. Move R-14 over its entire range. If this gives output, set R-14 at the point where 12 to 15 volts rms (1000 cycles) appears at the 1-KC output terminals with no external load. This voltage should be measured with a high-impedance-input vacuum-tube voltmeter.

6.62 Turn rheostat R-13 in a clockwise direction until oscillations begin as indicated by a 1000-cycle note at the 1-KC output terminals. R-13 should not be advanced much beyond the point where oscillations just begin as the output waveform will become badly distorted. NOTE: Setting of R-13 can be increased slightly to maintain oscillation if the line voltage decreases to 105 volts.

6.63 R-14 should now be reset as in Section 6.61.

7.0 NO AMPLIFICATION, OR LOW AMPLIFICATION

A signal of 10mv, at 1000 cycles, applied at the ends of the input cable should give 4 v at the PHONE terminals on open circuit with AMPLIFIER RESPONSE switch set at 1-KC and AMPLIFIER GAIN control full on. With AMPLIFIER RESPONSE switch set at FLAT, this output voltage should be 6 to 9 volts.

7.1 Check tube V-3 and operating voltages.

7.2 Check AMPLIFIER RESPONSE switch S-3 for loose or dirty contacts.

7.3 Test resistors R-4, and R-16 through R-21 for open circuits and proper values.

7.4 Test capacitors C-4, C-7, C-13 through C-16 for open or short circuits and leakage.

7.5 When no output appears with the AMPLIFIER RESPONSE switch set at 1KC:

7.51 Test resistors R-22 through R-24 for open circuits and proper values.

$$\text{NOTE: } \frac{R-22 + R-23}{4} = R-24 \pm 0.5\%$$

7.52 Test capacitors C-17 through C-19 for open or short circuits and leakage.

$$\text{NOTE: } C-18 + C-19 = C-17 \pm 0.5\%$$

TYPE 650-P1 OSCILLATOR-AMPLIFIER

8.0 POWER SUPPLY

- 8.1 Check switch S-1 for loose or dirty contacts.
- 8.2 Check transformer T-1 for open circuits and continuity.
- 8.3 Test tube V-1 and operating voltages.
- 8.4 Test resistor R-1 for open circuit and proper value.
- 8.5 Check capacitors C-1 through C-3 for open or short circuits.

9.0 REPLACEMENT OF COMPONENTS

Owing to the compact design and construction of this instrument and the number of component parts mounted in the available space, it is necessary to use a number of mechanical expedients. This makes removal of parts for testing or service difficult without following specific instructions. The instrument is divided into three sub-assemblies; namely, power supply, amplifier, and oscillator and referred to as SA-1, SA-2, and SA-3 respectively in these instructions and on the photographs. Care should be taken to replace disconnected wires and components in their proper places when reassembling.

CAUTION: Soldering should be done with the instrument lying on its side. Use care to avoid dropping small bits of solder into the instrument as these can cause short circuits resulting in serious damage.

9.1 Power Supply, Subassembly SA-1.

9.11 Remove the two hexagonal panel screws holding the POWER receptacle.

9.12 Unsolder connections shown on photograph labeled SA-1.

- 9.121 Green-yellow wires to power socket.
- 9.122 Tan wires to D.C.+ and S-2.
- 9.123 Orange wires to terminals 7 and 8 of V-2 socket.
- 9.124 Black-red wire to terminal 4 of S-2.
- 9.125 Black-green wire to terminal 3 of S-2.
- 9.126 Resistor R-26 at ground lug.

9.13 Remove the two small binder head machine screws on bottom of SA-1.

9.2 Amplifier, Subassembly SA-2.

9.21 Remove the two hexagonal panel screws at right end of panel.

9.22 Remove AMPLIFIER GAIN control knob.

9.23 Unsolder connections shown on photograph labeled SA-2.

9.231 Orange wires to terminals 7 and 8 of V-2 socket.

9.232 Black wires to ground terminal on SA-3.

9.233 Capacitor C-16 to high PHONE terminal.

9.234 Black-red and black-green wires to SA-3.

9.24 Remove switch S-3 from panel.

9.25 Remove the two binder head machine screws opposite those mentioned in Section 9.13.

9.3 Oscillator, Subassembly SA-3.

9.31 Remove SA-1 and SA-2.

9.32 Remove OSCILLATOR GAIN control knob.

9.33 Remove the two hexagonal panel screws at center of panel.

9.34 Unsolder connections shown on photograph labeled SA-3.

9.341 Solid, bare wires to S-2.

9.342 Insulated wires to 1-KC output terminals.

NOTE: Care should be taken to replace these leads in exact positions as located before their removal. This is necessary to minimize capacitance to ground.

10.0 VACUUM-TUBE DATA

Table of tube socket voltages measured from socket pin to ground unless otherwise noted using a 20,000 ohm-per-volt meter (Weston 772 Analyzer). D-C voltages may vary as much as $\pm 20\%$.

Symbol	Type	Socket Pin Number						Function
		2	3	4	5	6	8	
V-1	6H6	6.7 (AC)	150	300			150	Rectifier Oscillator Amplifier
V-2	6SL7GT	235	3.4		300	3.6	6.7(AC)	
V-3	6SL7GT	200	2.2		200	2.25	6.7(AC)	

CONDITIONS:

POWER switch ON, 115/230 v., 60 cycle, 10 watts.

BRIDGE INPUT switch at 1 KC.

AMPLIFIER RESPONSE switch at 1 KC.

OSCILLATOR GAIN and AMPLIFIER GAIN at maximum clockwise positions.

No external connections to instrument terminals.

GENERAL RADIO COMPANY

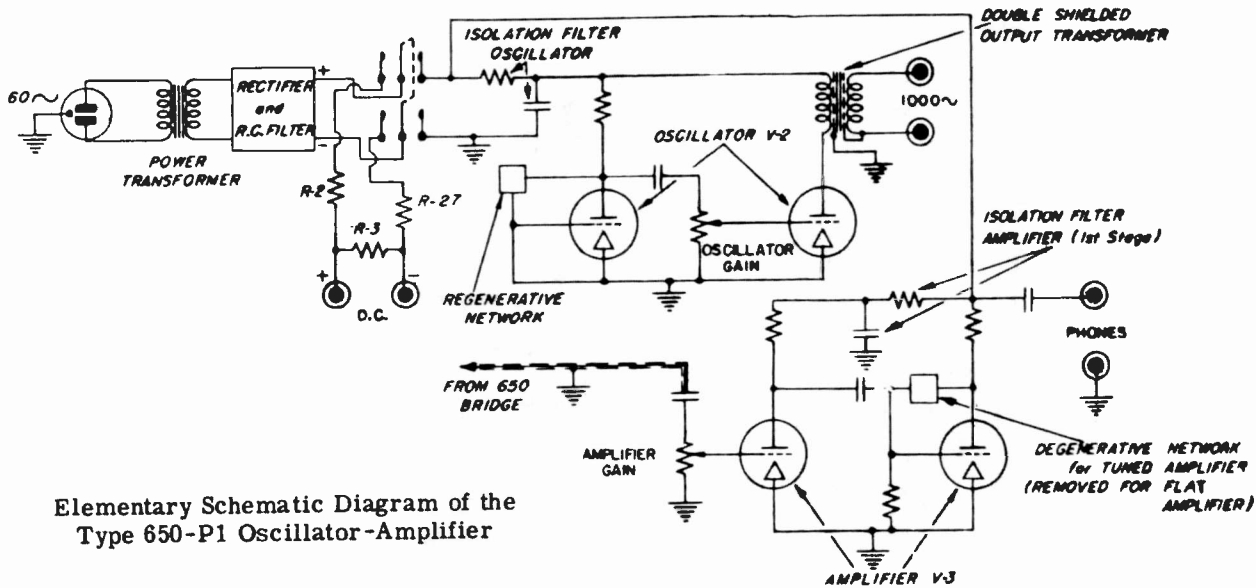

Elementary Schematic Diagram of the Type 650-P1 Oscillator-Amplifier

RESISTORS

R-1 =	470 Ohms	±10%	REC-20BF
R-2 =	15 K Ohms	±10%	REC-41BF
R-3 =	47000 Ohms	±10%	REC-30BF
R-4 =	470 Ohms	±10%	REC-20BF
R-5 =	470 Ohms	±10%	REC-20BF
R-6 =	0.1 Megohm	±10%	REC-20BF
R-7 =	1 Megohm	±10%	REC-20BF
R-8 =	1 Megohm	±10%	REC-20BF
R-9 =	50000 Ohms		POSC-7
R-10 =	178 K Ohms	± 1%	REF-1
R-11 =	178 K Ohms	± 1%	REF-1
R-12 =	22000 Ohms	±10%	REC-20BF
R-13 =	50000 Ohms	±20%	POSC-11
R-14 =	1000 Ohms	±10%	POSW-3
R-15 =	1200 Ohms	±10%	REC-20BF
R-16 =	0.1 Megohm		POSC-7
R-17 =	0.1 Megohm	±10%	REC-20BF
R-18 =	0.1 Megohm	±10%	REC-20BF
R-20 =	1200 Ohms	±10%	REC-20BF
R-21 =	1.8 Megohms	±10%	REC-20BF
R-22 =	160 K Ohms	± 1%	REF-1
R-23 =	160 K Ohms	± 1%	REF-1
R-24 =	80 K Ohms	± 1%	REF-1
R-25 =	180 Ohms	±10%	REW-3C
R-26 =	15 Ohms	±10%	REW-2C
R-27 =	18 k Ohms	±10%	REC-41BF

$\frac{R-22 + R-23}{4} = R-24 \pm 0.5\%$ by SELECTION

TUBES

V-1 =	RCA	6N6
V-2 =	RCA	6SL7GT
V-3 =	RCA	6SL7GT

TOP VIEW OF INSTRUMENT
TUBE LAYOUT

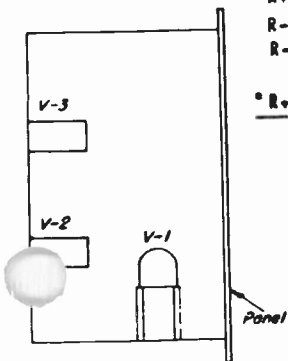

CONDENSERS

C-1 =	20	μf	450 DCV	COE-5
C-2 =	20	μf	450 DCV	COE-20
C-3 =	20	μf		
C-4 =	20	μf		
C-5 =	20	μf	450 DCV	COE-20
C-6 =	20	μf	150 DCV	COE-8
C-7 =	200	μf	10 DCV	COE-6
C-8 =	0.02	μf		COM-50B
C-9 =	0.005	μf		COM-35B
**C-10 =	0.002	μf		650-39
**C-11 =	0.001	μf		
**C-12 =	0.001	μf		
C-13 =	0.04	μf		COM-50B
C-14 =	0.005	μf		COM-35B
C-15 =	0.02	μf		COM-50B
C-16 =	0.01	μf		COM-41B
**C-17 =	0.002	μf		650-39
**C-18 =	0.001	μf		
**C-19 =	0.001	μf		

MISCELLANEOUS

P-1 =	Pilot Light	2LAP-080 Mazda No. 20
PL-1 =	Plug	ZCDPP-10
T-1 =	Transformer	845-414
T-2 =	Transformer	746-407
S-1 =	Switch DPST	SWT-283, NP
S-2 =	Switch DPDT	SWT-286, NP
S-3 =	Switch DPST	SWT-288, NP

**Selected Critical Values

C-18 + C-19 =	C-17 ±0.5%	by SELECTION
C-11 + C-12 =	C-10 ±0.5%	by SELECTION

TYPE 650-P1 OSCILLATOR-AMPLIFIER

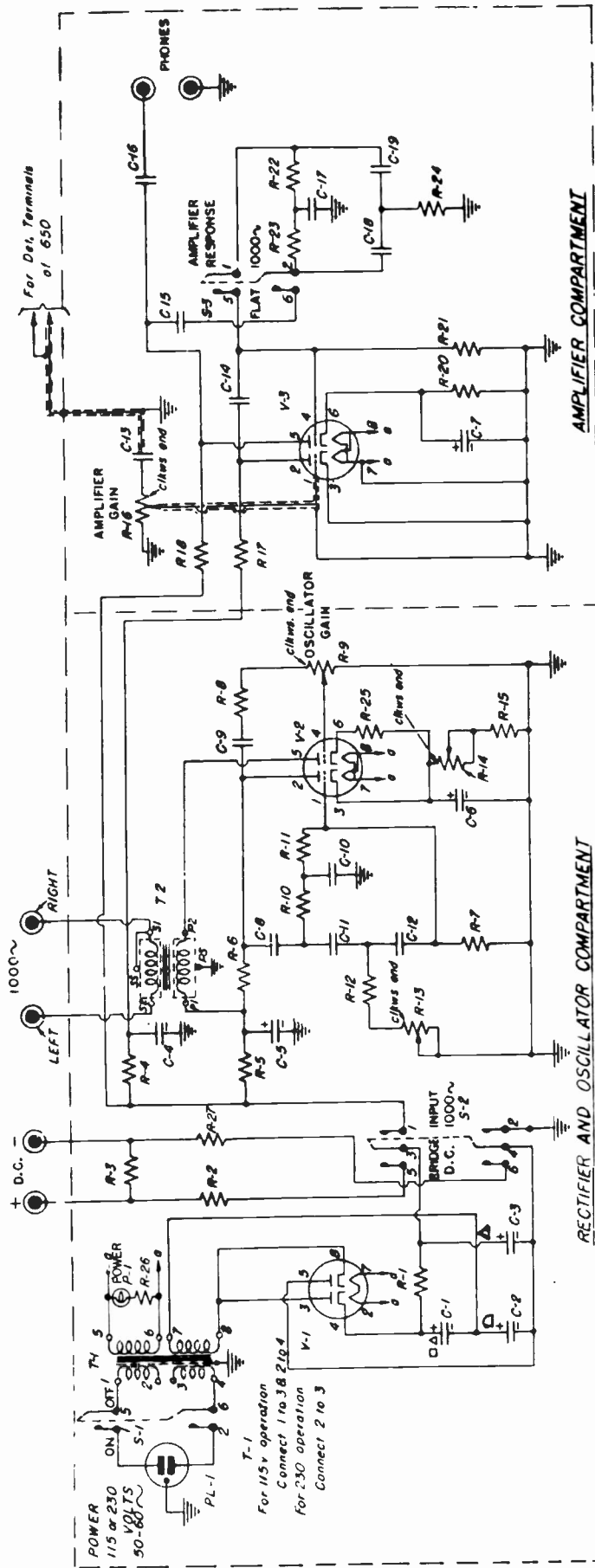

Figure 2. Complete Wiring Diagram of Type 650-P1 Oscillator-Amplifier.

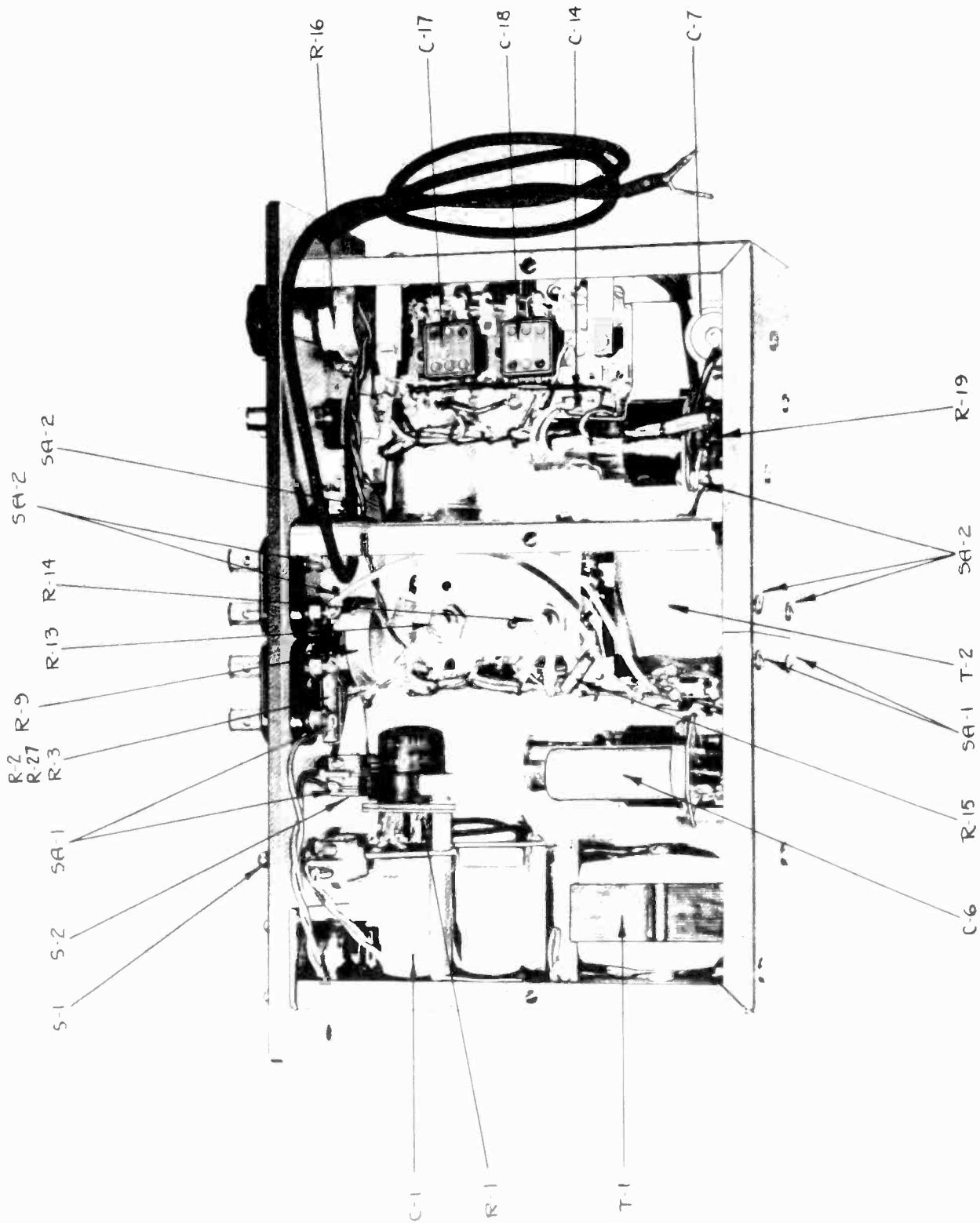

Figure 3. View of Type 650-P1 with Covers Removed.

TYPE 650-P1 OSCILLATOR-AMPLIFIER

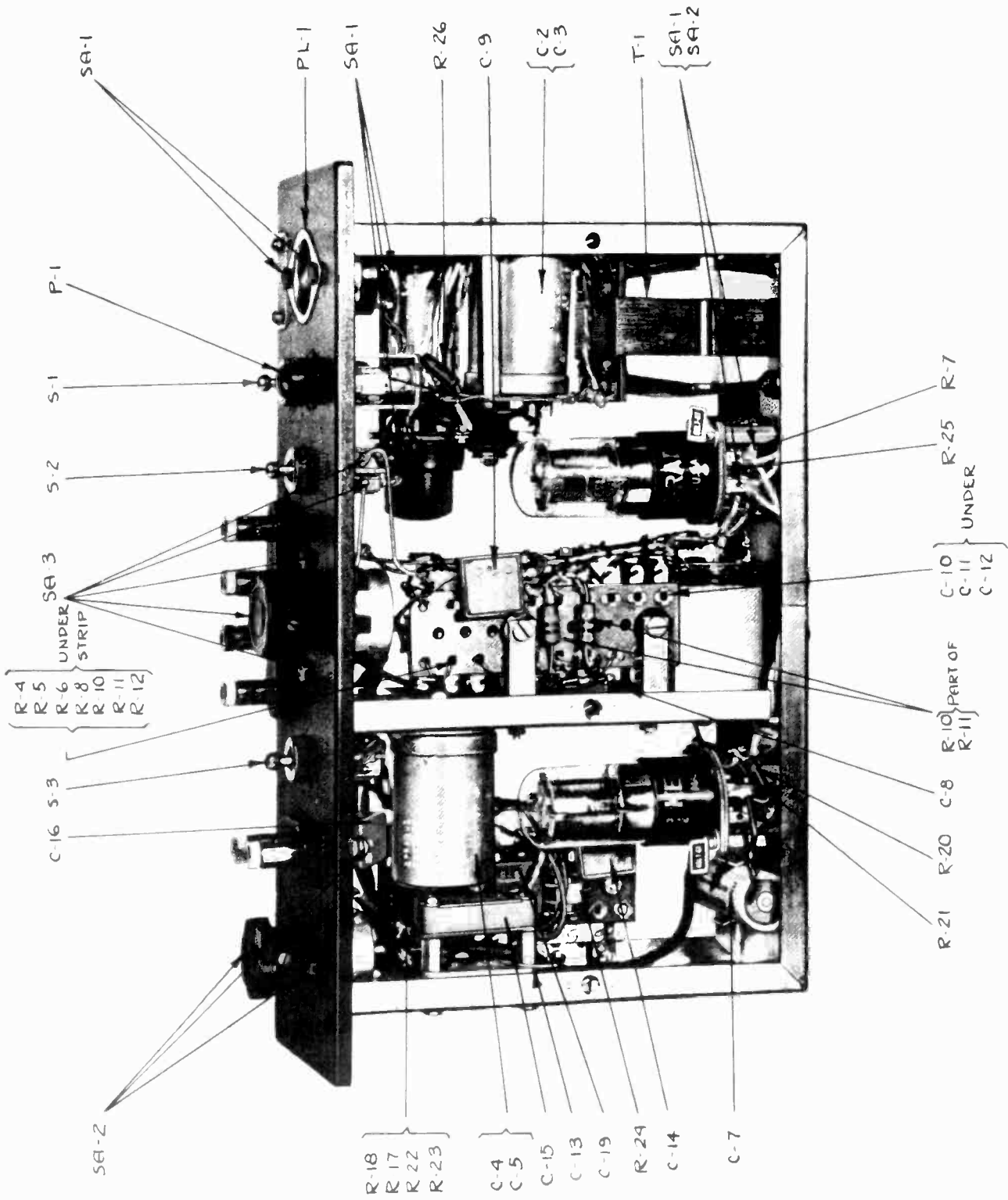

Figure 4. View of Type 650-P1 with Covers Removed.

GENERAL RADIO COMPANY

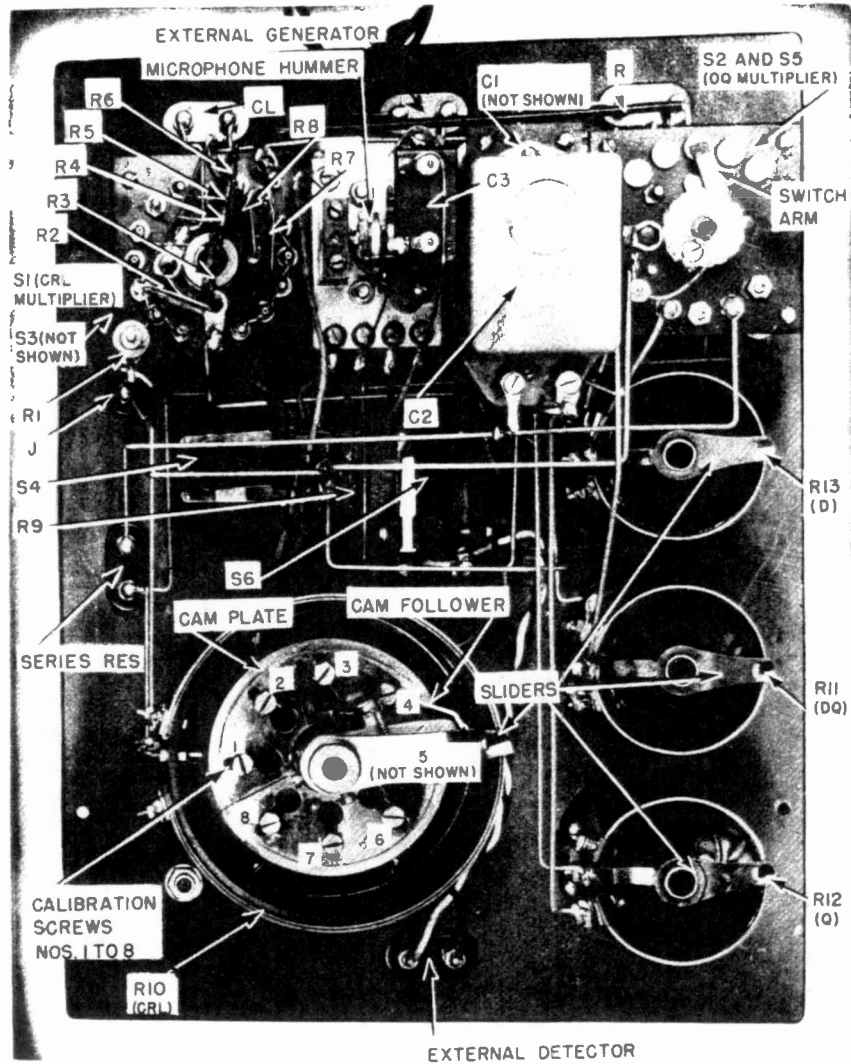
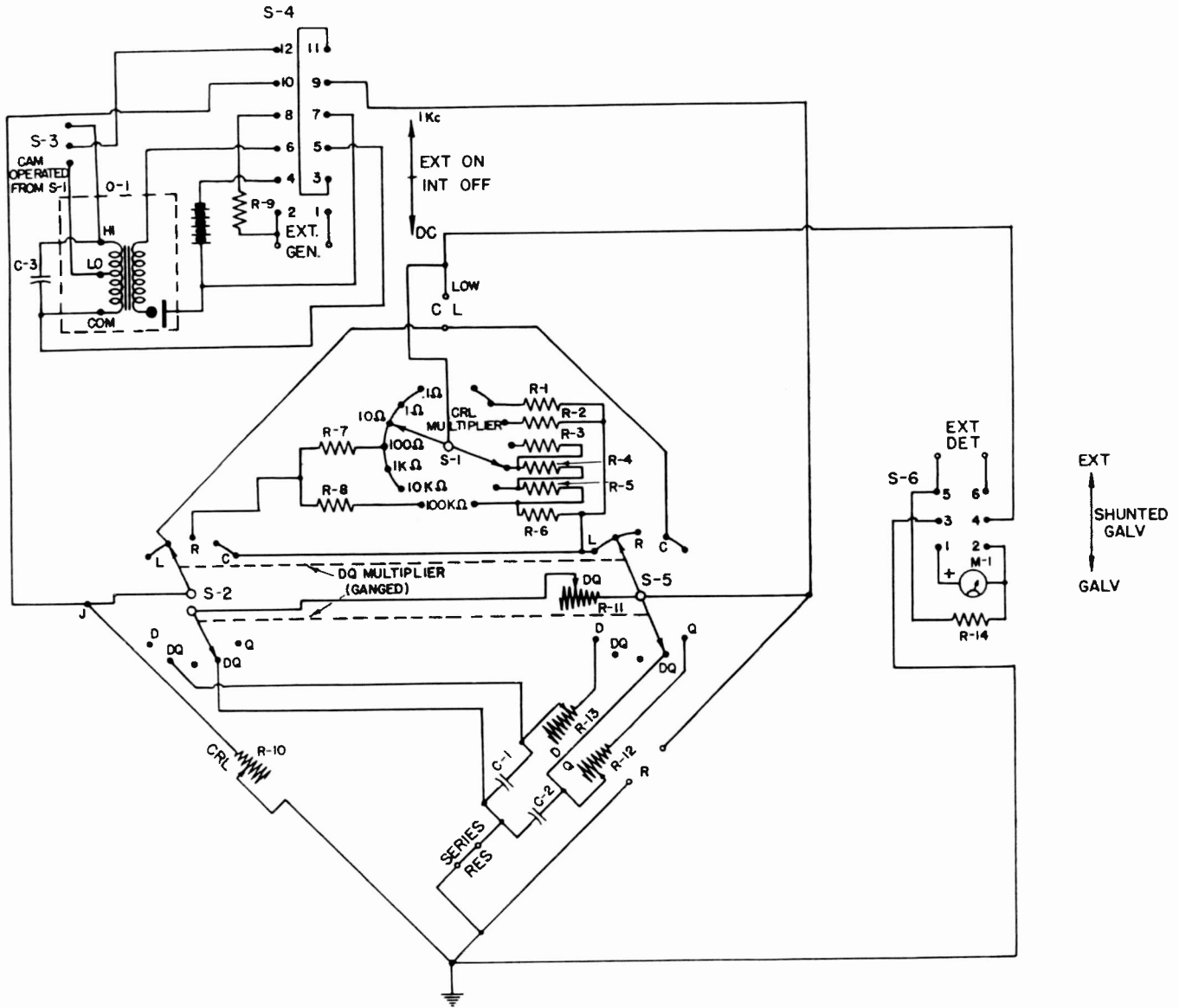

Figure 5. Interior View of Type 650-A Impedance Bridge.

R-1	100 K Ohms $\pm 0.25\%$	REPR-16	C-1	0.00990-0.00995 μ f	505
R-2	10 K Ohms $\pm 0.1\%$	602-305-2	C-2	0.09950-0.1 μ f	505
R-3	900 Ohms	650-300	C-3	0.5 μ f	COW-3
R-4	90 Ohms				
R-5	9 Ohms				
R-6	0.99 Ohms $\pm 0.25\%$				
R-7	10 K Ohms $\pm 0.1\%$	510-343	M-1	200 μ a	588-306A
R-8	1 K Ohms $\pm 0.1\%$	650-304	O-1	Microphone Hummer	572-B
R-9	60 Ohms $\pm 2\%$	433-300			
R-10	0-11.2 K Ohms	650-306	S-1	Part of Sub. Assembly 650-32	
R-11	0-16 K Ohms	650-311	S-2	Part of Sub. Assembly 650-32	
R-12	0-160 Ohms	650-308	S-3	339-A	
R-13	0-1.6 K Ohms	650-305	S-4	Part of Sub. Assembly 650-32	
R-14	2 Ohms $\pm 5\%$		S-5	339-B	
			S-6		

TYPE 650-A IMPEDANCE BRIDGE



TYPE 650-A IMPEDANCE BRIDGE

Figure 6. Complete Wiring Diagram of Type 650-A Impedance Bridge.

See next page for details of connections to generator and detector switches.

GENERAL RADIO COMPANY

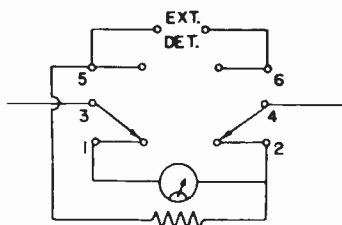

GALV.

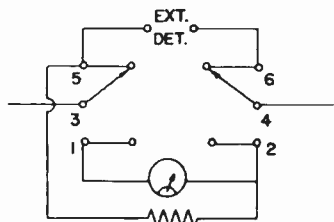

EXT. DET.

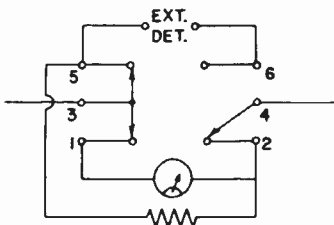

SHUNTED*
GALV.

* BLADE FOR CONTACT #3
CONNECTS TO BOTH #5
AND #1 IN THIS POSITION.

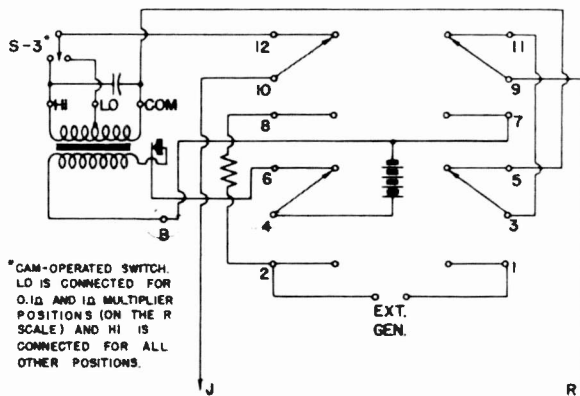

* CAM-OPERATED SWITCH.
LO IS CONNECTED FOR
0.1Ω AND 1Ω MULTIPLIER
POSITIONS (ON THE R
SCALE) AND HI IS
CONNECTED FOR ALL
OTHER POSITIONS.

CONNECTIONS FOR 1 Kc POSITION
OF GENERATOR SWITCH

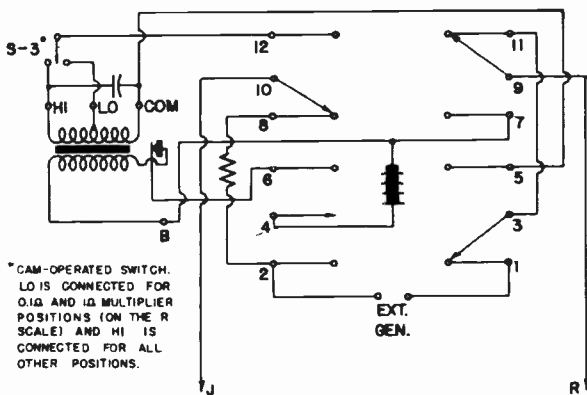

* CAM-OPERATED SWITCH.
LO IS CONNECTED FOR
0.1Ω AND 1Ω MULTIPLIER
POSITIONS (ON THE R
SCALE) AND HI IS
CONNECTED FOR ALL
OTHER POSITIONS.

CONNECTIONS FOR EXT. ON-
INT. OFF POSITION OF
GENERATOR SWITCH

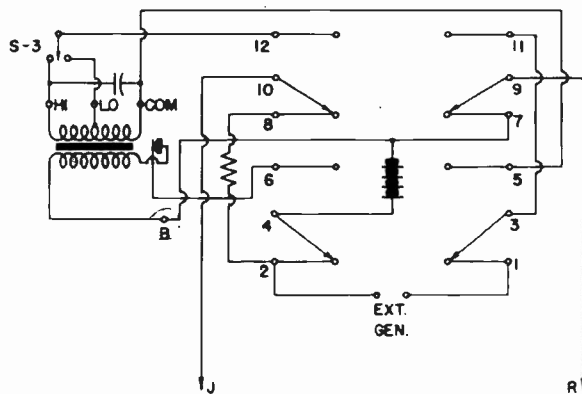

CONNECTIONS FOR DC POSITION
OF GENERATOR SWITCH

Figure 7. Connections for Various Positions of Generator and Detector Switches of Type 650-A.

The GENERAL RADIO EXPERIMENTER

VOL. VII. Nos. 11 and 12



APRIL-MAY, 1933

ELECTRICAL COMMUNICATIONS TECHNIQUE AND ITS APPLICATIONS IN ALLIED FIELDS

THE CONVENIENT MEASUREMENT OF C, R, AND L

T H E important considerations in the large majority of bridge measurements made in the average experimental laboratory are the ease and speed of making the readings, and the ability to measure any values of resistance, inductance, or capacitance, as they may exist in any piece of equipment. A completely satisfactory bridge should immediately indicate the answer to such questions as the following:

Is the maximum inductance of this variable inductor at least 5 mh, its minimum inductance 130 uh, and its direct-current resistance less than 4 Ω ?¹

Has this choke coil at least 20 h inductance and an energy factor Q of at least 20?

Has this tuning condenser a maximum capacitance of 250 uuf and a 20 to 1 range?

Has this filter condenser at least 4 μf capacitance and a power factor of only 0.5%?

Is the resistance of this rheostat 200 k Ω ?

¹ These are the standard abbreviations of the Institute of Radio Engineers. Note that 1 m Ω is 0.001 ohm and that 1 M Ω is 1,000,000 ohms.

Is the zero resistance of this decade-resistance box only 5 m Ω ?

The TYPE 650-A Impedance Bridge will furnish the answers to all these questions and many others. It will measure direct-current resistance over 9 decades from 1 m Ω to 1 M Ω , inductance over 8 decades from 1 μh to 100h, with an energy factor ($Q = \omega L/R$)

up to 1000, capacitance over 8 decades from 1 uuf to 100 uf, with a dissipation factor ($D = R\omega C$) up to unity.²

These results are read directly from dials having approximately logarithmic scales similar to those used on slide rules. The position of the decimal point and the proper electrical unit are indicated by the positions of two selector switches. Thus the CRL multiplier switch in Figure 1 points to a combined multiplying factor and electrical unit of 1 uf so that the indicated ca-

² The fact that this bridge is capable of measuring a condenser with large energy losses makes it necessary to distinguish between its dissipation factor R/X and power factor R/Z . The two are equivalent when the losses are low.

Since the bridge measures $R\omega C$ directly, the term dissipation factor has been used, even though the two terms are, for most condensers, synonymous.

capacitance as shown on the CRL dial is 2.67 μf , because the D-Q multiplier switch has been set on C for the measurement of capacitance. It also shows that the DQ dial is to be read for dissipation factor D with a multiplying factor of 0.1 yielding 0.26.

If the condenser had a smaller dissipation factor, this D-Q multiplier switch would have been set for the D dial with a multiplying factor of 0.01. Thus the D dial, as shown in Figure 1, indicates a dissipation factor of 0.0196 or a power factor of 1.96%.

For the measurement of pure resistance the D-Q multiplier switch would be set at R so that the CRL dial indicates a resistance of 2.67 Ω .

For the measurement of inductance the D-Q multiplier switch would be set at L and the CRL dial indicates 2.67 mh. Using the DQ dial the multiplier is 1 and the energy factor Q as shown in Figure 1 is 2.6. Had the coil under measurement been a large iron-core choke coil, the CRL multiplier switch might have been set at the 10 h point, thus indicating 26.7 h. Then the D-Q multiplier switch would have been set to indicate the Q dial with a multiplier of 100 and an energy factor Q of 41 as read on the Q dial.

The ease of balancing the bridge depends on the use of the logarithmically tapered rheostats and the two multiplier switches. To illustrate this, take first the measurement of direct-current resistance.

With the unknown resistor connected to the R terminals, the D-Q multiplier switch is set at R, the GENERATOR switch at DC, and the DETECTOR switch at SHUNTED GALV. The galvanometer immediately deflects, indicating by the direction of its deflection which way

the CRL multiplier switch should be turned to obtain approximate balance. The CRL dial is then turned for exact balance, having thrown the DETECTOR switch to the GALV. position.

Because the calibration of the CRL dial extends to 0, the bridge can be balanced for a number of different settings of the CRL multiplier switch. This is very helpful in ascertaining the approximate value of a resistor. Obviously greatest accuracy of reading is obtained when the balance point on the CRL dial is within the main decade which occupies three-quarters of its scale length.

An inductor or condenser is measured by connecting it to the CL terminals. The GENERATOR switch is set at 1 KC. and the DETECTOR switch at EXT, head telephones being connected to the EXTERNAL DETECTOR terminals. The D-Q multiplier switch is set on L or C as the case demands, pointing to the DQ dial. The CRL dial is swept rapidly over its range to indicate the direction of balance. The CRL multiplier switch is then moved in the direction indicated and balance obtained on the CRL dial. The DQ dial is then turned for balance. From its setting the desirability of using the D dial or the necessity of using the Q dial will be indicated.

The reactance standards are *mica* condensers having all the excellent characteristics of the TYPE 503 Condensers described in the *Experimenter* for January.

The bridge circuit used for measuring condensers is the regular capacitance bridge having pure resistances for its ratio arms. Maxwell's bridge is used for inductors, whose energy factors Q are less than 10. Above this value Hay's bridge is used. The interdependence of the two balances of these last two

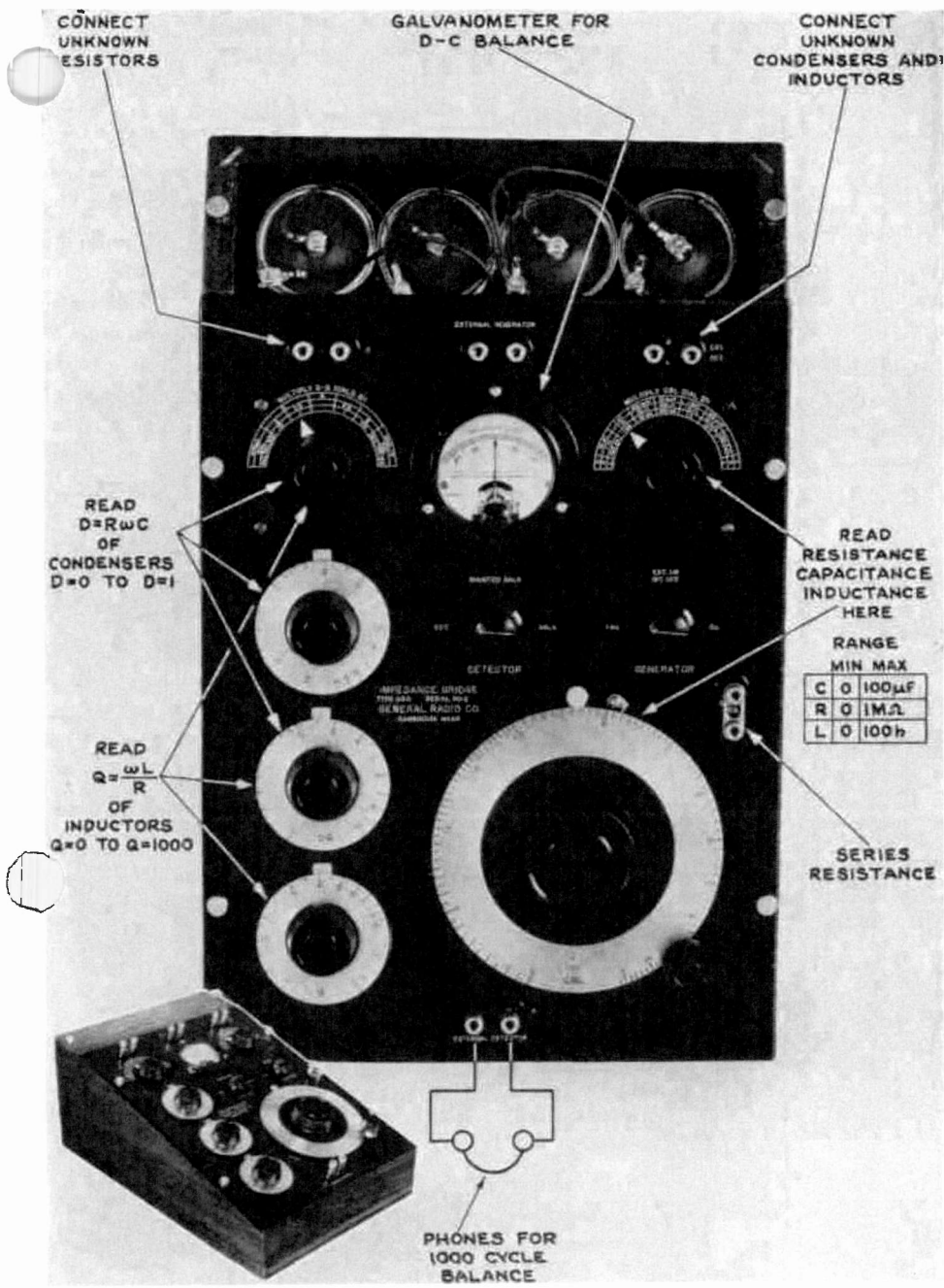

FIGURE 1. This photograph of the panel emphasizes the simplicity and wide range of the impedance bridge. In the corner at the left is a side view of the instrument

bridge circuits cannot, of course, be prevented, but the use of the logarithmic rheostats for balancing makes it very easy to follow the drift of the balance points.

The accuracy of calibration of the CRL dial is 1% over its main decade. It may be set to 0.2% or a single wire for most settings of the CRL switch. The accuracy of readings for resistance and capacitance is 1%, for inductances 2%, for the middle decades. The accuracy falls off at small values because the smallest measurable quantities are 1 *mΩ*, 1 *μf*, and 1 *μh*, respectively. Zero readings are approximately 10 *mΩ*, 4 *μf*, and 0.1 *μh*, respectively. The accuracy falls off at the large values, becoming 5% for resistance and capacitance and 10% for inductance. The accuracy of calibration of the DQ dials is 10%. The accuracy of readings for dissipation factor and energy factor is either 20% or 0.005, whichever is the larger.

The power for the bridge is drawn from four No. 6 dry cells mounted at the back of the cabinet. The liberal size of these batteries assures a very long life. External batteries of higher voltage

may be used to increase the sensitivity of the bridge for the measurement of the highest resistances. The internal batteries operate a microphone hummer for the production of the 1-kc current. The capacitance of this hummer to ground is small and has been allowed for in the bridge calibration.

An external generator may be used, though its capacitance to ground may introduce considerable error. Subject to this limitation, the frequency may be varied over a wide range from a few cycles to 10 kc. The reading of the CRL dial is independent of frequency. The readings of the D and DQ dials must be multiplied by the ratio of the frequency used to 1 kc to give the correct values of dissipation and energy factors, while the reading of the Q dial must be divided by this ratio. For frequencies other than 1 kc the ranges of the DQ dials are altered so that they will no longer overlap. Additional resistance may be inserted by opening the SERIES RES. terminals. The TYPE 526 Rheostats, described on page 7, are quite satisfactory for this use.

—ROBERT F. FIELD

SPECIFICATIONS

Dimensions: Panel, (width) 12 x (depth) 16 inches. Entire instrument, (width) 12 x (depth) 23 x 9 inches, over-all.

Net Weight: 22 pounds. Batteries, 8 1/4 pounds additional.

Code Word: BEAST.

Price: \$175.00, without batteries.

THE SKELETON-TYPE IMPEDANCE BRIDGE

THERE are many individual bridge measurements for which the wide range of the TYPE 650-A Impedance Bridge is unnecessary, while its ease and speed of making readings are essen-

tial. Examples of these uses are the following:

Limit bridges for resistance, inductance, and capacitance, whose ranges may be changed easily, though not in-

stantaneously. Bridges for the individual experimenter who is willing to forego the convenience of multiple switching and to manually interconnect the various arms of the bridge for the sake of a considerable reduction in price.

Bridges for schools and colleges with which the student may make up the various bridge circuits.

The TYPE 625-A Bridge is eminently adapted to this type of measurement. It consists of a skeleton bridge circuit, in which one arm contains a direct-reading logarithmic rheostat and the other three arms are brought out to pairs of terminals. A 1-kc microphone hummer, batteries, and their associated switches are also connected in circuit. TYPE 500 Resistors may be used as ratio arms, TYPE 505 Condensers as reactance standards, and TYPE 526 Rheostats as added resistors to indicate energy factor Q and dissipation factor D . These resistors and condensers are plugged directly into the bridge terminals. The rheostats can be connected through TYPE 274 Plugs and cables.

The panel arrangement is shown in Figure 1. The wiring diagram is engraved in the lower left corner. The slide on which the ratio arms and standards may be stored is opened for inspection. Appropriate values of these units are 10,000 Ω , 1000 Ω , 100 Ω , 1 μf , and 0.01 μf . With these units resistance may be measured over 6 decades from 1 Ω to 1 $M\Omega$, inductance over 6 decades from 100 μh to 100 h, capacitance over 6 decades from 100 μf to 100 f . By the addition of a few other units these ranges may be extended to the same values as are covered

by the TYPE 650-A Impedance Bridge. (See page 3.)

Table I shows the proper combinations of these plug-in units for the entire range of values mentioned. This table is for all settings of the logarithmic rheostat between 10 Ω and 10,000 Ω .

Another table giving the values of the added resistance to be obtained from the TYPE 526 Rheostats, for values of dissipation factor D up to 1

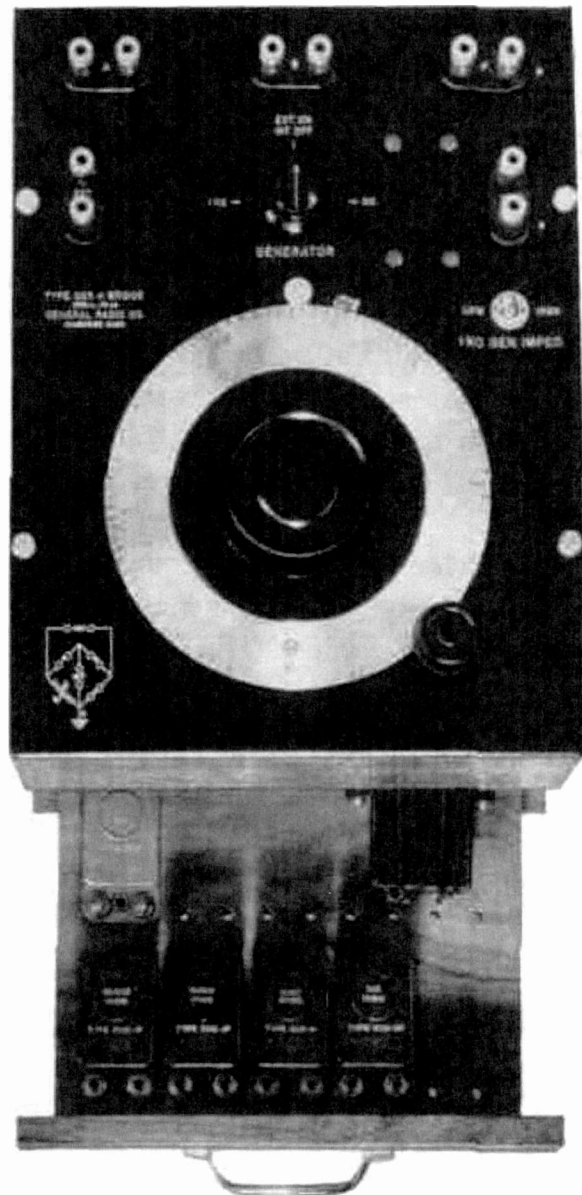

FIGURE 1. The skeleton-type bridge with the drawer pulled out to show the method of storing standard resistors and condensers when not in use

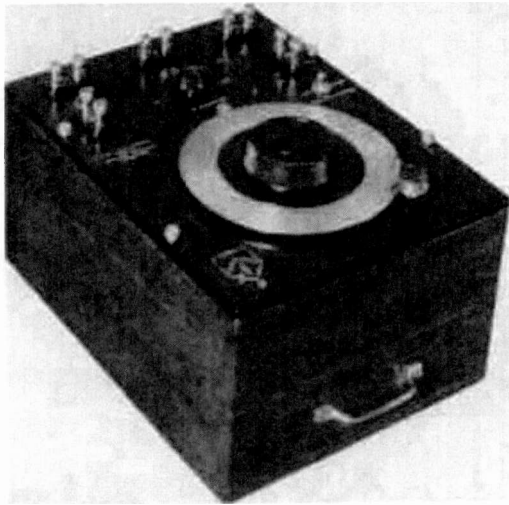

FIGURE 2. TYPE 625.A Bridge

and values of energy factor Q up to 1000, is shown in the instruction book accompanying the bridge.

The wiring diagrams of the various

bridges which should be used are shown in Figure 3. Capacitance is measured on a simple bridge having two resistance arms and two capacitance arms. Inductance is measured in terms of a standard condenser. The resistor added for making the resistance balance is placed either in parallel or in series with the standard condenser. The parallel connection is Maxwell's bridge and may be used for all values of energy factor Q , except that for large values the added resistance is too large to be obtainable on a variable resistor. The series connection is Hay's bridge and while it may also be used for all values of energy factor Q , the complicated correction term containing frequency becomes negligible only when Q is greater than 10. — ROBERT F. FIELD

TABLE I

Values of C, R, and L that can be measured with recommended standards. Unknown quantities in bold face type.

A ARM	B ARM	PARM	N DIAL
100 <i>O</i>	10,000 <i>O</i>	1000 <i>O</i> -1,000,000 <i>O</i>	Unknown quantities (printed in bold face type) correspond to the complete range of 10 to 10,000 Ω, covered by the Logarithmic Rheostat N. Greatest accuracy is obtained by using the main decade on N (N = 1000 Ω to N = 10,000 Ω).
1000 <i>O</i>	10,000 <i>O</i>	100 <i>O</i> - 100,000 <i>O</i>	
10,000 <i>O</i>	10,000 <i>O</i>	10 <i>O</i> - 10,000 <i>O</i>	
10,000 <i>O</i>	1000 <i>O</i>	1 <i>O</i> - 1000 <i>O</i>	
10,000 <i>O</i>	100 <i>O</i>	0.1 <i>O</i> - 100 <i>O</i>	
10,000 <i>O</i>	10 <i>O</i>	0.01 <i>O</i> - 10 <i>O</i>	
10,000 <i>O</i>	1 <i>O</i>	0.001 <i>O</i> - 1 <i>O</i>	
100 <i>O</i>	0.1 <i>uf</i> - 100 <i>uf</i>	1 <i>uf</i>	
1000 <i>O</i>	0.01 <i>uf</i> - 10 <i>uf</i>	1 <i>uf</i>	
10,000 <i>O</i>	1000 <i>uuf</i> - 1 <i>uf</i>	1 <i>uf</i>	
1000 <i>O</i>	100 <i>uuf</i> - 0.1 <i>uf</i>	0.01 <i>uf</i>	
10,000 <i>O</i>	10 <i>uuf</i> - 0.01 <i>uf</i>	0.01 <i>uf</i>	
10,000 <i>O</i>	1 <i>uuf</i> - 1000 <i>uuf</i>	1000 <i>u</i>	
100mh-100h	10,000 <i>O</i>	1 <i>uf</i>	
10 mh- 10 h	1000 <i>O</i>	1 <i>uf</i>	
1mh- 1h	10,000 <i>O</i>	0.01 <i>uf</i>	
100uh-100mh	1000 <i>O</i>	0.01 <i>uf</i>	
10 uh- 10 mh	100 <i>O</i>	0.01 <i>uf</i>	
1 uh- 1 mh	10 <i>O</i>	0.01 <i>uf</i>	

SPECIFICATIONS

Accuracy: The scale of the logarithmic rheostat is correct to 1%. The frequency of the internal microphone hummer is 1000 cycles to within 5%.

Power Supply: Power for driving the hummer and for d-c measurements is derived from two 4.5-volt batteries (Burgess No. 2370 or Eveready No. 771).

Accessories: Balance detectors suggested: head telephones for a-c measurements; zero-center, 200-ua full scale galvanometer for d-c measurements.

Standards: The following units make suitable standards and they can, for convenience, be ordered at the same time as the bridge if desired.

TYPE 500 RESISTORS

(See page 12, Catalog G)

500-AP	1 <i>O</i>	\$2.00
500-BP	10 <i>O</i>	2.00
500-DP	100 <i>O</i>	2.00
500-HP	1000 <i>O</i>	2.00
500-JP	10,000 <i>O</i>	2.00

TYPE 505 CONDENSERS

(See January, 1933, *Experimenter*)

505-FP	0.001 uf	\$3.50
505-LP	0.01 uf	4.00
505-QP	0.05 uf	4.50

A 1-uf condenser is also available: TYPE 625-P1, Code Word BAIZE, Price \$2.00.

Dimensions: Panel, (width) 9x (depth) 12 inches. Cabinet, (height) 7 inches, over-all.

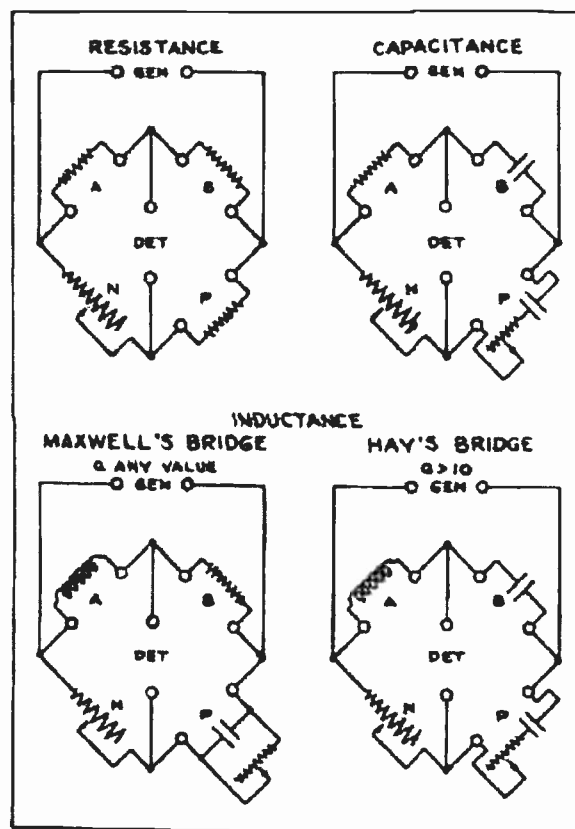

FIGURE 3. These are the basic circuits used in the TYPE 650-A Impedance Bridge and the ones recommended for use with the TYPE 625-A Bridge

Net Weight: 9 pounds. Batteries, 2 pounds additional.

Code Word: BEACH.

Price: \$.65.00 without batteries or the standards suggested in the *Accessories* paragraph above.

MOUNTED RHEOSTAT-POTENTIOMETERS

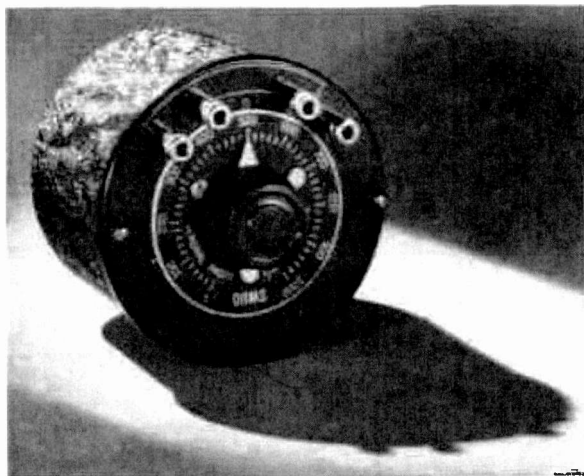

TYPE 471 Rheostat-Potentiometers are available mounted in drawn steel cases, the same size as used for the TYPE 247-G Variable Air Condenser. Each has an etched dial graduated in 50 divisions. The total resistance has been adjusted to within 2 1/2% of the rated value.

Type	resistance	Price
526-D	0-100 <i>O</i>	\$8.50
526-A	0-1000 <i>O</i>	8.50
526-B	0-10,000 <i>O</i>	8.50
526-C	0-100,000 <i>O</i>	8.50

PITCH AND INTENSITY MEASUREMENTS WITH A VACUUM-TUBE OSCILLATOR

THE psychological and physiological departments of many universities, including Brown, Oregon, Princeton, and Yale, are making use of modern electrical vacuum-tube oscillators and associated measuring equipment to increase the speed and precision of audio-sound demonstrations and researches.

Dr. Robert H. Seashore of the University of Oregon, who has used this equipment for some time, writes, "We find the oscillator most useful for a number of demonstrations and experiments in the psychological and musical courses and special research projects. So far, we have used it as follows:

"(1) To demonstrate the range of the most useful portion of the audible sound stimuli

"(2) To show the independent variation of intensity at any pitch

"(3) To show the lowest audible tones (in a telephone receiver)

"(4) To demonstrate beats and difference tones when sounded with a tuning fork or other instrument

"(5) To demonstrate the small variations in pitch which lead to 'consonant' or 'dissonant' sound combinations (with a tuning fork)

"(6) The most important function for our purposes, to be able to measure pitch discrimination by the method of paired comparisons at any place in the musical scale."

The central instrument for this work is a vacuum-tube oscillator which, when used to operate ordinary telephone receivers or radio loudspeakers, produces sound vibrations of the sort obtained from tuning forks and other mechanical vibrators. The electrical oscillator has the great advantage over such mechanical oscillators that the vibration frequency can be adjusted rapidly and accurately over a wide range and that the amplitude can be

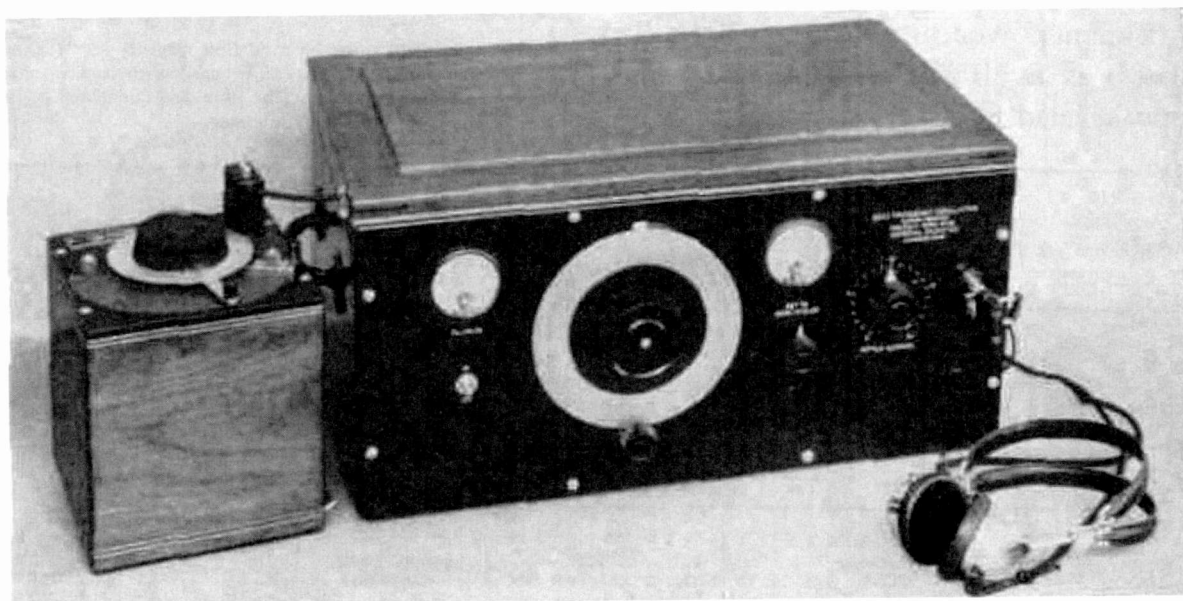

Any pitch between 5 and 10,000 vibrations per second is obtainable from the TYPE 613-B Beat-Frequency Oscillator. Incremental variations on either side of a given frequency are obtained by means of the condenser at the left

adjusted from zero to maximum by one turn of a switch.

Any tone in the range from 5 to 10,000 cycles per second can be selected instantly by setting the large central dial on which the frequency is engraved. The overtone or harmonic content of these well-designed electrical oscillators is negligible.

Experimenters have found that it is desirable to be able to vary the pitch over a small range from some base frequency. For this the TYPE 539-P Incremental-Pitch Condenser is provided. It is a direct-reading vernier adjustment for the electrical oscillator for changing its pitch by a total of 100 vibrations per second for a rotation of a full half turn of a large dial. This dial is calibrated for 100 divisions, each one effecting a change in pitch of *exactly* one vibration per second.

The base frequency of the oscillator can be anything from 100 cycles per second (about an octave below middle C) to 10,000 cycles (over five octaves above). The incremental pitch will read correctly for any setting in this range. Sufficient power output (about 10 milliwatts) is available to cause a strong tone in head telephones. For classroom

demonstrations this sound volume can be enormously increased by the use of a vacuum-tube amplifier.

A third most useful auxiliary unit is a calibrated control of the volume of sound. The TYPE 529-B Attenuation Box is calibrated in steps of 2 decibels, the standard unit of relative sound volume, to cover a range from 0 to 60 decibels. This represents an attenuation control range from 0 to 1,000,000 in sound volume.

An interesting class demonstration is conducted by Dr. Harold Schlosberg of Brown University to determine, using the whole class and voting by a display of hands, the just noticeable difference of pitch at several frequencies. Then, with individuals selected from the class, using a headphone, the lower threshold of hearing at various frequencies is determined.

—ARTHUR E. THIESSEN

PRICES

*TYPE 613-B Beat-Frequency Oscillator.....	\$210.00
TYPE 539-P Incremental Pitch Condenser	50.00
TYPE 529-B Attenuation Box	34.00

*This instrument must be modified slightly so that the incremental-pitch condenser can be used with it. The extra charge for this work and for the shielded connector is included in the price of the condenser.

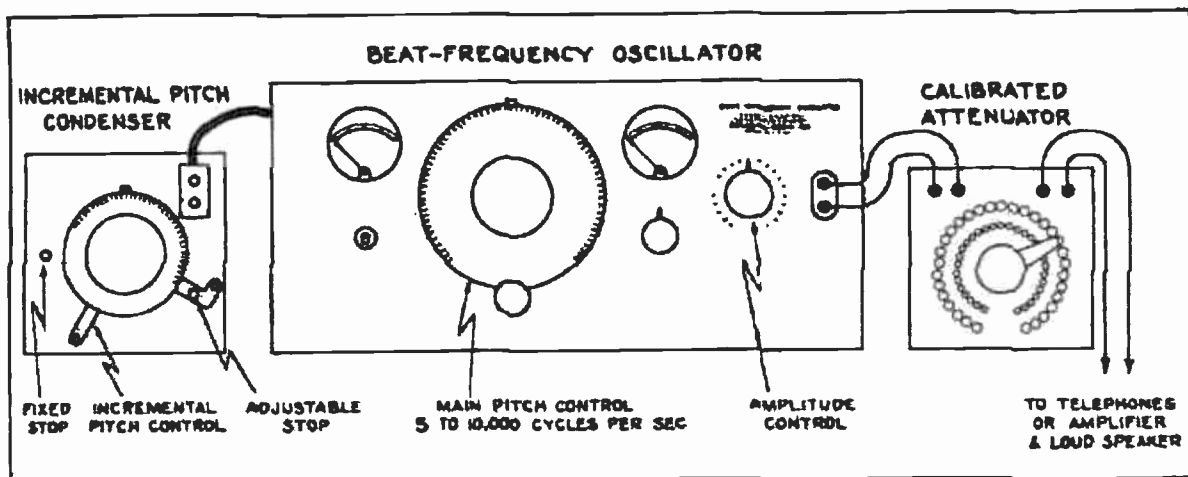

Studies involving intensity changes as well as pitch changes can be made by adding a calibrated attenuator to the apparatus shown on the opposite page

LARGE SIZE PLUGS AND JACKS

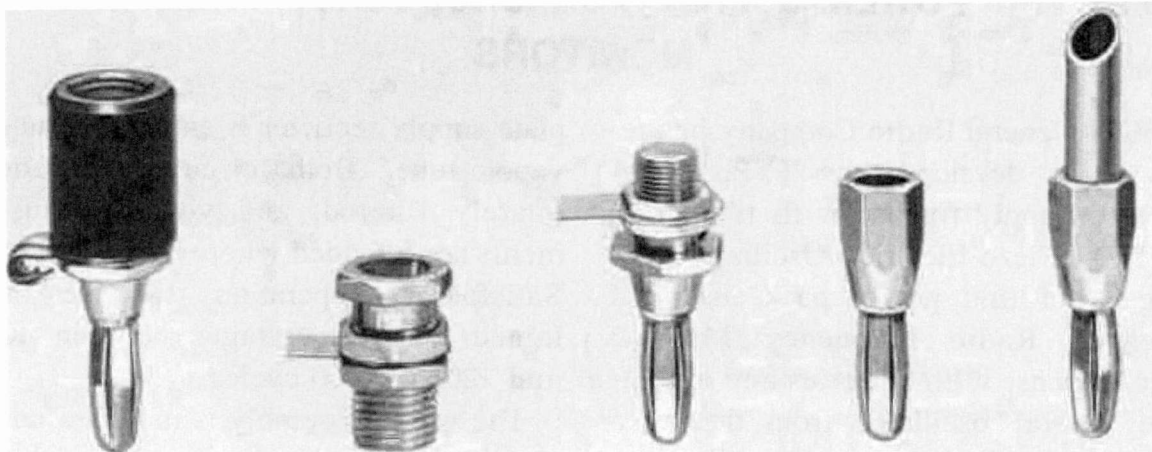

674-D \$0.50

674-J \$0.25

674-P \$0.35

674-C \$0.20

Plug-in inductors made of 1/4-inch copper tubing can be sweated into the new TYPE 674-C Plug shown at the right. The cup is tinned. Illustration approximately one-half size

DIAL PLATES

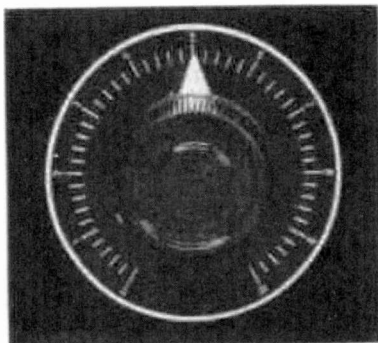

523-A

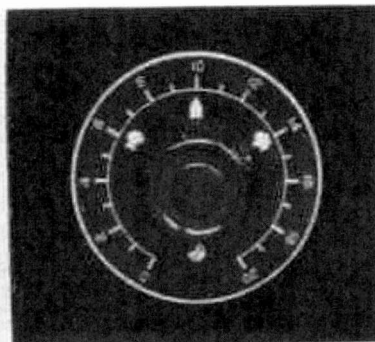

318-A

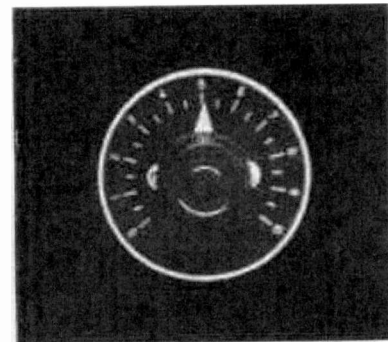

522.A

Dial plates made of etched nickel silver are now available for use with General Radio rheostat-potentiometers. TYPE 523-A is for TYPES 371, 314, and 471; TYPE 318-A is for TYPE 214; and TYPE 522-A is for TYPE 301.
Price: \$.35, each

A TWO-SECTION BAND-SPREAD CONDENSER

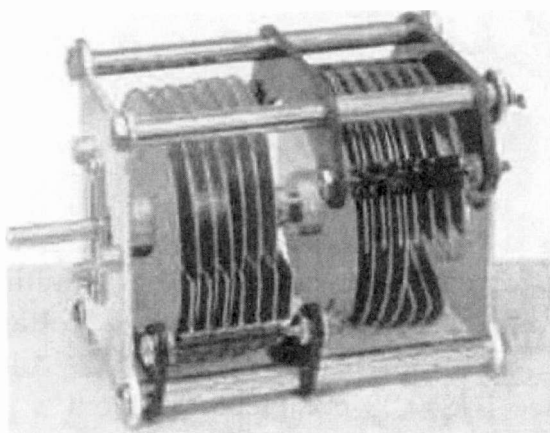

The new TYPE 756-A Condenser shown at the left is adapted for use in Colpitts oscillators in transmitters and frequency meters and in multi-circuit receivers. The maximum capacitance is 225 *uuf* and the minimum is adjustable between 100 *uuf* and 180 *uuf*. Price \$6.00.

AN A-C POWER SUPPLY FOR BROADCAST FREQUENCY MONITORS

THE General Radio Company has recently developed the TYPE 531-A Power Supply for use with the TYPE 575-D Piezo-Electric Oscillator. By means of this power pack, users of General Radio Frequency Monitors can dispense with batteries and operate the crystal oscillator from the alternating-current line.

The TYPE 531-A Power Supply includes two rectifiers with their associated filters. A copper-oxide rectifier is used in the 6-volt circuit which supplies current for the tube filament and the temperature-control relay. The

plate-supply rectifier is an 83 mercury-vapor tube. Both circuits are adequately filtered, and voltage adjustments are provided wherever necessary. Satisfactory operation can be obtained on line voltages between 105 and 120 volts, 60 cycles.

The whole assembly is mounted on a standard 19-inch relay-rack panel, 7 inches high. The panel is finished in black crackle lacquer to match the oscillator panel.

The price of the TYPE 531-A Power Supply is \$100.00, exclusive of the rectifier tube.

VOLTAGE REGULATOR TRANSFORMER

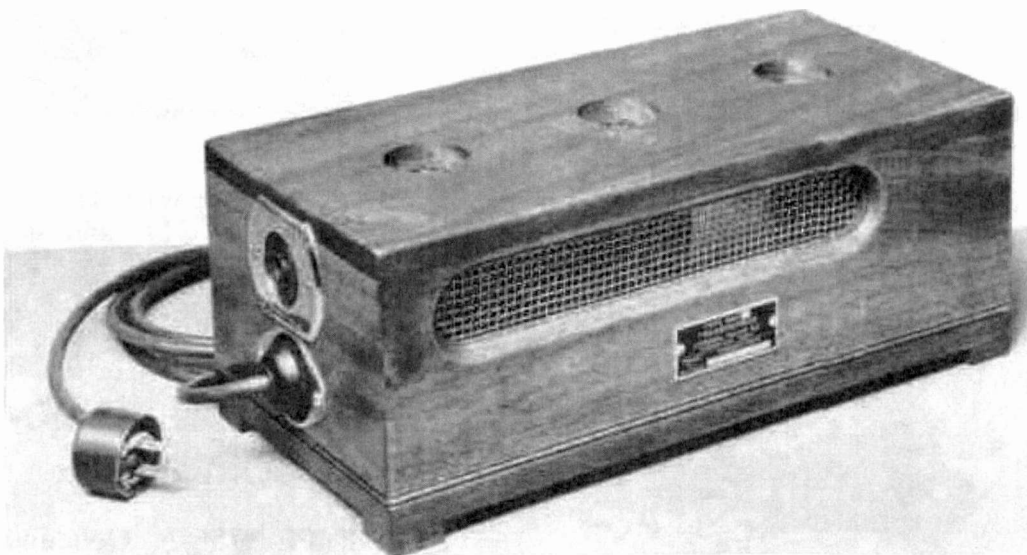

This TYPE 440-R Transformer is a voltage-regulating device capable of handling a load of 100 volt-amperes. Its output voltage remains constant at a voltage between 112 and 115 volts for input voltage variations between 95 and 130 volts, 60 cycles, alternating current. Its price is \$40.00 complete with cord

PRECISION RESISTORS WITH A HIGH POWER RATING

THE laboratory worker engaged in electrical measurements must often make a choice between the risk of burning out a precision resistor and using a less-accurate standard. Inevitably in experimental work, the requirements of many problems lie just beyond the safe limits of precision units.

The General Radio Company has recently designed a precision-type resistor capable of dissipating large amounts of power. This resistor, shown in Figure 1, consists of a mica card wound with resistance wire, clamped between two aluminum castings and insulated from them by two thin sheets of mica, the whole unit being supported on porcelain insulators. The aluminum castings are heavily ribbed to give a large heat-radiating surface.

The TYPE 525 Resistor is conservatively rated at 50 watts dissipation, although considerably more power can be dissipated for long periods without any damage to the resistor, since it is built to withstand high temperatures. A plot of temperature rise versus power

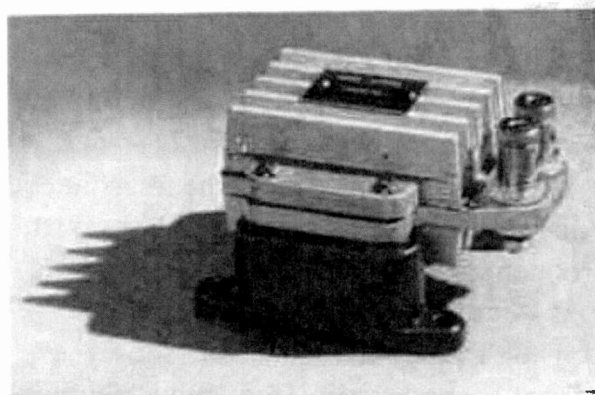

FIGURE 1. Type 525-L Resistor

dissipation is shown in Figure 2. These data were taken in still air, and if a fan is used to keep the air in motion, the temperature rise is much smaller. The increase in resistance with temperature is small, since the temperature coefficient is only 0.002% per degree at temperatures below 100° Centigrade.

Heavy-duty resistors are extensively used in the determination of the power output of radio transmitters. All such resistors have appreciable series inductance and shunt capacitance, and the resistance usually tends to rise with frequency as shunt resonance is ap-

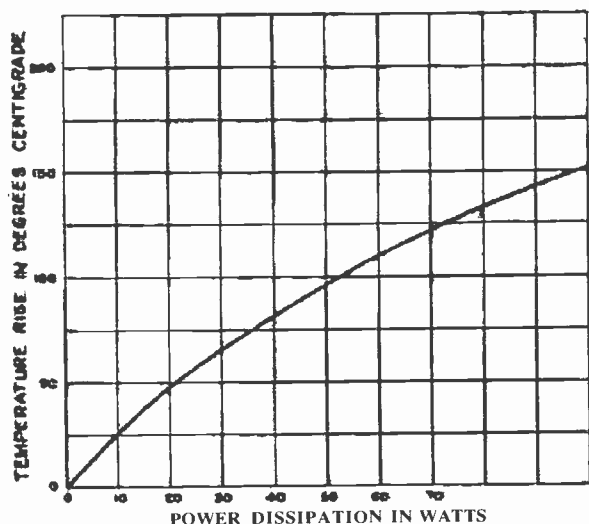

FIGURE 2. Temperature rise in a TYPE 525 Resistor as a function of power dissipation. This is essentially the same for all sizes

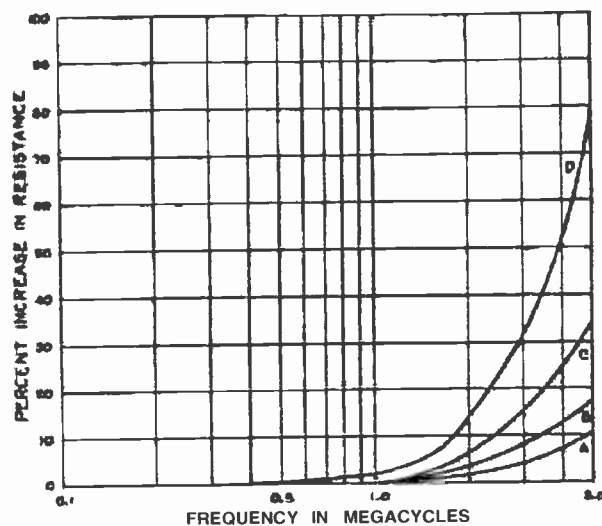

FIGURE 3. Frequency characteristics of 10-ohm (A and B) and of 40-ohm (C and D) TYPE 525 Resistors. Data for A and C were taken with the shield floating, B and D with the shield connected to one terminal

proached. Superimposed on this effect is the increase in resistance due to skin effect in the resistance wire itself.

That portion of the resistance which is due to reactance depends upon the equivalent inductance $L = L - R^2C$.* For positive values of L the resistance (disregarding skin effect) increases with frequency, and for negative values of L it decreases.

The TYPE 525 Resistor shows extremely good radio-frequency charac-

teristics, particularly in the smaller sizes. Figure 3 shows the variation of resistance with frequency for two of these units.

Curves A and B are for the 10-ohm resistor and curves C and D for the 40-ohm size. A and C represent the resistance with the aluminum shield floating and curves B and D with the shield connected to one (continued on page 14)

*"Frequency Characteristics." Robert F. Field, General Radio *Experimenter*, February, 1932.

SALE OF DISCONTINUED RESISTANCE DEVICES

WHEN a new catalog is issued, some of our older instruments are dropped in favor of more up-to-date designs. It is seldom possible to avoid having small stocks of the discontinued items when this change is made, and a number of such instruments are now available. At least one of each of the resistance devices listed in the follow-

ing table are available at substantial reductions in price so long as the supply lasts. Additional specifications will be found in Catalog F.

Every item is new and carries with it the same promise of satisfactory operation as though the regular price were paid.

DECADE-RESISTANCE BOXES		Former Price	SALE PRICE
Type			
102-J	11,110 ohms in steps of 1 ohm—4 dials.	\$50.00	\$30.00

ATTENUATION BOXES		Former Price	SALE PRICE
Type			
329-H	55 db in steps of 0.5 db—H—600 ohms	\$140.00	\$50.00
339-K	55 db in steps of 0.5 db—H—6000 ohms	185.00	50.00
329-L	55 db in steps of 0.5 db—Balanced-H—6000 ohms..	190.00	50.00
329-P	22 db in steps of 0.2 db—Balanced-H—6000 ohms..	200.00	50.00
429-K	55 db in steps of 0.5 db—T—6000 ohms	175.00	50.00
429-R	22 db in steps of 0.2 db—T—6000 ohms	200.00	50.00

(Can Be Used as Attenuation Boxes)		Former Price	SALE PRICE
Type			
552-LA	30 db in steps of 1.5 db—L—50 ohms	\$28.00	\$15.00
552-LB	30 db in steps of 1.5 db—L—200 ohms	28.00	15.00
552-LC	30 db in steps of 1.5 db—L—500 ohms	28.00	15.00

PRECISION RESISTORS WITH A HIGH POWER RATING

(Concluded)

terminal. In the latter case, the shunt capacitance is greater, resulting in a lower resonant frequency.

The characteristics of the 4-ohm unit are similar to those of the 10-ohm. The 600-ohm unit has an effective induc-

tance which is always negative. This factor is much larger than the skin effect, and the resistance will, therefore, decrease with frequency.

TYPE 525 Resistors are available in the following values:

SPECIFICATIONS

Type	Resistance	Accuracy	Code Word	Price
525-C	4 ohms	0.1%	CABAL	\$8.00
525-D	10 ohms	0.1%	CABIN	8.00
525-F	40 ohms	0.1%	CABOB	8.00
525-H	100 ohms	0.1%	CADDY	8.00
525-L	600 ohms	0.1%	CADET	8.00

SPECIAL PRICE ON CATHODE-RAY OSCILLOGRAPH TUBES

WE have five Western Electric No. 224-B Cathode-Ray Oscillograph Tubes in our laboratory stock that are now available for sale at a price well below the list price. They were purchased for use by our own engineering staff before development was completed on the General Radio Cathode-Ray Oscillograph and we now have them.

This is an excellent opportunity for interested laboratories to replenish their stocks of these tubes. No. 224-B is similar to and interchangeable with No. 224-A; the former taking a smaller filament current.

Each tube is in its original sealed carton. Price: \$30.00, each.

AN OUTPUT TRANSFORMER FOR THE NEW 2A3 TUBES

THE new 2A3 amplifier tube should be of exceptional interest to all who are interested in high-quality reproduction, since two of these tubes in a push-pull output stage have a greater power handling ability than the usual push-pull pentode output stage and compare very favorably in this respect with Class B systems. In addition, a Class A out-

put stage, using the 2A3's, will generate considerably less harmonic distortion than either of these other two commonly-used output systems.

The General Radio Company has developed a new output transformer for use with these tubes. Because of its unusually high efficiency, nearly all of the output power is actually delivered to

the speaker. This transformer, which is known as the TYPE 541-D, has a practically flat characteristic from 20 to above 10,000 cycles per second. The secondary is tapped to match impedances from 1.5 to 12 ohms. This allows operation into any of the more usual types of dynamic speakers, or several speakers in parallel or in series.

The accompanying diagrams show an amplifier (and associated rectifier) designed particularly for the 2A3 tubes.

The actual quality delivered by an amplifier of this type is extremely good. The maximum power output is approximately 10 to 12 watts, which will overload two or three dynamic speakers of the usual type used in receiver sets. When operated at normal room volume, there is no fuzziness (as is often encountered in Class B amplifiers) and power peaks are easily taken care of, resulting in a brilliancy and realism in the reproduction which are quite amazing for an amplifier of these proportions.

— H. H. SCOTT

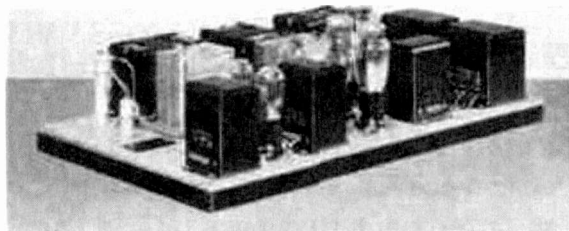

An amplifier using the new 2A3 tubes and parts described in the accompanying article

PRICE LIST		
Type	Description	Price (each)
541-D		\$7.50
541-J		7.50
349	4-Prong Socket (3 req'd)	.35
438	5-Prong Socket (2 req'd)	.35
	C ₁ —Pyranol Condenser, 4 uf; peak voltage	
	1 9 8 0	6.60
*AD18	T ₁	3.00
*AD20	T ₂	5.05
*AD30	L ₁	4.55
*AD40	L ₂	4.55

Any standard by-pass condensers and resistors having satisfactory voltage and current ratings can be used.

*These are manufactured by the Delta Manufacturing Company and are obtainable from General Radio at the regular net prices given above.

Wiring diagram for the 2A3 amplifier shown above. Note that other standard input transformers are available, for use on 500-ohm lines, for instance

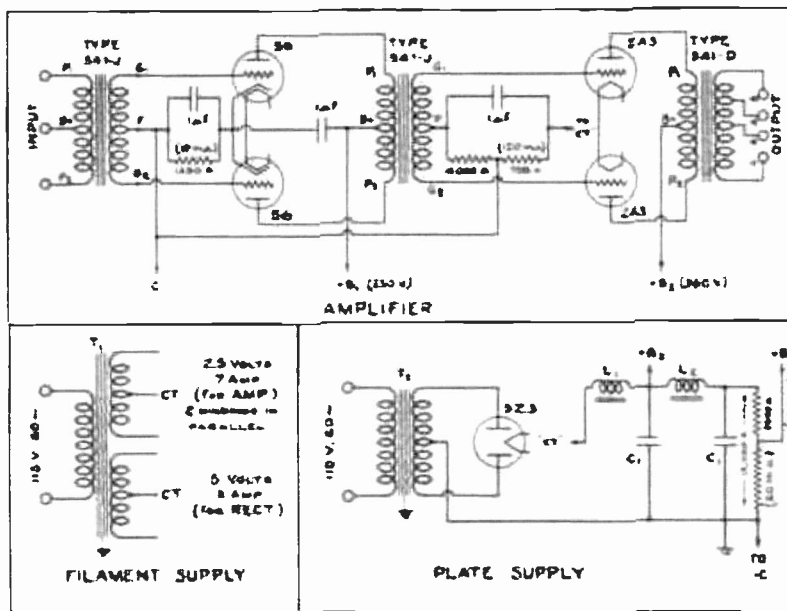

USING THE EDGERTON STROBOSCOPE IN AUTOMOTIVE RESEARCH

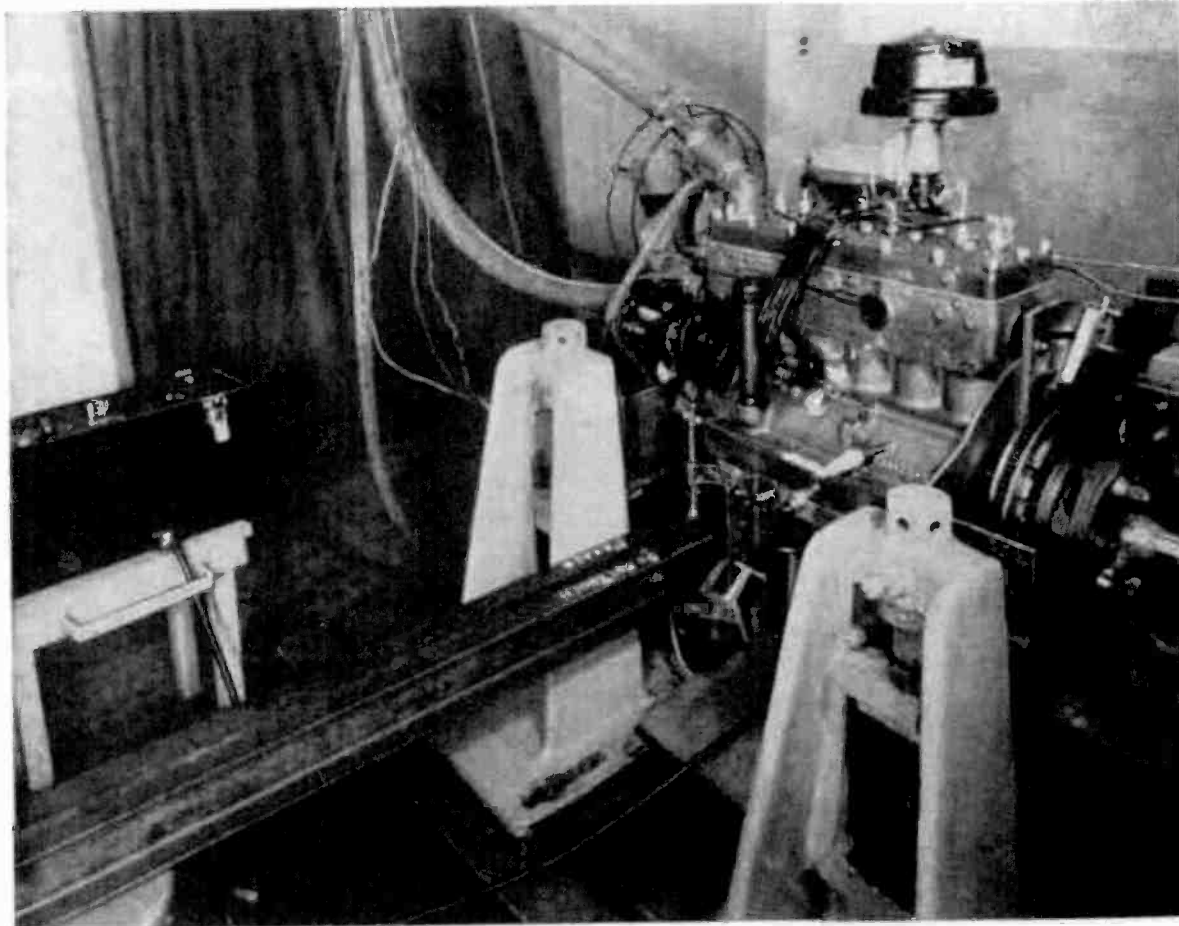

Chrysler engineers measure crankshaft whip and vibration with the Edgerton Stroboscope. For an interesting description of the method, see page 75 of *Instruments* for April, 1933. Reprints can be had from General Radio Company without charge



THE GENERAL RADIO COMPANY mails the Experimenter, without charge, each month to engineers, scientists, and others interested in communication-frequency measurement and control problems. Please send requests for subscriptions and address-change notices to the

GENERAL RADIO COMPANY

30 State Street - Cambridge A, Massachusetts

U.S.A.

