

THE 1997 HARRIS CATALOGUE

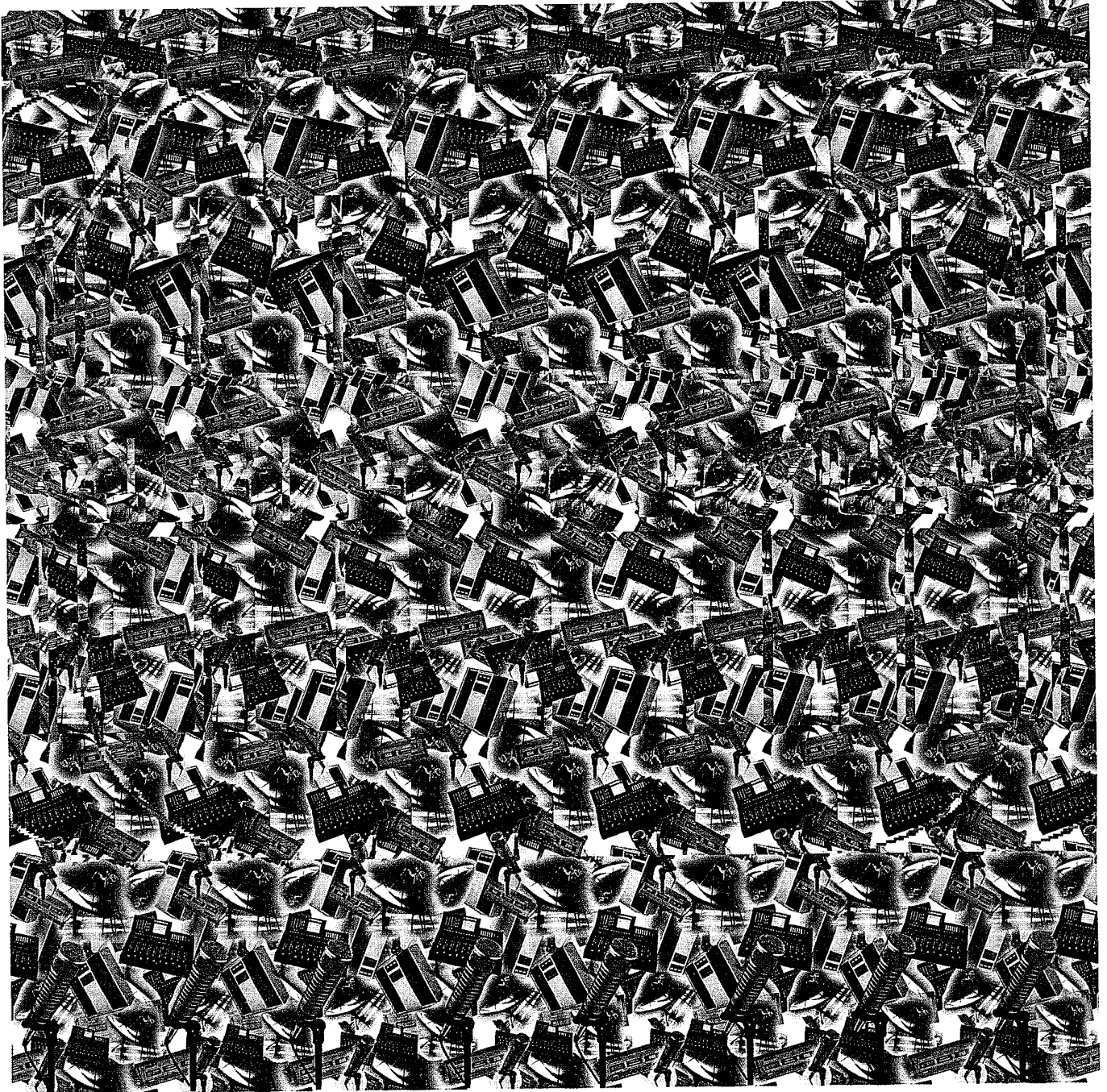

**You've Asked For It and
Waited Quite Some Time.
And Now, after all the excitement,
It's Here.
It Has *Finally* Arrived.**



The 1997 Harris Catalogue.

***Go Ahead. Tear Into It.
(You Know You Want To.)***

Harris— A World Of

FLORENCE, KY USA

7920 Kentucky Drive
Florence, KY
U.S.A.
TEL: (606) 282-4800
FAX: (606) 283-2818

QUINCY, IL USA

3200 Wismann Lane
P.O. Box 4290
Quincy, IL 62305
U.S.A.
TEL: (217) 222-8200
FAX: (217) 224-1439

KUALA LUMPUR

Unit 11-09B, 10th floor
Kelana Parkview Tower
Kelana Jaya
47301 Selangor, Malaysia
TEL: 603 704 6303
FAX: 603 703 1814

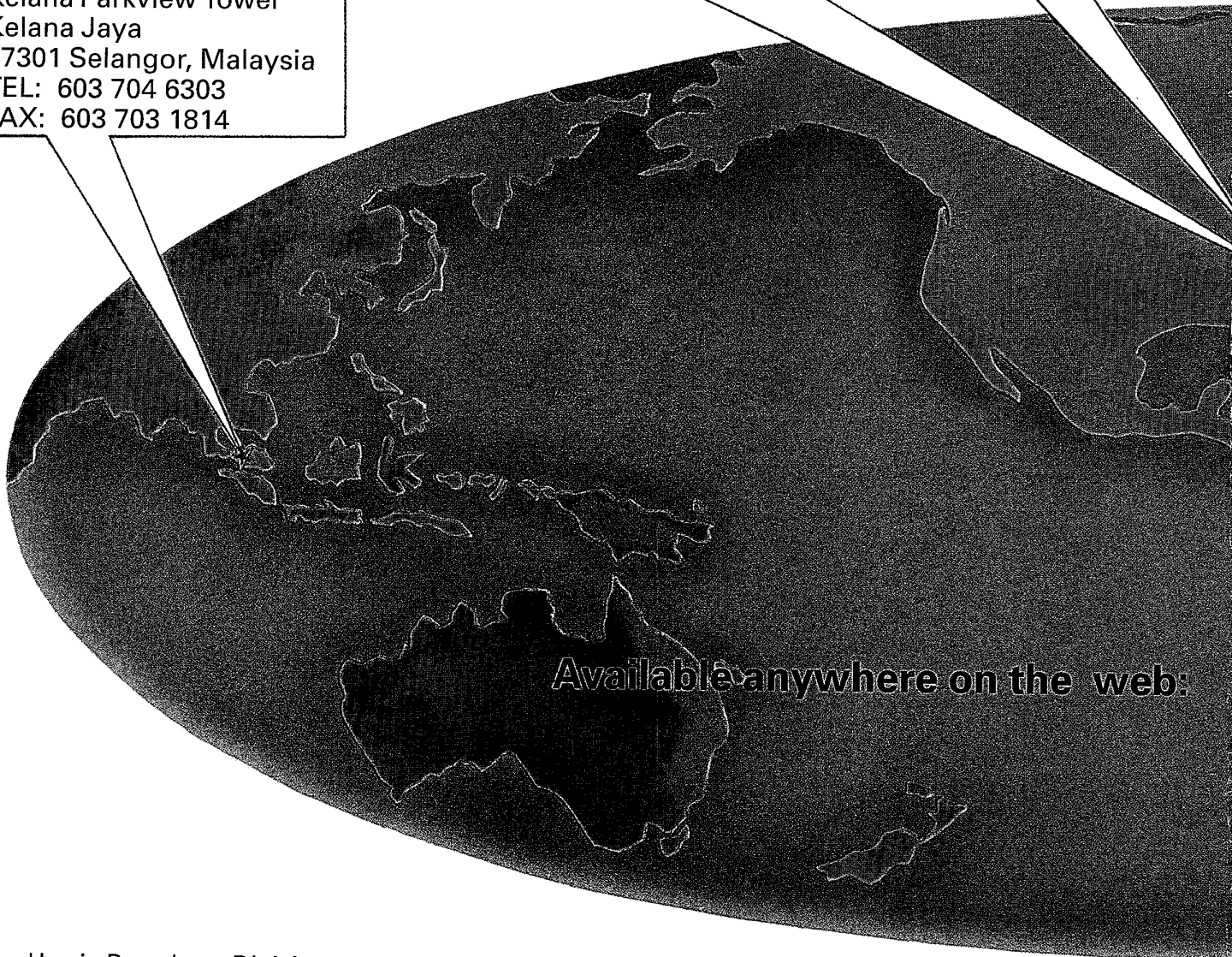

Available anywhere on the web:

Harris Broadcast Division supplies radio and television transmission systems, distributes more than 10,000 radio broadcast products, and provides video and production and custom systems. The division serves broadcasters in more than 150 countries. As North America's oldest and largest broadcast manufacturer, the division has introduced more than 50 major innovations in broadcast

Broadcast Solutions.

RICHMOND, IN USA

3712 National Road West
P.O. Box 1487
Richmond, IN 47374
U.S.A.
TEL: 1-800-622-0022
FAX: (765) 966-0623

CAMBRIDGE, ENGLAND

515 Coldhams Lane
Cherry Hinton
Cambridge CB1 3JU
England/U.K.
TEL: +44 1223 415459
FAX: +44 1223 210441

PARIS, FRANCE

47, av. des Genottes
BP 8282
95802 Cergy-Pontoise Cedex
France
TEL: +33 1 30 73 60 31
FAX: +33 1 30 73 60 64





























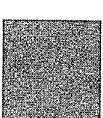









<http://www.broadcast.harris.com>

transmission technology and is a leader in solid-state transmitters. The division is also active in high-definition television transmission.

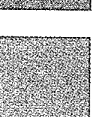
The above is a small representation of where to find Harris. If you do not find an office near you, call and we'll direct you to the nearest rep. More than likely, we're right next door!

**All numbers subject to change without prior notice.*

Table of Contents

 Amplifiers Pages 6-12	 Hard Disk Systems Pages 89-94	 Studio Accessories Pages 141-161
 Antennas Pages 13-33	 Headphones/Headsets Pages 95-96	 Studio Furnishings Pages 162-164
 Audio Distribution & Routing Pages 34-36	 ISDN/Telco Products/ Codecs Pages 97-104	 Systems Pages 165-186
 Audio Processing Pages 37-50	 Microphones Pages 105-113	 Telephone Interface Pages 187-194
 Cartridge Machines Page 51	 Mini Disc Pages 114-115	 Test Equipment Pages 195-196
 Cassette Recorders Pages 52-54	 RBDS Page 116	 Training Pages 197-198
 CD Players/Recorders/ Accessories Pages 55-58	 Reel-to-reel Page 117	 Transmitters Pages 199-236
 Consoles/Mixers Pages 59-71	 Remote Control Pages 118-119	 Transmitting Acces- sories Pages 237-251
 DAT Pages 72-75	 RPU Pages 120-122	 Voltage Control/ Conditioning/UPS Pages 252-254
 Delays Pages 76-77	 Satellite Pages 123-128	 Engineering Data Pages 255-258
 Digital Accessories Pages 78-79	 Service Pages 129-130	 Glossary Pages 259-261
 Digital Recorders Pages 80-82	 Speakers Pages 131-137	 Index Pages 262-264
 Digital Workstations/ Editors Pages 83-88	 STL/TSL Pages 138-140	

Icons

Product of Choice

Choice products get the gold trophy from our products line managers. Look for this icon throughout the catalogue to see which have been carefully selected by our "choosy" staff.

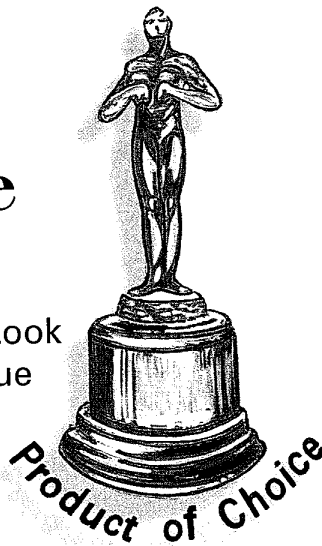

About The Catalogue

Both the domestic and international versions of the 1997 Harris Catalogue were produced with desktop publishing at Harris Broadcast Division, Richmond, Indiana U.S.A.

*Catalogue Coordinator
Debra Chagares*

*Graphic Artists
Rhonda Webb
Melany Wooley
Lauren L. Darr*

*Copywriters
Dave Burns
Martha B. Rapp
Vendors*

*Publisher/Editor
Lauren L. Darr*

*Inspiration
Pru Harris*



Clearly Digital

Harris' own copyrighted logo indicates products that are truly digital through and through.

No. 1 Best Seller

Our best sellers get the gold! See what everyone else in the industry is buying and call us to find out why!



New product photographs were captured using a digital studio camera (filmless) at the Hammer Graphics, Inc. Dayton, Ohio U.S.A. facility with print production completed at the Piqua, Ohio U.S.A. plant.



HAMMER GRAPHICS, INC.
Printers Since 1895

*3D artwork
Brian Small*

*Icon artist
Steve M'Gunegill*

*Cover art
Hafenbrack Graphic Design*

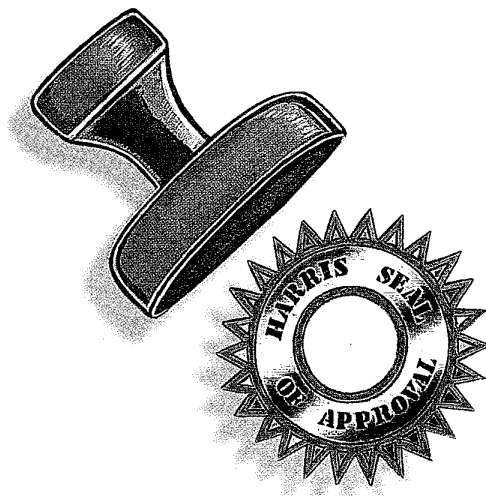

Harris Seal of Approval

Looks good. Works like a horse. You just couldn't ask for a better piece of gear! That's why Harris tech people give these products this stamp.

**Alesis
RA-100™**

The Alesis RA-100™ Reference Power Amp is a 100 watt-per-channel power amplifier engineered to deliver clean amplification with low noise and low distortion. The RA-100's large heat sinks facilitate high heat dissipation without the use of a fan, and its 1/4" plus push-clip speaker connectors allow for easy installation in any system. Whether used for studio reference monitoring, live sound reinforcement, or instrument amplification, the RA-100 provides clean, quiet, reliable power with the high quality found in all Alesis products.
\$349.00 List Price



**ATI
Match-Maker™ MM100 Bi-Directional Stereo Interface**

Keep your audio crisp and clean while matching up consumer and pro equipment. Forget problems with loading, distortion, hum loops, RF pick-up, and high frequency roll off. The Match-Maker™ solves these problems with less than 0.02% THD, 20Hz to 20kHz with +0/-0.25dB response, and over 98dB of dynamic range. The Match-Maker™ performs exceptionally thanks to design features such as transformer balanced outputs.

\$299.00 List Price

DP100

The DP100 uni-directional stereo interface is designed to invisibly interface consumer digital compact disc playback units or other unbalanced output products to professional levels, with absolutely no reduction of the superb performance available from the digital system. This is guaranteed by its 102dB dynamic range, flat frequency response (20Hz to 20kHz, ±.25dB) and 0.005% THD.

\$279.00 List Price

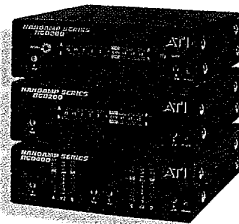
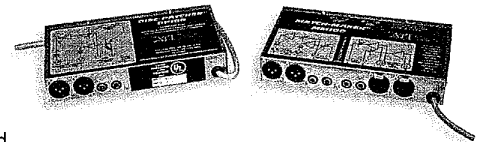

**ATI
NANOAMP SERIES™ BGD200 & BGD400 Dual and Quad Bargraph Meters**

Economically display up to twelve critical audio lines in only a single rack space. Remote shared power supplies let you mount these bright three color VU or PPM meters directly under video monitors or critical audio circuits with no possibility of magnetic interference.

**ATI
NanoAmp Series™ BI100, BU400, UB400 IHF to PRO Interface Amplifier**

Three inexpensive, high quality IHF (-10dBu, 10Kohm, un-balanced) to pro (+4dBm, 600 ohm, balanced) Interface Amplifiers provide a choice of configurations to allow the easiest connection and use of semi-pro equipment in professional low impedance line applications. Gold plated RCA type phono jacks connect to the IHF world and rugged rear mounted XLR type connectors interface with the pro side. Balanced +22dBm low distortion outputs are capable of driving balanced or un-balanced 600 ohm lines.

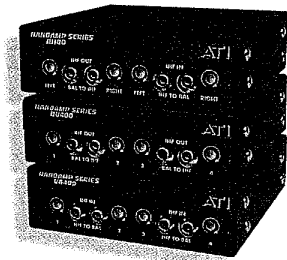

**ATI
MICROAMP SERIES™ L1000 Dual Line Amplifiers**

The ATI L1000 dual line series of MICROAMPS™ is rackable, micro-sized, stackable, versatile and RF protected. Its flat frequency response (20Hz to 20kHz ±.25dB), high input clip level of +24dBu, THD typically .001%, guarantees transparent operation. The series provides +22dBm at clipping for transformer and +26dBm for active balanced differential outputs. They're quiet; total amplifier noise is typically within 1dB of the thermal noise of source impedance.

L1000-1 \$379.00 List Price

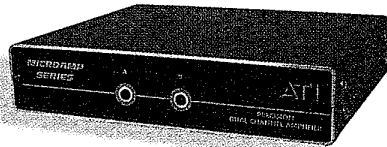

**ATI
NANOAMP SERIES™ L200-XLR Dual Line/Buffer Amplifier**

The NANOAMP SERIES™ L200-XLR Dual Line/Buffer Amplifier is an inexpensive high performance amplifier which is ideal as a gain block, attenuator, impedance converter and signal splitter. It can also be configured as a stereo to mono summing amplifier with the addition of an internal jumper.

\$215.00 List Price

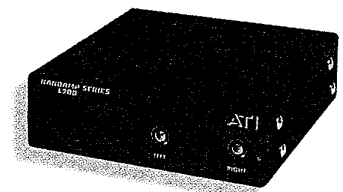

**ATI
MICROAMP SERIES™ HD1000/HD100 Stereo Headphone
Amplifiers**

The HD1000 is designed for attractive desk or EIA rack mounting singly or two side-by-side. The HD100 module is small enough to hang under a desk or mount behind a panel and attractive and rugged enough to place on top; external power source is UL listed. Drive four stereo headphone outputs directly from the HD1000 with a mix of a stereo line level input plus a panned front panel microphone input for adding paging, annotation or instructor comments. RF proof, shielded internal power supply, single or dual rack mount optional.

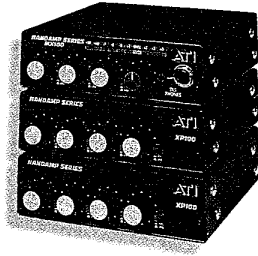

**ATI
NanoAmp Series™ MX100 & XP100 Mike Line Mixer & Expander**

The NANOAMP SERIES™ mixers allow you to configure your setup to your unique requirements. The MX100 is a three channel switchable microphone/line mixer with low noise balanced inputs, phantom power, an adjustable headphone output and a metered +22dBm, low distortion line output. Input capability can be increased using one or several XP100 expanders. Each XP100 adds four switchable microphone/line inputs and includes all DC and audio interconnect cables. For enhanced portability, an optional battery pack runs the MX100 for up to three hours or use a DC to DC converter for automobile operation.

**ATI
NanoAmp Series™ MXS100/ XPS100/XPS200 Stereo Mixer
and Input Expanders**

The MXS100 is a studio or portable, three channel, switchable microphone/line mixer with low noise balanced inputs, phantom power, pan pots, switched low cut filters and a test tone oscillator driving stereo, metered, low distortion, servo balanced line outputs with switchable peak limiting. Expand the MXS100 mixer with an XPS100 for four additional microphone inputs with pan pots.

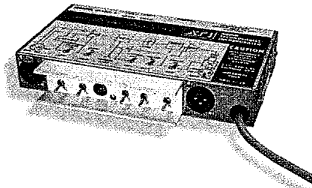

**ATI
ULTIMIKE™ M100 Microphone Amplifier**

The M100 microphone amplifier eliminates dimmer noise, RF pick-up and hum loops. Mount this small, rugged, full-featured preamp right near the audio source. The unusually quiet, direct balanced, instrumentation amplifier input has impressive hum and RF rejection and accepts +20dBm maximum input.
\$349.00 List Price

**ATI
ENCORE SERIES™ MLA/MMA 400/800 Multiple Amplifier
Arrays**

These feature four or eight individual channels to boost either microphone or line level balanced inputs up to +24dBm, 600 ohm line levels with active or transformer balanced outputs. Use as a microphone, line buffer, audio distribution and level matching amplifier.

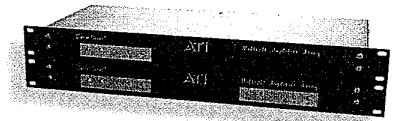

**ATI
MICRO-METER™ VU1000 Eight Line Switcher, Meter and
Monitor Amplifier**

Capable of many functions, use the VU1000 as an input line selector to an audio or video recorder, a remote line selector into your console and for general metering and monitoring of critical signals. Eight balanced bridging inputs are front panel- and remotely-selectable to feed a LED bargraph meter with both VU and PPM ballistics plus a balanced line output and a headphone jack. A range switch sets the reference line output and 0VU indications for five input levels from -10 to +18dBm. An optional built-in 6 watt power amplifier drives external speakers. Interconnect two for slaved stereo switching.
\$789.00 List Price



Amplifiers



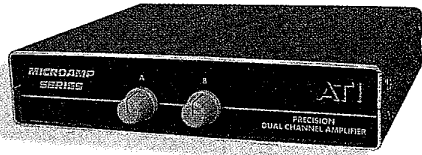

**ATI
MICROAMP SERIES™
M1000 Dual Microphone Amplifier**

The M1000 Dual Microphone amplifier provides two independent and totally isolated channels to drive a pair of 600 ohm outputs from 50 to 250 ohm impedance microphones. The units provide high gain, 72dB, low input noise, -126dBm, plenty of headroom @ +22dBu, flat frequency response 30Hz to 20kHz ±.25dB, low THD typically .01% and output clip level in excess of +22dBm, along with excellent shielding for outstanding RF immunity. The M1000 will satisfy your most demanding requirements. Optional 48VDC phantom power.

M1000-1 \$429.00 List Price

**ATI
ENCORE SERIES™
P100S Stereo Turntable Amplifier**

No pretty paint or shiny pushbuttons, but an economical, RF proof package wrapped around high performance circuitry makes this preamp a great value. A subsonic warp filter, DIP switch R and C cartridge loading, precision equalizer, low noise front end and a line isolated active balanced output makes this preamp a great buy.

\$329.00 List Price

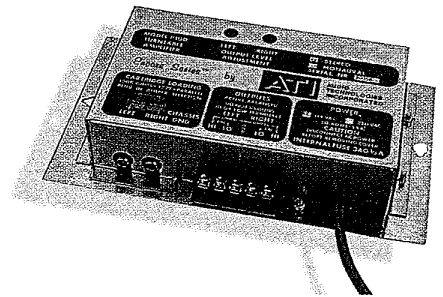

**Circuit Werkes
RP-1 Portable Mic & Headphone Amp**

The RP-1 combines a high quality single channel mic amp with a headphone amp in a compact package that's ideal for locker room reports & other extended remote broadcasts. The RP-1's features include: headphone amp with variable level, balanced input and adjustable sidetone for monitoring IFB and your program audio. Active, balanced mic pre amp and auxiliary unbalanced line inputs with separate controls. built in 1kHz calibration oscillator. LED metering switchable to program output or cue input. Standard XLR mic and program output connector, 1/4" stereo headphone/cue jack and 3.5mm auxiliary jack. Battery powered for portability.

\$299.00 List Price

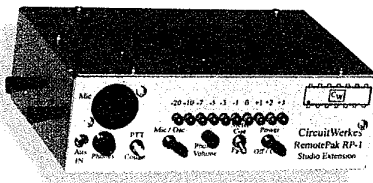

**Crown
D-75 Stereo Power Amplifier**

Perfect for moderate power applications such as recording or broadcast. Balanced Neutrik combination XLR and quarter inch phone input connectors per channel. IOC input-output comparator indicators, signal presence lights. Forty watts per channel into eight ohms. Three year no-fault warranty.

\$625.00 List Price



**Crown
D-45**

A smaller version of the D-75 rated at 25 watts into eight ohms. Balanced Neutrik combination XLR and quarter inch phone input connectors. Detented controls. IOC indicator lights and signal presence lights are standard. Full Crown performance and reliability at a budget price. Three year no-fault warranty.

\$425.00 List Price



**Crown
Studio Reference II**

Amazing transparency, depth and detail creates an experience of stunning realism. For critical studio monitoring applications the Reference II is the answer. Signal to noise ratio of 120 dB. Damping factor of over 10,000. Rated at 555 watts per channel into four ohms, 355 watts per channel into eight ohms. Three year no-fault warranty included. For more power consider the Studio Reference I rated at 1160 watts into four ohms, 780 watts into eight ohms.

\$2,475.00 List Price for Reference I

\$3,950.00 List Price for Reference II

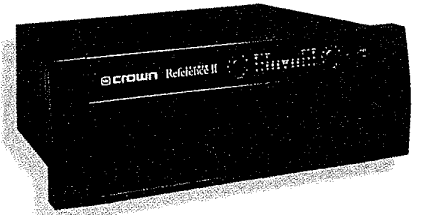

**Crown
D-150A II**

Recording studios, auditoriums, churches, traveling sound companies, discos, and sports arenas throughout the world have recognized the Crown D-150A power amplifier as a standard of audio excellence. The D-150A Series II continues this tradition as a well-designed, thoroughly safe and reliable amplifier. Its rugged front panel with scratch-resistant, baked enamel finish features a convenient level control for each channel. 95 watts per channel into 8 ohms.

\$995.00 List Price



**Electro-Voice
7100 Amplifier**

This powerful, single rack-space amplifier delivers 100 watts per channel into 8 ohms, perfect for driving control room monitors. Also, the convenient front panel TRS jack makes it the ideal choice for distortion free headphones. The 7100 is convection-cooled so there is zero fan noise! Thirty-one position detented attenuators make it easy to match channel gain settings. Octal sockets allow use of E/V crossover and equalizer modules.

\$545.00 List Price



**Hafler
P1000**

Award winning design technology from Hafler Professional engineering in a compact single rack height! The P1000 continues the heritage of sonic superiority that has made them different from all the rest. The P1000 has every advantage: value, price, features, versatility and a full 5-year warranty! 50 watts per channel.

\$499.00 List Price



**Hafler
P1500**

The trans•nova P-1500 from Hafler! A company rich with heritage and experience. Building only the finest audio power amplifier for professionals and audiophiles the world over since 1975. The P-1500 trans•nova is perfect for many studio monitoring, touring, sound or fixed installations. Featuring Professor James Strickland's radical trans•nova topology (TRANS conductance Nodal Voltage Amplifier). This patented principle was first introduced in the 9500 and promptly blew away expensive esoteric amps taking audio technology up to a whole new level in performance. 75 watts per channel.

\$549.00 List Price



**Hafler
P3000**

Amazing Price, Performance, and Features: Up in power! - with new high voltage lateral MOSFET's! New full blown LED light display. Lightning fast slew rate (100 volts per microsecond) Quiet balanced circuitry. Unique electronic fuse (with no loss in audio quality). Precise imaging, depth and soundstage. Made in the U.S.A. In Hafler's state of the art facility. 5 year Hafler world class warranty. 150 watts per channel.

\$799.00 List Price



Amplifiers





**Hafler
P9505/9303**

The 9505/9303 models set a new standard of sonic excellence for professional applications. The trans•nova is a simple three-stage amplifier with unparalleled speed and accuracy. Its power, soundstage, and exceptional image focus have previously been found only in exotic amplifiers costing 3 to 5 times the price of the trans•nova. The 9505/9303 utilize Strickland's U.S. patented J-FET input / MOSFET output circuit in a unique and flexible balanced design. 250 watts per channel.

\$1,300.00 List Price for P9303
\$2,200.00 List Price for P9505

**Hafler
P7000**

The P7000 trans•nova DIABLO (patent pending) amplifier is the most powerful and versatile amplifier Hafler has ever made! It features Jim Strickland's trans•nova circuitry (patent #4467288). Dynamically Invariant A-B Linear Operation (patent application in progress). The DIABLO transconductance driver stage combines the linearity of Class A operation with the current headroom of a Class B system resulting in a significant advancement in the art of power amplifier design. 350 watts per channel.

\$2,200.00 List Price



**Mackie
FR Series M1200 Power Amplifier**

Mackie's New M1200 Premium Amplifier has more current output, more useful features, and more solid reliability, for less money than ever before. In terms of specs, features, durability and build quality, the FR Series M1200 is a "money is no object" amplifier. Yet in terms of "watts per dollar" (not to mention feature set), it's a far better value than comparably-priced, stripped down models. Fast Recovery refers to the M1200's ability to sound good when driven to the edge and beyond into ugly reactive loads (loudspeakers). The key is low negative feedback and some exotic technology borrowed from high speed digital circuitry.

\$599.00 List Price

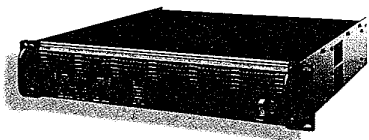

**Shure
FP11**

FP11 Mic-to-Line amplifier provides up to 84 dB of gain in fourteen 6 dB steps for boosting microphone and auxiliary level devices to the line level. The FP11 features a transformer-balanced XLR input and output; switchable peak limiter; peak/limiter LED indicator; aux line level mini-phone jack input; balanced line-level binding post output; and removable belt clip. Powered by a standard 9-volt battery, not included.

\$370.00 List Price

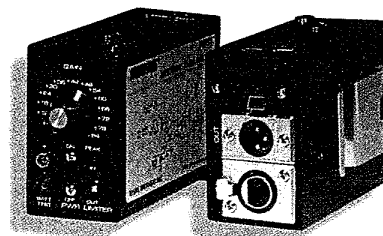

**Shure
FP22**

The FP22 Stereo headphone amplifier provides professional quality stereo headphone monitoring and is ideal for field production, studio recording, and trouble-shooting applications. The FP22 is powered by one optional 9V battery. With 81 dB of gain, the FP22 can monitor a wide range of signal sources in many different configurations. The FP22 has loopthrough input circuitry to monitor a signal without affecting the original signal source, balanced XLR connectors (accepts mic or line level), two pairs of headphone outputs, red Power On LED, a removable belt clip and two stereo 1/4" loopthrough jacks.

\$425.00 List Price

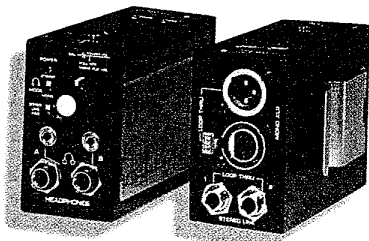

**Shure
M64A**

A compact stereo preamplifier which solves a variety of level and equalization problems. The 3-position slide switch selects standard RIAA equalization (phono) or NAB equalization for tape heads (tape). In the flat position, the M64A can be used as a low-gain microphone pre-amplifier or a buffer amplifier where long cable lengths are necessary. Ideal for interfacing turntables with PA systems. 120/240 Vac.

\$160.00 List Price

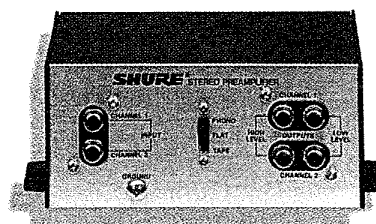

Hafler[®] PROFESSIONAL amplification

P1000 trans•ana▶



"My mixes start in the basement...That's where the bottom end lives. And then, all of a sudden like magic, the sun comes up and the top end is born. 'Hafler Amplifiers are Fat from the bottom up!'"

Gary Lux
Recording Engineer/
Producer



"At Spotted Peccary Studios, we have found no other amplifier that even comes close to the Hafler Trans•nova for its depth-of-field and definition, smoothness and clarity, and warmth and musicality. The Hafler Trans•nova is understatedly outstanding in a class of its own."

Howard Givens
Spotted Peccary Studios

Award Winning
AMPLIFIERS



"Hafler Amps:
More powerful
than a 2 day
old diaper!"

Carlene Scovill
with favorite
producer,
engineer, dad,
Robert Scovill
MusiCanvas
Studio, SAG Inc.
Eldon's Boy
Records



"The new Trans•nova, regardless of power rating, out performs any other amplifier in the industry."

Michael Jones, Conservatory of
Recording Arts and Sciences

- Lower Price!
- Single rack space
- Usable new features
- State of the art surface mount construction
- True audiophile sonic performance (not just a claim!)

P1000 Trans•ana with NOMAD Specifications

Power Rating:	FTC (20Hz-20kHz, <0.2% THD)	EIA (1kHz, 0.2% THD)
	50 wpc into 8Ω	55 wpc into 8Ω
	55 wpc into 4Ω	60 wpc into 4Ω
	110 wpc into 8Ω (bridged mono)	120 wpc into 8Ω (bridged mono)



"In a word, I am ready to qualify the P1000 as a best-buy amp in terms of audio quality. And no wonder. Designer Jim Strickland has condensed the wonderful sound of the larger trans•nova MOSFET amps (called trans•ana in this model) into a one-rack unit. The little Hafler amp is wonderfully transparent and nonfatiguing.

I tried it with all kinds of near fields: ported and acoustic suspension: single and dual-woofer alike - and it flattered them all.

I did have a few other bi-polar amps that I compared. Sure enough, the MOSFET Hafler was definitely easier on the ears at moderate-to-higher volumes over several hours of listening. The other amps made me want to turn them down over the long haul - even though the levels were the same.

Way to go Hafler. Your engineers have done it again in a smaller package."

John Gatski
Editor, Pro Audio Review, Sept. 1996

HAFLER PROFESSIONAL, A DIVISION OF ROCKFORD CORPORATION • TEMPE, ARIZONA 85281 USA
1-800-366-1619 • INTERNATIONAL FAX 602-967-8132 • IN CANADA, CONTACT CABLE TEK 604-942-1001

MADE
IN THE
USA



**Tascam
PA-20 MKII**

Every recording or project studio needs at least one set of near field monitors for critical listening. And so, every studio needs to power them with a reliable, clean-sounding power amp that won't add distortion to the incoming signal. The Tascam PA-20 MKII fills the bill with reliable, high-performance audio power amplification for near field studio monitoring and other low-level sound reinforcement applications. With its dual power and switchable stereo/mono design, it excels in control room and recording booth applications, whether its powering single speakers, stereo pairs or bridged series. 25 watts per channel.
\$250.00 List Price

**Tascam
MA-8 Mic Preamp**

This mic preamp includes 8 high quality mic preamps in a one-rack space unit, switchable phantom power, with front panel trim controls, and unbalanced RCA outputs, all for a great price!
\$400.00 List Price

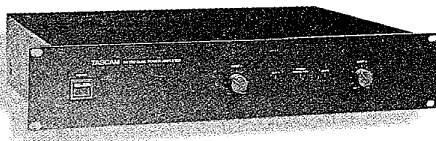

**Tascam
PA-150**

Every broadcast, project or recording studio needs amps. And when it comes to monitoring signals from mixers, MIDI equipment and other gear, you need to power those near field or studio monitor speakers. Clean sound, space consciousness, high-performance and flexibility are your criteria. And that's exactly what makes the TASCAM PA-150 an ideal fit for personal and project studios or for major studios looking for a high-value power amp for a B suite or off-line editing room. 105 watts per channel.
\$450.00 List Price

Amplifier Comparison Chart

Model#	RUs	FTC Watts/ Channel/8ohms	Distortion % at Rated Power	Noise Floor
Alesis RA100	2	100	0.05	105dB
Crown D45	1	25	0.1	106dB
Crown D75A	1	40	0.1	106dB
Crown D150A II	3	95	0.1	110dB
E/V 7100	1	100	0.1	100dB
Hafler P1000	1	50	0.1	100dB
Hafler P1500	2	75	0.1	100dB
Hafler P3000	2	150	0.1	100dB
Hafler P7000	2	350	0.1	100dB
Hafler 9505	3	250	0.07	100dB
Mackie M-1200	2	225	0.025	108dB
QSC USA 400	3	125	0.025	105dB
QSC USA 900	3	270	0.025	104dB
QSC MX 700	2	150	0.025	100dB
QSC MX1000	2	250	0.025	100dB
Tascam PA 20MkII	1	25	0.05	100dB
Tascam PA150	2	105	0.08	100dB



Antenna Section

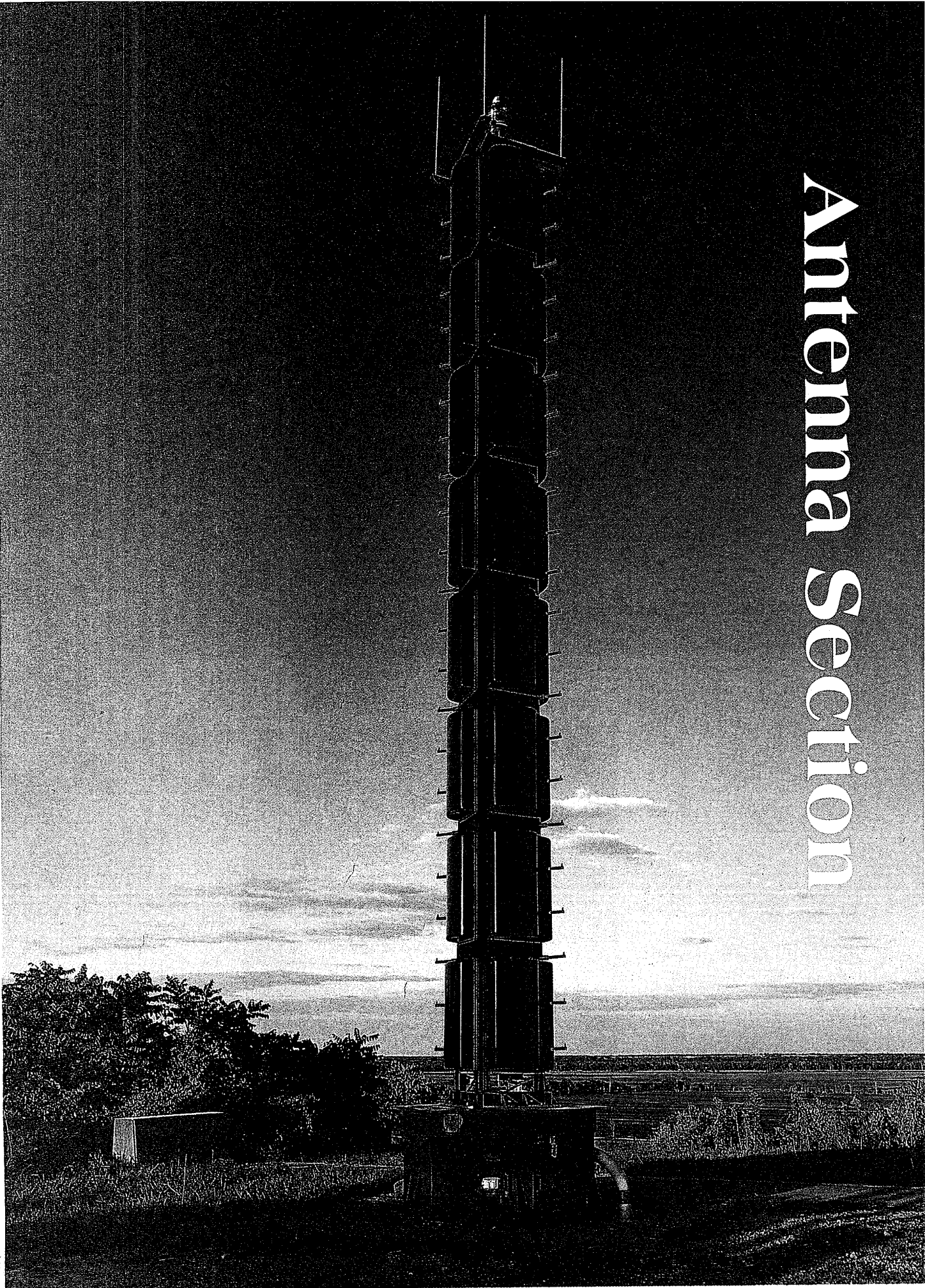

Harris UHF ATV Antenna during test

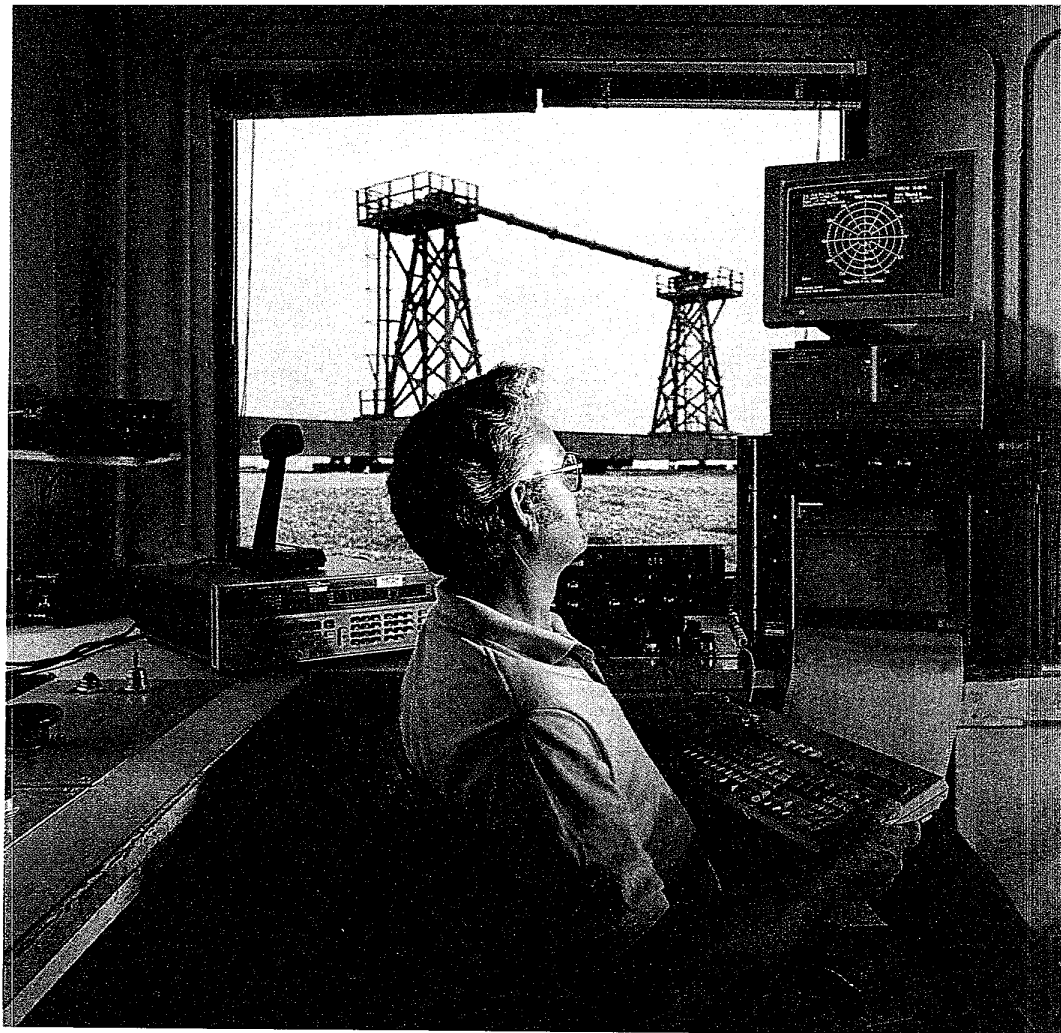

Harris UHF Wavestar
far field pattern testing

Harris UHF Wavestar near
field testing



Harris Antenna Capabilities

Your station is planning a new antenna system. You want your antenna to provide long-term trouble-free performance. You want your antenna to precisely and reliably meet all of your coverage requirements. You want to count on the manufacturer for around-the-clock service and any level of support you may need. You want your antenna to be practically perfect, because after-installation modifications are highly impractical, inconvenient and expensive.

At Harris Broadcast Division, we understand that while many broadcasters regard the antenna as the most complex component in broadcasting, it is also one of the most critical. We can provide standard cost-effective "off-the shelf" antennas or custom antenna systems that are engineered, manufactured and tested to meet your most exacting requirements. We can provide any level of support you want, including rapid emergency standby antenna turnaround. We also provide the most extensive after-sales support of any broadcast supplier.

Harris is ready to work with you from the earliest stages of your project. A field representative will meet with you to discuss the details. A team of engineers and applications specialists will help to determine the antenna that will best meet your current and future requirements. Unlike companies that limit themselves to antenna systems alone, Harris will approach your project with the perspective of a leading integrator of complete broadcast systems.

Your Harris antenna will be built to provide long life, maximum performance, top reliability and trouble-free service. We purchase components of the highest quality from key suppliers with whom we have forged long-term alliances. Our ISO 9001-registered Quincy, Illinois factory is equipped to meet all fabrication and machining demands, ensuring tight quality control. We also conduct the most rigorous sub-assembly and final testing in broadcast equipment manufacturing.

Every Harris antenna undergoes extensive testing to verify that specifications are fully met. Tests include impedance optimization, cylindrical near-field pattern testing and far-field pattern measure-

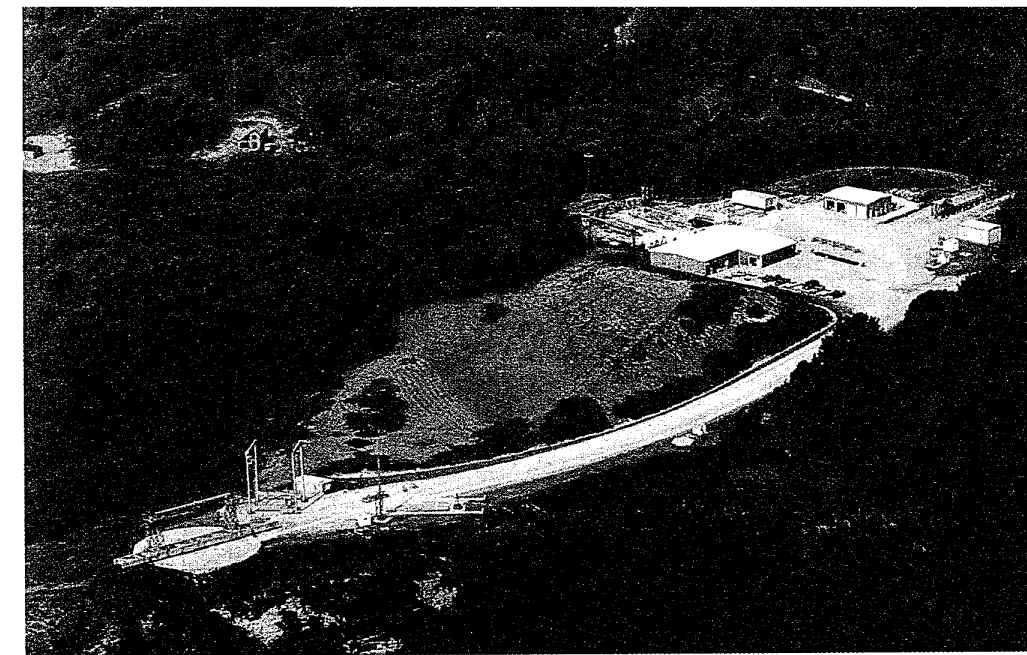

Aerial view of Harris antenna test range in Palmyra, Missouri

ment. Our customers are encouraged to witness any portion of the testing.

Harris' 40-acre antenna assembly and test facility is ideally situated on a 230-foot bluff near the Mississippi River. Our test range, with transmitters located in the Mississippi bottom lands, provides conditions which approximate the "free space" situation of an installed antenna. The range includes areas for near-field and far-field testing. Computerized control and monitoring systems ensure accurate and repeatable results.

No Harris-manufactured antenna is shipped unless pattern characteristics are verified to fully meet customer specifications. Harris' unmatched combination of technical expertise, test procedures, facilities and test equipment offer full assurance that when you purchase a Harris antenna, you'll get the performance and pattern you expect.

Harris support will continue even after your product is delivered. We provide 24-hour technical assistance for Harris products. Our parts department is staffed around the clock. We operate a repair department, and our service engineers can provide routine or emergency field service. We also are the only broadcast manufacturer to sponsor a Broadcast Technology Training Center with regular RF training and Harris product courses. Custom training also is available.

We invite you to contact us to discuss your antenna project and to learn about the new world of broadcast solutions we offer.

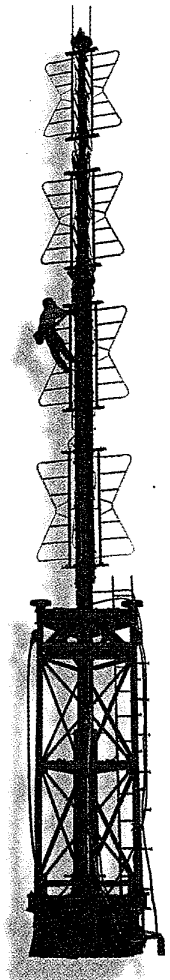

**Harris VHF Batwing
on test range**

**Harris
FM Series Antennas**

GENERAL FEATURES:

- Power ratings to meet every application
- Excellent bandwidth for top stereo/SCA performance
- Long life and trouble-free maintenance with rugged brass and stainless steel construction
- Fully assembled and tested to ensure top performance
- Brackets included for face- or leg-mount on typical tower

Options:

- Half-wave element spacing
- Electrical deicers or radomes
- Pattern testing/optimization with custom measurements on specified frequency and tower size

All standard Harris FM Series antennas have the same published gain for equivalent number of bays as shown below:

# Bays	Power Gain
1	0.4611
2	0.9971
3	1.5588
4	2.1322
5	2.7154
6	3.3028
7	3.8935
8	4.4872
9	5.0826
10	5.6800
11	6.2783
12	6.8781
13	7.4785
14	8.0800

Omnidirectional, circularly polarized without beam tilt and null fill, and with one wavelength vertical element spacing per polarization.

**Harris
Cavity Backed Radiator
(CBR) FM Antennas**

GENERAL FEATURES: (see photo page 17)

- RH circularly polarized (elliptical available on request)
- Harris-exclusive wide flat grid dipole radiator
- CBR panel construction
- Infinite azimuth patterns: variable panel mounting position, number of panels per face, phasing to panels and amplitude to panels
- Custom elevation patterns at no extra cost
- Wide impedance bandwidth
- Capable of multiplex operation
- Ideal for existing towers
- Easy to install
- Crossed dipole element design
- Excellent axial ratio
- Half the feedpoints and feedlines of a competitive quad dipole panel
- Rugged cavity design for dipole protection
- Stainless steel feedline supports
- Molded ABS radomes to protect feedpoint from ice build-up and minimize VSWR increases under icing conditions
- Optimum tower face size of 2.0 meters

CBR FM SPECIFICATIONS

Model	TAC-FMA	TAC-FMAHP	TAC-FMB	TAC-FMBHP
ELEMENT PATTERN	COS squared Type A	COS squared Type A	COS Type B	COS Type B
ELEMENT GAIN	4.5 dB nominal	4.5 dB nominal	3.5 dB nominal	3.5 dB nominal
ELEMENT AVERAGE POWER RATING	10 kW nominal	20 kW nominal	10 kW nominal	20 kW nominal
MOUNTING	Square tower sections	Square tower sections	Triangle tower sections	Triangle tower sections
INPUT	Two 7/8" 50 ohm EIA panel inputs	Two 1-5/8" 50 ohm EIA panel inputs	Two 7/8" 50 ohm EIA panel inputs	Two 1-5/8" 50 ohm EIA panel inputs
FEEDLINE PRESSURIZATION	Pressurized to panel feedpoints	Pressurized to panel feedpoints	Pressurized to panel feedpoints	Pressurized to panel feedpoints
FEEDLINES	Available with 1/2" or 7/8" 50 ohm air dielectric feeders	Available with 7/8" (standard or hi-temp) or 1-5/8" 50 ohm air dielectric feeders	Available with 1/2" or 7/8" 50 ohm air dielectric feeders	Available with 1/2" (standard or hi-temp) or 1-5/8" 50 ohm air dielectric feeders
PANEL VSWR	<1.1:1.0 over complete band	<1.1:1.0 over complete band	<1.1:1.0 over complete band	<1.1:1.0 over complete band
OTHER	Welded steel dipole construction. Dipole hot-dip galvanized.	Low-weight welded aluminum dipole construction.	Welded steel dipole construction. Dipole hot-dip galvanized.	Low-weight welded aluminum dipole construction.



**Harris
Arrowhead FM Antenna**

GENERAL FEATURES: *(not pictured)*

- RH circularly polarized (elliptical available on request)
- Flat panel construction
- Crossed dipole element design
- Infinite azimuth patterns: variable panel mounting position, number of panels per face, phasing to panels and amplitude to panels
- Custom elevation patterns at no extra cost
- Wide impedance bandwidth
- Capable of multiplex operation
- Ideal for existing towers
- Easy to install
- Half the feedpoints and feedlines of a competitive quad dipole panel
- Welded steel grid panel and dipole construction
- Panel and dipole hot-dip galvanized after fabrication
- Stainless steel feedline supports
- Molded ABS radomes to protect feedpoint from ice build-up and minimize VSWR increases under icing conditions
- Optimum tower face size of 2.0 meters

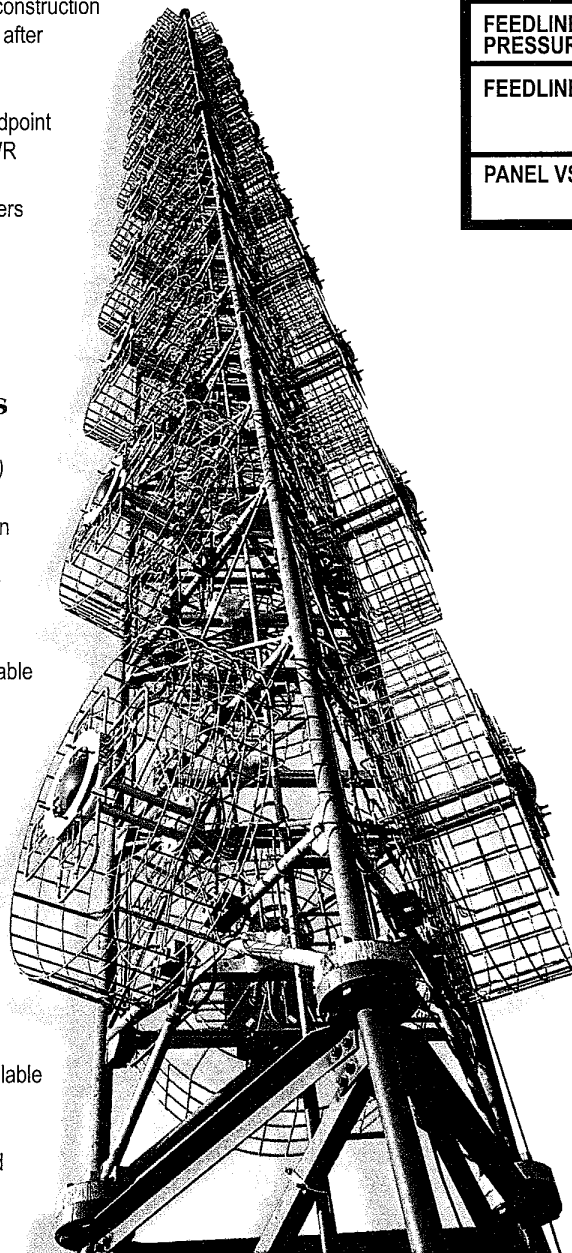

**Harris
Batwing FM Antennas**

GENERAL FEATURES: *(not pictured)*

- Field-proven Batwing turnstile design
- Horizontally polarized
- Pole type design for minimum tower loading
- One to eight bays available
- Top mount design; side mount available
- Bury type mount standard for easy tower interface; flange mount available
- Excellent omnidirectional azimuth pattern
- Custom elevation patterns at no extra cost
- Standard dual inputs
- Improved stainless steel line support for long life
- Grounded radiating element for maximum resistance to lightning
- Stainless steel feedline supports
- Simple calrod electrical deicers available for severe icing conditions
- Welded "edge bar" grid element construction for low windloading and easy climbing
- Steel element and pole hot-dip galvanized

ARROWHEAD FM SPECIFICATIONS

Model	TAP-FMB
ELEMENT PATTERN	COS Type B
ELEMENT GAIN	3.5 dB nominal (each polarization)
ELEMENT AVERAGE POWER RATING	10kW nominal
MOUNTING	Triangular tower sections
INPUT	Two 7/8" 50 ohm EIA panel inputs
FEEDLINE PRESSURIZATION	Pressurized to panel feedpoints
FEEDLINES	Available with 1/2" or 7/8" 50 ohm air dielectric feeders
PANEL VSWR	<1.2:1.0 over user-specified 10 MHz band

BATWING FM SPECIFICATIONS

Model	TAB-FM
NUMBER OF BAYS	1 to 8
AVERAGE POWER RATING PER BAY	10 kW nominal
MOUNTING	Top mount design; side mount available
FEEDLINE PRESSURIZATION	Pressurized feedlines to element feedpoints
FEEDLINES	7/8" copper feedlines
PANEL VSWR	<1.1:1.0 over 6 MHz band
OTHER	Wide impedance bandwidth; capable of multiplex operation

Harris FM CBR Antenna (see page 16 for specifications)

Antennas



DELTAWING FM SPECIFICATIONS

Model	TAD-FMA	TAD-FMALP	TAD-FMB	TAD-FMBLP
ELEMENT PATTERN	COS squared Type A	COS squared TypeA	COS Type B	COS Type B
ELEMENT GAIN	7.5 dB nominal	7.5 dB nominal	6.5 dB nominal	6.5 dB nominal
ELEMENT AVERAGE POWER RATING	5 kW	500 W	5 kW	500 W
MOUNTING	Square tower sections	Square tower sections	Triangular tower sections	Triangular tower sections
INPUT	Single 7/8" 50 ohm EIA panel input	Single Type N panel feed line input	Single 7/8" 50 ohm EIA panel input	Single Type N panel feed line input
FEEDLINE PRESSURIZATION	Pressurized to panel feedpoint	Main power dividers pressurizable	Pressurized to panel feedpoint	Main power dividers pressurizable
FEEDLINES	1/2" or 7/8" 50 ohm air dielectric	1/2" 50 ohm flexible foam filled	1/2" or 7/8" 50 ohm air dielectric	1/2" 50 ohm foam filled
PANEL VSWR	<1.1:1.0 over complete band	<1.2:1.0 over user-specified 6 MHz band	<1.1:1.0 over user-specified 10 MHz band	<1.2:1.0 over user-specified 3 MHz band
OTHER	Wide impedance bandwidth; capable of multiplex operation		Wide impedance bandwidth; capable of multiplex operation	

Antennas

Harris FM Series Antenna

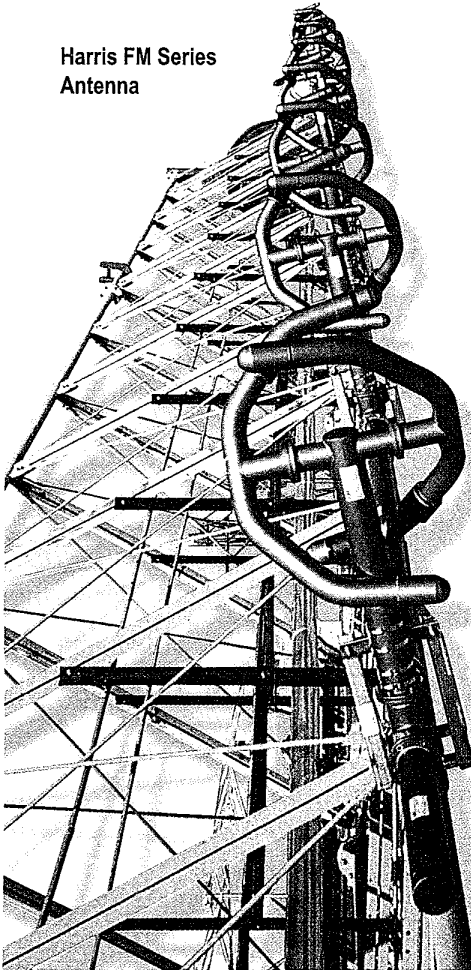

Harris Deltawing FM Antennas

GENERAL FEATURES:

- Horizontally polarized (vertical available)
- Panel construction
- Infinite azimuth patterns: variable panel mounting position, number of panels per face, phasing to panels and amplitude to panels
- Custom elevation patterns at no extra cost
- Ideal for existing triangular or square towers
- Easy to install
- Half the feedpoints and feedlines of a standard dipole panel
- Grounded radiating element for maximum resistance to lightning
- 50 ohm EIA antenna inputs sized to meet power requirements
- Stainless steel feedline supports
- Molded ABS radomes to protect feedpoint from ice build-up and minimize VSWR increases under icing conditions
- Simple calrod electrical deicers available for severe icing conditions
- Optimum tower face size of 2.0 meters
- Welded steel grid panel construction
- "Edge bar" back screen for low windloading and easy climbing
- Hot-dip galvanized after fabrication
- Knock-down construction for cost-effective packing

Harris Dipole Panel FM Antennas

GENERAL FEATURES:

- Standard dipole construction
- Infinite azimuth patterns: variable panel mounting position, number of panels per face, phasing to panels and amplitude to panels
- Custom elevation patterns at no extra cost
- Ideal for existing towers
- Easy to install
- Grounded radiating element for maximum resistance to lightning
- Optimum tower face size of 2.0 meters
- Welded steel grid panel construction
- Hot-dip galvanized after fabrication
- "Edge bar" back screen for low windloading, easy climbing
- Stainless steel feedline supports
- Feedpoint radomes available to minimize VSWR increases under icing conditions
- Knock-down construction for cost-effective packing

See Page 19 for specification chart



**Harris
Side-Mount Dipole
FM Antennas**

GENERAL FEATURES:

- Side-mount dipole construction
- Low windload and low weight
- Custom elevation patterns at no extra cost
- Ideal for existing triangular or square towers
- Easy to install
- Mounts to tower leg or vertical mounting pipe
- Branch feed system for wide impedance and pattern bandwidth
- Feedpoint radomes available to protect feedpoint area from ice build-up and minimize VSWR increases under icing conditions
- Grounded radiating element for maximum resistance to lightning
- Stainless steel feedline supports
- Welded steel construction
- Hot-dip galvanized after fabrication
- Knock-down construction for cost-effective packing

FM SIDE-MOUNT DIPOLE SPECIFICATIONS				
Model	HFM-H	HFM-HLP	HFM-V	HFM-VLP
POLARIZATION	Horizontal	Horizontal	Vertical	Vertical
ELEMENT PATTERN	Omnidirectional free space element pattern	Omnidirectional free space element pattern	Omnidirectional free space element pattern	Omnidirectional free space element pattern
ELEMENT GAIN	0.0 dB nominal	0.0 dB nominal	0.0 dB nominal	0.0 dB nominal
ELEMENT AVERAGE POWER RATING	5 kW nominal	500 W nominal	5 kW nominal	500 W nominal
INPUT	Single 7/8" 50 ohm EIA panel input	Single Type N element feedline input	Single 7/8" 50 ohm EIA panel input	Single Type N element feedline input
FEEDLINE PRESSURIZATION	Pressurized to element input	Main power dividers pressurizable	Pressurized to element input	Main power dividers pressurizable
FEEDLINES	1/2" or 7/8" 50 ohm air dielectric feeders	1/2" 50 ohm flexible foam filled feedlines	1/2" or 7/8" 50 ohm air dielectric feeders	1/2" 50 ohm flexible foam filled feedlines
PANEL VSWR	<1.2:1.0 over user-specified 3 MHz band	<1.1:1.0 over user-specified channel	<1.2:1.0 over user-specified 3 MHz band	<1.1:1.0 over user-specified channel
OTHER	Wide impedance bandwidth; capable of multiplex operation		Wide impedance bandwidth; capable of multiplex operation	

Antennas

DIPOLE PANEL FM SPECIFICATIONS						
Model	HDPH-FMA	HDPH-FMALP	HDPV-FMA	HDPV-FMALP	HDPC-FMA	HDPC-FMALP
POLARIZATION	Horizontally polarized	Horizontally polarized	Vertically polarized	Vertically polarized	RH circularly polarized	RH circularly polarized
CONSTRUCTION	Double dipole	Double dipole	Double dipole	Double dipole	Quad dipole	Quad dipole
ELEMENT PATTERN	COS squared Type A	COS squared Type A	COS squared Type A	COS squared Type A	COS squared Type A	COS squared Type A
ELEMENT GAIN	7.5 dB nominal	7.5 dB nominal	7.5 dB nominal	7.5 dB nominal	4.5 dB nominal (each polarization)	4.5 dB nominal (each polarization)
ELEMENT AVERAGE POWER RATING	5 kW nominal	1000 W nominal	5 kW nominal	1000 W nominal	10 kW nominal	2000 W nominal
MOUNTING	Square tower sections	Square tower sections	Square tower sections	Square tower sections	Square tower sections	Square tower sections
INPUT	Two 7/8" 50 ohm EIA panel inputs	Two Type N panel feedline inputs	Two 7/8" 50 ohm EIA panel inputs	Two Type N panel feedline inputs	Four 7/8" 50 ohm EIA panel inputs	Four Type N panel feedline inputs
FEEDLINE PRESSURIZATION	Pressurized to panel inputs	Main power dividers pressurizable	Pressurized to panel inputs	Main power dividers pressurizable	Pressurized to panel inputs	Main power dividers pressurizable
FEEDLINES	1/2" or 7/8" 50 ohm air dielectric feeders	1/2" 50 ohm flexible foam filled feedlines	1/2" or 7/8" 50 ohm air dielectric feeders	1/2" 50 ohm flexible foam filled feedlines	1/2" or 7/8" 50 ohm air dielectric feeders	1/2" 50 ohm flexible foam filled feedlines
PANEL VSWR	<1.2:1.0 over user-specified 3 MHz band	<1.1:1.0 over user-specified channel	<1.2:1.0 over user-specified 3 MHz band	<1.1:1.0 over user-specified channel	<1.2:1.0 over user-specified 3 MHz band	<1.1:1.0 over user-specified channel
OTHER	Wide impedance bandwidth; capable of multiplex operation		Wide impedance bandwidth; capable of multiplex operation		Wide impedance bandwidth; capable of multiplex operation	

CERTAIN PRODUCTS NOT AVAILABLE IN ALL AREAS



ORDERING AND TECHNICAL SUPPORT:
(217) 222-8200

VHF DELTAWING LOWBAND AND MIDBAND SPECIFICATIONS

Model	TAD-LA/MA	TAD-LALP/MALP	TAD-LB/MB	TAD-LBLP/MBLP
ELEMENT PATTERN	COS squared Type A	COS squared Type A	COS Type B	COS Type B
ELEMENT GAIN	7.5 dB nominal	7.5 dB nominal	6.5 dB nominal	6.5 dB nominal
NOMINAL PEAK POWER RATING Lowband Midband	8 kW 7 kW	1 kW 1 kW	8 kW 7 kW	1 kW 1 kW
IDEAL MOUNTING	Square tower sections	Square tower sections	Triangular tower sections	Triangular tower sections
INPUT	Single 7/8" 50 ohm EIA panel input	Single Type N panel feed line input	Single 7/8" 50 ohm EIA panel input	Single Type N panel feed line input
FEEDLINE PRESSURIZATION	Pressurized to panel feedpoint	Main power dividers pressurizable	Pressurized to panel feedpoint	Main power dividers pressurizable
FEEDLINES	1/2" or 7/8" 50 ohm air dielectric feeders	1/2" 75 ohm flexible foam filled feedlines	1/2" or 7/8" 50 ohm air dielectric feeders	1/2" 75 ohm flexible foam filled feedlines
PANEL VSWR	<1.1:1.0 over typical 6 MHz channel	<1.2:1.0 over typical 6 MHz channel	<1.1:1.0 over typical 6 MHz channel	<1.2:1.0 over typical 6 MHz channel
OTHER	All: Wide impedance bandwidth; Lowband and Midband: special models capable of multiplex operation		All: Wide impedance bandwidth; Lowband and Midband: special models capable of multiplex operation	

VHF DELTAWING HIGHBAND SPECIFICATIONS

Model	TAD-HA/HDA*/HDAHP*	TAD-HALP/HDALP*	TAD-HB/HDB*	TAD-HBLP/HDBLP*
ELEMENT PATTERN	COS squared Type A	COS squared Type A	COS Type B	COS Type B
NOMINAL ELEMENT GAIN	HA: 7.5 dB HDA/HDAHP: 10.5 dB	HALP: 7.5 dB HDALP: 10.5 dB	HB: 6.5 dB HDB: 9.5 dB	HBLP: 6.5 dB HDBLP: 9.5 dB
NOMINAL PEAK POWER RATING	HA/HDA: 4 kW HDAHP: 7 kW	HALP/HDALP: 500 W	4 kW	500 W
IDEAL MOUNTING	Square tower sections	Square tower sections	Triangular tower sections	Triangular tower sections
INPUT	HA/HDA: Single 7/8" 50 ohm EIA panel input HDAHP: Single 1-5/8" 50 ohm EIA panel input	HALP/HDALP: Single Type N panel feedline input	Single 7/8" 50 ohm EIA panel input	Single Type N panel feedline input
FEEDLINE PRESSURIZATION	Pressurized to panel feedpoint	HALP/HDALP: Main power dividers pressurizable	Pressurized to panel feedpoints	Main power dividers pressurizable
FEEDLINES	HA/HDA: 1/2" or 7/8" 50 ohm air dielectric feeders HDAHP: 1-5/8" 50 ohm air dielectric feeders	HALP/HDALP: 1/2" 50 ohm flexible feedlines	1/2" or 7/8" 50 ohm air dielectric feeders	1/2" 50 ohm flexible foam filled feedlines
PANEL VSWR	<1.1:1.0 over complete band	<1.2:1.0 over typical 6 MHz channel	<1.1:1.0 over complete band	<1.2:1.0 over typical 6 MHz channel
OTHER	Wide impedance bandwidth; capable of multiplex operation		Wide impedance bandwidth; capable of multiplex operation	

*Duplet Deltawing panels (HDA, HDALP, HDAHP, HDB, HDBLP) with two elements packaged on a single unitized frame.



Harris Deltawing VHF Antennas

GENERAL FEATURES:

- Field-proven design
- Horizontally polarized (vertical available)
- Panel construction
- Infinite azimuth patterns: variable panel mounting position, number of panels per face, phasing to panels and amplitude to panels
- Custom elevation patterns at no extra cost
- Ideal for existing towers
- Easy to install
- Half the feedpoints and feedlines of competitive dipole panel
- Grounded radiating element for maximum resistance to lightning
- 50 ohm EIA antenna inputs sized to meet power requirements
- Stainless steel feedline supports
- Molded ABS radomes to protect feedpoint from ice build-up and minimize VSWR increases under icing conditions
- Simple calrod electrical deicers available for severe icing conditions
- Optimum tower face size: 4.0 meters for lowband (47 - 68 MHz); 3.0 meters for midband (66 - 88 MHz); 1.2 meters for highband (174 - 230 MHz)

Lowband and Midband:

- Welded steel grid panel construction
- "Edge bar" back screen for low windloading and easy climbing
- Hot-dip galvanized after fabrication
- Knock-down construction for cost-effective packing

Highband:

- Complete unitized welded steel grid panel construction
- Hot-dip galvanized after fabrication
- Complete panel assembly and factory test

See Page 20 for specifications

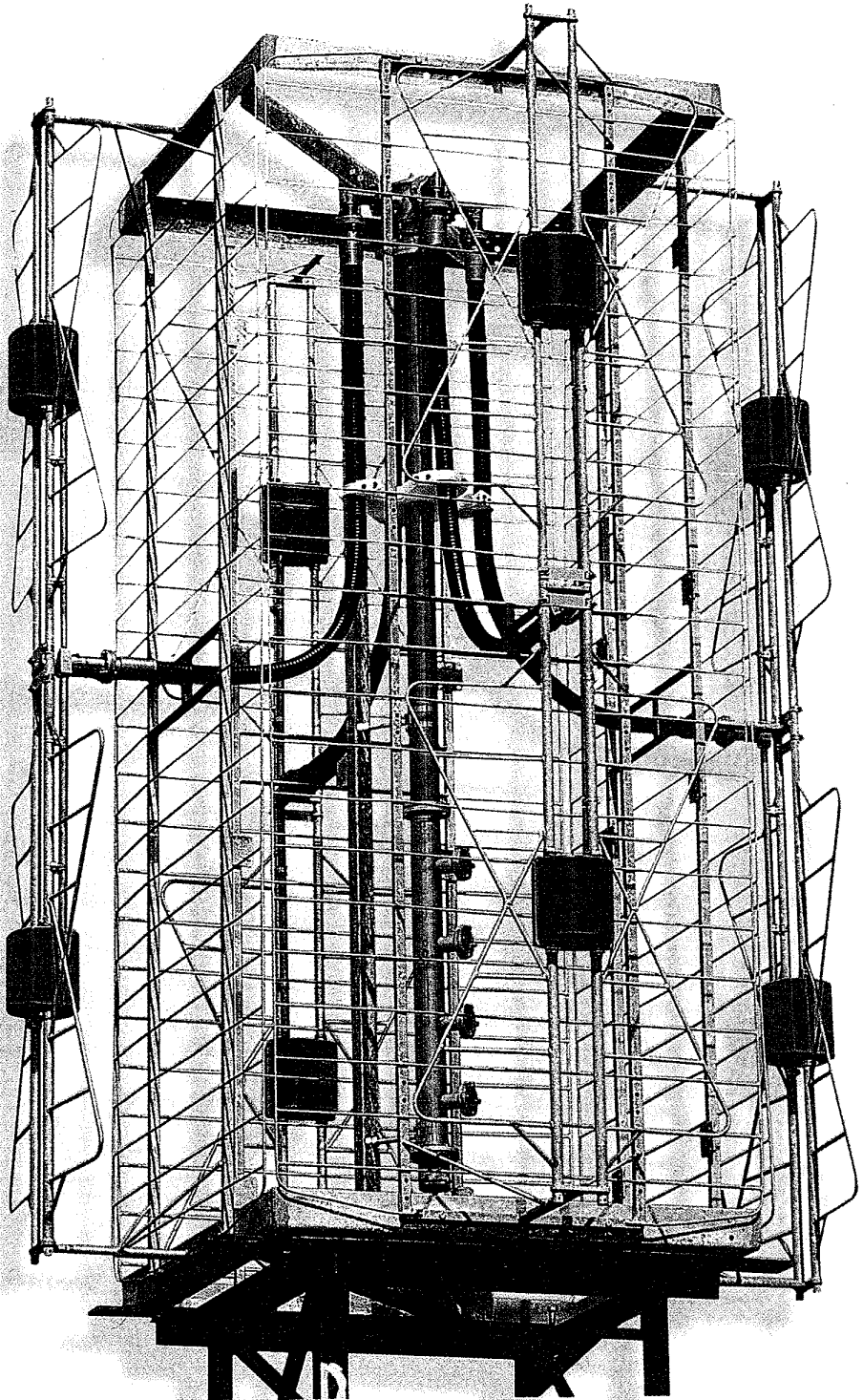

Harris VHF TAD-HDAHP
Duplet Deltawing Array

Antennas

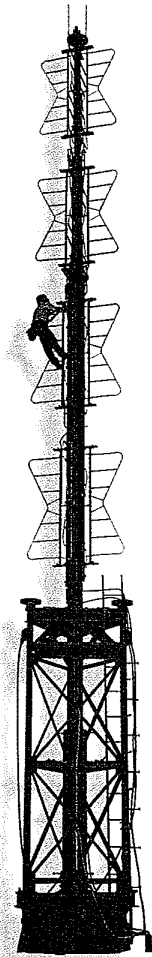

Harris 4-Bay Low Band VHF Batwing during test

Harris Batwing VHF Antennas

GENERAL FEATURES:

- Field-proven Batwing turnstile design
- Horizontally polarized
- Pole type design for minimum tower loading
- Excellent omnidirectional azimuth pattern
- Custom elevation patterns at no extra cost
- Standard dual inputs require only a simple hybrid diplexer
- Improved stainless steel line support for long life
- Grounded radiating element for maximum resistance to lightning
- Stainless steel feedline supports
- Simple calrod electrical deicers available for severe icing conditions

BATWING VHF SPECIFICATIONS

Model	TAB-L	TAB-1LLP	TAB-M	TAB-1MLP	TAB-H	TAB-HLP
BAND	47 - 68 MHz	47 - 68 MHz	66 - 88 MHz	66 - 88 MHz	174 - 230 MHz	174 - 230 MHz
NUMBER OF BAYS	1 to 6	1 per antenna	1 - 8	1 per antenna	1 - 12	1 - 4
CONSTRUCTION	Welded tubular grid element construction; steel element and pole hot-dip galvanized	Welded "edge bar" grid element construction; low-weight aluminum	Welded tubular grid element construction; steel element and pole hot-dip galvanized	Welded "edge bar" grid element construction; low-weight aluminum	Welded tubular grid element construction; steel element and pole hot-dip galvanized	Welded "edge bar" grid element construction; low-weight aluminum
NOMINAL PEAK POWER RATING	20 kW per bay	5 kW per bay	18 kW per bay	5 kW per bay	12 kW per bay	2 kW per bay
MOUNTING	Top mount; low-weight side mount available. Bury type mount standard; flange mount available	Bury type mount standard; flange mount available	Top mount; low-weight side mount available	Bury type mount standard; flange mount available	1 - 4 bays: Flange type standard; 6 - 12 bays: bury mount standard; flange mount available	Bury type mount standard; flange mount available
INPUT		Single 1-5/8" 50 ohm EIA pressurizable input		Single 1-5/8" 50 ohm EIA pressurizable input		Single 1-5/8" 50 ohm EIA pressurizable input
FEEDLINES	7/8" diameter copper feedlines; pressurized to element feedpoints	1/2" flexible foam filled feedlines	7/8" diameter copper feedlines; pressurized to element feedpoints	1/2" flexible foam filled feedlines	7/8" diameter copper feedlines; pressurized to element feedpoints	1/2" flexible foam filled feedlines
PANEL VSWR	<1.1:1.0 over typical 6 MHz channel	<1.2:1.0 over typical 6 MHz channel	<1.1:1.0 over typical 6 MHz channel	<1.2:1.0 over typical 6 MHz channel	<1.1:1.0 over typical 6 MHz channel	<1.2:1.0 over typical 6 MHz channel
OTHER	Wide impedance bandwidth; special models capable of multiplex operation		Wide impedance bandwidth; special models capable of multiplex operation		Wide impedance bandwidth; special models capable of multiplex operation	



**Harris
Cavity Backed Radiator (CBR)
VHF Antennas**

GENERAL FEATURES:

- Field-proven design
- RH circularly polarized (elliptical available on request)
- Harris-exclusive wide flat grid dipole radiator
- CBR panel construction
- Infinite azimuth patterns: variable panel mounting position, number of panels per face, phasing to panels and amplitude to panels
- Custom elevation patterns at no extra cost
- Ideal for existing towers
- Easy to install
- Crossed dipole element design
- Excellent axial ratio
- Rugged cavity design for dipole protection
- Optimum tower face size: 4.0 meters lowband (54 - 66 MHz); 3.0 meters midband (66 - 88 MHz); 1.0 meters highband (174 - 230 MHz)
- Welded steel grid cavity and dipole construction; hot-dip galvanized
- Stainless steel feedline supports
- Molded ABS radomes to protect feedpoint from ice build-up and minimize VSWR increases under icing conditions

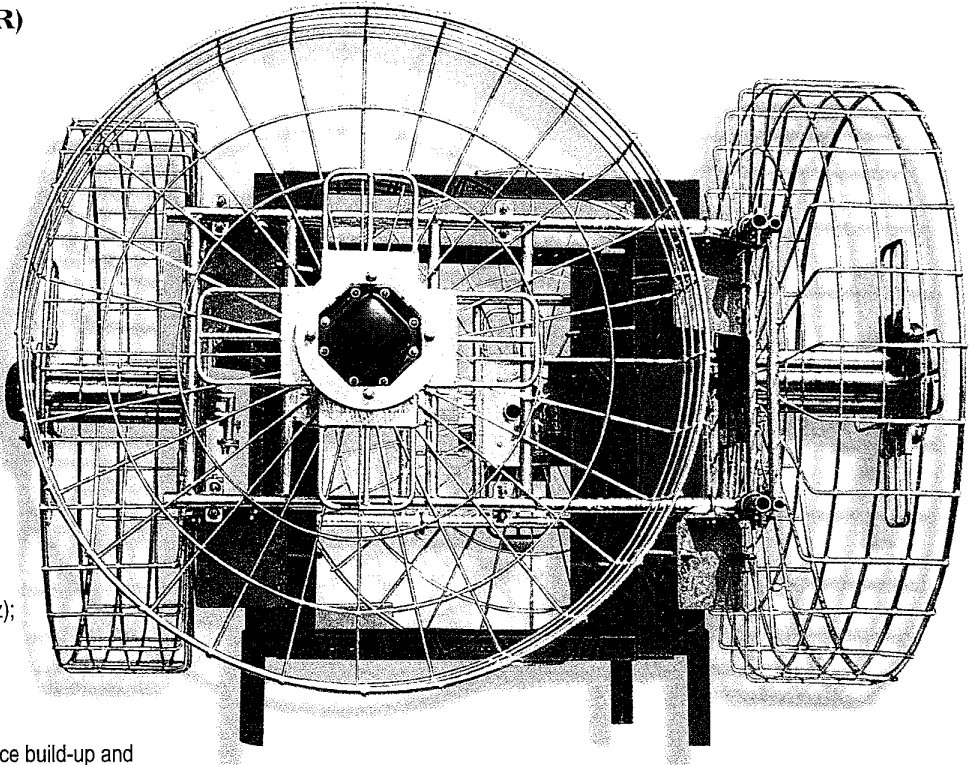

**Harris 1-Bay High Band
VHF CBR antenna**

Highband:

- Complete panel assembly and factory test
- Full element "dome" radome available

Antennas

CBR VHF SPECIFICATIONS

Model	TAC-LA	TAC-LB	TAC-MA	TAC-MB	TAC-HA	TAC-HB
BAND	47 - 68 MHz	47 - 68 MHz	66 - 88 MHz	66 - 88 MHz	174 - 230 MHz	174 - 230 MHz
PATTERN	COS squared Type A	COS Type B	COS squared Type A	COS Type B	COS squared Type A	COS Type B
NOMINAL ELEMENT GAIN	4.5 dB (each polarization)	3.5 dB (each polarization)	4.5 dB (each polarization)	3.5 dB (each polarization)	4.5 dB (each polarization)	3.5 dB (each polarization)
NOMINAL PEAK POWER RATING	10 kW	10 kW	10 kW	10 kW	5 kW	5 kW
IDEAL MOUNTING	Square tower sections	Triangular tower sections	Square tower sections	Triangular tower sections	Square tower sections	Triangular tower sections
INPUT	Two 7/8" 50 ohm EIA panel inputs; pressurized to panel feedpoints	Two 7/8" 50 ohm EIA panel inputs; pressurized to panel feedpoints	Two 7/8" 50 ohm EIA panel inputs; pressurized to panel feedpoints	Two 7/8" 50 ohm EIA panel inputs; pressurized to panel feedpoints	Two 7/8" 50 ohm EIA panel inputs; pressurized to panel feedpoints	Two 7/8" 50 ohm EIA panel inputs; pressurized to panel feedpoints
FEEDLINES AVAILABLE	1/2" or 7/8" 50 ohm air dielectric feeders	1/2" or 7/8" 50 ohm air dielectric feeders	1/2" or 7/8" 50 ohm air dielectric feeders	1/2" or 7/8" 50 ohm air dielectric feeders	1/2" or 7/8" 50 ohm air dielectric feeders	1/2" or 7/8" 50 ohm air dielectric feeders
PANEL VSWR	<1.1:1.0 over 6 MHz channel	<1.1:1.0 over 6 MHz channel	<1.1:1.0 over 6 MHz channel	<1.1:1.0 over 6 MHz channel	<1.2:1.0 over complete band	<1.2:1.0 over complete band
OTHER	Wide impedance bandwidth	Wide impedance bandwidth	Wide impedance bandwidth	Wide impedance bandwidth	Wide impedance bandwidth; capable of multiplex operation	Wide impedance bandwidth; capable of multiplex operation



**Harris
Arrowhead TAP VHF Antennas**

GENERAL FEATURES:

- RH circularly polarized (elliptical available on request)
- Flat panel construction
- Crossed dipole element design
- Infinite azimuth patterns: variable panel mounting position, number of panels per face, phasing to panels and amplitude to panels
- Custom elevation patterns at no extra cost
- Ideal for existing towers
- Easy to install
- Ideal for triangular tower sections
- Optimum tower face size: 4.0 meters lowband (54 - 66 MHz); 3.0 meters midband (62 - 88 MHz); 1.2 meters highband (174 - 230 MHz)
- Stainless steel feedline supports
- Molded ABS radomes to protect feedpoint from ice build-up and minimize VSWR increases under icing conditions

Lowband and Midband:

- Welded steel grid panel and dipole construction; hot-dip galvanized
- "Edge bar" back screen for low windloading; easy climbing

Highband:

- Welded steel grid panel construction
- Welded steel unitized dipole construction
- Hot-dip galvanized
- Complete panel assembly and factory test
- Full element "dome" radome available

**Harris 3-bay High Band
VHF Arrowhead
Panel Antenna**

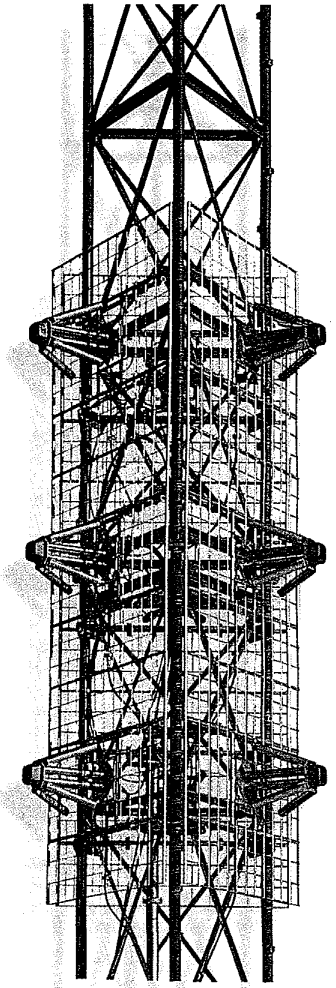

ARROWHEAD TAP VHF SPECIFICATIONS

Model	TAP-LB	TAP-MB	TAP-HB
BAND	47 - 68 MHz	66 - 88 MHz	174 - 230 MHz
PATTERN	COS Type B	COS Type B	COS Type B
NOMINAL ELEMENT GAIN	3.5 dB (each polarization)	3.5 dB (each polarization)	3.5 dB (each polarization)
NOMINAL PEAK POWER RATING	10 kW	10 kW	5 kW
IDEAL MOUNTING	Triangular tower sections	Triangular tower sections	Triangular tower sections
INPUTS	Two 7/8" 50 ohm EIA panel inputs; pressurized to panel feedpoints	Two 7/8" 50 ohm EIA panel inputs; pressurized to panel feedpoints	Two 7/8" 50 ohm EIA panel inputs; pressurized to panel feedpoints
FEEDLINES	1/2" or 7/8" 50 ohm	1/2" or 7/8" 50 ohm	1/2" or 7/8" 50 ohm
AVAILABLE	air dielectric feeders	air dielectric feeders	air dielectric feeders
PANEL VSWR	<1.2:1.0 over 6 MHz channel	<1.2:1.0 over 6 MHz channel	<1.2:1.0 over user-specified 20 MHz channel
OTHER		Wide impedance bandwidth	Wide impedance bandwidth; capable of multiplex operation



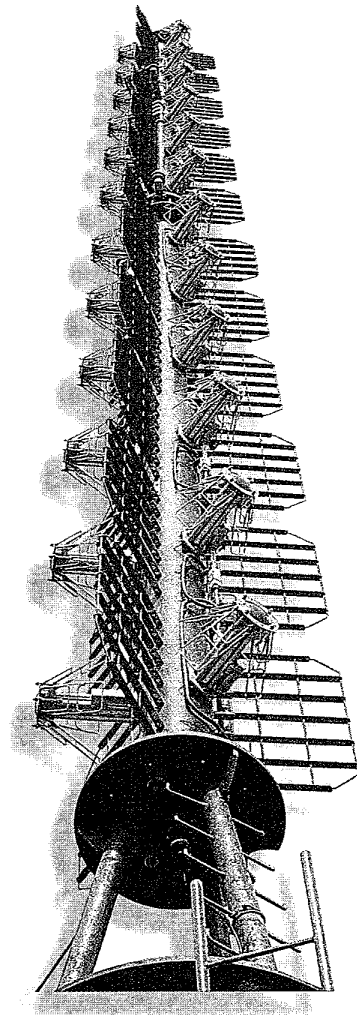

**Harris
CPV VHF Antennas**

GENERAL FEATURES:

- Field-proven dipole design
- RH circularly polarized (elliptical available on request)
- Quadrature-fed crossed dipole elements to minimize effects of moderate icing
- Pole-type design for minimum tower loading
- Omnidirectional and directional patterns available
- Three crossed dipole elements per bay for omnidirectional operation
- Custom elevation patterns at no extra cost
- Bury or flange mount designs available
- Molded ABS radomes to protect feed point from ice build-up and minimize VSWR increases under icing conditions
- "Edge bar" screens for low windloading; easy climbing
- Welded steel grid panel and dipole construction; hot-dip galvanized
- Complete factory assembly and testing
- Single or dual line inputs available for multiple bays

**Harris 12-Bay
CPV VHF Array**

Antennas

CPV VHF SPECIFICATIONS

Model	TAV-L	TAV-M	TAV-H
BAND	54-66 MHz	66-72 MHz	174-216 MHz
NUMBER OF BAYS	1-6	1-6	1-12
NOMINAL GAIN PER BAY	-3.187 dB rms/ per pol (omni operation)	-3.187 dB rms/ per pol (omni operation)	-3.187 dB rms/ per pol (omni operation)
NOMINAL PEAK POWER RATING	35 kW per bay	24 kW per bay	20 kW per bay
MOUNTING	Top mount. Bury or flanged	Top mount. Bury or flanged	Top mount. Bury or flanged
INPUT	Dual 3-1/8" 50 ohm over 2 bays	Dual 3-1/8" 50 ohm over 2 bays	Dual 3-1/8" 50 ohm over 2 bays
FEEDLINES AVAILABLE	1/2" or 7/8" 50 ohm air dielectric feeders	1/2" or 7/8" 50 ohm air dielectric feeders	1/2" or 7/8" 50 ohm air dielectric feeders
ELEMENT VSWR	<1.1:1 across 6 MHz channel	<1.1:1 across 6 MHz channel	<1.2:1 across band
OTHER	Per bay power may be limited by input	Per bay power may be limited by input	Wide impedance bandwidth; capable of multiplex operation. Per bay power may be limited by input.



Antennas

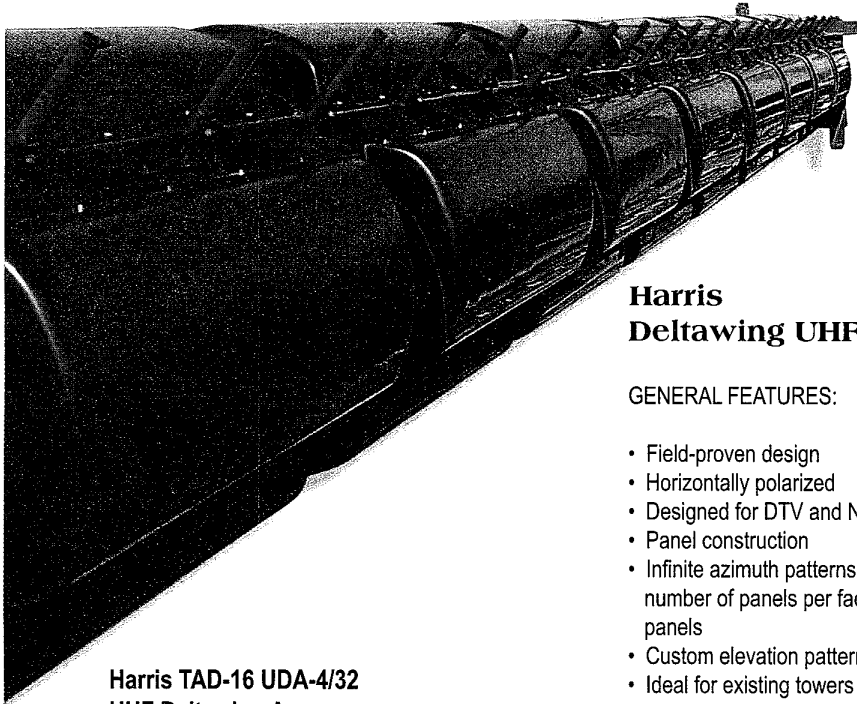

**Harris TAD-16 UDA-4/32
UHF Deltawing Array**

**Harris UHF
Deltawing Antenna**

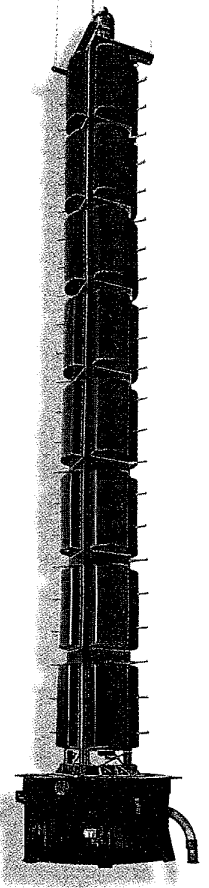

**Harris
Deltawing UHF Antennas**

GENERAL FEATURES:

- Field-proven design
- Horizontally polarized
- Designed for DTV and NTSC operation
- Panel construction
- Infinite azimuth patterns: variable panel mounting position, number of panels per face, phasing to panels and amplitude to panels
- Custom elevation patterns at no extra cost
- Ideal for existing towers
- Easy to install
- Full panel radomes included
- Low downtower radiation
- Optimum tower face size 0.61 meters
- Half the feedpoints and feedlines of competitive dipole panel
- Grounded radiating element for maximum resistance to lightning
- Wide impedance bandwidth
- Capable of multiplex operation

DELTAWING UHF SPECIFICATIONS

Model	TAD-UDA	TAD-UDALP	TAD-UDALPA	TAD-UDAHP	TAD-UDAUP
ELEMENT PATTERN	COS squared Type A	COS squared Type A	COS squared Type A	COS squared Type A	COS squared Type A
NOMINAL ELEMENT GAIN	11.6 dB	11.6 dB	11.6 dB	11.6 dB	11.6 dB
NOMINAL PEAK POWER RATING	2.5 kW	500 W	500 W	5.0 kW	5.0 kW
IDEAL MOUNTING	Square tower sections	Square tower sections	Square tower sections	Square tower sections	Supplied with complete supporting mast
INPUT	Single 7/8" 50 ohm EIA panel input	Single Type N 50 ohm panel input	Single Type N panel feedline input	Single 1-5/8" 50 ohm EIA panel input	Single 1-5/8" 50 ohm EIA panel input
FEEDLINE PRESSURIZATION	Pressurized to panel feedpoint	Main power dividers pressurizable	Main power dividers pressurizable	Pressurized to panel feedpoint	Pressurized to panel feedpoint
FEEDLINES	1/2" or 7/8" 50 ohm air dielectric feeders	1/2" 50 ohm flexible foam filled feedlines	50 ohm LMR-600 flexible foam filled feedlines	1-5/8" 50 ohm air dielectric feeder	Complete rigid 1-5/8" 50 ohm EIA panel input
PANEL VSWR	<1.1:1.0 over band	<1.1:1.0 over band	<1.2:1.0 over band	<1.1:1.0 over band	<1.1:1.0 over band
CONSTRUCTION	Stainless steel panel construction	Stainless steel panel construction	Corrosion-resistant aluminum panel construction; lightweight	Stainless steel panel construction	Stainless steel panel construction
OTHER					Semiflexible cables not used. Antenna inputs sized to match power requirements. Completely factory-assembled and tested.



**Harris
Circular Waveguide
Wavestar UHF Antennas**

GENERAL FEATURES:

- Ideal for super power single-channel applications
- Field-proven design
- Horizontally polarized (V-pol available)
- Antenna impedance optimized to better than 1.1:1.0 VSWR over typical 6 MHz channel
- Top-mounted slotted pole-type construction
- Nearly unlimited power handling capability
- No center conductor — maximizes reliability
- External climbing ladder for beacon access
- Bolted flange connection to tower top
- Steel tube hot-dip galvanized for long life
- Nominal 8-30 elevation gain available
- Full cylindrical fiberglass radome: pressurized for maximum environmental protection; eliminates costly electrical deicers
- 6-1/8" 75 ohm input standard; also available: 6-1/8" 50 ohm coaxial; 8-3/16" and 9-3/16" 75 ohm coaxial, and rectangular Waveguide

**HARRIS CIRCULAR WAVEGUIDE
WAVESTAR ANTENNA MODELS:**

Model:	Notes:
TWS	Omnidirectional azimuth pattern; horizontally polarized
TWS-T	Trilobe directional azimuth pattern; horizontally polarized
TWS-D	Broad cardioid directional azimuth pattern; horizontally polarized
TWS/V	Omnidirectional azimuth pattern; elliptically polarized using simple grounded "Tau" monopole elements; adjustable level of V-pol
TWS-TV	Trilobe directional azimuth pattern; elliptically polarized using simple grounded "Tau" monopole element; adjustable level of V-pol



Antennas

Harris UHF Wavestar on near field range

**Harris
Lunar Waveguide
Wavestar UHF Antennas**

GENERAL FEATURES:

- Ideal for high power single-channel applications
- Field-proven lunar "wrapped rectangular" design
- Horizontally polarized (V-pol available)
- Antenna impedance optimized to better than 1.1:1.0 VSWR over typical 6 MHz channel
- Top-mounted slotted pole-type construction
- Nearly unlimited power handling capability
- No center conductor — maximizes reliability
- Climbing steps for beacon access
- Bolted flange connection to tower top
- Steel tube hot-dip galvanized for long life
- Nominal 8-30 elevation gain available
- Unpressurized fiberglass slot cover radomes for minimum windloading
- Patented rectangular waveguide input standard; coaxial input available

**HARRIS LUNAR WAVEGUIDE WAVESTAR
ANTENNA MODELS:**

Model:	Notes:
TWS-C	Cardioid directional azimuth pattern; horizontally polarized
TWS-C/V	Cardioid directional azimuth pattern; elliptically polarized using simple grounded "Tau" monopole elements; adjustable V-pol level. Beam width of V-pol azimuth pattern can be varied independently of H-pol azimuth pattern



**Harris
Top-Mounted Coaxial Wavestar UHF Antennas**

GENERAL FEATURES:

- Ideal for high power single-channel applications
- Field-proven coaxial design with patented non-contact inner conductor expansion device; high power end-fed design
- Horizontally polarized (V-pol available)
- Wide selection of azimuth patterns
- Antenna impedance optimized to better than 1.1:1.0 VSWR over typical 6 MHz channel
- Top-mounted slotted pole-type construction
- Custom elevation patterns at no extra cost
- Bolted flange connection to tower top
- Steel tube hot-dip galvanized for long life
- Nominal 8-30 elevation gain available
- 6-1/8" 75 ohm input standard; also available: 6-1/8" 50 ohm coaxial, 8-3/16" and 9-3/16" 75 ohm coaxial and rectangular Waveguide
- Environmental protection matched to customer requirements:
 - Full cylindrical fiberglass radome: pressurized for maximum protection; eliminates costly deicers; external climbing ladder for beacon access
 - Low-profile fiberglass slot cover radomes: low windload; eliminates costly electrical deicers; climbing steps for beacon access
 - Low-profile PTFE slot covers with electrical deicers: lowest windload option; ideal for existing towers; simple calrod heating elements; climbing steps for beacon access

HARRIS TOP-MOUNTED COAXIAL WAVESTAR ANTENNA MODELS:

Model:	Notes:
TWSC	Omnidirectional azimuth pattern; horizontally polarized; choice of environmental protection
TWSC-C	Cardioid directional azimuth pattern; horizontally polarized; choice of environmental protection
TWSC-P	Peanut directional azimuth pattern; horizontally polarized; choice of environmental protection
TWSC-T	Trilobe directional azimuth pattern; horizontally polarized; choice of environmental protection
TWSC/V	Omnidirectional azimuth pattern; elliptically polarized using simple grounded "Tau" monopole elements; adjustable level of V-pol; full cylindrical fiberglass radome
TWSC-P/V	Peanut directional azimuth pattern; elliptically polarized using simple grounded "Tau" monopole elements; adjustable level of V-pol. Beam width of V-pole azimuth pattern can be varied independently of H-pol azimuth pattern; full cylindrical fiberglass radome
TWSC-T/V	Trilobe directional azimuth pattern; elliptically polarized using simple grounded "Tau" monopole elements; adjustable level of V-pol; full cylindrical fiberglass radome

**Harris
High Power Side-Mounted Coaxial Wavestar UHF Antennas**

GENERAL FEATURES:

- Ideal for high power single-channel applications
- Field-proven coaxial design with patented non-contact inner conductor expansion device; high power end-fed design
- Horizontally polarized (V-pol available)
- Wide selection of azimuth patterns
- Antenna impedance optimized to better than 1.1:1.0 VSWR over typical 6 MHz channel
- Side-mounted slotted pole-type construction
- Custom elevation patterns at no extra cost
- Bolted connection to tower
- Steel tube hot-dip galvanized for long life
- Nominal 8-30 elevation gain available
- 6-1/8" 75 ohm input standard; also available: 6-1/8" 50 ohm coaxial, 8-3/16" and 9-3/16" 75 ohm coaxial and rectangular Waveguide
- Environmental protection matched to customer requirements:
 - Full cylindrical fiberglass radome: pressurized for maximum protection; eliminates costly deicers
 - Low-profile fiberglass slot cover radomes: low windload; eliminates costly electrical deicers
 - Low-profile PTFE slot covers with electrical deicers: lowest windload option; ideal for existing towers; simple calrod heating elements

HARRIS HIGH POWER SIDE-MOUNTED COAXIAL WAVESTAR ANTENNA MODELS:

Model:	Notes:
TWSC/SM	Omnidirectional azimuth pattern; horizontally polarized; choice of environmental protection
TWSC-C/SM	Cardioid directional azimuth pattern; horizontally polarized; choice of environmental protection
TWSC-P/SM	Peanut directional azimuth pattern; horizontally polarized; choice of environmental protection
TWSC-T/SM	Trilobe directional azimuth pattern; horizontally polarized; choice of environmental protection



**Harris
Medium Power Branch Fed
Side-Mounted Coaxial
Wavestar UHF Antennas**

GENERAL FEATURES:

- Ideal for low and medium power single-channel applications
- Field-proven branch fed coaxial design
- Horizontally polarized (V-pol available)
- Wide selection of azimuth patterns
- Antenna impedance optimized to better than 1.1:1.0 VSWR over typical 6 MHz channel
- 4-slot module type construction
- Custom elevation patterns at no extra cost
- Bolted connection to tower
- Heavy-wall aluminum tubing
- Nominal 8-32 elevation gain available
- Choice of 50 ohm coaxial inputs
- Low-profile PTFE slot covers: lowest windload and weights; ideal for existing towers

**HARRIS MEDIUM POWER BRANCH FED
SIDE-MOUNTED COAXIAL WAVESTAR
ANTENNA MODELS:**

Model:	Notes:
TWSLP/SM	Omnidirectional azimuth pattern; horizontally polarized
TWSLP-C/SM	Cardioid directional azimuth pattern; horizontally polarized
TWSLP-P/SM	Peanut directional azimuth pattern; horizontally polarized
TWSLP-C/SM-V	Cardioid directional azimuth pattern; elliptically polarized using simple grounded "Tau" monopole elements; adjustable level of V-pol

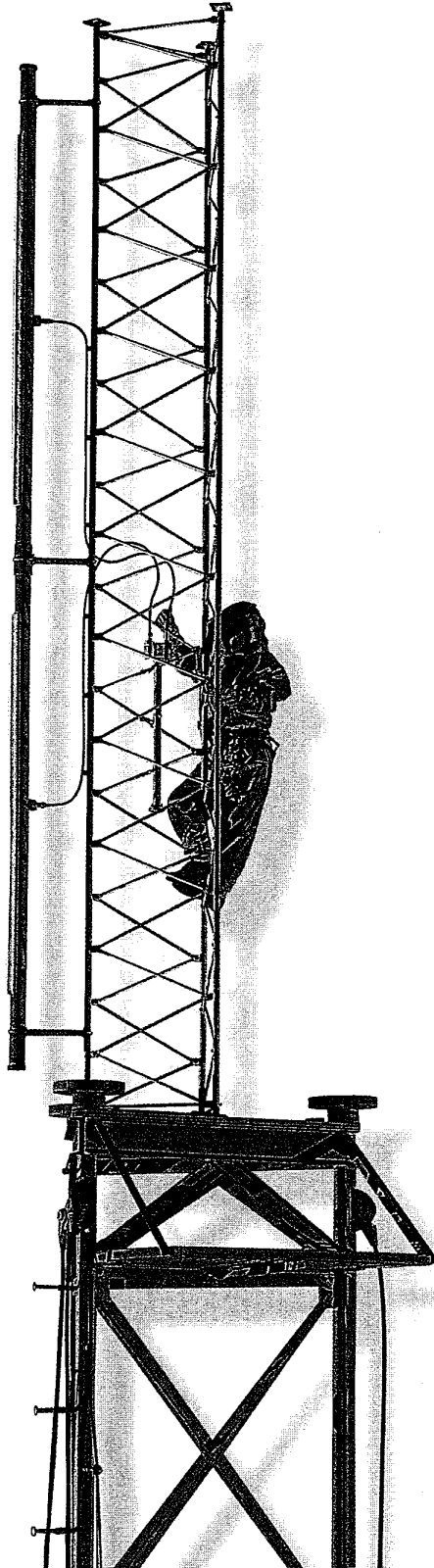

**Harris
Medium Power
Side-Mounted Coaxial
Wavestar UHF Antennas**

GENERAL FEATURES:

- Ideal for medium power single-channel applications
- Field-proven coaxial design
- Horizontally polarized (V-pol available)
- Wide selection of azimuth patterns
- Antenna impedance optimized to better than 1.1:1.0 VSWR over typical 6 MHz channel
- Side-mounted slotted pole-type construction
- Custom elevation patterns at no extra cost
- Bolted connection to tower
- Heavy-wall brass tubing
- Nominal 8-30 elevation gain available
- 6-1/8" 75 ohm input standard; also available: EIA 50 ohm coaxial
- Full cylindrical fiberglass radome: pressurized for maximum protection; eliminates costly deicers

**HARRIS MEDIUM POWER SIDE-MOUNTED
COAXIAL WAVESTAR ANTENNA MODELS:**

Model:	Notes:
TWSM/SM	Omnidirectional azimuth pattern; horizontally polarized
TWSM-C/SM	Cardioid directional azimuth pattern; horizontally polarized
TWSM-P/SM	Peanut directional azimuth pattern; horizontally polarized

**Harris Medium Power TWS-LP
Side-Mount UHF Antenna**

Antennas



Antennas

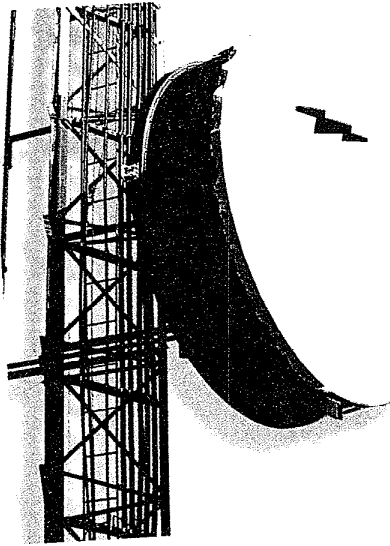

HP-Series

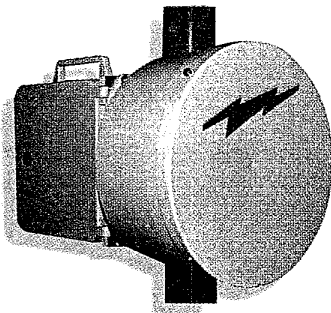

ValuLine

Andrew Microwave Antennas for High Frequencies

Andrew offers various types of antennas for applications in the 6 GHz, 13GHz, and 18 GHz bands. Andrew Unshielded, P-series antennas are ideal for low capacity links where interference potential is low; Shielded, HP-series antennas are well suited for higher capacity links where interference potential is high and a more stringent antenna pattern is required. The ValuLine series of antennas are available in both shielded and unshielded versions and are available for applications from 10 to 57 GHz, and range in size from 1 ft. (0.3m) to 6 ft. (1.8m). These antennas are also well suited for direct integration of radio OEM units.

List Prices Vary

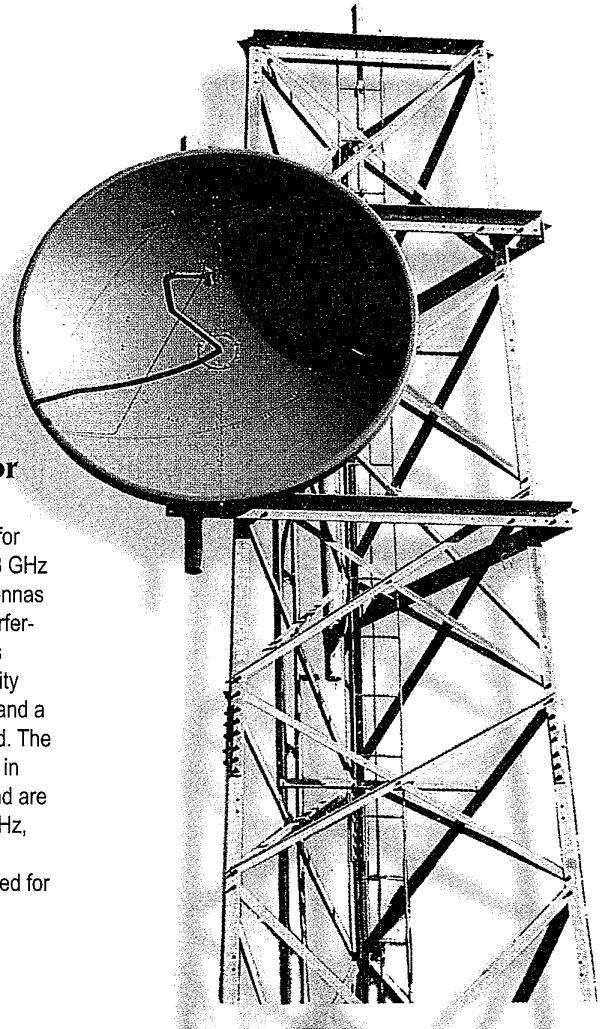

P-Series

Andrew GRIDPAK Antennas for STL Links

Andrew GRIDPAK antennas are available for applications from 300 MHz to 2.7 GHz. GRIDPAK antennas are available in field or factory assembled versions, and range in diameter from 4 ft. (1.2m) to 13 ft. (3.7m). They feature a patented grid rod retention design which eliminates the need for welding of the grid rods to the antenna's outer rim, and provides a more durable antenna than others offered in the marketplace.

List Prices Vary by Application

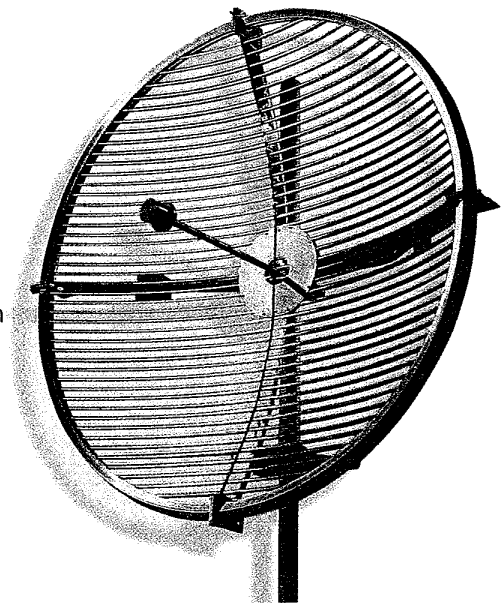

Comsat RSI Mark Antennas

Microwave Grid Parabolic antennas 335-2700 MHz

Mark Antennas Division offers a variety of sizes of Heli-Arc welded aluminum Multi-Element Grid parabolas for point-to-point relay operation in the 335 to 2700 megahertz frequency range. The grid construction is lightweight, yet extremely strong. One of the outstanding advantages of the grid antenna is that it has wind loading characteristics of only 25% to 40% of comparable size solid parabolas.

Heated grid parabolas come with completely installed de-icing equipment. The jacketed heater cable is securely mounted to the back side of each grid element and terminated in a weatherproof cast aluminum enclosure. The thermostat is preset to activate when the temperature drops to the ice forming range. De-icing power is applied only between 25 and 35 degrees fahrenheit.

The grid parabola is made of heavy walled, aluminum pipe Heli-Arc welded for superior strength and rigidity. Feeds are constructed of heavy brass components protected against oxidation. The radiator's active element is protected by a durable Teflon (335-960 MHz) or Plexiglass (1400-2700 MHz) feed housing which assures long life with trouble free operation, with up to 10 p.s.i. pressurization.

Mark's Standard, High and Maximum Performance Antennas are available from 450 MHz through 40 GHz. Mark also manufactures a full line of Wireless Communication Antennas for cellular, SMR, GSM, and SCADA applications.

- Meets or exceeds all existing FCC requirements.
- Lightweight, yet extremely strong. Electrical characteristics equal to comparable diameter solid parabolic reflectors.
- De-icing available on all models.
- Nesting design for shipping ease and economy.
- Survival: 125 MPH with 1/2" of Radial Ice.

List Prices Vary

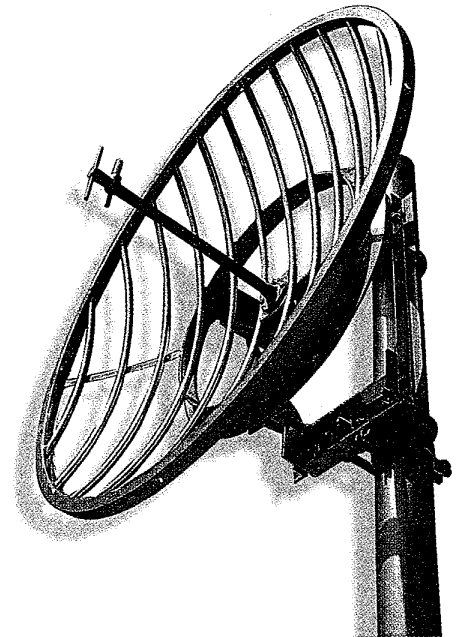

Antennas

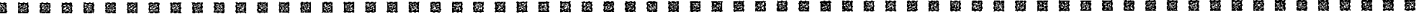

ERI

FMH and FML Circularly Polarized FM Antennas

The FMH and FML series antennas' original and distinctive design combine the exceptional engineering features of an internally fed, fully pressurized antenna with superior fabrication characterized by totally welded feed connections, machined brass fittings, and TIG welding. Input power ratings vary from 9kW to 120kW. This stalwart design has over 20 years of dependable service from the deserts of Saudi Arabia to the peaks of Alaska and is ideal when a rugged, maintenance free antenna is required.

List Prices Vary

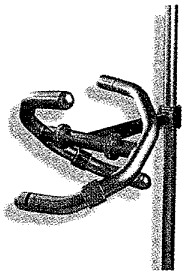

ERI

FMXH and FMXL Series Circularly Polarized FM Antennas

The FMXH and FMXL antenna are the latest development in the FMH and FML design. Expanded impedance bandwidth and an increased ability to uniformly control the radiated energy distribution when combined with the I (lambda) antenna mounting system are just two of its additional benefits while maintaining the dependability of the original design. Input power ratings of 9kW to 120kW are available depending upon array configuration.

List Prices Vary

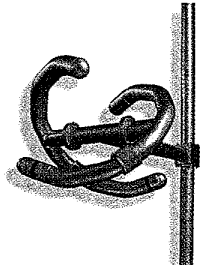

ERI

FMC Series Circularly Polarized FM Antennas

The FMC series is a durable antenna capable of input power ratings from 5kW to 63kW. The all brass and copper design also feature TIG weld construction and machined fittings. The large diameter radiating arms resist material fatigue and corona discharge. The reduced wind and weight loads make this antenna ideal for an economical installation.

List Prices Vary

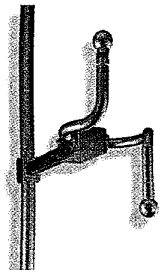

ERI

P-300 Series Vertical Polarized FM Antenna

This vertical only antenna retains the internal and fully pressurized feed design of the FMH and FMXH antennas and is the perfect choice when TV channel 6 protection is required. The large diameter radiating dipoles provide excellent impedance bandwidth which in turn provide improved resistance to VSWR changes due to inclement environment conditions.

List Prices Vary

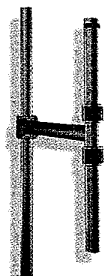

Antennas

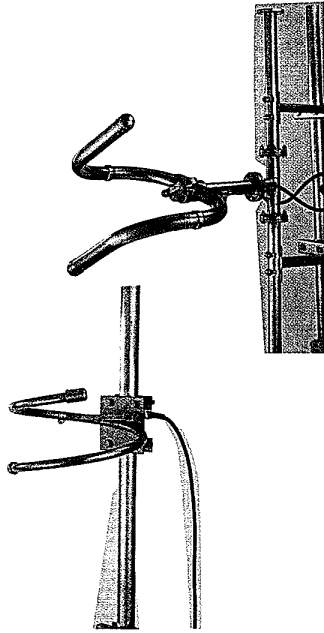

**Cablewave
FM Broadcast Antennas**

Cablewave systems offers a comprehensive line of omni-directional antenna systems and accessories for the FM Broadcast industry. CFM LP/HP circularly polarized antennas and HFM LP/HP horizontally polarized antennas are designed for commercial broadcast applications and have a power handling capability of 5 to 40 kilowatts depending on the specific antenna configuration. Pressurization is required. CP-1000 circularly polarized antenna and HP-1000 horizontally polarized antenna provide a low power alternative to the CFM and HFM antennas for applications up to 4 kilowatts where high power handling is not required.

List Prices Vary

**Cablewave
Educational FM Broadcast Antennas**

The ECFM-4 antenna is a 4-bay antenna designed especially for FM educational service. Capable of conservatively handling 500 watts per bay, this antenna is fabricated of 7/8 inch stainless steel tubing with a stainless steel coupling loop attached to the radiating element. Configuration of 1 1/2 helix provides excellent circular polarization coverage. Gamma strap design allows for easy field tuning. Input connector to the antenna feed harness is type N female, weatherproof throughout by marine shrink tubing makes the ECFM an excellent choice for high performance with effective cost. Available in 1 to 6 bays configuration.

List Prices Vary

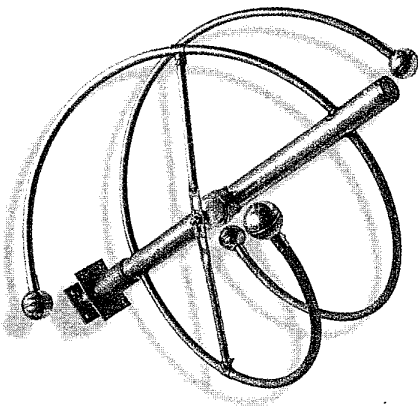

**Dielectric
DCR FM Antennas**

The DCR Ring Style FM antennas range from an input power rating of 500 watts through 18 kW per bay and can be arranged in stacks up to 16 sections in some models. Each model in the series is constructed of the highest quality heavy duty stainless steel for exceptional reliability and long life. Customized directional patterns and bay spacing are available. Options include deicers, radomes, beam tilt and null fill.

List Prices Vary

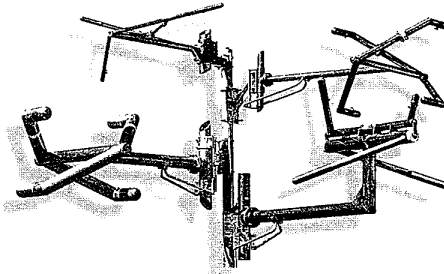

**JAMPRO
JAMPRO FM Sidemount
Designs**

JAMPRO manufactures a complete line of FM Antennas and associated RF products, including the original "Penetrator" series of FM sidemount antennas, the JBCP "Rototiller" design, and the revolutionary JBBP balun fed balanced sidemount. Available in a wide variety of power levels and configurations, a JAMPRO engineered and a well manufactured antenna is always choice for any FM project you may have. JAMPRO ANTENNAS, INC. puts over 35 years of manufacturing know-how into every antenna, combiner, filter and rigid line component they manufacture.

List Prices Vary

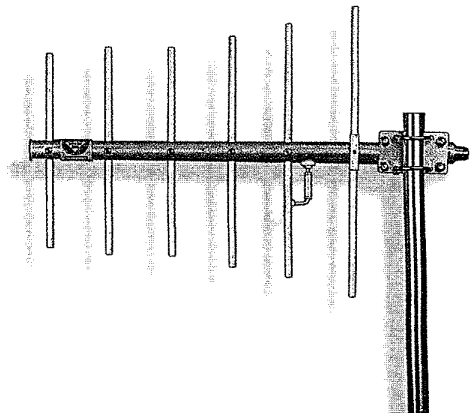

**Marti
YAGI Antennas**

The MARTI YC Series 6 element YAGI, 10db gain antennas are designed for use in a variety of situations, from permanent tower mount to portable applications, horizontally or vertically polarized. All functional components except the "N" female connector are hand-fitted and each antenna is tuned across a wide band of frequencies to assure proper performance in the field. Specify for RPU, TSL, or STL use.

List Prices Vary

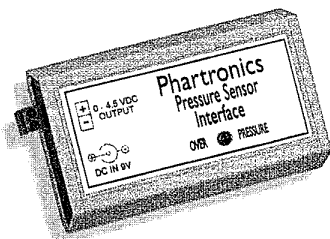

**Phartronics
PSI-V3 Pressure Sensor Interface**

The Phartronics Pressure Sensor Interface model PSI-V3 provides a precise sample voltage of 0-4.5 VDC that varies linearly with line pressure. The DC sample provided by the interface is compatible with any brand of remote control. Hook-up is easy - simply "T" into your existing pressure line to provide a line pressure sample to the interface and connect the output sample voltage to your remote control. With dial-up remote controls you can now be constantly informed anytime, anywhere.

\$215.00 List Price



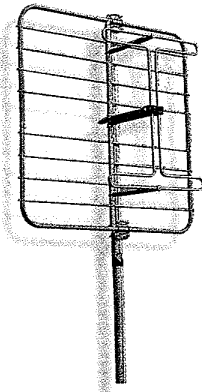

**Scala
DRV Broadband VHF Panel
Antenna**

The Scala DRV is a rugged broadband panel designed for low-power (500 watt RMS) VHF-TV. Its broad frequency range makes it ideal for multi-channel systems, thereby saving tower space and loading. The internal feed system minimizes exposure to mechanical and lightning damage. The reflector and feed system are DC grounded, fabricated of heavy-wall aluminum pipe and tubing, and anodized for corrosion resistance.

\$4,270.00 List Price

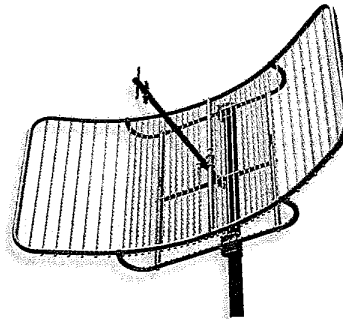

**Scala
PR-950 Paraflector Antenna**

For more than 35 years, the Scala Paraflector has been an industry standard for point-to-point STL and telemetry. Easier to assemble and install than a parabolic dish, the antenna's universal mounting system allows for either vertical or horizontal polarization. Paraflectors are manufactured for ruggedness and longevity, using laminated screen elements, 6061-T6 aluminum, and tenz alloy castings. All elements are at DC ground potential, including the feed element, which is sealed to prevent moisture accumulation. The Paraflector is available in a wide range of frequencies for other applications, including UHF-TV.

\$650.00 List Price



**Scala
SL-8 Paraslot UHF-TV
Transmit Antenna**

The Scala SL-8 Paraslot antenna is a high performance slot array offering excellent performance for UHF-TV omnidirectional coverage requirements. With its internal feed system and standard slot covers, the Paraslot's pattern and gain remain stable during periods of ice and snow buildup. The SL-8 is available in single and multi-channel models, with input power ratings up to 1,000 watts RMS. Null fill and additional beam tilt are among the available options.

\$4,100.00 List Price

Antennas

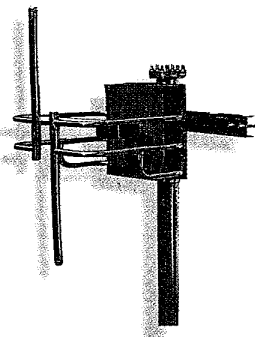

**Shively Labs
Model 6810
High Power Circularly Polarized FM Antenna**

The 6810 has a 10 kW per bay power rating to a maximum of 40 kW for an array. The broad bandwidth assures excellent stereo, SCA performance and is Digital Ready. The 6810 is uniquely capable of being accurately directionalized and can be used in formal directional antenna requirements. Shively Labs manufactures a full range of broadcast antennas for FM, UHF, & MMDS.

\$5,000.00 List Price

**Will Burt
Telescoping Pneumatic Masts**

Pneumatic telescoping masts are used on Electronic News Gathering (ENG) vans and Satellite News Vehicles (SNV) to support transmitting and receiving antennas at extended heights from 20 to 58 feet. ENG vans equipped with telescoping masts set-up for transmission of live remote broadcasts from locations miles away from the studio. On SNV trucks, masts allow the vehicle to be used for both network satellite transmission and separate terrestrial microwave link to the local station simultaneously or local ENG alone.

List Prices Vary

**Will Burt
Hurry-Up Mast**

The 25-foot Hurry-Up Telescoping Mast is designed for fast, easy deployment of lightweight antennas. This portable 20 lb. telescoping mast is ideal for elevating equipment such as small ENG microwave antennas and RPU antennas. (not pictured)

\$1,450.00 List Price

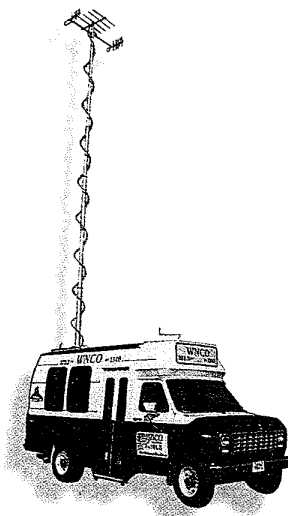



**ATI
DA1000 & DA2008**

A single, high output, active balanced driver per channel is resistively split into 4 or 8 outputs each, all driven at precisely the same level. Up to +24dBm balanced in and out. Features transparent performance, RF protected output, clipping LEDs and a headphone/metering jack in a half rack package that you can mount as a single or side-by-side in only 1-3/4". One RU of space.

Prices Start at \$355.00



**ATI
DA1008 & DA2016** (not pictured)

These high quality, top-of-the-line units will satisfy your most demanding applications. Each unit has a headphone monitoring jack, LED metering with switchable calibration and input overload indicators. Set your levels with individual output adjustments.

Prices Start at \$829.00

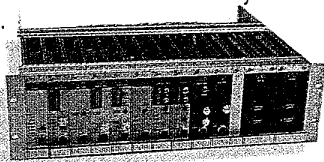

**ATI
System 10,000**

Mix interchangeable distribution, microphone or line amplifier modules into one rack frame. Each 5-1/4" rack holds up to ten amplifier modules and two redundant plug-in power supplies. Features: Headphone jacks on all modules allow a quick signal check. Backup, alarmed, load sharing power supply modules with separate fusing and regulation in each amplifier module minimize localized heat buildup and yield the highest system reliability. Barrier blocks with pre-wirable fanning strips or punch block type rear connectors make installation a snap!



**audio-metrics
DA-16000 MultiAmp**

Until now, you had to pay a premium price for an audio distribution amplifier with specifications like this. Now, Harris brings you the audio-metrics DA-16000 Multi-Amp, the last distribution amplifier you'll ever have to buy. That's because the DA-16000 is configurable as a quad, a stereo, or a 16 output mono DA. Its variable input gain and individually adjustable output attenuators provide a full 48dB range of amplification.

\$499.00 List Price

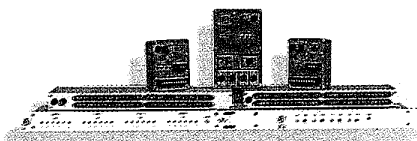

**ESE
Audio DA Family**

ESE has a wide variety of audio distribution amplifiers. The ES-218 (1x4), ES-217 (1x4 with separate output controls), ES-246 (Quad 1x6) and the ES-245 (Quad 1x6 with separate output controls) are audio distribution amplifiers which accept a balanced or unbalanced audio signal and produce copies of that signal. All inputs and outputs are accessible on terminal blocks, or "XLR" connectors can be specified as an option on some models.

Prices Start at \$142.00



**ATI
DA206 & DA412**

These units offer six or twelve balanced outputs divided among two or four independent, 1-in to 3-out channels. Internal jumper plugs parallel inputs for 1X6, 2X6 or 1X12 operation. These DAs have master input gain controls plus programmable gain for various nominal inputs; individual output taper gain controls are adjustable from +8 to -10dBm.

Prices Start at \$479.00



**ATI
PB2X8**

Eliminate the usual press conference microphone clutter with just a single or back-up pair of microphones. Feed each of eight transformer isolated channels from either input or both MIC/Line inputs mixed. Drive a high level XLR and a medium or low level TRS line simultaneously from each output. Use as a 2X8 DA, stereo 1X4 DA or two input mixer. Studio grade performance, field proven ruggedness.

\$1,399.00 List Price

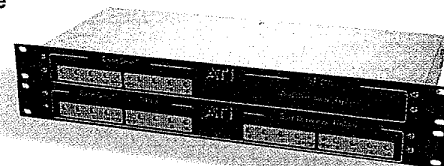

**ATI
DA208 & DA416**

To solve your specific distribution needs, these units offer eight or sixteen balanced outputs divided among two or four independent, 1-in to 4-out channels. Parallel inputs on rear connectors allow 1X8, 2X8 or 1X16 operation. Set your individual levels with the audio taper output controls adjustable from +8 to -10dBm. LED indicators warn of overdriven shorted output. Transparent performance and RF protected. Max gain is 20dB.

Prices Start at \$379.00



**Conex
AS-101**

The AS-101 is a high-performance 10 stereo in - 1 stereo out audio switcher. Features include: front panel accessible input and output level controls, plug-in screw-clamp terminals for easy connection, transformerless balanced inputs and outputs, plug-in IC's, low noise, low distortion circuitry. Options available: the AS-401 remote control, AS-201 Serial interface, AS-501 relay board and AS-88 battery backup module.

\$962.12 List Price

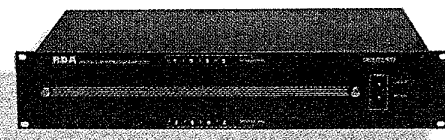

**Gentner
Routing DA**

Gentner's RDA takes conventional distribution amps to the next level. It provides 8 actively balanced inputs and 28 actively balanced outputs; any of the inputs can be selected to any of the outputs, in any combination. Use it to create custom mixes, mix-minus feeds, or send inputs to exactly the right number of destinations. Input destinations can be reconfigured from the front panel...no need to pull the unit from the rack.

\$1,629.00 List Price



**Logitek
Pre-6 Audio
Switcher**

The Pre-6S is a stereo 6x1 switcher. Passive circuitry allows the Pre-6 to be used as a 1x6 distribution switch as well. With its compact size, enclosed terminal block and built in label strip, the Pre-6 is perfect for expanding a console input, replacing a small patch panel or anywhere reliable switching is required.

\$110.00 List Price

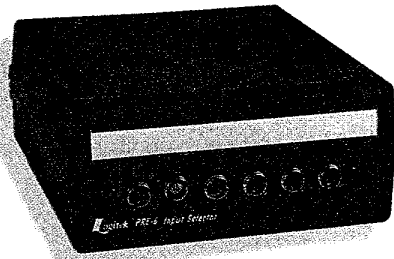

**Logitek
Mon-10 Audio Meter/Monitor**

The Mon-10 multi-source meter/monitor feeds any one of ten stereo inputs to a single stereo output. The selected source also feeds a multi-range VU meter with peak flasher, a 6-watt speaker and a front panel stereo headphone jack. The meter can display left input, right input, left+right or left-right.

\$855.00 List Price

Sierra Automated Systems

SAS 16000

The SAS 16000 Audio Routing Switcher brings SAS quality and reliability to the broadcast plant which requires up to a 32 X 32 matrix, all at a very attractive price. The micro-processor based SAS 16000 is available in 32 X 16 and 32 X 32 configurations. The unit is housed in a two rack unit chassis and provides alphanumeric controls on the front panel. The system comes complete with stereo partitioning PC software which allows any pair of sources and/or destinations to be programmed for stereo operation.

Prices on Application

Sierra Automated Systems

SAS 64000

A high performance, high density microprocessor based audio switching system, the SAS 64000 utilizes the latest in LSI technology to provide uncompromising performance and extremely high density; 256 X 256 in one equipment frame! One fourteen rack unit frame houses all input modules, output modules and plug-in redundant power supplies for a complete system.

\$11,485.00 List Price

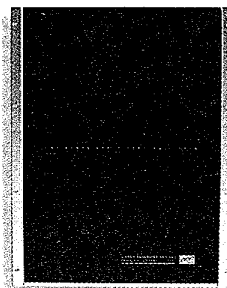

Sierra Automated Systems

DAS 9600

The DAS 9600 Digitally Controlled Audio System frame houses 12 universal module slots, a frame controller and two redundant plug-in power supplies. With 12 DCA-8 modules the DAS 9600 provides 96 independent digitally controlled amplifiers. The frame controller module provides serial communication ports, both RS-232 and RS-422, for external control or interface.

\$7,700.00 List Price

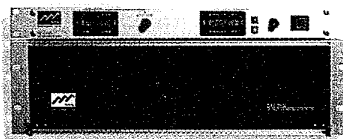

**Logitek
Pre-10 Audio Switcher**

The Pre-10 is a 10x2 switcher available in mono or stereo versions. Passive circuitry allows the Pre-10 to be used as a 2x10 distribution switcher as well. Installation is simple and label strips are provided for easy identification of sources.

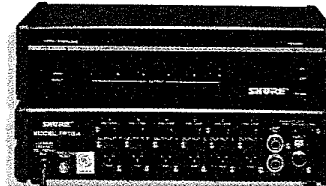

Front

Rear

**Shure
FP-16A Audio Distribution Amplifier**

A 1-input, 6-output portable audio distribution amplifier for routing multiple audio feeds. Ideal as a portable press bridge. Includes: XLR transformer-balanced input and outputs (each switchable for microphone or line level operation), phantom power, link jacks for connecting additional FP16A units or outboard devices, screwdriver-adjustable gain controls. Rack-mountable with A16R. Battery (three standard 9-volt alkaline) or 12/240 Vac power.

\$645.00 List Price

Sierra Automated Systems

SAS 32000

The SAS 32000 Audio routing & Mixing Switcher is a high performance microprocessor based audio switching and summing system. The advanced multi-processor architecture and comprehensive range of control options enhance reliability and flexibility for specialized and critical applications. The SAS 32000 is superb for central plant/remote routing, transmitter/studio routing, monitor switching and even mix-minus mixing.

Prices on Application

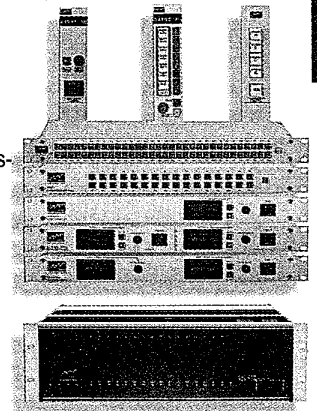

Sierra Automated Systems

MMS 32000

The MMS Mix-Minus/Surround mixing System is effective wherever many mixes are required, such as mix-minus feeds for remote communications, multi-channel sound for TV and even film stage monitor mixing! Only 2RU for control panels provides the operator with controls for setting the channel combination to each destination and for storing and retrieving 32 complete "matrix snapshots."

Prices on Application

**Wohler
Audio Routing Switchers / Source Selectors**

Inexpensive, great quality CMOS switchers to meet all applications and budgets. Over 25 configurations from 5 mono inputs to 20 stereo inputs plus very useful configurations for multiple VTR use: select one of five four-channel groups, or select one of five eight-channel groups. 5 x 4 matrix available. All Wohler routers are single rackspace.

Prices Starting at \$700.00



Audio Distribution



SAS ROUTERS

PUTTING AUDIO IN ITS PLACE

S A S
6 4 0 0 0



SAS 16000 SERIES — Configures in mono and stereo to 32x32.
Compact unit with built-in control and monitoring.

S I E R R A
S Y S T E M S
SAS 64000 SERIES ▶
Configures in mono and stereo to 256x256.

SAS 32000
STEREO 256x256 EXPANDABLE

SAS 32000 SERIES
32x16 expandable to 128x128 with full summing.

SIERRA AUTOMATED SYSTEMS
BROADCAST & COMMUNICATIONS



Sierra Automated Systems & Engineering Corporation

2112 North Glenoaks Blvd. Burbank, CA 91504 818.840.6749 Fax 818.840.6751





**Air Corp.
500PH & 500TV**

AirCorp microphone processors work hard in Radio and TV. Predictable levels of loudness are maintained with a unique compressor/expander combination. Room and equipment noises go away. Its 3-band equalization tunes out off-mic problems. AirCorp 500 PH for radio...AirCorp 500TV for video applications.
\$799.00 List Price For 500PH
\$889.00 List Price for 500TV



**Aphex
320A**

The 320A Compellor features dual monaural circuitry providing two independent channels. Use as dual or mono stereo. The 320A uses patented control circuitry as well as reference level switching from the rear panel; leveling speed switchable from the front panel; peak limiter defeatable from the front panel; two remote controllable bypass relays. To find out how the Compellor 320A can be called the "automatic fader" in a box..call us today.
\$1,350.00 List Price



**Alesis
MidiVerb 4**

The MidiVerb 4 offers 18 bit A/D and D/A converters and 20 bit internal processing for a 20Hz-20kHz bandwidth and 90dB dynamic range, making it ideal for digital recording. Plus, its valuable Auto Level Sensing feature can instantly set the optimum input levels for you, saving time and frustration. MidiVerb 4's thirty-two effects algorithms give you a complete arsenal of fully programmable effects, many using true stereo parallel processing. You can take advantage of the 128 Preset or 128 User Programs (256 total), or create your own custom programs from scratch. With its large custom backlit LCD and online help, programming your own effects is a snap. And, with its MIDI controller routing and programmable footswitch, you'll have complete creative control over every aspect of your sound.
\$399.00 List Price



**Aphex
720 Dominator™**

Aphex Dominator™ II precision multiband stereo peak limiter models 720 and 722 were designed to fit a wide range of audio applications. Through the use of multiband techniques along with new proprietary circuits, the audibility of limiting action has been greatly reduced, especially when compared to conventional limiters. Greater limiting depth is possible, resulting in higher loudness with maintained audio quality. At virtually any limiting depth, the Dominator II is free of "hole punching", "dullness", and most other effects normally associated with limiters. As a peak overshoot protection limiter, the Dominator II is undetectable in line while it absolutely prevents levels from exceeding a user settable output level. Model 722 offers pre/de-emphasis.
\$1,350.00 List Price for 720
\$1,495.00 List Price for 722

**Alesis
Q2**



This is Alesis' most powerful effects processor. The Q2's most impressive feature is the excellent sonic quality of its algorithms. Each of the more than fifty effect types were crafted with extreme attention to detail, making all of Q2's effects perfect for professional use. These algorithms are the building blocks of Q2's 100 preset and 200 user programs (300 total). To interface with a wide variety of gear, the Q2 accepts both balanced +4 dBu and unbalanced -10 dBV audio signals. Q2 offers the ADAT Optical Digital I/O to interface with every ADAT-format recorder and compatible products from dozens of manufacturers.
\$799.00 List Price



**Aphex
250 Aural Exciter**

The remarkable Aphex III studio aural exciter is a unique proprietary audio processing device that makes use of highly advanced psycho-acoustic principles to effectively restore and enhance audio presence, brightness and intelligibility.
\$995.00 List Price



**Aphex
106**

The Easyrider is a four channel compressor which incorporates the ideals of Aphex design. A pristine audio path controlled by intelligent detector circuits. The heart of the audio path is the exclusive Aphex Voltage Controlled Attenuator, VCA 1001. It outperforms all other VCAs and is one of the reasons that Aphex products sound better than other dynamic processors. The detector circuits of the Easyrider monitor the peak-to-average ratio of the input and adjust layered attack and release times automatically. The Easyrider is incredibly easy to use, simple and quick to set up, and sounds great for individual voices, instruments and sub-mixes as well as full program. Its slower time constants allow for openness at the same time the faster time constants control peaks.
\$449.00 List Price

**Aphex
400 Digidocoder™**



The Aphex Digidocoder™ stereo generator provides unequalled sonic transparency of Class A analog with the separation and stability of digital and sustains maximum loudness. Plus it interfaces to your existing equipment with no A to D converter. The Digidocoder is easy to use and requires no maintenance.
\$3,995.00 List Price

Audio Processing





Aphex System
104 Aural Exciter Type C2

The Aphex Aural Exciter Type C2 Model 104 offers improved circuitry making it quieter, more musical and easier to set up and use. It also features Big Bottom, a new circuit which increases the "perception" of low frequencies without substantially increasing the peak output level. The harmonic controls feature tune; mix; overhang, and girth.

\$349.00 List Price

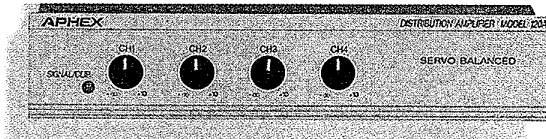

Aphex System
120A Distribution Amp

The model 120A is a high performance audio distribution amplifier with a single high impedance input and four low impedance outputs, all electronically servo-balanced. Each output has its own amplifier and level control for maximum versatility and isolation. The sturdy steel chassis may be rackmounted with optional rack mount.

\$319.00 List Price



Aphex System
124A IHF/PRO Matcher

The Aphex Audio Level Interface is designed to allow use of -10dBV consumer hi-fi equipment with +4 or +8 dBm professional and industrial audio systems. The 124A provides an extremely clean, reliable two-way buffer so both systems can operate at maximum performance levels, matching impedances and operating levels. Features also include digital ready, transformerless outputs, servo balanced inputs and outputs, recessed controls, and pushbutton 600 ohm input termination.

\$229.00 List Price



Circuit Research Labs
DP-100 Digital FM-Processor

The DP-100 is something special. Easy to operate with touch screen control and "picture based" menus. Stunningly clear audio made possible by a powerful digital FM audio processor ever. A 32-bit, floating point Digital Signal Processing (DSP) array handles all functions in the digital domain from AES/EBU input to the composite stereo generator. Incredibly versatile with a full complement of analog, digital, and composite inputs and outputs, you'll find the DP-100 a "sound" investment in building larger listening audiences.

\$11,000.00 List Price

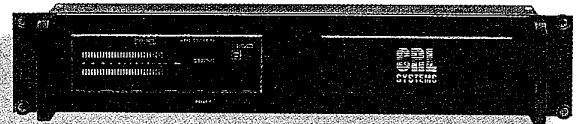

Circuit Research Labs
TVS-3001 Gain Controller for Television

The TVS-3001 Tri-band Audio Gain Controller is a feature packed MTS Stereo processing system. Audio inputs feature automatic stereo phase reversal correction to protect your viewers with mono receivers and High-Q notch filtering for sync suppression. Precision matched filters remove audio asymmetry to provide excellent voice peak control despite differences in voice and microphone characteristics. Improved CBS loudness controller and 30 dB+ tri-band linearized AGC provide seamless sound control over both dialog and music programming.

\$4,895.00 List Price



Circuit Research Labs
FM Amigo FM Stereo Processing System

The Amigo is a new concept in FM audio processing systems, a single rack high unit complete audio processing system — flexible, powerful and easy to set up. The Amigo contains a dual band AGC, variable pre-emphasis multi-band limiter, adjustable bass frequency boost, stereo image enhancement and a digitally synthesized stereo generator with more than 50 dB of separation. The Amigo gives you precise control over audio levels and peak modulation with outstanding stereo sound clarity.

\$3,195.00 List Price



Circuit Research
AM Amigo Processing System

The Amigo AM is a complete audio processing system for C-QUAM/AM stereo. CRL has built the best technology into a high performance unit designed to be economical, powerful, and simple to use. Installing this AM stereo audio processing system is a breeze with the quick adjusting input level meter. Outstanding Amigo AM features include a dual band AGC, patented 3-band stereo matrix limiter, single channel limiting, NRSC output filtering, stereo enhancement and full processing controls.

\$3,195.00 List Price

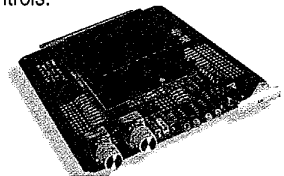

Cobalt Blue
Neural Network

Cobalt Blue is the genesis of Neural Networks for broadcast. Neural Networks are the next step beyond digital. They are a new technology emerging from university laboratories across the country. Now, Neural Networks power the most advanced, on-air audio processor you can buy. For under a thousand dollars, you can plug this new technology into your existing Optimod 8100*.

\$975.00 List Price

*Optimod is a trademark of Orban, San Leandro, CA.

Audio Processing



Discover how good your station can sound!

Audio Processing from CRL Systems

DP-100 Digital Processor



The Next Generation FM digital processor with natural sound, superior loudness & outstanding audio quality.

No matter the size of your station or the size of your budget CRL has a quality system to fit your needs. Experience CRL's audio products for Radio and Television.

Try CRL. We will help you get the most from your audio processing investment!

FM Radio

- DP-100 Digital Processor
- SC-100 Digital RDS/RBDS Generator
- Amigo FM Processor
- FM-2G+ Modular System

AM Radio

- AM Stereo Amigo
- AM-4M Mono Modular System
- MBL-100 News/Talk/Sports

Television

- TVS-3003 Limiter & MTS Generator
- TVS-3001 Audio Controller
- TVS-3005 SAP Generator
- BAP-2000 Mono Processor



Circuit Research Labs, Inc.

Audio processing for every market & every budget!



**Circuit Research Labs
TVS-3003 Generator Limiter for
Television**

The TVS-3003 Tri-band Audio Gain Controller is a feature packed MTS stereo processing system. Audio inputs feature automatic stereo phase reversal correction to protect your viewers with mono receivers and High-Q notch filtering for sync suppression. Precision matched filters remove audio asymmetry to provide excellent voice peak control, despite differences in voice and microphone characteristic. Improved CBS loudness controller and 30 dB+ tri-band linearized AGC provide seamless sound control over both dialog and music programming
\$8,795.00 List Price



**Circuit Research Labs
BAP-2000 & TVS-3005 for Television**

BAP-2000 and TVS-3005 from CRL are a great team for your Second Audio Program. The BAP-2000 provides consistent audio levels with a dual-band AGC, auto-locking gain reduction, Dynafex® single-ended noise reduction, Fh/2Fh notch filtering and a variable transfer function pre-emphasis limiter. The TVS-3005 has excellent modulation linearity with an ultra-linear, phase-locked VCO and a wide bandwidth current-to-frequency converter. A genuine dbx® encoder accurately matches SAP decoders. Sub-carrier muting is automatic or by remote control.
Prices vary

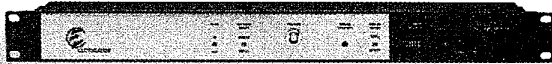

**Cutting Edge
Dividend**

The Dividend reduces noise in the upper composite spectrum (53kHz to 99kHz) that is often generated by audio processing and microwave STLs. With the Dividend, stations can achieve a noise floor of greater than -60dB, providing a clean SCA environment for the demanding subcarriers. The Dividend is a boon to stations that want to regain lost modulation or reduce multipath-related distortion. Squeeze every last bit of quality out of your signal with the Dividend.
\$1,195.00 List Price

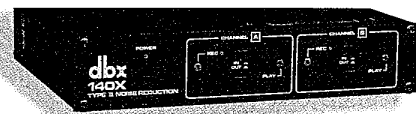

**dbx
140X**

The 140X provides two channels each of encode and decode Type II noise reduction in a single package, with front panel bypass switches for each circuit. The 140X doubles the dynamic range to a maximum of 115dB for typical limited bandwidth media such as cart machines, telephone/PTT lines, videotape audio tracks, and low bandwidth digital systems. Type II's detector pre-emphasis is greater than in Type I, which causes additional gain reduction at high frequencies. This helps to overcome the limitations generally imposed by the lack of high frequency headroom in broadcast audio equipment.
\$319.95 List Price



**dbx
160A Compressor/Limiter**

In the world of compressor/limiters, the 160A is known as the standard - and with good reason. It delivers outstanding performance and easy-to-use operational flexibility in a slimline rack-mount package. Its metering system provides an instantaneous picture of the gain reduction of the compressed signal compared with either the input or the output level. The 160A is a textbook lesson in compression.
\$459.95 List Price



**dbx
166A Compressor/Limiter**

The concept is total dynamics control - every needed processing function, every point in the signal path, from input to output. The combination of noise gate, OverEasy compressor, and PeakStop limiting provides for complete manipulation of the dynamics of the input. For recording, performing, broadcasting, producing, and other sound installations, the 166A gives you what you need.
\$419.95 List Prices

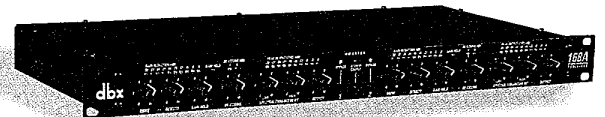

**dbx
168A Processor**

Getting the highest level audio processing used to mean buying dedicated hardware for each application. Not today. The all new dbx 168A puts three studio-quality dynamics processors at your fingertips in a convenient, single-space rack-mount package. With its all-in-one design, intuitive operation, and automatic adjustment to source material, you can count on the 168A to provide the fastest, most effective solutions to your dynamics processing needs. Equally at home in recording and broadcast studios, motion picture and video post-production suites, and sound reinforcement systems, the 168A delivers unsurpassed dynamics processing when you need it most: today, tomorrow, and - given dbx's proven reliability - for years to come.
\$999.95 List Price



**dbx
1066**

After producing among the world's most renowned series of compressors, the task of producing a new compressor worthy of the dbx reputation would be daunting for most engineers. Not for dbx. Their engineers know audio. Now the fruits of their talents are available to you in the form of the 1066 Stereo Compressor/Limiter/Gate.
\$549.00 List Price

Audio Processing



**dbx
1046 Compressor**

In today's recording and sound reinforcement environments, the need for multiple channels of high quality, easy-to-use, compression is growing rapidly. The new dbx 1046 is designed to provide the audio professional with just that: 4 channels of great sounding dbx compression for a variety of applications. Incorporating the industry standard dbx designs and the latest available manufacturing techniques, the dbx 1046 provides pristine sonic quality with that classic dbx sound.
\$649.00 List Price



**dbx
3031 Graphic Equalizer**

The dbx 3031 Graphic Equalizer is a high performance multifunctional unit designed to deliver all the flexibility and power that professional users demand. The 3031 offers 31 ISO standard center, 1/3 octave, constant-Q frequency bands in a single package. Selectable 6 or 12 dB of boost/cut gives the user superior signal processing control, while the use of low tolerance components yields accurate frequency centers.
\$749.00 List Price



**dbx
3215 Dual Graphic Equalizer**

The dbx 3215 Graphic Equalizer is a high performance multifunctional unit designed to deliver all the flexibility and power that professional users demand. The 3215 offers 2-channels of 15 ISO standard center, 2/3 octave constant Q frequency bands in a single package. Selectable 6 or 12 dB of boost/cut gives the user superior signal processing control, while the use of low tolerance components yields accurate frequency centers. Features variable high pass and switchable low pass filters. XLR, barrier strip, and 1/4 inch tip-ring-sleeve connectors make the unit easy to integrate into any type of balanced or unbalanced audio system.
\$749.00 List Price

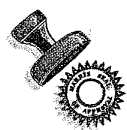
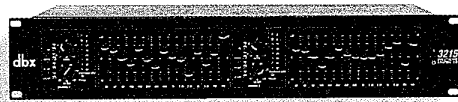

**Eventide
DSP4000B**

Eventide's premier stereo signal processor features unique and ingenious effects created by sound designer Jay Rose of DSE fame. Hundreds of sound environments, effects and voices — from the "announcer from hell" to a fast-food drive-in window are instantly ready for air or production use. Lush reverbs, superb pitch change, Timesqueeze, time compression and expansion and much more are standard. Create your own effects, too. Digital I/O optionally available. Make your station stand out with the DSP4000B.
\$3,995.00 List Price

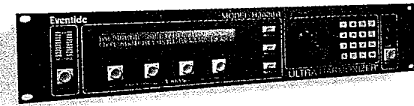

**Eventide
H3000B+**

Radio's workhorse stereo signal processor gives station promos, commercials, and on-air personalities hundreds of terrific voice and effects at the touch of a button. Dense reverbs, pitch change programs, Timesqueeze, time compression/expansion and more are also included.
\$2,995.00 List Price

**Furman Sound
Q-Series Graphic Equalizers**

The Q-Series includes six models. The Q-151 and the Q-301, dual 15 band and single 30 band models, use 20 mm sliders and are housed in single rack space chassis. The Q-602 is a dual 30 band model using 20 mm sliders in a double rack space chassis. The Q-152 and Q-302 use 60 mm sliders, suitable for the most critical applications, in double rack space chassis. All these models feature constant-Q equalization for the truest graphic representation of the actual response curves, fail-safe "straight wire" bypass switches, and are available with or without XLR balanced inputs and outputs. The sixth model, the Q-541, offers four channels of 5 band stereo equalization.
List Prices Vary

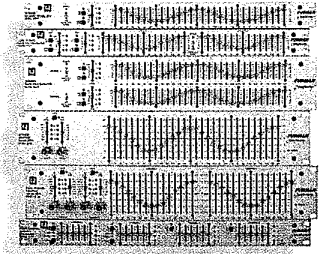

**Hnat Hides
Ultramod 2000 FM Processor**

The Ultramod UM 2000 is a self-contained FM processing system incorporating a split vband stereo audio processor with an ultra transparent built-in digital stereo generator. Two composite outputs are provided along with a separate pilot output to facilitate interfacing with the Hnat Hides, Inc. CP-2013 composite processor. The Ultramod is a timely product for today's cost conscious broadcaster who demands the best possible on-air sound and the latest innovative circuitry.
\$2,995.00 List Price



**Hnat Hides
Ultramod 2001**

The DSG-2001 Ultramod Digital Stereo Generator is designed to meet the changing needs of today's broadcasters by providing a cost effective alternative without sacrificing performance or reliability. The generator portion consists of large scale integrated circuitry configured in a format to implement four-bit digital control of both pilot phase and 38kHz derived sampling of left and right audio.
\$1,295.00 List Price

Audio Processing



Audio Processing



**Hnat Hindes
CP2013 Composite Baseband Processor**

The CP-2013 represents the latest in composite baseband processing. Unlike the brutality of composite clippers, the CP-2013 literally integrates the L+R amplitude into the L-R resulting in extremely high levels of discrete left and right outputs in the receiver demod process. As a rule, previous composite processors were comprised of clippers only, which generate substantial baseband clutter. This harmonic clutter takes on a mono image due to the fact that it is generated in the composite domain and cannot be assigned.

\$1,150.00 List Price



**Hnat Hindes
TXL210 Transmission Limiter**

Due to the makeup of digital program material, rich in transients, and wide in bandwidth, a modern processor must be able to control this pure resource without adding artifacts or producing a sound unlike the original source. These artifacts manifest themselves in the form of pumping, fluttering, spitting, and modulation of background noise. These annoyances are what cost you rating points. The TXL-210 is designed to control any kind of energy, including complex wave forms encountered in digital and synthesized audio, and when installed in front of your processing chain will ensure that all subsequent processing will function within a safe dynamic environment without going into overload.

\$1,295.00 List Price



**Hnat Hindes
Mic-Maze Mic Processor**

The Mic-Maze mic processor is specifically designed for today's high quality microphones, providing a means to an exceptional warmth and presence without destroying transient response. Until now, microphone processors were subject to gasping and severe pumping as a result of high energy transients produced by consonant and syllabic sounds in speech. The Mic-Maze is the only microphone processor available today that will literally process intact, a 10kHz square waveburst.

\$695.00 List Price



**Hnat Hindes
Tri-Maze Mono/Stereo Processor**

The Tri-Maze is designed to interface directly to the multiplex input on all stereo generators as opposed to correcting symptomatic problems associated with other processors by operating in a pre-process capacity. The front end of the Tri-Maze is a broadband AGC amplifier of exceptional transparency capable of high levels of gain reduction with very low distortion. The input section utilizes Triggered Absolute Level Expansion which automatically determines the mode of expansion for both voice and music.

\$1,650.00 List Price



**Focusrite
Green Range**

The Green Range has been designed to offer the professional recording musician the best in control and creativity, at a price you'd associate with processors that merely do the job. Thanks to affordable digital tape and disk recorders, the recording fidelity available in even a relatively modest personal facility can equal that of major studios. Now the essential link for direct recording has arrived, with the Focusrite Green Range of input processors.

\$1,349.00 List Price



**Lexicon
Reflex Reverb**

Dynamic MIDI® Reverberator with automatable effects. New Algorithms. Features: 16 phenomenal presets, 128 user registers (pre-programmed for 96 total effect programs), input, mix and output controls, easy front panel editing, advanced programming mode, edit/compare for referencing a preset and your modifications, MIDI bulk data dumps, MIDI auto tempo for synchronizing delays to MIDI clock, reverb with randomizer and early reflections. It offers up to 10 adjustable parameters using MIDI SysEx or Lexicon MRC remote. Remote control (MRC) is optional.

\$499.00 List Price



**Lexicon
Alex Processor**

Alex is a rack-mount processor with sixteen studio-quality Lexicon digital effects. It features: Sixteen user registers, more than four thousand effects combinations, three adjustable parameters - delay, decay and FX level, bypass & custom user-register chains controlled by footswitch, stereo outputs, edit/compare for referencing a preset and your modifications, concert halls, multi-tap delay, plates, rooms, gated & inverse rooms, flanging, chorus. No MIDI required.

\$399.00 List Price



**Lexicon
MXP-1 Multi-Effects Processor**

MXP-1 is Lexicon's top product for the Performance Series. It offers multi-effects processing without compromising sound quality. The features include balanced analog I/O, digital inputs and outputs, 18 bit A/D, 20 Bit D/A conversion, 250 programs (200 presets and 50 user registers), up to 5 simultaneous stereo effects with uncompromised stereo reverb, 6 effects blocks, and much more.

\$1,299.00 List Price





**Logitek
Bright VU Audio Meter**

The Bright-VU meter uses a 20 LED bargraph to cover a 53 dB dynamic range. VU and true peak measurements are displayed simultaneously using IEC standard ballistics. The 1 RU enclosure holds up to six meters with an internal power supply. Both analog and digital inputs are available. The optional alarm output can sense both over-and-under-level conditions and is user adjustable.
\$795.00 List Price



**Logitek
4VUB Mechanical VU Meter**

The Logitek 4VUB supplies four large, accurate, mechanical, mechanical VU response meters in a 2 RU self powered box. Each meter has a balanced, bridging, high impedance input and a rear panel zero adjustment control. A phase button for each pair of meters places left plus right on the left meter and left minus right on the right meter.
\$790.00 List Price



**Logitek
Ultra-VU Audio Meter**

The Ultra-VU uses tri-color LEDs which allows VU to always be green while peak is always red. The switchable peak hold dot is also red. The 62 segment bargraph covers a 70 dB dynamic range plus clipping. Other modes include a phase display, a .2 dB/LED fine mode and a loudness monitor. The 1RU enclosure can hold 2 or 4 meters with an internal supply. Options include analog, digital or combination inputs and alarm outputs.
\$2,300.00 List Price



**Modulation Sciences
CLD 2504 Composite Line Driver**

CLD Series Wired STLS, Composite Line Drivers, Receivers and Distribution Amplifiers distribute stereo composite baseband as easily as audio or video. Model CLD-2500 transmits composite baseband up to 2,500 feet over Belden 9463 cable. Model CLD-2504 allows connection of multiple transmitters and alternate stereo generator/processor setups without interaction.
\$950.00 List Price CLD-2504
\$1860.00 List Price CLD-2500



**Modulation Sciences
CP-803 Composite Processor**

Keeps your FM station loud, clean and legal. Upgrades your existing audio procession chain. Eliminates peaks of over-modulation. Limits composite signal without affecting stereo pilot.
\$1,495.00 List Price



**Modulation Sciences
MYB-2 FM Audio Enhancer**

Makes your sound bigger, not just louder. Installs in audio chain, works with all loudness processors to provide that extra dimension to make your sound distinctively larger. Smart circuitry does not over-enhance, does not affect mono sources, such as DJ mic.
\$2,889.00 List Price



**NTI
EQ3D Sound Enhancement**

The EQ3D is the next generation equalizer from NTI. It features the adjustable AirBand™ shelf--Vari-Air™. This capability allows the selection of the beginning elbow frequency on the AirBand™ shelf, making it possible to move above the noise floor or sibilance and still add that "airy" presence so sought after. The EQ3D is not a parametric or surgical EQ, but rather it is a dimensional equalizer. The net effect is a broadened dimensional image that is fuller than ever before possible.
\$995.00 List Price



**NTI
PreQ3 Mic Preamp**

NTI PreQ3 is the only full-featured microphone preamp with NTI's Variable AirBand™ equalizer, useable also on line inputs. The adjustable, high-frequency shelf equalizer can move above the microphone hiss and bring out the high-end before any distortion is introduced by any active circuits. The PreQ3, with switching power supply balanced transformer-coupled inputs and actively balanced outputs, provides four channels in a single rack space, also available as a two channel upgradable unit.
\$2,595.00 List Price

Audio Processing



Audio Processing

Orban Optimod-FM 8200A/U2S

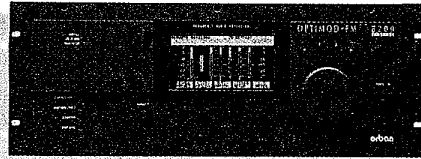

The 8200 employs proprietary, all-digital processing structures that attain the highest possible average and peak modulation levels with the least amount of audible compression and transparent peak limiting. The built-in, Digital Hadamard Transform Baseband Encoder™ produces a tightly controlled spectrum with outstanding stereo separation, extremely low distortion, and indiscernible noise. The standard 8200 has analog inputs and outputs, and is fully compatible with all commonly found transmitters and studio-transmitter links. Orban also offers two digital I/O options for integrating the 8200 into all-digital systems. The 8200D/32 accepts 32kHz AES/EBU input and produces a pre-emphasized 32 kHz AES/EBU output. The 8200D/SRC with sample rate conversion accepts and produces AES/EBU-standard signals at sampling rates of 32, 44.1, or 48 kHz; the output can be at a different sampling rate than the input, and can be flat or pre-emphasized.

\$7,400.00 List Price for 8200A/U2S

Orban Digital FM Stereo



The 8208 stand-alone stereo encoder (generator) is fully compatible with any analog or digital studio-to-transmitter link. All encoding is executed in DSP for superior performance and long-term stability. The 8208 accepts either analog or AES/EBU digital input signals; the digital input is automatically synchronized and de-jittered at any sampling rate. To accommodate different transmission schemes, the 8208 also responds to status bits in the AES/EBU signal for automatic switching of pre-emphasis and/or J.17 (NICAM) de-emphasis.

\$1,975.00 List Price

Orban Optimod-FM 2200



Designed specifically for stations on a tight budget, the OPTIMOD-FM 2200 is based on the pioneering technology of the OPTIMOD-FM 8200. The 2200's protection mode provides transparent limiting, effectively controlling peak modulation with no audible change in the sound. Digital stereo generation produces an exceptionally stable composite output that needs no periodic adjustment. OPTIMOD-FM 2200 also features remote control, alignment tone generator, and multifunction LED indicators for set-up and monitoring. The standard 2200 version has analog inputs and outputs; the 2200-D version has AES/EBU input and output signals.

\$3,850.00 List Price for 2200

\$4,450.00 List Price for 2200D



Orban Optimod-FM 8100A1-U75

The 8100A combines level control, peak control and stereo generation functions into an integrated audio processing system for FM broadcast. The 8100A1 can be adjusted to provide automatic bass equalization-increasing bass on thin-sounding source material and decreasing it with heavy bass material. OPTIMOD-FM's built-in stereo encoding, pre-emphasis and filtering are handled before the peak control to prevent loss of loudness, and to eliminate modulation-robbing overshoots caused by outboard stereo generators.

\$5,950.00 List Price

Orban Optimod 8100A-XT2

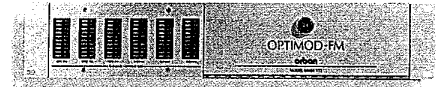

For enhanced loudness and added processing flexibility, the XT2 adds six-band limiting and multi-band distortion-canceled clipping. It also provides separate control over compression, density, bass warmth, "punch," presence, brilliance and clipping. Added processing power from the XT2 makes your signal "jump out" of car and portable radios, yet with a sound that is still open and musical.

\$2,950.00 List Price

Orban Optimod 8100AST-U



Installed in the studio just before the telephone lines or STL, the 8100ST provides level control to maximize available dynamic range without overload. Compressor circuit cards from the main 8100A. Chassis (at the transmitter) are relocated to the Studio Chassis.

\$1,000.00 List Price

Orban Optimod-TV Digital 8282

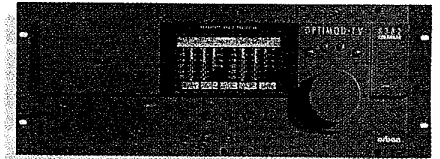

OPTIMOD-TV DIGITAL 8282 is the first digital audio processor designed specifically for the demands of both analog and digital television audio. It also meets the special requirements of the various stereo and dual-language systems in use around the world. The 8282's digital processing offers significant refinement of analog processing techniques pioneered by Orban's OPTIMOD-TV 8182A. The 8282 controls audio program dynamics to maintain a comfortable range for the typical home viewer. It also controls peak subjective loudness to prevent highly-processed commercials from becoming overly obtrusive. Additional processing controls peak modulation and bandwidth to prevent over-modulation of the transmitter. Flexible design architecture and digital I/O allow easy adaptation to evolving digital standards. In addition to the time-tested OPTIMOD-TV processing, the 8282 also incorporates "Protection" processing that is completely inaudible in its operation and "Multi-band" processing to add "punch" to MTV-type formats or to correct poorly mixed or older program material. The 8282 is equipped with a wide selection of factory presets and the ability for the user to store custom presets. Presets can be recalled remotely, by computer, or programmed to automatically switch on a time/date schedule.

\$12,000.00 List Price



Orban Optimod-TV 8182A Audio

The 8182A is an integrated signal processing system designed specifically for stereo or mono television. It provides gain riding to compensate for varying input levels, adjustable dynamic range control, an Automatic Loudness Controller to tame blaring commercials, and patented circuits for transparent peak limiting to prevent overmodulation. Used by thousands of stations and networks around the world, the 8182A combines exceptional audio quality and proven, cost-effective analog technology.

\$6,450.00 List Price



25,000 broadcast stations can't be wrong.

If you want an audio processor that makes your sound come through loud and clear, you can't do better than OPTIMOD®.

Just ask your fellow broadcasters who have installed our processors at 25,000 radio, television and shortwave stations worldwide.

They'll tell you what they've told us: OPTIMODs produce a cleaner, brighter, louder sound than any other processor or limiter. Not to mention they're unmatched in reliability.

What more could you want?

Fact is, OPTIMODs have been the preferred choice of broadcasters for more than 20 years. Available today in a variety of models.



OPTIMOD-FM

Offers top performance and programming flexibility with digital processing along with an integrated stereo generator.

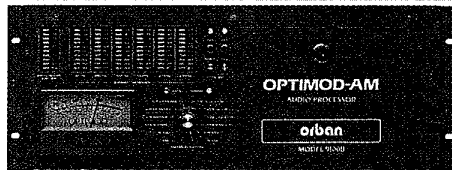

OPTIMOD-AM

Dramatically improves AM signal fidelity and increases volume for FM-like quality.



OPTIMOD-TV

Sets the standard for TV audio loudness control with natural sound and the ability to automatically control any type of TV audio feed.

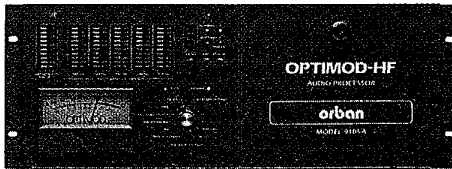

OPTIMOD-HF

Used by the world's largest shortwave broadcasters. Punches through atmospheric noise for greatly improved intelligibility.



OPTIMOD-FM

Digital FM processing that any station can afford in a compact, efficient design.

Whichever OPTIMOD you need, you'll get a sound that will attract and hold your audience.

We have 25,000 examples to prove it.

orban

H A Harman International Company

Audio Processing



**Orban
Optimod-TV 8182AST/U Studio**

The Studio Chassis provides comprehensive STL protection at the studio when the 8182A is installed at the transmitter site.

\$1,000.00 List Price



**Orban
Automatic Stereo Synthesizer**

The 275A effectively reprocesses mono material into synthesized stereo to "open up" mono programs when heard on stereo TVs. The sound of the 275A is remarkably convincing, producing a pleasing sense of ambiance and spaciousness while maintaining perfect mono compatibility. The Stereo Synthesizer 275A is designed for permanent placement in the program line, automatically detecting if the program is mono or stereo and smoothly cross-fading from bypass to synthesized stereo output when true stereo program is absent. The 275A also provides detection and automatic correction of any polarity reversed ("out-of-phase") signals.

\$2,400.00 List Price

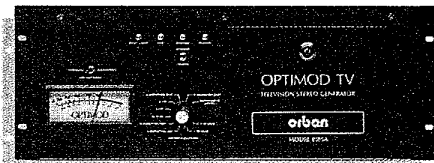

**Orban
Optimod 8185A Stereo TV**

Orban's second-generation 8185A provides an ultra-stable BTSC composite stereo signal for broadcast transmission. With its Hadamard Transform Baseband Encoder™, it provides superb audio quality with outstanding measured performance. The 8185A includes a dbx® noise reduction encoder, a monitoring system with separate dbx decoder to verify system performance, a built-in Bessel null-tone generator for ease of calibration, and peak-indicating meters to verify proper operation. The 8185A is compatible with both the digital 8282 and the analog 8182A OPTIMOD-TV audio processors.

\$7,200.00 List Price

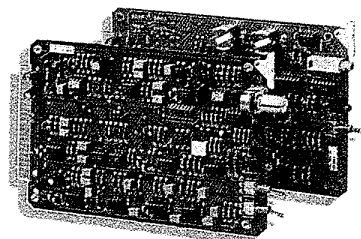

**Orban
8185A-PRO Pro Channel Generator**

The 8185APRO is a high-stability subcarrier generator consisting of two cards that plug into the 8185A TV Stereo Generator. It includes specialized processing to maximize voice intelligibility and provides data conditioning for 1200 baud FSK data transmission.

\$1,300.00 List Price



**Orban
Optimod 8182A-SAP**

The 8182ASAP is a BTSC-standard SAP subcarrier generator that includes one channel of OPTIMOD-TV audio processing. It can be used alone or with the Orban TV Stereo Generator 8185A (or earlier 8182A/SG).

\$5,900.00 List Price

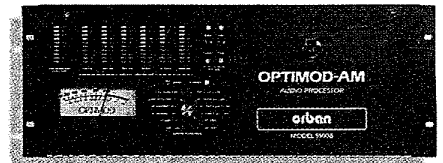

**Orban
Optimod-AM
9100B2-U10**

The 9100B is a complete audio processing system for AM broadcast-mono or stereo, LW or MW. It provides automatic gain control to ride levels, high-frequency boost that compensates for the roll-off in receivers (for a brighter sound), and a six-band limiter with distortion-canceling clipper for a very loud and clean sound. Low-pass filters are switchable for NRSC or CCIR/EBU standard. The 9100B also provides compensation for the LF tilt and HF overshoot that often produce over-modulation in less-than-perfect transmitters and antennas. The result is noticeably more loudness. The 9100B is available in mono or stereo for C-QUAM. Mono units are easily upgraded to stereo in the field.

\$6,350.00 List Price Stereo

\$4,550.00 List Price Mono



**Orban
Optimod-HF 9105**

OPTIMOD-HF 9105A is specifically optimized for international high-frequency/shortwave broadcast, both conventional AM and SSB. It also helps produce highly intelligible speech even on very narrowband radios. OPTIMOD-HF produces an exceptionally dense sound and extremely high average modulation without introducing unacceptable distortion. The frequency balance is tailored to enhance speech intelligibility and reduce unnecessary low-frequency information that wastes expensive transmitter power.

\$5,850.00 List Price



**Orban
Transmission Limiter 4000/U75**

The 4000 is designed for use in transmission networks to protect microwave links, satellite links, telephone lines and digital links. Not a processor or AGC, the 4000 goes into action only when necessary to protect the link from high frequency or peak overload. The 4000 is totally inaudible in its operation. The 4000 can be field configured for any of the standard pre-emphasis curves (including NICAM's J.17), providing flat or pre-emphasized output. Clean, clear and absolutely faithful to the input signal, the Orban Transmission Limiter 4000 provides assured system protection without introduction of a "processed" sound.

\$2,500.00 List Price



Orban
Programmable Voice Processor

In one compact unit, the 787A combines all of the processing power required to precisely define the sound of DJs, announcers, narrators or singers. Integrated processing functions are fully programmable, and include level control, compression, gating, three bands of parametric equalization, and de-essing. Control settings for a particular voice may be stored in non-volatile memory for total recall. The 787A will store up to 99 complete setups, eliminating the need for laborious "tweaking" of multiple individual processors before each airshift, recording session or special event. System options include a companion second channel slave unit (787ASL), a small remote control box for easy recall of presets from the console/desk, a Jensen-transformer microphone preamp, and an RS232 interface.

\$1,450.00 List Price



Orban
Optimod Studio Chassis 8200ST

The 8200ST provides transparent gain riding, adjustable compression, high-frequency limiting and absolute peak control—all in a single rack-space package. Applications include STL protection (when used in conjunction with the OPTIMOD-FM 8200 or OPTIMOD-AM), studio level control and budget FM processing. The 8200ST features a variable density control to provide inconspicuous gain riding, to increase punch and density for a louder sound, or to create any desired effect in between. The high-frequency limiter is adjustable for all standard pre-emphasis curves. Clean, logical control layout makes the 8200ST exceptionally easy to use.

\$1,000.00 List Price



Rane
VP12 Voice Processor

The Rane VP 12 is a mic or line level voice processor incorporating a studio-grade microphone pre-amp, low and hi cut filters, de-esser, gate/compressor, and two channels of parametric equalization. The microphone 3-pin (XLR) input features switchable 48V phantom power and an input gain control. A separate balanced line level input arrives from either screw terminals or a 1/4" TRS jack. A front panel switch selects whether the mic, line, or the sum of both inputs will be processed by the VP 12. The sum feature allows the line input of the VP 12 to act as an expand input for other outboard mic preamps. The line level input easily accepts the output of wireless mic systems. Variable low and hi cut filters tailor the overall frequency range to the specific application.

\$599.00 List Price



Rane
PE17 Parametric EQ

The Rane PE 17 Parametric Equalizer/Notch Filter advances the features and performance of the popular Rane PE 15 parametric equalizer design. The PE 17 adds separate in and out gain controls, sweepable low and high cut filters, 100% overlapping bands, with improved dynamic range and noise performance. Special design techniques and components used in the design of the PE 17 guarantee residual noise levels below digital recording equipment. This makes the PE 17 ideally suited for all critical digital audio studio, sound reinforcement and broadcast applications.

\$549.00 List Price



Rane
ME60 Dual Graphic Equalizer

The Rane ME60 is a two channel, 1/3-octave constant-Q micrographic equalizer. The ME60 utilizes compact 20 mm sliders. Two adjustable band-limiting filters add to each channels' versatility. The low cut filter has a range from 10 Hz to 250 Hz, and the high cut filter sweeps from 3 kHz to 40 kHz, rolling off unwanted frequencies at both ends of the spectrum. The rear of the units provides 1/4" Tip-Ring-Sleeve, RCA phono jacks, and 3-pin (XLR type) connectors for each of the inputs and outputs. The inputs and outputs are fully actively balanced. Unbalanced sources may be connected through the use of either "mono" 1/4" connectors or by tying the ring to the sleeve on TRS type plugs.

\$699.00 List Price



Rane
DMS22 Dual Microphone Preamp

The Rane DMS 22 is a dual channel studio-grade microphone preamp with equalization and a stereo mixer. The DMS 22 is useful in installations when comprehensive mic equalization is required. Each microphone 3-pin (XLR) Input features switchable 48V phantom power, polarity invert switch, and input gain control. Balanced, line-level 1/4" TRS outputs with level controls are provided for each channel. Pan controls (defeatable) send to a separate 3-pin (XLR type) stereo pair of mix outputs, allowing a stereo mix of the two microphones when hard left/right is not appropriate.

\$549.00 List Price



Rane
AVA22 TV Alignment Delay

The Rane AVA 22 Audio/Video Alignment Delay is a fully balanced two input, two output audio alignment delay providing a range of 0.0 to 9.5 NTSC frames (8.0 PAL/SECAM frames) on each output. The delay of each output is independently adjustable in field (half-frame) increments. Each output has two nonvolatile memories, A and B, for easy access to previously stored delay values. The AVA 22 features 3-pin (XLR type) connectors. Both NTSC and PAL/SECAM broadcast standards are supported. A recessed rear panel switch is available for locking out front panel controls. In this mode, all of the front panel pushbuttons are disabled with the exception of the recall buttons. Independent relays provide a fail safe, hard-wired bypass in case of power loss.

\$899.00 List Price



Rane
ME15B Dual Graphic Equalizer

The Rane ME 15B is a two channel, 2/3-octave constant Q micrographic equalizer. The ME 15B utilizes compact 20 mm sliders, and features a range switch for high slider resolution in the +/-6 dB mode. The +/-12 dB mode provides a wide range of control over system audio. Front panel controls and indicators, aside from the sliders and the filter range switches, include an overall level control for each channel as well as overload indicators and passive bypass switches.

\$429.00 List Price



Audio Processing





Rane
ME30B Graphic Equalizer

The Rane ME 30B is a single channel, 1/3-octave constant Q micrographic equalizer. The ME 30B utilizes compact 20 mm sliders, and features a range switch for high slider resolution in the +/-6 dB mode. The +/-12 dB mode provides a wide range of control over system audio. Front panel controls and indicators, aside from the sliders and the filter range switch, include an overall level control as well as an overload indicator and a passive bypass switch. The rear of the unit provides both 1/4" tip-ring-sleeve and 3-pin (XLR type) connectors for each of the inputs and outputs. The inputs and outputs are full active balanced.

\$419.00 List Price



Symetrix
528E Voice Processor

Voice talent is expensive. So why not get your money's worth? The 528E is the industry standard voice processing toolbox, featuring a top quality preamp, compressor, de-esser, three bands of parametric EQ, and a downward expander plus a phase rotator all in one unit. Three overlapping parametric equalizers. Variable compression ratio. Three bands of variable frequency EQ. Switchable phase rotator.

\$699.00 List Price

Audio Processing

Roland
VT1

The BOSS VT-1 Voice Transformer is a unique device for altering and effecting the human voice. The VT-1 lets DJs, broadcasters and voice-over artists convincingly raise or lower their voice, changing vocal gender without the artificial-sounding "chipmunk" effect. The VT-1 can even produce some funky robot-like talking and digital reverb effects, and all settings can be saved into one of four built-in user memories. With the VT-1 it's very easy to create special effects or even new on-air voice characters.

\$395.00 List Price

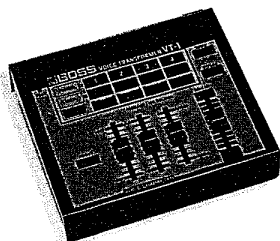

Symetrix
422 Compressor/Limiter

By making loud sounds quieter and quiet sounds louder, the 422 solves level control problems which conventional compressors can't remedy. Automatically corrects level variations between program sources. Ends complaints about loud commercials on cable TV systems. Maintains optimum input levels for digital audio storage. Improves STL modulation. 422 is mono.

\$595.00 List Price



Sabine
FBX-SOLO Feedback Exterminator

Sabine's FBX-SOLO Feedback Exterminator offers patented, state-of-the-art technology — low-cost, automatic feedback control for individual microphones. Using digital signal processing, it automatically detects and eliminates feedback in less than 1/2 second by assigning one of six very narrow, 1/10-octave digital notch filters to eliminate only the feedback without damaging the sound. Model SL-610 is for line level insert points on mixers' inputs; model SM-610, with microphone preamp and selectable phantom power, is for mixers without insert points.

\$349.00 List Price for SM-610

\$324.00 List Price for SL-610



Symetrix
551E Parametric EQ

A parametric equalizer provides accuracy and precision not possible with a graphic EQ. On-Air... the 551E offers ultra-low distortion, minimal phase shift and wide dynamic range. In your production studio... five full-spectrum bands plus independent low cut and high cut filters make audio sweetening and audio problem solving a snap. The 551E is mono; order two units for stereo applications.

\$499.00 List Price

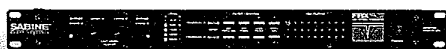

Sabine
FBX-901 Feedback Exterminators

Eliminate feedback quickly with the Sabine FBX-901 or FBX-2020 Feedback Exterminator. Like other Sabine FBXs, the FBX-901 and -2020 automatically detect and eliminate feedback in less than 1/2 second. The FBX-901 provides nine narrow feedback filters, and the dual-channel FBX-2020 provides nine filters per channel, plus faster processing and additional front panel features. For automatic feedback control, clearer sound and more gain before feedback, try a Sabine FBX Feedback Exterminator.

\$649.00 List Price for FBX-901

\$1,199.00 for FBX-2020



Thum & Mahr
Yellowtec VIP-1 Voice Processor

Switchable high pass filter, de-esser with adjustable frequency, ratio and threshold, parametric 3-Band-EQ expander, compressor, limiter meter switching (to show the input or the output levels). Line input and output level adjustable with dip switches. RS 232 interface, 3 preset buttons for instant access, and storage of individual settings on an intelligent chip card are available. Mic-preamp and transformer-balanced input/output are optional.

Pricing upon Request



**Valley Audio
VP401 Voice Processor**

Valley Audio's Model 401 Microphone Processor provides high quality mic preamplification with a 48 volt internal phantom power supply, 3-band equalization, compression, downward expansion, noise gating, sibilance control and multilevel output line drive. Its controls and indicators are arranged for easy operation by nontechnical personnel.

\$799.00 List Price



**Valley Audio
730LTADD Processor**

At \$3,500, Valley Audio's Model 730 DynaMap Digital Dynamics processor was a bargain. EQ Magazine said "The 730 can look ahead to see what is going to happen before you actually hear it." That's why many of the world's leading mixing labs own one. MIX said, "For sound quality and flexibility, the 730 is in a class by itself."

\$1,990.00 List Price



**Yamaha
Rev 500**

New professional stereo digital reverb processing system. Features include 32 bit digital signal processing power (same digital signal processor as ProR3 and O2R), coupled with precision 20 bit AD/DA converters. Rotary controls for quick editing of pre delay, reverb, high ratio RT and early reflection parameters. Large, easy to read LCD. 100 preset programs and 100 user programs with organized libraries. Balanced input and outputs (XLR and TRS).

Price available upon request



**Yamaha
ProR3 Stereo Digital Processing System**

New professional digital reverb processing system. Features include 32 bit digital signal processing power coupled with precision 20 bit AD/DA converters, digital pre and post reverb equalization, programmable noise gate, full function compressor, programmable dynamic filter, top quality reverb based effects with early reflection, modulation, pitch change and pan parameters. The ProR3 offers a compare function that allows instant A/B comparisons between original and edited processing. Balanced input and outputs (XLR and TRS).

\$1,599.00 List Price

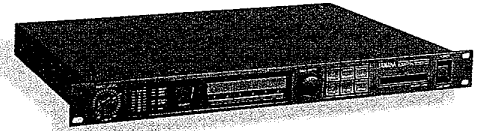

**Yamaha
SPX990 Multi-Effects Processing**

Professional stereo digital multi-effects processing system. Features include 28 bit internal processing with precision 20 bit AD/DA converters, 80 preset effect programs with pre and post effect processing, 100 internal memory locations for user programs, and optional external memory card. These programs include reverb effects, early reflections, delay (LCR) and echo, modulation, pitch change, pan, multi-effects and sampling programs. Balanced input and outputs (XLR and TRS).

\$1,179.00 List Price



**Yamaha
YDG2030 Graphic Equalizer**

Professional digital graphic equalizer. Features include 24 bit internal processing (50 bit for EQ calculations) with precision 20 bit AD/DA converters and 40 program memory. Each channel offers 30 band equalization, 4 programmable notch filters, HPF, LPF, time delay (714 msec) and Y485 serial bus for computer control. Balanced input and outputs (XLR and TRS).

\$1,299.00 List Price



**Yamaha
YDP2006 Graphic Equalizer**

Professional digital graphic equalizer. Features include 24 bit internal processing (50 bit for EQ calculations) with precision 20 bit AD/DA converters and 40 program memory. Each channel offers 30 band equalization, 4 programmable notch filters, HPF, LPF, time delay (714 msec) and Y485 serial bus for computer control. Balanced input and outputs (XLR and TRS).

\$1,299.00 List Price

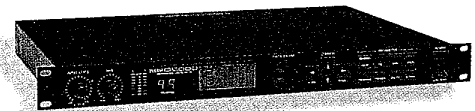

**Yamaha
D5000 Digital Delay**

Professional digital delay. Features include 24 bit internal processing (50KHz sampling frequency) with precision 20 bit 64X over sampling AD conversion and 20 bit 8X oversampling DA conversion and 100 program memory. Each channel offers multiple delays (programmable in SMPTE frames) and sampling with programmable loops (delay/sampling to 5,200 ms stereo/ 10,400ms mono). Added features include programmable modulation, feedback loops, ducking and gating parameters. Balanced input and outputs (XLR and TRS).

\$1,499.00 List Price

Audio Processing



Orban and FM Transmission Audio Processing Robert Orban

In the early '70s and before, FM transmission audio processing was a hit-or-miss affair. Engineers assembled compressors, limiters, clippers, and stereo encoders from different manufacturers, often with indifferent results. Time constant incompatibilities caused pumping and other artifacts that made the sound unnatural and fatiguing. Headroom problems often caused unintended clipping in the audio chain. And even if everything else was under control, the 15kHz low-pass filters in the FM stereo encoder would overshoot and ring, increasing peak levels without affecting the average levels that determine loudness. To prevent excessive peak flasher activity, engineers at the time would have to turn down transmitter drive levels 2 or 3 dB. Even then, a muted trumpet might come along and drive things crazy!

Orban™ Associates was founded in 1970 as a division of my father's company. For the first four years we concentrated on studio equipment - spring reverbs, de-essers, and parametric equalizers. Our sales were modest, and we needed to find an area that could fuel our company's growth.

I had spent 1963 through '67 at WPRB, Princeton University's student radio station. At 103.3 MHz with 17kW ERP, it was one of the few student-run FM stations in the country with a commercial license. It supported itself by selling advertising, just like a "real" radio station. There I learned a great deal about radio engineering and programming, and I designed and built my first broadcast limiter plus several generations of cart machines.

When I graduated in '67 and moved to California to do my Master's in electrical engineering at Stanford, a friend, Lee Gahagan, who had been General Manager of WPRB for one year, moved out also and bought a small class-A radio station, KPGM, Los Altos (97.7MHz). I did some work for Lee in exchange for rent on a small 100-square-foot work area at the station. Part of the work was construction of a custom FM stereo limiter that used a pre-emphasized clipper as a means of final peak limiting.

This was where I first became aware of the problem that a signal that was perfectly peak-controlled at the output of the audio processor could wildly overmodulate by the time it passed through the transmitter. A call to Arno Meyer at

Belar gave me the clue that the main problem was overshoot and ringing in the low-pass filters in the transmitter's stereo encoder. That insight gave me the idea to make the compressor, limiter, high-frequency limiter, peak-controlling elements, and stereo generator in one box as a system so I could optimize headroom and dynamic range through the system. By using non-linear low-pass filters, I could prevent loudness-robbing overshoot. The resulting system was Optimod™-FM 8000A, which was gratifyingly successful in the marketplace and which engendered a line of analog processors including the even-more-successful 8100.

In 1988 it became clear that digital signal processing (DSP) was finally becoming inexpensive enough to use in a broadcast audio processor. Motorola had introduced the DSP 56000 series of integrated circuits that used 24-bit words. This was enough resolution to permit excellent results, and the chips were cost-effective enough to allow us to design a system with nine DSP chips that cost only about 10% more than its analog predecessor. So Orban quietly began working on the next generation of Optimod-FM. After four years of intensive development, the 8200 created far more value for the customer than the earlier analog processors. Its programmable DSP-based architecture allowed it to emulate several different signal processing chains and to switch from one emulation to the next within milliseconds. So the 8200 could be anything from an aggressive five-band processor to an extremely transparent protection limiter (more transparent than even the old 8000A, which was very "minimalist" by today's standards).

Designed by me in cooperation with Greg Ogonowski (creator of the legendary, limited-edition Gregg Laboratories processors), the five-band algorithm represents a significant improvement in quality (particularly in terms of high-frequency clarity and power-handling ability) over previous Orban analog processors, allowing major-market stations to be extremely competitive while retaining a clean, natural sound. Factory presets allowed even non-experts to get on-air quality that formerly required a consultant's services. And versatile setup controls let experienced engineers create custom presets that could be recalled to match the requirements of the on-air program material.

Of course, a complicated project like the 8200 required a strong engineering team. We had a very talented DSP engineer who worked closely with Greg and me to implement the intricate system block diagram, including functions that were only practical in a digital processor. An excellent control and interface engineer designed the software that ran on the 8200's Z80 control microprocessor. All DSP and control software was tightly written in assembly language to get the absolute maximum performance from the hardware.

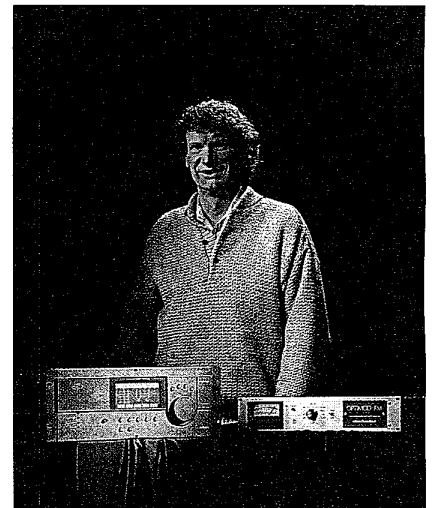

In terms of sales volume, the 8200 is the most successful product in Orban's history. It became clear to us that there was strong market demand for high-quality digital transmission processors, so it seem logical to try and bring the cost of digital down to the point where stations that couldn't afford an 8200 could still obtain many of the advantages of Orban's digital expertise. Fortunately Motorola had released a lower-cost DSP chip (the 56004) that had many of the advantages of the chips used in the 8200 including full 24-bit precision. So we decided to port the 8200's Protect and Two-Band structures to the 56004, creating the new Optimod-FM 2200.

By packaging the unit in a one rack-unit chassis and putting all circuitry on one large PC board, we were able to create a unit that almost any FM station could afford. To ensure a bright, competitive sound, we developed a High-Frequency Enhancer (essentially a program-adaptive dynamic shelving equalizer) and put it ahead of the Two-Band Structure. Further, we used the experience we had obtained in developing Orban's high-end stand-alone DSP-based stereo-encoder (the 8208) to implement a very high-performance DSP-based stereo encoder in the 2200.

As Orban looks to the future, we are thankful that we live in interesting times. Our acquisition in 1989 by AKG Acoustics and then AKG's acquisition in 1993 by Harman International has provided us with the resources of a billion dollar company. The Digital Audio Radio revolution, though temporarily stalled in the U.S., is moving forward rapidly in many other countries. Orban will be involved in DAR, as well as in many other aspects of the digitization of radio, such as our DSE-7000 digital workstation. Finally, as I look back over more than 25 years, I am most grateful to Orban's customer whose loyalty has helped make Orban the industry-leading company it is today.

**Audi-Cord
DL Series NAB Cartridge Machines**

Audi-Cord NAB Cartridge machines are designed for continuous, broadcast operation. Reliable, durable cart machines with professional features and an economical price. Available as recorders and reproducers in mono and stereo configurations.

Prices vary

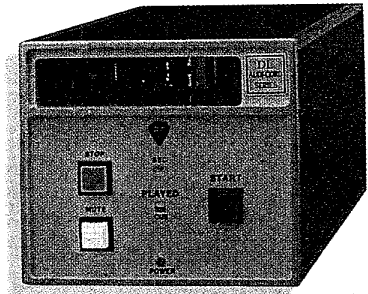

Cartridge Machines

**Fidelipac
395 Eraser
Blank-It Bulk Eraser**

If you need blank tape fast and are worried about recorder erase head wear, then worry no more. With the easy-to-handle "BLANK-IT" eraser from Fidelipac. You'll save time - no need to run the tape through your eraser/splice finder. You'll save money - it allows instant reuse of the erased tape without worry about program residue or those mind destroying "whomps". "BLANK-IT" is hand-held for rapid, accurate tape erasing in any setting.

\$100.00 List Price

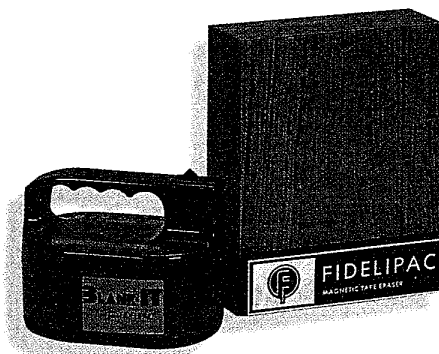

**Fidelipac
400 Bulk Eraser**

The model 400 features a removable guide pin, a scuff resistant top, a power-on indicator and wood case. It can erase all audio, video and computer tapes up to 1" wide and it has a thermal protected core that will not burn out.

\$195.00 List



**Fidelipac
CTR10 Series Cartridge Machine**

The Dynamax CTR10 Series is Fidelipac's least expensive cartridge machine. However, it is filled with the following features: fast forward (3x normal speed); flashing cart-played indicator; strappable repeat play disable; selectable high speed recue; all front panel switches illuminated; front panel 1 kHz defeat with dedicated indicator; versatile, switch-selectable audio/test metering; bar graph LED VU meters. Models: CTR12 Stereo Playback; CTR14 Stereo Record/Play; CTR11 Mono Playback; CTR13 Mono Record/Play.

Prices vary

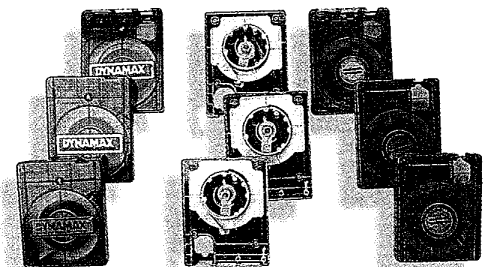

**Various
NAB Carts**

Harris has quality broadcast audio cartridges available that provide excellent performance at a reasonable price. Call Harris today for availability and price.

Prices vary





**Denon
DN-790R 3-Head Dolby® S
Cassette Recorder**

We still live in an analog world so, why not make the very best analog cassette recordings with the improvements that Dolby® S has to offer such as: 10 dB of noise reduction below 200Hz and 24 dB noise reduction between 2kHz and 10kHz. Cassettes recorded in Dolby® S will sound better when played back on Dolby® B decks, too. The DN-790R offers a 3-head, 3-motor system with balanced XLR in/out jacks as standard features.

\$1,000.00 List Price



**Denon
DN-770R Bi-directional
Output Cassette Recorder**

The Denon DN-770R was developed to met the requirements of the nineties for DJs, musicians or sound installations. Features include: auto-reverse, relay recording, high speed dubbing, HX Pro™, and music search. Other conveniences allow you to playback two different cassettes at the same time, record simultaneously on both decks, automatically change decks for continuous audio, change key of a song during playback, memory rewind (return-to-zero) and many more high-quality high-tech features.

\$700.00 List Price

**INDY AUDIO
SQUEEZE PLAY**



SQUEEZE PLAY, the "Skimmer", has several useful applications. The most obvious is to skim a competing station, quickly and painlessly gathering useful information on playlist and rotations. Or, a PD might want to skim his own station, perhaps to determine if the overnight jock is really following the music rotation, or just to evaluate the effectiveness of the music rotation scheme. An enterprising PD might swap skimmer tapes with colleagues in other markets, studying successful stations who employ similar formats.

\$179.95 List Price

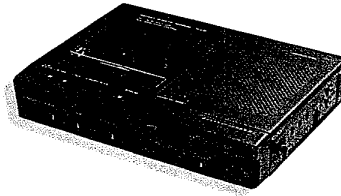

**Marantz
PMD201, Mono Deck**
\$379.00 List Price

SPECIFICATIONS

- Anti-roll transport with micrograin capstan for smooth, stable sound
- Limiter and Automatic Level Setting for cleaner recordings
- Tape Speed selector for double-length recording and playback
- Microphone attenuator
- Ambient Noise Control
- Pitch Control
- Large Needle VU meters with peak LED and low battery indicator

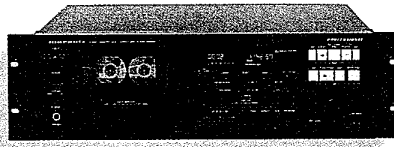

**Marantz
PMD350 Combination CD
Player/Cassette Deck**

The PMD350 by Marantz gives the audio professional the most comprehensive package to date, featuring Marantz quality and performance in a space saving design. It offers specialized performance features including independent pitch controls, headphone monitor select, stereo microphone inputs, independent fader starts, CD A-B memo points, one-track CD play programming, and a lock for remaining track time.

The PMD350 has a one piece (3RU) front panel for stability, heavy duty controls and the look and feel desired by professionals.

\$740.00 List Price



**Marantz
PMD510 Double Cassette
Deck**

Two full independent cassette decks in one 19" 3RU unit. A unit created for professional applications. Each deck has its own discrete set of stereo inputs and outputs, two motors, two heads, Pitch Control, stereo bargraph meters, linear time counters, Dolby B, C and HX PRO™ and large, easy to operate transport keys. The headphone output is switchable between deck A, deck B or a combination of both.

The two decks can also work together to provide parallel recording and playback. A cascade connection allows connection of several PMD510s for multiple deck continuous recording (for logging and other long-record applications) or playback. All auto-reverse circuits, deck-switching circuits and cascade circuits are optical sensing for minimal data-loss in continuous recording modes.

\$829.00 List Price



**Marantz
PMD222, XLR Mono Deck**
\$479.00 List Price

SPECIFICATIONS

- Three-heads for off-tape monitoring
- Anti-roll transport with micro grain capstan for smooth, stable sound
- Tape speed selector for double-length recording and playback
- Large needle VU meters with peak LED and low battery indicator
- Pitch Control
- Limiter and Automatic Level Setting for cleaner recordings
- Three position mic attenuator
- Three position Ambient Noise Control
- Comprehensive professional standard inputs, XLR Mic, modular telephone and mini (Mic/Tel) jacks

Cassette Recorders



Otari
DP-8 Series Cassette Copier

- DP-8-C3 Master Copier: 1 master station and 3 copy stations
- DP-8-Z4 Slave Copier: 4 copy stations
- Copy Ratio 1:16
- Simultaneous duplication of A & B-side or A-side only
- Copy station with erase head for instant over-recording
- Short copy tape error detection & automatic master cassette rewind
- LED peak meter display for 4 channels & independent level controls
- Rugged metal base for durable operation & CPU full logic control
- Simple one-button operation

DP-8-C3 \$3,795.00 List Price

DP-8-Z4 \$3,695.00 List Price

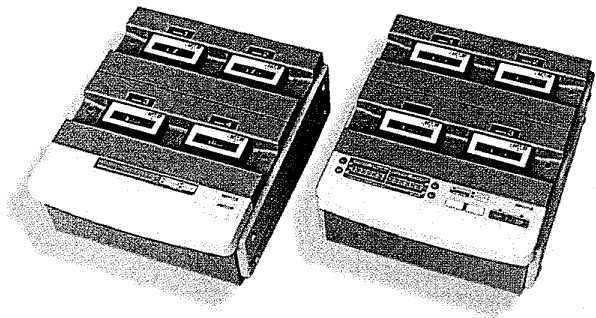

Cassette Recorders



Tascam
102 MKII Stereo Cassette Deck

- Dolby® B & C noise reduction
- 2-motor IC logic transport control system
- Electronic digital tape counter
- Auto tape selection
- BIAS fine tune control

This is the best value cassette deck for the sound contractor. This precision-built, rack-mountable cassette sounds great due to its extremely wide frequency response. Dolby® noise reduction and HX PRO™ sound technology are standard features. The rugged Tascam transport means years of trouble-free operation.
\$369.00 List Price

Tascam
103 Stereo Production Cassette Deck

- 3-head design for recording and confidence monitoring
- Dolby® B & C noise reduction
- Dolby® HX PRO™ for high-frequency performance
- Twin motor IC logic transport control system
- Electronic digital tape counter
- Auto monitor lets you display Tape or Source on the multi-function display
- BIAS fine tune control

You won't find a better value in a 3-head stereo mixdown deck. This 3-head design facilitates simultaneous recording and confidence monitoring of program material. The Tascam 103 features a durable transport designed for years of heavy-duty operation and multiple noise reduction technologies for the best-sounding tapes.
\$569.00 List Price

Tascam
202 MKIII Dual Rack Mount Dubbing Deck

- Dual synchronous record mode
- Sync reverse and dubbing capability
- Auto reverse and repeat
- Normal and high-speed dubbing
- Blank Scan automatically FFs to start the next PGRM or selection
- Record/Mute autospace automatically inserts 4 seconds of silence
- Dolby® B, C & HX PRO™

This dual cassette deck is ideally suited for both dubbing and continuous looping playback applications. Two twin-head cassette decks in a durable rack-mount housing can be used separately or in tandem during recording and playback. Additional features include dual recording speeds, computerized program searching and other functions that make editing tapes quick and easy.
\$529.00 List Price



Cassette Recorders

**Tascam
302 Dual Auto
Reverse Cassette
Recorder**



- Auto-reverse capability on both decks
- Individual/simultaneous record capability - both decks
- Independent RCA unbalanced In/Out for each deck
- Cascade and control I/O capability for interconnecting up to 10 machines
- Sync reverse function enables both decks to be reversed at the same time
- Dolby® B/C noise reduction with HX PRO™
- Normal/high speed dubbing
- Optional wireless remote control (RC-302)

For applications where long-format recording or playback are essential, the acclaimed dual auto-reverse, bi-directional Tascam 302 cassette deck is ideal. Each of the 302's two decks are capable of recording independently or simultaneously giving you exceptional flexibility. With total control over each deck, the 302 offers simple programming and lets you access either side of the tape whenever you wish.

\$699.00 List Price

**Accessories: WR7000
Sync Cable**



**Tascam
112 MKII High Stability Stereo Cassette
Deck**

- Servo direct drive capstan motor for high stability recording and playback
- Gear independent stereo VU meters
- 2-memory locations and RTZ function
- Pitch control
- Dolby® B & C with HX PRO™

This is the classic "no frills" production workhorse! For production studios and installations, this 2-head cost-effective cassette deck is ideal for production mastering, mixdown and playback. The 112MKII is extremely rugged and reliable. It features a parallel port for external control and an optional balanced connector kit means it is flexible enough to integrate into any environment.

\$849.00 List Price

**Accessories: LA112 Balancing Kit
RC31 Remote Control**

**Tascam
134B Syncaset®**

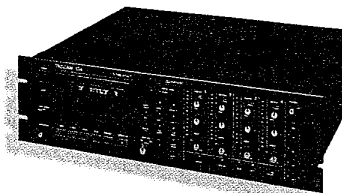

- 4-track/4-channel
- Built-in 4 x 2 mixer
- Dual-speed tape transport high speed for optimum audio quality
- Built-in 25 Hz cue tone generator
- Pitch and shuttle control
- Dolby® B & C

Designed for audio/visual, and multimedia production, the Tascam 134B is a sophisticated 4-track, 4-channel cassette recorder/reproducer. An easy-to-use interface makes recording, overdubbing and editing simple and quick. A shuttle knob lets you monitor and cue-up tape locations at highly variable speeds – much like "rocking the reels" of a reel-to-reel recorder. A built-in internal mixer lets you create the perfect soundtrack for any production.

\$1,629.00 List Price



**Tascam
122 MKIII 3-Head Cassette Deck**

- 3-head high-performance cassette deck
- Balanced and unbalanced I/O
- Bias & level calibration and pitch controls
- Gear and clutch-coupled input level control
- Two auto-locator points for book-marking tape locations, and RTZ function
- Dolby® B, C & HX-PRO™
- 400 Hz or 10 kHz oscillator adjustment signals
- Parallel port for external or fader start control
- Record/Mute auto spacer

The industry standard for production and broadcast facilities. Tascam's best cassette deck features smooth faultless tape handling mechanisms, a 3 head transport with high-performance Cobalt Amorphous record and playback heads and precision servo direct-drive capstan motors.

\$1,349.00 List Price

Accessories: RC 134 Remote Control

**Tascam
112R MKII Auto Reverse
Deck**

- 3-head, auto reverse (play and record) cassette deck
- Super Acculign™ rotating head system
- Advanced servo control HTSC™ system
- Dolby B & C with HX PRO™
- Optional balanced connector kit
- Parallel port for external or fader start control
- Auto tape bias system

Exceptional playback for engineers and contractors looking for a sonically uncompromising, auto reversing and continuous play cassette deck. With a bi-directional, 3-head transport, the 112R MKII features independently-operating Cobalt Amorphous heads combined with precision FG servo direct-drive capstan motors.

\$1,149.00 List Price



**Accessories: LA112
RC112R
Remote Control**



The Most Trusted CD Player Is Now AES/EBU



The New World Player!

It Now Works & Plays Everywhere. . . Just Plug & Play.

Now in generation 3 and having evolved from CD10E to CD2001, this is the CD player that broadcasters trusted first (and have trusted most) to play their CD libraries direct-to-air. Why? RELIABILITY!

Since generation one (CD10) way back in 1988, our achieved goal has been to deliver a CD player that's:

- Friendly at first sight
- Worry and hassle free
- Built for maximum MTBF
- Easy to service



*AES/EBU
& Analog Output*

*120/240 VAC
50/60 Hz*

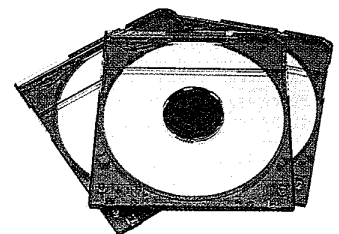

**ACD5 Protective
Caddy**

Now with world-standard digital AES/EBU (AES3) out, the CD2001 works and plays *everywhere* and has proven to be twice as reliable as its nearest competitor.

 **HARRIS**

1-800-622-0022

FAX: (765) 966-0623

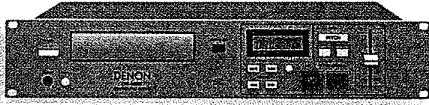

**Denon
DN-650F Studio CD Player**

The DN-650F is Denon's professional rackmount, single CD player that offers 18-bit, 8x oversampling digital filters along with Denon's Super Linear Converter. Instant start/pause and cue buttons are located on the front panel with the addition of a pitch control slider of $\pm 8\%$. Balanced XLR outputs and a digital coaxial output come as standard factory features.

\$800.00 List Price



**Denon
DN-951FA CD Cart Player™**

The Denon DN-951FA CD Cart Player™ combines performance and value, offering greater efficiency and Denon's audio quality. The Auto Track Select System gives programming control of ON AIR playback of CDs. The DN-951FA reads special bar-coded labels, (sold separately) available in 3 different configurations. The narrow profile allows three units to fit across on a rack shelf. Other features include full remote control capability and large digital display.

\$1,500.00 List Price

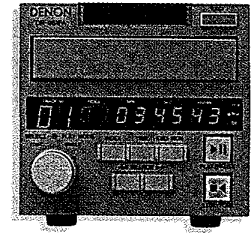

**Denon
DN-961FA Compact Disc Player**

Unprecedented performance with enhanced, reliable operating ease, greater efficiency and unsurpassed audio quality make the Denon DN-961FA a broadcaster's dream. Its superior digital audio sound quality is attained from a super linear converter system, with dual 18bit DACs and 8 times oversampling, 20-bit dual filter for low noise and transient response. Broadcasters will find features in the DN-961FA which improve the ON AIR playback of CDs.

\$1,500.00 List Price



**Marantz
PMD321
Compact
Disc Player**



This is the big brother of the PMD320. Equipped with an XLR analog output (+4dBu) and digital XLR out, fader start, audio cue and pitch control this product meets the demands of many in broadcasting and DJ applications. All features are standard on this model.

With the audio cue function switched on, the PMD321 will start playback of tracks right at the beginning of the music. The audio cue detection level is -40 dB.

It really doesn't matter where you apply this CD player, with the PMD321 we assure you top performance at a very competitive price level. You'll be amazed.

\$529.00 List Price

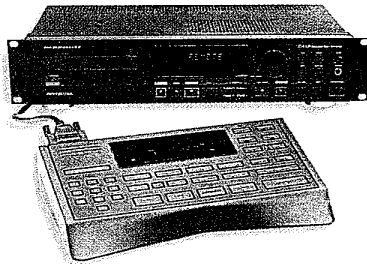
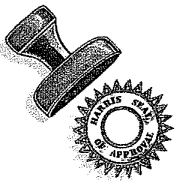

**Marantz
CDR615 & CDR620 Compact Disc
Recorders**

Cut your own music-mix CDs.

The Marantz Professional CDR615 and CDR620 Compact Disc Recorders represent the next-generation in stand-alone write-once CD recorders. They offer a truly comprehensive set of features for a wide range of applications including recording studios, mastering facilities, post production, broadcast, and more.

CDR615 \$2,786.00 List Price

CDR620 \$3,600.00 List Price

SPECIFICATIONS

- 2U/19 inch rackmount
- Fader Start
- Pitch Control $\pm 8\%$
- RCA XLR analog output
- SPDIF XLR digital output
- Radio cue (-40dB)
- Easy programming
- Serial remote in/out





**Tascam
CD-201 Compact Disc Player**

- RCA audio outputs
- Wired or wireless 10-key remote (optional)
- Auto cue & link function
- 20-program memory
- 4-way repeat play
- S/PDIF digital output

The ideal digital compact disc playback system for the budget-conscious, production studio or playback installation. Rack mountable, the CD-201 easily integrates into cramped environments, and interfaces easily with production and broadcast mixers for smooth fader starts.

\$529.00 List Price **Accessories: RC-31 Remote Control**



**Tascam
CD-301 MKII Compact Disc Player**

- Advanced delta-sigma D/A conversion system
- Balanced XLR & unbalanced RCA audio outputs
- Repeat play
- Remote fader start capability
- Wired 10-key remote (optional)
- Auto cue & link function
- 20-program memory

For playback and DJ applications, the CD-301 is an excellent choice for today's professional. Superb sound quality, reliability, durability, smooth operation, and compatibility with other equipment are just a few of the many features that make up this outstanding cost/performance package.

\$739.00 List Price **Accessories: RC-31 Remote Control**

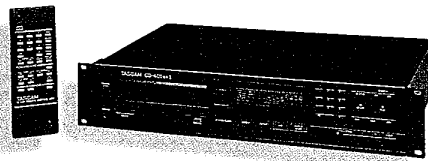

**Tascam
CD-401 MKII Compact Disk Player**

- Auto-cue with selectable sensitivity
- 4-way repeat play
- Advanced delta-sigma D/A conversion system
- Create custom play lists including repeat
- Fader start jack
- Chain multiple 401MKIIs for coordinated playback
- XLR-type-balanced and RCA unbalanced connectors

This durable pro-quality programmable CD player offers auto cue-to-music, or first-frame audio, pitch control, superior audio quality and is easily fitted with included 19" rack-mount ears making it perfect for the production or recording studio.

\$1,049.00 List Price



**Tascam
CD-305 5 Disc CD Player**

The fully programmable, great-sounding, industrial grade 5 Disc CD Player

The Tascam CD-305 is the ideal digital compact disc system for any environment where long playback duration is a requirement. With a rotating carousel that accommodates five CDs, it's quick to set up, easy to program and offers premium quality digital sound at a highly competitive price.

\$599.00 List Price

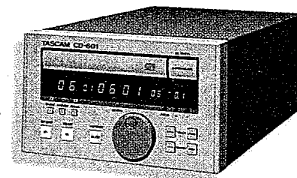

**Tascam
CD-601 Production Compact Disc Player**

- Balanced XLR & Unbalanced RCA outputs
- Precision cueing control & Auto Cue
- Phones/monitor jack
- Serial control port and link port
- Linear motor-driven pick-ups eliminate dead air
- Optional RC-601 remote control unit adds additional features and convenience
- Optional BU-2 RAM for instant start and seamless loops up to 3 minutes

Frame-accurate cueing precision, extremely high-fidelity and a small form make the CD-601 ideal for post-production applications where sound effects and music are "flown-in" from compact discs. The CD-601 integrates with most post-production equipment including mixers, video editors and computer studio controllers.

\$1,799.00 List Price



**Tascam
CD-701 Production Compact Disc Player**

- Vibration-free ridged disc clamping system
- Optional BU-1 RAM buffer for instant start & seamless loop
- Link/Control port
- Auto-cue function
- Rear panel dip switches for studio customization
- Includes RC-7 remote, optional RC-701 remote for use with multiple CD-701s

Big production value in a compact CD player that comes complete with an advanced full-featured remote control unit. The best CD player TASCAM makes, the CD-701 features 16-bit linear quantization, outstanding audio specifications, linear motor-driven pickups and programmability. Plus, multiple CD-701s can be linked for coordinated playback.

\$2,499.00 List Price

CD Players/Recorders/Accessories



Why MD for TV?

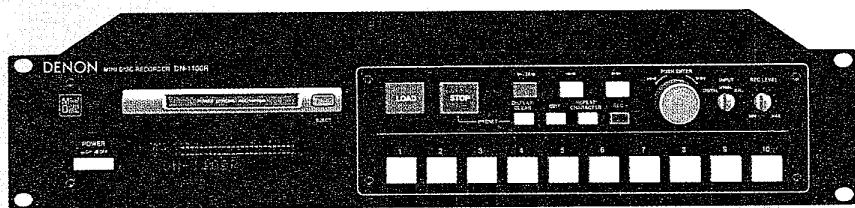

Great for TV news and live shows: Denon's DN-1100R MiniDisc Recorder has 10 independent HOT START buttons on the front panel allowing any combination of 10 tracks to be assigned from a total of 255 tracks per disc. Want a quick access to a sports theme or personality sound-byte? Press the HOT START key and it is instantly played back. Lengths of tracks are inconsequential. Want a new track assigned? Just replace it with a new track.

The DN-1100R also has PARALLEL REMOTE SUPPORT. It has a 25-pin port on the rear panel to which an optional external Hot Start Control Box can be connected. All this performance is made available by THE MiniDisc company, Denon.

•**Recordability.** MD is a universal recording/playback standard, regardless of make or model with the ability to re-record over a million times without signal degradation. No other medium, analog or digital, has this capability.

•**Portability.** Eliminate the need for expensive networking. MiniDisc gives you the ability to hand carry, mail, or deliver a medium to another facility, edit bay, production room, etc.

•**Archiveability.** New findings have revealed DAT tape to have a shorter life span than originally specified. Don't take chances, use MD to archive and backup all your audio needs, including hard disc audio.

•**Instant Access.** It's faster than the quickest DAT or analog tape. Electronic labeling provides access to any one of 255 tracks and title information on a MiniDisc within 0.8 seconds.

•**Performance.** Quality equal to that of CDs. Compared to analog tape dubs, MiniDisc vastly exceeds all performance specs.

Why NOT?



Operators will feel right at home with DN-980 Cart Player Series from Denon. They are user-friendly and easy to setup. Installs in less than 30 minutes. Anyone comfortable operating a CD Cart machine will adjust to MiniDisc with ease.

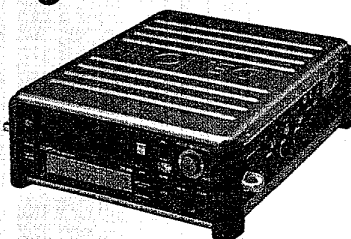

The portable MiniDisc recorder/player from Denon is the DN-80R. Take a full-featured MiniDisc system with your remote unit for easy electronic news gathering, complete with field editing capability.

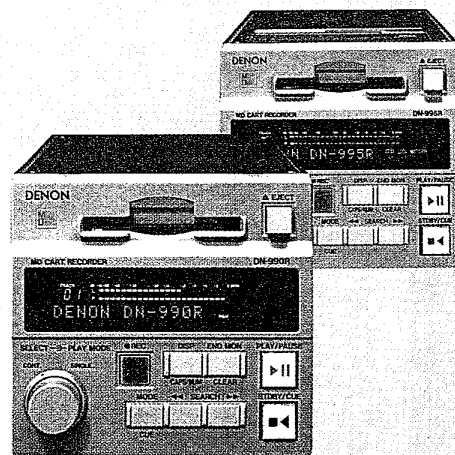

Denon's DN-990 Cart Recorder Series is a digital alternative to NAB Cart machines and more economical when compared to other cart machines. Major advantages include instant start, digital editing, and superior fidelity.

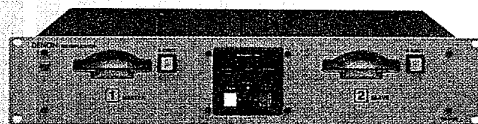

Make exact duplicates for professional replication with the DN-045R from Denon. Make dubs up to 3.5 times faster than real time. Includes a unique defragmenting feature.

Call Today!
1-800-622-0022

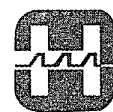

HARRIS

© 1996 Harris Corp.



**AEQ
BC-300 Console**

The BC-300 console, winner of the "COOL STUFF AWARD NAB '96", a professional On-Air Console, is loaded with standard features such as built-in telephone hybrid and audition stereo speakers. Also comes with a built-in power amplifier 10W/channel for studio monitors, a built-in talk-back microphone and a headphone connector. All these features are standard in the practical and modern layout of the two versions, at an extremely competitive price.

\$2,795.00 List Price BC312
\$1,975.00 List Price BC306



**AEQ
TLE-02 Mixer**

The TLE-02 from AEQ integrates a digital hybrid with frequency extender and mic/line mixer. This compact unit provides two-input mixing (mic/line and a line AUX.), a front panel telephone key pad. High performance hybrid, easy to operate, connects to the phone line by standard phone connector. The frequency extended mode requires two units (send/receive) with full duplex extension capability. Compatible with most analog frequency extenders in the market.

\$1,130.00 List Price

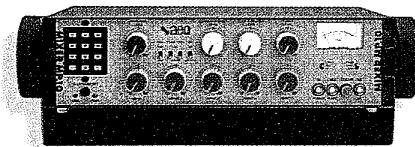

**AEQ
MP-10 Portable Mixer**

A compact and flexible unit for demanding remotes. Five XLR transformer balanced inputs support mic and line with selectable phantom power. Three headphone output jacks. Internal Nicad battery provides 4-hour autonomy cycle. Features two XLR audio outputs of 20 Hz - 20kHz. A front panel dialing pad and a standard phone connector facilitate phone line communications. Supplied accessories: carrying case, phone cable connector and 5-pin XLR connector and Mic connector adapter.

\$1,495.00 List Price

Consoles/Mixers

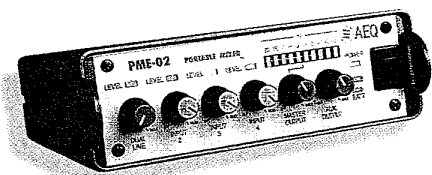

**AEQ
PME-02 Portable Mixer**

Excellent audio quality at an affordable price. Successfully introduced at NAB '96, designed to make your remote transmission problem free. Features four inputs: Three mic/line selectable inputs (optional transformer balanced) featuring the new XLR 1-1/4 inch female connector. The fourth input is stereo line with mini-jack connector. Level control per input on the front panel. Two outputs with level control. VU meter for the main output. It can be connected to the AEQ Telephone Line Extender, the TLE-02, to send the mixed audio to the studio via telephone line with superb audio quality or it can easily be connected to another PME-02 to enhance the number of inputs. Portable carrying case included. It works with 8 optional AA batteries, external power supply or car cigarette lighter adapter. Great price!

\$445.00 List Price

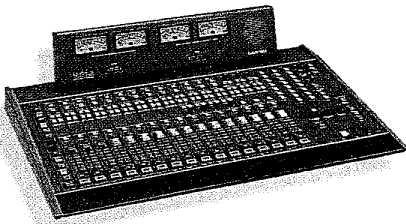

**Auditratics
NuStar 3000 Digital Audio**

The first USEABLE and AFFORDABLE Digital Audio Console for Broadcast Radio represents the merging of requested operational functions with digital technology. The console system consists of the "control surface" console mainframe, and the "digital signal processing electronics" rack-mounted unit. The NuStar console looks, acts, and feels just like the control surface your operators are used to. It is fully modular and ready for the upgrade path. It has extensive self, user, and remote test capability. Technical highlights include: digital input AES-EBU receivers handle professional and consumer formats. Internal digital signal processing has optional sample-rates with up to 24-bit data formats and 80-bit accumulators. Analog inputs and outputs are stereo balanced line level using delta-sigma A/D and D/A conversion with internal 64X oversampling. NuStar digital is noticeably cleaner and quieter.

Pricing Upon Request

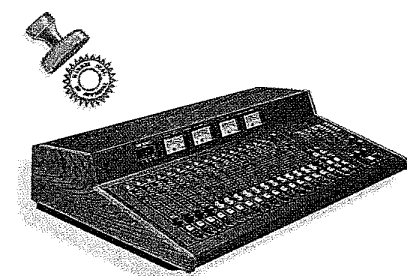

**Auditratics
2500 Series Radio Console**

A small footprint audio console with features for Radio On-Air/Production with music or talk formats. Stereo program, audition, and 2 mono mix-minus buses round out this value-priced, compact and flexible audio control system. 6, 12, 18, and 24 input mainframe sizes and a 10 input mini-mixer style are available with table-top or drop-in options. The 2500 series has the most extensive user-programmable logic control system in its class and audio specifications as required for Digital Audio Broadcasting. This is an incredible package for the dollar.

Model 2500-6 Console \$4,345.00 List Price
Model 2500-12 Console \$6,495.00 List Price
Model 2500-18 Console \$8,595.00 List Price
Model 2500-24 Console \$10,695.00 List Price



QUINTESSENTIAL

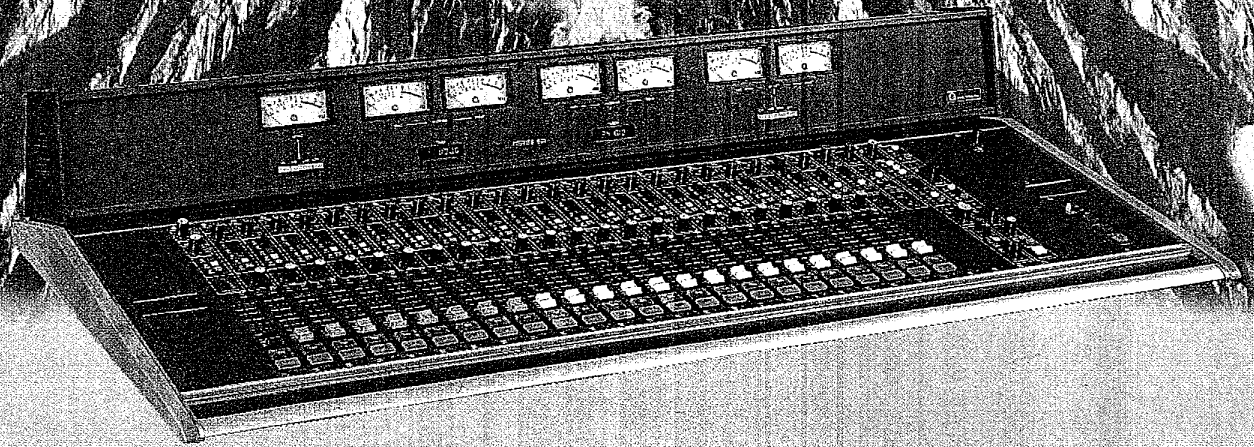

The 801 Series in Every Way

When you need the Best Audio, Auditronics has it. The 801 Series has just what you need. Extremely Versatile and Flexible and yet Simple to operate. Absolute Top of the Line quality in every detail with Buses, Logic and Features galore.

- ◆ 12, 18, 24 Input Position mainframes
- ◆ Stereo Program and Audition with separate Voice and Music buses
- ◆ Stereo Utility bus and pot mix stereo Auxiliary bus
- ◆ 2 Mono Mix/Minus buses
- ◆ Options include:
 - ◆ Mono/Stereo Equalizers
 - ◆ Compressor/Limiter
 - ◆ 10 position Line Selectors
 - ◆ Multiple dual Studio Output modules with Talkback
 - ◆ Multi-channel Intercom system with Remote Stations

The 801 has the most extensive logic control system in its price range and console specification exceed those required for Digital Audio Broadcasting. Get your Best Audio from Auditronics, with 30 years of Customer Commitment and Service.

QUINTESSENTIAL 801, LOOK IT UP!

AUDITRONICS

3750 Old Getwell Road, Memphis, TN 38118 USA
(901) 362-1350 FAX: (901) 365-8629
GSA Contract #GS-03F-4032B

CE Compliant

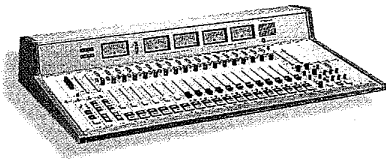

**Auditrronics
210 Series Radio**

The 210 Series is the industry standard drop-in audio console for on-air broadcast and has been designed with exceptional quality and long term reliability at a very attractive price. Available in 6, 12, 18, 24 input mainframe sizes, it covers any application from a newsroom environment to large multiple studio installations. Each mainframe has nine accessory positions for the large assortment of optional modules available. The 210 is totally modular, with 2 Stereo and 2 Mono Output buses and comes standard with built-in Cue speaker and Headphone outputs. High quality linear faders control VCA's on each input and a complete user programmable logic system is standard.

Pricing Upon Request

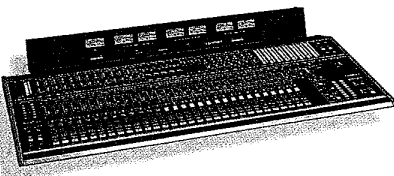

**Auditrronics
851 Series TV On-Air**

This versatile on-air and production audio console is designed for live, interactive television audio. Available in 12, 18, 24, and 30 input position mainframes, the 851 includes stereo program and audition buses, a stereo utility bus, and 2 mono mix/minus buses. Also included is an independent pot mix stereo auxiliary bus, highly useful for talent foldback, and a communications bus. Stereo input module options can handle stereo microphones and can process 2 channel Audio. Other optional modules include mono/stereo equalizers, compressor/limiters, 10 position line selectors, multiple dual studio output modules providing monitoring and IFB, and a multi-channel Intercom system with remote intercom stations for rack, wall, and desk mounting. A distribution amplifier module is available. The 851 has the most extensive user-programmable logic control system in its price range and console specifications exceed those required for digital audio broadcasting.

List Prices Vary



**Auditrronics
310 Series TV
On-Air Console**

The 310 Series is

versatility in action-it smoothly handles on-air needs and heavy production in the same package. Four auxiliary buses with pre/post and on/off switching, handle the mix-minus needs with IFB capability and the built-in cue and solo handles the operator's needs. In production, the console can be a 4 or 8 track recording console with inputs with full mono or stereo equalization, high/low filtering, and submaster outputs with over-dub/remix capabilities. Four input fader groups with master mute are standard to ease massive console changes on the fly. Mic modules feature front panel gain, phase and phantom with an overload indicator. Great specs and a lot of console.

Model 310-16-4 \$17,530.00 List Price

Model 310-16-8 \$20,555.00 List Price

Model 310-24-4 \$19,785.00 List Price

Model 310-24-8 \$22,845.00 List Price

Model 310-32-4\$26,310.00 List Price

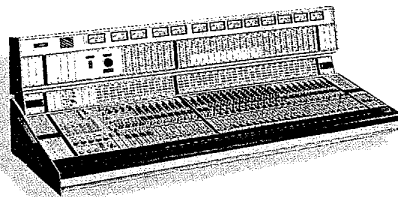
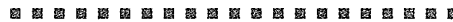

**Auditrronics
900 Series**

The Auditrronics 900 Series console is specifically designed and configured for television audio applications. Its computer controlled input preselect system sets it apart from other consoles. It can directly address your house router system or stand alone with 64 set-up memories with recall and supplied with optional alpha-numerical read-outs for each input module. The 900 Series consoles are available in 24, 32, and 40 input mainframe configurations, with 8 submaster output and 2 master output capability. Standard features also include 4 AUX sends and returns, 4 group master faders, VCA fader control, cue, stereo solo, stereo monitoring, phantom mic power and a complete metering package. There is a wide range of optional accessory modules available.

900 pkg. 1 \$55,200.00 List Price

900 pkg. 2 \$64,030.00 List Price

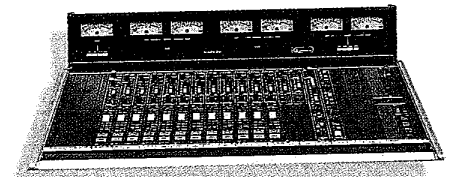

**Auditrronics
801/851 Series Radio
On-Air Console**

The absolute top of the line on-air and production audio console for radio is loaded with extras. Available in 12, 18, 24, and 30 input position mainframes, the 801/851 includes stereo program and audition buses with separate voice and music signal paths, a stereo utility bus, an independent pot mix stereo auxiliary bus, and 2 mono mix/minus buses. Options include mono/stereo equalizers, compressor/limiters, 10 position line selectors, multiple dual Studio Output modules providing monitoring and IFB, and an integrated multi-channel Intercom system with remote intercom stations for rack, wall, and desk mounting. Even a distribution amplifier module is available. The 801/851 has the most extensive user-programmable logic control system in its price range and console specifications exceed those required for digital audio broadcasting.

Pricing Upon Request

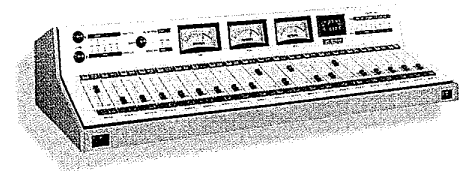
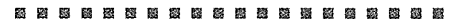

**Autogram
R/TV 20 Console**

The R/TV 20 is Autogram's top-of-the-line console that can literally run itself! With 20 dedicated pots, etched panel, and full RF shielding, R/TV 20 can be found in many major-market stations. With the optional live-assist package the R/TV 20 can run itself and your machines, and can even be controlled via RS232 from your computer. An internal silence-sensor minimizes audible mess-ups! Call your Harris rep for more about the amazing R/TV 20.

\$13,451.00 List Price

Consoles/Mixers



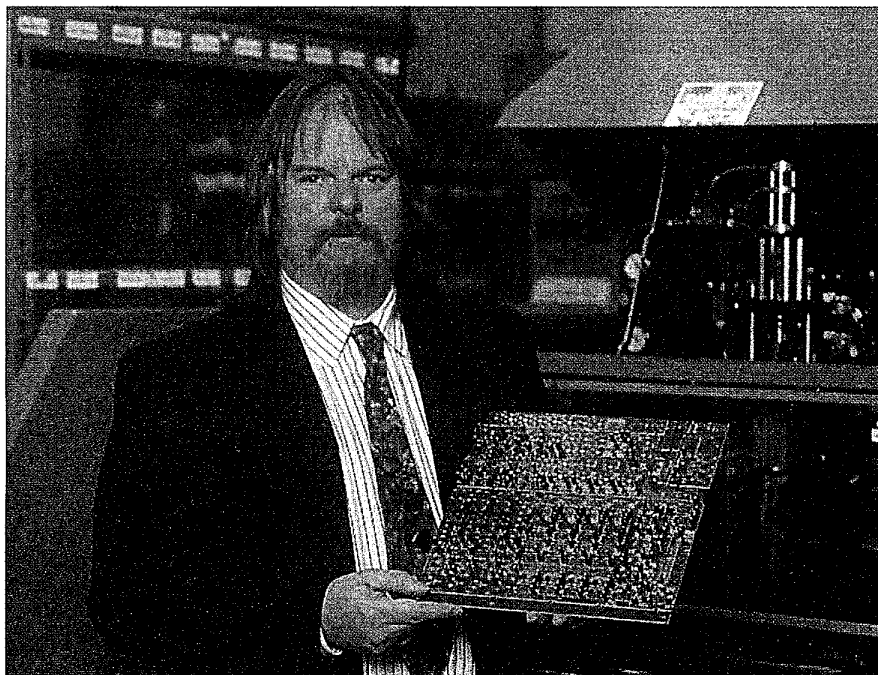

Mixing it Up For 29 Years- The Mackie Story by Greg Mackie, Mackie Designs

From the day we started Mackie Designs, we've done things differently than the big, established mixer companies — we've never been satisfied with just doing things "the way they've always been done." So we've pioneered new features, new technology and new production methods, all in the quest to make products that satisfy three objectives: extremely high sonic quality, legendary reliability, and the best value around. In fact, that's been my mandate for nearly thirty years.

I co-founded TAPCO (Technical Audio Products) in 1969 because back then you couldn't find a mixer able to handle rock 'n' roll. The first mixers we made were admittedly primitive compared to what we make today. But people said they had the features and headroom they wanted, at prices they could afford.

For the last seven years with Mackie Designs we've been creating highly-usable mixers that have found their niches in a number of areas. Broadcasters use them, from network TV and top market radio stations to high school broadcast programs. Multimedia artists use them to make CD-ROMs and interactive web sites. You'll also find Mackie mixers in home project studios and recording studios, churches and school auditoriums, and probably in some weird places our copywriter can't even come up with. How do we satisfy so many demanding users? By designing mixers that fill their needs. To do that we use manufacturing methods that let us produce large enough quantities to make our feature-packed mixers extremely affordable. The radial, axial and surface-mount parts insertion machines we use do in minutes what used to take hours, and allow us to achieve a density of parts unequaled by many other manufacturers.

And let's not forget reliability. We accomplish this in two ways: by using premium parts (bought in large quantities), and by installing quality-control measures at every step of the manufacturing process. Consequently, out of the box we have a very small failure/repair/ replacement rate. And over the years, too, Mackie mixers rarely come back for service. We know that anyone plunking down the bucks for a mixer wants a high quality unit that delivers great sound, is easy to use, and is a real value. That's because we listen to what users want. Through warranty card comments, through our own employees — many of them use mixers regularly — and through the good ol' telephone line, we hear you.

Use a Mackie mixer — for remote broadcasts, for in-studio production, or for field recording — and you'll see just what we mean. All of our mixers were designed with Very Low Impedance (VLZ) architecture for extremely low noise. We created incredibly low-noise mic preamps that deliver the dynamic range and low-noise specs required for use with DAT, MiniDisc, and other digital media. And all of our mixers feature balanced inputs and outputs for trouble-free use with pro and semi-pro equipment. (Examples of the various types of connections, including the little-known Jovian Cyberplug, can be found on page 259 of this catalog.)

All of our mixers have phantom power, too, so whether you use condenser mics regularly or only once in a blue moon, you'll have the power necessary to operate them. We know that RFI is a nuisance, so we use metal jacks, internal shunting capacitors and the mixer's own chassis to dissipate the noise before it gets into your mix.

Anyone who's ever used a mixer knows you can never have too many routing options, so our MS1202-VLZ and MS1402-VLZ have something we call Alt 3-4, which turns a 2-bus mixer into a 3- or 4-bus. And the Control Room/Phones matrix gives you lots of monitoring, mixdown and metering options.

Finally, should you need to perform a little "aural surgery," all of our mixers include 3-band EQ, low cut filters (on mic channels) to effectively reduce mic thumps and wind noise, and PFL/AFL (Solo In Place) Solo for cueing sources before they hit the faders or after effects. (The MS1202-VLZ has PFL only.) Our log-taper faders deliver consistently smooth fades throughout the fader path. (The MS1202-VLZ uses our ultra-quiet rotary pots.)

As we grow into other areas of the audio market — including active studio monitors, power amps, digital mixers, and more — we will continue to design products that live up to our users' expectations. We know we couldn't have gotten to where we are today without their input. And output.

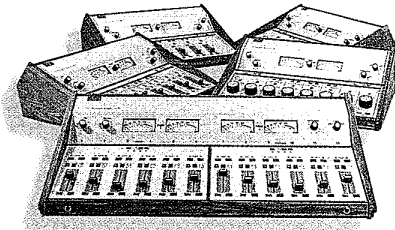

ATI Vanguard Series Consoles

These consoles from ATI are unique because most functions are controlled with raised, silent membrane switches which replace conventional trouble-prone push-button and lever key switches for input selection and bus assignment. The legends are color graphics behind a tough polycarbonate overlay. The front panel hinges for access to the plug-in amplifier modules and punch-block audio connections. Available with rotary (R) or linear (L) faders for the 6 and 8 channel models and linear faders in the 12 channel model. Each console includes dual stereo program outputs, each with a mono mix, dual VU meters switchable between program outputs. The 12 channel model includes four VU meters which monitor program 1 (L + R) and 2 (L + R) simultaneously.

List Prices Vary

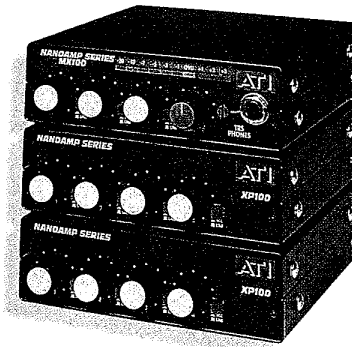

ATI MX100/XP100 Nano Amp Series

The NANOAMP SERIES™ mixers allow you to configure your setup to your unique requirements. The MX100 is a three channel switchable microphone/line mixer with low noise balanced inputs, phantom power, an adjustable headphone output and a metered +22dBm, low distortion line output. Input capability can be increased using one or several XP100 expanders. Each XP100 adds four switchable microphone/line inputs and includes all DC and audio interconnect cables.

\$359.00 List Price MX100XLR
\$289.00 List Price XP100XLR



ATI MXS100/XPS100/XPS200

The MXS100 is a studio or portable, three channel, switchable microphone/line mixer with low noise balanced inputs, phantom power, pan pots, switched low cut filters and a test tone oscillator driving stereo, metered, low distortion servo balanced line outputs with switchable peak limiting. A stereo 100mW headphone output is switchable from normal stereo program to split L+R / Q monitoring. The headphone Q feed is internally selectable from any input channel and/or an external cue input jack.

Expand the MXS100 mixer with an XPS100 for four additional microphone inputs with pan pots or combine with the XPS200 to add two stereo line level inputs. Use multiple input expanders to precisely meet your requirements. Expanders include all audio and DC interconnects.

List Prices Vary

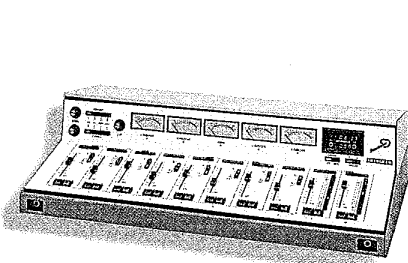

Autogram Pacemaker 1032

The Autogram Pacemaker 1032 with 10 pots and 32 total inputs is designed to meet the demands of live on-air, 24-hours a day service. Features include independently selectable program, audition, and mix-minus buses, easy plug-in connections, jumper-selectable muting and cueing options, Penny and Giles slide faders, machine control outputs, and our etched, no-rub-off front panel.

\$7,527.00 List Price

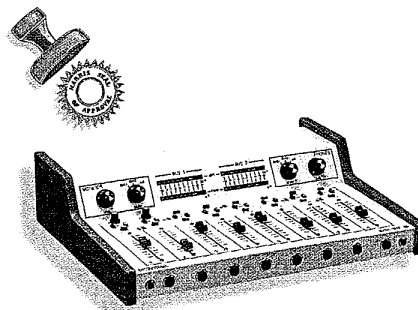

Autogram Mini-Mix 8A Mixer

With the Autogram Mini-Mix 8A, there's no need to give up needed features such as monitoring muting, stereo pots, on-air light relay contacts, or on-air monitoring. The Mini-Mix also features dual stereo buses, remote starts, and an internal cue speaker. Our low-noise VCAs result in smooth, noiseless audio fades. The Mini-Mix 8A features 2 mic inputs, 6 stereo balanced professional inputs, and 6 stereo unbalanced inputs as well as balanced and unbalanced outputs plus a mono sum.

\$2,499.00 List Price

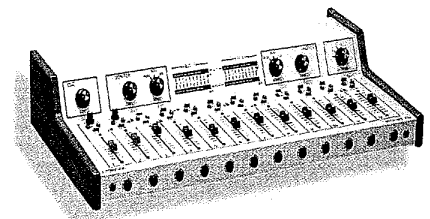

Autogram Mini-Mix 12A

Autogram's top-selling console, the Mini-Mix 12A, is the answer for today's small to medium market stations. It has all the true radio console features of the Mini-Mix 8A and more. A total of 2 mics plus 25 stereo inputs (15 balanced and 10 unbalanced) means plenty of room for all your audio sources. Couple that with Autogram's 2-year limited warranty and great tech support and you'll see why the Mini-Mix is 12A is so popular.

\$3,499.00 List Price

Consoles/Mixers



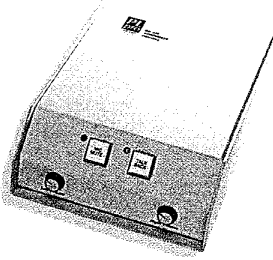

**Clear-Com
AB-100 Announcer's
Console**

Clear-Com's PL-Pro Announcer's Console is a compact desktop unit designed specifically for sports, live event broadcasting, and voice-over work. The AB-100 integrates all of the inputs, outputs and controls necessary at the announce position, including intercom "Talkback," IFB, and a silent "Mute" button that provides noise-free "cough" and "mic on/off" switching. Since many announcer applications have unique requirements, the AB-100 is designed so that all connectors and volume controls can be easily changed, and the console's physical construction lends itself to easy customization. Complete, easy-to-understand documentation makes configuration and customization simple. **\$925.00 List Price**



**Electro-Voice
ELX-1A Broadcast Mixer**

The ELX-1A mixer is a compact, high-performance audio mixer designed for professional applications where clean audio is a must. It has extensive rf shielding which makes it ideal for broadcast applications. The ELX-1A incorporates a 1-kHz oscillator, a headphone output for monitoring, and a switchable limiter to prevent clipping. **\$625.00 List Price**

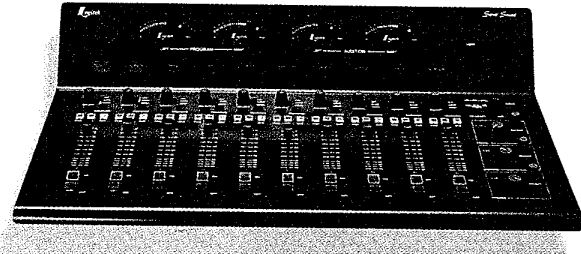

**Logitek
Serial Sound On-Air Console**

The Serial Sound is a digital console featuring a rackmount audio engine with up to 64 stereo inputs and outputs. Built-in routing allows any input to appear on any slider of the separate tabletop control surface. Analog ins and outs are handled with 20-bit conversion and each digital input has a sample rate converter. Four serial ports are provided for direct connection to computer automation and hard disk systems. **\$7,000.00 List Price**

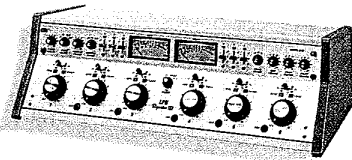

**LPB
Signature III Audio
Consoles**

Designed and manufactured to a high level of operational capability and electronic/mechanical reliability for the on-air and production requirements of the professional broadcaster. Extensive human engineering and over 20 years of experience in console design have been combined to provide the operator with a console which is both visually appealing and easy to operate. Internally the approach is similar, with immediate visual identification and ease of access to every component and connection in the console. **List Prices Vary**

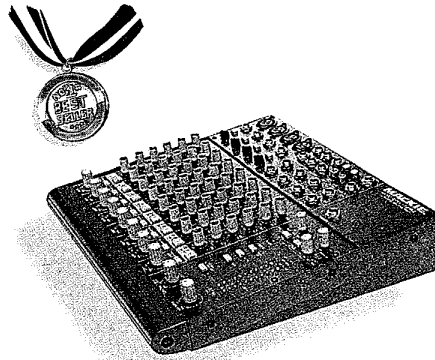

**Mackie Designs
1202 VLZ**

The updated MS1202-VLZ features 4 low-noise/high-headroom mic preamps, 3-band EQ on all channels, and Low Cut Filter (75Hz, 18dB/oct) on mic channels. This compact mic/line mixer uses Mackie's VLZ — Very Low Impedance — design, with balanced inputs and outputs, extreme RF rejection, and balanced XLR outputs. The Mute/Alt 3-4 lets you use a channel's mute button to route that channel to an extra stereo (or 2 mono) bus. Also includes global 48V phantom power and PFL Solo. Optional rack rails available. **\$429.00 List Price**

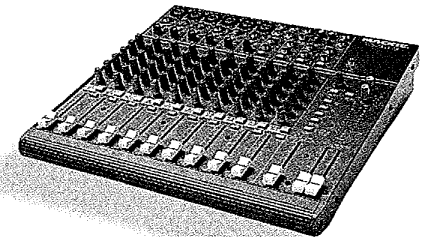

**Mackie Designs
1402 VLZ**

MicroSeries 1402-VLZ audio mixer 6 low-noise/high-headroom mic preamps and log-taper faders make it an audio pro's dream. Mackie's 60mm faders provide a consistent fade throughout the fader's path. The 1402-VLZ has a Low Cut Filter (75Hz, 18dB/oct) on each of the 6 mic channels, 3-band EQ on all channels, and Mackie's VLZ — Very Low Impedance — design. Also included are balanced inputs and outputs (with balanced XLR outs), extreme RF rejection, 48V phantom power, PFL/AFL solo, and major routing flexibility. Optional rack rails available. **\$599.00 List Price**

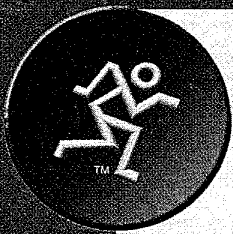

VLZ MICROSERIES: SMALL MIXERS WITH WHAT IT TAKES TO HANDLE SERIOUS PROJECTS.

MICRO SERIES
1202 VLZ
4 MONO CHS.
4 STEREO CHS.
\$429*

MICRO SERIES
1402 VLZ
6 MONO CHS.
4 STEREO CHS.
\$599*

CALL TOLL FREE FAX OR E-MAIL FOR YOUR 40-PG "IN YOUR FACE" COMPACT MIXER TABLOID AND APPLICATIONS GUIDE

*suggested U.S. retail

BOTH MODELS HAVE:

Studio-grade mic preamps with discrete circuitry for high headroom, low noise (-129.5 dBm E.I.N.) and wide frequency response (over 300kHz).

Low Cut filters (18dB/oct. @75Hz) on mono mic/line channels allow use of low-frequency EQ on vocals without boosting room rumble, mic thumps, P-pops and wind noise.

Trim Controls on mono channels have 60dB total gain range for boosting weak sound sources and a 10dB "virtual pad" for taming hot digital multitrack outputs.

2 Aux Sends per channel (one globally switchable pre/post, one post-fader), each with 15dB of gain above Unity to boost weak effects.

3-band equalization with 12kHz High shelving EQ, broadband musical 2.5kHz peaking Midrange & 80Hz Low shelving EQ.

Constant loudness pan controls.

Stereo in-place Solo.

Mute button routes signal to "bonus" Alt 3-4 stereo bus outputs & Control Room matrix. Handy for both recording and live applications.

MS1402-VLZ ONLY: 60mm logarithmic-taper faders based on our exclusive 8-Bus design. Long-wearing wiper material and tight polymer lip seals to protect against dust & other crud.

Built-in power supplies — no outlet-eating wall warts or hum-inducing line lumps.

Phantom power so you can use high quality condenser microphones. XLR outputs with mic-line level switch (along with 1/4" TRS outputs on top panel).

MS1202-VLZ • 12x2 • 4 MIC PREAMPS



MS1402-VLZ • 14x2 • 6 MIC PREAMPS

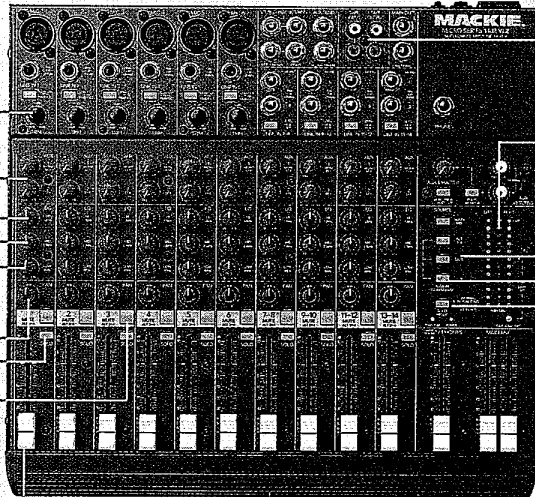

All inputs & outputs are balanced¹ to cut hum & allow extra-long cable runs, but can also be used with unbalanced electronics. ¹except RCA tape jacks, headphone jack & inserts.

VLZ (Very Low Impedance) circuitry first developed for our 8-Bus console series dramatically reduces thermal noise & crosstalk in critical areas.

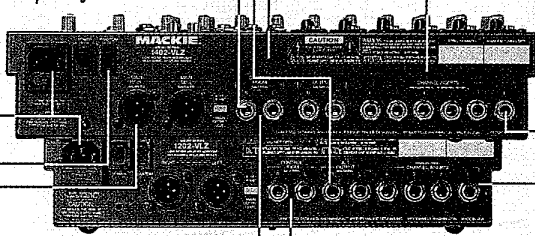

Control Room outputs feed monitor speakers without tying up the headphone jack.

BOTH MODELS HAVE:

Radio Frequency Interference protection via metal jacks & washers plus internal shunting capacitors.

High-output headphone amp can drive virtually any set of phones to levels even a drummer can appreciate.

Aux I Master level control & pre/post switch.

Effects Return to Monitor switch folds Aux Return 1 effects into a stage monitor mix via Aux Return 2 level control.

RCA-type tape inputs & outputs.

Peak-reading LED meters with Level Set LED combined with In-Place Solo allows fast, accurate setting of channel operating levels for maximum headroom and lowest noise floor.

Control Room/Phones Matrix adds monitoring, mixdown & metering flexibility. Select any combination of Main Mix, Tape In and Alt 3-4 signals for routing to phones, Control Room outputs and meters. Can be used as extra monitor or headphone mix, tape monitor, or separate submix. Way cool.

Tape Assign To Main Mix assigns unbalanced RCA tape inputs to main mix. Besides its obvious use as a tape monitor; it can also add an extra stereo tape or CD feed into a mix or play music during a break. MS1402-VLZ only: Global Solo Mode selects PFL or AFL solo modes.

Solid steel chassis & thick fiberglass internal circuit boards resist abuse. Channel inserts on mono channels.

Not every production project requires dozens of input channels and boatloads of buses.

But doing ANY audio job well requires a mixer with superb specs...and the right combination of useful features.

Our MicroSeries 1202-VLZ and 1402-VLZ might have small footprints, but when it comes to performance, they walk very tall.

Since both are basically chips off our blockbuster 8-Bus Series consoles, they have big-board specs:

greater than 90dBu signal to noise ratio, less than 0.005% distortion, more dynamic range than compact discs and frequency response that's only down 1dB at 60,000 Hz.

Why own an imitation when you can own the brand of compact mixer that serious pros prefer. Call for info today.

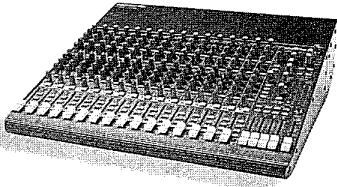

**Mackie Designs
CR1604VLZ**

Updating Mackie's classic CR-1604, the CR1604-VLZ is a true 4-bus mixer. It's got 16 low-noise/high-headroom mic preamps, as well as low cut filters (75Hz, 18dB/oct) for cutting out mic thumps and wind noise, and 3-band EQ with sweepable mids (100Hz-8kHz) on all channels. 60mm log-taper faders make for consistent fades, and the Very Low Impedance — VLZ — design makes it a low-noise marvel. It has 6 aux sends per channel, PFL/AFL Solo function, 48V phantom power, and much more.
\$1,199.00 List Price

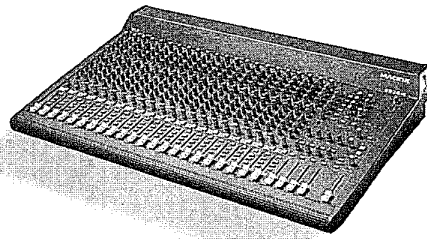

**Mackie Designs
SR24X4**

The SR24•4 is a 4-bus live sound mixer with major capabilities. It has 20 mono channels, each with low-noise/high-headroom mic preamp, 3-band EQ with sweepable mids (100Hz-8kHz), 6 aux sends with 2 switchable pre- or post-fader, and Low Cut Filter (75Hz, 18dB/oct). Stereo channels have 4-band EQ. All channels have inserts, 48V phantom power (mono channels), and incredible routing capabilities. Subgroups have Mackie's "AIR" EQ circuit for extra sheen and clarity. Balanced inputs and outputs, with stereo XLR outs and separate Mono XLR out (with level control).
\$1,599.00 List Price

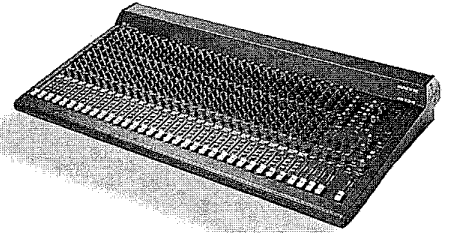

**Mackie Designs
SR32X4**

Like the SR32•4, except the SR32•4 has 28 mono channels with low-noise/high-headroom mic preamps. It also features 3-band EQ with sweepable mids (100Hz-8kHz) and low cut filters (75Hz, 18dB/oct) on mono channels. (Stereo channels have 4-band EQ.) Of course there is 48V phantom power for condenser mics, balanced inputs and outputs, stereo XLR outs and separate mono XLR out (with level control). The "AIR" EQ circuit adds top-end clarity. Routing capabilities are practically endless.
\$2,299.00 List Price

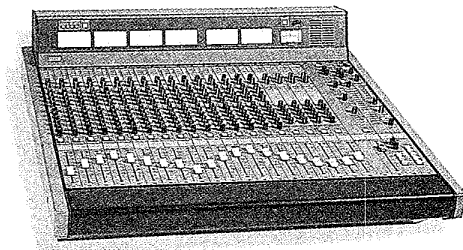

**Otari
B-1024-10064**

The Otari B-10 broadcast audio mixing console is compact but fully featured. Custom configurations using any combination of VCA controlled mono or stereo input and group modules allow for fader start/stop and external control. These modules, in combination with the master, monitor and talkback/oscillator modules, allow the board to function as either a high quality off-line production console or on-air board.
\$31,490.00 List Price



**Radio Systems
RS Series Console**

10,046* and counting! That's how many RS-Series consoles have been sold to broadcasters around the world since they were introduced just over 5 years ago. Many stations have bought 4 or 5 of these super-dependable and super flexible consoles. RS-Series consoles are so popular because they are such a good value. Right out of the box they provide;

- 6, 12, 18 or 24 channel capacity
- mic thru line level on every input
- 3 output buses
- full metering and monitoring
- fully programmable logic and complete remote control

Radio Systems consoles continue to set the standard for affordability, value and performance.
List Prices Start At \$4,795.00 (for RS-6)

*as of 1/1/97



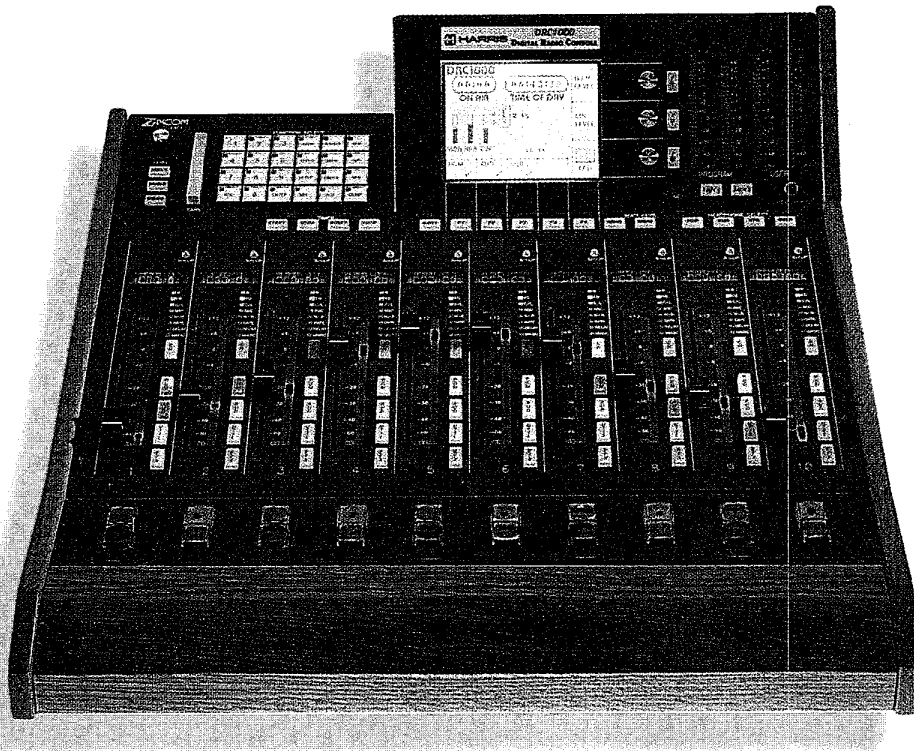

Harris DRC 1000 Digital Console

Why settle for second best? Get the console that surpasses the rest!

Maximize your potential with the Harris DRC1000 digital audio console. This high powered digital console delivers "state of the art" capabilities in a secure and reliable user friendly design. The DRC1000 provides you with the high level of digital sonic quality you expect. Standard features on the DRC1000 include 11 stereo (22 mono) AES/EBU digital inputs, 5 band parametric EQ available on each channel, pan, compressor/limiter, AGC, internal sample rate conversion, 7 stereo (14 mono) output busses, output in simultaneous analog and digital, and much more. These features are all made possible by utilizing 32 bit internal precision Floating Point DSP Technology. The DRC1000's six (6) Sharc DSPs have plenty of processing power. This allows us to offer options like reverb, pitch shift, delay, while maintaining future growth capacity.

Do you have someone that wants their microphones on the right side of the console during their air shift? Digital makes it easy! Why spend hours reconfiguring your hardware. You can reconfigure your console to match your needs in just seconds! Easy to read on-screen graphics, LED source labels, and lighted soft keys make it simple. The DRC1000 utilizes Penny and Giles 4" faders with cue detent. You have instant access to multiple user configurations which can be stored internally or externally on PCMCIA slot cards. The DRC1000 has 16 GPI inputs and 20 GPI outputs for complete contact closure control.

No matter what the future holds in store for your operation, the DRC1000 will keep in stride. It is designed to be expandable and grow as you do. Additional 10 channel fader bank, and audio processing units may be added. The system even has a built-in security system to allow you peace of mind. Today's digital products offer us new levels of efficiency never before thought possible. All of these capabilities in a reliable, yet easy to use package. Call today to see how the DRC1000 can improve your sound, your staff's capabilities, and your bottom line.

List Prices Start At \$17,995.00

Bringing Portable Mixing to the Next Level.

Impressively quiet and with more features than many mixers twice its size, the Shure FP32A set a new standard in field production.

Now comes the FP33. With new high-precision sealed input potentiometers, an improved battery switching circuit, internal headphone level adjustments, and durable 3.5mm jacks, the FP33 takes portable mixing to the next level.

Professional Mixing That Goes Wherever You Do.

The Shure FP33 is a 3-input, 2-output portable mixer specifically designed for:

- ▣ Remote audio recording
- ▣ Electronic field production
- ▣ Electronic news gathering
- ▣ Location film production

The FP33 weighs just 3.5 lbs and is about the size of two video cassettes. Providing 8 hours use with just two 9V alkaline batteries — or powered by any 12 to 30 VDC power supply — the FP33 will go wherever you do.

Quiet Enough For DAT.

The FP33 has an exceptionally low self-noise and a wide dynamic range — making it perfect for use with DAT and other digital recording media.

So Many Features In So Little Space.

The new FP33 gives you all the features of the FP32A and more, including:

- ▣ Sealed, conductive plastic input potentiometers
- ▣ Dynamic range of over 100dB
- ▣ 48V phantom, 12V phantom and 12V T (A-B) power
- ▣ LED indicators of input levels, output peaks, limiter action, and low battery
- ▣ Pop-up pan pots
- ▣ Link switch to couple inputs 2 & 3 into a stereo pair
- ▣ Mix bus to connect an additional FP33 or FP32A
- ▣ Comprehensive headphone monitoring control with MS stereo matrix
- ▣ Internal DIP switches for over 4,000 customized set-ups

If you're looking to bring your mixing to the next level, make sure to pick up a Shure FP33 portable stereo mixer.

For the Shure FP dealer nearest you, call 1-800-25-SHURE.

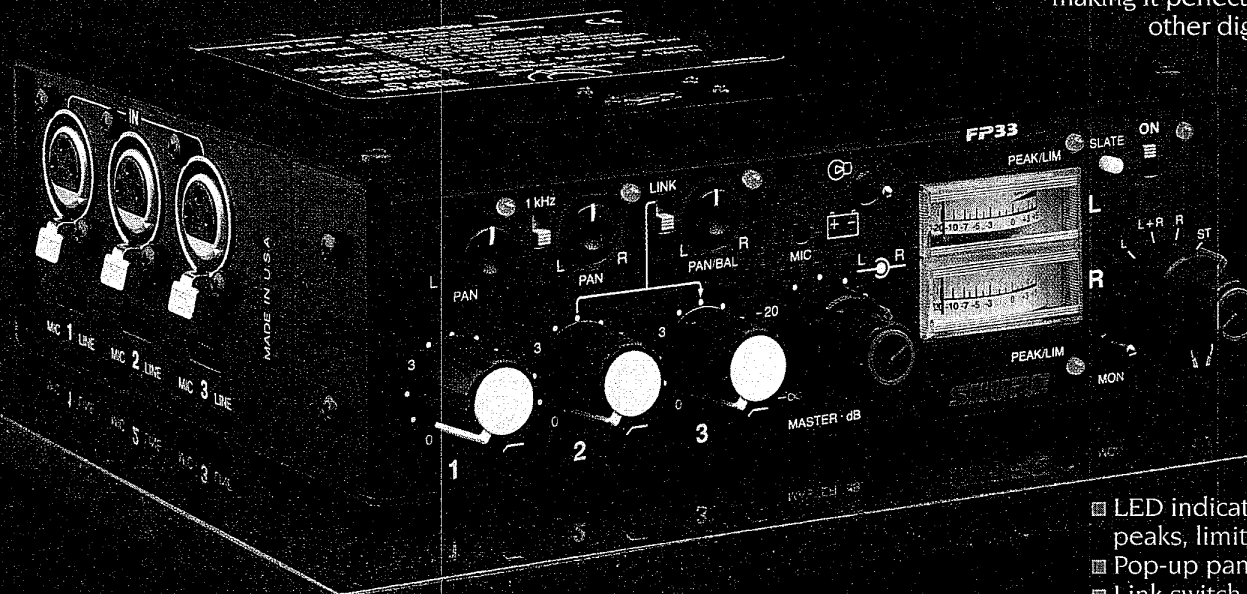

THE SOUND OF PROFESSIONALS... WORLDWIDE®

SHURE®

www.americanradiohistory.com

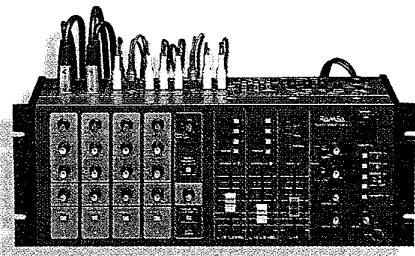

**Ramsa
WR-M10A Mixer**

The Ramsa WR-M10A is a compact yet powerful audio control center. It offers legendary RAMSA sonic excellence and reliability in a flexible package. There are 4 balanced XLR mic/line inputs. Each stereo input can handle 3 stereo line inputs and 1 stereo phono input. Auto ducking capability is built in. It can cue cart machines and send effects on all mono inputs with dedicated effects return channel. Versatile 2 band EQ on inputs and outputs, rack, wall, shelf and recessed table top mounting.

\$1,050.00 List Price

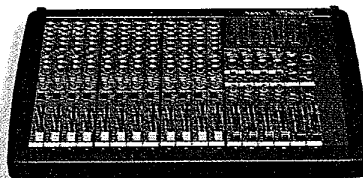

**Ramsa
WRS4412A Mixer**

Derivative of the world renowned WR-S840 tour sound console, the 4400 Series mixers offer amazing sonic purity, great flexibility and reliability. There are 12, 16, and 24 channel configurations with stereo input and matrix versions. All inputs are dual switchable and balanced. Excellent grounding eliminates hum. Noise and distortion are very low. It offers versatile 3 bank EQ. Highly durable monocoque construction.

\$1,995.00 List Price for WRS4412A

\$2,395.00 List Price for WRS4416A

\$3,195.00 List Price for WRS4424A

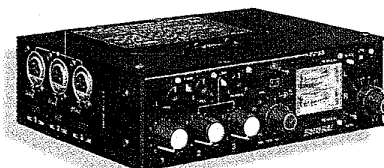

**Shure
FP-33 Mini Stereo Mixer**

The new FP33 gives you all the features of the FP32A and more, including: High-quality, sealed input potentiometers, dynamic range of over 100dB 48V phantom, 12V phantom power, and 12V T (A-B) power, LED indicators of input levels, output peaks, limiter action, and low battery. Pop-up pan pots and a link switch to couple inputs 2 & 3 into a stereo pair, mix bus to connect an additional FP33 or FP32A, comprehensive headphone monitoring control including headphone MS stereo matrix, internal DIP switches for over 4,000 customized set-ups. The FP33 has an exceptionally low self-noise and a wide dynamic range that are perfect for use with DAT and other digital recording media.

\$1,795.00 List Price

Consoles/Mixers

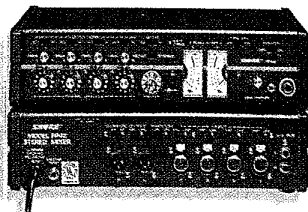

**Shure
FP-42 Stereo Mixer**

With full stereo capability, the FP-42 is perfect for mixdown in video editing suites. Four XLR transformer-balanced mic/line inputs and two outputs (one for each stereo channel). Pull-pot cueing on all inputs provides channel previewing. Lo-cut filters, mono-stereo switch, mix bus linking, headphone amplifier, tone oscillator, switchable limiter, phantom power and dual VU meters. Rack-mountable with A16R. Three standard 9-volt alkaline batteries or 120/240 VAC power.

\$1,240.00 List Price

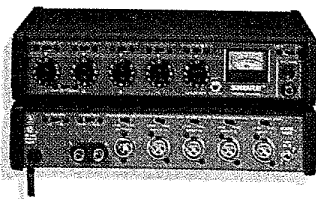

**Shure
M267 Mono Mixer**

The industry standard M267 is specifically designed for professional applications. The excellent performance, versatility and features of this complete, compact console make it an ideal choice for studio, remote or sound reinforcement use and as an add-on mixer for expanding existing facilities. It is also ideally suited for use with audio and video tape recorders to provide multiple microphone inputs.

\$625.00 List Price

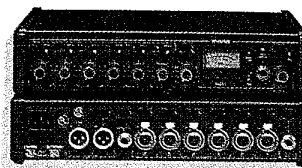

**Shure
M367 Mono Mixer**

The M367 incorporates all the M267 features and adds several new features to meet the needs of demanding field production environments. The M367 has 25dB quieter circuitry, six balanced mic/line inputs, 12- and 48-volt phantom power, input clipping LEDs, two XLR outputs, two position mix bus and easy-access side battery compartment. The M367 also has a detachable power cord, output peak/limiter LED, adjustable limiter threshold, headphone monitor circuit, power on LED, and color-coded rubberized knobs with tactile position indicators. Battery (two standard 9-volt alkaline) or 120/230 Vac power.

\$795.00 List Price

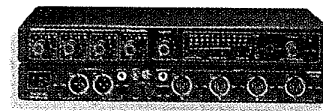

**Shure
FP-410 Mono
Automixer**

The FP410 uses Shure INTELLIMIX® to dramatically improve audio quality by providing greater gain-before-feedback, reducing the pickup of ambient noise and reverberation, and virtually eliminating comb filtering effects. INTELLIMIX® combines three key features: noise-adaptive threshold activates, a microphone for speech but not for constant room noise; Maxbus limits the number of activated microphones to one per talker; last microphone lock-on keeps the most recently activated microphone open until a newly activated microphone takes its place.

\$1,650.00 List Price



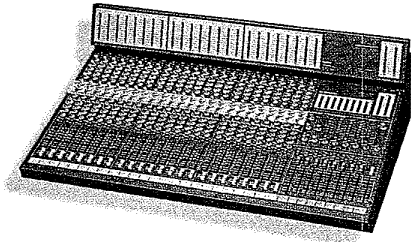

Tascam M1600/24 Mixer

Looking for the perfect console for your Modular Digital Multitrack or hard-disk recorder? The TASCAM M1600 is part of TASCAM's next generation series of recording consoles. Featuring multiple options for inputs and outputs and using the same easy-to-install D-sub cable connectors as TASCAM's top-of-the-line consoles, the M1600 packs more recording and ease of use features into a compact design. Expansion options include a meter bridge and additional MIC pre-amp circuit modules (in groups of 8). Plus, an exclusive selectable monitor function gives you more options during tracking and mixdown – ideal for live or virtual MIDI tracks.
\$1,699.00 List Price

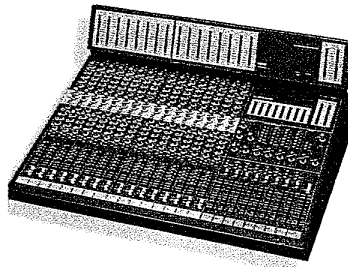

Tascam M2600/16 MK II Mixer

The next-generation 8-bus recording console, the M2600 MKII, is available with 16, 24, or 32 inputs. This insert automation-ready console features more AUXes, advanced low-noise circuitry and premium-quality mic pre-amps. Plus, its multiple recording specific features make it the ideal console for multitrack recording – and the sound decision for using with modular digital multitrack recorders such as the DA-88, DA-38 or hard disk recording systems.
\$3,199.00 List Price for 2600/16 MK II

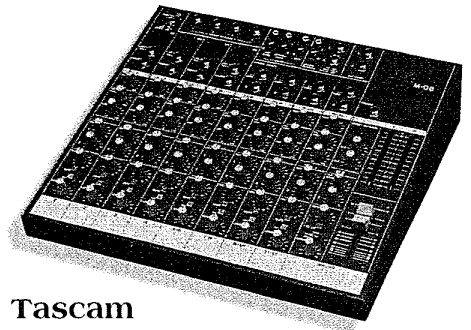

Tascam MO8 Mixer

The best choice for submixing, live recording, public address, multimedia production and other applications where a rugged and compact, full-featured, high-caliber and versatile mixer is required
\$349.00 List Price

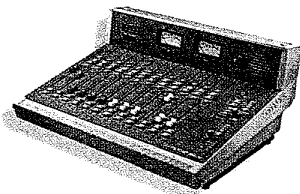

Soundcraft (Europe) RM100 Console

This modular mixer is a fully-featured and very affordable studio control package, designed for radio installation and available in a range of frame sizes to provide 8, 12 or 20 inputs configured according to customer choice. The modular design of the RM100 allows considerable flexibility in specification: inputs may be selected from mono, stereo and telco modules. A script tray is included. Principal features include program and audition stereo outputs, VCA faders on all inputs, comprehensive monitoring facilities, remote start/stop controls and, on the deluxe version, a timer and cue speaker. Output master faders are optional.

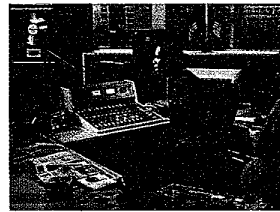

Soundcraft (Europe) Series 10 Console

Designed for on-air and production applications, the Soundcraft Series 10 is simple to use for the novice, but flexible enough for the expert. With a proven record in broadcasting worldwide, Soundcraft puts a wealth of experience into each console, giving the end user the confidence to do the job. The Series 10 is available in 12, 20 and 28 input frame sizes, with a choice of five different input modules and custom-configured meter bridge.

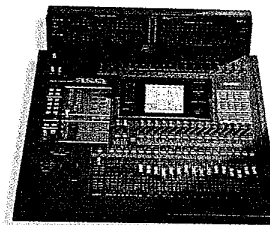

Yamaha O2R Digital Mixer

New professional 40 input, 8X2 digital recording console that is fully compatible with all major digital audio formats. Features include 32 bit internal signal processing LSIs with twin RISC CPUs, precision 20 bit AD/DA converters, full on-board automation, 64 scene memories for total recall of all parameters, digital cascading of multiple consoles, 4-band parametric equalization, 50 dynamics processors, 2 internal effects processors, 8 auxiliary buses and 100mm faders.
\$8,699.00 List Price

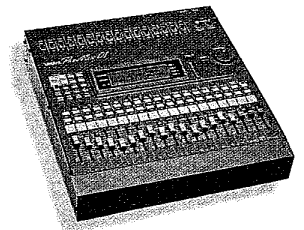

Yamaha Pro Mix 01 Digital Mixer

Professional rack mountable 16X2 digital mixing console. Features include 24 bit internal signal processing with 32 bit processing for equalization, 20 bit AD/DA converters with 64 times A/D oversampling and 8-times D/A oversampling, S/PDIF stereo digital output, 50 scene memories for total recall of all parameters, 3-band parametric equalization, 3 stereo dynamics processors, 2 internal effects processors and 4 auxiliary buses.
\$2,199.00 List Price

O2R Praise From Post Production Pros

Greg Geddes: President, Novastar Digital Sound Services. Novastar's most recent credits include THX supervised Dolby AC3 laser disk mastering of Speed, The Last of the Mohicans, My Fair Lady, Courage Under Fire and Independence Day.

"Our clients expect a comprehensive digital environment. The O2R made it possible for us to achieve an all-digital path without compromising quality or choice of work stations, digital recorders or signal processors."

Lee Murphy: Owner and Emmy Award-Winning Sound Designers Briggs Bakery.

"My pre-install concern that the O2's Automix would be difficult to master was quickly dispelled. It's powerful and it works, efficiently and friendly. I was mixing digital and analog with surprising ease."

Steve Lawson: Bad Animals/Seattle, recent credits Disney Presents "Bill Nye the Science Guy," The Discovery Channel "Goldrush" and "Klondike," PBS "The Art of Magic."

"Selecting the Yamaha O2R to replace our existing post production consoles has proven to be a win, win, win situation. Our Emmy award-winning sound design team brags about its versatility and powerful automation. Our technical staff likes its simplicity. Our bean counters love the price."

Paul Sandweiss: President, Sound Design Corporation.

"If you consider the power, size, intuitiveness and reliability of the O2R, there are no equals. There are many things I like about the O2R. The scene snapshot recall is amazing for different types of laybacks that may require alternative processing and routing, literally cutting your console setup time to zero for repeat shows that take place all the time."

Dennis Leonard: Sound Designer & Re-recording Mixer, Skywalker Sound, A Division of Lucas Digital Ltd.

"I use my Yamaha O2R console for radio & TV commercial post production at Skywalker Sound. The O2R gives me the ability to move from project to project without excessive paperwork and long set-up times. The O2R, as well as being a great performer, has a very friendly user interface."



NOVASTAR

Two Yamaha O2Rs at Novastar Digital Sound Services, Los Angeles

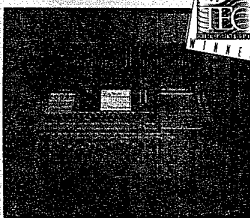

O2R
DIGITAL MIXING CONSOLE

The Yamaha O2R Digital Recording Console is a breakthrough product at a breakthrough price. For less than \$10,000, O2R is the only recording system that gives you all of these features:

- 44 Channels; digital I/O for ADAT, Tascam and AES/EBU products
- Automation and instant recall of ALL mix settings
- Integrated dynamics and effects processors

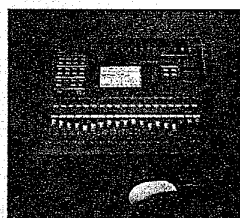

O3D
DIGITAL MIXING CONSOLE

The Yamaha O3D, available in the spring of 1997, provides all of the O2R's features in a 26 input package with a smaller footprint and a smaller price—less than \$4000. The O3D also gives you digital aux sends, surround sound, and control of external digital products—like hard disk recorders—directly from the console.



YAMAHA[®]
SMART MIXING

DAT

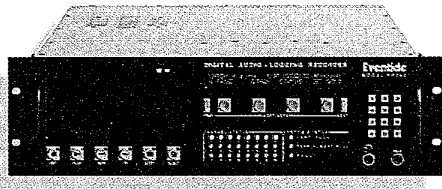

**Eventide
VR240 MarkIII Digital Broadcast Logger**

Records and plays 500+ hours divided among up to 24 audio channels, on a single tiny DAT tape. Optional 8mm drives provide even longer record times. One or two drive units are available. An internal hard disk keeps recording even if the tape runs out or is stopped. A hi-fi VR240 version offers user-selectable audio bandwidths — up to full broadcast quality for on-air replay or time zone delay, with shorter record times.

\$15,390.00 List Price for 2 drive unit
\$12,500.00 List Price for single



**Eventide
VR204 Digital Broadcast Logger**

Record everything that goes out on your station, verify commercials, aircheck the competition and do it all hassle-free with the affordable Eventide VR204. Each tiny DAT tape holds 500+ hours, divided among one to four channels. An internal hard disk keeps recording even if the tape runs out, or is switched to playback mode. VP204 playback-only model is also available. Both units can play back all 24 channels recorded on an Eventide VR240 logger.

\$7,495.00 List Price for single

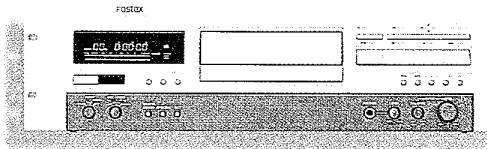

**Fostex
D-5**

The new Fostex D-5 digital master recorder satisfies the demands of the semi-professional market. The D-5 can record or playback four hours of music. And, it includes optical input and output complying to S/PDIF and TOC functions that are as easy to use as a CD player. Plus, the D-5 is equipped with basic pro-features such as ID editing function, 300 times max-speed locate and search functions, AES/EBU digital interface and XLR-type connectors. No SCMS flags.

\$1,495.00 List Price

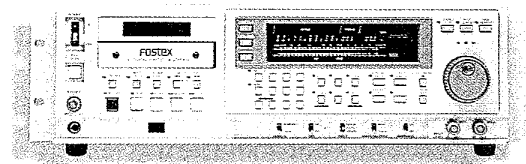

**Fostex
D-10**

Features include: AES/EBU I/Os, Two Sampling Frequencies: 44.1 and 48kHz, and optical I/O: make copies of your tape complete with PNOs. For applications in music recording and editing, radio and broadcast production, as well as video and film post production, the Fostex D-10 delivers critical features and functions required for fast and efficient performance.

\$2,895.00 List Price

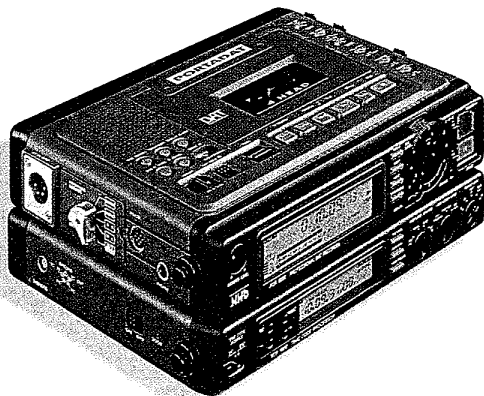

**HHB
Portadat PDR1000**

The combination of superb sound quality, excellent handling and a full complement of professional features has established the HHB Portadat as the professional industry standard in portable DAT recording.

Designed to be light, strong and easy to operate in the field, the Portadat PDR1000 uses a rugged 4 motor transport for optimum reliability. Four heads provide the essential off tape monitoring feature that professional users require, and a Nickel Metal Hydride rechargeable battery powers the recorder for up to 2 hours without the 'Memory Effect' problems associated with Ni-Cads. Sample rates are switchable for 44.1, 48 and 32kHz recording via XLR analog inputs and a choice of AES/EBU and S/PDIF digital I/Os ensures compatibility with digital audio editing systems

\$3,495.00 List Price.



Otari

DTR-8 Digital Audio Tape Recorder

The DTR-8 follows the concept of the familiar DTR-7, but with greatly enhanced capabilities. The DTR-8 uses a high quality 2-head mechanism and conforms to the EIAJ conference standard for compatibility with other R-DAT recorders, including consumer models. Built for professional use, the DTR-8 has +4 dBu (-10dBV switchable) active balanced analog I/O with XLR type connectors and has both AES/EBU and S/PDIF digital I/O. In search mode the DTR-8 uses TOC information from tape to locate at up to 300 times normal play speed. Three sampling rates; 32 kHz, 44.1 kHz and 48kHz are switchable from the front panel for maximum flexibility in professional environments.

\$2,000.00 List Price

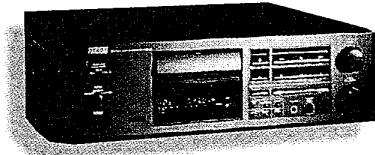

Panasonic

SV-3800

The New Standard of the Industry

Building on the success of the legendary SV-3700, the SV-3800 sets a new standard for value and performance. We kept the reliability, superb sonics and ease of use of the SV-3700 and we've added:

- Smart front end for easy configurability
NO MORE DIP SWITCHES!
- Single program play - one touch does it
- New 20-bit resolution DACs for wider dynamic range, lower noise and greater linearity
- Independent recording level controls
- Variable output level control
- Interface to the full functioned RC-410 remote

\$1,604.00 List Price

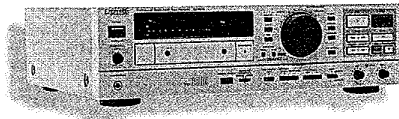

Panasonic

SV-3900 Digital Audio Tape Deck

The Panasonic SV-3900 Pro-DAT Recorder provides outstanding record/play quality and comprehensive serial remote control via industry-standard serial protocols. Unlike other DAT machines, the SV-3900 is designed specifically for remote control applications, using either the full-featured SH-MK390 Remote Controller (optional), or external computer interfaces. Select simultaneous control of up to 32 individually addressable machines connected on an ES-bus local area network, or single machine/controller combinations using P2 protocols.

\$2,895.00 List Price



Panasonic

MDA-1

Multi-Channel Digital Audio Tape Recorder

\$3,495.00 List Price

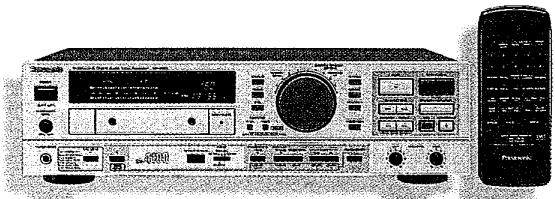

The Panasonic of ADATS

- 18 bit, 128X oversampling A/D converters
- 20 bit equivalent D/A converters
- Flexible XLR and RCA interfaces
- Intelligent software controlled transport
- On board track cloning and time shifting
- High resolution fluorescent display
- Ten point autolocate system
- Rugged, stable diecast aluminum chassis
- Optional controller accessories

Panasonic

SV-4100

The flagship of the Panasonic Line, the SV-4100 features onboard RAM for trim, rehearsal and instant start plus the ability to sync to its own internal clock, NTSC black burst, or word clock from a digital work station. It's the best sounding DAT Panasonic has ever made with new 20 bit equivalent D/A converters and the easiest to use with a new software controlled front end.

\$2,950.00 List Price



DAT

**Sony
PCM-2800**

The Sony PCM-2800 offers 4-head construction for read-after-write confidence monitoring at an affordable price. In addition, this durable unit features a 4-motor direct drive transport for reliable tape handling, and Sony's patented Super Bit-Mapping (SBM) process, which simulates 20 bit resolution. Professional interfaces include digital XLR AES/EBU and coaxial S/PDIF, and analog balanced XLR I/Os. **\$2,695.00 List Price**

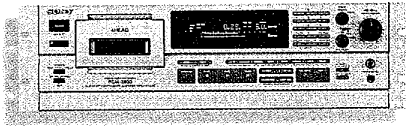

**Sony
PCM-2600**

The Sony PCM-2600 is the only DAT deck in its price range to offer a 4-motor direct drive transport mechanism. This provides you with a more robust, long-lasting transport, and more reliable, accurate tape handling during recording and playback. It also features Sony's patented Super Bit-Mapping (SBM) process, and rapid front panel search function. Professional digital XLR AES/EBU and coaxial S/PDIF I/Os, and analog balanced XLR I/O's are standard. **\$ 1,875.00 List Price**



**Tascam
DA-20 DAT Recorder**

Great value in a digital mastering deck. Perfect for installation, production and broadcast studios. High-performance durable DAT recorder in a 3U rack-mountable package. **\$1,099.00 List Price**

Features
• Multiple sampling rates (48kHz, 44.1kHz, 32kHz)
• Extended (4-hour) play at 32kHz
• S/PDIF Digital I/O
• RCA Unbalanced In/Out
• SCMS-free recording
• Full-function wireless remote included



**Tascam
DA-P1 Portable DAT
Recorder**

In the field or in the studio, the DA-P1 features Tascam's legendary durability and performance in a compact, high-impact metal reinforced casing. High-end features will appeal to broadcast, post-production and remote recording professionals. **1,899.00 List Price**

Features
• Multiple sampling rates (48 kHz / 44.1 kHz / 32 kHz)
• Balanced XLR MIC/LINE inputs with switchable 48V phantom power
• RCA unbalanced In/Out
• Built-in limiter & 20dB pad
• S/PDIF digital I/O with SCMS free recording
• Quick charge battery system with 2 hour play/rec. time
• Backlit LCD display for low light conditions



- **Optional accessories:**
CB-D1 external charger
CS-D1 carrying case
BP-D1 battery pack

**Tascam
DA-30 MKII DAT Master**

- Variable speed (Fwd/Rev) shuttle wheel
- Digital I/O – AES/EBU & S/PDIF
- XLR Balanced & RCA Unbalanced I/O
- SCMS free recording w/selectable ID
- Parallel port for control I/O from external equipment

Arguably the best sounding DAT anywhere, the DA-30 MKII is the standard mastering DAT deck for production studios worldwide. Featuring legendary Tascam quality and durability, its data/shuttle wheel allows for high-speed cueing, quick program entry and fast locating. **\$1,599.00 List Price**



**Tascam
DA-60 MKII 4 Head Timecode DAT Recorder**

- 4-head design with confidence monitoring
- Memory start and rehearsal
- Differential power supplies for A/D and D/A converters
- Tascam exclusive servo system enables jam sync timecode recording
- Seamless continuous timecode recording with onboard or external timecode generator
- Onboard support of Sony P2 protocol
- Pre or post stripe timecode

You won't find a better 4 head synchronizable DAT value than Tascam's DA-60 MKII. With complete Sony P2 support, the DA-60 MKII behaves like VTR and can be integrated with edit controllers and hard disk systems making it the perfect DAT for post-production environments. More important, its onboard synchronizer and improved servo system means virtually instant lock-up times. And with advanced A/D and D/A converters, the DA-60 MKII delivers extremely high dynamic range and very high signal to noise ratios. **\$6,499.00 List Price**

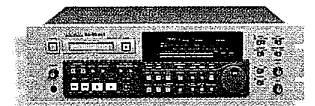

DAT



THE ONLY TALK SHOW DELAY THAT CAN MAKE THESE STATEMENTS.

Bad words, **#@%&*%!** like bad news, often come in threes. The new Eventide BD500 is the only obscenity delay in the world that can eliminate them. Now, when you hit the Dump button, you don't lose the whole delay and the obscenity **%#@*%!** protection that goes with it. You can divide the total available delay time into not one, or even two, but several discrete segments. You still have protection even after dumping two consecutive **&*%#@#!** no-no's.

You also get the cleanest, quickest delay catch-up you can buy. Because there's only one way to maximize audio quality and still catch-up rapidly after a delay dump... and Eventide owns the patent. Over the years, several other brands of delay have come and gone. But the simple fact is that the catch-up methods others use must be painfully S-L-O-W to avoid serious audio problems.

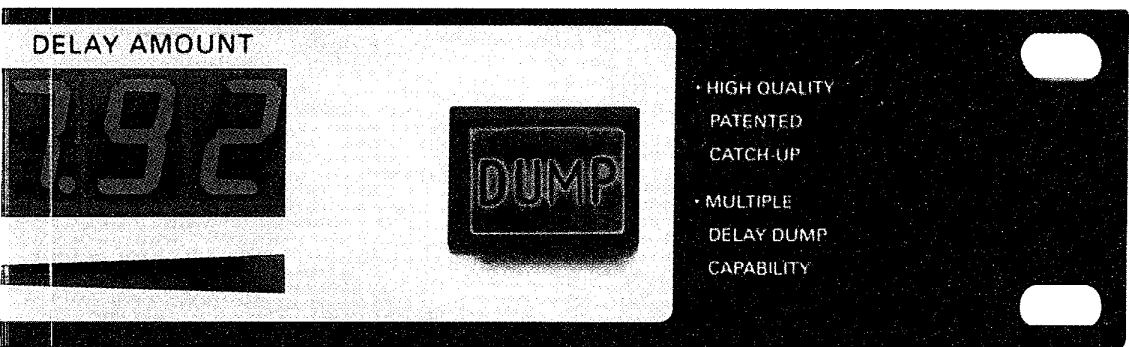

And, because you may not be using that analog console forever, the BD500 is also the only broadcast delay that's digi-

tal-ready with optional AES/EBU digital audio inputs and outputs. It's stereo, of course. A convenient new "sneeze" button allows the talent to sneeze, cough, etc. without being heard on air, and without dead air. All front panel switches (except configure) and all status indicators can be remoted (both RS-232 and dry contacts are provided.) Plus, only the BD500 gives talent both a digital readout of delay time and a "quick read" LED bar graph that shows "you're safe" at a glance.

For all these features and quality, you'd expect top-of-the-line pricing. But surprise! The BD500 costs thousands less. It's the best value ever in a broadcast talk show delay. Exactly what you'd expect from the people who invented digital broadcast delays in the first place. Call your distributor, Eventide direct, or check it out on the Web at <http://www.eventide.com>



BD500
Eventide
the next step

Eventide Inc. 1 Alsan Way, Little Ferry, NJ 07643 • Tel (201) 641-1200 • Fax (201) 641-1640 • <http://www.eventide.com>

Delays



Eventide

BD500 Talk Show Delay

The new world standard stereo digital broadcast delay for features, audio quality and value. A multiple delay dump feature gives added protection by dumping only a portion of the delay each time the button is pressed. Exclusive Eventide-patented catch-up provides the only delay rebuild that is both fast and high quality. Exclusive optional digital I/O and full RS232 remote make the BD500 talk show obscenity delay ready for today and tomorrow.

\$3,395.00 List Price

Eventide

BD1020 Video Delay with Audio

The third-generation BD1020 video delay from Eventide is smaller, offers more features and gives superior performance at a much lower price. The unit is available in a wide variety of video delay configurations and with up to four audio channels. Many broadcast and cable networks rely on Eventide video delays to eliminate the possibility of obscene and other libelous material being broadcast during awards shows, talk programs, courtroom TV, news and other live events.

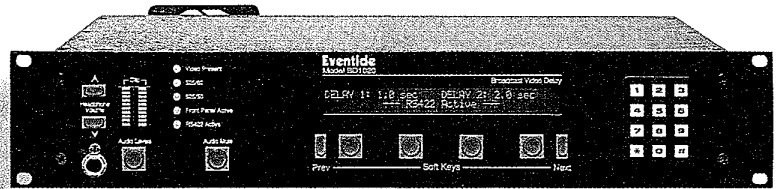

Eventide

BD941 and BD942 Talk Show Delays

These simple, reliable and economical digital talk show delays are on the job at hundreds of stations worldwide. The mono BD941 is available with a fixed delay of 6 or 12 seconds; the stereo BD942 is available in 3 and 6 second delay versions. Contacts can trigger an external cart machine or other playback device to cover the delay interval if an obscenity is dumped.

\$1,795.00 List Price for BD941-6 model

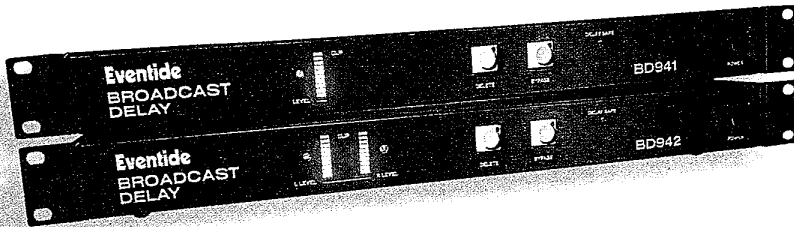

Symetrix

610 Delay

The Symetrix 610 Stereo Broadcast Delay allows talk show hosts to "Dump" obnoxious callers and automatically build back 7.5 seconds of delay time.

Two-stage dump option allows quick turn-around of callers. The "Cough" button mutes the program without dead air. Easy "plug & play" installation.

\$2,695.00 List Price

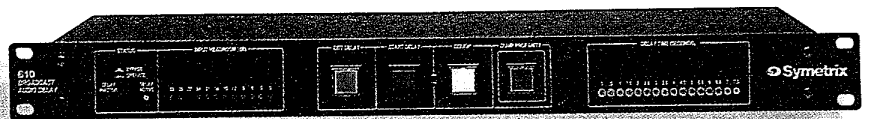

Symetrix

Audible Differences!



The 610 delay makes talk radio safe and easy!

The Symetrix 610 Stereo Broadcast Delay allows talk show hosts to "Dump" obnoxious callers and automatically build back 7.5 seconds of delay time.

Two-stage dump option allows quick turn-around of callers.
The "Cough" button mutes the program without dead air.
Easy "plug & play" installation.



The 528E Voice Processor makes any radio voice a star!

Voice talent is expensive. So why not get you money's worth? The 528E is the industry standard voice processing toolbox, featuring a top quality preamp, compressor, de-esser, three bands of parametric EQ, and a downward expander plus a phase rotator all in one unit.

Three overlapping parametric equalizers.
Variable compression ratio.
Three bands of variable frequency EQ.
Switchable phase rotator.



There are impressive reasons to use the 422 stereo AGC/Leveler!

By making loud sounds quieter and quiet sounds louder, the 422 solves level control problems which conventional compressors can't remedy.

Automatically corrects level variations between program sources. Ends complaints about loud commercials on cable TV systems. Maintains optimum input levels for digital audio storage. Improves STL modulation.

Contact your Harris Representative today!

 **HARRIS**

TEL: 800-622-0022
FAX: 765-966-0623
<http://www.broadcast.harris.com>

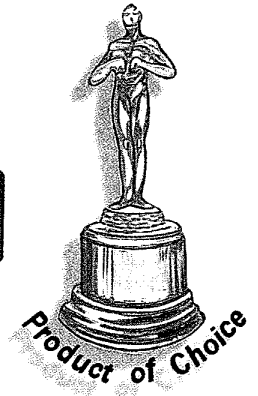
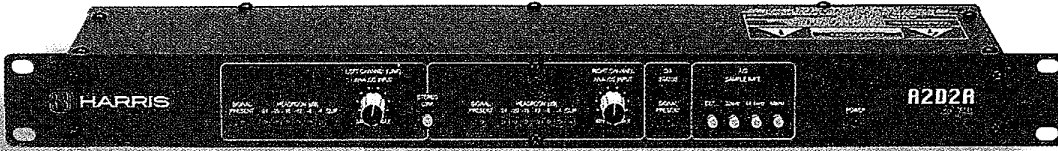
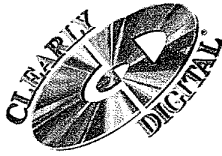

Digital Accessories

**Harris Digital
A2D2A Analog to Digital Converter**

The A2D2A provides the perfect connection between analog and digital audio equipment. The unit—the Harris A2D2A—not only brings 20-bit conversion technology to broadcast and production studios, but it is priced at less than half of its nearest competition. The A2D2A also performs A/D and D/A conversions simultaneously.

The A2D2A's LED indicators for left and right channels show you exactly where to set the analog input controls to optimize the analog to digital conversion process for low noise and a wide dynamic range. Sample rate conversion permits you to select from three rates—48kHz, 44.1kHz or 32kHz, or you may lock the A/D converter to an external AES/EBU reference signal.

\$599.00 List Price

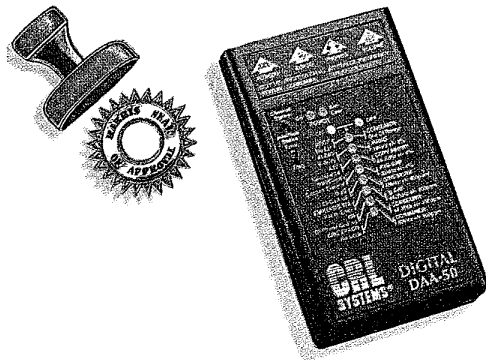

**Circuit Research Labs
DAA-50 Digital Audio Analyzer**

Compact, easy to carry, the DAA-50 clips to your belt for easy troubleshooting in the digital audio domain. The DAA-50 allows you to see signal status and hear your stereo audio quality at any point in the digital audio path. A multi-function LED array reports on numerous signal parameters such as sampling frequency, status flags in the AES/EBU and S/PDIF standards and signal confidence (signal standards as per IEC-958, section 5.2.3.3.). NiCad battery, charger, balanced and unbalanced interface cables included.

\$795.00 List Price

**Marantz
IS5022 and IS5021 Digital Sound Processors**

Marantz is pleased to introduce two new products that offer recording studio engineers, home studio owners, post production facilities, corporate A/V centers, archivists, and broadcast professionals unmatched performance and value for an integrated set of advanced sound processing technologies developed by Philips.

These two products, the IS5022 and IS5021 include the following:

- 20-Bit A/D converters
- High Quality D/A converter (based on the Philips DAC7)
- Sample rate converter for interfacing between digital equipment operating at different sample rates
- Digital Sound Processing

\$2,400.00 List Price for the IS5022

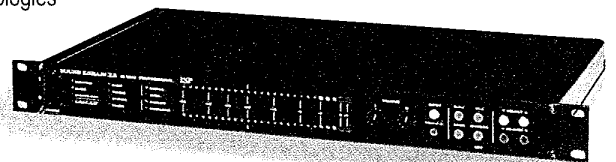

Harris enjoys the good fortune of a terrific relationship with NVision, one of our primary digital interface equipment suppliers. NVision permitted us to publish this excerpt....

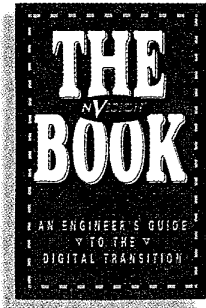

Chapter 3. AES3 Interconnect & Distribution

Part 1: Interconnection

Pops, clicks and other unacceptable sounds are often generated when data is transferred between two pieces of equipment designed to meet the AES3 standard. In a large facility, three or more pieces of equipment configured in series may produce different results. AES3 digital audio is fast becoming the only format available on many machines, therefore a solution must be found for these problems. Larger, all digital facilities with centralized routing and distribution are being designed and installed. Techniques must be developed which permit reliable transfers of digital audio data between various pieces of equipment.

	AES3 1985	AES3 1992	AES3 ID
Signal Level	3 to 10 Volts	2 to 7 Volts	1 Volt ± 20%
Source Impedance	110 Ohms	110 Ohms	75 Ohms
Input Impedance	250 Ohms	110 Ohms	75 Ohms
Cable Impedance	NO SPEC	110 Ohms	75 Ohms
Connector	XLR	XLR	BNC

Table 1 Electrical Interconnect Specifications for AES3 Data

These symptoms are common to three unique problems: impedance mis-match, jitter, and frequency inaccuracy. Any combination of these may be present simultaneously. The key is to eliminate as many of these problems as possible, if not all. Each problem, its causes and some solutions follow.

Impedance Mis-match

Table 1 compares the essential features of the AES3 1985, AES3 1992 and AES ID Standards and guidelines. The bandwidth of the AES3 signal is much higher than analog audio, 5 to 6 MHz versus 20 kHz. AES3 data interconnections must be treated as transmission lines. Successful connection of equipment requires careful practice of techniques used for high frequency signals: source, input and cable characteristic impedance should all match.

Look at Table 1 again. Two sources of mis-match are readily apparent in the AES3 1985 standard: input impedance and cable impedance.

Correct the major problem first. Convert all AES3 1985 equipment input to be compatible with AES3 1992. Use a 196 Ohm resistor, a standard 1 percent value, as shown in figure 1. With care, this resistor fits inside the mating XLR plug. This change should be made throughout your facility. The easiest way to verify equipment impedance as either 110 or 150 Ohms is by schematic examination. Transformer coupling prevents DC measurement of internal resistance.

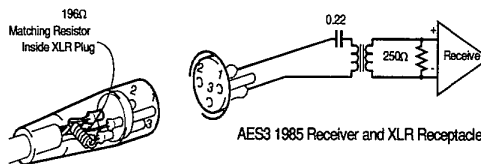

Figure 1: Impedance Correction of AES3 1985 Receivers

Alternatively, isolate AES3 1985 equipment with a digital audio distribution amplifier such as the NV1021. Place the NV1021 as close as possible to the destination equipment, allow a maximum of 10 feet for cable between the NV1021 and the AES3 1985 equipment. This configuration provides a matched termination to the original source and minimizes path length of the reflected signal at the load. Accurate data recovery by the receiver is now possible. Figure 2 shows this connection.

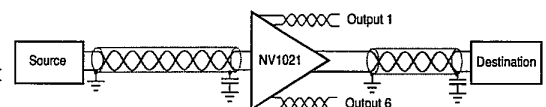

Figure 2. Load Isolation

Correcting cable impedance is not as easy. Ideally, an impedance matching resistor is connected as shown in figure 1 so that the combined value is equal to that of the cable. Instead of 196 Ohms, a 45 Ohm analog audio cable requires 54.9 Ohms to match a 250 Ohm input or 76.8 Ohms to match a 110 Ohm input. Fortunately, for short cable runs where reflection amplitude is the greatest, the NV1021 DA will accurately recover the data with its input impedance selected to 110 Ohms. Ideally, existing analog audio wiring is replaced with 110 Ohm, low capacitance cables, however, it may be desirable to salvage long runs of pre-installed analog audio twisted pair. A cable equalizer enables reliable transmission for these applications and provides even longer transmission distances for 110 Ohm cable. A cable equalizer corrects cable transmission loss with a filter that typically provides more gain at higher frequencies than lower frequencies. Once properly equalized, the data may be accurately recovered by the receiver. Cable equalization is provided by digital audio distribution amplifiers (DAs), such as the NV1021, at affordable prices. Using DAs is often less expensive than pulling new cable runs. Figure 3 shows this application and Table 2 provides some typical results for various types of cable.

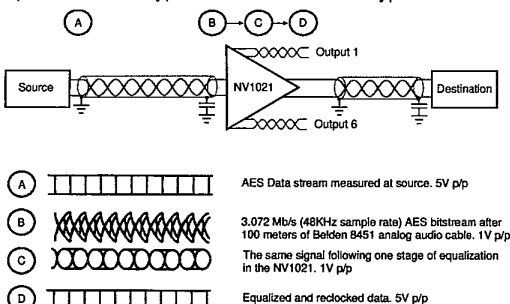

Figure 3. Cable Equalization

The NV1021 DA will equalize cable for both twisted pair and coaxial applications. The difference is transmission distance. A typical analog cable can be equalized for up to 1000 feet, digital audio cable for 2000 feet and coaxial cable for 4000 feet or more. These results are a general guide. Cable type and topology determine the exact transmission distance for any given cable run. Table 1 shows various cables types and their typical transmission distances.

	NO EQ	NV1021 w/Max EQ
45 Ohm Twisted Pair, 30pf/ft	250 feet	1000 feet
100 Ohm Twisted Pair, 12pf/ft.	500 feet	2000 feet
100 Ohm Twisted Pair, 12pf/ft.	800 feet	2500+ feet
75 Ohm Coax, 20pf/ft	2000 feet	4000+ feet

Table 2: Cable Types and Typical Transmission Distances

Order your FREE copy of this 145 page book while supplies last at FAX: 765-966-0623 or 3712 Nat'l Rd. West; Richmond, IN 47374 USA



Digital Recorders

360 Systems DigiCart/II

When 360 systems first introduced the DigiCart audio recorder, its unique combination of features and attractive price made it an immediate best seller. With DigiCart/II, the benchmark is redefined: More powerful software, even greater storage options, and enhanced remote control capabilities. DigiCart/II earns its keep by doing the work of three machines: a hard disk recorder, a mini audio workstation and a digital cart machine. This impressive combination sets a new standard for versatility and performance.

\$5,495.00 List Price

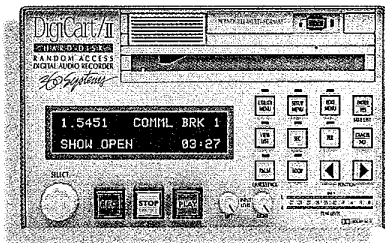

360 Systems Instant Replay

Instant Replay is a new breed of digital recorder from 360 Systems that places an entire audio library at your fingertips. It's unique design stores 1,000 cuts on an internal hard disk, and offers instant access via hot-key presets. The result is an exceptionally powerful and convenient way to manage an on-line audio library.

\$3,495.00 List Price

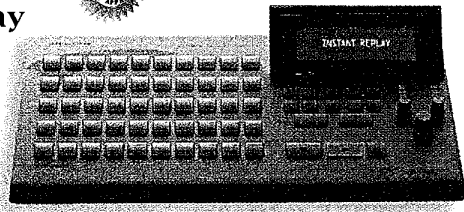

Alesis BRC™ Master Remote Control

The BRC™ Master Remote Control adds a set of powerful creative and operational tools to your ADAT or ADAT-XT digital recording system. It provides SMPTE, MIDI and Video synchronization, digital editing, and a full-function multi-machine autolocator with an onboard memory. The BRC is the only device that allows you to control up to 128 ADAT tracks from one location, either table top mounted, in a studio rack, or on an optional roll-around stand. Another BRC function that can't be found anywhere else is the ability to edit and assemble your songs using bars and beats. Other features include sample-accurate auto punch in/out and rehearsal modes, 460 location points with 8-character alphanumeric names, full control of track delay (up to 170 ms per track), Tape Offset between multiple recorders, SMPTE Offset and Generation, MIDI Tempo Maps and Clock generation, and MIDI Machine Control.

More than just a remote control, the BRC is a SMPTE time code synchronizer, allowing ADATs to chase-lock to time code from video or analog recorders. SMPTE offsets may be set to single sample (1/48,000th of a second) accuracy. You can select ADAT's tape time, SMPTE time, or bars and beats as a display reference. All BRC settings and memories may be stored digitally on the data header of each ADAT tape for quick recall at any time. When you need to bring your ADATs together into a complete, fully-professional system, the BRC is the ultimate in digital audio recording control.

\$1,499.00 List Price

Alesis ADAT-XT™

Alesis' groundbreaking ADAT® Digital Audio Recorder changed the way music was recorded, allowing musicians to create professional-quality albums in home and project studios. The ADAT-XT™ keeps the ease of use and great sound that made the ADAT the most popular digital multitrack of our time, and adds new tricks of its own. The audio quality actually improves on the ADAT's high standard, recording 8 tracks of audio with 18 bit 128 times oversampling A/D converters and 20 bit, 8 times oversampling D/As. The ADAT format records on readily-available S-VHS® video cassettes, and up to 16 ADAT recorders can be linked together for 128 tracks with no external synchronizer required and without sacrificing a track to timecode. The ADAT-XT offers an improved transport which operates up to 4 times faster than the original ADAT, with new Dynamic Braking control for more accurate locates and faster lock times.

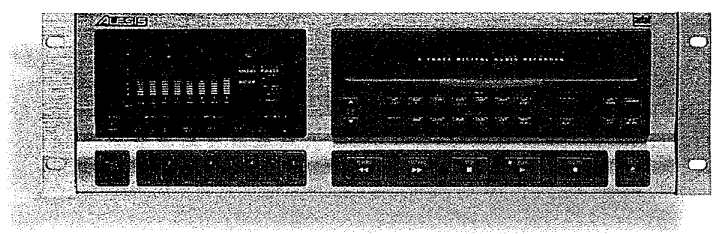

An onboard digital editor allows you to make flawless copy-paste digital edits between tracks on a single unit, or between multiple machines. The XT features Tape Offset, Track Copy, Track Delay, and ten autolocate buttons for sophisticated flexibility and control over your productions. Both +4 dBu balanced and -10 dBV unbalanced connections and the ADAT Optical Digital Interface™ are provided for flexible hookup in your studio. A comprehensive Vacuum Fluorescent Display provides all the critical information. A rugged six pound die-cast aluminum chassis offers strength and stability while lessening torque stress on the transport mechanism. With its fast, software-controlled transport, onboard digital editor, 10-point autolocator and 100% compatibility with over 70,000 ADATs worldwide, the ADAT-XT builds upon the ADAT format as the world's most popular professional multitrack recorder.

\$3,499.00 List Price

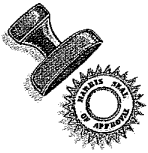

**Arrakis
Digilink 4**

A revolutionary new workstation with a breakthrough in price and features to replace carts, reel machines, DATs etc. It features simultaneous triple play and record from hard disk, MPEG compression, 12 hours of stereo audio storage, plus 2 separate audio outputs for on air and production at the same time. Even link up to 32 machines to a common audio library. Control from the simple LCD front panel, a PC, or a Digilink workstation.

DL4-4000 \$4,795.00 List Price
DL4-600 \$3,495.00 List Price

Digital Recorders

**Fostex
CX-8**

The Fostex CX-8 sounds fabulous. New ultra-high fidelity converters provide better-than-CD audio quality—a frequency response of 20Hz to 20kHz ±0.5dB, a signal-to-noise ratio greater than 92dB, adjacent channel crosstalk better than 90 dB, and unmeasurable wow-and-flutter. Figures that translate into sound which approaches audio perfection. If you've ever had any reservations about digital audio—questions about 'warmth' and suspicions about 'brittle'—you want a CX-8. 8 digital tracks.

\$3,495.00 List Price

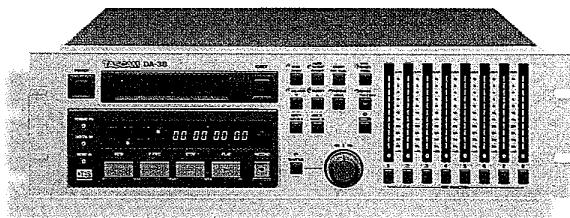
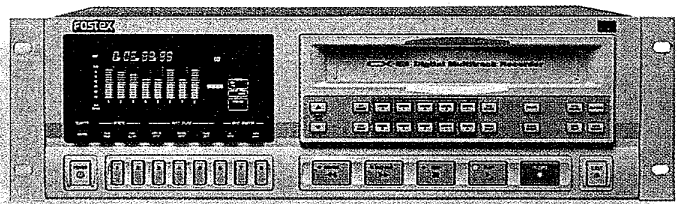

**Tascam
DA-38 Digital Multitrack Recorder**

- 1 hour & 48 minutes recording time on a single 120 tape
- Expandable up to 128 Tracks/16 machines
- Fully compatible w/DA-88 tapes
- Digital Track Copy function / Electronic patchbay
- User-definable track delay, advance & crossfade
- Shuttle cueing capability
- Auto punch with rehearsal
- Options include:
RC-808/848 Remote Controllers
IF-88AE/IF88SD digital interfaces
MMC-38 MIDI machine control interface

**Tascam
DA-88 Digital Multitrack Recorder**

- 1 hour & 48 minutes recording time on a single 120 tape
- Expandable up to 128 Tracks/16 machines
- User-definable track delay & crossfade
- Shuttle & Job capability
- Auto punch with rehearsal
- SMPTE, MIDI and Sony 9-Pin sync capability
- Options include:
RC-808/848 Remote Controllers
IF-88AE/IF88SD digital interfaces
MU-Series meter bridge
MMC-88 MIDI machine control interface SY-88 Sync Card



The DA-38 delivers the great sound of Hi8 digital audio format. This digital multitrack has the functionality that production studios & musicians require. The new DA-38 delivers the great sound, cutting edge features and rock solid stability that recording professionals expect.

\$3,499.00 List Price

The DA-88 delivers the best of TASCAM's Hi8 digital audio format. The standard digital multitrack for post-production and winner of the coveted Emmy award for technical excellence. Its modular design allows for easy servicing and performance enhancements with third-party products.

\$4,799.00 List Price



It's 9:30 am. You've got to edit
nine phone-ins, cut a dozen
spots, record four station I.D.s
and two promos before lunch.

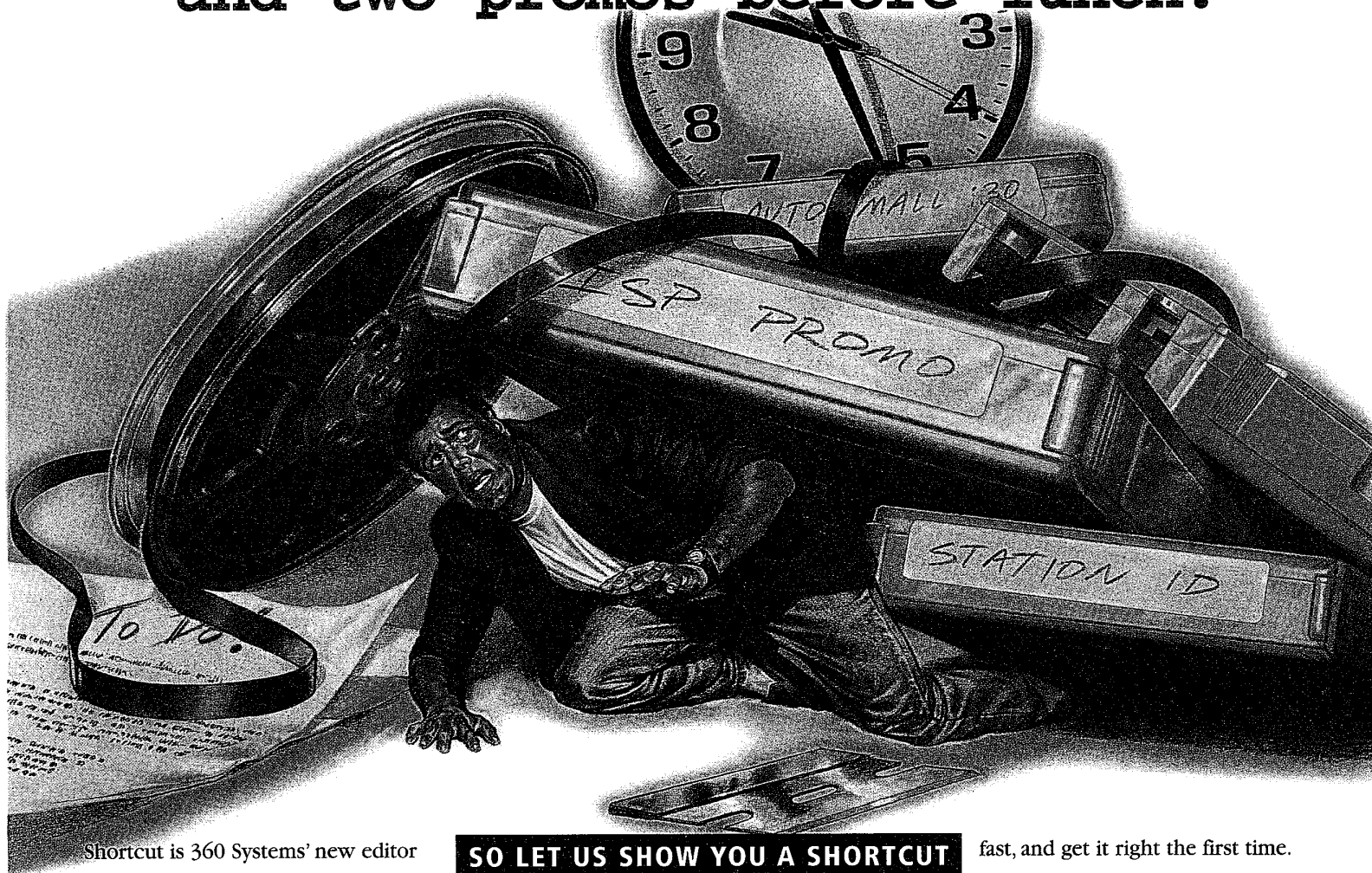

Shortcut is 360 Systems' new editor

SO LET US SHOW YOU A SHORTCUT

fast, and get it right the first time.

for people in a hurry. It's powerful enough for production yet easy enough to use on-air. Shortcut delivers massive storage, scrub editing, a bright waveform display, and even built-in speakers. All this in a compact self-contained package with the muscle to handle your toughest assignments. We know you need to move

That's why Shortcut gives you real buttons for direct access to editing commands. No need for computers, monitors, or mice. Shortcut is complete and ready to go. So if you have too much work and too little time, just take a Shortcut.

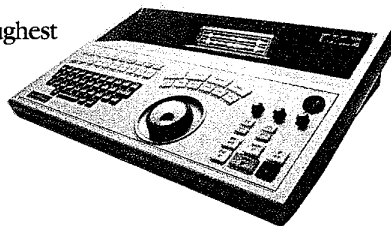

Shortcut
PERSONAL AUDIO EDITOR™

360 Systems
PROFESSIONAL DIGITAL AUDIO



**360 Systems
Shortcut 2-Track Editor**

Shortcut is completely self-contained, and even includes stereo speakers, a high-quality mic pre-amp, and a headphone jack for field work. At about twelve pounds, Shortcut is portable enough for field work, and its auto-switching power supply allows it to work with any of the world's voltages. With both analog and AES-EBU digital inputs and outputs, Shortcut has the power to handle your toughest editing assignment on the fly.

\$3,495.00 List Price 3.0 Hour Version
\$2,995.00 List Price 1.5 Hour Version

Digital Workstations

**Arrakis
TrakStar 3 Multitrack Editor**

TrakStar is a powerful 8 track digital editor designed specifically for fast paced radio applications - and - the only editor that backs up on air.* With instant play, high speed scrub, real time fade, stereo effects loop, punch in & out, etc., TrakStar produces spots and programs quickly and easily. It even edits programs up to 6 hours long. Once produced, simply network transfer your program in perfect digital to your on air Digilink for playback to air.

Model TS3-600 \$5,995.00

**When connected to an Arrakis DL3 hard disk system.*

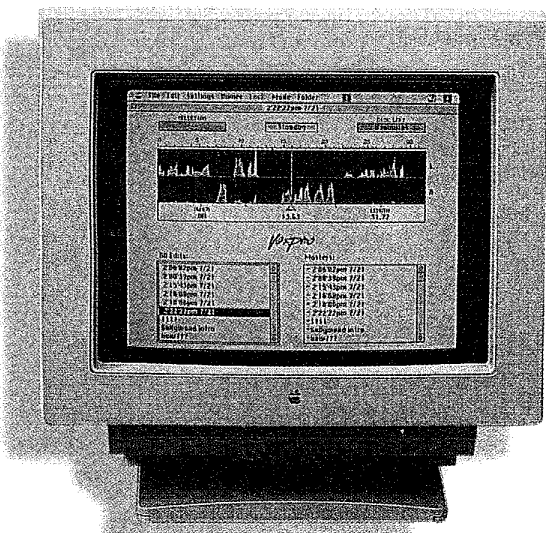
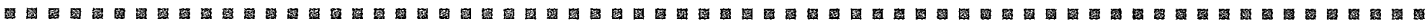
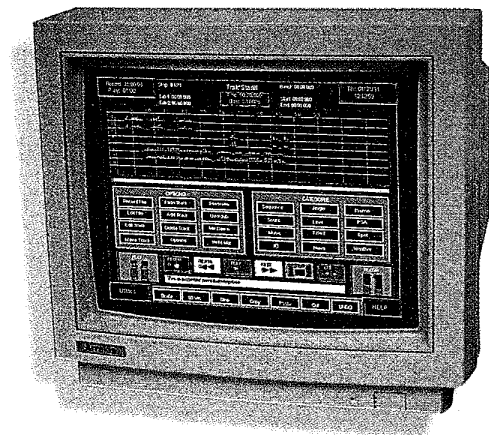

**Audion
VoxPro Digital Sound Editing System**

VoxPro was the first digital sound editing system specifically designed to replace reel-to-reel tape recorders used on the air. The VoxPro system allows you to record and edit: phone bits, contests, actualities, sound effects, and more, on the fly, with speed and precision. An optional remote control panel allows the user to operate the system with one hand. Its dedicated keys provide unmatched ease-of-use and performance. VoxPro operates like a word processor for sound. It begins by providing true one-touch recording. So no matter what editing or review task is underway, VoxPro starts a new recording with a single push of the record button and automatically saves what you were working on. A record-insert features lets you automatically and seamlessly add new material to an existing recording. The ability to add an afterthought to a recorded telephone call is the reason many VoxPro users report substantial gains in the quality of their on-air programs. Great for news, too.

Pricing Upon Request



Digital Workstations

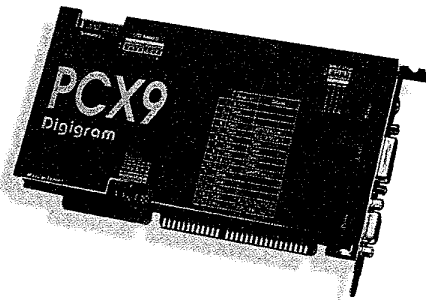

Digigram PCX9/PCXi9 Audio Interfaces

PCX9 and PCXi9 are Digigram's top of the line cards, designed to deliver the highest audio quality demanded by professionals. The PCX9 is a PC-based card which runs on the ISA bus. The PCXi9 designed for the PCI bus, is the PCX9's counterpart. Both cards offer unequalled processing power and excellent performance. Both cards provide superb processing power for coding, processing and decoding in real time using the ISO/MPEG audio standard. Both also operate in PCM mode for those applications which do not use compressed audio. 66MHz DSP.

Prices Vary

- 2-channel independent analog (balanced) inputs/outputs, and digital inputs/outputs in the AES/EBU or SPDIF format.
- Simultaneous coding decoding in real time, according to the ISO/MPEG audio standard.
- Operation in PCM mode or ISO/MPEG.
- Real-time mixing of up to 18 MPEG audio mono tracks (in layer 2 - 128 kbits/s)
- Available in record/play version, or in play only.
- Completely compatible with the entire line of Digigram PCX audio equipment.
- Inter-card synchronization.
- Available with drivers for DOS, OS2, Windows® 3.x, Windows® NT and Windows® 95.

Digigram PCX11 Audio Interface

As Digigram's mid-range board, it provides access to the whole range of PCX technology. PCX11 provides the same processing power as the PCX9 and PCXi9 cards, for excellent performance for coding, processing and decoding in real time, according to the ISO/MPEG audio standard. It can also operate in PCM mode (without compression.)The standard version PCX11 has analog interfaces. An AES/EBU digital input/output interface is available as an option, making the PCX11 an equivalent of a PCX9 card if used only for digital applications.

- 2-channel independent analog inputs/outputs.
- AES/EBU inputs/outputs available as an option.
- Simultaneous coding/decoding in real time, according to the ISO/MPEG audio standard
- Operation in PCM mode or ISO/MPEG.
- Real-time mixing of up to 18 MPEG audio mono tracks (in layer 2 - 128 kbits/s)
- Completely compatible with the entire line of Digigram PCX audio equipment.
- Inter-card synchronization.
- 61 MHz DSP

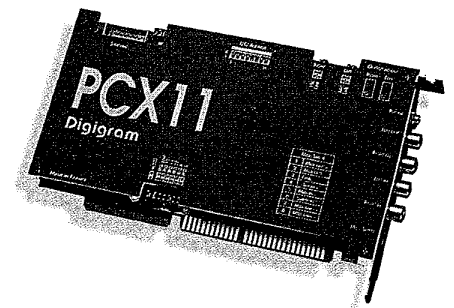

Pricing Upon Request

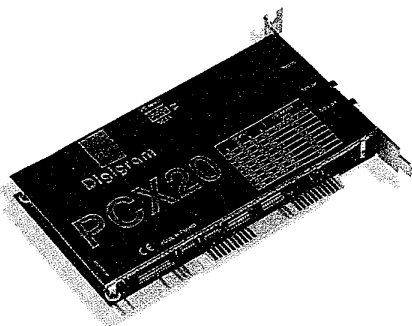

Digigram PCX20 Playback-Only Card

PCX20 is a low cost PC card (ISA bus) designed for playback applications featuring two independent analog audio outputs. Based on the PCX technology platform, the PCX20 board facilitates processing and decoding in real-time according to the ISO/MPEG audio standard. The PCX20 offers 40mHz DSP compared with 66mHz DSP offered by either the PCX9 or PCX11. It also operates in PCM mode for applications which do not use compressed audio.

- 2-unbalanced, independent, analog, mono audio outputs.
- Decoding in real time, according to the ISO/MPEG audio standard.
- Operation in PCM mode.
- Mixing of up to 10 MPEG audio mono tracks in real time (in layer 2-128 kbits/s)
- Compatible with the whole line of Digigram PCX audio cards.
- Available with drivers for DOS, Windows® 3.x, Windows® NT and Windows® 95.

Pricing Upon Request

Digigram PCX80 Multi-Output Board

PCX80 is a PC/AT long board that provides eight independent analog mono outputs with PCX9 quality. It decodes in real time using the MPEG audio standard. With an optional daughterboard with two analog inputs and one digital input (AES/EBU), PCX80 can be used for recording and coding. An optional board with four digital outputs and two digital inputs (AES/EBU) is available. PCX80 has the same DSP power as two PCX9 boards and is compatible with Digigram's other PCX boards.

Pricing Upon Request

- 8-channel independent analog (balanced) outputs.
- PC/AT long card.
- Operation in ISO/MPEG audio standard or PCM mode.
- Real-time mixing of up to 32 MPEG audio mono tracks on 4 channels and 20 mono tracks on 8 channels.
- AES/EBU 1 IN / 4 OUT available as an option.
- Available in record/playback version with 2 IN/8OUT.
- Completely compatible with the entire line of Digigram PCX audio equipment.
- Inter-card synchronization.
- Available with drivers for DOS, OS2, Windows® 3.x, Windows® NT and Windows® 95.



Digigram Xtrack Workstation

The Windows version of Xtrack, Digigram's multi-track-digital audio workstation. As the essential tool for post production, Xtrack features real-time virtual editing, simultaneous record/playback, time expansion/compression, noise reduction, pitch shifting, equalization, mixing, direct CD-Audio access, sound library management, various synchronization modes, video insertion, network operation and a dedicated remote control.

Based on our experience with real-time virtual audio editing on Xtrack, we've developed a specific version of this editing software for OEMs. By simply adding it to their PCX-based software, integrators can offer the end user an intuitive and reliable tool for creating audio applications used for broadcasting, transmission, storage, etc.

Pricing Upon Request

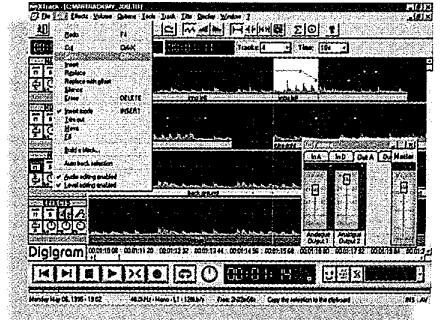

Digital Workstations

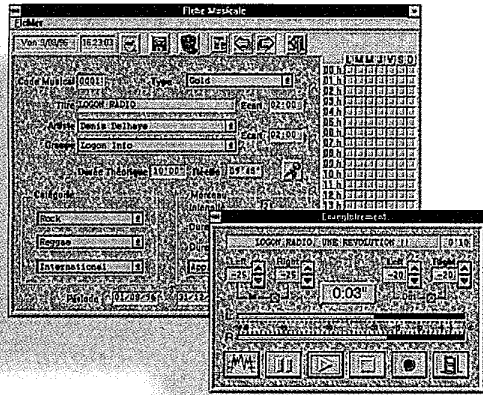

Logon Radio Automation Software

Logon Radio is a low-cost software and audio card package for automating even the smallest radio facility. It includes:

- Advertising scheduling
- Music scheduling
- Format clocks
- Insertion of jingles, promos etc.
- Automated audio recording and playback
- Live assist with eight virtual cart machines

Logon Radio operates under Windows®, and its simplicity, extensive facilities and low cost make Logon Radio best in its class.

Pricing Upon Request

Roland VS-880 Digital Studio Workstation

Roland's latest breakthrough product is the VS-880 Digital Studio Workstation, the first affordable integrated digital recorder, digital mixer, digital editor and effects processor in the world. Data storage is accomplished via the internal Iomega Jaz drive with 1 GB removable disks or a fixed 540MB hard drive. An expansion slot can be fitted with the VS8F-1 Effects Expansion Board, providing two powerful, independent onboard multi-effects units. The unbelievably low price point makes the VS-880 an even more incredible value.

\$2,995.00 List Price

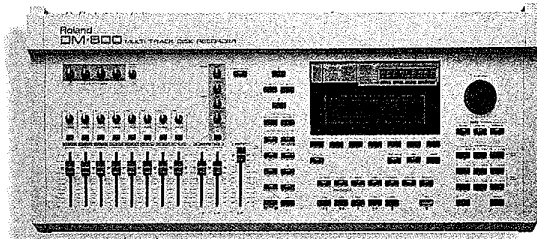

Roland DM-800 Multi Track Disk Recorder

The Roland DM-800 Multi Track Disk Recorder is a compact, stand-alone digital audio recorder, mixer and editor. The DM-800 features eight digital/analog outputs and six digital/analog inputs with storage of up to 24 hours of 300 virtual tracks via an external hard disk. Comprehensive, non-destructive digital editing can be performed quickly and intuitively on the DM-800, which also has video-out capability.

\$7,595.00 List Price



Digital Workstations

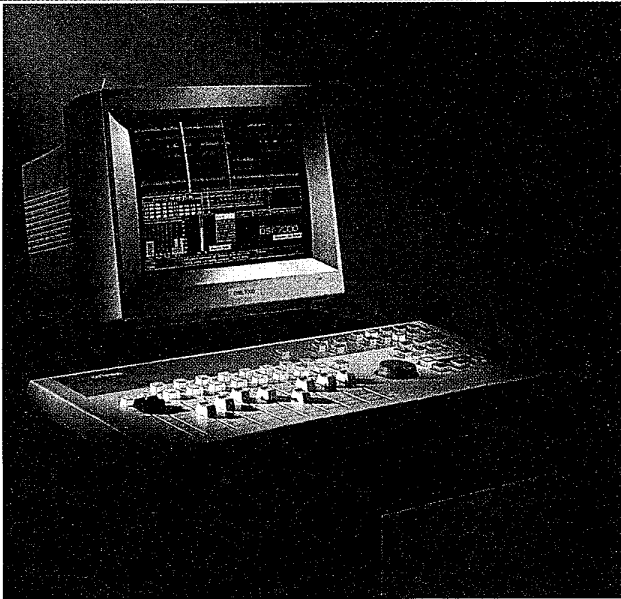

Orban Dse 7000 FX



DSP FX Engine

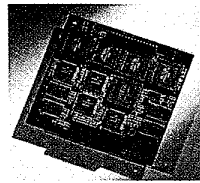

FX Turbo Track

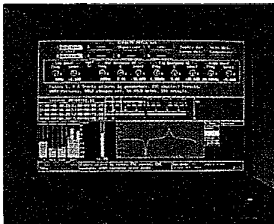

EQ Screen

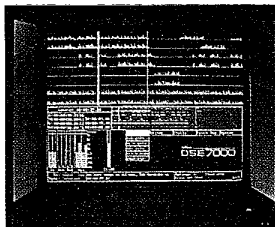

Compression Screen

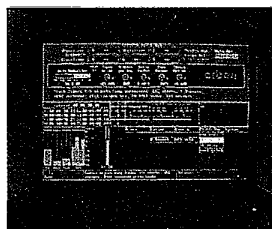

Reverb Screen

Orban DSE 7000FX

The DSE 7000 is known worldwide as the ultimate tool for commercial broadcast production. Because it makes audio production significantly faster and easier, the DSE has earned a reputation for dramatically increasing staff productivity and boosting profitability. Now Orban has introduced an even more powerful version, the DSE 7000FX, which includes a full complement of built-in digital effects and advanced SMPTE features for cutting audio to picture.

The DSE 7000FX works with blazing speed because it is the only broadcast-oriented workstation with 100% RAM-based editing. You never have to wait—not even for a second or two—while the computer rewrites your file to disk. Before your finger leaves the DSE's edit button, your edit is done. An on-board hard disk provides automatic backup and archiving for source material, with up to 8 hours of storage available.

The learning curve on the DSE 7000FX is similarly fast, and is measured in hours instead of days or weeks. The DSE's control surface is immediately familiar to anyone who has ever used a mixer and a tape deck. Most new users report doing meaningful work on the system in under two hours (even with no computer background). This approach is ideal for radio and TV stations: they don't have to waste time or money on operator training, and more people can use the system over multiple shifts. Downtime due to staff turnover is virtually nonexistent. This means increased productivity and creativity — more good spots and promos produced — without increased investment.

The new digital multi-effects package (standard on all systems) includes a parametric EQ designed by Bob Orban, OPTIMOD compression algorithms, and reverb/delay modules by Lexicon. Factory preset programs are provided for virtually every effects combination needed in commercial production, with sonic results indistinguishable from the very best outboard units. DSE 7000FX software also includes a powerful time compression/expansion system, so a couple keystrokes is all it takes to squeeze 32 seconds down to 29, with no audible artifacts.

The investment in an Orban workstation continues to pay back over the years. System software upgrades are free, with new features being added regularly. A rigorous pre-testing program in dozens of studios and radio stations, and revolutionary self-diagnosing software insures that upgrades are reliable. In over a million run time hours of commercial use at collective sites, there hasn't been a single instance of lost audio due to software failure.

The DSE also networks to hard disk cart replacement systems, linking the production studio to the on air studio over a high speed local area network (LAN). Initial networking collaborations were with Enco Systems' DAD Pro and BE's AudioVault. A link to Orban's own AirTime audio delivery system will be the next networking option.

Spec sheets and words are no substitute for experience. With 25 years in the broadcast business, Orban is one of the few workstation manufacturers to offer a test drive program to radio and TV stations. They will loan a demo unit to qualified users- without insisting that a demo person stand over their shoulder. Most production people get up to speed in no time, with no confusion or frustration, and agree that the DSE 7000FX is the fastest, easiest, most intuitive workstation for broadcast production. There's nothing else like it.

Pricing Upon Request

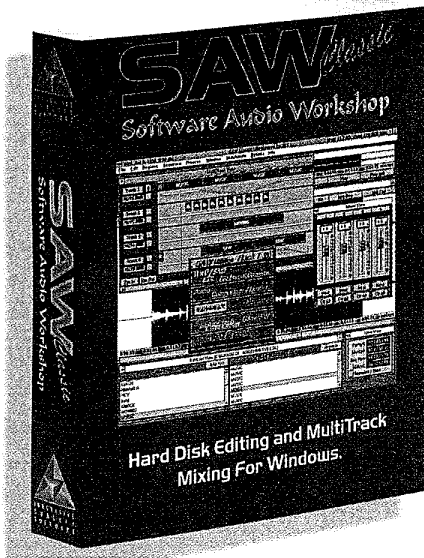

**Innovative Quality Software
SAW Classic Editing Software**

SAW Classic plays up to four stereo tracks on any Windows-compatible sound card. Features include non-destructive editing and mixing, sample rate and format conversion, volume, compressor/gate, limiter/normalizer, vari-pitch, SMPTE generate/trigger, looping and reversing, auto-pan functions, paragraphic equalizer, echo/delay effects, and much more. Recommended minimum: 486-DX2 66 MHZ PC; 8 MB RAM; Windows®; 16-bit stereo sound card.

\$299.00 List Price

**Innovative Quality Software
SAW Editing Software**

SAW plays up to four mono or stereo tracks simultaneously on as many as two Windows-compatible sound cards. Features include drag and drop non-destructive, SMPTE generate/trigger, real-time vari-pitch, reverse, sample rate and format conversion, volume, mute, solo, pan, compressor/gate, limiter/normalizer, paragraphic equalizer, echo/delay effects and much more. Accepts FX Plug-ins. Min. requirements: 486-66 PC (Pentium 90 recommended); 12MB RAM; Windows; 16-bit stereo sound card(s); 800x600 256 colors.

\$599.00 List Price

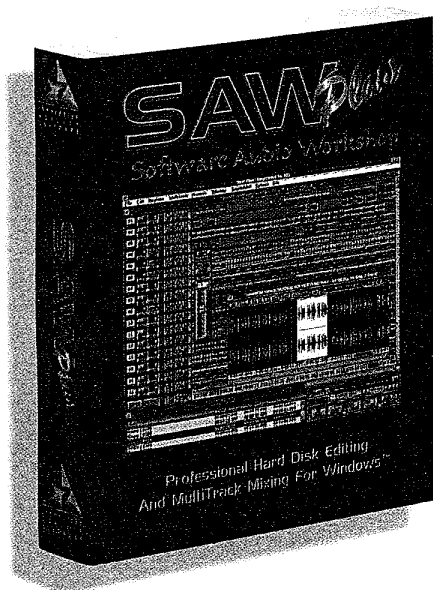

**Innovative Quality Software
SAW Plus Editing Software**

SAW Plus plays up to sixteen mono or stereo tracks simultaneously on as many as four Windows-compatible sound cards. Features include drag and drop non-destructive editing, SMPTE generator/trigger and lock/resolve, punch in/out, real-time vari-pitch, reverse, sample rate and format conversion, volume, mute, solo, pan, compressor/gate, limiter/normalizer, paragraphic equalizer, echo/delay effects on all tracks, and much more. Accepts FX Plug-ins. Min. requirements: Pentium 90; 16MB RAM; Windows; 16-bit stereo sound card(s); 800x600 256 color monitor.

\$999.00 List Price

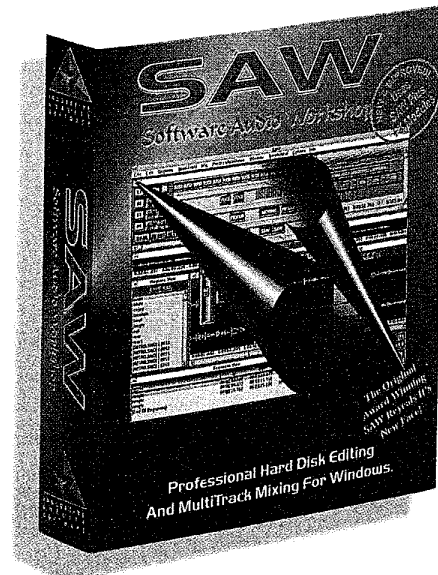

Digital Workstations



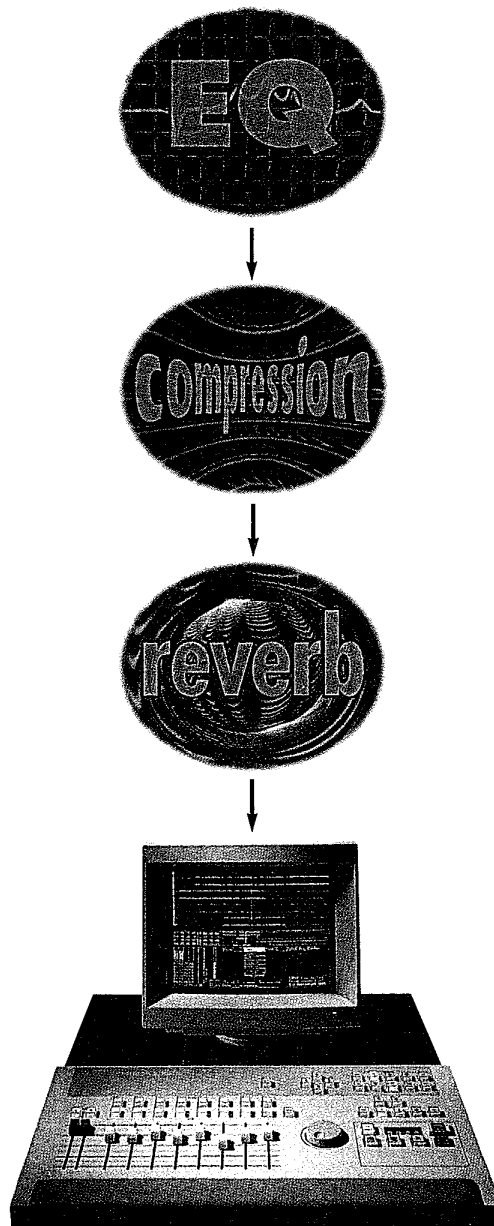

If you need more professional help than this the new DSE 7000FX has a shrink on board.

Relax. Lie back. And think about all those times you were editing spots, racing against a deadline, and suddenly you had to send out for sound effects. Is it any wonder you need professional help? Well, consider this sound therapy.

On board the new DSE 7000FX, you'll find every digital effect you need to create the coolest, most professional spots: EQ by Orban, Compression by OPTIMOD, Reverb by Lexicon. In effect, you get the very *same* effects professional

studios spend thousands on. Except these come standard with the new DSE 7000FX. They work seamlessly with the DSE's legendary mixing console and on-screen interface. And they're incredibly easy to use.

You'll also find that the fastest workstation in radio has gone *turbo*. With added processing power, you'll get more spots done. Be able to add more effects. And on those occasions when sessions get ugly and your :60's seem to run into :70's, relax. The DSE's time compression will shrink to fit.

orban[®]

H A Harman International Company

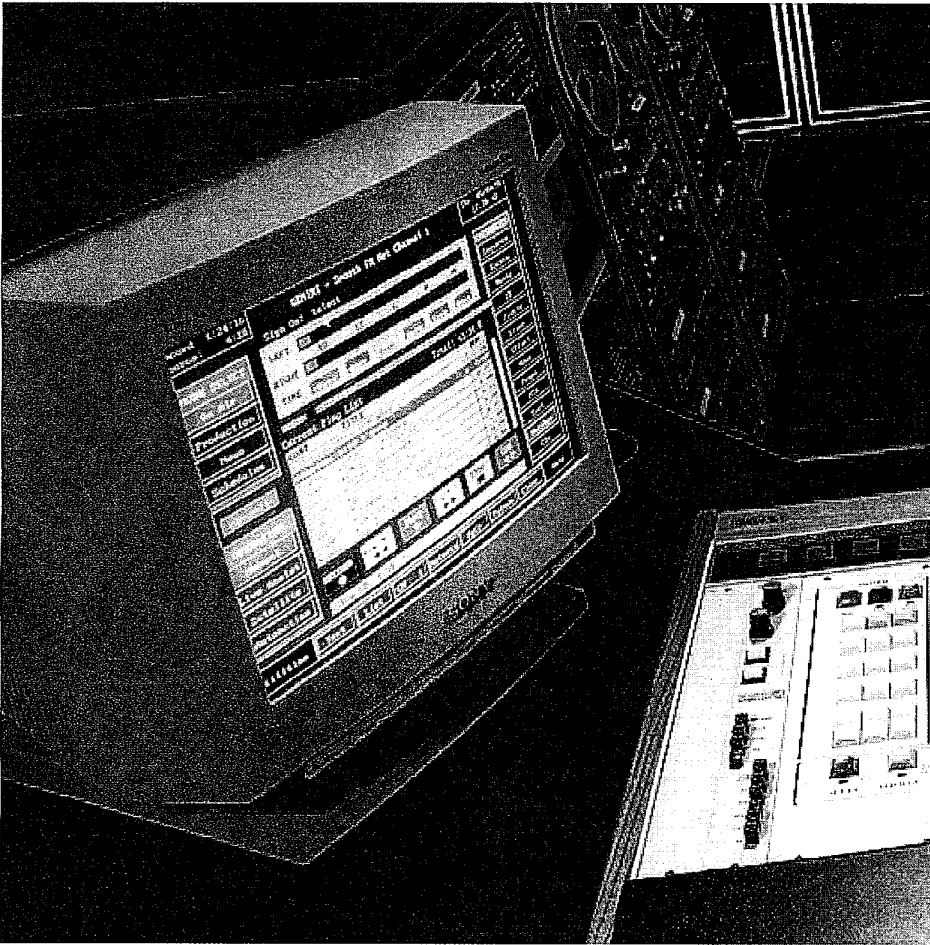

**Arrakis
DL3**

Digilink is a hard disk automation system for radio. Able to record, play, crossfade, and network transfer at the same time, Digilink is ideal for satellite, CD, and hard disk automation. Schedule up to one week with the internal scheduler or import schedules from popular scheduling programs. Network multiple Digilink workstations for On Air, Production, and News. Features such as "Smart Squeeze" and "Autofill" adjust sets to meet the exact size of breaks.

Pricing upon request

Hard Disk Systems



**Fostex
DMT-8 Digital Multitracker**

The Fostex DMT-8 provides 8 recording tracks, 4 of which may be used simultaneously. Up to 40 total minutes of uncompressed, 16-bit, 44.1 kHz recording time is available. The 540 mB internal hard disk is upgradable to 1.7GB.
\$1,995.00 List Price

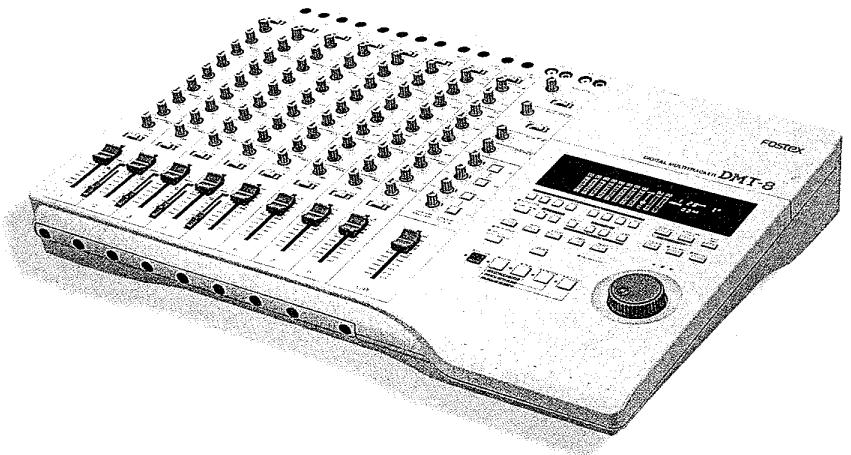

ELEGANT SIMPLICITY

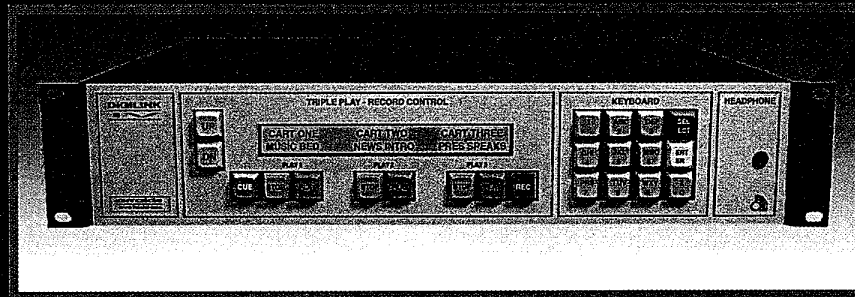

DIGILINK IV

- *On Air or Production digital workstation*
- *Triple Play Cart Machine, Jingle box, & more...*
- *Simultaneous Triple Play & Record & Store Forward*

Digilink Four is a revolutionary new digital workstation from Arrakis. At a break through price, the DL4 is cost effective enough to replace cart machines, reel machines, DAT's etc. The easy to use LCD control panel makes the DL4 ideal for On Air, Production, Editing, & News. To make the DL4 even more powerful, it can be connected to a Digilink 2 or 3 as if it were a CD jukebox for inexpensive hard disk libraries with MPEG Layer II compression. Including a digital satellite, ISDN, and modem store forward interface, the DL4 is the most versatile workstation in radio today.

arrakis
SYSTEMS INC.

**ENCO
DADpro**

The DADpro Digital Audio Delivery System provides very powerful and high quality production recording, editing, on-air reproduction and management, and interfaces to both scheduling and billing systems. It is ideal for both live assist and automated operations, with seamless transition between them during various dayparts.

A single stand alone DAD workstation can provide simultaneous automated on-air and production capabilities, or multiple workstations can be configured to transparently share data via a dedicated file server and Local Area Network. Options also exist for Global Wide Area Networking between systems utilizing ISDN or other fractional T1 technology.

DAD is far more than a simple cartridge machine replacement. It can replace most or all of the recording and reproduction equipment found in a typical studio, including cart machines, cassette machines, turntables, open reel recorders, CD players, DAT machines, etc. It can also immediately increase the efficiency of information flow, from scheduling-to-air, news-copy-to-air, and from traffic to air to billing.

Each operator may have a personalized setup providing preferred on-screen layout and functionality, and be presented with a wide range of pre-scheduled or free access "Virtual Cartridge Machines", random access "Cart Walls", and "Hot" Buttons. Script Display may also be implemented for handling live copy, news, weather, or traffic information, and may even have audio files embedded within the copy for immediate access. Local Recording, Editing, and Audition functions may be added to handle telephone calls, other extemporaneous material, or the automatic timeshifting of external feeds. Touchscreen is the preferred mode of control for this application, although control via console fader starts, on/off switches, or other external logic is optionally available.

DAD may be programmed for any period of automated but "Live Sounding" operation. "Virtual Cartridge Machines" are loaded with playlists that can include crossfaded or overlapped segues, voice tracks, time synchronized events, a wide variety of logic commands to start or stop external equipment or other DAD functions, and even to initiate the routing and/or recording of external feeds. Playlists may be created in short segments for ease of management, then chained together for execution.

DAD is similar to automation, but with the added functionality of externally-controlled activation via



Hard Disk Systems

decoded satellite receiver tones. A mix of "Virtual Cartridge Machines" and "Priority Buttons" can be configured to manage insertion of any local material, magic calls, rotations, even match IDs and Liners with the appropriate personality.

DAD includes several "Virtual Cartridge Recorders" with both manual and automated capabilities. Graphic cut & paste assembly editing capabilities is a standard feature. Digital audio files created on many other editing systems, from inexpensive multimedia products to sophisticated multichannel editors such as the Orban DSE 7000 may be easily imported and utilized by DAD.

Scheduling may be manually accomplished within DAD, or imported from any of the commonly available professional traffic and music scheduling programs. Accurate as-played information may be exported to automated billing systems.

While many similar systems require a complex infrastructure of interconnect cabling, the only connection between DAD workstations and the file server is a single run of network cabling. All audio and logic inputs & outputs are localized within the studio, similar to previous analog installations.

As DAD operates on commonly available non-proprietary Pentium™/PCI computer hardware, any

of the many forms of data protection and redundancy are optionally available, including but not limited to hard disk mirroring, redundant file servers, RAID disk arrays, and local hard disk drives for emergency use. Occasional data tape backup is recommended.

Any number of facilities and their respective DAD systems, may be interconnected via a Global Wide Area Network for the transparent sharing of audio, scheduling, and other data between them. Remote control capabilities via modem are optionally available.

Two ancillary products, the DADSAT Store Forward Management System, and the DADJR Limited Junction Workstation, provide capabilities for transferring locally produced spots, IDs, and liners to unmanned downlink sites utilizing unused time on a satellite link, permitting management control and operation of an entire network of facilities from a single host site.

Pricing Upon Request

CERTAIN PRODUCTS NOT AVAILABLE IN ALL AREAS



**ORDERING AND TECHNICAL SUPPORT:
1-800-622-0022**

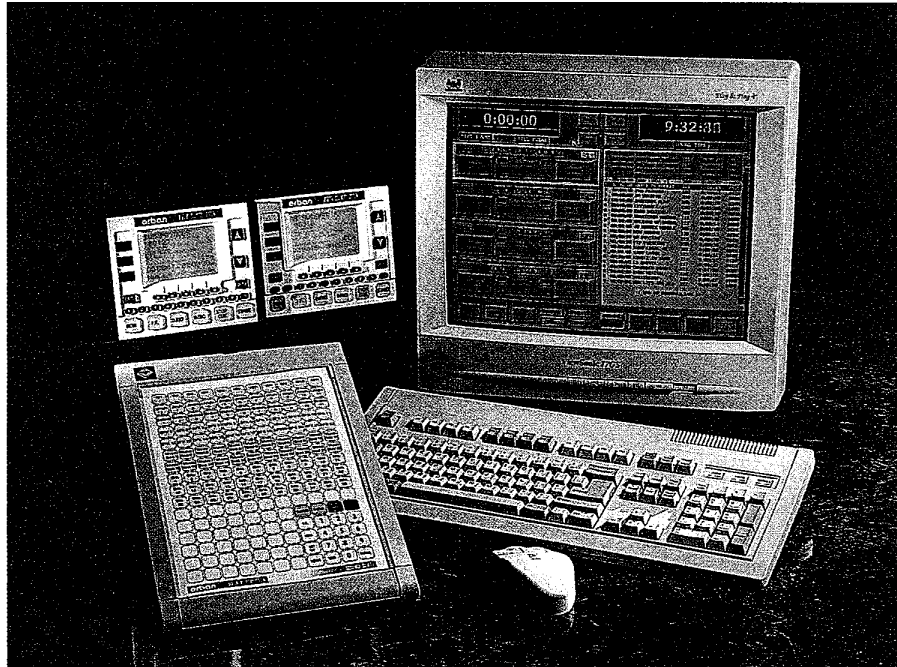

Orban AirTime™

Orban's AirTime™ has distinguished itself from other hard disk audio systems in two important ways. This premier audio management system is designed to eliminate the learning curve for its radio and TV users. Plus, it uses modular software that allows each system to be configured according to each user's specific needs.

Start with operator interfaces that are designed around your current working style. AirTime includes cart machine emulators, sound slate keypads, touch screens and workstations. You can work the same way as before, but with some welcome improvements. These multiple interfaces can work together or are interchangeable for live assist and automation functions.

By far the most distinctive interface is the playback cart emulator, the Sound Cube™. Not only is the Sound Cube sized like an analog cart machine, but it actually looks and works like one. Equipped with large, lighted START, STOP and RE-CUE buttons, Sound Cube is designed for mistake-proof use by on-air talent with minimal training. Your on-air talent will have no trouble using Sound Cube.

Other operator interfaces include the Sound Slate™, which gives on-air talent instant access to their own libraries of intros, liners or sound effects at the touch of a single button. Traditional computer workstations and touch screens are alternatives for those comfortable with keyboards and mice. Workstations are configured for production and traffic applications as well.

Don't be fooled by AirTime's user-friendly interfaces. Supporting them is an incredibly powerful computer with the flexibility to adapt to virtually any environment. Built on QNX, a multi-user, multi-tasking real-time operating system, AirTime provides true network capability. QNX is a derivative of UNIX, an operating system that has proven itself in the most demanding applications (nothing like the Internet to test the demands of multiple users). With a database of up to 99,999 cuts, AirTime™ efficiently handles multiple programs, multiple users and multiple user requests simultaneously. That means you can even run multiple stations from a single control room.

AirTime is smart. Its real-time operating system prioritizes all tasks, giving primary attention to the most critical—like on-air audio playbacks and database sorts. Even when other functions are being performed, you can count on AirTime to air a cut instantly when the PLAY button is hit. You can enhance the quality and consistency of your sound with confidence.

And just as the demands of your facility can change dramatically with acquisitions and consolidations, AirTime can adapt easily to changing needs. The system is built for easy and cost-effective future expansion. You can add storage, channels, extensions and users without duplicating your entire system.

Of course, AirTime plays from a variety of audio sources, including hard disk, satellite and live feeds. To ensure the highest audio quality, AirTime supports PCM and MPEG Layer II audio compression standards.

And don't underestimate the importance of Orban service and support. Since 1968 they've been the first name in broadcast solutions.
Pricing upon request



**Sine Systems
Time-Temp Thing**

Hearing the current time and temperature is important to your radio audience. The Time-Temp Thing makes this possible on satellite and automated stations. It can speak the time, the temperature, or both. It even automatically changes the way it speaks the information so it doesn't sound like a machine. A contact-closure or open-collector output is all it needs to make it speak and an EOM contact is provided when it is finished.

\$599.00 List Price

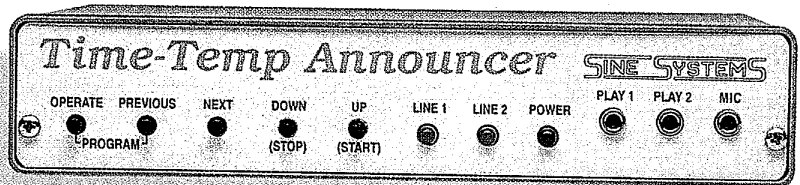

**Sine Systems
Time Temp Announcer**

A radio station is an ideal business to operate a telephone "time and temperature service." Thanks to the low cost of the Time-Temp Announcer, this is now possible in even the smallest communities. Selling advertising on the service is a new revenue source and the cross-promotion possibilities are tremendous. The basic unit answers two lines and comes complete with everything you need to get started. Expansion units allow up to 62 lines.

\$1,499.00 List Price



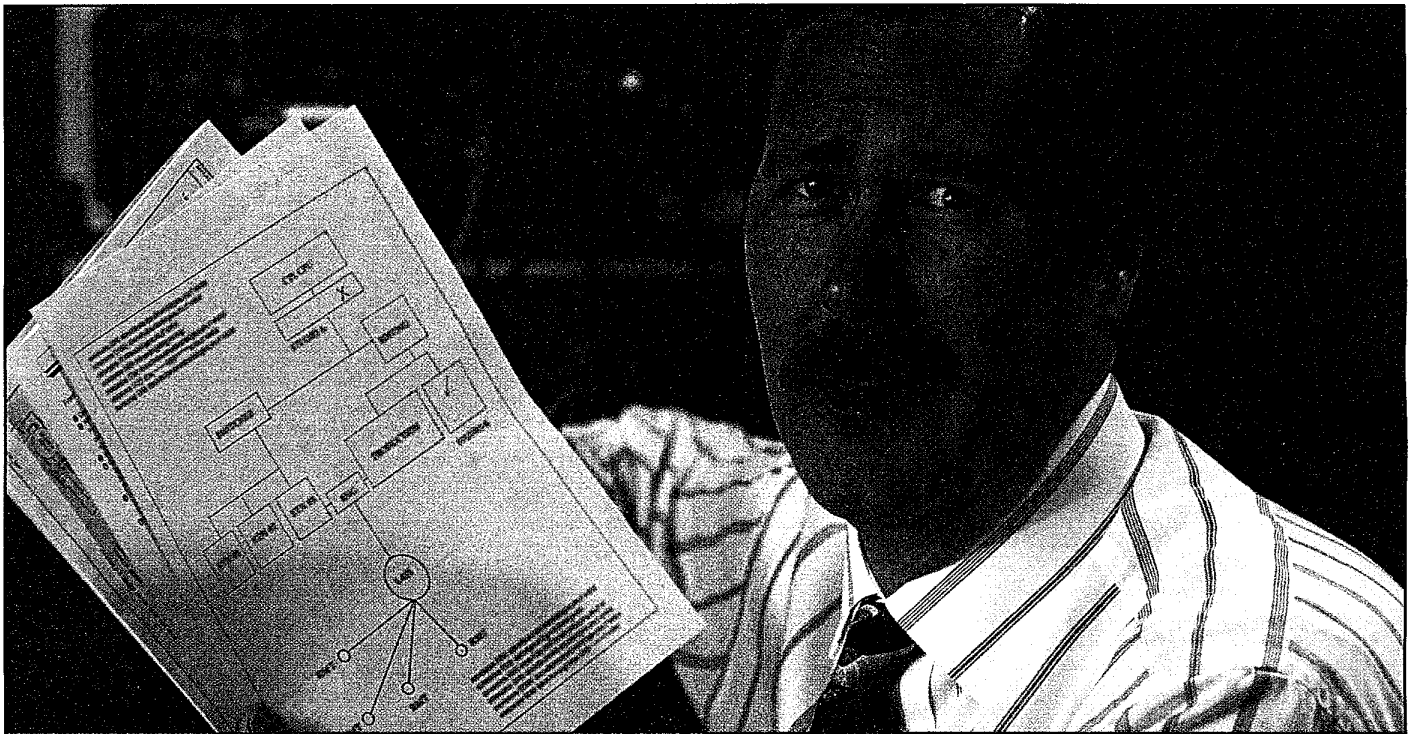

TRYING TO MAKE SENSE OUT OF DIGITAL AUDIO SYSTEMS?

There is a better way!

It's not easy trying to understand the conflicting claims made by different manufacturers when you're buying a Digital Audio On-Air & Production System, whether a single, multipurpose Workstation or an integrated, multiple studio setup. At one end of the spectrum, you're faced with a wide variety of simple "Cart Machine Replacements," and on the other, products whose complexity confounds even the most seasoned broadcast engineer.

The ENCO DAD^{PRO} Digital Audio Delivery System from Harris solves the problem! DAD is simply the most powerful On-Air & Production system available, yet its uncomplicated approach and inherent ease of operation makes immediate sense to any user.

- Intuitive On-Screen displays that are immediately familiar to operators. Optional Touchscreen makes operation quick and easy.
- Complete On-Air flexibility with various "Virtual Machines" for Live Assist, Automation, or Satellite Programmed operations. Interface to other equipment plus scheduling and billing packages. Seamless segue and voiceover transitions sound "Live" in all modes. Script capabilities can be included.

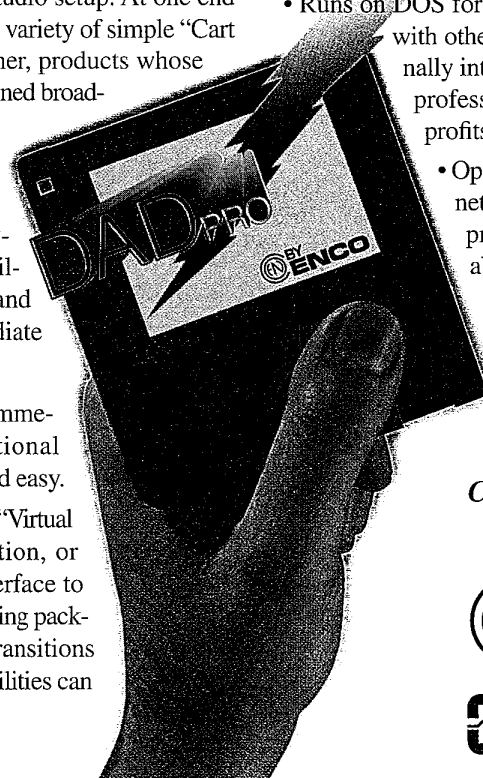

- Full production capabilities, including Graphic Cut & Paste Assembly Editing. Includes analog and digital inputs/outputs. Interfaces with most multichannel editing packages.
- Runs on DOS for proven speed, reliability, and compatibility with other equipment; not an operating system originally intended for multimedia applications. This is a professional tool meant to produce efficiency and profits, not entertain the staff!
- Operates on common off the shelf computers and network architecture. You won't be locked into proprietary hardware that may not be available whenever you need service.
- No monthly licensing fees, DAD is an outright purchase. Software upgrades are free for the first year.
- DAD is proving itself everyday in radio and TV facilities worldwide.

*Call Your Harris Sales Representative
For Complete Information*

 **ENCO**
SYSTEMS, INC.

 **HARRIS**



**AKG
K240M**

One of AKG's most popular monitor headphones, the K240M features a semi-open-back design with a self-adjusting headband resulting in excellent comfort. The dynamic full-range drivers provide firm bass and an extremely clear high-end. Frequency range 15Hz - 20kHz; sensitivity 88dB/mW; impedance $\leq 600\Omega$; power handling capability 200 mW. 10 ft. cable. (3 meters)
\$133.00 List Price



**AKG
K141M**

Found in professional studios throughout the world, the K141M features a semi-open-back design with a self-adjusting headband. Dynamic drivers provide solid bass and a well defined high-end. The K141M has been rated best price/performance ratio in its price range and has received more awards than any other headphone in the world. Frequency range 20Hz-20kHz; sensitivity 97.5dB/mW; impedance $\leq 600\Omega$; power handling capability 200 mW. 10 ft. cable. (3 meters)
\$99.00 List Price

**beyerdynamic
DT 290**

A new series of professional headphones and headsets for studio, radio and TV broadcasting. The 200 series includes single or double muff models, with dynamic or condenser microphones and optional built-in preamp (for carbon insert). The 200 series low visual profile and broadcast quality elements make it useful for every application.
\$299.00 List Price

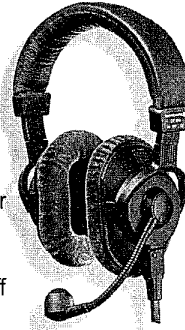

**Fostex
T-20RP**

RP Headphones are the most popular in the RP series. They have achieved something that cannot be designed and cannot be bought: positive word-of-mouth approval by studio producers and engineers all over the world. You've seen these headphones on music videos and albums. "Now I can really hear what I'm doing" and "I can use these headphones for hours without a major case of listening fatigue" are common comments on the virtues of the T-20s. Impedance: $50\Omega @ 1\text{ kHz}$.
\$119.00 List Price



**beyerdynamic
DT 108/109**

The industry standard for communication headsets. These rugged headsets are field-serviceable, and feature extended-response ear monitors and an adjustable, noise-canceling microphone for clear, audible speech transmission. Available in a variety of impedances.
DT108 \$289.00 List Price single earpiece
DT109 \$349.00 List Price dual earpiece



**beyerdynamic
DT 190**

Beyerdynamic's DT 190 was designed to meet the needs of the modern broadcast community. Built on the same rugged chassis as the industry standard 108/109 models, the DT 190 adds beyerdynamic's best ear monitoring transducers, plus a hypercardioid patterned, neodymium element for broadcast quality sound. An excellent choice for on-air talent where durability and reliability are a must. Also available in single-ear versions.
\$419.00 List Price

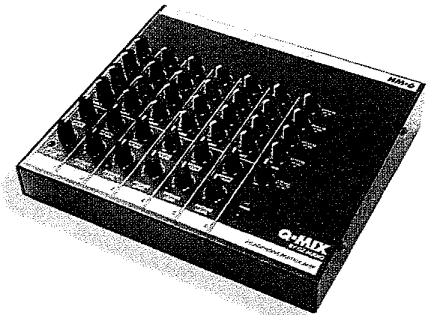

**Oz Audio
Q-Mix HM 6**

The HM 6 solves the never-ending problems of headphone monitoring by creating six independent stereo headphone mixes from a main stereo input plus four auxiliary inputs. There's even an effects send with stereo return. The HM 6 features balanced inputs, sealed pots and a sturdy metal chassis. The HM 6 is great for interview and call-in shows, production studios, on the air, in your news room, and those complicated remotes.
\$299.00 List Price





**Rane
HC 6 Headphone Console**

The Rane HC 6 is one of the most indispensable products in today's audio industry. Featuring six stereo headphone amplifiers, the HC 6 performs a number of necessary tasks, not all of which are headphone related. The HC 6 provides Master Stereo Inputs which can drive any or all of the 6 stereo headphone amplifiers. A mono switch is provided on the front panel to drive both channels of all 6 amplifiers from a common mono source. Six individual unbalanced stereo inputs are available to drive any individual amplifier from a separate stereo source. These inputs can be converted to mono balanced inputs through internal jumpers if required.

\$479.00 List Price



**Sennheiser
HD265**

Designed to meet the stringent demands of studio professional and audiophile alike, the HD265 breaks new ground in the sealed-chamber headphone format. It incorporates these features and more:

- Neodymium-ferrous magnets for superb diaphragm control
- "Duofol" composite diaphragm for ultralinear response
- Triple wound aluminum voice coils for quick transients
- Field replaceable parts
- Polycarbonate dome-damping to minimize resonant distortion.

Nominal impedance: 150 ohms; Frequency response: 10-30,000 Hz
\$249.00 List Price

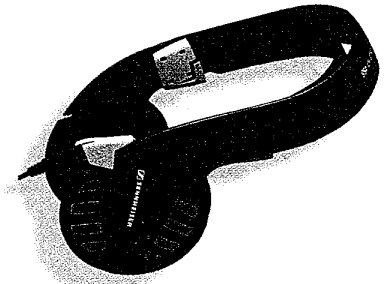

**Sennheiser
HD455**

First in a series of new lightweight high-performance headphones, the HD455 offers all the advantages of an open-are design plus unparalleled style and comfort. It features replaceable parts and excellent reproduction of sound and good bass response as well as a kevlar-reinforced, oxygen-free copper cable. Triple wound copper voice coils offer smoothness and detail. Nominal impedance: 52 ohms; Frequency response: 18-21,000 Hz
\$99.00 List Price



**Sennheiser
HD25SP**

The HD25SP is a closed, dynamic headphone designed for professionals who rely on studio monitor headphones for work and pleasure. It is very lightweight (5.0 oz., 142 gms) and offers effective attenuation of background noise to minimize risk of feedback. The neodymium-ferrous magnets and aluminum/copper voice coils insure high transient response. All headphone parts including headband, cushions, driver elements and cable are replaceable for long term value and durability. Nominal impedance: 85 ohms; Frequency response: 30-16,000 Hz
\$149.00 List Price

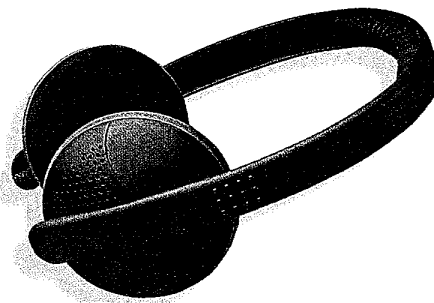

**Sennheiser
HD445**

Combining stylish design and comfort, the HD445 open hi-fi stereo headphone brings hi-fi quality sound at a very affordable price. Its radial bead diaphragm offers accurate sound reproduction and replaceable parts offer lasting value. The 10 ft. (3 meters) kevlar-reinforced oxygen-free copper signal cable with 1/8" to 1/4" stereo phone plug can be connected directly to personal stereos, CD players, DAT recorders or other components. Nominal impedance: 52 ohms; Frequency response: 20-20,000 Hz.
\$79.00 List Price

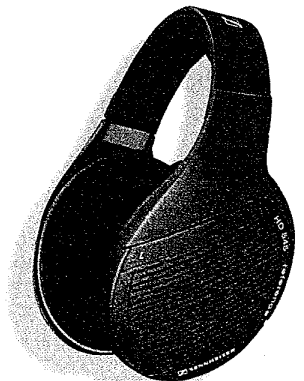

**Sennheiser
HD545**

The HD545 digitally compatible, open-are, circumaural headphone takes the listener to the heart of the musical presentation. Its transparent sound reproduction and highly detailed resolution make the HD545 an excellent choice for all types of music. Features include:

- "Duofol" composite diaphragm for ultralinear response
- Triple wound aluminum voice coils for powerful bass, high output and greater durability
- 10 ft. (3 meters) Kevlar-reinforced oxygen-free copper signal cable
- Replaceable parts
- Neodymium ferrous magnets to ensure optimum sensitivity.

Nominal impedance: 150 ohms; Frequency response: 16-28,000 Hz
\$199.00 List Price



The One-Box ISDN Solution



The Nexus travels light.

It takes up less room in your briefcase than your lunch. Yet, this 15 kHz codec provides a built-in terminal adapter with NT1, mic or line input and a variable output mix of local program and codec return. There is even a data port for connecting your computer for complete digital communications.

The weight? Less than 3 pounds. The price? Just \$2300.

Call us for details
800-237-1776
<http://www.comrex.com>

COMREX
We make great connections

COMREX Corporation, 65 Nonset Path, Acton, MA 01720 USA Tel: 508-263-1800 Fax: 508-635-0401
Email: info@comrex.com Fax-on-Demand: 508-264-9973 Toll-free: 800-237-1776 in N.A. or 0-800-96-2093 in the U.K.

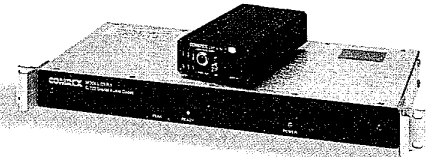
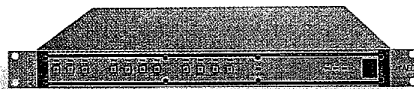

ISDN/Telco Products/Codexes

**Aeta
Scoop Reporter**

Remotes on the fly?
No time or budget to
book a satellite path?
ISDN IS NOT
possible? Quality is a must?



With a Scoop Reporter at
each end of a plain old
dial-up telephone path,
you can bring it back with
broadcast quality.

The Scoop Reporter is the portable codec that
lets you send and receive 7.5 kHz quality over
the least expensive circuits available: long
distance telephone lines!

Scoop Reporter features dual mic and line mixer,
internal modem, battery (5 Ds optional) or AC
operation ready, on board keypad, full duplex
transmission, and padded carry case.

If your schedule includes lots of remotes... if your
budget could use the relief of dial-up circuits for
those remotes, the Scoop Reporter brings them
back with lots of life!
\$3,950.00 List Price

**AEQ
ACD-3001 Audio codec**

Designed for sending and receiving mono audio
through 56 and 64 Kbps lines. User selectable
compression between ISO/MPEG and G.722.
Easy control lay out on front panel. Compatible
with most audio codecs on the market.
Automatic synchronization capability allows
interfacing with the audio codec in the other end.
Uses X.21 and V.35 interfaces. Provides
Auxiliary Data Channel at 300 or 1200 bps, user
selectable in the ISO/MPEG mode via a RS-232
port. Depending on operation modes provides
7.5 kHz up to 10 kHz of bandwidth audio.

\$1,895.00 List Price

**Comrex
DXR.1/DXP.1 G.722 Codec**

These widely compatible, low-cost codecs
incorporate Comrex's "turbo" G.722 providing 7.5
kHz audio at 56/64 kb/s and 15 kHz audio at 112/
128 kb/s. The DXP.1 is the portable version, with an
externally adjustable mic/line input and headphone
output. The DXR.1 rack mount has line level input
and output. Proper input levels and sync status are
indicated on the front panels of both units.

\$1,500.00 ea. List Price

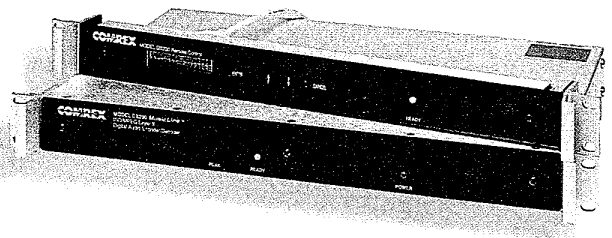

**Comrex
DX200 Layer II Codec**

The DX200 is an ISO/MPEG Layer II codec, capable of 20 kHz stereo on BRI
ISDN or two SW56 lines. It includes Comrex's "turbo" G.722 for low delay requirements and is
widely compatible with other Layer II or G.722 codecs. 24, 32 and 48 kHz sampling rates are available and
operating modes include stereo, joint stereo, dual mono and mono. An optional control panel is available for
"on-the-fly" configuration.

\$3,000.00 List Price
Control panel: **\$300.00**



**Comrex
HotLine**

The HotLine is a POTS codec, which means it works on
Plain Old Telephone Service. Sometimes it's impractical to install a
special circuit like ISDN for a one-time remote. However, usually a plain
telephone line is available. Wouldn't it be nice if, on that plain line, you could
have high quality two-way audio? That's just what you get with the
HotLine... Up to 10 kHz bi-directional transmission on POTS!

\$3,250.00 List Price

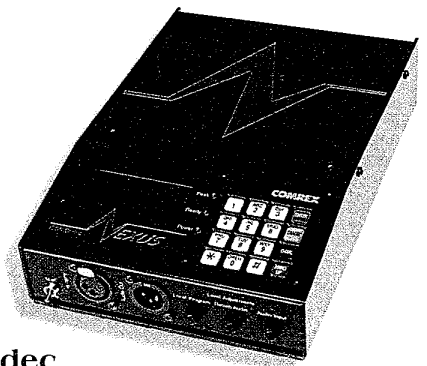

**Comrex
Nexus ISDN Codec**

The Nexus is an ISDN audio codec that's easy on the
budget and a cinch to operate. It delivers 15 kHz bidirectional, low delay
audio on ISDN and is compatible with virtually all codecs (at G.722.) The
complete ISDN interface is built-in, so no external boxes are needed. It has
mic or line input with a variable output mix of local program and codec
return and even a data port for computer hookup.

\$2,300.00 List Price



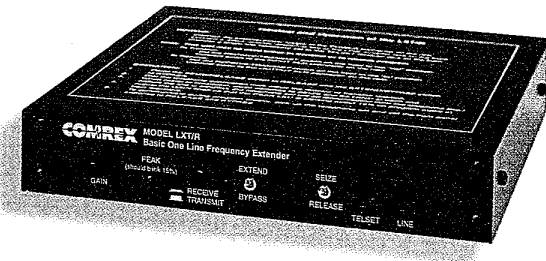

Comrex LXT/R One Line Frequency Extender

The one line frequency extender is the least expensive, most reliable way to upgrade "raw" telephone feeds by restoring low frequency fullness to program material. The LXT/R will operate as a send or receive unit (one is needed at each end of the line) and it is compatible with all other Comrex one line extenders. It will also work through a cellphone's "fax adapter" port, providing improved audio on cellular calls.
\$850.00 List Price
 Optional rack mount



Comrex 2XP/2XR Two Line Frequency Extender

When there's no ISDN and you suspect that even the POTS lines aren't the greatest, remember that the Comrex Two Line Frequency Extender system will provide 5 kHz, noise-free audio over two ordinary dial lines, from anywhere in the world ... with no processing delay. The encoder is the 2XP and the decoder is the 2XR.
2XP \$3,500.00 List Price
2XR \$3,000.00 List Price
 Optional road case for 2XP \$125.00

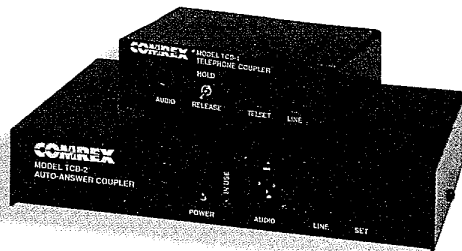

Comrex TCB-1 and TCB-2 Telephone Couplers

The TCB-1 manual coupler gives a switched hold connection to the phone line, eliminating the need for special telephone sets with push-to-talk buttons or exclusion keys. The TCB-2 automatically answers on the first ring and disconnects when the calling party hangs up. A dial tone detect option is available. Both couplers provide a clean, transparent transformer connection from phone lines to audio equipment.
TCB-1 \$150.00 List Price
TCB-2 \$250.00 List Price
 TCB-2 DTD option \$125.00

Comrex Codec Buddy Remote Mixer



The Codec Buddy is a complete remote studio packed into a solidly built 8 lb package, handling program mix, headphone feeds, communications, codec return, and PA feed ... with a built-in one-line frequency extender as a bonus. It is ideal for use with ISDN codecs (see the Comrex Nexus on page 98) and is equally at home feeding phone lines, cellphones, and RPUs.
\$1,900.00 List Price
 Optional road cases: \$125 (for Buddy only) or \$300 (for Buddy, Nexus and accessories.)

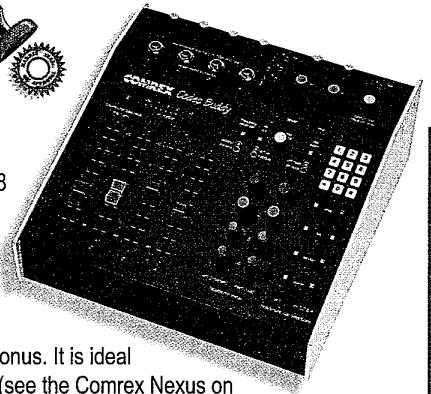

Comrex 3XP/3XR Three Line Frequency Extender

The Three Line Frequency Extender works in the same way as the two line system, but delivers 8 kHz audio using three standard dial lines. It provides automatic dialing, auto answering and setup and works with any two line frequency extender.
3XP \$4,500.00 List Price
3XR \$4,500.00 List Price
 Optional road case for 3XP \$125.00

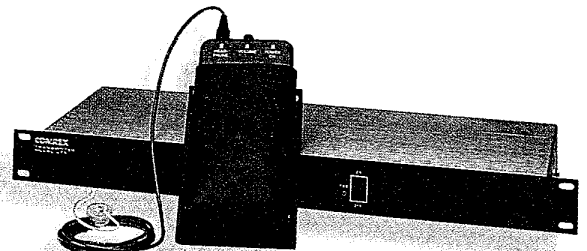

Comrex CTA/LPQRA Wireless Cue System

The Comrex Cue System relays program and instructions from a transmitter, installed in a van, press box, stadium, etc., to pocket receivers. The system is built for ENG/SNG field control and is configured specifically to provide maximum field operating range with broadcast-quality audio. Cue audio automatically overrides program, with program remaining audible. The 1-watt CTA transmitter operates in the 26 MHz band and is FCC type accepted. The LPQRA receiver comes with leather belt pouch and headphone.
CTA \$1,350.00 List Price
LPQRA \$625.00 List Price

ISDN/teleco Products/Codecs





ISDN/Telco Products/Codex

Dolby DP503 Audio Codec

The Dolby DP503 encoder accepts one or two channels of digital or analog audio, plus auxiliary RS-232 data (18-bit A/D converters are provided for analog inputs). Clock synchronization is derived from either an internal data clock or the user's external clock. PCM audio is processed by the user-selected algorithm and formatted into a single serial RS-449 output data stream at the chosen data rate. The front panel features an alphanumeric display that facilitates storing codec parameters and selecting algorithms. Codec parameters can also be stored along with ISDN phone numbers for remote locations, enabling virtually automatic ISDN interconnection.

\$3,100.00 List Price

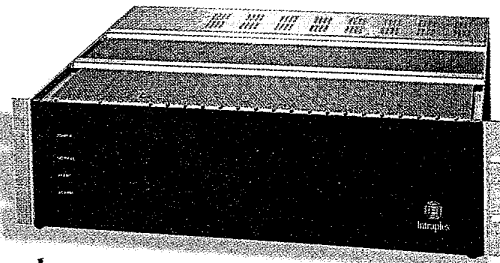

Intraplex STL Plus

The STL PLUS is a fully integrated STL package designed to transmit uncompressed, linear stereo audio over T1 lines. The STL+ system employs T1 multiplexing, which provides a significant benefit not available from other STL products on the market: it allows you the option of adding your choice of one or more extra STL/TSL channels. Voice, data, remote control, and 7.5 or 15 kHz audio, can be added to the basic unit. These extra channels can be added as one-way or full duplex, in the same circuit, without affecting the quality of the broadcast signal in any way.

\$8,800.00 List Price

Dolby DP524 Audio Codec

The Dolby DP524 decoder accepts the RS-449 serial data stream and clock signal and features automatic algorithm detection to recover the audio and RS-232 auxiliary data. Both digital and analog outputs are provided, with 20-bit D/A converters for the latter. Both encoder and decoder provide front-panel system status indicators, rear-panel logic level tallies, and test tone generators for system set-up and troubleshooting.

\$2,990.00 List Price



Intraplex 4464 Codec

The Series 4464 Audio Codec Transceiver is small, about the size of a book, yet includes sophisticated features and a complete set of functionality needed by broadcasters for remote broadcasts. The unit provides MPEG Layer II encoding of 15 kHz and 20 kHz audio in two directions simultaneously, BONDING® compatible inverse multiplexing, and a built in terminal adapter with both S/T and U interfaces for direct connection to the ISDN network. A unique user interface allows broadcasters to set up calls between studios and remote locations with a single button.

List Prices vary

JK Audio RemoteMix Telephone Handset Interface

RemoteMix replaces the handset of your telephone with a mini broadcast console. RCA jacks for tape send and receive, one XLR microphone input, XLR line input and output for connecting to a mixing console. VU meters indicate levels in and out of the telephone. Works with analog or digital PBX, ISDN or Key telephone systems. The three position switch selects the three major handset types. Powered by optional 9-volt battery or included AC adapter.

\$625.00 List Price

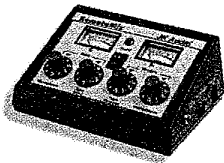

JK Audio RemoteMix C+ Portable Mixer

RemoteMix C+ is a rugged battery powered telephone hybrid/mixer with two balanced XLR microphone inputs, RCA jacks for tape send and receive, and a headphone jack. It also has standard telephone features such as a DTMF keypad, ringer with on/off switch, a handset jack, and an adjustable hybrid null circuit. RemoteMix C+ runs over 36 hours on two optional 9-volt batteries and also includes an AC adapter.

\$595.00 List Price

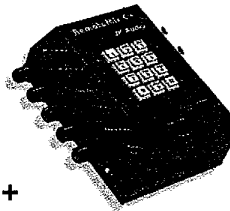

JK Audio RemoteMix 3 Phone Line and Telephone Handset Mixer

RemoteMix 3 is a combination of our telephone handset interface and our phone line hybrid mixer. You can either plug it into an analog phone line or replace the handset on a digital PBX, ISDN or Key telephone system, or add a fax/modem adapter to your cellular phone and go wireless. Includes the same features as RemoteMix C+ and also includes a call setup talkback circuit with internal speaker and microphone, and a transmit VU meter.

\$895.00 List Price





Former talk show host and radio station group engineer Steve Church pioneered the application of digital signal processing (DSP) to professional broadcast products when he invented the Telos 10 in 1984.

BETTER, CHEAPER, FASTER. What ISDN and Audio Coding Means to You.

By Steve Church, President, Telos Systems

ISDN/teleco Products/Codecs

In the beginning, there were telephones

Almost from the start, radio stations and networks have used telephone lines to get audio from event locations to transmitter sites. The sound was never great, but you could not beat the convenience of using the readily available, inexpensive dial-up telephone network.

In the mid-1960's, the telephone companies started to equip their networks with digital transmission capabilities. At first, they were only interested in using digital techniques to increase the number of telephone conversations on their carriers. Gradually, they came to appreciate digital audio for the same reasons we in the broadcast community have: immunity to noise, ease and flexibility of routing and multiplexing, and the potential for lower operating costs.

By the 1990's, with nearly all city-to-city phone signals digitally transmitted, the next logical step was to develop a worldwide standard to bring switched, digital telephone circuits into every business and home. That standard is the Integrated Services Digital Network, better known as ISDN.

The form of ISDN of most interest is Basic Rate Interface, or BRI. (In Europe, this service is called S0.) On a single pair of ordinary phone wires, BRI offers two "bearer" channels at a 64kbps transmission rate and one "data" channel at 16kbps.

Meanwhile, back in the lab

CD players and audio devices using digital signal processing started to be deployed at radio stations in the mid-1980's. Transmitting digital audio data was not a simple task, because without data rate reduction, high-quality audio requires a transmission capacity of about 700kbps for each audio channel. Channels that can handle data rates that high are very expensive and hard to get. More affordable and accessible channels, such as the two 64kbps channels in each ISDN circuit, offer a rate of only about 9% of that of a compact disc. To send digital audio over ISDN, it must be coded at a smaller bit rate.

Early coding schemes, such as G.722, had limited bandwidth and fidelity. Then, in the late 1980's, research labs on both sides of the Atlantic started to realize great success in the area of perceptual audio coding. Based on the principal that certain audio creates a "mask" that hides other audio, perceptual coding retains only information that can be perceived by the ear and the brain.

MPEG Audio Layer III is the most sophisticated method for the coding of digital audio. It uses a unique combination of psychoacoustic masking, redundancy reduction, and bit reservoir buffering to attain high coding ratios while preserving audio quality.

When combined with ISDN, a Layer III codec (coder/decoder) makes it possible to transmit broadcast-quality audio with the convenience, global availability, and low cost of the dial-up telephone network. MPEG Audio Layer II, designed for higher bit rates, was introduced before Layer III and is also used for ISDN audio transmissions.

What does this do for you?

ISDN transmissions are ideal for remote broadcasts, ad hoc networks, voiceovers, commercial distribution, backup to microwave and satellite links, and many other applications. For point-to-point audio delivery, ISDN eliminates the inflexibility of reserved satellite time, is fully two-way, and has relatively low hardware costs.

When selecting equipment for ISDN audio transmissions, look for products that offer the widest compatibility options in each of the two main sections of the equipment, the audio codec and the ISDN terminal adapter. Codecs that adhere to the international standards and offer a range of coding options will allow you to connect to the most sites. For ease of operation, consider equipment that is designed primarily for ISDN and is easy for non-technical personnel to use.

ISDN/Telco Products/Codexes



**Marti
SMARTI® Telephone Codec**

The most versatile telephone codec for remote broadcasting from the Remote Pickup experts - Marti Electronics. The Smarti® is capable of sending and receiving 7.5 kHz audio over a single standard analog (POTS) telephone line. Smarti® utilizes the latest in MPEG compression algorithms coupled with modern DSP technology. No other codec offer the capabilities of the Smarti®: 4 inputs, 2 relay contact closures, three operating modes, selectable delay, high or low speed computer/data channel, and field intercom system. The Smarti® is capable of "learning" the conditions of your telephone line and adapting to it to guarantee a solid connection. Smarti® operates from 90 to 265 volts (50/60 Hz) or any voltage in between. Smarti® offers better than RPU quality with phone line convenience. The incredible features and price makes this unit your SMART choice.

\$3,400.00 per end List Price

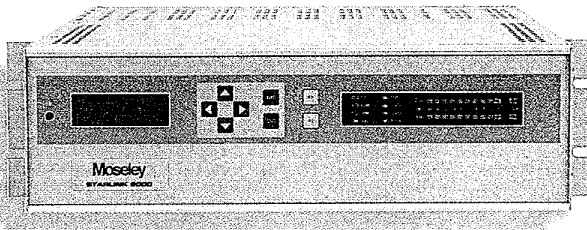

**Moseley
Starlink 9003T1**

The Moseley Starlink 9003T1 provides an all-digital, modular system for transmitting CD-quality audio over T1 lines.

The versatility and power of the Starlink 9003T1 come from a complete range of personality modules and daughter cards that can be housed in a 3 RU mainframe.

\$8,250.00 List Price

Features Include:

- 16-bit PCM linear digital audio
- ISO/MPEG Layer II or apt-X source coding
- Speech / Fax / Data cards

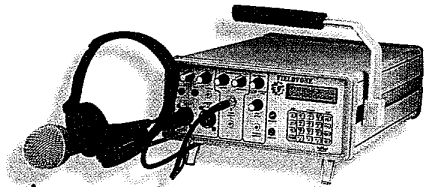

**Musicam
FIELDFONE**

A portable POTS codec. Simultaneously sends and receives 7.5 kHz audio over a single analog telephone line. Ideal for news gathering, sports, instant remotes, and anywhere that ISDN lines are not available or practical. FieldFone has one mic and one line level input, and one headphone output with independent send and receive level controls. FieldFone can actuate four independent relay contacts in StudioFone (see below) to control remote equipment, signal network breaks, etc. Operates on 110 or 220 VAC (specify).

\$3,350.00 List Price

**Musicam
FIELDFONE II**

A portable POTS codec. Simultaneously sends and receives 7.5 kHz audio over a single analog telephone line. Has two mic inputs and one switchable mic/line input. Two headphone outputs, each with independent send and receive level controls. Four onboard relays can be actuated from the far end unit for cueing and remote control. World power supply standard, can operate from external DC power.

\$3,800.00 List Price

**Musicam
STUDIOFONE**

Rack mount companion to FieldFone or FieldFone II for studio use. Has two switchable mic/line inputs. Remoteable IFB circuit with front panel mic permits talk-back to remote site. Front panel speaker and headphone jack monitor send and receive audio. Four on-board relays can be actuated from any FieldFone, FieldFone II or StudioFone to operate studio equipment. World power supply.

\$3,800.00 List Price

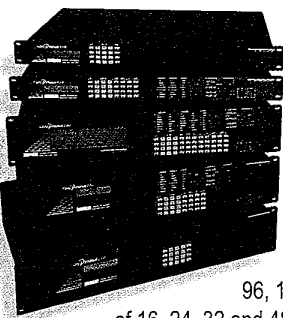

**Musicam
CDQPrima Digital Audio Codexes**

CDQPrima codexes give you outstanding performance specifications, and more features and flexibility than any other codec available. All five CDQPrima models come with MUSICAM®, the exclusive MUSICAM USA enhancement to the ISO/MPEG Layer II algorithm, certified Layer II compatible by the IRT, ISO/MPEG Layer III, and G.722. All units support transmission bit rates of 24, 32, 48, 56, 64, 80,

96, 112, 128, 144, 160, 192, 224, 256, 320 and 384 kb/s, and sampling rates

of 16, 24, 32 and 48 kHz. AES/EBU digital inputs and outputs with automatic rate adaptation are standard on all models except 110 (optional). All models have 20-bit A/D converters and deliver better than 92 dB dynamic range and less than 0.01% THD+N. Gold plated connectors are used throughout for signal integrity. CDQPrima features automatic functions, such as dial-on-audio, hang-up-on-silence, Prima Logic Language, full remote computer control, multiple ancillary data streams with rates up to 38,400 bps, 256 speed dial addresses, multiple TA support for broadcasting, and Dual Channel Send. CDQPrima's modular design permits easy upgrades. World power supply operates on 90-250 VAC, 47-65 Hz. All CDQPrima models are manufactured in an ISO-9000 certified facility for superior performance under harsh conditions.

List Prices start at \$3,250.00



**Musicam
ROADRUNNER**

An economical, compact, portable mono ISDN codec/mixer. Full duplex bi-directional operation. Contains MUSICAM®, Layer II, Layer III, G.722 and G.711 algorithms, plus hybrid interface for direct connection to an analog telephone line. Up to 15 kHz on one ISDN "B" channel, 20 kHz on two "B" Channels. Bit rates: 56, 64, 112 & 128 kb/s. Two mic inputs, plus switchable mic/line input. Two headphone outputs, each with independent send and receive level controls. Four onboard relays can be actuated from the far end unit for cueing and remote control. Complete with internal terminal adapter and NT1. World power supply standard, can operate from external DC power.

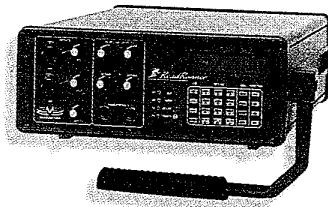

**Musicam
OLYMPIAN**

The top of the line codec that goes where you go! A portable, easy to use stereo ISDN codec/mixer. Full duplex bi-directional operation. Contains MUSICAM®, Layer II, Layer III, G.722 and G.711 algorithms, plus hybrid interface for direct connection to an analog telephone line. Three mic inputs, each with stereo pan, plus analog and AES/EBU digital audio stereo line inputs. Three headphone outputs, each with separate send and return level controls. 256 Speed-Dial addresses, plus storage for multiple venue terminal adapter configurations. Olympic Memory Snap Shot—OMSS™—smart preset lets you save all parameters.

\$5,200.00 List Price

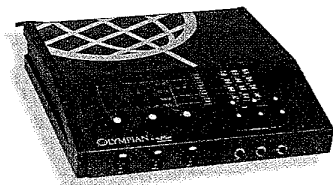

**RE America
RE 660/661**

The RE 660/661 is a single rack space Digital Audio Codec providing up to 20kHz of audio bandwidth and features mono, dual mono, stereo and joint stereo operation, with selectable bit rates from 56 to 384 kb. Applications include network program distribution, remote pick-ups for sports, concerts, special events, news gatherings, STL back-up, audio backhaul, recording and post production studios. Standard features include AES/EBU and S/PDIF digital interface, two-times V.35, X2.1 or RS 422 interface and a front panel digital headphone jack for monitoring of digital or analog inputs. AES/EBU interface optional.

\$2,795.00 List Price

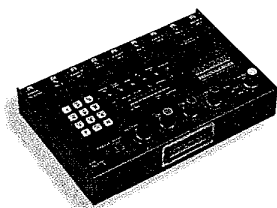

**Telfax
GX-440 Phone Remote Mixer**

The Telfax GX-440 Phone Remote Mixer is ideal for sports, news, and special event broadcasts. You'll be on the air in minutes, not hours. GX-440 features include: built-in phone line interface, tone and pulse dialing, headphone amp/cue, rechargeable batteries, ringer, limiter, squelch, tape in/out, four microphone inputs, second phone line capabilities, Low Frequency Extender interface jack, radio monitor input, and AC power adapter/charger. The GX-440 measures 1.5" x 6.1" x 9.4", and weighs only 3 pounds. A hard plastic protective case is now included. Remotes have never been easier!

\$1,295.00 List Price

**Telfax
"TalkPort" (TLX-2000)**

Telfax scores another "first" with the new "TalkPort" Micro-Cellular Phone Remote Mixer. This revolutionary communications link opens up a host of new possibilities for broadcasters...instant remote broadcasts from virtually any location utilizing the cellular telephone network. The Telfax TalkPort weighs only 4 pounds, so strap it over your shoulder or on your belt, plug in a headset and you're "on the air". TalkPort is equipped with a modular jack so the unit can be used on standard phone lines too. Other features include: two Mic inputs, tape input/output, audio limiter, headphone amplifier, electronic ringer, radio monitor input, 4-hour battery pack (transmit time), AC power adapter/fast charger, and padded case. And check out the price....it's definitely a "best buy".

\$1,295.00 List Price

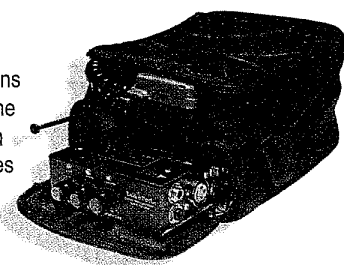

**Telos Systems
ZephyrExpress Portable ISDN Audio
Transceiver**



ZephyrExpress is the ideal solution for remote broadcasts and other applications, eliminating the need to lug additional electronics. It combines a full-featured audio codec with MPEG Audio Layer III and II as well as G.722,

a built-in ISDN terminal adaptor, and an audio mixing/monitoring system in a road-rugged chassis. Designed for ease-of-use by non-technical staff, ZephyrExpress has a selectable SAFE feature that locks it into the preferred configuration.

\$5,280.00 List Price



**Telos Systems
Zephyr Studio ISDN Transceiver**

The best way to hear from there, Zephyr can transmit two-way, 20kHz stereo audio virtually anywhere in the world on a single ISDN circuit. Zephyr offers MPEG Audio Layer III and II, as well as G.722. The built-in ISDN terminal adapter was designed by Telos specifically for broadcast applications. The controls are straightforward for easy operation by non-technical users and Zephyr includes full metering, mic/line inputs, and input protection limiting.

\$4,980.00 List Price

ISDN/Telco Products/Codecs



Now with Layer III, there's one more reason to love CDQPrima™

When you need to send audio, CDQPrima gives you three or four times the features of any digital audio codec on the market.

NOW CDQPrima adds the Layer III algorithm to give you increased compatibility and 15 kHz response on a single ISDN B channel.

NOW your new CDQPrima is compatible with more codecs in more locations than any other codec, with CCS MUSICAM®, Layer III and G.722.

NOW because of CDQPrima's incredible 92 dB dynamic range and ultra-low distortion, Layer III NEVER SOUNDED BETTER.

AND, because CDQPrima works at all bit rates up to 384 kb/s in MUSICAM and 320 kb/s Layer III, you can produce *contribution quality* audio feeds.

PLUS you get all the terrific features that only CDQPrima offers:

- ♥ Programmable functions to do automatically what other codecs make you do yourself: dial-on-audio/hang-up-on-silence, and more
- ♥ 18-bit A/D and D/A converters for the best audio quality
- ♥ AES/EBU with automatic rate adaptation is standard in all but the budget Model 110
- ♥ Gold-plated Neutrik® XLR connectors to preserve maximum signal-to-noise ratio
- ♥ SMPTE Timecode, stereo audio, *two* ancillary data streams and up to *eight* contact-closures in only 128 kb/s
- ♥ Downloadable software directly over ISDN—no need to take CDQPrima out of the rack for software upgrades
- ♥ Sophisticated but simple Speed Dial stores not only 256 addresses but all configurations for fast, easy connection. You never need to change sampling or bit rates—just dial!
- ♥ Send audio to up to six locations with no additional hardware
- ♥ ISDN J.52 IMUX BONDING puts CDQPrima ahead of the industry curve for error-free connectivity

What's Not To Love?

Call us today and we'll help you select the CDQPrima that's just right for you.



MUSICAM USA
Formerly CCS Audio Products

670 N. Beers St., Bldg. 4
Holmdel, NJ 07733 USA
Tel: 908/739-5600
Fax: 908/739-1818
Fax On Demand: 908/935-2777
Internet: <http://www.musicamusa.com>

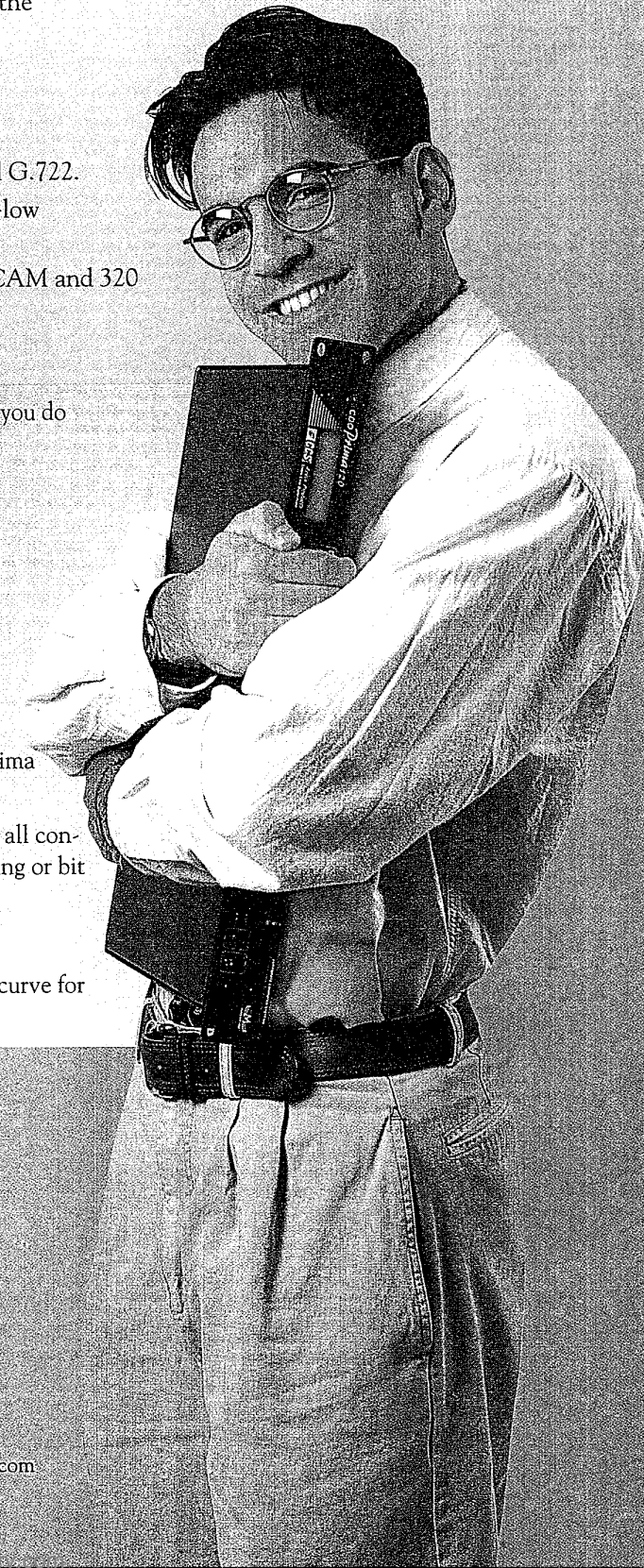



**Audio Technica
ATM 25**

The ATM25 is a rugged hypercardioid dynamic microphone that is specially constructed to respond cleanly in high SPL environments. This microphone is characterized by a low end response that is full and warm and a presence that is well defined and distinct. It's response

lends itself well for announce, close up vocals and dialogue. The ATM25 is also perfect for high SPL instrument miking.

\$278.00 List Price

**Audio Technica
AT4033/SM**

The AT4033/SM is designed for the most demanding studio applications. This cardioid condenser microphone incorporates symmetrical and transformerless low noise circuitry, resulting in exceptional transient response and an extremely clean output. It is well suited for studio and broadcast applications where natural reproduction is required. The microphone operates on phantom power.

\$725.00 List Price

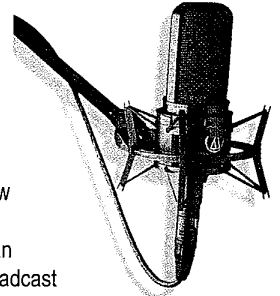

Microphones

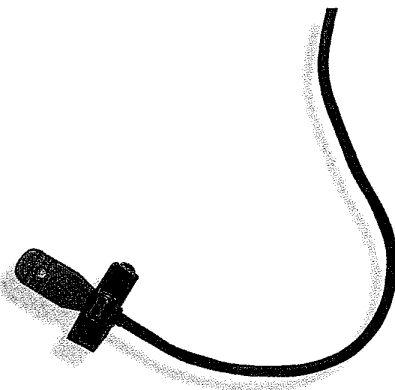

**Audio Technica
MT830R**

The MT830R is a subminiature omnidirectional lavalier and is ideal for applications which require minimum visibility. Its small size can easily be concealed in clothing, costumes, props, etc. Operates on phantom power only.

\$200.00 List Price

**Audio Technica
AT831B**

This miniature unidirectional microphone lends itself well to lavalier use as well as musical instrument use. It is ideal for applications where room noise or feedback is a problem. Its excellent presence makes the AT831B perfect for optional broadcast applications. Battery or phantom powered and also has on/off/rolloff switch.

\$200.00 List Price

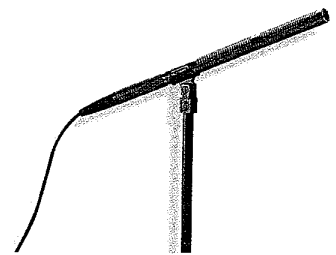
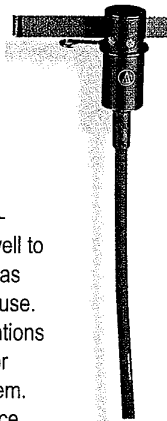

**Audio Technica
AT835B**

The AT835B is a line + gradient "shotgun" microphone, ideal for challenging distant miking applications such as film and video, ENG, outdoor recording and theater. At 14.5" (36.83 cm) long, the AT835B has an acceptance angle with which the user can easily follow fast moving action, yet reject unwanted off axis activity. It is powered by a single internal AA cell or by phantom power.

\$329.00 List Price

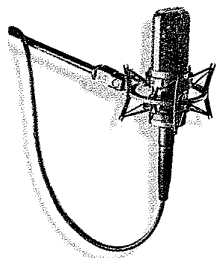

**Audio Technica
AT4050/
CM5**

The AT4050/CM5 is a multiple pattern studio microphone and incorporates symmetrical and

transformerless low noise circuitry, resulting in exceptional transient response and an extremely clean output. The user can switch between omni, cardioid, and figure 8 polar patterns to suit the needs of the application. The microphone is characterized by open, transparent reproduction and handles high SPLs with ease. Phantom power operation only.

\$995.00 List Price

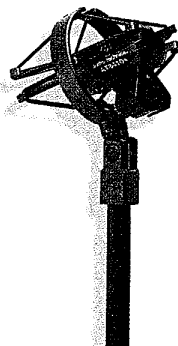

**Audio Technica
AT8410A**

The AT8410A universal shock mount isolates a microphone from unwanted mechanical vibration. It incorporates a universal spring loaded clamp that fits tapered and cylindrical microphones.

\$60.00 List Price

**Audio Technica
AT822**

This is an X/Y configured stereo condenser microphone with full mono compatibility. Particularly well suited for camera mount or DAT recording, it is also at home in the television studio and other field applications. The AT822 provides full, natural stereo ambiance in a compact, lightweight design. This microphone offers a switchable low cut filter, windscreen and camera mount and operates on a single AA battery. Includes a shielded cable with connector and a 3.5mm stereo mini plug output.

\$399.00 List Price

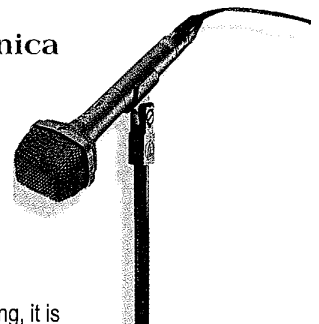



AKG C414B/ULS

Combining transformerless electronics with a capsule matching the specifications of the legendary C12, the C414B's extraordinary warmth and character makes it an excellent choice for today's digital recording requirements. This 1" dual diaphragm, pressure

gradient microphone provides 4 selectable polar patterns, a three position bass cut switch and a switchable attenuator. A maximum, SPL of 160dB makes it suitable for virtually any vocal or instrument miking application. 20Hz - 20kHz.
\$1,249.00 List Price

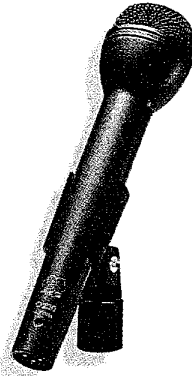

AKG D230

An omnidirectional dynamic capsule enclosed in a rugged, extra long all-metal body makes the D230 the choice for ENG applications. Designed for the toughest outdoor assignments, the integrated windscreen and tailored frequency response ensure that your voice is transmitted

perfectly clear and free from distortion. And of course the D230 comes with a matte, non-reflective finish. Frequency range 40Hz - 20kHz.
\$239.00 List Price

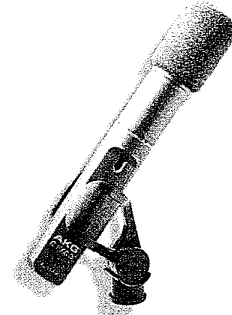

AKG C1000S

The famous AKG studio condenser sound in a versatile and affordable microphone for stage or studio use. The C1000S operates from an internal 9V battery or from phantom power.

The polar pattern converts in seconds between cardioid and hypercardioid. Its exceptional high gain-before-feedback and rugged all-metal body make it suitable for any stage or studio vocal application. Frequency range 50Hz - 20kHz.
\$524.00 List Price

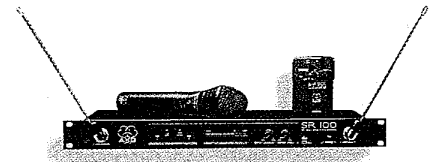

AKG WMS100/3800

Enjoy the rugged reliability and exceptional sound quality of the D3800 without the cord. The WMS100/3800 wireless microphone system features a true diversity receiver with noise reduction, adjustable squelch, calibrated audio and RF metering in a 19" rack-mountable 1 RU package. Automatic muting circuit prevents noise bursts when transmitter is switched off. Your choice of 13 available frequencies.
\$1,110.00 List Price



AKG C3000S

A revolution in studio quality microphones, the C3000S combines a large diaphragm and micro transducer technology to provide the clarity, character and warmth of a studio standard vocal microphone in an affordable package. Selectable

polar patterns (cardioid or hypercardioid), bass roll-off and pre-attenuation allow for close miking of instruments. Other features include an internal suspension system, integrated windscreen and exceptionally rugged casing. Frequency range 20Hz - 20kHz.
\$838.00 List Price

AKG D3800

The D3800 dynamic microphone offers exceptional sound quality and ruggedness for the professional user. Featuring a hypercardioid pattern, the D3800 is designed for minimum feedback. The unique triangular shaft, innovative suspension system and TPS (Transducer Premium System) design combine to provide a comfortable microphone with reduced handling noise and a high output. For the discriminating vocalist. Frequency range 40Hz - 21kHz.
\$246.00 List Price



Audix OM-7

The OM-7 delivers a clear, natural and undistorted sound even under the most critical conditions. Designed specifically for pro use, the OM-7 features a "controlled low-gain output stage" resulting in significantly higher gain before feedback.
\$359.00 List Price



Audix OM-5

The design of the OM-5 was in response to the market's demand for a super high-output mic with natural, undistorted sound. Unlike other brands using exotic magnets and having unnatural sound and excessive feedback, the OM-5 does not sacrifice sonic quality or feedback rejection to achieve its high levels of gain.
\$329.00 List Price



Audix OM-3xb

The original VLM Technology, high-output transformerless mic, the OM-3xb produces a natural, accurate sound without distortion. It's ideal for a variety styles and applications.
\$199.00 List Price



THE
ONE
YOU'VE
BEEN
WAITING
FOR



SHURE UHF WIRELESS

This is as good as it gets.

The new Shure UHF Wireless delivers everything you'd expect from a premium-quality UHF system. And then some.

Like programmable LCD displays on both transmitters and receivers. A generous 191 channels of frequency-agility. The flexibility to perform flawlessly in practically any application. And the built-to-last reliability you expect from Shure. All at a fiercely competitive price. You patiently waited for it. Now it's waiting for you.

To learn more about the new Shure UHF Wireless System, call 800-25-SHURE.

SHURE[®]

The Sound of Professionals...Worldwide.[®]



beyerdynamic U 600

Beyerdynamic's top-of-the-line UHF wireless system has an impressive list of features: better than 100dB signal-to-noise ratio for clear, clean transmission, 119dB dynamic range, digital "grip" ident tone locking system, simultaneous operation of 15 frequencies in one TV channel, multi-user mode, 12 hour battery life plus beyerdynamic's all new computer control system — all of which add up to a new standard in UHF wireless! Available in hand held or bodypack/lavalier models.

\$4,999.00 List Price

beyerdynamic M 58

The M 58 is an omnidirectional microphone specifically designed for the demands of the ENG market. An internal blast-filter and its specially shock-mounted element make it less susceptible to wind and handling noise. Its tailored frequency response enhances intelligibility and its Nextel finish is rugged and glare-proof. Like all beyerdynamic microphones, it carries a liberal two-year warranty.

\$259.00 List Price



beyerdynamic MC 736

Beyerdynamic's MC 736 is a short shotgun microphone designed for field use. Its hypercardioid/lobe pickup pattern make it ideal for film and television productions where off-axis rejection is critical. It features a smooth, wide frequency response for a natural sound in the studio or on location, an extremely sensitive element and unusually high signal-to-noise ratio. The MC 736 has a variable bass rolloff and will accept any phantom power from 8-52v. Also available in long-shotgun version as the MC 737.

\$1,099.00 List Price

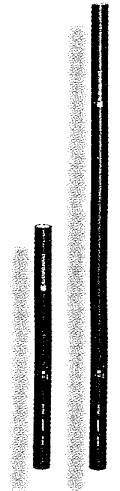

beyerdynamic MC 834

The MC 834 is beyerdynamic's newest studio condenser microphone. It's ruler-flat frequency response, wide-cardioid polar pattern, and transformerless design, make it a perfect mic for voice-overs and other studio applications. The MC834 has a three-position bass rolloff and variable input stages. Now carries a lifetime warranty!

\$999.00 List Price



beyerdynamic MCE 86 S Kit

The MCE 86 S is a versatile, lightweight short-shotgun that's ideal for camera or boom mount. It will operate on any phantom power from 8-52V, or on a single AA battery. It's extremely smooth frequency response and tight hypercardioid/lobe pattern make it an excellent choice for studio or location use. Kit includes Rycote Softie, suspension mount and clip all housed in a flight case.

\$899.00 List Price

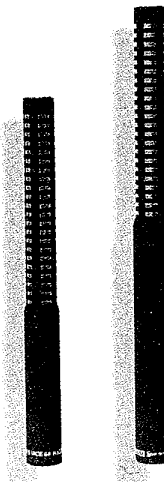

Clear-Com Systems Pro-40 Communications Headset

The CC-85 and CC-250 headset is specifically designed to work with major types of communication systems including party line and Matrix intercoms. It is designed for use in intercom and sportscaster/announcer applications where audio quality, reliability, and comfort are of prime importance.

Prices start at \$175.00

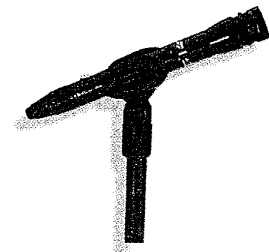

Crown CM-700

The CM-700 is an extremely versatile condenser microphone for professional recording and sound reinforcement applications. High noise handling capability of 151 dB before overload. Excellent for miking acoustic instruments. Three position roll off switch. Offers unusually high performance at an

extremely competitive price. Cardioid pattern.

\$289.00 List Price



Crown CM-311HS

Crown's unique differoid noise canceling microphone for use with the Sony MDR-7506 and MDR-V6 headphone. Provides full clear distortion free sound in high noise environments. Adapts quickly and easily with no drilling to Sony headsets. Cough switch included. Perfect for sporting events, traffic helicopters, etc. Frequency response: 50 Hz to 15 kHz. Impedance: 75 ohms.

\$299.00 List Price (Sony headset not included)



**Electro-Voice
RE1000**

Based on feedback from the RE2000, the RE1000 utilizes the same technology in a cost-effective model optimized for vocals. Its transformerless design minimizes low-frequency distortion and hum susceptibility attributed to low-cost, poorly-shielded transformers. The externally-biased, high-voltage transducer is nearly identical in design to the RE2000, but has an articulated high-end which helps vocals cut through the mix and an extended bass response which provides a rich, warm low-end.
\$774.00 List Price

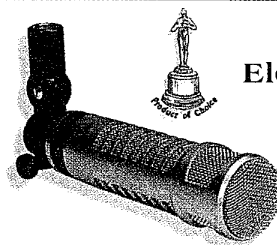

**Electro-Voice
RE27N/D**

The RE27N/D features the same heavy-duty construction of the RE20 and combines it with the high output of N/DYM, technology. A higher output than the RE20 and an even wider frequency response, the RE27N/D incorporates two different high-pass filters, and one low-pass filter. The first high-pass gives a 6dB roll-off from 250 to 100 Hz. The second high-pass provides a gentle roll-off of 12dB from 1,000 to 100Hz. The low-pass filter decreases the high-frequency rise by 3dB.
\$744.00 List Price

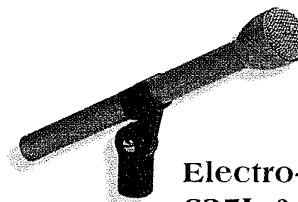

**Electro-Voice
635L & 635L-B**

With the proliferation of "mic flags", additional handle area is needed for the talent to grasp the microphone. The 635L has the same inner workings as the original "Buchanan Hammer", but provides an additional 3.5 inches in length. Additionally, the longer handle will give you better leverage when driving nails. The 635L is available in both fawn beige and camera black(635L-B)
\$165.00 List Price



**Electro-Voice
RE50 & RE50/B**

Another standard-of-the-industry, the RE50 is seen on the news more than any other microphone. It is a shock-mounted version of the 635A, with the same frequency response and output characteristics. The rubber shock-mount "mic-in-a-mic" system achieves isolation that has previously been unheard of. A four-stage pop and blast filter provides excellent protection from wind noise, excessive sibilance, and "p-popping". The RE50 is available in both fawn beige and camera black (RE50/B).
\$250.00 List Price

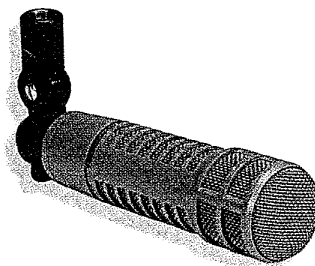

**Electro-Voice
RE20**

A world-standard voice-over, production and instrument microphone. The RE20 has been a favorite due to its flat response over a large frequency range. The Variable-D, design virtually eliminates "bass-boosting" proximity effect, making it very easy to work the microphone without losing audio quality. A heavy p-pop/blast filter allows you to be up against the microphone without the worry of popping it. The RE20 incorporates a bass roll-off switch that dips the response 4.5 dB from 400 to 100 Hz.
\$597.00 List Price

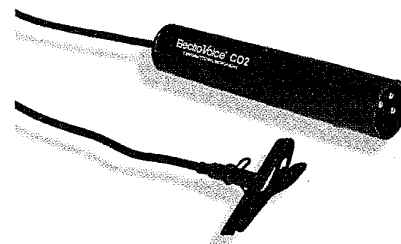

**Electro-Voice
CO₂**

It is better to be heard and not seen... This is what industry professionals told us they needed in a miniature lavalier microphone. The CO₂ can be hidden practically anywhere, and still maintain a natural, open sound. The CO₂ is available in both black and white versions for easy concealment. Plus the exclusive Tincture' surface may be painted with acrylics allowing custom colors for any situation. A host of clips make it simple to attach the CO₂.
\$209.00 List Price

Microphones

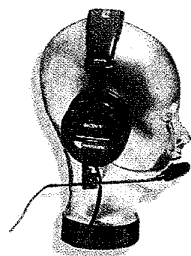

**Crown
CM-312HS**

Extremely comfortable head-worn microphone. Hypercardioid design. Ideal for talk radio, TV announcers, and live sound where high quality is vital. Nine volt battery or phantom power. Easy connection to any wireless transmitter. Frequency response: 50 Hz to 17 kHz. Impedance: 75 ohms. Attaches to Sony headphone.
\$279.00 List Price (Sony headset not included)

**Crown
CM-10**

Highly affordable broadcast quality miniature lapel mic. Field replaceable capsule/cable features solderless connectors that make service a snap. Side exit cable for low mechanical noise and reduced cable stress. Flex relief on cable connector improves reliability. Dual mic clip also available.
\$149.00 List Price

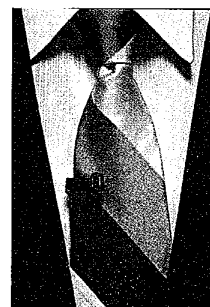

**RAMSA
800MHz
UHF
Wireless
400 & 800
Series**

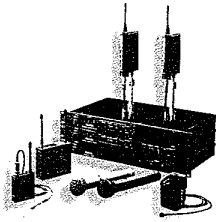

The Ramsa 400 and 800 Series offer outstanding performance and reliability in a system designed for broadcast and production applications.

Features

- 96 dB dynamic range superb sonic quality
- 49 channels built in dial around interface
- Four receivers in one RU save valuable rack space
- Hand-held transmitter utilizes Shure SM-58 dynamic mic capsule for superb sonic performance
- Belt pack transmitters are rugged and reliable
- Camera back receiver for EFP/ENG

**Sennheiser
HMD25-1**

The HMD25-1 supraural, closed headphone with dynamic, supercardioid boom microphone has been designed specifically for use in noisy environments. The microphone can be worn on either left or right side, and a two-piece padded headband offers exceptional comfort. The headset is lightweight at 18.0 oz.



Headphone Nominal Impedance: 600 ohms;
Headphone Frequency Response: 30-16,000 Hz
Microphone Electrical Impedance: 200 ohms;
Microphone Frequency Response: 50-12,000 Hz
\$450.00 List Price

**Sennheiser
HME25-1**

The HME25-1 is similar to the HMD25-1, however it features an electret, omnidirectional boom microphone (MKE2 Red Dot). This broadcast quality microphone offers superb transmission due to extremely flat frequency response and may be worn on either left or right side.
\$525.00 List Price



**Sennheiser
MD421 II**

The MD421 II cardioid dynamic microphone incorporates all of the classic characteristics of its MD421-U predecessor and offers several improvements. A faster, more open and transparent microphone, the MD421 II combines advanced materials and modern manufacturing techniques, making it a more rugged microphone, even closer tolerances than the MD421-U, the MD421 II consistently delivers its proven classic sound. Its 5-position bass roll-off switch makes the MD421 II highly adaptable for most any audio application ranging from on-air radio broadcasting to vocal recording and instrument miking.



Nominal Impedance: 200 Ohms
Frequency Response: 30-17,000 Hz
\$485.00 List Price

**Sennheiser
MD441-U**

A dynamic, supercardioid microphone with separate low and high equalization switches, the MD441-U offers excellent feedback rejection and sound quality. Accurate signal response and low distortion are ensured, even with the highest sound pressure levels. A spring suspended capsule provides low sensitivity to handling noise. The MD441-U includes a five position bass roll-off switch, brilliance switch and integral pop filter.



Nominal Impedance: 200 ohms
Frequency Response: 30-20,000 Hz
\$895.00 List Price

**Sennheiser
MD504**

Designed primarily for instrument miking the MD504 compact, dynamic, cardioid microphone with integrated swivel mount can easily be fit into the smallest space, making it ideal for drum kits. The microphone's ability to withstand sound pressure levels higher than 160 dB without distortion, combined with an extremely smooth frequency response make the MD504 a perfect choice for capturing the sonic potency of guitar amplifiers, horns, and drums. Its rugged glass composite construction and excellent specifications make it ideal for touring applications.



Nominal Impedance: 350 ohms
Frequency response: 40-18,000 Hz
\$169.00 List Price

**Sennheiser
MD736**

As part of the ProForce series of microphones, the MD736 dynamic, supercardioid microphone harnesses Sennheiser's innovations in material science and manufacturing efficiency to provide true, powerful sound reproduction. The MD736's precise supercardioid pattern and tailored frequency response provide maximum feedback rejection. Equipped with strong Neodymium/Iron/Boron magnets and featherweight membranes and voice coils, the MD736 can withstand very high sound pressure levels without distortion. A noiseless, magnetic reed on/off switch is included.

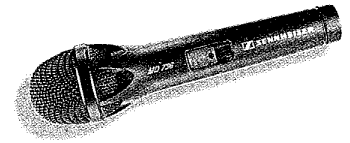

Electrical Impedance: 350 ohms
Frequency Response: 50-18,000 Hz
\$199.00 List Price

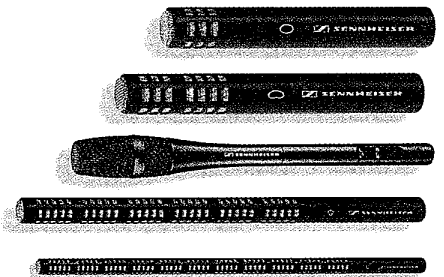

**Sennheiser
K6/ME Series**

The K6 system is a versatile professional condenser microphone system of exceptionally high quality. It is available with a wide variety of modules for different powering arrangements, polar patterns and capsule sizes. The K6 powering module operates for 150 hours on a single AA battery, or may be used with 12-48 volt phantom power. The K6 features an on-off switch and bass roll-off switch which compensates for proximity effect in close miking, or for wind rumble in field recording. Capsule choices include:

- ME62: Omnidirectional \$185.00 List Price**
- ME64: Cardioid \$210.00 List Price**
- ME65: Supercardioid Handheld \$295.00 List Price**
- ME66: Short Shotgun \$279.00 List Price**
- ME67: Long Shotgun \$375.00 List Price**





Shure SM57

The classic SM57 is the "workhorse" microphone of stages and studios worldwide. Its carefully contoured frequency response means clean, well defined instrumental reproduction and rich, warm vocal pickup on lecterns or stages. The standard for drum, percussion and instrument amplifier miking. Cardioid (unidirectional) dynamic. Frequency response: 40 to 15,000Hz. SM57-LC (less cable)
\$146.00 List Price



Shure SM58 Microphone

Consistently the first choice of professional performers around the globe, the SM58 is a genuine world standard and a true audio legend. Although the "58" is often imitated in appearance, its lively, yet intelligible, powerful sound and rugged reliability have never been duplicated. Makes rock, R&B, pop and country vocals sound their best. Cardioid (unidirectional) dynamic. Frequency response: 50 to 15,000 Hz. SM58-LC (less cable)
\$188.00 List Price



Shure VP64 Microphone

A sleek, ergonomic design and a high energy neodymium magnet make the VP64 the perfect choice for "on-camera" video production and broadcast handheld use. The upper-midrange presence rise adds clarity, while the low-end rolloff minimizes boominess and background noise. Handsome appearance, consistent audio quality on or off axis, high output, low noise, effective shock isolation and extremely rugged construction. Windscreen and swivel adapter supplied. Omnidirectional dynamic. Frequency response: 50 to 12,000 Hz
\$135.00 List Price



Shure SM2 Headset with Boom Mic

A professional headset for close-talk use with a dynamic cardioid microphone and dual-ear headphones for mono or stereo operation. Microphone element is designed for excellent noise rejection. Ideal for TV, radio, film and video applications. Features large, pillow-soft ear pads; double-braced, covered metal headband; supplied with detachable cable with connector at earpiece end only. Cardioid dynamic. Frequency response: 50 to 15,000
\$277.00 List Price

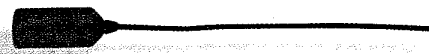

Shure SM11CN Microphone

For those who need a dynamic lavalier microphone, the SM11 is the smallest Shure model available. Shure ruggedness and dependability are found in this microphone which is approximately 1.5 inches (3.81 cm) long. Supplied with tie tack and tie bar mounting accessories. Omnidirectional dynamic. Frequency response: 50 to 15,000 Hz. SM11-CN (with attached cable)
\$116.00 List Price

Shure MX184 Microphone

Professional supercardioid lavalier. Patented accessories for unobtrusive mounting are provided, including a 4-way tie bar, double-mic tie bar, two multi-purpose mounting blocks, and foam windscreen. Side-exit cable minimizes handling noise and is easy to conceal. Compact, lightweight beltpack preamp operates on standard 9-volt battery or phantom power. Frequency response: 80 to 20,000 Hz.
\$290.00 List Price

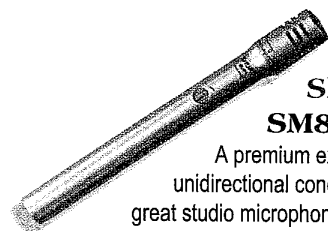
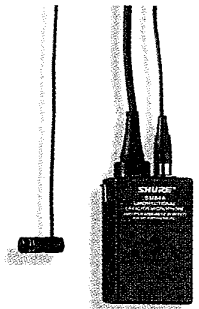

Shure SM81 Microphone

A premium example of Shure engineering, the unidirectional condenser SM81 is one of the world's great studio microphones, providing the ultimate in precise, detailed sound reproduction. Excellent for use with most acoustic instruments, both in live performance and in the recording studio. A world standard for choir and overhead cymbal applications. The SM81's ruler-flat response may be modified with a built-in low-end rolloff switch. Built-in 10 dB attenuator. Windscreen included. Phantom power only. Cardioid condenser. Frequency response: 20 to 20,000 Hz. SM81-LC (less cable)
\$441.50 List Price

Shure SM7 Dynamic Microphone

Acclaimed as one of the finest dynamic microphones in use today and a fixture in studios around the world. The "smooth and silky" unidirectional SM7 is famous for making voices and other sources sound their best. Extremely popular for radio and television work, especially voice-over recording. Unique tailoring switches (for presence boost and low-end rolloff) permit the choice of four different response curves. Yoke assembly allows exact positioning. Effective built-in windscreen for close-up use. Cardioid dynamic. Frequency response: 40 to 16,000 Hz.
\$566.50 List Price



Microphones



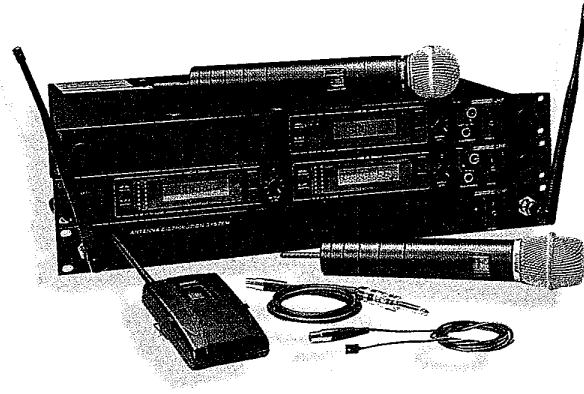

Shure LX Wireless Series

Widely used and accepted in the installed sound and live music markets, the LX Wireless Series Systems deliver unmatched performance and reliability at a moderate price. With diversity and single antenna receivers, a full line of professional handheld, lavalier, instrument and headworn microphones, as well as an instrument cable, the LX Wireless Series offers a wireless system that fits most every sound reinforcement application

Prices vary

The Shure Wireless Family

Shure SC Wireless Series

The SC Series Wireless Systems are feature-rich MARCAD Diversity systems created with fixed installation sound requirements in mind. Each SC Wireless system is capable of operating at eight different frequencies (four different frequencies for systems operating in the traveling frequency band). Digital frequency control provides greater freedom from RF interference and virtually "bulletproof" signal reliability. SC Wireless Series are available with handheld, lavalier, instrument, or headworn microphone options, and up to twelve SC Wireless systems can be operated simultaneously in a single installation.

Starting at \$954.00 List

Shure UHF Wireless Systems

The new Shure UHF Wireless System delivers everything you'd expect from a premium-quality UHF system, including exclusive features you'll find nowhere else.

As you'd expect from a leader in the sound reinforcement technology, audio quality is unsurpassed. You can choose from Shure's premium assortment of handheld microphones, including the Beta 87 and Beta 58A, known worldwide as the mics of choice for live concert sound. A variety of high-performance lavalier and headworn microphones are also available.

Starting at \$2,390.00 List

Shure VP88 Stereo Condenser Microphone (not pictured)

This single-point M-S stereo condenser microphone is unique in its ability to capture all of the realism and drama of "being there" while withstanding the punishment of daily use in rigorous production environments.

The VP88 is ideal when superior stereo imaging is required from a single microphone. Widely used in sound reinforcement, live and studio music recording, video production, electronic news gathering and sporting events coverage. VP88 includes windscreen, swivel adapter and Y-cable. Frequency response: 40 to 20,000 Hz. 100% Mono compatible.

\$995.00 List Price

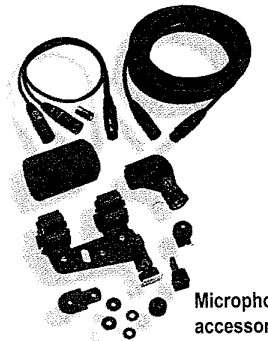

Microphone accessories

Telex FMR-450 UHF

Wireless Microphone System

The Telex FMR-450 system avoids the interference and congestion common in VHF systems by operating in the UHFband between 524 MHz and 746 MHz. That means broadcast-quality audio with up to 50 systems operating all at once — in one location.



With Telex's patented Posi-i-Phase™ true diversity circuitry, the FMR-450 system operates over long distances reliably — so microphone users can roam freely with complete confidence.

Starting at \$1,525.00 List

Telex ENG-500

Performance and flexibility in an ENG/EFP Package. Until now, you could have either great audio performance with the risk of interference, or frequency agility with inferior audio quality. Today, Telex gives you the best of both worlds: the Pro® ENG-500 system. The ENG-500 is a flexible wireless microphone system that combines the benefits of crystal-control with real frequency agility. The results are rock solid RF performance and the premium audio quality you have come to expect from a Telex wireless system.

\$1,995.00 List Price

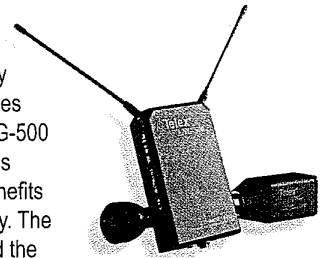

The choice is *crystal* clear.

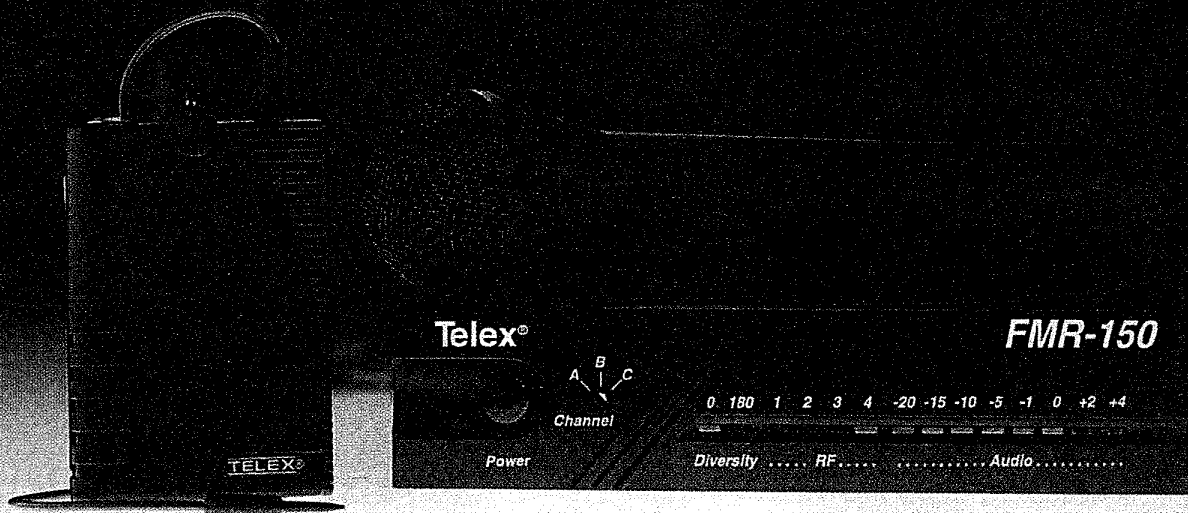

The new FMR-150 wireless microphone system from Telex offers maximum audio and RF quality with an added feature: noiseless crystal-controlled frequency agility. Our patented Posi-Phase™ true-diversity circuitry gives rock-solid freedom from dropouts and noise-ups, while Posi-Squelch™ auto suppression combines the improved range and audio quality of a true noise squelch, with the security of a tone-coded squelch. The FMR-150 also features a wider range and choice of stock

frequencies, with custom frequencies available. This crystal-controlled system utilizes three widely-spaced frequencies that allow the user to instantly select a clear channel in the event of interference. You'll feel confident recommending a system that's designed and built in the U.S.A. with our exclusive 3-year warranty. And behind it all is our reputation for reliability and performance. Just what you'd expect from a sound company like Telex.

Telex®

9600 Aldrich Avenue South • Minneapolis, Minnesota 55420 USA • 612-884-4051 Fax 612-884-0043

Mini Disc



**Denon
DN990R/DN-981F
MD Card Series Recorders/Players**

The DN-990R recorders and DN-981F players offer all the advantages of MD without the conventional NAB Tape Card problems of wow and flutter or annoyances of drop-outs and tape stretching. These full-function units provide audio and computer interface as well as a multitude of options including synchronization. Optional "Hot Start" switchbox adds instant playback of any 10 tracks (DN-981F).

**DN990R \$3,500.00 List Price
DN-981F \$2,800.00 List Price**

**Denon
DN-1100R MD Recorder**

The DN-1100R MD recorder offers 74 minutes of stereo recording time with a 44.1 kHz sampling rate, 16-bit linear (A/D converter) quantization and ATRAC audio compression. The unit also features 10 independent "Hot Start" buttons to which any 10 tracks from a total of 255 can be assigned. This feature is ideal for sound effects access, soundbytes, live shows, commercials, music, jingles, liners, and announcements.

\$2,600.00 List Price

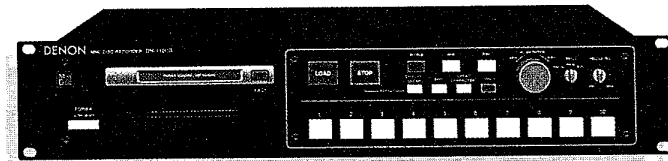

**Otari
MR-10RP/MR-10P**

Random access, fast editing, 74 minutes capacity, digital quality. They're all available in one remarkable technology that professionals have borrowed from a clever consumer unit... Mini Disc!

Just a few short years ago, you would have needed an audio machine as large as a dishwasher to do everything the Otari MR-10 does now. From its small size to its large recording capacity, the MR-10 puts the power and convenience of random access editing right in your hands.

Otari's legendary reliability combined with the speed and flexibility of digital disc make the MR-10 perfect for stereo broadcast, production, jingles, sound effects, audio archiving and programmed music/announcements for radio post-production and sound reinforcement applications.

**MR-10RP \$3,255.00 List Price
MR-10P \$2,625.00 List Price**

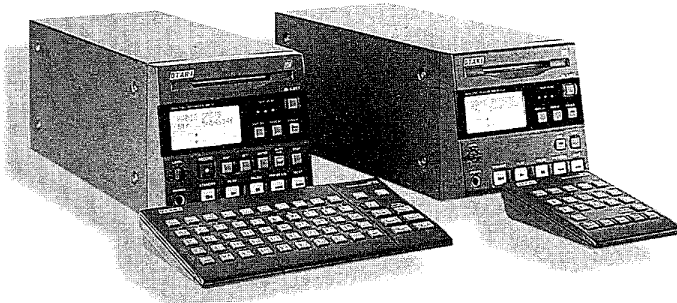

Sony

MDS-B3 & MDS-B4P

From Sony, the creator of Minidisc, comes the MDS-B3 Minidisc recorder/player, and the MDS-B4P Minidisc player. With high quality digital sound, instant non-linear access, auto cue and EOM functions, these units are ideal for on air applications in radio and TV broadcasting stations, as well as for audio archiving, PA announcements, theatrical sound effects and more. The MDS-B3 recorder includes a remote control with keyboard for easy recording, editing and track titling capability.

MDS-B3 \$3,325.00 List Price

MDS-B4P \$2,500.00 List Price

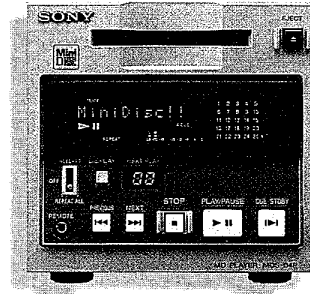

Mini Disc

Sony

MZ-B3

Sony's latest addition to the Minidisc family is this Walkman® size Minidisc recorder/player. It includes a built in microphone and speaker, and is ideal for live field recording and news gathering. The MZ-B3 can record 74 minutes stereo, or up to 148 minutes in the mono mode. It also incorporates the newest ATRAC version 3.0, which provides better sonic performance than ever before on the Minidisc format.

\$899.00 List Price

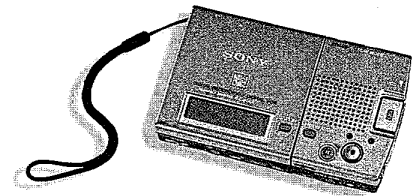

Tascam

MD-801R & MD-801P MiniDisc Systems

These are perhaps the most advanced recording, editing and playback machines utilizing MiniDisc (MD) technology. Ideal for theme parks, museums or other presentation environments requiring frequent, continuous or unattended playback of program material. Plus, because of its random access capability, it is ideal for the production and broadcast studio environment. TASCAM offers two versions (1) a record & playback systems (MD-801R) and (2) a lower-cost, playback-only unit (MD-801P).

MD-801R \$2,499.00 List Price

MD-801P \$2,399.00 List Price

Features
• Random access features include move, insert, combine, divide, plus title and others
• Instant locate and repeat playback
• Single frame accurate jog/data wheel
• +4dBm balanced (XLR) & -10dB unbalanced (RCA) in/out
• AES/EBU & S/PDIF digital I/O
• Program title using data wheel or via optional standard PC keyboard (user bits)
• RS-232C and parallel interfaces



Yamaha

MD4

The new self-contained personal digital multitrack recording system offering the flexibility of digital-based multitrack systems with the convenience of recording and archiving on a removable minidisc format. Features include 4-track simultaneous recording (with zero wow and flutter and pitch fluctuation), built in 4-channel mixer with mic/line gain and 3-band EQ, fast and accurate search and locate, precise auto punch in/out and adjustable pitch control (-6% to +6%). The new MD Data disc format permits up to 37 minutes of 4-track, 74 minutes of 2-track and 148 minutes of mono recording.

\$1,199.00 List Price

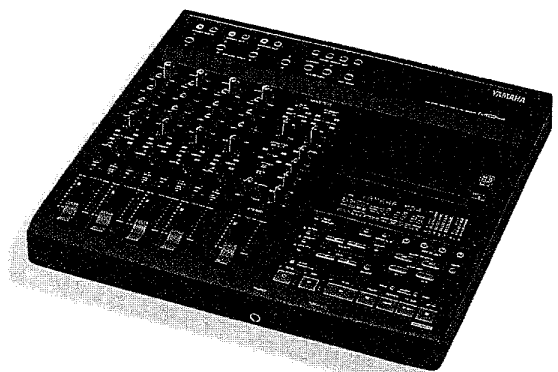

CERTAIN PRODUCTS NOT AVAILABLE IN ALL AREAS



**ORDERING AND TECHNICAL SUPPORT:
1-800-622-0022**

RBDS

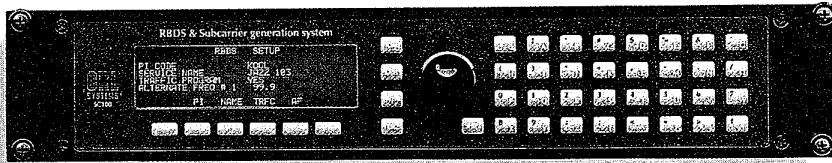

**Circuit Research Labs
SC-100 Digital RDS/RBDS
Generator**

The SC-100 generates an RDS/RBDS subcarrier through 100% Digital Signal Processing (DSP). All static programming is accomplished from the front panel keyboard without a PC, and stored in nonvolatile memory. Dynamic data is input via serial port. RDS paging is supported via an internal database or TNPP protocol. An internal real time clock and large fluorescent back-lit LCD display make the SC-100 easy to program.

\$3,395.00 List Price

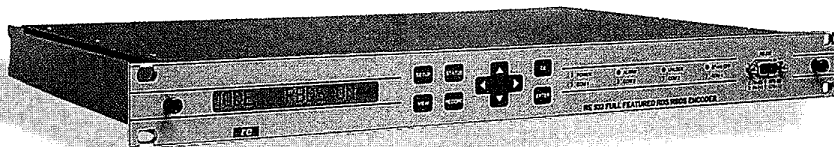

**RE America
RE532**

The RE532 is a single rack space encoder designed to meet full RDS/RBDS specifications and data management. The RE532 will intelligently manage and maintain the integrity of the broadcaster's RDS/RBDS data. All five data ports may be prioritized with inherent system security. The unit can operate as a stand alone subcarrier generator or as a composite loop-through, in-line adder. The product also comes complete with easy to use PC control software.

\$3,800.00 List Price

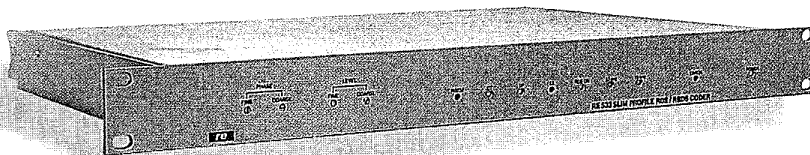

**RE America
RE 533**

The RE 533 is a single rack space RDS/RBDS coder which can be easily interfaced in the FM composite signal chain, allowing fast installation at either the transmitter or studio site. In addition, the RE 533's features include traffic and emergency alerts, alternative frequency linking, clock time and radio text messages that allow immediate control of the enhanced RDS/RBDS broadcast. With radio text, the station will be able to send 64 character messages that are displayed on the listener's "smart radio."

\$2,415.00 List Price



Otari

Model MX5050BIII

the Otari MX5050 Series allows the audio professional to select exactly the right machine for the application. Among these workhorses, a broadcast favorite is the MX5050B, now in its third generation on a model III. Two track stereo, 3 3/4 / 7.5 ips or 7.5/15 ips selectable.



The MX5050BIII maintains a position of favor in control and production rooms worldwide.

Wherever analog tape is still the need, Otari delivers with the 2-track stereo MX5050BIII as well as 4- and 8-track units in the series.

The extremely rugged mechanical construction includes a 1/8" deckplate with cast aluminum side panels and steel support members. All circuit boards are designed to swing out or unplug for full service access.

\$4,452.00 List Price

Otari

MX-50IIN 1/4" Two-Channel Audio Recorder

The Otari MX-50IIN is an affordable audio machine that, regardless of its cost-effective design, incorporates the performance you require.

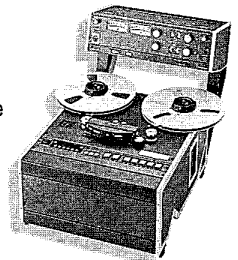

The standard machine is a 1/4" NAB two-channel configuration accepting from 5" (EIA) to 11.8" (DIN) reel sizes. Inputs are transformerless active balanced, with XLR-type connectors. The transport mechanism is mounted on a machined aluminum alloy deck plate, and features a DC quartz PLL capstan motor with front panel selection of operating speed from either 15/7.5 or 7.5/3.75 ips speed pairs. (An internal switch selects the desired pair, however, field conversion is required for equalization.) A front panel control provides 7% vari-speed.

\$3,233.00 List Price

Tascam

BR20 & BR20T Master Recorders

- Parallel port for synchronizer control
- 3 microprocessor-controlled auto locate points and return to zero
- Precision tension servo control system
- XLR balanced & RCA unbalanced I/O
- Spot erase
- Gapless Punch-in/out
- One-button synchronization
- Two tape speeds



Tascam

34B Production Presentation Multitrack

- 2-speed 1/4" 4-track (7.5 or 15 ips) with ±12% pitch control
- Uses both 7" and 10.5" reels
- Digital tape counter with zero return
- Dump edit function
- Full logic transport, NAB/IEC equalization
- LINE IN accepts stereo input for audio equipment



The TASCAM 34B is a high-performance 4-track 1/4" reel-to-reel multitrack recorder ideal for mastering, radio broadcast production, video and film soundtrack production or even multimedia production and presentation.

\$3,049.00 List Price

Like the BR20, the BR20T is a high-performance 1/4" format 2-track, but adds a center/line timecode track. Designed for video post-production and other production applications, the center/line track features a timecode waveform optimization system that eliminates the need for timecode level monitoring, offsets and adjustments. Alternatively, the center/line track can also be used to store production information.

BR-20 \$3,149.00 List Price

BR-20T \$3,799.00 List Price

Tascam

32 2-Track Master Recorder

- Multi-speed: 15 ips and 7.5 ips
- Use 7" or 10.5" tape reels
- Digital tape counter with zero return
- Cue capability for monitoring at all times
- Pitch control
- Dump edit function
- Bipolar power supply
- Optional RC-71F remote control unit

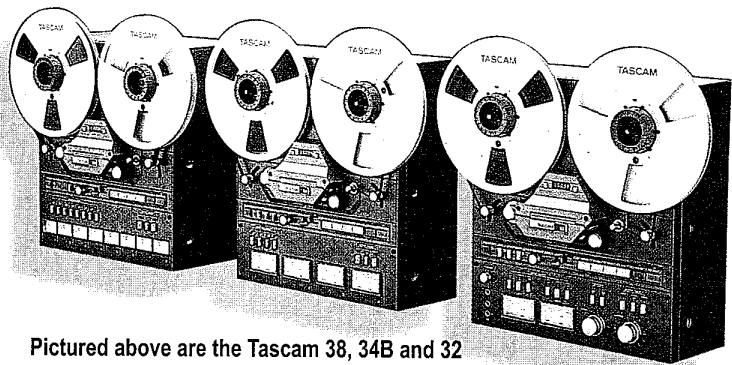

Pictured above are the Tascam 38, 34B and 32

The 1/4" 2-track production workhorse. A high-performance machine, the TASCAM 32 combines a rugged precision transport and exceptional audio electronics with a complement of performance features which exceed the demands of today's broadcast studio environments. A standard for high-quality mastering.

\$ 2,399.00 List Price



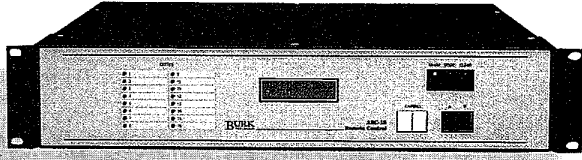

**Burk
ARC-16 Remote Control**

The ARC-16 includes 16 analog metering channels, 16 status channels and 32 command outputs (16 raise & 16 lower). The single unit configuration includes the transmitter unit with front panel 32 character digital display and the new Enhanced Speech Interface (ESI). This allows full remote control from any Touch-Tone® telephone. With a Studio Controller, the system has a constant link with the transmitter for instant response to any problem, and you can still have access via telephone. The ARC-16 can be configured to control up to three separate transmitter locations, or a single transmitter from up to three studio units. The AutoPilot™ software allows for fully automatic control. With modes defined by the user, the program will take executive corrective action when needed.

\$3,895.00 List Price

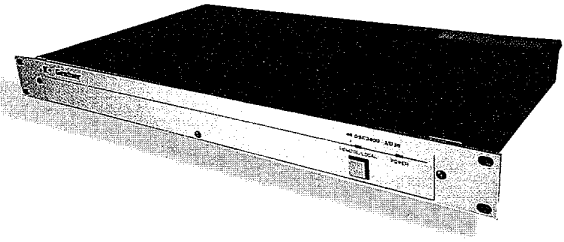

**Gentner
GSC3000**

Gentner's new GSC3000 is the next generation of transmitter remote control. This networkable, expandable system provides all the metering, status and command channels needed for your operation, with friendly Windows® operation. Multiple GSC3000 units can be "stacked" at a site, and multiple sites can be controlled from one location. Operating software is included.

**8 Channels \$1495.00 List Price
16 Channels \$2495.00 List Price**

Remote Control

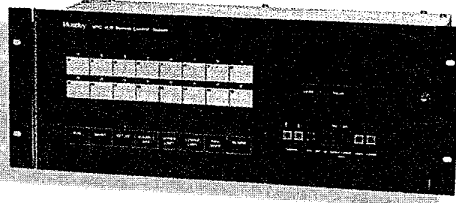

**Moseley
MRC1620**

The MRC1620 is an intelligent, integrated Supervisory Control and Data Acquisition (SCADA) system that offers flexibility and sophistication in an economical and dependable package for general remote control applications in broadcast, utility, transportation and telecommunications industries. PC control is made possible through the Taskmaster 20 software package. 32 raise/lower commands with 16 status and 16 analog inputs.

\$1,550.00 List Price

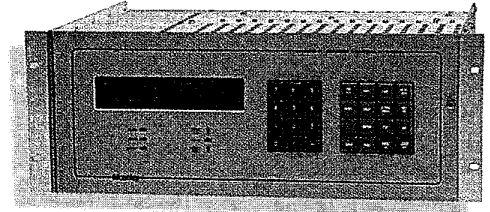

**Moseley
MRC2**

The Moseley MRC 2 is a modular remote control system allowing maximum flexibility in interconnecting Control and Remote Terminals. The Master Controller PC Control software emulates the control terminal and provides the user with a multi tasking system capable of time-oriented and event-oriented control functions. Up to 99 remote sites and up to 256 status, commands and telemetry channels.

\$12,960.00 List Price

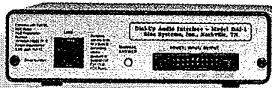

**Sine
RFC-1 Dial-Up Remote Control**

Control and monitor your transmitter from any telephone with the famous RFC-1: one of the world's most affordable fully-featured dial-up remote control. It speaks to you with a natural human voice! It can also telephone you to report out-of-tolerance conditions and can automate transmitter power/pattern changes. The basic system consists of one RFC-1 and one RP-8 eight-channel relay panel. It is expandable to 64 channels. Many optional accessories.

Starting at \$1,598.00 List



**Sine
Thermal Sentry**

The Thermal Sentry can provide important early-warning information about conditions that, if uncorrected, could lead to down-time and costly damage. To accomplish this it uses two precision air-temperature sensors; one installed at the cooling-air intake and the other at the cooling-air exhaust of a transmitter. The temperature difference (0.1 degree F resolution) is displayed on a green LED display on the front panel. Remote metering and alarm outputs are provided so that the Thermal Sentry may be used with many brands.

\$299.00 List Price



INTRODUCING
THE EASIEST WAY
TO MONITOR
TRANSMITTER
SITES...



WITHOUT TAKING ONE
STEP AWAY FROM YOUR

COMFY
LITTLE DESK
RIGHT HERE.

With the introduction of the GSC3000, you can now control from one to 256 transmitter sites while barely moving a muscle. What's more, if you decide you've had enough of the office and would rather monitor your sites from

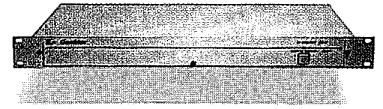

home, the GSC3000 can be controlled from a network – either local or wide area. Heck, you can even control them from your laptop, on a beach in the Bahamas. The GSC3000 simply brings you more transmitter site control and expandability than you've ever seen before. And no, it's not expensive and it's not complex. Because the system is modular, each site can be set up to control from 8 to 256 channels of metering, status, and command. So it can meet the needs and budgets of a single site radio operation or be expanded for the most complex television broadcast company.



The GSC3000 also features automatic and time of day commands, and macro command functions. Plus, the friendly Windows® interface makes the whole thing as simple as point and click. For more information on specs and features, please give us a call.

 **Gentner**

1 - 800 - 945 - 7730
OR 1 - 801 - 975 - 7200

Windows is a registered trademark of Microsoft Corporation.

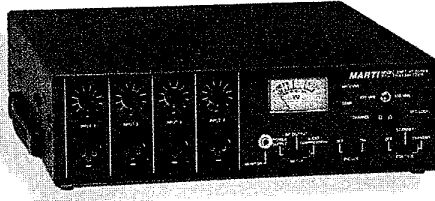

**Marti
SRPT-40 SRPT-20**

The SRPT-40 and SRPT-20 frequency agile RPU transmitters are for today's crowded spectrum demands. These transmitters incorporate all the features found in the popular RPT-15 and RPT-30 transmitters AND add the ability to change frequency by means of front panel thumbwheel switches. Thanks to new switching power supplies they produce 30% more power with 30% less weight and run cooler, too. These two new transmitters are designed specifically to be used with the SR-10 receiver (introduced in 1995). Perfectly compatible with your existing system when not compounded.

SRPT-40 \$2,795.00 List Price
SRPT-20 \$1,995.00 List Price

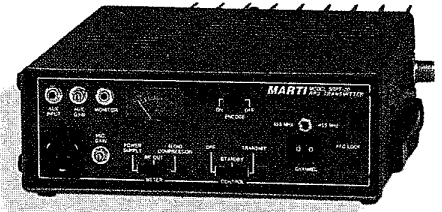

**Marti
SR-10**

SR-10 frequency agile base station receiver provides frequency agility and superior selectivity to help maneuver through high interference levels that plague today's RPU bands. Along with all the new high-tech features of the SR-10, we have preserved the traditional high audio quality and reliability broadcasters have always expected from MARTI. The features, too numerous to list here, make the SR-10 the perfect companion receiver to the new frequency agile transmitter or for group owners with multiple frequencies.

\$2,500.00 List Price

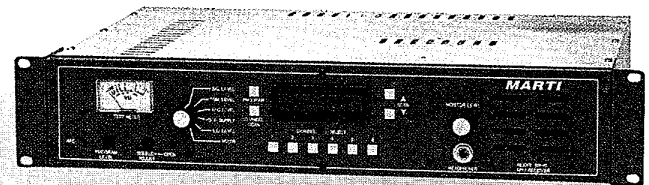

**Marti
RPT-30**

RPT-30 featuring 45 watts at 140-180 MHz and 30 watts at 400-480 MHz is today's hottest selling RPU product. Single and dual frequency models available. 100% duty cycle with 4 inputs (all mic level or 3 mic/1 line). FM-quality limiter included. 120VAC and 12VDC operation included. 3"H x 11"W x 13"D. Unit weight-13 lbs.

\$1,815.00 List Price

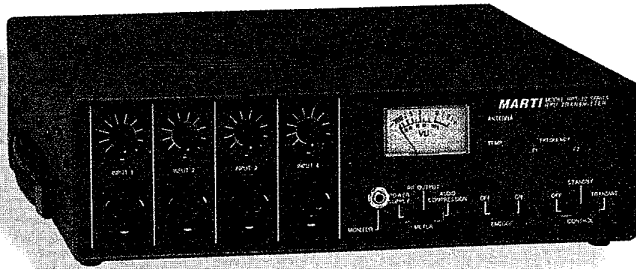

**Marti
RPT-15**

The Model RPT-15 is a compact 15 watt transmitter designed for portable or mobile remote broadcast service. It delivers the maximum power allowed by the Commission for airborne remotes such as traffic reports. The RPT-15 has a built in power supply for operation on 120 VAC. It will also operate on an external 12-14 VDC supply. Standard features include single or dual frequency and subaudible encoder for use with Marti automatic repeaters. All this plus the famous Marti broadcast quality and continuous duty operation. 33"H x 8"W x 2"D. Unit weight: 10 lbs.

\$1,165.00 List Price

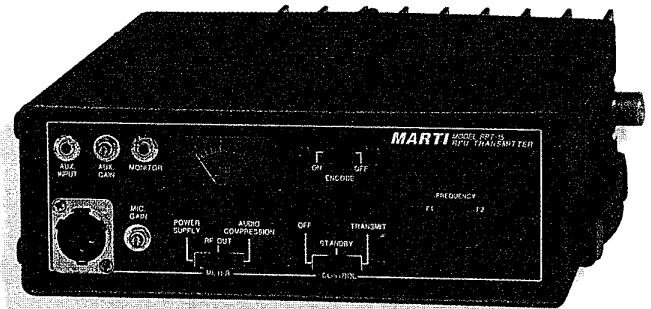

**Marti
RPT-2 Hand-Carried
Transmitter**

The RPT-2 is a hand-carried broadcast quality continuous duty transmitter. It will operate from its internal ni-cad battery, from 115 VAC power or from external 12 VDC power. A special subaudible encoder enables the RPT-2 to access Marti mobile repeaters for coverage of indoor events. 33"H x 8"W x 11"D. Unit weight-7 lbs. Including battery.
\$1,155.00 List Price

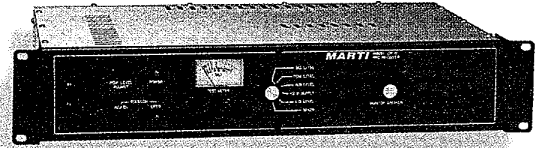
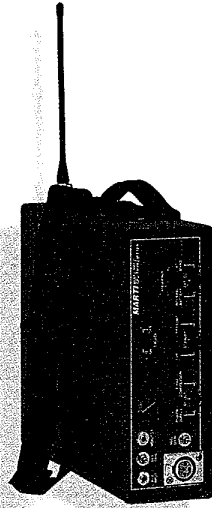

**Marti
CR-10 RPU Base Station Receiver**

Model CR-10 is a rack-mounted VHF or UHF base station receiver designed for broadcast remote pickup service. Marti technology has provided the highest frequency response with the lowest noise and distortion possible for the assigned channel bandwidth. The CR-10 features a built-in test meter, squelch relay, built-in sub-audible tone decoder, monitor speaker, special noise reduction circuit, 90 dB spurious rejection. 3"H x 19"W x 12"D. Available in single or dual frequency versions.
\$1,395.00 List Price single frequency
\$1,425.00 List Price dual frequency

**Marti
AR-10 Mobile-Relay RPU Receiver**

The Marti AR-10 series Receiver is a portable or mobile repeat receiver. This receiver has a built-in AC power supply, and will operate from an external source of 12-15 volts DC. A built-in sub-audible tone decoder meets FCC rule 74.431, allowing this receiver to automatically turn on a mobile transmitter upon receiving an encoded signal from a hand-carried portable transmitter, thus automatically relaying a broadcast to the base station receiver over a greater distance. Available as a single or dual frequency unit, the AR-10 also includes a monitor speaker and terminals for feeding telephone lines in portable operations.
\$1,395.00 List Price single frequency
\$1,425.00 List Price dual frequency

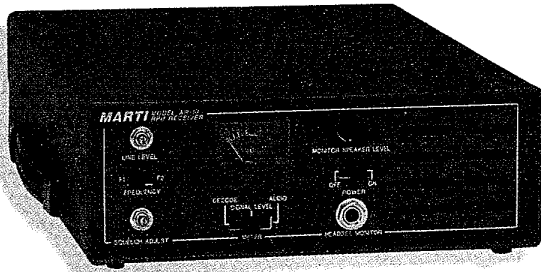

**Moseley
Starlink 9001SS**

Digital RPL: Using the latest in spread spectrum RF technology and audio source coding, the Starlink 9001SS provides CD-quality stereo remotes over distances of up to 30 miles. Untethered from telco services, point-to-point local remotes can be established quickly and efficiently. Open architecture allows a user to select plug-and-play modules for ISO/MPEG Layer II or Apt-X source coding. In addition, the same open architecture allows the user to select between analog or AES/EBU input and output modes. A built-in sample rate converter keeps operation considerations to a minimum. Starlink 9001 takes advantage of the recently assigned 2.4 GHz band for spread spectrum which requires no license.
List Price varies by configuration

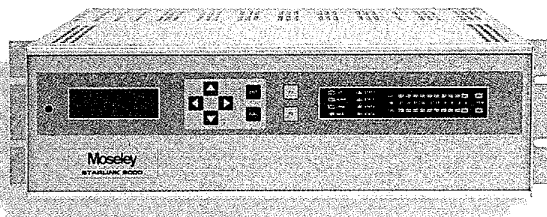

**Moseley
RPL 4000**

Traditional methods for remote transmission over expensive telephone lines are really only adequate for voice transmission. The demands for total live program quality audio can now be achieved by the Moseley Remote Programming Link 4000. The convenience and high performance characteristics of the RPL bring new meaning to the words "Live Radio". In the selectable wideband mode, 30Hz to 14 kHz response is typical.
\$5,900.00 List Price



PLUG-IN to a SMARTER telephone codec.

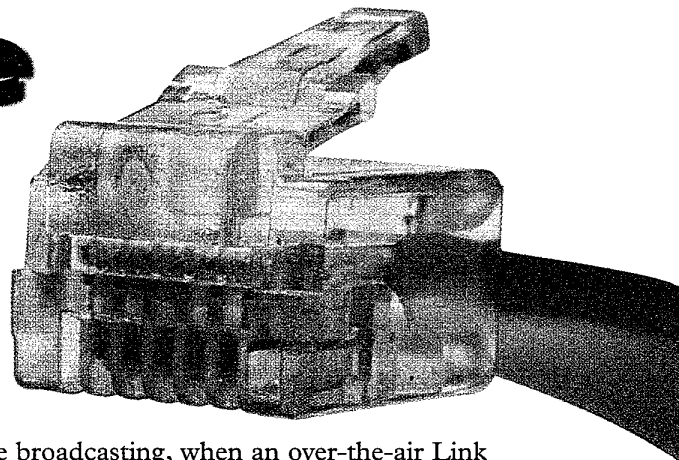

Introducing the new SMARTI from MARTI Electronics

A SMART Idea.

After years of asking radio pros what they wanted in a codec for remote broadcasting, when an over-the-air Link wasn't an option, MARTI engineers have developed the SMARTI - an all new telephone codec. Just plug in any standard telephone line and go.

The new SMARTI is so simple to operate. Just plug it in and go, it takes care of itself and it's completely reliable, dependable and made by MARTI Electronics, a name you've known and trusted for the best in remote pickup technology at exceptional value.

SMART Features

The new SMARTI can send and receive 7.5 KHz audio over a single standard analog telephone line. Its audio quality is the best in the market because the SMARTI uses MPEG 2 LAYER III which is a much more accurate modeling algorithm than the existing products on the market. The other products use earlier versions of MPEG and some are optimized for voice transmissions only.

SMARTI actually offers three different operating modes; High quality selectable delay 7.5KHz audio, low delay CELP G.728, and direct analog telephone interface. Plus, SMARTI uses the fastest modem speed available today and automatically adjusts speed to match telephone line conditions.

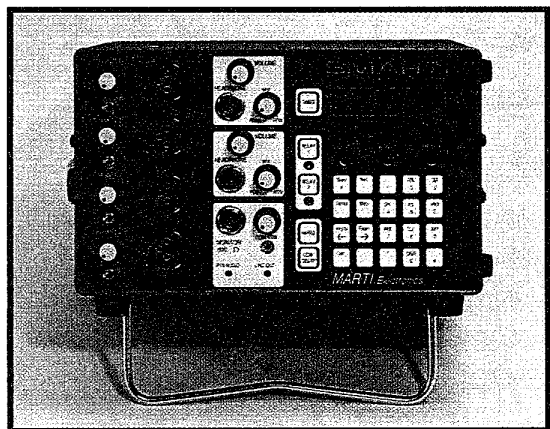

It's One SMART Box

SMARTI incorporates many features not found in Remote Pickup systems or other codecs;

- 2 relay contact closure switches for control at both ends of the link
- Compression algorithm selection switch
- Headphone jacks with program and return switches
- 4 audio inputs, 3 mic/line and one mic/intercom
- Program Flash Memory fully field upgradable via the SMARTI internal modem and a call to the MARTI Factory
- Return audio and line output level adjustments
- Operates from 90 to 264 volts (50/60Hz) or any voltage in between without setting switches or jumpers
- Full duplex variable rate data connection - great for connecting two laptops that can be used for signaling and teleprompting

To Order, Contact your Harris Dealer

MARTI
ELECTRONICS
World Class Performance • World Class Value

MARTI Electronics

Box 661, Cleburne, Texas 76033 U.S.A.

PH: (817) 645 -9163 FX: (817) 641-3869

www.marti.bdcast.com or e-mail: marti@bdcast.com

©1996 MARTI Electronics

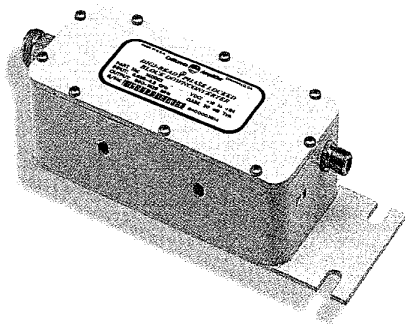

**California Amplifier
PLL LNB**

California Amplifier #31846 PLL-LNB. When the lowest phase noise performance is required, this is the LNB that answers the need. Perfect for QPSK digital and analog SCPC audio reception. Available in the usual noise temperatures. Center pin DC power between +15 to +24 VDC is required. Standard C-band input and L-band output.

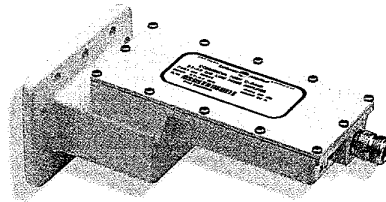

**California Amplifier
LNA GR 30622-XX**

California Amplifier LNAs are the standard by which others are measured. The entire C-Band is covered (3.6 to 4.2 GHz) by all models. Input flange is a type WR229G and the output is a type "N" connector. Power (+16 to +28 VDC) is through the center pin. The California Amplifier has a weather proof housing with LED power presence indicator. Available in numerous noise temperatures.

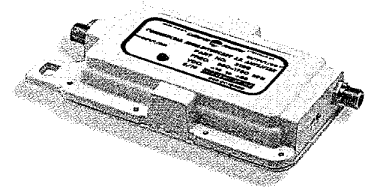

**California Amplifier
C-Band to L-Band**

Need C-Band amplification? California Amplifier's #30944CA will do the job. Rated gain is specified as 18 to 24 dB typical. Input is type N connector. Output is type N connector. Power is via center pin. Compatible with analog video and BPSK digital.

Satellite

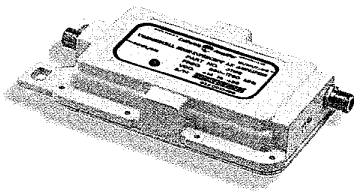
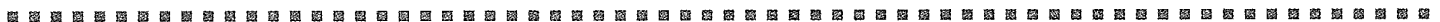

**California Amplifier
L-Band Amp**

The best buy for L-band amplification is the California Amplifier #31192 high intercept amplifier. Specified frequency is 950-1750 MHz (it is usable down to 600 MHz) with a rated minimum gain of 17 dB. This device is center pin powered (+16 - +28VDC @ 130 ma max) and is perfect for compensating for long cable runs with their respective loss. Compatible with analog, BPSK, and QPSK digital.

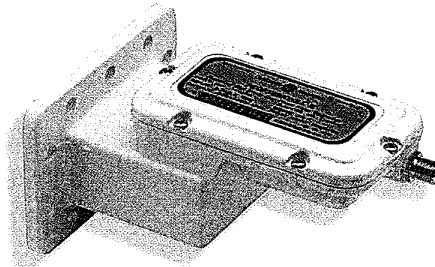

**California Amplifier
LNB 140105-XX**

California Amplifier LNB #140105 is the 500 kHz stabilized version of the popular California Amplifier LNB. This particular model answers the need for additional stability and lower phase noise without the expense of the true PLL variety. Usually recommended for digital BPSK transmission.

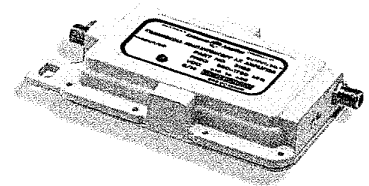

**California Amplifier
140001 Block Down
Converter**

This is a high stability way to convert C-Band (4GHz) to L-band (1GHz). A perfect block converter for analog SCPC and all digital transmission methods including QPSK. Gain is typically 20 dB. Center pin power with a type N connector for the input and a type F connector for the output. Power required is +16 to +24 VDC at 210 mA max. This is the tops in stability with California Amplifier quality.

**CERTAIN PRODUCTS NOT
AVAILABLE IN ALL AREAS**



ORDERING AND TECHNICAL SUPPORT:
(765) 962-8596

123

Satellite

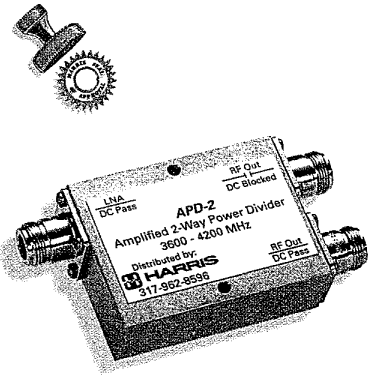

**Harris
APD-2 Amplified 2 Way
Splitter**

The amplified splitter (APD-2) is a C-Band splitter without loss. Actually its an amplifier and splitter combined in one package. One port passes DC power, the second port of DC blocked. Power is required through the center pin of 15-28VDC.

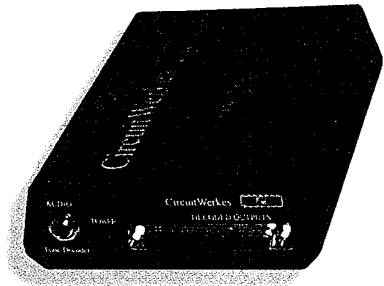

**Circuit Werkes
DTMF-16 Touch Tone
Decoder**

The DTMF-16 is perfect for interfacing networks to your automation, controlling remote satellite receivers, repeaters, etc. It listens to practically any audio source and activates its appropriate optocoupler output when it hears any of the sixteen DTMF tones. Jumper settable modes include: momentary, interlocked-latching, two-tone and anti-falsing. The DTMF-16 is also great for: Backup transmitter control over STL, radio or telephone coupler, remotely controlled audio switcher, and remote control of TV camera pan and tilt heads.
\$195.00 List Price



**Circuit Werkes
DS-8 Sequence Decoder for
Touch Tone**

The DS-8 is a DTMF Sequence Decoder providing dry closures for EIGHT different tone sequences. Can decode four digit DTMF sequences used by networks for automating closed circuit feeds and local insertions. Each relay can be set for one to four digit codes. Relays can easily (and independently) programmable, via DTMF phone, to operate in momentary, latching, or interlocked latching modes. Any mixture of modes and code lengths can be used. Remembers all settings in power failure.
\$299.00 List Price



**Circuit Werkes
DR-10 Programmable,
Dialup Controller**

The DR-10 lets you control equipment anywhere there's a phone. After entering your password, you control 10 relays that can be individually programmed for momentary, latching, or interlocked. Relays can be assigned to any tones. Anti-falsing modes prevent accidental closures during remote broadcasts. Relays can beep when activated. 4 logic inputs can activate a relay and/or call your pager. Includes a studio hybrid for control while monitoring external audio. Program it with any DTMF telephone. Compatible with the Silencer and call progress options.
\$439.00 List Price



**Circuit Werkes
Silencer Option**

The Silencer option board, combined with our DTMF-16, AD-16 or DR-10, lets you send inaudible DTMF control signals on your RPU receiver, via satellite, over dedicated loops, or standard dial-up phone lines. Your talent or producer in the field can fire ID's, start breaks, fully automated remote broadcasts, light up attention flasher, without getting any tones on the air.
\$344.00 List Price

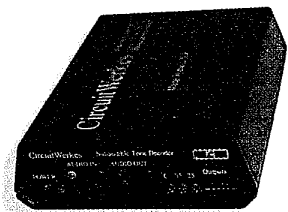

**Circuit Werkes
SUB-3 Subaudible Tone**

The Circuit Werkes Subaudible Tone Decoder decodes industry standard 25Hz, 35Hz, and combined 25/35Hz tones and provides dry relay contracts to the user. It features audio presence and audio clipping LED indicators to help make setup a snap. Input gain adjustment and a variable, balanced output allow for level matching. Integral filtering substantially reduces the presence of subaudible tones at the Sub-03's audio output.
\$289.00 List Price



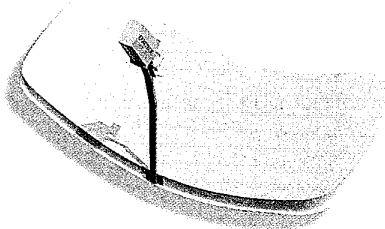

Comtech Offsat

The Comtech "Offsat" is the response to the new stricter transmit requirements for C-Band Transmit. It features a one piece antenna reflector which has the surface tolerance necessary for Ku-Band as well. The original "Offsat" is the only antenna in its size category capable of exceeding all FCC specifications for 2 Degree spacing. The Comtech "Offsat" features an offset feed to eliminate feed support reflections. A wide selection of feeds are available. Fixed and motorized mounts are available. Also the reflector is available heated for automatic de-icing.

Prices Vary

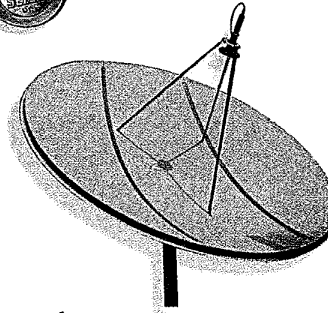

Comtech 3.8 Meter Antenna

The most popular for C-Band radio network reception, for one reason, it works extremely well! This is the antenna that most radio networks have recommended for years because of the excellent gain and performance in the current crowded satellite environment. A fiberglass reflector that holds its shape. A choice of mounts, starting with the AZ/EL single pipe that is rugged and yet quick and easy to set up to the manual and motorized polar mounts. For inclined satellite reception there is a motorized dual axis mount which can be integrated with a tracking controller to provide auto-tracking capability for unmanned video, voice and data operations. A large selection of feeds are available. Optional full reflector de-ice is also available.

Pricing Upon Request

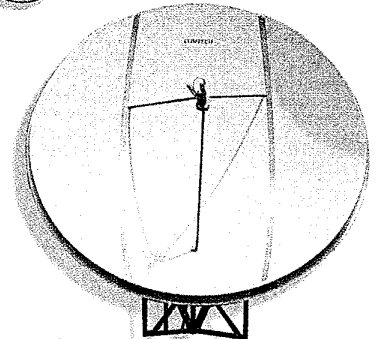

Comtech 5.0 Meter

The Comtech 5 Meter is popular with the television broadcasters. A number of radio broadcasters have found the 5 meter was a way to get satellite reception at a location that previously was prone to reception interference. Available on fixed and motorized mounts this is one performing satellite antenna! A large selection of feeds including the popular 4-port (2 Cband/2 Ku-Band) as well as linear and circular models. Reflector heat is available as an option. The controller for the motorized versions is a feature loaded Comtech EC-8, which can manage up to four antennas.

Pricing Upon Request

Satellite



Conex CS-25B10 25 Hz Tone Sensor

The CS-25B Tone Sensor is a compact and modular 25 Hz tone sensor for use in remote tone signaling in satellite audio feeds, broadcast automation, and translators. The sensor detects 25 Hz sub-audible tones that typically signal the end of a program selection. The resulting relay contact closures can be used to start the next program source. Another module that fits in the same chassis is a high-pass filter for removing the 25 Hz tones from the audio source before going on-the-air.

\$439.64 List Price

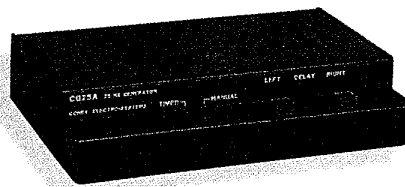

Conex CG-25A 25 Hz Tone Generator

The CG-25A tone generator provides a simple, economical method for encoding audio with 25 Hz (or 35 Hz) tones for tone signaling applications such as satellite systems, reel-to-reel tape, and translators. CG-25A features include: Rack mountable. (Optional rack mount kit). Remote controllable. Plug-in type terminal strips for easy connection. Balanced bridging inputs and balanced 600 ohm outputs. Built-in stereo high-pass filters to eliminate 25 Hz content from program material. Low distortion circuitry.

\$451.50 List Price

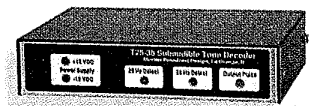

Mueller T25-35SA

Automate your satellite-delivered programming with the T25-35SA Subaudible Tone Decoder. This self-contained unit includes tone detectors, decoding circuits and 120 volt AC power supply in an aluminum enclosure. It works with any network using the 25, 35 and 25+35 Hz cue tone format, providing a 250 millisecond output pulse via three normally-open relay contacts. An easily-adjusted input level control sets operating levels, and balanced audio inputs and outputs are provided.

\$307.00 List Price



Satellite

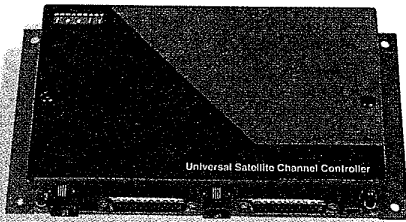

**Broadcast Tools Inc.
USC-16**

The USC-16 when operated with contact closures or logic control provides sixteen channel selections for DATS-SEDAT™ digital audio decoder cards installed in the Scientific Atlanta DAT-32 series and Comtech/Fairchild DART-384. In addition, sixteen memory selections are available for the Scientific Atlanta ENCORE, DSR-3610 OR DSR-4595 receivers. When the USC-16 is controlled from a computer's serial port, unlimited channel selections are provided for the DATS-SEDAT™ digital audio decoder cards and four open collector outputs. These four outputs may be used to control transponder selection. The serial control also allows control of ALL 100 memory selections for the Scientific Atlanta "ENCORE" DSR-3610 or DSR-4595 receivers.
\$377.00 List Price

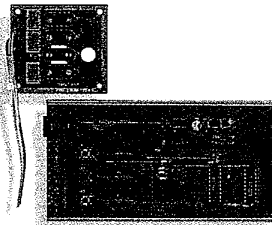

**Broadcast Tools Inc.
XP-3**

The XP-3 provides remote transponder selection for Scientific Atlanta, Comtech/Fairchild and Ariel receivers. It allows selection of the three active transponder channels with momentary or latched TTL/CMOS 5 volt logic levels, open collector or dry contact closures and allows control by the users remote control systems or switch contacts. The XP-3 has three jumpers to configure which transponder is selected during power-up. The XP-3 is equipped with a wire captive terminal strip providing remote control and status, along with local switches for transponder selection.
\$299.00 List Price

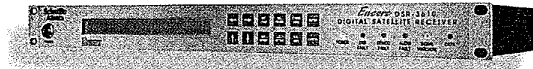

**Scientific Atlanta
Encore DSR-3610**

The receiver for full transponder format digital audio. Compatible with dats 7.5kHz, 15kHz, the SEDAT™ family and M-PEG 128JS algorithm this surpasses all others. Small on size (only 1 R.U./1 3/4in) and big on features! The Encore is completely transponder and audio channel agile with control via two-line LCD display and pushbutton keys. Input is L-band to be compatible with LNBS or block converters. Audio output is 600 ohm active balanced or digital AES/EBU. Two audio channel outputs are standard, with an four channels are possible. A printer port is provided for networks providing printer service. Remote control of transponder and channel selection is also available as an option. Network cues are also supported and appear as an opto-isolated open collector or with the relay option open contact closure. In short the Encore DSR-3610 is the easiest to operate, most versatile, most expandable and most updatable digital satellite receiver available.
\$3,595.00 List Price

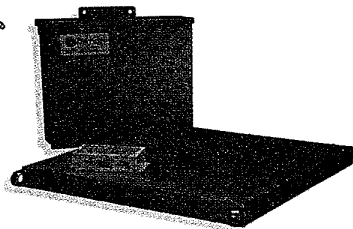

**Ortel
System 10,000**

The Ortel 10,000 System is a fiberoptic system to transport the output of the satellite LNA or LNB to the receivers without the use of coax. Variable input and output gain to optimize C/N, linearity and link loss. Rack mount/plug-in style with up to 4 full spectrum polarizations per chassis. C-band and L-band versions as well as a combination of C-band and L-band on one fiber. A choice of models to meet your specific needs.
List Price Varies

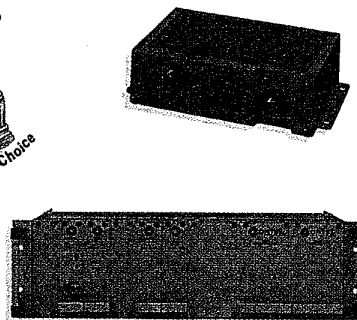

**Ortel
3100/4100 Systems**

A new way to connect your LNA or LNB to your satellite receiver! Instead of coax the Ortel uses fiberoptic cable which has virtually identical performance at 100 feet or 1,000 feet. Fiberoptic cable is lightweight, flexible and provides electrical isolation and immunity from EMI. A system consists of the 3100 series fiberoptic transmitter, 4100 series fiberoptic receiver and the link of single mode fiberoptic cable. Broadcast performance specifications!
List Price Varies

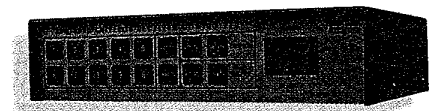

**Scientific Atlanta
SRC-3550 Remote Control**

The perfect way to control the Scientific Atlanta Encore series of satellite receivers. The SRC-3550 remote is compact in size and allows the receivers preset configurations to be conveniently selected from the front panel keypad. This is ideal for stations that would prefer the satellite receiver to be away from the studio such as in an equipment room or across town at the transmitter site. The remote control also interfaces between automation systems for unattended tuning. The receiver's 99 presets can all be recalled by the SRC-3550.
Pricing Upon Request



Harris Service

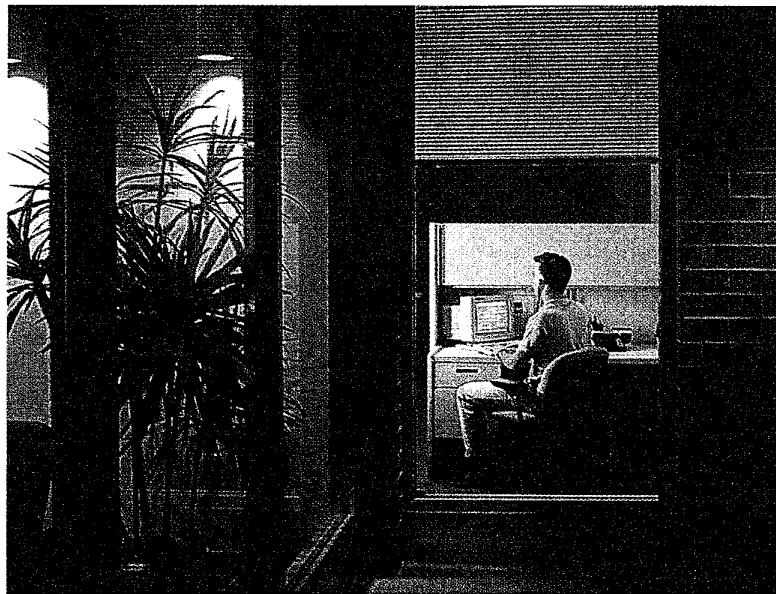
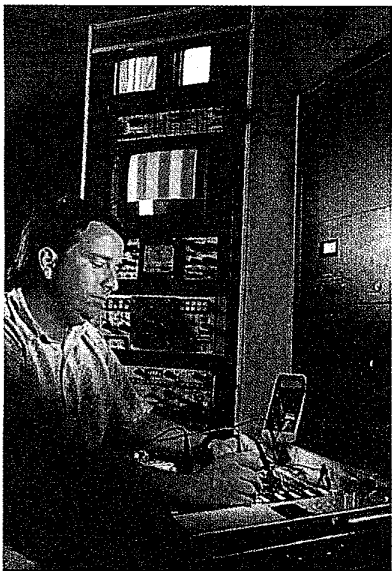
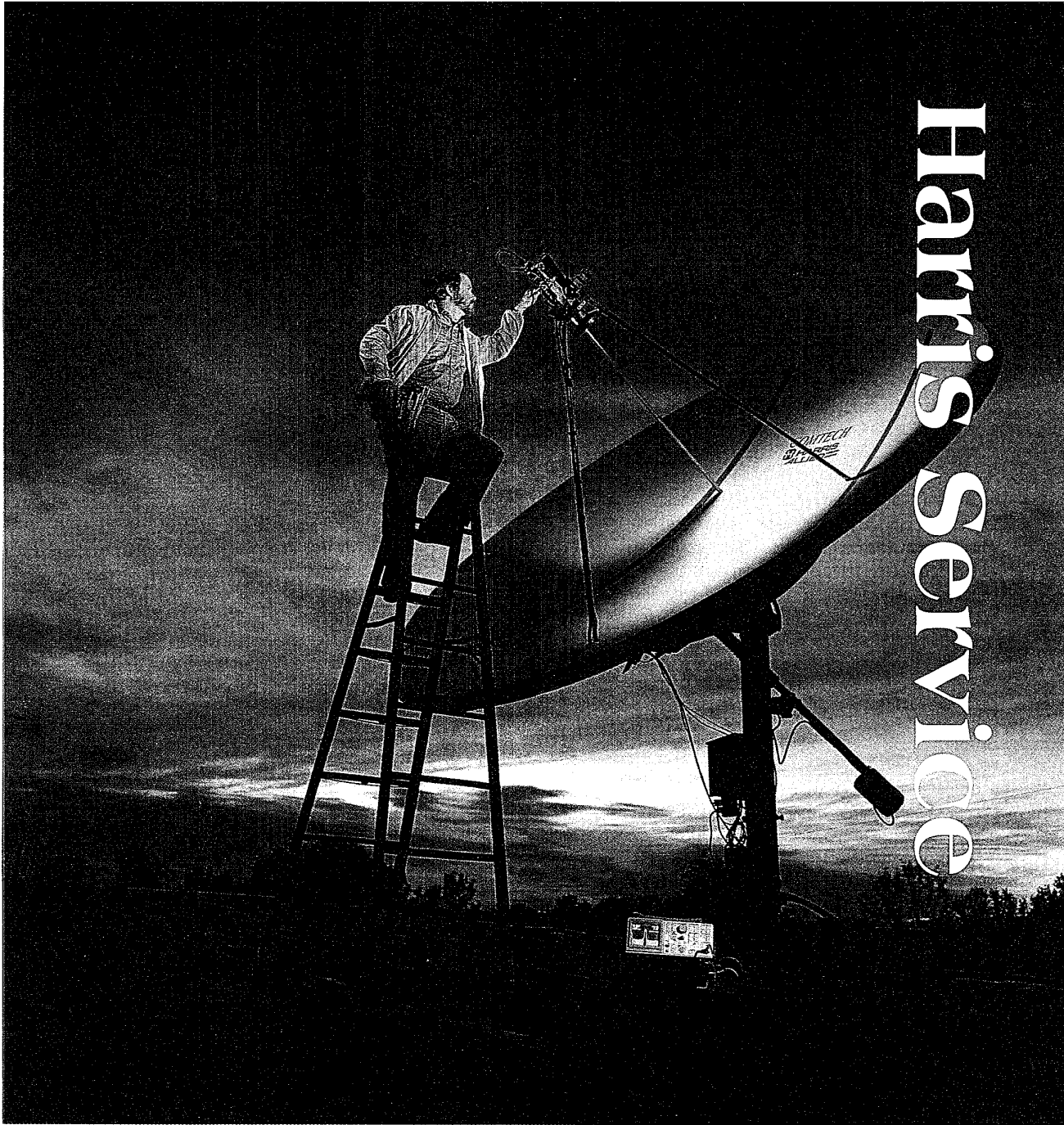

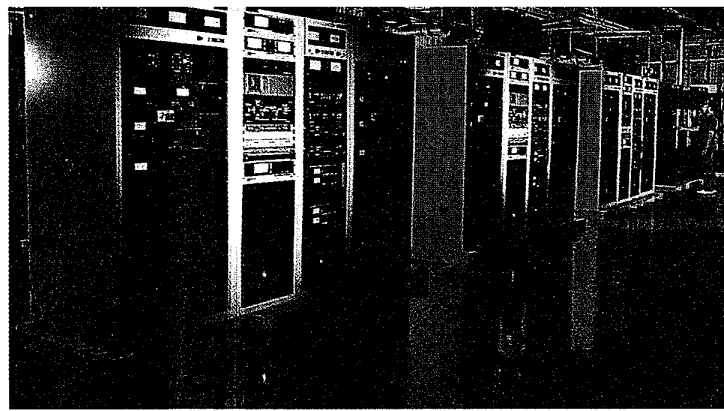
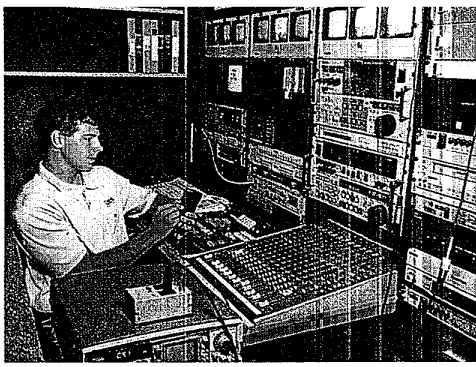

Harris Service Sustaining Support: Our Philosophy

One of the most compelling reasons for selecting broadcast equipment from Harris is the level of support you'll receive. We call it Sustaining Support, because its purpose is to sustain your equipment at a level which provides the highest return on your investment. We also want to sustain your confidence in Harris as your preferred supplier, whether you select radio or television transmission equipment we manufacture, a system we integrate or a product we distribute. You may never have to call us, but you can always count on us if you need us.

On Call, All the Time

No one can predict when an emergency situation will occur. That's why we support our transmission equipment and systems with 24-hour-a-day telephone service 365 days a year. We also provide extensive telephone support for radio studio products we distribute. Our service staff can work with your engineers to solve many equipment problems over the telephone.

Every call for technical assistance is entered in our computer database to ensure proper tracking and complete follow-up. Emergency off-air and under-power situations are given the highest priority.

When necessary, our field service engineers will be dispatched to help you resume normal operation as quickly as possible. Our field service personnel are also available to visit your site to provide scheduled maintenance and service, including installations, new equipment check-out, proof of performance and training.

Parts: On Hand for Timely Delivery

Harris' multi-million dollar inventory of spare parts enables us to respond quickly to the large installed equipment base around the world. Our parts

department is staffed around the clock, every day of the year, to ensure your emergency or general maintenance parts order is handled on a timely basis.

On-Site Service, In-House Repairs

Harris-manufactured items small enough to ship can be repaired quickly and economically at our factory repair center. In addition, we offer over 60 different modules used in Harris transmitters through our module exchange program. Refurbished modules, which carry the same warranty as new modules, are available at lower cost. Harris also repairs radio studio equipment from most of the 300-plus product lines we distribute and serves as a factory warranty repair center for many of these product lines.

In-Depth Training

Whether it's general training for new personnel or specialized training on a new piece of equipment, only Harris offers the extensive programs required to keep your staff knowledgeable.

We schedule approximately 30 RF training programs annually at our Broadcast Technology Training Center. Here we provide general RF training as well as programs on specific Harris transmitters.

To meet special needs, we can also design customized training programs on RF products, studio equipment and systems. These programs can be offered at Harris or at any customer site.



Sustaining Support: Our Commitment

Beyond quality products designed to deliver years of value, Harris is committed to providing unparalleled Sustaining Support to protect your investment for the long term.

SERVICE PHONE NUMBERS

- RF Parts 217-221-7500
- Radio RF 217-221-7528
- TV RF 217-221-7529
- TV & Satellite Systems 606-282-4800 Ext. 4830
- Cambridge TV 44- (0) 1223-214632
- Radio Studio Products 765-962-8596 Ext. 234
- Satellite Audio 765-962-8596 Ext. 208

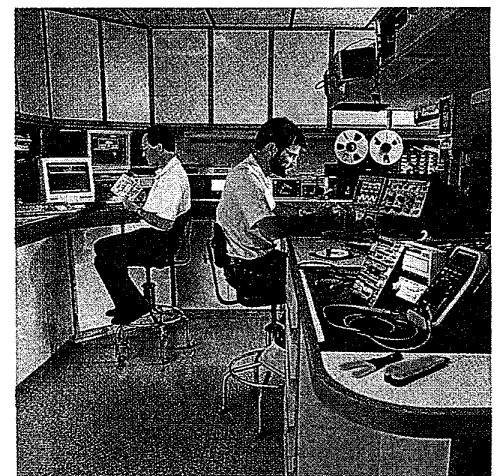

**Alesis
Monitor One™**

The Alesis Monitor One™ Near Field Studio Reference Monitor offers excellent image and transient reproduction, powerful bass and smooth, extended high frequency detail. Designed by engineers with decades of experience, the TEC Award-winning Monitor One provides the last critical link in the recording/production studio's signal chain; giving you accurate reproduction of what is being recorded.



Most small speakers used for near-field monitoring give disappointing results in their lowest octave. They are either sealed enclosures (limiting the amount of air the driver can move) or they have a small vent (whose effect at lower frequencies is nullified by the effect of turbulence in the port). The Monitor One overcomes these limitations by using Alesis' exclusive SuperPort™ speaker venting technology, which eliminates the "choking" effect of port turbulence, for solid high-power bass transients and extended low frequency response.

The Monitor One uses a 1" silk-dome high frequency driver which is ferrofluid cooled for improved power handling. The silk dome eliminates the harshness and ear fatigue associated with metal or plastic tweeters, making long mixing sessions easier. A proprietary 6.5" low frequency driver with a mineral-filled polypropylene cone, and a 1.5" voice coil wound on a high-temperature Kapton former are behind the Monitor One's powerful bass response. The excellent sonic quality and widespread popularity of the Monitor One makes it the new standard for near field studio monitoring.

\$399.00 Per pair List Price

**Dynaudio
Acoustics
BM5**



Thee BM5 from Dynaudio Acoustics close-field monitor is designed for all music and speech recording and mixing applications. It is suitable for use in Radio Stations, O.B. Vehicles, Broadcasting and Audio Post Production suites, and for use as rear channel monitor in surround systems, and in any small control room environment which requires precision, accuracy and realism in the audio monitors. It features technology common to all Dynaudio Acoustics monitors – providing very low distortion, high dynamic/high resolution sonic performance.

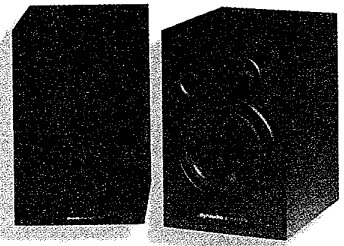

The BM5 is a two-way front-ported passive system utilizing a 6.5 in. high sensitivity magnesium impregnated polypropylene bass driver with a large 3 in. aluminum voice coil. The 28mm tweeter developed specially for this model employs a neodymium magnet and aluminum voice coil and is thermally protected.

The BM5 exhibits an exceptionally linear phase response with frequency response from 50 Hz to 20 kHz (±3dB). The fully shielded cabinet has an adjustable bass port for personal tuning of the bass response. Heavily internally damped cabinets are made in mirror-imaged pairs and are provided with removable grilles. Connectors are professional gold-plated five way binding posts.

\$699.00 per pair List Price

Speakers

**Audix
Studio 1A**

The Studio 1A offers startlingly clear and concise sound reproduction across the full-frequency spectrum without distortion or false coloration. Studio 1A is ideally suited to a wide range of applications including studios, location recording and critical listening. Although matching the performance levels of much larger-sized monitors, Studio 1a is compact and unobtrusive whether in a studio or on the road. 18 lbs light in a package 13x9x10 small.

\$599.00 per pair List Price

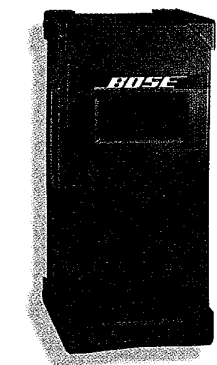
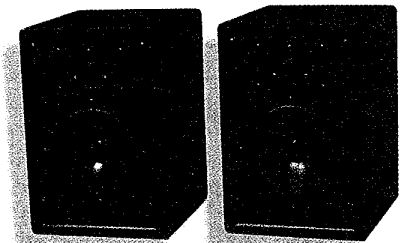

**Bose
502BP**

If you have the need to increase your output to play larger events, you can easily add a 502BP bass unit and a second amp. The 402C or the 802C-II controller will electronically reroute the bass frequencies to the 502BP Acoustimass bass

enclosure. The Bose 502BP bass unit delivers thunderous bass because its 12" driver contains a 4" voice coil — enormous for a driver of this size — which enables it to handle a full 900 watts of power.
\$1,143.00 List Price

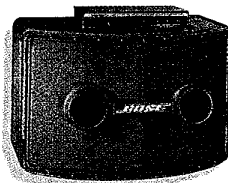

**Bose
S802**



The Bose S802 system is a great system for anyone requiring high-quality sound,

substantial output, and extreme ease of transport. The system's 802, Series II speakers provide increased power handling, along with balanced frequency response, making this system a good choice for reinforcing synthesized music that makes demands across the full audio spectrum. Each of the eight drivers in the 802 enclosure is individually capable of reinforcing the full range of frequencies (55Hz-16kHz). Minimum/maximum power recommendations per 802 speaker are 240/480 watts @ 8 ohms
\$2,550.00 List Price

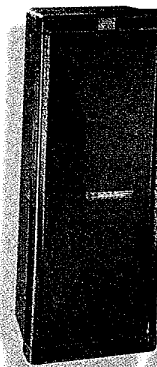

**Bose
S402**

The Bose S402 system provides full-frequency, natural sound reinforcement. The arrangement of the drivers in the arrays provides wide dispersion and balanced frequency response (90Hz-16kHz) ensuring that the entire audience hears everything. And when the performance is

finished, the S402 system packs up in a single case weighing just 36 lbs. Minimum/maximum power recommendations per 402 speaker are 120/240 watts @ 8 ohms.
\$1,750.00 List Price



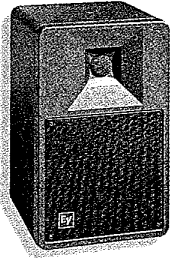

**Electro-Voice
S-60B**

The S-60B compact monitor is a two-way video-shielded speaker. Its design provides tight low-frequency response with constant directivity; the low-frequency 6.5 inch woofer is installed in an optimally vented enclosure for extended bass response and high efficiency, and the 1 inch tweeter is mounted on a dispersion controlling "Direktor" which ensures a consistent 120 degree by 120 degree coverage with no hot spots. Both components employ low-leakage magnet designs, and the woofer is also screened to permit use close to video monitors. Automatically-resetting tweeter-protection circuitry protects from long-term power extremes. The S-60B may be wall or ceiling mounted either with the optional S-60MB or the Omnimount series support.

\$237.00 List Price

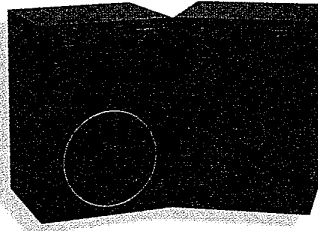

**Electro-Voice
Sentry 100A**

For over fifteen years, the Sentry 100A has been a standard reference monitor for the broadcast and production industry. Known for high efficiency with extended, uniform low-frequency response, the Sentry 100A employs an 8-inch direct-radiating woofer and a super-dome tweeter capable of handling 25 watts of power. The cabinet is specifically designed to enable rack mounting, with the optional SRB-7 rack-mount/wall mount kit.

\$390.00 List Price each

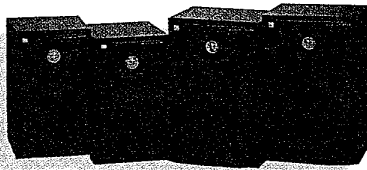

**JBL
4200 Series**

The JBL 4200 Series, console-top monitor models are designed specifically for use in the near field. Both the 165 mm (6.5 in) model 4206 and the 200 mm (8 in) model 4208 bring a new look, a new sound and a new standard to the multi-purpose studio environment of today.

The remarkable 4200 Series, console-top monitors was designed in the studio, for the studio. These monitors offer exceptional sonic performance, incorporating technology and features typically associated with systems several times their price.

4200 Series: the shape, and the sound, of things to come.

Prices Vary

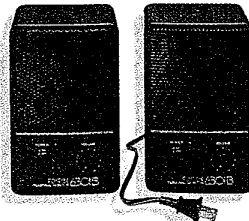

**Fostex
6301B**

A built-in 10 watt amplifier provides a big sound from these small, versatile monitors. They accept any line level signal, so they can be used on remote, in the studio or in video productions and multi-media presentations—an extremely wide variety of applications. Features include a power switch with LED indicator, level control and a jack for accessing the amplifier output independently—for driving headphones or another speaker.

Made of die-cast aluminum, these great little utility speakers have earned high marks over the years among production and presentation professionals for being rugged and road worthy.

Model 6301B has 1/4" phone jacks; Model 6301BEAV has an XLR input and is shielded for use in proximity to video and computer monitors.

\$478.00 List Price 6301 BEAV per pair

\$398.00 List Price 6301B per pair

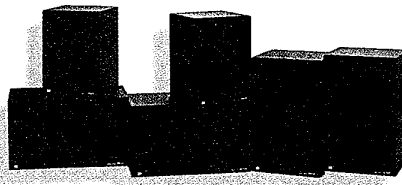

**JBL
4400 Series**

For several years, JBL 4400 Series Studio Monitors have played a major role in the audio industry. Countless music recordings and movie and television soundtracks have been created with 4400 Series monitors as the critical listening source. Numerous broadcast studios world-wide have relied on 4400 Series systems for studio playback, requiring the monitors to deliver faithful sound reproduction, typically 24 hours a day, every day of the week. In short, 4400 Series monitors have been and continue to be one of, if not the most vital of components in the studio control room.

Prices Vary

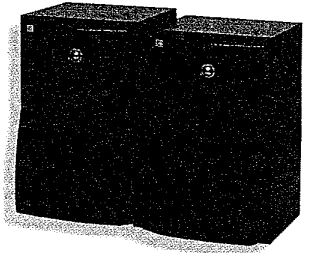

**JBL
6208**

Designed specifically for use in the near field, the 6201 Bi-amplified Reference Monitor combines optimized electronics with an 8", two-way speaker system on a Multi-Radial™ baffle.

The electronically balanced input is compatible with both -10 dBV and +4 dBu nominal operating levels and input connection can be via XLR or 1/4" connectors.

The model 6208 was designed to provide an accurate reference in a small, portable package.

\$998.00 per pair List Price

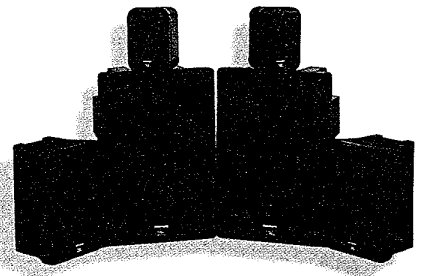

**JBL
Control Series**

Production, recording and broadcast engineers are looking for one thing. Control. They need to listen for the clarity and vividness of individual sounds and for balance, shading and full stereo imaging.

The 4310, and later the 4311, gave engineers the control they were looking for. And the legacy of these enviably successful studio monitors is the heart and soul of Control® Series Loudspeaker Systems. Control Series is pure JBL, combining high performance, compact design and rugged construction into loudspeaker systems with an unprecedented degree of versatility. There is a Control product to fit your needs.

Prices Vary

Speakers



The JBL 6208 Bi-Amplified Reference Monitor

For the power hungry with an appetite

for... **PERFECTION.**

6208 Bi-amplified Reference Monitor

JBL

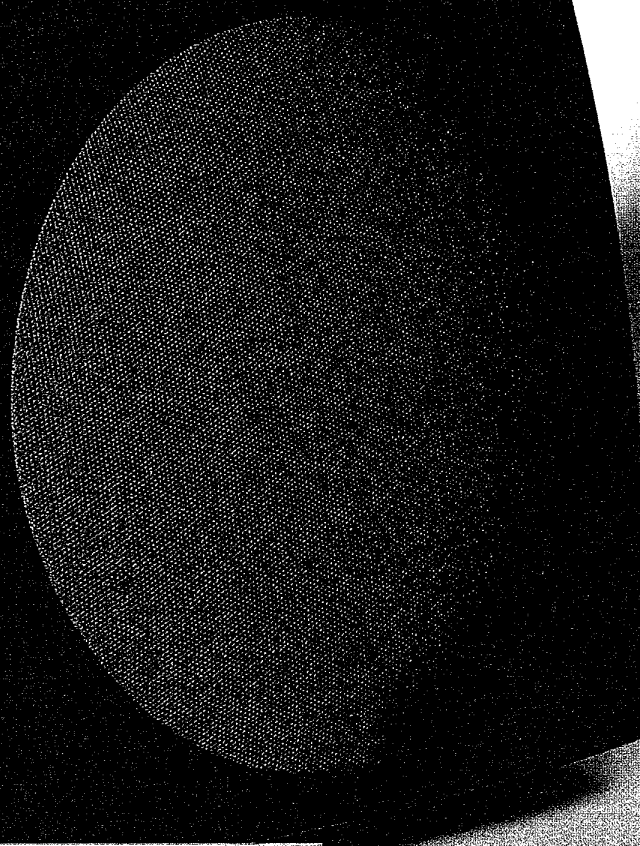

RADIO WORLD MAGAZINE
COOL STUFF AWARD WINNER
NAB 1995

The Best System Starts with the Best Parts.

JBL has more experience in designing and building transducers for professional studio monitors than any other company in the industry. We not only use the latest engineering and design equipment, but also the most important test device of all, the human ear. We believe in physics, not fads, so while other companies pick parts off somebody else's shelf, we create our components from scratch. And by utilizing more than 50 years of experience in transducer design, we create the perfect transducer for each system.



Multi-Radial Design - An Ideal Solution to a Complex Problem.

Combining individual transducers into a system is a delicate balance of acoustics, electronics and architecture. Our exclusive Multi-Radial baffle is contoured to bring the drivers into perfect alignment, so the high and low frequencies reach your ears simultaneously. This reduces time smear for a smooth transition between the low and high frequency drivers. In addition, the gently rounded edges of the 6208 provide controlled dispersion and balanced power response. That means even off-axis, you will hear an accurate representation with wide stereo separation and an immense depth of field.

Gold/Titanium Hybrid Dome.



By mating the materials to a large magnetic structure, the 6208 can produce extremely flat frequency response and low distortion for hours of fatigue-free listening. JBL pioneered the use of the light but rigid gold/titanium hybrid construction to provide a transient response that is quick and precise for pinpoint accuracy.

Shielded Drivers for Flexible Placement.

JBL shields all of the drivers so you can place the 6208 right next to your audio workstations without interaction. Gone are the days of compromised monitor placement in your production environment.

Why Bi-Amplification?

It's a simple fact, a separate amp for each speaker produces the most accurate sound. Each of the 6208's two amplifiers is designed to reproduce the assigned frequencies. And by combining the amplifiers inside the cabinet, you improve the amplifier's ability to control the speaker it's driving for controlled low end punch.

“We played just about every type of instrument through these speakers and they reproduced it with flying colors.”
- Bobby Owsinski
EQ Magazine

Active Crossovers Provide Accurate Response Tailoring.

By carefully tailoring each amplifier's performance to the response characteristics of the drivers, you get the most faithful reproduction possible. By using active crossovers, power is not robbed by passive

The passive 4200 Series provides accurate, natural and powerful value for about \$400 per pair.

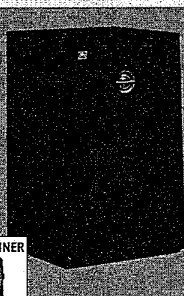

components like inductors and resistors. The result is clear, accurate sound at the highest levels.



H A Harman International Company
8500 Balboa Boulevard, Northridge, CA 91329-USA

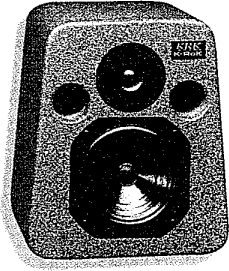

**KRK
6000**

KRK Model 6000 Monitors are the latest and most competitively priced close-field monitors to join the renowned KRK line. Engineered using the same KRK design parameters, the Model 6000 utilizes the latest in aerospace materials, and the same high quality components found in our more expensive models. The very affordable KRK Model 6000 is ready to make its mark.
\$775.00 List Price each

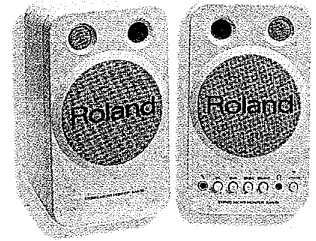

**Roland
MA-8 Stereo Micro Monitors**

The MA-8 Stereo Micro Monitors are a new dedicated stereo speaker system. With a ported design for increased bass response, internal 8W + 8W amplifier, precision 10cm woofer and 4.7cm tweeter and individual bass and treble controls, the MA-8's deliver enhanced sound for all monitoring applications. Their CD-quality audio and platinum color make the MA-8's a great audio reference tool.
\$99.00 per pr. List Price

Speakers

**KRK
K•RoK**

The KRK K•RoK represents a new generation of closefield monitors designed for the production recording studio. The cost-competitive K•RoK delivers the smooth response and high power handling capability that have made KRK monitors legendary.
\$495.00 List Price each

**Tannoy
SBM**

The SBM utilizes a 6.5" injection molded low frequency driver and a robust 3/4" fluid cooled material dome tweeter. Designed specifically for the smaller project studio, the new SBM delivers linear extended low frequency down to 45Hz, smooth and extended high frequency and the well controlled, detailed midrange that Tannoy is famous for. The SBM is destined to set a new performance vs. investment benchmark.
\$295.00 per pr. List Price

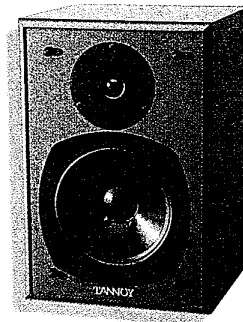
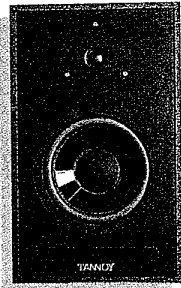

**Tannoy
PBM 6.5II**

The PBM 6.5II is the market leader in its class as it has been since the original was developed in 1987. The Mark II is the result of many years of fine tuning. A 6.5" two way design featuring a hardwired, hand selected minimalist crossover network providing uncompromising detail, precise spectral resolution and flat frequency response. The fully radiused, rear ported cabinet design reduces resonance and diffraction while providing deep extended low frequency.
\$475.00 per pr. List Price



**Tannoy
PBM 8II**

The Tannoy PBM 8II is a truly gifted performer. Reviewed in the industry's most respected publications 9 times with overwhelming positive response. The exceptionally smooth transition from extended low frequency (-10dB @ 33Hz) through the mid band and high frequency makes you forget the speaker, leaving only the music. This transparency is the ultimate mixing tool for bang-on mixes the first time. Out performs competitors at twice the price.
\$795.00 per pr. List Price

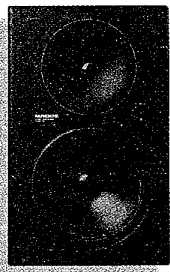

**Mackie
HR824 High Resolution Series
Active Studio Reference
Monitor**

For precise imaging, low distortion, and flat response, the HR824 is an affordable, top-quality powered studio monitor. The 1" ferro fluid cooled tweeter and 8" mineral-filled die-cast woofer are housed in an extremely rigid, "H"-braced enclosure of 19mm thick MDF construction, and is magnetically shielded. Power is supplied by Mackie's FR Series™ Fast Recovery amp module, with settings to enhance room placement, high frequency contour switch and low frequency roll-off switch to emulate typical home stereo speakers.
\$749.00 ea. List Price

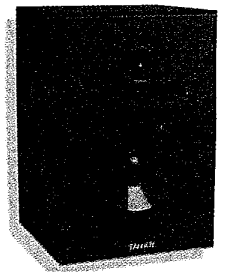
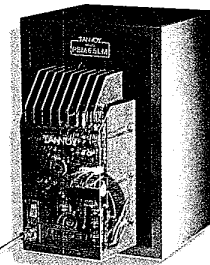

**Tannoy
PBM5.6 LM and PBM 8 LM**

The classic PBM monitor with factory mounted Limpet modules. The system includes an L.E.D. indicating power on (green) and clip indicator (when green turns to red). The best performance vs. investment in the powered monitor industry.
PBM5.6 LM \$1,075.00 per pr. List Price
PBM 8 LM \$1,395.00 per pr. List Price



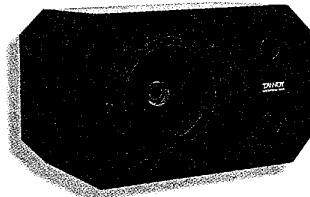
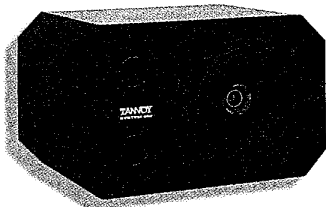

Tannoy System 600/800

Both System 600 and System 800 possess high sensitivity (+90dB) and power handling (150W+) to achieve high sound pressure levels at the mix position. Coupled with the phase coherent, point source Dual Concentric drive units is a new, innovative landscape cabinet design which provides a clear line over the console, improves overall tonal balance and results in deeper bass extension for both models. The frequency responses are 52Hz - 20kHz and 47Hz-20kHz plus or minus 3dB respectively. The new System 600 and 800 provide the tools to create well defined, well balanced mixes.

600 \$695.00 per pr. List Price
800 \$995.00 per pr. List Price

Tannoy Limpet Power Module

The Limpet is a unique design combining a one piece high pressure die cast metal housing, a very high current toroidal power supply, fully discrete amplification stages and ultra wide bandwidth capabilities (10 Hz - 80 kHz). Featuring a Neutrik combi connector (3 pin XLR or 1/4"), switchable voltage, 3 position input sensitivity and is compatible with all makes of studio monitor. 150 watts/4 ohms, 135 watts 6 ohms, 125 watts/8 ohms.

\$349.00 ea. List Price

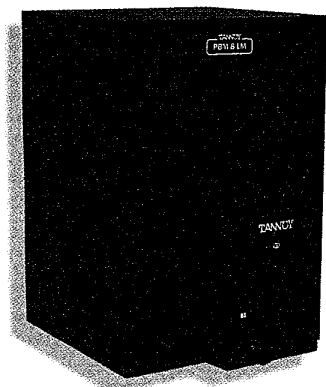

Wohler AMP-1A/PF

Identical audio performance as the AMP-1A, but includes level meters and phase indicators. Level meters tri-colored LED bargraphs, VU or PPM. Nominal 0 can be set at -6, 0, +4, +8 dBv - all user-selectable. Phase indicator shows polarity information, and distinguishes stereo from mono (same basic information as from an X-Y scope, but at a fraction of the size and cost!) Other options: All Wohler AMP-1A & AMP-2 Series can accept multiple inputs from analog and digital (AES & Serial Digital) sources.

\$975.00 List Price

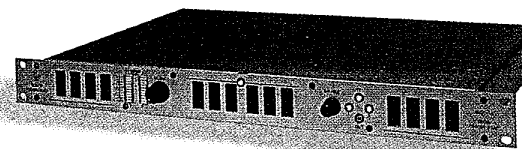

Wohler AMP-2

This is the premier Wohler speaker system. If you have 2U (3.5") of available rackspace-this is the unit for you. Louder than the 1U AMP-1A series, its three amplifiers and three audiophile quality speakers produce 104 dB with frequency response of 80Hz-16kHz. Large level meters and phase indicator are standard. As with all Wohler products, many options are available: multiple input switching, headphone outs, mute switch, mono switch and variable outputs.

\$1,095.00 List Price

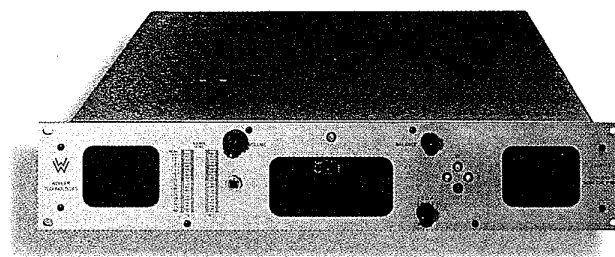

Yamaha NS10MS/NS10MC

The standard for close-field monitoring in professional studios. Optimum low frequency/high frequency driver matching and careful crossover design ensure smooth, natural transition between frequency ranges with minimal phase variation. Frequency range is remarkably flat from 60Hz to 20kHz, and superior transient response delivers crisp transparent sound. Rugged horizontal-placement design for on-console placement and large screw type connector terminals are provided for heavy gauge cable. The NS10MC offers the same features/performance as the Ns10MS with steel mounting taps and front grill.

NS10MS \$478.00 each List Price
NS10MC \$598.00 each List Price

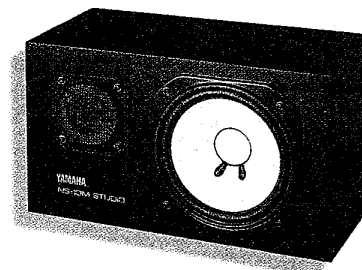

Wohler AMP-1A

Quality stereo speakers in the smallest (1U), easiest-to-install package available. Realistic bass and treble response, at volumes loud enough to be heard in the noisiest environments; AMP-1A's sound is loud, wide, and clean. Fully magnetically shielded, balanced and unbalanced inputs. Over 8,500 different option combinations available to meet your application needs and budget. Wohlers have been an industry standard for over ten years and comprise the widest range of in-rack audio monitoring products available.

\$710.00 List Price

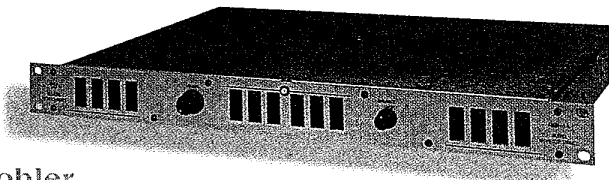

Speakers





Wohler Technologies



Self-Powered
Speaker Systems

Routing &
Source Selection

Level Meters &
Phase Indicators

Alarms for Audio Loss
& Overrange

Innovative Audio Monitoring Systems



When it comes to Audio Monitoring, it comes from Wohler!

Our customers love Wohler because they provide the most comprehensive range of In-Rack audio monitoring products in the industry, providing solutions for all audio monitoring needs. They created the In-Rack revolution nearly ten years ago, and continue to offer quality products for all budgets.

Renowned for their self-powered speaker systems which have become the industry standard, Wohler also manufactures:

Level & Phase Meters (now including In-Picture); Alarms for audio errors and location and Audio Routers / Source Selectors.

Speak with your Harris representative to find out how Wohler products can help you.

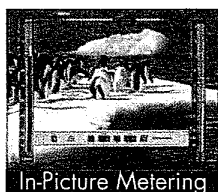

In-Picture Metering

- Hundreds of models for all applications & budgets
- Only 1 or 2 U high - perfect for space-critical environments
- Magnetically shielded - put Wohlers right next to video screens
- Accepts multiple inputs from analog & digital sources - AES & SDI
- Plug-and-Play - just drop in the rack - no installation hassles

Focused Sound™ is a monitoring technique first offered by Wohler, and made possible through the use of close-range, in-rack, high fidelity drivers located right in front of the user.

Because the sound travels a much shorter distance from its source to the operator's ears, volume settings can be kept lower. The result is greater clarity, greatly reduced room noise, and much less acoustic crosstalk between adjacent bays.

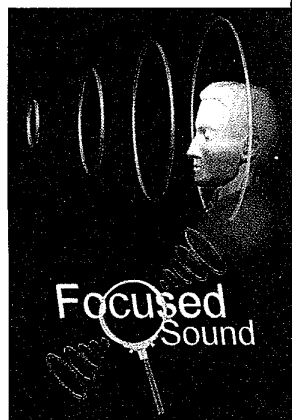

A to D to A? A2D2A!

20 bit analog to digital & digital to analog conversion.

'Need to make the perfect connection between your analog and digital audio equipment? The A2D2A shatters price barriers to bring 20 bit A/D and D/A conversion technology to production and broadcast studios. The internal 16 and 18 bit converters found in today's workstations, signal processors, and digital multitracks can't deliver the transparent sound quality demanded by leading artists, producers, and savvy listeners. If you suffer from bititis, try a 20 bit A2D2A. It will make an immediate and dramatic improvement to your sound at an unbelievably low cost. The A2D2A also can perform A/D and D/A conversions *simultaneously*.

20 Bit
Performance



- **Professional sound quality:** While providing superior stereo imaging and clarity, the A2D2A's oversampling 20 bit delta sigma technology gives you 100 dB of A-weighted dynamic range in both analog to digital and digital to analog signal paths.
- **Studio friendly:** For interfacing with your analog studio equipment, industry standard XLR and 1/4" connectors are provided. (Most people use balanced connections whenever possible, but if some of your equipment has unbalanced or 'semi-pro' connections, we can connect to it too— no problem). As for the connections to and from your digital gear, the A2D2A supports both the professional AES/EBU and the consumer S/PDIF (IEC 958) formats.
- **Awesome A/D:** Calibrated LED indicators for left and right channels show you exactly where to set the analog input controls to optimize the analog to digital conversion process for low noise and wide dynamic range. You can select from three sample rates of 48kHz, 44.1 kHz, or 32kHz, or lock the A/D converter to an external AES/EBU reference signal.
- **Dazzling D/A:** A front panel LED confirms that digital input is present. The A2D2A's D/A circuitry automatically locks to the sample rate of the incoming digital bit stream. Low impedance balanced and unbalanced output jacks give your professional level analog signals to drive inputs of any impedance.

SINUS

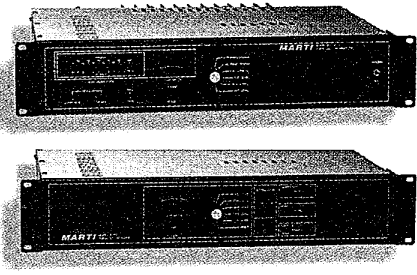

Marti

STL-15C Composite Studio Transmitter Link

The STL-15C system uses the STL-15C Transmitter and the R-15C receiver to provide a link that can carry many different types of signals. Depending on available bandwidth, you can transmit composite FM stereo with two sub-carriers, digital stereo audio (with external modems), multi-channel audio or data with external multiplexers or digital data with external modems. Complex systems with bi-directional capability, multiple relay or repeaters and automatic hot standby features can be configured. The STL-15C frequency selection is via DIP switches and selectable pre- and de-emphasis.

STL-15C \$3,500.00 List Price

R-15C \$3,500.00 List Price

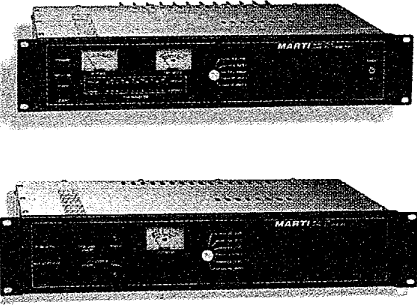

Marti

STL-10 Aural Studio Transmitter Link

The STL-10 is a single channel per carrier (SCPC) link that offers the highest stereo separation, signal-to-noise ratio and reliability. The transmitter features a precision bar-graph modulation meter with a "peak-hold" that takes the guess work out of setting up your system and has a 10 watt RF output. A stereo system can handle up to 4 subcarriers and has the inherent backup capability of SCPC. The system can be ordered on several different frequency bands between 140 MHz and 960 MHz, depending on your licensing. The receiver is the model R-10. There is also an STL-30 transmitter in the 140 MHz-450 MHz bands for use outside of the USA.

STL-10 \$1,775.00 List Price

R-10 \$1,775.00 List Price

Marti

Digital Encoder and Decoder

The Marti MD-2E and companion R-15C Receiver can be combined with the STL--15C Transmitter and MD-2D digital modems to form a cost effective a high-quality frequency-synthesized 2 channel digital radio link. Complex systems can be built having multiple relay (repeater), bi-directional (full duplex) and automatic switching hot-standby features.

MD-2E Encoder \$2,500.00 List Price

MD-2D Decoder \$2,500.00 List Price

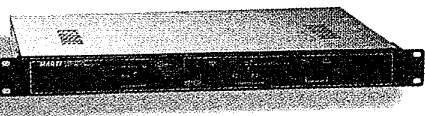
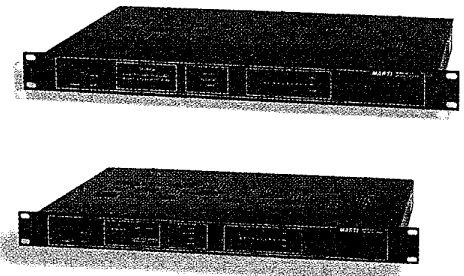

Marti

SCG-10 Subcarrier Generator

The SCG-10 subcarrier generator is designed to operate in SCA service with an FM broadcast transmitter or, with an SCD-10 to form a subcarrier link on a microwave (STL) system. Audio processing options include selectable pre-emphasis of zero, 75, 150 or 225 microseconds. Low pass audio filters of 3 kHz, 5 kHz or 7.5 kHz are available. 4.5 lbs. (2 kg)

\$798.00 List Price

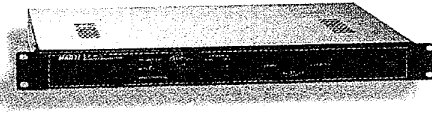

Marti

SCD-10 Subcarrier Demodulator

The SCD-10 subcarrier demodulator is designed for use with the SCG-10 subcarrier generator to provide a high quality subcarrier channel on a microwave link (STL) or FM station. A wide range of options make this equipment flexible and versatile. Unit weight-4.5 lbs. (2 kg)

\$798.00 List Price

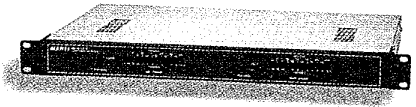

Marti

CD-15

For users looking for a cost effective way to demodulate a composite signal to baseband left and right audio, Marti has introduced the CD-15 Composite Demodulator. This product enables audio monitoring at repeater sites, running a composite AM transmitter feed, or even running composite remotes (export only). All controls are front panel mounted and set-up is simple with simultaneous left and right metering. Independent output level adjustments for each channel insure an exact match to your system. 110-125 VAC, 50-60 Hz. 12.5 VDC (neg. gnd.), 220 VAC on request.

\$1,495.00 List Price



Marti

TSL Packages

The Marti TSL Telemetry Links provide reliable circuits for AM, FM and television stations. Expensive and unreliable Telco lines can now be replaced with cost effective Marti TSL systems. These links are simple to install, easy to operate and maintain. Marti has assembled complete equipment packages consisting of transmitter, receiver, Yagi antennas, identifier and optional items.

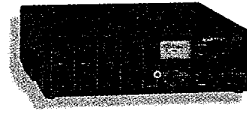
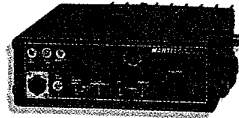
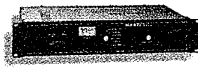

TSL-2 Package

- 1 RPT-2/450 Transmitter
- 1 CR-10/450 Receiver
- 1 Model 1402 Station Identifier
- 1 RMH-3 Rack Shelf

\$2,748.00 List Price

TSL-15 Package

- 1 RPT-15/450 Transmitter
- 1 CR-10/450 Receiver
- 1 Model 1402 Station Identifier
- 1 RMH-3B Rack Shelf

\$2,848.00 List Price

TSL-30 Package

- 1 RPT-30/450 Transmitter
- 1 CR-10/450 Receiver
- 1 Model 1402 Station Identifier
- 1 700-253- Rack Mounting Kit

\$3,452.00 List Price

Moseley

PCL 6000 Aural STL

The PCL 6000 STL is a broadcast standard. This Transmitter/Receiver pair offers a highly selective and transparent link for broadcast applications. The receiver is available in three levels of performance (PCL6020/6030/6060) to provide the end-user with the maximum price-performance advantage. With DSP 6000 upgrade, the PCL 6000 is digital STL capable.

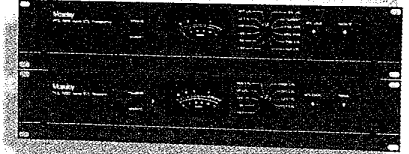

Moseley

DSP 6000

Digital Transmission System

The DSP6000 Digital Transmission System consists of an Encoder and Decoder that provide up to 4 channels of digital audio and auxiliary data channels. The program material is digitally processed to obtain high spectral efficiency. The system is field retrofittable for existing analog STL applications.

Starting at \$5,990.00 List

Applications include:

- Digital STL (Studio-Transmitter Link),
- Digital audio for Fractional T1
- Digital Repeaters, and
- Path extender for difficult hops.
- Great sound!

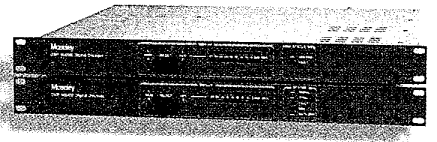

QEI Corporation

CAT-LINK

It's pure digital. It provides real-time encoding/decoding with no compression techniques and with no audible delays to annoy on-air talent. It can send composite and high quality discrete audio channels. And it means flawless bidirectional transmission for your station. It's CAT-LINK (Composite Audio Transmission Link) from QEI. CAT-LINK is the digital STL/TSL for the 90's and beyond. Its output signal is compatible with T-1 (DS-1) facilities, fiber optic transmission media, and T-1 (DS-1) microwave using commercially available T-1 subcarrier generators with a bandwidth as little as 1 Mhz. Plug it in, turn it on and notice the difference immediately.

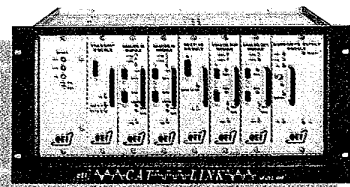

QEI

QUICK-LINK II

Imagine...a remote broadcast without paying the telephone company for the lines (and waiting for them to be installed) or fighting to get a frequency allocation (and then hoping that someone does not come up on your frequency). Imagine an almost instant remote broadcast from your clients' premises, without hiss, noise or interference! Imagine a license free STL or TSL with high quality 16 Bit digital stereo audio. Imagine no more... with QUICK-LINK II there is nothing but pure, clean, uncompressed digital audio. No external encoders or decoders to buy, it's all in one package ready to go. Inexpensive digital stereo audio transmission is now reality with QEI's QUICK-LINK II system.

\$8,495.00 List Price

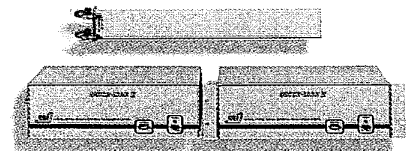

CERTAIN PRODUCTS NOT AVAILABLE IN ALL AREAS



ORDERING AND TECHNICAL SUPPORT: 1-800-622-0022

139

STL/TSL

Strengthen Your Airchain



with the
Moseley DSP 6000
Digital STL System

The strength of any chain is always determined by its weakest link. Same is true of your Airchain. You may have the finest format, talent, studio facilities and audio processing, but if your link to the transmitter isn't a Moseley, you could be in for some tough breaks. Sonic clarity and reliability are what you and your listeners demand. Nothing fits

the bill like a Moseley Digital STL System. The DSP 6000 virtually eliminates the problems associated

with conventional analog transmission systems such as noise due to signal fades, birdies from intermod interference, and lack of spectrum for multiple audio feeds to LMA and Duopoly sites. The DSP 6000 digital encoder/

decoder works with any existing Moseley composite system to give your link the digital upgrade necessary for today's audio purity.

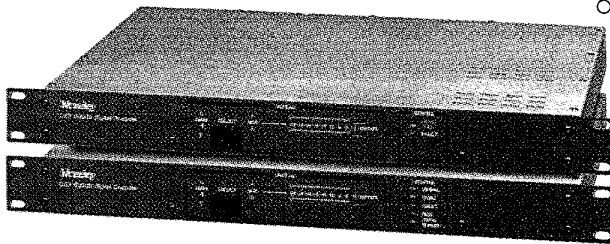

Moseley

Moseley Associates Inc.
111 Castilian Drive
Santa Barbara, CA 93117

Legendary Quality. Uncompromised Audio. Incredible Reliability.
Moseley STLs — Strengthen your Airchain.

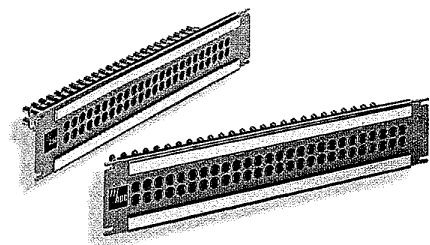

**ADC
ADC Video Panels**

ADC is recognized as a world leader in video jackfields. Several jack options are available in standard size as well as "true" 75W midsize. Styles include single and dual switching in both terminated and non-terminated versions. All ADC video jacks feature gold plated center conductors, and precision components for the highest reliability.

The Professional Video (PV) family of products incorporates the ultimate in cable management of video signals. PV video panels feature a solid aluminum chassis with an insulated face plate, a top cover, side brackets, and a cable tray which provides superior cable support and strain relief, as well as maximum jack protection. Video Patch Panel (PPI) products utilize a standard one or two rack space insulated aluminum faceplate with an attached phenolic panel. Both PPV and PPI panels feature the SJ-2000 dual switching self-normalling 75w video jack which provides low return loss, and frequency response up to 750 Mhz.

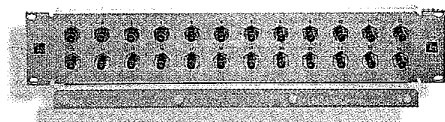

**ADC
Video I.C.O.N.**

ADC's video Integrated Cable Organization Network (I.C.O.N.) makes installations of coaxial cable cleaner, easier, and simpler to identify when changes are necessary. The VI-24 is a rack mountable central distribution panel with 24 high-quality true 75W BNC bulkhead feedthrough connectors mounted to a durable powder coated steel panel with a cable trough and tie down lances. Up to 24 circuits can be terminated and cross connected at the two rack space VI-24 panel.

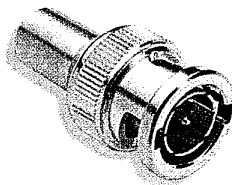

**ADC
True 75w BNC Connectors**

BNC connectors are the most often overlooked part of system design because they are considered commodity items. In reality, poor quality BNCs, or non-75w connectors can often times be responsible for numerous system difficulties. ADC has perfected the traditional BNC connector with a complete range of straight, right angle, right angle adaptors, and bulkhead feedthrough styles for any installation need.

75w features/benefits:

- True 75w design, minimizes loss and reflections of the signal
- Locking center conductor, eliminates misaligned center conductors
- 12 point crimp tool compatible
- Precision parts meet MIL. Spec. G-45204-Type 1, Grade C, Class 1
- Crimp sleeves marked for cable type
- Common center pins & crimp sleeves for straight & right angle
- Common strip lengths for straight & right angle
- Compatible with industry standard tools & die sets

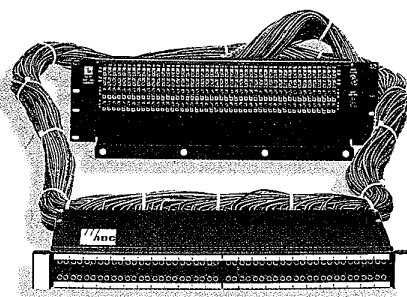

**ADC
QCP**
ADC QCP is available in either a Pro-Patch™ patchbay or jackfield configuration. In the Pro-Patch configuration, terminations are mounted on the back plane of the self contained patch bay. In a jackfield configuration, terminations are mounted to a "UP" panel at the end of a prewired umbilical cable. The "UP" can be mounted anywhere in the rack, allowing further flexibility in system access and configuration. Punch down tool available.

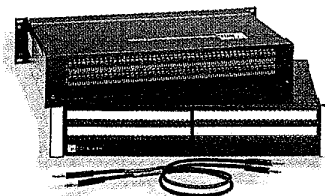

**ADC
Digital Patchbays**

ADC's Digital Audio Jackfields are designed for patching AES/EBU digital audio signals. The normals strapped or half normalled panels are used to patch AES digital audio signals up to a total circuit length of 300 feet (91.5 m). Precision 110 ohm impedance, low capacitance, shielded twisted pair cable is used to meet stringent AES standards for digital audio transmission lines. All digital jackfields and the associated patch cords meet this requirement to ensure error free transfer of the digital data.

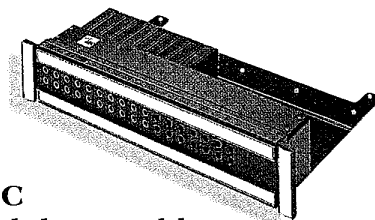

**ADC
Modular Patchbays**

ADC has turned the traditional "audio only" patchbay into a space-saving audio and video patching system that grows as your system requirements increase. The Video Audio Modular Patchbay (V.A.M.P.) chassis accommodates up to twenty modules of longframe, bantam, dual switching coax to BNC, and single coax to BNC jacks. The V.A.M.P. system is the perfect solution for small and medium sized applications that do not need a single configuration audio or video panel, or where audio & video need to be in the same chassis.

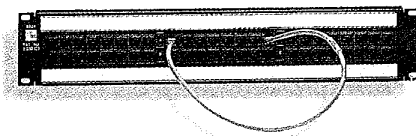

**ADC
Data Patch**

ADC's data patch products provide flexibility for video editing systems, parallel digital video, ethernet, T1, ISDN, and other data transmission applications up to 20 Mbps. The PEMJ patch by exception data jackfields are normalled through, eliminating the need for extensive patch cords for normal use. PEMJ products are designed to patch only when necessary, during testing or rerouting of signals.

- Full eight pin as per ANSI/SMPTE 207M-1992
- High density.

Studio Accessories



Studio Accessories

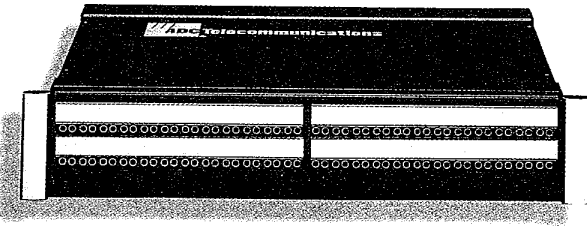

**ADC
Pro-Patch Broadcast Jackfield**

Standard panel configurations are available in either single rack space 1.75" (88mm) or two rack space 3.5" (88mm) footprints. Custom panel sizes are available by special quote.

- Patented QCP split cylinder "punch down" for quick install
- EDAC/ELCO 90, 56, 38, and 3 pin connectors
- "UP" panel (Jackfields only)
- QCP prewired umbilical cord
- Stub end cut to length
- Punch down tool available

**ADC
Pro-Patch Patchbay**

ADC's standard line of audio jackfields feature an extensive selection of jacks, panel sizes, normal options, and a variety of rear terminations. Broadcast jackfields are available with standard or custom umbilical cable lengths.

Pro-Patch patchbays and jackfields are available with either standard longframe or space-saving bantam jacks. The stereo spaced option places jacks in pairs along the panel to avoid cross circuits.

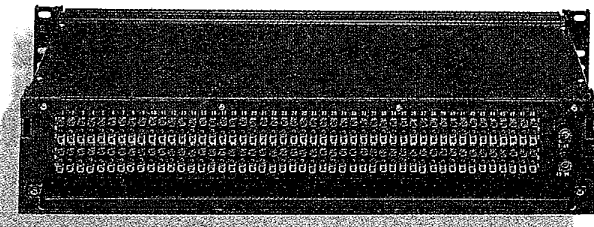
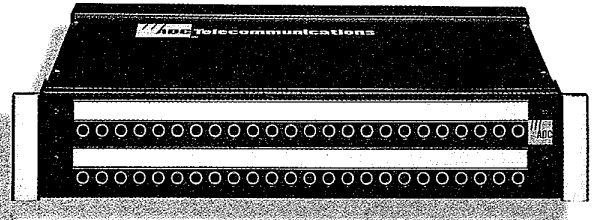

Back View

**ADC
Pro Patch Mark II**

ADC's Pro Patch patchbays and jackfields are the standard of the industry incorporating the exclusive patented QCP split cylinder "punch down" contact system. With QCP, changes in normalizing configuration, or movement of the patching panel can be accomplished in minutes, and each QCP contact is rated for a minimum of 200 insertions/withdrawals. QCP's will easily terminate 22-26 (.4mm-.79mm) gauge wire with a "gas tight" termination, which means greater reliability and flexibility over time. All QCP contacts are individually insulated for elimination of short circuits, and color coded for easy identification. The self cutting punch-down system terminates and cuts the excess wire in one easy punch, and the insulators double as an effective strain relief for each cable. Punch down tool available.

**Neutrik
Patch Panels**

Neutrik offers three patch panels to suit your needs. All are rack mountable. The PatchLink™ is a low cost patch panel. The NPP-TT and NPP-TB versions utilize solderless push-down terminal blocks and are the only patch panels capable of both analog and digital signal. Accessories for the NPP-TT and NPP-TB panels, such as colored labeling tabs, patch cords and 14"-18" extension slides are offered for your convenience.

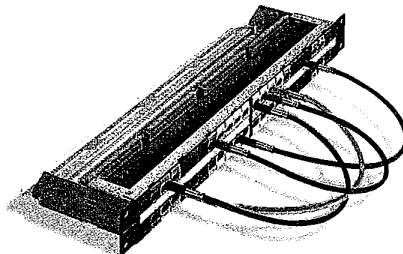
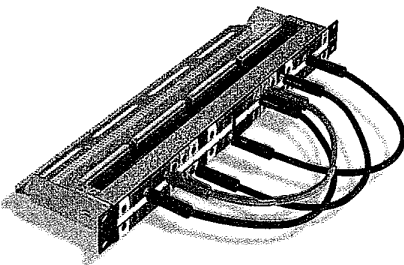

ADC

HUM-1 Humbucker

Common mode hum caused by differences in ground potential is often found in long video cables, incoming and outgoing lines, and separate power distribution systems. The Humbucker eliminates 99.6% of a 10V p-p, 50/60 Hz ground-induced hum in a 200' (61m) RG59 B/U coax run. The actual amount of hum reduction depends on cable length, cable type, ground loop potential and ground loop frequency. BNCs in and out.

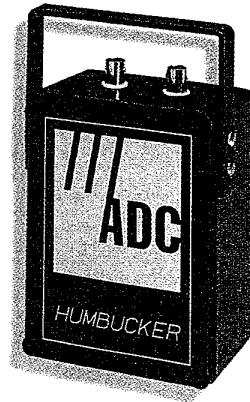

Canare Impedance Transformers

Canare impedance transformers are designed to convert 2-channel digital audio signals between balanced 100 ohm XLR and unbalanced 75 ohm BNC. This cost-effective adapter allows you to switch from a limited length microphone cable to a much longer Impedance matched 75 ohm coax cable. Now, conveniently route D1, D2, R-DAT and DAW signals via 75 ohm Canare video patchbays, BNC plugs and super flexible coaxial cable. Advanced system solutions for your future available through Harris.

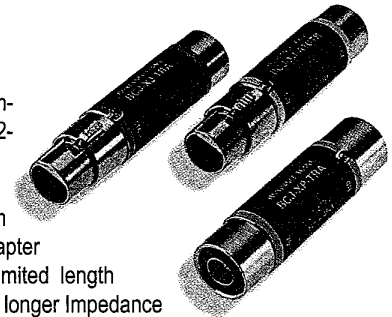

Studio Accessories

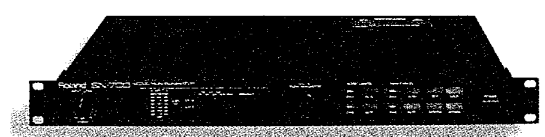
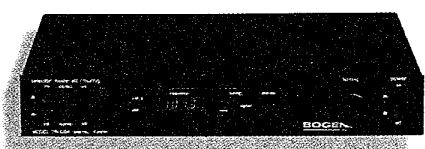

Bogen

TP-100A FM/AM Tuner

The Bogen TP100A tuner provides FM stereo and AM mono reception. TP-Series Tuners are manufactured using solid-state circuitry for dependable, continuous operation. Bogen tuners are the choice for precise tuning and superior signal quality. Optional rack mount available.

- Excellent sensitivity, image rejection, and frequency response
- Easy precise tuning with LED indicators
- Extremely low hum, noise, distortion
- Solid-state, high reliability circuitry
- Supplied with FM dipole and built-in AM loopstick antennas
- UL listed

\$326.70 List Price

Roland

SN-700 Noise/Hum Eliminator

Roland's new SN-700 Noise/Hum Eliminator is a sophisticated digital signal processor which removes virtually any type of noise in recording, broadcasting or performing environments. This stereo noise eliminator is designed to identify and isolate troublesome frequencies and noise sources in a variety of applications. With simple "Threshold," "Release" and "Frequency" settings, users can easily dial out annoying noises and hums. The special "Auto" function will even set these parameters automatically for unparalleled ease-of-use.

\$1,295.00 List Price

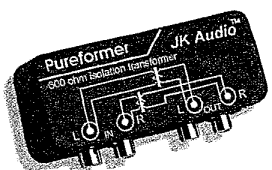
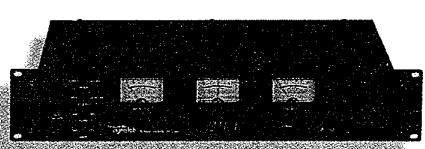

Magnum Dynalabs

Pro 101 FM Tuner/Monitor

The basic Pro101 features a wide band composite FM output with sufficient drive for direct connection to an FM exciter to be used as a relay receiver. Among the options are demodulated SCA outputs at 67 and 92 kHz, an alarm for both carrier and modulation loss and a balanced audio output. The front panel meters provide a continuous readout of RF input and relative multipath interference levels. The third meter is for accurate center tuning.

\$1,600.00 List Price

JK Audio

Pureformer

Stereo Isolation Transformer

Pureformer contains two 600 ohm to 600 ohm isolation transformers with gold plated RCA jacks for stereo input and output. Simply connect Pureformer between any two pieces of audio equipment that are prone to ground loop hum. Pureformer also helps reduce noise between PC audio cards and your studio equipment by isolating your high end equipment from the noisy PC ground. Unbalanced.

\$59.00 List Price

Rolls

RS78b

The Rolls RS78b is a digital PLL synthesized AM/FM tuner in a single rack space chassis. The unit uses capacitance backup for preset memory, which lasts for approximately four days without power-up. The unit is intended for installations that require a high performance digital tuner. The RS78b has a large LCD display that can be read in the daylight that displays the frequency and preset. The unit will auto search up and down as well as store up to 16 FM and 8 AM stations.

\$247.00 List Price

CERTAIN PRODUCTS NOT AVAILABLE IN ALL AREAS



ORDERING AND TECHNICAL SUPPORT: 143
1-800-622-0022



**Dorrough
280/380 2-Channel Digital
Audio Meter**

The Dorrough Models 280 (*horizontal*) and 380 (*vertical*) AES/EBU 2-channel digital-reading audio meter feature AES/EBU inputs; 2 channels per meter; simultaneous display of peak and perceived power; selectable peak-hold function; over indication; 40dB range (Model 280/380D) or 60dB range (model 280/380E); gate-array technology; console or panel mount; screw terminals and fits standard 1.5" console openings (minimum 5.0" height and 5.2" depth). Requires external power (12 - 24 Vdc, 0.5A).
\$850.00 ea. List Price



**Dorrough
40A2 Loudness Monitor**

This meter offers a solution to the problem of inconsistent loudness that results in varying discrepancies of end product. It features a dual function on a single LED display. The LED bargraph shows normally weighty RMS material which the operator is directed to hold at center 0 dB, and a dot mode for peak indication which has a normal operator range at +13 dB. Red LEDs are at these two maximum points and the operator simply adjusts level up to the red. Equal perceived loudness is achieved by riding maximum gain to either point of reference. Now all Dorrough loudness meters have fully integrated peak-hold functions.

\$475.00 List Price



**Dorrough
1200 Stereo Signal Test Set**

Dorrough's model 1200 is ideal for FM stereo, recording, duplicating, uplink and stereo television applications. This simple and easy to operate gain set allows stereo measurements of level, balance, crosstalk, and signal-to-noise over the entire dynamic range of your system from noise floor to clipping. The solution for balanced stereo lines.

\$1,650.00 List Price



**ATI
MICROAMP SERIES™
VU200, VU400, VU600,
VU800 Studio Metering
Systems**

Give yourself that warm, secure, all-is-well feeling by economically displaying all your important signal lines simultaneously. Know at a glance where your signals are (or are not). Display one, two, three or four stereo lines (eight channels) on bright, three color, sixteen segment, LED bargraphs with simultaneous VU and PPM indication. Balanced, bridging inputs are switchable for 0VU at -10, +4 and +8dBm line levels. Wide range, backlit scale, compact 3-1/2" rack mount.

- VU200 One Stereo Display
- VU400 Two Stereo Displays
- VU600 Three Stereo Displays
- VU800 Four Stereo Displays

Prices Vary



**Furman
VU-40 Stereo Monitor**

The VU-40 is an inexpensive dual 20-segment LED meter that can monitor either line levels or amplifier power output levels. Metering scales are calibrated with a positive action, resettable switch matrix on the rear panel. Features include familiar VU meter scales with green/yellow/red coding; peak or average response switch; line level/power out switch for each channel; line level may be set to -10, 0, or +4 dBu; sixteen power out choices from 20 to 1260 watts; accommodates 25 volt and 70.7 volt lines. An on/off transient muting function can be used to protect speakers. Available with or without XLR balanced inputs and outputs.

\$249.00 List Price



**Wohler Technologies
MLH-2**

Two-channel level metering unit features large, (5.25") tri-colored, 25 segment, LED displays with peak indicators. Analog or digital signals. Provides full dynamic range for two to 20 channels and fits in 1RU. Options include phase indicators, alarm modules that identify audio error conditions (loss-of-audio, overrange, and phase problems), and problem location.

\$610.00 List Price



**Wohler Technologies
MLH-4**

Four-channel level metering unit features large 25 segment, tri-colored LED displays with peak indicator. Analog or digital signals. Provides full dynamic range and fits in 1RU. All Wohler meters are VU or PPM. User-selectable overrange thresholds. Wohler makes a complete range of level meters, phase indicators, and alarm systems that identify audio errors and location. Call for details.

\$945.00 List Price



**Wohler Technologies
MSH-8AL**

Eight-channel level metering unit with optional alarm system that checks audio for errors and reports error condition type (loss-of-audio or overrange) via a large flashing red LED and a mutable buzzer alarm. Bi-color LEDs show condition status and location. Threshold parameters are user selectable. Delay range is from 10 ms to 10 minutes. Wohler manufactures a complete range of alarm systems. Two to 64 channels can be alarmed in a single rackspace unit (1U).

\$2,180.00 List Price

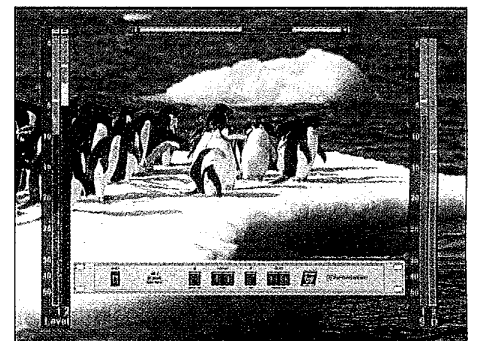

**Wohler Technologies
AM-2/AM-4**

In-Picture audio metering system. Dedicated on-screen audio level meter displays up to 4 channels of analog or digital audio in bargraph form. Phase bar is available. A wide range of analog scales and ballistics may be user-selected plus two AES/EBU digital scales when a digital input card is fitted. All bar positions and colors are user-selectable.

AM-4 \$3,500.00 List Price

Studio Accessories



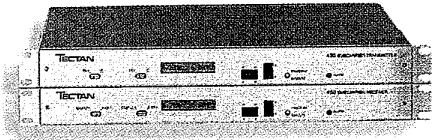

**Tectan
450 Family**

The 450 provides superior audio quality for two audio channels in one enclosure. Effective baseband utilization with a per-channel peak carrier deviation of only ± 75 kHz essentially conserves spectrum to allow twice the number of channels in the same spectrum as one conventional sub-carrier. Tectan's patented threshold extension detector permits flawless tracking of the incoming FM signal even under severe noise conditions. Top audio performance, with better than 90 dB dynamic range and less than 0.1% THD, no quantizing distortion and flat frequency response for a virtually transparent audio path for program material.

List Prices Vary

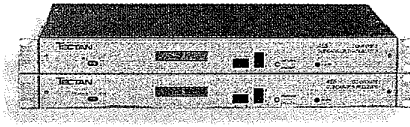

**Tectan
455 Composite Subcarrier**

The 455 for composite MTS/BTSC stereo and for digital conversion. The 455 provides one ultralinear wideband channel capable of carrying the entire multi channel BTSC composite signal with virtually no degradation of stereo performance. Proof is in the specs! Frequency response ± 0.1 dB to 70 kHz and THD $< 0.05\%$ @ 1 kHz. This is also perfect for the multi channel digital converter boxes now on the market, allowing digital quality while conserving spectrum. This digital is the perfect solution for preventing signal degradation through multiple hops.

List Prices Vary

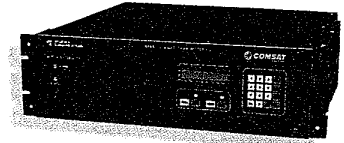

**Wegener
DVT 2000 Series**

Compact and rugged the DVT2000 series MPEG-2 digital video transmitter delivers broadcast quality, MPEG-2 compressed video data. Ideal for network program distribution yet tough enough for satellite news gathering (SNG). The DVT2000 features an integral 70 MHz modulator, selectable video coding rate (2.5 to 15 Mbps), selectable aggregate data rate, selectable FEC coding rate, and up to three stereo audio pairs per video signal — all in only 5.25 inches of rack space. The DVT2000 includes RS422 data output interfaces. The transmitter accepts either NTSC or PAL analog video, component and serial D1. The DVT2000 is compatible with Wegener network control protocol.

List Prices Vary

Satellite



**Wegener
DR96Q Series**

Wegener's SCPC (Single Channel Per Carrier Integrated Receiver/Decoders) are L-band receivers and feature the world standard MPEG Layer II compression, extensive diagnostics, QPSK or BPSK modulation, forward error correction, rapid carrier tuning and acquisition, auxiliary data output, and audio mute, fade, and boost. Both rack mount and desktop configurations are available. An optional relay board is available for rack mount units. The receivers offer local and remote control, or over-the-link control using Wegener's ANCS network control protocol.

List Prices Start at \$1,295.00



**Wegener
DR185 Series**

In use world wide to receive audio for business and radio programming distribution, Wegener's subcarrier digital audio IRDs are L-band receivers that deliver MPEG Layer II digital audio transmitted on video or FM2 subcarriers. The receivers are available in both rack mount and desktop configurations and feature extensive diagnostics, auxiliary data channel, synthesized channel tuning and mono, dual mono, and stereo operation, and a selection of relay boards for rack mount units. The receivers offer local and remote control, or over-the-link control using Wegener's network control protocol.

List Prices Start at \$1,295.00

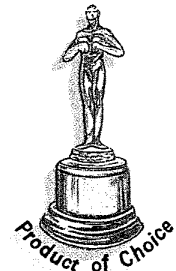

**Wegener
ANCS Addressable Network
Control System** (not pictured)

Wegener's Addressable Network Control System (ANCS and ANCS Plus) are in use throughout the world providing network communications and control for addressable audio, video and data networks. The power of Wegener's Network Control lies in its flexibility. Featuring advanced proprietary command structure, e-mail, data, and commands are targeted to specific receivers, groups of receivers, or the entire network. Groups of receive sites are defined by name at the uplink. Any receiver may belong to any combination of groups and group memberships may be changed at any time. This is the superior control system that leading networks rely on.

\$8,400.00 List Price



The Sky's The Limit...



Scientific Atlanta Encore 3610.

Tomorrow's digital audio receiver today. From the company that introduced digital satellite to radio. Scientific Atlanta invented SEDAT, plus complete compatibility with DAT channels. Fully agile and absolutely the lowest price.

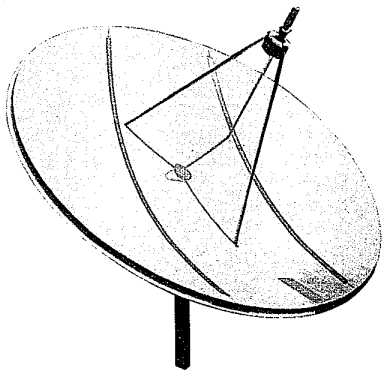

Comtech 3.8 Meter Antenna.

The proven top satellite antenna performer. This is the dish to use when you want broadcast reliability. Ask anyone who has a Comtech 3.8 Meter. Your needs can be met from the vast selection of Comtech options.

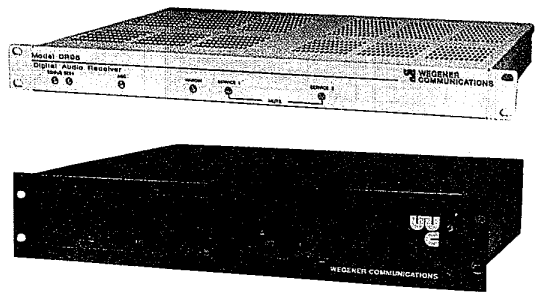

Wegener DR96 & DR180.

The latest in digital satellite audio transmission. MUSICAM efficiency in subcarrier, FM-cubed, BPSK and QPSK. All available with the feature loaded ANCS Data Control System. Wegener is top digital performance at a reasonable price.

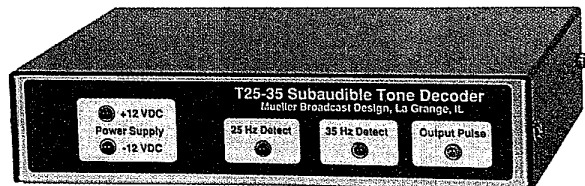

Mueller T25-35SA Subaudible Tone Decoder.

Automate your satellite-delivered programming with Mueller. Compatible with network 25/35 Hz automation tones. This one works. Simply loop your audio through the Mueller and you're in business.

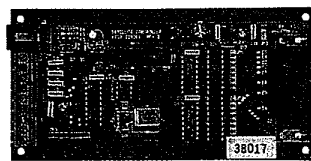

Broadcast Tools.

Finally, a remote control for Scientific Atlanta's DAT32 and Fairchild's Dart 384. Model XP-3 does the crystal switching and SCC-4 does the audio channel switching. Smart accessories for your satellite needs.

Satellite Solutions from Harris.

Phone 765-962-8596 FAX 765-962-8961





**Benchmark
AD2004**

The AD2004 quad 20-bit analog to digital converter was designed for no-compromise performance and space efficiency. Three units mount in a 1RU panel providing 12 channels of A to D conversion. It is intended for studios recording in 20 or more bits and is ideal for broadcast environments that need four channels of audio conversion.

\$2,000.00 List Price



**Benchmark
Audio World™**

Audio World Interface is a rack mountable stand alone device with XLR and RCA type rear connectors that will interface all audio and video tape recorders. Additionally, it will perform as a balanced-in, balanced-out line amp, with a simple switch actuation. A second switch allows line amp operation with reversed channels. With both switches engaged, the device becomes a mono mix amplifier, with two outputs, each of which have independent level control.

\$225.00 List Price

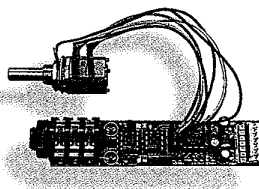

**Benchmark
HPA-1**

The HPA-1 is a robust stereo headphone amplifier mounted on a 1/4" jack. It uses a current boosted TL072 with 60 kHz bandwidth at full gain and a gain range of Off to +20 dB. The exceptionally clean performance offers phenomenal listening with today's high performance headphones. It is ideal for headphones in the 60 to 600 ohm range, that need a higher voltage swing and moderate current drive. Requires external power.

\$70.00 List Price



**Benchmark
Jr. Audio Director Plus™**

The Jr. Audio Director Plus™ is a rack mountable stereo mode controller with four switch selectable inputs per channel. Four primary inputs are available to both channels via internal jumpers. The unit offers output selection between left only, right only, mono, stereo, and stereo reverse. Right channel polarity is provided to correct polarity inversion in source material. It has gain adjustment of both L and R inputs providing control over mix in the mono mode, and an easy level adjustment for the two channels.

\$550.00 List Price



**Benchmark
Jr. Audio Director**

Featuring balanced inputs and outputs, the Jr. Audio Director provides output source selection between left, right, mono, stereo, and stereo reverse. Right channel polarity is provided to correct polarity inversion in source material that causes sum and difference swapping in stereo broadcasts. It has manual gain adjustment of both Left and Right inputs providing control over mix in the Mono mode and includes LEDs to indicate the operating mode. Optional rack panel is available.

\$350.00 List Price



**Broadcast Tools
The 2X1 Stereo Audio
Switcher/Router**

The 2X1 Stereo Audio Switcher/Router passively switches or routes two stereo inputs to one stereo output, or vice versa. The 2X1 features passive switching through gold contact relays and is configured to route audio to the output in case of loss of power to the unit. Input, output and control interfacing is via wire captive terminals. The 2X1 allows control with 5 volt logic levels, open collector, or switch contacts.

The 2X1 comes equipped with wall transformer and may be rack mounted with an optional RM-2 rack mount adapter.

\$139.00 List Price



**Broadcast Tools
8X2A/3X2 Active Dual
Stereo Audio Switchers**

The 8x2A and 3x2 Dual Stereo Audio Switchers can switch their stereo inputs (3 or 8) to two stereo outputs via front panel switches with LED indicators. The inputs will accept either balanced or unbalanced sources and may be programmed to either overlap, mix, or interlock any source. Additional features on the 8X2A include up to 10 dB OD dimming on each input; EPROM programming for power-up input select, mute input, step input, front panel switch disable, monaural outputs, summing inputs and unbalanced outputs for multiple unit cascading and output selectable silence sensor. Both units feature RS-232 serial ports for remote control and status.

8X2 \$629.00 List Price

3X2 \$399.00 List Price



**Broadcast Tools
6x1B**

The 6x1B is a six input stereo switcher/router which can select up to six stereo balanced inputs to one stereo output. It provides passive switching through sealed gold contact relays allowing a very transparent audio path that makes it ideal for both switching and routing applications. Front panel switches with LEDs provide interlocked source selection and status. A rear panel 15 pin D connector allows for remote control and status. Remote control inputs may be momentary or maintained TTL/CMOS, open collector or contact closure and status is an open collector. The 6x1B provides loss of power bypass on input one and may be programmed to allow selecting which of any source is active at power-up. Additional features include audio mute, allowing the user to turn off the audio output when activated; an enable switch, providing a safety lock to the front panel source selection switches; a step input, providing a means of stepping through each source; programmable non-selected input termination and wire-captive terminal strips for input/output connections. Housed in a half rack width chassis, the 6x1B may mount on a desktop or be rack mounted with the RM-1 optional rack shelf and FP-1 filler panel.

\$399.00 List Price

Studio Accessories





Studio Accessories

Broadcast Tools

The 10X1 Stereo Audio Switcher/Router

The 10X1 Stereo Audio Switcher/Router passively switches or routes ten different stereo sources. The 10X1 provides passive switching through gold contact relays and accepts levels between -20dB and +20dB. The 10X1 features front panel switching with LED indicators. Additional features include: full front panel remote control and status, programmable front panel enable, audio mute control, selective channel power-up programming and a 2400 baud serial port.

The 10X1 is in a single rack unit profile and comes standard with wall transformer and serial cable. Audio input and output connections are via wire captive terminal strip.

\$529.00 List Price



Broadcast Tools

Rack-O-Switches/Box-O-Switches Remote Utility Switch Panels

Rack-o-Switches (R.O.S.) and Box-o-Switches (B.O.S.) are compact, convenient and reliable products for all of your remote switching needs. Both units allow remote switching of any kind of equipment needing a normally open dry contact closure. Each of the 12 switches contains a bright red LED displaying the active status of the associated equipment connected to the R.O.S. or B.O.S. Use the R.O.S. or B.O.S. to remote start and stop CD players, recorders, automation gear or any other equipment you need to control with the push of a button. All connections on the B.O.S. are made on wire captive terminals mounted inside the unit. R.O.S. utilizes dual DB-25 connectors for all connections.

\$199.00 List Price



Broadcast Tools

AFC - Audio Fade Controller

Add professional audio quality fade control to any audio source with the AFC. It offers two ranges of fade speed, on/off and preset dimming (-6 dB) via TTL/CMOS compatible control inputs. The AFC is also equipped with an 8 node addressable RS-232 serial port allowing full control of level and fade rate. It provides balanced stereo outputs and will accept any balanced stereo input with levels from -15 to +10 dBv.

\$199.00 List Price

Broadcast Tools

DC-8A Dial-Up DTMF Controller

The DC-8 is designed to connect to a standard dial-up telephone line or program feed, allowing the user to control eight SPDT relays and monitor eight digital inputs via any standard Touch-Tone® telephone or DTMF source. The relays may be configured for momentary, latching, interlocking or group latch/unlatch operation. The DC-8 incorporates a "PAGER ALERT" function, which when activated, will dial a digital pager and display a programmed phone number. Additional features include: programming via standard Touch-Tone® telephone; 1kHz tone generator; audio input/output switching to/from telephone line; status LEDs for tone, off-hook, local control, ring and power; single high/low tones used for status of the eight relays and digital inputs. Optional rack kit available.

\$399.00 List Price

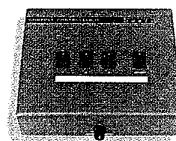

Broadcast Tools

CCII

Console Controller II (CCII) provides the solution for interfacing non-broadcast consoles such as the Mackie CR1604, or digital workstations to the broadcast studio. It offers three channels of insert switching to turn on or off console input channels or other source equipment (i.e. mic pre's) as indicated by a bright red LED on each switch. The LEDs on each channel may be programmed to flash when activated. Additionally, the CCII offers monitor amplifier mute control (channel three may be programmed not to mute the monitors when activated), front panel monitor level control and the ability to switch between internal or external (program/off-air) monitor input sources. Installation utilizes simple insert cables with no modification to the mixer.

\$299.00 List Price



Broadcast Tools Silence Monitor

The Silence Monitor is designed to monitor any stereo or monaural audio source for activity. Sources to monitor may be modulation monitors, AM/FM/TV tuners, etc. The absence of audio will extinguish the "signal" LED and close a relay after a programmable time delay. The relay remains closed for the duration of the loss of audio, while a second relay is latched and may be set to flash. The precise time delay is programmed via dip switches in increments of 2 seconds with a maximum time delay of eight and a half minutes. The Silence Monitor is equipped with an on card silence alarm reset switch, opto-isolated remote reset and defeat inputs and LEDs that display presence of audio, power and silence alarm. The Silence Monitor is supplied in an aluminum chassis with mounting holes allowing convenient mounting. The optional RM-2 allows two units to be mounted in a 19" rack.

\$199.00 List Price

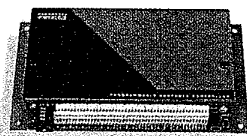

Broadcast Tools

The PSC

The PSC: Programmable Schedule Controller, stores and controls up to 160 time and date events. The PSC is equipped with 20 SPST relays, and can also send up to 12 serial custom commands. All program events are stored in non-volatile eeprom™ memory. Programming the PSC is simple - just attach it to a non-dedicated PC, running standard, off the shelf, communications software, such as Bitcom™, ProComm Plus™, Windows® Terminal, etc. The PSC features an AC line, 60 Hz time base for precise timing. A supercap is provided to operate the clock processor when the PSC is not attached to an AC power source.

\$399.00 List Price





Broadcast Tools
SM6 Source Mixer

The SM6 provides a convenient way to mix up to 6 stereo input sources to a single balanced stereo or mono output. Front panel switches allow you to select as many sources as you want in your mix. Inputs are balanced with multi-turn input level adjust and can convert levels from IHF to Pro. An external sum input allows ganging of units. 19" rack mount or under-counter mounting kits available.

\$349.00 List Price

Broadcast Tools
SRC-8A

The SRC-8A adds remote relay control to your DSP-6000 (or equivalent) digital STL or ISDN remote equipment. Applications include direct relay control for your dial-up remote control, a supplement to your dedicated remote control, relay control of satellite, transponder or remote audio switching as well as machine control and talent alerting for remotes. The standard system provides one-way control. The SRC-8B is available for bi-directional control and status. All SRC's utilize a high integrity data format for maximum reliability. The SRC-8A consists of both transmit and receive units. Each unit is mounted in an aluminum case with mounting holes allowing convenient mounting. The optional RM-2 rack may be purchased for mounting two units in a 19" rack. Power adapters and serial cables are provided.

SRC8A \$399.00 List Price

SRC8B \$499.00 List Price

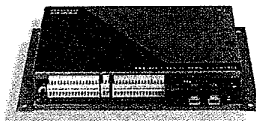

Henry Engineering
USDA

USDA stands for "Utility Summing and Distribution Amplifier". USDA is a unique 2 X 4 mini-DA that can split or combine (sum) audio signals. There are 2 balanced inputs (1 stereo pair) and 4 balanced outputs (2 stereo pairs). Either (or both) output pairs can operate in stereo or mono. Get stereo and mono simultaneously from a stereo source. Gain control for each output. Up to 20dB gain, excellent specs. Operates balanced or unbalanced.

\$195.00 List Price

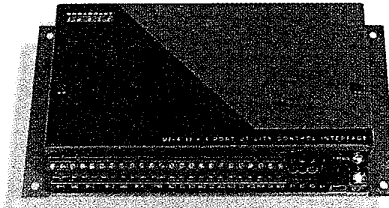

Broadcast Tools
UI-4 II Universal Interface

The UI-4 II Universal Interface facilitates interfacing transmitters, audio/video equipment or any piece of equipment with differing logic levels or functions. It is outfitted with four optically isolated/bridged 5-28 volt AC or DC inputs that operate four SPDT relays with LED indicators. Internal DIP switches allow the UI-4 II to be configured in dozens of different ways. It can operate independently and may be paired for latched or momentary outputs. It also allows inputs to be momentary or continuous. The UI-4 II is compatible with TTL/CMOS logic levels, open collectors, contact closures or any voltage between 5 and 28 VDC/VAC and may be configured to directly connect to most phone lines. The UI-4 II operates with a supply voltage of 14 to 28 VDC or 12 to 18 VAC. A 12 or 16 VAC wall transformer is provided. The UI-4 II is mounted in a compact aluminum case with mounting holes allowing convenient mounting. The optional RM-2 rack mount may be purchased for mounting two units in a 19" rack.

\$139.00 List Price



Henry Engineering
MATCHBOX II

The Matchbox II is the newest version of the industry's most popular level & impedance interface. Bi-directional, stereo, converts audio levels from -10dBv (unbalanced) to +4dBm (balanced). All levels adjustable, with special hi-gain mode for use with computer sound cards. Pro-grade gold-plated RCA connectors, 3-wire AC cord with isolated ground. Superb specs. Also available: Twinmatch, for CD players and other "play-only" devices. 4 channels of -10dBv unbalanced to +4dBm balanced audio conversion.

\$195.00 List Price

Broadcast Tools
Talking Duck

The Talking Duck, unlike any other product available, conveniently identifies any audio circuit. By simply connecting the wall transformer to the Talking Duck and pressing the RECORD button, a 16 second identifying message may be recorded. On playback, a 4 second 1 kHz tone along with the recorded message will continually run. By connecting the Talking Duck to a telco loop or ISDN equipment, the user can immediately identify a remote circuit by dialing up or selecting the circuit and listening to the message. The Talking Duck will continually feed the circuit until a 1/4" TRS plug is inserted into the front panel jack, at which point, the recording is disconnected and the source equipment is switched to the circuit.

\$139.00 List Price

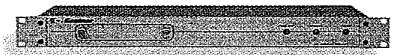
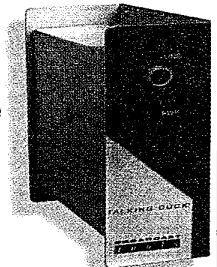

Gentner
Silence Sensor

Gentner's Silence Sensor is a useful tool for both studio and transmitter applications. In the studio, it monitors your audio source, observing both rising and falling edges of audio. If it notes a loss of audio, an output is triggered and a count-down timer is started. If audio does not return by the user-set countdown time, a relay is thrown to start backup audio sources. At the transmitter, the Silence Sensor provides "fail safe" operation to shut your transmitter down in the event that normal remote control ability is lost.

\$539.00 List Price



Henry Engineering
MixMinus Plus

This unique problem-solver adds a "Mix-Minus" output to a broadcast console, typically used to feed the "send" input on a telephone hybrid. MixMinus Plus™ subtracts caller audio from the main program mix, to eliminate feedback and echo from the on-air caller signal. Also ideal for eliminating talent-echo on return cue feeds to remote broadcast sites.

\$195.00 List Price

Studio Accessories



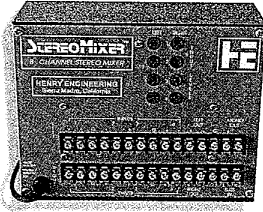

Henry Engineering Stereo Mixer

Stereo Mixer is a handy 8-input, 3-output stereo line mixer for utility "set-and-forget" applications. There are 8 balanced inputs (4 stereo pairs) and stereo and mono balanced line level outputs. Stereo Mixer is ideal as an input expander or line source submixer. It can also be used as an add-on effects bus or as a submixer for cue or IFB applications. Also available: MicroMixer, a smaller 4-input, 2-output stereo line mixer. **\$250.00 List Price**



Henry Engineering DigiStor

DigiStor™ is an auto-answering telephone message system, ideal for radio station "information lines", e.g., ski report, concert information, school closings, etc. DigiStor stores up to 8 1/2 minutes of audio in digital memory. It auto-answers the phone line and plays the message to the caller, either once or continuously. Messages always play from the beginning, with no re-cue time. DigiStor can also be used for message-on-hold in auto-repeat mode. All functions remotely-controllable. Four versions available, with various audio quality and storage time capacities. For applications requiring multiple messages, see Audio Online. **Starting at \$395.00 List Price**

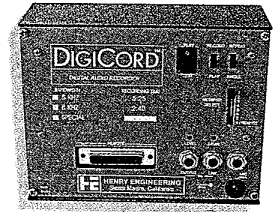

Henry Engineering DigiCord II

DigiCord™II is a general-purpose digital audio recorder for non-critical broadcast and audio applications. It records up to 5:30 minutes of audio with 5kHz bandwidth (or 2:40 with 8kHz bandwidth). Up to 16 different messages can be recorded, with instant playback in any order. Messages can play once, then stop, or play continuously in auto-repeat mode. DigiCord is ideal for applications such as news-delay recorder, translator ID with spot insert, and as a general-purpose message repeater. Mic and balanced line inputs and outputs. All functions are remotely controllable. **\$695.00 List Price**

Studio Accessories



Henry Engineering Superelay Control Interface

Superelay™ is a multi-purpose control interface for use in broadcast station control rooms, A/V systems, or any installation requiring multiple circuit control. Superelay is ideal for controlling the various equipment functions that need to be switched when, for example, a control room mic is turned ON, e.g., EAS receiver mute, intercom speaker defeat, telephone bell disconnect, skimmer recorder start, "ON THE AIR" warning lights on, etc. Superelay can be controlled by virtually any console's muting output, or by any external switch, either momentary or maintained. It provides two types of outputs: relay and switched AC. **\$250.00 List Price**

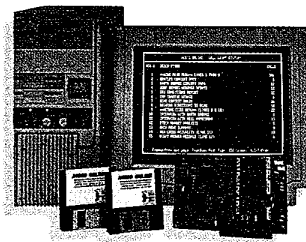

Henry Engineering AUDIO ONLINE

Audio Online is a caller-interactive telephone information system that is ideal for broadcast stations, PR firms, schools, political offices, and institutional users who need to make high quality audio presentations (interviews, news reports, public safety updates, soundbites) available via telephone line. Audio Online is a special modem card and software that is used with a simple DOS computer (386 or higher). Up to 999 separate messages can be Touch-Tone™ selected by the caller. A typical 80MB hard drive will store over one hour of recording time. Audio Online supports from 2 to 16 incoming phone lines. **Starting at \$1,000.00 List Price**

Sine Systems Message-Board Controller:

The MBC-1, combined with a locally-purchased off-the-shelf electronic message-board, results in a versatile and attractive studio display system. One MBC-1 can drive several message-boards and is easy to install. The MBC-1 monitors up to 15 control-room devices and can display a unique, prioritized message for each one. It's a great way to improve the appearance and efficiency of your broadcast and production studios. **\$299.00 List Price**

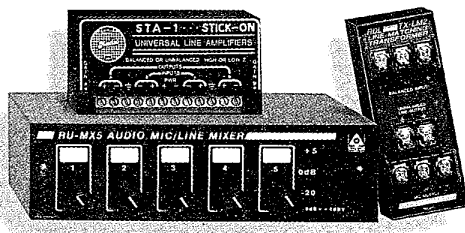
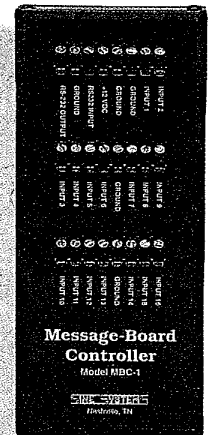

Radio Design Labs

Radio Design Labs is the manufacturer of a full line of versatile and competitively priced products marketed under the trade names Stick-On™, Rack-Up™ and TX Series™. Products include audio line amplifiers, microphone preamplifiers, mixers, distribution amplifiers, power amplifiers, metering, audio control and audio switching, oscillators, attenuators, video products, interconnect products, transformer interface products and accessories. All products meet the demanding specifications required for broadcast and carry a full three year warranty. Detailed brochure available.





AUDIBLE RESULTS.

**NEW BELDEN® DIGITAL AUDIO CABLES...
110 OHM IMPEDANCE DESIGN
PROVIDES ERROR-FREE TRANSMISSION
OVER EXTENDED DISTANCES.**

Suppose you need a digital audio cable that meets the latest AES/EBU standard? Simple! It has to be high flex? Or NEC* rated? You got it! A patch cable? Or snake? No problem when you specify Brilliance® from Belden.

Belden has developed three new Brilliance cable lines to meet the digital audio needs of your television, radio, post-production

or recording studio. And each offers tight impedance tolerance and low capacitance unbalance to minimize signal reflections and jitter.

- High Flex Cable (Belden No. 1696A)
- Cables available in 1 pair CM rated (Belden No. 1800A), 1 pair CMP rated (No. 1801A), and 2 pair Zip-style CM rated (No. 1802A)
- NEC Rated Snake Cables in 4 pair (Belden No. 1803A), 8 pair (No. 1805A), and 12 pair (No. 1806A)



For more information, contact
the Harris Broadcast Sales Center at **1-800-622-0022**.



© Copyright 1994, Belden Inc.

* Tradename of the National Fire Protection Association, Quincy, MA

Studio Accessories

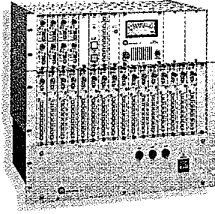

**Auditrone
1900 Series Mix-Minus/
IFB Rack System**

A unique modular rack-mounted mix-minus/IFB audio system with unlimited input, output and IFB configurations. It is especially suited for remote talent mix-minus foldback and video conferencing. This system can expand your

current console's output assignment capability while providing extensive IFB for the operator and producers alike. Features include balanced line-level inputs that handle mono or stereo signals, on/off logic control, cue and level trim. With the optional test oscillator/voice slate module, talkback return module, and built-in cue speaker, meter, and headphone output, setup and monitoring is a breeze for the system's operator. The 1900 is the great problem solver.

1900MCM \$1,735.00 List Price
1900IR \$1,000.00 List Price

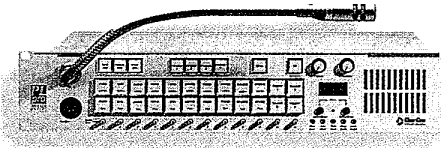

**Clear-Com
MS-812A Multi-Channel Intercom Station**

The MS-812A is a multi-channel micro-processor controlled intercom station that provides a variety of programmable features and functions. It provides 12 channels of standard Clear-Com Party-Line™ intercom.

The multi-channel capability and extensive programmable features make the MS-812A an ideal intercom control center for many types of television, performing arts, and industrial/aerospace applications. It is exceptionally flexible, easy to operate and program. It features separate listen and talk buttons, individual channel listen level controls, programmable relays, internal and external program interrupt.

\$3,160.00 List Price

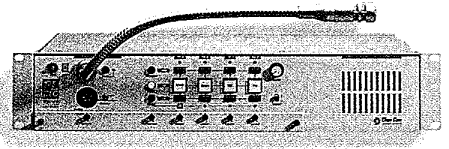

**Telex
RTSTM Model KP-12**

The RTS™ Model KP-12 is compatible with all RTS Digital

Matrix Systems. The keypanel fits in a single rack space and has twelve intercom keys with four-character alpha-numeric displays. Its compact size makes it ideal for use in broadcast vans or any location where equipment space is at a premium.

\$1,795.00 List Price

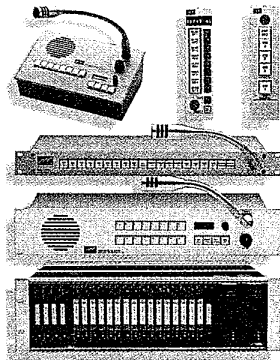

**Sierra Automated Systems (SAS)
SAS Intercom/IFB Systems**

The SAS Intercom/IFB Systems define advanced level professional communication systems for radio, built around the SAS 32000 Switching and Mixing Matrix. Excellent audio specifications and multi-microprocessor architecture combine to shape a robust yet economical high performance programmable intercommunication system which services 32 user stations within a 3 RU frame. Software programmable features include full eight character alphanumeric subscriber designation, separate talk and listen capability, interruptible foldback (IFB) and programmable groups. Fully featured control panels also include an auto answer pushbutton, dim/mute functions, relay outputs and opto inputs, communications mic/preamp, loudspeaker and amplifier.

**Clear-Com
RS-501 Beltpack**

The Clear-Com Series 500 intercom stations incorporate the most advanced beltpack design available. They are incredibly rugged (will survive a drop of 60 feet) with excellent audio quality. Designed for maximum speech intelligibility in high-noise environments these beltpacks are ideal for live performance, television industrial, aerospace, school and rental applications.

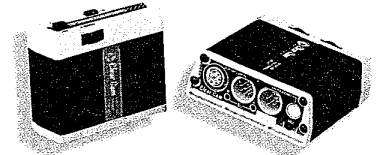

Visual "call" signaling is used to attract the attention of operators who have removed their headsets. All beltpacks include visual call signaling with very high-intensity, multi-segment LEDs as standard features.

\$215.00 List Price

**Clear-Com
MS-440 Party Line Intercom System**

The 440 series is Clear-Com's most advanced Party Line intercom system. Each station is a four channel intercom with superior audio and versatile channel-access to provide unmatched communication flexibility. All front panel controls are intuitive and easy to operate. The station's front panel buttons are programmable and can be customized for a wide variety of applications that will meet the demands of any stage, studio or field producer. Separate volume controls for every channel insure the perfect audio mix in the headset or on the built-in speakers.

Other features include separate audio sources for all intercom channels and three built-in IFB program interrupts for talent cueing.

\$1,299.00 List Price

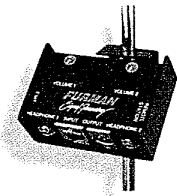

**Furman Sound
HR-2A**

The compact HR-2A headphone remote station is a passive headphone box that provides two headphone jacks, each with its own volume control. The HR-2 clamps to any microphone stand using included hardware. Any number of HR-2s may be connected to a Furman HA-6A or SP-20A Headphone Amplifier by daisy-chaining with standard mic cables, or, with the use of an adapter, to any power amp.

\$79.00 List Price



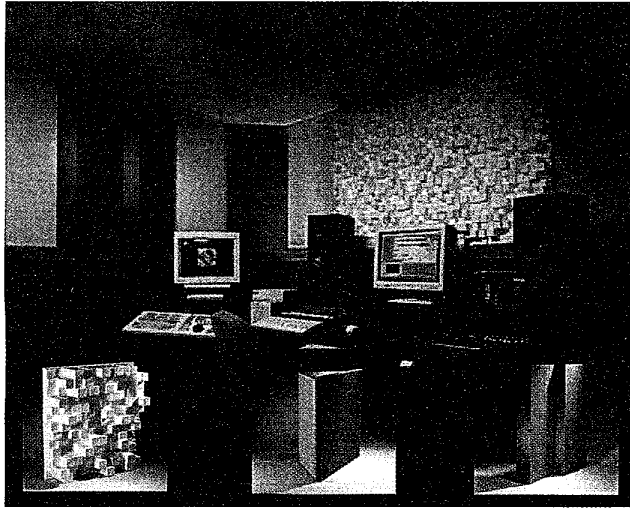

**RPG Acoustic Tools
Audio Treatment & Conditioning**

Electronic advances in broadcast technology continue to provide significant improvements in signal quality. Unfortunately, poor room acoustics often prohibit broadcast engineers from hearing these sonic advances. The reason is that the room's low frequency modal response, speaker/boundary interference and room reflections distort the true sound. To solve these acoustical problems, RPG developed three new acoustic tools for broadcast studios. The Skyline™ provides optimum sound diffusor, the Abflector provides broad bandwidth sound absorber and the BASS Trap™ controls modal emphasis. These acoustic tools are integrated into easy to use packages to simplify application. Prices Vary

Studio Accessories

**Auralex Acoustics
Studiofoam**

Studiofoam is our premium wedge-cut acoustic foam panel solution and is available in 1", 2", 3" & 4" thicknesses. All Studiofoam panels are 2' x 4' and ship in box quantities. Standard colors include charcoal gray, blue, brown and tan; other custom colors are also available. Studiofoam offers 15 to 60% more sound absorption and greater longevity than other brands at half the price!

- 1"x2x4 Ultrax \$220.61
- 2"x2x4 Ultrax \$173.61
- 3"x2x4 Ultrax \$160.00
- 4"x2x4 Ultrax \$164.34

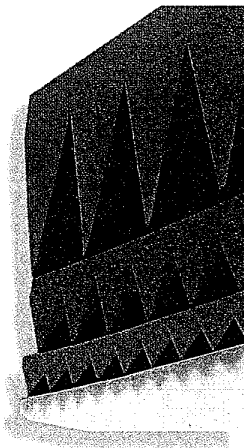

**Auralex Acoustics
LENRD Bass Traps**

Our proprietary Low End Node Reduction Device (LENRD) is acoustically engineered to absorb low-frequency sound waves in studios, control rooms and broadcast booths. LENRD provides excellent low-end absorption (NRC + 1.24@125Hz) and fits into 90 degree corner-wall or wall-ceiling junctions. LENRD is available in all Studiofoam colors and provides a complete room solution when used with Studiofoam. It is sold in box quantities of (9) 2' sections and offers an outstanding, cost-effective solution for bass trapping. Check out LENRD today! Truly no other product compares. Two pieces per box cover 16 sq. ft.

\$150.00 List Price

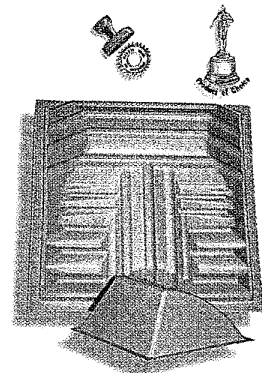
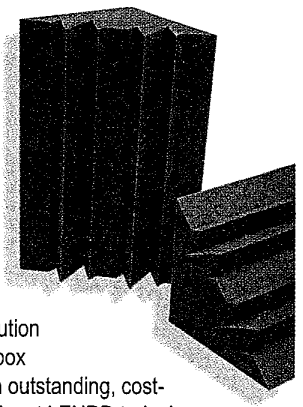

**Auralex Acoustics
T-Fusors and MiniFusors**

Auralex offers two outstanding diffusor alternatives. The T-Fusor™ is a 2' x 2' diffusor offering superior performance over much higher-priced alternatives. It is designed for wall or ceiling placement and will also drop into a ceiling grid system. The MiniFusor™ is a 1' x 1' diffusor offered for those who have limited or unique space requirements. Both products are made of

a high-impact thermoplastic resin. They are white in color and can easily be painted to match any decor. Both offer terrific performance at a small fraction of the cost of other alternatives.

- 1x1" MiniFusor \$103.00
- 2x2" T-Fusor \$160.00

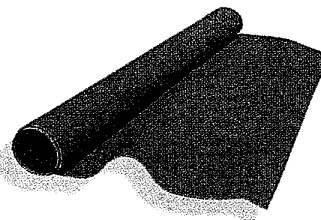

**Auralex Acoustics
SheetBlok and
U-Boats**

If you're looking for sound isolation, SheetBlok™ is an excellent barrier product for placement in or on walls, ceilings and floors. SheetBlok yields an STC of 27 (stops 27dB) and is available in both 4' x 10' and 4' x 30' sizes. U-Boat™ floating floor channels are designed to de-couple floors/risers, etc. from the existing structure. They provide a very cost-effective way to float floors in studios and broadcast facilities. Both products are great solutions if minimizing sound transmission is your objective.

- 10x4 SheetBlok \$145.00
- 20x4 SheetBlok \$399.28

**CERTAIN PRODUCTS NOT
AVAILABLE IN ALL AREAS**



ORDERING AND TECHNICAL SUPPORT: 151
1-800-622-0022

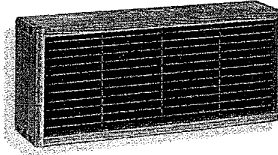
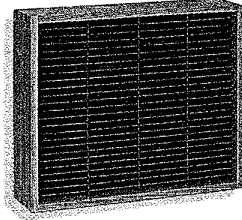
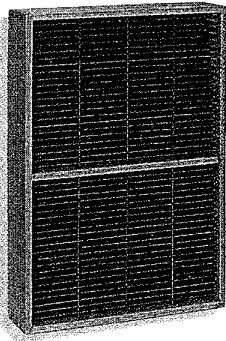

**A-LINE
CD Storage Racks**

Natural wood CD storage in three sizes, one or more to fit your storage needs. Solid oak construction with tempered masonite slots and dove-tailed, boxed ends. Available in storage capacities of 48, 100, 180, and 244. Jewel box or caddy.

**Bevco
4200CC Low Pneumatic Chair**

Our Studio chair has been seating talent and saving management money for years. Here's the latest model. The Model 4200 height adjusts between 19 & 24" with an integrated pneumatic adjustment. The wide contoured seat and back are great for any length airshift. All this combined with bullet-proof construction present the "comfort level" for ultimate seating.

\$191.00 List Price

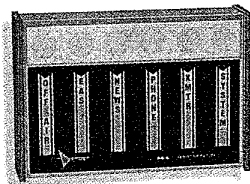
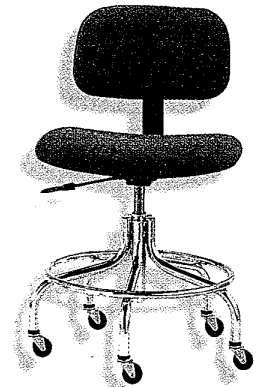

**Enberg Electronics
BA-6 and BA-6RX Alert Monitors**

Enberg alert monitors can provide your control room with a practical, versatile and attractive system for keeping informed of important status conditions. Three modes of operation on each channel: telephone-latching, auto reset and manual reset. Other features include opto isolated inputs, solid state relays and flashing 4000HR indicators. A DC output for each channel is provided capable of driving remote monitors and piezo buzzers, etc. Thirty standard labels included, custom labels are available.

BA-6 \$389.00 List Price

BA-6RX \$389.00 List Price

**CircuitWerkes
TeleRadio Remote Controlled Listen Line**

With the TeleRadio at your stations, you can listen to every radio station in each of your markets, in real-time, without ever leaving your office. The TeleRadio is a DTMF controlled tuner combined with a telephone coupler. When it answers, the internal radio begins playing down the phone line to you. You control the radio with your phone. An external audio port lets it double as a standard IFB telephone coupler too. Remote, real-time, listening makes it ideal for program consultants.

\$689.00 List Price

**Harris
Equipment Shoulder Bag**

Kaces bags feature sturdy web handles, heavy duty metal zippers, burgundy trim zippers, tear resistant nylon, ultra thick padding and an accessories compartment. For a small investment you get a lot of protection for your gear.



**Harris
The Rack Bag**

Bag it! Until you've used a rack bag, you won't know how much easier a remote can be and how much more protection your gear will enjoy. Order from 1 RU to 6RU and in-between sizes, too.

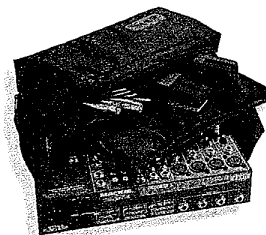

Audio, Video & Broadcast Cables

Cable products designed, developed, and proven for professional use.

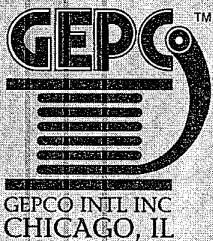
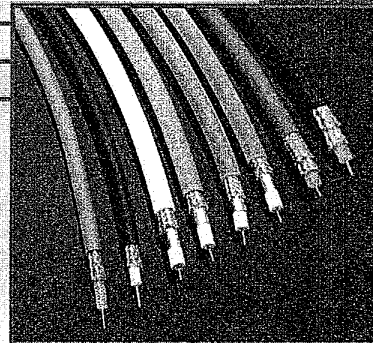
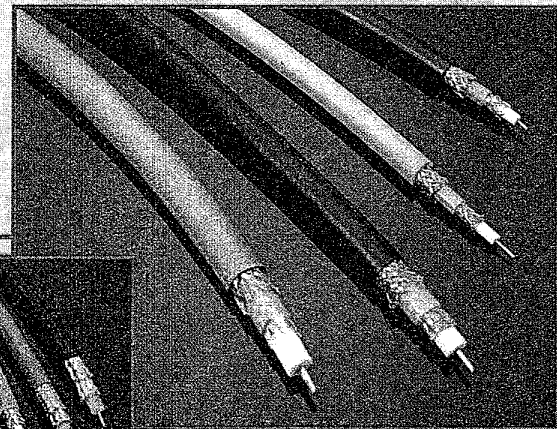
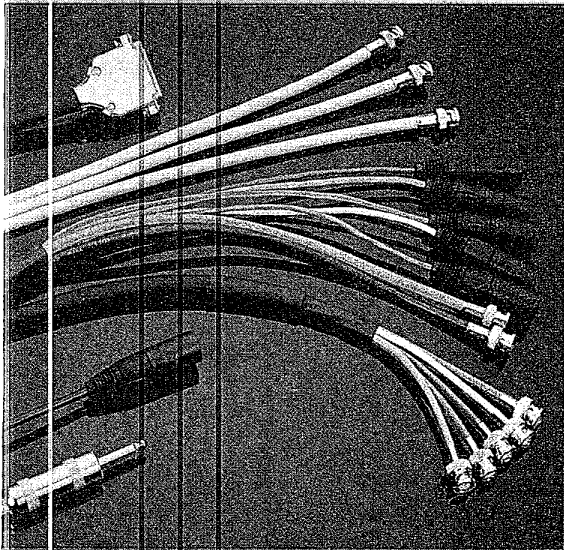
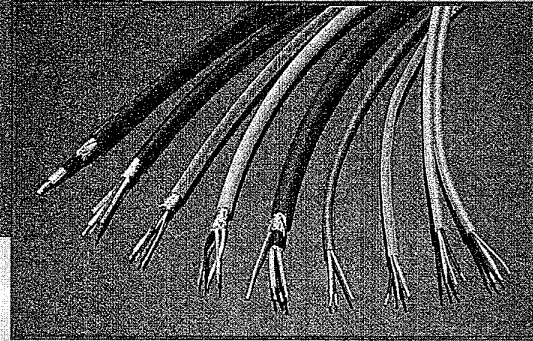
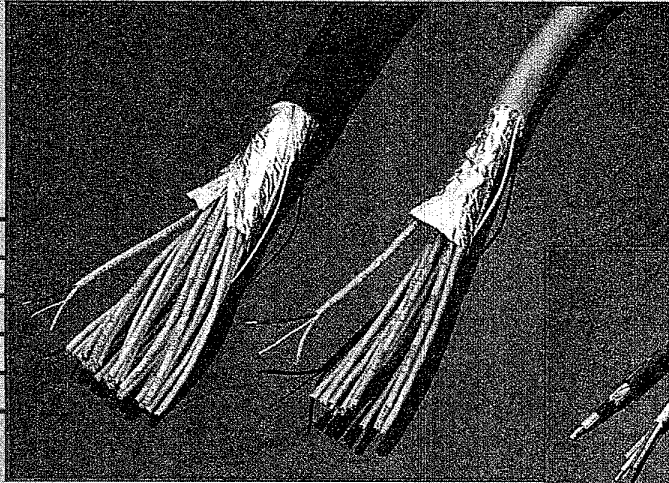

GEPCO INTERNATIONAL

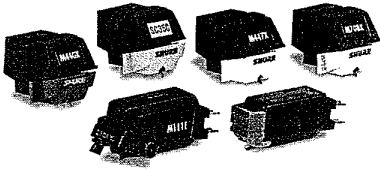

**Shure
SC35C Professional Cartridge**

The SC35C is designed for use on the heaviest and most rugged tonearms which require a tracking force of 4 to 5 grams. The stylus assembly of the SC35C is rigid enough to withstand the punishment of continuous backcueing, yet compliant enough to offer excellent mid and high frequency reproduction. The SS35C is the spherical replacement stylus for this cartridge.

\$55.95 List Price

**Stanton
Trackmaster-AL/-EL**

This cartridge is an integrated headshell design that eliminates the problems of alignment and wiring. It combines high precision tracking, back cueing performance and durability for superior performance in studio or mobile application. They are also available packaged with one or two extra styli.

\$128.00 List Price

**Stanton
890AL**

This state-of-the-art unit provides the best sound quality ever offered for DJ use, yet is specifically designed for backcueing, scratch mixing and slip cueing. It is designed with a special compliance that allows the stylus to stay firmly in the groove under all conditions. This highly engineered cantilever and suspension system is combined with an ultra high polished diamond which allows the system to have a vertical tracking force of 2-7 grams. The 890AL comes with an extra stylus.

\$101.40 List Price

**Stanton
680EL**

This is the world's most popular stereo cartridge for the professional. The 680EL provides the best balance between a responsive musical cartridge and rugged construction that can stand up to the demands of the professional.

The cantilever on the 680EL is designed for optimum strength and minimum mass. The 680EL diamond is designed to stay in the groove under even the most demanding situations. The 680EL comes with an extra stylus.

\$77.50 List Price

**Stanton
500AL**

The "workhorse" of the professional industry. This cartridge provides the perfect blend of economy, reliability, ruggedness and optimum performance. The 500AL is ideal for the DJ who is very demanding on his equipment. The diamond on the 500AL is designed to fit firmly in the record groove, minimizing miscueing while backcueing, scratch mixing and even mishandling. Its thick wall, large diameter cantilever has a sturdy suspension that permits high tracking forces. Its sturdy grounded cartridge body is designed to minimize hum and deliver good sound quality.

\$25.00 List Price

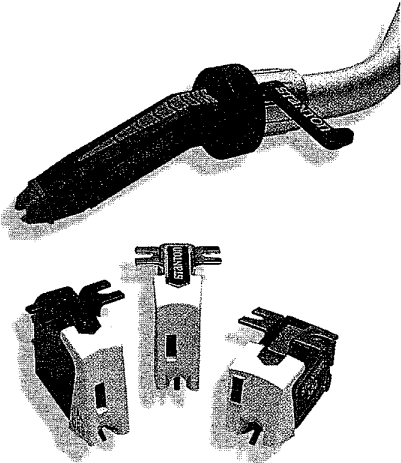

Studio Accessories

**Technics
SL-1200MKII Direct
Drive Turntable**

Precision molded aluminum diecast cabinet and heavy rubber base material absorb unwanted vibrations. Unwavering quartz DD accuracy: wow & flutter 0.01% WRMS, rumble -78dB (DIN B). Very high torque for quick start-ups. Heliocoid tonearm height adjustment. Total quartz locked continuous pitch adjustment up to ± 8%. Highly sensitive low mass tonearm with gimbal suspension.

\$600.00 List Price



**Vestax
PDT-5000 Turntable
"HIGH TORQUE"**

- direct drive quartz lock
- start up time: 0.5 sec.
- pitch ± 10%
- wow & flutter: 0.03% W.R.M.S.
- analog pitch meter with indicator
- detachable mini light
- remote: momentary start

\$680.00 List Price

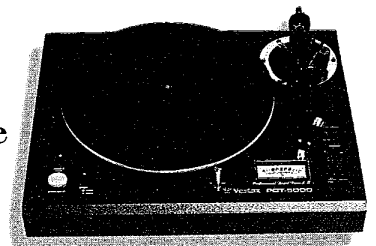

**Sage
ENDEC**

The Sage ENDEC provides user friendly programming and operation through a computer interface with easy to use software, or use the built in programming controls. If you choose to use the computer interface, once the unit is programmed the computer is no longer needed. The Sage ENDEC also features six user controllable RS-232 ports for connections to remote controls, character generators, computers and LED signboards. It also features three user configurable relays that can activate buzzers, strobes, automation systems or a telephone dialer.

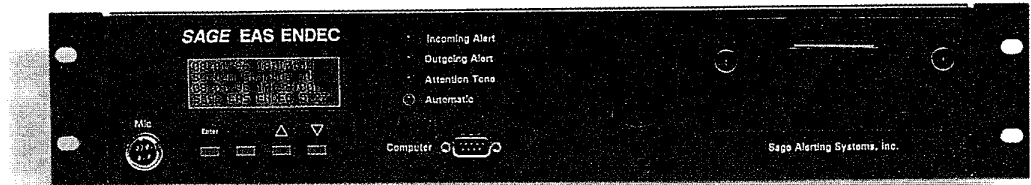

Sage Alerting Systems specializes in developing, manufacturing and installing alerting and warning systems like the ENDEC. Sage has over 30 years of experience in this area and Sage is the only company to have already deployed emergency warning system on a statewide basis in New Jersey. They are also working on systems in Texas and the San Francisco Bay area. No other company has the depth of experience in the field as Sage Alerting Systems.

Sage ENDEC Features

- * Event codes and expanded text messages are displayed on front panel display, hand held remote controller, or on a connected PC.
- * Unauthorized access is prevented by password codes.
- * Microphone and line inputs provide sources for audio messages.
- * Three programmable relays provide control and switching.
- * Two minutes of high quality (5kHz) audio are stored digitally.
- * Operated over a wide range of temperatures, humidity and power line voltages.
- * Operates in high RF fields found at AM, FM, or TV facilities.
- * Can monitor numerous sources including National Weather Service, RBDS, satellite, public switch telephone network, and other sources of EAS messages.
- * Decoder automatically resets if end of message code is not received.
- * Operate in Manual mode (requires operator action to initiate a program interrupt), semiautomatic mode (manual operation with automatic interrupt after time-out), or automatic mode (immediate program interrupt) with front panel LED indicating status.
- * Continuously monitors six audio sources for EAS messages.
- * Automatic delay of received audio by a few seconds to avoid loss of audio inherent in EAS daisy chain design.
- * XLR connectors for main program audio pass-through and interrupt.
- * Internal speaker routed through a back panel jumper so speaker can be muted by the station's audio console.

Data Protocols:

AFSK 520.83 bits per second.

- Mark-2083.3 Hz
- Space-1562.5 Hz
- 7-bit ASCII code.

Attention Tone 853 Hz and 956 Hz ±.5 Hz.

Compatible with NWS WRSAME coding.

Fully supports RBDS EWS system as defined in 1993 US RBDS Standard.

6 Configurable RS-232 ports-1200/9600 baud.

Configurable character generated interface.

Pricing upon request

Options available:

RC-1 Remote Control

MSRP Multi-Station Relay Panel

VCG Video Character Generator

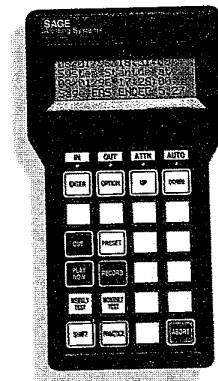

RC-1 Remote Control

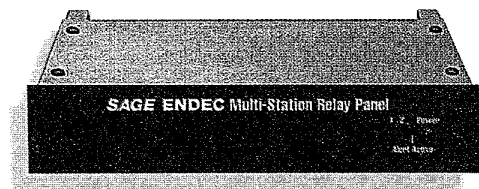

MSRP Multi-Station Relay Panel



VCG Video Character Generator

Studio Accessories

CERTAIN PRODUCTS NOT AVAILABLE IN ALL AREAS



**ORDERING AND TECHNICAL SUPPORT: 155
1-800-622-0022**

Studio Accessories

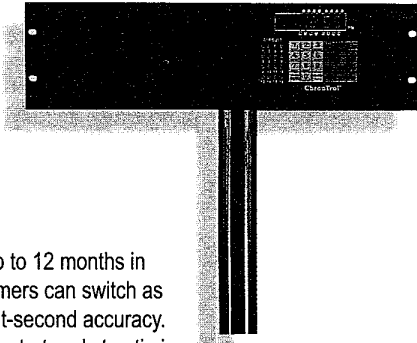

**ChronTrol
XT-R2F**

Automate station events up to 12 months in advance. Rack-mounted timers can switch as many as 16 relays with split-second accuracy. Pushbutton control lets you start and stop timing sequences of any duration, from one second to one year. Stores up to 40 programs with daily, weekly, or monthly schedules. Password-protected against unauthorized changes. Battery backup protects against power failure and memory loss. Change power, patterns, etc.
\$580.00 List Price



**Autogram
Autoclock**

Put complete time and temperature information is at your fingertips with the Autogram Autoclock. Get time and date, count up or count down timings, current outside temperature, and the high and low for the day and the times they occurred. The panel mount version mounts in any Autogram console except the Mini-Mix and the compact stand-alone version will go just about anywhere. The Autoclock interfaces with most consoles, and multiple Autoclocks can be synched together.
\$375.00 List Price

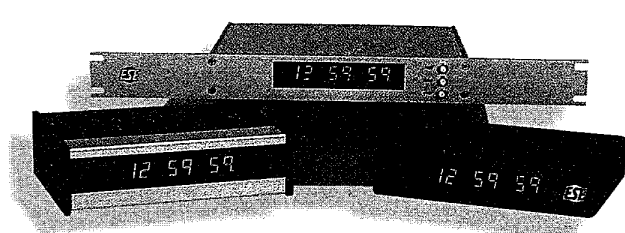

**ESE
ES-192A**

ES-192A (12 Hr) /ES-194A (24 Hr) are six-digit Master Clocks with .56" yellow LED displays, and has an ESE Time Code output capable of driving 100 digital or self-setting analog slaves. The LX-192A and the LX-194A are mounted in the "LX" series enclosure. The aluminum enclosure is black texture painted and certain to fit perfectly into any environment where form as well as function is a concern. Both "LX" and "ES" models reference the AC line frequency (50/60 Hz). Optional rackmount and battery back-up are available.
Prices vary

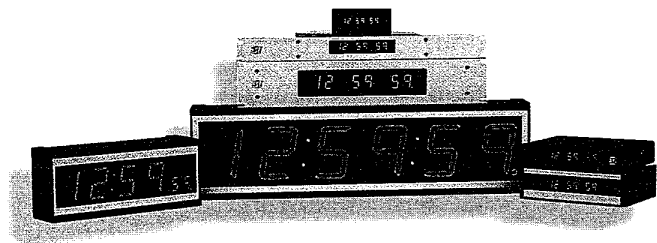

**ESE
Digital Slave Displays**

ESE offers a wide variety of "Slave Displays". Display sizes range from .4" to 4.0" high and the enclosures available include, "LX", desk top, console mount, wall mount and rack mount. Also, available as an option, is the time zone offset which allows a slave display to be set to any time zone. These units are designed to decode and display ESE serial time code from any of our ESE master clocks, and all of our master clocks are capable of driving up to 100 slaves at up to 4000 feet.
Prices vary

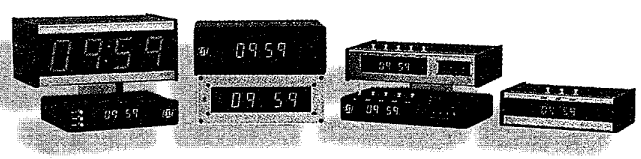

**ESE
Timer Family**

ESE's family of Digital Clocks & Timers offer a diverse selection of "Up" Timers, "Up/Down" Timers, "Real Time" Clocks and "Clock/Timers" to meet most any timing requirement. Units are available in several different style enclosures with displays ranging from .4" to 4". Also, many units can be used as a "Master" Timer or "Master" Clock and are capable of driving "Slave" displays or being interfaced with a computer or video system.
Prices vary

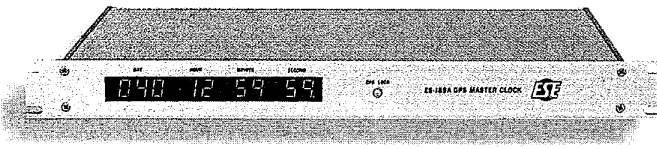

**ESE
ES-185A**

ES-185A GPS (Global Positioning Satellite System) Master Clock and Time Code Generator provides extremely accurate time and date information anywhere in the world. The ES-185A features a 1PPS accuracy better than 130 nS and four serial time code outputs (SMPTE/EBU, ASCII, ESE & IRIG-B). Time and date information is received via the internal eight channel GPS receiver and displayed on the nine .56" yellow LED's. An indoor/outdoor antenna and 4 hour battery back-up are included.
\$2,494.00 List Price



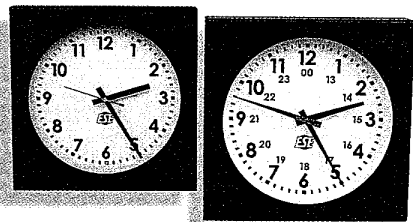

**ESE
LX-5112**

This 12" analog clock is designed to operate as a time code reader, a stand-alone clock or an impulse clock. The LX-5112 is capable of automatically setting itself to the correct time as received via any one of three different time code inputs (SMPTE/EBU, ASCII or ESE). Alternate modes of operation on the LX-5112 allow the clock to synchronize with an alternating 12 or 24 volt impulse signal, or to act as a stand-alone clock. Sweep or step silent modes and time zone offset are user-set via rear-mounted DIP switches. Options for a lighted dial (with brightness control) and rack mounting are also available. Also available LX-5105 (5") & LX-5116 (16").

\$575.00 List Price

**ESE
ES-244**

ES-244 audio level interface is a stereo, bi-directional coupling unit that either meets or beats the specs of the other "audio level & impedance interface" type products. The ES-244 provides a simple/cost effective means of connecting equipment with unbalanced inputs/outputs to equipment with balanced inputs/outputs. "Consumer" CD players, etc. are now easily interfaced with "Professional" recorders and mixing consoles. Single and dual rack mount options are available.

\$185.00 List Price

Studio Accessories

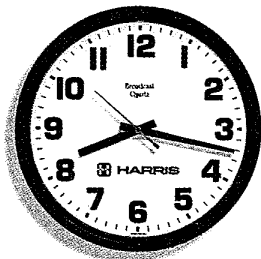

**Harris
Standard Quartz Clock**

The standard in studios and control rooms around the world is the Harris quartz line of clocks. Where accuracy and visibility are a must, the Harris line is just what the announcer or engineer ordered. 12" face size. A similar clock is available from ESE which may be impulse driven.

\$29.95 List Price

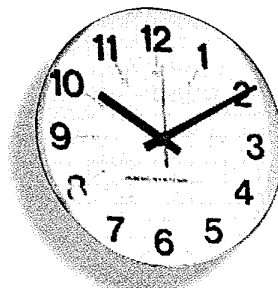
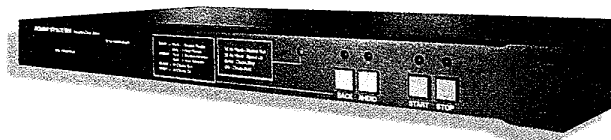
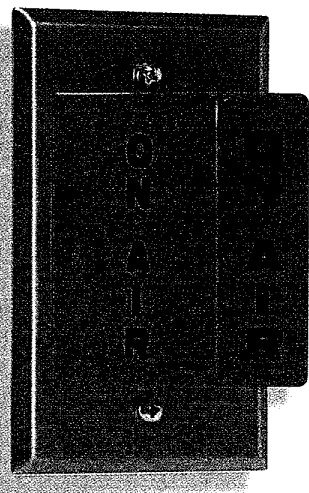

**Harris
Micro Series Warning Lights**

The Harris Micro Series warning light has one 1820/28 volt lamp, designed for use with 24 volts for extended life. All models mount on standard single gang wall boxes or plaster rings. The wedge shaped translucent cover is available in red or white. Available with on air or blank lens.

**Radio Systems
Clocks and Timers**

Talk about a clock system! Radio Systems covers the gamut with analog and digital slaves and masters that inter-connect in all conceivable configurations. Use an ultra-bright 2" high digital display to drive a 12" analog clock - or mix slaved clocks and timers on one RS-485 digital drive line. This product is the flexible, and designed with growth in mind.

AMD-1 Driver \$525.00 List Price

AC12 Clock \$65.00 List Price

**CERTAIN PRODUCTS NOT
AVAILABLE IN ALL AREAS**



**ORDERING AND TECHNICAL SUPPORT: 157
1-800-622-0022**

Studio Accessories

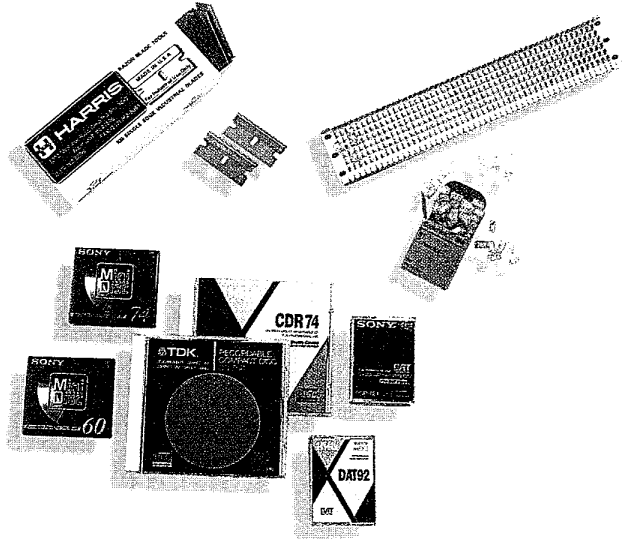

Harris

These are the little things that make your station hum. We stock your daily needs in depth so that we can respond overnight, if necessary. Bulk pricing is available in most cases. Razor blades, connectors, recording media, cotton swabs and everything else you require.

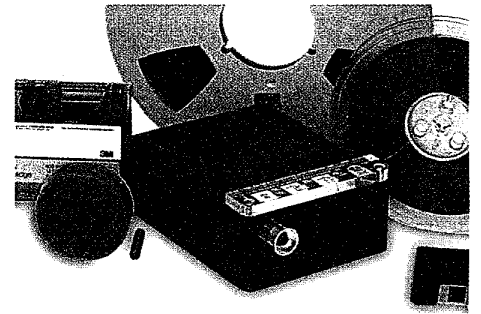

Audiolab Electronics TD-1B

No more hassles with trying to record over an existing recording. The TD-1B completely erases magnetic data by neutralizing the magnetic particles in the tape. An AC magnetic field alternates between positive and negative polarities leaving the tape magnetically neutral with no sign of any previous data. The TD-1B is designed with ease of operation in mind. The operator activates the degausser by simply pushing a single button.
\$145.00 List Price

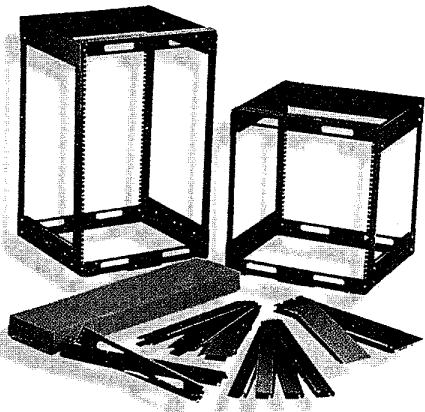

Atlas/Soundolier 900 Series Stackable Utility Frames

Atlas/Soundolier's 900 series racks are easy-to-assemble, stackable frames ideal for customer-designed rack-mount installations in theater, residential, broadcast, and retail applications.

The innovative 900 series, which is engineered for assembled strength, storage, and shipping economies, may be stacked, joined side-by-side, or used as a single unit. Models assemble easily and are available in 17-1/2" and 26-1/4" panel space heights.

Frame assemblies are shipped knocked-down and are suitable for easy storage and UPS shipment.
Prices vary

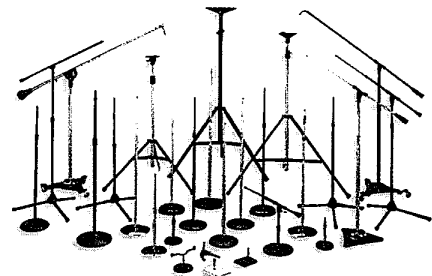

Atlas/Soundolier Atlas Sound Microphone Stands, Equipment Stands and Accessories

Atlas Sound microphone stands and accessories are the proven performance standard. They are synonymous with durability and quality, and include a wide selection of floor, desk, and studio stands, boom attachments, loudspeaker equipment stands, and over 40 adapters and fittings.

This unique selection offers the professional broadcaster, performer, or lecturer the flexibility to choose models which satisfy application, performance, and budget requirements.

Count on reliable service from these contemporary-styled models.
Prices vary

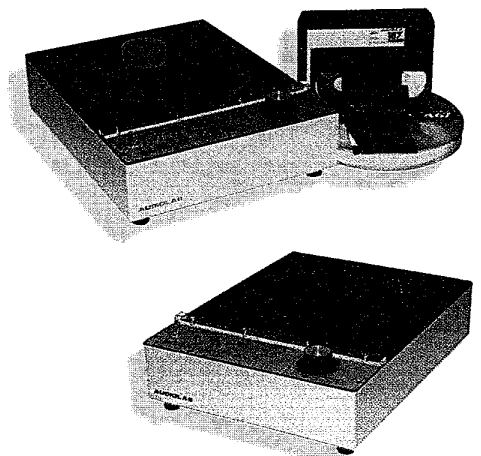

Audiolab Electronics TD-4A and TD-5

The TD-4A and the TD-5 degaussers are configured for tabletop operation. They both accommodate all sizes of media, including tape reels and pancakes up to 16 inches in diameter. Both operate continuously without overheating in the low field strength setting (good for VHS and S-VHS) and intermittently in the high field strength setting. The difference between the two degaussers is in the strength of the magnetic field. The TD-5 has a stronger magnetic field than the TD-4A and is designed for erasure of metal particle tapes with coercivities up to 1600, such as Beta SP and MII.
TD-4A \$950.00 List Price
TD-5 \$1,695.00 List Price





**Fidelipac
Model Warning Lights**

Your broadcast or recording studio will really be "off limits" when Fidelipac studio warning lights are lit. Their brilliant red lettering on jet black background can be seen even in the brightest ambient light conditions. With a faceplate of unbreakable plexiglas, the light includes lamps and mounting hardware. RECORDING message also available. Custom legend minimum 6 pieces. Size: 5"H x 10"W x 2-1/2"D. 110 VAC easily adaptable to 220 VAC. Also available with ON AIR in French, German, Greek, Polish, Russian, Spanish or Swedish Model 340-S.

Prices vary

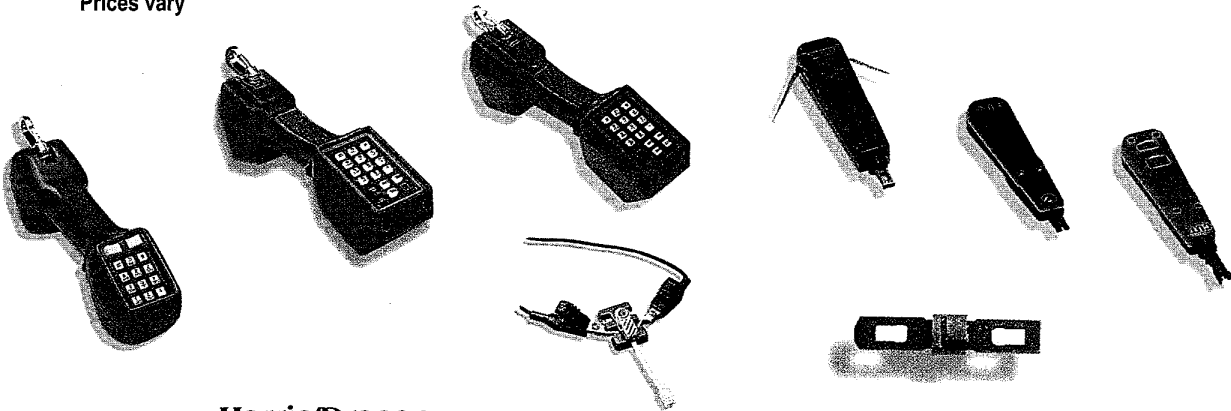

**Harris/Dracon
Studio Accessories**

Harris Dracon is the name to look for when you want the best test sets available. They're compact, light weight and tested in drops of up to 20 feet. Available with or without speaker phone. DataSafe™ units also available. Test clips and cords supplied optionally.

TS22a Test Set \$414.75 List Price

TS21 Test Set \$224.65 List Price

TS22L Test Set \$352.25 List Price

D914 Impact Tool \$56.15 List Price

D714 Impact Tool \$35.45 List Price

D814 Impact Tool \$60.00 List Price

66 Type Replacement Tip \$17.00 List Price

Modular Adapter \$11.25 List Price

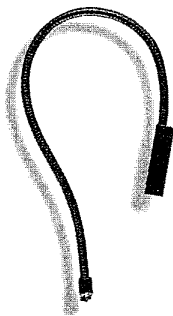

**Littlite
Single Shot**

With their sleek, unobtrusive look, Littlites™ are ideally suited to any task requiring accurate, close, detail work. Several mounting options and powering schemes are available. Choose from 6, 12 and 18 inch lengths. Littlite is the flexible gooseneck lamp with versatility and style.

List Prices start @ \$37.00 ea.

Studio Accessories

**Switchcraft
A3M & A3F
Connectors**

Switchcraft's broadcast connector is a standard. A real machine with clever, "I wish I'd thought of that" construction which makes XLRs not so bad to install, after all. All types of Switchcraft™ connectors available. Prices vary

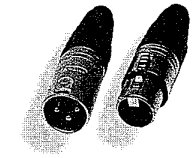
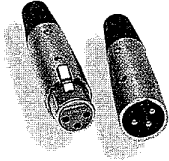

**Neutrik
NC*FX &
NC*MX
Connectors**

Neutrik's high quality cost effective cable connectors are available in 3-7 pin configurations for all audio applications. Black & nickel housings offered with silver or gold contacts (black housing only). All types of Neutrik™ connectors available. Prices vary

**Omnimount
OmniMount
Universal
Mounting
Systems**

Omnimount Universal mounting systems offer an elegant, cost-efficient and safe method of mounting equipment in almost any location. Objects to be mounted can weigh from 5 lbs. (2.3kg) to 225 lbs. (102kg). OmniMount assemblies give omnidirectional adjustability, beyond the usual pan-and-tilt functions, Omnimount™ combines omnidirectional movement of the clamp assembly with lateral and rotational movement of the tube - to get exactly the angle needed. Call today for complete specifications and details of what it's made of and how it works. A mounting hardware reference guide is available for recommended wall or ceiling assembly. Harris carries the entire line of OmniMount systems.

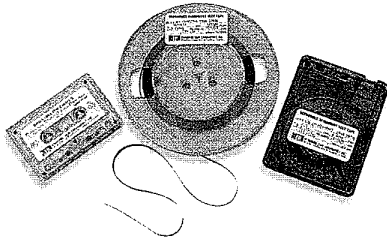
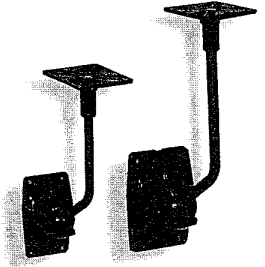

**STL Standard Tape
Laboratory, Inc.
Analog Magnetic Test
Tapes**

- Azimuth
- Level
- Frequency Alignment
- Reel to Reel
- Cartridge
- Cassette
- Stereo or Mono

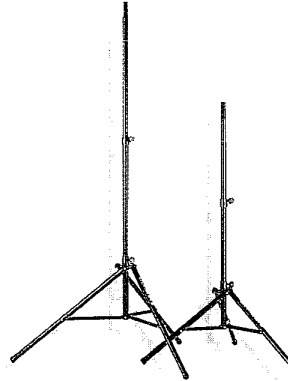

**Ultimate Support
Tripods**

Sturdy lightweight aluminum tripods for secure support of speakers and lighting equipment. Available in black or silver finish with or without tote bags. What makes Ultimate's tripods better? Strength and endurance. We select the finest materials and manufacturing processes... glass reinforced polycarbonate fittings, drawn aluminum tubing, and two-step anodizing... to give you durable and dependable lightweight tripods that will last a lifetime.

**Panduit
Type G**

Choose from 27 sizes of Panduit® Type G Wiring Duct; from 0.75" x 0.75" up to 4" x 5". Used for control panel wiring and to route and protect wiring in communication closets. The non-slip cover conceals all wiring and is easy to install. The duct and cover form a flush sidewall providing increased capacity and improved aesthetics.

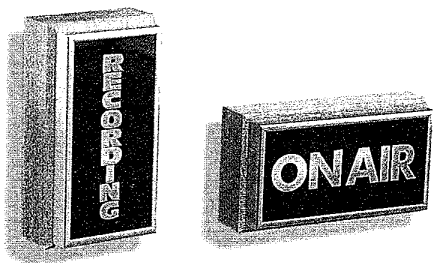
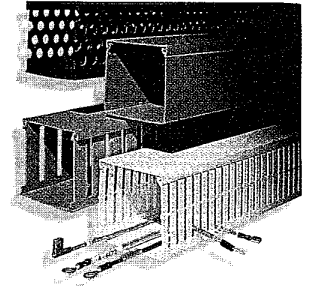

**Titus Tech Labs
On Air Light Series**

Finally an "on air" light that adds to the appearance of your studios! Titus Technological laboratories on air light series provides the broadcaster and recording studio with a beautiful but practical means of indicating that a studio is in use. The TTL on air light features a smoked plexiglass window, mounted in either a silver or gold frame which is attached to a solid oak mounting base. The warning message only appears when illuminated and is blacked out when not in use. \$125.00 List Price



**Titus Technological Labs
MLW-1**

The MLW-1 has long been the broadcast industry standard automatic stereo router capable of correcting many of the problems encountered by most broadcast facilities. Normally placed in series with the broadcast audio chain, the MLW-1 will automatically switch to an alternate channel on the loss of an input channel (channel fill) or bring up an alternate or tertiary source if the alternate source doesn't have the same problem. It will even correct for audio polarity inversion (out-of-phase) audio. \$1,800.00 List Price



**Titus Technological Labs
MLW-8**

The MLW-8 is a state-of-the-art audio router designed to "surround" a VTR. The MLW-8 contains two 4 by 4 balanced audio routers interfaced with a programmable control system. You can feed any source into the four channels of a VTR via the first 4 by 4 router, then any four channels out via the second 4 by 4 router. The MLW-8 allows you to instantly re-assign audio channels during record or playback at the push of a button. \$1,995.00 List Price



Technics

The Science of Sound



SL-1200MK2

Quartz Synthesizer Direct Drive Turntable

- Total quartz locked continuous pitch adjustment
- Aluminum diecast cabinet and special heavy rubber base material provide acoustic isolation
- High torque for fast starts
- High sensitivity, low mass, gimbal suspension tonearm
- Helicoid tonearm height adjustment

RS-TR373

Double Auto-Reverse Cassette Deck

- Advanced tape transport mechanism with 2X FF/REW speed
- Motor drive cassette well doors
- Direct operation minimizes button pressing
- Dual TL electronic counters with tape run indicators
- Dolby HX Pro & Dolby D/C NR system
- High speed editing with synchro start/stop
- 2-Color FL Peak hold meters
- Remote control capability with selected Technics receivers



RS-TR262

Double Auto-Reverse Cassette Deck

- Full two-color FL level meters
- FL Electronic Counter
- Dolby R & C noise Reduction
- Dolby HX Pro headroom extension
- CD Synchro Editing with selected Technics CD Players
- Most functions remote controllable with selected Technics receivers
- Cue & Review
- Auto record mute



TEL: 800-622-0022

FAX: 765-966-0623

<http://www.broadcast.harris.com>

 HARRIS

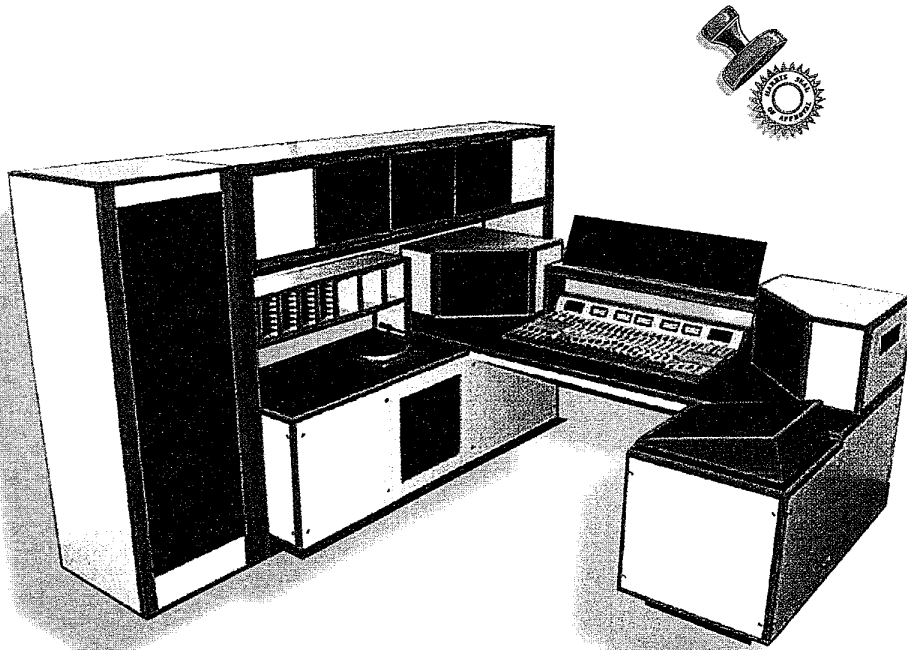

**Arrakis
Modulux Studio
Furniture**

The #1 selling furniture system in radio. It is modular, expandable, UPS shippable, and assembles in minutes. Options such as tabletop pedestals, console overbridges, storage racks, keyboard drawers, shock mounts, pedestal racks, etc. make Modulux easy to configure to meet your exact needs. Finished inside and out, and manufactured with a heavy aluminum post and panel construction, Modulux is rugged and attractive for long years of broadcast use.

Pricing Upon Request



**Arrakis
Radius Furniture**

The Radius line of studio furniture is designed specifically for very high end, major market level applications. Rounded table surfaces and end panels, extra large and deep pedestals and tabletops, combine with designer styling to create a truly unique and beautiful, yet ergonomic studio. The heavy aluminum post and panel construction assures tighter tolerances, greater strength, and metal edging around racks. Rugged, durable, easily customized. Radius is ideal for your next showcase studio.

Pricing Upon Request

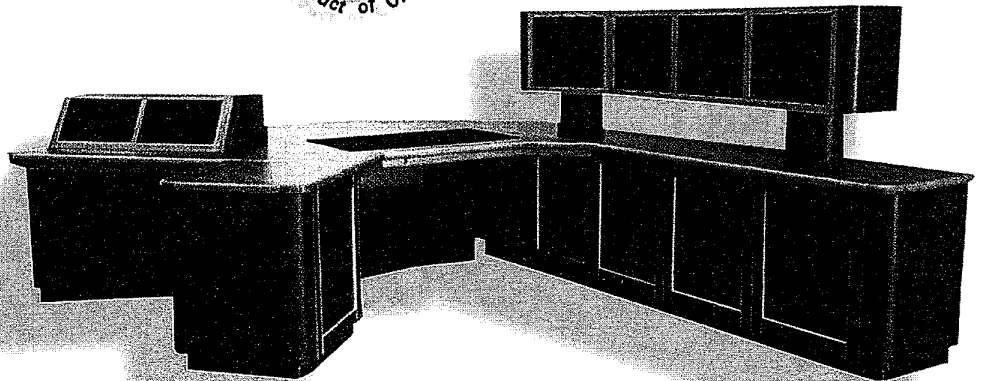

ELEGANT SIMPLICITY

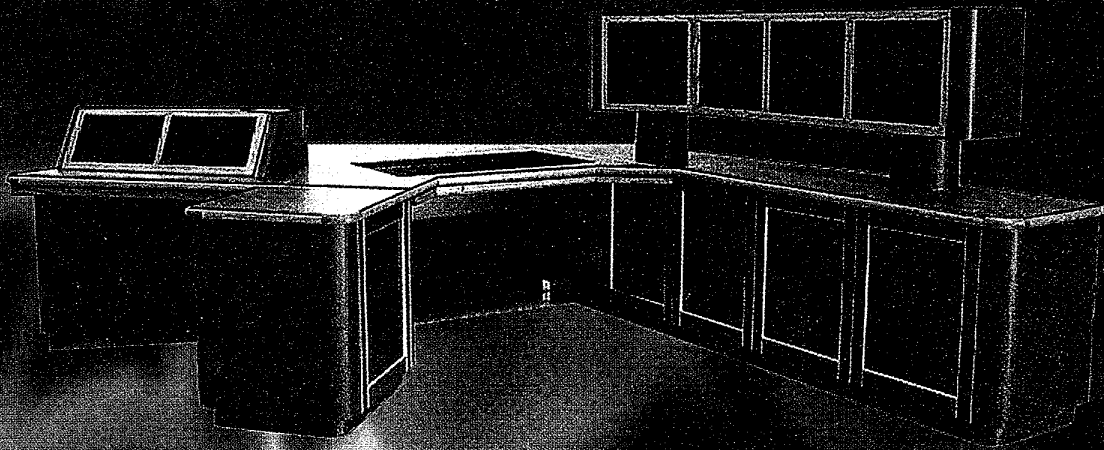

RADIUS

The new RADIUS line of studio furniture from Arrakis is designed specifically for high end, major market level applications. Sleek radiused table surfaces and end panels, extra large and deep pedestals and tabletops, combine with designer styling to create a uniquely beautiful yet ergonomic studio. The heavy aluminum post and panel construction assures much tighter tolerance manufacture than custom wood cabinets while providing greater strength and metal edging for racks to eliminate laminate splitting. Rugged, durable, easily customized, and attractive, RADIUS is ideal for your next showcase studio.

arrakis
SYSTEMS INC.

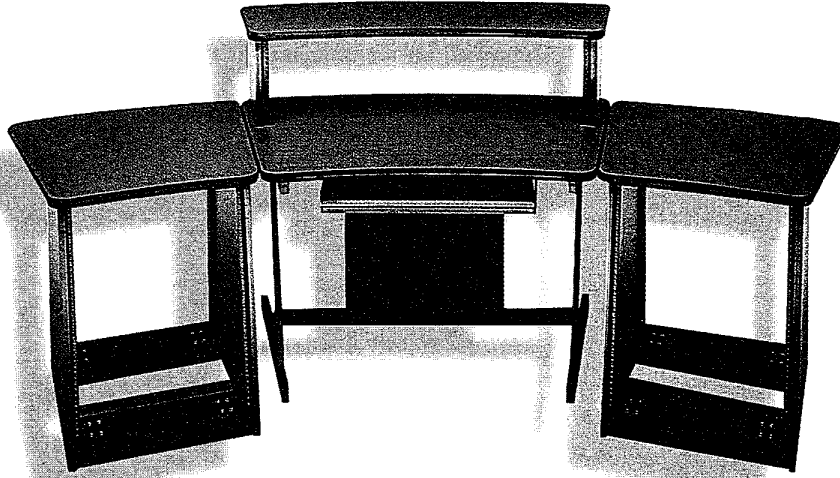

**Middle Atlantic
MultiDesk™ System**

The unique MultiDesk system is a modular approach to studio furniture, allowing for a wide variety of custom configurations depending on your application and studio environment. The MD-48 (shown with optional modesty panel), features their proprietary folding steel tube leg system, and assembles easily in about 2 minutes with the hardware and tools provided. The MD-48 top (like all MultiDesk system tops) is a grey speckled, high pressure laminate that attaches to the leg system using threaded inserts for added strength and stability. Adjustable leveling feet provide a desktop height range of 28.75" to 29.75".

Pricing Upon Request

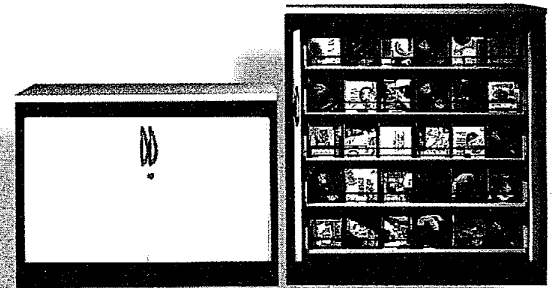
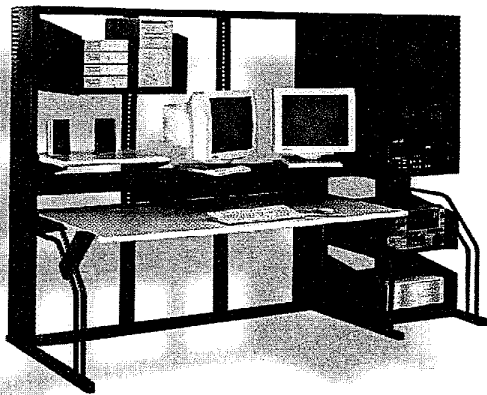

Wright Line

Your engineering department will appreciate the professional environment and comfort, and your manager will love the productivity that Wright Line Technical Furniture provides.

Your station's investment is protected because Wright Line never becomes obsolete. Just reconfigure or add to as your needs change.

Call us and we'll put a Wright Line expert on your project.

Pricing Upon Request



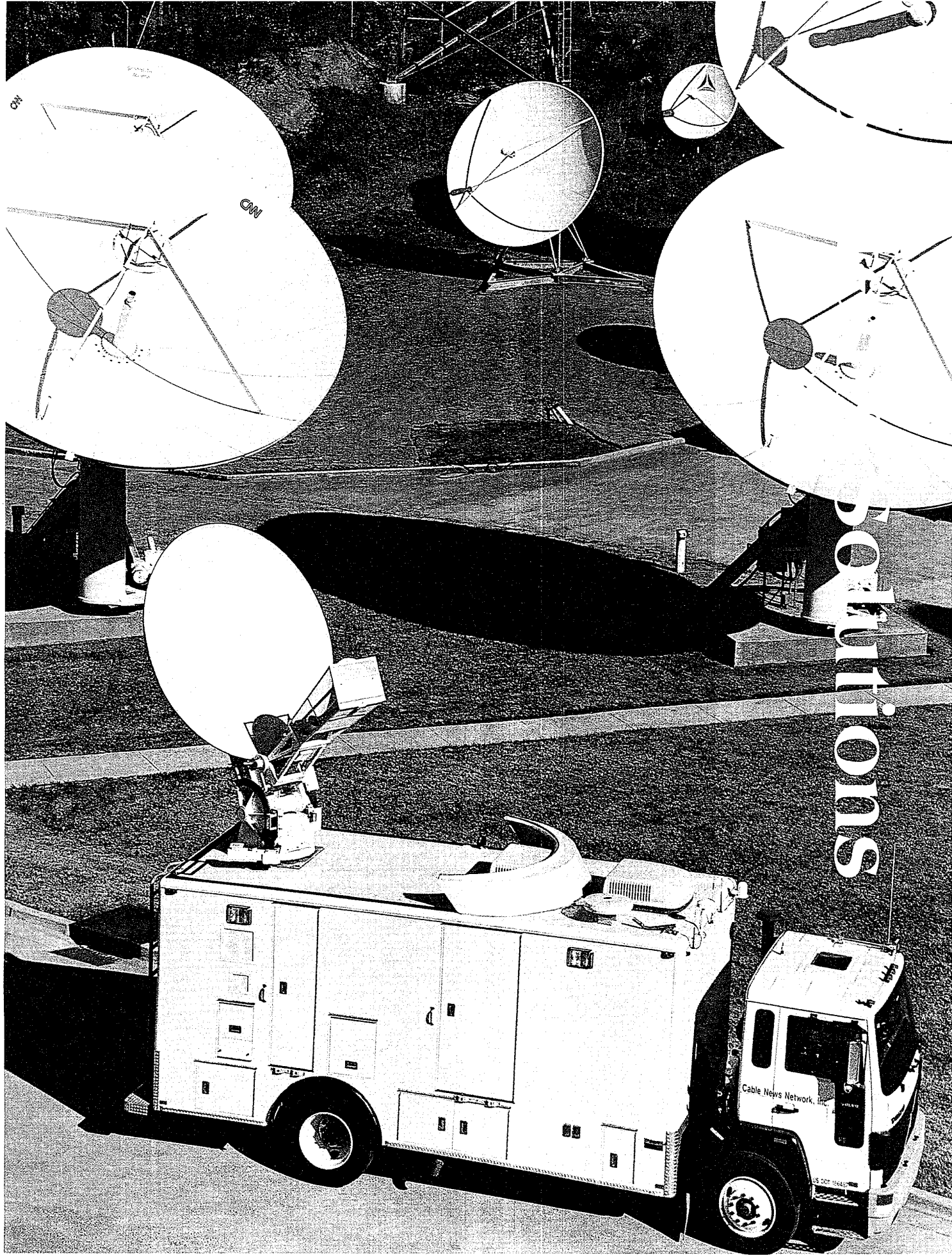

SOLUTIONS



A unique trailerized satellite uplink system, the Harris S-20T is designed to be parked for days--or even weeks--on end. The tow vehicle provides ready local ground transportation for on-site crew.



Advanced digital storage systems provide over 500 hours of on-line storage (left) and more than 50,000 hours of near-line storage.



With robotic cameras, one person at a control console can perform live production functions that used to require three or four camera operators and a lighting technician.

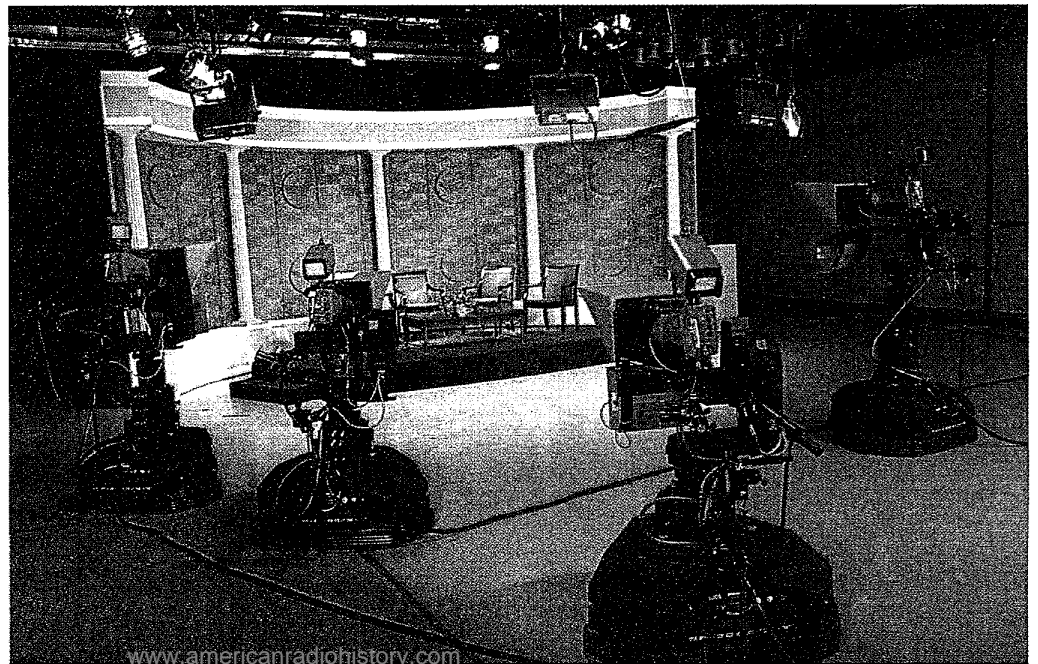

A New World of Systems Solutions

You are about to make a major investment in your radio or television broadcast, production, post-production or satellite systems. Your project may range in complexity from the upgrade of your existing studios to the creation of a massive digital multimedia center to the establishment of a complete network.

You want a partner with the proven talent, skills and experience to provide the system that meets your most exacting requirements. Harris Broadcast Division would like to be your partner.

With Harris, you will find a partner you can turn to for any level of assistance you desire, from planning, design, engineering, equipment selection and procurement, assembly, installation, testing, documentation and maintenance.

With Harris, you will find a partner with the stability of a large company and the long-term experience that comes from more than two decades in the broadcast systems business.

With Harris, you will find a partner with expertise in all aspects of systems design and integration. Our staff's commitment to value engineering is backed by exceptional technical training, direct field experience and more than 600 years' cumulative systems experience.

With Harris, you will find a supplier with an unmatched understanding of current and emerging technologies. Our "open architecture" approach to system design and close relationships with all major equipment manufacturers allows us to select the best components for the job--components that will meet your current requirements and be ready to take you into the future.

With Harris, you will also find a resource with field-proven systems and equipment in more than 150 countries and an unrivaled reputation for superb after-sales support.

Cornerstones of Harris Systems Design:

Every Harris system project is planned and designed with four basic cornerstones in mind:

Your system will be designed to be cost effective for the long term. In every case our engineers will strive to create designs that incorporate the best equipment available within your budget constraints. However, our ultimate goal will be long-term economy. We may not always recommend the product with the least expensive initial purchase price, but we will recommend equipment that is regarded as the most reliable and appropriate for

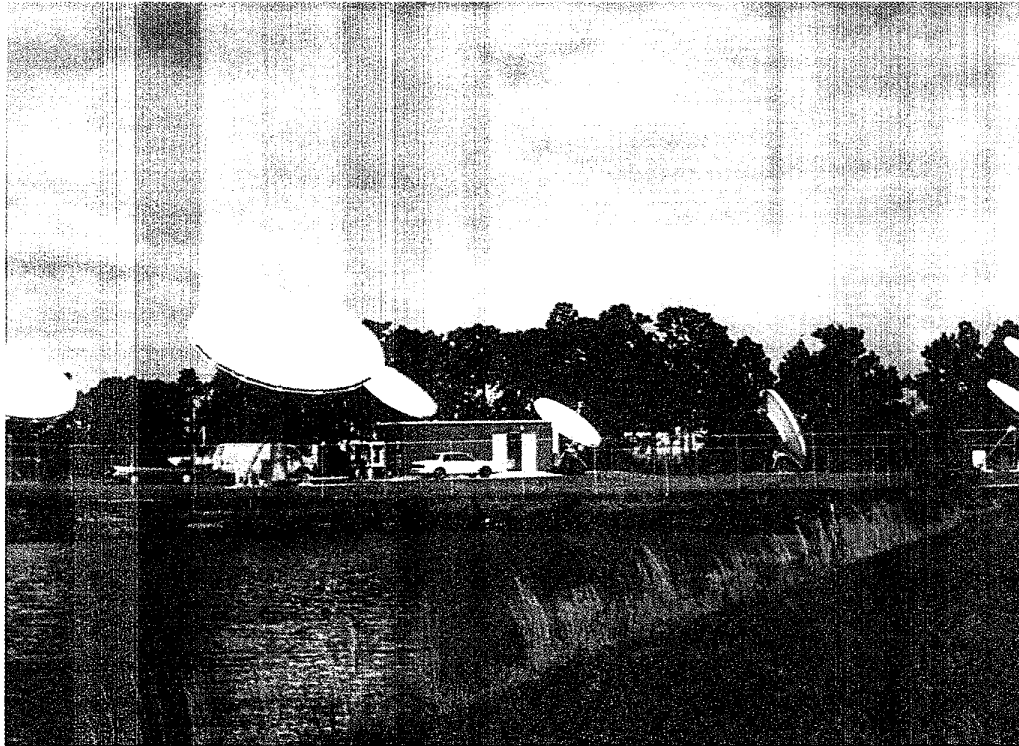

Fiber optic links between The Golf Channel's teleport and network operations center provide two major advantages: 1) All receivers, encoders and encryption equipment is at the fingertips of operators in the network operations center. 2) The links allow The Golf Channel to upgrade to digital satellite transmission without rewiring the plant.

your type of project. Over the years when initial cost is weighed against reliability and other factors, our designs have been proven to be the most cost effective available.

Your system will be designed for the future. Our engineers take the long view when they plan a system because they know technology is accelerating at a breathtaking pace. To this end, they not only use the state-of-the-art technologies, but they also anticipate future developments.

Your system will be designed to be user friendly. It may be true that technological advances are making some pieces of equipment inherently more complex. However, this doesn't mean your overall system has to be so complex that your operators must have extensive training to use it. Our designers incorporate equipment and technology in a manner that simplifies operation and minimizes on-going labor requirements.

Your system will be designed for maximum flexibility. For example, our engineers can combine digital technology, automated machine control and high-level patching to create systems that allow for extensive component sharing. The result is elimination of unnecessary duplicate equipment and associated costs.

For more information or to discuss your specific project, please contact your Harris representative or call us directly: Telephone: (606) 282-4800; Fax: (606) 283-2818.

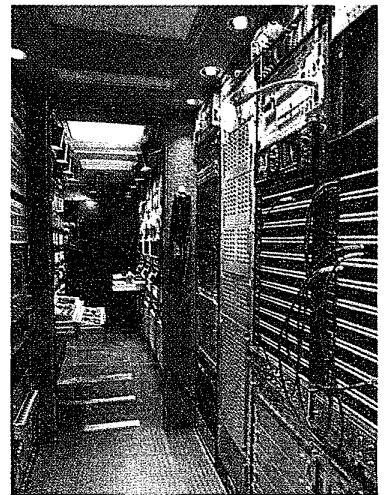



Ensuring Your News Vehicle Is Safe
By JAY C. ADRICK
Systems Product Line Director

You're in charge of selecting a new ENG/SNG truck for your station.. As you research equipment, price and delivery, there's one important area to keep in mind — truck safety. Although there are dozens of companies in the business of designing and selling news vehicles, there are no guarantees each of them will provide a safe truck. Why? Because there are no defined safety requirements for news vehicles.

Still, accidents happen. And they're most likely to happen to people in a hurry to perform routine functions — your news crew. Choosing the safest possible system is of your most important responsibilities. Here are some safeguards to consider:

THE VEHICLE

Safety begins by selecting a vehicle of the right size and power with a balanced equipment layout. Obviously you'll consider whether you need 4-wheel drive, heavy-duty suspension or heavy-duty cooling. You'll also ensure that your truck's gross vehicle weight (GVW) is sufficient to accommodate your crew, cameras and other portable equipment after modifications are made and fixed equipment is installed.

Balance of equipment, racks and mast is also critical. Overweight or unbalanced loads put undue

stress on a chassis and can cause structural damage over time.

TRANSIT SAFETY

Equipment mounting techniques that are fine in your studio may be deadly during transit with sudden stops, rear-enders or other accidents.

Your truck should use only welded steel-frame racks that are securely bolted into the floor of the vehicle. Racks bolted only to the wood floor and ceiling have been known to rip free from their mountings and slam into the front of the truck during sudden stops.

Likewise, equipment must be securely mounted. Heavy or deep equipment must be mounted to both front and back rails with all screws in place at all times. Any equipment slide-rails should be properly used, then the equipment secured to the rack with proper rack screws.

Non-racked equipment must be secured as well. If possible, your truck should include a rear compartment behind the racks for portable equipment, camera, tripod and lights. There also should be compartments in the front for spare batteries, headsets, mics, and even tape.

Secure mountings and tie-downs are essential for roll-around chairs during transit, and mounted swivel seats by equipment racks should be locked in the forward-facing position any time the truck is moving. (Swivel seats are illegal and unsafe in the front of a van.)

POWER

You must ensure deadly exhaust from any on-board generator is vented outside. The generator needs to be mounted in a closed compartment designed to keep fumes from entering the vehicle. A carbon monoxide sensor should be installed and maintained.

The on-board battery also must be vented to the outside of the vehicle, and the power hookup at the station your trucks use should be on a Ground Fault Circuit Interrupter (GFCI).

WORK ENVIRONMENT

A safe exterior is also important. Ladder steps and the roof work surface should have grip-strut surfacing. If you plan to use the top of your truck for a manned camera platform, guard rails should be installed.

Appropriate lights at the rear of the truck (and the side if necessary) should be provided for night operations. A light on top of the vehicle is also needed to illuminate the mast and the area above it.

RF RADIATION

RF radiation is a silent danger. Microwave antennas emit harmful radiation that can cause serious injury with long-term exposure. Satellite trucks pose even greater risk. Ku-band radiation can cause RF burns and severe eye injury.

Make sure a "Check Transmitter Light" sign is installed where it will be noticed. Sign or not, a well-trained and attentive crew is your only real safeguard.

ENG MAST/SATELLITE ANTENNA

A redundant ignition lock-out system to prevent moving the vehicle with the mast or antenna up is the most important safety precaution you can take.

Of course installation is important. Your ENG mast should be mounted in a recessed pocket in the rear of the vehicle behind equipment racks. The recessed pocket makes the mast more stable and its rear location keeps the mast away from your crew if something does go wrong. The mast should NEVER face the front of the vehicle and/or merely be bolted to the truck floor.

If a mast is overloaded or its top severely strained by some external force, the bottom inside your truck could kick out. Anyone operating your truck will need to be aware of the mast's maximum load and stick to it. Air pressure used to raise the mast should be treated with respect, and air pressure regulator settings checked on a regular basis.

The mast switch should be located outside of the vehicle, allowing the operator to observe any overhead obstructions during deployment. A pressure "dump" valve should be installed next to the mast-up switch for emergencies.

Care also should be taken in positioning and mounting a satellite dish, and the same operating precautions followed.

Stabilizing jacks should be provided for easy use whenever the mast or dish is up. Remember that stabilizers are designed to work on moderately level ground — not on slopes or to level a truck with two wheels on the sidewalk and two on the street.

A FINAL WORD

We are amazingly creative when it comes to hurting ourselves. We can block, defeat, work-around or ignore almost any safety feature. Even with the safest possible news truck, day-to-day safety will rely on the training, the experience and the common sense of the crew behind the wheel.



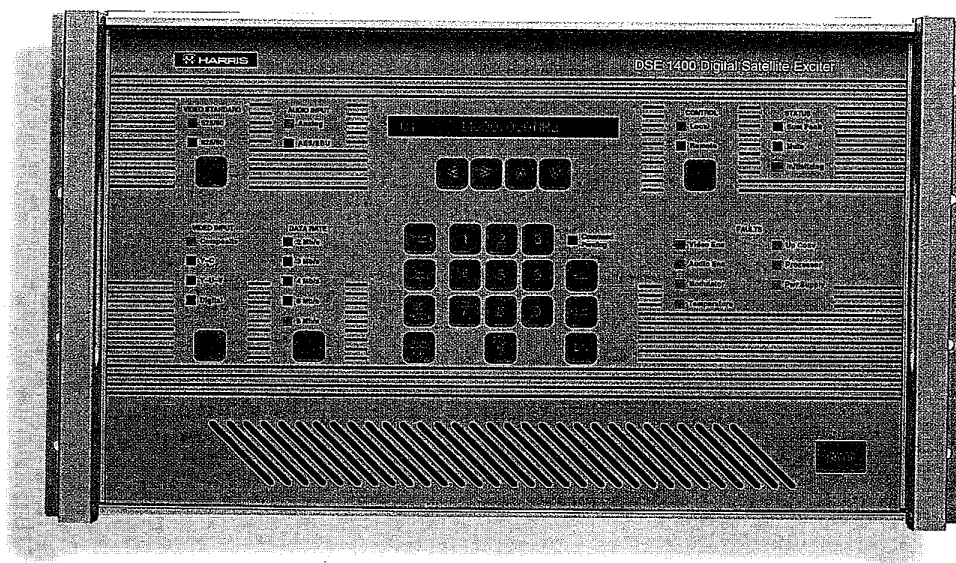

Harris DSE 1400/DSR 1400 Digital Satellite Television System

The DVB-interoperable Harris DSE 1400 Digital Satellite Exciter/DSR 1400 Digital Satellite Receiver provides significant advantages over analog technology

Operator friendly: The DSE 1400 integrates an MPEG-2 encoder, QPSK modulator and frequency converter into a single 6RU-high chassis. These subsystems, which are under the command of a single controller, require no special adjustments during set-up in routine operations. The DSR 1400 Integrated Receiver Decoder (IRD) is similarly designed to provide L-band downconversion, demodulation and decoding.

Reduced operating costs: The DSE 1400 will practically pay for itself with substantial reductions in transponder charges, lower power amplifier costs, and greater access to a wider range of transponders.

New installations or retrofits: The DSE 1400/DSR 1400 are ideal for new installations or upgrades.

Ruggedly designed: The DSE 1400 is built for continuous operation anywhere — despite being routinely subjected to long treks over rough terrains, extreme temperatures, G-force shocks and other conditions to which SNG vehicles and fly-aways routinely are subject.

FEATURES

- DVB interoperable
- MPEG-2 video compression with I, P and B frames
- Variable data rates
- Analog composite video, S-VHS component, and Betacam component inputs
- CCIR 601 serial digital video input
- Two-channel digital audio with analog or AES3 input
- 64 kbps auxiliary data channel
- Operator-friendly with CPU set-up feature
- Universal power supply (85 - 265 VAC, 47 - 63 Hz)



Systems

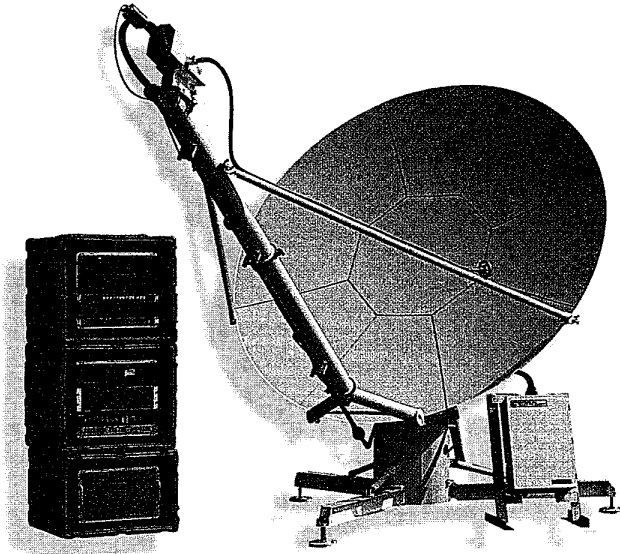

Harris S-2D

**Harris
Fly-away
Portable Satellite Uplink Systems**

The Harris S-2D takes fly-away satellite uplink systems to new heights. Combining the Harris DSE 1400 Digital SNG Exciter and a 2.2 meter lightweight carbon fiber antenna, the S-2D provides incomparable flexibility, economy and portability to news crews worldwide. Harris — the first U.S. company to offer fly-away systems — also offers popular analog fly-away systems.

S-2D FEATURES

- Self-contained DSNG system
- Ku-band, C-band or dual band
- Harris DSE 1400 Digital Satellite Television Exciter
 - MPEG-2 video compression
 - DVB interoperable
 - Variable data rates
 - Integrated, user-friendly design
- Solid state power amplifier
- 2.2 meter carbon fiber antenna
 - Intelsat and Eutelsat-approved
 - Segmented for easy packing and travel
- Stackable equipment cases for studio-like control and monitoring
- Audio/video program switching and monitoring
- Complete audio and video baseband package
- Set-up time under 30 minutes
- Can be checked as baggage on international and domestic flights

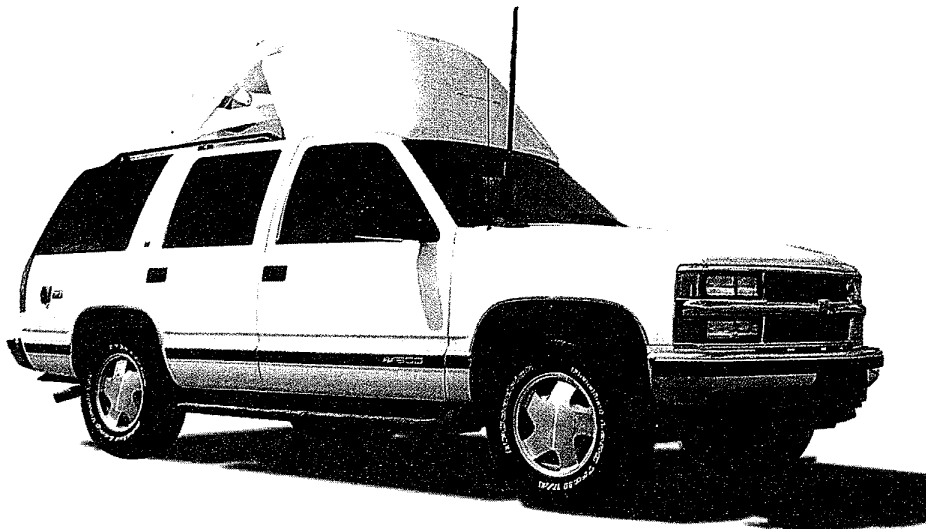

Harris S-15

**Harris
S-15
Digital Satellite Communications System**

The S-15 is the most rugged, flexible and compact SNG vehicle on the market. Based on a medium-size 4-wheel drive vehicle such as a Chevrolet Suburban or GMC Yukon, the S-15 incorporates an MPEG-2/DVB-interoperable satellite exciter and a new-generation carbon-fiber antenna for unprecedented flexibility, performance and economy.

TYPICAL VEHICLE

- Compact yet rugged 4-wheel drive chassis
- All heavy-duty components
- On-board power take-off AC generator system

TYPICAL EQUIPMENT

- RF
- Harris DSE/R 1400 digital MPEG-2 DVB exciter and receiver with 15 Mb/s capability
 - 1.2 meter carbon fiber 4-port antenna system
 - 40 watt solid state power amplifier
 - RF monitoring
- Baseband
- Typical equipment complement
- Option
- VCR



**Harris
S-18 Mobile Satellite
Communications System**

The S-18 is a high performance satellite communications system that can maneuver easily in city traffic or on county roads. A flexible communications system, the S-18 is ideal for uplinking news or special events and is easily adaptable for voice and data applications.

TYPICAL VEHICLE

- One-ton extended body van
- V-8 engine
- Three equipment racks standard; room for fourth rack
- 13,500 BTU commercial-grade air conditioner with integrated 5,000 BTU heat strip
- Electrically-deployed stabilizing system
- Integral vehicle security
- GFI protected AC outlets
- Dual 6.5 kW AC generators

TYPICAL EQUIPMENT

RF Systems

- 1.8 m antenna
- 300 W TWT amplifier
- Intelsat-approved Ku-band exciter
- Dual front panel-controlled agile audio subcarriers
- Frequency-agile Ku-band video receiver
- Two-port receive/transmit feed
- LNC/LNA systems
- Spectrum monitor
- RF patching

Baseband Equipment

- Test generator
- Source ID generator/reader
- Video/audio patching
- AFV switching
- Distribution amplifiers
- Video and waveform monitoring
- Stereo audio mixer
- Many options available

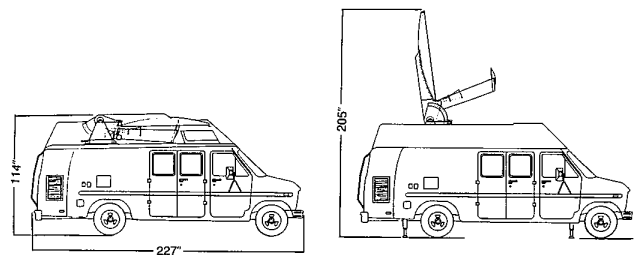

Systems

**Harris
S-21 Mobile Satellite
Communications System**

The S-21 combines the latest in mobile satellite uplink technology and full production capability into a compact, yet comfortable mobile satellite communications system. The S-21 is available with a variety of chassis types and two body styles in either a 2- or 4-rack configuration.

TYPICAL VEHICLE

- Variety of chassis with gasoline or diesel engines
- Typical GVWR to 20,000 lbs.
- Lightweight, corrosion-resistant body
- Two body lengths - 11' or 12'6"
- Heavy-duty antenna mounting support
- Thermally stable and soundproof working environment
- Weatherproof communication port between cab and operations area with optional walk-through passage
- Custom storage cabinet and two custom equipment racks standard
- Dual 15,000 BTU roof-mounted air conditioners and a 5,000 BTU electric heater standard
- Electrically-operated stabilizing jacks; capable of emergency manual retraction
- Full security system
- Single or dual generators' output power from 6.5 kW to 20 kW
- Interior and exterior GFI-protected duplex outlets
- Custom power control panel for AC, DC and generator functions

TYPICAL EQUIPMENT

RF Systems

- Variety of RF subsystems available - analog or digital
- 1.8 m or 2.4 m high-gain Ku-Band antenna
- 300 W TWT amplifier standard; optional redundancy and/or phase-combined
- Intelsat-approved Ku-band exciter; redundant exciters with automatic or manual switchover available
- Ku-band receiver with LNB

Baseband Equipment

- Sound/ID generator
- Audio and video patching
- Video test generator
- Two AFV 10x1 switchers
- Audio and video distribution amplifiers
- Audio and video monitoring
- Waveform/vector monitoring
- Audio mixer and processing

Options

- Camera systems
- VTR packages
- Microwave systems
- RF monitoring
- Communication systems
- Other options available

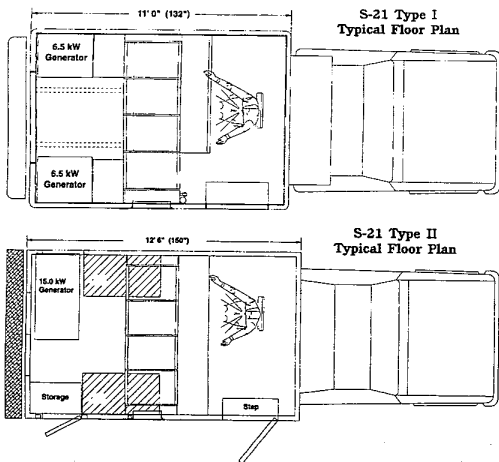

CERTAIN PRODUCTS NOT AVAILABLE IN ALL AREAS



**ORDERING AND TECHNICAL SUPPORT:
(606) 282-4800**

ELECTRONIC NEWS GATHERING SYSTEMS

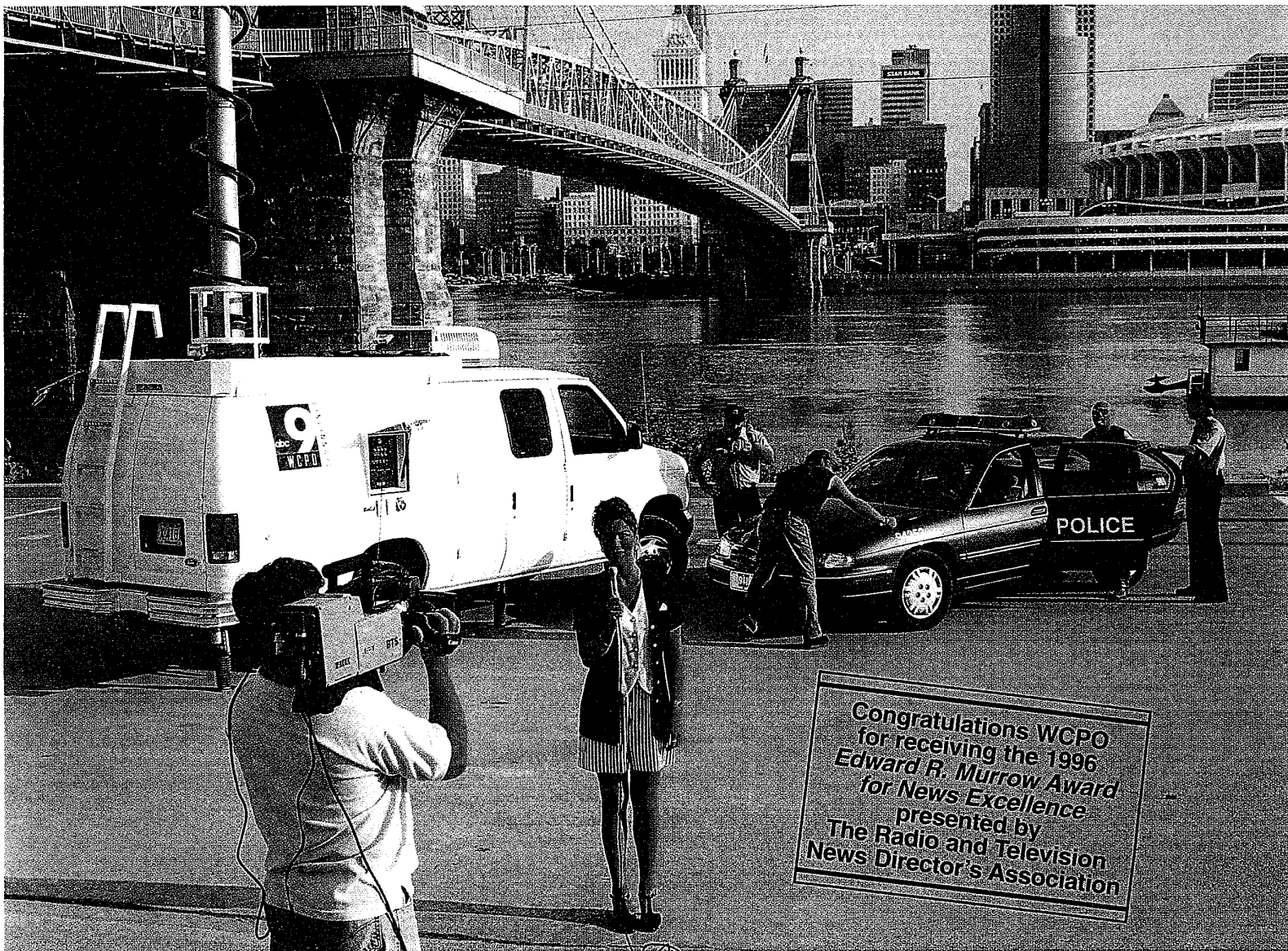

Congratulations WCPO
for receiving the 1996
Edward R. Murrow Award
for News Excellence
presented by
The Radio and Television
News Director's Association

Their last Harris ENG truck got them 10 years hard labor.

When the chips are down, your news crews must know that they can count on their ENG vehicle to get them to the hottest stories quickly and safely...and then help them capture the moment. For over ten years, two Harris M-1ENG vehicles have been doing this for WCPO in Cincinnati. That's longer than some Harris imitators have been in business.

Kevin Betts, WCPO's Director of News Operations, sums it up perfectly. "Our Harris trucks and the

Harris people have always gone the extra mile to help us get a story. They've proven over and over again that we can count on Harris for strong trucks, the right electronics, high value and great support."

With over 500 years of design and integration team experience, and unrestricted customizing as the rule, not the exception, your Harris ENG or SNG vehicles can be everything you want in a mobile system. Our full-time staff provides unmatched expertise in every discipline, including elec-

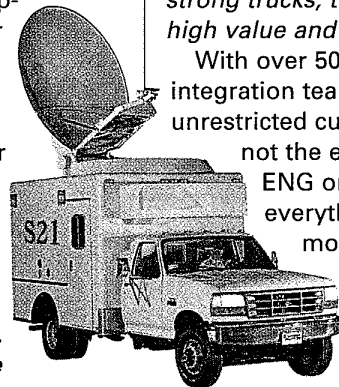

trical, mechanical, RF and systems engineering. And we offer the broadest selection of electronic equipment, backed by the industry's finest warranty and 24-hour support, worldwide.

To find out how you can get 10 years hard labor and love every minute of it, contact Harris.

HARRIS CORPORATION BROADCAST DIVISION

7920 Kentucky Drive
Florence, KY 41042 USA
TEL: +1 606 282-4800
FAX: +1 606 283-2818



Systems: Electronic News Gathering – Flyaway Satellite – Mobile Production – Radio Studio – Satellite News Gathering – Satellite Uplink
Television Production – Television Transmission – Wireless Cable

©1996 Harris Corp.

**Harris
S-23 Satellite
Communications System**

The S-23 is known worldwide for its ruggedness and dependability. Available in a wide variety of configurations and on several chassis models, the S-23 can be used for satellite news gathering, remote programming, backhaul, teleconferencing and remote data and communication links. The S-23 has enough room in its operations area to accommodate a full video production suite.



TYPICAL EQUIPMENT

RF Systems

- Variety of RF subsystems available - Ku-band, C-band, analog, digital
- Typical configurations including single PA, redundant PA, phase-combined dual PA, and triple path/triple PA
- Vertex 2.4 m DMK antenna
- Ku-band exciter; redundant exciters with automatic or manual switchover available
- Ku-band receiver with LNB
- Spectrum monitor
- Test loop translator

Baseband Equipment

- ID generator
- Audio and video patching
- Video test generator
- Two AFV 10x1 switchers
- Audio and video distribution amplifiers
- Audio and video monitoring
- Waveform monitoring

Options

- Camera systems
- Videotape systems
- Microwave systems
- Intercom/IFB
- Other options available

TYPICAL VEHICLE

- Variety of chassis - Ford, Volvo, Mack and others
- All-aluminum corrosion-resistant body
- Ultra-durable welded/Very High Bond adhesive construction
- Lengths to 27'
- Heavy-duty antenna mounting support
- Fully insulated body
- Storable writing desk and six 72" equipment racks standard; four, five and seven racks available
- Lockable external storage compartments
- Wide variety of interior layouts
- Two 13,500 BTU roof-top air conditioners; one 5,000 BTU wall-mounted electric heater
- Four hydraulic microprocessor-controlled stabilizers; automatic mode for self-leveling
- Central custom power control panel for AC, DC and generator functions
- GFI-protected exterior duplex outlets
- Rooftop storage shroud for antenna protection
- 20 kW diesel generator

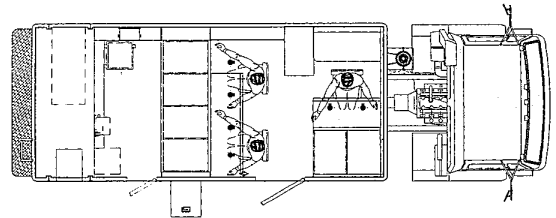

Systems

**Harris
S-30 Mobile Satellite
Communications System**

The S-30 is the ultimate transportable uplink system. Available in C-band or Ku-band configurations, the S-30 is ideal for program origination, teleconferencing or news applications.

TYPICAL EQUIPMENT

RF Systems

- Configurations for C-band or Ku-band
- Two- or four-port 3.7 or 4.5 m antenna
- 300 W TWT amplifier (Ku-band) or 3.3 kW klystron amplifier (C-band)
- Intelsat-approved exciter; redundant exciters available

Baseband Equipment

- ID generator
- Video/audio patching
- Video test generator
- AFV switching
- Distribution amplifiers
- Video monitoring
- Waveform monitoring
- Audio mixing

Options

- Camera systems
- Videotape and production systems
- Communication systems

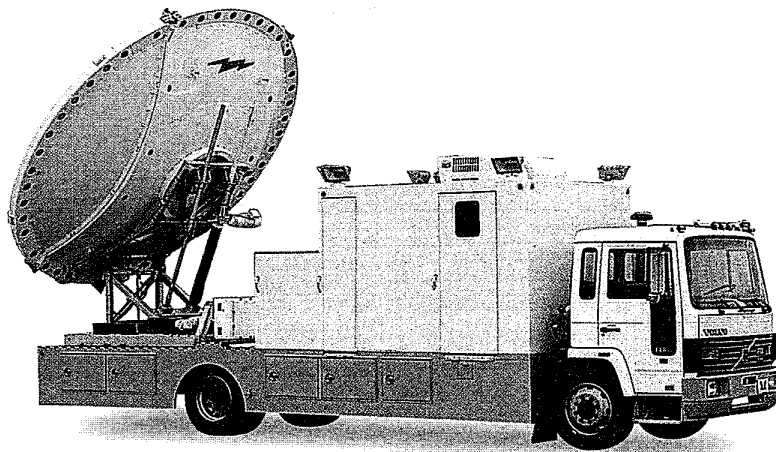

TYPICAL VEHICLE

- Turbo six-cylinder diesel engine standard; other chassis available
- Custom-welded aluminum body
- Full insulation
- Dual 13,500 BTU air conditioners and 5,000 BTU wall heater
- Hydraulic stabilizing jacks
- Storable desk and four custom 72" equipment racks
- Custom power control panel
- 20 kW diesel generator

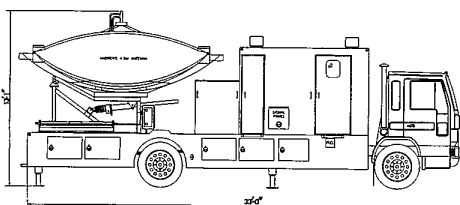

DIGITAL STUDIO SYSTEMS



The Golf Channel wanted the world's best all-digital television network facility to be designed and built in perfect form. At Harris, that's par for the course.

When The Golf Channel asked Harris to create an all-digital television network facility, we responded with a turnkey solution that included design, construction and unique system integration.

Our solution used the latest serial-digital and fiber optic technologies, and integrated one of the most advanced automation and machine control systems of any broadcast facility in the world.

Here's what The Golf Channel

VP of Operations, Matt Scalici, had to say:

"Harris provided a complete and thorough solution to a complex challenge . . . the innovation of our plant's design lies more in the system integration than in the individual components. And innovative thinking is what the Systems Group of Harris is known for."

Harris also integrated a digital-ready C- and Ku-band teleport facility for The Golf Channel. Whatever

your facility requirements, from a re-build to the design and implementation of a complex network, you'll love our follow through.

HARRIS CORPORATION BROADCAST DIVISION

7920 Kentucky Drive
Florence, KY 41042 USA
TEL: 606 282-4800
FAX: 606 283-2818



Systems: Electronic News Gathering – Flyaway Satellite – Mobile Production – Radio Studio – Satellite News Gathering
Satellite Uplink – Television Production – Television Transmission – Wireless Cable

©1996 Harris Corporation

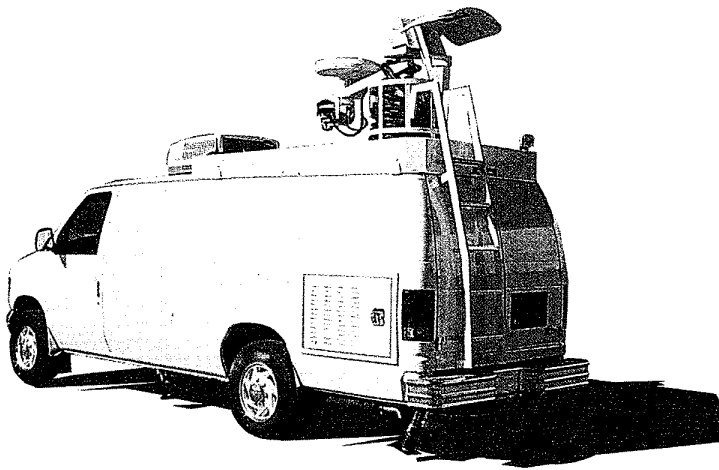

**Harris
M-1ENG/M-1 Mobile News
Gathering System**

The Harris M-1ENG fills the electronic news gathering needs of even the most budget-conscious news operations while the M-1, a mobile production control system provides exceptional convenience and flexibility to the production crews.

TYPICAL VEHICLE

- Heavy-duty one ton vehicle
- Variety of chassis available
- V-8 engine
- Full interior insulation
- Extensive custom design and construction
- 13,500 BTU rooftop air conditioner with integrated 5,000 BTU heating strip
- Two or three 48" equipment racks
- Full-intrusion alarm system
- Lockable weathertight signal panel compartment
- Custom power control panel
- GFI-protected duplex exterior AC outlet
- AC line conditioning for rack electronics
- Full DC power system
- Many optional features

M-1ENG

- OSHA-approved rooftop operation platform
- Heavy-duty 30' - 52' pneumatic mast with pan-tilt head
- Electrically-operated vehicle stabilizers
- Optional mast-mounted camera in all-environment housing

TYPICAL EQUIPMENT (M-1ENG)

RF

- 2, 3.5 or 7 GHz video transmitter with two aural subcarriers
- Low-profile offset fed parabolic dish antenna

Options

- 2/2.5 GHz receive, 7 and 13 GHz transmit/ receive and antenna systems
- Off-air broadcast receive antenna
- Cellular phone system
- 2-way radio system
- Pro-channel receiver

Baseband

- 10x1 AFV switcher with integral audio monitoring
- Color receiver/monitor
- Waveform monitor
- 4-input audio mixer (mono; stereo mixer optional)
- 2-channel IFB/intercom with 4 program and 2 telco inputs
- Color bar/ID generator

Options

- VTR systems (choice of formats)
- Camera packages
- Portable microwave systems

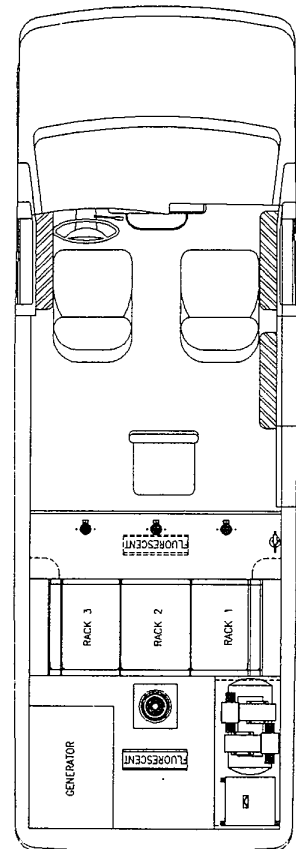

**3-Rack Configuration with
Operations storage**

Systems



SATELLITE NEWS GATHERING SYSTEMS



S-2D Fly-away DSNG. Pack your bags and get out of town fast.

Your next hot news story can occur anywhere, at any time, so you've got to be ready to fly into action on a moment's notice. That's why, when leading broadcasters want a competitive edge for their state-of-the-art, all-digital news facilities, they select the Harris S-2D.

An S-2D Fly-away DSNG Uplink System contains everything you need for operation on Ku-, C-band or both, including satellite monitor and control, and audio/video program switching and monitoring systems. The lightweight high-performance carbon fiber antenna is segmented

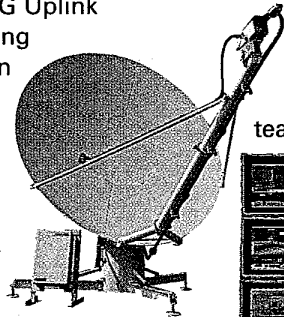

for easy packing and travel, but sets up on site in only a few minutes.

S-2D instrument cases can be stacked quickly to provide studio-like control capabilities, and the MPEG-2, DVB interoperable Harris DSE1400 Digital Satellite Television Exciter provides money-saving broadcast effi-

ciencies which make the S-2D the most economical fly-away choice of all.

Over 50 years of Harris team experience in design and integration means that your Harris Fly-away DSNG System can be anything you want it to be, as you take it anywhere you want to go...

over and over again.

Harris offers the broadest selection of electronic equipment, backed by the industry's finest warranty and 24-hour service, worldwide.

To find out how you can do more on the fly, for less, and beat your competition all over the world, contact Harris.

HARRIS CORPORATION BROADCAST DIVISION

7920 Kentucky Drive
Florence, KY 41042 USA
TEL: +1 606 282-4800
FAX: +1 606 283-2818



A new world of broadcast solutions

Systems: Electronic News Gathering — Fly-away Satellite — Mobile Production — Radio Studio — Satellite News Gathering — Satellite Uplink
Television Production — Television Transmission

**Harris
M-11 ENG Mobile
Electronic News
Gathering System**

The Harris M-11ENG is a rugged, full-featured ENG system that has proven itself in operations worldwide. This low-profile, highly mobile system is designed to take a two-person rapid response news team and all of its equipment anywhere, from tight urban locations to the most isolated or seemingly inaccessible rural sites.

TYPICAL VEHICLE

- Variety of medium-size wagon-type vehicles available
- Heavy-duty automatic transmission with overdrive
- Field-convertible interior layout
- Vehicle-powered air-conditioning/heating
- Manual "scissors jack" leveling system
- 42' pneumatic mast
- Mast-extended transmission lockout system
- 2.8 kW AC generator
- GFI-protected exterior outlet
- Analog metering of voltage and frequency
- Complete vehicle security system

TYPICAL EQUIPMENT

RF

- 2, 2.5, or 7 GHz microwave transmitter and power amplifier
- Semi-parabolic antenna

Baseband

- Audio/video switcher
- Color monitor/receiver
- Color bar/ID generator
- Audio mixer
- VHF or UHF 2-way radio system
- Cellular telephone
- Multiband scanner
- IFB controller

Options

- Camera packages
- VCR packages
- Portable lighting kits

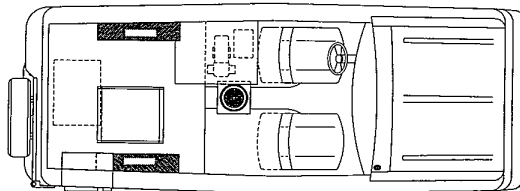
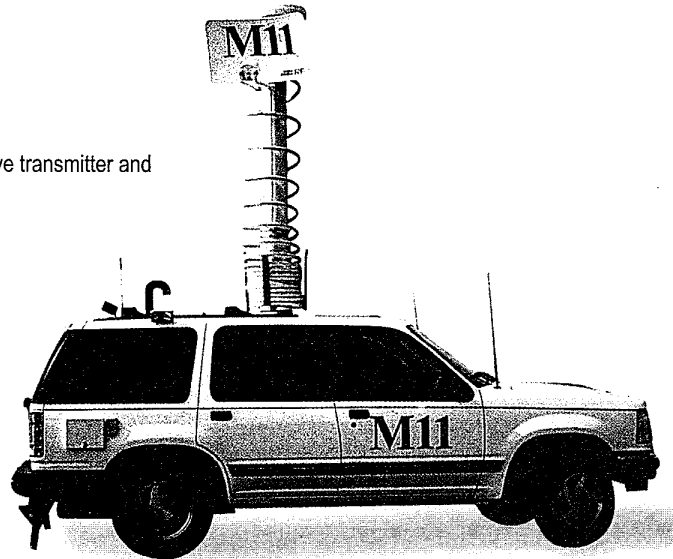

M-11 ENG Plan View

Systems

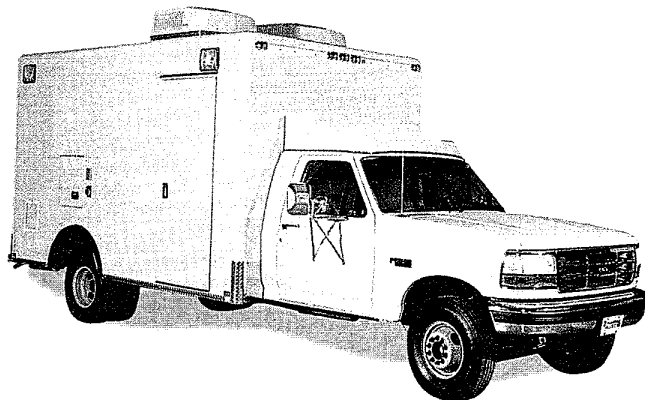

**Harris
M-24 Mobile Production System**

The Harris M-24 is a mid-size mobile production system which provides full-feature capabilities in a cost-efficient package. The electronic production suite is custom-designed to meet specific medium-range production requirements.

TYPICAL VEHICLE

- Heavy-duty cab chassis
- Dual rear wheels for increased capacity
- V-8 engine
- Rugged 14-1/2' aluminum body with full 15-year warranty
- Full insulation
- Four custom 76" electronic racks and secondary console
- 13,500 BTU rooftop air conditioner with integrated 5,000 BTU heater
- Intrusion alarm security system
- Custom power control panel
- GFI-protected AC outlets
- AC line conditioning for equipment racks
- Full DC power system
- Many options

TYPICAL EQUIPMENT

- Up to four cameras with support equipment
- Up to four VCRs (customer's choice of format)
- 8- to 12-input video switcher, one or two M/E.
- Color program and preview monitors
- Monochrome source monitors
- Waveform and vector monitoring
- 8- to 16-input audio mixer (mono or stereo)
- Audio, video and pulse distribution amplifiers
- Color sync generator
- AFV routing switchers
- Single- or dual-channel character generator

Option

- Single or multichannel intercom/IFB systems

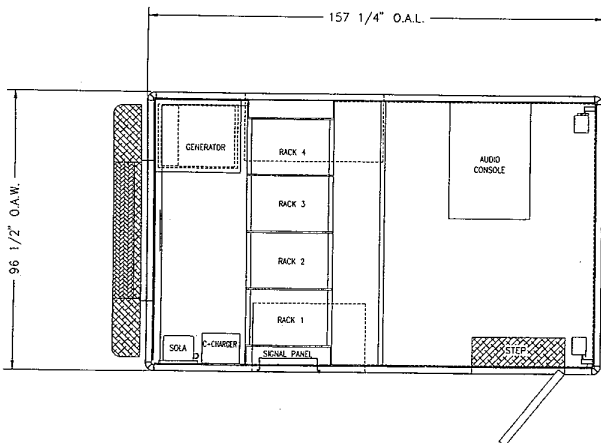

SATELLITE NEWS GATHERING SYSTEMS



S-15 4x4 DSNG Because the road to a hot story may not be a road.

Digital satellite news gathering has risen to new heights with the introduction of the Harris S-15 DSNG Vehicle. Built on a versatile 4x4 sport utility chassis, the S-15 can take your news crew virtually anywhere, in any weather, rapidly and securely.

An under-the-hood 5 kW generator gives them the power to

set up on the run, so you can be on the air moments after arrival, and long before your competition.

An S-15 DSNG Vehicle contains everything you need, including a Ku-band uplink, satellite monitoring and control, switching and monitoring systems, audio and video equipment,

and videotape units. The lightweight, high-performance, 1.2 meter antenna folds behind an aerodynamic cowling for high-speed highway travel, and raises automatically on command.

The on-board, DVB Interoperable, Harris DSE1400 Digital Satellite Television Exciter provides money-saving broadcast efficiencies

which may make the S-15 the most economical choice of all.

With a low height of just over 8 feet, this standard weight-class passenger vehicle can carry a crew of three without needing a special motor vehicle license.

Over 500 years of Harris team

experience in design and integration, with unrestricted customizing as the rule, means that your S-15 DSNG system can be anything you want it to be, as it takes you anywhere you want to go.

Harris offers the broadest selection of electronic equipment, backed by the industry's finest warranty and 24-hour support, worldwide.

To find out how you can do more for less, and do it first, contact Harris.

HARRIS CORPORATION BROADCAST DIVISION

7920 Kentucky Drive
Florence, KY 41042 USA
TEL: +1 606 282-4800
FAX: +1 606 283-2818



Systems: Electronic News Gathering – Flyaway Satellite – Mobile Production – Radio Studio – Satellite News Gathering – Satellite Uplink
Television Production – Television Transmission

©1996 Harris Corporation

**Harris
M-30
Mobile Production System**

The Harris M-30 provides full remote production capabilities in a smaller, cost-effective package. Although the M-30 is compact, it provides a comfortable and functional environment.

TYPICAL VEHICLE

- Variety of chassis
- Typical GVWR to 50,000 lbs.
- Welded aluminum sheet and framing
- Weathertight underbody storage
- Body lengths to 28'
- 7' interior height
- Custom consoles and up to 11 full (78") and 3 half-height custom equipment racks Three operating areas
- Dual air conditioning/heating units, air conditioning to 72,000 BTU
- Full security system
- Separate custom power control panels for AC and DC with full metering
- GFI-protected exterior AC outlets
- AC interior lighting with DC auxiliary lighting
- Full AC isolation and regulation for technical loads
- Full DC power system

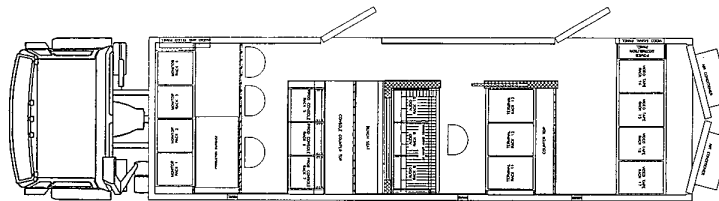
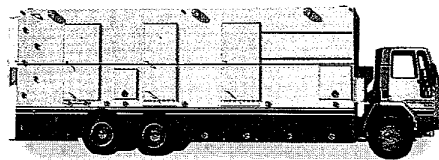
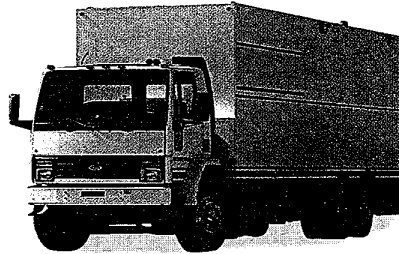

TYPICAL EQUIPMENT

- Up to 6 camera systems with lenses and support equipment
- VTRs (Type C, U-Matic, Beta, Mil or Digital formats)
- Redundant sync generators with automatic changeover
- Full audio, video and pulse distribution amplifier systems
- Stereo audio follow video routing switcher
- Video processing amplifier
- Frame synchronizer(s)
- 16- to 24-input video switcher (2 - 3 M/E)
- Digital effects and still store systems
- Up to 36-input stereo audio console
- Audio processing and recording equipment
- Color and monochrome picture monitors
- Waveform and vector monitoring
- Multichannel intercom/IFB interfaced to central multi-line telephone system

Option

- 2-way radio packages

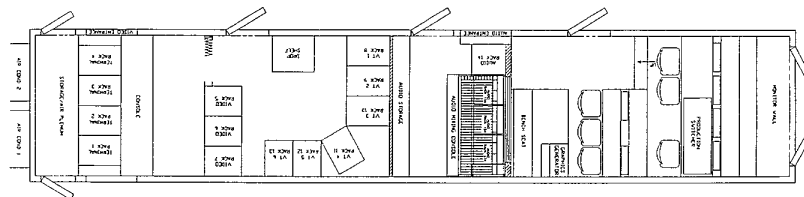
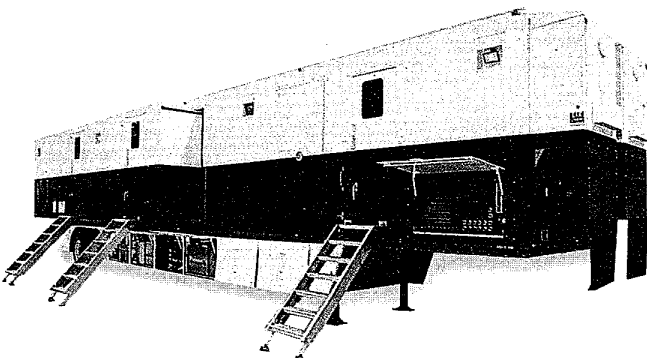

**Harris
M-40
Mobile Production System**

The Harris M-40 is the ultimate remote production system. Available in straight or expandable body style in lengths to 53', the M-40 provides maximum capability for major remote production.

TYPICAL VEHICLE

- Custom-built aluminum trailer
- GVWR to 65,000 lbs.
- Lengths to 53'; widths to 102"; expandable sections can be provided
- Standard interior height 7'
- Multiple full-width underbody storage compartments
- Custom 78" equipment racks and consoles
- Dual front-or rear-mounted air conditioners to 72,000 BTU
- Integral alarm system
- Separate AC and DC control panels with metering
- GFI-protected exterior AC outlets
- AC interior lighting and DC auxiliary lighting
- Full DC power system

TYPICAL EQUIPMENT

- Up to 10 camera systems with lenses and support equipment
- VTRs (Type C, U-Matic, Beta, Mil or Digital formats)
- Single or redundant sync generators with automatic changeover
- Full audio, video and pulse distribution amplifier systems
- Stereo audio follow video routing switcher
- Video processing amplifier
- One or more frame synchronizer(s)
- 16- to 32-input video switcher (2 - 3 M/E)
- Single or multichannel digital effects and still store systems
- Up to 48-input stereo audio console
- Audio processing and recording equipment
- Color and monochrome picture monitors
- Waveform and vector monitoring
- Multichannel intercom/IFB interfaced to central multi-line telephone system
- 2-way radio and UHF repeater packages

Systems



VHF TV TRANSMITTERS



Harris Platinum Series® Transmitters. Out of sight. Out of mind. But never out of service.

And backed by a 5-year warranty.

Unsurpassed reliability.

World-leading Harris Platinum Series® VHF TV Transmitters — from 500 W to 60 kW — are so reliable your engineers will seldom visit them. But day after day, year after year, you can count on your unattended Platinum Series Transmitter to provide a signal that will impress everyone — viewers, advertisers, management, and your accounting department, too.

Harris quality and the industry's best warranty.

Platinum's solid-state, hot-swappable modules have 500,000 hours MTBF, and that's only the beginning. A positive pressure, integrated air system maintains consistent cooling even if a module is removed.

Add built-in transient protection and superbly regulated power supplies, plus all the benefits of our ISO 9001 Quality System and two things become crystal clear: You won't service your Platinum Transmitter very often, but when you do it will be quick and easy. This is why we back every Platinum VHF Transmitter with an unprecedented 5-year warranty.



Whether your transmitters are locked in the next room, out back, or on a distant mountain top, Harris Platinum guarantees you the highest performance and lowest maintenance. Contact Harris for more information. It's the key to improving your station.

HARRIS CORPORATION BROADCAST DIVISION

US and Canada
TEL: +1 217 222-8200
FAX: +1 217 224-1439
Elsewhere
TEL: +1 217 222-8290
FAX: +1 217 224-2764



Transmitters: Platinum HT EL and Platinum Series® Solid State VHF – UltraVision Solid State UHF – Sigma™ Series IOT UHF – UM Series Depressed Collector Klystron • VHF, UHF and HDTV-Ready Antennas • Remote Control Systems – Digital HDTV/ATV Systems

©1995 Harris Corp.

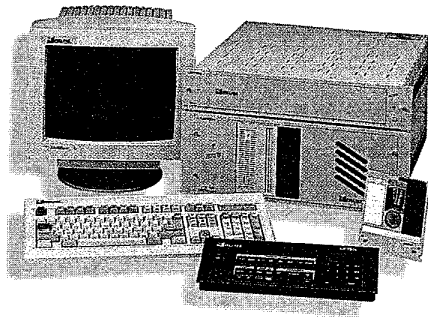

**Leitch
StillFile®**

New to StillFile® is client workstation which allows existing StillFiles to communicate with any outside equipment operating under the TCP/IP standard. The client performs format translations such as TGA, TIFF and D1 to D2, and centralizes all stills on a network to allow accessibility from a variety of browser clients.

List Prices Vary

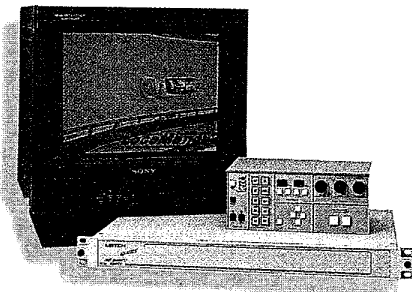

**Leitch
LogoMotion®**

New to LogoMotion® is a time and temperature option which allows users to display the current time-of-day and outside temperature along with logos keyed into any video signal. Also new is vertical blanking interval control which allows a network's headquarters to control local affiliate logo insertion from network video feed.

List Prices Vary

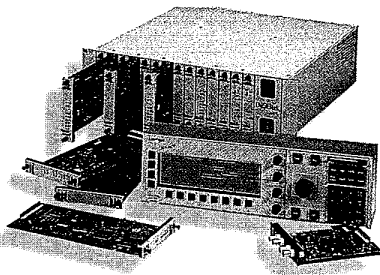

**Leitch
DigiBus®**

Leitch's DigiBus® system of digital interface/conversion modules is in the forefront of the broadcast industry. For example, with its audio demultiplexer module any broadcast format can be converted to fiber, then transferred. And with the adaptive comb filter module, high-quality, composite-to-component video conversion can be accomplished.

List Prices Vary

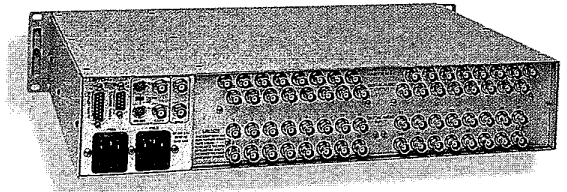

**Leitch
VIA® 32 Series**

The VIA® Series of 32x32 and 32x16 routers can be combined to create sophisticated, multilevel systems at an economical price. Whether facilities require analog audio, analog video, AES/EBU digital audio or serial digital video routing, the VIA units fulfill most requirements without sacrificing high-level performance and flexible control.

List Prices Vary

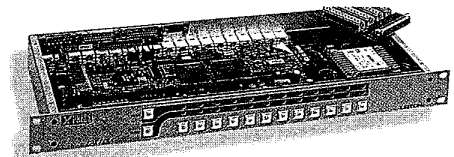

**Leitch
XPRESS® Series**

The XPRESS® Series of 12x1 stereo audio and video routers increases productivity, saves space and time, and expands on standard control options. These routers include models to suit any monitoring application including analog and digital audio and video and combination audio and video models.

List Prices Vary

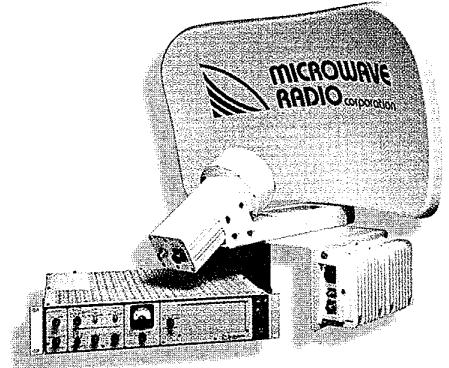

**Microwave
Radio
Millennium®
Series
VanPack
Modules**

The Millennium Series VanPack microwave transmitter offers

broadcasters and mobile van system integrators an ideal combination of features and performance. Featuring many of the same features as our portable transmitters, The Millennium VanPack generates the RF signal adjacent to the antenna, eliminating the need for a separate power amplifier.

List Prices Vary

**Microwave Radio
Millennium TBT Triband
Portable**

Millennium TBT Triband portable microwave transmitter up to three bands from 2 to 15 GHz. The Millennium TBT Triband transmitter offers outstanding operational versatility in a modern, compact transmitter package. Through extensive usage of surface mount devices and MMIC technology, the Millennium TBT is able to offer three operating bands 2, 7 and 13 GHz in the physical size of a typical single-band microwave transmitter.

List Prices Vary

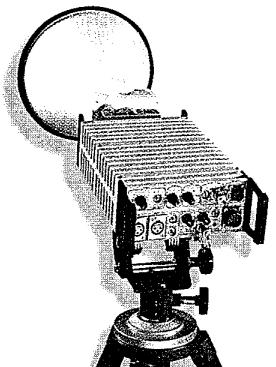

Systems



When Television Broadcasters Around the World Need Reliable, High-Quality Microwave Systems,

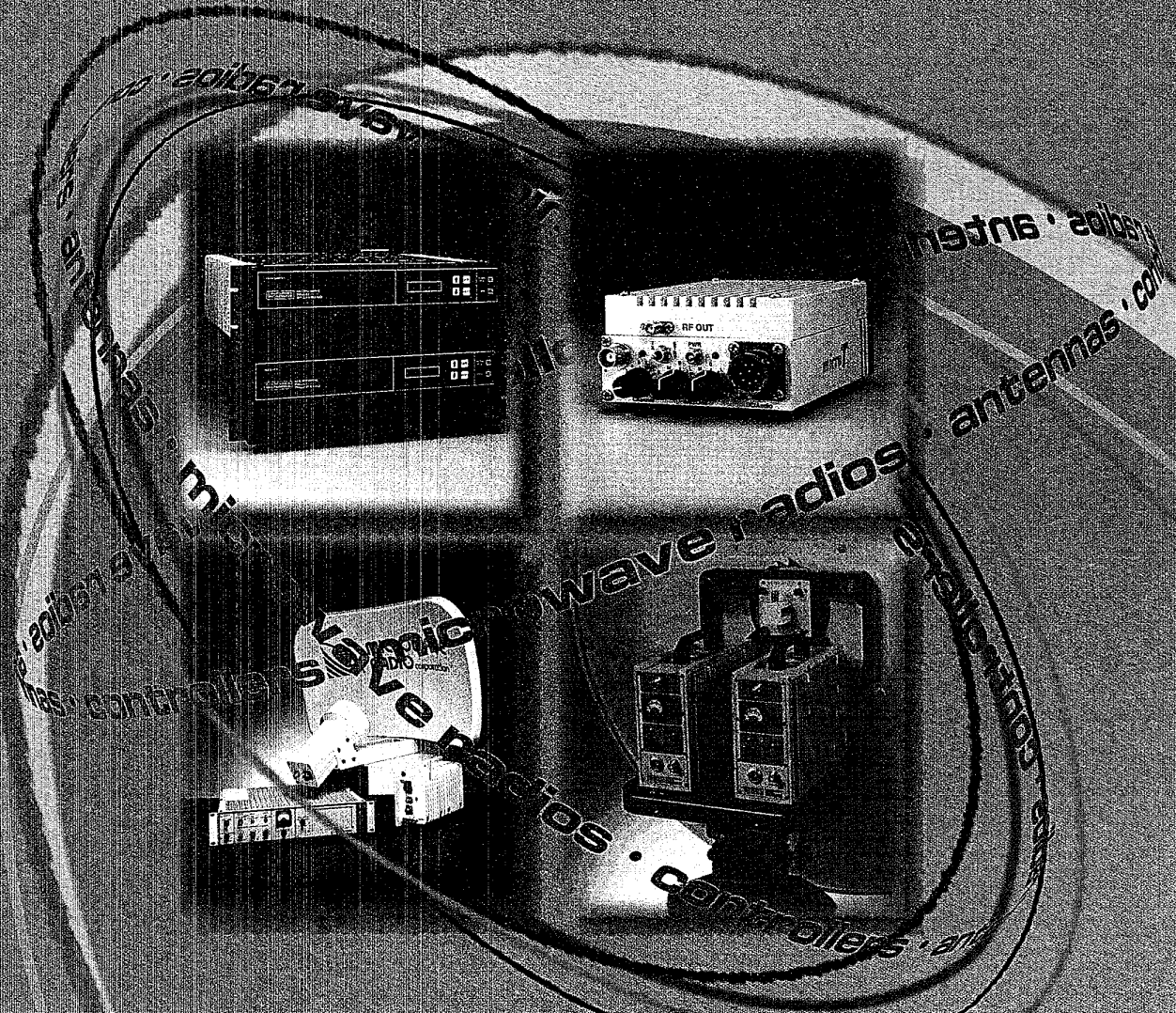

They Turn to Microwave Radio Communications.

For national networks, STLs, outside broadcast, and portable applications, there's no substitute for the product depth, market understanding, customer commitment, and global operations provided by the Microwave Radio Communications division of California Microwave, Inc.

From the latest fixed radios for digital video transmission to central receive systems and innovative portable products, Microwave Radio Communications offers broadcasters and common carriers the features and performance that today's competitive

environments demand. And those radios can be counted on to operate reliably and economically for years.

The next time you need a microwave radio system for fixed, mobile, or portable video signal transport, turn to the company that provides the industry's widest product line, longest history of continuous product support, and greatest focus on video microwave solutions. Turn to Microwave Radio Communications.

**CALIFORNIA
MICROWAVE**

**MICROWAVE
RADIO
COMMUNICATIONS**

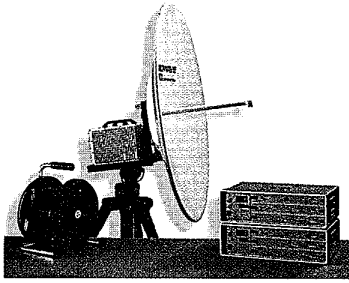

**Microwave Radio
Millennium® PML & PML-DR**

The Millennium® PML tow-box microwave radios are designed for international applications requiring widely separated RF units and control units. In a standard configuration, the RF unit can be separated from the control unit by up to 250 meters with the 70 MHz IF signal feeding through a single triax cable.

List Prices Vary

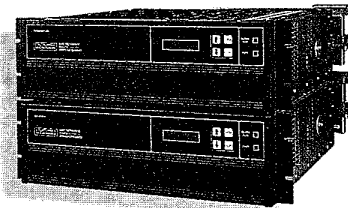

**Microwave Radio
FLH-DAR**

The FLH-DAR digital-analog microwave radio system offers models from 2 to 15 GHz for STLs, multi-hop and multi-channel broadcast, CATV, and ATV video networks. The FLH-DAR radios are designed to provide broadcast quality video transmission and will accept MRC's optional modules for digital modulation or analog modulation.

List Prices Vary

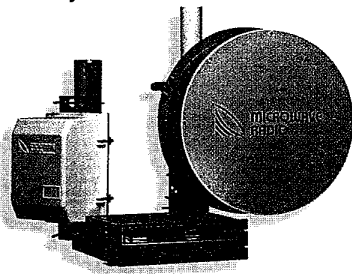

**Microwave Radio
MicroLink® III**

The MicroLink® III 18/23 GHz video microwave system is a high-performance short-haul system designed to deliver broadcast-quality video in the 17.7 to 19.7 or 21.2 to 23.6 GHz frequency bands. The MicroLink III is available in simplex, duplex, multiplex, and hot-standby configurations.

List Prices Vary

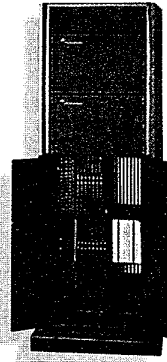

**Nvision
NV3512A**

The NV3512A digital router series represents the ultimate in expandable switching systems. The minimum size starts at 8 X 32 and it can be incrementally expanded to 2048 X 2048. This switch supports asynchronous AES digital audio (A), synchronous AES audio (SA) and SMPTE time code (TC). The NV3512A provides for redundant systems if required and the synchronous version is ideal for large 'on air' or 'hot switch' applications. The asynchronous version will allow the switching of mixed AES sample rates for systems that require flexibility, its primary application is post production where pre-select routing is acceptable. The time code version utilizes all digital processing and ensures that data is reliably received at the destination even in high speed shuttle modes.

List Prices Vary

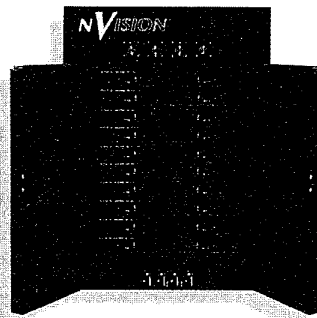

**Nvision
NV3128/3256D**

NVISION's unique RS422/232 data routing switches provide the greatest operational flexibility available. The patented dynamic port architecture ensures the routing of RS422 or RS232 machine control data is as simple as selecting a source and a destination. The routers intelligent control logic will determine if a port should be 'controlled' or 'controlling' and will ensure that transmit and receive lines appear on the correct pins for the function selected. The NV3128 is available in 32 port to 128 port sizes, the NV3256 also starts at 32 ports but has a maximum of 256 ports. Naturally both switches are fully expandable in 32 port increments to the maximum size.

List Prices Vary

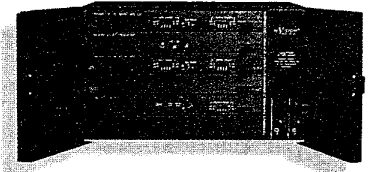

**Nvision
NV3064A, SA + TC**

Like the NV3512, the NV3064 is available in Synchronous or asynchronous AES processing formats as well as digital time code. This switch is available in 32 X 32 and can be readily expanded to 64 X 64. Like all NVISION routers the NV3064 is available with redundant power supplies and can reside under a wide range of existing control systems.

List Prices Vary



**Nvision
FR1000**

Clean and economical digital audio system design begins with the FR1000 rack frame and power supply. Plug in any combination of up to twelve NV1000 series digital audio distribution, conversion, synchronization or Processing modules. Choose the number and type of modules to exactly meet your system design goals. There are no artificial connector constraints to limit your configuration; each module is supplied with its unique I/O back panel. Enjoy flexibility and density not available in any other rack frame design.

List Prices Vary



**Nvision
NV1035/NV1045**

Reference standard audio conversion design starts with NV1035 A/Ds and NV1045 D/As. High performance, high density and low cost make these modules the best conversion choice for digital audio mixing consoles or 2 channel reference quality conversion. NV1035 and NV1045 modules meet the exacting needs of the audio production industry. 20 bit dynamic range assures sonic clarity for mixing or other signal processing which occurs in audio post production, even at the lowest recording levels.

List Prices Vary

Systems



We're Philips Broadcast
Television Systems Company.
We've got solutions.

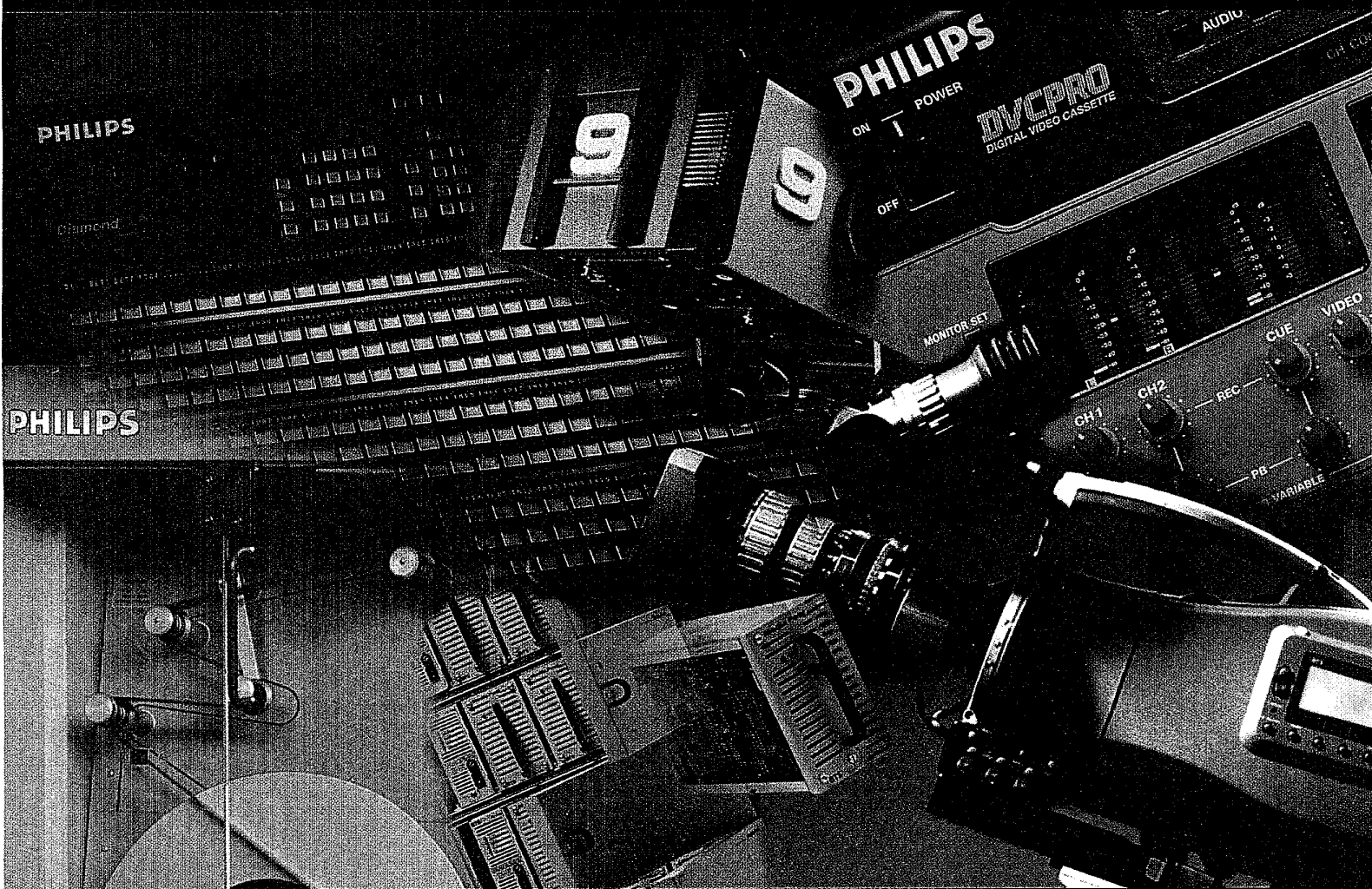

Whether you're looking for cameras, production switchers, video servers, routing switchers, station automation, telecines, or facility control, we've got a systems solution for you.

For the complete story on all our products call our toll-free product information line at 1-800-962-4287.

Let's make things better.

**"We make creative tools
for creative people."**



PHILIPS

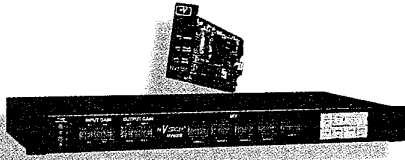

**Nvision
NV1055**

Avoid the staggering expense of "full blown" production mixers loaded with options you rarely use. The NV1055 has the features you use for a fraction of the cost. This module converts two synchronous AES3 inputs into 4 digital audio channels. Rearrange the channels any way you want. Correct inverted phase. Perform stereo or quad mix downs, or voice and music & effects overs. Adjust input channel gain and final mix output levels independently. All the functionality you need for duplication, dubbing and more is available with end-to-end digital processing, offering superior performance for less money than A/Ds, D/As and an analog mixer.

List Prices Vary

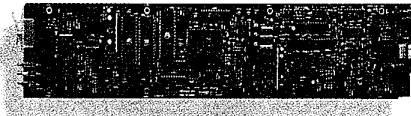

**Nvision
NV1080**

Inexpensive and efficient synchronization network design starts with NV1080 reference generator modules. These modules lock automatically to composite PAL or NTSC. They also lock to an AES3 signal or SDIF-2 word clock at either 48 or 44.1 kHz. Independent of reference input format and frequency, easy selection of 48 kHz or 44.1 kHz. output rates are available with the NV1080 and NV1082. For specialized audio production the NV1083 provides 0.1% slow outputs. These "off-speed" signals, 47.952 kHz and 44.056 kHz, are locked to any of the "on-speed" inputs described. The NV1080 family provides full featured digital audio synchronization at an affordable price. For environments with multiple video formats, the NV5000 family provides simultaneous NTSC, PAL and digital audio reference signals synchronized to a common clock.

List Prices Vary



**Standard Communication
MT830BR/MT830IBR**

The Agile Omni Global Vu Broadcast model MT830BR/MT830IBR is acknowledged as the leading rebroadcast quality satellite TV receiver offering RS250C and CCIR 567 proof of performance. The ease of use, flexibility and remote control capabilities make the Omni Global Vu the most advanced satellite receiver in the commercial TVRO market. Features include C/Ku selection, I.F. bandwidth select, synthesized tuning, three enhanced audio demodulators, and computer remote control allowing you to adjust the receiver remotely or manually by the front panel display. Contact the manufacturer for details on upgrading your MT830 receiver. Contact Harris for the complete specs.

List Prices Vary

Systems



**Nvision
NV2000**

The NV2000 series digital audio transmission system offers an integrated approach to multi-channel audio conversion, transmission and distribution requirements. Designed for telecommunications and audio transmission applications, the NV2000 series can transmit and/or receive ten precisely phased channels of audio over a single coaxial or fiber optic cable. Up to twelve NV2000 system modules may be installed in a single 2RU frame. The rack frame includes a single power supply (110/240 VAC, 50/60 Hz) and power cord.

List Prices Vary

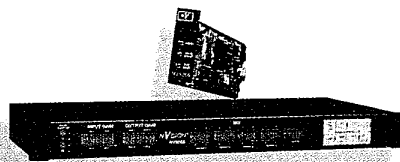

**Nvision
NV9055**

Simplify plant operations with the NV9055 remote control panel. Up to 16 NV1055 modules may be controlled from any location you want. The NV9055 provides an intuitive display and user interface allowing configuration of phase, input, and output gain and channel mix for 32 AES signals (64 audio channels), from the comfort of your edit suite chair. Rapidly configure your audio mix with presets. Card configurations can be stored and recalled for later use and/or use on other cards. A compact key field and rotary knob provides one-handed operation. Displays are easy to read, showing configuration information in an intuitive format. Changes occur in real-time. You hear the result immediately. Recalled configurations are instantaneously applied to the appropriate module.

List Prices Vary



**Standard Communication
MT900 Broadcast Satellite**

From INTELSAT to all DOMSAT formats, in C/Ku and S-band frequencies, the Intercontinental offers RS250C and CCIR 567 proof of performance certification with rebroadcast quality certified video on NTSC, PAL and SECAM signals. The Intercontinental model MT900 features six I.F. band pass filters (36 MHz to 16 MHz), dual audio demodulators offering five filter selections (990 to 75 kHz), and six de-emphasis circuits, with a universal power supply built for rigorous 24-hour-a-day operation. A unique 70 MHz I.F. spectrum inversion circuit allows Ku-band to C-band or vice versa I.F. uplink or downlink turnarounds.

List Prices Vary



THE NAME YOU'LL FIND ON THE WORLD'S BEST LENSES.

**CANON'S IFplus LENSES: J15aX8B IRS/IAS • J9aX5.2B IRS/IAS
J20aX8B IRS/IAS • J33aX11B IAS • J33aX15B IAS**



*Emmy winner for
"Implementation in
Lens Technology to
Achieve Compatibility
with CCD Sensors."*

Canon's IFplus lenses take our great IF technology and makes it better, giving users more of what they want. More quality and more selection. This includes the J15aX8B-IRS/IAS multi-purpose lens; the J9aX5.2B IRS/IAS widest angle; the J20aX8B IRS/IAS with large magnification ratio for ENG, sports and production; the J33aX11B IAS telephoto portable EFP style zoom; and the J33aX15B IAS longest portable style zoom.

IFplus means wider angles at shorter MOD's and the widest angle lens available. It means higher MTF performance (corresponding to 6MHz) an advance that is consistent with the needs of 16:9 formats, where the density of the scanning lines are 20% greater than 4:3. It means reduced chromatic aberration, the result of a new glass material Hi-UD. IFplus also features an ideally angled "Ergonomic Grip" allowing the user to enjoy fatigue-free shooting even over a long period of time. A special protein paint even absorbs perspiration.

When you want the best family of lenses, be sure to look for the IFplus name. We'd like to tell you more. For information, please call 1-800-321-4388. (In Canada call 905-795-2012)

Canon
The Number One Lens

Web site @ <http://www.usa.canon.com>



**Hello, You're On the Air
By: Russ Gentner, CEO
Gentner Communications
Corporation**

Putting calls on the air has been a standard practice for years, and is considered a vital part of programming at many stations. But just how is it done?

First, let's look at a standard telephone line - also known as "POTS", or "Plain Old Telephone System." A POTS phone line, as delivered to a subscriber consists of a pair of wires containing both send and receive audio. At the subscriber's telephone, and also at the phone company, this two-wire circuit is converted to a four-wire path to separate the two sides of the conversion. The device used for this conversion is called a "telephone hybrid," or just "hybrid." (See diagram 1.)

Before Gentner came on the scene in 1981, there weren't many telephone interfaces available. Most stations either designed their own interface or made do with QKT couplers. However, these interfaces were cumbersome, hard to set up, and frequently did nothing to even out the audio levels between the announcer and caller.

Gentner introduced its first hybrid, the SPH-3, in 1982. This "analog hybrid" connected directly to the line with an RJ-11C Jack and contained balanced audio inputs and outputs as well as a "mix" output for recording calls. (A version of this product, the SPH-3A, continues to sell very well.) Other analog products, made by Gentner and

other manufacturers, have been introduced over the years and are still considered a good price / performance value.

Unfortunately, analog hybrids are not without their drawbacks. The most significant drawback is caused by the electrical characteristics of the telephone line. Each call has different characteristics because of the nature of the wires, electrical and atmospheric changes, and other influences. Analog hybrids have a very difficult time adjusting to these different characteristics (known as "complex impedance") and can create feedback if a significantly different line is connected. This feedback is also known as "sidetone" or "line echo" and can be very annoying! If this happens to you frequently, an analog hybrid may not be your best solution for on-air calls.

The secret of achieving "perfect" connections each time is found in three words: Digital Signal Processing (DSP). In a digital telephone hybrid, a DSP takes a sample of the audio being sent down the telephone line and compares it with the audio being received on the line. As it detects line echo, the DSP "builds" a filter - an inverse image of the signal - and cancels out the echo. (See diagram 2.) This filter is usually established during connection to the phone line and remains in place during the call (some digital hybrids constantly observe and modify the filter during the progress of the call). If you hear a "shhh" sound when you're placed on-air, you've been connected to a digital hybrid.

Gentner's first digital hybrid was introduced in 1986; Gentner and other leading manufacturers have continued to improve DSP hybrid technology over the past several years. Gentner was the first to add automatic mix-minus capability to its digital hybrids. (mix-minus refers to the type of console feed required for telephone hybrids; it contains a mix of console audio minus the caller's own audio.) Gentner's automatic mix-minus is also achieved with DSP's; the hybrids sample received audio and compare it with audio on the console. The caller's audio is then removed from the signal going down the line. These "Superhybrids" greatly simplify installation because program audio can be used as a feed source. (Gentner's G2500, G3200, and TS612 are examples of automatic mix-minus devices.)

A new challenge in telephone hybrids is now being tackled: interfacing to digital telephone lines and systems. Gentner has made the first step with its TeleHybrid, a device that connects between a digital telephone and its handset. The TeleHybrid uses a special echo canceling circuit to match audio equipment to the "four-wire" domain of the telephone handset.

To the future of telephone interface products: it's no secret that as telephone systems evolve around the world, the interface equipment will follow. Our goal, as always, is to make it easy for you to put people on the air. We welcome your ideas!

Russ Gentner is the CEO and President of Gentner Communications Corporation, Salt Lake City, Utah. Gentner is a leading manufacturer of telephone and talkshow products, audioconferencing systems, and transmitter remote controls.

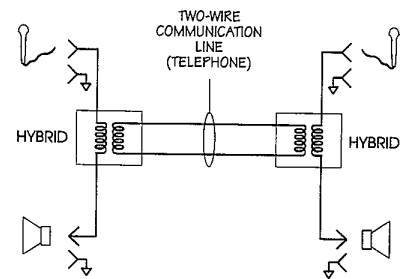

Diagram 1

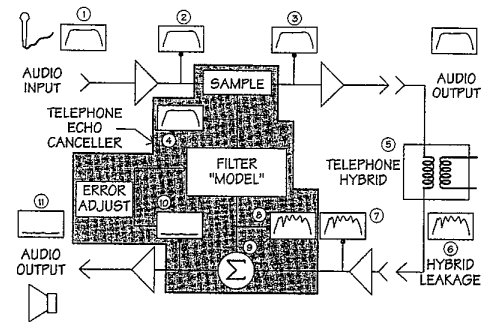
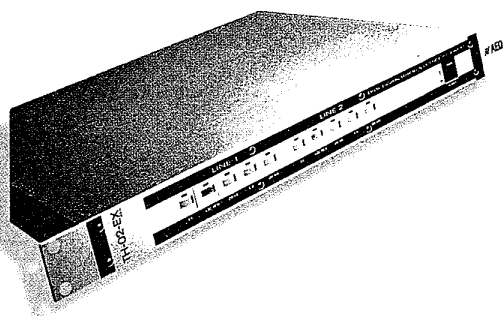

Diagram 2



**AEQ
TH-02 EX Digital Telephone Hybrid**

A superb digital hybrid provides automatic phone line adjustments, and has frequency extension as a standard feature. Compatible with most extenders in the market. Works with one phone line; when the second phone line (optional) is in use, it provides multiplexing capabilities so that the on-air personality and two callers may establish an on-air conversation. When the multiplex function is off the unit provides a separate output per line. Offers ease of operation and faultless on-air performance. Ideal companion to work with AEQ Portable Digital Line Extender TLE-02.

\$1,686.00 List Price

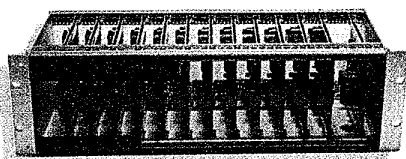

**Circuit Werkes
AC-12 Rack-Mount AutoCoupler Bay**

Get up to a dozen full-featured, very affordable, autocouplers in 5-1/4 of rack space. The AC-12 has two bridging, balanced input, switchable, busses for audio distribution. Optional AC-1B cards have individual, 600 ohm, bi-directional audio connection for special feeds and many features found on the couplers too. Cards can be removed or installed while powered without affecting the others. You'll be pleased at how much space (and headaches) you can save with the AC-12.

**\$329.00 List Price for AC-12
\$155.00 List Price for AC-1B**

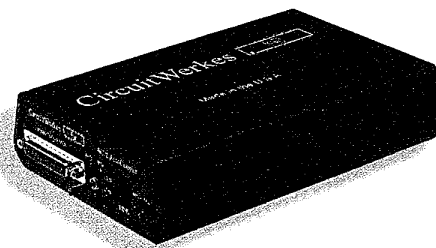

**Circuit Werkes
AC-2 Telephone AutoCoupler**

The AC-2 autocoupler's automatic features make it ideal for a variety of telephone tasks such as listen lines, concert lines and remote broadcasting. Dry relay contacts can interface almost any external device. An inhibit input allows a cart machine, etc. to re-cue before answering. Comes ready to auto-couple right out of the box. Just plug it in and go. Its extra features make the AC-2 among the most versatile coupler available.

\$199.00 List Price



**Conex
DT55 Telephone Remote Control**

The DT55 is a state of the art telephone access remote control and status monitoring system. The DT55 answers a phone line, accepts a user access code, then allows remote control of ten SPDT relays and remote monitoring of ten external switch contacts or logic levels. The DT55 is simple to understand, simple to install, secure and effective. Some of the features of the DT55 include: magnetic latching relays, miniature screw-clamp terminals for easy connection, switch selectable access code, plug-in ICs for easy maintenance.

\$339.00 List Price

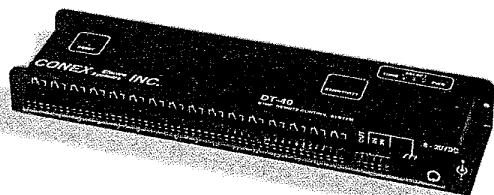

**Conex
DT40 DTMF Remote System**

The DT40 DTMF remote control system accepts DTMF tones from an audio line, receiver, or other source, accepts a user access code, then allows remote control of sixteen SPDT relays. The relays can be momentary, latching, or interlocking. The DT40 is easy to understand and can be connected in minutes. Features include: magnetic latching relays, miniature screw-clamp terminals for easy connection, plug-in ICs for easy maintenance.

\$399.00 List Price

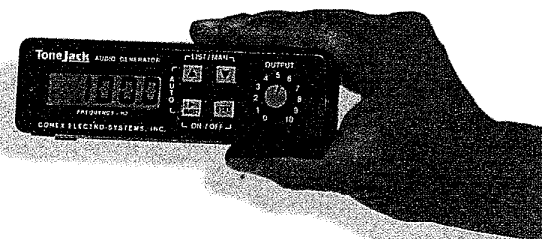

**Conex
RX-11**

The RX-11 ToneJack® is a compact, battery operated, frequency generator capable of generating sine and square waves of very accurate frequencies from 1 Hz to 29,999 Hz. It is useful in testing the frequency response of systems, filters, tone sensors, etc. In addition, the ToneJack® can perform other functions that make audio testing easier and faster including: tone burst, sweep generation, user programmed frequencies, and computer control.

\$229.00 List Price



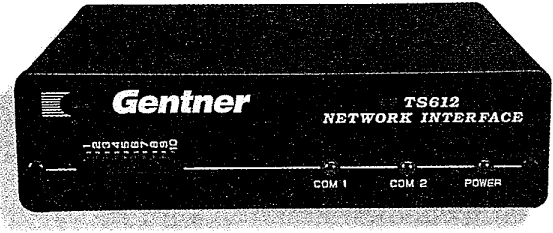
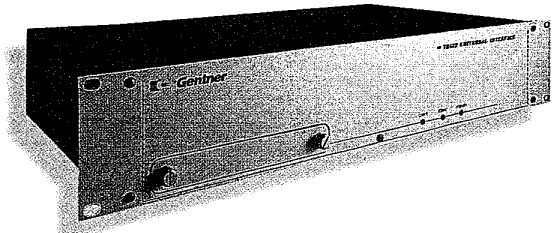

**Gentner
TS612 Universal Interface**

Now you can have all the features of the TS612 and the convenience of connection to your 1A2 Key system. The Universal Interface provides the link to your 1A2, providing line status to both the 1A2 and the TS612 to prevent accidental pick-up of calls. The Universal Interface may also be installed "upstream" from a digital key system to provide line status to and from a networked TS612 system.

\$1,295.00 List Price

**Gentner
TS612 Network Interface**

Now you can share twelve phone lines among several TS612 systems. The Network Interface™ provides communication between the TS612 system mainframes to indicate whether lines are in use by another studio. Active lines are locked out from other studios, but may be put on hold by one studio and picked up by another. Up to 10 mainframes may be linked; one Network Interface is required for each "link."

\$495.00 List Price

Telephone Interface

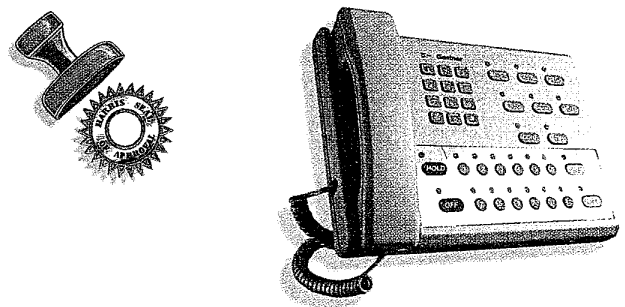

**Gentner
Multi-Studio / Multi-Station TS612 systems**

Gentner can provide a complete telephone system for your operation - up to 120 phone lines and 10 TS612 systems may be connected. Phone lines may be dedicated, shared, or switched around as necessary. PC control of telephone lines plus the convenience of the TS612 will give you the flexibility you need in your LMA or combo operation.

\$2995.00 List Price for 6-line
\$3990.00 List Price for 12-line

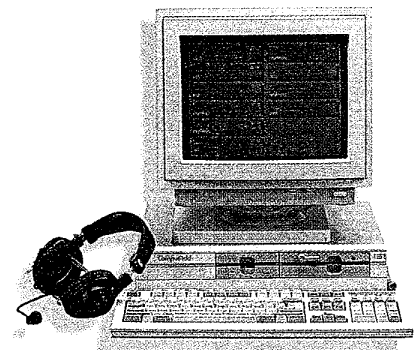

**Gentner
TS612 ScreenWair™**

This call screening package "talks" to your TS612 system to give you real-time status of calls. The screener and host can see at a glance who is waiting, how long they have been waiting, and what they want to discuss. Callers are color-coded to indicate if they are on hold, screened, or on air. The ScreenWair™ package includes DOS based software, a breakout box with a telephone handset, and cables to connect ScreenWair™ to your PC and the TS612 mainframe. You'll need to provide a PC (386 or higher preferred) and two VGA monitors. Computer not included.

\$595.00 List Price

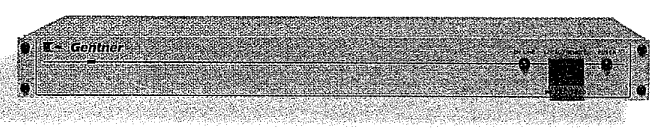
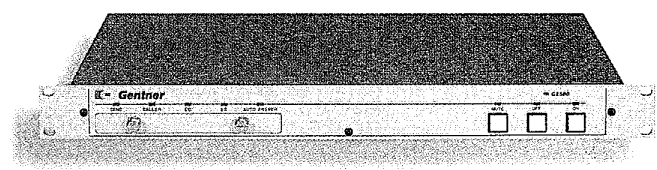

**Gentner
G2500 Super Hybrid™**

The G2500 SuperHybrid™ does not need special console outputs...it generates its own "mix minus" feed from program audio. This digital hybrid is ideal for use with older consoles, in production rooms or TV audio booths, newsroom modules, etc. Multiple units can be linked for easy conferencing of calls. The unit is RS-232 controllable and can be used with any voltage worldwide.

\$1,995.00 List Price

**Gentner
VRC2000**

The original dial-up remote control system! The VRC2000 provides 16 channels each of metering, status, and command (command channels have dual outputs), plus the ability to control the system with either data or DTMF tones. Automatic correction, alarm reporting, time-of-day functions, and synthesized voice make the VRC2000 a favorite among engineers everywhere. Setup software and telephone line surge protector included.

\$2,995.00 List Price



Telephone Interface

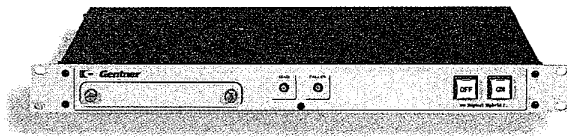

Gentner Digital Hybrid 1A™

If you have trouble with inconsistent telephone lines, the Digital Hybrid 1A™ can help. It automatically nulls to the telephone line and continues to monitor line conditions during the call, "fine tuning" its null for optimum performance. The Digital Hybrid 1A is an excellent tool for newsrooms, production rooms and on-air applications.
\$1,199.00 List Price

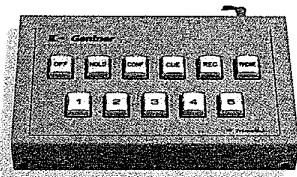

Gentner TeleSwitch™

If you just want the convenience of bringing up to 5 phone lines to a single point for connection to your telephone hybrid, the TeleSwitch™ is for you. It provides plug-in connection of up to 5 phone lines, "loop through" connections to your business phone system, hold (with hold audio of your choice), and the ability to select a line either to your telephone or your analog or digital telephone hybrid.
\$995.00 List Price

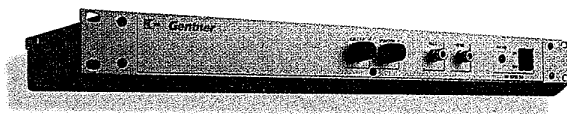

Gentner SPH-3A

An inexpensive analog hybrid, the SPH-3A has proven itself over the years to be a dependable, useful device. It provides front panel caller level control and a two-watt power amplifier, making it ideal for use in newsroom modules, dedicated guest lines, or home studios.
\$499.00 List Price



Gentner TC100 RTT

More than just a telephone coupler, the TC-100 provide sufficient hybrid null to use it on-air if desired. The TC-100 auto-answers after a selectable number of rings (1 to 8), provides momentary and latching closures upon answer, and has an internal DTMF decoder which provides individual outputs for received DTMF tones.
\$629.00 List Price



Gentner Couplers

Just need to get audio on or off the phone line? Gentner couplers provide the interface between the line and your equipment at minimal cost. The Hybrid Coupler, a passive device requiring no power, operates at telephone line levels with two modes of operation: seize, which disables your telephone, or tap, which keeps the telephone set active. The Auto Coupler amplifies signals to line level and offers automatic answer and disconnect, or manual connection.
Hybrid Coupler \$189.00 List Price

Gentner Microtel™

A long-time favorite of news reporters, sportscasters, and television production crews! The Microtel™ is a battery-operated device that connects to the handset cord of your telephone, allowing you to use your microphone and headphones to talk over the phone. Numerous input and output jacks allow you to record telephone audio, send feeds down the line, or mix external audio with the telephone audio. An optional wall adapter power supply is available.
\$259.00 List Price



Gentner SPH-5

Gentner's SPH-5 combines great sounding caller audio with the best performance available from an analog telephone hybrid. Like the Digital Hybrid II, it offers the convenience of record and cue functions. The SPH-5 is ideal for small to mid sized radio stations who want to use both live and delayed calls on-air.
\$879.00 List Price



Gentner Digital Hybrid III™

Gentner's Digital Hybrid III™ combines excellent telephone audio quality with operational features that make on-air phone calls easy. The Digital Hybrid III provides a quiet connection to the phone line with automatic nulling, automatic re-null on selection of a new line and send AGC. The REC and CUE buttons make it easy to talk with a caller off-air (and activate your tape machine for recording calls).
\$1,895.00 List Price

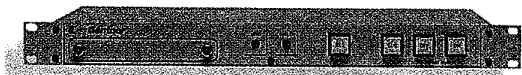



THE FIG LEAF
4000 B.C.

FITS ALL SIZE
NAKEDNESS



THE TUBE SOCK
1946

FITS ALL SIZE
FEET

THE TS612
1996

FITS ALL SIZE
BROADCAST FACILITIES



It seems those things that develop the ability to adapt are the ones time treats most kindly. That's why the TS612 will be around for a while. No matter what size station you operate, or even how many stations

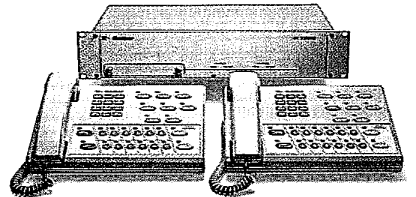

you'd like to network, the TS612 has the versatility to adapt to your needs. Regardless if you're a group owner, LMA, a large station or a single broadcaster, this system is prepared for any contingency. Need anywhere from 6 to 120 lines? No problem, just network multiple systems together. Want crystal clear audio for conferencing calls? That's what the dual superhybrids are for. Have a bunch of stations operating from the same facility? You can maintain each station's identity (even those with shared lines) with hold audio, dedicated lines and call screening. Go on or off air at the same time, expand to a second studio with just an additional control surface, have it calculate your taxes (well, OK, we're still working on that one). The point is, if you're looking for a system that's changing and adapting as fast as you are, you've found it. For more information, give us a call.



1-800-945-7730
OR 1-801-975-7200

Telephone Interface

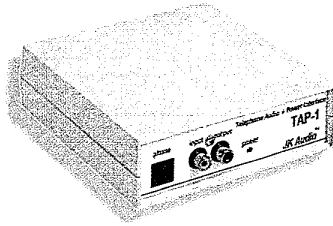

JK Audio TAP-1™

Telephone Audio + Power Adapter. Use TAP-1™ when you need to put a telephone on a film or TV studio set and you want to get audio in and out of the telephone. TAP-1™ powers a telephone with 48 VDC and breaks tip and ring down to separate RCA input and output. Adjustable input and output level and hybrid null. High quality hybrid circuit suitable for laboratory use.

\$245.00 List Price



JK Audio QuickTap

Handset Audio Tap. Simply connect QuickTap between the handset and the base of your telephone. You can still talk over the handset, but now the audio signal from both sides of the call is available on a mono mini 1/8" jack for output to your mixer or amplified speaker. Transformer isolated for a low noise, clean signal.

\$59.00 List Price



JK Audio QuickTap™ IFB

Handset IFB Tap. Simply connect QuickTap™ IFB between the handset and the base of your telephone, or just replace the handset altogether. The audio from the telephone is available on a mono mini 1/8" jack with a volume control. The 1/8" jack will drive an IFB earpiece directly at nominal levels. The transformer isolated 600 ohm balanced XLR output will get the telephone signal to a distant amplifier or mixer. Pocket sized, completely passive, no batteries or AC needed.

\$125.00 List Price



JK AUDIO THAT-1™

Telephone Handset Audio Tap. Simply connect THAT-1™ between the handset and the base of your telephone. You can still talk over the handset, but now the audio signal from both sides of the call is available on an RCA jack for output to your mixer or amplified speaker. THAT-1™ also lets you send audio into the telephone. The Handset / Line In button chooses between talking on the handset or sending a signal into the input RCA jack.

\$150.00 List Price

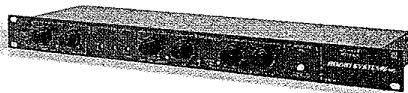

Radio Systems TI-101

Still affordable and practical analog telephone hybrid. The TI-101; now from Radio Systems.

On-board EQ, null adjust, and send limiting have made this the industry workhorse for a single-line telephone interface.

\$495.00 List Price

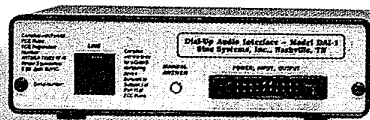

Sine Systems DAI-1

The DAI-1 Dial-Up Audio Interface provides an array of features seldom seen in the industry. It combines an autocoiler, a dial-out alarm, two AGCs, a DTMF-operated equipment controller and an audio switcher into one affordably-priced device. Common applications are emergency broadcasts and "dial-up" remote broadcasts when the studios are unmanned. Several optional accessories are available including the DAI-RP relay panel/installation kit.

\$928.00 List Price

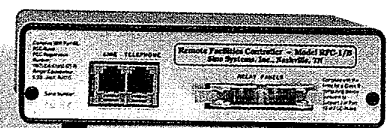



TELOS SYSTEMS

100 Delta® Digital Hybrid

The 100 Delta® produces the most natural sounding, two-way conversation even on the most difficult telephone lines. It achieves superior trans-hybrid loss for full-duplex audio as well as consistent output level. Smart digital gain control and digital dynamic equalization offer the highest level of caller intelligibility. In addition, callers can be monitored through open speakers without feedback. Integrates with the Telos family of accessories as part of a complete talk show system.

\$2,180.00 List Price

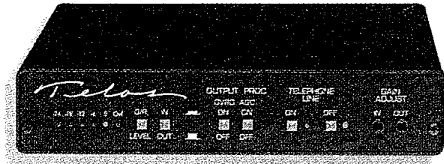

TELOS SYSTEMS

Telos ONE® Digital Hybrid Telephone Interfaces

The ONE® presents superb digital telephone hybrid performance to broadcast applications. All hybrid functions, gain control, and filtering are completely in the digital domain. Fast, automatic digital nulling allows smooth, natural, simultaneous conversation. Three versions: A single hybrid, in either a compact modem case or standard rack mounting chassis, and the ONE plus ONE dual hybrid with a built-in mix-minus system.

\$1,050.00 List Price

Telephone Interface

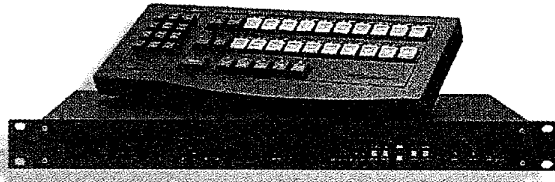

TELOS SYSTEMS

ONE-x-SIX Talk Show System

The ONE-x-Six has all the equipment needed for talk show programming. A single rack mounting unit houses both a Telos ONE digital hybrid and a six-line broadcast phone system. For system control, the ONE-x-Six is packaged with our desktop switch console. The ONE-x-Six is very easy to install and provides clean, quiet, and reliable switching of multiple telephone lines. With the ONE-x-SIX, successful talk shows sound great and are easy to produce.

\$2,180.00 List Price

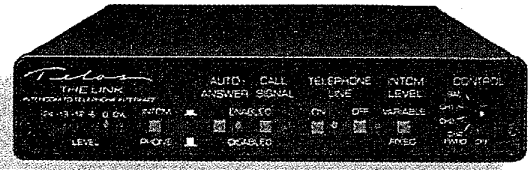

TELOS SYSTEMS

Link® Intercom-to-Telephone Interface

The Telos Link® solves the problem of interconnecting production intercom systems with dial-up telephone lines. Anyone with access to a telephone, even a cellular phone, can instantly and automatically be connected with your intercom. Digital auto-nulling hybrids on both the telephone and intercom audio paths allows connections to be made without the usual gain and feedback problems while maintaining natural, full-duplex operation. The result is significantly improved communication capability.

\$1,680.00 List Price

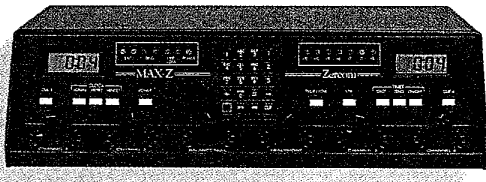

Zercom

Max-Z Remote Broadcast Console

The Max-Z is a remote broadcast console that provides maximum flexibility, utility, and above all, audio quality. A short list of the many standard features includes 4 high or low level mic inputs (mic or line), 4 headphone outputs, modular telco jack, tone or pulse touch pad dialing, carrying case, built-in rechargeable battery and charger, clock, stopwatch/ timer, VU meter, and 2 cue channels. Power supply is external to reduce noise.

\$1,225.00 List Price

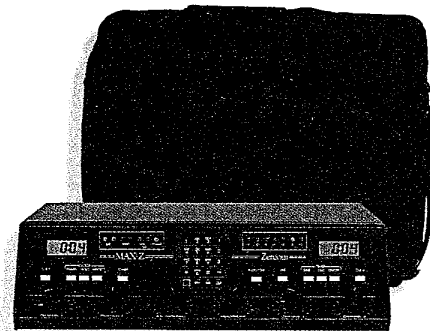

MAX-Z w/optional case

Zercom

Max-Z II Remote Broadcast Console (not pictured)

If your needs are for the same quality as the Max-Z, but in a smaller package, check out the Max-Z II. Half the facility as the Max-Z, with the same world class quality. 2 high, or low level inputs (mic or line), 2 headphone outputs, and cue channel. Almost everything else is the same as its big brother "Z." Includes carrying case. Power supply is external to reduce noise.

\$750.00 List Price



The hybrid you put between these cables is your most important connection for successful talk shows

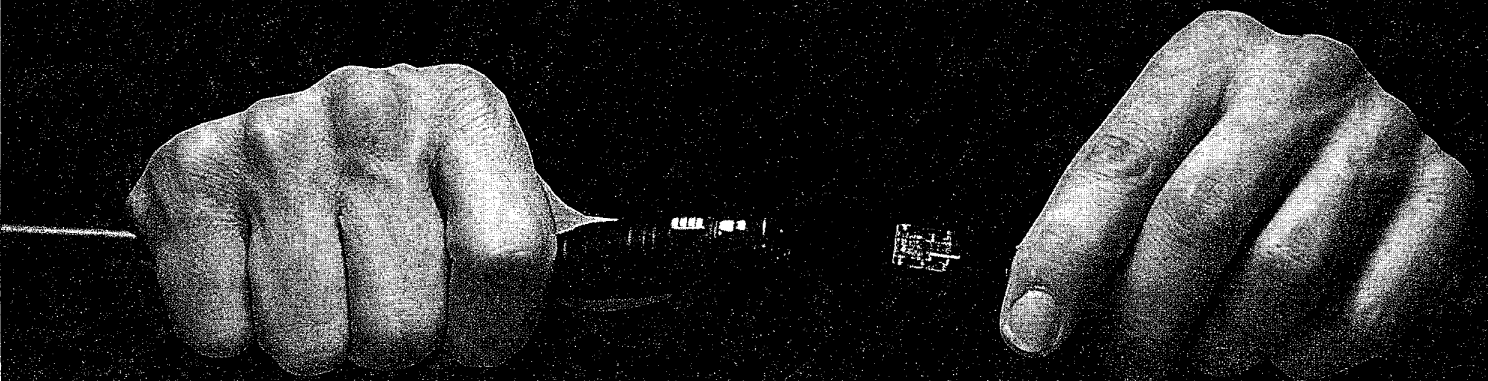

Listeners and programmers agree.

The quality of your talk shows and call-ins are as critical as who you have talking.
And stations who are most serious about their sound and ratings use Telos.

Telos' digital hybrids have earned their reputation for exceptional performance.
In addition to full-duplex audio, Telos hybrids achieve consistent levels from caller to caller.

Our full range of products includes the top of the line Telos 100 Delta with a digital dynamic equalizer so advanced you won't find it anywhere else. When it comes to complete talk-show systems, you don't have to spend a lot to get Telos quality and features.

Let Telos connect you to your callers. Isn't it time you experienced great phones?



only from
Telos



**ATI
NG-1™
Audible
Noise
Generator**

The NG-1 Audible Noise Generator from ATI provides white or pink noise outputs, pulsed or continuous operation. A useful tool for broadband level matching of multiple microphones in studios, teleconferencing rooms and A/V installations. The NG-1 is an excellent source of background masking noise for injection into office background music systems or via direct acoustic radiation into small rooms.

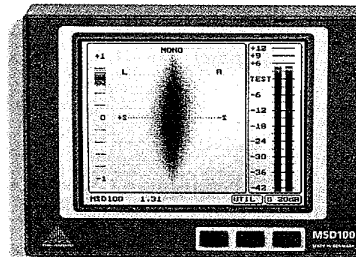
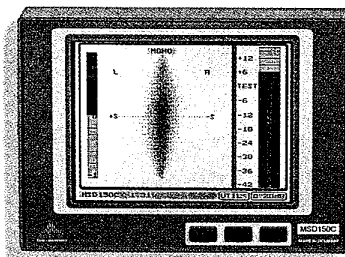
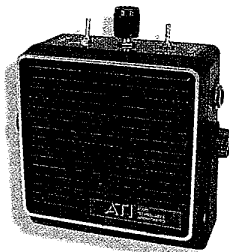

**DK Audio
MSD 150C
MSD 100**

See what you hear...Hear what you see!
Dk audio master stereo displays combine a level meter (ppm and vu scales) with a phase correlation meter and audio vectorscope in one compact (10x7x16in.) package. Available in 2 channel (Analog or Digital inputs) and 4 channels versions (digital), the msd series includes monochrome and color models. Optional FFT1024 band spectrum analyzer available.

Built-in speaker or can drive external amplifiers and speakers. Powered by an internal 9VDC battery (not included) for total portability or a UL listed AC/DC wall adaptor for continuous use. Rugged, compact ABS enclosure with swivel type mount.
\$199.00 List Price

Test Equipment

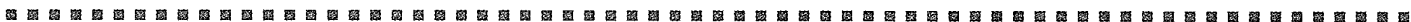

Lindos LA100

The Lindos LA100 Audio Analyser, comprising the LA101 oscillator and the LA102 audio measuring set, is renowned throughout the industry for its easy to use automatic sequence testing. With three key strokes, the system will perform a full evaluation of a stereo audio system in under a minute. A further keystroke will enable printing to virtually any type of printer, and software is available to allow results to be downloaded to a PC or Psion 3a computer. A comprehensive set of test sequences is included, each of which is freely editable to meet every conceivable application. The LA100 can be set to respond automatically to test signals, so that data can be gathered in remote locations, or at night, without an engineer present. The LA100 also operates in manual mode, providing the ideal tool for aligning, maintaining and repairing all types of audio equipment. Measuring distortion to <-86dB (.005%) and noise to better than -100dB (-105 dB typical) means that even the latest generation of digital equipment can be analyzed. The LA100 was designed to meet the needs of the busy service engineer. It is still the only pro-audio analyzer to offer set AC/battery operation, and its robust construction can take the knocks of life in the field.

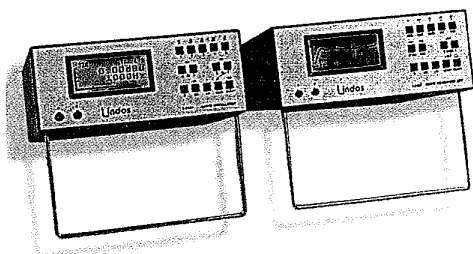

**Potomac
Audio Analyzer AA-51A**

The AA-51A is a multipurpose, precision audio analyzer which was designed specifically to enable the measurement of critical audio parameters in terrestrial broadcast transmitter facilities. This instrument measures audio level, total harmonic distortion, intermodulation distortion, frequency response, wow & flutter, stereo signal phasing, left channel/right channel amplitude ratio, and frequency. The AA-51A exhibits excellent RF shielding and is rugged, portable, accurate, simple to operate, and suitable for extended field use. AG-51 makes for a complete system.
\$3,969.00 List Price

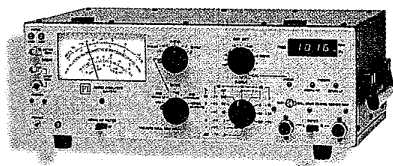

**Potomac
Stereo Audio Generator AG-51**

The AG-51 produces low distortion sine wave signals from 20 Hz to 200 kHz, a 3.15 kHz fixed frequency wow & flutter test signal, and an intermodulation test signal of 60 Hz & 7 kHz at a 4:1 ratio. Output signals are simultaneously available at levels of up to +20 dBm at separate left and right output ports. Outputs may be selected for left only (L), right only (R), left and right in phase (L+R), or left with right in 180° opposition (L-R). Outputs are fully balanced (or unbalanced) at a source impedance of 600 ohms (or 150 ohms).
\$3,525.00 List Price

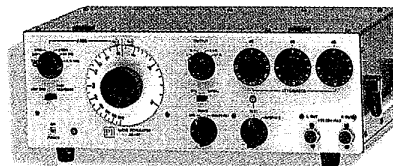

Major-League Pitch Control

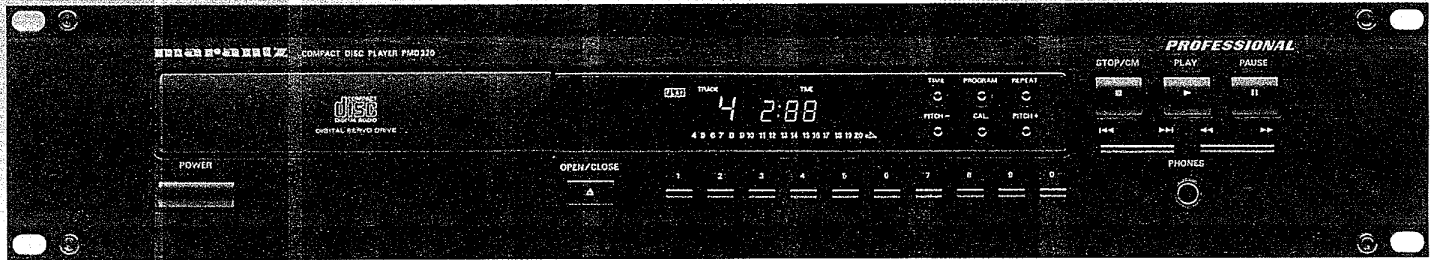

**Both the PMD320 & PMD321
Pitch Control CD Players offer:**

- $\pm 12\%$ pitch control in .1% increments.
- CAL key for quick speed calibration.
- Fader Start Trigger input so an engineer or DJ can start a track simply by bringing up the associated fader.
- All-Metal 2U rackmount chassis.
- 32X oversampling and 4th-order noise shaping.
- Cue and review keys for audible searching.
- Connection to the Marantz CD-R system via the IEC958-II digital interface for convenient digital copies of both music and track information.
- 10-key direct track access.
- Optional wired remote control. RC-5 bus for IR or third-party remote.

The PMD321 adds:

- Cue-to-music feature for starting a track from the first bit of musical information, rather than at the pause or subcode start points.
- +4 dBu balanced XLR outputs.

Marantz PMD320 & PMD321

Whether you need your music high and tight or low and slow, the Marantz PMD320 & PMD321 CD players are certain to brush you back. That's because the PMD320 and PMD321 can change the speed and pitch of CDs.

Both models are pro-level CD players and ideal for any broadcast environment. Housed within a metal 2U rackmount chassis the unit is durable and resistant to shock. The 10 digit key pad eliminates the possibility of any fouls when directly accessing a track. To insure a home run both models have RCA digital-out and fader start capability. The PMD320 goes that extra inning with balanced XLR outputs and a cue-to-music feature.

So when your music needs a major-league change-up, count on a major-league CD player: Marantz.

***Step up to the plate and call
Harris for more information!***



marantz®

Superscope Technologies, Inc.

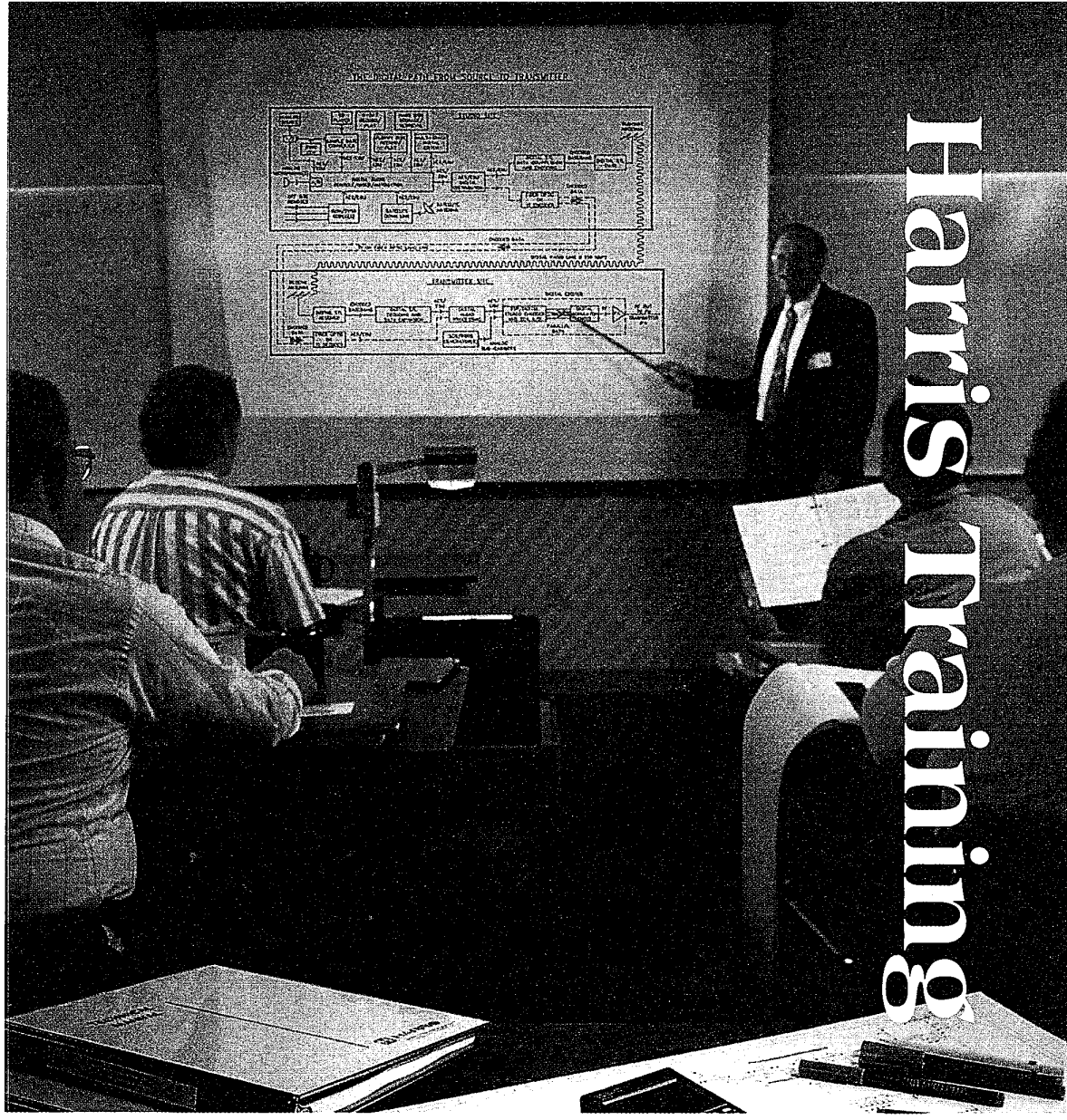

Harris Training



Harris Training Education and Training: Our Philosophy

Proper operation and maintenance of broadcast equipment impacts its long-term reliability. Our philosophy is to provide engineers with the skills and knowledge required to ensure maximum equipment longevity and performance.

The Harris Broadcast Technology Training Center

Harris is the only transmitter manufacturer to sponsor a dedicated Technology Training Center. Since its inception in 1975, more than 2,700 broadcasters from around the world have participated in our RF training programs. Each year we offer over 30 regularly scheduled programs for engineers at all levels of experience.

To meet special needs, we also design customized training programs for broadcasters which can be taught at Harris or at any customer site.

General Training

General RF training programs are normally offered two times a year at the Center and include:

- AM Transmitter Workshop
- FM Transmitter Workshop
- TV Transmitter Workshop
- RF Circuits I
- RF Circuits II
- RF Circuits III- DTV
- UHF Workshop

Specialized Training

Programs focusing on specific families of Harris radio and television transmitters are also offered. This "hands-on" training allows engineers to perform actual procedures and solve real-world problems associated with operation, maintenance, troubleshooting and repair.

Beyond Training: An Education

More than a decade ago, Harris joined forces with John Wood Community College in Quincy, Illinois, to offer a fully accredited two-year program in Broadcast Technology, leading to an Associate's degree and SBE certification.

Since 1979, more than 300 students have graduated from this program, and over 90 percent of them have been employed in the electronics industry within 90 days of graduation. Others have transferred to four-year colleges and universities to complete Bachelor of Science requirements.

In addition, Harris offers an annual two-week training program for broadcast engineers from developing nations under the auspices of the United States Telecommunications Training Institute. Since 1983, over 300 engineers from 65 countries have participated in this joint Harris/USTTI program.

Our Commitment

In addition to offering quality products designed to deliver years of value, Harris is committed to providing unparalleled training for operating and maintenance personnel today and supporting broadcast technology education for tomorrow.

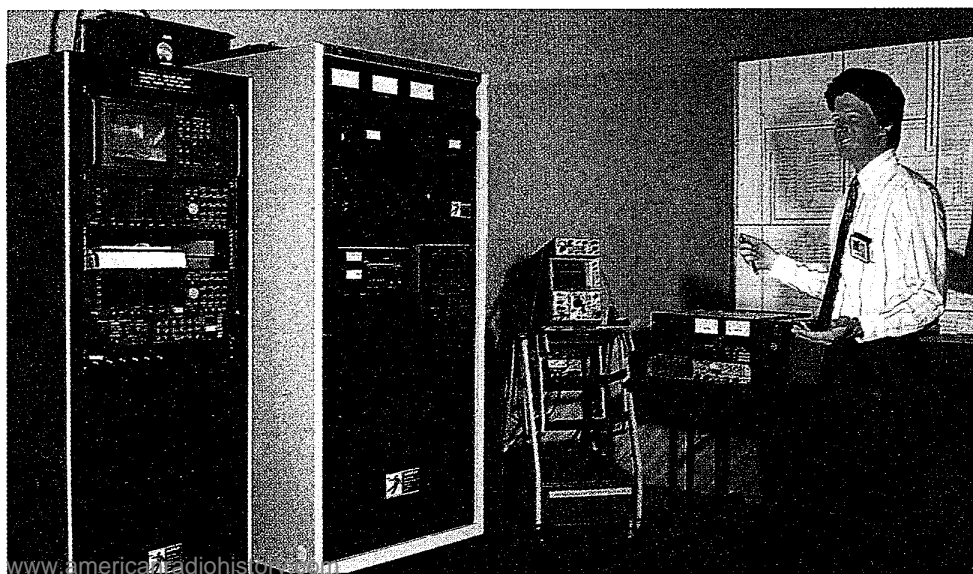
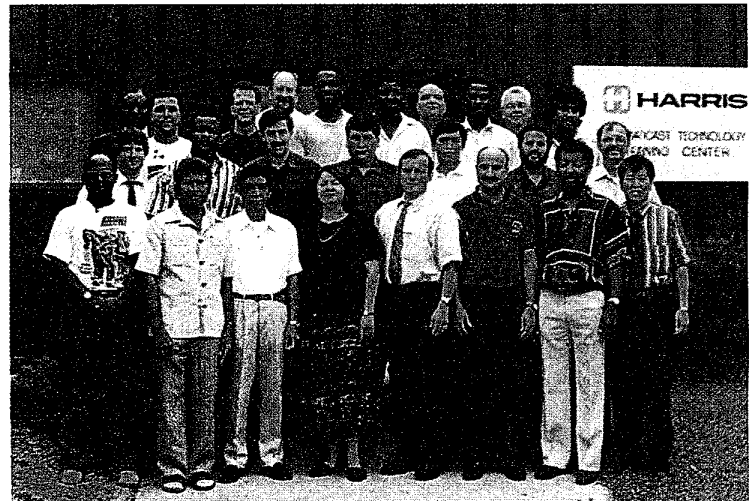

Transmitter Solutions

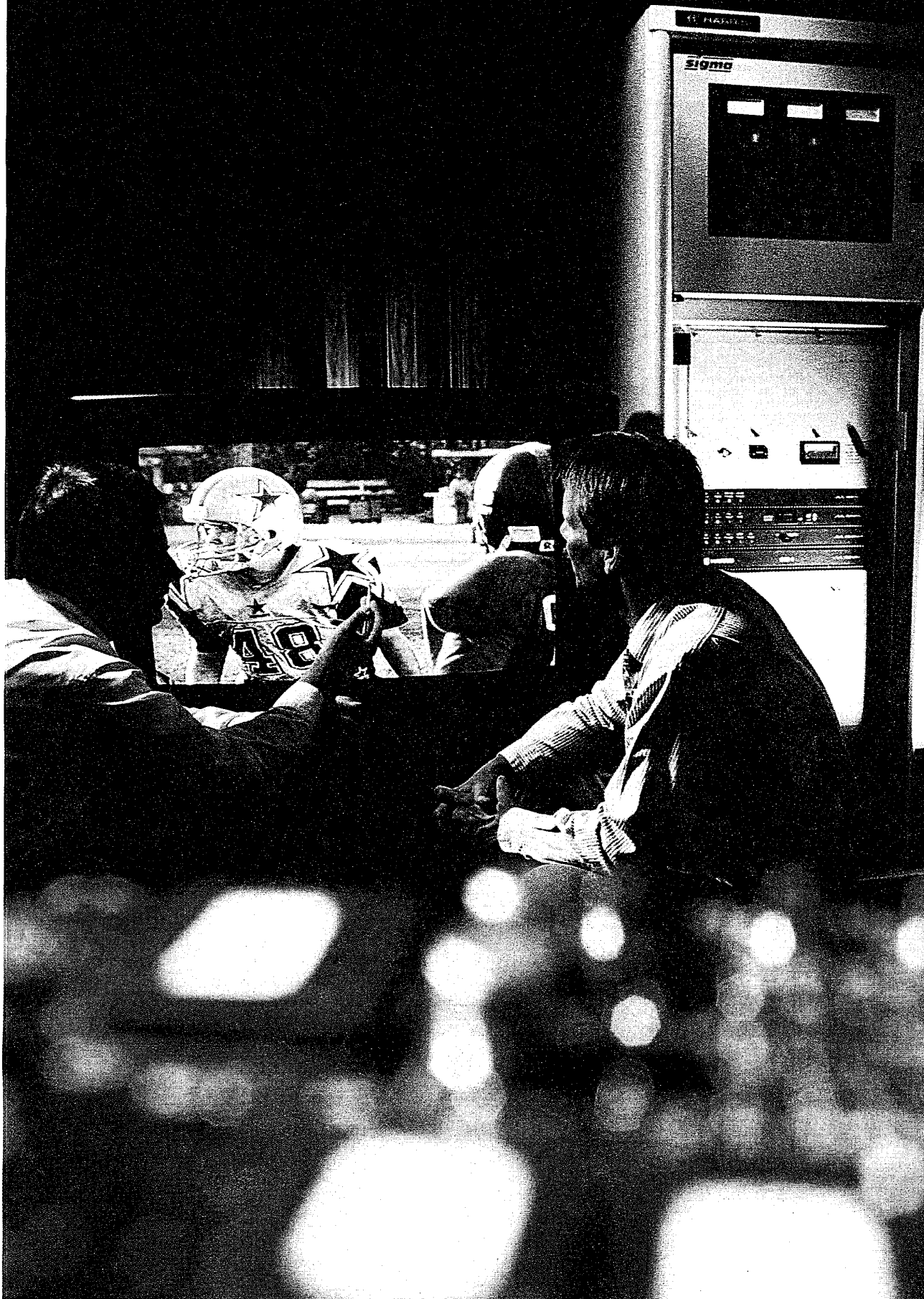

A new world of transmitter solutions

You are planning to invest in a transmitter. You know you will depend on your transmitter for 15 or more years, so you want to make certain it meets some very stringent requirements. You want your transmitter to be reliable with a design that will keep you on the air under the most extreme environmental conditions. You want your transmitter to provide the performance quality your listeners and viewers have come to expect. You want your transmitter to be engineered for straightforward operation and maintenance by a technical staff that is already taxed by rigorous demands. You want your transmitter to be future-ready, able to accommodate to evolving technologies. And you want your transmitter to be cost-effective for the long term.

Harris would like to provide your transmitters.

Since we began manufacturing our first radio transmitters 60 years ago, we have invested heavily in research and development. Our aim has been to apply the best available technologies to meet broadcasters' requirements. Over the years, our work has led to more than 50 major technical developments, including many world standards. The benefit to you is a range of transmitters that provide unrivaled advantages throughout the broadcast band.

Breakthroughs with real-world benefits

In AM, Harris has invented every modulation technology used in modern medium wave transmitters. One breakthrough — Digital Amplitude Modulation that is used in DX Series Transmitters — has made it possible to extend the reliability and other benefits of solid state to 2,000 kilowatt transmitters. DX transmitters also practically pay for themselves in reduced power costs; provide FM-comparable performance, and redefine reliability with such features as RF power amplifier modules which have achieved a cumulative MTBF exceeding 6 million hours.

In FM, Harris has developed technologies that have made the uncompressed digital audio air chain a reality. Harris' DIGIT Digital FM Exciter has become a world standard: in the first three years after its 1993 launch, approximately 95 0 were delivered. DIGIT also is the first exciter with an AES3 input. Harris' CD LINK, an STL that transports uncompressed digital audio over the 950MHz frequency in the allotted 300kHz channel, is another major first. Harris also has led the way in mid-power solid state FM transmitters that are available for the price of vacuum tube models with its Platinum Z line.

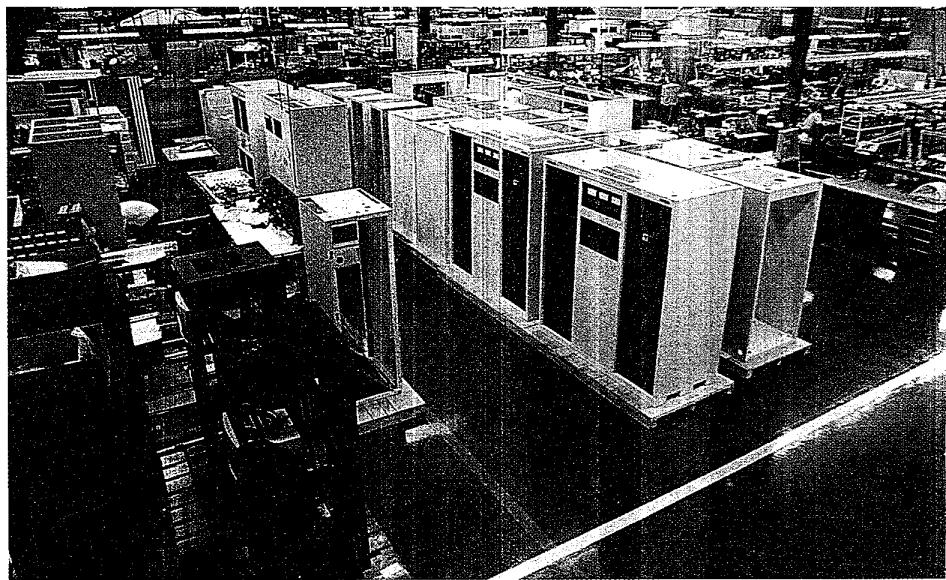

Harris operates ISO 9001-registered transmitter factories in the U.S. and UK. The main Quincy, Illinois factory occupies 125,000 square feet.

In VHF, Platinum Series solid state transmitters have established themselves as the VHF reliability leader. Platinum's FET solid state RF power amplifier modules have achieved a MTBF exceeding 500,000 hours — the highest in the industry. Platinum transmitters are the only VHF transmitters backed by a full 5-year warranty.

In UHF, Harris has developed a complete range of transmitters, including solid state, IOT/klystron IOT, and depressed collector klystron models. Harris UHF transmitters have been proven to be capable of field upgrade for digital transmission.

In Digital Television, Harris developed the world's first commercially-viable 8VSB exciter to meet ATSC requirements for the FCC-adopted DTV transmission standard. Harris also provided equipment for the U.S.' first DTV television station. Harris offers a complete range of solid state digital television transmitters in the VHF and UHF bands, as well as tube transmitters for the UHF band.

Quality manufacturing

Harris has the greatest manufacturing capacity of any broadcast transmitter manufacturer. Its Quincy, Illinois, factory is the largest, with 125,000 square feet, and a second Quincy factory supports high-power AM manufacturing and test. We also operate a large factory in Cambridge, UK. To ensure transmitters are manufactured under the most exacting conditions, Harris has voluntarily sought and achieved ISO 9001 Quality Standard registration for both its U.S. and UK manufacturing operations.

Long-term support

At Harris, we offer more than transmitters that provide significant benefits and are manufactured under the highest quality standards. We also provide unrivaled long-term support. Our broadcast customers can call on us for 24-hour technical service, field service, around-the-clock parts, and repair services. Harris also is the only transmitter manufacturer to sponsor a training center with a complete complement of general training classes as well as Harris product courses. Customized training also is available.

Since our founding in 1922, we have worked to offer innovative solutions to broadcasters. If we can be of service, please contact us.

Harris solid state transmitters have achieved new levels of reliability in the field. Platinum VHF transmitters are the first solid state VHF transmitters to be backed by a full 5-year warranty.

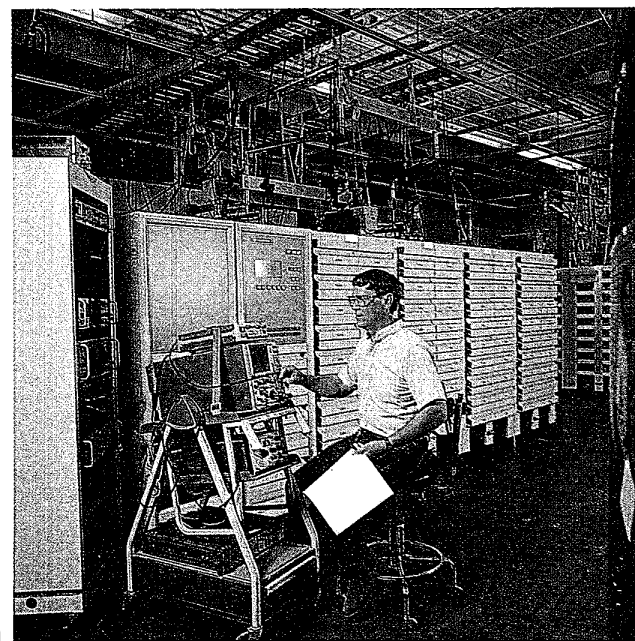

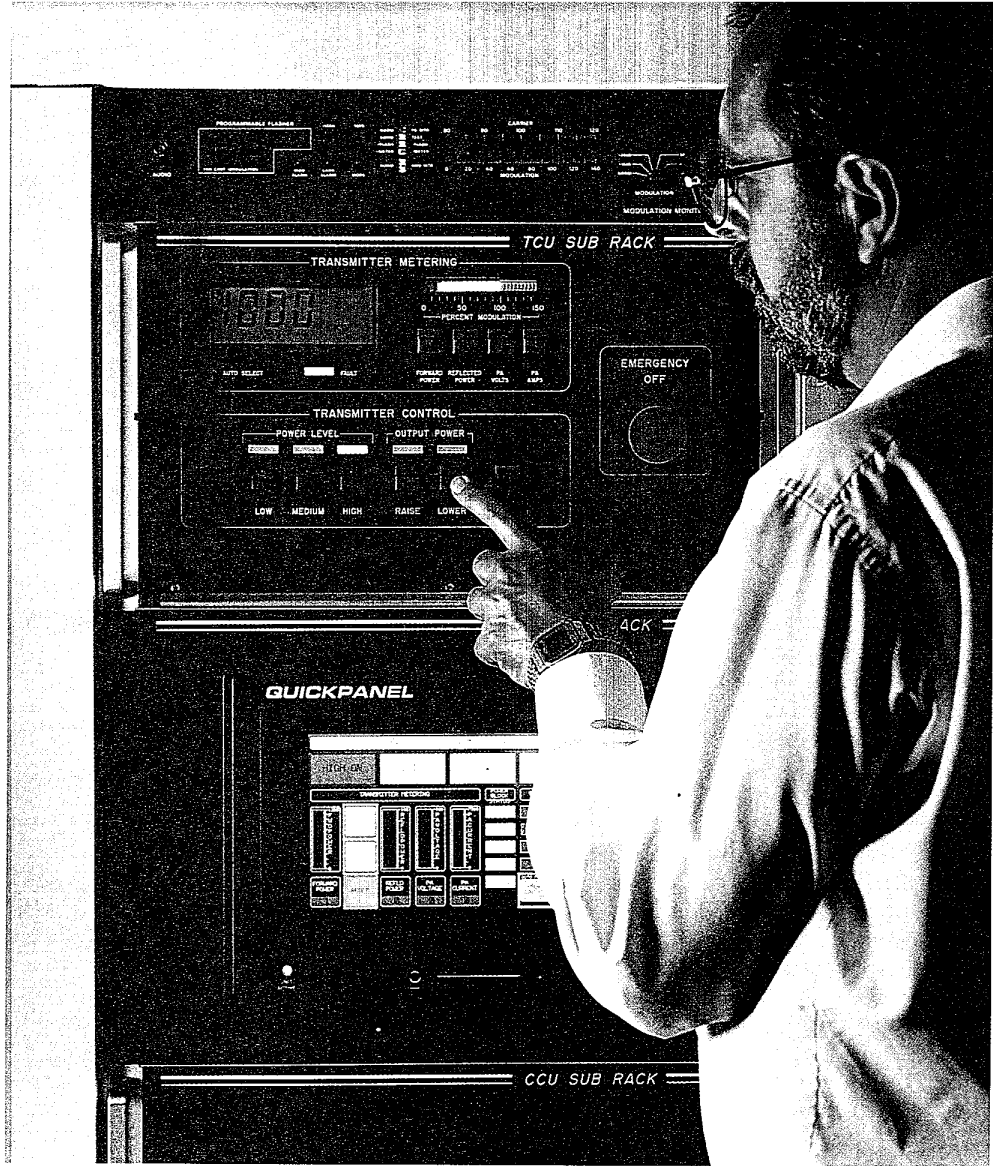

Digital Amplitude Modulation has made it practical to provide super-power solid state medium wave transmitters.

Harris is the first broadcast manufacturer to offer digital AM and FM transmission equipment.

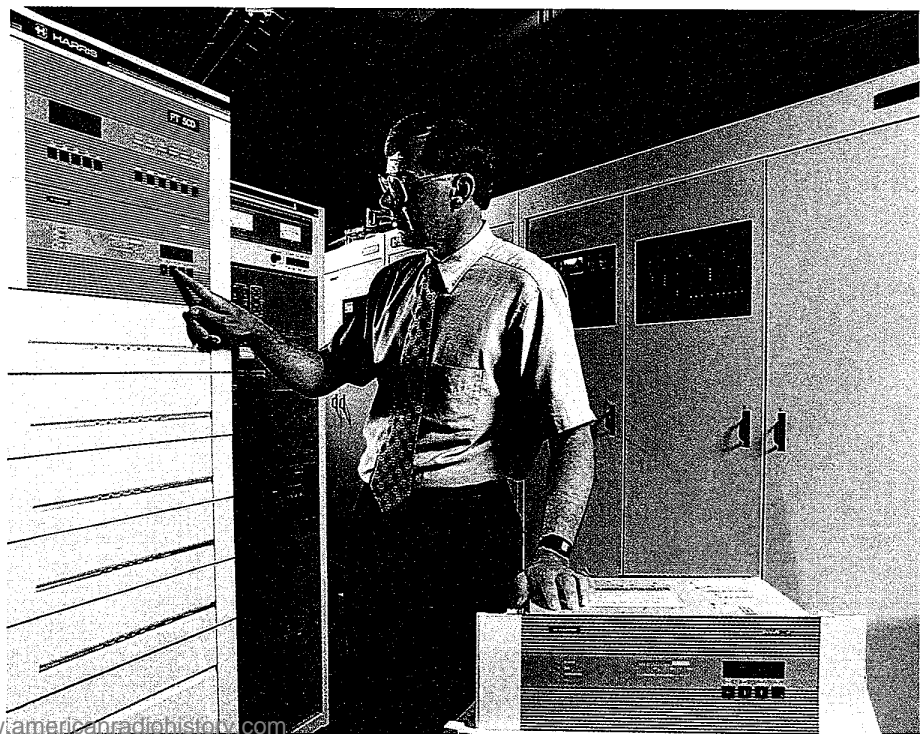

Harris CD 1 8-VSB Digital Television Exciter

With its CD 1 8-VSB digital television exciter, Harris has opened the door to the next generation of television. This revolutionary exciter is the first commercially-viable television exciter to fully implement the ATSC-specified and FCC-approved 8-VSB modulation system. The CD 1 uses patent-pending coding and modulation processes to produce a DTV signal of unparalleled integrity.

Operation: Unlike analog exciters that accept separate audio and video inputs, the CD 1 accepts 19.39Mbps digital bit stream which carries audio, video and data information. The exciter's input is the specified ATSC-compliant serial data transport stream. The CD 1 accepts a wide range of input formats of both the data and clock. The CD 1 converts incoming data to the ATSC-specified Transmission Layer, providing frame synchronization, data randomization, Reed-Solomon encoding, data interleaving, Trellis coding, and field and frame sync insertion. The signal is then filtered, converted to analog IF, and upconverted to channel frequency. The upconverter processes the signal with amplitude, group delay and other adjustments to pre-correct the transmitter, ensuring optimum on-channel performance.

Performance: The superior integrity of the CD 1 signal has been verified in extensive field operation. The exciter's unique nonlinear digital corrector provides linearity correction over upper and lower adjacent channels. An industry-leading 32dB signal-to-noise ratio guarantees transparent transmitter operation. Special transmitter correction circuits minimize out-of-band emissions.

Ease of operation: The CD 1 is easy to operate and maintain. Front-panel power raise and lower controls allow the user to easily adjust power. Power readout and status indicators also are provided on the front of the exciter. The pull-out, three-drawer design provides easy access to all components.

Future-ready design: The CD 1 is housed in a compact 19" chassis that occupies the same amount of rack space as a conventional analog exciter. The three-drawer, modular architecture provides for easy upgrades from NTSC to DTV service.

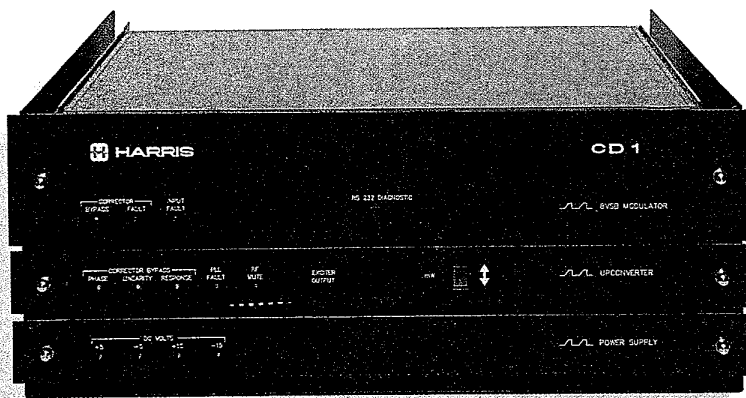

Transmitters

SPECIFICATIONS

RF LOAD IMPEDANCE	50 ohms.	
RF OUTPUT CONNECTOR	SMA.	
FREQUENCY RANGE	470 - 860MHz. VHF optional.	
DATA INPUT	19.39 Mb/s serial, Harris transport interface.	
PFC INPUT	10 MHz, 0 to 10dBm, SMA.	
POWER OUTPUT	1W peak, 250mW average.	
CARRIER FREQUENCY STABILITY	+/-200 Hz/month ¹ .	
FREQUENCY OFFSETS	Per GA requirements.	
REGULATION OF OUTPUT POWER	1% or less.	
ERROR VECTOR MAGNITUDE	4% or less.	
SIDE BAND RESPONSE	-4.0 MHz and below	<-50dB.
	-0.125 MHz	<-40dB.
	-0.0 MHz	<-19dB.
	0.31 MHz	-3dB.
	0.62 to 5.07 MHz	+/-0.5dB.
	5.69 MHz	<-19dB.
	6.125 MHz	<-40dB.
10 MHz and above	<-50dB.	
SIZE	19" W, 25" D, 7" H.	
WEIGHT	50 lbs.	
ELECTRICAL REQUIREMENTS	110/220 Volts, +/-10%, single phase.	
POWER CONSUMPTION	150W typical.	

¹ Referenced to data clock frequency.

Specifications subject to change without notice





Robert C. Davis is a senior scientist at Harris Corporation's Broadcast Division. He holds a Masters Degree in Electrical Engineering from the University of Alabama. His prior experience includes 28 years of high level research and development efforts in digital communication systems. His professional interests are in convolutional and trellis coding for error correction, bandwidth-efficient digital modems, equalization, adaptive predistortion for correcting amplifier nonlinearities, and in digital radio and television broadcast transmission equipment. In these various areas, Mr. Davis holds ten U.S. patents.

Bob's outside interests include amateur radio for which he holds the U.S. Amateur Extra Class license with call sign K4VNO, as well as personal computers, reading, and writing.

Digital techniques are already pervasive in modern commercial and consumer equipment. They stand poised to become even more deeply embedded. Almost all of us are aware of the quantum leap in audio recording technology brought about by the shift to CDs. The sound is stored on a CD in digital form. The CD player performs the conversion from the digital form to the analog form for playback into speakers. The retrieval of the data from the CD recording medium is rendered error-free and of unprecedented audio quality through the twin miracles of error-correction coding and digital signal processing techniques. Even though the CD medium has imperfections that cause errors in the raw data retrieved from the medium, the error-correction decoder built into a CD player repairs this data damage caused by the medium.

In an analogous way, the transmission of television images via a digital transmitter is rendered error-free at the viewer's receiver, even though the broadcast channel causes many imperfections such as multipath-induced "ghosting" and erroneously received data bits. The damage caused by these channel imperfections is repaired through the technical magic of adaptive equalizers, error-correction decoders, and digital signal processing techniques. As a result, the viewer receives—for all appearances—a perfect signal.

Audio recording technology has not been the only important consumer area to benefit from digital conversion. Many of us are aware of other widely used devices that employ digital transmission, processing and signaling techniques including personal computers, hand-held telephones, cellular telephones, microwave oven controllers, automobile electronic ignitions, and electronic fuel-injection controllers. Thus digital techniques already reach deep into various mass consumer markets.

Digital technology will certainly change the world. In fact, MIT's Negroponte imagines the day when a broadcaster, receiving a 20 million bps license from the FCC, uses 15 million to transmit three TV channels, and the other 5 million to create two digital radio stations, a stock-data broadcast system, a paging service, a personalized newspaper; or on Superbowl Sunday, a super-high resolution TV picture.

So, indeed, we must stop thinking of TV as TV. The box so comfortably settled in our homes for the last 50 years is changing beyond our ability to accurately predict its future. It's a revolution: part technological, part cultural, and one that will bring many great opportunities.

An Introduction to Digital Television

by Robert C. Davis, Senior Scientist

"The key to the future of television is to stop thinking about television as television," says MIT professor Nicholas Negroponte in his best-selling book "Being Digital."

Indeed, the United States is on the threshold of a broadcasting revolution—one that will challenge all presumptions about our beloved "TV".

The new Digital TV (DTV), which relies on digital rather than analog transmission, will offer viewers nearly double the line resolution of current TV receivers (1080 lines versus the current 525 lines). Furthermore, the images will be delivered with fewer transmission anomalies than ever before possible. The pictures will be ghost-free and snow-free.

For broadcasters, the programming possibilities are endless. The digital transmission of images will allow stations to transmit multiple (four or more) channels of lower-resolution material over the same 6 MHz bandwidth assignment, all at the choice of the broadcaster. The choices can even change throughout the programming day.

For example, a station might choose to transmit four channels of afternoon programming at lower resolution—but still better than current NTSC signaling—then switch to a single, high definition 1080-line picture for the national news. This might be followed by two hours of a return to four channels—perhaps a current sitcom transmitted simultaneously with three popular shows from past seasons. Then the prime-time 9:00 p.m. to 11:30 p.m. schedule might conclude with a blockbuster hit movie transmitted using full-channel capacity in stereo surround-sound as a single, high definition channel.

What makes Digital TV's special capabilities possible? It's digital. With digital transmission, in most respects, the transmitter does not care what the underlying data represents. As far as the transmitter is concerned, its only task is to modulate the roughly 20 megabit per second data stream onto an 8-VSB carrier.

As long as the receiver and the data source agree on the meaning and interpretation of the bits transmitted, the transmitter need not know what the bit stream represents. This is a major point and is a principal reason digital transmission is so flexible. The meanings of the bits (for example, resolution, aspect ratio, progressive scan, interlaced scan, etc.) can change during the broadcast day, or even at some future date, as long as the receiver can be informed of the new meanings and thus be able to decode the bits into images. All the transmitter cares about is that the payload bit stream rate be 20 megabits per second.

HARRIS EXPLAINS



CERTAIN PRODUCTS NOT AVAILABLE IN ALL AREAS



**ORDERING AND TECHNICAL SUPPORT:
(217) 222-8200**

203

Transmitters



**Harris
SigmaCD
UHF Digital Television
Transmitters**

Harris SigmaCD Series is the first family of UHF transmitters specifically developed for digital terrestrial television transmission. Designed to fully exploit the potential of digital television, SigmaCD transmitters offer significant advantages over today's best analog transmitters.

Performance: Harris' CD 1, the first commercially-viable exciter to implement the ATSC-tested/ FCC-adopted DTV standard for the U.S., is at the key to SigmaCD's revolutionary performance. The CD 1 redefines reliability, stability and linearity. SigmaCD's feedforward IPA ensures exceptional linearity and efficiency better than Class A amplifiers. Advanced correction and equalization provide low levels of intermodulation and minimum adjacent channel interference.

Reliability: SigmaCD transmitters are designed to avoid conditions that compromise reliability. Automatic Level Control circuitry and a high-speed thyatron protect each power amplifier. Automatic VSWR foldback ensures SigmaCD transmitters will operate at the maximum safe power level under antenna icing conditions.

Ease of operation: Straightforward logic control, front-panel LED status indicators and an accessible design simplify operation and maintenance. Typical Mean Time To Repair is 30 minutes.

**Harris
Platinum CD
VHF Digital Television Transmitters** (not pictured)

Harris' standard-setting Platinum and HT EL solid state VHF transmitters have been designed to accept the Harris CD 1 8-VSB exciter. The result is 100% DTV-compatible transmitters for those stations that receive VHF DTV allocations.

Leadership: Harris Platinum transmitters have been the standard for analog VHF solid state TV transmitters for nearly a decade. Over 700 have been installed worldwide. With the CD 1 exciter and Harris' expertise in digital transmission, the Platinum Series will set standards for excellence in the new world of digital television.

Power levels: DTV models ranging from 100 watts average to 20 kilowatts average (and beyond) are available.

Flexibility: Since each Platinum power amplifier cabinet has its own logic control, AC feed, air cooling and power supplies, PA cabinets may be added or split off for future power upgrades or dual NTSC-DTV service.



ASK US ABOUT NEW SOLID STATE DTV TRANSMITTERS BASED ON LD MOS AND SiC TECHNOLOGIES



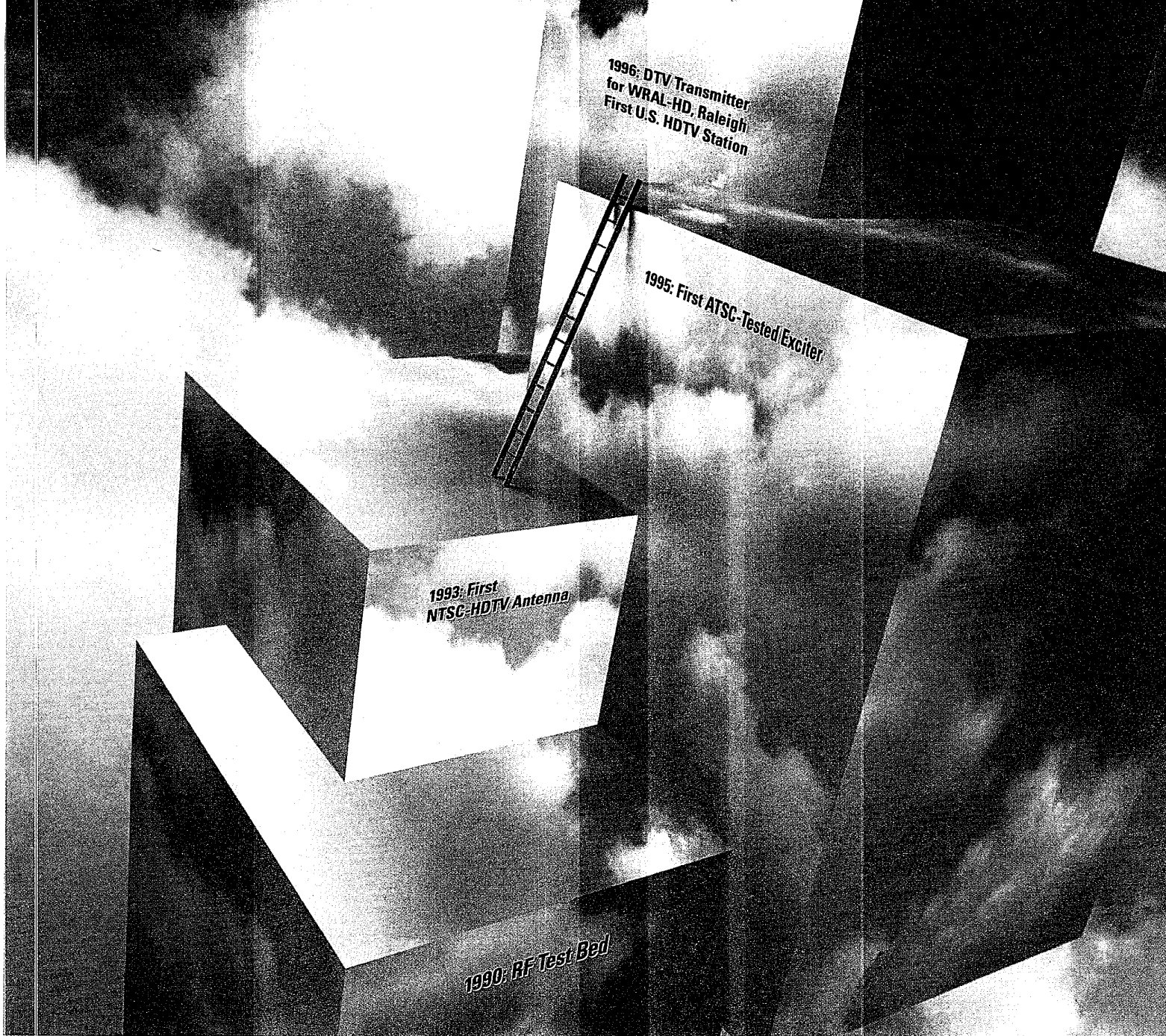

We took a few remarkable steps to give you the smoothest path to DTV.

As you begin planning your move to digital television (DTV), you'll want a partner who can give you the quickest, easiest and safest path possible. Harris would like to be your partner.

From the start of the revolution leading to DTV, we have had only one goal—to give you the smoothest path. So we've been willing to take the hardest steps ourselves, from developing the RF test bed used by the ATTC to evaluate every HDTV system proposed for the U.S., to delivering

the proven DTV transmitters operating on the air today.

The list of Harris' "firsts" is long. But they all add up to one simple benefit for you. No matter where DTV technology takes us, you can count on Harris for proven solutions. To learn what numerous major groups who have DTV Transmitter Equipment Agreements with Harris have discovered, please call. Find out how you can count on Harris to help you make the leap to tomorrow. Today.

Harris Corporation Broadcast Division

US and Canada
Phone: 1 217 222-8200
FAX: 1 217 224-1439
Elsewhere
Phone: 1 217 222-8290
FAX: 1 217 224-2764



A new world of broadcast solutions

©1997 Harris Corp.

Harris HX1V VHF Television Exciter

Harris' HX1V visual/aural exciter is engineered to provide the highest levels of performance, stability, reliability and simplicity available in a VHF exciter. The HX1V is standard in Harris Platinum Series and HT EL transmitters.

Performance: The HX1V provides superb visual performance and aural performance comparable to a high quality FM stereo exciter.

Pre-correction: The HX1V includes all precorrection circuitry needed for top transmitter performance. Harris' surface acoustic wave (SAW) filter provides vestigial sideband shaping and receiver equalization for System M, eliminating conventional receiver equalizers that require periodic and time-consuming maintenance with special test equipment.

Design: The HX1V is contained in a 19-inch rack-mountable slide-out drawer. The exciter contains all video, audio, IF, RF boards and power supply. Space is available for an optional notch diplexer equalizer, receiver equalizer and stereo aural group delay corrector.

Ease of Operation: Extensive built-in precorrection circuitry facilitates transmitter set-up and provides stable operation. Front-panel LEDs provide at-a-glance status assessment. The HX1V is remote control-ready.

Stand-Alone Operation: With the addition of filtering, the HX1V can be used for stand-alone operation.

Options: The optional notch diplexer equalizer compensates for group delay distortion caused by the notch diplexer. The optional aural group delay corrector board allows a less expensive single cavity notch diplexer to be used for stereo service without sacrificing performance. The Precise Frequency Control option enhances viewer reception in the presence of co-channel interference. Optional dual carrier (IRT) and NICAM sound formats are also available.

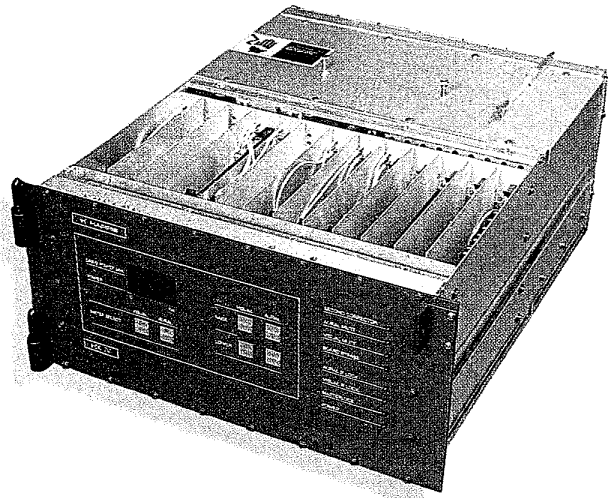

Transmitters

SPECIFICATIONS

CIR SYSTEMS	M/N, B, D/K, I, K1.
COLOR FORMATS	NTSC, PAL, SECAM.
SOUND FORMATS	Monaural, BTSC, Dual Carrier (IRT), NICAM.
FREQUENCY RANGE	47 - 88MHz; 174 - 230MHz.
FREQUENCY STABILITY	±250Hz (over 30 days).
DIFFERENTIAL PHASE/GAIN	1° or better/3% or better.
INCIDENTAL PHASE MODULATION	±1° or better.
LUMINANCE NONLINEARITY	2% or better.
HARMONIC DISTORTION	0.2%.
FREQUENCY RESPONSE	±0.5dB (30 - 15,000Hz).
AM/FM NOISE	-55dB/-60dB.
ELECTRICAL REQUIREMENTS	208/240V, ±10%, 50/60Hz, 1 phase.
DIMENSIONS	19" (48cm) W, 22" (56cm) D, 8.75" (22cm) H.
WEIGHT	51 lbs. (23kg).

Specifications subject to change without notice



**Harris
Platinum Series® HT EL
500W - 10kW VHF Transmitters**

POWER LEVELS

HT EL500LS/HS 500 watts peak	HT EL1000LS/HS 1000 watts peak	HT EL2000LS/HS 2000 watts peak
HT EL5LS/HS* 5000 watts peak	HT EL10LS/HS* 10,000 watts peak	

LS: 47 - 88MHz (Band I); HS: 170 - 230MHz (Band III).
Standard main-standby and dual configurations available.

Based on the same solid-state architecture that made higher power Harris Platinum Series transmitters the world standard in VHF, HT EL transmitters provide the highest reliability and performance and the best long-term value available in low- to medium-power VHF transmitters.

Reliability: As part of the Harris VHF Platinum family, HT EL transmitters are backed by the industry's only 5-year VHF transmitter warranty. HT EL transmitters replace the tube with conservatively-rated solid state RF power amplifier modules that operate in parallel. Hot-pluggable PA modules have achieved the highest MTBF in the industry. Built to withstand even the harshest environments, HT EL transmitters have been subjected to rigorous 6kV transient testing for assurance of the highest possible immunity to lightning and other static discharges.

Performance: The Harris HX1V is standard in HT EL transmitters. The HX1V provides superb visual performance and aural performance comparable to a high quality FM stereo exciter.

Ease of Operation: HT EL transmitters are so simple that station personnel can operate them safely with a minimum of training. Control and monitoring are provided on an eye-level front panel. Operating status is available via digital meters and LED indicators.

Maintenance: HT EL transmitters require up to 90% less routine maintenance than their tube counterparts, and are designed so that a great deal of maintenance can take place during transmitter operation. Most components, including RF power amplifier modules, power supplies and exciter(s), are readily available from the front of the transmitter.

Remote Control: These transmitters are ideal for reliable, unattended operation. An accessible interface provides a ready connection to major remote control systems.

SPECIFICATIONS

CCIR SYSTEMS	M/N, B, D/K, I, K1.
COLOR FORMATS	NTSC, PAL, SECAM.
SOUND FORMATS	Monaural, BTSC, Dual Carrier (IRT), NICAM.
FREQUENCY RANGE	47 - 88MHz; 174 - 230MHz.
DIFFERENTIAL PHASE/GAIN	1° or better/3% or better.
INCIDENTAL PHASE MODULATION	±1.5° or better relative to blanking.
LUMINANCE NONLINEARITY	1dB or better.
AUDIO HARMONIC DISTORTION	0.2% (30Hz - 15kHz after de-emphasis).
AURAL FREQUENCY RESPONSE	±0.5dB (30 - 15,000Hz).
AM/FM NOISE	-55dB/-60dB.
ELECTRICAL REQUIREMENTS	HT EL500 through HT EL2000: 208/240V, ±10%, 50/60Hz, 1 phase. HT EL5 and HT EL10: 208/240V, ±10%, 50/60Hz, 3 phase; 380/415, ±10%, 50Hz, 3 phase, 4 wire.

POWER CONSUMPTION

Model	Power Consumption (Black Picture)
HT EL500	2.7kW typical.
HT EL1000	3.5kW typical.
HT EL2000	7kW typical.
HT EL5	13kW typical.
HT EL10	24kW typical.

DIMENSIONS/WEIGHT

HT EL500:	26" (66cm) W, 35" (89cm) D, 45" (114cm) H. 430 lbs. (195kg).
HT EL1000:	26" (66cm) W, 35" (89cm) D, 45" (114cm) H. 450 lbs. (205kg).
HT EL2000:	26" (66cm) W, 35" (89cm) D, 45" (114cm) H. 800 lbs. (363kg).
HT EL5:	57" (145cm) W, 61.3" (156cm) D, 72" (183cm) H. 2000 lbs. (909kg).
HT EL10:	57" (145cm) W, 61.3" (156cm) D, 72" (183cm) H. 2640 lbs. (1200kg).

Specifications subject to change without notice

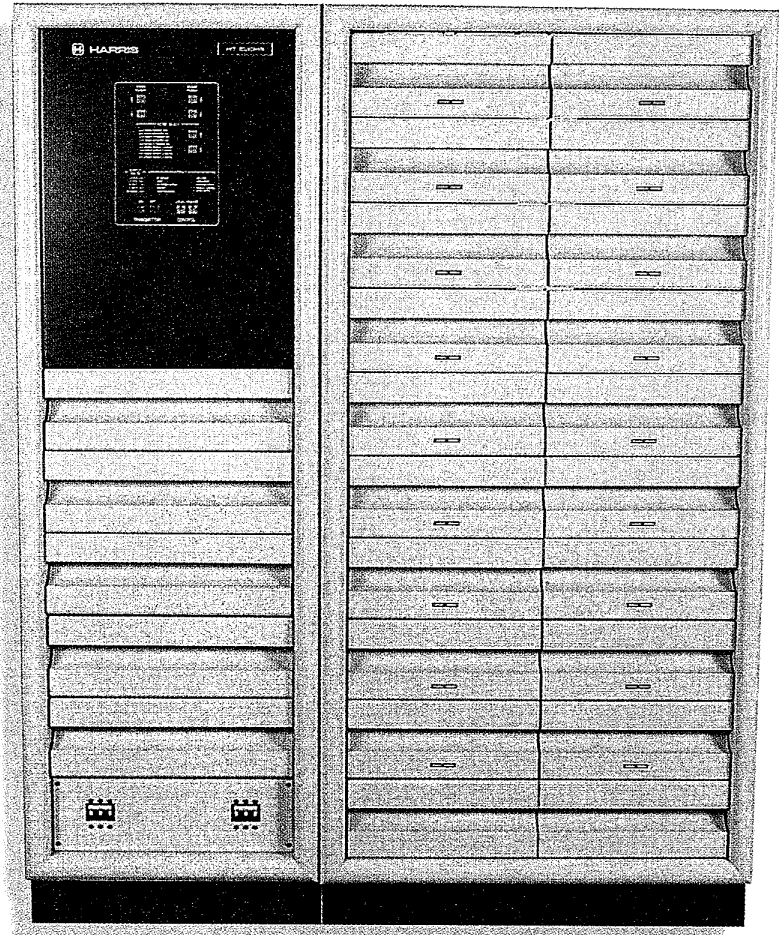

Transmitters



**Harris
Platinum Series® VHF Transmitters**

POWER LEVELS

HT 5LS/HS 5 kilowatts peak	HT 10LS/HS 10 kilowatts peak	HT 15LS/HS 15 kilowatts peak	HT 20LS/HS 20 kilowatts peak	HT 30LS/HS 30 kilowatts peak
HT 30HSP 30 kilowatts peak	HT 33LSP 33 kilowatts peak	HT 40HSP 40 kilowatts peak	HT 44LSP 44 kilowatts peak	HT 45LS/HS 45 kilowatts peak
HT 60LS/HS 60 kilowatts peak				

LS: 47 - 88MHz (Band I); HS: 170 - 230MHz (Band III).

HT 30HSP and HT 33LSP each feature three independent RF paths; HT 40HSP and HT44LSP each feature four independent RF paths.

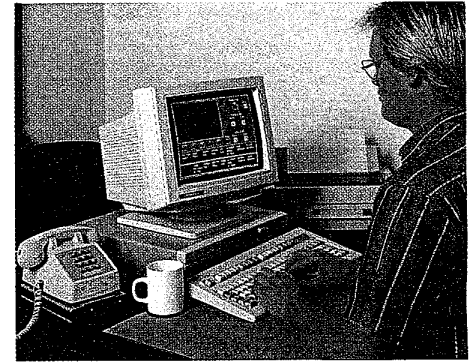

Transmitters

With an ultra-redundant solid state architecture and an unprecedented five year warranty, Harris Platinum Series VHF transmitters have established themselves as the world standard in VHF TV broadcasting. Introduced in 1988, Platinum transmitters are redefining reliability, simplicity and quality for hundreds of broadcasters on six continents.

Reliability: Parallel redundancy of major components significantly increases transmitter reliability. Tubes are replaced by multiple hot-pluggable FET solid state power amplifier modules which operate in parallel. Self-protecting modules have obtained the highest MTBF in the industry. Rigorous 6kV transient testing ensures greater immunity to lightning and other static conditions.

Performance: The HX1V exciter is standard in Platinum VHF transmitters. The HX1V ensures superb visual performance and aural performance comparable to a high quality FM stereo exciter. Superbly-linear Platinum transmitters have been used successfully in digital transmission tests.

Ease of Operation: Platinum transmitters are designed for safe and easy operation by station personnel who have had minimal training. Easy-to-read bargraphs and digital information on an eye-level control panel provide immediate and comprehensive status information.

Maintenance: Platinum transmitters require up to 90% less maintenance than tube transmitters, with fewer adjustments at less frequent intervals. RF power amplifier modules, power supplies and exciter(s) are readily accessible from the front of the transmitter. Platinum transmitters allow a great deal of maintenance to take place on the air.

Remote Control: Harris' Platinum Sentry PC Interface option provides extensive remote or extended monitoring and control from a personal computer. This option allows users to review every status screen that would be available on the Platinum control panel from any location. Sentry also provides control capability.

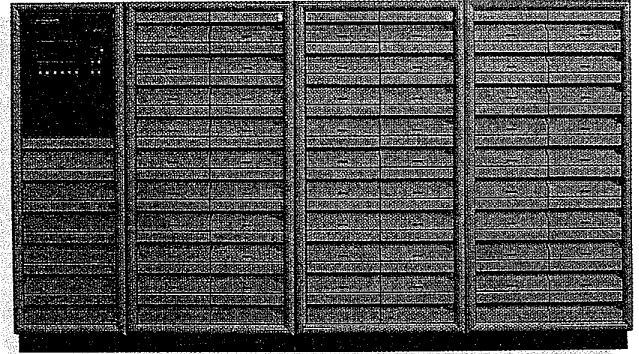

SPECIFICATIONS

CCIR SYSTEMS	M/N, B, D/K, I, K1.
COLOR FORMATS	NTSC, PAL, SECAM.
SOUND FORMATS	Monaural, BTSC, Dual Carrier (IRT), NICAM.
FREQUENCY RANGE	47 - 88MHz; 174 - 230MHz.
DIFFERENTIAL PHASE/GAIN	1° or better/3% or better.
INCIDENTAL PHASE MODULATION	±1.5° or better relative to blanking.
LUMINANCE NONLINEARITY	1dB or better.
AUDIO HARMONIC DISTORTION	0.2% (30Hz - 15kHz after de-emphasis).
AURAL FREQUENCY RESPONSE	±0.5dB (30 - 15,000Hz).
AM/FM NOISE	-55dB/-60dB.
ELECTRICAL REQUIREMENTS	208/240V, ±10%, 50/60Hz, 3 phase; 380/415, ±10%, 50Hz, 3 phase.

POWER CONSUMPTION

Model	Power Consumption (Black Picture)	(Average Picture)
HT 5LS/HS	13.2kW	11.2kW.
HT 10LS/HS	24.4kW	19.3kW.
HT 15LS/HS	32/35kW	25kW/28kW.
HT 20LS/HS	48kW	37kW.
HT 30LS/HS	63/69kW	50/55kW.
HT 30HSP	65kW.	
HT 33LSP	65kW.	
HT 40HSP	90kW.	
HT 44LSP	90kW.	
HT 45LS/HS	93/102kW	74/81kW.
HT 60LS/HS	123/135kW	98/108kW.

DIMENSIONS/WEIGHT

HT 5LS/HS - HT10LS/HS: 57" (145cm) W, 61.3" (156cm) D, 72" (183cm) H. 2475 lbs. (1,122kg); HT 5HS: 2500 lbs. (1,134kg); HT 10LS/HS: 2720 lbs. (1234kg)
 HT 15LS/HS - HT 20LS/HS: 91" (231cm) W, 61.3" (156cm) D, 72" (183cm) H. HT 15LS: 4200 lbs. (1905kg); HT 15HS: 4900 lbs. (2223kg); HT 20LS/HS: 5000 lbs. (2268kg).
 HT 30LS/HS, HT 30HSP and HT 33LSP: 125" (318cm) W, 61.3" (156cm) D; 72" (183cm) H. HT 30LS: 6300 lbs. (2860kg); HT 30HS: 6750 lbs. (3068kg); HT 30HSP: 7040 lbs. (3200kg); HT 33HSP: 7040 lbs. (3200kg)
 HT 40HSP, HT 44LSP and HT 45LS/HS: 159" (404cm) W, 61.3" (156cm) D; 72" (183cm) H. HT 40HSP: 9240 lbs. (4200kg); HT 44LSP: 9240 lbs. (3200kg); HT 45LS: 8590 lbs. (3896kg); HT 45HS: 9313 lbs. (4224kg)
 HT 60LS/HS: 227" (577cm) W, 61.3" (156cm) D; 72" (183cm) H. HT 60LS: 12,630 lbs. (5606kg); HT 60HS: 13,760 lbs. (6242kg).

Specifications subject to change without notice



**Harris
UltraVision™ Series
3 - 15kW UHF Transmitters**

POWER LEVELS

Ultra-3 3 kilowatts peak	Ultra-5 5 kilowatts peak
Ultra-10 10 kilowatts peak	Ultra-15 15 kilowatts peak

Harris UltraVision Series UHF transmitters have been designed to maximize the advantages of solid state technology. The result is a series of exceptionally reliable and cost-effective transmitters.

Reliability: Major components — including multiple solid state RF power amplifier modules which each have their own high-efficiency switched power supplies — operate in parallel. Hot-pluggable modules are designed for simple, safe removal and insertion during transmitter operation. UltraVision's unique circulator protection ensures maximum power under VSWR conditions. Standard overall system protection further enhances reliability.

Performance: The UltraVision exciter incorporates broadband RF precorrection and video input signal processing circuitry. This circuitry optimizes signal transparency, ensuring the best possible picture quality. Additionally, each module includes Harris' exclusive dynamic linearity compensation for APL-related distortions.

Ease of Operation: Straightforward controls and comprehensive status displays are located on the front of the transmitter. A VDU display is operationally available.

Maintenance: UltraVision transmitters require up to 90% less maintenance than tube transmitters. A majority of components, including RF power amplifier modules, individual module power supplies, and exciter(s), are readily accessible from the front of the transmitter. The typical maintenance interval is six months.

Remote Control: UltraVision transmitters are designed for unattended operation with a standard remote control and monitoring interface.

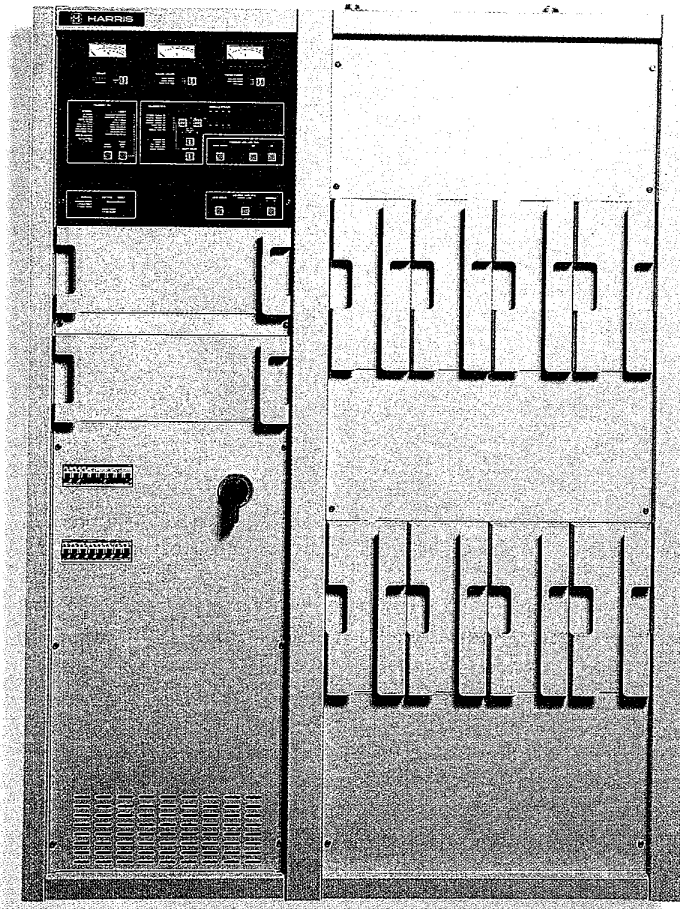

Transmitters

SPECIFICATIONS

CCIR SYSTEMS	G, I, K, K1, M, N.	
COLOR FORMATS	NTSC, PAL, SECAM.	
SOUND FORMATS	Monaural, BTSC, Dual Carrier (IRT), NICAM G, NICAM I.	
FREQUENCY RANGE	470 - 860MHz.	
DIFFERENTIAL PHASE/GAIN	3° or better /5% or better.	
INCIDENTAL PHASE MODULATION	±2° or better relative to blanking.	
LUMINANCE NONLINEARITY	10%.	
AUDIO HARMONIC DISTORTION	0.5% (for modulation signals from 30Hz - 15kHz).	
AURAL FREQUENCY RESPONSE	±0.5dB (30 - 15,000Hz).	
AM/FM NOISE	-50dB/-60dB.	
ELECTRICAL REQUIREMENTS	380V (-15%) - 415V (+10%) or 460V (-17%) - 480V (+12%), 3 phase, 4 wire, 47 - 63Hz.	
POWER CONSUMPTION	Model	Power Consumption (Average Picture)
	Ultra-3	11kw typical.
	Ultra-5	15kW typical.
	Ultra-10	30kW typical.
	Ultra-15	46kW typical.

DIMENSIONS

Ultra-3 and Ultra-5: 54.3" (1380 mm)W, 57" (1450mm) D, 71" (1811mm) H.
 Ultra-10: 85.8" (2180mm) W, 57" (1450mm) D, 71" (1811mm) H.
 Ultra-15: 117" (2980mm) W, 57" (1450mm) D, 71" (1811mm) H.
 Combiner (all): 23" (590mm) W, 57" (1450mm) D, 71" (1811mm) H.

Specifications subject to change without notice

**CERTAIN PRODUCTS NOT
AVAILABLE IN ALL AREAS**



**ORDERING AND TECHNICAL SUPPORT:
(217) 222-8200**

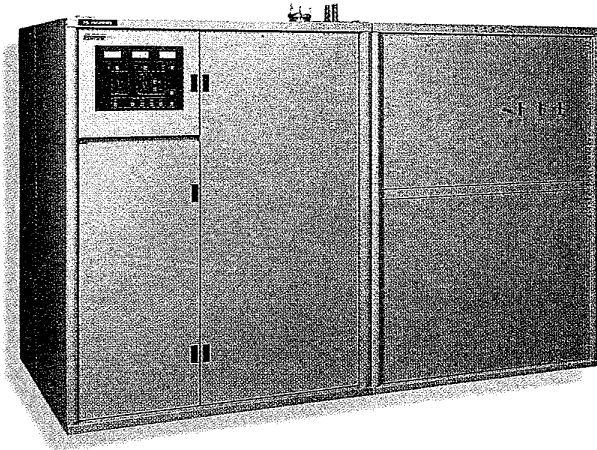

Harris SigmaPLUS™ 20 - 240kW UHF Transmitters

POWER LEVELS*
(Combined visual/aural models)

HD 20CP1 20 kilowatts peak	HD 30CP1 30 kilowatts peak	HD 40CP1 40 kilowatts peak	HD 50CP1 50 kilowatts peak
HD 60CP2 60 kilowatts peak	HD 80CP2 80 kilowatts peak	HD 100CP2 100 kilowatts peak	HD 90CP3 90 kilowatts peak
HD 120CP3 120 kilowatts peak	HD 150CP3 150 kilowatts peak	HD 120CP4 120 kilowatts peak	HD 160CP4 160 kilowatts peak
HD 200CP4 200 kilowatts peak	*Other configurations using 20, 30, 40 and 50kW IOTs or klystrodes/IOTs available. Separate visual/aural models available.		

SigmaPLUS UHF transmitters are designed to provide maximum reliability, superb performance, and exceptional efficiency. The flexible architecture allows broadcasters to choose the best amplifier type and configuration for their specific operations. Externally duplexed or common amplification systems are available.

Performance: SigmaPLUS transmitters not only provide exceptional analog performance, but they have the linearity and the headroom needed for digital transmission. Among features is feedforward correction — a technique well proven in other areas of the telecommunications industry — which provides linearity as good as (or better than) a typical Class A amplifier.

Efficiency: With either the IOT or klystrode/IOT power amplifiers, SigmaPLUS transmitters achieve typical system efficiency of 70% (including transmitter, cooling, and associated equipment).

Reliability: A high level of redundancy is provided. Each power amplifier has its own IPA driver stage, its own high-voltage power supply and its own control and monitoring. The cooling system uses redundant fans and dual pumps, and separate cooling for each power amplifier is optionally available. Automatic Level Control circuitry protects power amplifiers when the transmitter is turned on, and thyatron crowbar protection safeguards power amplifiers from catastrophic arcing conditions. Automatic VSWR foldback ensures operation at maximum safe power under such conditions as antenna icing.

Ease of Operation: Straightforward pushbutton control is provided on an eye-level panel. SigmaPLUS transmitters are designed for operation by technicians with little RF experience. Interfaces for remote control and monitoring are conveniently located.

Maintenance: Front-panel LEDs provide at-a-glance status information. Most components are readily accessible, and SigmaPLUS transmitters are designed so that Mean Time To Repair for any subassembly is 30 minutes.

SPECIFICATIONS

CCIR SYSTEMS	M, N, G, I, K, K1.		
COLOR FORMATS	NTSC, PAL, SECAM.		
SOUND FORMATS	Monaural, BTSC, Dual Carrier (IRT), NICAM G, NICAM I.		
FREQUENCY RANGE	470 - 860MHz.		
DIFFERENTIAL PHASE/GAIN	3° or better/5% or better.		
INCIDENTAL PHASE MODULATION	±2°, relative to blanking.		
LUMINANCE NONLINEARITY	10% or better.		
AUDIO HARMONIC DISTORTION	0.5% or less, 30Hz - 15kHz.		
AM/FM NOISE	-55dB/-60dB.		
FREQUENCY RESPONSE	±0.5dB, 30 Hz to 15kHz, with pre-emphasis.		
ELECTRICAL REQUIREMENTS	380/460 VAC, 3 phase, 50/60Hz; other voltages available on request.		
POWER CONSUMPTION	Model	Black picture	Model Black Picture
	HD 20CP1	41.3kW.	HD 30CP1 58.1kW.
	HD 40CP1	74.5kW.	HD 50CP1 90.7kW.
	HD 60CP2	112.7kW.	HD 80CP2 145.5kW.
	HD 90CP3	167.7 kW.	HD 120CP3 216.9 kW.
	HD 120CP4	223.5 kW.	HD 160CP4 289.1 kW.

Specifications subject to change without notice

**Harris
UM Series
60 - 240kW UHF Transmitters**

POWER LEVELS

TV-60UM
60 kilowatts peak

TV-120UM
120 kilowatts peak

TV-180UM
180 kilowatts peak

TV-240UM
240 kilowatts peak

70kW depressed collector klystron also available.

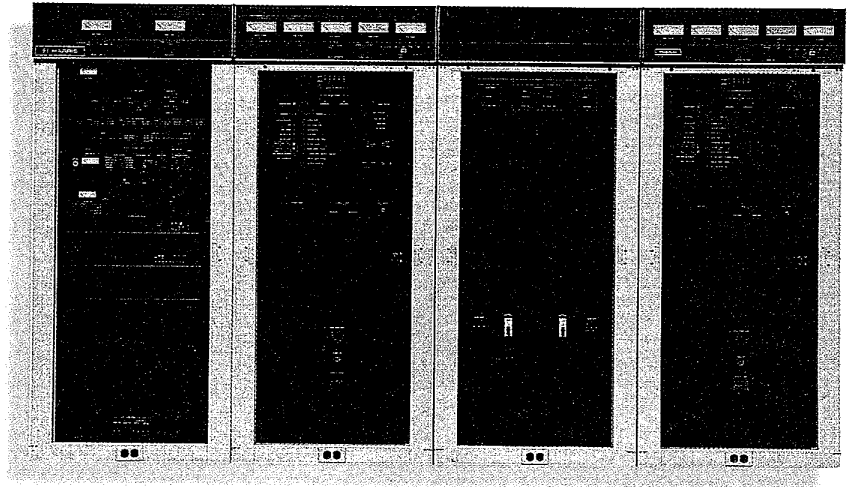

Transmitters

Harris UM Series transmitters with depressed collector klystron RF power amplifiers have established themselves as highly efficient and reliable transmitters. Depressed collector klystrons combine the durability of familiar external cavity klystron technology with a figure of merit greater than 130. The result is outstanding value.

Efficiency: Depressed collector klystrons reduce power consumption by up to 50% over earlier generation power amplifiers. Sync reduction circuitry further reduces power consumption.

Reliability: Proven klystron technology plus such features as Harris' advanced liquid and air-cooling systems enhance reliability.

Performance: SAW filters, solid state IPAs and independent pulsers for each klystron deliver exceptional visual and aural signals.

Ease of Operation: Front panel LED displays provide straightforward status information.

Maintenance: UM transmitters provide easy access to all components. Harris' exclusive breakaway line section facilitates tube replacement, and the visual and aural exciters are housed in slide-out drawers. Independent amplifier shutdown capability allows one amplifier to be serviced while the other remains on the air.

SPECIFICATIONS

CCIR SYSTEM	M/N. (Other systems on request)	
COLOR FORMAT	NTSC./PAL	
FREQUENCY RANGE	470 - 860MHz.	
DIFFERENTIAL PHASE/GAIN	3° or better/5% or better.	
INCIDENTAL PHASE MODULATION	±2% relative to blanking.	
LUMINANCE NONLINEARITY	1.0dB or better.	
AUDIO HARMONIC DISTORTION	0.5% or less, 30Hz - 15kHz after de-emphasis.	
AURAL FREQUENCY RESPONSE	+0.5dB, 30Hz - 15kHz.	
AM/FM NOISE	-55dB/-60dB	
POWER CONSUMPTION	Model	Average Picture
	TV-60UM	92kW.
	TV-120UM	165kW.

DIMENSIONS

TV-60UM: Transmitter 126" (320 cm) W, 74" (189.4 cm) D, 73.5" (186.7 cm) H; 5000 lbs. (2268kg); system includes 2 power supplies, pump module, fan/coil module and 2 line control units.

TV-120UM: Transmitter: 189" (480 cm) W, 74" (189.4 cm) D, 73.5" (186.7 cm) H; 7100 lbs. (3220kg); system includes 3 power supplies, pump module, high purity pump module, fan/coil module and 3 line control units.

Power Supply: 52" (132 cm) W, 68" (172.72 cm) D, 67.5" (171.45 cm) H; 7100 lbs. (3220kg).
 Pump Module: 36" (91.44 cm) W, 55" (140 cm) D, 64" (163 cm) H; 950 lbs. (431 kg) without coolant.
 Fan/Coil Module: 54" (137 cm) W, 106" (270cm) D, 45" (114cm) H; 800 lbs. (363kg) without coolant.
 Line Control: 24" (61cm) W, 24" (61cm) D, 48" (122cm) H; 300 lbs. (136kg).

Specifications subject to change without notice

**CERTAIN PRODUCTS NOT
AVAILABLE IN ALL AREAS**



**ORDERING AND TECHNICAL SUPPORT:
(217) 222-8200**

211



Harris Dual Sound Encoder

Harris' Dual Sound Encoder provides signal encoding for dual carrier sound formats. The encoder processes two audio inputs, adds a pilot locked to the video line frequency, and provides two coded channel signal outputs for dual sound, stereo, or mono operation. The encoder operates on both PAL and NTSC systems but is not designed for NICAM sound formats.

Construction: The encoder is housed in a standard 19" rack mount chassis for easy mounting in a Platinum HT EL transmitter or standard rack.

Easy use: Modes are selected via a front panel or via TTL-compatible rear panel remote control. Operating status is displayed on front-panel LEDs. While no operator adjustments are required, the user can trim encoded output levels if desired. The encoder operates on European and domestic line voltages and automatically senses the applied voltage.

Harris DC-128 Remote Control System

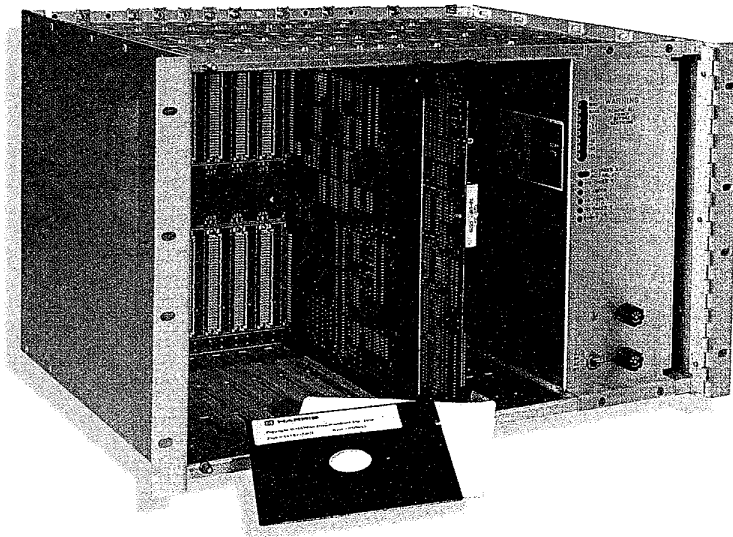

The Harris DC-128 is an intelligent and flexible remote control system. The DC-128 provides 16 analog telemetry channels with direct, linear and squared calibration; 16 status inputs, and 16 control outputs. The system is field-expandable via plug-in expansion cards to 128 analog inputs, 128 status inputs, and 128 control outputs.

PC-based system: The PC-based system connects up to three personal computers directly or via modem. Complete dial-up capability is provided.

Programming capability: A simple, pull-down menu gives the user easy programming capability at the PC keyboard.

Extensive user-programmable capabilities: The DC-128 provides a whole range of user-programmable capabilities, including four partitions, status failure action, series functions, time functions, adjustable fail-safe timer, and automatic power-up execution.

System protection: Multiple levels of password protection are standard. An on-board NICAD battery provides power failure protection.

Options: A wide variety of options makes it easy to configure the system that meets your precise requirements.

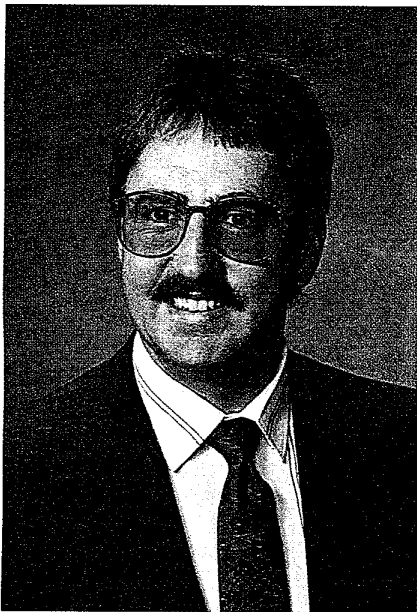

John L. Delay has been involved in the broadcast field for over 19 years. He has held management and engineering positions in manufacturing, design, component and reliability engineering and has been responsible for customer service during his career. Since 1992 John has served as the AM product line manager for Harris Broadcast Division with responsibility for profit and loss of the product line. Since that time he has led the company's efforts to provide solid state technology for the high power AM market.

John holds a BSEET degree from Culver-Stockton College, Missouri, and Bradley University, Illinois.

John served as president of the American Society of Quality Control, Quinsippi Chapter and served on the regional board for the Midwest ASQC Chapter.

Harris DX transmitters utilize a bandpass filter in the output network. It is important to note that DX transmitters do not require a PDM type filter because the output bandpass filter serves the function of filtering any switching frequencies. Therefore, DX transmitters deliver superior audio performance into poor antenna systems. Harris DX transmitters also provide better RF intermodulation performance in duplexed applications due to the bandpass filter.

In PDM type transmitters, the PDM filter is designed to have the transmitter output terminate into an ideal 50 ohm impedance. When a PDM transmitter operates into a mistuned antenna system, the PDM filter also becomes mistuned. When the PDM filter becomes mistuned, both the frequency response and distortion of the transmitter are degraded. This is not the case in a DX transmitter.

Harris DX customers have reported superior signal quality, improved coverage, higher reliability, higher efficiency and less maintenance as a result of their new transmitters. All of these benefits will not go unnoticed in today's demanding broadcast environment. Contact your Harris sales manager for information.

The Advantages of Digital AM Modulation

by John L. Delay, AM Product Line Manager

Modern AM transmitters use either Pulse Duration Modulation (PDM) or Digital Amplitude Modulation for signal generation. Both modulation methods were developed by Harris Senior Scientist Hilmer Swanson. Both methods are excellent, and both are used in current Harris transmitters. However, digital amplitude modulation, which was introduced in Harris DX Series Transmitters in 1987, has gained wide recognition for its superior performance. Digital Amplitude Modulation also is recognized for its proven ability to transmit the In Band/On Channel (IBOC) digital audio signal.

One reason Digital Amplitude Modulation provides superior performance is that it eliminates the need for any type of PDM audio low-pass filter. In general, a transmitter that does not change the shape of an audio waveform by passing the signal through a PDM audio low pass filter provides superior performance. The PDM filter causes deviation from flatness and phase-linearity. This, in turn, causes spurious modulation peaks because the shape of the peak-limited waveform is changed. Because peaks of this nature add nothing to the average modulation level, the average modulation level must be lowered. This is necessary to accommodate these overshoots or peaks and prevent over-modulation.

In Harris DX transmitters, the RF envelope is directly digitally synthesized and then passed through an RF bandpass filter. The signal does not pass through any type of PDM audio low-pass filter. The result is that DX transmitters provide superior audio to RF phase linearity with flat frequency response from 30-10,000 Hz. A few key performance parameters unique to DX transmitters follow:

Overshoot

Overshoot is an extremely critical performance measurement when it comes to achieving the maximum modulation level. DX transmitters virtually eliminate overshoot, allowing the transmitter to deliver higher average power in the sidebands. DX transmitters develop the AM envelope by directly synthesizing the RF envelope. As a result, no audio low-pass filter is needed to eliminate the PDM switching frequencies: DX transmitters do not require an audio filter to be switched in and out to achieve good overshoot performance specifications the way PDM based transmitters do.

Slew Induced Distortion

Slew induced distortion (SID) is caused by having an amplifier which has an insufficient rate of change of its output waveform. Some amplifiers exhibit slew induced distortion when the program waveforms try to force the output of the amplifier to change faster than the amplifier's slew rate limit. It is not widely recognized that different modulation methods result in drastically different levels of slew induced distortion. It is also not recognized that some transmitters measure good for THD and frequency response, yet sound bad due to slew induced distortion.

Most PDM transmitters require that an audio filter be switched in to make overshoot performance look good and switched out to make SID look good. DX transmitters do not require any filters. Again, the result is superior performance.

Better Performance into Narrow Band Loads

HARRIS EXPLAINS



Works Great. . .

You're Gonna Love It. . .

Sign Here. . .

Press Hard—Five Copies. . .

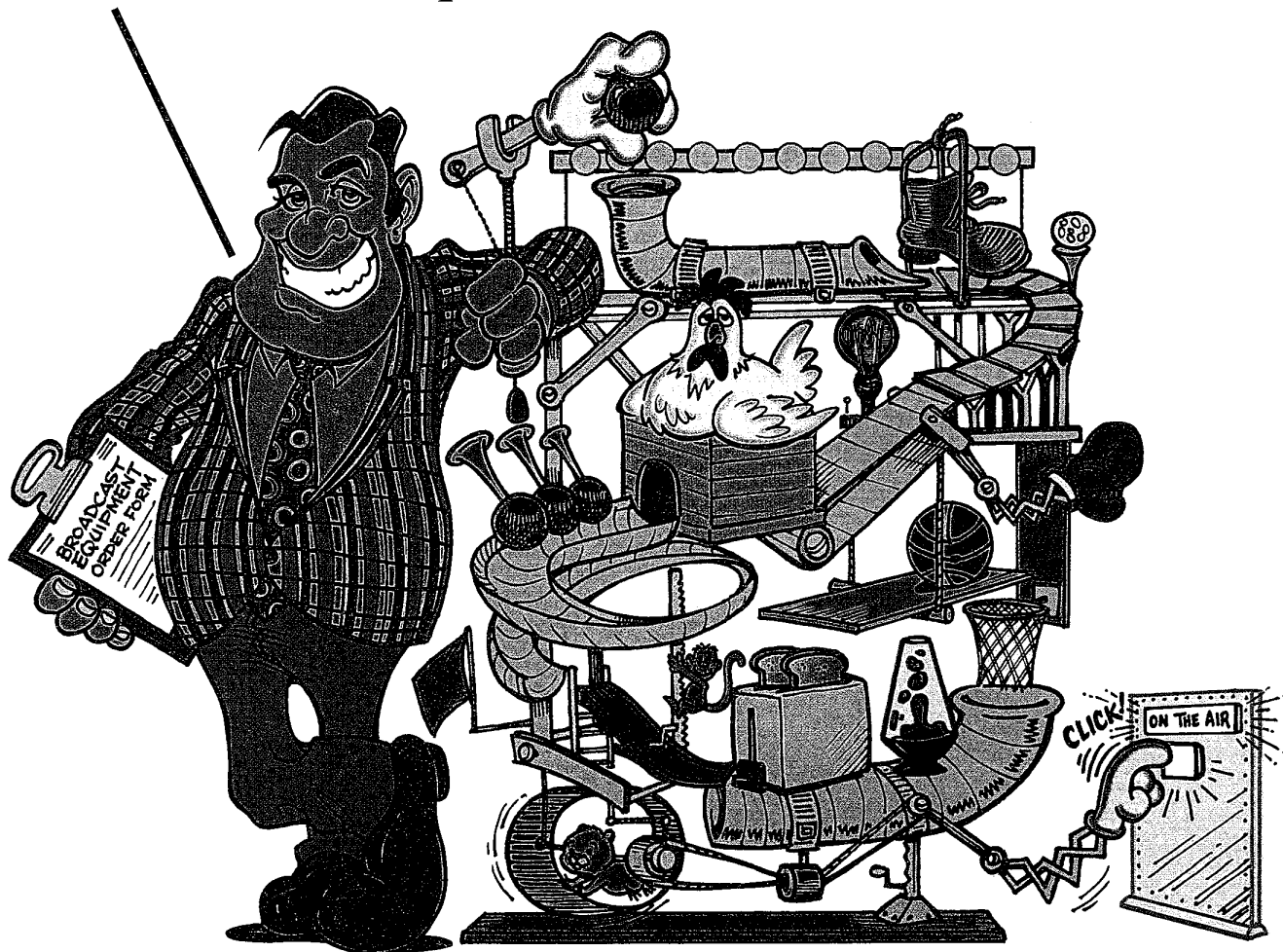

**Sometimes
the business of
radio calls for
smarter answers.**

Automation
LMAs
Workstation
Duops
Triopoly
TSA
Cash Flow

Harris Transmitters

Harris Studio Products

Harris Systems

Budgets
Remotes
Return On Capital

**Got questions?
Call Harris.**

Harris Corporation Broadcast Division

U.S.:
TEL.: 1-800-622-0022
FAX: 317-966-0623

CANADA:
TEL.: 800-269-6871
FAX: 514-421-2712

<http://www.broadcast.harris.com>



© 1996 Harris Corp.

**Harris
Gates® Series 1 - 5 kW Medium Wave Transmitters**

POWER LEVELS

Gates One
100 - 1100 watts

Gates Two
250 - 2750 watts

Gates Five
500 - 5600 watts
(Frequency-agile model available)

Main/alternate or combined configurations; single or three-phase power; 50 or 60 Hz.

With a fourth-generation solid state design and Harris-patented Polyphase Pulse Duration Modulation, Gates transmitters deliver outstanding value and performance.

Reliability: Field-proven MOSFETs replace the PA tube and are used in the modulator section. High-speed automatic VSWR protection keeps Gates transmitters on the air at the highest safe power under VSWR conditions. Gates transmitters maintain constant output power and modulation levels despite line voltage fluctuations, and will resume operation automatically after AC power interruptions.

Cost of ownership: Typical PA efficiency >85% and overall efficiency to 72% minimizes power costs. Tube replacements and associated labor costs are also eliminated.

Performance: Polyphase Pulse Duration Modulation is standard. This technique minimizes distortion and overshoot for a clean, crisp sound and high average modulation levels for superb reach. Gates transmitters are capable of +130% positive peak modulation and 100% sine wave modulation. A bandpass output network further improves performance by providing superior phase and amplitude linearity with low distortion and minimal overshoot.

Ease of operation: A front-panel discrete logic controller includes six independently-adjustable power levels to accommodate most PSA/PSSA requirements. An easy-to-read signal flow diagram, status LEDs and eye-level meters provide at-a-glance status information.

Maintenance: Solid state transmitters inherently require less maintenance than tube models. Such features as accessible socketed PA MOSFETs, and an innovative and cleaner "chimney design" air handling system further reduce maintenance in Gates transmitters.

SPECIFICATIONS

TRANSMITTER TYPE Medium Wave, 100% solid state.

FREQUENCY RANGE 531 - 1705kHz.

TYPE OF MODULATOR Patented Harris Polyphase PDM.

POSITIVE PEAK CAPABILITY Greater than +130%.

AUDIO RESPONSE ±0.5 dB from 20Hz to 10kHz (Bessel filter out).

AUDIO DISTORTION Less than 1.0% at rated power, 20Hz - 10kHz at 95% modulation.

AM NOISE FIGURE Better than 60dB below 100% modulation.

POWER CONSUMPTION (At rated power)

Model	0% Modulation	100% Modulation	Typical Programming
GATES ONE	1428W	2143W	≤1923W
GATES TWO	3846W	5769W	≤4807W
GATES FIVE	≤7692W	≤11,538W	≤9615W

STEREO CAPABLE Yes; optional Harris AMS-G1 stereo exciter available.

REMOTE CONTROL/MONITORING Self-contained interface for most remote control systems; TTL-compatible.

SIZE 28" (71 cm) W, 30" (76 cm) D, 72" (183 cm) H.

Specifications subject to change without notice

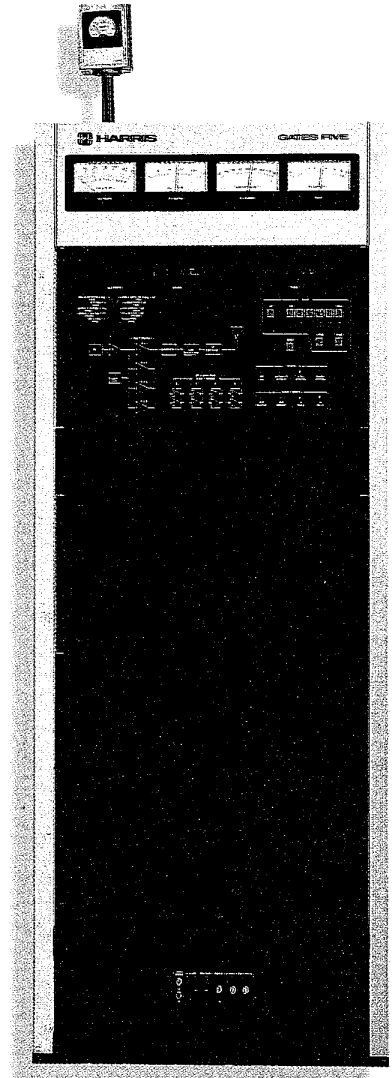

Transmitters



Transmitters

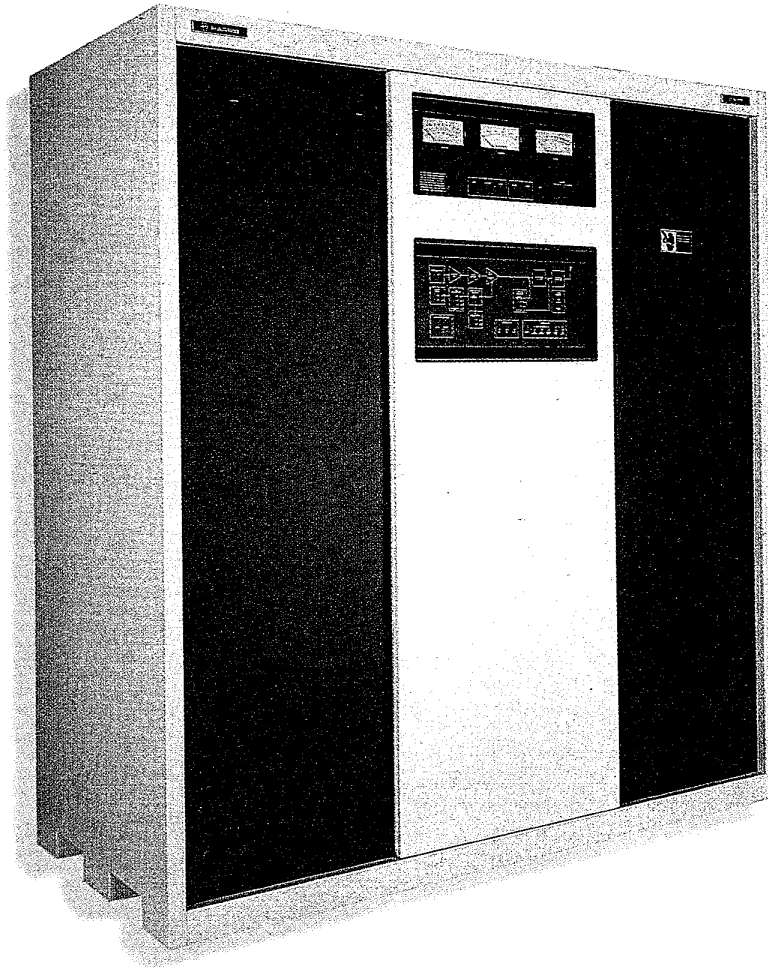

Harris DX Series 10 - 100 kW Medium Wave Transmitters

POWER LEVELS

DX 10 1 - 11kW	DX 15 1.5 - 16.5kW	DX 25U 10 - 27.5kW (Upgradeable to DX 50)
DX 50 10 - 60kW	DX 100 20 - 100kW	

Main/Alternate or combined configurations; 50 or 60Hz.

Since introduction in 1987, DX transmitters have become the industry standard by which all other Medium Wave transmitters are measured. Combining Harris-patented Digital Amplitude Modulation and an ultra-reliable solid state design, DX is delivering today's most advanced and cost-effective AM performance to more than 700 broadcasters worldwide.

Reliability: Multiple, identical RF power amplifier modules replace tubes. With a cumulative RF module Mean Time Between Failure rate >6 million hours, DX transmitters provide unmatched reliability. High-speed lightning protection, VSWR foldback and automatic protection against power line fluctuations further enhance reliability.

Cost of ownership: With overall efficiency to 86% (or higher), DX transmitters practically pay for themselves with substantial power cost reductions. Recurring tube replacements are also a thing of the past.

Performance: Digital Amplitude Modulation generates the loudest, clearest signal available. Even non-technical listeners have compared DX sound to FM! DX provides superior square wave response and peak modulation to 145%. These transmitters are stereo-ready.

Ease of operation: A front-panel signal flow diagram uses separate LEDs to provide at-a-glance information about key operating stages. A matching network is standard, and DX transmitters include an external interface for extended and remote control.

Maintenance: For easy maintenance, DX transmitters feature a modular design with accessible and interchangeable plug-in RF power amplifiers modules.

Future-ready: DX has proven itself ready for emerging digital broadcast services and operation on expanded band frequencies.

SPECIFICATIONS

TRANSMITTER TYPE	Medium Wave, 100% solid state.
FREQUENCY RANGE	531 - 1705kHz.
TYPE OF MODULATOR	Patented Harris AM Digital Amplitude Modulation
POSITIVE PEAK CAPABILITY	DX 10/25U/50: 145%; DX 15/100: 135%.
DUTY CYCLE	Continuous, 100% modulated sine wave at rated power.
AUDIO RESPONSE	+0.5 dB from 20Hz - 10kHz.
AUDIO DISTORTION	0.3% - 0.5% typical at 95% modulation, 30Hz - 10kHz.
AM NOISE	-65 dB or better below 100% modulation (unweighted).

POWER CONSUMPTION (At rated power)

Model	0% Modulation	100% Modulation
DX 10	11.6kW	17.4kW
DX 15	17.4kW	26.2kW
DX 25U:	≤29.4kW	≤44.1kW
DX 50	≤59kW	≤88kW
DX 100	≤118kW	≤176kW

EFFICIENCY DX 10/15: 86% typical; DX 25U/50/100: 85% typical.

POWER FACTOR 0.98% typical.

STEREO CAPABLE Yes; optional Harris AMS-G1 stereo exciter available.

REMOTE CONTROL/MONITORING Self-contained remote control interface.

Specifications subject to change without notice



OVER 850 ON-AIR WORLDWIDE.



#1 BEST SELLER.

- SECOND GENERATION - NEW FEATURES AND IMPROVED SPECIFICATIONS
- NUMERICALLY CONTROLLED OSCILLATOR - TRUE DIGITAL GENERATION
 - DIGITAL STEREO GENERATOR - SUPERIOR STEREO SEPARATION
 - EXCLUSIVE DIGITAL COMPOSITE LIMITER - LOUDER AND CLEANER
- WORLD LEADER IN PERFORMANCE

DIGIT CD THE DIGITAL LEADER

FOR MORE INFORMATION OR TO ARRANGE A DIGIT DEMO CONTACT HARRIS.

HARRIS CORPORATION
BROADCAST DIVISION

US and Canada

TEL: +1 217 222-8200

FAX: +1 217 222-1439

Elsewhere

TEL: +1 217 222-8290

FAX: +1 217 224-2764

<http://www.broadcast.harris.com>



© 1996 Harris Corp.

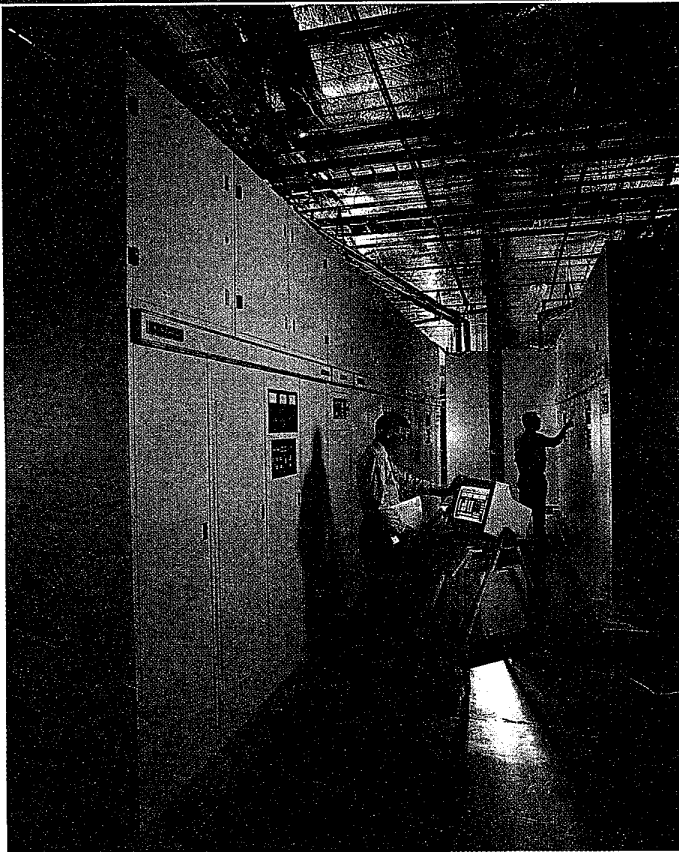

Harris DX Series 300 - 2000kW Medium Wave Transmitters

It is not surprising that Harris' 300 - 2000 kilowatt DX transmitters have become the industry standard worldwide. Using a flexible and ultra-reliable "power block" architecture, these transmitters extend the benefits of digital amplitude modulation and solid state to high and super power applications.

Power Block architecture: "Power blocks" are the basic building block for high-power DX transmitters. Harris offers air-cooled 150 and 200kW power blocks and water-cooled 170 and 200kW power blocks.* For redundancy, each power block has a single transformer and rectifier as its main DC source. High power DX transmitters are made up of several components, including multiple power blocks which are combined to produce rated power.

"N-1" combining: Depending on transmitter power level, a 2-way or 3-to-6-way combined mode is used. The combiner provides for automatic "N-1" operation: For example, if a 200kW power block is out of service in a DX 600 transmitter, the combiner system will automatically retune itself for 400kW operation and place the off-air power block into a test mode. This feature allows DX power blocks to be removed from service for maintenance during transmission.

Reliability: High-power DX transmitters provide unsurpassed redundancy. These transmitters use solid state RF power amplifier modules that have achieved a cumulative Mean Time Between Failure rate >6 million hours. Power blocks themselves have a MTBF rate — defined as the point where transmitter output falls to 70% or less — of >100,000 hours.

Cost of ownership: DX transmitters have the lowest operating cost of any transmitter. High power systems typically pay for themselves in less than five years in energy cost savings: power blocks typically achieve AC-to-RF

efficiency up to 85%, including the cooling system. Optional Adaptive Carrier Control can reduce energy consumption by an additional 35% (depending on modulation conditions). Beyond power savings, the all-solid state design totally eliminates recurring tube replacement costs.

Performance: Digital amplitude modulation provides superior performance to earlier modulation techniques. Audio distortion and frequency response approach levels that typically are achievable only with FM. Digital Amplitude Modulation and circuits used in DX transmitters result in outstanding IMD, IQM, square-wave tilt and overshoot performance. Exceptional phase and transient response demonstrates the linearity of digital modulation.

Safety: Maximum voltage is 250VDC, versus 30kVDC for typical tube transmitters. A keylock system also is standard. These transmitters meet IEC 215 safety requirements.

* Water-cooled power blocks are recommended for power levels above 400 kilowatts.

TYPICAL DX SYSTEM CONFIGURATIONS

Power Level	Air-cooled		Water-cooled		Rectifier Cabinet	Power Transformer	Combiner	2-Way Combiner	3-Way Combiner	4-Way Combiner	5-Way
	150kW	200kW	170kW	200kW							
300kW	2				2	2		1			
400kW		2			2	2	1				
500kW			3		3	3			1		
600kW				3	3	3			1		
800kW				4	4	4				1	
1000kW				5	5	5					1

Harris Frequency-Agile DX Series Medium Wave Transmitters

POWER LEVELS: DX 100A DX 300A
100 kW 300 kW

Harris DX Series 100 and 300 kilowatt medium wave transmitters are available in frequency-agile models. A built-in frequency synthesizer and front panel control make it easy to tune to any medium wave frequency in a matter of minutes. DX 100A frequency tuning time is less than three minutes (30 seconds is typical), and DX 300A frequency tuning time, less than 15 minutes (five minutes typical). These frequency-agile transmitters offer many advantages over other models:

Reliability-enhancing efficiency: Typical overall efficiency of 83% — the highest of any high-power frequency agile systems — reduces power costs. High efficiency maximizes on-air availability by reducing fuel consumption requirements when powered by AC generators.

Maximum signal performance: Digital audio processing ensures strong, clear reception. High average and peak modulation capability permits maximum signal loudness, even when interference is present.

Rugged construction: Ruggedly built and strengthened for mobile applications, these transmitters can be deployed rapidly in emergencies. Long Wave DX Transmitters also available.

Harris Medium Wave Phasors, ACUs Diplexers and Accessories

KEY BENEFITS

- Power levels available from 250 watts through 1.5 megawatts.
- Harris is experienced in assembling consultant-designed phasors which typically have highly customized parts.
- Computer-aided design and analysis of complete phasing system ensures best impedance and pattern bandwidth attainable for any given pattern.
- Complete line of phasing and ACU cabinets is available for almost any need. Wall panel construction is also offered.
- Factory pretuning to predicted values with a vector impedance meter and network analyzer ensures accurate impedance matches and phase shifts and can greatly reduce initial set-up time.

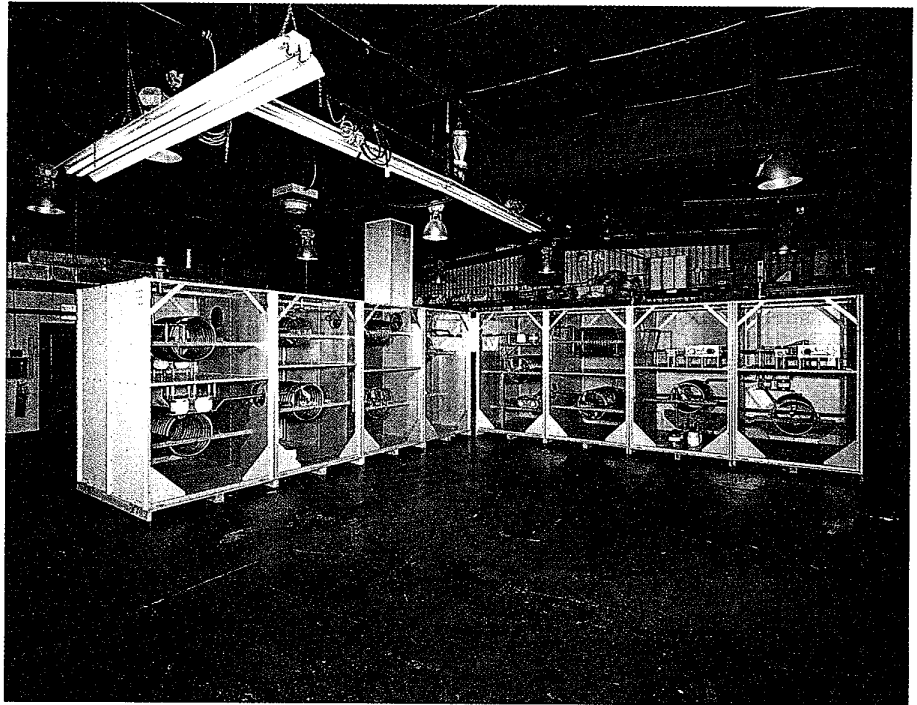

200kW x 200kW (400 kW total power) diplexer

- Cabinets use an alodyne finish to improve conductivity. Copper ground straps are available to enhance electrical conductivity.
- Silver-plated coils and tubing are used throughout the system. Silver-plated strapping is used only on fixed coils for flexible shorting applications.
- Convenient test jacks are included at points where measurements are to be taken. Jacks are installed so that leads from an RF impedance bridge do not cross.
- Horn gaps are available for improved lightning protection.
- Phasor cabinets are available with front-panel Delta Common Point Bridge and RF ammeter.
- Front and rear panels make all phasor components easily accessible. Phasor cabinet rear panels are interlocked with the transmitters to ensure personnel safety.
- Weather-proof ACU/Diplexer cabinets use a front-door lock to prevent unauthorized entry.
- Front-panel cyclometers with counter dials for variable components facilitate adjustment.
- Cabinet interior lights available.

HS-4P 30 AMP RF CONTACTOR

- Provides trouble-free operation in phasors, ACUs, transmitter dummy load switching or any similar RF switching application; provides reliable operation over wide temperate range.
- Requires no adjustment.
- Uses only 1/16 the power of conventional contactors.
- Has anticipated life of 30 years under normal use.

4 PORT MOTORIZED TRANSFER SWITCH

- Handles up to 8kW RF power at 125% modulation.
- Transfers main or auxiliary transmitter to station antenna system or test load (optional); designed around Harris' HS-4P RF Motorized Contactor, transfer time is less than 0.5 seconds.
- Features pushbutton control operation and switch position indicator lights on 19-inch rack-mount panel.
- Accommodates 208/240 VAC, 50/60 Hz; remote operation by contact closure rated at 24 VDC, 0.5 amp.

IMPEDANCE MATCHER

- Power levels available from 250 watts to 1.5 megawatts.
- Allows transmission lines with other than 50 ohm impedance to connect to a 50 ohm transmitter.
- Factory pretuned to calculated values with vector impedance meter to greatly reduce set-up time.
- Aluminum enclosure with alodyne finish ensures good conductivity and corrosion resistance.

ISOLATION COIL

- Allows a non-insulated RF sample loop's coaxial cable to cross the base insulator of antenna tower.
- Options on coaxial cable line size and manufacturer; connector types on either end, and weatherproof or non-weatherproof enclosure.
- Optional resonating capacitor to present a very high impedance at the operating frequency.
- Constructed with the same type of coaxial cable used in the sampling system; unique intertwining cable design ensures consistency and stability.

POWER SPLITTER

- Allows smaller portion of overall power to be used when transmitter is unable to drop its power output to the desired level.
- Can couple transmitter to any transmission line characteristic impedance.
- Factory pre-tuned to calculated values with vector impedance meter.
- Aluminum enclosure with alodyne finish can be constructed to desired dimensions.

TEST JACKS

- Three types available, including low current and high current two-pole jacks as well as a three-pole jack for switching between a common and two poles.

SILVER PLATED COILS

- Harris carries a complete line of fixed and variable coils. Fixed coils are rated to 150 amps (larger current ratings available on request).

CHOKES

- Two models available: Static Drain Choke provides DC path to ground. Tower Lighting Choke provides DC path to ground and transfers AC power to tower lights.

RF CURRENT METERS

- Two models available: Toroidal Current Meter obtains sample voltage proportional to the RF current flowing through the conductor. Thermocouple Meter plugs directly in-line with the circuit using a special "make before break" jack.

HORN GAP (IN PHASING CIRCUITS)

- Helps protect equipment from lightning strikes.

MICA AND VACUUM CAPACITORS

- Many different types available.

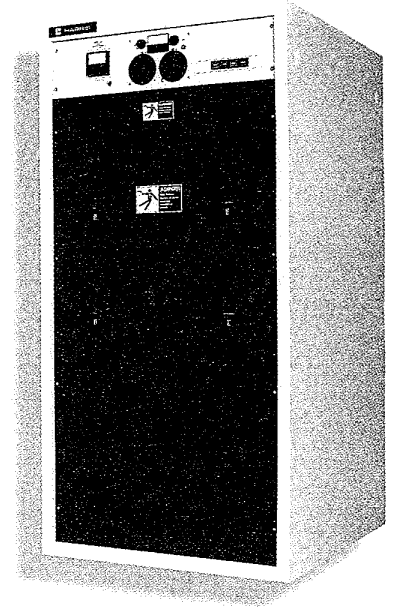

Standard Phasor

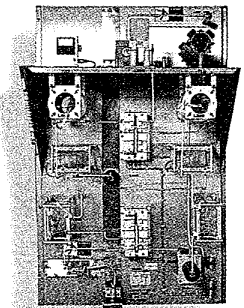

Antenna Coupling Unit

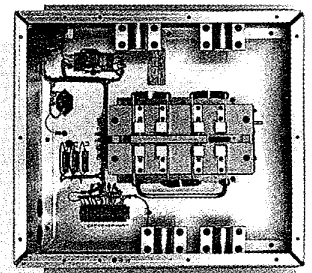

4-Port Motorized Transfer Switch

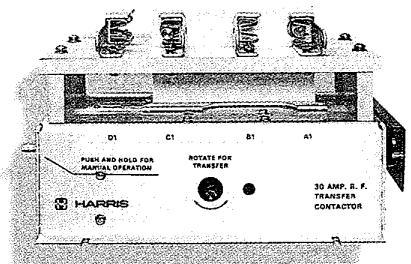

HS-4P 30 Amp RF Contactor

Transmitters





Geoffrey N. Mendenhall, P.E., earned his BEE degree from the Georgia Institute of Technology in Atlanta, Georgia.

Geoff has designed broadcast, communications, and telemetry equipment for several manufacturers. His practical experience includes engineering and operations work for several radio and television stations.

Geoff is Vice President- Radio Product Line Manager for Harris Broadcast Division in Quincy, Illinois. Previously he was vice president of research and product development for Broadcast Electronics, Inc.

Geoff holds three U.S. Patents for electronic designs utilized in broadcast equipment and is a registered professional engineer in the State of Illinois. He has authored numerous technical papers, is an associate member of the Association of Federal Communications Consulting Engineers and a senior member of the Institute of Electrical and Electronic Engineers.



How and Why Should You Convert to an All-Digital Studio to Transmitter Path?

By **Geoffrey N. Mendenhall, Vice President, Radio Product Line Manager**

The acceptance of the AES/EBU serial digital audio data interface standard by all the major broadcast equipment manufacturers makes it possible to build an all digital studio with an all-digital link to the transmitter using standard off-the-shelf equipment.

The AES3 (Audio Engineering Society/European Broadcast Union) serial data standard is defined in AES3-1985, ANSI S4.40-1992 and AES3-1992 documents as the digital audio data format to be used as the interface standard for audio sources, mixing/control equipment, audio processing equipment, STL equipment, and transmitter inputs. The European Broadcasting Union has republished a standard which is identical to the AES3 standard, except for the use of transformer coupling. Some highlights of the AES3 data format are:

- The interface format can accommodate 16, 20 or 24-bits of digital audio information.
- The interface handles serial data transmission of two channels of digitized audio over a conventional shielded, twisted-pair wire, for distances up to 100 meters.
- The interface uses standard 3 pin, XLR-type connectors, carrying balanced, RS-422 compatible signals that are polarity independent. The input and output impedance for the interface is 110 ohms.
- The data is sent least significant bit (LSB) first, with alternating subframes for Channel 1 and Channel 2.
- The data is self-clocking, and does not require an additional CLOCK connection to synchronize the source and destination.
- Auxiliary data bits are available to transport system control information along with the audio data.

Standard AES3 transmit and receive chipsets support the three commonly used data rates of 48.0kHz, 44.1kHz, and 32.0kHz. Since the current FM stereo transmission standard limits the frequency response of the left and right channels to a maximum of 15kHz, a 32kHz data rate is often used.

The AES3 output from the studio console can be distributed to other locations including the transmitter site. Two common ways to deliver the AES3 data are either through a digital STL radio link or through a T1 digital telephone line. Digital STLs and Digital STL modems (used to upgrade analog STLs) are now available. Analog phone lines are being replaced by T1 digital phone lines capable of carrying high data rates. A new generation of digital audio processing equipment accepts a digital audio input, processes this data fully in the digital domain, and outputs this processed data without any analog to digital (A/D) or digital to analog (D/A) conversions.

There are many advantages to using an all-digital path to your transmitter over discrete analog or baseband transmission. The advantages of an all-digital path include:

1. The elimination of all intervening A/D and D/A conversions and the distortions they introduce.
2. Full digital quality delivered to the "On-Air" signal without the noise and distortion build-up of an analog system.
3. Plug and Play - easy interfacing between equipment without worries about level adjustments or hum pickup.
4. Absolute frequency response and amplitude matching between stereo channels.
5. Absolute phase matching and differential phase stability between stereo channels.
6. Absolute stability and repeatability day-after-day, year-after-year without adjustments.
7. Resistance to interference.
8. Greatly improved fade margin for radio links.
9. Half the cable population - one AES3 cable replaces two analog cables.
10. Ability to transport some auxiliary control data along with audio data on one cable.

Harris offers a full range of AES3 compatible equipment including the revolutionary CD-LINK uncompressed STL and the industry leading DIGIT digital FM exciter to make the transition to a full digital air chain easy.

HARRIS EXPLAINS



**Harris
DIGIT® CD Digital FM Exciter**

Harris' DIGIT® is the world's first digital FM exciter. True CD-quality sound is only one significant advantage that has made DIGIT the choice of over 950 broadcasters in only three years. Now in its second generation, DIGIT CD has even better performance and more features!

Performance: DIGIT uses Direct Digital Synthesis (DDS) to generate an on-air signal with true 16-bit digital audio quality. A digital input module allows direct connection to digital (AES3) program sources, with no loss of digital audio quality.

Reliability: DIGIT replaces the voltage controlled oscillator (VCO) traditionally used in analog exciters for program modulation with a 32-bit numerically controlled oscillator. VCO/PLL problems — for example, poor low-frequency separation and PLL unlock from audio transients — are eliminated. DIGIT CD is immune to subsonic transients that can cause faults in an analog exciter and force a station off the air.

Stability: Drift-free circuits maintain DIGIT's original performance year after year, without operator adjustments.

Frequency Agile: For N+1 operation, DIGIT allows any assigned channel to be selected with no requirements for output tuning.

Future-Ready: DIGIT is available with either an analog input module or a digital (AES3) input module. Broadcasters can start with the analog input module, then upgrade to a digital input module in a couple of minutes when a digital signal to the transmitter becomes available.

Digital Input Module: A DSP-based stereo generator and a digital composite limiter (DCL) are included. DIGIT CD's stereo signal-to-noise ratio is 83dB for AES3 digital audio input, far exceeding the performance of any other stereo exciter. The DCL, an implementation of the WAVES L1 Ultramaximizer™ used by many digital recording studios, uses proprietary look-ahead circuitry to anticipate and eliminate overmodulation peaks before they occur.

New DIGIT CD Features: In addition to improved stereo signal-to-noise performance, DIGIT CD can be ordered for externally-controlled carrier frequency synchronization (GPS) capability for use in on-channel "booster" systems. DIGIT CD also includes a synchronous AM reduction circuit as a standard feature.

SPECIFICATIONS:

POWER OUTPUT	1 - 55 watts.
MODULATION TYPE	Direct Digital Synthesis using a 32-bit numerically controlled oscillator (NCO).
FREQUENCY RANGE	87 to 108MHz, digitally programmable in 50Hz increments.
FREQUENCY STABILITY	±150Hz, 0 - 50°C ambient temperature range.
MODULATION CAPABILITY	208% (±75kHz reference standard). Factory programmable in 6dB increments to ±468kHz.
PLL/AFC OVERLOAD CHARACTERISTICS	Immune to carrier dropouts caused by high energy, low frequency modulation. (Program audio is not applied to the VCO).
MODULATION INDICATION	Digitally generated peak reading, 0.25% accuracy (at 150% modulation setting). Color-coded LED display with baseband overmodulation indicator.
WIDEBAND FM SNT (SIGNAL TO NOISE v. TIME)	>90dB for eight samples per second over a 15 second time interval, no averaging; 75 microsecond de-emphasis, DC-100kHz bandwidth.
ASYNCHRONOUS AM NOISE	75dB minimum below equivalent 100% amplitude modulation by 400Hz using 75 microsecond de-emphasis (no FM modulation).
SYNCHRONOUS AM NOISE	60dB minimum below equivalent 100% amplitude modulation with 75uS de-emphasis (FM deviation ±75Hz by a 1kHz sine wave).
AC INPUT POWER	90 - 132VAC or 180 - 264VAC, 50/60Hz, 320 watts maximum.
DIMENSIONS	19" (48.3cm) W, 12.5" (31.8cm) D, 7" (17.8cm) H.
WEIGHT	38 lbs. (17.3kg).
MOUNTING	Standard 19" (48.3cm) EIA rack mountable. Slide-out mounting rails included.



STEREO PERFORMANCE WITH DIGITAL INPUT MODULE

DATA FORMAT	AES3.
DIGITAL STEREO GENERATOR	Complete digital composite stereo waveform generated in the digital domain from incoming AES3 stereo audio data, using a digital signal processor (DSP).
DIGITAL BASEBAND COMPOSITE LIMITING	WAVES L-1 Ultramaximizer™ "lookahead" techniques for control of peaks before overmodulation can occur. Active with on-board DSP stereo generator in stereo or monaural mode; pilot carrier and SCA signals unaffected. Limiter on/off and limit setting adjustable from 0 - 18dB either locally or by standard remote control systems.
STEREO SEPARATION	65dB or greater, 10Hz - 15kHz.
FM SIGNAL TO NOISE (L or R)	83dB below 100% modulation at 400Hz; measured in a DC to 22kHz bandwidth with 75 microsecond de-emphasis and DIN "A" weighting. Does not exhibit the subsonic noise associated with analog exciters.
STEREO TOTAL HARMONIC DISTORTION	0.005% or less for any modulating frequency from 10Hz to 15kHz, measured in DC to 22kHz bandwidth with 75 microsecond de-emphasis.
EMERGENCY ANALOG COMPOSITE MODE	Switchable locally or by standard remote control systems to mute the on-board DSP stereo generator and accept analog composite stereo on SCA Port #2. Nominal input sensitivity (all SCA ports in this mode): 3.5Vp-p (1.24V RMS) for ±75kHz deviation. FM signal to noise ratio: 85dB below 100% modulation. Total composite harmonic distortion: 0.008%.

Specifications subject to change without notice.

Transmitters



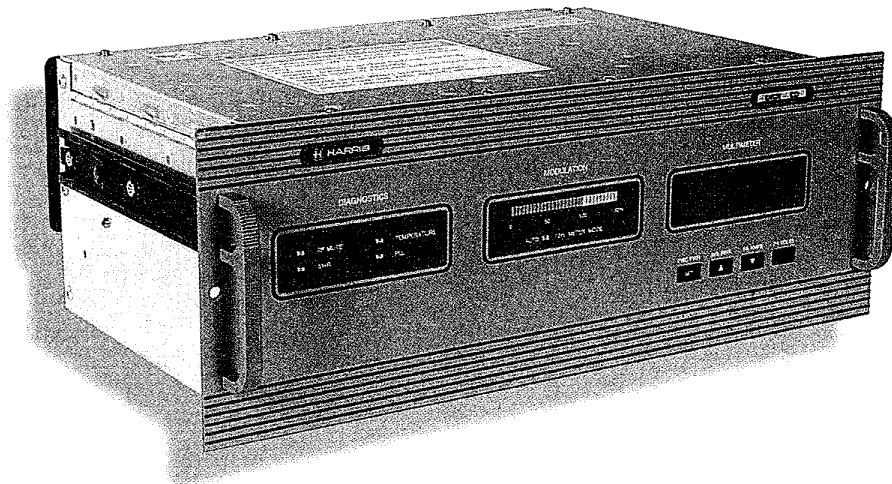

Harris DIGIT CD pictured here is featured on Page 222.

Transmitters

Harris SuperCiter™ Analog FM Exciter

Harris' SuperCiter is a high-quality 55 watt exciter designed for broadcasters who need top quality analog performance at a value price.

Performance: SuperCiter combines time-proven PLL technology and modern RF amplifier circuits to provide driving power of very high quality to any FM transmitter. The exciter includes standard monaural, composite, and SCA/RBDS inputs for compatibility with current analog STLs and analog studio source equipment.

Reliability: SuperCiter includes automatic power control, VSWR foldback and overload protection.

Ease of Operation: A digital multimeter and front-panel modulation display provide ready access to operating status. A remote control interface is provided.

Options: An harmonic filter/RF sample assembly enables SuperCiter to be used as a low-power transmitter. A remote control extension cable with terminal strip also is optional.

SPECIFICATIONS

POWER OUTPUT	55 watts.
MODULATION TYPE	Direct Carrier Frequency Modulation (DCFM).
RF OUTPUT IMPEDANCE	50 ohms, BNC female connector.
FREQUENCY RANGE	87.5 to 108MHz in 10kHz steps.
FREQUENCY STABILITY	±3ppm, 0 - 50°C (4 minute stabilization period).
MODULATION CAPABILITY	±350kHz.
AC INPUT POWER	90 - 132VAC or 180 - 264VAC, 50/60Hz, 1 phase, 2 wire, 300W maximum.
DIMENSIONS	19" (48.3cm) W, 12.5" (31.8cm) D, 7" (17.8cm) H.
WEIGHT	36 lbs. (16.4kg).
MOUNTING	Standard 19" (48.3cm) EIA rack mountable. Slide-out mounting rails included.

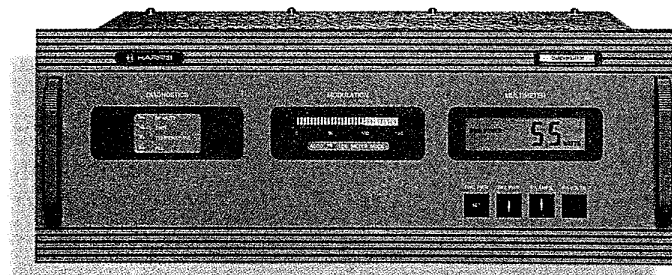

Harris SuperCiter™

STANDARD WIDEBAND COMPOSITE OPERATION

AMPLITUDE RESPONSE	±0.1dB, 30Hz - 53kHz.
FM SIGNAL TO NOISE RATIO	80dB below ±75kHz deviation at 400Hz with 75 microsecond de-emphasis, 22Hz - 500kHz bandwidth.
HARMONIC DISTORTION	0.02%, 30Hz - 100kHz with 75 microsecond de-emphasis.
INTERMODULATION DISTORTION	0.03% (60Hz/7kHz tone pair).
CCIF INTERMODULATION DISTORTION	All distortion products down 74dB (reference 14kHz/15kHz tone pair).
ASYNCHRONOUS AM NOISE	55dB below equivalent 100% amplitude modulation.
SYNCHRONOUS AM NOISE	60dB below equivalent 100% amplitude modulation with 75 microsecond de-emphasis (FM modulation ±75kHz at 1kHz).
STEREO SEPARATION	30Hz - 300Hz: 40dB; 300Hz - 15kHz: 50dB (as limited by external stereo generator).

Specifications subject to change without notice.



From 10 kW to 1 Megawatt, nobody even comes close.

Proven quality and unmatched power.

For nearly a decade, Harris has raised the world standards of reliability, efficiency and power for medium wave transmitters. With solid state power amplifier modules delivering an MTBF of 6 million hours, typical AC to RF efficiency to 86 percent and a signal that sounds like FM, Harris DX transmitters have proven to be the choice of more than 600 broadcasters around the world.

To meet the demands of the global market, Harris provides DX transmitters at all power ranges from 10 kW to 1000 kW. In fact, with our 1995 International Broadcasting Award-winning DX 1000, Harris is *the only company in the world that can deliver — and has delivered — a 1-Megawatt solid state AM transmitter.*

**Digital is here
now, with Harris.**

As the only transmitter proven

to be capable of digital medium wave broadcasting, Harris DX Transmitters have been used for every on-air In Band/On Channel AM DAB test to date. And, because DX is the only medium wave transmitter compatible with both analog *and* digital transmission, while meeting IBOC DAB standards, Harris stands alone in its ability to meet your broadcasting demands today, while preparing you for tomorrow.

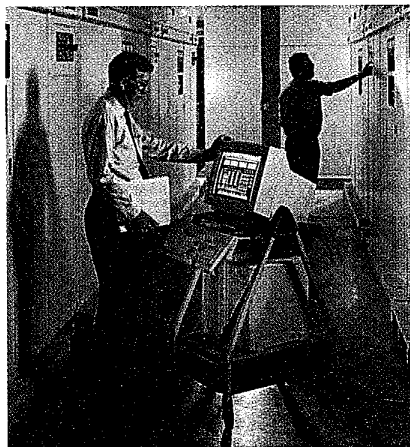

Experience that serves you well.

Broadcasters worldwide rely on the vast experience and resources of Harris. From medium wave to FM, UHF, VHF, satellite and wireless cable networks, Harris has repeatedly proven its ability to help clients get the most out of their facilities and their budgets.

And that's a matter of record, too.

So, why settle for coming close, when Harris can take you all the way? For more information, just call Harris.

HARRIS CORPORATION BROADCAST DIVISION

US and Canada
TEL: +1 217 222-8200
FAX: +1 217 224-1439

Elsewhere
TEL: +1 217 222-8290
FAX: +1 217 224-2764



Harris
Quest Series 100 - 1000W
FM Transmitters

POWER LEVELS

QUEST 100
 25 - 110 watts

QUEST 250
 65 - 275 watts

QUEST 500
 125 - 550 watts

QUEST 1
 250 - 1,100 watts

Main/alternate configurations; 50 or 60Hz.

Harris Quest FM transmitters are the value leaders in low power FM. Featuring a cost-effective solid state design, Quest transmitters are built for years of reliable operation. For remote, unattended sites, these transmitters are available in main/alternate configurations with automatic switching.

Reliability: Quest transmitters feature the same basic FET solid-state RF pallets used in Harris' premium Platinum Series[®] FM transmitters. These pallets have achieved a field MTBF exceeding 250,000 hours. Standard features include automatic power control, VSWR foldback, VSWR protection, temperature and AC/DC overload protection.

Integrated Design: These highly-compact 19" EIA rack-mountable transmitters include an integrated FM exciter. Exciter modulation performance is excellent, with noise and distortion typical of stand-alone exciters.

Ease of Operation: The microprocessor controller performs comprehensive monitoring, control and calculating functions not found in other transmitters in this power range. A convenient LCD display and LED status indicators provide status information. Remote control and status ports are open-collector compatible, eliminating the need for an external relay panel. The controller provides automatic restart after AC failures as well as presettable high/low power modes.

Maintenance: Major components are easy to remove. They can be replaced on a modular basis or repaired on site.

SPECIFICATIONS

TRANSMITTER TYPE	FM, solid state.
EXCITATION	Integrated 10 watt exciter.
TYPE OF MODULATION	Direct carrier frequency modulation (DCFM).
AC POWER INPUT	120VAC, 60Hz or 208/220/240VAC, 50/60Hz, 1 phase, 2 wire, +10/- 15% line variation.

POWER CONSUMPTION

Model	Power Consumption
Quest 100	400W.
Quest 250	800W.
Quest 500	1,200W.
Quest 1	2,200W.

SIZE 19" (48.3cm) W, 22.2" (56.3cm) D, 24.5" (62.2cm) H.

WEIGHT Quest 100: 160 lbs. (72.7cm); Quest 250: 170 lbs. (77.3cm); Quest 500: 195 lbs. (88.6cm); Quest 1: 230 lbs. (104.5cm).

STANDARD WIDEBAND COMPOSITE OPERATION

AMPLITUDE RESPONSE	±0.1dB, 30Hz - 53kHz.
FM SIGNAL TO NOISE RATIO	80dB below ±75kHz deviation at 400Hz with 75 microsecond de-emphasis, 22Hz - 500kHz bandwidth.
HARMONIC DISTORTION	0.02%, 30Hz - 100kHz with 75 microsecond de-emphasis.
INTERMODULATION DISTORTION	0.03% (60Hz/7kHz tone pair).
CCIF INTERMODULATION DISTORTION	All distortion products down 74dB (reference 14kHz/15kHz tone pair).
ASYNCHRONOUS AM NOISE	55dB below equivalent 100% amplitude modulation.
SYNCHRONOUS AM NOISE	60dB below equivalent 100% amplitude modulation with 75 microsecond de-emphasis (FM modulation ±75kHz at 1kHz).
STEREO SEPARATION	30Hz - 300Hz: 40dB; 300Hz - 15kHz: 50dB (as limited by external stereo generator).
OPTIONS	Remote barrier strip, power supply crossover and 7/8" EIA adapter.

Specifications subject to change without notice.

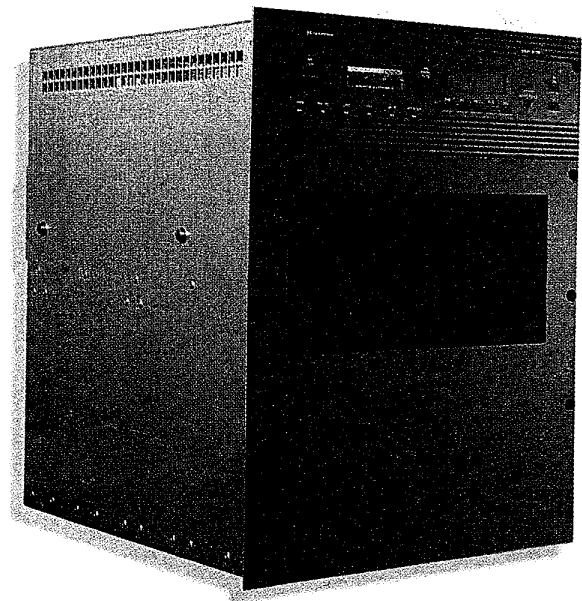

Transmitters

HARRIS EXPLAINS



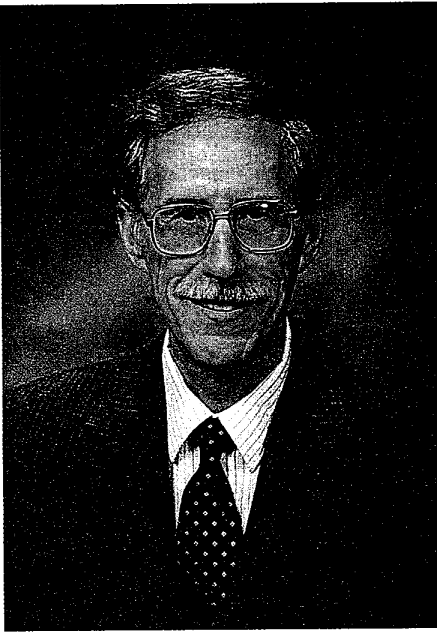

Richard Fry has over 35 years of experience in the broadcast industry, ranging from Chief Engineer at an AM/FM combo to TV station switching and transmitter operation. He was a supervisor for RCA Broadcast Field Service from 1965 to 1980, after which he joined Harris Corporation. Presently Richard is the Applications Engineer for the FM Product Line, where he is responsible for technical support to customers, salespeople, and consultants concerning FM transmission products and RF systems. Richard's technical software is used by the Harris sales force to help analyze and define RF systems for Harris customers.

Fry is an SBE Certified Professional Broadcast Engineer and has a BA degree from National College in Evanston, IL.

bandwidth capability increases the inventory and resale value of the transmitter for the owner and buyer. Tube amplifiers are more narrow band and can limit the quality of the FM signal as it is amplified. And while the frequency of tube transmitters can be changed, it is a more complicated process sometimes requiring parts changes and careful settings and adjustments by a skilled engineer. Therefore a typical tube transmitter is not quickly frequency-agile so as to serve as an emergency standby transmitter for several frequencies. Solid state is the clear winner in this category.

5. **Safety:** Harris solid state FM transmitters use safe, low DC voltages inside the cabinet. In fact the DC voltages are so low that U.S. and international safety standards do not even require the use of interlocks on Harris solid state FM transmitters. Use of low voltage gives a safer working environment for station personnel, and also reduces dust attraction within the transmitter. In contrast, vacuum tube transmitters use dangerous, high DC voltages that can be a safety hazard, and which do attract dust to those components — increasing the need for routine maintenance.

Solid state FM transmitters can be somewhat more expensive initially than tube transmitters of equivalent power. This is the result of the cost of the many low power amplifiers required, and the cost of the necessary combining circuits. But when adding up the savings and service benefits provided by a well designed solid state transmitter over its lifetime, it is clear to see why so many broadcasters are finding it very profitable to switch to a Harris solid state FM transmitter.

The Transition from Tube to Solid State FM Transmitters

By Richard J. Fry, FM Applications Engineer

Until the last few years, the broadcast industry has relied on vacuum tube technology to generate the RF power needed for FM broadcasting. However, solid state transmitters are now replacing vacuum tube FM transmitters. The reasons for this move are:

1. **Greater Amplifier Reliability:** Solid state devices have extremely long life. A vacuum tube uses a high-temperature filament that wears or burns out, like a light bulb. A typical RF power tube must be replaced after two to four years of operation, at a cost of thousands of dollars — and some off-air time to make the change as well. Solid state devices have no filament or other failure-prone architecture. The projected life of a solid state amplifying device is typically over 30 years. A solid state amplifier just keeps working.

2. **"Soft Failure":** Solid state FM transmitters use many relatively low-powered amplifier sections combined to develop the total output power required. Loss of one or several of the low power stages has only a minor affect on the output power of the transmitter. In most cases, the coverage area of the station is hardly affected. In today's solid state FM transmitters from Harris, an inexpensive low power amplifier section can be replaced at any time of day, without going off the air. But a typical tube transmitter will be off the air completely whenever the tube goes bad. And this could happen unexpectedly — even in prime commercial time. Solid state designs are clearly better than tubes in this respect.

3. **Reduced Maintenance:** For the reasons outlined above, solid-state FM transmitters seldom require service. It has been estimated that a solid state FM transmitter needs only about 10% of the maintenance time and cost of a comparable vacuum tube transmitter. Solid state allows better manpower utilization and fewer "emergency" trips to the transmitter site. Maintenance can be scheduled to coincide with site access issues, avoiding trips to the transmitter site when it might be difficult due to the ice and snow conditions.

4. **Bandwidth:** Harris solid state FM transmitters use broadband circuits that have negligible affect on the quality of the FM signal as it is amplified. Harris solid state FM transmitters can be easily and quickly changed by the owner (or new buyer!) to operate on any FM frequency, 87.5 through 108MHz. This feature is valuable for group owners who may want to send a transmitter from one site to another for a facility upgrade, or as a frequency-agile standby transmitter for all other FM's in a given market. This

HARRIS EXPLAINS



**Harris
Platinum Z5CD and Z10CD 5 and 10kW FM Transmitters
with DIGIT CD Digital FM Exciter**

POWER LEVELS:

Z5CD
1.25 - 5.5 kilowatts

Z10CD
2.5 - 11 kilowatts



Main/alternate or combined configurations; single or three phase power; 50 or 60Hz.

Harris proudly presents Platinum Z, the newest dimension in FM transmitters. Developed with the latest Z-axis electronic design tools, ZCD transmitters provide solid state advantages at the price of vacuum tube technology.

Reliability: The ultra-redundant transmitters use the same solid state RF power amplifier devices that have achieved an MTBF >250,000 hours in hundreds of Platinum FM transmitters operating worldwide. Other standard features include redundant IPAs, automatic power control, VSWR overload protection, automatic VSWR foldback, RF power "soft start," and AC restart. Optional dual exciters and a redundant power supply controller are available.

Performance: DIGIT CD, Harris' industry-reference digital FM exciter, is standard. As the world's first all-digital FM exciter, DIGIT can accept AES3 digital audio and generate a fully-modulated FM carrier totally in the digital domain. The result is true 16-bit digital audio quality with the lowest noise and distortion of any FM transmitter.

N+1 Capability: A broadband design eliminates tuning adjustments from 87 through 108MHz. Frequency can be changed manually in less than five minutes using simple switch settings, and in less than half a second using the optional external controller.

Ease of Operation: A microprocessor-based controller monitors important operating functions and makes intelligent decisions based on operating conditions. Detailed system information is available via a front-panel diagnostic display. ZCD transmitters are designed for direct connection to standard remote control systems and include an RS-232 serial communications port. A directional RF sample port is also standard.

Maintenance: Redundant, hot-pluggable power amplifier modules, redundant power supplies and a low-voltage design enable much on-air service to be performed. ZCD transmitters require up to 90% less routine maintenance than their tube counterparts.

Future-Ready: DIGIT CD is supplied with either an analog input module or an AES3 input module. Broadcasters can start with the analog input module and upgrade to the digital module in minutes when a direct digital signal to the transmitter becomes available.

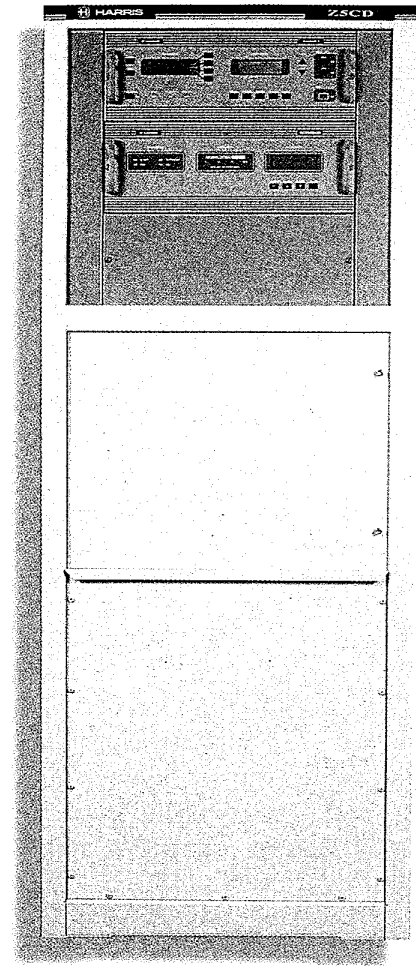

Transmitters

SPECIFICATIONS

TRANSMITTER TYPE	FM, solid state.
EXCITATION	Harris DIGIT CD Digital FM Exciter standard. (Harris SuperCiter Analog FM Exciter available on request.)
AC POWER INPUT	190 - 250VAC, 3 phase, 50/60Hz, 3 wire plus safety ground <u>or</u> 360 - 415 VAC, 3 phase, 50/60Hz, 4 wire, <u>or</u> 190 - 250VAC, 1 phase. 50/60Hz, 2 wire plus safety ground.
POWER CONSUMPTION	
Model	Power Consumption
Z5CD	8.33kW @ 5kW output.
Z10CD	16.7kW @ 10kW output.
DIMENSIONS	Z5CD, 1 or 3 phase: 28.5" (72.4cm) W, 36" (91.4cm) D, 72" (182.9cm) H. Fan assembly adds 13-3/16" (33.5cm) to depth. Z10CD, 3 phase: : 28.5" (72.4cm) W, 36" (91.4cm) D, 72" (182.9cm) H. Fan assembly adds 13-3/16" (33.5cm) to depth. Z10CD, 1 phase, adds a second cabinet of equal size.
PERFORMANCE	Essentially defined by exciter specifications.

Specifications subject to change without notice.

**CERTAIN PRODUCTS NOT
AVAILABLE IN ALL AREAS**



**ORDERING AND TECHNICAL SUPPORT:
(217) 222-8200**

227

DIGITAL FM TRANSMITTERS



Platinum Z Solid-state FM Transmitters. Full CD-quality sound that sends listeners to a new dimension without sending your budget down the tubes.

The phenomenal CD-quality sound provided by true digital FM generation is now a surprisingly affordable reality.

Harris introduces the CD Series™ Platinum Z™ transmitters. These fifth-generation FM solid-state transmitters are available in 2 to 20 kW models and feature the world-standard DIGIT CD™, digital FM exciter.

The big news for broadcasters is that Platinum Z provides the reliability of solid-state digital technology at a price comparable to conventional tube type transmitters. Platinum Z transmitters feature Z-axis design, utilizing all three dimensions...X, Y and Z axes. Platinum Z transmitters also use innovative Z-plane combining, which enables seamless transmission during maintenance

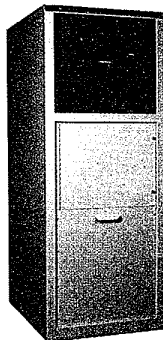

and enhances redundancy. If you remove a hot-pluggable RF module from a Platinum Z transmitter at any time, for any reason, the remaining modules will compensate to continue broadcasting at full power. Incredible RF module MTBF of 250,000 hours further ensures the reliable performance of Platinum Z.

Platinum Z features:

- DIGIT CD exciter (digital or analog input)
- Hot-pluggable RF modules
- Redundant IPA system
- Redundant power supplies
- Broadband design (N+1 capable)
- Life support backup controller
- Dual-output power setting
- Built-in auto exciter switcher
- High overall efficiency

Digital CD-quality performance... solid-state reliability and redundancy...a price comparable to tube type

transmitters...and backed by Harris 24 hour world-wide service!

Is there any reason to consider a transmitter other than Platinum Z?

To discover for yourself how full CD-quality sound can take your listeners and your ratings to the new "Z" dimension *without* blowing a hole in your budget, contact Harris.



HARRIS CORPORATION BROADCAST DIVISION

U.S. and Canada
TEL: +1 217 222-8200
FAX: +1 217 224-1439

Elsewhere
TEL: +1 217 222-8290
FAX: +1 217 224-2764



A new world of broadcast solutions

Radio-FM: DIGIT CD™- Digital FM Exciter • SuperCiter™ Analog FM Exciter • CD LINK™ Digital STL • Quest, Platinum and Platinum Z Solid State FM Transmitters • HT Single-tube FM Transmitters • FM Antennas **Radio-AM:** DX - Digital Solid State AM Transmitters • GATES® Solid State AM Transmitters **Radio-DAB:** DAB 2000 Transmitters **Studio Products:** Digital and Analog Studio Equipment **Systems:** Mobile and Fixed Studios and Satellite Systems

**Harris
Platinum Series® 2 - 10kW FM Transmitters with DIGIT CD
Digital FM Exciter**

POWER LEVELS:

PT 2CD	PT4CD	PT5CD	PT8CD	PT10CD
1 - 2.2 kilowatts	2 - 4.4 kilowatts	2.5 - 5.5 kilowatts	4 - 8.8 kilowatts	5 - 11 kilowatts

Main/alternate or combined configurations; single or three phase, 60Hz; three phase, 50Hz.

Platinum PT CD transmitters have become the industry standard by which all solid state FM transmitters are judged. With hundreds in operation worldwide, PT CD has redefined reliability and serviceability. Harris' DIGIT became the standard exciter in 1995, adding true CD sound to PT CD's impressive list of benefits.

Reliability: Multiple interchangeable 1,350 watt solid state RF power amplifier modules, fans, and other components operate in parallel, ensuring superb reliability even without a standby transmitter. FET power amplifier modules have achieved an MTBF >250,000 hours. Other standard features include automatic power control, VSWR overload protection, VSWR foldback, RF power "soft start," and AC restart.

Performance: DIGIT CD, Harris' industry-reference digital FM exciter, not only is the world's first all-digital FM exciter, but it is the first exciter that can directly accept AES3 digital audio. The result is true 16-bit sound preferred by today's listeners. Uncompromised bandwidth ensures superb signal quality, minimum group delay variation, and low synchronous AM noise.

N+1 Capability: PT CD transmitters have a broadband design that makes changing transmitter frequency as easy as selecting exciter frequency: Frequency can be changed manually in less than five minutes using DIGIT's simple switch settings, and in less than half a second using the optional external controller.

Ease of Operation: Even a non-technical person can operate a PT CD transmitter. A large LCD display on the control panel and status LEDs on each module provide at-a-glance status information. A built-in interface is compatible with standard TTL/open collector remote control systems.

Maintenance: PT CD transmitters require only 10 percent of the recommended routine maintenance of tube transmitters. Extensive redundancy and a low-voltage design enable much service to take place during transmitter operation.

High-Power Applications: Higher power combined PT CD transmitters can be ordered with Harris' optional switchless combiner. The combiner ensures continuous signal transmission when changing from dual to single transmitter operation.

Future-Ready: DIGIT CD is supplied with either an AES3 digital input module or an analog input module. Broadcasters can start with the analog input module and upgrade to the digital module in minutes when a direct digital signal to the transmitter becomes available.

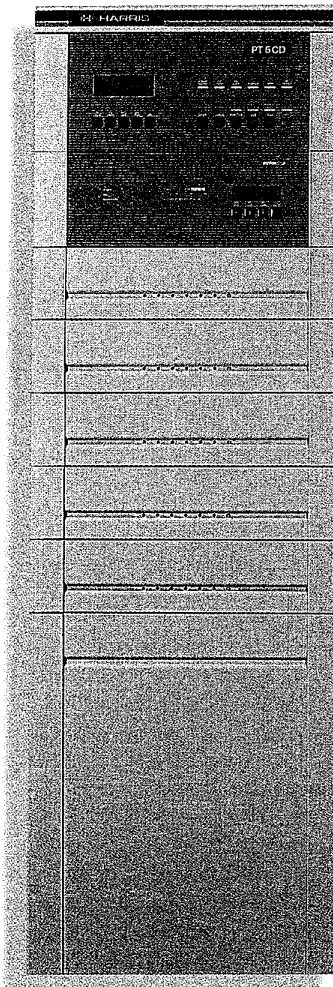

Transmitters

SPECIFICATIONS

TRANSMITTER TYPE	FM, solid state.
EXCITATION	Harris DIGIT CD Digital FM Exciter standard. (Harris SuperCiter Analog FM Exciter available on request.)
AC POWER INPUT	197 - 250VAC, 3 phase, 50 or 60Hz, 3 phase, 3 wire closed delta or WYE; 360 - 415VAC, 50 or 60Hz, 3 phase, 4 wire WYE; or 197 - 250 VAC, 1 phase, 60 Hz (only), 2 wire.
POWER CONSUMPTION	
Model	Power Consumption
PT 2CD	4kW @ 2kW output.
PT 4CD	8kW @ 4kW output.
PT 5CD	10kW @ 5kW output.
PT 8CD	16.9kW @ 8kW output.
PT 10CD	21.2kW @ 10kW.
DIMENSIONS	PT 2/4/5CD: 23.5" (59.7cm) W, 38-1/4" (97.2cm)D, 72" (182.9cm) H. PT 8/10CD: 47" (119.4cm) W, 38-1/4" (97.2cm) D, 89" (226cm) H.
WEIGHT	PT 2CD: 1,050 lbs. (477.3kg); PT 4CD: 1,150 lbs. (522.7kg); PT 5CD: 1,200 lbs. (545.5kg); PT 8CD: 2,710 lbs. (1,231.8kg); PT 10CD: 2,800 lbs. (1,272.7kg).
PERFORMANCE	Essentially defined by exciter specifications.
Specifications subject to change without notice	



**Harris
HT 3.5/5/7/10CD
3.5 - 10kW FM Transmitters
with DIGIT CD Digital FM Exciter**

POWER LEVELS

- HT 3.5CD
800 watts - 4 kilowatts
- HT 5CD
1500 watts - 5 kilowatts
- HT 7CD
3 kilowatts - 8 kilowatts
- HT 10CD
5 kilowatts - 10 kilowatts



Single phase only in 3.5 and 5kW models; single or three phase available in 7 and 10kW models; 50 or 60Hz.

HT CD transmitters are the world's first transmitters to incorporate a digital FM exciter as standard with a conservatively-rated tetrode. The HT CD family is demonstrating its superior performance in many hundreds of installations worldwide.

Performance: At the heart of HT CD transmitters is Harris' DIGIT CD Digital FM Exciter. DIGIT delivers the true 16-bit CD sound preferred by today's listeners and other significant advantages (please see DIGIT CD listing). A single, rugged tetrode in Harris' broadband quarter-wave cavity provides twice the bandwidth of half-wave cavity designs for superior performance.

Reliability: Standard automatic power control, ramp-up soft-start to protect the tube when the transmitter is turned on, proportional VSWR foldback and other features provide top reliability. Harris' FlexPatch™ RF patching keeps HT CD transmitters on the air in emergencies.

Ease of Operation: Front-panel analog and digital meters and LEDs that monitor all important circuits provide at-a-glance status information. An optically-isolated remote control command and status interface provides a ready link to standard remote control systems.

Future-Ready: DIGIT CD is supplied with either an analog input module or an AES3 input module. Broadcasters can start with the analog input module and upgrade to the digital module in minutes when a direct digital signal to the transmitter becomes available.

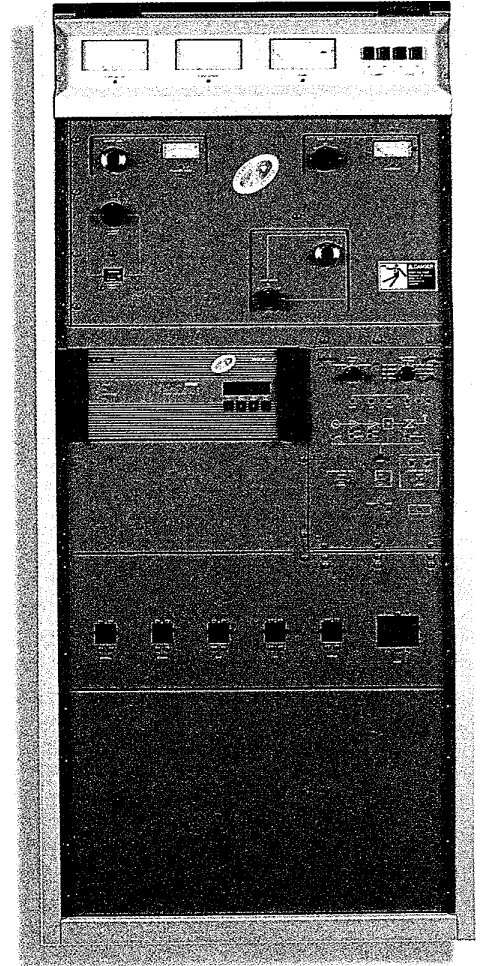

SPECIFICATIONS

TRANSMITTER TYPE	FM.
EXCITATION	Harris DIGIT CD Digital FM Exciter standard. (Harris SuperCiter Analog FM Exciter available on request.)
POWER AMPLIFIER	Tube (tetrode): HT 3.5/5CD: 4CX3500A; HT 7/10CD: 4CX7500A.
AC POWER INPUT	50 or 60Hz; HT 3.5/5/7/10CD: 197 - 251VAC, 1 phase, 2 wire; HT 7/10CD (alternate): 197 - 251 VAC, 3 phase, 3 wire closed delta or WYE; 3 phase, 4 wire WYE or 197 to 251 VAC, 1 phase, 2 wire.
POWER CONSUMPTION	
Model	Power Consumption
HT 3.5CD	7.5kW @ 4kW output.
HT 5CD	8.9kW @ 5kW output.
HT 7CD	13.5kW @ 8kW output .
HT 10CD	15.7kW @ 10kW output .
DIMENSIONS	33" (84cm) W, 34" (86cm) D, 72" (182.9cm) H.
WEIGHT	HT 3.5CD: 880 lbs. (400kg); HT 5CD: 1,025 lbs. (465.9kg); HT 7CD: 1,050 lbs. (477.3kg); HT 10CD: 1,125 lbs. (511.4kg).
PERFORMANCE	Essentially defined by exciter specifications.
Specifications subject to change without notice	



**Harris
HT 20/25CD
20 and 25kW FM Transmitters
with DIGIT CD Digital FM Exciter**

POWER LEVELS

HT 20CD
8 kilowatts - 20 kilowatts

HT 25CD
8 kilowatts - 25 kilowatts

Main/alternate or combined configurations available; 50 or 60Hz.



HT CD transmitters are the world's first transmitters to incorporate a digital FM exciter as standard with a conservatively-rated tetrode. The HT CD family is demonstrating its superior performance in many hundreds of installations worldwide.

Performance: At the heart of HT CD transmitters is Harris' DIGIT CD Digital FM Exciter. DIGIT delivers the true 16-bit CD sound preferred by today's listeners and other significant advantages (please see DIGIT CD listing). A single, rugged tetrode in Harris' broadband quarter-wave cavity provides twice the bandwidth of half-wave cavity designs for superior performance.

Reliability: Standard automatic power control, ramp-up soft-start to protect the tube when the transmitter is turned on, proportional VSWR foldback and other features provide top reliability. Harris' FlexPatch™ RF patching keeps HT CD transmitters on the air in emergencies.

Ease of Operation: Front-panel analog and digital meters and LEDs that monitor all important circuits provide at-a-glance status information. An optically-isolated remote control command and status interface provides a ready link to standard remote control systems.

Future-Ready: DIGIT CD is supplied with either an analog input module or an AES3 input module. Broadcasters can start with the analog input module and upgrade to the digital module in minutes when a direct digital signal to the transmitter becomes available.

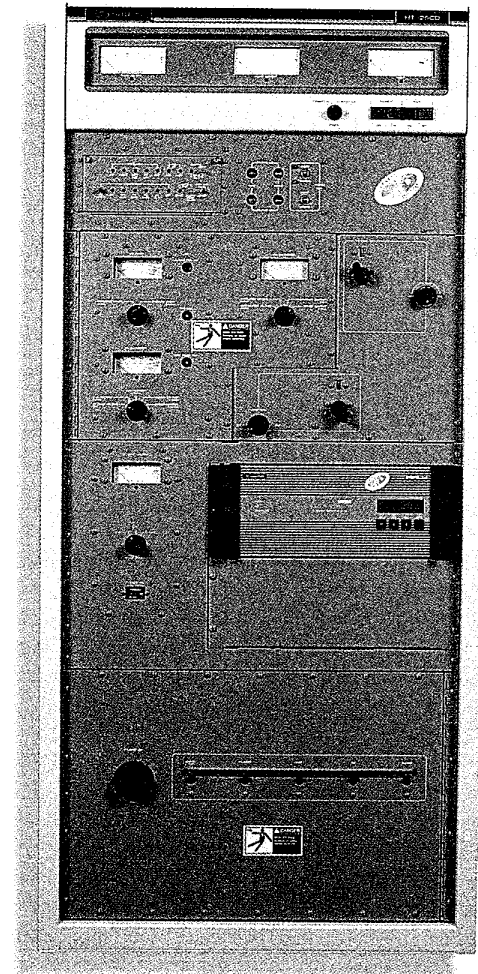

Transmitters

SPECIFICATIONS

TRANSMITTER TYPE	FM.						
EXCITATION	Harris DIGIT CD Digital FM Exciter standard. (Harris SuperCiter Analog FM Exciter available on request.)						
POWER AMPLIFIER	Single Tube (tetrode): 4CX20,000A.						
AC POWER INPUT	50 or 60Hz: 197 - 250 VAC, 3 phase, 3 wire closed delta or WYE; or 360 - 415 VAC, 3 phase, 4 wire WYE.						
POWER CONSUMPTION							
	<table border="0"> <tr> <td>Model</td> <td>Power Consumption</td> </tr> <tr> <td>HT 20CD</td> <td>30.8kW</td> </tr> <tr> <td>HT 25CD</td> <td>37.5kW</td> </tr> </table>	Model	Power Consumption	HT 20CD	30.8kW	HT 25CD	37.5kW
Model	Power Consumption						
HT 20CD	30.8kW						
HT 25CD	37.5kW						
SIZE	Main Cabinet: 33.3" (84.6cm) W, 30.2" (76.7cm) D, 72" (182.9cm) H; Power Supply: 48" (122 cm) W, 24.1" (61cm) D, 60" (152.4cm) H.						
WEIGHT	HT 20CD: 2,550 lbs. (1,159kg); HT 25CD: 2,700 lbs. (1,227kg).						
PERFORMANCE	Please refer to exciter specifications.						

Specifications subject to change without notice



**Harris
HT 30/35CD
30 and 35 kW FM Transmitters
with DIGIT CD Digital FM Exciter**

POWER LEVELS

HT 30CD
10 kilowatts - 30 kilowatts

HT 35CD
10 kilowatts - 35 kilowatts

Main/alternate or combined configurations available; 50 or 60 Hz.

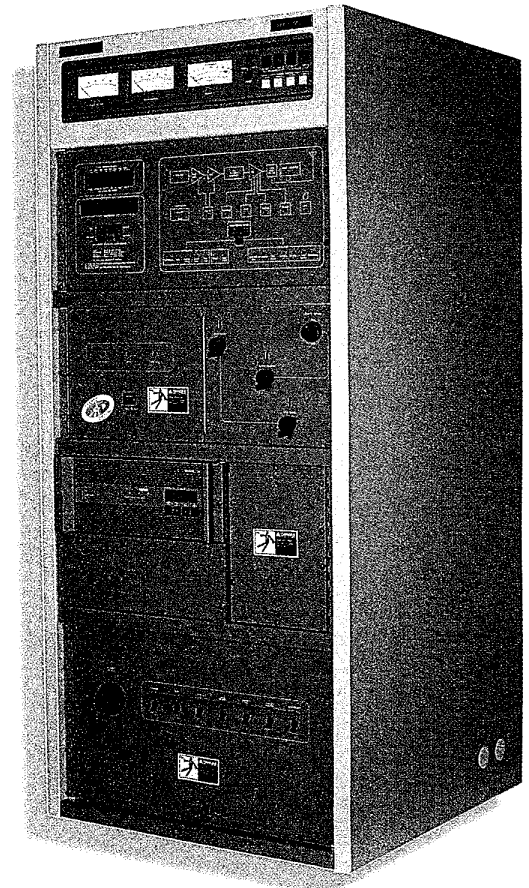

HT CD transmitters are the world's first transmitters to incorporate a digital FM exciter as standard with a conservatively-rated tetrode. The HT CD family is demonstrating its superior performance in many hundreds of installations worldwide.

Performance: At the heart of HT CD transmitters is Harris' DIGIT CD Digital FM Exciter. DIGIT delivers the true 16-bit CD sound preferred by today's listeners and other significant advantages (please see DIGIT CD listing). A single, rugged 4CX20000D tetrode in Harris' broadband quarter-wave cavity provides twice the bandwidth of half-wave cavity designs for superior performance.

Reliability: Standard automatic power control, ramp-up soft-start to protect the tube when the transmitter is turned on, proportional VSWR foldback and adjustable/metered filament voltage control. Harris' FlexPatch™ RF patching keeps HT CD transmitters on the air in emergencies.

Ease of Operation: A front-panel signal flow block diagram uses tri-color LEDs to show circuit status instantly. A digital multimeter provides multi-digit accuracy, including proper units of measure, for 48 different parameters. A non-volatile memory stores time/date of up to 56 overload events for quicker troubleshooting. For easy tuning and matching, IPA forward and reflected power are shown simultaneously on a dual bar-graph display. An optically-isolated remote control command and status interface provides a ready link to standard remote control systems.

Future-Ready: DIGIT CD is supplied with either an analog input module or an AES3 input module. Broadcasters can start with the analog input module and upgrade to the digital module in minutes when a direct digital signal to the transmitter becomes available.

SPECIFICATIONS

TRANSMITTER TYPE	FM.	
EXCITATION	Harris DIGIT CD Digital FM Exciter standard. (Harris SuperCiter Analog FM Exciter available on request.)	
POWER AMPLIFIER	Single Tube (tetrode): 4CX20,000D.	
AC POWER INPUT	50 or 60Hz: 197 - 250VAC, 3 phase, 3 wire closed delta or WYE; or 360 - 415VAC, 3 phase, 4 wire WYE.	
POWER CONSUMPTION	Model	Power Consumption
	HT 30CD	44.8 kW.
	HT 35CD	52 kW.
SIZE	Main Cabinet: 33.3" (84.6cm) W, 33.3" (84.6cm) D, 72" (182.9cm). High Voltage; Power Supply: 52" (132cm) W, 26" (66cm) D, 60" (152.4cm) H.	
WEIGHT	HT 30CD: 2,800 lbs. (1,273kg); HT 35CD: 2,900 lbs. (1,318kg).	
PERFORMANCE	Essentially defined by exciter specifications.	



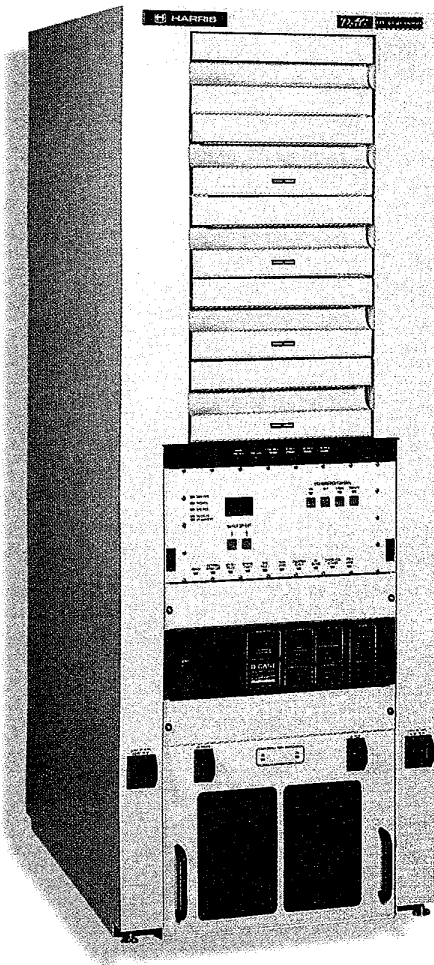

DAB 1000

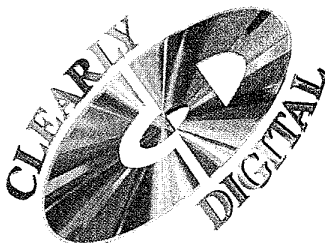

Harris
DAB 2000 Series 300 - 2000W
DAB Transmitters with COFDM Encoder/Modulator

Harris DAB 2000 transmitters are designed to provide cost-effective DAB services without compromise. These transmitters offer near-CD sound, unmatched reliability, superb flexibility and long-term economy.

Reliability: DAB 2000 transmitters use field-proven components and design techniques. The solid state design is based on standard-setting FET technology which is operating in hundreds of Harris VHF transmitters worldwide. Multiple, conservatively-rated FET solid state RF power amplifier modules operate in parallel. Modules have achieved an MTBF of 500,000 hours and are backed up by an unprecedented five-year warranty. Other features, including an integral, isolated air-handling system and VSWR foldback, further enhance reliability.

Performance: COFDM — a digital modulation technique proven to minimize fades and interference — is provided by a fourth-generation encoder. The encoder meets all Eureka 147 requirements and supports all modes of DAB operation.

Ease of operation: DAB 2000 transmitters are designed for straightforward operation. A front-panel LED display provides digital readouts of forward and reflected power, power supply voltage, and other operating parameters. Every serviceable component is accessible from the front of the transmitter.

On-air maintenance: DAB 2000 transmitters permit a great deal of maintenance to take place safely during transmission with hot-pluggable power amplifier modules and power supplies.

DAB 1000 SPECIFICATIONS

OUTPUT PERFORMANCE

POWER OUTPUT	300 to 1000 watts RMS.
FREQUENCY RANGE	216 to 230 MHz. (Range extensions available on request.)
OUTPUT SPECTRUM	Shoulders at +/- 968 kHz, -35dB minimum; meets ETSI 300 401 carrier masks.
OUTPUT IMPEDANCE	50 ohms.
OUTPUT CONNECTOR	EIA 5/8" or Type N.
UPCONVERTER INPUT FREQUENCY	35 to 40 MHz.
UPCONVERTER INPUT LEVEL	0dBm.
INPUT IMPEDANCE	50 ohms.
FREQUENCY STABILITY	+/-150Hz after 60 days aging.
COFDM CODER/MODULATOR	Optional.
COOLING	Internal air; external air ducting optional.
DIMENSIONS	66cm W, 112cm D, 183cm H.
WEIGHT	360 kg.
ELECTRICAL REQUIREMENTS	208 to 240VAC; 50/60Hz, single phase.
REGULATION	+/-10%.
POWER CONSUMPTION	4 kW input for 1 kW RMS output

Specifications subject to change without notice





Daryl Buechting is the FM product line manager at Harris Corporation, Broadcast Division in Quincy, Illinois. He has been employed at Harris for 18 years. Before becoming the FM product manager in 1994, Daryl was a senior radio applications engineer, providing technical support to the radio product line, international sales and domestic sales. After receiving his degree from the University of Missouri, he spent seven years in broadcast engineering at both AM/FM radio and television stations. He also possesses a General Class Commercial FCC License and an Extra Class Amateur Radio License.

In his current position, Daryl is responsible for all aspects of the Harris FM product line, including leader in new FM product development, sales support, promotion, and business considerations.

Generally these "lossy compression" systems work pretty well. However, if compression algorithms are used in series, many times, compression distortion products become very noticeable. There is always a risk of this cascading effect occurring because many digital studio products also use digital compression. If your STL also uses digital compression, your sound is very likely to have cascaded compression distortions.

Fortunately, Harris has a solution — a revolutionary digital STL that does not use any digital compression. The new and exclusive Harris CD LINK™ is a 950MHz STL that carries AES3 bit-for-bit in your authorized bandwidth of 300kHz. With the CD LINK, you no longer have to worry about distortion caused by using lossy compression schemes. In fact, now for the first time, a completely digital radio station can deliver all the digital sound from compact discs to listeners without data compression and its artifacts.

The best news is that the CD LINK is a fully FCC-compliant 950MHz STL that delivers uncompressed AES3 digital audio at a price that is competitive with compressed digital STLs.

Studio-to-Transmitter Links Go Digital... *without* Compression

by Daryl Buechting, FM Product Line Manager

We live in a digital world. No matter where we look — whether we know it or not — 1's and 0's are very much a part of our lives. Almost every current electronic product uses some form of digital technology. Radio broadcast equipment is no exception. Today we have digital source material in compact discs, digital audio tapes, and all forms of digital audio storage devices. It is possible to have a 100% digital broadcast station. Harris transmitters enable you to take studio-standard AES3 digital audio and convert it into AM and FM broadcast signals. In this article, we will concentrate on the studio-to-transmitter portion of the 100% digital broadcast chain.

As you may know, some people have purchased add-on digital encoders and decoders (CODECs) to carry the digital signals over their existing STL links. There are advantages and disadvantages to using digital STLs:

The first big advantage is greater signal-to-noise ratio with lesser fade margins. If you have ever experienced noisy audio from signal fading of your analog STL, you may find that converting to a digital STL will solve this problem. The digital STL will provide high-quality audio instead of the noisy analog audio.

Another advantage of going digital is the ability to deliver high-quality audio to your transmitter site. With the digital STL, your audio will have very low distortion and your signal-to-noise ratio and stereo separation generally will exceed 90dB.

As a disadvantage, if you lose enough signal that the digital error exceeds the capability of the system to correct itself, you will lose the entire audio signal. In an analog system, you may have a noisy signal but perhaps not lose it entirely. Fortunately, most STL paths are engineered for good analog STL performance. With the extra 20dB of digital fade margin, loss of the digital signal should not be a problem.

There is another (perhaps even most) limiting factor in adding digital CODECs to your analog STL system: All digital CODECs have to use some type of digital signal compression to avoid exceeding the bandwidth restrictions of their assigned channel. Digital signal compression normally involves discarding some of the digital signal to limit occupied bandwidth.

There are several digital compression systems that use some form of psychoacoustic algorithm to delete data the program doesn't think you will miss.

HARRIS EXPLAINS



**Harris
CD LINK
Uncompressed 950 MHz Digital STL**

The revolutionary Harris CD LINK, uncompressed, digital, 950 MHz studio-to-transmitter link outperforms every other 950 MHz STL. Only CD LINK transports AES3 studio standard digital audio in a standard, 300kHz RF channel over your STL path without any form of digital data compression or psychoacoustic bit reduction. All the sound your studio is capable of producing is delivered to your transmitter site intact. The CD LINK offers all the advantages of digital STLs without compromises in sound quality. Your station will sound great.

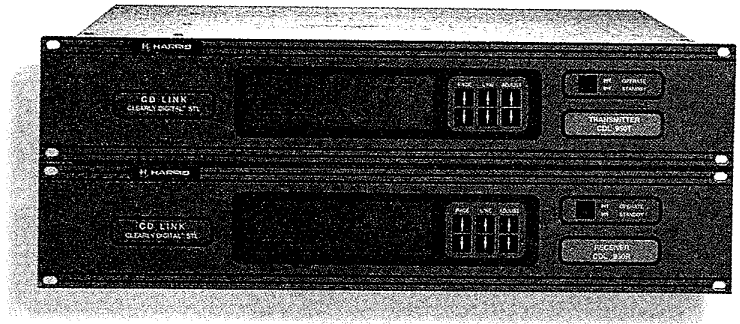

Transmitters

Performance: Uncompressed "bit-for-bit" transmission permits highest quality sound from your digital system. As CD LINK uses no digital compression, you don't have to worry about the effects of cascading compression algorithms which can cause very noticeable distortions in your audio. You receive a typical signal-to-noise ratio of 93 dB and frequency response of ± 0.1 dB.

Capability: A unique, spectrum-efficient RF design allows the CD LINK to transport one AES3 stereo signal and two data channels. Additionally, stereo analog inputs and outputs are provided. Optionally, an analog stereo composite output and auxiliary audio (2 x 6kHz or 1 x 12kHz) are available.

Integrated Design: Digital and RF circuits are integrated into a single 3-1/2 inch high 19" rack mount cabinet for the transmitter and receiver.

Ease of Operation: AES3 XLR, coax N connector and AC power plug allows for very simple installation. CD LINK is designed to replace existing analog STLs. No special skills are needed. Similar transmitter and receiver layouts and controls simplify operation and make CD LINK very user-friendly.

PROGRAM CHANNEL SPECIFICATIONS

SYSTEM	Digital I/O (Standard).
FORMAT	Input: AES3 digital audio, uncompressed; or L & R analog. Output: AES3 and L & R analog (simultaneously).
DATA RATE	Input: 32 or 48kb/s; Output: 32 kb/s.
CONNECTORS	Input: XLR female; optical (alternate). Output: XLR male, optical (alternate).
IMPEDANCE	Input: 220 ohms balanced (AES3 standard). Output: 110 ohms balanced.

MAIN ANALOG CHANNEL I/O AND PERFORMANCE (STANDARD)

NUMBER OF CHANNELS	Two.
FREQUENCY RESPONSE	5Hz-15kHz ± 0.1 dB.
PRE-EMPHASIS	Transparent to incoming signal; passes flat, 25, 50 or 75 μ s.
TOTAL HARMONIC DISTORTION	0.005% at 1kHz.
DYNAMIC RANGE	≥ 90 dB.
SIGNAL-TO-NOISE RATIO	≥ 90 dB at 1kHz.
DATA CHANNELS	Two; 9600 and 4800 baud, simultaneously.
AUXILIARY AUDIO CHANNELS (OPTION)	Two, maximum @ 6 kHz bandwidth or one @ 12 kHz bandwidth.
MECHANICAL/ENVIRONMENTAL DIMENSIONS (Transmitter/Receiver)	19" (48.3cm) W x 3.5" (8.9cm) H x 13" (33cm) D, EIA rack mountable.
WEIGHT	
Transmitter	15 pounds (6.8kg).
Receiver	10 pounds (4.5kg).
AC POWER REQUIREMENTS	90-132 or 180-264 VAC, 50/60 Hz, single phase.
POWER CONSUMPTION	
Transmitter	50W, nominal.
Receiver	35W, nominal.



Specifications subject to change without notice

CERTAIN PRODUCTS NOT AVAILABLE IN ALL AREAS



**ORDERING AND TECHNICAL SUPPORT:
(217) 222-8200**

235

HDTV BROADCASTERS

ARE YOU LOOKING FOR
OUT OF THIS WORLD QUALITY?

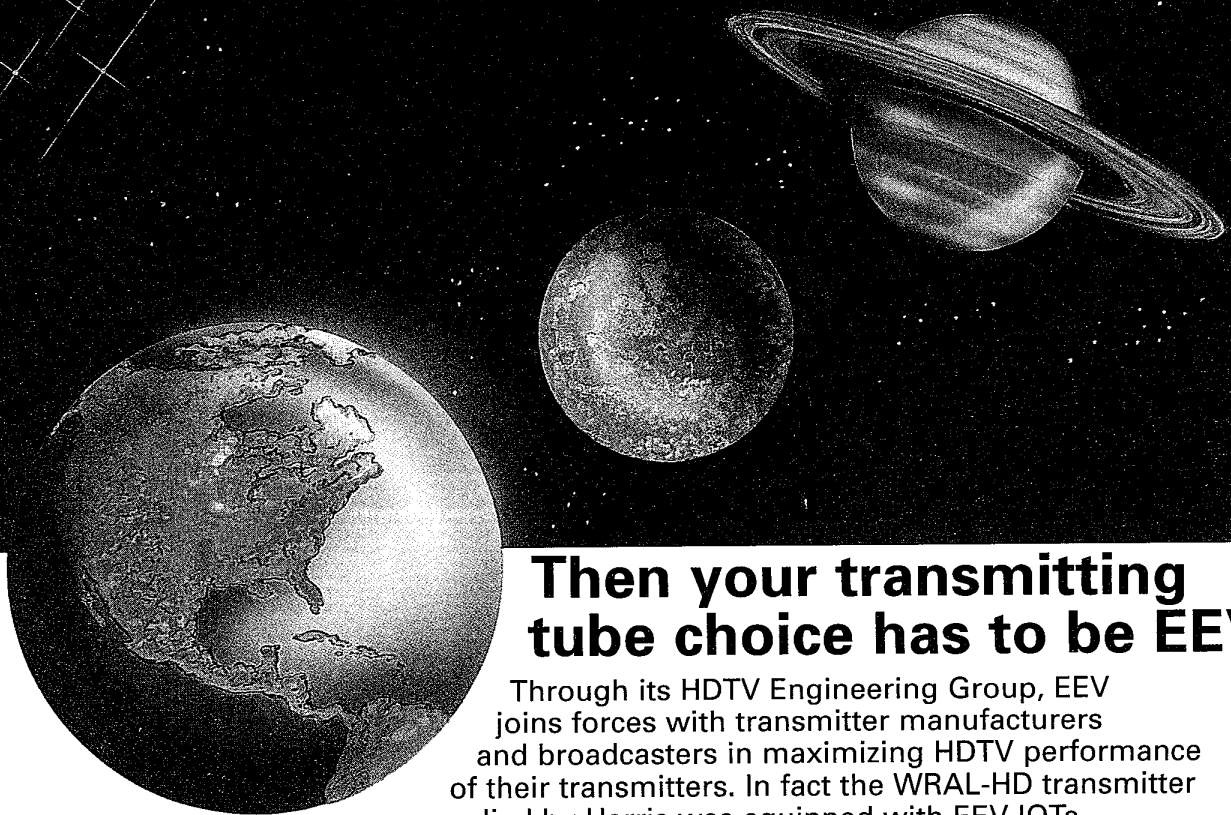

Then your transmitting tube choice has to be EEV

Through its HDTV Engineering Group, EEV joins forces with transmitter manufacturers and broadcasters in maximizing HDTV performance of their transmitters. In fact the WRAL-HD transmitter supplied by Harris was equipped with EEV IOTs.

EEV remains committed to working closely with Harris in developing innovative designs to fully support broadcasters for years to come.

EEV Broadcast Products

Serving the needs of the broadcast industry for over 40 years

IOTs - Klystrons - ESCs

Camera Tubes - Tetrodes - Ku Band Satcom Amplifiers

Subsidiary of the General Electric Company plc of England *see*



**Andrew
HeliAx Coax Cable**

HeliAx coaxial cable is supplied in long continuous lengths which simplifies and lowers installation cost. The low attenuation and excellent heat

transfer properties of HeliAx cables combined with temperature stabilized dielectric materials, results in safe long term operation at high average power levels. Andrew standard coaxial transmission line has PTFE dielectric peg insulators and silver soldered flanges. Fully compatible with both EIA standard RS-225 and IEC recommendations, standard rigid line flanges and inner connectors do not require adaptors or special sections.

**Andrew
HR Line® Rigid Line
Cable**

Andrew's new HR Line® (premium rigid line provides) increased reliability by eliminating sliding inner contacts or "bullets." Thermal expansion and contraction are compensated for, through a continuously corrugated inner conductor. HR Line® maintains conventional rigid line outer conductor and flange configurations, but uses a patented bolted inner joint at the flange. Compared to conventional rigid line, HR Line® offers long term, trouble-free operation. HR Line® is available in 6 1/8" size with either 50 or 75 ohm impedance.

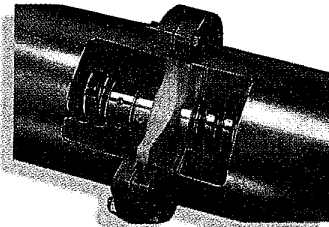

**Andrew
EASIAx® Cable
Cutting Tool**

Andrew's EASIAx® (eliminates hacksawing cable while precisely and consistently cutting through the outer jacket. The clean cut makes flaring easier than ever. The EASIAx® blade depth makes it impossible to cut the inner conductor. EASIAx® kits consisting of tool, instruction sheet and 5 extra blades are available for different cable series.

\$30.00 List Price

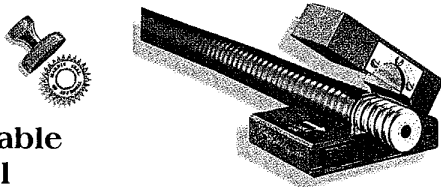

**Andrew
DryLine® Dehydrator**

The Andrew DryLine® (dehydrator is the industry's most advanced system for pressurizing transmission lines. DryLine® sets new standards for drying performance, reliability and convenience. DryLine® meets UL/CSA requirements and is warranted for three years.

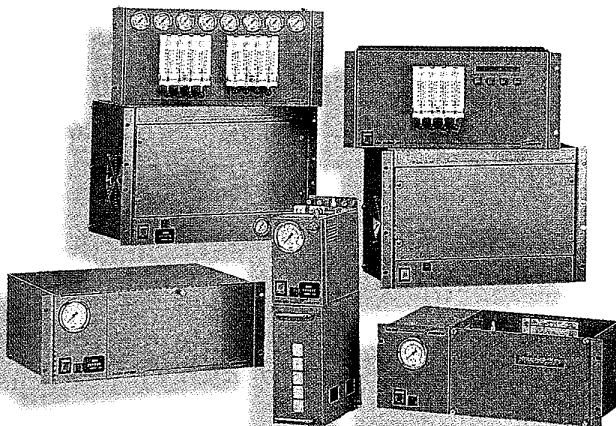

**Belar
Electronics
FMM-2 Mod
Monitor**

The FMM-2 is a precision baseband FM monitor and demodulator that has become the standard in the industry, found in the test racks of many broadcast equipment manufacturers in addition to thousands of broadcasters worldwide. Utilizing such advanced design features as an ultra-linear digital discriminator, an almost distortionless and absolutely flat baseband signal is produced to ensure precise stereo and SAC decoding. Add the optional PWM-1 peak weighting module for variable peak response.

\$1,790.00 List Price

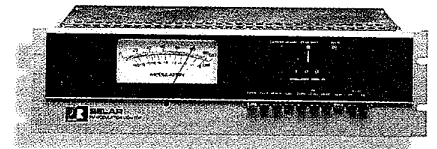

**Belar
Electronics
FMS-2 Stereo
Mod Monitor**

The FMS-2 is the perfect addition to the FMM-2 for stereo measurement and decoding. Two independent autoranging voltmeters make measurements a dream with the best performance in the industry (70 dB separation, 0.01% distortion) ensures that you are measuring your air chain and not just your monitor. Its composite input makes it suitable for accurate measurement of stereo generators, stereo decoding of FM composite STLs, and a number of other applications.

\$2,050.00 List Price

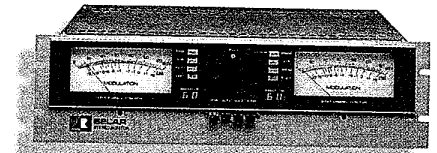

**Belar Electronics
FMMA-1**

The FMMA-1 "The Wizard"™ opens a whole new world of modulation measurements and analysis. Protected by U.S. patent, the FMMA-1 takes a myriad of measurements of your total modulation with complete user control over the parameters of measurement. Wizard software enables real-time graphing, logging, and remote communications to any unit in The Wizard system. For use at the transmitter, order option 01 (demod) and option 02 (down converter/synchronous AM noise detector) or the DC-4. For use off-air, order option 01 and the RFA-4 or RFA-1A.

\$3,300.00 List Price



**Belar Electronics
FMSA-1FM Digital Stereo Mod Monitor**

The FMSA-1 is a DSP-based, microprocessor-controlled FM Stereo Modulation Monitor/Analyzer that digitizes the composite baseband signal and decodes the stereo multiplex portion using digital signal processing techniques. The FMSA-1 can be used with the FMMA-1 or FMM-2 for a complete stereo mod monitor set, or separately to test stereo generators composite STLs and other applications. In addition to analog outputs, a digital AES/EBU output is provided. An RS-232 and Wizard Interface port enable remote operation.

\$3,900.00 List Price

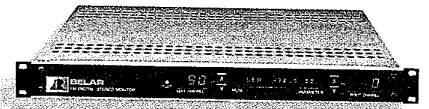

Transmitting Accessories



In The Broadcast World

Andrew Is Everywhere

Take a closer look at the communicating world around you and you will see Andrew everywhere.

For close to 60 years, Andrew has applied its expertise to develop broadcast transmission products and systems that help bring clear, reliable broadcast communications into homes and businesses around the globe.

Today, Andrew broadcast products continue to set the standard for quality and performance. In addition to offering the industry's largest selection of HELIAX® Air and Foam Dielectric Coaxial Cable, Waveguide, and Connectors, the Andrew range of products includes DryLine® Dehydrators and Terrestrial Microwave Antennas.

You can trust Andrew to provide quality products that optimize the performance of your broadcast system.

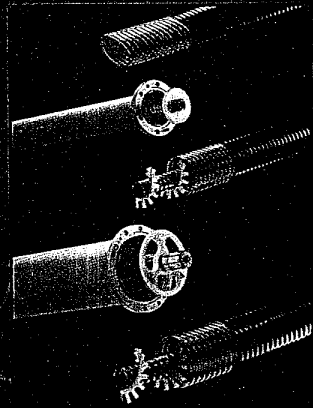

HELIAX® Coaxial Cable and Waveguide

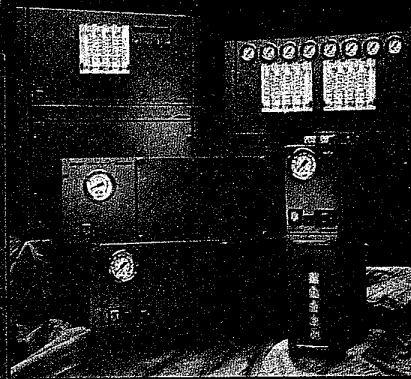

DryLine® Dehydrators

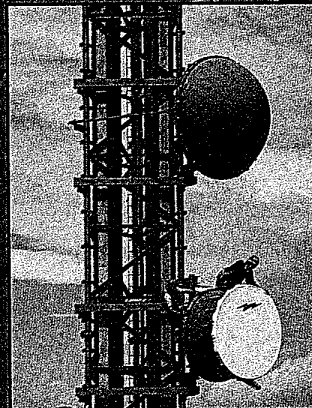

Terrestrial Microwave Antennas

**ANDREW®**

**Belar Electronics
RFA-4
Frequency RF
Agile Amplifier**



The RFA-4 frequency agile FM RF amplifier adds precision off-air frequency agility to the Belar FMM-2 or the FMMA-1 "Wizard." This microprocessor-controlled unit features programmable memory locations for one-button access to 10 stations with call letters. The optional Wizard interface enables remote operation through the FMMA-1. Separation of better than 60 dB can be obtained with the FMM-2 or Wizard demod. The RFA-1A offers the same performance in a crystal-controlled fixed-frequency unit.
\$1,190.00 List Price



**Belar Electronics
RDS-1 RDS/RBDS Monitor**

The Belar RDS-1 is essential for any station broadcasting RBDS or RDS. The RDS-1 allows the broadcaster to measure the RDS injection and the phase relationship between the RDS subcarrier and the stereo pilot. The RDS-1 decodes all the major group types and provides the data in fully decoded and hexadecimal formats. RS-232 interface and a Wizard interface are built in to the RDS-1 for remote communication and full-screen displays.
\$2,200.00 List Price

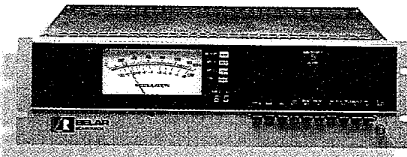

**Belar Electronics
SCM-2 SCA
Modulation Monitor**

The SCM-2, when added to a baseband FM monitor or rebroadcast receiver provides complete monitoring and test functions for SCA, data transmission and remote telemetering applications. Up to four frequency switch positions (67 kHz plus three optional additional frequencies) allow four channels to be operated and tested. The SCM-2 features an autoranging voltmeter and variable deviation for maximum ease of use. The digital discriminator is wideband for minimum distortion, and a built-in calibrator is included.
\$2,050.00 List Price



**Belar Electronics
AMMA-1 "The Wizard"™**

The AMMA-1 "The Wizard"™ opens a whole new world of modulation measurements and analysis for AM and shortwave broadcasters. The AMMA-1 takes a myriad of modulation measurements of your total modulation with complete user control over the parameters of measurement. A unique "normal" modulation light tells you that all measurements are within the parameters that you set. The AMMA-1 is compatible with dynamically-controlled carrier schemes. The Wizard software enables real-time graphing, logging, and remote communications
\$3,300.00 List Price



**Belar Electronics
TVM-100/101
Precision
Aural Monitor**



The Belar TVM-100 precision aural monitor is a wide-band TV aural modulation monitor designed to measure the total modulation characteristics of mono as well as multi-channel television transmitters. The TVM-100 is also used as a low-distortion, low-noise main channel demodulator for driving audio monitor amplifiers and audio distortion analyzers. The TVM-100 can be used at the transmitter or with an antenna for off-air measurements. The TVM-101 is similar to the TVM-100 but lacks a quasi-parallel mode and the front-panel digital display.
**\$3,750.00 List Price for 100
\$4,750.00 List Price for 101**

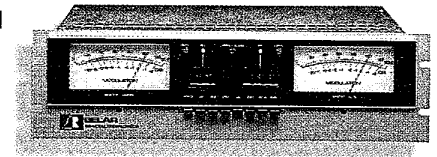

**Belar Electronics
AMM-3 AM Modulation Monitor**

The Belar AMM-3 modulation monitor is precision AM demodulator designed to measure AM transmitter modulation characteristics over a frequency range of 200 kHz to 160 MHz. Automatic carrier leveling enables the monitor to handle up to a ±30% change in carrier level automatically, with no need for operator intervention. Two meters are provided for simultaneous positive and negative modulation measurement, along with individual thumbwheel programmable peak indicators in addition to fixed +125% and -100% indicators.
\$1,790.00 List Price

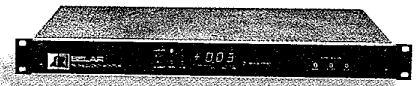

**Belar Electronics
FMM-4A Digital Frequency Monitor**

Belar offers a complete range of digital frequency monitors for FM, AM, shortwave and TV applications. The FMM-4A automatically measures carrier, pilot and SCA frequencies (with source of filtered pilot and SCA), with off-frequency and low-level alarms. The FMM-4 has a frequency range of 10 kHz to 50 MHz for AM and shortwave applications. The TVM-2A (for VHF) and the TVM-3A (for UHF) measure visual, aural, and intercarrier frequencies.
\$1,590.00 List Price

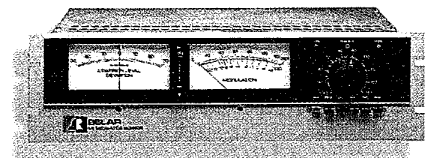

**Belar Electronics
AMM-2B**

The Belar AMM-2B modulation monitor is an all-solid-state AM demodulator designed to measure the total modulation characteristics of AM broadcast transmitters. Since the input circuitry is non-frequency-discriminating, the AMM-2B is suitable for measuring shortwave and VHF transmitter modulation. The AMM-2B utilizes a unique modulation cancellation scheme to recover unmodulated carrier which provides reference to modulation peaks. Thus the instantaneous program peaks are referenced to the instantaneous carrier without the need of time constants, as with AGC devices.
\$1,590.00 List Price

Transmitting Accessories





Belar Electronics
FMRR-4 Rebroadcast Receiver

The FMRR-4 FM rebroadcast receiver is a microprocessor controlled, tunable receiver designed for rebroadcasting and other applications that require accurate FM reception and composite. The FMRR-4 boasts excellent specifications, with a specification/measurement of 85 dB, distortion of less than 0.01%, and a capture ratio of 1.5 dB. The FMRR-4 also features a carrier-fail relay and a built-in calibrator. A crystal-controlled fixed-frequency version, the FMRR-1A, is also available.

\$1,890.00 List Price



Belar Electronics
TVM-230 Stereo Monitor Analyzer

The Belar TVM-230 is a DSP-based, microprocessor-controlled digital BTSC TV stereo monitor/analyzer. The TVM-230 digitizes the composite baseband signal and decodes the stereo multiplex portion using digital signal processing techniques. Unlike an analog design, a DSP-based design is immune to variations due to temperature or the aging and tolerance of components. As a result, the TVM-230 attains superlative performance while requiring virtually no adjustment. Linear-phase FIR filters eliminate phase distortion in the recovered audio. An RS-232 port is included for remote operation.

\$5,850.00 List Price

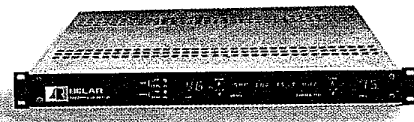

Belar Electronics
TVM-250 Dual Monitor Monitor

The Belar TVM-250 SAP/PRO monitor is a dual modulation monitor system for systems broadcasting the MTS Second Audio Program (SAP) and/or professional channels. Operated in conjunction with the Belar TVM-100/101 or other wideband aural demodulator, the TVM-250 combines simultaneous demodulation and peak modulation measurement of both SAP and PRO subcarriers. All operational and metering functions can be controlled from the front panel. An RS-232 port is included for remote operation. An analog meter panel, the MP-250, is also available.

\$3,500.00 List Price



Belar Electronics
DSD-1/DSD-1A Stereo

The Belar DSD-1 and DSD-1A are precision FM stereo decoders that produce 48 kHz AES/EBU digital stereo audio by digitally demodulating analog stereo composite signals. The DSD-1A also provides balanced analog Left, Right, L+R and L-R outputs on XLR connectors. The DSD-1 or DSD-1A is suitable for applications that require digital stereo signals or precision analog left and right stereo signals. Examples include obtaining a digital input for use with the Harris DIGIT™ exciter or demodulating composite STLs for AM stereo.

\$1,900.00 List Price

Bird Electronics
RF Test Equipment

Thruline™, Termaline™ and Tenuline™.... Bird Electronics trademarks of confidence. Accurately measure, terminate and attenuate from 0.45 to 2500 MHz and from milliwatts to 250 kilowatts. RF test equipment and accessories from Bird, a recognized world standard.

List Prices Vary

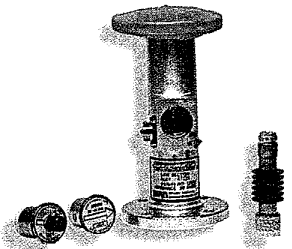

Coaxial Dynamics
81100-A/81600-A

The 81100-A through 81600-A Series High Power RF Directional Wattmeters. Coaxial Dynamics high accuracy wattmeters are designed to measure RF power in 50 ohm coaxial transmission lines. Coaxial Dynamics provides high power wattmeters for 1-5/8", 3-1/8", 4-1/16" and 6-1/8" lines. The RF directional wattmeter is comprised of a line section and a high quality meter with three computer generated scales and advanced taut band technology for reliable and accurate readings.

List Prices Vary

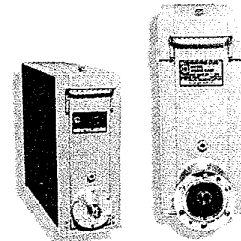

Coaxial Dynamics
84000 Series Terminating RF Liquid/Air Loads

Coaxial Dynamics new 84000 Series liquid/air loads provide the latest advances in RF Load Resistor design for use during adjustment, testing and alignment of transmitters. These new liquid/air loads are available to cover CW power ranges from 600 watts up to 10 kilowatts and are virtually maintenance free. All models are available with optional thermal overload switches to interface with the user's interlock or warning circuitry.

List Prices Vary

Coaxial Dynamics
81979/81080

The 81070 through 81080 Series Coaxial Dynamics Wattchman station monitor/alarm system consists of a 19" dual meter panel, line section and two elements for monitoring both forward and reflected power. The Wattchman is supplied with two 25' DC cables for connection to the line section and a 6' AC power cord. The Wattchman warns the remote operator of abnormal load conditions caused by low power, AC line conditions, high VSWR due to lightning, antenna icing or transmission line problems.

List Prices Vary

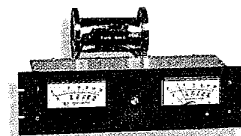

Transmitting Accessories



> Single Station
LMA, Duopoly
Multiple Ownership

> On Site, Off-Air
Preselection, or
RS-232 Remote
Access

> AM, FM, TV
Stereo, SCA, RDS
BTSC, SAP, PRO
or Shortwave

We have the right
monitoring system for you.

Belar monitors have the best separation,
the lowest noise, the lowest distortion,
and are the most accurate made.

It's no wonder that Belar monitors
are used as test gear by more
manufacturers of broadcast equipment
than all of our competitors combined.

Take a look at what Belar offers today.
You'll be amazed at what you can do.



BELAR ELECTRONICS LABORATORY, INC.

119 LANCASTER AVENUE • BOX 76 • DEVON, PA 19333 USA

TEL +1 610 687-5550 • FAX +1 610 687-2686

INTERNET: sales@belar.com • <http://www.belar.com/>



**Delta Electronics
ASM-1 Stereo
Monitor**



AM stereo without compromise. The ASM-1 AM stereo exciter and ASM-1 modulation monitor provide a C-Quam™ quadrature modulated stereo signal featuring low distortion and channel separation greater than 35 dB throughout the audio spectrum. The ASE-1 exciter circuitry includes all required processing features. Limiters are provided to prevent excessive positive and negative modulation. Pre-emphasis is not required.

\$8,395.00 List Price

**Delta Electronics
TCA-5EX RF
Ammeter
Systems**

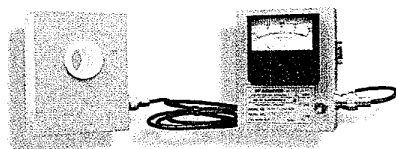

The transformer coupled ammeter (TCA) series of RF ammeters provides AM broadcasters with an accurate and reliable instrument for measuring common point and antenna base currents. The ammeter uses a toroidal current transformer to obtain a sample voltage proportional to the RF current flowing in a conductor. This voltage sample is connected by a 50 ohm coaxial cable to a temperature compensated rectifier circuit. This circuit converts the RF voltage to a DC voltage which is applied to a linear scale meter, calibrated in RF Amperes, for display of current magnitude. The ammeter provides a DC output voltage for remote current monitoring.

List Prices Vary

**Delta Electronics
TCT3 Transformer**

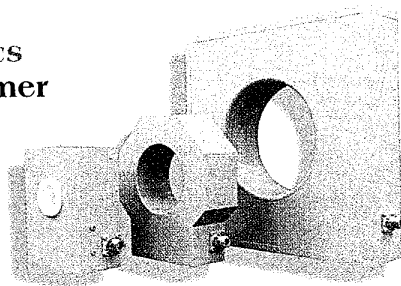

The TCT series of precision toroidal current transformers provides sample voltages for RF current phase and magnitude measurement on broadcast antenna arrays. The transformers are available with center conductor voltage ratings of 10 kVRMS (TCT-N), 20 kVRMS (TCT-N-HV) or 42.4 kVRMS (TCT-N-XHV) for use with low to high power antenna arrays and standard to high impedance antennas. The TCT-3 and TCT-3-HVC transformers provide a 1.0 VRMS/Ampere sample across a 50 ohm external load and are rated for currents up to 20 ARMS.

List Prices Vary

**Delta Electronics
6730E**

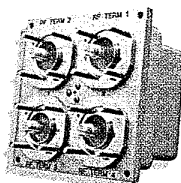

The Model 6730E coaxial transfer switches are double-pole, double throw, high power switches for use with 1-5/8 inch, 50 ohm transmission line. The manually or remotely operated transfer switches enable the changing of coaxial connections between transmitters and antennas/dummy loads with a minimum of changeover or off-air-time. Transmission line switching occurs in approximately one second. The Model 6730E operates with 12 VAC, 50/60 Hz main power.

List Prices Vary

**Dielectric
Combiners**

Dielectric's FM multistation combiners are designed for maximum isolation between input ports with minimum insertion loss and input VSWR. Each system is custom designed using our modular construction filters to provide the best price/performance for your system. Combiner systems can be designed using a simple branch combiner or a balanced (constant impedance) approach. Constant impedance designs are recommended for closely spaced frequencies of 1.4 MHz or less, combiners with 4 or more stations, extremely high input powers, or for systems where redundancy is desired.

List Prices Vary

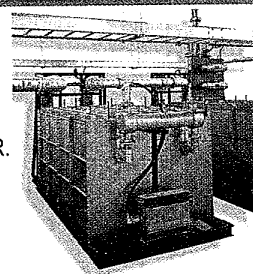

**Dielectric
Motorized Switches**

The 50000 Series Motorized Switches are blade type SPDT or 4 port transfer switches. Isolation exceeding 60 dB is typical. Sizes range from 7/8" through 6-1/8". Reliable design and quality construction allow as many as 100,000 cycles without failure. Switch position is indicated by a mechanical pointer and through auxiliary switches used for readout and interlocking circuits. In the closing mode, the interlock switches do not activate until the RF contacts are ready to accept full power. In the opening mode, the interlock switches open prior to the RF contacts to prevent the breaking of the RF contacts while under power. Manual operation is provided for by a knob. Terminations are standard EIA fixed flanges with non-removable male connectors.

List Prices Vary



**Dielectric
Transmission Line**

Dielectric is the world's largest manufacturer of rigid coaxial transmission line. Dielectric quality advantages include heliarc welded flanges, thick walled elbows, disc type inner conductor insulators, and time proven expansion compensation. Standard sizes range from 7/8" to 9-3/16", custom sizes are also available. Our record of reliable service and superior quality, as well as our ongoing research and development programs have helped Dielectric maintain its position as an industry leader.

List Prices Vary

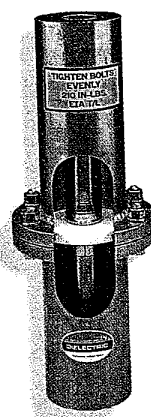

**Eimac
Power Tubes**

Ever advancing technology has resulted in development of super high power broadcast tubes capable of output power in excess of 2 1/2 megawatts; pioneering the use of pyrolytic graphite grids for high-power tubes, technology now common in advanced tube designs; and development of the world's first inductive output tube (IOT) the klystron[®] IOT, for UHF TV broadcasting. Eimac is a fully ISO 9001 certified facility and also produces power tubes for other markets in communications, radar, industrial heating and drying, science and medical applications.

List Prices Vary

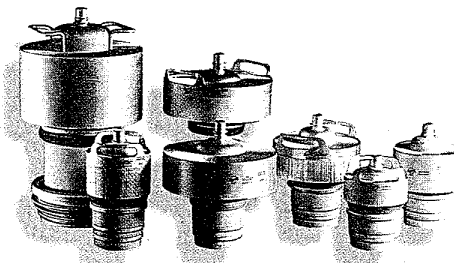

UNCOMPRESSED DIGITAL STL



CD LINK™ STL Full CD-quality sound that blows minds and blows away competition.

If you thought an *uncompressed* Studio-to-Transmitter Link was impossible in a 300 kHz bandwidth, think again. *Harris makes it economical and easy* for you to have an uncompressed bit-for-bit AES3 path that delivers rich, full, digital sound like your audience has never heard before from an FM broadcast station. Sound that can boost ratings, attract more advertisers, make your station more profitable, draw hotter talent, and start an upward success spiral that leaves your competitors singing the compressed digital blues.

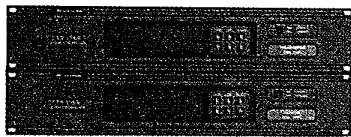

We've made history by introducing CD LINK, the world's first UNCOMPRESSED 950 MHz digital STL.

Now the radio broadcast chain can be 100% digital, with CD-quality sound uncompromised by dueling algorithms and lossy compression schemes. Whether your present STL is analog or digital, a Harris CD LINK STL can provide AES3, left/right analog, composite stereo, one 12 kHz or two 6 kHz AUX audio channels, plus data and remote control channels.

CD LINK is another in a long line of firsts from Harris, designed to make you first in your markets. Contact Harris now for the information you need to make sound decisions.



HARRIS CORPORATION BROADCAST DIVISION

U.S. and Canada
TEL: +1 217 222-8200
FAX: +1 217 224-1439
Elsewhere
TEL: +1 217 222-8290
FAX: +1 217 224-2764



A new world of broadcast solutions

Radio-FM: DIGIT CD™ - Digital FM Exciter • SuperCiter™ Analog FM Exciter • CD LINK™ Digital STL • Quest, Platinum and Platinum Z Solid State FM Transmitters • HT Single-tube FM Transmitters • FM Antennas **Radio-AM:** DX - Digital Solid State AM Transmitters • GATES® Solid State AM Transmitters **Radio-DAB:** DAB 2000 Transmitters **Studio Products:** Digital and Analog Studio Equipment **Systems:** Mobile and Fixed Studios and Satellite Systems

©1997 Harris Corporation

Electro Impulse Air Cooled Loads

Electro Impulse developed dry, forced air cooled loads for use up through FM frequencies. ELI offers RF coaxial loads with oil dielectric, twin line loads in a balanced input configuration, coaxial water loads, dry balun calorimeters, automatic test equipment, high power RF attenuators, RF power meters, in-line directional wattmeters and special cooling systems.

List Prices Vary

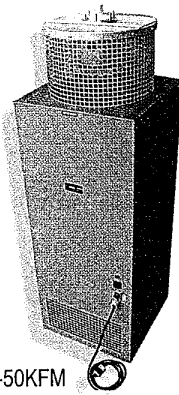

DPTC-50KFM

Dry, Forced Air Cooled
Frequency: DC - 110 MHz
VSWR: 1.15:1
Power: 55 KW continuous
Input: Std. 3-1/8
220VAC, 7A, 60Hz
(50Hz available optional)
Reject load option available

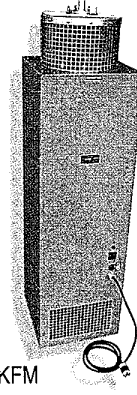

DPTC-10KFM

Dry, Forced Air Cooled
Frequency: DC - 110 MHz
VSWR: 1.1: 1 Max
Power: 10,000 watts continuous
Input: Std. 3-1/8" (1-5/8" avail.)
AC Power: 115VAC
(50 Hz available option)

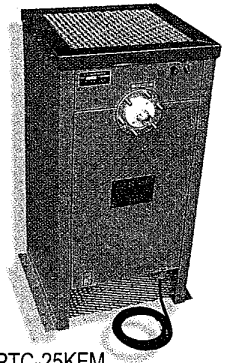

DPTC-25KFM

Dry, Forced Air Cooled
Frequency: DC - 110 MHz
VSWR: 1.15:1
Power: 25,000 watts continuous
Input: Std. 3-1/8 (1-5/8" avail.)
220 VAC, 5A, 60HZ
Reject load option available

ERI Electronics Filters and Combiners

ERI filters and combiners have served the broadcast industry for over 25 years. Our past dedication is your future guarantee for some of the best designed, manufactured and installed products. The basic building block is the unique filter cavity. Only ERI offers an all copper cylindrical cavity with a self-regulating temperature compensator. The cylindrical shape enables uniform expansion and eliminates the need for cumbersome external bracing. The internal temperature compensator maintains the filters tuning through a wide range of operating temperatures. The modular design facilitates easy installation and a variety of space saving footprints.

List Prices Vary

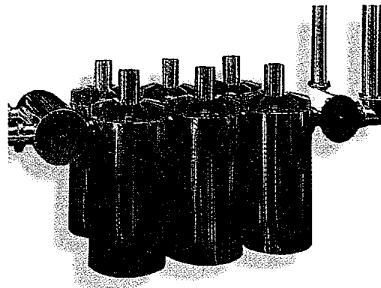

ERI Electronics Lambda Mounting Systems

The Lambda Mounting System will increase the predictability of the antenna-tower interaction and the resulting antenna pattern shape. The results is more signal to your market and elimination of "holes" in your coverage area. Each Lambda segment is electrically symmetrical relative to the antenna element's mounting position. This allows an identical, controlled energy distribution and minimizes any antenna gain loss due to non uniform current flow on the surface of the support structure.

List Prices Vary



ERI Electronics Lighting Protection And Grounding

The Lightning Spur™ is the most efficient dissipation system tested to a voltage potential of 360 kV/m. Stainless steel tips and connection hardware are replaceable. The universal galvanized steel connection bracket accommodates tower leg sizes ranging from 1 to 8 inches and horizontal members from 1/2 to 4 inches. A beacon plate mount is also available. The slender silhouette minimizes unnecessary tower wind load and antenna pattern distortion. Can be shipped over night.

List Prices Vary

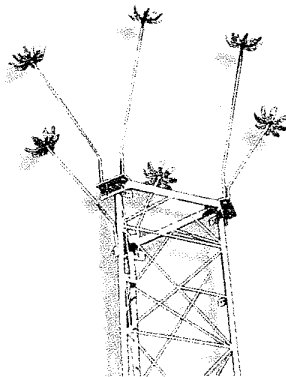

ERI Electronics K-Rod™

The K-ROD™ is an electrically enhanced copper grounding rod with up to ten times the conductivity and three times the service life of a driven grounding rod. A large diameter and highly conductive copper body and silver solder, water proof electrical connection provide a stable, low resistance cathode interface with true earth in a wide variety of soil conditions. Standard or custom lengths can be shipped over night.

List Prices Vary



ERI Electronics Towers and Antenna Supports

ERI offers a complete line of guyed and self-supporting towers, monopoles, and custom support structures. Each design is approved by ERI's in-house, professional engineers and is fabricated using the latest in CNC machining and welding techniques. Solid steel construction provides the highest strength to surface area ratio and the most efficient, cost effective tower design.

List Prices Vary

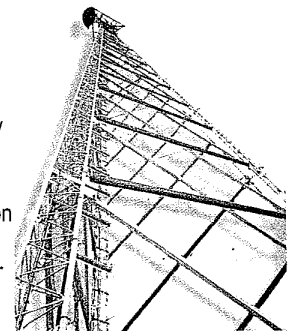

ALTRONIC RESEARCH INC.

Performance By Design



High Power Resistors

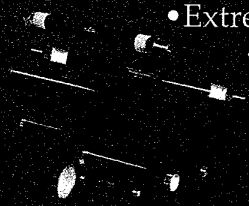

- Extremely durable •very low TCR
- Non-reactive cermet resistors
- For air, water or oil cooled
- Stable under power
- 1 to 20 Meg Ohms
- Custom designs available

Water Cooled Loads

- Single resistor water cooled loads
- Performance for todays modern RF application
- 5kW to 300kW •Frequency range up to 2.5GHz
- Most are field repairable



Digital Calorimetry

- For air or water loads •Backlit touchscreen LCD display •Monitors power and other parameters •Motorola HC11 family processor •RF hardened remote data acquisition unit



Medium Wave Air Cooled Loads

- Designed for todays high power MW transmitters
- Dependable service with excellent RF characteristics
- From 1000W to 1500 kW continuous

- Inside or outside operation
- No tuning needed

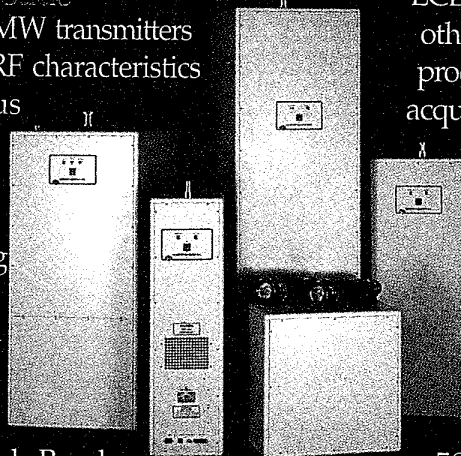
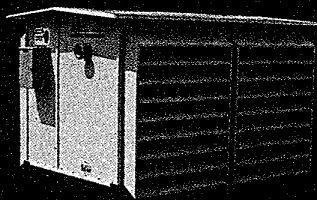

Air Cooled Dummy Loads

6700 Series

- 1kw to 75kw •DC thru VHF High Band
- Quiet Operation •Standby Operation •Interlock
- Easy air ducting •Alarm output •Superior RF performance •Silver contacts on resistors and clips

Self-Contained Heat Exchangers

5800 Series

- 5kW to 80kW •1Kh up to 2.5GHz •Quiet operation •Interlock •Casters for ease of mobility
- Compact size •Remote load capabilities

ALTRONIC RESEARCH INC.

P.O. Box 249 • Yellville, Arkansas 72687 • 501-449-4093 • Fax: 501-449-6000

Transmitting Accessories

ERI Electronics

MAG-ROD

The MAG-ROD prevents the detrimental galvanic and electrolytic corrosion of tower anchor shafts while providing a low impedance interface with true earth in a variety of soil conditions. The large diameter, magnesium/aluminum body is an excellent conductor which will sacrifice to electrically connected underground steel structural supports. The result is decreased electrical grounding impedance as a function of time and the prevention of galvanic corrosion of the dissimilar metals. The MAG-ROD grounding system is ideal for AM guy anchors where galvanic corrosion is most prevalent.

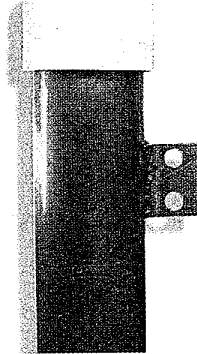

List Prices Vary

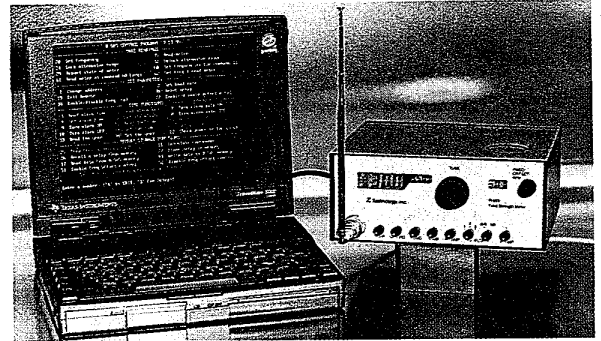

Z-Technology

Field Strength Meter

Model R-505 is ideal for coverage evaluation, signal analysis at a specific location, site surveys, and tracking down EMI and other RF interference. With R-505's serial and your IBM compatible computer combined with straight forward software routines, the user can measure any set of frequencies and then transfer the data to the PC for storage and analysis. Accessories and software available. Internal nicad batteries and AC transformer/charger included. Coverage 3.0 mHz to 1000mHz. Computer not included.

\$6,950.00 List Price



Loral nardalert

With nardalert, you always know if you are in an RF danger zone. The patented nardalert family of personal monitors helps provide fail-safe, wearable protection against overexposure to non-ionizing radiation. When the nardalert detects an emission higher than its preset alarm level, the exposure indicator will latch on, and the audible alarm will vary its repetition rate with the level of emission. This feature helps the wearer detect the direction of the strongest emission and helps minimize overall exposure time.

List Prices Vary

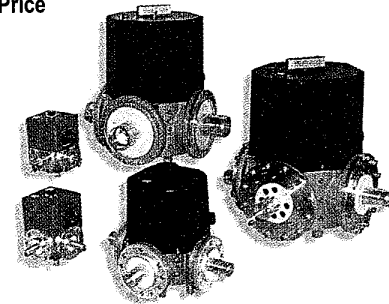

Micro

61104 Coaxial Transfer Switches

Micro Communications offers coaxial transfer switches in power levels to suit most needs. Standard, of-the-self, EIA sizes are available in flanged and unflanged configurations. The unique co-planer port arrangement allows for a neater, compact layout. MCI also produces complete passive RF systems and components for FM, VHF, UHF, LPTV and DTV.

\$3,600.00 List Price

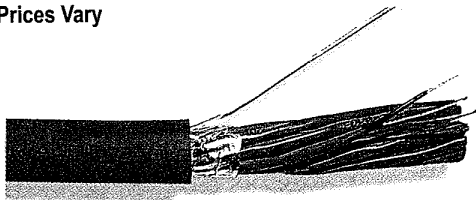

Gepco 618 Series

The 618 series of multipair cable features 22 AWG tinned copper audio pairs individually shielded and jacketed with a 22 AWG tinned copper drain. Individual pair jackets are identified with alphanumeric print. The foil shield is bonded to the pair jacket so both can be stripped in one operation. This cable has an overall foil shield with an AWG tinned copper drain wire. Matte jacket color is blue. This cable is (UL) listed type CM. Available pair counts: 2, 4, 6, 8, 10, 12, 16, 20, 26 and 32.

List Prices Vary

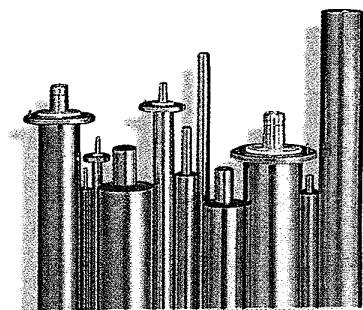

Myat

Rigid Coaxial Transmission Line

In every size from 7/8" to 9-3/16" rigid line, MYAT is the name to remember for quality, reliability and on-time delivery. Manufactured from the highest quality pure copper and thoroughly tested before delivery, MYAT is specified by many transmitter and systems manufacturers. Designing a new system? Our engineers will work with you. And if you need an emergency replacement, call Harris today. MYAT's extensive inventory is as close as your phone.

List Prices Vary

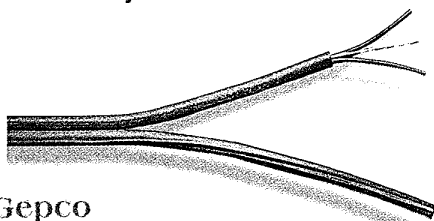

Gepco D61801EZ™

The D61801EZ™ (also referred to as Dual EZ) is two 22 AWG tinned copper audio pairs individually shielded with a 22 AWG tinned copper drain wire. This dual channel, thin profile cable has one overall jacket extruded in a zip cord construction (figure "8"). The foil shield is bonded to the jacket so both can be stripped in one operation. The jacket color is blue and the right channel is marked with a red stripe. This cable is UL listed type CM.

List Prices Vary





**MYAT
makes the
difference**

- Performance
- Reliability
- On-time delivery

WHAT'S MOST IMPORTANT TO YOU, when you need rigid transmission line, components, combiners, dividers or adapters?

You need all three of course, and that's what makes MYAT different. MYAT products are designed for maximum performance. We use the highest quality materials for reliability that lasts. Just as important, we take delivery commitments very seriously.

That's why you'll find MYAT products in so many transmitters and turnkey installations.

MYAT engineers will provide you with technical assistance when designing a new FM, TV or ATV facility, just as we do with OEMs. And MYAT will really come through for you if you need emergency replacements. Our extensive inventory, ready for immediate delivery, is as close as your phone.

Check out the MYAT products listed in this catalog. You'll find our unique **E★STAR™** Power Combiners. At 99% efficiency, **E★STAR** combiners are far more efficient than any hybrid combiner.

You'll also see our wide range of elbows, reducers, connectors, hangers and other components. There's our test-quality adapters, and MYAT Power Dividers. And of course, MYAT is the name to know for all sizes of rigid

coaxial transmission line.

When you need RF transmission line and related products, there's no need to compromise on performance, reliability or prompt delivery. Call for the MYAT difference and get it all.



**Myat
E*STAR™ Power
Combiners**

Myat's exclusive hybridless design provides better than 99% efficiency—far more efficient than any coaxial hybrid combiner. Available in 3 to 8 port models for UHF and VHF TV and FM radio, E*STAR™ combiners have no moving parts and no adjustments to fuss with. Fault tolerant design assures that inputs stay matched even if one or more ports are faulted. Ideal for solid-state transmitters. Choose E*STAR™ for economical operation and low maintenance costs.
List Prices Vary

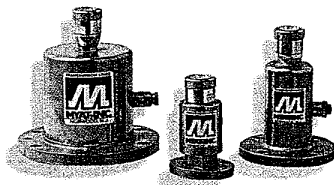
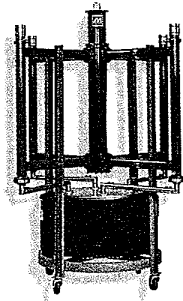

**Myat
Test-Quality Adapters**

Myat adapters are suitable for test setups as well as daily operations. Model 58 7/16 DIN to EIA adapters for example, available in 7/8", 1-5/8" and 3-1/8" EIA sizes, feature a full pressure gas stop with threaded port. They provide a very low VSWR of better than 1.04 and transmission loss of < .05dB. Call Harris for the full range of Myat adapters.
List Prices Vary

**Myat
RF-Line Components**

There are hundreds of different MYAT elbows, reducers, connectors rigid and spring hangers, and other RF line components to choose from. Every one is made from the finest quality materials and is carefully tested before shipping. And, every one is available from Harris. Call us for special attention to emergency replacements. We can also help with technical assistance for new projects and rebuilds.
List Prices Vary

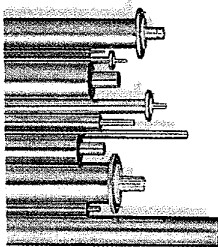

**Myat
Power Dividers** (not pictured)

Myat power dividers are the answer for feeding any configuration of broadcast antennas. Myat can furnish dividers for all line sizes, with any division, and quarter wave, binomial or isolated ports are available. High quality materials and design assure low VSWR and long life. Put Myat's experience to work for you. Call Harris for info on the entire line of Myat transmission line and components.
List Prices Vary

**Potomac
FIM-71**

The FIM-71 is a portable instrument intended to provide accurate, on-site, field strength measurements in the 45 MHz to 225 MHz spectrum. Designed specifically to measure the radiated patterns of terrestrial FM and TV broadcast facilities, the FIM-71 combines a calibrated half-wave dipole antenna with an internal calibration source, and a highly accurate tuned voltmeter with a 140 dB dynamic range. A buffered output of the receiver tracking calibration oscillator is provided for direct insertion loss measurements of coaxial lines and filters.
\$11,434.00 List Price

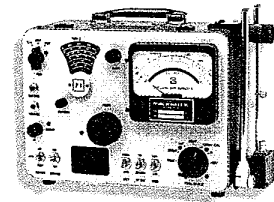

**Potomac
FIM-41**

The FIM-41 is a portable field strength meter designed to provide precise, direct measurements of electromagnetic fields in the 540 kHz to 5.0 MHz spectrum. This instrument consolidates a laboratory quality receiver, integral shielded loop antenna, precision attenuator, and an internal calibration source. With calibration accuracy traceable to the National Institute of Standards and Technology, this instrument meets the most exacting requirements of both government and industry.
\$6,720.00 List Price

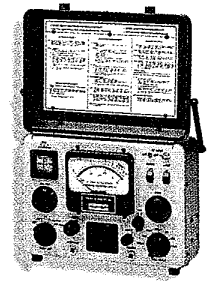

**Potomac
1901-2 Antenna Monitors**

The Type 1900 products include two separate antenna monitors (1901 & 1903) and an extension control & display panel (1902) which may be used with either monitor. The 1900 Series equipment provides jitter free Phase and Ratio measurements in the presence of high level modulation and its simultaneous analog outputs are fully compatible with modern microprocessor based remote control systems. It incorporates plug-in module architecture which offers improved field service options and a higher degree of system flexibility than previous generation equipment.
\$5,710.00 List Price



**Potomac
1750 Tower Light Monitor**

The 1750 TLM is designed to provide a reliable means for detecting beacon or obstruction light failures by monitoring the current in the tower light power circuits. The device contains an onboard power line voltage tracking circuit which enables comparator reference levels to "float" with the supply line voltage thereby prohibiting false triggering of the comparators during periods of abnormal power line voltage fluctuation. Output driver circuits are provided to toggle status inputs of remote control systems or individual relays in the event of a detected failure.
\$550.00 List Price



**Introducing...
THE RIGHT
TOOLS FOR
GETTING THE
JOB DONE.**

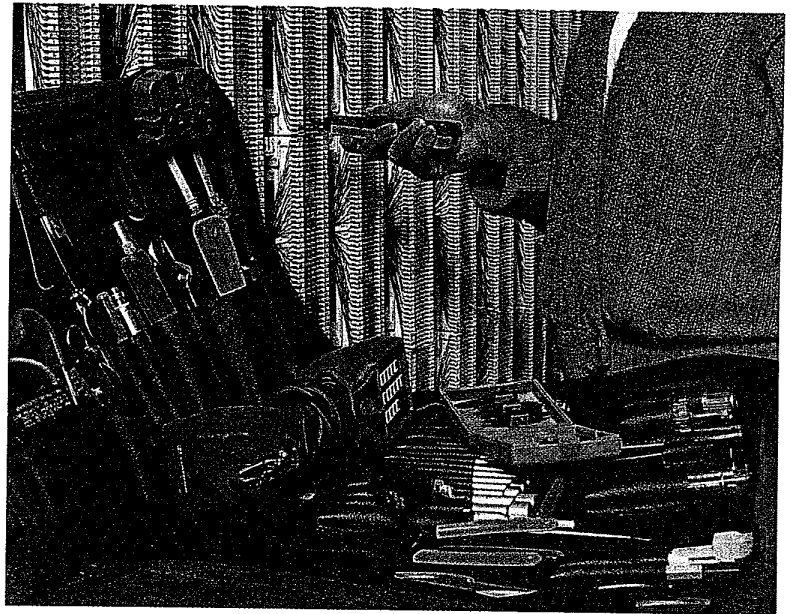

BUTT-IN TEST SETS



TS21

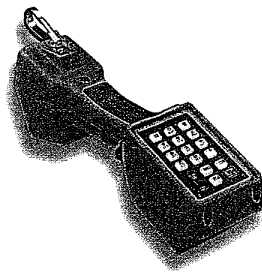

TS22A

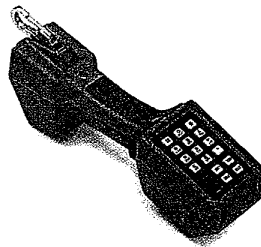

TS22L

Harris offers a variety of test sets to fit your requirements including features such as; Hearing aid compatible receivers, Last Number Redial, and quality solid state circuitry for greater reliability and protection. The *new* TS22L Test set offers data protection against a variety of high frequency circuits including T1, ISDN PRI and ISDN BRI.

IMPACT TOOLS

Harris offers three models- from the first D714 to the industry's finest adjustable D914 model combining impact and torque features. The new D914 impact tool uses the same interchangeable blades as the industry standard D814 impact tool.

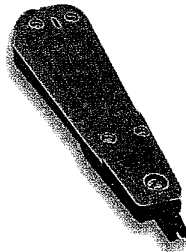

D714

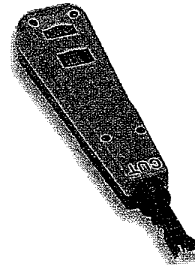

D814

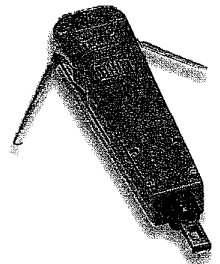

D914

**THE FOX
TONE GENERATOR & TRACER SET**



THE FOX



HOUND 2

Harris offers this wire tracing set designed for use in high density high traffic environments, where the ability to map a system and spot problems is of paramount importance.



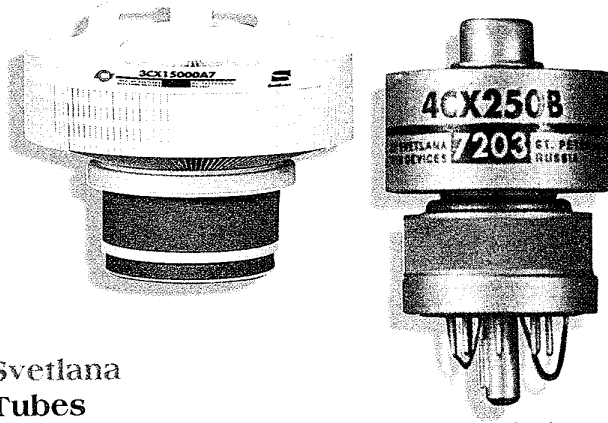

Svetlana Tubes

Russian quality power tubes are now available from Harris. Svetlana, Russia's leading designer and manufacturer of power grid tubes, provides a product line featuring high-quality exact drop-in replacement tubes for most radio broadcast transmitters. To confirm Svetlana's manufacturing quality, Svetlana tubes are backed by the best warranty in the business. Svetlana's time warranty does not begin until the tube is put into operation.

List Prices Vary

Cablewave Rigid Line Systems

This 90 degree elbow 50 ohm, copper and brass construction with mitre joint reinforced is representative of the extensive product line for complete rigid line systems. All rigid line sections and accessories such as the elbow shown are fabricated from high conductivity, hard drawn copper tubing. Standard 50 ohm impedance is offered from 7/8" to 9 3/16" diameter. Expansion inner conductor assemblies are available for larger sizes from

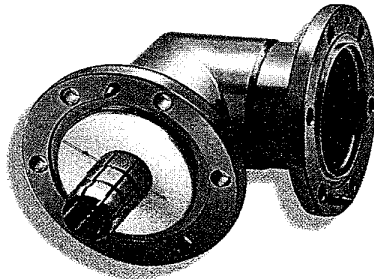

3 1/8" O.D. All EIA flanges meet EIA standard RS-225. All full line of mounting hardware is available for all common sizes. Optimization of all components in a system is available.

List Prices Vary

Cablewave HCC300-50J Transmission Line

Flexwell, HCC300-50J, 3.0 inch air dielectric transmission line is one of the wide variety of semi-flexible air dielectric cables offered that are ideally suited for broadcast service. The cables 1 5/8" to 9.0" O.D. feature a

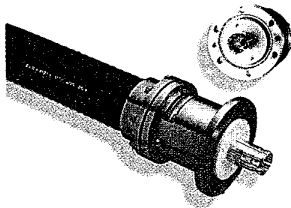

copper corrugated center conductor with a unique spiral vertebrae insulator for uniform impedance, excellent mechanical stability and lower R.F. loss. All large sizes have copper corrugated outer conductor for ease of flexing and black polyethylene jacket for burial protection. The HCC300-50J 3.0" and HCC312-50J 3 1/2" offer ideal options for medium to high power requirement for FM Radio, VHF, UHF Television and H.F. Broadcasting. Accessories such as weather proof low VSWR connectors are available and designed for easy field installation. Pressurization is required. Low VSWR version available. All Flexwell cables are sequentially marked with mechanical footage for easy inventory.

List Prices Vary

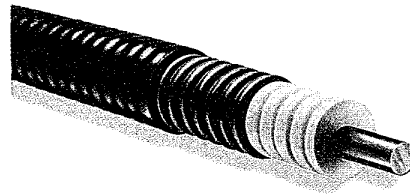

Cablewave FLC12-50J

Flexwell Low Loss 1/2" transmission line features a proprietary design of closed cell dielectric, copper clad aluminum center conductor, and annular corrugated outer conductor. This cable also features a black polyethylene jacket for burial protection. Sequentially marked with mechanical length every two feet for easy inventory, this 1/2" cable is ideally suited for low power FM, sampling systems for AM and a wide variety of mobile applications. Its closed cell exhibits a superior phase temperature coefficient which makes it a perfect choice for any low power, phased array system. No pressurization is required.

List Prices Vary

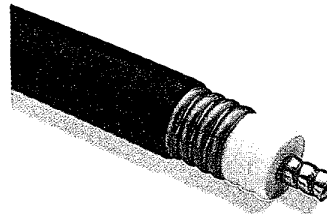

Cablewave FLC158-50J Transmission Line

Flexwell, low loss 1 5/8" transmission line is a proprietary design featuring a closed cell foam dielectric, copper corrugated center conductor and annular copper corrugated outer conductor. A black polyethylene jacket marked I/A/W MIL-C-28830 is sequentially marked every two feet with the exact mechanical footage and serves as excellent corrosive burial protection. The closed cell dielectric exhibits low R.F. loss equal to air dielectric cables for maximum efficiency. The outer conductor is annularly corrugated for improved flexibility, and crush strength and to prevent revention of water.

List Prices Vary

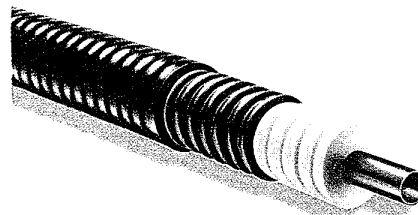

Cablewave FLC78-50J Transmission Line

Flexwell low loss 7/8" transmission line is a proprietary design featuring closed cell foam dielectric, copper tube center conductor, and annular outer conductor. A black polyethylene jacket marked I/A/W Mil-C-28830 sequentially marked every two feet with exact mechanical footage serves as excellent burial protection. The closed cell dielectric exhibits R.F. loss equal to air dielectric cables for maximum efficiency. The outer conductor with its annular corrugations improves flexibility, and prevents water migration. This 7/8" diameter cable is most suitable for medium power FM, and AM phased arrays as well as serving the requirements of PCS and Cellular Radio.

List Prices Vary



Harris analog. Harris digital. Harris solutions.

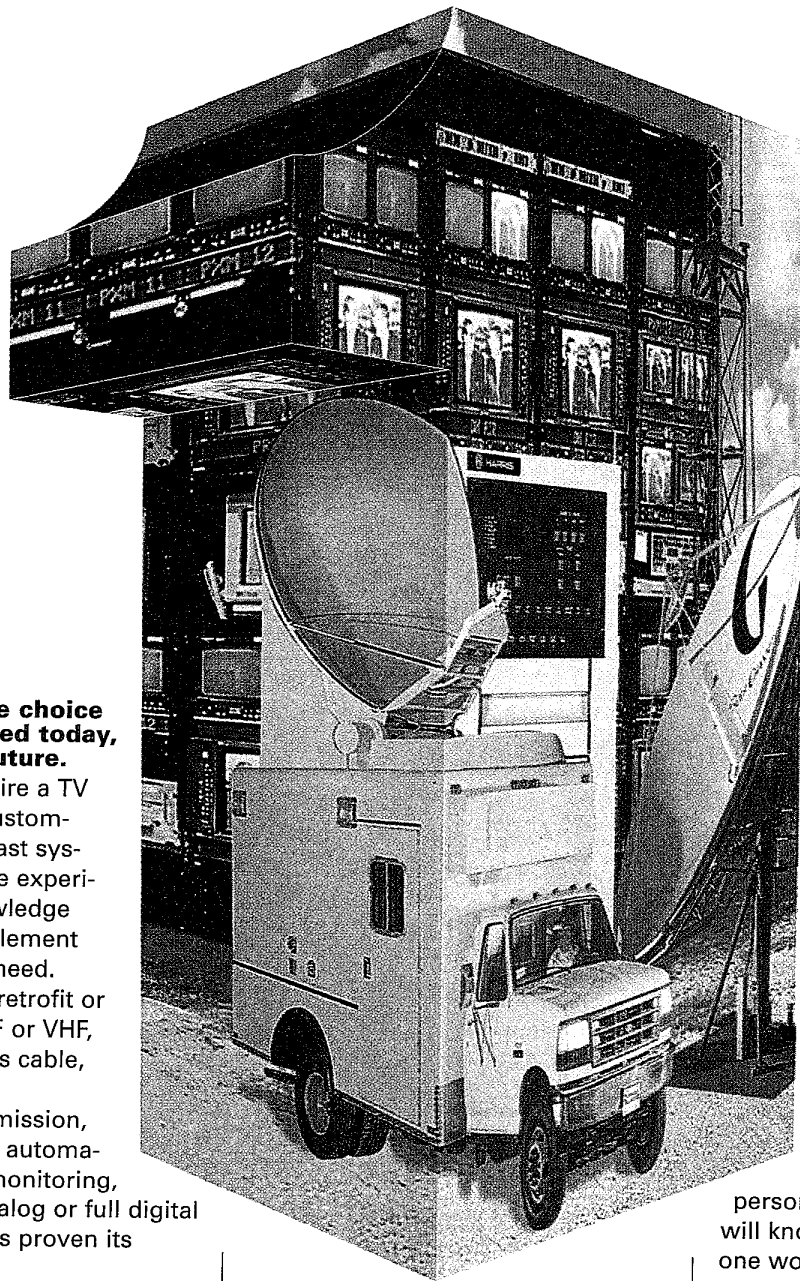

The number-one choice for what you need today, and for the future.

Whether you require a TV transmitter or a custom-integrated broadcast system, Harris has the experience and the knowledge to design and implement exactly what you need. Analog or digital, retrofit or a new facility, UHF or VHF, satellite or wireless cable, Harris does it all.

From RF transmission, satellite reception, automation, control and monitoring, to digital-ready analog or full digital systems, Harris has proven its global capabilities.

The world's highest transmitter standards.

With more than 60 "firsts" in broadcast technology, Harris is well known for its transmitter and antenna solutions. Harris Platinum Series® VHF TV Transmitters with their 5-year warranty, Harris Sigma™ Series and Ultravision™ UHF TV Transmitters, and Harris Antennas, including the world's first HDTV model, are often the yardstick by which other equipment is measured. We integrate

these and other top-quality Harris products with the finest equipment from many leading manufacturers. This insures that you never have to settle for less — or pay for more than you really need — to have the system you want.

Broadcasters worldwide rely on Harris.

The vast resources of Harris can provide every kind of broadcasting system, with every advanced feature

available, to help make your facility more efficient and more profitable.

Harris can provide everything from ENG vehicles or SNG vehicles employing the latest video and audio compression standards, to total all-component serial digital television networks, digital-ready teleports, and nationwide television systems.

Continuous Harris support.

From your first contact with Harris, to the training of your personnel and life-long service, you will know why Harris is the number one worldwide.

For analog or digital broadcasting solutions you can count on, call Harris.

HARRIS CORPORATION BROADCAST DIVISION

US and Canada
TEL: +1 217 222-8200
FAX: +1 217 224-1439

Elsewhere
TEL: +1 217 222-8290
FAX: +1 217 224-2764



Transmitters: Platinum HT EL and Platinum Series® Solid State VHF - UltraVision Solid State UHF - Sigma™ Series IOT UHF - UM Series Depressed Collector Klystron UHF • VHF, UHF and HDTV-Ready Antennas • ENG and SNG Vehicles • Systems: Digital HDTV/ATV - Flyaway Satellite - Mobile Production - Satellite Communications - Television Production - Television Transmission - Terrestrial Microwave - Wireless Cable

Best Power Uninterruptible Power Supplies

Let Best Power, global manufacturer of proven-reliable uninterruptible power systems (UPSs), help you protect your valuable equipment and hard-to-replace data from powerline disturbances. With a comprehensive line of advanced power protection solutions, Best Power is "the answer in power protection"!

Patriot®

Basic power protection for PCs and POS equipment

- 280VA to 850VA Models available
- Coupon for FREE CheckUPS® II Suite power management software included with every Patriot unit

\$129 to \$599 List Price

Fortress®

Advanced power management for enterprise network computing

- 660VA to 3kVA models available
- 720VA to 1420VA rackmount models available
- CheckUPS® II Suite power management software is now bundled FREE with every Fortress UPS

\$549 to \$2,499 List Price

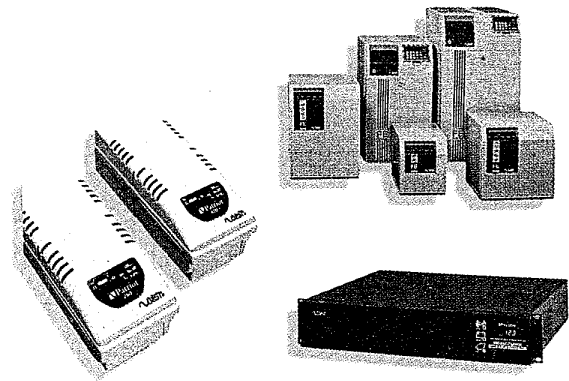

Ferrups®

Bulletproof power integrity for communications and large computer systems

- 500VA to 18kVA models available

\$949 to \$13,995 List Price

Rackmount also available 850VA to 7kVA

- CheckUPS® II Suite power management software is now bundled FREE with every FERRUPS® UPS

\$1,899 to \$7,549 List Price

Furman PRO-SERIES Power Conditioners

Furman's new PRO Series

20 amp/2400 watt power conditioners provide the most complete and comprehensive protection from power-line-related problems available. There are three rackmount models: The PL-PRO has slide-out rack lights, plus a microprocessor-controlled, self-checking AC voltmeter with flashing alerts for marginal conditions. The PM-PRO is for applications where lights are not needed. It features the same AC voltmeter as the PL-PRO, and adds an RMS-reading AC ammeter. The PS-PRO is capable of powering up a rack full of equipment in a three-step delayed sequence. (Furman also makes 15 amp models for less demanding applications.)

List Prices Vary

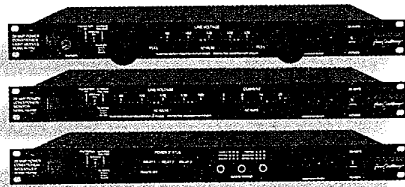

Furman Sound IT-1220 Isolation Transformer

Furman's IT-1220 20 Amp Balanced Power Isolation Transformer takes advantage of the recent National Electrical Code recognition of 120/60V single-phase balanced AC power for critical, ultra-low-noise applications. The IT-1220 all but eliminates ground currents by the common-mode cancellation effect, reducing the need to adopt cumbersome and expensive star-ground systems, massive bus bars, or heavy ground rods. The IT-1220 provides a total of 14 balanced outlets, as well as a "SMART" AC voltmeter, extreme voltage shutdown, and a "soft start" circuit.

\$1,479.00 List Price

Energy Control Systems HP Series

The HP Series "Protector" is widely used and acclaimed in the broadcast industry as the product of choice for all transmitters. Available in both single and three phase models. It's key features include: 160,000 AMPS per phase peak surge current, high energy dissipation (up to 11,250 joules), 10 year "unlimited" free replacement warranty (even if destroyed by lightning), electro chemical technology - no deterioration no clamping drift, response time is less than 1 nanosecond, and all mode protection (normal/common).

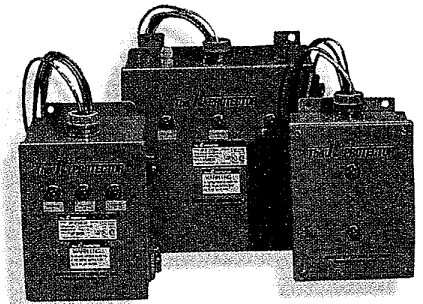

Furman Sound AR-1215 AC Line Voltage Regulator

Model AR-1215 (shown) delivers a stable 120 ±5 VAC at 15 amps whenever the input AC line voltage is between 97V and 141V. It uses a low magnetic leakage, eight-tap toroidal autoformer, switching taps only at voltage zero-crossings to avoid creating glitches. Special features include eight regulated outlets on the back panel, one on the front; a 10-LED bar-graph Input Voltage meter; Extreme Voltage Shutdown circuit with indicator LED; and an Output In Regulation indicator. Furman also makes 20 amp (model AR-1220) and 30 amp (model AR-PRO) regulators, the latter with a wide 88 to 264 volt capture range, ideal for international travel.

\$599.00 List Price Model AR-1215

\$899.00 List Price Model AR-1230

\$2,295.00 List Price Model AR-PRO

**Feeding your
automated
workstation
unconditioned
power is like
driving without
a seatbelt.**



**If you
crash,
it's all
over.**

**Superior Electric's *
family of advanced
STABILINE® Voltage Conditioning Products
offers a full range of power protection
options to prevent such a disaster.**

Did you know that the seemingly harmless fluctuations in electricity that cause momentary flickers in your studio lights can literally fry the internal mechanisms of digital and analog broadcast equipment? It's true.

The AC power line feeding your entire station is filled with voltage irregularities: surges, sags, spikes and noise, among others. And if this "dirty" power reaches the sensitive circuitry that controls your commercial and music inventory or traffic computer, for example, the results can be devastating. Lost or corrupted data, satellite delivery interruptions, mechanical failure – whatever the outcome, it's always bad news. Which means it's bad for business.

That's why you need STABILINE® Power Protection Products. Whether you're looking for voltage regulation, power conditioning, battery backup power or a combination thereof, we've got you covered.

Why take unnecessary risks? Invest in STABILINE® power protection. *We're your best insurance against a crash!*

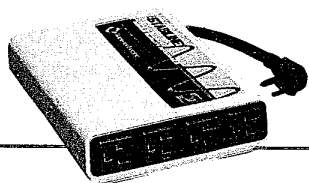
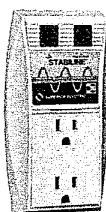
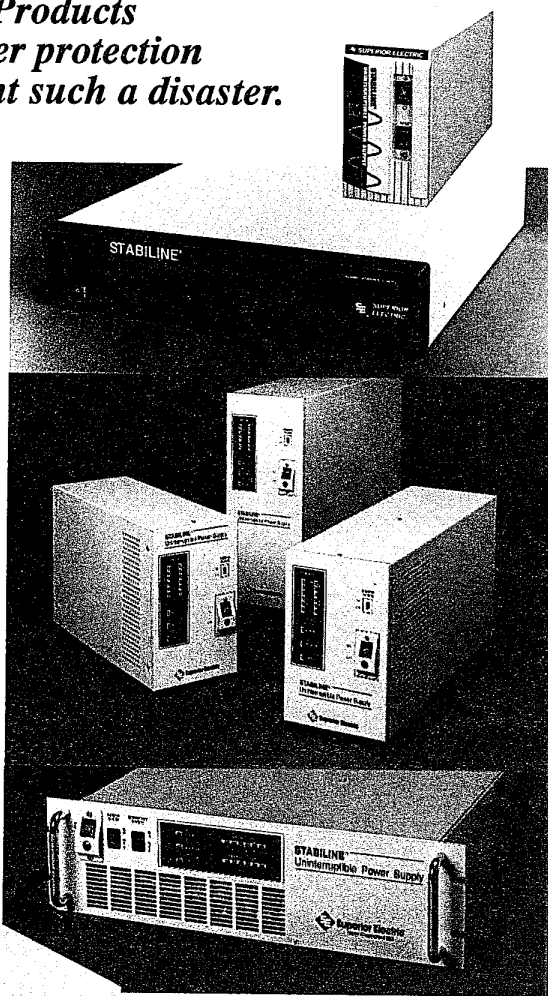

**Transient Voltage
Suppressors/RFI Filters**
Wall mount, desktop, 19-inch rack
mount, NEMA 12, industrial hard-
wired. Ratings to 20 amperes.

Power Conditioners
120 VAC, 60 Hz and international
50 Hz types. Ratings to 125 kVA.
Portable and cabinet models available.

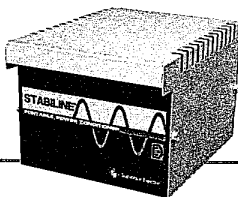

Voltage Regulators
Power ratings from 2 to 1680 kVA.
Cabinet or 19-inch rack mount models.

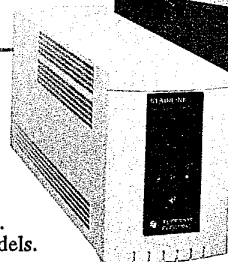

Uninterruptible Power Supplies
Domestic 110, 120 or 127 VAC, 60 Hz
or international 220, 230 or 240 VAC,
50/60 Hz types to 2200 VA. Wide range
of desktop, cabinet and rack mount types.

SUPERIOR ELECTRIC
WARNER ELECTRIC



See other STABILINE®
products on page 254.

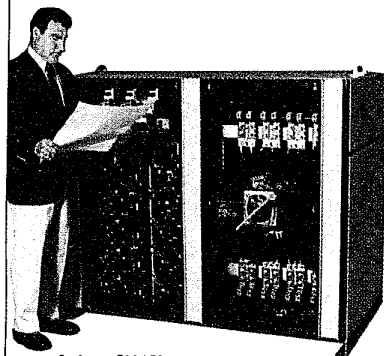

3-phase, 500 kVA WHR Series model.



Harris PowerWerks 3002 Convenience Outlets

The PowerWerks 3002 is the perfect accessory, providing power protection essential to audio/video equipment. Features include two slide-out swiveling light tubes, digital display voltmeter, sophisticated EMI/RFI multi-stage Pi filter with four toroidal chokes, ProTec circuit indicator warns of loss of surge and spike protection, separate ground indicator, eight rear mounted receptacles unequally spaced to accommodate all sizes plug-in power (wall wart) supplies, front mounted unswitched receptacle, ten foot power cord, 1800 watts/15 Amps @ 120V, IU.

\$229.95 List Price

Warner/Superior Electric WHR Series STABILINE Voltage Regulators

WHR Series STABILINE Voltage Regulators are the preferred choice of broadcasters worldwide for use with transmitters, receiving stations, studios and mobile production vehicles. These high power voltage regulators correct the wide fluctuations in input voltage that can cause irreparable damage to sensitive components in electronic apparatus. They maintain constant voltage even when the power line input voltage and system load vary widely. Because they are insensitive to the magnitude and power factor of the load, they can be used with almost any load, even those with high inrush current. Harmonic distortion is less than 0.25%

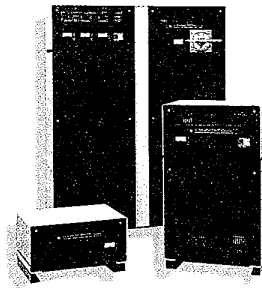

PowerWerks 2005

The PowerWerks 2005 features eight rear mounted receptacles unequally spaced to accommodate all sizes of plug-in power (wall wart) supplies, two front mounted receptacles, ProTec circuit continually monitors protection circuit and warns of loss of surge and spike protection, RFI filtering, ten foot power cord, 180 watts/15 Amps @ 120V, single rack spacing.(not pictured)

\$149.00 List Price

PowerWerks 2006

The PowerWerks 2006 features two slide-out swiveling light tubes, eight rear mounted receptacles unequally spaced to accommodate all sizes of plug-in power supplies, ProTec circuit continually monitors protection circuit and warns of loss of surge and spike protection, RFI filtering, ten foot power cord, 1800 watts/15 Amps @ 120V, single rack spacing.(not pictured)

\$189.95 List Price

Warner/Superior Electric STABILINE Voltage Regulator WHR11SSCX1R

This versatile voltage regulator is designed for stand-alone or rack mount installation and is widely used for mobile production vehicles, studio and workstation duty. It is a 120 V nominal, 50/60 Hz, single phase rapidly responding voltage regulator. Its design utilizes a solid-state control module and a power module consisting of a variable transformer and buck-boost transformer arrangement. The combination permits user selection of either narrow or wide range input voltage correction and a dual output rating of 114 A, 13.7 kVA or 57 A, 6.8 kVA.



Warner/Superior Electric PQI Series STABILINE Power Quality Interfaces

Divert and suppress electromagnetic interference, spikes and transients before they reach the circuitry of sensitive broadcast electronic equipment. Offers bi-directional protection from source or load disturbances. Unique state-of-the-art, performance-proven, multistage suppression and filtration design. Packaged in an aluminum enclosure with easy-to-reach AC input and output connections. Feature a front panel pilot light, circuit breaker on/off switch and six output receptacles in differing configurations. Rated for 120 VAC, 60 Hz, 15 A duty, all conform to ANSI standards for 19-inch rack mounting. Full 10-year warranty.



Warner/Superior Electric SP Series STABILINE Standby Power Supplies

Instantly switches to battery power when an AC power outage occurs. Multistage suppression and filtration design effectively filters out noise moving to or from the utility power line and protects the critical load from destructive overvoltages such as surges, spikes and transients. Utilizes economical synthesized sine wave (step wave) output technology. Has audible and visual alarms and optional (400 and 600 VA models only) computer interface software for Novell, UNIX and other platforms. Available in UL 1778 listed and CSA certified North American 120 VAC, 60 Hz models and VDE certified international 230 VAC, 50/60 Hz models with power ratings of 220, 300, 420, 500 and 650 VA. Full 2-year warranty.

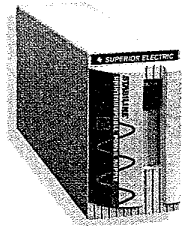

Warner/Superior Electric SL Series STABILINE Uninterruptible Power Supplies

Line-interactive devices that provide continuous sinewave output to digital and analog broadcast equipment. Use a "boost/buck" tap system for tight output regulation and control over chronic low or high voltage conditions. Bi-directional surge diverting/filtering circuitry protects from electrical noise generated from either AC input or protected load. UL 1778 listed and CSA certified North American models permit user-selectable 110, 120 or 127 VAC, 60 Hz operation and VDE certified international models permit, user-selectable 220, 230 or 240 VAC, 50/60 Hz operation. Full 2-year warranty.

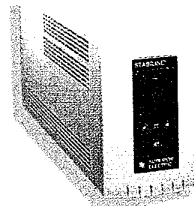

Warner/Superior Electric Model UPSY61005 STABILINE Uninterruptible Power Supply

UPSY Series Model UPSY61005 provides a reliable source of clean, continuous sinewave AC power for voltage sensitive broadcast equipment. It is a triple conversion true on-line UPS system that regulates voltage, protects equipment from noise and provides battery backup power in the event of utility failure. North American models are UL 1778 listed and CSA certified; international models are TUV certified. An optional rack mounting kit is available to adapt the unit for rack installation. Each mounting kit consists of a pre-assembled chassis/front panel assembly designed for 19-inch rack mounting. Full 2-year warranty.

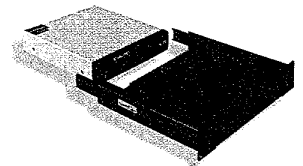

APPROXIMATE DISTANCES TO THE RADIO HORIZON
VS VARIOUS TOWER HEIGHTS (FOR FM and TV)

TOWER HEIGHT IN METERS(M)
DISTANCE TO RADIO HORIZON IN KILOMETERS(KM)

M	KM	M	KM	M	KM	M	KM
6	10.1	162	52.5	318	73.5	474	89.8
12	14.3	168	53.4	324	74.2	480	90.3
18	17.5	174	54.4	330	74.9	486	90.9
24	20.2	180	55.3	336	75.6	492	91.4
30	22.6	186	56.2	342	76.2	498	92.0
36	24.7	192	57.1	348	76.9	504	92.5
42	26.7	198	58.0	354	77.6	510	93.1
48	28.6	204	58.9	360	78.2	516	93.6
54	30.3	210	59.7	366	78.9	522	94.2
60	31.9	216	60.6	372	79.5	528	94.7
66	33.5	222	61.4	378	80.2	534	95.3
72	35.0	228	62.2	384	80.8	540	95.8
78	36.4	234	63.1	390	81.4	546	96.3
84	37.8	240	63.9	396	82.0	552	96.9
90	39.1	246	64.7	402	82.7	558	97.4
96	40.4	252	65.4	408	83.3	564	97.9
102	41.6	258	66.2	414	83.9	570	98.4
108	42.8	264	67.0	420	84.5	576	98.9
114	44.0	270	67.7	426	85.1	582	99.5
120	45.2	276	68.5	432	85.7	588	100.0
126	46.3	282	69.2	438	86.3	594	100.5
132	47.4	288	70.0	444	86.9	600	101.0
138	48.4	294	70.7	450	87.5	606	101.5
144	49.5	300	71.4	456	88.0	612	102.0
150	50.5	306	72.1	462	88.6	618	102.5
156	51.5	312	72.8	468	89.2	624	103.0

TOWER HEIGHT IN FEET (FT)
DISTANCE TO RADIO HORIZON IN MILES (MI)

FT	MI	FT	MI	FT	MI	FT	MI
20	6.3	520	32.2	1020	45.2	1520	55.1
40	8.9	540	32.9	1040	45.6	1540	55.5
60	11.0	560	33.5	1060	46.0	1560	55.9
80	12.6	580	34.1	1080	46.5	1580	56.2
100	14.1	600	34.6	1100	46.9	1600	56.6
120	15.5	620	35.2	1120	47.3	1620	56.9
140	16.7	640	35.8	1140	47.7	1640	57.3
160	17.9	660	36.3	1160	48.2	1660	57.6
180	19.0	680	36.9	1180	48.6	1680	58.0
200	20.0	700	37.4	1200	49.0	1700	58.3
220	21.0	720	37.9	1220	49.4	1720	58.7
240	21.9	740	38.5	1240	49.8	1740	59.0
260	22.8	760	39.0	1260	50.2	1760	59.3
280	23.7	780	39.5	1280	50.6	1780	59.7
300	24.5	800	40.0	1300	51.0	1800	60.0
320	25.3	820	40.5	1320	51.4	1820	60.3
340	26.1	840	41.0	1340	51.8	1840	60.7
360	26.8	860	41.5	1360	52.2	1860	61.0
380	27.6	880	42.0	1380	52.5	1880	61.3
400	28.3	900	42.4	1400	52.9	1900	61.6
420	29.0	920	42.9	1420	53.3	1920	62.0
440	29.7	940	43.4	1440	53.7	1940	62.3
460	30.3	960	43.8	1460	54.0	1960	62.6
480	31.0	980	44.3	1480	54.4	1980	62.9
500	31.6	1000	44.7	1500	54.8	2000	63.2

Frequency Designation of FM Broadcast Channels

Freq. (MHz)	Channel No.	Freq. (MHz)	Channel No.	Freq. (MHz)	Channel No.	Freq. (MHz)	Channel No.	Freq. (MHz)	Channel No.
88.1	201	98.1	251	90.9	215	100.9	265	94.5	233
88.3	202	98.3	252	91.1	216	101.1	266	94.7	234
88.5	203	98.5	253	91.3	217	101.3	267	94.9	235
88.7	204	98.7	254	91.5	218	101.5	268	95.1	236
88.9	205	98.9	255	91.7	219	101.7	269	95.3	237
89.1	206	99.1	256	91.9	220	101.9	270	95.5	238
89.3	207	99.3	257	92.1	221	102.1	271	95.7	239
89.5	208	99.5	258	92.3	222	102.3	272	95.9	240
89.7	209	99.7	259	92.5	223	102.5	273	96.1	241
89.9	210	99.9	260	92.7	224	102.7	274	96.3	242
90.1	211	100.1	261	92.9	225	102.9	275	96.5	243
90.3	212	100.3	262	93.1	226	103.1	276	96.7	244
90.5	213	100.5	263	93.3	227	103.3	277	96.9	245
90.7	214	100.7	264	93.5	228	103.5	278	97.1	246
				93.7	229	103.7	279	97.3	247
				93.9	230	103.9	280	97.5	248
				94.1	231	104.1	281	97.7	249
				94.3	232	104.3	282	97.9	250
								104.5	283
								104.7	284
								104.9	285
								105.1	286
								105.3	287
								105.5	288
								105.7	289
								105.9	290
								106.1	291
								106.3	292
								106.5	293
								106.7	294
								106.9	295
								107.1	296
								107.3	297
								107.5	298
								107.7	299
								107.9	300

Decibels Vs Ratio

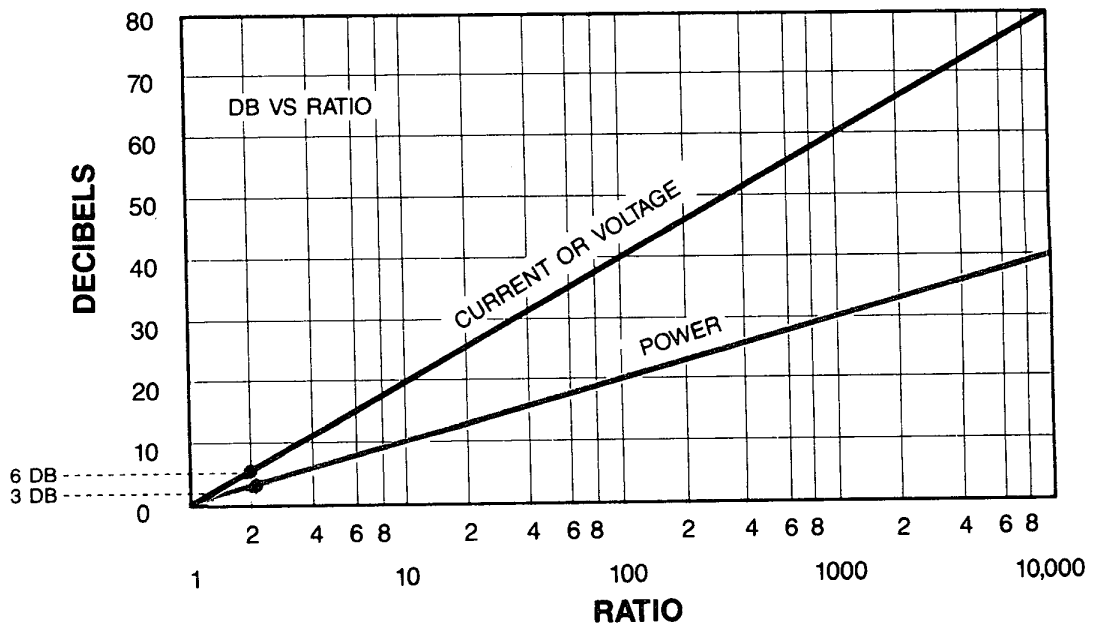

Volume Level to Power and Voltage Conversion

REFERENCE LEVEL: 0 DBM = 1 MW, 600 OHMS					
MILLIWATTS	VOLTS	DBM	WATTS	VOLTS	DBM
0.000001	0.0007746	-60	0.001000	0.7746	0
0.000010	0.002449	-50	0.002512	1.228	+4
0.000100	0.007746	-40	0.006310	1.946	+8
0.001	0.02449	-30	0.01000	2.449	+10
0.010	0.07746	-20	0.1000	7.746	+20
0.100	0.2449	-10	1.000	24.49	+30
1.000	0.7746	0	10.00	77.46	+40

Voltage Standing Wave Ratio Relationships

VSWR	REFLECTION COEFFICIENT	RETURN LOSS	POWER RATIO	PERCENT REFLECTED
1.01 : 1	.0050	46.1 dB	.00002	.002%
1.02 : 1	.0099	40.1 dB	.00010	.010%
1.04 : 1	.0196	34.2 dB	.00038	.038%
1.06 : 1	.0291	30.7 dB	.00085	.085%
1.08 : 1	.0385	28.3 dB	.00148	.148%
1.10 : 1	.0476	26.4 dB	.00227	.227%
1.20 : 1	.0909	20.8 dB	.00826	.826%
1.30 : 1	.1304	17.7 dB	.01701	1.7%
1.40 : 1	.1667	15.6 dB	.02778	2.8%
1.50 : 1	.2000	14.0 dB	.04000	4.0%
1.60 : 1	.2308	12.7 dB	.05325	5.3%
1.70 : 1	.2593	11.7 dB	.06722	6.7%
1.80 : 1	.2857	10.9 dB	.08163	8.2%
1.90 : 1	.3103	10.2 dB	.09631	9.6%
2.00 : 1	.3333	9.5 dB	.11111	11.1%
2.20 : 1	.3750	8.5 dB	.14063	14.1%
2.40 : 1	.4118	7.7 dB	.16955	17.0%
2.60 : 1	.4444	7.0 dB	.19753	19.8%
2.80 : 1	.4737	6.5 dB	.22438	22.4%
3.00 : 1	.5000	6.0 dB	.25000	25.0%
3.50 : 1	.5556	5.1 dB	.30864	30.9%
4.00 : 1	.6000	4.4 dB	.36000	36.0%
4.50 : 1	.6364	3.9 dB	.40496	40.5%
5.00 : 1	.6667	3.5 dB	.44444	44.4%
6.00 : 1	.7143	2.9 dB	.51020	51.0%
7.00 : 1	.7500	2.5 dB	.56250	56.3%
8.00 : 1	.7778	2.2 dB	.60494	60.5%
9.00 : 1	.8000	1.9 dB	.64000	64.0%
10.00 : 1	.8182	1.7 dB	.66942	66.9%
15.00 : 1	.8750	1.2 dB	.76563	76.6%
20.00 : 1	.9048	.9 dB	.81859	81.9%
30.00 : 1	.9355	.6 dB	.87513	87.5%
40.00 : 1	.9512	.4 dB	.90482	90.5%
50.00 : 1	.9608	.3 dB	.92311	92.3%

Engineering Data

$$VSWR = \frac{1 + |p|}{1 - |p|} = \frac{1 + \sqrt{(Prfl/Pfwd)}}{1 - \sqrt{(Prfl/Pfwd)}}$$

POWER RATIO = (Prfl/Pfwd)

$$p = \frac{VSWR - 1}{VSWR + 1} = \text{REFLECTION COEFFICIENT}$$

RETURN LOSS = $-20 \log |p|$

Helpful Technical Tips

Courtesy of Mackie Designs

COMMON MIXER PLUGS

1/4" tip - ring - sleeve

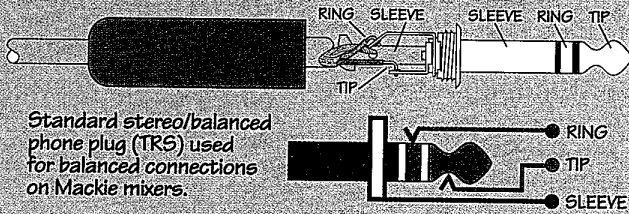

Balanced XLR

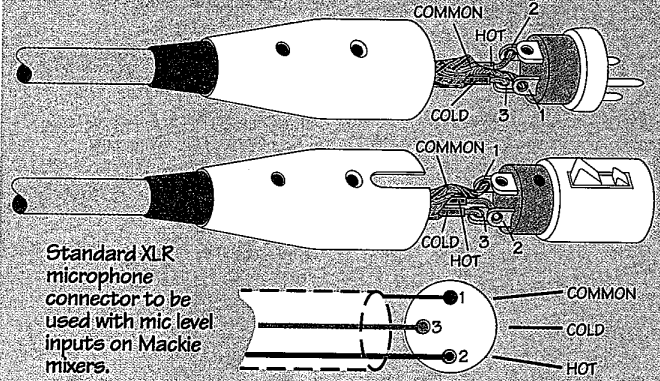

Jovian cyberplug

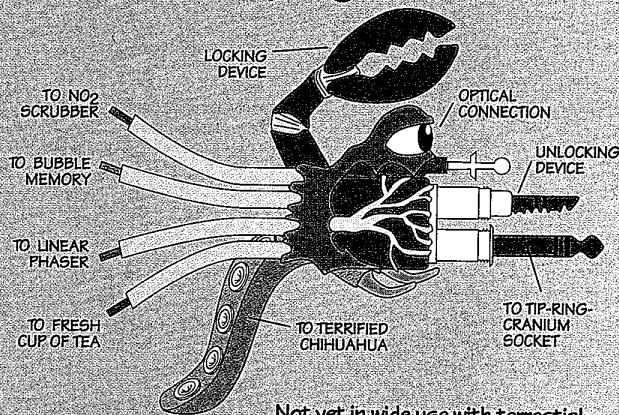

Not yet in wide use with terrestrial musicians, the cyberplug's telepathic polarity sensor and ability to be used as a defensive weapon against hostile audiences in really seedy bars have popularized it in other arms of the galaxy.

1/4" tip - sleeve

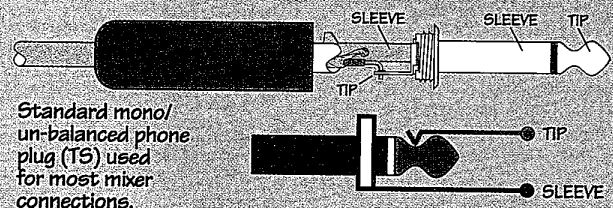

RCA/phono plug

Tape deck connections on the MicroSeries 1202 & LM-3204 Line mixer.



Hybrid 1/4" plug set for connecting effects to inserts

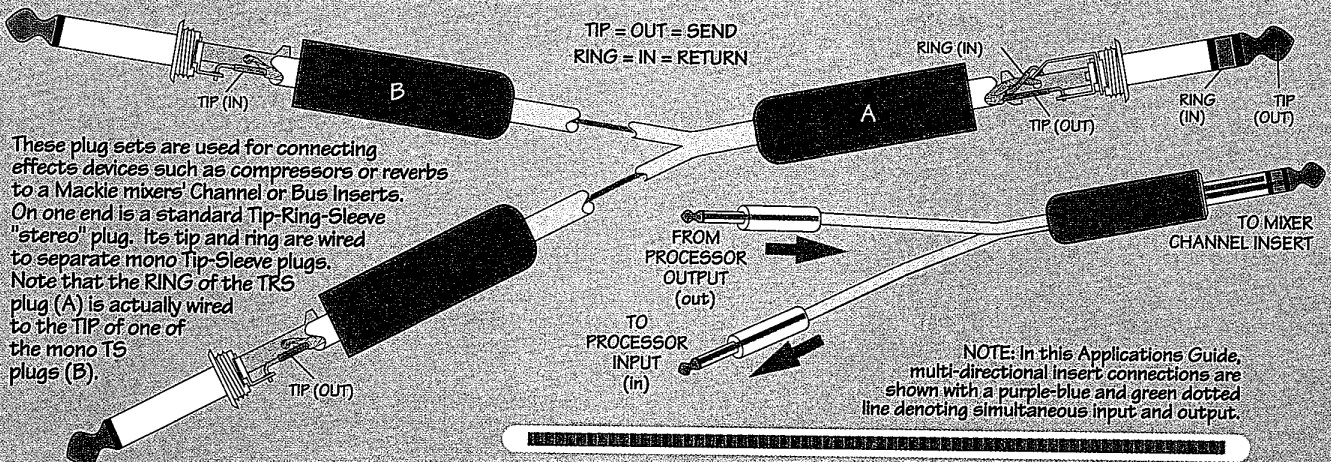

*** 4:2:2:**

A Standard for sampling video signals. The numbers refer to the sampling frequency of luminance.

*** 16:9 Format**

This is the ratio of the width to the height of a DTV display. Current TV sets are standardized for a 4:3 format.

AES/EBU

Audio Engineers Society/European Broadcasters Union - Two organizations that agreed upon a standard for the exchange of digital audio within the studio environment.

ALGORITHM

A formula or set of steps used to simplify, modify, or predict data. Complex algorithms are used to selectively reduce high digital audio and video data rates. These algorithms utilize physiologists' knowledge of hearing and eyesight.

AM

Amplitude modulation.

ANALOG AUDIO

A continuous, varying voltage which represents the electrical equivalent of sound. Analog Audio has infinite precision within limits of S/N, since it is continuous. Analog audio of sufficient level may be used directly to drive an audio speaker, which changes the electrical energy back into acoustic energy (sound).

ANALOG TO DIGITAL CONVERTER

A device, usually an integrated circuit, which samples the incoming analog audio and outputs digital audio of defined word lengths such as 12 bit A/D or 16 bit A/D, or 20 bit A/D.

ATM

Asynchronous Transfer Mode, a specification of a protocol defining an ATM data cell and its handling in a network. Allows dynamic bandwidth allocation and may support multiple media.

BANDWIDTH COMPRESSION

Reducing the bandwidth that is required for transmission of a given digital data rate. Compression makes it possible to reduce gigabits of raw data into a DTV signal of about 20 Megabits per second. This signal can be transmitted over the allotted 6 MHz bandwidth.

BER

Bit Error Rate - This term is an important indicator of the performance of the digital system. BER is the number of bits received in error divided by the number of bits sent. In various systems, there is a qualitative as well as quantitative aspect to bit errors. Some bit errors can cause more problems than others.

BINARY NUMBERS

Numbers based on the power of 2 and expressed as either a 1 or 0. For example, number 1 appears in a 5 bit word as 00001; number 2 appears in a 5 bit word as 00010; number 4 appears in a 5 bit word as 00100, etc.

*** BIT**

The smallest increment of digital information. A bit may be either a "1" or a "0." A single bit may be thought of as insignificant in the 20 millions of bits per second used for DTV.

bps/Hz

bits per second per Hertz is a spectral efficiency number. Bps divided by occupied bandwidth gives bit/sec/Hz.

BPSK

Bi-Phase Shift Keying - Digital bits are sent one at a time by shifting the carrier phase back and forth 180 degrees. This method also requires wide bandwidth, however it does have the advantage of being least susceptible to noise. (Also, BSK Binary Shift Keying.)

CCD

An abbreviation for Charge Coupled Device.

CCIR

Comite Consultatif International des Radio Communications (The International Radio Consultative Committee). This standardization committee is now called ITU-R.

CCIR REC.601

The most important studio standard for digital video based on analog component 4:2:2 signals. Describes how to sample the component signal and how to structure the data.

CCIR REC.656

The standard describing how to interface to a CCIR Rec.601 formatted signal (serial and parallel 4:2:2 interfaces, commonly known as D-1 interfaces).

CCITT

Comite Consultatif International Telegraphic et Telephonique (The International Telegraph and Telephone Consultative Committee). This standardization committee is now called ITU-T.

CLEAR CHANNEL

AM radio station allowed to dominate its frequency with up to 50 kW of power; their signals are generally protected for distance of up to 750 miles at night.

*** CLIFF EFFECT**

At the fringes of reception, current TV pictures degrade by becoming "snowy." With DTV, relatively small changes in received power in weak signal areas will cause the DTV picture to change from perfect to nothing and hence the name: cliff effect.

*** COFDM**

Coded Orthogonal Frequency Division Multiplexing.

COMPRESSION

The technique of reducing the amount of data needed to represent a video or audio signal. International standards are ETSI, MPEG, JPEG, G.722, etc.

DAB

Digital Audio Broadcasting is a generic term which is used for the delivery of digital audio by any method such as satellite, microwave, BC carrier, etc.

DAR

Digital Audio Radio - DAB as it refers to digital radio broadcasting.

DAT (RDAT)

Stereo digital audio recording format using rotary heads on 3.81 mm tape cassette.

DATA INTEGRITY

General term for any action or strategy which minimizes the proportion of data bits in a system which are corrupted.

DATA PORT

The physical and electrical protocol used by a codec and the DSU (Data Service Unit) or TA (Terminal Adapter) to transfer data between each other. A codec comes with either a V.35 or X.21 protocol built in. These numbers refer to CCITT international standards with V.35 very common for networks in North America and X.21 popular on European-manufactured ISDN terminal adapters.

dBm

Unit of audio level which dissipates one milliwatt in a load. With a load of 600 Ohms, 0dBm is 0.775 V rms.

DBS

Direct Broadcast Satellite.

dBu

Unit of audio level where 0dBu is 0.775 V rms.

DIGITAL

A discontinuous electrical signal that carries information in binary fashion. Data is represented by a specific sequence of off-on electrical pulses. (See Bits, See Binary Numbers)

DIGITAL AUDIO

A representation of analog audio created by taking samples of the analog audio at specific points in time. Digital audio uses bits to record the analog voltage. Because digital audio is finite, the more bits used at each sample point, the better the quality of the recreated audio when converting digital audio back to analog audio.

DIGITAL TO ANALOG CONVERTER

A device, usually an integrated circuit, which converts digital words into a standard varying audio voltage which is representative of the original analog audio.

DIRECTIONAL ANTENNA

An antenna that directs most of its signal strength in a specific direction rather than at equal strength in all directions. Used chiefly in AM radio operation.

DISTORTION

Change in the waveform of an audio or video signal. Linear distortion due to phase shifts does not change the signal spectrum. Non-linear distortion introduces harmonics.

DITHER

Noise added to linearize quantizing step.

DOWNLINK

Earth station used to receive signals from satellites.

DSP

Digital Signal Processing is the process of changing analog audio signals to a digital format that may also be compressed and stored or transmitted in the digital domain.

DSU/CSU

Data Service Unit/Channel Service Unit. Required between a codec and SW56 or DDS circuits, used to interface and condition the data coming on and off the network. It may contain diagnostic testing functions and will perform dialing tasks for switched services.

DTE/DCE

Data Terminal Equipment and Data Computer Equipment. To avoid confusion, the data protocols mentioned above designate equipment and ports as either DTE or DCE. In

the case of the codec, the DSU/CSU or TA is always the DCE and the codec is always the DTE.

*** DTV (HDTV, ATV)**

U.S. Authorized Digital Television transmission standard enabling much higher digital picture resolution and quality, multiple simultaneous program capability and digital, CD quality sound.

EARTH STATION

Equipment used for transmitting or receiving satellite communications.

EMC

Electromagnetic compatibility. General term for set of regulations and procedures to ensure that electronic equipment neither suffers from nor generates interference.

ENG

Electronic News Gathering.

ENTROPY

The unpredictable part of a signal which has to be transmitted by a compression system if quality is not to be lost.

ETSI

European Telecommunications Standards Institute, which produces standards through a number of technical committees.

ETV

Educational Television

FEC

Forward Error Correction - A system that substitutes for an error bit what it believes the correct bit should be. It may also be used in a generic sense for any system that encodes data to help minimize bit errors on the receiving end. r = rate. For example, 3/4 FEC means for every 3 data bits sent, 1 FEC bit is sent.

FIBER-OPTIC CABLE

Wires made of glass fiber used to transmit video, audio, voice or data providing vastly wider bandwidth than standard coaxial cable.

FIELD

Half of the video information in the frame of a video picture. The NTSC system displays 59.94 fields per second.

FM

Frequency modulation.

FOOTPRINT

Area on earth within which a satellite's signal can be received.

FRACTIONAL

Relative to a part of a data rate. For instance 64 kbit/s fractional of the 1.544 Mbit/s T-1 service

FRAGMENTATION

After writing information to a hard disk for a period of time, the disk develops areas too small to fit complete files. The system must spread the file over several areas of the disk to store. Because the read/write head must jump between these locations, the access time is slowed down, sometimes drastically.

FREQUENCY

The number of cycles a signal is transmitting per second, measured in Hertz.

GEOSTATIONARY ORBIT

Orbit 22,300 miles above earth's equator where satellites circle earth at same rate earth rotates.

*Specific to DTV

- GHz**
GigaHertz. 1000 MegaHertz (cycles)
- GROUP DELAY**
This term defines the amount of time delay that may occur in a modulated signal as a function of frequency. Any unwanted delays in time affect phase relationships which may upset the proper decoding of the QAM signal. In some cases, group delay problems may be improved by transmitter precorrection circuitry.
- HEADROOM**
Range of signal levels between standard operating level and level at which clipping or overload occurs.
- HERTZ**
A measurement of frequency. One cycle per second equals one Hertz (Hz).
- IBOC**
In Band On Channel - A form of DAB in which the digital audio is broadcast within the same channel allocation as the standard analog program audio.
- INTERLACED SCANNING**
The concept of splitting a TV picture into two fields of odd and even lines.
- ISDN**
Integrated Services Digital Network. The worldwide standard for digital telephony, it actually describes a complex set of international standards.
- ISO/MPEG ***
A source compression algorithm proposed by two organizations: International Standards Organization/Moving Picture Experts' Group. This algorithm is also associated with digital television.
- ITFS**
Instructional Television Fixed Service
- ITU-R**
See CCIR
- JITTER**
Unwanted frequency or phase variations of a data stream or phase noise of a carrier signal.
- kHz**
Kilohertz. One thousand Hertz (cycles) per second.
- LAYER II**
A specific subset of the audio part of the MPEG-1 and MPEG-2 standards. The Layer II specification features 32 to 384 kbit/s data rate, compression in 32 subbands with adaptive bit allocation determined by a psychoacoustic model, sampling rates from 16 to 48 kHz, and various coding modes.
- LPTV**
Low-power television.
- MDS**
Multipoint distribution service.
- MHz**
MegaHertz. One million Hertz (cycles) per second.
- MICROWAVE**
Frequencies above 1,000 mHz
- MJPEG**
An abbreviation for Motion JPEG, a method of compression where each frame or field in a video signal is compressed using JPEG.
- MPEG**
Moving Pictures Experts Group (or often Motion Picture Experts Group). A working group under ISO/IEC that sets standards for the coding of moving pictures and associated audio. Standards are the MPEG-1 and the MPEG-2.
- MPEG-1**
A standard for the coding of moving pictures and associated audio for digital storage media up to about 1.5 Mbit/s. Includes separate specifications for audio and video. Used for broadcast audio (Layer II), CD video, etc.
- MPEG-2**
A specification that defines generic syntax (that is, universally applicable rules of handling data) for transport of video and associated audio by means of data compression. Includes separate specifications on audio and video.
- MTBF**
Mean Time Before Failure is the estimated life for devices such as hard disks, etc.
- NON-LINEAR**
An editing system in which random access storage is used so that non-linear access to the material is possible.
- NRSC**
National Radio Systems Committee - a U.S. radio industry-sponsored group interested in setting standards for the improvement and compatibility of radio systems. NRSC is particularly interested in IBOC DAB systems.
- NTSC**
National Television Standards Committee, the American TV transmission standard which uses an interlaced 525-line, 30-frames-per-second picture.
- OPTIMIZATION**
A process where the computer reorganizes the information on the hard drive in order to eliminate the fragmented areas. This in turn improves the access time for the disk. Depending on the size of the disk, this process can take many hours and precludes any other operation on the computer.
- OVERSAMPLING**
Temporary use of a higher than necessary sampling rate in converters in order to simplify analog filters.
- PAC**
Perceptual Audio coding - A source compression algorithm which also uses psychoacoustic knowledge and statistical information.
- PAL**
Phase Alternating Line, a European TV transmission standard found in several variants. Uses an interlaced 625-line, 25-frames-per-second picture, except PAL-M (only in Brazil), which uses an interlaced 525-line, 30-frames-per-second picture.
- PCM**
Pulse code modulation. Conversion of voice signals into digital code.
- PCS**
Personal Communications Service. New digital wireless telephone technology, with smaller and less expensive outdoor cells and consumer telephone sets than current cellular service. Cable television operators are among the entrepreneurs for PCS. Also called PCN (Personal Communications Network).
- Progressive Scanning ***
A method of displaying the horizontal video lines used in computer displays. The horizontal video lines used in the latest computers - and those that are planned for the future - use progressive scanning. Progressive scanning will be used in both DTV and computers. See Interlaced Scanning.
- PUBLIC RADIO**
Radio stations and networks that are operated on a noncommercial basis.
- PUBLIC TELEVISION**
Television stations and networks that operate as noncommercial ventures.
- Q**
Used to represent a phase shifted signal or vector when compared to the reference I. It is used when referring to a 90-degree phase shift, also known as quadrature.
- QPSK**
Quadrature Phase Shift Keying - This digital modulation method sends four digital data states. Four phase positions are utilized 45, 135, 225 and 315 degrees at a fixed amplitude.
- QUANTIZING**
The process of converting the voltage level of a signal into digital data after the signal has been sampled.
- RAM**
Random Access Memory. Memory that can store data that can be changed.
- RANDOM ACCESS**
Storage device like a disk where contents can be output in any order. Contrasts with serial access.
- RELOCKER**
A combination of a slicer and a phase-locked loop which can remove noise and jitter from a digital signal.
- ROM**
Read Only Memory. It can store data but cannot be changed.
- SAMPLE RATE**
The number of times per second (frequency) in which the analog audio is read and a digital word is created to represent that particular voltage at that point in time.
- SAMPLING**
A process in which some continuous variable is measured at discrete (usually uniform) intervals.
- SAC**
Subsidiary communications authorizations. Authorizations granted to FM broadcasters for using subcarriers on their channels for other communications services.
- SECAM**
Sequential Encoded Color Amplitude Modulation. 625/50 television encoding and transmission standard. B-Y and R-Y incompatible with PAL.
- SHF**
Super high frequency.
- SHORTWAVE**
Transmissions on frequencies of 6-25 mHz.
- SIGNAL-TO-NOISE RATIO**
The ratio between the strength of an electronically produced signal to interfering noises in the same bandwidth.
- SDI**
Serial Digital Interface - digital video interface for production equipment.
- SNR**
Signal to Noise Ratio - Same as RF S/N.
- S/PDIF**
Sony/Philips digital interface - consumer grade digital audio interface.
- SYMBOL**
A grouping of a defined number of bits that is sent together as encoded data. For example, it could be 1, 2, 3, or more bits per symbol.
- THD**
Total Harmonic Distortion.
- TA**
Terminal Adapter. This, in effect, is a CSU/DSU for an ISDN line. It adapts non-ISDN equipment to the ISDN user rate.
- TRANSLATOR**
Broadcast station that rebroadcasts signals of other stations without originating its own programming.
- TRANSPONDER**
Satellite transmitter/receiver that picks up signals transmitted from earth, translates them into new frequencies and amplifies them before retransmitting them back to ground.
- UHF**
Ultra high frequency band (300 mHz-3,000 mHz), which includes TV channels 14-83
- UPLINK**
Earth station used for transmitting to satellite.
- VHF**
Very high frequencies (30 mHz-300 mHz), which include TV channels 2-13 and FM radio.
- WORD**
The number of bits expressed in binary form is used to define or represent a particular sample port (12 bit word, 14 bit word, 16 bit word). The more bits, the better the ability of the digital information to recreate the analog audio. Number of bits define the level of audio quality to be recovered from the digital audio.
- WORM**
Write Once Read Many. A data storage device such as CDs, and some magneto optical disks.
- YUV**
A component video signal consisting of a luminance signal (Y) and two chrominance difference signals (U and V).

*Specific to DTV

—A—

360 SYSTEMS
 DigiCart II, Instant Replay.....80
 Short Cut.....83

A-LINE
 Cassette & CD Storage.....152

ACOUSTIC TOOLS (RPG).....151
ACOUSTIC TREATMENT.....151
 ACUs.....219

ADC.....141-143
AEQ
 Codec.....98
 Consoles, Mixers.....59
 Hybrid.....188

AETA.....98
AIR CORP.....37
AKG
 Headphones/Headsets.....95
 Microphones.....106

ALESIS
 Amplifiers.....6
 Audio Processing.....37
 Digital Recorders.....80
 Speakers.....131

ALIGNMENT TAPES.....160
ALTRONIC RESEARCH.....245
AM STEREO.....242
AM TRANSMITTER.....215-216, 218
AMPLIFIERS
 Buffer Amp.....6-7, 38, 147
 Distribution Amp.....34-36, 38, 147
 Headphone Amp.....7-8, 10, 95
 Line Amp.....6-7, 10, 34
 Mic Amp.....7-8, 10, 34
 Monitor Amp.....7
 Phono Amp.....10
 Power, Mono/Stereo Amp.....6-12

ANALYZER, DIST/NOISE.....195
A TO D CONVERTER(ADA).....78, 145
ANDREW
 Antenna.....30
 Coax.....237
 Dryline Dehydrator.....237
 Easiac.....237
 Heliac.....237
 HRLine Rigid Line.....237

ANTENNA MONITOR.....242, 248
ANTENNAS
 Arrowhead FM.....17
 Arrowhead TV.....24
 Batwing VHF.....22
 Capabilities.....15
 CBR FM.....16
 CBR VHF TV.....23
 CPV VHF.....25
 Deltawing FM.....18
 Deltawing VHF TV.....20-21
 Deltawing UHF TV.....26
 FM.....16-19, 31-33
 Wavestar UHF.....27-29
 Microwave Grid.....30-31, 33
 Mast, Mount.....33
 Satellite Dish.....125
 STL/TSL.....30, 33

APHEX.....37-38
ARRAKIS
 Digital Recorder DL4.....81
 Digital Workstation TS3.....83
 Furniture, Modulux.....162
 Hard Disk System DL3.....89
 Radius.....162

ATI
 Audio Meter.....6-7, 144
 Buffer Amp.....6
 Consoles.....7, 63

Line Amp.....6-7
 Mic Amp.....7, 34
 Monitor Amp.....7
 Phono Preamp.....8
 Power Amp.....7
 DA.....34
 Noise Generator.....195

ATLAS.....158
AUDI-CORD.....51
AUDIOLAB.....158
AUDIOMETRICS (HARRIS) DA.....34
AUDIO METER.....7, 35, 43
AUDION.....83
AUDIO TECHNICA.....105
AUDITRONICS
 Consoles.....59-61
 Mix-Minus IFB.....150

AUDIX.....106
AURALEX (PARAMOUNT).....151
AURAL EXCITER.....37-38
AUTOCOUPERS.....99, 188
AUTOGRAM
 Consoles.....61, 63
 Event Timer.....156

AUTOMATION.....85, 89, 91-93, 125

—B—

BAGS, EQUIPMENT.....152
BELAR.....237, 239-241
BELDEN.....149
BENCHMARK.....145
BEST.....252
BEVCO.....152
BEYERDYNAMIC
 Headphones.....95
 Microphones.....108

BIRD.....240
BOGEN.....143
BOSE.....131
BROADCAST TOOLS.....126, 145-147
 Buechting, Daryl.....234

BURK TECHNOLOGY.....118
 Butt Sets.....159

—C—

CABLEWAVE
 Coax.....250
 FM Antennas.....32

CALIFORNIA AMPLIFIER.....123
CANARE.....143
CANON.....186
 CARTRIDGE MACHINES.....51
 CARTRIDGES, PHONO.....154
 CASSETTE DUPLICATOR.....53
 CASSETTE DECKS.....52-54
 CD PLAYERS.....55-58
 CD STORAGE.....152

CHRONTRON.....156
CHAIR, STUDIO.....152
CIRCUITWERKES
 Auto Couplers.....188
 Headphone/Mic Amp.....8
 Satellite Network Sequencers.....124
 TeleRadio.....152

CLEARCOM.....64, 108, 150
CLOCKS & TIMERS.....156-157
 COAXIAL CABLE.....237-238, 242, 246, 248, 250

COAXIAL DYNAMICS.....240
 COAXIAL SWITCH.....242, 246

COBALT BLUE.....38
 CODEC.....97-100, 102
 COMBINER, FM.....242, 244, 248
 COMPOSITE BASEBAND DEMOD.....138
 COMPOSITE LINE DRIVER.....43
 COMPOSITE PROCESSOR.....40, 42-43

COMPRESSORS/LIMITERS.....37,
 40-42, 46, 48-49

COMREX.....97-99
COMSAT RSI (MARK).....31
COMTECH.....125
CONEX.....125, 188
 DTMF.....180
 Switcher.....34
 Tone Generator, Sensor.....125, 180

CONSOLES, MIXERS.....59-71
 COTTON SWABS.....158
 COUPLERS, DIRECTIONAL.....240
 COUPLING UNIT, AM ANTENNA.....219

CRL
 Digital Audio Analyzer.....78
 Processors, Generators, Limiters...38, 40
 RDS.....116

CROWN
 Amplifier.....8-9
 Microphones.....108-109

CUTTING EDGE.....40
CYBERCLAW.....259

—D—

DAT RECORDERS.....72-74
DAT TAPES.....158
 Davis, Bob.....203

DBX.....40-41
DEHYDRATOR.....237
DELAY
 Line.....49
 Talk Show.....76
 TV Alignment.....47
 Delay, John.....234

DELTA.....242
 DEMODULATOR, SUBCARRIER...138

DENON
 Cassette Decks.....52
 CD Players.....56
 Mini Disc.....114

DIELECTRIC.....32, 242
DIGIGRAM.....84-85
DIGILINK.....81, 89
DIGIT.....222-224
 DIGITAL AUDIO ANALYZER.....78
 DIGITAL RECORDERS.....80-81
 DIGITAL TELEVISION.....See DTV
 DIGITAL WORKSTATIONS.....83-88

DISTORTION ANALYZER.....195
 DISTRIBUTION AMPS.....34, 38

DK AUDIO.....195
DOLBY.....100
DORROUGH.....144
 DTV.....205
 DUMMY LOAD.....240, 244

DUPLICATOR, CASSETTE.....53
DX TRANSMITTER.....216
DYNAUDIO ACOUSTICS.....131

—E—

EEV.....236
 EAS.....155

EASYRIDER.....37
EIMAC TUBES.....242
 ELECTRICAL PROTECTION.....252-254

ELECTRO IMPULSE.....244
ELECTROVOICE
 Amplifier.....9
 Mixer.....64
 Microphones.....109
 Speakers.....132

ENBERG.....152
ENCO.....91, 94
ENERGY CONTROL.....252
 ENG VEHICLES.....See Systems

EQUALIZERS.....41, 43, 47-49
 ERASERS.....51, 158

ERI.....31, 244, 246
ESE.....34, 156-157
EVENTIDE
 Delay.....76
 Effects Processor.....41
 Logging System.....72

EVENT TIMER.....146, 156
EXCITER, FM.....See Harris
EXCITER, TV.....See Harris

—F—

FEEDBACK ELIMINATOR.....48
FIDELIPAC
 Cart Machines, Erasers.....51
 On-Air Lights.....159

FIELD STRENGTH METER.....246, 248
FLYAWAYS, SATELLITE.....170
FM COMBINER.....242
FOCUSRITE.....42
FOSTEX
 DAT.....72
 Digital Multitrack Recorder.....81
 Hard Disk Multitracker.....89
 Headphone.....95
 Speakers.....132

FREQUENCY MONITOR.....239
 Fry, Dick.....226

FURMAN
 Audio Meter.....144
 Equalizers.....41
 Power Conditioning.....252

FURNITURE, STUDIO.....162, 164

—G—

GATES TRANSMITTER.....215
GENERATOR, SUBCARRIER.....138
GENERTOR, TONE.....188, 195
GENTNER
 Control Surface.....189
 Hybrid.....189-190
 Microtel.....190
 Remote Control.....118
 Routing DA.....34
 Russ Gentner.....187
 Screen Wair.....189

GEPCO.....153, 246
GLOSSARY.....260-261
GOLF CHANNEL.....174

—H—

HAFLER.....9-11
HARD DISK SYSTEMS.....89
HARRIS
 A2D2A.....78, 137, 145
 ACIs.....219-220
 Adrick, Jay.....168
 Antennas.....14-29
 Buechting, Daryl.....234
 CD Link.....235
 CD2001.....55
 Clock.....157
 DAB.....233
 DA.....34
 Davis, Bob.....203
 DC-128 Remote Control.....212
 Delay, John.....213
 DIGIT.....222-224
 Dracon.....159, 180
 DRC1000 Digital Console.....67
 DSE/DSR1400.....169
 DTV.....203, 205
 Dual Sound Encoder.....213
 DX.....216-218

—T—

TALK SHOW SYSTEMS.....187, 189-190, 193
TANNOY.....134-135
TAPE RECORDERS.....117
TASCAM
 Amplifier.....12
 Cassette Decks.....53-54
 CD Players.....57
 Console.....70
 DAT.....74
 Digital Multitrack Recorder.....81
 Mini Disc.....115
 Reel Recorders.....117
TECHNICS.....154
TECTAN.....127
TELEPHONE
 Couplers.....99, 188, 190
 Frequency Extenders.....99
 Hybrids.....188-189, 192-193
 Message Announcers.....148
 News Taps.....190, 192
 Remote Mixers.....99-100, 102, 192-193
 Talk Show Systems.....187, 189-190, 193
TELEX
 Intercom.....151
 Wireless Mics.....112-113
TELFAX.....103
TELOS
 Hybrids.....193
 Intercom to Telephone Interface.....193
 ISDN.....103
 Steve Church.....101
TEST EQUIPMENT...44, 188, 195, 240
TEST TAPES.....160
THUM & MAHR.....48
TITUS.....160
TONE GENERATOR/SENSOR...125
TOWER LIGHT MONITOR.....248
TOWERS.....244
TRAINING, HARRIS.....197
TRANSFORMERS
 Isolation.....143
 Digital Impedance.....143
 Humbucker.....143
TRANSMITTERS.....199-236
TRANSMITTING ACCESS.....237-250
TUBES.....242, 250
TUNERS.....143
TURNTABLES.....154

—U—

ULTIMATE.....160
UNTERRUPTIBLE POWER.....252-254

—V—

VESTAX.....154
VALLEY AUDIO.....49
VALVES.....242, 250
VIDEO DATA SYSTEMS.....155
VIDEO SATELLITE.....See Systems
VIDEO Fixed & Mobile.....See Systems
VOLTAGE CONTROL.....252-254
VOXPRO.....83

—W—

WARNING LIGHTS...152, 157, 159-160
WATT METERS.....240
WCPO.....172
WEATHER ANNOUNCER.....93
WEGENER.....127
WILL-BURT.....33
WOHLER TECHNOLOGIES.....35
 Audio Meters.....144
 Routing Switcher.....35
 Source Selector.....35
 Speaker Systems.....135
WRIGHT LINE.....164

—Y—

YAMAHA
 Delay.....49
 Equalizer.....49
 Mini Disc.....115
 Mixer.....70
 Reverb.....49
 Processor.....49
 Speakers.....135

—Z—

ZERCOM.....193
Z-TECHNOLOGY.....246

ADVERTISING INDEX

360 SYSTEMS.....82
ALTRONIC RESEARCH.....245
ANDREW.....238
ARRAKIS.....90
ARRAKIS.....163
AUDITRONICS.....60
BELAR.....241
BELDEN.....149
CANON.....186
CIRCUIT RESEARCH LABS.....39
COMREX.....97
DENON.....58
EEV.....236
ELECTRO-VOICE.....265
ENCO.....94
EVENTIDE.....75
GENTNER.....119
GENTNER.....191
GEPCO.....153
HAFLER.....11
JBL.....133
MACKIE.....65
MARANTZ.....196
MARTI.....122
MICROWAVE RADIO.....182
MOSELEY.....140
MUSICAM.....104
MYAT.....247
ORBAN.....45
ORBAN.....88
PHILIPS.....184
SHURE.....68
SHURE.....107
SIERRA AUTOMATED SYSTEMS.....36
SYMETRIX.....77
TECHNICS.....161
TELEX.....113
TELOS.....194
WARNER.....253
WOHLER.....136
YAMAHA.....71

All orders are subject to Harris acceptance and compliance with Harris Broadcast Division Standard Terms and Conditions of Sale. Please contact one of our sales offices for a copy.

This catalog is intended as a reference tool for use by our customers for planning purposes only. It represents a substantial cross section of our product and service offerings but by no means is intended to be complete. All descriptions, specifications and prices are accurate and complete as of this writing and to our knowledge. **Prices are subject to change without notice.** Any changes, updates, upgrades or obsolescence by the original equipment manufacturer not covered in this publication is unintentional and unavoidable. Complete current specifications and pricing may be obtained by contacting one of our sales offices.



Lindy Williams
V.P. Engineering
Lotus Communications
Los Angeles, California

"We've replaced some 'very expensive' condenser microphones with the RE27N/D ...now the GM wants the guest mic replaced, as well as the production studio and the newsroom microphones. You're blowing my engineering budget!"

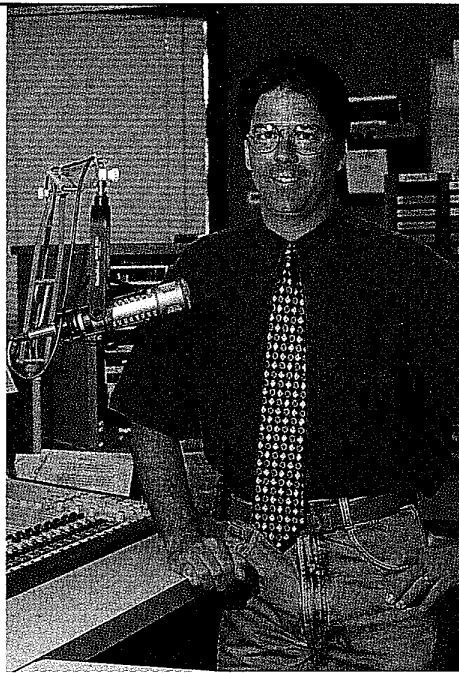

Steve Lariviere
Chief Engineer
WSNE

East Providence, Rhode Island
"We replaced six expensive German condenser microphones in favor of the RE27N/D. What a great sound!"

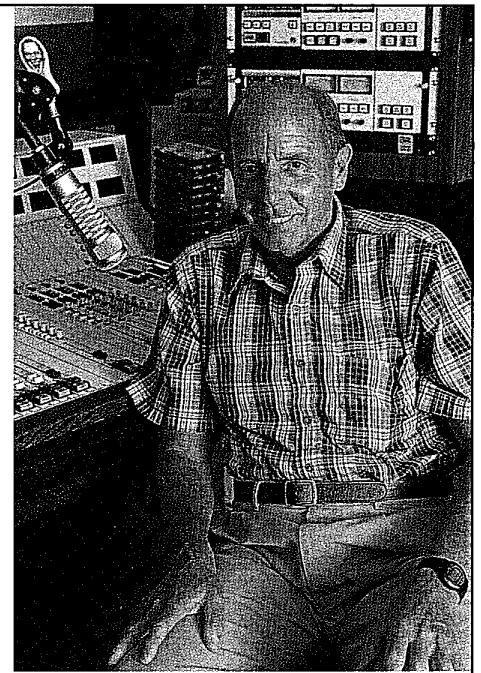

Marv Collins
Chief Engineer
KFI-KOST-KACE
Los Angeles, California

"The RE27N/D has the fullness of a ribbon with the punch of a shotgun condenser microphone. The pattern is very good, giving good backside rejection of noise. Congratulations on building such a fine microphone."

RE27N/D

Studio Dynamic Microphone

The new broadcast standard.



Electro-Voice®

Electro-Voice, Inc. a Mark IV company
600 Cecil Street · Buchanan, MI 49107
616/695-6831 · 800/234-6831
616/695-1304 Fax

See your local EV dealer, for a test drive.

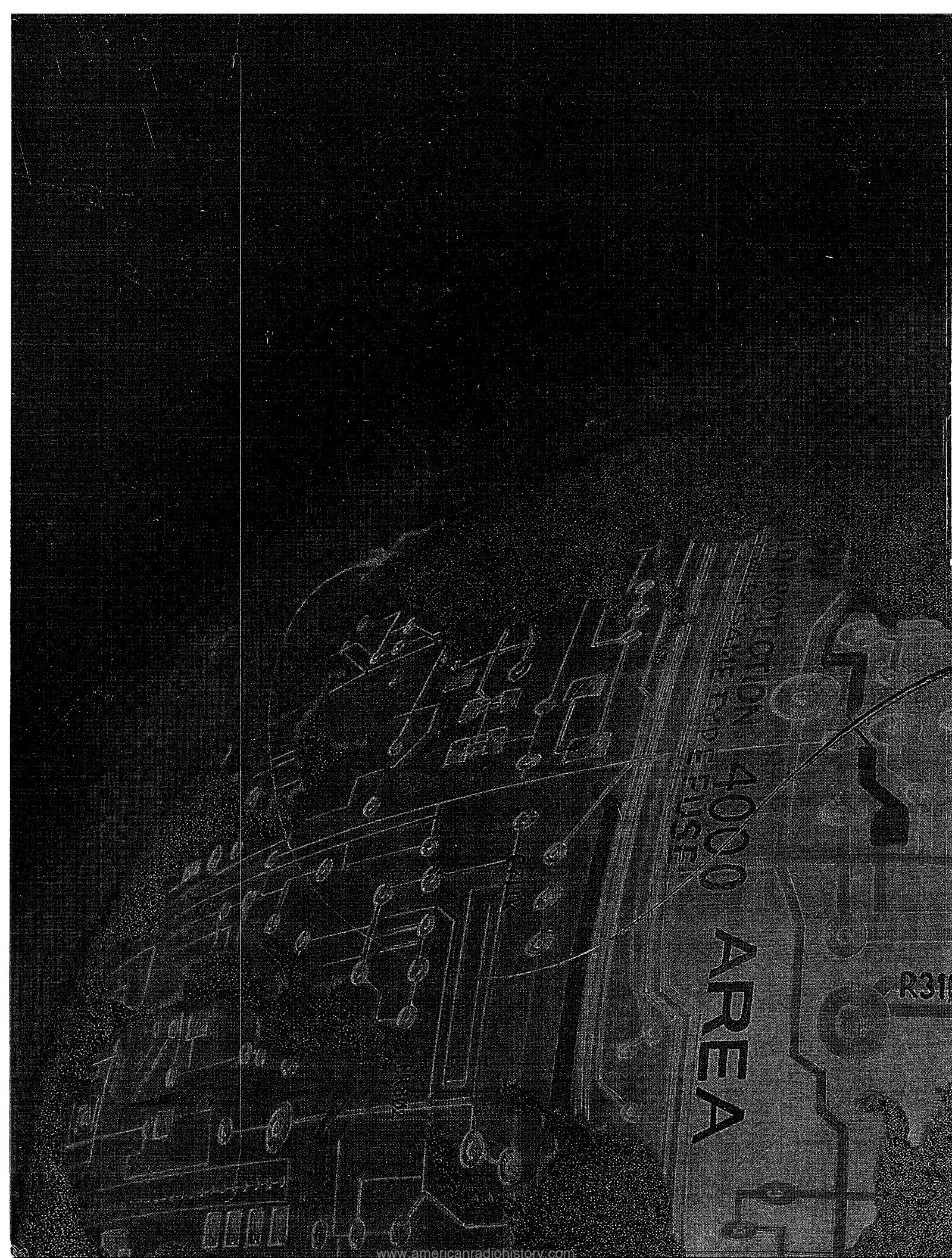

RADIO PIONEER
4000 AREA

R311